



**GAS COMPONENTS**



**ELECTRIC COMPONENTS**



**WATER TECHNOLOGY**



**MECHANICAL COMPONENTS**



**TOOLS**

Spare parts suitable for

**GIORIK**

Find the complete and up-to-date range of products in our GEV Webshop



# Manufacturer catalogue

The most important spare parts and accessories arranged clearly for every manufacturer

- ✓ Complete product range and all appliance data always up to date in the GEV Webshop
- ✓ Alphabetical Index at the end of the catalogue

## GEV Webshop

[www.gev-online.co.uk](http://www.gev-online.co.uk)

[www.gev-online.com](http://www.gev-online.com)









- 🔍 Add to Favourites
- 🔍 Sign In with email address and usual password
- 🔍 Easy-order – place several items in your basket at the same time
- 🔍 Quick Item search – no login needed









## heating elements

### heating elements for bain maries

			
<b>GEV No.</b>	416067	<b>Ref. No.</b>	6001024
<b>description</b>	heating element 1380W 230V heating circuits 1 L 346mm W 190mm connection M5 tube ø 8.5mm 2 hole fixing thread 1/4" immersion heater W1 70mm W2 105mm H 27mm mounting distance 67mm		
<b>For models:</b>	BME46, BME66, SPE46		
<b>spare parts for</b>	416067		
	<b>GEV No.</b>	510417	<b>Ref. No.</b> —
	flat gasket fibre ED ø 20mm ID ø 14mm thickness 2mm Qty 1 pcs		
<b>accessories for</b>	416067		
	<b>GEV No.</b>	361182	<b>Ref. No.</b> —
	nut thread 1/4" H 5mm nickel-plated brass WS 17 Qty 1 pcs		
	<b>GEV No.</b>	520228	<b>Ref. No.</b> —
	tooth lock washer ID ø 15.3mm ED ø 24mm steel Qty 1 pcs for thread M14		
	<b>GEV No.</b>	550262	<b>Ref. No.</b> —
	flat gasket copper ED ø 20mm ID ø 14mm thickness 2mm		
	<b>GEV No.</b>	560112	<b>Ref. No.</b> —
	plain washer ID ø 5.3mm ED ø 10mm thickness 1mm SS Qty 20 pcs DIN 125A for thread M5		
	<b>GEV No.</b>	560132	<b>Ref. No.</b> —
	hexagonal nut thread M5 H 4mm WS 8 SS DIN/ISO DIN 934 / ISO 4032/8673 Qty 20 pcs		

### heating elements for chip scuttles





			
<b>GEV No.</b>	416067	<b>Ref. No.</b>	6001024
<b>description</b>	heating element 1380W 230V heating circuits 1 L 346mm W 190mm connection M5 tube ø 8.5mm 2 hole fixing thread 1/4" immersion heater W1 70mm W2 105mm H 27mm mounting distance 67mm		
<b>For models:</b>	BME46, BME66, SPE46		
<b>spare parts for</b>	416067		
	<b>GEV No.</b>	510417	<b>Ref. No.</b> —
	flat gasket fibre ED ø 20mm ID ø 14mm thickness 2mm Qty 1 pcs		
<b>accessories for</b>	416067		
	<b>GEV No.</b>	361182	<b>Ref. No.</b> —
	nut thread 1/4" H 5mm nickel-plated brass WS 17 Qty 1 pcs		
	<b>GEV No.</b>	520228	<b>Ref. No.</b> —
	tooth lock washer ID ø 15.3mm ED ø 24mm steel Qty 1 pcs for thread M14		
	<b>GEV No.</b>	550262	<b>Ref. No.</b> —
	flat gasket copper ED ø 20mm ID ø 14mm thickness 2mm		
	<b>GEV No.</b>	560112	<b>Ref. No.</b> —
	plain washer ID ø 5.3mm ED ø 10mm thickness 1mm SS Qty 20 pcs DIN 125A for thread M5		

<b>accessories for</b>	416067		
	<b>GEV No.</b>	560132	<b>Ref. No.</b> —
	hexagonal nut thread M5 H 4mm WS 8 SS DIN/ISO DIN 934 / ISO 4032/8673 Qty 20 pcs		

### heating elements for fryers

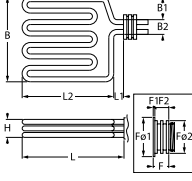
#### off-center connection

#### with thread

 			
<b>GEV No.</b>	416070	<b>Ref. No.</b>	6002137 6002137 + 6090144 + 6090145
<b>description</b>	heating element 10200W 230/400V heating circuits 3 L 300mm W 180mm H 33mm flange length 19.5mm flange length 1 9.5mm flange length 2 9.8mm flange ø1 62mm flange ø2 57mm thermostat sleeves ø 6.5mm sensor screw connection 2x M10x1 thermostat sleeve upper/lower L1 18mm L2 282mm W1 30mm W2 35mm thread M54x1.5 windings 5 tube ø 8.5mm cable length 450mm rotation flange immersion heater fryer connection length 130mm 2		
<b>spare parts for</b>	416070		
	<b>GEV No.</b>	510243	<b>Ref. No.</b> —
	O-ring Viton thickness 3.53mm ID ø 55.56mm Qty 1 pcs		
	<b>GEV No.</b>	550496	<b>Ref. No.</b> 6090144
	O-ring Viton thickness 3.53mm ID ø 50.39mm Qty 1 pcs		
<b>accessories for</b>	416070		
	<b>GEV No.</b>	510243	<b>Ref. No.</b> —
	O-ring Viton thickness 3.53mm ID ø 55.56mm Qty 1 pcs		
	<b>GEV No.</b>	550662	<b>Ref. No.</b> —
	ring nut thread M54x1.5 H 7mm		

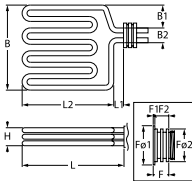
 			
<b>GEV No.</b>	416822	<b>Ref. No.</b>	6002137
<b>description</b>	heating element 10200W 230V heating circuits 3		
<b>For models:</b>	F15CL, F15L, F215CL, F215L		

<b>GEV No.</b>	416825	<b>Ref. No.</b>	6002151 6002151+6090144+6090145
<b>description</b>	heating element 12000W 230/400V heating circuits 3 mounting pos. right L 326mm W 180mm H 31mm flange length 19.5mm flange length 1 9.5mm flange length 2 9.8mm flange ø1 62mm flange ø2 57mm thermostat sleeves ø 7.5mm sensor screw connection 2x M10x1 thermostat sleeve upper/lower L1 19mm L2 307mm W1 33mm W2 33mm thread M54x1.5 windings 5 tube ø 8.5mm cable length 490mm rotation flange immersion heater fryer connection length 60mm		
<b>For models:</b>	15FE, 15FEC, 215FE, 215FEC		
<b>spare parts for</b>	416825		
	<b>GEV No.</b>	510243	<b>Ref. No.</b> —
	O-ring Viton thickness 3.53mm ID ø 55.56mm Qty 1 pcs		
<b>accessories for</b>	416825		
	<b>GEV No.</b>	550662	<b>Ref. No.</b> —
	ring nut thread M54x1.5 H 7mm		

<b>GEV No.</b>	416823	<b>Ref. No.</b>	6002138
<b>description</b>	heating element 15000W 230V heating circuits 3 windings 8		

<b>GEV No.</b>	416826	<b>Ref. No.</b>	6002152 6002152+6090144+6090145
<b>description</b>	heating element 16500W 230/400V heating circuits 3 mounting pos. right L 325mm W 255mm H 32mm flange length 19.5mm flange length 1 9.5mm flange length 2 10mm flange ø1 62mm flange ø2 57mm thermostat sleeves ø 9mm sensor screw connection 2x M10x1 thermostat sleeve upper/lower L1 18mm L2 307mm W1 31mm W2 34mm thread M54x1.5 windings 7 tube ø 8.5mm cable length 480mm connection cable rotation flange immersion heater fryer connection length 60mm		
<b>For models:</b>	20FE, 20FEC, 220FE, 220FEC, 920FE, 940FE, 940FEC		
<b>spare parts for</b>	416826		
	<b>GEV No.</b>	510243	<b>Ref. No.</b> —
	O-ring Viton thickness 3.53mm ID ø 55.56mm Qty 1 pcs		
	<b>GEV No.</b>	550496	<b>Ref. No.</b> 6090144
	O-ring Viton thickness 3.53mm ID ø 50.39mm Qty 1 pcs		
<b>accessories for</b>	416826		
	<b>GEV No.</b>	550662	<b>Ref. No.</b> —
	ring nut thread M54x1.5 H 7mm		

<b>GEV No.</b>	418835	<b>Ref. No.</b>	6002143 6002143+6090144+6090145
<b>description</b>	heating element 6800W 230/400V heating circuits 3 mounting pos. left L 370mm W 450mm H 33mm flange length 19mm flange length 1 9.5mm flange length 2 9.5mm flange ø1 62mm flange ø2 57mm sensor screw connection 2x M10x1 L1 18mm L2 352mm W1 30mm W2 34mm thread M54x1.5 tube ø 8.5mm cable length 500mm rotation flange fryer 2		
<b>For models:</b>	FP18S		
<b>accessories for</b>	418835		
	<b>GEV No.</b>	510243	<b>Ref. No.</b> —
	O-ring Viton thickness 3.53mm ID ø 55.56mm Qty 1 pcs		
	<b>GEV No.</b>	510245	<b>Ref. No.</b> —
	O-ring Viton thickness 3.53mm ID ø 50.8mm Qty 1 pcs		
	<b>GEV No.</b>	550662	<b>Ref. No.</b> —
	ring nut thread M54x1.5 H 7mm		

<b>center connection</b>			
<b>GEV No.</b>	415297	<b>Ref. No.</b>	6002136 6002136+6090144+6090145
<b>description</b>	heating element 6800W 230/400V heating circuits 3 L 299mm W 107mm H 35mm flange length 19.5mm flange length 1 9.5mm flange length 2 9.8mm flange ø1 62mm flange ø2 57mm thermostat sleeves ø 8.5mm sensor screw connection 2x M10x1 thermostat sleeve upper/lower L1 16mm L2 283mm W1 30mm W2 77mm thread M54x1.5 tube ø 8.5mm cable length 450mm rotation flange immersion heater		
<b>For models:</b>	F10CL, F10L, FRE46, FRE66		
<b>accessories for</b>	415297		
	<b>GEV No.</b>	510243	<b>Ref. No.</b> —
	O-ring Viton thickness 3.53mm ID ø 55.56mm Qty 1 pcs		
	<b>GEV No.</b>	510245	<b>Ref. No.</b> —
	O-ring Viton thickness 3.53mm ID ø 50.8mm Qty 1 pcs		
	<b>GEV No.</b>	550447	<b>Ref. No.</b> —
	ring nut thread M54x1.5		



<b>GEV No.</b>	416824	<b>Ref. No.</b>	6002150 6002150+6090144+6090145
<b>description</b>	heating element 7000W 230/400V heating circuits 3 L 325mm W 110mm H 33mm flange length 19.5mm flange length 1 9.5mm flange length 2 9.8mm flange ø1 62mm flange ø2 57mm thermostat sleeves ø 8mm sensor screw connection 2x M10x1 thermostat sleeve upper/lower L1 18mm L2 307mm W1 40mm W2 35mm thread M54x1.5 tube ø 8.5mm cable length 520mm rotation flange immersion heater fryer connection length 50mm 2		
<b>For models:</b>	210FE, 210FEC, 922FE, 922FEC		
<b>spare parts for</b>	416824		
	<b>GEV No.</b>	510243	<b>Ref. No.</b> —
	O-ring Viton thickness 3.53mm ID ø 55.56mm Qty 1 pcs		
	<b>GEV No.</b>	550496	<b>Ref. No.</b> 6090144
	O-ring Viton thickness 3.53mm ID ø 50.39mm Qty 1 pcs		
<b>accessories for</b>	416824		
	<b>GEV No.</b>	550447	<b>Ref. No.</b> —
	ring nut thread M54x1.5		

<b>GEV No.</b>	418818	<b>Ref. No.</b>	6002054
<b>description</b>	heating element 3280W 230V L 320mm W 190mm H 170mm L1 39mm L2 281mm W1 79mm W2 32mm flange length 70mm flange width 22mm hole distance 56mm windings 5 hole ø 6mm		
<b>For models:</b>	FT5		

<b>GEV No.</b>	418817	<b>Ref. No.</b>	6001129
<b>description</b>	heating element 2000W 230V L 285mm W 137mm H 172mm L1 22mm L2 33mm L3 230mm W1 50mm W2 37mm hole distance 28mm windings 3 hole ø 6mm flange length 90mm flange width 56mm cable length 180mm tube ø 8.5mm		
<b>For models:</b>	FT3N		

<h3>2 hole fixing</h3>			
<b>GEV No.</b>	416065	<b>Ref. No.</b>	6001139
<b>description</b>	heating element 1333W 230V heating circuits 1 L 283mm W 20mm H 40mm thread M12x1 tube ø 8.5mm connection M4 connection length 52mm mounting distance 31mm windings 2 immersion heater 2 hole fixing		
<b>For models:</b>	FRE46T, FRE66T, FTR26T, FTR6T		
<b>spare parts for</b>	416065		
	<b>GEV No.</b>	507313	<b>Ref. No.</b> —
	O-ring EPDM thickness 2.62mm ID ø 13.95mm Qty 1 pcs		
<b>accessories for</b>	416065		
	<b>GEV No.</b>	361182	<b>Ref. No.</b> —
	nut thread 1/4" H 5mm nickel-plated brass WS 17 Qty 1 pcs		
	<b>GEV No.</b>	510417	<b>Ref. No.</b> —
	flat gasket fibre ED ø 20mm ID ø 14mm thickness 2mm Qty 1 pcs		
	<b>GEV No.</b>	520228	<b>Ref. No.</b> —
	tooth lock washer ID ø 15.3mm ED ø 24mm steel Qty 1 pcs for thread M14		
	<b>GEV No.</b>	521103	<b>Ref. No.</b> —
	nut thread M4 H 3mm WS 7 brass Qty 20 pcs		
	<b>GEV No.</b>	521104	<b>Ref. No.</b> —
	washer ID ø 4.3mm ED ø 8mm thickness 0.5mm brass Qty 20 pcs for thread M4		
	<b>GEV No.</b>	550262	<b>Ref. No.</b> —
	flat gasket copper ED ø 20mm ID ø 14mm thickness 2mm		
	<b>GEV No.</b>	560111	<b>Ref. No.</b> —
	plain washer ID ø 4.3mm ED ø 9mm thickness 0.8mm SS Qty 20 pcs DIN 125A for thread M4		
	<b>GEV No.</b>	560131	<b>Ref. No.</b> —
	hexagonal nut thread M4 H 3.2mm WS 7 SS DIN/ISO DIN 934 / ISO 4032/8673 Qty 20 pcs		





<b>GEV No.</b>	416064	<b>Ref. No.</b>	6001144
<b>description</b>	heating element 3300W 230V heating circuits 1 L 285mm W 74mm H 42mm thread M12x1 tube ø 8.5mm connection M4 connection length 37mm windings 5 fryer heaters 2 hole fixing		
<b>For models:</b>	FRE46F, FRE66F, FTR26F, FTR6F		
<b>accessories for</b>	416064		
	<b>GEV No.</b>	520229	<b>Ref. No.</b> —
	nut thread M12x1 H 4mm WS 16 zinc-coated steel Qty 1 pcs		



Table continues overleaf

accessories for		416064	
	GEV No.	521103	Ref. No. —
nut thread M4 H 3mm WS 7 brass Qty 20 pcs			
	GEV No.	521104	Ref. No. —
washer ID ø 4.3mm ED ø 8mm thickness 0.5mm brass Qty 20 pcs for thread M4			
	GEV No.	521110	Ref. No. —
flat gasket fibre ED ø 20mm ID ø 13mm thickness 2mm Qty 1 pcs			
	GEV No.	521131	Ref. No. —
nut thread M12x1 H 3.5mm WS 17 SS Qty 1 pcs			
	GEV No.	528110	Ref. No. —
O-ring EPDM thickness 2.62mm ID ø 12.37mm Qty 1 pcs			
	GEV No.	560111	Ref. No. —
plain washer ID ø 4.3mm ED ø 9mm thickness 0.8mm SS Qty 20 pcs DIN 125A for thread M4			
	GEV No.	560131	Ref. No. —
hexagonal nut thread M4 H 3.2mm WS 7 SS DIN/ISO DIN 934 / ISO 4032/8673 Qty 20 pcs			

accessories for		416077	
	GEV No.	520228	Ref. No. —
tooth lock washer ID ø 15.3mm ED ø 24mm steel Qty 1 pcs for thread M14			
	GEV No.	521103	Ref. No. —
nut thread M4 H 3mm WS 7 brass Qty 20 pcs			
	GEV No.	521104	Ref. No. —
washer ID ø 4.3mm ED ø 8mm thickness 0.5mm brass Qty 20 pcs for thread M4			
	GEV No.	550262	Ref. No. —
flat gasket copper ED ø 20mm ID ø 14mm thickness 2mm			
	GEV No.	560111	Ref. No. —
plain washer ID ø 4.3mm ED ø 9mm thickness 0.8mm SS Qty 20 pcs DIN 125A for thread M4			
	GEV No.	560131	Ref. No. —
hexagonal nut thread M4 H 3.2mm WS 7 SS DIN/ISO DIN 934 / ISO 4032/8673 Qty 20 pcs			

### heating elements for pasta cookers

			
<b>GEV No.</b>	418032	<b>Ref. No.</b>	6002063
<b>description</b>	heating element 2000W 240V heating circuits 1 L 280mm W 75mm Hmm 2 hole fixing connection M4 thread 1/4" tube ø 8.5mm mounting distance 67mm pasta cooker		
<b>For models:</b>	22CP, 2CP, CPE66		
<b>accessories for</b> 418032			
	GEV No.	361182	Ref. No. —
nut thread 1/4" H 5mm nickel-plated brass WS 17 Qty 1 pcs			
	GEV No.	510417	Ref. No. —
flat gasket fibre ED ø 20mm ID ø 14mm thickness 2mm Qty 1 pcs			
	GEV No.	520228	Ref. No. —
tooth lock washer ID ø 15.3mm ED ø 24mm steel Qty 1 pcs for thread M14			
	GEV No.	550262	Ref. No. —
flat gasket copper ED ø 20mm ID ø 14mm thickness 2mm			

			
<b>GEV No.</b>	416077	<b>Ref. No.</b>	6002064
<b>description</b>	heating element 2520/3000W 220/240V heating circuits 1 L 445mm W 66mm Hmm 2 hole fixing connection M4 thread 1/4" tube ø 8.5mm mounting distance 58mm connection length 34mm pasta cooker immersion heater		
<b>For models:</b>	23CP, 3CP, CP1, CP1BM		
<b>accessories for</b> 416077			
	GEV No.	361182	Ref. No. —
nut thread 1/4" H 5mm nickel-plated brass WS 17 Qty 1 pcs			
	GEV No.	510417	Ref. No. —
flat gasket fibre ED ø 20mm ID ø 14mm thickness 2mm Qty 1 pcs			

### heating elements for salamanders/toast-

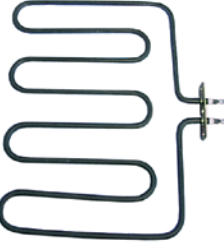
			
<b>GEV No.</b>	415659	<b>Ref. No.</b>	6001067 (old version)
<b>description</b>	heating element 2000W 230V heating circuits 1 L 230mm W 303mm L1 35mm L2 195mm W1 135mm W2 33mm flange length 70mm flange width 22mm hole distance 56mm tube ø 8.5mm dry heating element connection M5 rectangular flange hole ø 5mm H 8.5mm		



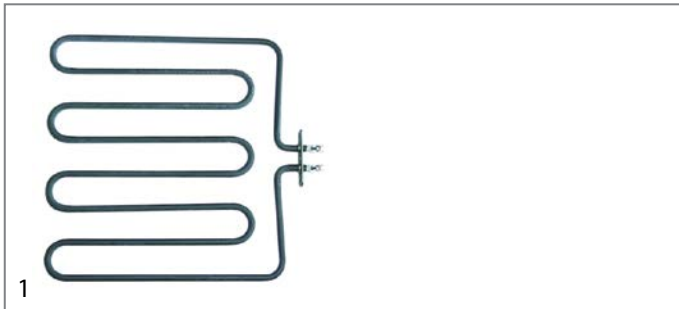

			
<b>GEV No.</b>	419230	<b>Ref. No.</b>	6001067
<b>description</b>	heating element 2185W 230V heating circuits 1 L 230mm W 303mm L1 35mm L2 195mm W1 135mm W2 33mm flange length 70mm flange width 22mm hole distance 56mm tube ø 8.5mm dry heating element connection M5 rectangular flange hole ø 5mm for salamander grill		
<b>For models:</b>	S505		

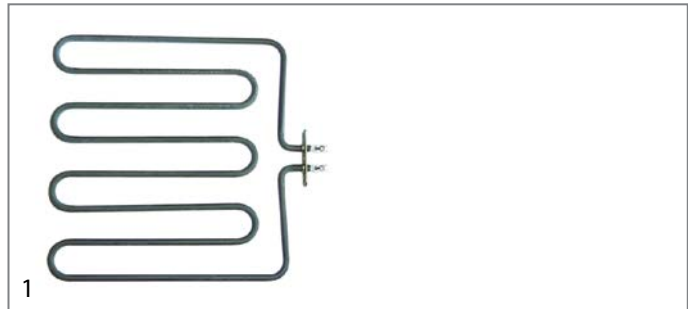

<b>GEV No.</b>	415215	<b>Ref. No.</b>	6002021
<b>description</b>	heating element 2570W 230V heating circuits 1 L 305mm W 297mm L1 19mm L2 286mm W1 132mm W2 22mm flange length 70mm flange width 22mm hole distance 56mm tube ø 8.5mm dry heating element connection M5 rectangular flange hole ø 5mm H 8.5mm		
<b>For models:</b>	S510		



<b>GEV No.</b>	415217	<b>Ref. No.</b>	6003022
<b>description</b>	heating element 3100W 400V heating circuits 1 L 309mm W 295mm L1 24mm L2 285mm W1 130mm W2 33mm flange length 70mm flange width 22mm hole distance 28mm tube ø 8.5mm dry heating element connection M4 rectangular flange hole ø 5mm H 8.5mm		
<b>accessories for</b>	415217		

	<b>GEV No.</b>	521103	<b>Ref. No.</b>	—
		nut thread M4 H 3mm WS 7 brass Qty 20 pcs		
	<b>GEV No.</b>	521104	<b>Ref. No.</b>	—
		washer ID ø 4.3mm ED ø 8mm thickness 0.5mm brass Qty 20 pcs for thread M4		
	<b>GEV No.</b>	560111	<b>Ref. No.</b>	—
		plain washer ID ø 4.3mm ED ø 9mm thickness 0.8mm SS Qty 20 pcs DIN 125A for thread M4		
	<b>GEV No.</b>	560131	<b>Ref. No.</b>	—
		hexagonal nut thread M4 H 3.2mm WS 7 SS DIN/ISO DIN 934 / ISO 4032/8673 Qty 20 pcs		

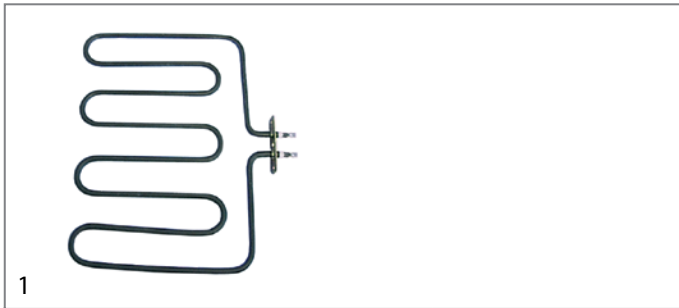

<b>GEV No.</b>	415660	<b>Ref. No.</b>	6001068 724-5085533
<b>description</b>	heating element 2800W 230V heating circuits 1 L 230mm W 298mm L1 20mm L2 210mm W1 133mm W2 32mm flange length 70mm flange width 22mm hole distance 56mm tube ø 8.5mm dry heating element connection M5 rectangular flange hole ø 5mm H 8.5mm		
<b>For models:</b>	S505R		

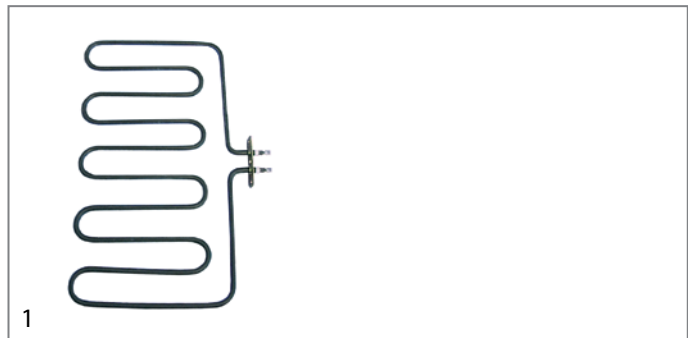

<b>GEV No.</b>	415213	<b>Ref. No.</b>	6001133
<b>description</b>	heating element 3300W 230V heating circuits 1 L 240mm W 380mm L1 24mm L2 220mm W1 174mm W2 33mm flange length 70mm flange width 22mm hole distance 56mm tube ø 8.5mm connection length 28mm dry heating element connection M5 rectangular flange hole ø 4mm		
<b>For models:</b>	SE520		

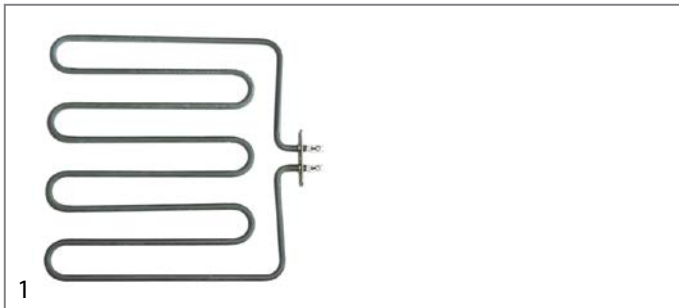

<b>GEV No.</b>	415623	<b>Ref. No.</b>	6003022
<b>description</b>	heating element 3100W 230V heating circuits 1 L 305mm W 295mm L1 25mm L2 280mm W1 131mm W2 33mm flange length 70mm flange width 22mm hole distance 56mm tube ø 8.5mm dry heating element connection M4 rectangular flange hole ø 5mm H 8.5mm		
<b>For models:</b>	S510S		

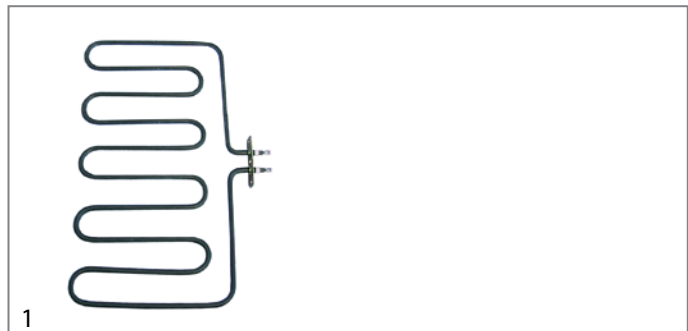





<b>GEV No.</b>	415214	<b>Ref. No.</b>	6003133
<b>description</b>	heating element 3300W 400V heating circuits 1 L 235mm W 380mm L1 20mm L2 216mm W1 174mm W2 33mm flange length 70mm flange width 22mm hole distance 56mm tube ø 8.5mm connection length 22mm dry heating element connection M5 rectangular flange hole ø 5mm		

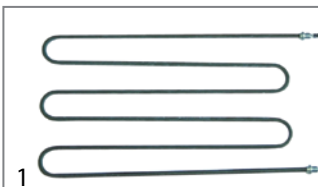

<b>GEV No.</b>	415220	<b>Ref. No.</b>	6002066
<b>description</b>	heating element 2730W 230V L 490mm W 270mm 2 hole fixing thread 1/4" mounting distance 261mm dry heating element tube ø 8.5mm heating circuits 1 H 8.5mm		
<b>For models:</b>	S511		



<b>GEV No.</b>	415209	<b>Ref. No.</b>	6003052
<b>description</b>	heating element 3000W 400V L 489mm W 270mm 2 hole fixing thread 1/4" mounting distance 265mm connection M5 dry heating element tube ø 8.5mm heating circuits 1 connection length 18mm		
<b>For models:</b>	S511S		

<b>spare parts for</b>	415209			
	<b>GEV No.</b>	510417	<b>Ref. No.</b>	—
	flat gasket fibre ED ø 20mm ID ø 14mm thickness 2mm Qty 1 pcs			
<b>accessories for</b>	415209			
	<b>GEV No.</b>	361182	<b>Ref. No.</b>	—
	nut thread 1/4" H 5mm nickel-plated brass WS 17 Qty 1 pcs			
	<b>GEV No.</b>	520228	<b>Ref. No.</b>	—
	tooth lock washer ID ø 15.3mm ED ø 24mm steel Qty 1 pcs for thread M14			
	<b>GEV No.</b>	550262	<b>Ref. No.</b>	—
	flat gasket copper ED ø 20mm ID ø 14mm thickness 2mm			



<b>GEV No.</b>	415450	<b>Ref. No.</b>	6002058
<b>description</b>	heating element 650W 230V L 265mm W 55mm thread M15x1 mounting distance 45mm connection length 38mm tube ø 10mm heating circuits 1 dry heating element 2 hole fixing H 10mm		
<b>For models:</b>	SR512, SR512R		



<b>GEV No.</b>	416820	<b>Ref. No.</b>	6001071
<b>description</b>	heating element 930W 230V L 260mm W 55mm thread M15x1 mounting distance 45mm connection length 26mm connection M4 tube ø 10mm heating circuits 1 dry heating element 2 hole fixing H 10mm		



<b>GEV No.</b>	416001	<b>Ref. No.</b>	6001066 6001070	
<b>description</b>	radiation heater rectangular 1500W 230/240V L 265mm W 165mm H 32mm heating circuits 1 connections 2 connection type cable cable length 700mm EGO salamander grill			
<b>For models:</b>	SH505R, SH510P, SH510R, SH520G, SH520GM, SH560P			
<b>accessories for</b>	416001			
	<b>GEV No.</b>	390880	<b>Ref. No.</b>	6010039
	safety rod thermostat switch-off temp. 780°C temperature range°C 2-pole 1NC/1NOA probe ø 4mm probe L 170mm capillary pipemm capillary pipe isolatedmm gland nut shaft ømm			
	<b>GEV No.</b>	403523	<b>Ref. No.</b>	—
	solid state relay ANLY 1 phase 40A 24-280V 4-32VDC L 47.5mm W 43mm screw type ASR-40DA			

immersion heating elements

3 hole flange ø57.5mm



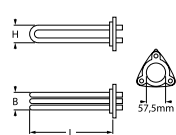

<b>GEV No.</b>	418085	<b>Ref. No.</b>	6003295	
<b>description</b>	heating element 10000W 230V mounting ø 57.5mm heating circuits 3 L 393mm W 38mm H 52mm number of thermostat sleeves 1 thermostat sleeves ø 7mm length thermostat sleeves 350mm thermostat sleeve not clinging tube ø 8.5mm hole distance 73mm hole ø 8mm connection length 33mm connection M4 3 hole flange immersion heater			
<b>For models:</b>	VE20EC, VE20MX			
<b>spare parts for</b>	418085			
	<b>GEV No.</b>	510409	<b>Ref. No.</b>	—
	O-ring EPDM thickness 5.34mm ID ø 56.52mm Qty 1 pcs			

<b>GEV No.</b>	418084	<b>Ref. No.</b>	6003290
<b>description</b>	heating element 7599W 230V mounting ø 57.5mm heating circuits 3 L 340mm W 36mm H 42mm number of thermostat sleeves 1 thermostat sleeves ø 7mm length thermostat sleeves 270mm thermostat sleeve clinging tube ø 8.5mm hole distance 72mm hole ø 8mm connection M4 3 hole flange immersion heater		
<b>For models:</b>	EN10VE-EC-ESN1033, VE06EC, VE06MX, VE102EC, VE102MX, VE10EC, VE10MX		



heating elements for convection





1

<b>GEV No.</b>	418087	<b>Ref. No.</b>	6002125
<b>description</b>	heating element 15000W 230/400V heating circuits 3 ID ø 398mm ED ø 415mm L 452mm H 121mm L1 32mm W1 105mm H1 80mm H2 25mm flange length 142mm flange width 25mm hole distance 126mm connection M4 tube ø 8.5mm convection heating element hole ø 6mm rectangular flange		
<b>For models:</b>	CE10MX, CE20MX, DE10EC, DE10ES, DE10MX, EF10GM, EF8PM, VE10EC, VE10MX, VE20EC, VE20MX		
<b>accessories for</b>	418087		
	<b>GEV No.</b>	550548	<b>Ref. No.</b> 2005173
	gasket L 144mm W 25.5mm thickness 2.2mm for heating element suitable for GIORIK equiv. no. 2005173		



1

<b>GEV No.</b>	418088	<b>Ref. No.</b>	6002121
<b>description</b>	heating element 25000W 400V heating circuits 3 ID ø 388mm ED ø 406mm L 452mm H 150mm L1 35mm W1 105mm H1 21mm H2 130mm flange length 142mm flange width 25mm hole distance 126mm connection M4 connection length 72mm tube ø 8.5mm convection heating element hole ø 6mm rectangular flange		
<b>For models:</b>	CE102MX, DE102EC, DE102MX, VE102EC, VE102MX		
<b>accessories for</b>	418088		
	<b>GEV No.</b>	550548	<b>Ref. No.</b> 2005173
	gasket L 144mm W 25.5mm thickness 2.2mm for heating element suitable for GIORIK equiv. no. 2005173		



1

<b>GEV No.</b>	418858	<b>Ref. No.</b>	6002100
<b>description</b>	heating element 7350W 230V heating circuits 3 ID ø 215mm ED ø 230mm L 267mm H 85mm L1 38mm W1 102mm H1 5mm H2 80mm flange length 142mm flange width 25mm hole distance 63mm cable length 1000mm convection heating element hole ø 6mm		
<b>For models:</b>	EF4PM, EF5GM		



1

<b>GEV No.</b>	418086	<b>Ref. No.</b>	6002001
<b>description</b>	heating element 8400W 230V heating circuits 3 ID ø 218mm ED ø 235mm L 275mm H 112mm L1 40mm W1 105mm H1 32mm H2 80mm flange length 142mm flange width 25mm hole distance 64mm connection M4 tube ø 8.5mm convection heating element hole ø 6mm rectangular flange		
<b>For models:</b>	CE06MX, DE06EC, DE06ES, DE06MX, VE06EC, VE06MX		
<b>accessories for</b>	418086		
	<b>GEV No.</b>	550548	<b>Ref. No.</b> 2005173
	gasket L 144mm W 25.5mm thickness 2.2mm for heating element suitable for GIORIK equiv. no. 2005173		

radiation heaters



1

<b>GEV No.</b>	416001	<b>Ref. No.</b>	6001066 6001070
<b>description</b>	radiation heater rectangular 1500W 230/240V L 265mm W 165mm H 32mm heating circuits 1 connections 2 connection type cable cable length 700mm EGO salamander grill		
<b>For models:</b>	SH505R, SH510P, SH510R, SH520G, SH520GM, SH560P		
<b>accessories for</b>	416001		
	<b>GEV No.</b>	390880	<b>Ref. No.</b> 6010039
	safety rod thermostat switch-off temp. 780°C temperature range°C 2-pole 1NC/1NOA probe ø 4mm probe L 170mm capillary pipemm capillary pipe isolatedmm gland nut shaft ømm		
	<b>GEV No.</b>	403523	<b>Ref. No.</b> —
	solid state relay ANLY 1 phase 40A 24-280V 4-32VDC L 47.5mm W 43mm screw type ASR-40DA		

accessories

sealing washers

O-rings

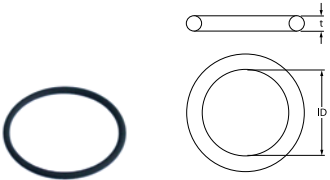



1

<b>GEV No.</b>	550496	<b>Ref. No.</b>	6090144
<b>description</b>	O-ring Viton thickness 3.53mm ID ø 50.39mm Qty 1 pcs		
<b>For models:</b>	15FE, 15FEC, 20FE, 20FEC, 210FE, 210FEC, 215FE, 215FEC, 220FE, 220FEC, 920FE, 920FEC, 922FE, 922FEC, 940FE, 940FEC, F10CL, F10L, F15CL, F15L, F215CL, F215L, FP18NS, FP18S, FP27S, FRE46, FRE66		



## flange gaskets

			
1			
<b>GEV No.</b>	550548	<b>Ref. No.</b>	2005173
<b>description</b>	gasket L 144mm W 25.5mm thickness 2.2mm for heating element suitable for GIORIK equiv. no. 2005173		
<b>For models:</b>	CE06MX, CE102MX, CE10MX, CE20MX, DE06EC, DE06ES, DE06MX, DE102EC, DE102MX, DE10EC, DE10ES, DE10MX, EF10GM, EF4PM, EF5GM, EF8PM, VE06EC, VE06MX, VE102EC, VE102MX, VE10EC, VE10MX, VE20EC, VE20MX		

			
1			
<b>GEV No.</b>	510368	<b>Ref. No.</b>	2005174
<b>description</b>	gasket L 70mm W 23.5mm hole ø 5mm hole distance 56mm FIBER thickness 2mm for heating element		
<b>For models:</b>	EF4, EF6PM, EF7GM, EN10VE-EC-ESN1033		

## hot plates

## square &amp; rectangular

## with radiused edge

			
1			
<b>GEV No.</b>	490074 <sup>1</sup>	<b>Ref. No.</b>	6001061
<b>description</b>	hot plate dimensions 300x300mm 4000W 400V with spill ring connection 4 screw clamps protector yes square		

<sup>1</sup>incl. protector

## round

## with radiused edge

## for domestic and commercial kitchens

			
1			
<b>GEV No.</b>	490020	<b>Ref. No.</b>	5910021
<b>description</b>	hot plate ø 220mm 2600W 230V connection 4 screw clamps with 8mm spill ring		
<b>accessories for</b>	490020		
	<b>GEV No.</b>	550796	<b>Ref. No.</b> —
fixing plate for hot plate ø220mm			

## energy regulators

## EGO

## 1-circuit

			
1			
<b>GEV No.</b>	380015	<b>Ref. No.</b>	6031023
<b>description</b>	energy regulator 230V 13A single-circuit turn direction right shaft ø 6x4.6mm shaft L 23mm mounting thread M4 power release 6-100% no. 50.57021.010		
<b>For models:</b>	DE06ES, DE06MX, DE102MX, DE10ES, DE10MX, DG06ES, DG06MX, DG102MX, DG10ES, DG10MX, EF10GM, EF4PM, EF5GM, EF6PM, EF7GM, EF8PM, GF10GM, GF4PM, GF5GM, GF6PM, GF7GM, GF8PM, S505, S505R, S510, S510S, S511, S511S, SR512R, VE06MX, VE102MX, VE10MX, VE20MX, VG06MX, VG102MX, VG10MX, VG20MX		

## thermostats

## control and safety thermostats

## EGO



## control thermostats

## 55.10/19\_ series

			
1			
<b>GEV No.</b>	375548	<b>Ref. No.</b>	6010024
<b>description</b>	thermostat t.max. 142°C temperature range fixed 142°C 1-pole 1CO 16A probe ø 4mm probe L 157mm capillary pipe 870mm capillary pipe isolated 870mm gland nut shaft ø 6x4.6mm shaft Lmm shaft position		

55.13\_ series



<b>GEV No.</b>	375007	<b>Ref. No.</b>	6010015
<b>description</b>	thermostat t.max. 110°C temperature range 30-110°C 1-pole 1NO 16A probe ø 6mm probe L 113mm capillary pipe 870mm capillary pipe isolated gland nut M9x1 shaft L 25mm shaft position upper rotation 270°		
<b>For models:</b>	BME46, BME66, CP1BM, CPG1BM, SPE46		
<b>accessories for</b>	375007		
	<b>GEV No.</b>	110119	<b>Ref. No.</b> —
	knob thermostat t.max. 110°C ø 50mm shaft ø 6x4.6mm shaft flat upper black temperature range 30-110°C rotation 270°		
	<b>GEV No.</b>	110241	<b>Ref. No.</b> —
	knob thermostat t.max. 110°C ø 50mm shaft ø 6x4.6mm shaft flat upper black temperature range 30-110°C		



<b>GEV No.</b>	375492	<b>Ref. No.</b>	6010005
<b>description</b>	thermostat t.max. 190°C temperature range 94-190°C 1-pole 1NO 16A probe ø 6mm probe L 94mm capillary pipe 1090mm capillary pipe isolated 960mm gland nut M10x1 shaft ø 6x4.6mm shaft L 23mm shaft position upper rotation 310° probe material SS		
<b>For models:</b>	13FG, 15FE, 17FG, 207FG, 20FE, 210FE, 213FG, 215FE, 217FG, 220FE, 917FG, 920FE, 922FE, 927FG, 934FG, 940FE, F10L, F15L, F215L, FP-18NS, FP18S, FP27S, FRE46, FRE46F, FRE46R, FRE66, FRE66F, FRE66R, FT3N, FT5, FTR26F, FTR6F		

55.34\_ series



<b>GEV No.</b>	375602	<b>Ref. No.</b>	6010016
<b>description</b>	thermostat t.max. 120°C temperature range 45-120°C 3-pole 3CO 16A probe ø 6mm probe L 140mm capillary pipe 900mm capillary pipe isolated 870mm gland nut shaft ø 6x4.6mm shaft L 23mm shaft position upper rotation 270°		
<b>For models:</b>	22CP, 23CP, 2CP, 3CP, CP1, CP1BM, CPE66		



<b>GEV No.</b>	375435	<b>Ref. No.</b>	6010004
<b>description</b>	thermostat t.max. 190°C temperature range 56-190°C 3-pole 3NO 16A probe ø 6mm probe L 130mm capillary pipe 900mm capillary pipe isolated 670mm gland nut M10x1 shaft ø 6x4.6mm shaft L 23mm shaft position upper rotation 318° probe material SS		
<b>For models:</b>	FRE46T, FRE66T, FTR10, FTR26T, FTR6T		



<b>GEV No.</b>	375362	<b>Ref. No.</b>	5910028 6010091
<b>description</b>	thermostat t.max. 320°C temperature range 55-320°C 3-pole 3NO 10A probe ø 4mm probe L 128mm capillary pipe 900mm capillary pipe isolated gland nut shaft ø 6x4.6mm shaft L 23mm shaft position upper rotation 270°		

safety thermostats

55.10/19\_ series



<b>GEV No.</b>	375376	<b>Ref. No.</b>	2001046 2011140
<b>description</b>	safety thermostat capillary pipe 870mm probe ø 6mm 1-pole probe L 133mm 0.5A capillary pipe isolated gland nut M10x1 switch-off temp. 224°C probe		
<b>For models:</b>	13FG, 17FG, 207FG, 213FG, 917FG, 917FGC, 927FG, 927FGC, 934FG, 934FGC, FG07L, FG13L, FG213L		



<b>GEV No.</b>	375339	<b>Ref. No.</b>	6010020
<b>description</b>	safety thermostat switch-off temp. 225°C 1-pole 0.5A probe ø 6mm probe L 133mm capillary pipe 870mm capillary pipe isolatedmm gland nut M10x1 probe		
<b>accessories for</b>	375339		
	<b>GEV No.</b>	551083	<b>Ref. No.</b> —
cap for safety thermostat thread M8x1			

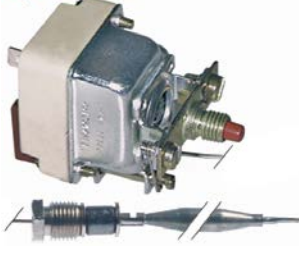

<b>GEV No.</b>	375968	<b>Ref. No.</b>	6010026
<b>description</b>	safety thermostat switch-off temp. 360°C 1-pole 1NC 16A probe ø 6mm probe L 77mm capillary pipe 870mm capillary pipe isolated 660mm gland nut M10x1 probe probe material SS M8x1		
<b>For models:</b>	CG102MX, CG10MX, DG06EC, DG06ES, DG06MX, DG102EC, DG-102MX, DG10EC, DG10ES, DG10MX, EF4, GF10GM, GF4PM, GF5GM, GF6PM, GF7GM, GF8PM, VG06EC, VG06MX, VG102EC, VG102MX, VG10EC, VG10MX		

55.32\_ series



<b>GEV No.</b>	375277	<b>Ref. No.</b>	6010002
<b>description</b>	safety thermostat switch-off temp. 150°C 3-pole 3NC 20A probe ø 6mm probe L 79mm capillary pipe 900mm capillary pipe isolated 700mm gland nut probe		
<b>For models:</b>	22CP, 23CP, 2CP, 3CP, CP1, CP1BM, CPE66, EN10VE-EC-ESN1033, VE06EC, VE06MX, VE10EC, VE10MX, VG06EC, VG06MX, VG102EC, VG102MX, VG10EC, VG10MX, VG20EC, VG20MX		

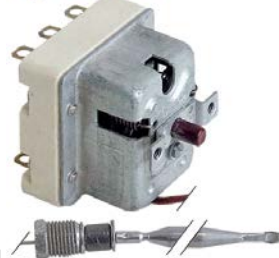

<b>GEV No.</b>	375375	<b>Ref. No.</b>	6010036
<b>description</b>	safety thermostat switch-off temp. 230°C 3-pole 20A probe ø 6mm probe L 94mm capillary pipe 900mm capillary pipe isolated 670mm gland nut M10x1 probe SS		
<b>For models:</b>	210FE, 210FEC, 922FE, 922FEC, F10CL, F10L, F15CL, F15L, F215CL, F215L, FP18NS, FP18S, FP27S, FRE46, FRE46R, FRE46T, FRE66, FRE66R, FRE66T, FTR10, FTR26T, FTR6T		

55.14\_ series

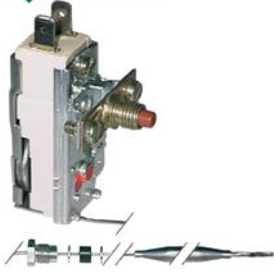

<b>GEV No.</b>	375260	<b>Ref. No.</b>	6010006
<b>description</b>	safety thermostat switch-off temp. 240°C 1-pole 16A probe ø 6mm probe L 77mm capillary pipe 1280mm capillary pipe isolated 1050mm gland nut M10x1 probe SS		
<b>For models:</b>	FRE46F, FRE66F, FT3N, FT5, FTR26F, FTR6F		

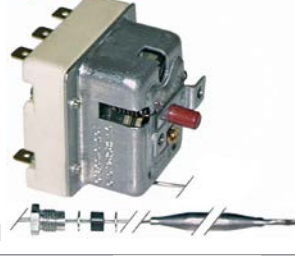

<b>GEV No.</b>	375258	<b>Ref. No.</b>	6010037
<b>description</b>	safety thermostat switch-off temp. 232°C 3-pole 20A probe ø 6mm probe L 94mm capillary pipe 900mm capillary pipe isolated 670mm gland nut M10x1 probe SS		
<b>For models:</b>	15FE, 15FEC, 20FE, 20FEC, 215FE, 215FEC, 220FE, 220FEC, 920FE, 920FEC, 940FE, 940FEC		



<b>GEV No.</b>	375628	<b>Ref. No.</b>	6010008
<b>description</b>	safety thermostat switch-off temp. 350°C 3-pole 20A probe ø 4mm probe L 120mm capillary pipe 900mm capillary pipe isolated 670mm gland nut M10x1 probe SS		
<b>For models:</b>	CE06MX, CE102MX, CE10MX, CE20MX, CG06MX, CG20MX, DE06EC, DE06ES, DE06MX, DE102EC, DE102MX, DE10EC, DE10ES, DE10MX, EF10GM, EF4PM, EF5GM, EF6PM, EF7GM, EF8PM, EN10VE-EC-ESN1033, VE06EC, VE06MX, VE102EC, VE102MX, VE10EC, VE10MX, VE20EC, VE20MX, VG20EC, VG20MX		

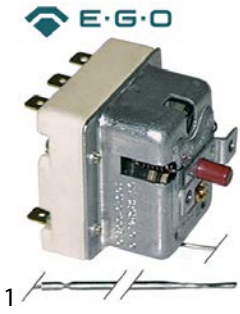

<b>GEV No.</b>	390142	<b>Ref. No.</b>	5910029
<b>description</b>	safety thermostat switch-off temp. 360°C 3-pole 20A probe ø 3.1mm probe L 188mm capillary pipe 1490mm capillary pipe isolated 800mm gland nut probe SS		

rod thermostats

safety rod thermostats



<b>GEV No.</b>	390880	<b>Ref. No.</b>	6010039
<b>description</b>	safety rod thermostat switch-off temp. 780°C temperature range°C 2-pole 1NC/1NOA probe ø 4mm probe L 170mm capillary pipemm capillary pipe isolatedmm gland nut shaft ømm		
<b>For models:</b>	SH520G, SH520GM, SH560P		

accessories

gland nut accessories

ducts



<b>GEV No.</b>	100820	<b>Ref. No.</b>	7050025
<b>description</b>	gland duct ET M14x1.5 IT M10x0.75 probe ø max. 6.5mm WS 22		

bolts with slot



<b>GEV No.</b>	520244	<b>Ref. No.</b>	6030024
<b>description</b>	bolt with slot thread M10x1 Qty 10 pcs nickel-plated brass		
<b>For models:</b>	FTR10		

connecting bows



<b>GEV No.</b>	550060	<b>Ref. No.</b>	6030016
<b>description</b>	connecting bow long for thermostat Qty 1 pcs		
<b>For models:</b>	FRE46F, FRE46R, FRE66F, FRE66R, FT3N, FT5, FTE100, FTE107, FTE46, FTE46B, FTE46R, FTE47L, FTE66L, FTE66LB, FTE66LM, FTE66LMB, FTE66R, FTE66RM, FTR26F, FTR6F, SPE46		



switches and momentary switches

push/momentary push switches

ø16mm



<b>GEV No.</b>	346345	<b>Ref. No.</b>	6032020
<b>description</b>	momentary push switch mounting ø 16mm black 1NO 250V 3A connection male faston 2.8mm ambient temperature max. 85°C protection IP40		
<b>For models:</b>	CE06MX, CE102MX, CE10MX, CE20MX, CG06MX, CG102MX, CG10MX, CG20MX, DE06MX, DE102MX, DE10MX, DG06MX, DG102MX, DG10MX, VE06MX, VE102MX, VE10MX, VE20MX, VG06MX, VG102MX, VG10MX, VG20MX		



<b>accessories for</b>	346345			
	<b>GEV No.</b>	346343	<b>Ref. No.</b>	6032021
	protective cover			
	<b>GEV No.</b>	346344	<b>Ref. No.</b>	6032022
	ring for protecting cover			





			
1			
<b>GEV No.</b>	346346	<b>Ref. No.</b>	6032038
<b>description</b>	momentary push switch mounting ø 16mm red 1NO/indicator light 250V 3A connection male faston 2.8mm ambient temperature max. 125/55°C protection IP40		
<b>For models:</b>	CG20MX, DG06EC, DG06ES, DG06MX, DG102EC, DG102MX, DG10EC, DG10ES, DG10MX, GF10GM, GF4PM, GF5GM, GF6PM, GF7GM, GF8PM, VG06EC, VG06MX, VG102EC, VG102MX, VG10EC, VG10MX, VG20EC, VG20MX		

accessories

protective covers

			
1			
<b>GEV No.</b>	346343	<b>Ref. No.</b>	6032021
<b>description</b>	protective cover		
<b>For models:</b>	CE06MX, CE102MX, CE10MX, CE20MX, CG06MX, CG102MX, CG10MX, CG20MX, DE06MX, DE102MX, DE10MX, DG06EC, DG06MX, DG102EC, DG102MX, DG10EC, DG10MX, VE06MX, VE102MX, VE10MX, VE20MX, VG06EC, VG06MX, VG102EC, VG102MX, VG10EC, VG10MX, VG20EC, VG20MX		
<b>accessories for</b>	346343		
		<b>GEV No.</b>	346344
	ring for protecting cover	<b>Ref. No.</b>	6032022

			
1			
<b>GEV No.</b>	346344	<b>Ref. No.</b>	6032022
<b>description</b>	ring for protecting cover		
<b>For models:</b>	CE06MX, CE102MX, CE10MX, CE20MX, CG06MX, CG102MX, CG10MX, CG20MX, DE06MX, DE102MX, DE10MX, DG06EC, DG06MX, DG102EC, DG102MX, DG10EC, DG10MX, VE06MX, VE102MX, VE10MX, VE20MX, VG06EC, VG06MX, VG102EC, VG102MX, VG10EC, VG10MX, VG20EC, VG20MX		
<b>accessories for</b>	346344		
		<b>GEV No.</b>	346343
	protective cover	<b>Ref. No.</b>	6032021

microswitches

lever actuated

			
1			
<b>GEV No.</b>	345773	<b>Ref. No.</b>	6043085
<b>description</b>	microswitch with lever 250V 16A 1CO connection male faston 6.3mm L 60mm ambient temperature max. 125°C mounting distance 22mm actuating force: 65g lever length 51mm		
<b>For models:</b>	15FE, 15FEC, 20FE, 20FEC, 210FE, 210FEC, 215FE, 215FEC, 220FE, 220FEC, 920FE, 920FEC, 922FE, 922FEC, 940FE, 940FEC, F10CL, F10L, F15CL, F15L, F215CL, F215L, FP18NS, FP18S, FP27S, FRE46, FRE46R, FRE66, FRE66R, SH510P, SH560P		

pin-plunger actuated

			
1			
<b>GEV No.</b>	345060	<b>Ref. No.</b>	6043086
<b>description</b>	microswitch with plunger 250V 16A 1NO connection male faston 6.3mm ambient temperature max. 85°C mounting distance 22mm type BS1010 actuating force: 350g red stroke 9mm		
<b>For models:</b>	FT3N, FT5, FTR10		

M10

			
1			
<b>GEV No.</b>	346347	<b>Ref. No.</b>	6043088
<b>description</b>	microswitch with plunger thread M10x0.75 thread L 14mm 250V 6A 2NO connection male faston 6.3mm stroke 4mm mounting distance 22mm ambient temperature max. 85°C actuating force: 100g		
<b>For models:</b>	CE06MX, CE102MX, CE10MX, CE20MX, CG06MX, CG102MX, CG10MX, CG20MX, DE06EC, DE06ES, DE06MX, DE102EC, DE102MX, DE10EC, DE10ES, DE10MX, DG06EC, DG06ES, DG06MX, DG102EC, DG102MX, DG10EC, DG10ES, DG10MX, VE06EC, VE06MX, VE102EC, VE102MX, VE10EC, VE10MX, VE20EC, VE20MX, VG06EC, VG06MX, VG102MX, VG10EC, VG10MX, VG20EC, VG20MX		



cam switches

on/off

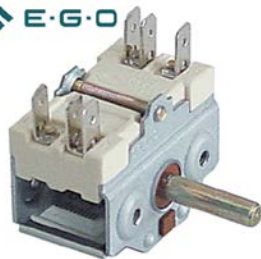

1

<b>GEV No.</b>	300129	<b>Ref. No.</b>	6030007
<b>description</b>	cam switch 2 operating positions 2NO sequence 0-1 16A shaft ø 6x4.6mm shaft L 23mm connection male faston 6.3mm ceramic		
<b>For models:</b>	13FGC, 17FGC, 207FGC, 213FGC, 217FGC, 917FGC, 927FGC, 934FGC, BM711, BM721, BM911, BM921, BME46, BME66, CE06MX, CE102MX, CE10MX, CE20MX, CG06MX, CG102MX, CG10MX, CG20MX, EF10GM, EF4PM, EF5GM, EF6PM, EF7GM, EF8PM, EN10VE-EC-ESN1033, FG07CL, FG213CL, GF10GM, GF4PM, GF5GM, GF6PM, GF7GM, GF8PM		



2

<b>GEV No.</b>	300139	<b>Ref. No.</b>	6030012
<b>description</b>	cam switch ON-OFF connection male faston		
<b>For models:</b>	210FEC, 922FEC, EF4, F10CL, F15CL, F215CL, FP18NS, FP18S, FP27S, FTR10, SH505R, SH510P, SH510R, SH520G, SH520GM, SH560P		

7-position



1

<b>GEV No.</b>	300004	<b>Ref. No.</b>	6030014
<b>description</b>	cam switch 7 operating positions 1NO/2CO sequence 0-1-2-3-4-5-6 16A shaft ø 6x4.6mm shaft L 23mm connection male faston 6.3mm 7-position ceramic		
<b>For models:</b>	PCE46, PCE66M, PCE66T		



1

<b>GEV No.</b>	300106	<b>Ref. No.</b>	6030001
<b>description</b>	cam switch 7 operating positions 1NO/2CO sequence 0-1-2-3-4-5-6 32A shaft ø 6x4.6mm shaft L 23mm connection screw 7-position shaft flat upper		

4 operating positions



1

<b>GEV No.</b>	300081	<b>Ref. No.</b>	6030036
<b>description</b>	cam switch 4 operating positions 3NO/2CO sequence 0-1-2-3 16A shaft ø 6x4.6mm shaft L 23mm connection screw		



1

<b>GEV No.</b>	300239	<b>Ref. No.</b>	6030040
<b>description</b>	operation switch 4 operating positions 4NO sequence 0-1-2-3 16A shaft ø 6x4.6mm shaft L 23mm connection male faston 6.3mm plastic		

operation switches



1

<b>GEV No.</b>	300002	<b>Ref. No.</b>	6030019
<b>description</b>	cam switch 2 operating positions 4NO 16A sequence 0-1 shaft ø 6x4.6mm shaft L 23mm connection male faston 6.3mm ceramic		



1

<b>GEV No.</b>	300166	<b>Ref. No.</b>	6030019
<b>description</b>	cam switch 2 operating positions 4NO 16A sequence 0-1 shaft $\varnothing$ 6x4.6mm shaft L 23mm connection male faston 6.3mm ceramic 4-pole ambient temperature max. 318°C		
<b>For models:</b>	210FE, 22CP, 23CP, 2CP, 3CP, 922FE, CP1, CP1BM, CPE66, F10L, F15L, F215L, FRE46, FRE46R, FRE46T, FRE66, FRE66R, FRE66T, FTE66L, FTE66LB, FTE66R, FTE67L, FTE67LM, FTR26T, FTR6T		



1

<b>GEV No.</b>	300115	<b>Ref. No.</b>	5910023
<b>description</b>	cam switch 2 operating positions operation switch sequence 0-1 shaft $\varnothing$ 6x4.6mm connection screw clamp 5-pole ambient temperature max. 318°C		



1

<b>GEV No.</b>	300200	<b>Ref. No.</b>	6030015
<b>description</b>	operation switch 2 operating positions 2NO 16A sequence 0-1 shaft $\varnothing$ 6x4.6mm shaft L 23mm connection male faston 6.3mm operation switch ceramic		
<b>For models:</b>	13FG, 17FG, 207FG, 213FG, 217FG, 917FG, 927FG, 934FG, CP1BM, CPG1BM, FRE46F, FRE66F, FT3N, FT5, FTE100, FTE107, FTE46, FTE46B, FTE46R, FTE47L, FTE66LM, FTE66LMB, FTE66RM, FTR26F, FTR6F, SPE46		

rotary switches

BREMAS

A1600 series



1

<b>GEV No.</b>	346342	<b>Ref. No.</b>	6030031
<b>description</b>	rotary switch 7 1-2-3-4-5-6-7 sets of contacts 9 type CS0169137 400V 16A shaft $\varnothing$ 4x5mm shaft L 20mm shaft square connection screw		
<b>For models:</b>	VE06MX, VE102MX, VE10MX, VE20MX, VG06MX, VG102MX, VG10MX, VG20MX		



1

<b>GEV No.</b>	346341	<b>Ref. No.</b>	6030030
<b>description</b>	rotary switch 8 1-2-3-4-5-6-7-8 sets of contacts 10 type CS0169134 400V 16A shaft $\varnothing$ 4x5mm shaft L 20mm shaft square connection screw		
<b>For models:</b>	DE06EC, DE06ES, DE06MX, DE102EC, DE10EC, DE10ES, DE10MX, DG06EC, DG06ES, DG06MX, DG102EC, DG102MX, DG10EC, DG10ES, DG10MX, VE06EC, VE102EC, VE10EC, VE20EC, VG06EC, VG102EC, VG10EC, VG20EC		

GIOVENZANA

rotary switches



1

<b>GEV No.</b>	348053	<b>Ref. No.</b>	6030003
<b>description</b>	rotary switch 2 0-1 sets of contacts 4 type CX32 600V 32A shaft $\varnothing$ 5x5mm shaft L 26mm shaft square connection screw		
<b>For models:</b>	15FE, 15FEC, 20FE, 20FEC, 215FE, 215FEC, 220FE, 220FEC, 920FE, 920FEC, 940FE, 940FEC		

encoders and potentiometers



1

<b>GEV No.</b>	401169	<b>Ref. No.</b>	6010102
<b>description</b>	encoder cable length 125mm		
<b>For models:</b>	DE06EC, DE102EC, DE10EC, DG06EC, DG102EC, DG10EC, SH505R, SH510P, SH510R, SH520G, SH520GM, SH560P, VE06EC, VE102EC, VE10EC, VE20EC, VG06EC, VG102EC, VG10EC, VG20EC		



1

<b>GEV No.</b>	300146	<b>Ref. No.</b>	6010076
<b>description</b>	potentiometer		



1

<b>GEV No.</b>	300187	<b>Ref. No.</b>	6010097
<b>description</b>	potentiometer 4.7KOhm rotation 310° shaft $\varnothing$ 0.6x4.5mm shaft L 20mm cable length 650mm		
<b>For models:</b>	CE06MX, CE102MX, CE10MX, CE20MX, CG06MX, CG102MX, CG10MX, CG20MX, DE06ES, DE06MX, DE102MX, DE10ES, DE10MX, DG06ES, DG06MX, DG102MX, DG10ES, DG10MX, EF10GM, EF4PM, EF5GM, EF6PM, EF7GM, EF8PM, GF10GM, GF4PM, GF5GM, GF6PM, GF7GM, GF8PM, VE06MX, VE102MX, VE10MX, VE20MX, VG06MX, VG102MX, VG10MX, VG20MX		





# lamps

## indicator lights

### indicator lights 2-piece (lens and indicator lamp)

#### indicator light lenses



ø13mm (type SF-3)

 <p>1</p>			
<b>GEV No.</b>	357046	<b>Ref. No.</b>	6061070
<b>description</b>	indicator light housings mounting measurements ø13mm green Qty 10 pcs with adapter round		
<b>For models:</b>	EF4, FP18NS, FP18S, FP27S, FT3N, FT5, FTR10, FTR26F, FTR26T, FTR6F, FTR6T, SR512, SR512R		

ø13mm (type SFK-3)

 <p>1</p>			
<b>GEV No.</b>	359225	<b>Ref. No.</b>	6061069
<b>description</b>	indicator light housings mounting measurements ø13mm clear Qty 1 pcs		
<b>For models:</b>	EF4, FP18NS, FP18S, FP27S, FT3N, FT5, FTR10, FTR26F, FTR26T, FTR6F, FTR6T, S505, S505R, S510, S510S, S511, S511S		

### indicator lamps for socket type SRZ / SDK / SDY / SFK

 <p>1</p>							
<b>GEV No.</b>	359430	<b>Ref. No.</b>	6061067				
<b>description</b>	indicator lamp 230V clear connection cable 400mm						
<b>For models:</b>	EF4, FP18NS, FP18S, FP27S, FT3N, FT5, FTR10, FTR26F, FTR26T, FTR6F, FTR6T, S505, S505R, S510, S510S, S511, S511S						
<b>accessories for</b>	359430						
	 <p>1</p>	<table border="1"> <tr> <td><b>GEV No.</b></td> <td>359260</td> <td><b>Ref. No.</b></td> <td>—</td> </tr> </table>	<b>GEV No.</b>	359260	<b>Ref. No.</b>	—	
<b>GEV No.</b>	359260	<b>Ref. No.</b>	—				
<b>description</b>	indicator light housings mounting measurements ø12mm yellow round Qty 1 pcs						

 <p>1</p>			
<b>GEV No.</b>	359431	<b>Ref. No.</b>	6061068
<b>description</b>	indicator lamp 230V green connection cable 400mm cable material silicone		
<b>For models:</b>	EF4, FP18NS, FP18S, FP27S, FT3N, FT5, FTR10, FTR26F, FTR26T, FTR6F, FTR6T, SR512, SR512R		

### indicator lights (complete)

ø12mm

with screw socket

 <p>1</p>			
<b>GEV No.</b>	359048	<b>Ref. No.</b>	6061051
<b>description</b>	indicator light ø 12mm 230V yellow connection male faston 6.3mm		

30x22mm

 <p>1</p>			
<b>GEV No.</b>	346965	<b>Ref. No.</b>	5910033
<b>description</b>	indicator light mounting measurements 30x22mm 230V yellow		

### miscellaneous

 <p>1</p>			
<b>GEV No.</b>	359272	<b>Ref. No.</b>	6061073
<b>description</b>	indicator light green 230V		
<b>For models:</b>	15FE, 20FE, 210FE, 215FE, 220FE, 22CP, 23CP, 2CP, 920FE, 922FE, 940FE, BM711, BM721, BM911, BM921, BME46, BME66, CP1, CP1BM, CPE66, CPG1BM, F10L, F15L, F215L, FRE46, FRE46F, FRE46R, FRE46T, FRE66, FRE66F, FRE66R, FRE66T, FTE100, FTE107, FTE46, FTE46B, FTE46R, FTE47L, FTE66L, FTE66LB, FTE66LM, FTE66LMB, FTE66R, FTE66RM, FTE67L, FTE67LM, SPE46, SPR46		

 <p>1</p>			
<b>GEV No.</b>	359273	<b>Ref. No.</b>	6061072
<b>description</b>	indicator light yellow 230V		
<b>For models:</b>	15FE, 20FE, 210FE, 215FE, 220FE, 22CP, 23CP, 2CP, 3CP, 920FE, 922FE, 940FE, BM711, BM721, BM911, BM921, BME46, BME66, CP1, CP1BM, CPE66, CPG1BM, F10L, F15L, F215L, FRE46, FRE46F, FRE46R, FRE46T, FRE66, FRE66F, FRE66R, FRE66T, FTE100, FTE107, FTE46, FTE46B, FTE46R, FTE47L, FTE66L, FTE66LB, FTE66LM, FTE66LMB, FTE66R, FTE66RM, FTE67L, FTE67LM, PCE46, PCE66M, PCE66T...(Other models you can see in the webshop)		

## screw-on/push-on fit

### light bulbs

for ovens

 <p>1</p>			
<b>GEV No.</b>	359612	<b>Ref. No.</b>	6061053
<b>description</b>	light bulb t.max. 300°C socket E14 25W 230V ø 25mm L 56mm lens L 30mm for oven lamp type Philips		
<b>For models:</b>	EN10VE-EC-ESN1033		



**halogen lamp**  
for socket G4 / G6.35 / G9





<b>GEV No.</b>	359599	<b>Ref. No.</b>	6061054
<b>description</b>	halogen lamp socket G4 12V 20W temp.-resist. 500°C		
<b>For models:</b>	CE06MX, CE102MX, CE10MX, CE20MX, CG06MX, CG102MX, CG10MX, CG20MX, DE06EC, DE06ES, DE06MX, DE102EC, DE102MX, DE10EC, DE10ES, DE10MX, DG06EC, DG06ES, DG06MX, DG102EC, DG102MX, DG10EC, DG10ES, DG10MX, VE06EC, VE06MX, VE102EC, VE102MX, VE10EC, VE10MX, VE20EC, VE20MX, VG06EC, VG06MX, VG102EC, VG102MX, VG10EC, VG10MX, VG20EC, VG20MX		



<b>GEV No.</b>	532649	<b>Ref. No.</b>	6090141
<b>description</b>	O-ring Viton ID ø 63.17mm thickness 2.62mm Qty 1 pcs		
<b>For models:</b>	EF10GM, EF4PM, EF5GM, EF6PM, EF7GM, EF8PM, GF10GM, GF4PM, GF5GM, GF6PM, GF7GM, GF8PM		

**oven lamps**  
universal oven lamps  
mounting diameter 47.8mm



<b>GEV No.</b>	359499	<b>Ref. No.</b>	6060055
<b>description</b>	lamp socket socket E14 mounting ø 47.8mm connection male faston 6.3mm		
<b>For models:</b>	EF10GM, EF4PM, EF5GM, EF6PM, EF7GM, EF8PM, GF10GM, GF4PM, GF5GM, GF6PM, GF7GM, GF8PM		
<b>accessories for</b>	359499		
	<b>GEV No.</b>	359725	<b>Ref. No.</b> —
	oven lamp glass thread ø 44mm H 43mm ø 54mm hard glas temp.-resist. 350°C		

30x70mm



<b>GEV No.</b>	359338	<b>Ref. No.</b>	6063077
<b>description</b>	lamp glass		
<b>For models:</b>	CE06MX, CE102MX, CE10MX, CE20MX, CG06MX, CG102MX, CG10MX, CG20MX, DE06EC, DE06ES, DE06MX, DE102EC, DE102MX, DE10EC, DE10ES, DE10MX, DG06EC, DG06ES, DG06MX, DG102EC, DG102MX, DG10EC, DG10ES, DG10MX, VE06EC, VE06MX, VE102EC, VE102MX, VE10EC, VE10MX, VE20EC, VE20MX, VG06EC, VG06MX, VG102EC, VG102MX, VG10EC, VG10MX, VG20EC, VG20MX		

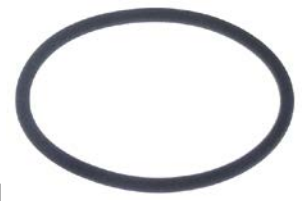

<b>GEV No.</b>	525313	<b>Ref. No.</b>	6090140
<b>description</b>	O-ring Viton ID ø 60.33mm thickness 3.53mm Qty 1 pcs		
<b>For models:</b>	EF10GM, EF4PM, EF5GM, EF6PM, EF7GM, EF8PM, GF10GM, GF4PM, GF5GM, GF6PM, GF7GM, GF8PM		



<b>GEV No.</b>	359337	<b>Ref. No.</b>	6063075
<b>description</b>	oven lamp socket G4 cable length 800mm connection Faston 6.3mm L 70mm W 29mm		
<b>For models:</b>	CE06MX, CE102MX, CE10MX, CE20MX, CG06MX, CG102MX, CG10MX, CG20MX, DE06EC, DE06ES, DE06MX, DE102EC, DE102MX, DE10EC, DE10ES, DE10MX, DG06EC, DG06ES, DG06MX, DG102EC, DG102MX, DG10EC, DG10ES, DG10MX, VE06EC, VE06MX, VE102EC, VE102MX, VE10EC, VE10MX, VE20EC, VE20MX, VG06EC, VG06MX, VG102EC, VG102MX, VG10EC, VG10MX, VG20EC, VG20MX		
<b>accessories for</b>	359337		
	<b>GEV No.</b>	359599	<b>Ref. No.</b> 6061054
	halogen lamp socket G4 12V 20W temp.-resist. 500°C		



55x70mm



1

<b>GEV No.</b>	359368	<b>Ref. No.</b>	6063074
<b>description</b>	lamp glass		

**lamps**

light bulbs



1

<b>GEV No.</b>	359612	<b>Ref. No.</b>	6061053
<b>description</b>	light bulb t.max. 300°C socket E14 25W 230V ø 25mm L 56mm lens L 30mm for oven lamp type Philips		
<b>For models:</b>	EN10VE-EC-ESN1033		

**halogen lamps**

for socket G4 / G6.35 / G9



1 500°C

<b>GEV No.</b>	359599	<b>Ref. No.</b>	6061054
<b>description</b>	halogen lamp socket G4 12V 20W temp.-resist. 500°C		
<b>For models:</b>	CE06MX, CE102MX, CE10MX, CE20MX, CG06MX, CG102MX, CG10MX, CG20MX, DE06EC, DE06ES, DE06MX, DE102EC, DE102MX, DE10EC, DE10ES, DE10MX, DG06EC, DG06ES, DG06MX, DG102EC, DG102MX, DG10EC, DG10ES, DG10MX, VE06EC, VE06MX, VE102EC, VE102MX, VE10EC, VE10MX, VE20EC, VE20MX, VG06EC, VG06MX, VG102EC, VG102MX, VG10EC, VG10MX, VG20EC, VG20MX		

**timers**

electric timers



1

<b>GEV No.</b>	350135	<b>Ref. No.</b>	6032059
<b>description</b>	timer MS65 operation time 120min time spreadmin 1CO/2NO at 250V 16A permanent position yes time range 0-120min impulse electric shaft ø 6x4.6mm shaft L 21mm mounting distance 28mm connection male faston 6.3mm screw mounting 250V voltage AC 50Hz		

with time spread



1

<b>GEV No.</b>	350074	<b>Ref. No.</b>	6032047
<b>description</b>	timer MS65 operation time 120min time spread 30min 1CO/2NO/1NC at 250V 16A permanent position yes impulse electric shaft ø 6x4.6mm shaft L 22mm mounting distance 28mm connection lateral Invensys 4-pole shaft position lower°		
<b>For models:</b>	CE06MX, CE102MX, CE10MX, CE20MX, CG06MX, CG102MX, CG10MX, CG20MX, DE06ES, DE06MX, DE102MX, DE10ES, DE10MX, DG06ES, DG06MX, DG102MX, DG10ES, DG10MX, EF10GM, EF4, EF4PM, EF5GM, EF6PM, EF7GM, EF8PM, GF10GM, GF4PM, GF5GM, GF6PM, GF7GM, GF8PM, VE06MX, VE102MX, VE10MX, VE20MX, VG06MX, VG102MX, VG10MX, VG20MX		

**mechanical timers**



1

<b>GEV No.</b>	350003	<b>Ref. No.</b>	6032040
<b>description</b>	timer M2 with bell 2-pole operation time 120min impulse mechanical 2NO at 250V 16A permanent position no shaft ø 6x4.6mm shaft 6x4.6mm shaft L 23mm mounting distance 28mm connection lateral		
<b>accessories for</b>	350003		
	<b>GEV No.</b>	<b>Ref. No.</b>	—
	110366		
	knob switch zero mark t.max.°C°C ø 44mm shaft ø 6x4.6mm shaft flat upper black		
	<b>GEV No.</b>	<b>Ref. No.</b>	—
	111199		
	dial plate graduation 120min permanent position no rotation 0-330° ø 60mm timers knob ø 45mm		

**alarm devices**

buzzer boards



1

<b>GEV No.</b>	401062	<b>Ref. No.</b>	6010090
<b>description</b>	buzzer board 230VAC L 48mm W 45mm connection Faston 6.3mm		
<b>For models:</b>	CE06MX, CE102MX, CE10MX, CE20MX, CG06MX, CG102MX, CG10MX, CG20MX, DE06MX, DE102MX, DE10MX, DG06MX, DG102MX, DG10MX, EF10GM, EF4PM, EF5GM, EF6PM, EF7GM, EF8PM, GF10GM, GF4PM, GF5GM, GF6PM, GF7GM, GF8PM		



## contactors

## GENERAL ELECTRIC (AEG)

## power contactors



1

<b>GEV No.</b>	380244	<b>Ref. No.</b>	6046043
<b>description</b>	power contactor resistive load 25A 230VAC (AC3/400V) 9A/4kW main contacts 3NO auxiliary contacts 1NO connection screw connection type AEG LS4K 10A type GE CL00A 310		
<b>For models:</b>	F10CL, F10L, F15CL, F15L, F215CL, F215L, FP18NS, FP18S, FP27S, FRE46, FRE66		

## ISKRA (FANAL)

## power contactors



1

<b>GEV No.</b>	380204	<b>Ref. No.</b>	6046033 6046038
<b>description</b>	power contactor resistive load 25A 230VAC (AC3/400V) 9A/4kW main contacts 3NO auxiliary contacts 1NO connection screw connection type Fanal DSL9 10 type ISKRA KNL9 10		
<b>For models:</b>	15FE, 15FEC, 20FEC, 210FE, 210FEC, 215FE, 215FEC, 220FEC, 920FEC, 922FE, 922FEC, 940FEC, CE06MX, CE102MX, CE10MX, CE20MX, CG06MX, CG102MX, CG10MX, CG20MX, DE06EC, DE06ES, DE06MX, DE102EC, DE102MX, DE10EC, DE10ES, DE10MX, DG06ES, DG06MX, DG102MX, DG10ES, DG10MX, EF10GM, EF4, EF4PM, EF5GM, EF6PM, EF7GM, EF8PM, EN10VE-EC-ESN1033, GF10GM, GF4PM, GF5GM, GF6PM, GF7GM, GF8PM, VE06EC, VE06MX, VE102EC...(Other models you can see in the webshop)		



1

<b>GEV No.</b>	380424	<b>Ref. No.</b>	6046041
<b>description</b>	power contactor resistive load 35A 230VAC (AC3/400V) 32A/15kW main contacts 3NO connection screw connection type Fanal DSL30 type ISKRA KNL30		
<b>accessories for</b>	380424		
	<b>GEV No.</b>	381378	<b>Ref. No.</b> —
	overload switch connection screw setting range 24,5-30A for contactors KNL30 type BR30 24.5-30A		

## LOVATO

## power contactors



1

<b>GEV No.</b>	380788	<b>Ref. No.</b>	6046046
<b>description</b>	power contactor resistive load 32A 230VAC (AC3/400V) 18A/7.5kW main contacts 4NO connection screw connection type BF18T4A230		

## relays

## power relays

## with DIN rail mounting

## lateral



1

<b>GEV No.</b>	380379	<b>Ref. No.</b>	6041013
<b>description</b>	power relays SCHRACK 230VAC 25A 2CO connection male faston 6.3mm DIN rail manuf. no. RM809730		
<b>For models:</b>	SH505R, SH510R		

## relay sockets



1

<b>GEV No.</b>	380487	<b>Ref. No.</b>	6040015
<b>description</b>	relay socket		
<b>For models:</b>	EN10VE-EC-ESN1033, VE06EC, VE06MX, VE102EC, VE102MX, VE10EC, VE10MX, VE20EC, VE20MX, VG06EC, VG06MX, VG102EC, VG102MX, VG10EC, VG10MX, VG20EC, VG20MX		

level relays

GICAR



1

<b>GEV No.</b>	401173	<b>Ref. No.</b>	6041043
<b>description</b>	level relay 230V connection F6.3 type RL30/3ES/F		
<b>For models:</b>	EN10VE-EC-ESN1033, VE06EC, VE06MX, VE102EC, VE102MX, VE10EC, VE10MX, VE20EC, VE20MX, VG06EC, VG06MX, VG102EC, VG102MX, VG10EC, VG10MX, VG20EC, VG20MX		



1

<b>GEV No.</b>	380606	<b>Ref. No.</b>	6042056
<b>description</b>	time relay LOVATO TM PL time range 2x 0.1s-100 days 12-240V AC/DC 8A 1CO connection grip connection		
<b>For models:</b>	DE06ES, DE06MX, DE102MX, DE10ES, DE10MX, DG06ES, DG06MX, DG102MX, DG10ES, DG10MX		

time relays

time relays



1

<b>GEV No.</b>	381119	<b>Ref. No.</b>	6042049
<b>description</b>	time relay LOVATO TM D time range 0.06-180s		
<b>For models:</b>	VE06EC, VE06MX, VE102EC, VE102MX, VE10EC, VE10MX, VE20EC, VE20MX, VG06EC, VG06MX, VG102EC, VG102MX, VG10EC, VG10MX, VG20EC, VG20MX		

transformers

encapsulated transformers

PMA



1

<b>GEV No.</b>	379054	<b>Ref. No.</b>	6010086
<b>description</b>	transformer primary 230VAC secondary 12VAC 3VA secondary 0.25A H 40mm L 45mm W 50mm connection screw 50/60Hz type 153/M		
<b>For models:</b>	SH505R, SH510R, SH520G, SH520GM		



1

<b>GEV No.</b>	380607	<b>Ref. No.</b>	6042054
<b>description</b>	time relay LOVATO TM M1 time range 0s-10 days 12-24V AC/DC 8A 1CO connection grip connection		
<b>For models:</b>	VE06MX, VE102MX, VE10MX, VE20MX, VG06MX, VG102MX, VG10MX, VG20MX		



1

<b>GEV No.</b>	401174	<b>Ref. No.</b>	6010079
<b>description</b>	transformer primary 230VAC secondary 12VAC 6VA secondary 0.5A connection screw 50Hz		
<b>For models:</b>	DE06EC, DE102EC, DE10EC, DG06EC, DG102EC, DG10EC, EN10VE-EC-ESN1033, SH510P, SH560P, VE06EC, VE102EC, VE10EC, VE20EC, VG06EC, VG102EC, VG10EC, VG20EC		

for lighting



1

<b>GEV No.</b>	401175	<b>Ref. No.</b>	6041065
<b>description</b>	transformer primary 230V secondary 11.5V 90VA		
<b>For models:</b>	CE06MX, CE102MX, CE10MX, CE20MX, CG06MX, CG102MX, CG10MX, CG20MX, DE06EC, DE06ES, DE06MX, DE102EC, DE102MX, DE10EC, DE10ES, DE10MX, DG06EC, DG06ES, DG06MX, DG102EC, DG102MX, DG10EC, DG10ES, DG10MX, VE06EC, VE06MX, VE102EC, VE102MX, VE10EC, VE10MX, VE20EC, VE20MX, VG06EC, VG06MX, VG102EC, VG102MX, VG10EC, VG10MX, VG20EC, VG20MX		





## electronic controllers

## EVCO - EVERY CONTROL

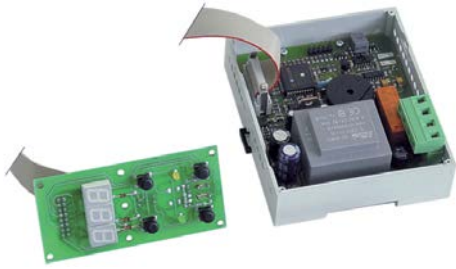
## producer-specific devices



1



<b>GEV No.</b>	379459	<b>Ref. No.</b>	6011142
<b>description</b>	electronic controller EVCO mounting measurements 90x110mm 230V voltage AC TC/J 0-700°C display 3 digits temperature controller DIN rail		
<b>For models:</b>	13FGC, 15FEC, 17FGC, 207FGC, 20FEC, 210FEC, 213FGC, 215FEC, 217FGC, 220FEC, 917FGC, 920FEC, 922FEC, 927FGC, 934FGC, 940FEC, F10CL, F15CL, F215CL, FG07CL, FG213CL		
<b>accessories for</b>	379459		
	<b>GEV No.</b>	379462	<b>Ref. No.</b> 6000106
	temperature probe thermocouple J (Fe-CuNi) cable Vetrotex probe -50 up to +750°C cable -50 up to +350°C connection plug thread probe ø6x200mm cable length 0.7m		
	<b>GEV No.</b>	693124	<b>Ref. No.</b> 2007069
	keypad foil for fryer		



## universal controllers

## built-in version



1

<b>GEV No.</b>	378169	<b>Ref. No.</b>	6011125 6011130
<b>description</b>	electronic controller EVERY CONTROL EV7401 mounting measurements 66.5x66.5mm built-in depth 90mm 24/230V voltage AC NTC/PTC/Pt100/TC(J,K)/mA relay outputs 1 CO-8A(3) NTC/PTC/Pt100/TC(-J,K)/mA yes protection IP54 dependend on probe°C display 4 digits		
<b>accessories for</b>	378169		
	<b>GEV No.</b>	379053	<b>Ref. No.</b> —
	temperature probe PTC 1kOhm cable PVC probe -50 up to +150°C cable -10 up to 100°C probe ø6x30mm cable length 3m without screw connection 2-wire		
	<b>GEV No.</b>	379062	<b>Ref. No.</b> —
	temperature probe thermocouple J (Fe-CuNi) cable Vetrotex probe -50 up to +750°C cable -50 up to +350°C probe ø6x50mm cable length 3m without screw connection 2-wire		

<b>accessories for</b>	378169		
	<b>GEV No.</b>	379064	<b>Ref. No.</b> —
	temperature probe PTC 1kOhm cable silicone probe -50 up to +150°C cable -50 up to +180°C probe ø6x40mm cable length 3m without screw connection 2-wire		
	<b>GEV No.</b>	379131	<b>Ref. No.</b> —
	temperature probe Pt100 cable Vetrotex probe -200 up to +600°C cable -50 up to +350°C probe ø6x85mm cable length 3m without screw connection 3-wire resistance at 0°C 100Ohm		
	<b>GEV No.</b>	379161	<b>Ref. No.</b> —
	temperature probe NTC 10kOhm cable thermoplastic probe -40 up to +110°C cable -40 up to +110°C probe ø6x14mm cable length 3m without screw connection 2-wire		

## SHANGFANG

## accessories



1

<b>GEV No.</b>	379054	<b>Ref. No.</b>	6010086
<b>description</b>	transformer primary 230VAC secondary 12VAC 3VA secondary 0.25A H 40mm L 45mm W 50mm connection screw 50/60Hz type 153/M		
<b>For models:</b>	SH505R, SH510R, SH520G, SH520GM		

## probes

## universal probes

## temperature probes

1

<b>GEV No.</b>	379860	<b>Ref. No.</b>	6000100
<b>description</b>	temperature probe NTC 10kOhm cable PVC probe -20 up to +80°C cable -10 up to 100°C probe ø6x40mm cable length 1.5m without screw connection 2-wire		

1

<b>GEV No.</b>	379222 <sup>1</sup>	<b>Ref. No.</b>	6000083
<b>description</b>	temperature probe Pt100 cable Vetrotex probe -200 up to +600°C cable -50 up to +350°C probe ø4x110mm cable length 1.4m 3-wire		
<b>For models:</b>	CE06MX, CE102MX, CE10MX, CE20MX, CG06MX, CG102MX, CG10MX, CG20MX, DE06ES, DE06MX, DE102MX, DE10ES, DE10MX, DG06ES, DG06MX, DG102MX, DG10ES, DG10MX, VE06MX, VE102EC, VE102MX, VE10MX, VE20MX, VG06MX, VG102MX, VG10MX, VG20MX		

<sup>1</sup>3-wire

1

<b>GEV No.</b>	379050 <sup>1</sup>	<b>Ref. No.</b>	6000085
<b>description</b>	temperature probe Pt100 cable Vetrotex probe -200 up to +600°C cable -50 up to +350°C probe ø6x100mm cable length 2.7m without screw connection 3-wire		
<b>For models:</b>	EF10GM, EF4PM, EF5GM, EF6PM, EF7GM, EF8PM, EN10VE-EC-ESN1033, GF10GM, GF4PM, GF5GM, GF6PM, GF7GM, GF8PM		

<sup>1</sup>3-wire



producer-specific probes

probes



1

<b>GEV No.</b>	379462	<b>Ref. No.</b>	6000106
<b>description</b>	temperature probe thermocouple J (Fe-CuNi) cable Vetrotex probe -50 up to +750°C cable -50 up to +350°C connection plug thread probe ø6x200mm cable length 0.7m		
<b>For models:</b>	207FGC, FG07CL, FG213CL		



1

<b>GEV No.</b>	403251	<b>Ref. No.</b>	6010110
<b>description</b>	keypad PCB salamander grill SRH1060 L 163mm W 70mm with display buttons 5		
<b>For models:</b>	SH510P, SH560P		

electronics

frequency converters



1

<b>GEV No.</b>	403841	<b>Ref. No.</b>	6010130 6010131
<b>description</b>	frequency converter with heat sink for combi-steamer L 135mm W 135mm 800W ECS P0010205-0		

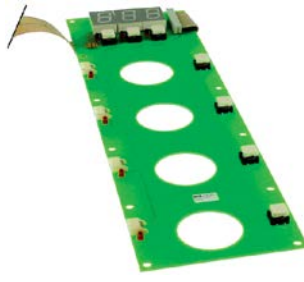

1

<b>GEV No.</b>	401168	<b>Ref. No.</b>	6010100
<b>description</b>	PCB		
<b>For models:</b>	DE06EC, DE102EC, DE10EC, DG06EC, DG102EC, DG10EC, VE06EC, VE102EC, VE10EC, VE20EC, VG06EC, VG102EC, VG10EC, VG20EC		

PCBs

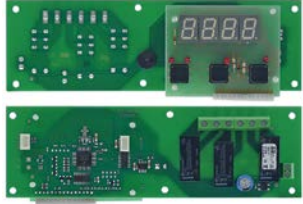

1

<b>GEV No.</b>	400736	<b>Ref. No.</b>	6010083
<b>description</b>	control PCB salamander grill SH50SR		
<b>For models:</b>	SH505R, SH510R, SH520G, SH520GM		



1

<b>GEV No.</b>	401170	<b>Ref. No.</b>	6010101
<b>description</b>	PCB		
<b>For models:</b>	DE06EC, DE102EC, DE10EC, DG06EC, DG102EC, DG10EC, VE06EC, VE102EC, VE10EC, VE20EC, VG06EC, VG102EC, VG10EC		

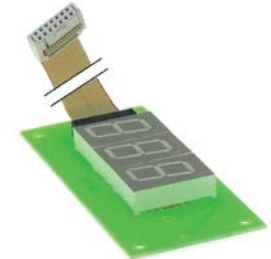

1

<b>GEV No.</b>	401166	<b>Ref. No.</b>	6010095
<b>description</b>	display		
<b>For models:</b>	CE06MX, CE102MX, CE20MX, CG06MX, CG102MX, CG10MX, CG20MX, DE06ES, DE06MX, DE102MX, DE10ES, DE10MX, DG06ES, DG06MX, DG102MX, DG10ES, DG10MX, EF10GM, EF4PM, EF5GM, EF6PM, EF7GM, EF8PM, GF10GM, GF4PM, GF5GM, GF6PM, GF7GM, GF8PM, VE06MX, VE102MX, VE10MX, VE20MX, VG06MX, VG102MX, VG10MX, VG20MX		



1

<b>GEV No.</b>	401171	<b>Ref. No.</b>	6010084
<b>description</b>	PCB combi-steamer		
<b>For models:</b>	CE06MX, CE102MX, CE10MX, CE20MX, CG06MX, CG102MX, CG10MX, CG20MX, DE06EC, DE06ES, DE06MX, DE102EC, DE102MX, DE10EC, DE10ES, DE10MX, DG06EC, DG06ES, DG06MX, DG102EC, DG102MX, DG10EC, DG10ES, DG10MX, EF4, EF4PM, EF6PM, EF8PM, GF4PM, GF6PM, GF8PM, VE06EC, VE06MX, VE102EC, VE102MX, VE10EC, VE10MX, VE20EC, VE20MX, VG06EC, VG06MX, VG102EC, VG102MX, VG10EC, VG10MX, VG20EC, VG20MX		



electric components





1

<b>GEV No.</b>	401172	<b>Ref. No.</b>	6010093
<b>description</b>	PCB combi-steamer VE 06/10		
<b>For models:</b>	VE06EC, VE06MX, VE102EC, VE102MX, VE10EC, VE10MX, VE20EC, VE20MX, VG06EC, VG06MX, VG102EC, VG102MX, VG10EC, VG10MX, VG20EC, VG20MX		



1

<b>GEV No.</b>	401167	<b>Ref. No.</b>	6010096
<b>description</b>	PCB combi-steamer VE 06/10 230V 50/60Hz		
<b>For models:</b>	CE06MX, CE102MX, CE10MX, CE20MX, CG06MX, CG102MX, CG10MX, CG20MX, DE06ES, DE06MX, DE102MX, DE10ES, DE10MX, DG06ES, DG06MX, DG102MX, DG10ES, DG10MX, EF10GM, EF4PM, EF5GM, EF6PM, EF7GM, EF8PM, GF10GM, GF4PM, GF5GM, GF6PM, GF7GM, GF8PM, VE06MX, VE102MX, VE10MX, VE20MX, VG06MX, VG102MX, VG10MX, VG20EC, VG20MX		
<b>accessories for</b>	401167		
	<b>GEV No.</b>	401062	<b>Ref. No.</b> 6010090
	buzzer board 230VAC L 48mm W 45mm connection Faston 6.3mm		



1

<b>GEV No.</b>	693124	<b>Ref. No.</b>	2007069
<b>description</b>	keypad foil for fryer		
<b>For models:</b>	13FGC, 15FEC, 17FGC, 207FGC, 20FEC, 210FEC, 213FGC, 215FEC, 217FGC, 220FEC, 917FGC, 920FEC, 922FEC, 927FGC, 934FGC, 940FEC, F10CL, F15CL, F215CL, FG07CL, FG213CL		



1

<b>GEV No.</b>	403791	<b>Ref. No.</b>	2012427 2016790
<b>description</b>	keypad foil for salamander grill model suitable for BARTSCHER ømm for mounting pos. suitable for for model L 547mm W 67mm		



1

<b>GEV No.</b>	403792	<b>Ref. No.</b>	2012890
<b>description</b>	keypad foil for salamander grill SH560P model suitable for GIORIK ømm for mounting pos. suitable for for model L 547mm W 67mm		
<b>For models:</b>	SH560P		



1

<b>GEV No.</b>	400739	<b>Ref. No.</b>	2012425
<b>description</b>	keypad foil salamander grill SH520 L 545mm W 67mm		
<b>For models:</b>	SH520G, SH520GM		

## keypads

## front foils



1

<b>GEV No.</b>	400737	<b>Ref. No.</b>	2012426
<b>description</b>	keypad foil		
<b>For models:</b>	SH505R		



1

<b>GEV No.</b>	400738	<b>Ref. No.</b>	2012423
<b>description</b>	keypad foil blue/grey/black suitable for SH510 L 715mm W 67mm		
<b>For models:</b>	SH510P, SH510R		

## solenoid valves

## solenoid valves (water)

RPE



1

<b>GEV No.</b>	374021	<b>Ref. No.</b>	6042071
<b>description</b>	solenoid valve double straight 230VAC inlet 3/4" outlet 10mm DN10 RPE		
<b>For models:</b>	CE20MX, CG20MX, VE06EC, VE06MX, VE102EC, VE102MX, VE10EC, VE10MX, VE20EC, VE20MX, VG06EC, VG06MX, VG102EC, VG102MX, VG10EC, VG10MX, VG20EC, VG20MX		







			
1			
<b>GEV No.</b>	374017	<b>Ref. No.</b>	6042070
<b>description</b>	solenoid valve single straight 230VAC inlet 3/4" outlet 10mm input 6l/min DN10 RPE polyamide flow regulating valve inlet white membranes NBR pressure range 0.2-10bar		
<b>For models:</b>	CE06MX, CE102MX, CE10MX, CG06MX, CG102MX, CG10MX, DE06EC, DE06ES, DE06MX, DE102EC, DE102MX, DE10EC, DE10ES, DE10MX, DG06EC, DG06ES, DG06MX, DG102EC, DG102MX, DG10EC, DG10ES, DG10MX, EF10GM, EF4, EF4PM, EF5GM, EF6PM, EF7GM, EF8PM, GF10GM, GF4PM, GF5GM, GF6PM, GF7GM, GF8PM		

reducers

outlet side

			
1			
<b>GEV No.</b>	371269	<b>Ref. No.</b>	6042091
<b>description</b>	reducer flow rate 0.07-0.14l/min brown		

			
1			
<b>GEV No.</b>	371265	<b>Ref. No.</b>	6042097
<b>description</b>	reducer flow rate 3l/min black		
<b>For models:</b>	VE06EC, VE06MX, VE102EC, VE102MX, VE10EC, VE10MX, VE20EC, VE20MX, VG06EC, VG06MX, VG102EC, VG102MX, VG10EC, VG10MX, VG20EC, VG20MX		

metal

CEME



solenoid valves

			
1			
<b>GEV No.</b>	370352	<b>Ref. No.</b>	6042075
<b>description</b>	solenoid valve 2-ways 230VAC inlet 1/2" IT outlet 1/2" IT L 55mm p max 0.5bar brass		
<b>For models:</b>	VE06EC, VE06MX, VE102EC, VE102MX, VE10EC, VE10MX, VE20EC, VE20MX, VG06EC, VG06MX, VG102EC, VG102MX, VG10EC, VG10MX, VG20EC, VG20MX		

fans



axial fans

ebm-papst

				
1				
<b>GEV No.</b>	601030 <sup>1</sup>	<b>Ref. No.</b>	6033175	
<b>description</b>	axial fan L 119mm W 119mm H 38mm 230VAC 50Hz 18W bearing ball bearing manuf. no. 4656Z metal connection male faston 2.8mm ebm-papst fan wheel ø 110mm temp.-resist. 75°C			
<b>accessories for</b>	601030			
	<b>GEV No.</b>	550898	<b>Ref. No.</b>	—
	connecting cable cable length 2000mm connection F 2.8 connection distance 7.9mm for axial flow fan			
	<b>GEV No.</b>	692497	<b>Ref. No.</b>	—
	guard ø 105mm mounting distance 150mm for axial fan ebm-papst-mm			

<sup>1</sup>with ball bearings

import

				
1				
<b>GEV No.</b>	601080 <sup>1</sup>	<b>Ref. No.</b>	6033175	
<b>description</b>	axial fan L 119mm W 119mm H 38mm 230VAC 50/60Hz 23/20W bearing ball bearing connection male faston 2.8mm metal ADDA fan wheel ø 110mm temp.-resist. 70°C			
<b>For models:</b>	CE06MX, CE102MX, CE10MX, CE20MX, CG06MX, CG102MX, CG10MX, CG20MX, DE06EC, DE06MX, DE102EC, DE102MX, DE10EC, DE10MX, DG06EC, DG06MX, DG102EC, DG102MX, DG10EC, DG10MX, VE06EC, VE06MX, VE102EC, VE102MX, VE10EC, VE10MX, VE20EC, VE20MX, VG06EC, VG06MX, VG102EC, VG102MX, VG10EC, VG10MX, VG20EC, VG20MX			
<b>accessories for</b>	601080			
	<b>GEV No.</b>	550898	<b>Ref. No.</b>	—
	connecting cable cable length 2000mm connection F 2.8 connection distance 7.9mm for axial flow fan			
	<b>GEV No.</b>	692519	<b>Ref. No.</b>	—
	guard L 120mm W 120mm plastic			

<sup>1</sup>with ball bearings



hot air motors

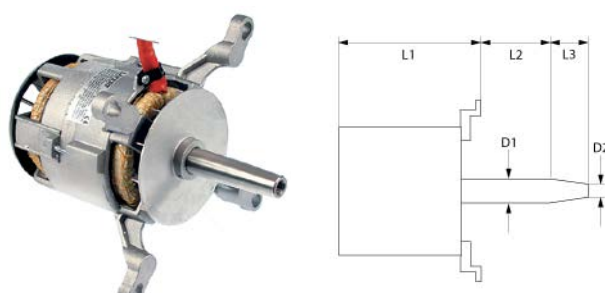

1

<b>GEV No.</b>	601046	<b>Ref. No.</b>	6033155
<b>description</b>	fan motor 220/380V 3 phase 50/60Hz 0.75kW 1350/1650rpm speeds 1 L1 185mm L2 42mm L3 47mm D1 ø 24mm D2 ø 20mm M12L IT 1.9/3.3A Cos(fi) 0.83 at 50Hz 200-240/346-415V at 60Hz 200-277/346-480V at 50Hz 1350rpm at 60Hz 1650rpm type ST80/4 no. 661512		
<b>For models:</b>	CE102MX, CE10MX, CE20MX, CG102MX, CG10MX, CG20MX, DE102MX, DE10MX, DG102MX, DG10MX, EF10GM, EF7GM, EN10VE-EC-ESN1033, VE102EC, VE102MX, VE10MX, VE20MX, VG102MX, VG10MX, VG20MX		



1

<b>GEV No.</b>	500641	<b>Ref. No.</b>	6033155
<b>description</b>	fan motor 220/380V 3 phase 50Hz 0.75kW 1420rpm speeds 1 L1 166mm L2 47mm L3 65mm D1 ø 24mm D2 ø 20mm M6R IT 1.4/2.4A Cos(fi) 0.83 at 50Hz 220/380V at 60Hz 240/415V type ST80/4 no. 643515 mounting distance 150mm		

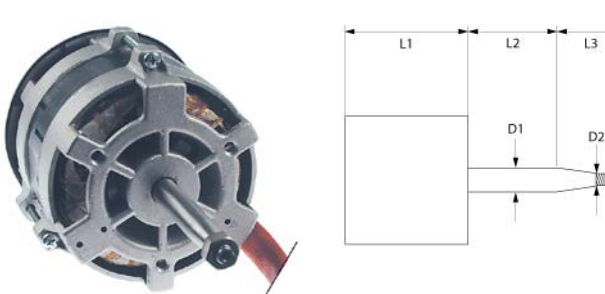

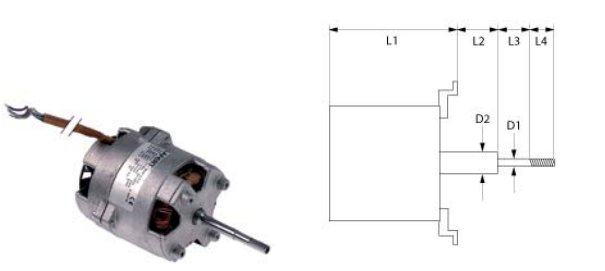

1

<b>GEV No.</b>	500640	<b>Ref. No.</b>	6032122
<b>description</b>	fan motor 220-240V 1 phase 50Hz 0.05/0.25HP 1400/2700rpm speeds 2 L1 145mm L2 65mm L3 35mm D1 ø 15mm D2 ø 12mm M10L ET 1.1/0.55A suitable capacitor 12.5µF/450V at 50Hz 1400/2700rpm type 2758D2253 no. 6032122		
<b>For models:</b>	CE06MX, CG06MX, DE06EC, DE06ES, DE06MX, DG06EC, DG06ES, DG06MX, VE06EC, VE06MX, VG06EC, VG06MX		
<b>spare parts for</b>	500640		
	<b>GEV No.</b>	560280	<b>Ref. No.</b> —
	nut thread M10L H 8mm WS 17 SS DIN/ISO DIN 934 / ISO 4032/8673 Qty 1 pcs		



1

<b>GEV No.</b>	601354	<b>Ref. No.</b>	6032128
<b>description</b>	fan motor 220-240V 1 phase 50Hz 0.11kW 2760rpm speeds 1 L1 130mm L2 32mm L3 30mm L4 18mm D1 ø 7/8mm D2 ø 9mm M4R IT 0.9A at 50Hz 230V at 50Hz 2760rpm suitable capacitor 4µF type LM63 shaft flat length 17mm		
<b>accessories for</b>	601354		
	<b>GEV No.</b>	365031	<b>Ref. No.</b> —
	operating capacitor capacity 4µF 450V tolerance 5% 50/60Hz ambient temperature max. -25 to +85°C ø 31mm L 58mm M8 plastic connection male faston 6.3mm protection		
	<b>GEV No.</b>	601061	<b>Ref. No.</b> —
	fan wheel D1 ø 160mm H1 60mm blades 15 D2 ø 18mm D3 ø 18mm H2 35mm		

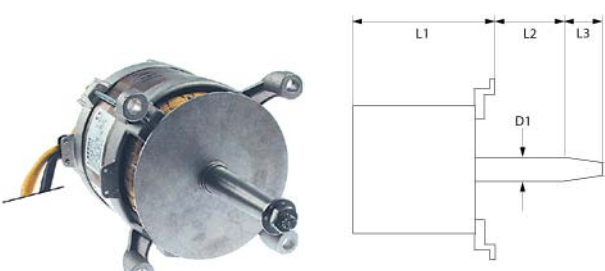

1

<b>GEV No.</b>	500643	<b>Ref. No.</b>	6034348
<b>description</b>	fan motor 230V 1 phase 50Hz 0.25/0.75kW 670/1370rpm speeds 2 L1 195mm L2 47mm L3 70mm D1 ø 24mm D2 ø 20mm M6R IT 1.5/4.7A suitable capacitor 50/20µF Cos(fi) 0.53/0.7 at 50Hz 670/1370rpm 4P/8P type FB100L no. 677325		
<b>For models:</b>	CE102MX, CE20MX, CG102MX, CG20MX, DE102EC, DE102MX, DG102EC, DG102MX, VE102EC, VE102MX, VE20EC, VE20MX, VG102EC, VG102MX, VG20EC, VG20MX		

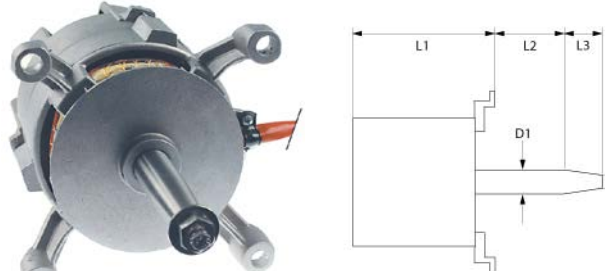

1

<b>GEV No.</b>	500642	<b>Ref. No.</b>	6033145
<b>description</b>	fan motor 380-415V 3 phase 50Hz 0.22/0.75kW 700/1400rpm speeds 2 L1 166mm L2 45mm L3 67mm D1 ø 24mm D2 ø 20mm M6R ITA at 50Hz 380-415V at 50Hz 700/1400rpm type FB80 4/8 no. 629764		
<b>For models:</b>	DE102EC, DE10EC, DG102EC, EF6PM, EF8PM, VE10EC, VE20EC, VG20EC		

1

<b>GEV No.</b>	602135	<b>Ref. No.</b>	5901101
<b>description</b>	fan wheel blades 12 D1 ø 180mm D2 ø 8mm D3 ø 6x9mm H1 100mm H2 27mm H3mm		



1

<b>GEV No.</b>	601202	<b>Ref. No.</b>	5901006
<b>description</b>	fan wheel D1 ø 180mm H1 100mm blades 16 D2 ø 11.5mm D3 ø 16mm H2 30mm		
<b>For models:</b>	CE06MX, CG06MX, DE06EC, DE06ES, DE06MX, DG06EC, DG06ES, DG06MX, VE06EC, VE06MX, VG06EC, VG06MX		



1

<b>GEV No.</b>	601203	<b>Ref. No.</b>	5901010
<b>description</b>	fan wheel D1 ø 310mm H1 100mm blades 30 D2 ø 19.5mm D3 ø 23mm H2 46mm		
<b>For models:</b>	CE10MX, CG10MX, DE10EC, DE10ES, DE10MX, DG10EC, DG10ES, DG10MX, VE10EC, VE10MX, VG10EC, VG10MX		



1

<b>GEV No.</b>	601204	<b>Ref. No.</b>	5901022
<b>description</b>	fan wheel D1 ø 350mm H1 135mm blades 30 D2 ø 19.5mm D3 ø 23mm H2 46mm		
<b>For models:</b>	CE102MX, DE102EC, VE102EC, VE102MX		

## condensators & interference suppression filters

### filters

#### interference suppression filters



1

<b>GEV No.</b>	365045	<b>Ref. No.</b>	6090050
<b>description</b>	interference suppression filter type FC701Y2F 250V 50-60Hz conductor 2 with E connection cable 200mm L 40mm ø 30mm Hmm Wmm plastic Qty 1 pcs		
<b>For models:</b>	13FG, 13FGC, 15FE, 15FEC, 17FG, 17FGC, 207FG, 207FGC, 20FE, 20FEC, 210FE, 210FEC, 213FG, 213FGC, 215FE, 215FEC, 217FG, 217FGC, 220FE, 220FEC, 917FG, 917FGC, 920FE, 920FEC, 922FE, 922FEC, 927FG, 927FGC, 934FG, 934FGC, 940FE, 940FEC, CE06MX, CE102MX, CE10MX, CG06MX, CG102MX, CG10MX, DE06EC, DE06ES, DE06MX, DE102EC, DE102MX, DE10EC, DE10ES, DE10MX, DG06EC, DG06ES, DG06MX, DG102EC...(Other models you can see in the webshop)		



1

<b>GEV No.</b>	365044	<b>Ref. No.</b>	6090050
<b>description</b>	interference suppression filter type FC701Y2F 250V 50-60Hz conductor 2 with E connection cable 200mm L 42mm ø 23mm Hmm Wmm plastic Qty 1 pcs		

## electric accessories

### terminals

#### porcelain clamps



1

<b>GEV No.</b>	550116	<b>Ref. No.</b>	6050641
<b>description</b>	porcelain terminal block 3-pole 10mm <sup>2</sup> hole distance 16mm max. 30A max 450V L 52mm W 30mm H 23mm mounting distance 16mm Qty 1 pcs		



## gas taps

## PEL

## 20S series



1

<b>GEV No.</b>	101094	<b>Ref. No.</b>	7060013
<b>description</b>	gas tap PEL type 20S gas inlet M16x1.5 (tube ø 10mm) bypass nozzle ø 0.35mm gas outlet M16x1.5 (tube ø 10/8mm) thermocouple connection M8x1 pilot connection shaft ø 8x6.5mm shaft L 22/15mm shaft flat lower		
<b>spare parts for</b>	101094		
	<b>GEV No.</b>	100408	<b>Ref. No.</b> —
	bypass nozzle type PEL20/21 bore ø 0.35mm thread M5x0.5		
	<b>GEV No.</b>	101060	<b>Ref. No.</b> —
	magnet unit standard L 39mm D1 ø 15.4mm D2 ø 11mm suitable for PEL20-21/JUNKERS/EGA		
	<b>GEV No.</b>	101205	<b>Ref. No.</b> —
	gas tap front part shaft ø 8x6.5mm shaft L 22/15mm shaft flat upper/lower suitable for PEL20		
	<b>GEV No.</b>	101230	<b>Ref. No.</b> —
	thermocouple nut T1: M8x1 T2: M18x1 aluminium		
<b>accessories for</b>	101094		
	<b>GEV No.</b>	101278	<b>Ref. No.</b> —
	olive for pipe ø 10mm Qty 1 pcs		
	<b>GEV No.</b>	101300	<b>Ref. No.</b> —
	union nut thread M16x1.5 tube ø 10mm		
	<b>GEV No.</b>	101450	<b>Ref. No.</b> —
	olive for pipe ø 8mm L 12.7mm Qty 1 pcs ED ø 10mm		
	<b>GEV No.</b>	101451	<b>Ref. No.</b> —
	union nut thread M16x1.5 tube ø 8mm		
	<b>GEV No.</b>	110081	<b>Ref. No.</b> —
	knob ø 70mm shaft ø 8x6.5mm shaft flat universal		
	<b>GEV No.</b>	110083	<b>Ref. No.</b> —
	knob dial plate gas tap without ignition flame silver		

## 21S series



1

<b>GEV No.</b>	107765	<b>Ref. No.</b>	7060016
<b>description</b>	gas tap PEL type 21S gas inlet pipe flange ø21mm bypass nozzle ø 0mm gas outlet M16x1.5 (tube ø 10/8mm) thermocouple connection M9x1 pilot connection M10x1 shaft ø 8x6.5mm shaft L 22/15mm shaft flat upper		

## 22S/O series



1











<b>GEV No.</b>	101086	<b>Ref. No.</b>	7060012
<b>description</b>	gas tap PEL type 22S/O gas inlet M20x1.5 (tube ø 12mm) bypass nozzle ø 0.35mm gas outlet M20x1.5 (tube ø 12/10mm) thermocouple connection M9x1 pilot connection M10x1 shaft ø 10x8mm shaft L 25/17mm shaft flat lower		
<b>For models:</b>	22CPG, 23CPG, 2CPG, 3CPG, CG740, CG780, CPG1, CPG1BM, CPG66, GG66, GG940, GG980, SG520, SG608		
<b>spare parts for</b>	101086		
	<b>GEV No.</b>	100259	<b>Ref. No.</b> —
	bypass nozzle type PEL22 bore ø 0.35mm thread M6x0.5		
	<b>GEV No.</b>	101058	<b>Ref. No.</b> —
	magnet unit L 39mm D1 ø 15.4mm D2 ø 13.5mm suitable for PEL22/EGA24197 standard		
	<b>GEV No.</b>	101201	<b>Ref. No.</b> —
	gas tap front part shaft ø 10x8mm shaft L 25/17mm shaft flat upper/lower suitable for PEL22		
	<b>GEV No.</b>	101231	<b>Ref. No.</b> —
	thermocouple nut T1: M9x1 T2: M18x1		
	<b>GEV No.</b>	101240	<b>Ref. No.</b> —
	gas connection thread M20x1.5 tube ø 12/10mm for PEL gas taps with gasket and screws horizontal		
	<b>GEV No.</b>	101460	<b>Ref. No.</b> —
	O-ring ø 12.37mm D1 ø 2.62mm suitable for PEL22		
	<b>GEV No.</b>	101461	<b>Ref. No.</b> —
	screw kit suitable for PEL22 Qty 4 pcs		
<b>accessories for</b>	101086		
	<b>GEV No.</b>	100908	<b>Ref. No.</b> —
	union screw thread M10x1 for pipe ø 4mm Qty 1 pcs		
	<b>GEV No.</b>	100909	<b>Ref. No.</b> 7050029
	union screw thread M10x1 for pipe ø 6mm Qty 1 pcs		
	<b>GEV No.</b>	101241	<b>Ref. No.</b> —
	gas connection thread M20x1.5 tube ø 12/10mm for PEL gas taps vertical		

Table continues overleaf





accessories for		101086		
	GEV No.	101246	Ref. No.	—
olive for pipe ø 4mm Qty 1 pcs				
	GEV No.	101248	Ref. No.	—
olive for pipe ø 12mm Qty 1 pcs suitable for PEL				
	GEV No.	101249	Ref. No.	—
olive for pipe ø 10mm Qty 1 pcs				
	GEV No.	101250	Ref. No.	—
union nut thread M20x1.5 for pipe ø 10mm				
	GEV No.	101251	Ref. No.	—
union nut thread M20x1.5 for pipe ø 12mm				
	GEV No.	101286	Ref. No.	—
olive ID ø 6mm Qty 1 pcs				
	GEV No.	110080	Ref. No.	—
knob ø 70mm shaft ø 10x8mm shaft flat universal				
	GEV No.	112206	Ref. No.	—
knob dial plate silver gas tap PEL21/22/23 t.max.°C ED ø 63mm ID ø 45.5mm				

## gas thermostats

### SIT

#### 630 Eurosit series

				
1				
<b>GEV No.</b>	107688	<b>Ref. No.</b>	7020232	
<b>description</b>	gas thermostat 100-340°C gas inlet 3/8" gas outlet 3/8" thermocouple connection M9x1 pilot connection M10x1 probe ø 4mm probe L 72mm capillary pipe 1050mm			

				
1				
<b>GEV No.</b>	101409	<b>Ref. No.</b>	7020211	
<b>description</b>	gas thermostat type 630 Eurosit series t.max. 280°C 40-280°C gas inlet 3/8" gas outlet 3/8" thermocouple connection M9x1 pilot connection M10x1 probe ø 4mm probe L 72mm capillary pipe 1050mm SIT			
<b>For models:</b>	FTG100, FTG46, FTG46B, FTG46R, FTG66L, FTG66LG, FTG66R			
<b>accessories for</b>	101409			
	GEV No.	100904	Ref. No.	—
locking screw M10x1 for pipe ø 4mm Qty 1 pcs				
	GEV No.	100905	Ref. No.	—
locking screw M10x1 for pipe ø 6mm Qty 1 pcs				
	GEV No.	101273	Ref. No.	—
olive for pipe ø 12mm L 9.5mm brass Qty 1 pcs suitable for universal				
	GEV No.	101276	Ref. No.	—
union screw thread 3/8" tube ø 12mm Qty 1 pcs				

				
1				
<b>GEV No.</b>	101700	<b>Ref. No.</b>	7020218	
<b>description</b>	gas thermostat type 630 Eurosit series t.max. 340°C 100-340°C gas inlet 3/8" gas outlet 3/8" thermocouple connection M9x1 pilot connection M10x1 probe ø 4mm probe L 72mm capillary pipe 1050mm SIT			
<b>accessories for</b>	101700			
	GEV No.	100904	Ref. No.	—
locking screw M10x1 for pipe ø 4mm Qty 1 pcs				
	GEV No.	100905	Ref. No.	—
locking screw M10x1 for pipe ø 6mm Qty 1 pcs				
	GEV No.	101273	Ref. No.	—
olive for pipe ø 12mm L 9.5mm brass Qty 1 pcs suitable for universal				
	GEV No.	101276	Ref. No.	—
union screw thread 3/8" tube ø 12mm Qty 1 pcs				
	GEV No.	101333	Ref. No.	—
plug thread 3/8" with O-ring				

710 Minisit series

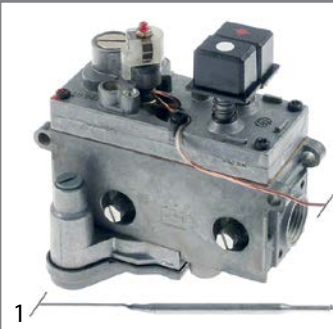

<b>GEV No.</b>	101437	<b>Ref. No.</b>	7020210
<b>description</b>	gas thermostat SIT type MINISIT 710 t.max. 190°C 110-190°C gas inlet 1/2" gas outlet 3/8" thermocouple connection M9x1 pilot connection M10x1 probe ø 6mm probe L 102mm capillary pipe 1050mm probe type type A3 pressure controller yes pressure regulator 3-18mbar gland nut		
<b>spare parts for</b>	101437		
	<b>GEV No.</b>	101053	<b>Ref. No.</b> —
	magnet unit T1: M9x1 T2: M24x1 L 45mm ø 17mm suitable for Minisit		
	<b>GEV No.</b>	102118	<b>Ref. No.</b> —
	probe 110-190°C probe ø 6mm probe L 102mm capillary pipe 1050mm t.max. 190°C fryer probe type type A3 suitable for MINISIT 710		
<b>accessories for</b>	101437		
	<b>GEV No.</b>	100809	<b>Ref. No.</b> 0925034
	O-ring EPDM thickness 2mm ID ø 21mm Qty 1 pcs		
	<b>GEV No.</b>	100820	<b>Ref. No.</b> 7050025
	gland duct ET M14x1.5 IT M10x0.75 probe ø max. 6.5mm WS 22		
	<b>GEV No.</b>	100904	<b>Ref. No.</b> —
	locking screw M10x1 for pipe ø 4mm Qty 1 pcs		
	<b>GEV No.</b>	100905	<b>Ref. No.</b> —
	locking screw M10x1 for pipe ø 6mm Qty 1 pcs		
	<b>GEV No.</b>	101054	<b>Ref. No.</b> —
	magnet unit T1: M10x1 T2: M24x1 L 45mm ø 17mm suitable for Minisit		
	<b>GEV No.</b>	101136	<b>Ref. No.</b> 7020230
	piezoelectric igniter suitable for Minisit with cover cap ømm connection F6.3x0.8		
	<b>GEV No.</b>	101137	<b>Ref. No.</b> —
	cover cap without piezoelectric igniter		
	<b>GEV No.</b>	101267	<b>Ref. No.</b> —
	reducer IT 3/8" ET 1/2" L 21mm		
	<b>GEV No.</b>	101268	<b>Ref. No.</b> —
	gas connection thread 3/8" angled with O-ring MINISIT 710		
	<b>GEV No.</b>	101269	<b>Ref. No.</b> —
	gas connection thread 1/2" angled with O-ring MINISIT 710		
	<b>GEV No.</b>	101270	<b>Ref. No.</b> —
	screw connection IT 3/8" ET 3/8" L 28mm		
	<b>GEV No.</b>	101272	<b>Ref. No.</b> —
	screw connection IT 1/2" ET 3/8" L 57mm		

<b>accessories for</b>	101437		
	<b>GEV No.</b>	101273	<b>Ref. No.</b> —
	olive for pipe ø 12mm L 9.5mm brass Qty 1 pcs suitable for universal		
	<b>GEV No.</b>	101274	<b>Ref. No.</b> 7070036
	olive for pipe ø 16mm Qty 1 pcs		
	<b>GEV No.</b>	101275	<b>Ref. No.</b> —
	union screw thread 1/2" for pipe ø 16mm Qty 1 pcs		
	<b>GEV No.</b>	101276	<b>Ref. No.</b> —
	union screw thread 3/8" tube ø 12mm Qty 1 pcs		
	<b>GEV No.</b>	110068	<b>Ref. No.</b> 5900200
	knob suitable for Minisit ø 37mm		

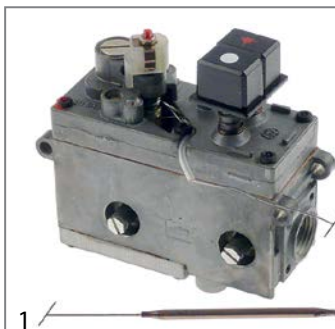

<b>GEV No.</b>	101435	<b>Ref. No.</b>	5910040
<b>description</b>	gas thermostat SIT type MINISIT 710 t.max. 340°C 100-340°C gas inlet 1/2" gas outlet 3/8" thermocouple connection M9x1 pilot connection M10x1 probe ø 4mm probe L 72mm capillary pipe 1050mm probe type type C1 pressure controller no pressure regulator mbar gland nut		
<b>spare parts for</b>	101435		
	<b>GEV No.</b>	101053	<b>Ref. No.</b> —
	magnet unit T1: M9x1 T2: M24x1 L 45mm ø 17mm suitable for Minisit		
	<b>GEV No.</b>	102107	<b>Ref. No.</b> —
	probe 100-340°C probe ø 4mm probe L 72mm capillary pipe 1050mm t.max. 340°C oven/grill probe type type C1 suitable for MINISIT 710		
<b>accessories for</b>	101435		
	<b>GEV No.</b>	100809	<b>Ref. No.</b> 0925034
	O-ring EPDM thickness 2mm ID ø 21mm Qty 1 pcs		
	<b>GEV No.</b>	100904	<b>Ref. No.</b> —
	locking screw M10x1 for pipe ø 4mm Qty 1 pcs		
	<b>GEV No.</b>	100905	<b>Ref. No.</b> —
	locking screw M10x1 for pipe ø 6mm Qty 1 pcs		
	<b>GEV No.</b>	101054	<b>Ref. No.</b> —
	magnet unit T1: M10x1 T2: M24x1 L 45mm ø 17mm suitable for Minisit		
	<b>GEV No.</b>	101136	<b>Ref. No.</b> 7020230
	piezoelectric igniter suitable for Minisit with cover cap ømm connection F6.3x0.8		
	<b>GEV No.</b>	101137	<b>Ref. No.</b> —
	cover cap without piezoelectric igniter		
	<b>GEV No.</b>	101267	<b>Ref. No.</b> —
	reducer IT 3/8" ET 1/2" L 21mm		



Table continues overleaf



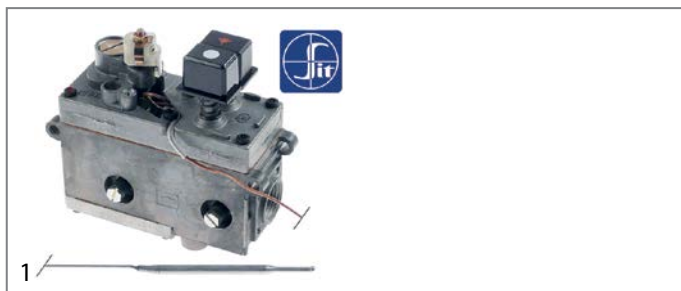

accessories for		101435		
	GEV No.	101268	Ref. No.	—
gas connection thread 3/8" angled with O-ring MINISIT 710				
	GEV No.	101269	Ref. No.	—
gas connection thread 1/2" angled with O-ring MINISIT 710				
	GEV No.	101270	Ref. No.	—
screw connection IT 3/8" ET 3/8" L 28mm				
	GEV No.	101272	Ref. No.	—
screw connection IT 1/2" ET 3/8" L 57mm				
	GEV No.	101273	Ref. No.	—
olive for pipe ø 12mm L 9.5mm brass Qty 1 pcs suitable for universal				
	GEV No.	101274	Ref. No.	7070036
olive for pipe ø 16mm Qty 1 pcs				
	GEV No.	101275	Ref. No.	—
union screw thread 1/2" for pipe ø 16mm Qty 1 pcs				
	GEV No.	101276	Ref. No.	—
union screw thread 3/8" tube ø 12mm Qty 1 pcs				
	GEV No.	110068	Ref. No.	5900200
knob suitable for Minisit ø 37mm				



GEV No.	101131	Ref. No.	7020200
<b>description</b>	gas thermostat without cap, button and angle SIT type MINISIT 710 t.max. 190°C 50-190°C gas inlet 1/2" gas outlet 3/8" thermocouple connection M9x1 pilot connection M10x1 probe ø 5mm probe L 98mm capillary pipe 1200mm probe type type A2 pressure controller no pressure regulator gland nut		
<b>For models:</b>	FG07L, FG13L, FG213L, FPG18		

spare parts for		101131		
	GEV No.	101053	Ref. No.	—
magnet unit T1: M9x1 T2: M24x1 L 45mm ø 17mm suitable for Minisit				
	GEV No.	102103	Ref. No.	—
probe 60-200°C probe ø 5mm probe L 98mm capillary pipe 1050mm t.max. 200°C fryer probe type type A2 suitable for MINISIT 710				

accessories for		101131		
	GEV No.	100809	Ref. No.	0925034
O-ring EPDM thickness 2mm ID ø 21mm Qty 1 pcs				
	GEV No.	100820	Ref. No.	7050025
gland duct ET M14x1.5 IT M10x0.75 probe ø max. 6.5mm WS 22				
	GEV No.	100904	Ref. No.	—
locking screw M10x1 for pipe ø 4mm Qty 1 pcs				

accessories for		101131		
	GEV No.	100905	Ref. No.	—
locking screw M10x1 for pipe ø 6mm Qty 1 pcs				
	GEV No.	101054	Ref. No.	—
magnet unit T1: M10x1 T2: M24x1 L 45mm ø 17mm suitable for Minisit				
	GEV No.	101136	Ref. No.	7020230
piezoelectric igniter suitable for Minisit with cover cap ømm connection F6.3x0.8				
	GEV No.	101137	Ref. No.	—
cover cap without piezoelectric igniter				
	GEV No.	101267	Ref. No.	—
reducer IT 3/8" ET 1/2" L 21mm				
	GEV No.	101268	Ref. No.	—
gas connection thread 3/8" angled with O-ring MINISIT 710				
	GEV No.	101269	Ref. No.	—
gas connection thread 1/2" angled with O-ring MINISIT 710				
	GEV No.	101270	Ref. No.	—
screw connection IT 3/8" ET 3/8" L 28mm				
	GEV No.	101272	Ref. No.	—
screw connection IT 1/2" ET 3/8" L 57mm				
	GEV No.	101273	Ref. No.	—
olive for pipe ø 12mm L 9.5mm brass Qty 1 pcs suitable for universal				
	GEV No.	101274	Ref. No.	7070036
olive for pipe ø 16mm Qty 1 pcs				
	GEV No.	101275	Ref. No.	—
union screw thread 1/2" for pipe ø 16mm Qty 1 pcs				
	GEV No.	101276	Ref. No.	—
union screw thread 3/8" tube ø 12mm Qty 1 pcs				
	GEV No.	110068	Ref. No.	5900200
knob suitable for Minisit ø 37mm				













# gas valves and ignition boxes

## gas control valves

SIT

NOVASIT



1	<b>GEV No.</b>	101956	<b>Ref. No.</b>	7020070
<b>description</b>	gas valve SIT series Novasit 820 230V 50Hz gas inlet 1/2" gas outlet 1/2" thermocouple connection M9x1 pilot connection M10x1 ignition pressure range 5-50mbar pressure regulator connection blind equiv. no. 0.820.031			
<b>For models:</b>	13FG, 13FGC, 17FG, 17FGC, 207FG, 207FGC, 213FG, 213FGC, 217FG, 217FGC, 917FG, 917FGC, 927FG, 927FGC, 934FG, 934FGC, FG07CL, FG213CL			
<b>spare parts for</b>	101956			
	<b>GEV No.</b>	101065	<b>Ref. No.</b>	—
magnet unit with cable L 44mm D1 ø 30mm D2 ø 20mm suitable for NOVASIT				
	<b>GEV No.</b>	101313	<b>Ref. No.</b>	—
solenoid coil 230V 50Hz				
<b>accessories for</b>	101956			
	<b>GEV No.</b>	100006	<b>Ref. No.</b>	—
piezoelectric igniter suitable for ELETROSIT body plastic blowing connection ø2.4mm ø 14mm				
	<b>GEV No.</b>	101305	<b>Ref. No.</b>	—
gas connection straight 1/2" flange 45x45mm ELETROSIT/V4400/4600/4605 suitable for SIT/HONEYWELL hole distance 36x36mm				
	<b>GEV No.</b>	101306	<b>Ref. No.</b>	7020011
gas connection angled flange 45x45mm hole distance 36x36mm 1/2" ELETROSIT/V4400/4600/4605 screw with O-ring suitable for SIT/HONEYWELL				
	<b>GEV No.</b>	101307	<b>Ref. No.</b>	—
gas connection straight flange 45x45mm hole distance 36x36mm 3/4" ELETROSIT/V4400/4600/4605 screw with O-ring suitable for SIT/HONEYWELL				
	<b>GEV No.</b>	101308	<b>Ref. No.</b>	—
gas connection angled flange 45x45mm hole distance 36x36mm 3/4" ELETROSIT/V4400/4600/4605 screw with O-ring suitable for SIT/HONEYWELL				
	<b>GEV No.</b>	101312	<b>Ref. No.</b>	—
microswitch				
	<b>GEV No.</b>	101314	<b>Ref. No.</b>	—
solenoid coil 24V 50Hz				
	<b>GEV No.</b>	101317	<b>Ref. No.</b>	—
plug with cable L 1000mm suitable for NOVASIT				
	<b>GEV No.</b>	101318	<b>Ref. No.</b>	—
cover cap for solenoid coil suitable for NOVASIT				

### accessories



1	<b>GEV No.</b>	101306	<b>Ref. No.</b>	7020011
<b>description</b>	gas connection angled flange 45x45mm hole distance 36x36mm 1/2" ELETROSIT/V4400/4600/4605 screw with O-ring suitable for SIT/HONEYWELL			
<b>spare parts for</b>	101306			
	<b>GEV No.</b>	517104	<b>Ref. No.</b>	—
O-ring EPDM thickness 2.62mm ID ø 31.42mm Qty 1 pcs				

### TANDEM



1	<b>GEV No.</b>	101881	<b>Ref. No.</b>	7020080
<b>description</b>	gas valve 230V 50Hz gas inlet 1/2" gas outlet 1/2" pilot connection level slow ignition ignition times pressure range 3-50mbar power supply for modulator equiv. no. 0.830.041 suitable for Tandem			
<b>For models:</b>	CG06MX, CG102MX, CG10MX, CG20MX, DG06EC, DG06ES, DG06MX, DG102EC, DG102MX, DG10EC, DG10ES, DG10MX, GF10GM, GF4PM, GF5GM, GF6PM, GF7GM, GF8PM, VG06EC, VG06MX, VG102EC, VG102MX, VG10EC, VG10MX, VG20EC, VG20MX			
<b>spare parts for</b>	101881			
	<b>GEV No.</b>	101379	<b>Ref. No.</b>	—
solenoid coil 230V 50Hz suitable for Tandem				
<b>accessories for</b>	101881			
	<b>GEV No.</b>	101274	<b>Ref. No.</b>	7070036
olive for pipe ø 16mm Qty 1 pcs				
	<b>GEV No.</b>	101275	<b>Ref. No.</b>	—
union screw thread 1/2" for pipe ø 16mm Qty 1 pcs				
	<b>GEV No.</b>	101925	<b>Ref. No.</b>	—
plug with O-ring thread M10x1 for pilot burner suitable for NOVASIT				
	<b>GEV No.</b>	102845	<b>Ref. No.</b>	—
gas connection angled 1/2" flange 32x32mm hole distance 24x24mm Tandem				
	<b>GEV No.</b>	102846	<b>Ref. No.</b>	—
gas connection straight 1/2" flange 32x32mm hole distance 24x24mm suitable for Tandem				
	<b>GEV No.</b>	102847	<b>Ref. No.</b>	—
O-ring				





ignition boxes

SIT



1

<b>GEV No.</b>	101685	<b>Ref. No.</b>	7020085
<b>description</b>	ignition box SIT type 503EFD electrodes 2 waiting time 1.5s safety time 10s 220/240V 10VA 50-60Hz protection IP40		
<b>For models:</b>	CG06MX, CG102MX, CG10MX, CG20MX, DG06EC, DG06ES, DG06MX, DG102EC, DG102MX, DG10EC, DG10ES, DG10MX, GF10GM, GF4PM, GF5GM, GF6PM, GF7GM, GF8PM, VG06EC, VG06MX, VG102EC, VG-102MX, VG10EC, VG10MX, VG20EC, VG20MX		



1

<b>GEV No.</b>	107837	<b>Ref. No.</b>	7020206
<b>description</b>	ignition box SIT type 579DBC for combi-steamer suitable for GIORIK equiv. no. 0.579.418 electrodes 2 waiting time 1.5s safety time 5s 220/240V 12VA 50/60Hz		

ignition parts

pilot burners



SIT











100 series



1

<b>GEV No.</b>	106906	<b>Ref. No.</b>	7090022
<b>description</b>	pilot burner SIT type 100 series 3 flames nozzle $\varnothing$ 0.2mm gas connection 6mm		
<b>For models:</b>	FG07CL, FG07L, FG13L, FG213CL, FG213L, SG608		

<b>spare parts for</b>	106906		
	<b>GEV No.</b>	100245	<b>Ref. No.</b> 7042005
	pilot burner nozzle LPG code 20 bore $\varnothing$ 0.2mm Qty 1 pcs thread M8x0.75		
	<b>GEV No.</b>	100855	<b>Ref. No.</b> —
	pilot burner bracket triple		
	<b>GEV No.</b>	100885	<b>Ref. No.</b> —
	air mixing sleeve for pilot burner Qty 1 pcs		

<b>spare parts for</b>	106906		
	<b>GEV No.</b>	100916	<b>Ref. No.</b> —
	compression spring for pilot burner Qty 1 pcs		
	<b>GEV No.</b>	100917	<b>Ref. No.</b> —
	gasket for pilot burner Qty 1 pcs aluminium		
	<b>GEV No.</b>	100918	<b>Ref. No.</b> —
	screw for pilot burner		
	<b>GEV No.</b>	107162	<b>Ref. No.</b> 7090002
	pilot burner cap SIT 3 flames Hmm Lmm Qty 1 pcs		
	<b>GEV No.</b>	107701	<b>Ref. No.</b> —
	pilot burner bottom part SIT 100 series nozzle $\varnothing$ 0.2mm		
<b>accessories for</b>	106906		
	<b>GEV No.</b>	100245	<b>Ref. No.</b> 7042005
	pilot burner nozzle LPG code 20 bore $\varnothing$ 0.2mm Qty 1 pcs thread M8x0.75		
	<b>GEV No.</b>	100246	<b>Ref. No.</b> —
	pilot burner nozzle natural gas bore $\varnothing$ 0.35mm Qty 1 pcs thread M8x0.75		
	<b>GEV No.</b>	100904	<b>Ref. No.</b> —
	locking screw M10x1 for pipe $\varnothing$ 4mm Qty 1 pcs		
	<b>GEV No.</b>	100905	<b>Ref. No.</b> —
	locking screw M10x1 for pipe $\varnothing$ 6mm Qty 1 pcs		
	<b>GEV No.</b>	102110	<b>Ref. No.</b> —
	pilot tube copper pipe $\varnothing$ 4mm thickness 1mm L 3000mm		
	<b>GEV No.</b>	102111	<b>Ref. No.</b> —
	pilot tube copper pipe $\varnothing$ 6mm thickness 1mm L 3000mm		
	<b>GEV No.</b>	107171	<b>Ref. No.</b> —
	pilot burner nozzle SIT natural/liquid gas bore $\varnothing$ 0.25mm Qty 1 pcs		
	<b>GEV No.</b>	107700	<b>Ref. No.</b> —
	pilot burner bottom part SIT 100 series nozzle $\varnothing$ 0.25mm		
	<b>GEV No.</b>	107702	<b>Ref. No.</b> —
	pilot burner bottom part SIT 100 series nozzle $\varnothing$ 0.35mm		

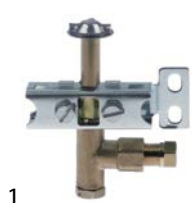

1





<b>GEV No.</b>	106907	<b>Ref. No.</b>	7090023
<b>description</b>	pilot burner SIT type 100 series 3 flames nozzle $\varnothing$ 0.35mm gas connection 6mm		
<b>For models:</b>	13FG, 13FGC, 17FG, 17FGC, 207FG, 207FGC, 213FG, 213FGC, 217FG, 217FGC, 917FG, 917FGC, 927FG, 927FGC, 934FG, 934FGC		
<b>spare parts for</b>	106907		
	<b>GEV No.</b>	100246	<b>Ref. No.</b> —
	pilot burner nozzle natural gas bore $\varnothing$ 0.35mm Qty 1 pcs thread M8x0.75		

Table continues overleaf

spare parts for		106907		
	GEV No.	100855	Ref. No.	—
pilot burner bracket triple				
	GEV No.	100885	Ref. No.	—
air mixing sleeve for pilot burner Qty 1 pcs				
	GEV No.	100916	Ref. No.	—
compression spring for pilot burner Qty 1 pcs				
	GEV No.	100917	Ref. No.	—
gasket for pilot burner Qty 1 pcs aluminium				
	GEV No.	100918	Ref. No.	—
screw for pilot burner				
	GEV No.	107162	Ref. No.	7090002
pilot burner cap SIT 3 flames Hmm Lmm Qty 1 pcs				
	GEV No.	107702	Ref. No.	—
pilot burner bottom part SIT 100 series nozzle ø 0.35mm				
accessories for		106907		
	GEV No.	100245	Ref. No.	7042005
pilot burner nozzle LPG code 20 bore ø 0.2mm Qty 1 pcs thread M8x0.75				
	GEV No.	100904	Ref. No.	—
locking screw M10x1 for pipe ø 4mm Qty 1 pcs				
	GEV No.	100905	Ref. No.	—
locking screw M10x1 for pipe ø 6mm Qty 1 pcs				
	GEV No.	102110	Ref. No.	—
pilot tube copper pipe ø 4mm thickness 1mm L 3000mm				
	GEV No.	102111	Ref. No.	—
pilot tube copper pipe ø 6mm thickness 1mm L 3000mm				
	GEV No.	107171	Ref. No.	—
pilot burner nozzle SIT natural/liquid gas bore ø 0.25mm Qty 1 pcs				
	GEV No.	107700	Ref. No.	—
pilot burner bottom part SIT 100 series nozzle ø 0.25mm				
	GEV No.	107701	Ref. No.	—
pilot burner bottom part SIT 100 series nozzle ø 0.2mm				

accessories

pilot burner caps

	1		
<b>GEV No.</b>	107162	<b>Ref. No.</b>	7090002
<b>description</b>	pilot burner cap SIT 3 flames Hmm Lmm Qty 1 pcs		



pilot burner nozzles

	1		
<b>GEV No.</b>	100245	<b>Ref. No.</b>	7042005
<b>description</b>	pilot burner nozzle LPG code 20 bore ø 0.2mm Qty 1 pcs thread M8x0.75		

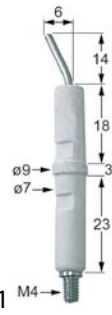
ignition electrodes













	1		
<b>GEV No.</b>	100706	<b>Ref. No.</b>	6010046
<b>description</b>	ignition electrode connection M4 Qty 1 pcs		
<b>For models:</b>	13FG, 13FGC, 17FG, 17FGC, 207FG, 207FGC, 213FG, 213FGC, 217FG, 217FGC, 917FG, 917FGC, 927FG, 927FGC, 934FG, 934FGC, FG07CL, FG07L, FG13L, FG213CL, FG213L, SG608		

140 - 145 -150 series

	1			
<b>GEV No.</b>	107114 <sup>1</sup>	<b>Ref. No.</b>	7090028	
<b>description</b>	pilot burner SIT type 140 series 2 flames nozzle ømm gas connectionmm			
<b>For models:</b>	CG740, CG780, GG940, GG980			
<b>spare parts for</b>	107114			
	GEV No.	100907	Ref. No.	—
screw connection thread M10x1 Qty 1 pcs type SEF 1 ømm for thermocouple				
<b>accessories for</b>	107114			
	GEV No.	100204	Ref. No.	—
pilot burner nozzle SIT LPG code 14 bore ø 0.18/0.20mm Qty 1 pcs suitable for 140 series				
	GEV No.	100205	Ref. No.	—
pilot burner nozzle SIT LPG code 19 bore ø 0.23/0.26mm Qty 1 pcs suitable for SIT 150 series				

<sup>1</sup>incl. thermocouple fitting  
Table continues overleaf





accessories for		107114		
	GEV No.	100206	Ref. No.	—
	pilot burner nozzle SIT natural gas code 36 bore ø 0.60/0.55mm Qty 1 pcs suitable for SIT 150 series			
	GEV No.	100207	Ref. No.	7042013
	pilot burner nozzle SIT natural gas code 27 bore ø 0.40/0.38mm suitable for SIT 140 series			
	GEV No.	100216	Ref. No.	—
	pilot burner nozzle SIT natural gas code 38 bore ø 0.45mm Qty 1 pcs suitable for SIT 150 series			
	GEV No.	100701	Ref. No.	6010062
	ignition electrode connection M4 Qty 1 pcs			
	GEV No.	100801	Ref. No.	—
	gasket for pilot burner Qty 1 pcs			
	GEV No.	100897	Ref. No.	—
	olive for pipe ø 4mm Qty 1 pcs for pilot burner			
	GEV No.	100898	Ref. No.	—
	olive for pipe ø 6mm Qty 1 pcs for pilot burner			
	GEV No.	100906	Ref. No.	5900317 7050028
	screw connection thread M10x1 for ignition electrode brass Qty 1 pcs WS 10			
	GEV No.	100908	Ref. No.	—
	union screw thread M10x1 for pipe ø 4mm Qty 1 pcs			
	GEV No.	100909	Ref. No.	7050029
	union screw thread M10x1 for pipe ø 6mm Qty 1 pcs			
	GEV No.	102110	Ref. No.	—
	pilot tube copper pipe ø 4mm thickness 1mm L 3000mm			
	GEV No.	102111	Ref. No.	—
	pilot tube copper pipe ø 6mm thickness 1mm L 3000mm			

accessories for		100051		
	GEV No.	100209	Ref. No.	—
	pilot burner nozzle POLIDORO natural gas code 40 bore ø 0.4mm Qty 1 pcs			
	GEV No.	100701	Ref. No.	6010062
	ignition electrode connection M4 Qty 1 pcs			
	GEV No.	100906	Ref. No.	5900317 7050028
	screw connection thread M10x1 for ignition electrode brass Qty 1 pcs WS 10			
	GEV No.	100907	Ref. No.	—
	screw connection thread M10x1 Qty 1 pcs type SEF 1 ømm for thermocouple			
	GEV No.	100908	Ref. No.	—
	union screw thread M10x1 for pipe ø 4mm Qty 1 pcs			
	GEV No.	100909	Ref. No.	7050029
	union screw thread M10x1 for pipe ø 6mm Qty 1 pcs			
	GEV No.	102110	Ref. No.	—
	pilot tube copper pipe ø 4mm thickness 1mm L 3000mm			
	GEV No.	102111	Ref. No.	—
	pilot tube copper pipe ø 6mm thickness 1mm L 3000mm			
	GEV No.	102508	Ref. No.	—
	union screw thread M10x1 for pipe ø 4mm Qty 5 pcs			
	GEV No.	102509	Ref. No.	—
	union screw thread M10x1 for pipe ø 6mm Qty 5 pcs			
	GEV No.	102699	Ref. No.	—
	pilot burner nozzle POLIDORO natural gas code 25.2 bore ø 2x0.25mm Qty 1 pcs 2 bores			
	GEV No.	102795	Ref. No.	—
	olive for pipe ø 4mm Qty 1 pcs			
	GEV No.	102797	Ref. No.	—
	olive for pipe ø 6mm Qty 1 pcs			
	GEV No.	106703	Ref. No.	7042008
	pilot burner nozzle POLIDORO natural gas code 27.2 bore ø 2x0.27mm Qty 1 pcs			
	GEV No.	106704	Ref. No.	—
	pilot burner nozzle POLIDORO LPG code 16.2 bore ø 2x0.16mm Qty 1 pcs			
	GEV No.	106763	Ref. No.	—
	pilot burner nozzle POLIDORO natural gas code 27.2A bore ø 2x0.27mm Qty 1 pcs			
	GEV No.	106859	Ref. No.	—
	pilot burner nozzle POLIDORO LPG code 24 bore ø 0.24mm Qty 1 pcs			







**POLIDORO**

**pilot burners**



<b>GEV No.</b>	100051	<b>Ref. No.</b>	7090026	
<b>description</b>	pilot burner POLIDORO 3 flames code gas connectionmm			
<b>For models:</b>	22CPG, 23CPG, 2CPG, 3CPG, CPG1, CPG1BM, CPG66, FTG100, FTG46, FTG46B, FTG46R, FTG66L, FTG66LG, FTG66R, GG66			
<b>spare parts for</b>	100051			
	GEV No.	100907	Ref. No.	—
	screw connection thread M10x1 Qty 1 pcs type SEF 1 ømm for thermocouple			
<b>accessories for</b>	100051			
	GEV No.	100000	Ref. No.	—
	pilot burner nozzle POLIDORO LPG code 22 bore ø 0.22mm Qty 1 pcs			
	GEV No.	100208	Ref. No.	—
	pilot burner nozzle POLIDORO LPG code 20 bore ø 0.2mm Qty 1 pcs			



			
<b>GEV No.</b>	100867	<b>Ref. No.</b>	7090027
<b>description</b>	pilot burner POLIDORO 3 flames gas pressurebar code gas connection 6mm		
<b>For models:</b>	SG520		
<b>accessories for</b>	100867		
	<b>GEV No.</b>	100000	<b>Ref. No.</b> —
	pilot burner nozzle POLIDORO LPG code 22 bore ø 0.22mm Qty 1 pcs		
	<b>GEV No.</b>	100208	<b>Ref. No.</b> —
	pilot burner nozzle POLIDORO LPG code 20 bore ø 0.2mm Qty 1 pcs		
	<b>GEV No.</b>	100209	<b>Ref. No.</b> —
	pilot burner nozzle POLIDORO natural gas code 40 bore ø 0.4mm Qty 1 pcs		
	<b>GEV No.</b>	100907	<b>Ref. No.</b> —
	screw connection thread M10x1 Qty 1 pcs type SEF 1 ømm for thermocouple		
	<b>GEV No.</b>	100908	<b>Ref. No.</b> —
	union screw thread M10x1 for pipe ø 4mm Qty 1 pcs		
	<b>GEV No.</b>	100909	<b>Ref. No.</b> 7050029
	union screw thread M10x1 for pipe ø 6mm Qty 1 pcs		
	<b>GEV No.</b>	102110	<b>Ref. No.</b> —
	pilot tube copper pipe ø 4mm thickness 1mm L 3000mm		
	<b>GEV No.</b>	102111	<b>Ref. No.</b> —
	pilot tube copper pipe ø 6mm thickness 1mm L 3000mm		
	<b>GEV No.</b>	102699	<b>Ref. No.</b> —
	pilot burner nozzle POLIDORO natural gas code 25.2 bore ø 2x0.25mm Qty 1 pcs 2 bores		
	<b>GEV No.</b>	102795	<b>Ref. No.</b> —
	olive for pipe ø 4mm Qty 1 pcs		
	<b>GEV No.</b>	102797	<b>Ref. No.</b> —
	olive for pipe ø 6mm Qty 1 pcs		
	<b>GEV No.</b>	106703	<b>Ref. No.</b> 7042008
	pilot burner nozzle POLIDORO natural gas code 27.2 bore ø 2x0.27mm Qty 1 pcs		
	<b>GEV No.</b>	106704	<b>Ref. No.</b> —
	pilot burner nozzle POLIDORO LPG code 16.2 bore ø 2x0.16mm Qty 1 pcs		
	<b>GEV No.</b>	106763	<b>Ref. No.</b> —
	pilot burner nozzle POLIDORO natural gas code 27.2A bore ø 2x 0.27mm Qty 1 pcs		
	<b>GEV No.</b>	106859	<b>Ref. No.</b> —
	pilot burner nozzle POLIDORO LPG code 24 bore ø 0.24mm Qty 1 pcs		





















			
<b>GEV No.</b>	100076	<b>Ref. No.</b>	7090024
<b>description</b>	pilot burner POLIDORO 3 flames natural gas code 29.2 gas connection 6mm		
<b>spare parts for</b>	100076		
	<b>GEV No.</b>	100907	<b>Ref. No.</b> —
	screw connection thread M10x1 Qty 1 pcs type SEF 1 ømm for thermocouple		
<b>accessories for</b>	100076		
	<b>GEV No.</b>	100000	<b>Ref. No.</b> —
	pilot burner nozzle POLIDORO LPG code 22 bore ø 0.22mm Qty 1 pcs		
	<b>GEV No.</b>	100208	<b>Ref. No.</b> —
	pilot burner nozzle POLIDORO LPG code 20 bore ø 0.2mm Qty 1 pcs		
	<b>GEV No.</b>	100209	<b>Ref. No.</b> —
	pilot burner nozzle POLIDORO natural gas code 40 bore ø 0.4mm Qty 1 pcs		
	<b>GEV No.</b>	100701	<b>Ref. No.</b> 6010062
	ignition electrode connection M4 Qty 1 pcs		
	<b>GEV No.</b>	100906	<b>Ref. No.</b> 5900317 7050028
	screw connection thread M10x1 for ignition electrode brass Qty 1 pcs WS 10		
	<b>GEV No.</b>	100907	<b>Ref. No.</b> —
	screw connection thread M10x1 Qty 1 pcs type SEF 1 ømm for thermocouple		
	<b>GEV No.</b>	100908	<b>Ref. No.</b> —
	union screw thread M10x1 for pipe ø 4mm Qty 1 pcs		
	<b>GEV No.</b>	100909	<b>Ref. No.</b> 7050029
	union screw thread M10x1 for pipe ø 6mm Qty 1 pcs		
	<b>GEV No.</b>	102110	<b>Ref. No.</b> —
	pilot tube copper pipe ø 4mm thickness 1mm L 3000mm		
	<b>GEV No.</b>	102111	<b>Ref. No.</b> —
	pilot tube copper pipe ø 6mm thickness 1mm L 3000mm		
	<b>GEV No.</b>	102508	<b>Ref. No.</b> —
	union screw thread M10x1 for pipe ø 4mm Qty 5 pcs		
	<b>GEV No.</b>	102509	<b>Ref. No.</b> —
	union screw thread M10x1 for pipe ø 6mm Qty 5 pcs		
	<b>GEV No.</b>	102699	<b>Ref. No.</b> —
	pilot burner nozzle POLIDORO natural gas code 25.2 bore ø 2x0.25mm Qty 1 pcs 2 bores		
	<b>GEV No.</b>	102795	<b>Ref. No.</b> —
	olive for pipe ø 4mm Qty 1 pcs		
	<b>GEV No.</b>	102797	<b>Ref. No.</b> —
	olive for pipe ø 6mm Qty 1 pcs		

Table continues overleaf



accessories for		100076		
GEV No.		106703	Ref. No.	7042008
	pilot burner nozzle POLIDORO natural gas code 27.2 bore $\varnothing$ 2x0.27mm Qty 1 pcs			
	pilot burner nozzle POLIDORO LPG code 16.2 bore $\varnothing$ 2x0.16mm Qty 1 pcs			
	pilot burner nozzle POLIDORO natural gas code 27.2A bore $\varnothing$ 2x0.27mm Qty 1 pcs			
	pilot burner nozzle POLIDORO LPG code 24 bore $\varnothing$ 0.24mm Qty 1 pcs			

**producer-specific pilot burners**

**GIORIK**

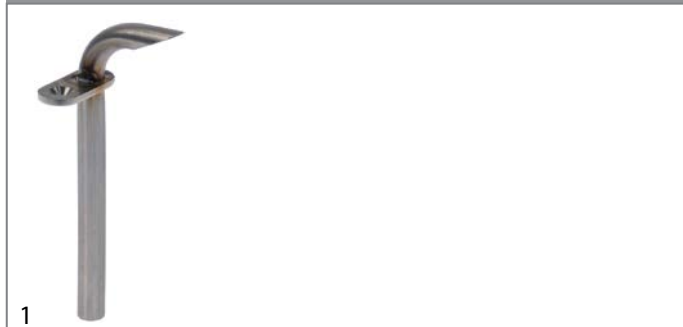

<b>GEV No.</b>	107764	<b>Ref. No.</b>	7090219
<b>description</b>	pilot burner L 93mm $\varnothing$ 8mm		



<b>GEV No.</b>	107763	<b>Ref. No.</b>	7090218
<b>description</b>	pilot burner L 95mm $\varnothing$ 8mm		

**electrodes**

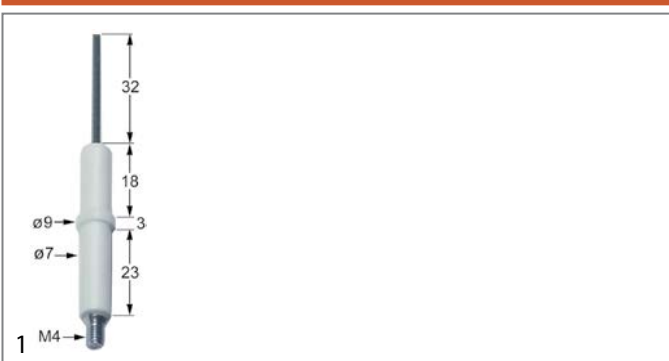

<b>GEV No.</b>	100701	<b>Ref. No.</b>	6010062
<b>description</b>	ignition electrode connection M4 Qty 1 pcs		
<b>For models:</b>	SG520		

**accessories for** 100701

	GEV No.	100906	Ref. No.	5900317 7050028
	screw connection thread M10x1 for ignition electrode brass Qty 1 pcs WS 10			

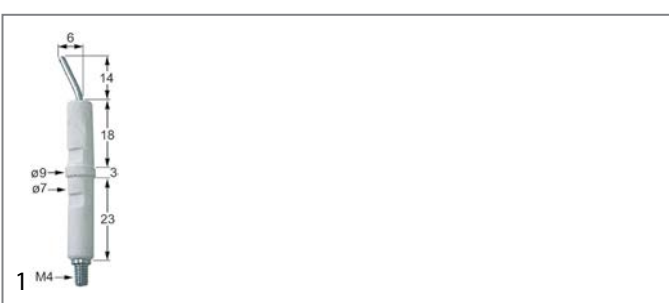

<b>GEV No.</b>	100706	<b>Ref. No.</b>	6010046
<b>description</b>	ignition electrode connection M4 Qty 1 pcs		
<b>For models:</b>	13FG, 13FGC, 17FG, 17FGC, 207FG, 207FGC, 213FG, 213FGC, 217FG, 217FGC, 917FG, 917FGC, 927FG, 927FGC, 934FG, 934FGC, FG07CL, FG07L, FG13L, FG213CL, FG213L, SG608		



<b>GEV No.</b>	102333	<b>Ref. No.</b>	2012111
<b>description</b>	ignition electrode D1 $\varnothing$ 7mm D2 $\varnothing$ 9mm connection M4 L1 23mm L2 19mm BL1 18mm BL2 3mm BL3 23mm to clip		
<b>For models:</b>	CG06MX, CG102MX, CG10MX, CG20MX, DG06EC, DG06ES, DG06MX, DG102EC, DG102MX, DG10EC, DG10ES, DG10MX, VG06EC, VG06MX, VG102EC, VG102MX, VG10EC, VG10MX, VG20EC, VG20MX		

<b>GEV No.</b>	102314	<b>Ref. No.</b>	6010061
<b>description</b>	ignition electrode D1 ø 7mm D2 ø 9mm connection M4 L1 2mm BL1 28mm BL2 3mm BL3 23mm to clip		
<b>For models:</b>	22CPG, 23CPG, 2CPG, 3CPG, CPG1, CPG1BM, CPG66, FRG46, FRG66, FTG100, FTG46, FTG46B, FTG46R, FTG66L, FTG66LG, FTG66R, GG66		

<b>GEV No.</b>	102334	<b>Ref. No.</b>	2012110
<b>description</b>	ignition electrode D1 ø 7mm D2 ø 9mm connection M4 L1 9mm L2 12mm L3 62mm BL1 18mm BL2 3mm BL3 23mm to clip		
<b>For models:</b>	CG06MX, CG102MX, CG10MX, CG20MX, DG06EC, DG06ES, DG06MX, DG102EC, DG102MX, DG10EC, DG10ES, DG10MX, VG06EC, VG06MX, VG102EC, VG102MX, VG10EC, VG10MX, VG20EC, VG20MX		

<b>GEV No.</b>	102331	<b>Ref. No.</b>	2012109
<b>description</b>	ignition electrode D1 ø 7mm D2 ø 9mm connection M4 L1 34mm L2 40mm L3 14mm BL1 18mm BL2 3mm BL3 23mm to clip		
<b>For models:</b>	VG06EC, VG06MX, VG102EC, VG10EC, VG10MX		

<b>GEV No.</b>	102332	<b>Ref. No.</b>	2012108
<b>description</b>	ignition electrode D1 ø 7mm D2 ø 9mm connection M4 L1 40mm L2 46mm BL1 18mm BL2 3mm BL3 23mm to clip		
<b>For models:</b>	VG06EC, VG06MX, VG102EC, VG102MX, VG10EC, VG10MX, VG20EC, VG20MX		

<b>GEV No.</b>	100906	<b>Ref. No.</b>	5900317 7050028
<b>description</b>	screw connection thread M10x1 for ignition electrode brass Qty 1 pcs WS 10		

ignition cables

pre-assembled cables

<b>GEV No.</b>	100176	<b>Ref. No.</b>	6050610
<b>description</b>	ignition cable cable length 1000mm connection ø2.4mm / ø4mm permanent temperature 200°C		
<b>For models:</b>	CG740, CG780, CPG1, CPG1BM, FPG18, FTG100, FTG46, FTG46B, FTG46R, FTG66L, FTG66LG, FTG66R, GG66, GG940, GG980, SG520		

<b>GEV No.</b>	100140	<b>Ref. No.</b>	6050051
<b>description</b>	ignition cable cable length 400mm connection ø2.4mm / ø4mm		
<b>For models:</b>	13FG, 13FGC, 17FG, 17FGC, 207FG, 213FG, 213FGC, 217FG, 217FGC, 22CPG, 23CPG, 2CPG, 3CPG, 917FG, 917FGC, 927FG, 927FGC, 934FG, 934FGC, CPG66, FG07CL, FG213CL, FRG46, FRG66, SG608		



<b>GEV No.</b>	100025	<b>Ref. No.</b>	6050065
<b>description</b>	ignition cable cable length 600mm connection ø4mm / F6.3mm		
<b>For models:</b>	FG07L, FG13L, FG213L		





			
<b>GEV No.</b>	100019	<b>Ref. No.</b>	6050610
<b>description</b>	ignition cable cable length 900mm connection $\varnothing 2.4\text{mm}$ / $\varnothing 4\text{mm}$		



piezoelectric igniters

mounting diameter 22mm

			
<b>GEV No.</b>	100039	<b>Ref. No.</b>	6010048
<b>description</b>	piezoelectric igniter body plastic blowing mounting $\varnothing 22\text{mm}$ connection F6.3x0.8 cable lengthmm		
<b>accessories for</b>	100039		
	<b>GEV No.</b>	100115	<b>Ref. No.</b> —
union nut ID $\varnothing M22 \times 1\text{mm}$			

			
<b>GEV No.</b>	100013	<b>Ref. No.</b>	6010047
<b>description</b>	piezoelectric igniter body plastic blowing mounting $\varnothing 22\text{mm}$ connection $\varnothing 2.4\text{mm}$ cable lengthmm		
<b>For models:</b>	22CPG, 23CPG, 2CPG, 3CPG, CG740, CG780, CPG1, CPG1BM, CPG66, FPG18, FRG46, FRG66, FTG100, FTG46, FTG46B, FTG46R, FTG66L, FTG66LG, FTG66R, GG66, GG940, GG980, PCG46, PCG66, SG520, SG608		
<b>accessories for</b>	100013		
	<b>GEV No.</b>	100023	<b>Ref. No.</b> —
female bullet size 2.3mm 0.5-1.5mm <sup>2</sup> CuZn t.max. 125°C Qty 20 pcs			

miscellaneous

			
<b>GEV No.</b>	nla <sup>1</sup>	<b>Ref. No.</b>	7020230
<b>description</b>	piezoelectric igniter suitable for Minisit with cover cap $\varnothing\text{mm}$ connection F6.3x0.8		
<b>For models:</b>	FG07L, FG13L, FG213L		
<b>spare parts for</b>	101136		
	<b>GEV No.</b>	100001	<b>Ref. No.</b> —
piezoelectric igniter suitable for Minisit connection F6.3x0.8 $\varnothing\text{mm}$			

<sup>1</sup>no longer available

ignition units

			
<b>GEV No.</b>	101002	<b>Ref. No.</b>	6041059
<b>description</b>	ignition unit outputs 2 230VAC dimensions 88x23x34mm mounting distance 73mm inlet F6.3x0.8 outlet F2.8x0.8 0.6VA 50/60Hz		
<b>For models:</b>	13FG, 13FGC, 17FG, 17FGC, 207FG, 207FGC, 213FG, 213FGC, 217FG, 217FGC, 917FG, 917FGC, 927FG, 927FGC, 934FG, 934FGC, FG07CL, FG213CL		

thermocouples

plug-in thermocouples

plug-in thermocouples standard

with barrel socket  $\varnothing 6(6.5)\text{mm}$

thermocouples SIT

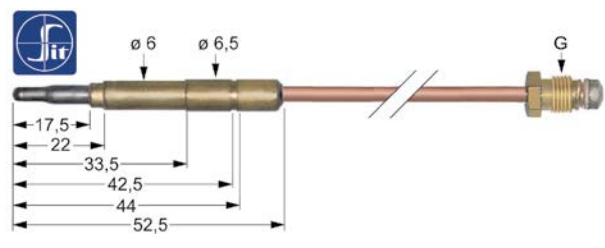
			
<b>GEV No.</b>	107609	<b>Ref. No.</b>	6010055
<b>description</b>	thermocouple SIT M9x1 L 600mm plug connection $\varnothing 6.0(6.5)\text{mm}$		
<b>For models:</b>	13FG, 17FG, 207FG, 213FG, 917FG, 917FGC, 927FG, 927FGC, 934FG, 934FGC, CG740, CG780, FG07L, FG13L, FG213L, FTG100, FTG46, FTG46B, FTG46R, FTG66L, FTG66LG, FTG66R, GG66, GG940, GG980, SG520, SG608		

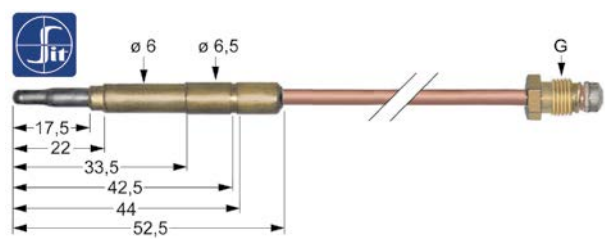
			
<b>GEV No.</b>	107611	<b>Ref. No.</b>	6010057
<b>description</b>	thermocouple SIT M9x1 L 850mm plug connection $\varnothing 6.0(6.5)\text{mm}$		
<b>For models:</b>	22CPG, 23CPG, 2CPG, 3CPG, CPG66		



plug-in thermocouples with interruption

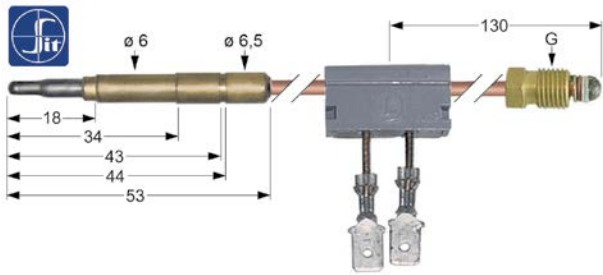



1	<b>GEV No.</b>	107177	<b>Ref. No.</b>	6010065
	<b>description</b>	thermocouple SIT with interrupter M9x1 L 600mm plug connection ø6.0mm F 6.3mm		

threaded thermocouples

threaded thermocouples standard

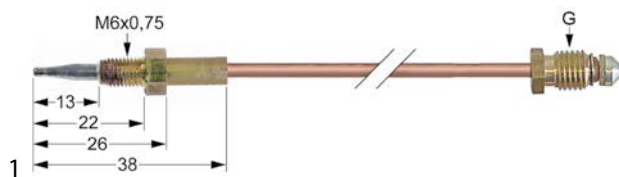
threaded thermocouples (miscellaneous)



1	<b>GEV No.</b>	107185	<b>Ref. No.</b>	6010171	
	<b>description</b>	thermocouple M9x1 L 600mm M6x0.75			
	<b>accessories for</b>	107185			
		<b>GEV No.</b>	103173	<b>Ref. No.</b>	—
		nut thread M6x0.75 H 4mm WS 10 brass Qty 1 pcs			

producer-specific hob burners

GIORIK

CG740G



1	<b>GEV No.</b>	104674	<b>Ref. No.</b>	7090212
	<b>description</b>	burner cap ø 65mm 4kW		



1	<b>GEV No.</b>	104676	<b>Ref. No.</b>	7090213
	<b>description</b>	burner cap ø 95mm 8kW		



1	<b>GEV No.</b>	104673	<b>Ref. No.</b>	7090216
	<b>description</b>	burner head ø 160mm for burner cap ø 65mm 4kW		



1	<b>GEV No.</b>	104675	<b>Ref. No.</b>	7090217
	<b>description</b>	burner head ø 160mm for burner cap ø 95mm 8kW		



1	<b>GEV No.</b>	104677	<b>Ref. No.</b>	7090214
	<b>description</b>	burner lower part for burner cap ø 65mm 4kW		

gas burners

hob burners

universal hob burners

GEV



1	<b>GEV No.</b>	103066	<b>Ref. No.</b>	7090044
	<b>description</b>	burner cap ø 80mm		

**accessories for** 103066

	<b>GEV No.</b>	103065	<b>Ref. No.</b>	—
		burner ring for burner cap ø 80mm		

	<b>GEV No.</b>	104100	<b>Ref. No.</b>	—
		burner head for burner cap ø 80mm		

	<b>GEV No.</b>	104101	<b>Ref. No.</b>	—
		burner holder for burner cap ø 80mm with nozzle holder with mixing sleeve		



1

<b>GEV No.</b>	104678	<b>Ref. No.</b>	7090215
<b>description</b>	burner lower part for burner cap ø 95mm 8kW		

screw connections



1

<b>GEV No.</b>	104679	<b>Ref. No.</b>	7090221
<b>description</b>	pilot burner centre part ø 8mm L 30.4mm WS 15 ball port ø 3.8mm		

pan supports



1

<b>GEV No.</b>	210026	<b>Ref. No.</b>	7090046
<b>description</b>	pan support W 345mm L 398mm H 48mm		

accessories

pan supports



1

<b>GEV No.</b>	210026	<b>Ref. No.</b>	7090046
<b>description</b>	pan support W 345mm L 398mm H 48mm		

bar burners

bar burners



1

<b>GEV No.</b>	105687	<b>Ref. No.</b>	2010923
<b>description</b>	bar burner 2 row L 370mm W 220mm ømm H 50mm chargrill		
<b>For models:</b>	CG740, CG780		



1

<b>GEV No.</b>	105475	<b>Ref. No.</b>	2010924
<b>description</b>	bar burner 2 row L 575mm W 225mm ømm H 45mm 11kW chargrill		
<b>For models:</b>	GG940, GG980		



1

<b>GEV No.</b>	105776	<b>Ref. No.</b>	7090100
<b>description</b>	bar burner ø 50mm Wmm Hmm L 305mm with bolt M5x12 flange width 52mm convection oven flange ø 75mm		
<b>For models:</b>	CG06MX, DG06EC, DG06ES, DG06MX, VG06EC, VG06MX		



1

<b>GEV No.</b>	105775	<b>Ref. No.</b>	7090101
<b>description</b>	bar burner ø 50mm Wmm Hmm L 425mm with bolt M5x12 flange width 52mm convection oven flange ø 75mm		
<b>For models:</b>	CG102MX, CG10MX, CG20MX, DG102EC, DG102MX, DG10EC, DG10ES, DG10MX, VG102EC, VG102MX, VG10EC, VG10MX, VG20EC, VG20MX		



			
1			
<b>GEV No.</b>	105774	<b>Ref. No.</b>	7090102
<b>description</b>	bar burner ø 60mm Wmm Hmm L 245mm with bolt M5x12 flange width 67mm flange length 67mm convection oven		
<b>For models:</b>	VG06EC, VG06MX, VG102EC, VG102MX, VG10EC, VG10MX, VG20EC, VG20MX		

			
2			
<b>GEV No.</b>	105310	<b>Ref. No.</b>	7090079
<b>description</b>	bar burner ø 60mm Wmm Hmm L 260mm flange width 67mm flange length 67mm pasta cooker		
<b>For models:</b>	22CPG, 2CPG, CPG66		

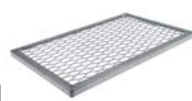
			
1			
<b>GEV No.</b>	104439	<b>Ref. No.</b>	2010949
<b>description</b>	lava rock grid L 540mm W 340mm H 20mm		

			
1			
<b>GEV No.</b>	105525	<b>Ref. No.</b>	2103520
<b>description</b>	surface burner ømm W 190mm H 43mm L 575mm salamander grill		
<b>For models:</b>	SG520		

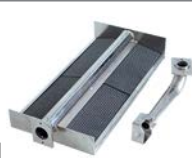
			
1			
<b>GEV No.</b>	105524	<b>Ref. No.</b>	2001246
<b>description</b>	surface burner ømm W 255mm H 80mm L 580mm with cast plates salamander grill		
<b>For models:</b>	SG608		

## lava rock grids

			
1			
<b>GEV No.</b>	104439	<b>Ref. No.</b>	2010949
<b>description</b>	lava rock grid L 540mm W 340mm H 20mm		

## tube burners

			
1			
<b>GEV No.</b>	105529	<b>Ref. No.</b>	2112970
<b>description</b>	tubular burner L 295mm W 55mm H 70mm for fryer oval		
<b>For models:</b>	207FG, 207FGC, 927FG, 927FGC		

			
1			
<b>GEV No.</b>	105532	<b>Ref. No.</b>	2112969
<b>description</b>	tubular burner L 295mm W 55mm H 70mm mounting pos. centre for fryer oval		
<b>For models:</b>	217FGC, 934FGC		

			
1			
<b>GEV No.</b>	105528	<b>Ref. No.</b>	2001231
<b>description</b>	tubular burner L 295mm W 55mm H 70mm mounting pos. centre/right for fryer oval		
<b>For models:</b>	FG13L, FG213CL, FG213L		

			
1			
<b>GEV No.</b>	105527	<b>Ref. No.</b>	2001230
<b>description</b>	tubular burner L 295mm W 55mm H 70mm mounting pos. left for fryer oval		
<b>For models:</b>	FG07CL, FG07L, FG13L, FG213CL, FG213L		



			
1			
<b>GEV No.</b>	105530	<b>Ref. No.</b>	2112968
<b>description</b>	tubular burner L 295mm W 55mm H 70mm mounting pos. left for fryer oval		
<b>For models:</b>	13FG, 13FGC, 17FG, 17FGC, 213FG, 213FGC, 217FG, 217FGC, 917FG, 917FGC, 934FG, 934FGC		

			
1			
<b>GEV No.</b>	105531	<b>Ref. No.</b>	2112967
<b>description</b>	tubular burner L 295mm W 55mm H 70mm mounting pos. right for fryer oval		
<b>For models:</b>	13FG, 13FGC, 17FG, 17FGC, 213FG, 213FGC, 217FG, 217FGC, 917FG, 917FGC, 934FG, 934FGC		

### ceramic burners

#### accessories

#### ceramic plates

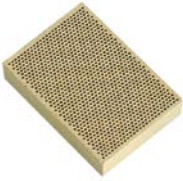
			
1			
<b>GEV No.</b>	105526	<b>Ref. No.</b>	7090073
<b>description</b>	ceramic plate L 69mm W 49mm H 13mm for salamander grill		
<b>For models:</b>	SG520		

### gas nozzles

#### main nozzles

#### gas nozzles M7x1

			
1			
<b>GEV No.</b>	100518	<b>Ref. No.</b>	7042726
<b>description</b>	gas injector thread M7x1 WS 10 bore ø 0.85mm		

### pilot burner nozzles

#### pilot burner nozzles POLIDORO

			
1			
<b>GEV No.</b>	106703	<b>Ref. No.</b>	7042008
<b>description</b>	pilot burner nozzle POLIDORO natural gas code 27.2 bore ø 2x0.27mm Qty 1 pcs		

#### pilot burner nozzles SIT

##### 100 series

			
1			
<b>GEV No.</b>	100245	<b>Ref. No.</b>	7042005
<b>description</b>	pilot burner nozzle LPG code 20 bore ø 0.2mm Qty 1 pcs thread M8x0.75		

##### 140/150 series



			
1			
<b>GEV No.</b>	100207	<b>Ref. No.</b>	7042013
<b>description</b>	pilot burner nozzle SIT natural gas code 27 bore ø 0.40/0.38mm suitable for SIT 140 series		

### auxiliary gas parts

#### screw connections





#### olives

 <p>Image not available</p>			
1			
<b>GEV No.</b>	106426	<b>Ref. No.</b>	7070025
<b>description</b>	olive		

			
1			
<b>GEV No.</b>	101274	<b>Ref. No.</b>	7070036
<b>description</b>	olive for pipe ø 16mm Qty 1 pcs		
<b>accessories for</b>	101274		
	<b>GEV No.</b>	101275	<b>Ref. No.</b>
			—
	 union screw thread 1/2" for pipe ø 16mm Qty 1 pcs		

union screws

			
1			
<b>GEV No.</b>	100906	<b>Ref. No.</b>	5900317 7050028
<b>description</b>	screw connection thread M10x1 for ignition electrode brass Qty 1 pcs WS 10		

			
1			
<b>GEV No.</b>	100909	<b>Ref. No.</b>	7050029
<b>description</b>	union screw thread M10x1 for pipe ø 6mm Qty 1 pcs		
<b>accessories for</b>	100909		
	<b>GEV No.</b>	100898	<b>Ref. No.</b> —
olive for pipe ø 6mm Qty 1 pcs for pilot burner			
	<b>GEV No.</b>	101286	<b>Ref. No.</b> —
olive ID ø 6mm Qty 1 pcs			
	<b>GEV No.</b>	101287	<b>Ref. No.</b> —
olive for pipe ø 6mm Qty 1 pcs			
	<b>GEV No.</b>	101288	<b>Ref. No.</b> —
olive for pipe ø 6mm L 6mm aluminium Qty 1 pcs ED ø 8.5mm			

miscellaneous

			
1			
<b>GEV No.</b>	550449	<b>Ref. No.</b>	2010311
<b>description</b>	special wrench for ring nut		

for convection ovens/combi-steamers

doors

			
1			
<b>GEV No.</b>	690585	<b>Ref. No.</b>	2011212
<b>description</b>	bush for door mechanism L 35mm ED ø 36mm int. ø 1 31mm int. ø 2 13mm mounting distance 28mm brass		
<b>For models:</b>	CE06MX, CE102MX, CE10MX, CE20MX, CG06MX, CG102MX, CG10MX, CG20MX, DE06EC, DE06ES, DE06MX, DE102EC, DE102MX, DE10EC, DE10ES, DE10MX, DG06EC, DG06ES, DG06MX, DG102EC, DG102MX, DG10EC, DG10ES, DG10MX, VE06EC, VE06MX, VE102EC, VE102MX, VE10EC, VE10MX, VE20EC, VE20MX, VG06EC, VG06MX, VG102EC, VG102MX, VG10EC, VG10MX, VG20EC, VG20MX		

door mechanics

miscellaneous

			
1			
<b>GEV No.</b>	690585	<b>Ref. No.</b>	2011212
<b>description</b>	bush for door mechanism L 35mm ED ø 36mm int. ø 1 31mm int. ø 2 13mm mounting distance 28mm brass		
<b>For models:</b>	CE06MX, CE102MX, CE10MX, CE20MX, CG06MX, CG102MX, CG10MX, CG20MX, DE06EC, DE06ES, DE06MX, DE102EC, DE102MX, DE10EC, DE10ES, DE10MX, DG06EC, DG06ES, DG06MX, DG102EC, DG102MX, DG10EC, DG10ES, DG10MX, VE06EC, VE06MX, VE102EC, VE102MX, VE10EC, VE10MX, VE20EC, VE20MX, VG06EC, VG06MX, VG102EC, VG102MX, VG10EC, VG10MX, VG20EC, VG20MX		

for salamander grills

			
1			
<b>GEV No.</b>	692729	<b>Ref. No.</b>	2013882
<b>description</b>	belt for salamander grill L 385mm W 13mm Hmm ED ømm ID ømm		
<b>For models:</b>	SH505R, SH510P, SH510R, SH520G, SH520GM, SH560P		

equipment-specific units

for deep fryers

door magnets

			
1			
<b>GEV No.</b>	690524	<b>Ref. No.</b>	5900352
<b>description</b>	door magnet L 87mm W 18mm H 15mm mounting distance 73mm for folding door hinge		
<b>For models:</b>	13FG, 13FGC, 15FE, 15FEC, 17FG, 17FGC, 207FG, 207FGC, 20FE, 20FEC, 210FE, 210FEC, 213FG, 213FGC, 215FE, 215FEC, 217FG, 217FGC, 220FE, 220FEC, 22CP, 23CP, 2CP, 3CP, 917FG, 917FGC, 920FE, 920FEC, 922FE, 922FEC, 927FG, 927FGC, 934FG, 934FGC, 940FE, 940FEC, CG740, CG780, CPE66, CPG66, GG940, GG980		



1			
<b>GEV No.</b>	692728	<b>Ref. No.</b>	2013873
<b>description</b>	spindle for salamander grill L 493mm Wmm Hmm ED ø 5mm ID ømm		
<b>For models:</b>	SH505R, SH510P, SH510R, SH520G, SH520GM, SH560P		

## knobs

### producer-specific knobs

GIORIK			
1			
<b>GEV No.</b>	111506	<b>Ref. No.</b>	2002915
<b>description</b>	knob energy regulator ø 50mm shaft ø 6x4.6mm shaft flat lower black		
<b>For models:</b>	S505, S505R, S510, S510S, S511, S511S, SR512R		

1			
<b>GEV No.</b>	112789	<b>Ref. No.</b>	2012984
<b>description</b>	knob gas tap with ignition flame t.max.°C ø 75mm shaft ø 8x6.5mm shaft flat lower black		

1			
<b>GEV No.</b>	112265	<b>Ref. No.</b>	2008671
<b>description</b>	knob gas tap with ignition flame t.max.°C ø 76mm shaft ø 10x8mm shaft flat upper black		
<b>For models:</b>	22CPG, 23CPG, 2CPG, 3CPG, CG740, CG780, CPG1, CPG1BM, CPG66, GG66, GG940, GG980		

1			
<b>GEV No.</b>	111511	<b>Ref. No.</b>	2008673
<b>description</b>	knob switch 0-1 t.max.°C ø 76mm shaft ø 6x4.6mm shaft flat upper black		
<b>For models:</b>	15FE, 20FE, 215FE, 220FE, 920FE, 940FE, BM711, BM721, BM911, BM921, BME46, BME66		

1			
<b>GEV No.</b>	112274	<b>Ref. No.</b>	2008674
<b>description</b>	knob thermostat 1-8 t.max.°C ø 67mm shaft ø 6x4.6mm shaft flat upper black		
<b>For models:</b>	BME46, BME66, CP1BM, CPG1BM, FTE100, FTE107, FTE46, FTE46B, FTE46R, FTE47L, FTE66L, FTE66LB, FTE66LM, FTE66LMB, FTE66R, FTE66RM, FTE67L, FTE67LM, SPE46		

1			
<b>GEV No.</b>	112273	<b>Ref. No.</b>	2008675
<b>description</b>	knob thermostat t.max. 110°C ø 76mm shaft ø 6x4.6mm shaft flat upper black temperature range 30-110°C rotation 270°		
<b>For models:</b>	22CP, 23CP, 2CP, 3CP, CP1, CP1BM, CPE66		

1			
<b>GEV No.</b>	111509	<b>Ref. No.</b>	2008672
<b>description</b>	knob thermostat t.max. 185°C ø 76mm shaft ø 6x4.6mm shaft flat upper black temperature range 140-185°C		
<b>For models:</b>	13FG, 15FE, 17FG, 207FG, 20FE, 210FE, 213FG, 215FE, 217FG, 220FE, 917FG, 920FE, 922FE, 927FG, 934FG, 940FE, F10L, F15L, F215L, FRE46, FRE46F, FRE46R, FRE46T, FRE66, FRE66F, FRE66R, FRE66T		



			
1			
<b>GEV No.</b>	111738	<b>Ref. No.</b>	2012261
<b>description</b>	knob switch zero mark ø 50mm shaft ø 6x4.6mm shaft flat left black		
<b>For models:</b>	CE06MX, CE102MX, CE10MX, CE20MX, CG06MX, CG102MX, CG10MX, CG20MX, DE06EC, DE06ES, DE06MX, DE102EC, DE102MX, DE10EC, DE10ES, DE10MX, DG06EC, DG06ES, DG06MX, DG102EC, DG102MX, DG10EC, DG10ES, DG10MX, SH510P, SH560P, VE06EC, VE06MX, VE102EC, VE102MX, VE10EC, VE10MX, VE20EC, VE20MX, VG06EC, VG06MX, VG102EC, VG102MX, VG10EC, VG10MX, VG20EC, VG20MX		

			
1			
<b>GEV No.</b>	111508	<b>Ref. No.</b>	2006823
<b>description</b>	knob switch zero mark ø 50mm shaft ø 6x4.6mm shaft flat left white		
<b>For models:</b>	13FGC, 15FEC, 17FGC, 207FGC, 20FEC, 210FEC, 213FGC, 215FEC, 217FGC, 220FEC, 917FGC, 920FEC, 922FEC, 927FGC, 934FGC, 940FEC, EF10GM, EF5GM, EF7GM, EN10VE-EC-ESN1033, F10CL, F15CL, F215CL, FG07CL, FG213CL, GF10GM, GF5GM, GF7GM, SH505R, SH510R, SH520G, SH520GM		
<b>spare parts for</b>	111508		
	<b>GEV No.</b>	551317	<b>Ref. No.</b> 5900253
knob spring			

			
1			
<b>GEV No.</b>	111739	<b>Ref. No.</b>	2012260
<b>description</b>	knob universal ø 50mm shaft ø 6x4.6mm shaft flat vertical universal		
<b>For models:</b>	DE06EC, DE102EC, DE10EC, DG06EC, DG102EC, DG10EC, SH510P, VE06EC, VE102EC, VE10EC, VE20EC, VG06EC, VG102EC, VG10EC, VG20EC		

accessories

button springs

			
1			
<b>GEV No.</b>	551317	<b>Ref. No.</b>	5900253
<b>description</b>	knob spring		
<b>accessories for</b>	551317		
	<b>GEV No.</b>	111508	<b>Ref. No.</b> 2006823
knob switch zero mark ø 50mm shaft ø 6x4.6mm shaft flat left white			

			
1			
<b>GEV No.</b>	550965	<b>Ref. No.</b>	5900242
<b>description</b>	knob spring ø 6x4.6mm Qty 1 pcs		
<b>For models:</b>	BME46, BME66, CPE66, FRE46, FRE46F, FRE46R, FRE46T, FRE66, FRE66F, FRE66R, FRE66T, FTE100, FTE107, FTE46, FTE46B, FTE46R, FTE47L, FTE66L, FTE66LB, FTE66LM, FTE66LMB, FTE66R, FTE66RM, FTE67L, FTE67LM, PCE46, PCE66M, PCE66T, PCG46, PCG66, SPE46		

handles and hand wheels

cylindrical handles

fixed

			
1			
<b>GEV No.</b>	540713	<b>Ref. No.</b>	5900235
<b>description</b>	cylindrical handle thread M8 ø 17mm L 38mm		
<b>For models:</b>	BME46, BME66, FP18NS, FP18S, FP27S, FPG18, FRE46, FRE46F, FRE46T, FRE66, FRE66F, FRE66T, FRG46, FRG66		

			
1			
<b>GEV No.</b>	691314	<b>Ref. No.</b>	2001110
<b>description</b>	cylindrical handle thread M8 ø 28mm L 86mm		
<b>For models:</b>	15FE, 15FEC, 20FE, 20FEC, 210FE, 210FEC, 215FE, 215FEC, 220FE, 220FEC, 920FE, 920FEC, 922FE, 922FEC, 940FE, 940FEC, F10CL, F10L, F15CL, F15L, F215CL, F215L		

levers

without handle

			
1			
<b>GEV No.</b>	540712	<b>Ref. No.</b>	2108943
<b>description</b>	lever		
<b>For models:</b>	BME46, BME66, FP18S, FP27S, FPG18, FRE46, FRE46F, FRE46T, FRE66, FRE66F, FRE66T, FRG46, FRG66		

## locks

### handle latches





#### universal

#### outside fixing

#### locks



1

<b>GEV No.</b>	694065	<b>Ref. No.</b>	5900125
<b>description</b>	door handle for headed units L 145mm W 40mm H 62mm spring length 33mm outer black		
<b>spare parts for</b>	694065		
	<b>GEV No.</b>	514390	<b>Ref. No.</b> —
	spring for door handle ø 6mm L 54mm W 27.5mm		
	<b>GEV No.</b>	694734	<b>Ref. No.</b> —
	door handle L 165mm W 40mm H 25mm black		
	<b>GEV No.</b>	694735	<b>Ref. No.</b> —
	cap ø 32mm black		
<b>accessories for</b>	694065		
	<b>GEV No.</b>	694066	<b>Ref. No.</b> —
	door catch with spigot 2-stage L 28mm W 14mm H 15mm H1 16mm total length 51mm thread M8 thread L 23mm stainless steel		
	<b>GEV No.</b>	694067	<b>Ref. No.</b> 5900124
	door catch with spigot 1-stage L 26mm total length 51mm thread M8		

### snap locks

#### universal



1

<b>GEV No.</b>	690596	<b>Ref. No.</b>	2000160
<b>description</b>	snap lock L 60mm W 15mm H 36mm mounting distance 48/28mm spring thickness 1.5mm complete with door catch zamak		

## espagnolette locks

#### universal



1

<b>GEV No.</b>	690040	<b>Ref. No.</b>	5900122
<b>description</b>	door catch with roller H 42mm L 40mm W 40mm zinc die cast mounting distance 26mm type 0751 series		
<b>For models:</b>	CE06MX, CE102MX, CE10MX, CE20MX, CG06MX, CG102MX, CG10MX, CG20MX, DE06EC, DE06ES, DE06MX, DE102EC, DE102MX, DE10EC, DE10ES, DE10MX, DG06EC, DG06ES, DG06MX, DG102EC, DG102MX, DG10EC, DG10ES, DG10MX, VE06EC, VE06MX, VE102EC, VE102MX, VE10EC, VE10MX, VE20EC, VE20MX, VG06EC, VG06MX, VG102EC, VG102MX, VG10EC, VG10MX, VG20EC, VG20MX		



1

<b>GEV No.</b>	700771	<b>Ref. No.</b>	5900123
<b>description</b>	latch gear opening to the left shaft intake ø 8x8mm L 170mm W 40mm H 40mm		

#### producer-specific

#### GIORIK



1

<b>GEV No.</b>	690585	<b>Ref. No.</b>	2011212
<b>description</b>	bush for door mechanism L 35mm ED ø 36mm int. ø 1 31mm int. ø 2 13mm mounting distance 28mm brass		
<b>For models:</b>	CE06MX, CE102MX, CE10MX, CE20MX, CG06MX, CG102MX, CG10MX, CG20MX, DE06EC, DE06ES, DE06MX, DE102EC, DE102MX, DE10EC, DE10ES, DE10MX, DG06EC, DG06ES, DG06MX, DG102EC, DG102MX, DG10EC, DG10ES, DG10MX, VE06EC, VE06MX, VE102EC, VE102MX, VE10EC, VE10MX, VE20EC, VE20MX, VG06EC, VG06MX, VG102EC, VG102MX, VG10EC, VG10MX, VG20EC, VG20MX		



1

<b>GEV No.</b>	690040	<b>Ref. No.</b>	5900122
<b>description</b>	door catch with roller H 42mm L 40mm W 40mm zinc die cast mounting distance 26mm type 0751 series		
<b>For models:</b>	CE06MX, CE102MX, CE10MX, CE20MX, CG06MX, CG102MX, CG10MX, CG20MX, DE06EC, DE06ES, DE06MX, DE102EC, DE102MX, DE10EC, DE10ES, DE10MX, DG06EC, DG06ES, DG06MX, DG102EC, DG102MX, DG10EC, DG10ES, DG10MX, VE06EC, VE06MX, VE102EC, VE102MX, VE10EC, VE10MX, VE20EC, VE20MX, VG06EC, VG06MX, VG102EC, VG102MX, VG10EC, VG10MX, VG20EC, VG20MX		



1

<b>GEV No.</b>	690584	<b>Ref. No.</b>	2013218
<b>description</b>	door handle L 190mm W 41.5mm metal mounting distance 55mm flange 45x72mm shaft 8x8mm shaft L 47mm		

**miscellaneous**



1

<b>GEV No.</b>	511482	<b>Ref. No.</b>	2006619
<b>description</b>	pressure pin L 52mm thread M10x1.5		
<b>For models:</b>	EF10GM, EF4PM, EF5GM, EF6PM, EF7GM, EF8PM, EN10VE-EC-ESN1033, GF10GM, GF4PM, GF5GM, GF6PM, GF7GM, GF8PM		

**producer-specific**

**GIORIK**



1

<b>GEV No.</b>	540700	<b>Ref. No.</b>	7060018	
<b>description</b>	ball valve straight thread 1/2" IT - 1/2" IT connection 1/2" mounting pos. total length 64mm shaft intake ø 9x7.5mm 1/2" rosette thread G2 3/8" total length 64mm			
<b>For models:</b>	22CP, 22CPG, 23CP, 23CPG, 2CP, 2CPG, 3CP, 3CPG, BM711, BM721, BM911, BM921, CP1, CP1BM, CPE66, CPG1, CPG1BM, CPG66			
<b>spare parts for</b>	540700			
	<b>GEV No.</b>	540701	<b>Ref. No.</b>	2001250
	lever handle plastic L 65mm H 40mm thread connection 9x7.5			



1

<b>GEV No.</b>	514006	<b>Ref. No.</b>	7060060
<b>description</b>	drain pipe L 200mm thread ø 22mm		
<b>For models:</b>	BME46, BME66, FP18NS, FP18S, FP27S, FPG18, FRE46, FRE46F, FRE46R, FRE46T, FRE66, FRE66F, FRE66R, FRE66T, FRG46, FRG66		



1

<b>GEV No.</b>	540701	<b>Ref. No.</b>	2001250
<b>description</b>	lever handle plastic L 65mm H 40mm thread connection 9x7.5		
<b>For models:</b>	22CP, 22CPG, 23CP, 23CPG, 2CP, 2CPG, 3CP, 3CPG, CP1, CP1BM, CPE66, CPG1, CPG1BM, CPG66		



1

<b>GEV No.</b>	540776	<b>Ref. No.</b>	7060030	
<b>description</b>	outlet tap L 83mm without handle thread 3/4" IT shaft L 9mm shaft ø 10x7.3mm handle M6			
<b>For models:</b>	BME46, BME66, FP18NS, FP18S, FP27S, FPG18, FRE46, FRE46F, FRE46R, FRE46T, FRE66, FRE66F, FRE66R, FRE66T, FRG46, FRG66			
<b>spare parts for</b>	540776			
	<b>GEV No.</b>	532453	<b>Ref. No.</b>	—
	O-ring EPDM thickness 2.62mm ID ø 21.89mm Qty 1 pcs			

Table continues overleaf

**fittings for catering equipment**

**outlet taps**

**universal**

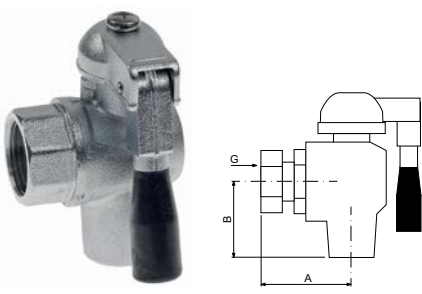

1

<b>GEV No.</b>	541540	<b>Ref. No.</b>	7060031	
<b>description</b>	outlet tap stainless steel W 38mm H 40mm thread 3/4" IT			
<b>For models:</b>	FTR10, FTR26F, FTR26T, FTR6F, FTR6T			
<b>spare parts for</b>	541540			
	<b>GEV No.</b>	697834	<b>Ref. No.</b>	—
	cone handle thread M6x1 ø 13mm plastic L 53mm black thread L 6mm			





<b>accessories for</b> 540776				
	<b>GEV No.</b>	110734	<b>Ref. No.</b>	—
	lever for outlet tap			
	<b>GEV No.</b>	514006	<b>Ref. No.</b>	7060060
	drain pipe L 200mm thread ø 22mm			
	<b>GEV No.</b>	514217	<b>Ref. No.</b>	—
	handle for outlet tap			
	<b>GEV No.</b>	540651	<b>Ref. No.</b>	—
	drain pipe total length 210mm shaft ø 22mm			
	<b>GEV No.</b>	540734	<b>Ref. No.</b>	—
	drain pipe thread			
	<b>GEV No.</b>	693082	<b>Ref. No.</b>	—
	lever handle thread			

**baskets**

**fryer baskets**

**GIORIK**

				
1				
<b>GEV No.</b>	970583	<b>Ref. No.</b>	2003018	
<b>description</b>	fryer basket L1 260mm W1 220mm H1 100mm chrome-plated steel			
<b>For models:</b>	FT5			

				
1				
<b>GEV No.</b>	970577	<b>Ref. No.</b>	2004579	
<b>description</b>	fryer basket L1 270mm W1 185mm H1 120mm chrome-plated steel			
<b>For models:</b>	FRE46F, FRE46T, FRE66F, FRE66T, FTR26F, FTR26T, FTR6F, FTR6T			

				
1				
<b>GEV No.</b>	970138	<b>Ref. No.</b>	2003001	
<b>description</b>	fryer basket L1 290mm W1 135mm H1 120mm L2 490mm H2 175mm H3 220mm chrome-plated steel			
<b>For models:</b>	F10CL, F10L, FG07CL, FG07L			

				
1				
<b>GEV No.</b>	970357	<b>Ref. No.</b>	2003008	
<b>description</b>	fryer basket L1 290mm W1 165mm H1 120mm chrome-plated steel			

				
1				
<b>GEV No.</b>	970356	<b>Ref. No.</b>	2003003	
<b>description</b>	fryer basket L1 290mm W1 230mm H1 120mm chrome-plated steel			
<b>For models:</b>	F15CL, F15L, F215CL, F215L, FG13L, FG213CL, FG213L, FRE46, FRE66, FRG46, FRG66			

				
1				
<b>GEV No.</b>	970642	<b>Ref. No.</b>	2010899	
<b>description</b>	fryer basket L1 290mm W1 230mm H1 120mm L2 240mm H2 200mm H3 200mm			
<b>For models:</b>	FTR10			

				
1				
<b>GEV No.</b>	970358	<b>Ref. No.</b>	2003009	
<b>description</b>	fryer basket L1 290mm W1 330mm H1 120mm L2 507mm H2 175mm H3 220mm chrome-plated steel			



1

<b>GEV No.</b>	970360	<b>Ref. No.</b>	2012892
<b>description</b>	fryer basket L1 310mm W1 110mm H1 120mm chrome-plated steel		
<b>For models:</b>	213FG, 213FGC, 215FE, 215FEC		



1

<b>GEV No.</b>	970359	<b>Ref. No.</b>	2012898
<b>description</b>	fryer basket L1 310mm W1 130mm H1 120mm chrome-plated steel		
<b>For models:</b>	207FG, 207FGC, 210FE, 210FEC, 922FE, 922FEC, 927FG, 927FGC		
<b>accessories for</b>	970359		
	<b>GEV No.</b>	970632	<b>Ref. No.</b> 2012897
	crumb screen L 338mm W 134mm H 100mm		



1

<b>GEV No.</b>	970362	<b>Ref. No.</b>	2012895
<b>description</b>	fryer basket L1 310mm W1 145mm H1 120mm chrome-plated steel		
<b>For models:</b>	217FG, 217FGC, 220FE, 220FEC, 934FG, 934FGC, 940FE, 940FEC		



1

<b>GEV No.</b>	970361	<b>Ref. No.</b>	2012893
<b>description</b>	fryer basket L1 310mm W1 230mm H1 120mm chrome-plated steel		
<b>For models:</b>	13FG, 13FGC, 15FE, 15FEC, 213FG, 213FGC, 215FE, 215FEC		



1

<b>GEV No.</b>	970363	<b>Ref. No.</b>	2012896
<b>description</b>	fryer basket L1 310mm W1 300mm H1 120mm chrome-plated steel		
<b>For models:</b>	17FG, 17FGC, 20FE, 20FEC, 217FG, 217FGC, 220FE, 220FEC, 917FG, 917FGC, 920FE, 920FEC, 934FG, 934FGC, 940FE, 940FEC		



1

<b>GEV No.</b>	970727	<b>Ref. No.</b>	2003019
<b>description</b>	fryer basket L1 315mm W1 190mm H1 120mm FT7		

pasta baskets

GIORIK



1

<b>GEV No.</b>	970776	<b>Ref. No.</b>	2003080
<b>description</b>	pasta basket H1 210mm ø 145mm H2 320mm H3 370mm stainless steel		



1

<b>GEV No.</b>	970770	<b>Ref. No.</b>	2003046
<b>description</b>	pasta basket H1 215mm W1 290mm L1 160mm H2 410mm		

1

<b>GEV No.</b>	970675	<b>Ref. No.</b>	2101603 3101603
<b>description</b>	pasta basket H1 215mm W1 290mm L1 490mm size GN 1/1		



1

<b>GEV No.</b>	970587	<b>Ref. No.</b>	2003080 old
<b>description</b>	pasta basket ø 145mm H 230mm stainless steel handle length 180mm		



1

<b>GEV No.</b>	970672	<b>Ref. No.</b>	2003047
<b>description</b>	pasta basket H1 230mm W1 143mm L1 160mm size GN 1/6 left		



1

<b>GEV No.</b>	691314	<b>Ref. No.</b>	2001110
<b>description</b>	cylindrical handle thread M8 ø 28mm L 86mm		
<b>For models:</b>	15FE, 15FEC, 20FE, 20FEC, 210FE, 210FEC, 215FE, 215FEC, 220FE, 220FEC, 920FE, 920FEC, 922FE, 922FEC, 940FE, 940FEC, F10CL, F10L, F15CL, F15L, F215CL, F215L		

crumb screens



1

<b>GEV No.</b>	970671	<b>Ref. No.</b>	2003045
<b>description</b>	pasta basket H1 230mm W1 143mm L1 163mm size GN 1/6 right		

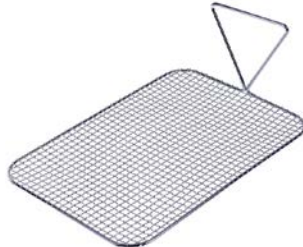

1

<b>GEV No.</b>	970628	<b>Ref. No.</b>	2104581
<b>description</b>	crumb screen L 285mm W 192mm H 100mm		
<b>For models:</b>	FRE46F, FRE46T, FRE66F, FRE66T, FTR26F, FTR26T, FTR6F, FTR6T		



1

<b>GEV No.</b>	970674	<b>Ref. No.</b>	2003075
<b>description</b>	pasta basket H1 230mm W1 300mm L1 330mm size GN 2/3		



1

<b>GEV No.</b>	970629	<b>Ref. No.</b>	2101364
<b>description</b>	crumb screen L 315mm W 235mm		
<b>For models:</b>	F15CL, F15L, F215CL, F215L, FG13L, FG213CL, FG213L, FRE46, FRE66, FRG46, FRG66		

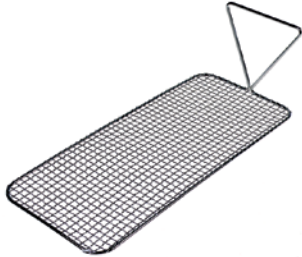

<b>GEV No.</b>	970632	<b>Ref. No.</b>	2012897
<b>description</b>	crumb screen L 338mm W 134mm H 100mm		
<b>For models:</b>	207FG, 207FGC, 210FE, 210FEC, 922FE, 922FEC, 927FG, 927FGC		

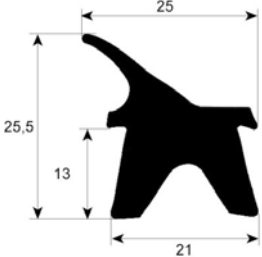

<b>GEV No.</b>	901351	<b>Ref. No.</b>	7070173
<b>description</b>	door seal profile 2402 W 490mm L 635mm external size		

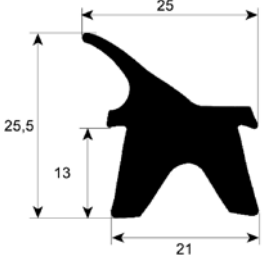

<b>GEV No.</b>	901158	<b>Ref. No.</b>	7070174
<b>description</b>	door seal profile 2402 W 640mm L 740mm		
<b>For models:</b>	EN10VE-EC-ESN1033		



<b>GEV No.</b>	902409	<b>Ref. No.</b>	7070100
<b>description</b>	door seal profile 2714 Qty supplied by meter suitable for GIORIK		

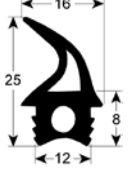

<b>GEV No.</b>	902410	<b>Ref. No.</b>	7070194
<b>description</b>	door seal profile 2714 W 438mm L 778mm suitable for GIORIK		

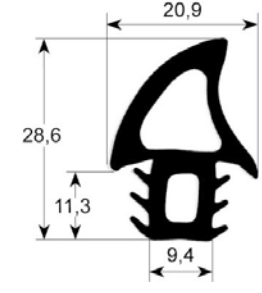

<b>GEV No.</b>	900439	<b>Ref. No.</b>	7070166
<b>description</b>	door seal profile 2750 Qty supplied by meter		
<b>For models:</b>	CE06MX, CE102MX, CE10MX, CE20MX, CG06MX, CG102MX, CG10MX, CG20MX, DE06EC, DE06ES, DE06MX, DE102EC, DE102MX, DE10EC, DE10ES, DE10MX, DG06EC, DG06ES, DG06MX, DG102EC, DG102MX, DG10EC, DG10ES, DG10MX, VE06EC, VE06MX, VE102EC, VE102MX, VE10EC, VE10MX, VE20EC, VE20MX, VG06EC, VG06MX, VG102EC, VG102MX, VG10EC, VG10MX, VG20EC, VG20MX		

**gaskets**

**gaskets for heated units**

**window seals**

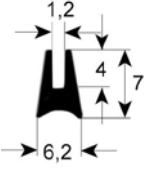

<b>GEV No.</b>	900440	<b>Ref. No.</b>	7070167
<b>description</b>	window gasket profile 1520 Qty supplied by meter		
<b>For models:</b>	CE06MX, CE102MX, CE10MX, CE20MX, CG06MX, CG102MX, CG10MX, CG20MX, DE06EC, DE06MX, DE102EC, DE102MX, DE10EC, DE10MX, DG06EC, DG06MX, DG102EC, DG102MX, DG10EC, DG10MX, VE06EC, VE06MX, VE102EC, VE102MX, VE10EC, VE10MX, VE20EC, VE20MX, VG06EC, VG06MX, VG102EC, VG102MX, VG10EC, VG10MX, VG20EC, VG20MX		

**door seals**

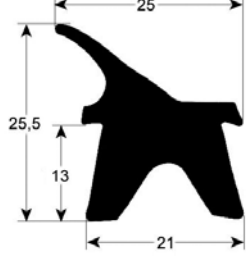

<b>GEV No.</b>	900348	<b>Ref. No.</b>	7070162 7070170 7070172 7070185
<b>description</b>	door seal profile 2402 Qty supplied by meter		
<b>For models:</b>	EF10GM, EF4, EF4PM, EF5GM, EF8PM, GF10GM, GF4PM, GF5GM, GF8PM		



O-rings

EPDM



<b>GEV No.</b>	100809	<b>Ref. No.</b>	0925034
<b>description</b>	O-ring EPDM thickness 2mm ID ø 21mm Qty 1 pcs		

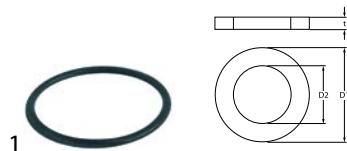

<b>GEV No.</b>	532118	<b>Ref. No.</b>	6090145
<b>description</b>	O-ring EPDM thickness 3.53mm ID ø 55.56mm Qty 10 pcs		
<b>For models:</b>	15FE, 15FEC, 20FE, 20FEC, 210FE, 210FEC, 215FE, 215FEC, 220FE, 220FEC, 920FE, 920FEC, 922FE, 922FEC, 940FE, 940FEC, F10CL, F10L, F15CL, F15L, F215CL, F215L, FP18NS, FP18S, FP27S, FRE46, FRE66		

Viton

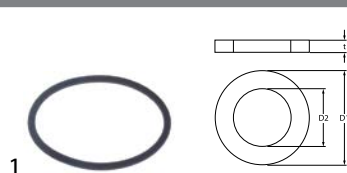

<b>GEV No.</b>	525313	<b>Ref. No.</b>	6090140
<b>description</b>	O-ring Viton ID ø 60.33mm thickness 3.53mm Qty 1 pcs		
<b>For models:</b>	EF10GM, EF4PM, EF5GM, EF6PM, EF7GM, EF8PM, GF10GM, GF4PM, GF5GM, GF6PM, GF7GM, GF8PM		

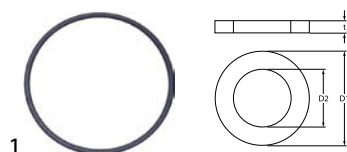

<b>GEV No.</b>	532649	<b>Ref. No.</b>	6090141
<b>description</b>	O-ring Viton ID ø 63.17mm thickness 2.62mm Qty 1 pcs		
<b>For models:</b>	EF10GM, EF4PM, EF5GM, EF6PM, EF7GM, EF8PM, GF10GM, GF4PM, GF5GM, GF6PM, GF7GM, GF8PM		



<b>GEV No.</b>	550496	<b>Ref. No.</b>	6090144
<b>description</b>	O-ring Viton thickness 3.53mm ID ø 50.39mm Qty 1 pcs		
<b>For models:</b>	15FE, 15FEC, 20FE, 20FEC, 210FE, 210FEC, 215FE, 215FEC, 220FE, 220FEC, 920FE, 920FEC, 922FE, 922FEC, 940FE, 940FEC, F10CL, F10L, F15CL, F15L, F215CL, F215L, FP18NS, FP18S, FP27S, FRE46, FRE66		

shaft gaskets

shaft gaskets



<b>GEV No.</b>	550549	<b>Ref. No.</b>	7070150
<b>description</b>	shaft sealing for fan motor		
<b>For models:</b>	CE06MX, CG06MX, DE06EC, DE06ES, DE06MX, DG06EC, DG06ES, DG06MX, VE06EC, VE06MX, VG06EC, VG06MX		



<b>GEV No.</b>	550550	<b>Ref. No.</b>	7070151
<b>description</b>	shaft sealing for fan motor		
<b>For models:</b>	CE102MX, CE10MX, CE20MX, CG102MX, CG10MX, CG20MX, DE102EC, DE102MX, DE10EC, DE10ES, DE10MX, DG102EC, DG102MX, DG10EC, DG10ES, DG10MX, VE102EC, VE102MX, VE10EC, VE10MX, VE20EC, VE20MX, VG102EC, VG102MX, VG10EC, VG10MX, VG20EC, VG20MX		

hoses

industrial hoses

PE hoses

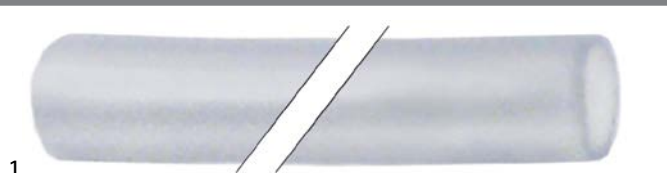

<b>GEV No.</b>	520549 <sup>1</sup>	<b>Ref. No.</b>	7090128
<b>description</b>	hose Lm operating p. 6bar burst p. 10bar t.max. 65°C LLDPE transparent ID ø 6mm ED ø 8mm John Guest supplied by meter		

<sup>1</sup>by the meter

fittings, hose and pipe connectors

fittings

angle pieces



<b>GEV No.</b>	520824	<b>Ref. No.</b>	7050374
<b>description</b>	angle piece thread 1/8" ET - 1/8" IT nickel-plated brass		

tools

hand tools

wrenches

miscellaneous



1

<b>GEV No.</b>	550449	<b>Ref. No.</b>	2010311
<b>description</b>	special wrench for ring nut		

<b>A</b>		<b>I</b>	
alarm devices	19	ignition boxes	33
axial fans	25	ignition cables	38
<b>B</b>		ignition units	39
bar burners	41	immersion heating elements	8
<b>C</b>		indicator lights	17
cam switches	15	indicator lights (complete)	17
ceramic burners	43	industrial hoses	53
condensators & interference suppression filters	27	<b>L</b>	
contactors	20	lamps	17
control thermostats	10	light bulbs	17
<b>D</b>		<b>M</b>	
door seals	52	mechanical timers	19
<b>E</b>		microswitches	14
electric accessories	27	<b>O</b>	
electric timers	19	O-rings	53
electronic controllers	22	oven lamps	18
energy regulators	10	<b>P</b>	
espagnolette locks	47	PE hoses	53
<b>F</b>		piezoelectric igniters	39
fans	25	pilot burners	33
filters	27	probes	22
fittings	53	push/momentary push switches	13
<b>G</b>		<b>R</b>	
gas burners	40	radiation heaters	9
gas control valves	32	relays	20
gas nozzles	43	rod thermostats	13
gas taps	28	rotary switches	16
gas thermostats	29	<b>S</b>	
gaskets for heated units	52	safety rod thermostats	13
<b>H</b>		safety thermostats	11
halogen lamp	18	shaft gaskets	53
hand tools	54	snap locks	47
heating elements	3	solenoid valves	24
heating elements for bain maries	3	switches and momentary switches	13
heating elements for chip scuttles	3	<b>T</b>	
heating elements for convection	9	temperature probes	22
heating elements for fryers	3	terminals	27
heating elements for pasta cookers	6	thermocouples	39
heating elements for salamanders/toasters	6	thermostats	10
hob burners	40	time relays	21
hoses	53	timers	19
hot air motors	26	tools	54
hot plates	10	transformers	21
		tube burners	42

**U**

universal probes 22

**W**

window seals 52

wrenches 54