



GAS COMPONENTS



ELECTRIC COMPONENTS



WATER TECHNOLOGY



MECHANICAL COMPONENTS



TOOLS

Spare parts suitable for

GRANDIMPIANTI

Find the complete and up-to-date range of products in our GEV Webshop



Manufacturer catalogue

The most important spare parts and accessories arranged clearly for every manufacturer

- ✓ Complete product range and all appliance data always up to date in the GEV Webshop
- ✓ Alphabetical Index at the end of the catalogue

GEV Webshop

www.gev-online.co.uk

www.gev-online.com





- 🔍 Add to Favourites
- 🔍 Sign In with email address and usual password
- 🔍 Easy-order – place several items in your basket at the same time
- 🔍 Quick Item search – no login needed



heating elements

heater battery

			
1			
GEV No.	415122	Ref. No.	52AD0000005
description	heater battery mounting distance 185mm W 40mm H 35mm 2000W 230V temperature restriction 105°C heating circuits 2 connection cable cable length 340mm L 197mm for cross flow fan		

			
1			
GEV No.	420227	Ref. No.	GR380001622500
description	heater battery W 229mm H 40mm 1700W 230V connection coded plug cable length 400mm laundry technology L 198mm		

heating rods

			
1			
GEV No.	420190	Ref. No.	GR54-GI-651118
description	heating element 1500W 220V connection bracket mounting L 975mm W 37mm H 5mm laundry technology		

			
1			
GEV No.	420191	Ref. No.	GR54-GI-651122
description	heating element 1800W 220V connection bracket mounting L 1175mm W 37mm H 5mm laundry technology		

immersion heating elements

with expansion flange 70 x 18mm

			
1			
GEV No.	420242	Ref. No.	GR422090011601
description	heating element 1400W 220V heating circuits 1 flange 70x18mm L 260mm W 71mm H 20mm L1 20mm L2 15mm L3 225mm tube ø 8.3mm connection male faston 6.3mm immersion heater expansion flange laundry technology		

			
1			
GEV No.	419156	Ref. No.	422090002401 GR50-GI-851112
description	heating element 2000W 230V heating circuits 1 flange 70x18mm L 210mm W 60mm H 16mm L1 26mm L2 14mm L3 170mm tube ø 8.5mm connection male faston 6.3mm immersion heater connection length 25mm expansion flange for washing machine		

			
1			
GEV No.	419219	Ref. No.	4PR342000028
description	heating element 3000W 230V heating circuits 1 flange 70x18mm L 260mm W 65mm connection male faston 6.3mm tube ø 8.5mm immersion heater		

			
1			
GEV No.	419050	Ref. No.	GR50-GI-851113
description	heating element 3000W 230V heating circuits 1 flange 70x18mm L 280mm W 60mm H 16mm L1 26mm L2 14mm L3 250mm tube ø 8.5mm connection male faston 6.3mm immersion heater connection length 25mm expansion flange for washing machine		

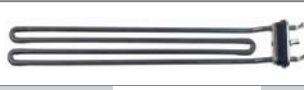
			
1			
GEV No.	419227	Ref. No.	50GI851116
description	heating element 4000W 240V heating circuits 1 flange 70x18mm L 440mm W 60mm tube ø 8mm connection male faston 6.3mm		

heating elements for convection

			
1			
GEV No.	417658	Ref. No.	GR50-GI-951041
description	heating element 2000W 230V L 500mm W 86mm connection male faston 6.3mm		

thermostats

bi-metal thermostats

bi-metal thermostats

			
1			
GEV No.	390811	Ref. No.	GR52-SQ0504518
description	bi-metal thermostat hole distance 41mm switch-off temp. 69°C connection F6.3		



control and safety thermostats

EGO

control thermostats

55.40_ series

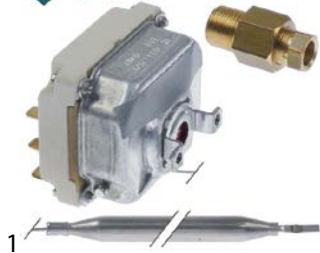

GEV No.	390819	Ref. No.	GR50-GI-851045
description	thermostat temperature range fixed°C 4-pole probe ø 8mm probe L 98mm capillary pipe 1500mm capillary pipe isolatedmm gland nut M14x1		

IMIT / TEMPOMATIC / ARTHERMO

safety thermostats



GEV No.	391051	Ref. No.	GR540751000028
description	safety thermostat switch-off temp. 235°C 1-pole 1CO probe ø 5mm probe L 68mm capillary pipe 1600mm 250V		

PRODIGY / FIRT

control thermostats

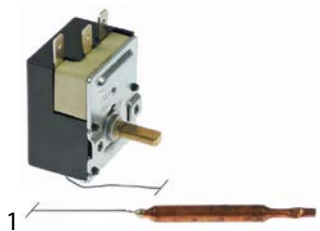

GEV No.	390820	Ref. No.	GR54-GI-751021
description	thermostat t.max. 220°C temperature range 40-220°C 1-pole 1CO 16A probe ø 6.5mm probe L 65mm capillary pipe 1500mm shaft ø 6x4.6mm shaft L 19mm shaft position lower° rotation 318° 250V contacts male faston 6.3mm		

various

control thermostats

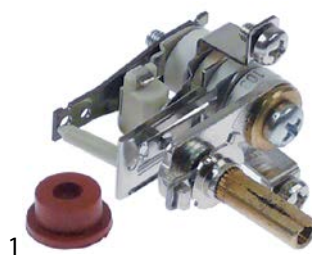

GEV No.	390827	Ref. No.	GR59-SI-100089
description	thermostat laundry technology		



GEV No.	390826	Ref. No.	1020089
description	thermostat t.max.°C temperature range°C 1-poleA probe ømm probe Lmm capillary pipemm capillary pipe isolatedmm gland nut shaft ø 6x4.6mm shaft L 16mm shaft position left outer switch 315 laundry technology		

safety thermostats



GEV No.	390798	Ref. No.	540751000028 GR540751000028 old version
description	safety thermostat switch-off temp. 235°C 1-pole 1CO probe ø 6mm probe L 63mm capillary pipe 1600mm capillary pipe isolated 80mm		

switches and momentary switches



rocker/momentary rocker switches

30x22mm



GEV No.	345163	Ref. No.	50GI851143
description	momentary rocker switch mounting measurements 30x22mm orange 2CO 250V 16A illuminated connection male faston 6.3mm ambient temperature max. 100/55°C protection IP40		



blank			
			
1			
GEV No.	347675	Ref. No.	GR50GI851145
description	momentary rocker switch mounting measurements 30x22mm green 2CO 250V 16A illuminated connection male faston 6.3mm ambient temperature max. 125/55°C protection IP65 with cover cap		
accessories for	347675		
			
GEV No.	301036	Ref. No.	—
description	protective cover internal size 30x22mm for rocker switch mounting measurementsmm		

position switches

CROUZET			
			
1			
GEV No.	347707	Ref. No.	GR422090025500
description	position switch with spring 1CO L 145mm W 25mm H 27mm		

TELEMECANIQUE (EFA)

			
1			
GEV No.	347732	Ref. No.	GR650000001700
description	position switch L 60mm W 64mm H 27mm protection IP66 type XCK-M		

timers

programme timers

			
1			
GEV No.	360547	Ref. No.	GR380001212100
description	timer AKO 514 engines 1 chambers 14 operation time 230V 50Hz shaft ø 6x4.6mm shaft L 25mm manuf. no. 38334034205		

mechanical timers

			
1			
GEV No.	350150	Ref. No.	GR50-GI-951006
description	timer M2 2-pole operation time 60min impulse mechanical 2NO at 250V 16A permanent position no shaft 3.5x3.5mm shaft L 17mm mounting distance 28mm mounting thread M4		

contactors

TELEMECANIQUE (Schneider Electric)

power contactors

			
1			
GEV No.	380513	Ref. No.	GR50-851000250 old version
description	contactor resistive load 20A 230VAC (AC3/400V) 9A/4kW main contacts 3NO auxiliary contacts 1NC connection screw connection type DPE 09		

			
1			
GEV No.	380479	Ref. No.	GR50-851000250
description	power contactor resistive load 25A 230VAC (AC3/400V) 9A/4kW main contacts 3NO auxiliary contacts 1NO/1NC connection screw connection type LC1D09P7		



transformers

open transformers

with clamp terminal



1

GEV No.	402787	Ref. No.	50-851000283 GR50-851000283
description	transformer primary 230/400/415/440V secondary 0-230VAC secondary 0-16V 50VA		

electronic controllers

EVCO - EVERY CONTROL

universal controllers

built-in version



1

GEV No.	379833	Ref. No.	GR65000000100
description	electronic controller EVERY CONTROL mounting measurements 71x29mm 12/24V voltage AC/DC TC/J 0 to +70°C display 3 digits type FK400A		

electronics

EPROMS



1

GEV No.	403113	Ref. No.	GR50-851000089
description	EPROM for washing machine		

PCBs



1

GEV No.	403110	Ref. No.	GR54060100022
description	display PCB for rotary iron L 135mm W 135mm		



1

GEV No.	403127	Ref. No.	GR54060100024
description	display PCB for rotary iron L 135mm W 135mm		



1

GEV No.	403129	Ref. No.	GR50-851000130
description	display PCB for washing machine L 100mm W 20mm		



1

GEV No.	403112	Ref. No.	GR422090027502
description	keypad PCB for washing machine L 150mm W 100mm buttons 4		



1

GEV No.	403137	Ref. No.	GR50-851000085 GR50851000113
description	keypad PCB for washing machine L 150mm W 100mm buttons 4		

1

GEV No.	403111	Ref. No.	GR50-GI-961025
description	keypad PCB L 174mm W 150mm with display buttons 4		



1

GEV No.	403128	Ref. No.	GR50-851000090
description	relay PCB for washing machine L 150mm W 70mm		



1

GEV No.	403080	Ref. No.	530751000032 GR530751000032
description	relay PCB washing machine L 81mm W 73mm		

keypads

membrane keypads



1

GEV No.	511934	Ref. No.	GR50-GI-951029
description	keypad foil for tumble dryer buttons 7 L 136mm W 88mm		



1

GEV No.	511935	Ref. No.	GR50-851000070
description	keypad foil for washing machine buttons 7 grey L 200mm W 110mm		

keypad units



1

GEV No.	403126	Ref. No.	GR50-851000028
description	keypad unit for washing machine buttons 16 L 180mm W 130mm		

solenoid valves

solenoid valves (water)

RPE



1

GEV No.	374016	Ref. No.	50GI851201
description	solenoid valve single angled 230VAC inlet 3/4" outlet 13mm DN10 duty cycle 100% RPE polyamide		



1

GEV No.	371148	Ref. No.	GR50-GI-851207
description	solenoid valve triple 230VAC inlet 3/4" outlet 13mm DN10 RPE		

solenoid valves with reducers

4-fold



GEV No.	371147	Ref. No.	GR50-GI-851205
description	solenoid valve 4-fold 230VAC inlet 3/4" outlet 14mm DN10 RPE pressure range 0.2-10bar		

TP



GEV No.	370020	Ref. No.	50GI851200
description	solenoid valve double angled 230VAC inlet 3/4" outlet 14mm DN10 TP		

spare parts for	370020		
	GEV No.	371013	Ref. No. —
	solenoid coil TP 230VAC 50/60Hz		

accessories for	370020		
	GEV No.	371220	Ref. No. —
	reducer TP flow rate 3l/min red tolerance ±15%		
	GEV No.	371221	Ref. No. —
	reducer TP flow rate 5.5l/min yellow tolerance ±15%		
	GEV No.	371222	Ref. No. —
	reducer TP flow rate 6l/min grey tolerance ±15%		
	GEV No.	371223	Ref. No. —
	reducer TP flow rate 10l/min white tolerance ±15%		
	GEV No.	371224	Ref. No. —
	reducer TP flow rate 12l/min bronze tolerance ±15%		
	GEV No.	371225	Ref. No. —
	reducer TP flow rate 16l/min light brown tolerance ±15%		
	GEV No.	371226	Ref. No. —
	reducer TP flow rate 20l/min red tolerance ±15%		
	GEV No.	371230	Ref. No. —
	reducer TP flow rate 0.25l/min red tolerance ±25%		
	GEV No.	371231	Ref. No. —
	reducer TP flow rate 0.35l/min violet tolerance ±25%		
	GEV No.	371232	Ref. No. —
	reducer TP flow rate 0.5l/min orange tolerance ±25%		
	GEV No.	371233	Ref. No. —
	reducer TP flow rate 0.8l/min white tolerance ±25%		

accessories for	370020		
	GEV No.	371234	Ref. No. —
	reducer TP flow rate 1l/min light blue tolerance ±25%		
	GEV No.	371235	Ref. No. —
	reducer TP flow rate 1.2l/min brown tolerance ±25%		
	GEV No.	371236	Ref. No. —
	reducer TP flow rate 1.5l/min light brown tolerance ±25%		
	GEV No.	371237	Ref. No. —
	reducer TP flow rate 2.5l/min yellow tolerance ±25%		
	GEV No.	371238	Ref. No. —
	reducer TP flow rate 3.4l/min dark green tolerance ±25%		
	GEV No.	371239	Ref. No. —
	reducer TP flow rate 5l/min black tolerance ±25%		
	GEV No.	371240	Ref. No. —
	reducer TP flow rate 8l/min blue tolerance ±20%		

metal

M&M

2-way

B204/205/206 series



GEV No.	370076	Ref. No.	50GI851194
description	solenoid valve 2-ways 230VAC connection 3/4" L 82mm DN 25mm slide-on receptacle compact -10 up to +90°C M&M type series B204/205/206 coil type 2700 membranes NBR (water) p max 16bar p min 0.3bar		

spare parts for	370076		
	GEV No.	371022	Ref. No. —
	solenoid coil M&M 230VAC 10VA 50Hz coil type 2700 seat ø 10mm		

accessories for	370076		
	GEV No.	371091	Ref. No. —
	power socket plug type DIN 43650B cable lengthmm small		



SIRAI			
solenoid valves steam (water)			
2-way			
L145-R series			
 <p>1</p>			
GEV No.	370323	Ref. No.	GR50-GI-851219
description	solenoid valve 2-ways 230VAC inlet 3/4" outlet 3/4" connection 3/4" L 79mm DN 16mm slide-on receptacle DIN -60 up to +170°C SIRAI type series L145-R coil type Z534A membranes PTFE (steam) p max 6bar p min 0.4bar		
spare parts for	370323		
	GEV No.	371067	Ref. No. —
	solenoid coil 230VAC 14VA SIRAI coil type Z534A seat ø 12mm		
	GEV No.	371165	Ref. No. —
	membrane connection 3/4" series L145-R membrane type PTFE		
accessories for	370323		
	GEV No.	371090	Ref. No. —
	power socket plug type DIN 43650A screw		

drain valves

 <p>1</p>			
GEV No.	371138	Ref. No.	422090007500 50GI851801 GR422090007500
description	drain valve 230V 50/60Hz electric inlet 77mm outlet 80/35mm model MDB-O-3		

 <p>1</p>			
GEV No.	371146	Ref. No.	50340050051 GR50-340050051
description	drain valve 230V 50/60Hz single inlet 76mm outlet 76mm model MDB-O-3RA		

pressure switches

for warewashing

ø65mm with coded plug

 <p>1</p>			
GEV No.	541790	Ref. No.	GR36ASK8064348
description	pressure control 2 pressure ranges pressure range 60/35 - 310/265mbar connection coded plug ø 65mm pressure connection horizontal warewashing pressure connection ø 5.5mm		

ø 78mm with male faston 6.3mm

 <p>1</p>			
GEV No.	541868	Ref. No.	GR420851000060
description	pressure control ø 79mm pressure connection ø 6mm pressure range 80/50bar 16A 150V connection male faston 6.3mm Invensys for washing machine ambient temperature max. 85°C		

miscellaneous

 <p>1</p>			
GEV No.	541877	Ref. No.	GR420851000065
description	pressure control ø 87mm pressure connection ø 6mm pressure range 80/50 - 110/70 - 165/95bar 16A 250V connection coded plug EATON (INVENSYS) laundry technology ambient temperature max. 85°C		

fans

cross flow fans

accessories for cross flow fans

heater battery

 <p>1</p>			
GEV No.	415122	Ref. No.	52AD0000005
description	heater battery mounting distance 185mm W 40mm H 35mm 2000W 230V temperature restriction 105°C heating circuits 2 connection cable cable length 340mm L 197mm for cross flow fan		

gas valves and ignition boxes

ignition boxes

HONEYWELL



1	GEV No.	101166	Ref. No.	GR50-GI-951507
description ignition box HONEYWELL type S4560B 1006 electrodes 1 waiting time 0s safety time 10s 220-240V 10VA 50Hz				



1	GEV No.	104599	Ref. No.	GR650000000500
description ignition box HONEYWELL type S4570BS 1002 safety time 10s 220-240V 10VA 50Hz				

gas nozzles

main nozzles

gas nozzles 3/8"



1	GEV No.	106547	Ref. No.	6500000006052
description gas injector thread 3/8" WS 17 bore ø 2.5mm				



1	GEV No.	107208	Ref. No.	6500000006058
description gas injector thread 3/8" WS 17 bore ø 4mm				

knobs

producer-specific knobs

GRANDIMPIANTI



1	GEV No.	112688	Ref. No.	50GI851048 GR50-GI-851048
description knob ø 45mm shaft ø 6x4.6mm silver for rotary iron				



1	GEV No.	112689	Ref. No.	53GI851048 543010187000 GR543010187000
description knob shaft ø 6x4.6mm black/silver for rotary iron				



1	GEV No.	112690	Ref. No.	6121245
description knob zero mark t.max.°C ø 19mm shaft ø 6x4.6mm shaft flat lower black laundry technology				

hinges

door bearing



1	GEV No.	514431	Ref. No.	4225300158175
description hinge L 109mm W 47mm H 37mm				

gaskets

special gaskets

miscellaneous



1

GEV No.	901534	Ref. No.	GR4225300158135
description	door seal suitable for GRANDIMPIANTI external hight 39mm external weith 26mm for washing machine		



1

GEV No.	901535	Ref. No.	GR400002401901
description	door seal suitable for GRANDIMPIANTI for washing machine ED ø 340mm ID ø 235mm		



1

GEV No.	901536	Ref. No.	GR380002133400
description	door seal suitable for GRANDIMPIANTI L 1200mm external hight 14mm external weith 12mm laundry technology		



1

GEV No.	901568	Ref. No.	GR422170000600
description	gasket suitable for GRANDIMPIANTI for front panel L 1100mm		

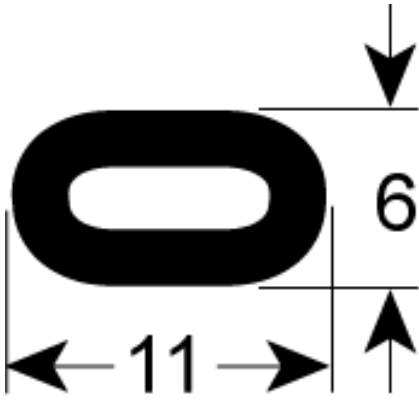

1

GEV No.	901569	Ref. No.	GR422230024200
description	gasket suitable for GRANDIMPIANTI for front panel Qty supplied by meterm		



1

GEV No.	901533	Ref. No.	GR52-SQ0501801
description	gasket suitable for GRANDIMPIANTI L 1920mm external weith 27mm for tumble dryer felt		



1

GEV No.	901532	Ref. No.	GR422230016800
description	gasket suitable for GRANDIMPIANTI L 3350mm external weith 38mm for washing machine thickness 4.5mm		



1

GEV No.	901570	Ref. No.	GR422190000600
description	gasket suitable for GRANDIMPIANTI L 4000mm		

transmission technology and ball bearings

ball bearings

deep-groove ball bearings 2Z



1

GEV No.	523022	Ref. No.	GR42215000103
description	deep-groove ball bearing shaft \varnothing 35mm ED \varnothing 80mm W 21mm type 6307-2Z DIN 625-1 with cover plate		



1

GEV No.	523023	Ref. No.	GR422150001600
description	deep-groove ball bearing shaft \varnothing 40mm ED \varnothing 80mm W 18mm type 6208-2Z DIN 625-1 with cover plate		

drive belts

high-performance V-belts, cogged



1

GEV No.	698355	Ref. No.	GR422260011400
description	toothed belt belt width 9.7mm L 1500mm H 8mm CODE SPZ-X1487 profile SPZX rubber with textile insertion W 9mm teeth 220 splitting 3-3		



1

GEV No.	697928	Ref. No.	GR50GI801228
description	V-belt belt width 9.7mm L 1850mm H 8mm CODE 1837Lw profile SPZ		

toothed belts



1

GEV No.	698356	Ref. No.	GR422260011100
description	toothed belt profile XPZ L 1337mm H 8mm teeth 210 splitting 5-2 rubber with textile insertion CODE 4450 W 10mm		

springs

gas tension springs

gas tension springs



1

GEV No.	701125	Ref. No.	GR543014005901
description	gas tension spring 400N D1 \varnothing 18mm D2 \varnothing 8mm hole distance 245mm L 265mm		

fastening material

fasteners

locking rings



1

GEV No.	696470	Ref. No.	GR422120003000
description	clamping ring \varnothing 84mm		

retaining rings

DIN 472



1

GEV No.	698375	Ref. No.	GR422520002700 GR50-GI-242008
description	retaining ring bore \varnothing 72mm thickness 2.5mm steel DIN 472		

B	
bi-metal thermostats	3, 3
C	
contactors	5
control thermostats	4
cross flow fans	9
E	
electronic controllers	6
F	
fans	9
fasteners	12
fastening material	12
G	
gas nozzles	10
H	
heater battery	3
heating elements	3
heating elements for convection	3
heating rods	3
I	
ignition boxes	10
immersion heating elements	3
L	
locking rings	12
M	
mechanical timers	5
P	
position switches	5
pressure switches	9
programme timers	5
R	
retaining rings	12
rocker/momentary rocker switches	4
S	
safety thermostats	4
solenoid valves	7
switches and momentary switches	4
T	
thermostats	3
timers	5