



GAS COMPONENTS



ELECTRIC COMPONENTS



WATER TECHNOLOGY



MECHANICAL COMPONENTS



TOOLS

Spare parts suitable for

HAKA

Find the complete and up-to-date range of products in our GEV Webshop



Manufacturer catalogue

The most important spare parts and accessories arranged clearly for every manufacturer

- ✓ Complete product range and all appliance data always up to date in the GEV Webshop
- ✓ Alphabetical Index at the end of the catalogue

GEV Webshop

www.gev-online.co.uk

www.gev-online.com









- 🔍 Add to Favourites
- 🔍 Sign In with email address and usual password
- 🔍 Easy-order – place several items in your basket at the same time
- 🔍 Quick Item search – no login needed







heating elements

heating elements for bain maries

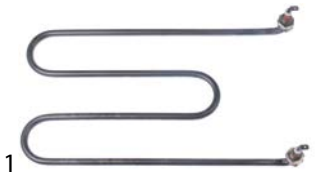





			
GEV No.	415428	Ref. No.	9007
description	heating element 1500W 230V L 292mm W 50mm connection male faston 6.3mm tube ø 8.5mm 2 hole fixing thread M14x1 immersion heater H 20mm mounting distance 37mm		
spare parts for	415428		
	GEV No.	507313	Ref. No. —
	O-ring EPDM thickness 2.62mm ID ø 13.95mm Qty 1 pcs		
accessories for	415428		
	GEV No.	102382	Ref. No. —
	nut thread M14x1 H 3.5mm WS 18 brass Qty 1 pcs		
	GEV No.	510417	Ref. No. —
	flat gasket fibre ED ø 20mm ID ø 14mm thickness 2mm Qty 1 pcs		
	GEV No.	520228	Ref. No. —
	tooth lock washer ID ø 15.3mm ED ø 24mm steel Qty 1 pcs for thread M14		
	GEV No.	550261	Ref. No. —
	nut thread M14x1 H 4mm WS 19 SS Qty 1 pcs		
	GEV No.	550262	Ref. No. —
	flat gasket copper ED ø 20mm ID ø 14mm thickness 2mm		

heating elements for chip scuttles

			
GEV No.	418252	Ref. No.	9008
description	heating element 1000W 230V L 330mm W 177mm connection length 19mm connection male faston 6.3mm tube ø 8.8mm 2 hole fixing thread M14x1.5 immersion heater chip scuttle H 25mm mounting distance 168mm		
accessories for	418252		
	GEV No.	510417	Ref. No. —
	flat gasket fibre ED ø 20mm ID ø 14mm thickness 2mm Qty 1 pcs		
	GEV No.	520228	Ref. No. —
	tooth lock washer ID ø 15.3mm ED ø 24mm steel Qty 1 pcs for thread M14		
	GEV No.	520230	Ref. No. —
	nut thread M14x1.5 H 5mm WS 19 zinc-coated steel Qty 1 pcs		
	GEV No.	521101	Ref. No. —
	nut thread M14x1.5 H 5mm WS 19 SS Qty 1 pcs		
	GEV No.	550262	Ref. No. —
	flat gasket copper ED ø 20mm ID ø 14mm thickness 2mm		

heating elements for fryers

2 hole fixing

			
GEV No.	418251	Ref. No.	9036
description	heating element 3500W 400V heating circuits 1 L 192mm W 74mm H 213mm H1 175mm H2 38mm thread M14x1.5 tube ø 8.5mm mounting distance 60mm windings 6 2 hole fixing connection male faston 6.3mm connection length 28mm fryer		
accessories for	418251		
	GEV No.	510417	Ref. No. —
	flat gasket fibre ED ø 20mm ID ø 14mm thickness 2mm Qty 1 pcs		
	GEV No.	520228	Ref. No. —
	tooth lock washer ID ø 15.3mm ED ø 24mm steel Qty 1 pcs for thread M14		
	GEV No.	520230	Ref. No. —
	nut thread M14x1.5 H 5mm WS 19 zinc-coated steel Qty 1 pcs		
	GEV No.	521101	Ref. No. —
	nut thread M14x1.5 H 5mm WS 19 SS Qty 1 pcs		
	GEV No.	550262	Ref. No. —
	flat gasket copper ED ø 20mm ID ø 14mm thickness 2mm		

			
GEV No.	415631	Ref. No.	9048
description	heating element 4000W 400V heating circuits 1 L 300mm W 68mm H 178mm H1 133mm H2 45mm thread 1/4" tube ø 8.5mm mounting distance 60mm windings 6 2 hole fixing connection male faston 6.3mm connection length 22mm immersion heater		
accessories for	415631		
	GEV No.	361182	Ref. No. —
	nut thread 1/4" H 5mm nickel-plated brass WS 17 Qty 1 pcs		
	GEV No.	510417	Ref. No. —
	flat gasket fibre ED ø 20mm ID ø 14mm thickness 2mm Qty 1 pcs		
	GEV No.	520228	Ref. No. —
	tooth lock washer ID ø 15.3mm ED ø 24mm steel Qty 1 pcs for thread M14		

Table continues overleaf





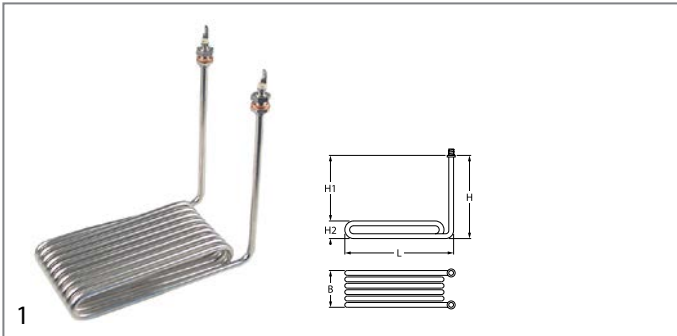

accessories for	415631			
	GEV No.	550262	Ref. No.	—
	flat gasket copper ED ø 20mm ID ø 14mm thickness 2mm			

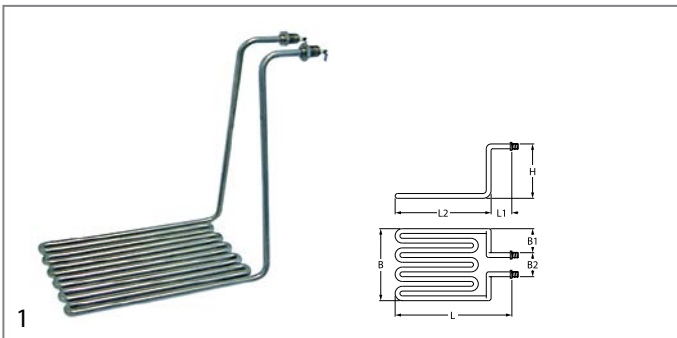

GEV No.	415632	Ref. No.	9049
description	heating element 6000W 400V heating circuits 1 L 242mm W 122mm H 218mm H1 178mm H2 40mm thread M14x1.5 tube ø 8.5mm windings 10 2 hole fixing connection male faston 6.3mm		





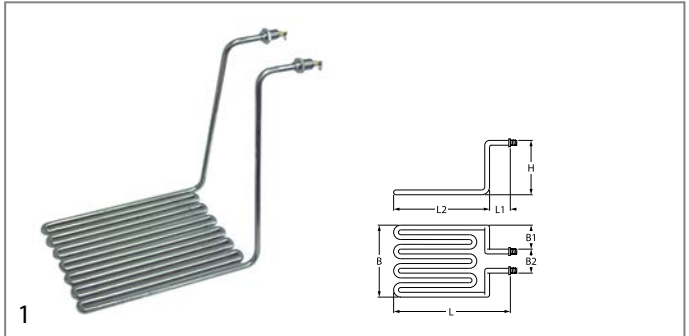

GEV No.	415628	Ref. No.	9002
description	heating element 3000W 230V heating circuits 1 L 308mm W 174mm H 254mm 2 hole fixing connection male faston 6.3mm fryer L1 46mm L2 253mm W1 50mm W2 74mm tube ø 8.5mm thread M14x1.5 windings 6 mounting distance 70mm		

accessories for	415628			
	GEV No.	510417	Ref. No.	—
	flat gasket fibre ED ø 20mm ID ø 14mm thickness 2mm Qty 1 pcs			
	GEV No.	520228	Ref. No.	—
	tooth lock washer ID ø 15.3mm ED ø 24mm steel Qty 1 pcs for thread M14			
	GEV No.	520230	Ref. No.	—
	nut thread M14x1.5 H 5mm WS 19 zinc-coated steel Qty 1 pcs			
	GEV No.	521101	Ref. No.	—
	nut thread M14x1.5 H 5mm WS 19 SS Qty 1 pcs			
	GEV No.	550262	Ref. No.	—
	flat gasket copper ED ø 20mm ID ø 14mm thickness 2mm			



GEV No.	415629	Ref. No.	9003
description	heating element 4500W 400V heating circuits 1 L 310mm W 186mm H 260mm 2 hole fixing connection male faston 6.3mm fryer L1 62mm L2 248mm W1 48mm W2 90mm tube ø 8.5mm thread M14x1.5 windings 7 mounting distance 82mm		

accessories for	415629			
	GEV No.	510417	Ref. No.	—
	flat gasket fibre ED ø 20mm ID ø 14mm thickness 2mm Qty 1 pcs			
	GEV No.	520228	Ref. No.	—
	tooth lock washer ID ø 15.3mm ED ø 24mm steel Qty 1 pcs for thread M14			
	GEV No.	520230	Ref. No.	—
	nut thread M14x1.5 H 5mm WS 19 zinc-coated steel Qty 1 pcs			
	GEV No.	521101	Ref. No.	—
	nut thread M14x1.5 H 5mm WS 19 SS Qty 1 pcs			
	GEV No.	550262	Ref. No.	—
	flat gasket copper ED ø 20mm ID ø 14mm thickness 2mm			

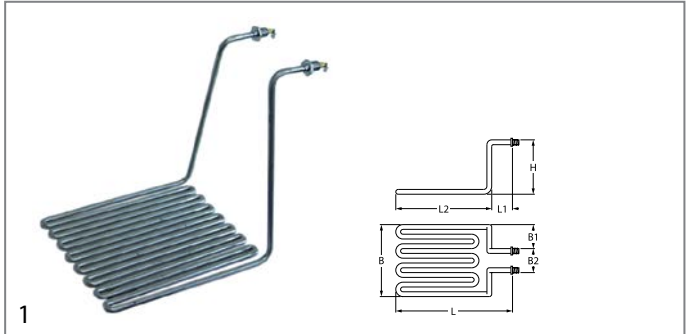

GEV No.	415630	Ref. No.	9004
description	heating element 6000W 400V heating circuits 1 L 296mm W 250mm H 255mm 2 hole fixing connection male faston 6.3mm fryer L1 46mm L2 250mm W1 33mm W2 185mm tube ø 8.5mm thread M14x1.5 windings 8 mounting distance 175mm connection length 10mm		





spare parts for	415630			
	GEV No.	550262	Ref. No.	—
	flat gasket copper ED ø 20mm ID ø 14mm thickness 2mm			
accessories for	415630			
	GEV No.	510417	Ref. No.	—
	flat gasket fibre ED ø 20mm ID ø 14mm thickness 2mm Qty 1 pcs			
	GEV No.	520228	Ref. No.	—
	tooth lock washer ID ø 15.3mm ED ø 24mm steel Qty 1 pcs for thread M14			
	GEV No.	520230	Ref. No.	—
	nut thread M14x1.5 H 5mm WS 19 zinc-coated steel Qty 1 pcs			





Table continues overleaf

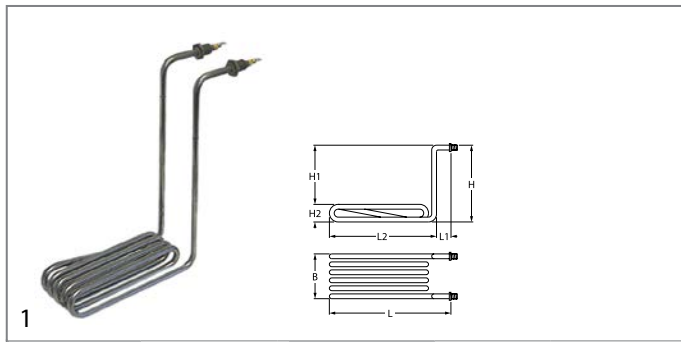

accessories for	415630			
	GEV No.	521101	Ref. No.	—
	nut thread M14x1.5 H 5mm WS 19 SS Qty 1 pcs			





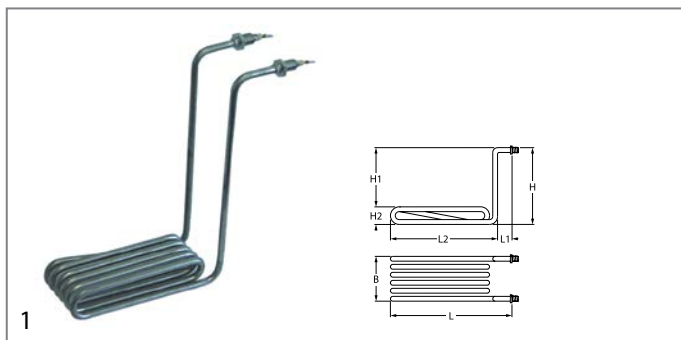

GEV No.	415626	Ref. No.	9000
description	heating element 2500W 400V heating circuits 1 L 242mm W 70mm H 257mm L1 50mm L2 192mm H1 220mm H2 37mm thread M14x1.5 tube ø 8.5mm 2 hole fixing connection male faston 6.3mm fryer windings 5		

accessories for	415626			
	GEV No.	510417	Ref. No.	—
	flat gasket fibre ED ø 20mm ID ø 14mm thickness 2mm Qty 1 pcs			
	GEV No.	520228	Ref. No.	—
	tooth lock washer ID ø 15.3mm ED ø 24mm steel Qty 1 pcs for thread M14			
	GEV No.	520230	Ref. No.	—
	nut thread M14x1.5 H 5mm WS 19 zinc-coated steel Qty 1 pcs			
	GEV No.	521101	Ref. No.	—
	nut thread M14x1.5 H 5mm WS 19 SS Qty 1 pcs			
	GEV No.	550262	Ref. No.	—
	flat gasket copper ED ø 20mm ID ø 14mm thickness 2mm			



GEV No.	415627	Ref. No.	9001
description	heating element 3500W 400V heating circuits 1 L 230mm W 74mm H 258mm L1 48mm L2 182mm H1 221mm H2 37mm thread M14x1.5 tube ø 8.5mm 2 hole fixing connection male faston 6.3mm fryer heaters windings 6		

accessories for	415627			
	GEV No.	510417	Ref. No.	—
	flat gasket fibre ED ø 20mm ID ø 14mm thickness 2mm Qty 1 pcs			
	GEV No.	520228	Ref. No.	—
	tooth lock washer ID ø 15.3mm ED ø 24mm steel Qty 1 pcs for thread M14			
	GEV No.	520230	Ref. No.	—
	nut thread M14x1.5 H 5mm WS 19 zinc-coated steel Qty 1 pcs			

accessories for	415627			
	GEV No.	521101	Ref. No.	—
	nut thread M14x1.5 H 5mm WS 19 SS Qty 1 pcs			
	GEV No.	550262	Ref. No.	—
	flat gasket copper ED ø 20mm ID ø 14mm thickness 2mm			

heating elements for griddles

	1		
GEV No.	415749	Ref. No.	9011
description	heating element 1500W 230V heating circuits 1 L 735mm W 55mm Hmm tube ø 6.5mm connection M4 connection length 24mm grill dry heating element		

heating elements for chargrills

	1		
GEV No.	415633	Ref. No.	9005 9005A
description	heating element 1500W 230V heating circuits 1 L 452mm W 73mm H 35mm windings 2 connection M4 hole distance 65mm hole ø 4mm dry heating element bracket mounting tube ø 8.5mm		

	1		
GEV No.	415644	Ref. No.	9013
description	heating element 400W 230V heating circuits 1 L 460mm dry heating element connection male faston 6.3mm connection length 23mm tube ø 8.5mm		

	1		
GEV No.	418253	Ref. No.	9025 9025 Klappbar
description	heating element 1260W 400V heating circuits 1 L 460mm W 83mm rectangular flange hole distance 57mm hole ø 6.5mm W1 20mm W2 43mm connection M4 cable length 2000mm flange length 70mm flange width 28mm tube ø 13x5mm dry heating element connection length 30mm		

	1		
Image not available			
GEV No.	418620	Ref. No.	9025 Feststehend
description	heating element 1260W 400V stationary		



heating elements for salamanders/toast-



1



GEV No.	415645	Ref. No.	9019
description	heating element 2250W 230V L 330mm W 215mm tube ø 6.5mm bracket mounting connection clamp mounting thread M5 hole distance 185mm heating circuits 1 lug length 30mm lug width 20mm dry heating element H 6.5mm		

ceramic heaters

245x60mm





1

GEV No.	415104	Ref. No.	9184
description	ceramic emitter 1000W 230V cable beaded cord L 245mm W 60mm H 35mm		
spare parts for	415104		
	GEV No.	415109	Ref. No.
			—
accessories for	415104		
	GEV No.	415110	Ref. No.
			—
	reflector L 245mm W 95mm H 31mm thickness 0.75mm hole ø 15x40mm		



1

GEV No.	415103	Ref. No.	9187
description	ceramic emitter 650W 230V cable beaded cord L 245mm W 60mm H 35mm		
spare parts for	415103		
	GEV No.	415109	Ref. No.
			—
accessories for	415103		
	GEV No.	415110	Ref. No.
			—
	reflector L 245mm W 95mm H 31mm thickness 0.75mm hole ø 15x40mm		

hot plates

round

with radiused edge

for domestic and commercial kitchens



1

GEV No.	490016	Ref. No.	9016
description	hot plate ø 180mm 2000W 230V connection 4 screw clamps with 8mm spill ring		



1

GEV No.	490020	Ref. No.	9017
description	hot plate ø 220mm 2600W 230V connection 4 screw clamps with 8mm spill ring		
accessories for	490020		
	GEV No.	550796	Ref. No.
			—
	fixing plate for hot plate ø220mm		



1

GEV No.	490061	Ref. No.	9030
description	hot plate ø 300mm 2500W 230V connection 4 screw clamps with 8mm spill ring		

thermostats

control and safety thermostats

EGO

control thermostats

55.10/19_series



1

GEV No.	375001	Ref. No.	9040
description	thermostat t.max. 112°C temperature range 30-110°C 1-pole 1NO 16A probe ø 6mm probe L 130mm capillary pipe 900mm capillary pipe isolatedmm gland nut M9x1 shaft L 23mm shaft position upper rotation 270°		



55.34_series

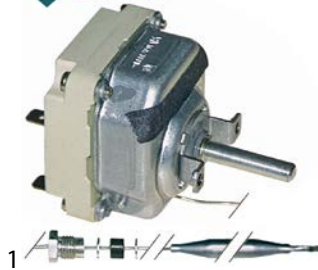

GEV No.	375143	Ref. No.	9041
----------------	--------	-----------------	------

description thermostat t.max. 110°C temperature range 32-110°C 3-pole 3NO 16A probe ø 6mm probe L 133mm capillary pipe 1480mm capillary pipe isolated 1100mm gland nut M9x1 shaft ø 6x4.6mm shaft L 23mm shaft position upper rotation 270°



GEV No.	375022	Ref. No.	9042
----------------	--------	-----------------	------

description thermostat t.max. 180°C temperature range 95-180°C 3-pole 3NO 16A probe ø 6mm probe L 133mm capillary pipe 1780mm capillary pipe isolated 1400mm gland nut M9x1 shaft ø 6x4.6mm shaft L 23mm rotation 270°



GEV No.	375038	Ref. No.	9044
----------------	--------	-----------------	------

description thermostat t.max. 300°C temperature range 50-300°C 3-pole 3NO 16A probe ø 6mm probe L 79mm capillary pipe 1740mm capillary pipe isolated 800mm gland nut shaft ø 6x4.6mm shaft L 23mm shaft position upper rotation 270°

accessories for 375038

	GEV No.	110123	Ref. No.	—
	knob thermostat t.max. 300°C ø 50mm shaft ø 6x4.6mm shaft flat upper black temperature range 50-300°C rotation 270°			

safety thermostats

55.32_series

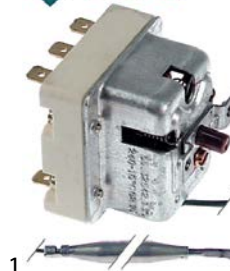

GEV No.	375704	Ref. No.	9047
----------------	--------	-----------------	------

description safety thermostat switch-off temp. 240°C 3-pole 20A probe ø 6mm probe L 87mm capillary pipe 890mm capillary pipe isolated 600mm gland nut probe SS

accessories

plunger sockets



GEV No.	550286	Ref. No.	9120
----------------	--------	-----------------	------

description thermowell

switches and momentary switches

cam switches

on/off

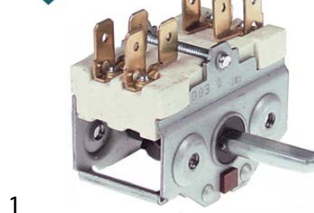

GEV No.	300074	Ref. No.	9020
----------------	--------	-----------------	------

description cam switch 4 operating positions 2NO sequence 0-1-0-1 16A shaft ø 6x4.6mm shaft L 23mm connection male faston 6.3mm ceramic



GEV No.	300017	Ref. No.	9021
----------------	--------	-----------------	------

description cam switch 4 operating positions 4NO sequence 0-1-0-1 16A shaft ø 6x4.6mm shaft L 23mm connection male faston 6.3mm ceramic



4-position

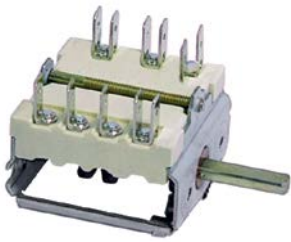

1

GEV No.	300007	Ref. No.	9022
description	cam switch 4 operating positions 1NO/2CO sequence 0-1-2-3 16A shaft \varnothing 6x4.6mm shaft L 23mm connection male faston 6.3mm 4-position ceramic		

7-position



1

GEV No.	300004	Ref. No.	9023
description	cam switch 7 operating positions 1NO/2CO sequence 0-1-2-3-4-5-6 16A shaft \varnothing 6x4.6mm shaft L 23mm connection male faston 6.3mm 7-position ceramic		

operation switches



1

GEV No.	300002	Ref. No.	9021h
description	cam switch 2 operating positions 4NO 16A sequence 0-1 shaft \varnothing 6x4.6mm shaft L 23mm connection male faston 6.3mm ceramic		

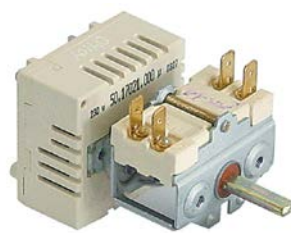

1

GEV No.	345635	Ref. No.	9028
description	operation switch with energy regulator		

lamps

indicator lights

indicator lights (complete)

 \varnothing 25mm

1

GEV No.	360551	Ref. No.	9060 9060W
description	indicator light \varnothing 25mm 230V white connection male faston 6.3mm temp.-resist. 85°C		

screw-on/push-on fit

light bulbs

for ovens



1

GEV No.	359610	Ref. No.	9064
description	light bulb t.max. 300°C socket E14 15W 230V \varnothing 22mm L 47mm lens L 20mm for oven lamp type Philips		



oven lamps

universal oven lamps

mounting diameter 35.5mm



1

GEV No.	359718	Ref. No.	9063	
description	oven lamp mounting \varnothing 35.5mm 230V 15W socket E14 temp.-resist. 300°C connection male faston 6.3mm hard glas			
spare parts for	359718			
	GEV No.	359701	Ref. No.	—
	lamp socket socket E14 220-230V mounting \varnothing 35.5mm connection male faston 6.3mm 15W			
	GEV No.	359740	Ref. No.	—
	light bulb t.max. 300°C socket E14 15W 230V \varnothing 22mm L 48mm lens L 20mm for oven lamp IMPORT			



			
1			
GEV No.	359709	Ref. No.	9058
description	oven lamp glass thr.ø 33.5mm ø 42mm hard glas temp.-resist. 350°C		

lamps

light bulbs

			
1			
GEV No.	359610	Ref. No.	9064
description	light bulb t.max. 300°C socket E14 15W 230V ø 22mm L 47mm lens L 20mm for oven lamp type Philips		

timers

mechanical timers

			
1			
GEV No.	350030	Ref. No.	9026
description	timer M2 2-pole operation time 120min impulse mechanical 2NO at 250V 16A permanent position no shaft ø 6x4.6mm shaft 6x4.6mm shaft L 23mm mounting distance 28mm connection lateral		
accessories for	350030		
	GEV No.	110366	Ref. No. —
	knob switch zero mark t.max.°C ø 44mm shaft ø 6x4.6mm shaft flat upper black		
	GEV No.	111199	Ref. No. —
	dial plate graduation 120min permanent position no rotation 0-330° ø 60mm timers knob ø 45mm		

motors

gear motors

for grills

			
1			
GEV No.	500492	Ref. No.	9135 9135 Gerätetyp 106
description	gear motor 230V 50Hz 2rpm shaft ø 18mm L 98mm W 70mm H 86mm for chicken rotisserie		

ignition parts

electrodes

			
1			
GEV No.	100729	Ref. No.	2-990021
description	ignition electrode L1 5mm D1 ø 8mm D2 ø 10mm BL1 41mm BL2 14mm connection F 2.8x0.8mm to clip with spring		

piezoelectric igniters

mounting diameter 18mm

			
1			
GEV No.	100004	Ref. No.	0010-540955
description	piezoelectric igniter body plastic blowing mounting ø 18mm connection ø2.4mm		



thermocouples

plug-in thermocouples

plug-in thermocouples standard



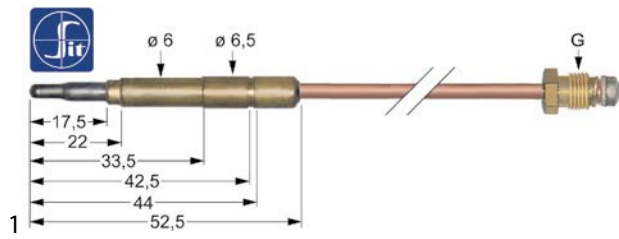

with barrel socket $\varnothing 6(6.5)$ mm

thermocouples SIT



GEV No.	107609	Ref. No.	2-9900423
description	thermocouple SIT M9x1 L 600mm plug connection $\varnothing 6.0(6.5)$ mm		

			
1			
GEV No.	104102	Ref. No.	2-990630
description	burner head for burner cap $\varnothing 100$ mm ext. $\varnothing 130$		

			
1			
GEV No.	104100	Ref. No.	2-990631
description	burner head for burner cap $\varnothing 80$ mm		
accessories for	104100		
	GEV No.	103065	Ref. No. 2-990620
	burner ring for burner cap $\varnothing 80$ mm		
	GEV No.	103066	Ref. No. 2-990610
	burner cap $\varnothing 80$ mm		
	GEV No.	104103	Ref. No. —
	burner holder suitable for burner $\varnothing 100$ mm with nozzle holder		



gas burners





hob burners

universal hob burners



GEV







GEV No.	103068	Ref. No.	2-990611
description	burner cap $\varnothing 100$ mm		
accessories for	103068		
	GEV No.	103067	Ref. No. 2-990621
	burner ring for burner cap $\varnothing 100$ mm		
	GEV No.	104102	Ref. No. 2-990630
	burner head for burner cap $\varnothing 100$ mm ext. $\varnothing 130$		
	GEV No.	104103	Ref. No. —
	burner holder suitable for burner $\varnothing 100$ mm with nozzle holder		

			
1			
GEV No.	103067	Ref. No.	2-990621
description	burner ring for burner cap $\varnothing 100$ mm		
accessories for	103067		
	GEV No.	103068	Ref. No. 2-990611
	burner cap $\varnothing 100$ mm		
	GEV No.	104102	Ref. No. 2-990630
	burner head for burner cap $\varnothing 100$ mm ext. $\varnothing 130$		
	GEV No.	104103	Ref. No. —
	burner holder suitable for burner $\varnothing 100$ mm with nozzle holder		



GEV No.	103066	Ref. No.	2-990610
description	burner cap $\varnothing 80$ mm		
accessories for	103066		
	GEV No.	103065	Ref. No. 2-990620
	burner ring for burner cap $\varnothing 80$ mm		
	GEV No.	104100	Ref. No. 2-990631
	burner head for burner cap $\varnothing 80$ mm		
	GEV No.	104101	Ref. No. —
	burner holder for burner cap $\varnothing 80$ mm with nozzle holder with mixing sleeve		

			
1			
GEV No.	103065	Ref. No.	2-990620
description	burner ring for burner cap $\varnothing 80$ mm		
accessories for	103065		
	GEV No.	103066	Ref. No. 2-990610
	burner cap $\varnothing 80$ mm		
	GEV No.	104100	Ref. No. 2-990631
	burner head for burner cap $\varnothing 80$ mm		
	GEV No.	104101	Ref. No. —
	burner holder for burner cap $\varnothing 80$ mm with nozzle holder with mixing sleeve		

knobs

producer-specific knobs

HAKA



1

GEV No.	110664	Ref. No.	9051 Leistung
description	knob energy regulator 1-10 ø 60mm shaft ø 6x4.6mm shaft flat upper		



1

GEV No.	110660	Ref. No.	9051 0-1
description	knob switch 0-1-0-1 t.max.°C ø 60mm shaft ø 6x4.6mm shaft flat upper		



1

GEV No.	110661	Ref. No.	9051 4-Takt
description	knob switch 4-position ø 60mm shaft ø 6x4.6mm shaft flat upper black		



1

GEV No.	110662	Ref. No.	9051 7-Takt
description	knob switch 7-position t.max.°C ø 60mm shaft ø 6x4.6mm shaft flat upper		



1

GEV No.	110665	Ref. No.	9051 110°C
description	knob thermostat t.max. 110°C ø 60mm shaft ø 6x4.6mm shaft flat upper black temperature range 30-110°C		

spare parts for 110665

	GEV No.	110885	Ref. No.	9035 110°C
	knob dial plate thermostat t.max. 110°C ED ø 45mm blue			



1

GEV No.	110666	Ref. No.	9051 180°C
description	knob thermostat t.max. 180°C ø 60mm shaft ø 6x4.6mm shaft flat upper black temperature range 90-180°C		



1

GEV No.	110659	Ref. No.	9051 Zeit
description	knob time 120min ø 60mm shaft ø 6x4.6mm shaft flat upper blue/black		

baskets

fryer baskets

HAKA



1

GEV No.	970245	Ref. No.	8101 8181
description	fryer basket L1 200mm W1 220mm H1 120mm L2 450mm H2 210mm H3 245mm		



1

GEV No.	970443	Ref. No.	8119
description	fryer basket L1 235mm W1 110mm H1 130mm		



1

GEV No.	970444	Ref. No.	8118
description	fryer basket L1 235mm W1 195mm H1 130mm		



1

GEV No.	970246	Ref. No.	8104
description	fryer basket L1 240mm W1 110mm H1 130mm		



1

GEV No.	970247	Ref. No.	8111
description	fryer basket L1 240mm W1 195mm H1 130mm		



1

GEV No.	970446	Ref. No.	8134
description	fryer basket L1 250mm W1 145mm H1 120mm L2 470mm H2 210mm H3 255mm chrome-plated steel		



1

GEV No.	970254	Ref. No.	8114
description	fryer basket L1 300mm W1 170mm H1 110mm		



1

GEV No.	970248	Ref. No.	8112
description	fryer basket L1 300mm W1 210mm H1 130mm		



1

GEV No.	970445	Ref. No.	8133
description	fryer basket L1 300mm W1 210mm H1 130mm		



1

GEV No.	970447	Ref. No.	8131
description	fryer basket L1 340mm W1 295mm H1 130mm		



1

GEV No.	970256	Ref. No.	8103
description	fryer basket L1 340mm W1 310mm H1 130mm		

C

cam switches	7
ceramic heaters	6
control thermostats	6

G

gas burners	10
-------------	----

H

heating elements	3
heating elements for bain maries	3
heating elements for charrills	5
heating elements for chip scuttles	3
heating elements for fryers	3
heating elements for griddles	5
heating elements for salamanders/toasters	6
hob burners	10
hot plates	6

I

indicator lights	8
indicator lights (complete)	8

L

lamps	8
light bulbs	8

M

mechanical timers	9
motors	9

O

oven lamps	8
------------	---

P

piezoelectric igniters	9
plunger sockets	7

S

safety thermostats	7
switches and momentary switches	7

T

thermocouples	10
thermostats	6
timers	9