



GAS COMPONENTS



ELECTRIC COMPONENTS



WATER TECHNOLOGY



MECHANICAL COMPONENTS



TOOLS

Spare parts suitable for

HATCO

Find the complete and up-to-date range of products in our GEV Webshop



Manufacturer catalogue

The most important spare parts and accessories arranged clearly for every manufacturer

- ✓ Complete product range and all appliance data always up to date in the GEV Webshop
- ✓ Alphabetical Index at the end of the catalogue

GEV Webshop

www.gev-online.co.uk

www.gev-online.com





- 🔍 Add to Favourites
- 🔍 Sign In with email address and usual password
- 🔍 Easy-order – place several items in your basket at the same time
- 🔍 Quick Item search – no login needed



heating elements

heating elements for hot counters

			
1			
GEV No.	418720	Ref. No.	X02.05.619.00
description	heating element 350W 220V heating circuits 1 L 133mm W 116mm H 113mm W1 41mm W2 34mm tube ø 8mm connection male faston 6.3mm L1 17mm L2 116mm rectangular flange hole distance 56mm flange length 70mm flange width 16mm hole ø 3mm		
For models:	FLVM1X		

			
1			
GEV No.	418721	Ref. No.	02.05.679.00 X02.09.258.00
description	heating element 700W 220V L 210mm W 85mm H 40mm tube ø 7mm connection male faston 6.3mm bracket mounting hole ø 5mm hole distance 66mm mounting distance 78mm heating circuits 1 lug length 25mm lug width 12.5mm dry heating element connection length 17mm mounting pos. upper		

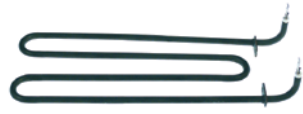
			
1			
GEV No.	418724	Ref. No.	X02.09.261.00
description	heating element 900W 220V L 290mm W 110mm H 40mm tube ø 7mm connection male faston 6.3mm with strap hole ø 5mm mounting thread 103 hole distance 66mm heating circuits 1 lug length 25mm lug width 12.5mm dry heating element connection length 17mm mounting pos. lower		

heating elements for chargrills

			
1			
GEV No.	417716	Ref. No.	02.08.101.00 2-08-101 R02.08.101D.00 R02-08-101
description	heating element 500W 115V heating circuits 1 L 485mm lug length 38mm lug width 25mm tube ø 6.5mm suitable for HATCO		

			
1			
GEV No.	417538	Ref. No.	R02.09.205.00 R02.09.205E.00
description	heating element 275W 220V L 34mm Wmm Hmm heating circuits 1		

heating elements for salamanders/toast-

			
1			
GEV No.	418723	Ref. No.	X02.09.260.00
description	heating element 1000W 220V L 290mm W 90mm H 40mm tube ø 7mm connection male faston 6.3mm with strap hole ø 5mm hole distance 66mm mounting distance 83mm heating circuits 1 lug length 25mm lug width 12.5mm dry heating element connection length 17mm mounting pos. upper		

			
1			
GEV No.	418207	Ref. No.	R02.08.142E.00
description	heating element 1100W 220V heating circuits 1 L 1095mm Wmm lug length 40mm lug width 18mm connection length 27mm connection M5 tube ø 6.3mm bracket mounting hole ø 5mm dry heating element		
For models:	GR 48		

			
1			
GEV No.	418722	Ref. No.	02.05.682.00 HAT02.05.682.00 X02.09.259.00
description	heating element 600W 220V L 210mm W 90mm H 40mm tube ø 7mm connection male faston 6.3mm with strap hole ø 5mm hole distance 66mm mounting distance 83mm heating circuits 1 lug length 25mm lug width 12.5mm dry heating element connection length 17mm mounting pos. lower		

			
1			
GEV No.	418208	Ref. No.	R02.08.143E.00
description	heating element 1250W 220V heating circuits 1 L 1245mm Wmm lug length 39mm lug width 25mm connection length 27mm connection M5 tube ø 6.5mm bracket mounting hole ø M4mm dry heating element		
For models:	GR 54		

			
1			
GEV No.	418209	Ref. No.	R02.08.144E.00
description	heating element 1400W 220V heating circuits 1 L 1400mm Wmm lug length 39mm lug width 25mm connection length 28mm connection M5 tube ø 6.5mm bracket mounting hole ø M4mm dry heating element		
For models:	GR 60		



1			
GEV No.	418210	Ref. No.	R02.08.145E.00
description	heating element 1560W 220V heating circuits 1 L 1565mm Wmm lug length 39mm lug width 25mm connection length 26mm connection M5 tube ø 6.5mm bracket mounting hole ø M4mm dry heating element		
For models:	GR 66		

2			
GEV No.	418211	Ref. No.	R02.08.148E.00
description	heating element 1725W 220V heating circuits 1 L 1715mm Wmm lug length 39mm lug width 25mm connection length 27mm connection M5 tube ø 6.8mm bracket mounting hole ø M4mm dry heating element		
For models:	GR 72		

1			
GEV No.	418203	Ref. No.	R02.08.138E.00
description	heating element 350W 220V heating circuits 1 L 335mm Wmm lug length 40mm lug width 18mm connection M5 tube ø 6.3mm rectangular flange mounting pos. dry heating element hole ø 5mm		
For models:	GR 18		

1			
GEV No.	418202	Ref. No.	R02.08.103.00 R02.08.103E.00 R02.08.136E.00 R02.8.103E.00
description	heating element 500W 220V heating circuits 1 L 485mm Wmm lug length 40mm lug width 18mm connection M5 tube ø 6.3mm rectangular flange hole ø M4mm dry heating element		
For models:	GR 24		

1			
GEV No.	418204	Ref. No.	R02.08.139E.00
description	heating element 660W 220V heating circuits 1 L 634mm Wmm lug length 40mm lug width 18mm connection male faston tube ø 6.5mm rectangular flange hole ø 4mm dry heating element		
For models:	GR 30		

1			
GEV No.	418205	Ref. No.	R02.08.140E.00
description	heating element 800W 220V heating circuits 1 L 790mm Wmm lug length 40mm lug width 18mm connection length 26mm connection M5 tube ø 6.3mm rectangular flange hole ø 5mm dry heating element flange length 40mm flange width 18mm		
For models:	GR 36		

1			
GEV No.	418206	Ref. No.	R02.08.141E.00
description	heating element 950W 220V L 940mm Wmm lug length 40mm lug width 18mm tube ø 6.3mm dry heating element flange length 40mm flange width 18mm		
For models:	GR 42		

heating elements for heated cabinets

1			
GEV No.	420568	Ref. No.	R02.08.003.00
description	heating element 350W 240V heating circuits 1 L 540mm flange length 38mm flange width 25mm connection M4 tube ø 6.5mm		

coil heating elements

1			
GEV No.	418719	Ref. No.	X02.05.620.00
description	heating element 1000W 230V L 180mm W 80mm H 84mm tube ø 22mm connection male faston 6.3mm connection length 36mm dry heating element heating circuits 1 bracket mounting		
For models:	FLVM1X		

energy regulators

EGO

1-circuit

1				
GEV No.	380666	Ref. No.	R02.19.019.00	
description	energy regulator			
For models:	GRAH18, GRAH30, GRAH42, GRAH54			
accessories for	380666			
	GEV No.	111825	Ref. No.	05.30.043.00 R05.30.043.00
	knob switch zero mark ø 30mm shaft ø 6x4.6mm shaft flat right silver			
	GEV No.	112946	Ref. No.	07.01.034.00
	bezel 0-7 dimensions 51x60mm			

thermostats

bi-metal thermostats

bi-metal thermostats

1			
GEV No.	390447	Ref. No.	X02.16.138.00
description	bi-metal thermostat hole distance 23.5mm switch-off temp. 130°C NC 1-pole 10A 250V connection F6.3		
For models:	FLVM1X		



			
1			
GEV No.	390511	Ref. No.	R02.16.029.00
description	bi-metal thermostat hole distancemm switch-off temp. 78°C 1NC 1-pole 10A connection F4.8		

accessories for	301230		
	GEV No.	691507	Ref. No. 04.08.240.00
	cover for toggle switch		

control and safety thermostats

IMIT / TEMPOMATIC / ARTHERMO

control thermostats



			
1			
GEV No.	375891	Ref. No.	X02.16.136.00
description	thermostat t.max. 85°C temperature range 0-85°C 1-pole 1CO 15A probe ø 6mm probe L 78mm capillary pipe 1000mm capillary pipe isolatedmm gland nut shaft ø 6x4.6mm shaft L 15mm probe material SS		
For models:	FLVM1X		

accessories			
			
1			
GEV No.	112947	Ref. No.	07.01.035.00
description	bezel L 60mm W 51mm		
For models:	GRAH18, GRAH30, GRAH42, GRAH54		

			
1			
GEV No.	691507	Ref. No.	04.08.240.00
description	cover for toggle switch		
For models:	GRAH18, GRAH30, GRAH42, GRAH54		

switches and momentary switches

rocker/momentary rocker switches

30x11mm			
			
1			
GEV No.	301010	Ref. No.	X02.19.180.00
description	rocker switch mounting measurements 30x11mm red 1NO/indicator light 250V 16A 0-1 connection male faston 6.3mm ambient temperature max. 85/125°C protection IP40		
For models:	FLVM1X		
accessories for	301010		
	GEV No.	301035	Ref. No. —
	protective cover mounting measurements 30x11mm		

			
1			
GEV No.	691506	Ref. No.	07.01.214.00
description	plate for toggle switch		
For models:	GRAH18, GRAH30, GRAH42, GRAH54		



microswitches

lever actuated

			
1			
GEV No.	347021	Ref. No.	X02.19.186.00
description	microswitch with lever 250V 5A 1CO connection soldering connection L 15mm ambient temperature max. 85°C mounting distance 10mm actuating force: 13g lever length 17mm		

toggle switches

M12x0.75

			
1			
GEV No.	301230	Ref. No.	R02.19.008A.00
description	toggle switch thread M12x0.75 2NO 250V 15A ON-OFF screw		
For models:	GRAH18, GRAH30, GRAH42, GRAH54		
accessories for	301230		
	GEV No.	112947	Ref. No. 07.01.035.00
	bezel L 60mm W 51mm		
	GEV No.	691506	Ref. No. 07.01.214.00
	plate for toggle switch		

float switches

			
1			
GEV No.	402061	Ref. No.	X02.01.249.00
description	float switch thread 9.7 1NO ø 26mm L 130mm mounting ø 10mm 230V 0.5A cable cable length 500mm		
For models:	FLVM1X		

cam switches

4-position



GEV No.	300022	Ref. No.	X02.19.174.00
description	cam switch 4 operating positions 2CO sequence 0-1-2-3 16A shaft ø 6x4.6mm shaft L 23mm connection screw		

magnetic switches

accessories

magnets



GEV No.	691503	Ref. No.	X05.30.099.00
description	magnet for door		
For models:	FLVM1X		

encoders and potentiometers



GEV No.	402057	Ref. No.	02.13.338.00 02.13.340.00 X02.13.330.00
description	potentiometer 0.5KOhm rotation 320° shaft ø 6mm shaft L 12.8mm 25W 230V type FVR25W cable length 150mm		
accessories for	402057		



GEV No.	112939	Ref. No.	X05.30.098.00 X05.30.098.00 old
description	knob switch zero mark ø 45mm shaft ø 6mm		

lamps

indicator lights

indicator lights (complete)

ø12mm

with plug-in socket



GEV No.	359041	Ref. No.	X02.19.175.00 X02.19.182.00
description	indicator light ø 12mm green 230V connection male faston 6.3mm temp.-resist. 120°C Qty 1 pcs		
For models:	FLVM1X		



GEV No.	359043	Ref. No.	X02.19.176.00 X02.19.181.00
description	indicator light ø 12mm red 230V connection male faston 6.3mm temp.-resist. 120°C Qty 1 pcs		
For models:	FLVM1X		



GEV No.	580014	Ref. No.	2-19-029 2-19-154
description	indicator light ø 12mm 230V red		

ø12.5mm



GEV No.	357009	Ref. No.	02.19.150.00
description	indicator light ø 12.5mm 230V green connection male faston 4.8mm		
For models:	GRAH18, GRAH30, GRAH42, GRAH54		

screw-on/push-on fit

light bulbs

for lighting



GEV No.	359849	Ref. No.	R02.30.058.00
description	light bulb t.max.°C socket E27 230V 60W ø 48mm L 102mm lens L 75mm PTFE coated for HATCO heated bridge GR Qty 1 pcs		



oven lamps

producer-specific oven lamps

HATCO



1

GEV No.	359500	Ref. No.	X02.30.102.00
description	lamp socket 250V socket E27 connection cable 250mm ø 35mm H 38mm mounting distance Qty 1 pcs		
For models:	FLVM1X		



1

GEV No.	359848	Ref. No.	02.30.045.00 R02.30.045.00
description	lamp socket socket E27 double for HATCO heated bridge GR		



1

GEV No.	359847	Ref. No.	02.30.044.00 R02.30.044.00
description	lamp socket socket E27 for HATCO heated bridge GR		

lamps

light bulbs



1

GEV No.	359849	Ref. No.	R02.30.058.00
description	light bulb t.max.°C socket E27 230V 60W ø 48mm L 102mm lens L 75mm PTFE coated for HATCO heated bridge GR Qty 1 pcs		

contactors

HARTLAND

power contactors



1

GEV No.	580012	Ref. No.	2-01-018
description	contactor resistive load 50A 240VAC 40A/10HP (AC3/240V) 40A/7.46kW main contacts 4NO connection screw clamp/male faston 6.3mm type HCCY4XU04CG		

electronics

PCBs



1

GEV No.	401799	Ref. No.	CM33580150
description	PCB ice maker N201/N301//N501 230V		
accessories for	401799		
	GEV No.	Ref. No.	—
	connection cable L 1300mm 2-pole level sensor suitable for ice maker connection plug plug type coded plug		



1

GEV No.	403125	Ref. No.	76-2782-3
description	PCB L 175mm W 99mm for ice-cube maker		



keypads

front foils



GEV No.	402059	Ref. No.	X07.03.465.00
----------------	--------	-----------------	---------------

description	front foil toaster TOASTMAX L 185mm W 85mm
--------------------	--



GEV No.	402060	Ref. No.	X07.03.466.00
----------------	--------	-----------------	---------------

description	front foil toaster TOASTMAX L 265mm W 85mm
--------------------	--

solenoid valves

solenoid valves (water)

ELBI



GEV No.	373001	Ref. No.	65010554
----------------	--------	-----------------	----------

description	solenoid valve single straight 230VAC inlet 3/4" outlet 11.5mm input/min output 2l/min 50/60Hz DN10 t.max. 90°C duty cycle 100% ELBI plastic
--------------------	--

fans

axial fans

import



GEV No.	601080 ¹	Ref. No.	X02.12.082.00
----------------	---------------------	-----------------	---------------

description	axial fan L 119mm W 119mm H 38mm 230VAC 50/60Hz 23/20W bearing ball bearing connection male faston 2.8mm metal ADDA fan wheel ø 110mm temp.-resist. 70°C
--------------------	--

accessories for	601080
------------------------	--------

GEV No.	550898	Ref. No.	—
----------------	--------	-----------------	---

description	connecting cable cable length 2000mm connection F 2.8 connection distance 7.9mm for axial flow fan
--------------------	--

GEV No.	692519	Ref. No.	—
----------------	--------	-----------------	---

description	guard L 120mm W 120mm plastic
--------------------	-------------------------------

¹with ball bearings

GEV No.	601055 ¹	Ref. No.	X02.12.093.00
----------------	---------------------	-----------------	---------------

description	axial fan L 92mm W 92mm H 25mm 230VAC 50/60Hz 14.5/14W bearing ball bearing connection male faston 2.8mm metal ADDA fan wheel ø 85mm temp.-resist. 70°C
--------------------	---

For models:	FLVM1X
--------------------	--------

accessories for	601055
------------------------	--------

GEV No.	550898	Ref. No.	—
----------------	--------	-----------------	---

description	connecting cable cable length 2000mm connection F 2.8 connection distance 7.9mm for axial flow fan
--------------------	--

GEV No.	691103	Ref. No.	—
----------------	--------	-----------------	---

description	guard ø 90mm mounting distance 83mm for axial fan 92mm
--------------------	--

¹with ball bearings

motors

gear motors

miscellaneous

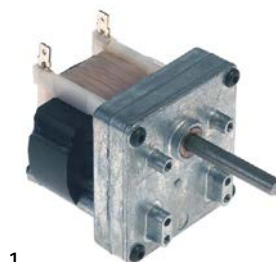

GEV No.	601483	Ref. No.	02.12.079.00
----------------	--------	-----------------	--------------

description	gear motor MERKLE type 4515UI-063 230V 50Hz 11rpm shaft ø 7x8mm L 125mm W 76mm H 69mm for toaster
--------------------	---

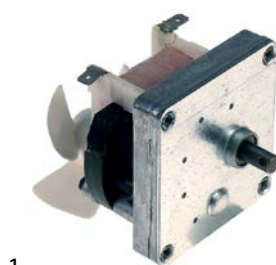

GEV No.	601484	Ref. No.	02.12.026.00
----------------	--------	-----------------	--------------

description	gear motor MK type S4355L 230V 50Hz shaft ø 7x8mm L 76mm W 70mm H 92mm for hot display
--------------------	--



pumps

pumps for ice machines



1

GEV No.	500752	Ref. No.	62043002
description	pump GRE 60W 230V 60Hz inlet ø 16mm outlet ø 21mm L 110mm rotation direction right for ice maker		



1

GEV No.	499122	Ref. No.	7626013
description	pump NBK MOTORS type YSP6PJDVF2 208-240V 50/60Hz outlet ø 26mm L 210mm rotation direction right for ice-cube maker		

condensators & interference suppression filters

filters

RC circuits



1

GEV No.	365076	Ref. No.	02.13.306.00
description	RC circuit 110-240V 50/60Hz conductor 2 connection cable Qty 1 pcs		
For models:	GRAH18, GRAH30, GRAH42, GRAH54		

fuses

fine fuses



1

GEV No.	358611	Ref. No.	63001510
description	fine fuse size ø5x20mm 16A fast-acting rated 250V Qty 10 pcs		



1

GEV No.	358028	Ref. No.	510127
description	fine fuse size ø10x38mm 20A rated 500V type Gg fast-acting Qty 1 pcs		

electric accessories

terminals

terminal blocks



1

GEV No.	550232	Ref. No.	R02.15.030.00
description	lustre terminal 12-pole cross section 2.5mm ² max. 32A max 450V temp.-resist. 150°C		
For models:	GRAH18, GRAH30, GRAH42, GRAH54		



1

GEV No.	508353	Ref. No.	X02.15.052.00
description	lustre terminal 3-pole cross section 4mm ² max. 32A max 750V temp.-resist. 150°C		

equipment-specific units

for ice-cube maker

probes



1

GEV No.	694544	Ref. No.	76-2781-3
description	sensor for ice thickness 1-pole cable length 1450mm		



1

GEV No.	694545	Ref. No.	76-0160-3
description	sensor for ice thickness 1-pole cable length 300mm		

valves

intake valves



1			
GEV No.	694548	Ref. No.	0200361201
description	intake valve with float		



1			
GEV No.	695613	Ref. No.	8369133
description	intake valve with float		

for toasters

miscellaneous



1			
GEV No.	691472	Ref. No.	X05.03.040.00
description	chain US norm 25-1 splitting 6mm links 30 internal width 3.3mm rollerø 4.3mm single closed		



1			
GEV No.	691473	Ref. No.	X05.03.044.00
description	chain US norm 25-1 splitting 6mm links 31 internal width 3.3mm rollerø 4.3mm single closed		



1			
GEV No.	694056	Ref. No.	05.03.036.00 X05.03.042.00
description	conveyor belt L 570mm W 260mm wire gauge ø 1.2mm for conveyor toaster		



1			
GEV No.	694057	Ref. No.	X05.03.041.00
description	conveyor belt L 580mm W 180mm wire gauge ø 1.2mm for conveyor toaster		



1			
GEV No.	694059	Ref. No.	X05.07.025.00
description	drive shaft ø 9.5mm L 235mm		
accessories for	694059		



GEV No.	691470	Ref. No.	X05.03.043.00
description	retaining ring E D1 ø 8mm D2 ø 16mm SS DIN 6799 thickness 1mm for shaft ø 9-12mm		



GEV No.	694060	Ref. No.	X05.02.024.00
description	flange for spindle		



1			
GEV No.	694058	Ref. No.	X05.07.026.00
description	drive shaft ø 9.5mm L 320mm		
accessories for	694058		



GEV No.	691470	Ref. No.	X05.03.043.00
description	retaining ring E D1 ø 8mm D2 ø 16mm SS DIN 6799 thickness 1mm for shaft ø 9-12mm		





GEV No.	694060	Ref. No.	X05.02.024.00
description	flange for spindle		



			
1			
GEV No.	694060	Ref. No.	X05.02.024.00
description	flange for spindle		

gear wheels

			
1			
GEV No.	691474	Ref. No.	X05.09.052.00 X05.09.053.00
description	sprocket-wheel DIN/ISO splitting 25-1 teeth 24 shaft intake ø 19mm H 18mm hub ø 19mm metal ø 50mm		

			
1			
GEV No.	691475	Ref. No.	05.09.055.00 X05.09.054.00 X05.09.055.00
description	sprocket-wheel DIN/ISO splitting 25-1 teeth 36 shaft intake ø 9.5mm H 18mm hub ø 19mm metal ø 74mm		

for heated display cases

miscellaneous

			
1			
GEV No.	691508	Ref. No.	X04.17.1054.00
description	rotation plate		

knobs

producer-specific knobs

HATCO

			
1			
GEV No.	111825	Ref. No.	05.30.043.00 R05.30.043.00
description	knob switch zero mark ø 30mm shaft ø 6x4.6mm shaft flat right silver		
For models:	GRAH18, GRAH30, GRAH42, GRAH54		

			
1			
GEV No.	112939	Ref. No.	X05.30.098.00 X05.30.098.00 old
description	knob switch zero mark ø 45mm shaft ø 6mm		
For models:	FLVM1X		

			
1			
GEV No.	112712	Ref. No.	05.30.020.00 X05.30.020.00 X05.30.098.00
description	knob switch zero mark t.max.°C ø 38mm shaft ø 6mm shaft flat		

accessories

fascias

			
1			
GEV No.	112946	Ref. No.	07.01.034.00
description	bezel 0-7 dimensions 51x60mm		
For models:	GRAH18, GRAH30, GRAH42, GRAH54		

equipment feet and end caps

equipment feet

with screw mounting

			
1			
GEV No.	691476	Ref. No.	05.30.007.00 X05.30.092.00
description	equipment foot thread 3/8"-16UNC thread L 12mm H 101-135mm plastic size 1½" Qty 1 pcs		

transmission technology and ball bearings

chains

roller chains 25-1 single



1

GEV No.	691472	Ref. No.	X05.03.040.00
description	chain US norm 25-1 splitting 6mm links 30 internal width 3.3mm rollerø 4.3mm single closed		



1

GEV No.	691473	Ref. No.	X05.03.044.00
description	chain US norm 25-1 splitting 6mm links 31 internal width 3.3mm rollerø 4.3mm single closed		

measuring equipment

thermometers

built-in thermometers

external power supply



1

GEV No.	403623	Ref. No.	X02.16.137.00
description	thermometer mounting measurements 65x20mm 220V 0 up to +99°C cable length 2900mm probe ø 6mm probe L 25mm		
For models:	FLVM1X		

fastening material

fasteners

retainer clips



1

GEV No.	691471	Ref. No.	X05.04.531.00
description	retainer clip L 48mm wire gauge ø 2.3mm stainless steel Qty 1 pcs		

retaining rings

DIN 6799



1

GEV No.	691470	Ref. No.	X05.03.043.00
description	retaining ring E D1 ø 8mm D2 ø 16mm SS DIN 6799 thickness 1mm for shaft ø 9-12mm		

consumables

fuses

fine fuses



1

GEV No.	358611	Ref. No.	63001510
description	fine fuse size ø5x20mm 16A fast-acting rated 250V Qty 10 pcs		

ø10x38mm 500V



1

GEV No.	358028	Ref. No.	510127
description	fine fuse size ø10x38mm 20A rated 500V type Gg fast-acting Qty 1 pcs		

A			
axial fans		8	
B			
bi-metal thermostats		4, 4	
C			
cam switches		6	
coil heating elements		4	
condensators & interference suppression filters		9	
consumables		12	
contactors		7	
control thermostats		5	
E			
electric accessories		9	
energy regulators		4	
F			
fans		8	
fasteners		12	
fastening material		12	
filters		9	
fine fuses		12	
float switches		5	
fuses		9, 12	
H			
heating elements		3	
heating elements for chagrills		3	
heating elements for heated cabinets		4	
heating elements for heating bridges		3	
heating elements for salamanders/toasters		3	
I			
indicator lights		6	
indicator lights (complete)		6	
L			
lamps		6	
light bulbs		6	
M			
magnetic switches		6	
measuring equipment		12	
microswitches		5	
motors		8	
O			
oven lamps		7	
P			
pumps		9	
pumps for ice machines		9	
R			
retainer clips		12	
retaining rings		12	
rocker/momentary rocker switches		5	
S			
solenoid valves		8	
switches and momentary switches		5	
T			
terminals		9	
thermostats		4	
toggle switches		5	