



GAS COMPONENTS



ELECTRIC COMPONENTS



WATER TECHNOLOGY



MECHANICAL COMPONENTS



TOOLS

Spare parts suitable for

HENDI

Find the complete and up-to-date range of products in our GEV Webshop



Manufacturer catalogue

The most important spare parts and accessories arranged clearly for every manufacturer

- ✓ Complete product range and all appliance data always up to date in the GEV Webshop
- ✓ Alphabetical Index at the end of the catalogue

GEV Webshop

www.gev-online.co.uk

www.gev-online.com



- 🔍 Add to Favourites
- 🔍 Sign In with email address and usual password
- 🔍 Easy-order – place several items in your basket at the same time
- 🔍 Quick Item search – no login needed





heating elements

heating elements for bain maries

 <p>1</p>			
GEV No.	420476	Ref. No.	900642
description	heating element 1200W 230V heating circuits 1 L 405mm W 150mm connection M4 connection distance 145mm tube ø 7mm		

heating elements for contact grills

 <p>1</p>			
GEV No.	419161	Ref. No.	912171
description	heating element 1100W 415V L 180mm W 180mm H 40mm tube ø 6.5mm connection M4		

 <p>1</p>			
GEV No.	419002	Ref. No.	902028
description	heating element 1400W 230V heating circuits 1 L 175mm W 305mm H 20mm W1 40mm W2 325mm tube ø 6.3mm windings 5		

 <p>1</p>			
GEV No.	419003	Ref. No.	902035
description	heating element 1550W 240V L 175mm W 305mm H 40mm tube ø 6.3mm connection M4 windings 5		

 <p>1</p>			
GEV No.	419160	Ref. No.	912140
description	heating element 900W 400V L 170mm W 180mm H 15mm W1 40mm W2 100mm tube ø 6.5mm windings 3 connection M4		

thermostats

bi-metal thermostats

safety bi-metal thermostats

 <p>1</p>			
GEV No.	390708	Ref. No.	902004
description	bi-metal safety thermostat hole distance 23.5mm switch-off temp. 180°C 1NC 1-pole 16A connection M3 mounting ø 15mm		

bi-metal thermostats

 <p>1</p>			
GEV No.	390886	Ref. No.	923153
description	bi-metal thermostat hole distance 24mm switch-off temp. 210°C 1NC 1-pole 16A 250V connection F6.3 2 hole fixing Qty 1 pcs		

control and safety thermostats

EGO

control thermostats

55.13_ series

 <p>1</p>			
GEV No.	390885	Ref. No.	205228
description	thermostat t.max. 190°C temperature range 0-190°C 1-pole 1NO 16A probe ø 6mm probe L 115mm capillary pipe 550mm capillary pipe isolated 260mm gland nut shaft ø 6x4.6mm shaft L 20mm shaft position 135° rotation 270°		



E·G·O



GEV No.	390884	Ref. No.	923092
description	thermostat t.max. 250°C temperature range 50-250°C 1-pole 1NO 16A probe ø 6mm probe L 62mm capillary pipe 1450mm capillary pipe isolatedmm gland nut shaft ø 6x4.6mm shaft L 16mm shaft position upper rotation 270° probe material SS		

E·G·O



GEV No.	375505	Ref. No.	902011
description	thermostat t.max. 320°C temperature range 50-320°C 1-pole 1NO 16A probe ø 3mm probe L 160mm capillary pipe 870mm capillary pipe isolatedmm gland nut shaft ø 6x4.6mm shaft L 23mm shaft position upper rotation 270°		

switches and momentary switches

rocker/momentary rocker switches

30x22mm



GEV No.	347791	Ref. No.	205426
description	rocker switch mounting measurements 30x22mm green 2NO 230V 20A illuminated 0-1 connection male faston 6.3mm ambient temperature max. 125/55°C protection IP65 with rubber collar		
For models:	221204		

cam switches

4 operating positions

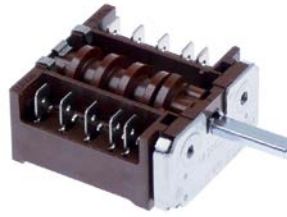

GEV No.	300243	Ref. No.	912102
description	cam switch 2 operating positions sequence 0-1 shaft ø 6x4.6mm shaft L 23mm connection male faston 6.3mm 4-pole		

lamps

indicator lights

indicator lights (complete)

ø12mm

with plug-in socket



GEV No.	357110	Ref. No.	912119
description	indicator light ø 12mm green 400V connection male faston 6.3mm temp.-resist. 100°C		



GEV No.	360509	Ref. No.	912003
description	indicator light ø 12mm yellow 230V connection male faston 6.3mm thermometer		



GEV No.	357111	Ref. No.	912126
description	indicator light ø 12mm yellow 400V connection male faston 6.3mm thermometer		



motors

motors

for citrus juicers



1

GEV No.	501426	Ref. No.	900956 JR2004-MS
description	motor for citrus juicers 180W 230-240V 50Hz shaft ø 8mm shaft length 40mm type RCJ298252 0.18kW		
For models:	221204		

fuses

thermal fuses



1

GEV No.	358139	Ref. No.	923160
description	thermal fuse switch-off temp. 142°C nominal 15A rated 250V Qty 1 pcs		

electric accessories

cables

cable harnesses



1

GEV No.	699172	Ref. No.	912089 917089
description	cable harness		



1

GEV No.	699173	Ref. No.	912188
description	cable harness		

terminals

connection terminals with screw connection



1

GEV No.	551109	Ref. No.	912041
description	connecting cable 4-pole max. 15A max 500V connection screw temp.-resist. 150°C		

equipment-specific units

for cutters

blades

blades

blades smooth



1

GEV No.	696558	Ref. No.	919613
description	knife L 140mm mounting distance 23mm threaded thickness 2mm		

for citrus juicers

spillage trays



1

GEV No.	696502	Ref. No.	900963
description	drain tray for citrus juicers ø 175mm hole ø 42mm H 110mm SS		
For models:	221204		

gaskets



1

GEV No.	532647	Ref. No.	900970
description	O-ring EPDM thickness 1.8mm ID ø 11.8mm Qty 1 pcs		
For models:	221204		



1

GEV No.	511953	Ref. No.	900871
description	seal kit for citrus juicers		
For models:	221204		

motors



GEV No.	501426	Ref. No.	900956 JR2004-MS
description	motor for citrus juicers 180W 230-240V 50Hz shaft ø 8mm shaft length 40mm type RCJ298252 0.18kW		
For models:	221204		

juicer insert



GEV No.	650168	Ref. No.	900901
description	filter for citrus juicers ø 155mm H 23mm plastic		
For models:	221204		



GEV No.	650167	Ref. No.	221266
description	juicer insert set for citrus juicers ø 57/62/79mm H 45/50/55mm plastic		
For models:	221204		

spindles



GEV No.	650170	Ref. No.	900895
description	spindle L 48mm square thread M8x1.25 for citrus juicers WS 12		
For models:	221204		

miscellaneous



GEV No.	650171	Ref. No.	900925
description	cover for spindle ø 44mm H 18mm aluminium		
For models:	221204		



GEV No.	650169	Ref. No.	221242
description	drip tray for citrus juicers ø 79mm H 20mm plastic black		
For models:	221204		

for grills

sumps



GEV No.	692237	Ref. No.	263990
description	grease collecting tray L 357mm W 37mm H 29mm		

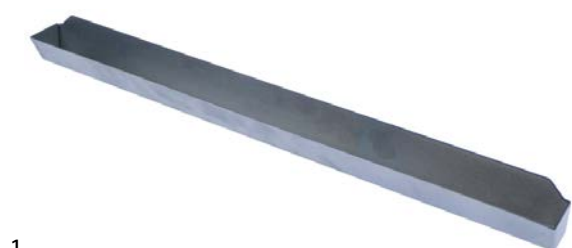

GEV No.	692238	Ref. No.	263983
description	grease collecting tray L 497mm W 37mm H 29mm		

for panini grill

guiding pieces

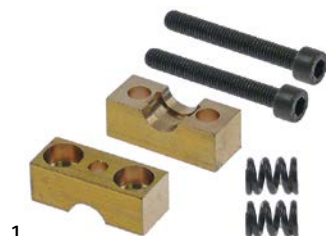

GEV No.	698565	Ref. No.	902097
description	shaft bearing mounting pos. rear L 35mm W 14mm H 12.5mm		

for contact grills

miscellaneous



GEV No.	692241	Ref. No.	902195 912195
description	spindle for contact grill		

1

GEV No.	692239	Ref. No.	902226
description	spindle for contact grill L 404mm ø 12mm		

knobs

producer-specific knobs

HENDI



1

GEV No.	112870	Ref. No.	904411
description	knob t.max. 300°C 50-300°C ø 58mm shaft ø 6x4.6mm shaft flat left		



1

GEV No.	112674	Ref. No.	904411 old version
description	knob thermostat t.max. 300°C 50-300°C ø 58mm shaft ø 6x4.6mm shaft flat lower		

handles and hand wheels

folding grill handles



1

GEV No.	692149	Ref. No.	902264
description	handle L 155mm ø 30mm seat ø 10mm for contact grill		

equipment feet and end caps

screw-in feet



1

GEV No.	701230	Ref. No.	900888
description	equipment feet kit thread M5 thread L 10mm ø 22mm H 12mm rubber WS Qty 4 pcs bore ø 5/10mm		
For models:	221204		



1

GEV No.	802048	Ref. No.	912058
description	equipment foot thread M6 thread L 14mm ø 30mm H 16mm Qty 4 pcs		

gaskets

gaskets for heated units

door seals with fixing hook



1

GEV No.	900394	Ref. No.	225332
description	oven gasket L 370mm W 640mm 6 hooks external size		

O-rings

EPDM



1

GEV No.	532647	Ref. No.	900970
description	O-ring EPDM thickness 1.8mm ID ø 11.8mm Qty 1 pcs		
For models:	221204		

shaft gaskets

miscellaneous



GEV No.	511953	Ref. No.	900871
description	seal kit for citrus juicers		
For models:	221204		

springs

torsion springs



GEV No.	700569	Ref. No.	901908
description	torsion spring \varnothing 21.5mm L2 40mm wire gauge \varnothing 3.3mm L1 100mm L3 45mm		

fastening material

fasteners

roll pins



GEV No.	692236	Ref. No.	902240
description	roll pin \varnothing 4mm L 40mm		

consumables

fuses

thermal fuses



GEV No.	358139	Ref. No.	923160
description	thermal fuse switch-off temp. 142°C nominal 15A rated 250V Qty 1 pcs		

B			
bi-metal thermostats	3, 3		
C			
cables	5		
cam switches	4		
consumables	8		
control thermostats	3		
D			
door seals with fixing hook	7		
E			
electric accessories	5		
F			
fasteners	8		
fastening material	8		
fuses	5, 8		
G			
gaskets for heated units	7		
H			
heating elements	3		
heating elements for bain maries	3		
heating elements for contact grills	3		
I			
indicator lights	4		
indicator lights (complete)	4		
L			
lamps	4		
M			
motors	5		
O			
O-rings	7		
R			
rocker/momentary rocker switches	4		
roll pins	8		
S			
safety bi-metal thermostats	3		
shaft gaskets	8		
switches and momentary switches	4		
T			
terminals	5		
		thermal fuses	8
		thermostats	3