



GAS COMPONENTS



ELECTRIC COMPONENTS



WATER TECHNOLOGY



MECHANICAL COMPONENTS



TOOLS

Spare parts suitable for

HOBART

Find the complete and up-to-date range of products in our GEV Webshop



Manufacturer catalogue

The most important spare parts and accessories arranged clearly for every manufacturer

- ✓ Complete product range and all appliance data always up to date in the GEV Webshop
- ✓ Alphabetical Index at the end of the catalogue

GEV Webshop

www.gev-online.co.uk

www.gev-online.com





- 🔍 Add to Favourites
- 🔍 Sign In with email address and usual password
- 🔍 Easy-order – place several items in your basket at the same time
- 🔍 Quick Item search – no login needed



heating elements

dry heating elements for dishwashers







			
GEV No.	420180	Ref. No.	229189-26
description	heating element 1220W 254V heating circuits 1 L 425mm W 65mm tube ø 8.4mm connection M4 dry heating element flange connection flange length 81mm flange width 28mm hole ø 6.6mm		

			
GEV No.	420179	Ref. No.	229189-22
description	heating element 1830W 254V heating circuits 1 L 425mm W 65mm tube ø 8.4mm connection M4 dry heating element flange connection flange length 81mm flange width 28mm hole ø 6.6mm		
For models:	CR-F		

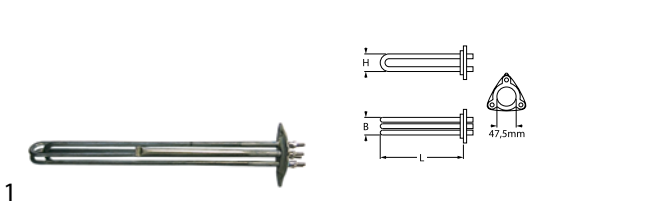

			
GEV No.	420178	Ref. No.	229189-23
description	heating element 2440W 254V heating circuits 1 L 425mm W 65mm tube ø 8.4mm connection M4 dry heating element flange connection flange length 81mm flange width 28mm hole ø 6.6mm		
For models:	FTX		



immersion heating elements

3 hole flange ø47.5mm

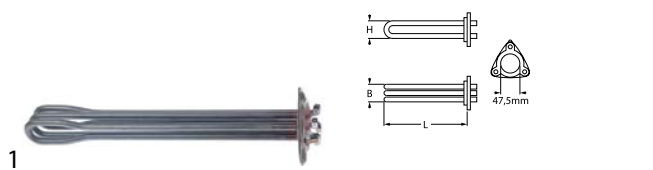
			
GEV No.	415001	Ref. No.	37145012
description	heating element 4500W 230V mounting ø 47.5mm heating circuits 3 L 316mm W 35mm H 34mm number of thermostat sleeves 1 thermostat sleeves ø 7mm length thermostat sleeves 180mm thermostat sleeve eccentric, non clinging tube ø 6.3mm hole distance 62mm hole ø 8mm connection M4 3 hole flange immersion heater		
For models:	GF-60, GF-60S		
spare parts for	415001		
	GEV No.	510408	Ref. No. —
	O-ring EPDM thickness 5.34mm ID ø 47mm Qty 1 pcs		
accessories for	415001		
	GEV No.	510562	Ref. No. —
	O-ring silicone thickness 5.34mm ID ø 47mm Qty 1 pcs		
	GEV No.	521103	Ref. No. —
	nut thread M4 H 3mm WS 7 brass Qty 20 pcs		
	GEV No.	521104	Ref. No. —
	washer ID ø 4.3mm ED ø 8mm thickness 0.5mm brass Qty 20 pcs for thread M4		
	GEV No.	560111	Ref. No. —
	plain washer ID ø 4.3mm ED ø 9mm thickness 0.8mm SS Qty 20 pcs DIN 125A for thread M4		

accessories for	415001		
	GEV No.	560131	Ref. No. —
	hexagonal nut thread M4 H 3.2mm WS 7 SS DIN/ISO DIN 934 / ISO 4032/8673 Qty 20 pcs		

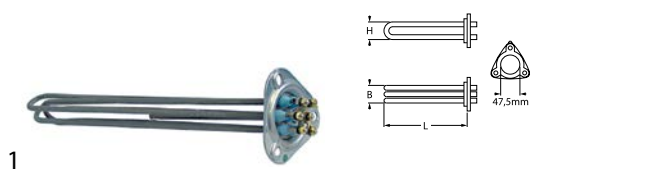
			
GEV No.	420302	Ref. No.	01-240761-001 01-240761-002 01-240761-1 240761-2
description	heating element 6000W 240V mounting ø 47.5mm heating circuits 3 L 325mm W 33mm H 37mm number of thermostat sleeves 1 thermostat sleeves ø 5mm length thermostat sleeves 140mm thermostat sleeve centre not clinging tube ø 8.3mm hole distance 62mm hole ø 10mm connection male faston 6.3mm 3 hole flange immersion heater		
For models:	AM-10, AM-11, AM-141, ECOMAX-402, ECOMAX-502, ECOMAX-602-10		
accessories for	420302		
	GEV No.	521030	Ref. No. 01-240135-011 01-240135-11 1-240135-11 240135-11
	O-ring Viton thickness 5.34mm ID ø 47mm Qty 1 pcs		

			
GEV No.	416240	Ref. No.	139321-1031
description	heating element 6545W 230/400V mounting ø 48mm heating circuits 3 L 355mm W 31mm H 37mm number of thermostat sleeves 1 thermostat sleeves ø 7mm length thermostat sleeves 175mm thermostat sleeve upper centre not clinging tube ø 6.5mm hole distance 63mm hole ø 10mm connection M4 3 hole flange immersion heater		
accessories for	416240		
	GEV No.	510408	Ref. No. —
	O-ring EPDM thickness 5.34mm ID ø 47mm Qty 1 pcs		
	GEV No.	510562	Ref. No. —
	O-ring silicone thickness 5.34mm ID ø 47mm Qty 1 pcs		



GEV No.	419005	Ref. No.	01-240135-002 01-240135-2 02-240135-001
description	heating element 7260W 250V mounting \varnothing 47.5mm heating circuits 3 L 375mm W 31mm H 35mm number of thermostat sleeves 1 thermostat sleeves \varnothing 5mm length thermostat sleeves 220mm thermostat sleeve centre not clinging tube \varnothing 8.5mm connection male faston 6.3mm 3 hole flange immersion heater		
For models:	AM900-10N, AM900-90, AMS900-10N, AMX, AMX-10HL, AMX-90, AMXR, AMXS, AMXT, AMXTS, AMXX, AMXXR, AMXXS, AUP, AUP-90, AUPS, AUXX, AUXXL-11N, AUXXLS-11N, AUXXR, AUXXS, AUXXT, AUXXTS, ECOMAX-602-11, ECOMAX-602S-11, ECOMAX-612-10, ECOMAX-612S-10, FP, FX, FX-McDonalds, GP, GX		
accessories for	419005		
	GEV No.	510408	Ref. No. —
	O-ring EPDM thickness 5.34mm ID \varnothing 47mm Qty 1 pcs		

GEV No.	416241	Ref. No.	139321-935
description	heating element 8000W 230V mounting \varnothing 47.5mm heating circuits 3 L 355mm W 35mm H 35mm number of thermostat sleeves 1 thermostat sleeves \varnothing 7.5mm length thermostat sleeves 185mm thermostat sleeve not clinging tube \varnothing 6.3mm hole distance 64mm hole \varnothing 8mm connection M4 3 hole flange immersion heater		
spare parts for	416241		
	GEV No.	510408	Ref. No. —
	O-ring EPDM thickness 5.34mm ID \varnothing 47mm Qty 1 pcs		
accessories for	416241		
	GEV No.	510093	Ref. No. 139321-053
	protection cap		
	GEV No.	510408	Ref. No. —
	O-ring EPDM thickness 5.34mm ID \varnothing 47mm Qty 1 pcs		
	GEV No.	510562	Ref. No. —
	O-ring silicone thickness 5.34mm ID \varnothing 47mm Qty 1 pcs		

GEV No.	415668	Ref. No.	139221-246 139321-246 371450-13
description	heating element 2625W 230V mounting \varnothing 47.5mm heating circuits 1 L 190mm W 41mm H 54mm number of thermostat sleeves 1 thermostat sleeves \varnothing 7mm length thermostat sleeves 170mm thermostat sleeve eccentric, non clinging tube \varnothing 6.3mm hole distance 62mm hole \varnothing 8mm connection M4 3 hole flange immersion heater		
For models:	GE-400, GF-60, GF-60S, GW-600, GW-600S, GW-601, GW-601S		
accessories for	415668		
	GEV No.	510562	Ref. No. —
	O-ring silicone thickness 5.34mm ID \varnothing 47mm Qty 1 pcs		

3 hole flange \varnothing 57.5mm

GEV No.	418140	Ref. No.	1235430
description	heating element 7500W 230V mounting \varnothing 57.5mm heating circuits 3 L 295mm W 34mm H 45mm number of thermostat sleeves 1 thermostat sleeves \varnothing 7mm length thermostat sleeves 275mm thermostat sleeve not clinging tube \varnothing 6.3mm hole distance 72mm hole \varnothing 8mm connection M4 3 hole flange immersion heater		

with compression flange 50 x 26mm

group 1

GEV No.	420071	Ref. No.	01-240766-001 01-240766-1 01-240766-101
description	heating element 2000W 240V heating circuits 1 flange 50x26mm L 320mm W 36mm H 45mm compression flange connection male faston 6.3mm tube \varnothing 8.6mm immersion heater		
For models:	ECOMAX-402, ECOMAX-502		
accessories for	420071		
	GEV No.	510387	Ref. No. —
	gasket L 46mm W 22mm \varnothing mm EPDM for heating element for flange 50x26mm		







1

GEV No.	420462	Ref. No.	01-240247-001 01-240247-1 01-515292-001 01-515292-1 01-515292-101
description	service kit 975W 250V flange 26.5x50mm L 168mm W 32mm heating circuits 1 tube ø 8.5mm H 35mm incl. accessories		
For models:	FP, FX, FX-McDonalds, GP, GX		



1

GEV No.	416292	Ref. No.	324187-2
description	heating element 2700W 230V heating circuits 1 flange 50x26mm L 380mm W 105mm L1 60mm L2 45mm L3 275mm M5 connection male faston 6.3mm tube ø 8.5mm immersion heater		
For models:	FE-W, FX, GX		
accessories for	416292		
	GEV No.	510387	Ref. No. —
	gasket L 46mm W 22mm ømm EPDM for heating element for flange 50x26mm		
	GEV No.	510388	Ref. No. —
	counterflange ømm hole distancemm perforation ømm L 43mm W 21mm SS for heating element for flange 50x26mm		





1

GEV No.	417517	Ref. No.	00-883423-001 883423-1
description	heating element 3000W 254V heating circuits 1 flange 50x26mm L 420mm W 70mm L1 58mm L2 70mm L3 320mm compression flange connection male faston 6.3mm horizontal tube ø 8.5mm immersion heater		
For models:	AM-10, AM-11, AM-141, AM900-10N, AM900-90, AMS900-10N, AMX, AMX-10HL, AMX-90, AMXR, AMXS, AMXT, AMXTS, AMXX, AMXXR, AMXXS, AUP, AUP-90, AUPS, AUXX, AUXXL-11N, AUXXLS-11N, AUXXR, AUXXS, AUXXT, AUXXTS, ECOMAX-602-10, ECOMAX-602-11, ECOMAX-602S-11, ECOMAX-612-10, ECOMAX-612S-10		





1

GEV No.	416293	Ref. No.	00-231982-009 231982-9
description	heating element 610W 254V heating circuits 1 flange 50x26mm L 370mm W 120mm L1 40mm L2 70mm L3 260mm compression flange connection 6.5 tube ø 8.5mm immersion heater		
For models:	AMX, AMX-E, AMX-ER, AMX-R, AUX, AUX_, AUX-E, AUX-ER, AUX-R, FE, FX, GX, HE, HE600-HL, HE-P, HX, HX-30, HX-30E, HX-30ES, HX-30S, HX-40, HX-40E, HX-40ES, HX-40S, HX-60-EHL, HX-E, HX-ES, HX-S, UXD-30		
accessories for	416293		
	GEV No.	510387	Ref. No. —
	gasket L 46mm W 22mm ømm EPDM for heating element for flange 50x26mm		
	GEV No.	510388	Ref. No. —
	counterflange ømm hole distancemm perforation ømm L 43mm W 21mm SS for heating element for flange 50x26mm		



1



GEV No.	416294	Ref. No.	231982-10
description	heating element 610W 440V heating circuits 1 flange 50x26mm L 365mm W 120mm L1 35mm L2 60mm L3 270mm compression flange connection male faston 6.3mm tube ø 8.5mm immersion heater		
For models:	AMX, AMX-E, AMX-ER, AMX-R, AUX, AUX_, AUX-E, AUX-ER, AUX-R, FX, GX, HX, HX-30, HX-30E, HX-30ES, HX-30S, HX-40, HX-40E, HX-40ES, HX-40S, HX-E, HX-ES, HX-S		
accessories for	416294		
	GEV No.	510387	Ref. No. —
	gasket L 46mm W 22mm ømm EPDM for heating element for flange 50x26mm		
	GEV No.	510388	Ref. No. —
	counterflange ømm hole distancemm perforation ømm L 43mm W 21mm SS for heating element for flange 50x26mm		



1

GEV No.	420538	Ref. No.	E230102
description	heating element 1600W 230V heating circuits 1 flange 50x26mm L 305mm W 47mm H 25mm tube ø 8.5mm connection F6.3		



GEV No.	416234	Ref. No.	139321-719
description	heating element 600W 230V heating circuits 1 flange 50x26mm L 160mm W 45mm H 27mm tube ø 8.8mm connection male faston 6.3mm connection length 40mm immersion heater compression flange		
For models:	CLG-25		
accessories for	416234		
	GEV No.	510387	Ref. No. —
	gasket L 46mm W 22mm ømm EPDM for heating element for flange 50x26mm		
	GEV No.	510388	Ref. No. —
	counterflange ømm hole distancemm perforation ømm L 43mm W 21mm SS for heating element for flange 50x26mm		

with expansion flange 40 x 16mm



GEV No.	416283	Ref. No.	324646-1
description	heating element 1830W 254V flange 40x16mm L 385mm W 36mm connection male faston 6.3mm heating circuits 1 tube ø 8.5mm immersion heater expansion flange		
For models:	FE, FE-W, FX, GX, HE, HE600-HL, HE-P, HX-60-EHL		





GEV No.	420353	Ref. No.	227953-1
description	heating element 2000W 220V flange 40x16mm L 335mm W 39mm connection male faston 6.3mm heating circuits 1 tube ø 8.4mm immersion heater compression flange mounting distance 24mm		
For models:	CM1E, FM-30, FM-30U, FM-400H, FM-400U, FM-500, FM-500H, UW-55, WM2E		



GEV No.	416284	Ref. No.	324646-2
description	heating element 2440W 254V flange 40x16mm L 402mm W 34mm connection male faston 6.3mm heating circuits 1 tube ø 8.5mm immersion heater expansion flange		
For models:	FE, FE-W, FX, GX, HE, HE600-HL, HE-P, HX-60-EHL		



GEV No.	416388	Ref. No.	324646-4 D324646-4
description	heating element 3000W 230V flange 40x16mm L 410mm W 33mm connection male faston 6.3mm heating circuits 1 tube ø 8.5mm immersion heater expansion flange		
For models:	FE, FE-W, FX, GX, HE, HE600-HL, HE-P, HX-60-EHL		
spare parts for	416388		
	GEV No.	416464	Ref. No. —
	heating element 2000W 230V L 600mm W 572mm thread 1/4" mounting distance 563mm connection length 45mm tube ø 8.6mm cable length 643mm heating circuits 1 dry heating element 2 hole fixing		



GEV No.	416285	Ref. No.	324646-3
description	heating element 3050W 254V flange 40x16mm L 400mm W 36mm connection male faston 6.3mm heating circuits 1 tube ø 8.5mm immersion heater expansion flange with temperature fuse		
For models:	FE, FE-W, FX, GX, HE, HE600-HL, HE-P, HX-60-EHL		

with expansion flange 70 x 18mm

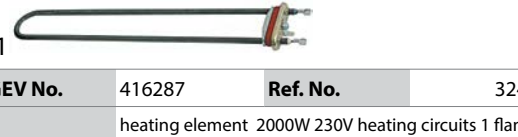



GEV No.	416287	Ref. No.	324644-2
description	heating element 2000W 230V heating circuits 1 flange 70x18mm L 388mm W 64mm connection male faston 6.3mm tube ø 8.5mm immersion heater expansion flange		
For models:	AM-700, CR-F, ECOMAX-600, ECW, UX, UX-30, UX-30B, UX-30E, UX-30EB, UX-30EH, UX-30ES, UX-30ESB, UX-30ESH, UX-30H, UX-30-McDonalds, UX-30S, UX-30SB, UX-30SH, UX-60, UX-60B, UX-60E, UX-60EB, UX-60EH, UX-60EHB, UX-60H, UX-60HB, UXL, UXLs, UXS		



GEV No.	416239	Ref. No.	230100
description	heating element 2600W 230V heating circuits 1 flange 70x18mm L 270mm W 65mm connection male faston 6.3mm tube ø 8.5mm immersion heater expansion flange		
For models:	ECOMAX-400-12, ECOMAX-400S-12		





			
GEV No.	416286	Ref. No.	324644-1
description	heating element 3000W 230V heating circuits 1 flange 70x18mm L 408mm W 65mm connection male faston 6.3mm tube ø 8.5mm immersion heater expansion flange connection length 18mm		
For models:	AMX, AMX-E, AMX-ER, AMX-R, AUX, AUX-E, AUX-ER, AUX-R, CR-F, ECOMAX-700, ECW, UX, UX-30, UX-30B, UX-30E, UX-30EB, UX-30EH, UX-30ES, UX-30ESB, UX-30ESH, UX-30H, UX-30-McDonalds, UX-30S, UX-30SB, UX-30SH, UX-60, UX-60B, UX-60E, UX-60EB, UX-60EH, UX-60EHB, UX-60H, UX-60HB, UXL, UXLS, UXS, UXT, UXTH, UXTHL, UXTHLS, UXTHS, UXTL, UXTLH, UXTLHS, UXTLS, UXTS		

			
GEV No.	419162	Ref. No.	775464-002 775464-2
description	heating element 3000W 240V heating circuits 1 flange 70x18mm L 318mm W 65mm connection male faston 6.3mm tube ø 8.5mm immersion heater expansion flange connection length 24mm TD ø 10mm with temperature probe		
For models:	AM900, AMS900, FX, GC, GC11, GC12, GC31, GC32, GC41, GC42, GX		
spare parts for	419162		
	GEV No.	Ref. No.	402906 775494-1
	 temperature probe NTC 10kOhm cable probe -40 up to +110°C cable°C connection male faston 4.8mm thread probe ø10x30mm cable lengthm		

			
GEV No.	416288	Ref. No.	00-324637-002 324637-... 324637-2
description	heating element 4000W 230V heating circuits 2 flange 70x18mm L 410mm W 63mm connection F2.8mm / F6.3mm tube ø 8.5mm immersion heater expansion flange connection length 30mm		
For models:	CR-F, UX-30, UX-30B, UX-30E, UX-30EB, UX-30ES, UX-30ESB, UX-30S, UX-30SB, UX-60, UX-60B, UX-60E, UX-60EB, UX-60EH, UX-60EHB, UX-60H, UX-60HB		





			
GEV No.	416289	Ref. No.	00-324637-001 324637-... 324637-1
description	heating element 6000W 230V heating circuits 2 flange 70x18mm L 417mm W 65mm connection male faston 6.3mm tube ø 9mm immersion heater expansion flange connection length 35mm		
For models:	AMX, AMX-E, AMX-ER, AMX-R, AMXX-1300, AMXXT, AUX, AUX-E, AUX-ER, AUX-R, AUXX-1300, AUXXL, AUXXT, CR-F, ECW, UX-60, UX-60B, UX-60E, UX-60EB, UX-60EH, UX-60EHB, UX-60H, UX-60HB, UXT, UXTH, UXTHL, UXTHLS, UXTHS, UXTL, UXTLH, UXTLHS, UXTLS, UXTS		

			
GEV No.	419139	Ref. No.	775464-1
description	heating element 6000W 240V heating circuits 2 flange 70x18mm L 315mm W 62mm connection male faston 6.3mm tube ø 8.5mm		
For models:	AM900, AMS900, FX, GC, GC11, GC12, GC31, GC32, GC41, GC42, GX		

			
GEV No.	419026	Ref. No.	324637-... 324637-3
description	heating element 6100W 254V heating circuits 2 flange 70x18mm L 420mm W 63mm connection F6.3 tube ø 8.5mm immersion heater expansion flange connection length 30mm		
For models:	AM-700, AMX-900, AMXR-900, AMXS-900, AMXX-1300, AMXXR-1300, AMXXS-1300, AMXXT, AUXX-1300, AUXXL, AUXXR-1300, AUXXS-1300, AUXXT, CN, CNA, CNB, CNR, CR, CR-F, CSA, ECOMAX-600, ECO-MAX-650, ECOMAX-800, ECW, FTN, FTX, UX-30, UX-30B, UX-30E, UX-30EB, UX-30ES, UX-30ESB, UX-30S, UX-30SB, UX-60, UX-60B, UX-60E, UX-60EB, UX-60EH, UX-60EHB, UX-60H, UX-60HB		

			
GEV No.	416243	Ref. No.	139321-463
description	heating element 7600W 230V heating circuits 3 flange 70x18mm L 390mm W 60mm H 13mm connection male faston 6.3mm tube ø 6.3mm immersion heater expansion flange INCOLOY-800		
For models:	CHF45, EF-40		

with round flange ø47.5mm

			
GEV No.	416295	Ref. No.	226807-1
description	heating element 3000W 230V heating circuits 3 mounting ø 47.5mm L 185mm W 79mm H 30mm L1 35mm L2 150mm W1 23mm W2 34mm round flange connection male faston 6.3mm immersion heater tube ø 6.5mm		
For models:	AM-12E, AM-12EC, AM-12EF, AM-12ER, AM-600, AM-600C, AM-600CR, AM-600R, UW-100, UW-105		
accessories for	416295		
	GEV No.	Ref. No.	510408 —
	 O-ring EPDM thickness 5.34mm ID ø 47mm Qty 1 pcs		
	GEV No.	Ref. No.	510562 —
	 O-ring silicone thickness 5.34mm ID ø 47mm Qty 1 pcs		
	GEV No.	Ref. No.	550002 —
	 tension strap H 10mm L 21mm W 10mm hole ø 6.5mm for heating element		





			
GEV No.	416296	Ref. No.	170495-2
description	heating element 6000W 230V heating circuits 3 mounting ø 47.5mm L 230mm W 128mm H 32mm L1 30mm L2 200mm W1 46mm W2 34mm round flange connection male faston 6.3mm immersion heater tube ø 6.3mm		
For models:	AM-12E, AM-12EC, AM-12EF, AM-12ER, AM-600, AM-600C, AM-600CR, AM-600R, UW-105		
accessories for	416296		
	GEV No.	Ref. No.	510408 —
	 O-ring EPDM thickness 5.34mm ID ø 47mm Qty 1 pcs		



Table continues overleaf



accessories for 416296			
	GEV No.	510562	Ref. No. —
O-ring silicone thickness 5.34mm ID ø 47mm Qty 1 pcs			
	GEV No.	550002	Ref. No. —
tension strap H 10mm L 21mm W 10mm hole ø 6.5mm for heating element			





GEV No.	416297	Ref. No.	173649-1 173649-2
description	heating element 7500W 230V heating circuits 3 mounting ø 47.5mm L 230mm W 123mm H 31mm L1 32mm L2 198mm W1 45mm W2 35mm round flange connection male faston 6.3mm immersion heater tube ø 6.5mm		
For models:	AM-600, AM-600C, AM-600CR, AM-600R, UW-105		

accessories for 416297			
	GEV No.	510408	Ref. No. —
O-ring EPDM thickness 5.34mm ID ø 47mm Qty 1 pcs			
	GEV No.	510562	Ref. No. —
O-ring silicone thickness 5.34mm ID ø 47mm Qty 1 pcs			
	GEV No.	550002	Ref. No. —
tension strap H 10mm L 21mm W 10mm hole ø 6.5mm for heating element			



GEV No.	416298	Ref. No.	226506-1 226506-2
description	heating element 9000W 230V heating circuits 3 mounting ø 47.5mm L 230mm W 120mm H 34mm L1 25mm L2 205mm W1 42mm W2 36mm round flange connection male faston 6.3mm immersion heater tube ø 8.5mm connection length 44mm		
For models:	AM-12E, AM-12EC, AM-12EF, AM-12ER, AM-600, AM-600C, AM-600CR, AM-600R, UW-100, UW-105, UW-135, UW-135H		

accessories for 416298			
	GEV No.	510408	Ref. No. —
O-ring EPDM thickness 5.34mm ID ø 47mm Qty 1 pcs			
	GEV No.	510562	Ref. No. —
O-ring silicone thickness 5.34mm ID ø 47mm Qty 1 pcs			
	GEV No.	550002	Ref. No. —
tension strap H 10mm L 21mm W 10mm hole ø 6.5mm for heating element			

with round flange (miscellaneous)



GEV No.	419183	Ref. No.	323949-1
description	heating element 7320W 254V L 355mm W 35mm H 35mm heating circuits 3 round flange connection F6.3 immersion heater tube ø 8.5mm		
For models:	EWB-S, UXT, UXTH, UXTHL, UXTHLS, UXTHS, UXTL, UXTLH, UXTLHS, UXTLS, UXTS		

accessories for 419183			
	GEV No.	510409	Ref. No. 00-276903-053 00-67500-016 00-67500-118 276903-53 670500-118 67500-118 67500-16
O-ring EPDM thickness 5.34mm ID ø 56.52mm Qty 1 pcs			



GEV No.	419103	Ref. No.	00-229148-001 229148-1 229148-1 (230V) 229148-2
description	heating element 9000W 240V L 520mm W 47mm H 41mm heating circuits 3 flange ø 71mm mounting thread M10 connection M4 tube ø 8.5mm connection length 21mm		
For models:	CR-F, CX, ECW, FTX, FUX, UW-135, UW-135H, UWX		



accessories for 419103			
	GEV No.	510409	Ref. No. 00-276903-053 00-67500-016 00-67500-118 276903-53 670500-118 67500-118 67500-16
O-ring EPDM thickness 5.34mm ID ø 56.52mm Qty 1 pcs			

special flanges







GEV No.	420351	Ref. No.	166151-1 166151-2 38658-1
description	heating element 10000W 220/380V heating circuits 3 L 360mm W 127mm flange length 90mm flange width 90mm connection 4 hole flange warewashing tube ø 8.5mm H 42mm		
For models:	UW-120, UW-200		







miscellaneous				
				
1				
GEV No.	416299	Ref. No.	324206-3 324206-6	
description	heating element 2200W 230V heating circuits 1 L 420mm W 45mm H 35mm number of thermostat sleeves 1 thermostat sleeves ø 5mm length thermostat sleeves 365mm tube ø 8.5mm hole distance 45mm hole ø 10mm connection length 25mm 4 hole flange immersion heater flange width 63mm flange length 63mm			
For models:	FX, GX, HX, HX-30, HX-30E, HX-30ES, HX-30S, HX-40, HX-40E, HX-40ES, HX-40S, HX-E, HX-ES, HX-S			
accessories for	416299			
				
GEV No.	505180	Ref. No.	00-233982-001 00-276903-021 233982-1 276903-21	
O-ring EPDM thickness 3.53mm ID ø 47.22mm Qty 1 pcs				

				
1				
GEV No.	416300	Ref. No.	324206-4	
description	heating element 4500W 230V heating circuits 3 L 413mm W 45mm H 45mm number of thermostat sleeves 1 thermostat sleeves ø 5mm length thermostat sleeves 377mm tube ø 8.5mm hole distance 45mm hole ø 10mm connection M4 4 hole flange immersion heater flange width 63.5mm flange length 63.5mm			
For models:	FX, GX, HX, HX-30, HX-30E, HX-30ES, HX-30S, HX-40, HX-40E, HX-40ES, HX-40S, HX-E, HX-ES, HX-S			

				
1				
GEV No.	416290	Ref. No.	324206-5	
description	heating element 7500W 230V heating circuits 3 mounting ø 47.5mm L 415mm W 44mm H 44mm number of thermostat sleeves 1 thermostat sleeves ø 5mm length thermostat sleeves 369mm tube ø 8.5mm hole distance 46mm hole ø 10mm connection M4 4 hole flange immersion heater flange width 63.5mm flange length 63.5mm			
For models:	FX, GX, HX, HX-30, HX-30E, HX-30ES, HX-30S, HX-40, HX-40E, HX-40ES, HX-40S, HX-E, HX-ES, HX-S			
accessories for	416290			
				
GEV No.	505180	Ref. No.	00-233982-001 00-276903-021 233982-1 276903-21	
O-ring EPDM thickness 3.53mm ID ø 47.22mm Qty 1 pcs				





				
1				
GEV No.	416502	Ref. No.	322158 322158-04 322158-4 845370-01 845370-1	
description	heating element 8000W 240V heating circuits 3 L 305mm W 40mm Hmm number of thermostat sleeves thermostat sleeves ømm length thermostat sleevesmm tube ø 6.3mm hole distance 44.9mm hole ø 10mm connection length 23mm connection male faston 6.3mm 4 hole flange immersion heater flange width 63.5mm flange length 63.5mm ø 40mm			
For models:	CO-0611E, CO-1011E, CO-2011E, CS-0611E, CS-0612E, CS-0612E-A, CS-1011E, CS-1012E, CS-1012E-A, CS-1022E, CS-1022E-A, CS-2011E, CS-2012E, CS-2012E-A, CS-2022E, CS-2022E-A, CSD-0611E, CSD-0612E, CSD-0612E-A, CSD-1011E, CSD-1012E, CSD-1012E-A, CSD-1022E, CSD-1022E-A, CSD-2011E, CSD-2012E, CSD-2012E-A, CSD-2022E, CSD-2022E-A			
accessories for	416502			
				
GEV No.	505180	Ref. No.	00-233982-001 00-276903-021 233982-1 276903-21	
O-ring EPDM thickness 3.53mm ID ø 47.22mm Qty 1 pcs				





				
1				
GEV No.	420204	Ref. No.	173906-1 173906-6	
description	heating element 9000W 230V heating circuits 3 L 295mm W 43mm H 39mm tube ø 8.5mm hole distance 45mm hole ø 10mm connection M4 flange connection immersion heater flange width 63.4mm flange length 63.4mm			
For models:	102-G, 103G, 104G, 202-G, 203G, 204G, 2226, 2227, 302-G, 303G, 304G, 304T			
accessories for	420204			
				
GEV No.	511655	Ref. No.	174529-1	
gasket fibre L 64mm W 64mm thickness 2.3mm hole ø 9mm hole distance 45mm 4 holes ID ø 46mm				







				
1				
GEV No.	416291	Ref. No.	324206-7 324206-8	
description	heating element 9000W 230V heating circuits 3 L 407mm W 42mm H 43mm number of thermostat sleeves 1 thermostat sleeves ø 5mm length thermostat sleeves 370mm thermostat sleeve eccentric, non clinging hole distance 45mm hole ø 10mm connection M4 4 hole flange immersion heater flange width 63.5mm flange length 63.5mm			
For models:	FX, GX, HX, HX-30, HX-30E, HX-30ES, HX-30S, HX-40, HX-40E, HX-40ES, HX-40S, HX-E, HX-ES, HX-S			
accessories for	416291			
				
GEV No.	505180	Ref. No.	00-233982-001 00-276903-021 233982-1 276903-21	
O-ring EPDM thickness 3.53mm ID ø 47.22mm Qty 1 pcs				

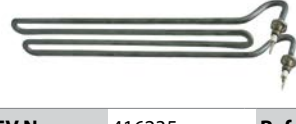

			
1			
GEV No.	415010	Ref. No.	139321203 371450205
description	heating element 2000W 230V heating circuits 1 L 260mm W 125mm H 20mm L1 110mm L2 150mm W1 42mm W2 83mm thread M10x1 mounting distance 70mm tube ø 6.5mm connection M4 immersion heater 2 hole fixing		
For models:	GE-400, GW-600, GW-600S, GW-601, GW-601S		
spare parts for	415010		
	GEV No.	510416	Ref. No. —
	flat gasket fibre ED ø 19mm ID ø 10.5mm thickness 1.5mm for thread M10 Qty 1 pcs		
accessories for	415010		
	GEV No.	504306	Ref. No. —
	gasket fibre ED ø 16mm ID ø 10mm thickness 2mm Qty 1 pcs		
	GEV No.	510893	Ref. No. —
	O-ring EPDM thickness 2.62mm ID ø 9.92mm Qty 1 pcs		
	GEV No.	520231	Ref. No. —
	nut thread M10x1 H 6mm WS 14 zinc-coated steel Qty 1 pcs		
	GEV No.	521103	Ref. No. —
	nut thread M4 H 3mm WS 7 brass Qty 20 pcs		
	GEV No.	521104	Ref. No. —
	washer ID ø 4.3mm ED ø 8mm thickness 0.5mm brass Qty 20 pcs for thread M4		
	GEV No.	521129	Ref. No. —
	nut thread M10 H 6mm SS WS 17 Qty 1 pcs DIN/ISO DIN 439		
	GEV No.	560111	Ref. No. —
	plain washer ID ø 4.3mm ED ø 9mm thickness 0.8mm SS Qty 20 pcs DIN 125A for thread M4		
	GEV No.	560131	Ref. No. —
	hexagonal nut thread M4 H 3.2mm WS 7 SS DIN/ISO DIN 934 / ISO 4032/8673 Qty 20 pcs		

			
1			
GEV No.	415665	Ref. No.	E230086
description	heating element 2750/3250W 220/240V heating circuits 1 L 380mm W 110mm H 30mm thread M10x1 mounting distance 75mm tube ø 6.5mm connection M4 immersion heater 2 hole fixing		
spare parts for	415665		
	GEV No.	510893	Ref. No. —
	O-ring EPDM thickness 2.62mm ID ø 9.92mm Qty 1 pcs		
accessories for	415665		
	GEV No.	510416	Ref. No. —
	flat gasket fibre ED ø 19mm ID ø 10.5mm thickness 1.5mm for thread M10 Qty 1 pcs		
	GEV No.	520231	Ref. No. —
	nut thread M10x1 H 6mm WS 14 zinc-coated steel Qty 1 pcs		



accessories for	415665		
	GEV No.	521103	Ref. No. —
	nut thread M4 H 3mm WS 7 brass Qty 20 pcs		
	GEV No.	521104	Ref. No. —
	washer ID ø 4.3mm ED ø 8mm thickness 0.5mm brass Qty 20 pcs for thread M4		
	GEV No.	521129	Ref. No. —
	nut thread M10 H 6mm SS WS 17 Qty 1 pcs DIN/ISO DIN 439		
	GEV No.	560111	Ref. No. —
	plain washer ID ø 4.3mm ED ø 9mm thickness 0.8mm SS Qty 20 pcs DIN 125A for thread M4		
	GEV No.	560131	Ref. No. —
	hexagonal nut thread M4 H 3.2mm WS 7 SS DIN/ISO DIN 934 / ISO 4032/8673 Qty 20 pcs		

			
1			
GEV No.	416235	Ref. No.	139321-922
description	heating element 3000W 230V heating circuits 1 L 320mm W 50mm H 40mm thread M10x1 mounting distance 44mm tube ø 6.3mm connection male faston 6.3mm 2 hole fixing L1 32mm L2 288mm		
spare parts for	416235		
	GEV No.	510893	Ref. No. —
	O-ring EPDM thickness 2.62mm ID ø 9.92mm Qty 1 pcs		
accessories for	416235		
	GEV No.	510416	Ref. No. —
	flat gasket fibre ED ø 19mm ID ø 10.5mm thickness 1.5mm for thread M10 Qty 1 pcs		
	GEV No.	510893	Ref. No. —
	O-ring EPDM thickness 2.62mm ID ø 9.92mm Qty 1 pcs		
	GEV No.	521129	Ref. No. —
	nut thread M10 H 6mm SS WS 17 Qty 1 pcs DIN/ISO DIN 439		
	GEV No.	560192	Ref. No. —
	tooth lock washer ID ø 10.4mm ED ø 18mm SS DIN/ISO DIN 6798A Qty 1 pcs for thread M10		



heating elements for convection



1

GEV No.	418916	Ref. No.	845265-02 845265-1
description	heating element 12000W 240V heating circuits 3 ID ø 390mm ED ø 410mm L 410mm H 100mm H1 25mm H2 75mm thread M12x1 6 hole fixing connection male faston 6.3mm tube ø 8.5mm convection heating element		
For models:	CSL-10E, CSM-1011E, CSM-1011N, CSM-1021E, CSM-1021N, CSM-2021E, CSM-2021N		
accessories for	418916		
	GEV No.	101566	Ref. No. —
	nut thread M12x1 H 10mm WS 19 SS Qty 1 pcs		
	GEV No.	506046	Ref. No. —
	flat gasket FIBER ED ø 19.5mm ID ø 13mm thickness 2mm Qty 1 pcs		
	GEV No.	528622	Ref. No. —
	spring ø 15.3mm L 25mm wire gauge ø 1.25mm for water filling		



1

GEV No.	418927	Ref. No.	N/A
description	heating element 12000W 240V heating circuits 3 ID ø 440mm ED ø 458mm L 472mm H 80mm L1 15mm H1 8mm H2 72mm thread M12x1 6 hole fixing connection male faston 6.3mm tube ø 6.3mm convection oven convection heating element		

1

GEV No.	418929	Ref. No.	845265-05
description	heating element 6000W 240V heating circuits 3 ID ø 395mm ED ø 415mm L 415mm H 100mm H1 15mm H2 85mm thread M12x1 6 hole fixing connection male faston 6.3mm tube ø 8.5mm convection oven convection heating element		
For models:	CSM-2011E, CSM-2011N		
accessories for	418929		
	GEV No.	101566	Ref. No. —
	nut thread M12x1 H 10mm WS 19 SS Qty 1 pcs		
	GEV No.	506046	Ref. No. —
	flat gasket FIBER ED ø 19.5mm ID ø 13mm thickness 2mm Qty 1 pcs		
	GEV No.	528662	Ref. No. —
	flat gasket copper ED ø 16mm ID ø 12mm thickness 1.5mm		



1

GEV No.	418930	Ref. No.	845265-04
description	heating element 6000W 240V heating circuits 3 ID ø 430mm ED ø 450mm L 470mm H 115mm H1 43mm H2 72mm thread M12x1 6 hole fixing connection male faston 6.3mm tube ø 8.5mm convection oven convection heating element		
For models:	CSM-2011E, CSM-2011N		
accessories for	418930		
	GEV No.	101566	Ref. No. —
	nut thread M12x1 H 10mm WS 19 SS Qty 1 pcs		
	GEV No.	506046	Ref. No. —
	flat gasket FIBER ED ø 19.5mm ID ø 13mm thickness 2mm Qty 1 pcs		
	GEV No.	528662	Ref. No. —
	flat gasket copper ED ø 16mm ID ø 12mm thickness 1.5mm		





			
1			
GEV No.	418926	Ref. No.	845265-03
description	heating element 8000W 240V heating circuits 3 ID ø 301mm ED ø 317mm L 328mm H 95mm L1 11mm H1 12mm H2 83mm thread M12x1 6 hole fixing connection male faston 6.3mm tube ø 8.5mm convection oven convection heating element		
For models:	CSL-06E, CSM-0611IE, CSM-0611N		

			
1			
GEV No.	418928	Ref. No.	845265-01
description	heating element 9000W 240V heating circuits 3 ID ø 458mm ED ø 475mm L 475mm H 114mm H1 31mm H2 73mm thread M12x1 6 hole fixing connection male faston 6.3mm tube ø 8.5mm convection oven convection heating element		
For models:	CSL-10E, CSM-1011IE, CSM-1011N, CSM-1021IE, CSM-1021N, CSM-2021IE, CSM-2021N		
accessories for	418928		
	GEV No.	101566	Ref. No. —
	nut thread M12x1 H 10mm WS 19 SS Qty 1 pcs		
	GEV No.	506046	Ref. No. —
	flat gasket FIBER ED ø 19.5mm ID ø 13mm thickness 2mm Qty 1 pcs		
	GEV No.	528662	Ref. No. —
	flat gasket copper ED ø 16mm ID ø 12mm thickness 1.5mm		

			
1			
GEV No.	418925	Ref. No.	233848-2
description	heating element 1500W 230V heating circuits 1 L 293mm W 106mm L1 32mm L2 261mm W2 83mm flange length 50mm flange width 26mm connection length 63mm connection male faston 6.3mm tube ø 8.5mm hole ø 6.2mm W1 23mm convection heating element convection oven INCOLOY windings 2		
For models:	CO-0611E, CO-1011E, CO-2011E, CS-0611E, CS-1011E, CS-2011E, CSD-0611E, CSD-1011E, CSD-2011E		
accessories for	418925		
	GEV No.	520588	Ref. No. —
	gasket L 46mm W 22mm hole distance 24.5mm silicone for heating element		

foil heating elements

			
1			
GEV No.	420355	Ref. No.	775763-1
description	foil heating element L 288mm W 87mm 305W 240V t.max.°C silicone cable length 800mm thickness 1mm connection Faston 6.3mm		
For models:	GC, GC11, GC12, GC31, GC32		

			
1			
GEV No.	420299	Ref. No.	898 126-1
description	foil heating element L 360mm W 95mm 545W 230V t.max.°C silicone cable length 1750mm thickness 1mm		
For models:	AM-700, AM900, AMS900, AMX-900, AMXR-900, AMXS-900, AMXX-1300, AMXXR-1300, AMXXS-1300, AMXXT, AUXX-1300, AUXXL, AUXXR-1300, AUXXS-1300, AUXXT, ECOMAX-650		

			
1			
GEV No.	420475	Ref. No.	775575-1
description	foil heating element L 370mm W 95mm 390W 230V t.max.°C cable length 790mm		
For models:	FX, GX		

energy regulators

EGO

1-circuit

			
1			
GEV No.	380015	Ref. No.	301200
description	energy regulator 230V 13A single-circuit turn direction right shaft ø 6x4.6mm shaft L 23mm mounting thread M4 power release 6-100% no. 50.57021.010		





thermostats

bi-metal thermostats

safety bi-metal thermostats



GEV No.	390233	Ref. No.	139321-17 139321-923 139321-934 371450-17
description	bi-metal safety thermostat hole distance 24mm switch-off temp. 110°C 1NC 1-pole 16A connection F6.3 2 hole fixing without holder		
For models:	CHF45, CHH-50, CHH-60D, CHH-70D, CLG-25, EF-40, EH-60, EH-70, GE-400, GF-60, GF-60S		
accessories for	390233		
	GEV No.	504736	Ref. No. —
	bracket for contact thermostat		
	GEV No.	550388	Ref. No. —
	bracket for contact thermostat mounting distance 24.5mm mounting ø 3.8		



GEV No.	390462	Ref. No.	226504
description	bi-metal safety thermostat hole distance mm switch-off temp. 105°C 1NC 1-pole 10A connection F6.3 1 hole fixing		
For models:	AM-12E, AM-12EC, AM-12EF, AM-12ER, AM-600, AM-600C, AM-600CR, AM-600R, CM1E, FM-30, FM-30U, FM-400H, FM-400U, FM-500, FM-500H, UW-100, UW-105, UW-135, UW-135H, UW-55, WM2E		
accessories for	390462		
	GEV No.	550388	Ref. No. —
	bracket for contact thermostat mounting distance 24.5mm mounting ø 3.8		



GEV No.	390318	Ref. No.	139321-721
description	bi-metal safety thermostat switch-off temp. 95°C 1-pole 2 hole fixing		
For models:	CLG-25		

bi-metal thermostats



GEV No.	390504	Ref. No.	236052
description	bi-metal thermostat hole distance 23.8mm switch-off temp. 90°C 1NO 1-pole 16A 250V connection F6.3 2 hole fixing probe ø 16mm		

control and safety thermostats

EGO

control thermostats

51._ series



GEV No.	390306	Ref. No.	139321532
description	thermostat t.max. 85°C temperature range fixed 85°C 1-pole gland nut		
For models:	CLG-25		

55.10/19_ series





GEV No.	375184	Ref. No.	144451108
description	thermostat t.max. 298°C temperature range 55-294°C 1-pole 1NO 16A probe ø 3.1mm probe L 226mm capillary pipe 870mm capillary pipe isolated 350mm gland nut shaft L 23mm shaft position upper probe material SS		

55.13_ series



GEV No.	375007	Ref. No.	139866-48
description	thermostat t.max. 110°C temperature range 30-110°C 1-pole 1NO 16A probe ø 6mm probe L 113mm capillary pipe 870mm capillary pipe isolated mm gland nut M9x1 shaft L 25mm shaft position upper rotation 270°		

accessories for	375007		
	GEV No.	110119	Ref. No. —
	knob thermostat t.max. 110°C ø 50mm shaft ø 6x4.6mm shaft flat upper black temperature range 30-110°C rotation 270°		
	GEV No.	110241	Ref. No. —
	knob thermostat t.max. 110°C ø 50mm shaft ø 6x4.6mm shaft flat upper black temperature range 30-110°C		



GEV No.	390472	Ref. No.	886638
description	thermostat t.max. 95°C temperature range 27-95°C 1-pole 1NO 16A probe ø 4mm probe L 203mm capillary pipe 1230mm capillary pipe isolated 800mm gland nut shaft ømm shaft Lmm shaft position° shaft position rotation 270°		

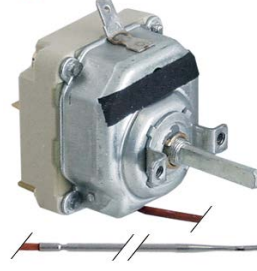

GEV No.	375355	Ref. No.	144605-71
description	thermostat t.max. 300°C temperature range 50-300°C 3-pole 3NO 16A probe ø 3mm probe L 219mm capillary pipe 900mm capillary pipe isolated 900mm gland nut shaft ø ø6x4.6mm shaft L 23mm shaft position upper rotation 270°		

55.34_series



GEV No.	375022	Ref. No.	T301062
description	thermostat t.max. 180°C temperature range 95-180°C 3-pole 3NO 16A probe ø 6mm probe L 133mm capillary pipe 1780mm capillary pipe isolated 1400mm gland nut M9x1 shaft ø ø6x4.6mm shaft L 23mm rotation 270°		

safety thermostats

55.13_series



GEV No.	390471	Ref. No.	227879
description	safety thermostat switch-off temp. 125°C 1-pole 16A probe ø 4mm probe L 128mm capillary pipe 1130mm capillary pipe isolated 800mm gland nut probe SS		
For models:	CR-F, CX, FX, GX, HX, HX-30, HX-30E, HX-30ES, HX-30S, HX-40, HX-40E, HX-40ES, HX-40S, HX-E, HX-ES, HX-S		

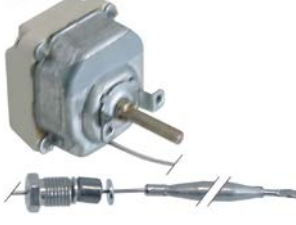

GEV No.	375417	Ref. No.	49360008
description	thermostat t.max. 200°C temperature range 65-200°C 3-pole 3NO 16A probe ø 6mm probe L 79mm capillary pipe 840mm capillary pipe isolateddmm gland nut M9x1 shaft ø ø6x4.6mm shaft L 23mm rotation 270°		

55.31_series



GEV No.	375803	Ref. No.	4936005
description	safety thermostat switch-off temp. 225°C 3-pole 3NC 20A probe ø 6mm probe L 269mm capillary pipe 830mm capillary pipe isolated-mm gland nut probe		



55.32_series



GEV No. 375984 **Ref. No.** 301061

description safety thermostat switch-off temp. 225°C 3-pole 3NC 20A probe ø 6mm probe L 94mm capillary pipe 900mm capillary pipe isolated 670mm gland nut M10x1 probe SS

55.33_series



GEV No. 390470 **Ref. No.** 378791

description safety thermostat switch-off temp. 100°C 3-pole 20A probe ø 4mm probe L 231mm capillary pipe 870mm capillary pipe isolated 800mm gland nut probe SS

For models: CDC, CN, CNA, CNB, CNR, CR, CSA, CTC, ECOMAX-700, ECW, FX, GX, UX, UX-30, UX-30B, UX-30E, UX-30EB, UX-30EH, UX-30ES, UX-30ESB, UX-30ESH, UX-30H, UX-30-McDonalds, UX-30S, UX-30SB, UX-30SH, UXL, UXLS, UXS

56._series



GEV No. 375442 **Ref. No.** 301066

description safety thermostat capillary pipe 1760mm probe ø 4mm 1-pole probe L 100mm 16A capillary pipe isolated 1600mm gland nut switch-off temp. 320°C probe

control thermostats with operation switch

55.34_series

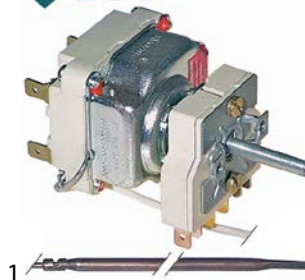

GEV No. 375246 **Ref. No.** 301034

description thermostat t.max. 645°C temperature range 100-615/645°C 2-pole 2NO 16A probe ø 4mm probe L 230mm capillary pipe 1100mm capillary pipe isolated 600mm gland nut shaft ø 6x4.6mm shaft L 25mm shaft position lower rotation 270° outer switch 2NO probe material copper

IMIT / TEMPOMATIC / AR THERMO

control thermostats

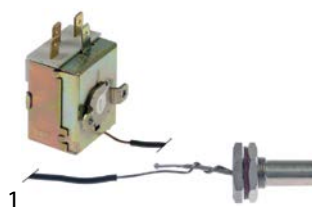

GEV No. 390913 **Ref. No.** 371450-206
E236042 (old version)

description thermostat t.max. 55°C temperature range fixed 55°C 1-pole 1CO 16A probe ø 11mm probe L 22mm capillary pipe 600mm capillary pipe isolated 600mm probe thread M14x1 250V contacts male faston 6.3mm





GEV No. 375847 **Ref. No.** E929044

description thermostat t.max. 90°C temperature range 0-90°C 1-pole 1CO 15A probe ø 6.5mm probe L 100mm capillary pipe 1500mm capillary pipe isolatedmm gland nut shaft ø 6x4.6mm shaft L 18mm shaft position +135° rotation 270° 250V

CAEM

control thermostats



GEV No.	390672	Ref. No.	139321-20 E236042
description	thermostat t.max. 53°C temperature range fixed 53°C 1-pole 1CO 16A probe ø 9.5mm probe L 30mm capillary pipe 600mm capillary pipe isolated 540mm gland nut shaft Lmm screw-in probe probe thread M14x1		
For models:	GW-600, GW-600S, GW-601, GW-601S		
spare parts for	390672		
	GEV No.	510417	Ref. No. —
	flat gasket fibre ED ø 20mm ID ø 14mm thickness 2mm Qty 1 pcs		
	GEV No.	550261	Ref. No. —
	nut thread M14x1 H 4mm WS 19 SS Qty 1 pcs		



GEV No.	390686	Ref. No.	236043 E236043
description	thermostat t.max. 83°C temperature range°C 1-pole 1CO 20A probe ø 6mm probe L 90mm capillary pipe 630mm capillary pipe isolated 550mm gland nut shaft ømm shaft Lmm shaft position rotation 270° probe material copper		
For models:	CLG-25, CLG-25-NA, ECOMAX-500		

COTHERM



GEV No.	390440	Ref. No.	154344 492105
description	safety thermostat t.max. 220°C temperature range°C 1-pole 1NC 25A probe ø 3mm probe L 130mm capillary pipe 1720mm capillary pipe isolatedmm gland nut switch-off temp. 220°C probe SS		
For models:	CS-0612E-A, CSD-0612E-A, CSD-0612ET, CSD-0612-UC, CSD-1012ET, CSD-1012-UC, CSD-1013G, CSD-1022-UC, CSD-2012ET, CSD-2012-UC, CSD-2013G, CSD-2022-UC, CSL-0423E, CSL-0423EK, CSL-0523E, CSL-0523EK, CSL-06E, CSL-10E, CSL-423E, CSL-423K, CSM-0611IE, CSM-0611N, CSM-1011IE, CSM-1011N, CSM-1021IE, CSM-1021N, CSM-2011IE, CSM-2011N, CSM-2021IE, CSM-2021N		

RATHGEBER

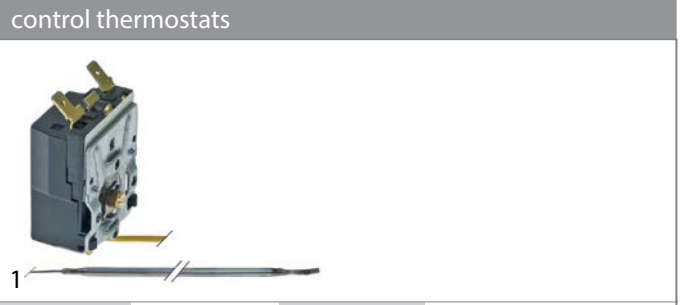

GEV No.	390816	Ref. No.	226505
description	thermostat t.max. 95°C 1NO 16A probe ø 4mm probe L 244mm capillary pipe 1180mm capillary pipe isolated 840mm shaft ø 6mm shaft L 3mm rotation 315°		
For models:	AM-12E, AM-12EC, AM-12EF, AM-12ER, AMX, AMX-E, AMX-ER, AMX-R, AUX, AUX_, AUX-E, AUX-ER, AUX-R, CM1E, CNA, CNR, CSA, ECO-MAX-600, ECOMAX-700, ECOMAX-800, FE, FX, GX, HE, HE600-HL, HE-P, HX, HX-30, HX-30S, HX-40, HX-40S, HX-S, UW-100, UX-30, UX-30B, UX-30E, UX-30EB, UX-30ES, UX-30ESB, UX-30S, UX-30SB, UX-60, UX-60B, UX-60E, UX-60EB, UX-60EH, UX-60EHB, UX-60H, UX-60HB, UXD-30... (Other models you can see in the webshop)		

accessories

plunger sockets



GEV No.	550995	Ref. No.	139321-893
description	thermowell thread M14x1 ID ø 5mm L 40mm SS ø 9mm		



connecting bows



1

GEV No.	550060	Ref. No.	300177
description	connecting bow long for thermostat Qty 1 pcs		

switches and momentary switches

rocker/momentary rocker switches

30x22mm



1

GEV No.	301003	Ref. No.	15243565 F15243565
description	rocker switch mounting measurements 30x22mm green 2NO 250V 16A illuminated 0-1 connection male faston 6.3mm ambient temperature max. 125/55°C protection IP65		
accessories for	301003		
	GEV No.	301036	Ref. No. —
	protective cover internal size 30x22mm for rocker switch mounting measurementsmm		

37x21mm



1

GEV No.	348098 ¹	Ref. No.	00-358628-1
description	rocker switch mounting measurements 37x21mm black 2CO 250V 10A with neutral position connection male faston 6.3mm ambient temperature max. 125/55°C protection IP55		

¹with neutral position

push/momentary push switches

ø12mm



1

GEV No.	347745	Ref. No.	302556
description	momentary switch with plunger thread M12x0.75 thread L 10mm 250V 2A 1NO connection male faston 6.3mm stroke 4mm ambient temperature max. 125°C type 1233A actuating force: 500g		

toggle switches

M12x0.75



1

GEV No.	348193	Ref. No.	00-087711-143-1 00-120388 875567
description	toggle switch thread M12x0.75 2NO 250V 15A ON-OFF F6.3		
For models:	6614-MEAT-SAW		

microswitches

lever actuated



1

GEV No.	345257	Ref. No.	139321-41
description	microswitch with lever 250V 16A 1CO connection male faston 6.3mm L 29mm L1 33mm ambient temperature max. 120°C mounting distance 22mm actuating force: 130g lever length 31.5mm		
For models:	GW-600, GW-600S, GW-601, GW-601S		

position switches

BERNSTEIN



1

GEV No.	345922	Ref. No.	324195 735221-1
description	microswitch with knee switch 1NO/1NC 240V 3A L 51mm W 26mm H 21mm protection IP30 actuating force: 580g screw connection mounting distance 15mm AC-15 3A		
For models:	FE, FE-W, FX, GX		



1

GEV No.	347237	Ref. No.	302440-1
description	position switch with handle with a switch 1NO/1NC		
For models:	UW-135, UW-135H		



1

GEV No.	345921	Ref. No.	228795
description	position switch with roller 1CO 240V 3A L 93mm W 36mm H 33mm protection IP65 actuating force: 1280g screw connection M20 mounting distance 25mm		
For models:	ACW, AM-12E, AM-12EC, AM-12EF, AM-12ER, AM-600C, AM-600CR, FM-30, UWX		



1

GEV No.	347721	Ref. No.	00-226916-000
description	position switch with roller plunger 1NO/1NC 240V 3A L 93mm W 36mm H 34mm protection IP65 actuating force: 1200g screw connection M18 mounting distance 24.5mm		
For models:	AM-600, AM-600C, AM-600CR, AM-600R, FTX, FUX, RRB, UW-100, UW-105		

TELEMECANIQUE (EFA)



1

GEV No.	347460	Ref. No.	785286-1
description	position switch with roller 1NO/1NC L 71mm protection IP67		
For models:	CN, CNA, CNB, CNR, CR, CSA, ECOMAX-800		

system switches (ROLD)



1

GEV No.	346498	Ref. No.	900055
description	element holder mounting measurements 28.5x28.5mm black single element holder		



1

GEV No.	346500	Ref. No.	E226080
description	element holder mounting measurements 28.5x77.5mm black three-fold element holder		



1

GEV No.	345606	Ref. No.	139321-455 E226071
description	momentary switch unit 2CO 250V 16A connection male faston 6.3mm		
For models:	CLG-25		



1

GEV No.	347517	Ref. No.	E207060 E227060
description	push button ø 21mm silver edition		



1

GEV No.	347705	Ref. No.	227061
description	push button ø 21mm silver with lens edition		
For models:	CLG-25, CLG-25-NA, ECOMAX-400-12, ECOMAX-400S-12, ECO-MAX-500		



1

GEV No.	345605	Ref. No.	E208010
description	switch 2CO 250V 16A connection male faston 6.3mm		

float switches

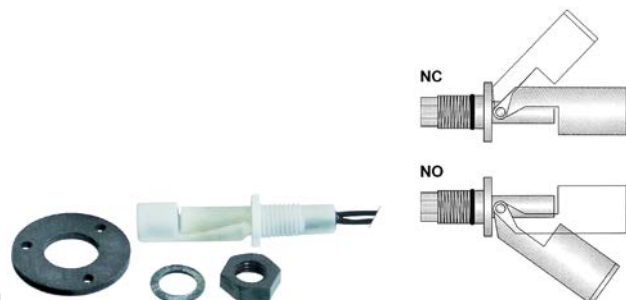

1

GEV No.	541323	Ref. No.	774033-1 ML102831
description	float switch		
For models:	FE, FTN, FX, GX, HE		



1

GEV No.	347491	Ref. No.	00-735171-001 735171-1
description	float switch thread M16x2 ø 18mm L 65mm cable length 1050mm 1-pole		

1

GEV No.	348128	Ref. No.	00-896960-000
description	float switch thread M16x2 ø 18mm L 65mm cable length 1050mm kit 1-pole temp.-resist. -20 up to +90°C		

1

GEV No.	403081	Ref. No.	102826 229519 ML102826
description	float switch thread 1/4" 1NC/1NO ø 12mm L 65mm mounting ø 16mm 24V 0.5A cable cable length 100mm		
For models:	ACW, CN, CNB, CNR, CX, EWB-S, FTN, FTX, FUX, UW-135H, UWX		
spare parts for	403081		
	GEV No.	Ref. No.	00-122674 122674
	float with magnet ø 47mm L 33mm Wmm Hmm PVC suitable for HOBART		

1

GEV No.	403914	Ref. No.	271621
description	float switch thread 1/4" ø 29mm L 100mm mounting ø 9.5mm coded cable length 240mm probe L 63mm		

floats

1

GEV No.	347433	Ref. No.	00-122674
description	float with magnet ø 47mm L 33mm Wmm Hmm PVC suitable for HOBART		
For models:	103G, 203G, 2226, 303G, ACW, AM-12E, AM-12EC, AM-12EF, AM-12ER, AM15, AM15F, AM15T, AM-600, AM-600C, AM-600CR, AM-600R, C44A, C44AW, C54A, C64A, CN, CNA, CNB, CNR, CR, CR-F, CSA, CX, ECOMAX-800, EWB-S, FTN, FTT, FTX, FUX, ML-110025, ML-110976, ML-110977, ML-32614, ML-32615, UW-105, UW-135, UW-135H, UWX		
accessories for	347433		
	GEV No.	Ref. No.	00-112467 112467
	bracket for magnetic switch ID ø 21mm ED ø 28.5mm		

cam switches

7-position

1

GEV No.	300025	Ref. No.	MRTCU700078
description	cam switch 7 operating positions 1NO/2CO sequence 0-1-2-3-4-5-6 16A shaft ø 6x4.6mm shaft L 23mm connection screw 7-position ceramic		
accessories for	300025		
	GEV No.	Ref. No.	—
	knob universal ø 70mm black without adaptor/dial plate		
	GEV No.	Ref. No.	—
	knob dial plate silver switch 7-position t.max.°C ED ø 63mm ID ø 45.5mm		
	GEV No.	Ref. No.	—
	knob adapter shaft ø 6x4.6mm L 0mm with spring		



4 operating positions



1

GEV No.	300077	Ref. No.	01-240135-003 1-240135-3 845259
description	cam switch 4 operating positions 5NO sequence 0-1-2-3 16A shaft ø 6x4.6mm shaft L 23mm connection male faston 6.3mm plastic		
For models:	CSL-0423E, CSL-0423EK, CSL-0523E, CSL-0523EK, CSL-06E, CSL-10E, CSL-423E, CSL-423K, CSM-0611IE, CSM-0611N, CSM-1011IE, CSM-1011N, CSM-1021IE, CSM-1021N, CSM-2011IE, CSM-2011N, CSM-2021IE, CSM-2021N		

8 operating positions

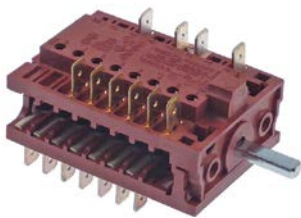

1

GEV No.	347924	Ref. No.	231960-5
description	cam switch 8 operating positions 13NO sequence 0-1-2-3-4-5-6-7 16A shaft ø 6x4.6mm shaft L 19mm connection male faston 6.3mm plastic		
For models:	AMX, AMX-E, AMX-ER, AMX-R, AUX, AUX_, AUX-E, AUX-ER, AUX-R, FX, GX, UX-30, UX-30B, UX-30H, UX-30-McDonalds, UX-30S, UX-30SB, UX-30SH, UX-60, UX-60B, UX-60H, UX-60HB, UXD-30		

operation switches



1

GEV No.	300080	Ref. No.	491175
description	cam switch 2 operating positions 4NO 16A sequence 0-1 shaft ø 6x4.6mm shaft L 23mm connection screw operation switch ceramic ambient temperature max. 150°C		
accessories for	300080		
	GEV No.	551456	Ref. No. —
gasket for switch ED ø 14mm ID ø 2.5mm thickness 3.5mm white			

rotary switches

BREMAS

A1200 series



1

GEV No.	300326	Ref. No.	E927034
description	rotary switch sets of contacts 6 0-1-2-3 type CS012015B 400V 12A shaft ø 5x5mm shaft L 18mm		

KRAUS & NAIMER

rotary switches



1

GEV No.	347506 ¹	Ref. No.	785574-6
description	rotary switch 2 0-1 sets of contacts 5 type KG100-DE10F769 400V 100A shaft L 52mm L1,L2,L3,N,PE connection screw code 53/000100 marking T104/D-A025		

¹incl. knob and dial plate

1

GEV No.	347240	Ref. No.	00-229580-000
description	rotary switch 8 0-1-2-3-4-5-6-7 sets of contacts 4 400V 20A connection screw		

VM



1



GEV No.	345917	Ref. No.	371450-172
description	rotary switch		
For models:	GF-60, GF-60S		



magnetic switches

1/4"



GEV No.	347490	Ref. No.	226282 226282-2
description	magnetic switch thread 1/4" cable length 2000mm L 62.5mm		
For models:	103G, 203G, 2226, 303G, AM-12E, AM-12EC, AM-12EF, AM-12ER, AM-600, AM-600C, AM-600CR, AM-600R, CNA, CNR, CR, CR-F, CSA, ECOMAX-800, FTT, UW-100, UW-105, UW-135, UW-135H		
accessories for	347490		
	GEV No.	347433	Ref. No. 00-122674 122674
	float with magnet ø 47mm L 33mm Wmm Hmm PVC suitable for HOBART		
	GEV No.	347927	Ref. No. 00-112467 112467
	bracket for magnetic switch ID ø 21mm ED ø 28.5mm		
	GEV No.	511516	Ref. No. —
	O-ring EPDM thickness 3.53mm ID ø 20.22mm Qty 10 pcs		

29x19mm

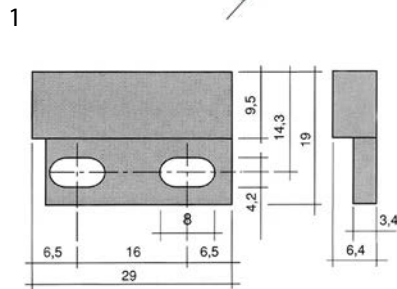
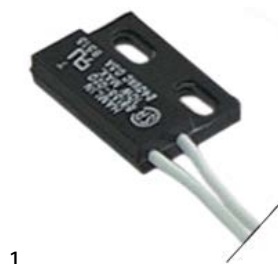

GEV No.	345117	Ref. No.	844951-2
description	magnetic switch L 28.5mm W 19mm 1NO 250V 0.04A P max. 10W connection cable cable length 1000mm		

36x13mm

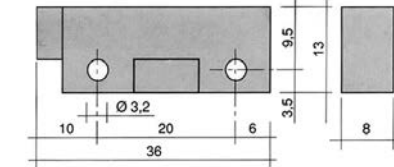
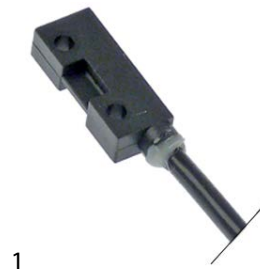

GEV No.	345118 ¹	Ref. No.	139321-344 139321-586 139321-919
description	magnetic switch L 36mm W 13mm 1NO 250V 1A P max. 50W connection cable length 980mm		
For models:	CHF45, CHH-50, CHH-60D, CHH-70D, CLG-25, EF-40, EH-60, EH-70, GE-400, GF-60, GF-60S, GW-600, GW-600S, GW-601, GW-601S, UX, UXL, UXLS, UXS, UXT, UXTH, UXTHL, UXTHLS, UXTHS, UXTL, UXTLH, UXTLHS, UXTLS, UXTS		
accessories for	345118		
	GEV No.	345399	Ref. No. —
	magnet ø 3.3mm L 40mm H 8mm W 13mm hole distance 30mm M3		

¹with coded connector

50x19mm

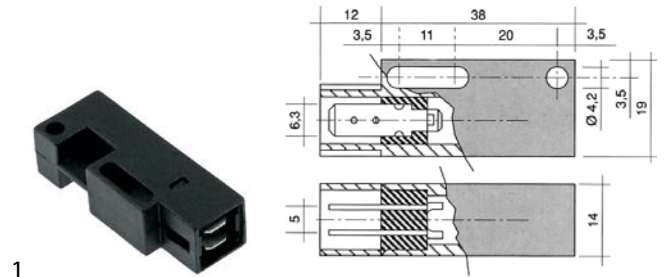

GEV No.	345821	Ref. No.	775491-1
description	magnetic switch L 50mm W 19mm 1NO 250V 1A P max. 50W connection male faston 6.3mm		
For models:	AM-700, AM900, AMS900, AMX, AMX-900, AMX-E, AMX-ER, AMX-R, AMXR-900, AMXS-900, AMXX-1300, AMXXR-1300, AMXXS-1300, AMXXT, AUX, AUX-E, AUX-ER, AUX-R, AUXX-1300, AUXXL, AUXXR-1300, AUXXS-1300, AUXXT, CNA, CNR, ECOMAX-650, ECOMAX-700, FX, GX, UX-30, UX-30B, UX-30E, UX-30EB, UX-30EH, UX-30ES, UX-30ESB, UX-30ESH, UX-30H, UX-30-McDonalds, UX-30S, UX-30SB, UX-30SH, UXD-30		
accessories for	345821		
	GEV No.	519049	Ref. No. —
	magnet ømm L 63mm H 10.7mm W 18.8mm hole distance 52mm M2 hole ø 2mm		



80x30mm

1 

GEV No.	347925	Ref. No.	229517
description	magnetic switch L 80mm W 30mm 1NO 250V 0.2A P max. 100W connection cable cable length 1300mm		
For models:	CN, CNB, CSA, ECOMAX-800, ECW, FTN, FTT, HX, HX-30, HX-30S, HX-40, HX-40S, HX-E, HX-ES, HX-S, UW-120, UW-200, UX-60EH, UX-60EHB, UX-60H, UX-60HB		

1 

GEV No.	345918	Ref. No.	229517-2
description	magnetic switch L 80mm W 30mm 1NO 250V 0.2A P max. 100W connection cable cable length 4500mm		
For models:	ECOMAX-600, ECOMAX-700, FTX, FUX, HE, HE600-HL, HE-P, HX-60-EHL		

1 

GEV No.	345920	Ref. No.	297980-4
description	magnetic switch L 80mm W 30mm 1NO 250V 3A connection cable 100W		
For models:	AMX, AMX-E, AMX-ER, AMX-R, AUX, AUX_, AUX-E, AUX-ER, AUX-R, UX-30, UX-30B, UX-30E, UX-30EB, UX-30EH, UX-30ES, UX-30ESB, UX-30ESH, UX-30H, UX-30-McDonalds, UX-30S, UX-30SB, UX-30SH, UX-60, UX-60B, UX-60E, UX-60EB, UX-60EH, UX-60EHB, UX-60H, UX-60HB		

1 

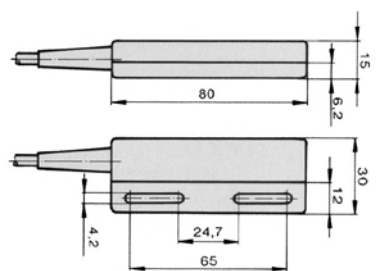

GEV No.	345919	Ref. No.	297980-3
description	magnetic switch L 80mm W 30mm connection cable		
For models:	HX, HX-30E, HX-30ES, HX-40E, HX-40ES, HX-E, HX-ES, HX-S		

ø 6mm

1 

GEV No.	347835	Ref. No.	01-235338
description	magnetic switch 150V 1A P max. 10W probe L 29mm 1NO connection 2-wire cable length 1700mm		

1 

GEV No.	347461	Ref. No.	01-240288-001 01-240288-1	
description	magnetic switch 28V 0.5A P max. 15W probe L 26mm 1NO connection coded plug cable length 280mm			
For models:	AM-10, AM-11, AM-141, AM900-10N, AM900-90, AMS900-10N, AMX, AMX-10HL, AMX-90, AMXR, AMXS, AMXT, AMXTS, AMXX, AMXXR, AMXXS, AUP, AUP-90, AUPS, AUXX, AUXXL-11N, AUXXLS-11N, AUXXR, AUXXS, AUXXT, AUXXTS, CN-Protronic, CN-Smartronic, CP-Protronic, ECOMAX-402, ECOMAX-502, ECOMAX-602-10, ECOMAX-602-11, ECOMAX-602S-11, ECOMAX-612-10, ECOMAX-612S-10, FP, FX, FX-McDonalds, GP, GX			
accessories for	347461			
	GEV No.	524661	Ref. No.	00-883838-001 883838-1
	bracket for magnetic switch L 34.5mm W 26mm H 9mm			

ø 8mm

1 

GEV No.	348194	Ref. No.	87711-352
description	magnetic switch 200V 0.5A P max. 10W W 8mm probe L 30mm 1NO connection coded plug cable length 290mm M8		



accessories

magnets



1

GEV No.	347926	Ref. No.	166964 170015
description	magnet ø 22.5mm Lmm H 11.5mm Wmm ID ø 5.2mm M5		
For models:	AM-700, AM900, AMS900, AMX, AMX-900, AMX-E, AMX-ER, AMX-R, AMXR-900, AMXS-900, AMXX-1300, AMXXR-1300, AMXXS-1300, AMXXT, AUX, AUX_, AUX-E, AUX-ER, AUX-R, AUXX-1300, AUXXL, AUXXR-1300, AUXXS-1300, AUXXT, CNR, CR-F, CX, ECOMAX-600, ECOMAX-650, ECOMAX-700, FTT, FTX, FUX, HE, HE600-HL, HE-P, HX, HX-30, HX-30E, HX-30ES, HX-30S, HX-40, HX-40E, HX-40ES, HX-40S, HX-60-EHL, HX-E, HX-ES, HX-S, UW-135...(Other models you can see in the webshop)		



1

GEV No.	347722	Ref. No.	00-774714-001 774714-1
description	magnet ø 34mm Lmm H 17mm Wmm ID ø 5mm M5 with cap hole ø 5.25mm		
For models:	CN, CNA, CNB, CN-Protronic, CNR, CN-Smartronic, CP-Protronic, CR, CSA, CS-Easytronic, ECOMAX-800, ECW, FTN, FTX, FUX, UX-30B, UX-30EB, UX-30EH, UX-30ESB, UX-30ESH, UX-30H, UX-30-McDonalds, UX-30SB, UX-30SH, UX-60, UX-60B, UX-60E, UX-60EB, UX-60EH, UX-60EHB, UX-60H, UX-60HB, UXD-30, UXTH, UXTHL, UXTHLS, UXTHS, UXTLH, UXTLHS		



1

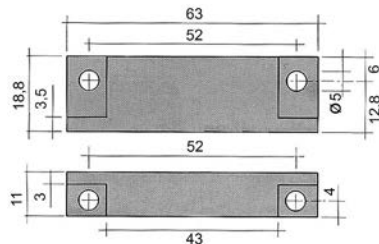

GEV No.	345336	Ref. No.	E926014
description	magnet ø 4.8mm L 63mm H 11mm W 18.8mm hole distance 51mm M4		



1

GEV No.	346953	Ref. No.	139321-820
description	magnet ømm L 23mm H 17mm W 18mm M6 hole ø 6.5mm		

miscellaneous



1

GEV No.	347927	Ref. No.	00-112467
description	bracket for magnetic switch ID ø 21mm ED ø 28.5mm		
For models:	103G, 203G, 2226, 303G, AM-12E, AM-12EC, AM-12EF, AM-12ER, AM15, AM15F, AM15T, C44A, C44AW, C54A, C64A, CN, CNA, CNB, CNR, CR, CR-F, CSA, CX, ECOMAX-800, EWB-S, FTN, FTT, FTX, FUX, ML-110025, ML-110976, ML-110977, ML-32614, ML-32615, UW-100, UW-105, UWX		



1

GEV No.	524661	Ref. No.	00-883838-001 883838-1
description	bracket for magnetic switch L 34.5mm W 26mm H 9mm		
For models:	AM-10, AM-11, AM-141, AM900-10N, AM900-90, AMS900-10N, AMX, AMX-10HL, AMX-90, AMXR, AMXS, AMXT, AMXTS, AMXX, AMXXR, AMXXS, AUP, AUP-90, AUPS, AUXX, AUXXL-11N, AUXXLS-11N, AUXXR, AUXXS, AUXXT, AUXXTS, CN-Protronic, CN-Smartronic, CP-Protronic, ECOMAX-402, ECOMAX-502, ECOMAX-602-10, ECOMAX-602-11, ECOMAX-602S-11, ECOMAX-612-10, ECOMAX-612S-10		

control equipment

MOELLER/EATON

push buttons - signal lamps



1

GEV No.	347512	Ref. No.	887015-33
description	push button mounting measurements ø22mm green illuminable momentary I		
For models:	RRB		



GEV No.	346339	Ref. No.	887015-25
description	push button mounting measurements ø22mm red mushroom cap latching EMERGENCY SHUT-DOWN		

knobs



GEV No.	346460	Ref. No.	887015-61
description	selector switch mounting measurements ø22mm black/white 0°-45° latching sequence 0-1		



GEV No.	346728	Ref. No.	887015-71
description	selector switch mounting measurements ø22mm black/white 330°-0°-30° latching sequence 1-0-2		
For models:	ECOMAX-800		

switch blocks



GEV No.	346293	Ref. No.	00-887015-012
description	contact block holder triple		

switches (complete)

push/momentary push switches



GEV No.	344003	Ref. No.	229576-2 229577-1 301776-9 895405 EPM-E-16-14
description	momentary push switch mounting measurements ø22mm green 1NO on momentary		
For models:	HSM20, HSM30, HSM40, NCM20, NCM300, NCM400		

SCHLEGEL

switches (complete)



GEV No.	347923	Ref. No.	324267-4 897900
description	momentary switch mounting measurements ø16/24x24mm white 1NO/1NC sequence 0-1 infinite		
For models:	ECOMAX-600, ECOMAX-700, FE, HE, HE600-HL, HE-P		

For models:	ECOMAX-600, ECOMAX-700, FE, HE, HE600-HL, HE-P		
--------------------	--	--	--

description	momentary switch unit mounting measurements ø16/24x24mm type momentary anthracite/transparent square		
--------------------	--	--	--

description	contact block latching 1NC/1NO connection male faston 2.8mm illuminable socket T5.5K type AFL		
--------------------	---	--	--

description	symbol plate white infinite		
--------------------	-----------------------------	--	--



GEV No.	358178	Ref. No.	897902
description	momentary switch mounting measurements ø16/24x24mm white square 1NO/1NC sequence 0-1 clock connection male faston 2.8mm type AT		

push buttons



GEV No.	359794	Ref. No.	324266-1
description	momentary switch unit mounting measurements ø16/24x24mm type momentary black/transparent square		
For models:	ECOMAX-600, ECOMAX-700, ECOMAX-800, FE, FX, GF-60, GF-60S, GX, HE, HE600-HL, HE-P		

symbol plates



GEV No.	359795	Ref. No.	00-324265-001 324265-1
description	symbol plate white clock		
For models:	ECOMAX-600, ECOMAX-700, FX, GF-60, GF-60S, GX, HE, HE600-HL, HE-P		





			
1			
GEV No.	359796	Ref. No.	324265-11
description	symbol plate white infinite		
For models:	ECOMAX-600, ECOMAX-700, HE, HE600-HL, HE-P		

			
1			
GEV No.	359189	Ref. No.	324265-10
description	symbol plate white on		
For models:	ECOMAX-600, ECOMAX-700, HE, HE600-HL, HE-P		

			
1			
GEV No.	359193	Ref. No.	324265-12
description	symbol plate white water		
For models:	ECOMAX-600, ECOMAX-700, HE, HE600-HL, HE-P		

switch blocks

			
1			
GEV No.	359194	Ref. No.	324267-1 32427-1
description	contact block latching 1NC/1NO connection male faston 2.8mm illuminable socket T5.5K type AFL		

			
1			
GEV No.	359187	Ref. No.	324267-3 897903
description	contact block latching 2NO/2NC connection male faston 2.8mm illuminable socket T5.5K type AFL2		
For models:	ECOMAX-600, ECOMAX-700, HE600-HL		

			
1			
GEV No.	359793	Ref. No.	324267-5 897901
description	contact block momentary 2NO/2NC connection male faston 2.8mm illuminable socket T5.5K type ATL2		
For models:	ECOMAX-600, ECOMAX-700, FE, HE600-HL		

lamps

indicator lights

indicator lights 2-piece (lens and indicator lamp)

indicator light lenses

ø12mm (type SDY-3)

			
1			
GEV No.	359262	Ref. No.	E926114
description	indicator light housings mounting measurements ø12mm green round Qty 1 pcs		

indicator lamps for socket type SRZ / SDK / SDY / SFK

			
1			
GEV No.	359130	Ref. No.	216006 E216006
description	indicator lamp 230V clear connection male faston 6.3mm ø 8mm		

indicator lights 3-piece (housing, lens and bulb)

lamps

light bulbs

			
1			
GEV No.	359608	Ref. No.	229167-1
description	light bulb socket E14 10/15W 230V ø 16mm L 51mm lens L 31mm Qty 1 pcs		
For models:	CX		

indicator lights (complete)

ø12mm

with plug-in socket

			
1			
GEV No.	580014	Ref. No.	347336-1 XNC25X68
description	indicator light ø 12mm 230V red		

screw-on/push-on fit

light bulbs

for indicator lights



GEV No.	359608	Ref. No.	229167-1
description	light bulb socket E14 10/15W 230V ø 16mm L 51mm lens L 31mm Qty 1 pcs		
For models:	CX		

halogen lamp

for socket G4 / G6.35 / G9



GEV No.	357193	Ref. No.	1235342
description	halogen lamp socket G4 12V 20W temp.-resist. 300°C OSRAM HALOSTAR OVEN		



GEV No.	359599	Ref. No.	844952
description	halogen lamp socket G4 12V 20W temp.-resist. 500°C		

fluorescent lamps

fluorescent lamps

G23



GEV No.	359933	Ref. No.	491761-001
description	fluorescent lamp socket G23 L 237mm 11W 230V		

oven lamps

lamps

halogen lamps

for socket G4 / G6.35 / G9



GEV No.	357193	Ref. No.	1235342
description	halogen lamp socket G4 12V 20W temp.-resist. 300°C OSRAM HALOSTAR OVEN		



GEV No.	359599	Ref. No.	844952
description	halogen lamp socket G4 12V 20W temp.-resist. 500°C		

timers

programme timers



GEV No.	360349	Ref. No.	139321-226 E238053	
description	timer CDC 11803 engines 1 chambers 3 operation time 150s 230V shaft ømm shaft Lmm manuf. no. 11803F1BEE000.0010 motor type M48R ATS type 11803F1 / 238046			
For models:	GW-600, GW-600S, GW-601, GW-601S			
spare parts for	360349			
	GEV No.	360673	Ref. No.	—
	motor kit pinion ø 6.8mm teeth 15 230V voltage AC 50/60Hz turn direction clockwise motor ø 48mm H 18.5mm motor type UDS-40NE1RNZ165 cable length 150mm with holder			

electric timers



GEV No.	350201	Ref. No.	00-294650-004-1 294650-4-1
description	timer M006 with bell operation time 15min time spreadmin 1NO permanent position yes impulse electric shaft ø 6x4.6mm shaft L 22mm mounting distance 28mm mounting thread M4 connection male faston 4.8mm 115V voltage AC 60Hz 1-pole		
For models:	A120, H600, H600C, H600D, L800, L800C, L800D, M802, ML-104483, ML-104484, ML-104674, ML-104683, ML-104686, ML-104687, ML-104694, ML-104696, ML-134118, ML-134185, ML-134188, V1401		



mechanical timers

			
1			
GEV No.	350168	Ref. No.	845384 895401-189
description	timer C53 2-pole operation time 120min impulse mechanical 1NO/1NC at 250V 16A permanent position no shaft 6x4.6mm shaft L 23mm mounting distance 28mm connection lateral		
For models:	CSL-0423E, CSL-0423EK, CSL-0523E, CSL-0523EK, CSL-06E, CSL-10E, CSL-423E, CSL-423K, CSM-0611IE, CSM-0611N, CSM-1011IE, CSM-1011N, CSM-1021IE, CSM-1021N, CSM-2011IE, CSM-2011N, CSM-2021IE, CSM-2021N		

alarm devices

buzzers

			
1			
GEV No.	350050	Ref. No.	173864
description	buzzer 230VAC connection male faston 6.3mm screw mounting thread M4 60dB		
For models:	CO-0611E, CO-0612E, CO-1011E, CO-1012E, CO-2011E, CS-0423E, CS-0423EK, CS-0523E, CS-0523EK, CS-0611E, CS-0612E, CS-1011E, CS-1012E, CS-2011E, CS-2012E, CS-2022E, CS-423E, CS-423K, CSD-0611E, CSD-0612E, CSD-1011E, CSD-1012E, CSD-2011E, CSD-2012E, CSD-2022E, CSL-06E, CSL-10E, CSM-0611IE, CSM-0611N, CSM-1011IE, CSM-1011N, CSM-1021IE, CSM-1021N, CSM-2011IE, CSM-2011N, CSM-2021IE, CSM-2021N		

contactors

GENERAL ELECTRIC (AEG)

power contactors

			
1			
GEV No.	380239	Ref. No.	00-695507-001
description	power contactor resistive load 20A 230VAC (AC3/400V) 8.4A/4kW main contacts 3NO auxiliary contacts 1NC connection screw connection type LS05 01A type AEG LS05 01A type GE MC1A 301A		

			
1			
GEV No.	380837	Ref. No.	695507-11
description	power contactor resistive load 20A 400VAC (AC3/400V) 9A/4kW main contacts 3NO auxiliary contacts 1NO connection screw connection type AEG LS0510A type GE MC1A 310A		
For models:	FE, HE		

auxiliary contacts

			
1			
GEV No.	380242	Ref. No.	695508-2 695570-2
description	auxiliary contact contacts 1NO/1NC for contactors M+LS05 connection screw AC-12 10A type AEG HS05K 11HS type GE MARN 211		
For models:	FE, HE, HE600-HL, HE-P		

HARTLAND

power contactors

			
1			
GEV No.	580012	Ref. No.	346466-14 346466-16 XNC6X129 XNC6X131
description	contactor resistive load 50A 240VAC 40A/10HP (AC3/240V) 40A/7.46kW main contacts 4NO connection screw clamp/male faston 6.3mm type HCCY4XU04CG		



MOELLER/EATON

power contactors



1			
GEV No.	380493	Ref. No.	296902-15
description	contactor resistive load 55A 230VAC main contacts 3NO		



1			
GEV No.	380549	Ref. No.	139270-1
description	power contactor resistive load 20A 230VAC (AC3/400V) 9A/4kW main contacts 3NO auxiliary contacts 1NO connection screw connection type DILM9 10		

For models: AM-12E, AM-12EC, AM-12EF, AM-12ER, H600, H800

accessories for 380549

	GEV No.	380555	Ref. No.	—
	auxiliary contact contacts 2NO/2NC AC15 16A for contactors DILEM connection screw type DILA-XHI22			
	GEV No.	380556	Ref. No.	—
	auxiliary contact contacts 4NO AC15 16A for contactors DILM 7-32 connection screw type DILA-XHI40			
	GEV No.	380557	Ref. No.	—
	auxiliary contact contacts 4NC AC15 16A for contactors DILM 7-32 connection screw type DILA-XHI04			
	GEV No.	380558	Ref. No.	—
	auxiliary contact contacts 3NO/1NC AC15 16A for contactors DILM 7-32 connection screw type DILA-XHI31			
	GEV No.	380559	Ref. No.	—
	auxiliary contact contacts 1NO/3NC AC15 16A for contactors DILM 7-32 connection screw type DILA-XHI13			
	GEV No.	380568	Ref. No.	—
	RC circuit suitable for DILM 9-12 rated 110-240V			

SIEMENS

power contactors



1			
GEV No.	381387	Ref. No.	E229037
description	power contactor resistive load 22A 230VAC (AC3/400V) 4kW main contacts 3NO auxiliary contacts 1NO connection screw connection type 3RT2016-1AP01		



1			
GEV No.	380389	Ref. No.	229037
description	power contactor resistive load 22A 230VAC (AC3/400V) 9A/4kW main contacts 3NO auxiliary contacts 1NO connection screw connection type 3RT10-16-1AP01		



1			
GEV No.	380957	Ref. No.	E927160
description	power contactor resistive load 22A 24VAC (AC3/400V) 12A/5.5kW main contacts 3NO auxiliary contacts 1NO connection screw connection type 3RT10-17-1AB01 50/60Hz		

TELEMECANIQUE (Schneider Electric)

power contactors





1			
GEV No.	380962	Ref. No.	00-695521-062 695521-62
description	contactor resistive load 20A 230VAC (AC3/400V) 9A/4kW main contacts 4NO connection screw connection type LC1K09004U7		
For models:	ECOMAX-402, ECOMAX-502		



			
1			
GEV No.	380966	Ref. No.	695521-1 695521-2
description	power contactor resistive load 20A 230VAC (AC3/400V) 6A/2.2kW main contacts 3NO auxiliary contacts 1NC connection screw connection type LC1K0601P7		

			
1			
GEV No.	380820	Ref. No.	00-695527-002
description	power contactor resistive load 25A 230VAC (AC3/400V) 9A/4kW main contacts 3NO auxiliary contacts 1NO/1NC connection screw connection type LC1D0900M7		

			
1			
GEV No.	380976	Ref. No.	296926-2
description	power contactor resistive load 32A 230VAC (AC3/400V) 18A/7.5kW main contacts 3NO auxiliary contacts 1NO/1NC connection screw connection		

motor protection circuit breakers			
			
1			
GEV No.	380948	Ref. No.	228717-6 695523-5
description	motor protection circuit breaker connection screw clamp setting range 0.63-1A type GV2ME05		

			
1			
GEV No.	381146	Ref. No.	695523-26
description	motor protection circuit breaker connection screw clamp setting range 24-30A type GV2ME32		

relays

power relays

with bracket mounting

			
1			
GEV No.	380312	Ref. No.	00-139321-354 229023
description	power relays FINDER 230VAC 10A 3CO connection male faston 4.8mm bracket mounting dimensions 52x32.2x36.5mm manuf. no. 60.63.8.230.0000		

			
1			
GEV No.	380139	Ref. No.	929115
description	power relays FINDER 230VAC 16A 2CO connection F6.3 bracket mounting dimensions 68x38.2x35.8mm manuf. no. 62.82.8.230.0000		

			
1			
GEV No.	380403	Ref. No.	900073
description	power relays FINDER 230VAC 16A 3CO connection F6.3 bracket mounting manuf. no. 62.83.8.230.0500		



GEV No.	380702	Ref. No.	139321-528
description	power relays FINDER 230VAC 16A 3NO connection male faston 6.3mm flange dimensions 36x38x68mm manif. no. 62.83.8.230.0300 230V		

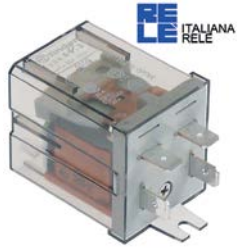

GEV No.	380185	Ref. No.	139321-686 371450-010
description	power relays Italiana Relè 230VAC 30A 1NO connection F6.3 bracket mounting dimensions 36.5x32.2x51.8mm manif. no. A10-230AC-FA		

time relays

time relays



GEV No.	380625	Ref. No.	228180-3
description	time relay DOLD CD7839.65/100 time range 0.5-5s 220-240VAC 4A 1NO connection grip connection		
For models:	FM-30, FM-30U, FX, GX, HX, HX-30, HX-30E, HX-30ES, HX-30S, HX-40, HX-40E, HX-40ES, HX-40S, HX-E, HX-ES, HX-S		



GEV No.	380624	Ref. No.	228180-1
description	time relay DOLD CD7839.65/100 time range 3-30s 220-240VAC 4A 1NO connection grip connection		
For models:	CM1E, FM-30, FM-30U, FX, GX, HX, HX-30, HX-30E, HX-30ES, HX-30S, HX-40, HX-40E, HX-40ES, HX-40S, HX-E, HX-ES, HX-S, WM2E		



GEV No.	380960	Ref. No.	774103-2
description	time relay DOLD IK817N.81/200 time range 0.02s-300h 12-240V AC/DC mounting measurements DIN railmm		
For models:	ECOMAX-600, ECOMAX-700		

transformers

encapsulated transformers

with screw connection



GEV No.	400800	Ref. No.	tran601
description	transformer		

electronic controllers

LOREME

analogue



GEV No.	379744	Ref. No.	480974
description	electronic controller LOREME type Dsl 94 mounting measurements 66x32mm 230V voltage AC TC/J 0-250°C display without display relay outputs 2 front measurements 70x34mm built-in depth 95mm		



GEV No.	379745	Ref. No.	480978 845246 845379-1
description	electronic controller kit LOREME type Dsl 94 mounting measurements 66x32mm 230V voltage AC TC/J 0-250°C display without display relay outputs 2 front measurements 70x34mm built-in depth 95mm cable length 2530mm probe L 20mm probe ø 4mm with probe and fastening material		
For models:	CSL-06E, CSL-10E, CSM-0611E, CSM-0611N, CSM-1011E, CSM-1011N, CSM-1021E, CSM-1021N, CSM-2011E, CSM-2011N, CSM-2021E, CSM-2021N		
spare parts for	379745		

GEV No.	379744	Ref. No.	480974
description	electronic controller LOREME type Dsl 94 mounting measurements 66x32mm 230V voltage AC TC/J 0-250°C display without display relay outputs 2 front measurements 70x34mm built-in depth 95mm		



probes

producer-specific probes

probes





1

GEV No.	402906	Ref. No.	775494-1
description	temperature probe NTC 10kOhm cable probe -40 up to +110°C cable °C connection male faston 4.8mm thread probe ø10x30mm cable lengthm		
For models:	AM900, AMS900, FX, GC, GC11, GC12, GC31, GC32, GC41, GC42, GX		



1

GEV No.	402905	Ref. No.	00-775612-001 775612-1
description	temperature probe NTC 10kOhm cable PVC probe -40 up to +110°C cable -10 up to 100°C connection coded plug thread probe ø5x35mm cable length 0.2m		
For models:	AM-10, AM-11, AM-141, AM-700, AM900, AM900-10N, AM900-90, AMS900, AMS900-10N, AMX, AMX-10HL, AMX-90, AMX-900, AMXR, AMXR-900, AMXS, AMXS-900, AMXT, AMXTS, AMXX, AMXX-1300, AMXXR, AMXXR-1300, AMXXS, AMXXS-1300, AMXXT, AUP, AUP-90, AUPS, AUXX, AUXX-1300, AUXXL, AUXXL-11N, AUXXL-11N, AUXXR, AUXXR-1300, AUXXS, AUXXS-1300, AUXXT, AUXXTS, CNA, CNB, CN-Protronic, CNR, CN-Smartronic, CP-Protronic, ECOMAX-602-10, ECOMAX-602-11, ECOMAX-602S-11, ECOMAX-612-10...(Other models you can see in the webshop)		
accessories for	402905		
	GEV No.	692218	Ref. No. 00-775489-001 775489-1
	probe clip for temperature probe L 35mm W 24mm H 5mm		



1

GEV No.	400910	Ref. No.	139321-591
description	temperature probe NTC 10kOhm cable silicone probe -40 up to +110°C cable -50 up to +180°C connection coded plug thread probe ø4.5x30mm cable length 0.35m		
For models:	CHF45, CHH-50, CHH-60D, CHH-70D, EF-40, EH-60, EH-70		



1

GEV No.	402901	Ref. No.	231016 E231016
description	temperature probe NTC 10kOhm cable silicone probe -40 up to +110°C cable -50 up to +180°C connection coded plug thread probe ø5x30mm cable length 0.35m		



1

GEV No.	524886	Ref. No.	737006
description	temperature probe NTC cable silicone probe -40 up to +110°C cable -50 up to +180°C connection plug thread M10x1.5 probe ø5x25mm cable length 1.2m		
For models:	104G, 204G, 205G, 2227, 2228, 304G, 304T, 305G		



1

GEV No.	379907	Ref. No.	298543-2
description	temperature probe Pt1000 cable silicone probe -50 up to +250°C cable -50 up to +180°C connection male faston 6.3mm thread probe ø6x50mm cable length 1.5m -50 up to +180°C		
For models:	AM-600, AM-600C, AM-600CR, AM-600R, FM-400H, FM-400U, FM-500, FM-500H, UW-105, UW-135H, UW-55		



1

GEV No.	378262	Ref. No.	298543-1
description	temperature probe Pt1000 cable silicone probe -50 up to +400°C cable -50 up to +180°C connection F6.3 thread probe ø6x50mm cable length 2.5m		
For models:	UW-125, UW-135, UW-135H, UW-205		



1

GEV No.	379906	Ref. No.	00-378584-000 229512-2
description	temperature probe PTC 2kOhm cable TPE probe -50 up to +150°C cable -40 up to +110°C connection coded plug thread probe ø4.8x30mm cable length 3.5m		
For models:	AMX-E, AMX-ER, AUX-E, AUX-ER, CN, CX, FE-W, FTN, FTX, FX, GX, HX-30E, HX-30ES, HX-40E, HX-40ES, HX-60-EHL, HX-E, HX-ES, UX-30E, UX-30EB, UX-30EH, UX-30ES, UX-30ESB, UX-30ESH, UX-30-McDonalds, UX-60E, UX-60EB, UX-60EH, UX-60EHB		



1

GEV No.	400803	Ref. No.	492997
description	temperature probe thermocouple J (Fe-CuNi) cable glass fibre probe -50 up to +750°C cable -50 up to +350°C connection 3-wire thread M8 probe ø5x20mm cable length 2.4m		
For models:	CS-0423E, CS-0423EK, CS-0523E, CS-0523EK, CS-0612E, CS-0612E-A, CS-1012E, CS-1012E-A, CS-1012G, CS-1022E, CS-1022E-A, CS-2012E, CS-2012E-A, CS-2012G, CS-2022E, CS-2022E-A, CS-423E, CS-423K, CSD-0612E, CSD-0612E-A, CSD-0612ET, CSD-1012E, CSD-1012E-A, CSD-1012ET, CSD-1013G, CSD-1022E, CSD-1022E-A, CSD-2012E, CSD-2012E-A, CSD-2012ET, CSD-2013G, CSD-2022E, CSD-2022E-A		



1

GEV No.	379793	Ref. No.	N/A
description	temperature probe thermocouple K (NiCr-Ni) cable silicone probe -50 up to 1150°C cable -50 up to +180°C connection 2-wire thread M10x1.5 probe ø3x40mm cable length 2.5m		

core probes



1	GEV No.	378452	Ref. No.	F15247515
description	core temperature probe NTC 2kOhm cable PVC probe -40 up to +120°C cable -10 up to 100°C connection 2-wire probe ø6x155mm thread cable length 1.5m handle ømm handle length 50mm			

accessories

fasteners



1	GEV No.	692218	Ref. No.	00-775489-001 775489-1
description	probe clip for temperature probe L 35mm W 24mm H 5mm			
For models:	AM-10, AM-11, AM-141, AM-700, AM900, AM900-10N, AM900-90, AMS900, AMS900-10N, AMX, AMX-10HL, AMX-90, AMX-900, AMXR, AMXR-900, AMXS, AMXS-900, AMXT, AMXTS, AMXX, AMXX-1300, AMXXR, AMXXR-1300, AMXXS, AMXXS-1300, AMXXT, AUP, AUP-90, AUPS, AUXX, AUXX-1300, AUXXL, AUXXL-11N, AUXXLS-11N, AUXXR, AUXXR-1300, AUXXS, AUXXS-1300, AUXXT, AUXXTS, CNA, CN-Protronic, CNR, CN-Smartronic, CP-Protronic, CSA, CS-Easytronic, ECOMAX-600, ECOMAX-602-10, ECOMAX-602-11...(Other models you can see in the webshop)			

electronics

EPROMS



1	GEV No.	403031	Ref. No.	897547-17
description	EPROM			

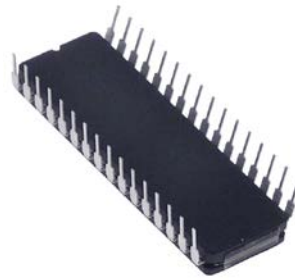

1	GEV No.	403046	Ref. No.	775233-3V
description	EPROM			



1	GEV No.	403245	Ref. No.	139321-731
description	EPROM for dishwasher CODE 225032-2			

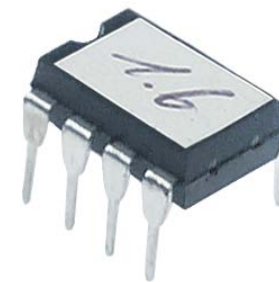

1	GEV No.	403702	Ref. No.	897547-15
description	EPROM Rev. 1.6 (04.06.2013)			



1	GEV No.	403217	Ref. No.	897503-2
description	EPROM type Rev 10.4/5D51 for dishwasher suitable for HOBART CODE 897503-2 17.07.07			
For models:	AM-700, AM900, AMS900, AMX-900, AMXR-900, AMXS-900, AMXX-1300, AMXXR-1300, AMXXS-1300, AMXXT, AUXX-1300, AUXXL, AUXXR-1300, AUXXS-1300, AUXXT, GC, GC11, GC12, GC31, GC32, GC41, GC42, UX, UXL, UXLs, UXS, UXT, UXTH, UXTHL, UXTHLS, UXTHS, UXTL, UXTLH, UXTLHS, UXTLS, UXTS			

1

GEV No.	403218	Ref. No.	774142-1 774142-1V
description	EPROM type Rev 13/6B17 for dishwasher suitable for HOBART CODE 774142-1 16.10.01		
For models:	AMX-E, AMX-ER, AUX-E, AUX-ER, FE-W, FX, HX-30E, HX-30ES, HX-40E, HX-40ES, HX-E, HX-ES, UX-30E, UX-30EB, UX-30EH, UX-30ES, UX-30ESB, UX-30ESH, UX-30-McDonalds, UX-60E, UX-60EB, UX-60EH, UX-60EHB		



1

GEV No.	403216	Ref. No.	897503-1
description	EPROM type Rev 7.06/403A for dishwasher suitable for HOBART CODE 897503-1 24.04.07		
For models:	FX, GX		



1

GEV No.	403030	Ref. No.	00-897547-006 897547-6
description	EPROM type REV. L2.3/6101 CODE 897547-6		



1

GEV No.	403241	Ref. No.	139321-688
description	EPROM type U61E for dishwasher CODE 81001-3		
For models:	CHH-50, CHH-60D, CHH-70D, EH-60, EH-70		

PCBs





1

GEV No.	402904	Ref. No.	00-897501-1
description	control PCB dishwasher AM/AMX 700/900 suitable for HOBART buttons 4		
For models:	AM-700, AM900, AMS900, AMX-900, AMXR-900, AMXS-900, AMXX-1300, AMXXR-1300, AMXXS-1300, AMXXT, AUXX-1300, AUXXL, AUXXR-1300, AUXXS-1300, AUXXT, CNA, CNR, ECOMAX-650, FX, GC, GC11, GC12, GC31, GC32, GC41, GC42, GX, UX, UXL, UXLS, UXS, UXT, UXTH, UXTHL, UXTHLS, UXTHS, UXTL, UXTLH, UXTLHS, UXTLS, UXTS		



1

GEV No.	403204	Ref. No.	00-897545-005 897545-5	
description	control PCB dishwasher C502/C602 L 148mm W 126mm without EPROM only for Ecomax			
accessories for	403204			
	GEV No.	403030	Ref. No.	00-897547-006 897547-6
	EPROM type REV. L2.3/6101 CODE 897547-6			
	GEV No.	403031	Ref. No.	897547-17
	EPROM			

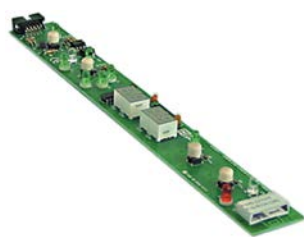

1

GEV No.	400897	Ref. No.	139321-456	
description	display PCB dishwasher GS 60			
For models:	CHF45, CHH-50, CHH-60D, CHH-70D, EF-40, EH-60, EH-70			
accessories for	400897			
	GEV No.	403250	Ref. No.	139321-684
	ribbon cable 10-pole L 3000mm plug type coded 2 row plug: number of poles 10			



1 

GEV No.	403032	Ref. No.	00-897560-001 00-897560-002 897560-1 897560-2
description	keypad PCB dishwasher C402(S)-/C502(S)-/C602(S)-xx L 185mm W 35mm suitable for COOKMAX with display buttons 4		
For models:	AM-10, AM-11, AM-141, ECOMAX-402, ECOMAX-502, ECO-MAX-602-10, ECOMAX-602-11, ECOMAX-602S-11, ECOMAX-612-10, ECOMAX-612S-10		



1 

GEV No.	400898	Ref. No.	139321-1012
description	keypad PCB dishwasher LP10/20/30 with display		
accessories for	400898		
	GEV No.	402970	Ref. No. 139321-1011
	ribbon cable 10-pole L 1200mm plug type 2 row coded Qty 1m		

1 

GEV No.	403041	Ref. No.	00-895401-016 895401-16
description	PCB cable length 220mm with relay		
For models:	CSD-0612-UC, CSD-1012-UC, CSD-1022-UC, CSD-2012-UC, CSD-2022-UC		

1 

GEV No.	403033	Ref. No.	00-897545-001 00-897545-002 00-897545-003 897543-002/00 897545-1 897545-2 897545-3
description	PCB control L 147mm W 125mm without EPROM 230V		
For models:	AM-10, AM-11, AM-141, AM900-10N, AM900-90, AMS900-10N, AMX, AMX-10HL, AMX-90, AMXR, AMXS, AMXT, AMXTS, AMXX, AMXXR, AMXXS, AUP, AUP-90, AUPS, AUXX, AUXXL-11N, AUXXLS-11N, AUXXR, AUXXS, AUXXT, AUXXTS, ECOMAX-402, ECOMAX-502, ECOMAX-602-10, ECOMAX-602-11, ECOMAX-602S-11, ECOMAX-612-10, ECOMAX-612S-10, FP, FX, FX-McDonalds, GP, GX		
accessories for	403033		
	GEV No.	403030	Ref. No. 00-897547-006 897547-6
	EPROM type REV. L2.3/6101 CODE 897547-6		
	GEV No.	403031	Ref. No. 897547-17
	EPROM		
	GEV No.	403702	Ref. No. 897547-15
	EPROM Rev. 1.6 (04.06.2013)		

1 

GEV No.	401895	Ref. No.	781142-1
description	PCB dishwasher CR type 5E 5A		

1 

GEV No.	402903	Ref. No.	00-897502-001 897502-1 897502-12 897502-2 897502-22
description	PCB dishwasher GX/FX/HX suitable for HOBART without EPROM		
For models:	AM-700, AM900, AMS900, AMX-900, AMXR-900, AMXS-900, AMXX-1300, AMXXR-1300, AMXXS-1300, AMXXT, AUXX-1300, AUXXL, AUXXR-1300, AUXXS-1300, AUXXT, ECOMAX-650, FX, GC, GC11, GC12, GC31, GC32, GC41, GC42, GX, UX, UXL, UXLS, UXS, UXT, UXTH, UXTHL, UXTHLS, UXTHS, UXTL, UXTLH, UXTLHS, UXTLS, UXTS		

1

GEV No.	401946	Ref. No.	324074-1 324250-1 374391-1 785422-1
description	PCB dishwasher HX		
For models:	FX, GX, HX, HX-E, HX-ES, HX-S		



1

GEV No.	401893	Ref. No.	00-087714-028-2 87714-28-2
description	PCB time control suitable for HOBART		
For models:	C44A, C44AW, C54A		

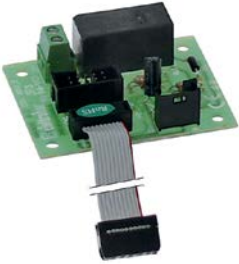





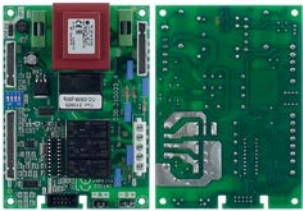

1

GEV No.	401049	Ref. No.	139321-691
description	PCB dishwasher LP10/20/30		



1

GEV No.	400899	Ref. No.	139321-451 139321-695 215023 E215023
description	power PCB dishwasher LP10/20/30 without EPROM		
For models:	CHF45, CHH-50, CHH-60D, CHH-70D, ECOMAX-601, EF-40, EH-60, EH-70, H66		
accessories for	400899		
	GEV No.	400761	Ref. No. —
	plug connector 5-pole		
	GEV No.	400900	Ref. No. —
	EPROM CODE 225029-3		
	GEV No.	401558	Ref. No. —
	EPROM CODE 81000-1		
	GEV No.	403241	Ref. No. 139321-688
	EPROM type U61E for dishwasher CODE 81001-3		
	GEV No.	550048	Ref. No. —
	female bullet		



1

GEV No.	361870	Ref. No.	01-235011 01-235011-000
description	PCB L 130mm W 100mm		



1

GEV No.	403882	Ref. No.	01-515340-001 01-515340-1
description	PCB suitable for HOBART		

keypads

front foils



1

GEV No.	403783	Ref. No.	41357
description	front foil dishwasher HOBART/EUROTEC L 144mm W 184mm		



GEV No.	402321	Ref. No.	296979-4
description	keypad foil		
For models:	AM-600, AM-600C, AM-600CR, AM-600R, FM-400H, FM-400U, FM-500, FM-500H, UW-105, UW-135, UW-135H, UW-55		



GEV No.	698701	Ref. No.	00-897500-001 897500-1
description	keypad foil dishwasher AMX 900 L 500mm W 41mm		
For models:	AM900, AMS900, AMX-900, AMXR-900, AMXS-900, AMXX-1300, AMXXR-1300, AMXXS-1300, AMXXT, AUXX-1300, AUXXL, AUXXR-1300, AUXXS-1300, AUXXT, FX, GX, UX, UXL, UXLS, UXS, UXT, UXTH, UXTHL, UXTHLS, UXTHS, UXTL, UXTLH, UXTLHS, UXTLS, UXTS		



GEV No.	403769	Ref. No.	00-897550-001 897550-1
description	keypad foil warewashing AM900 L 187mm W 45mm		
For models:	AM900-10N, AM900-90, AMS900-10N, AMX, AMX-10HL, AMX-90, AMXR, AMXS, AMXT, AMXTS, AMXX, AMXXR, AMXXS, FX, FX-McDonalds, GX		



GEV No.	694717	Ref. No.	N/A
description	keypad foil warewashing universal dishwasher black/white suitable for HOBART L 185mm W 144mm buttons 3		

membrane keypads



GEV No.	402918	Ref. No.	324202
description	membrane keypad warewashing GX/FX/HX buttons 7 suitable for HOBART L 152mm W 52mm		
For models:	AMX-E, AMX-ER, AUX-E, AUX-ER, FX, HX-30E, HX-40E, HX-E, UX-30E, UX-30EB, UX-30EH, UX-30ES, UX-30ESB, UX-30ESH, UX-30-McDonalds, UX-60E		

solenoid valves

solenoid valves (water)

ELBI

straight



GEV No.	373017	Ref. No.	371450-021
description	solenoid valve single straight 230VAC inlet 3/4" outlet 11.5mm DN10 ELBI		
spare parts for	373017		
	GEV No.	370467	Ref. No. —
	solenoid valve filter suitable for ELBI		



GEV No.	370246	Ref. No.	240010 371450-020
description	solenoid valve double straight 230VAC inlet 3/4" outlet 11.5mm t.max. 90°C ELBI plastic output B 0.5l/min flow regulating valve outlet B red		



GEV No.	370247	Ref. No.	139321-1
description	solenoid valve triple straight 230VAC inlet 3/4" outlet 11.5mm t.max. 90°C ELBI plastic flow regulating valve inlet orange output B 0.5l/min flow regulating valve outlet B red		
For models:	GW-600, GW-600S, GW-601, GW-601S		



INTERELEKTRIK

medium temperature: 90°C 90°C 60°C
 ambient temperature: 60°C 25°C 60°C
 duty cycle: 40% 100% 100%

with reducers



GEV No.	370676	Ref. No.	01-246164-003 01-246164-3
description	solenoid valve single straight 230VAC inlet 3/4" outlet 10.5mm input 15l/min t.max. 90°C		













GEV No.	370675	Ref. No.	00-883658-001 01-246164-001 01-246164-1 883658-1
description	solenoid valve single straight 230VAC inlet 3/4" outlet 10.5mm input 5l/min t.max. 90°C		
For models:	AM900-10N, AM900-90, AMS900-10N, AMX, AMX-10HL, AMX-90, AMX-900, AMXR, AMXR-900, AMXS, AMXS-900, AMXT, AMXTS, AMXX, AMXX-1300, AMXXR, AMXXR-1300, AMXXS, AMXXS-1300, AMXXT, AUP, AUP-90, AUPS, AUXX, AUXX-1300, AUXXL-11N, AUXXLS-11N, AUXXR, AUXXR-1300, AUXXS, AUXXS-1300, AUXXT, AUXXTS, ECOMAX-402, ECOMAX-502, ECOMAX-602-11, ECOMAX-602S-11, ECOMAX-612-10, ECOMAX-612S-10, ECOMAX-700, FP, FX, FX-McDonalds, GP, GX, UX, UXL, UXLS, UXS, UXT...(Other models you can see in the webshop)		
accessories for	370675		
	GEV No.	520015	Ref. No. 00-775559-007 00-775559-008 00-775559-013 00-775559-016 139321-125 139321-611 775559-13 775559-16 775559-7 775559-8
supply hose ID ø 10mm ED ø 17mm L 5m operating p. 20bar burst p. 60bar t.max. 95°C grey Qty 5m			









MÜLLER

medium temperature: 90°C
 duty cycle: 100%



GEV No.	370003	Ref. No.	324208-4
description	solenoid valve double angled 230VAC inlet 3/4" outlet 14.5mm DN10 t.max. 90°C duty cycle 100% MÜLLER		
For models:	FX		
spare parts for	370003		
	GEV No.	370128	Ref. No. —
solenoid valve body double angled inlet 3/4" outlet 14.5mm DN10 t.max. 90°C duty cycle 100% MÜLLER 230V double-ways			
	GEV No.	371002	Ref. No. —
solenoid valve holder MÜLLER flange support			
	GEV No.	371009	Ref. No. —
compression spring for solenoid coil			
	GEV No.	371011	Ref. No. —
spare parts kit membrane with long star star hight 8mm MÜLLER			
	GEV No.	371017	Ref. No. —
solenoid coil MÜLLER 230VAC connection male faston 6.3mm			
	GEV No.	371122	Ref. No. —
solenoid valve filter ø 19mm H 10mm suitable for MÜLLER			
	GEV No.	501161	Ref. No. —
tap head for solenoid valve holder for solenoid coils			
accessories for	370003		
	GEV No.	371010	Ref. No. —
solenoid coil 230VAC connection with cable cable length 2000mm			
	GEV No.	371037	Ref. No. —
solenoid coil 24VAC 50/60Hz connection male faston 6.3mm			
	GEV No.	371038	Ref. No. —
solenoid coil 230VAC connection appliance plug			



			
1			
GEV No.	370001	Ref. No.	324207-1
description	solenoid valve single angled 230VAC inlet 3/4" outlet 14.5mm DN10 t.max. 90°C duty cycle 100% MÜLLER		
For models:	AM3, AMX, AMX-E, AMX-ER, AMX-R, AUX, AUX_, AUX-E, AUX-ER, AUX-R, FE, FX, GX, HE, HE-P, HX, HX-30, HX-30E, HX-40, HX-40E, HX-60-EHL, HX-E, HX-ES, HX-S, UX-30, UX-30B, UX-30E, UX-30EB, UX-30EH, UX-30H, UX-30-McDonalds, UX-60, UX-60B, UX-60E, UX-60EB, UX-60EH, UX-60EHB, UX-60H, UX-60HB, UXD-30		
spare parts for	370001		
	GEV No.	370126	Ref. No. —
	solenoid valve body single angled inlet 3/4" outlet 14.5mm DN10 t.max. 90°C duty cycle 100% MÜLLER plastic		
	GEV No.	371002	Ref. No. —
	solenoid valve holder MÜLLER flange support		
	GEV No.	371009	Ref. No. —
	compression spring for solenoid coil		
	GEV No.	371011	Ref. No. —
	spare parts kit membrane with long star star hight 8mm MÜLLER		
	GEV No.	371017	Ref. No. —
	solenoid coil MÜLLER 230VAC connection male faston 6.3mm		
	GEV No.	371122	Ref. No. —
	solenoid valve filter ø 19mm H 10mm suitable for MÜLLER		
accessories for	370001		
	GEV No.	371010	Ref. No. —
	solenoid coil 230VAC connection with cable cable length 2000mm		
	GEV No.	371037	Ref. No. —
	solenoid coil 24VAC 50/60Hz connection male faston 6.3mm		
	GEV No.	371038	Ref. No. —
	solenoid coil 230VAC connection appliance plug		

ROBERTSHAW/INVENSYS

medium temperature: 90°C 90°C 60°C
 ambient temperature: 60°C 25°C 60°C
 duty cycle: 40% 100% 100%

solenoid valves with reducers

single



1			
GEV No.	374013	Ref. No.	775742-1
description	solenoid valve single straight 230VAC inlet 3/4" outlet 11.5mm 10 Invensys plastic flow regulating valve inlet pink		
For models:	AM-700, GC, GC11, GC12		

2-fold



1			
GEV No.	371155	Ref. No.	480043-2
description	solenoid valve double straight 230VAC inlet 3/4" outlet 11.5mm input 10l/min 10 EATON (INVENSYS) flow regulating valve inlet white output A 0.25l/min output B 0.25l/min flow regulating valve outlet A white flow regulating valve outlet B white		

RPE



1			
GEV No.	370857	Ref. No.	00-883658-002 883658-2
description	solenoid valve single straight 230VAC inlet 3/4" outlet 10.5mm input 15l/min t.max. 90°C RPE plastic		
For models:	AM-10, AM-11, AM-141, AMX-10HL, ECOMAX-402, ECOMAX-502, ECOMAX-602-10, FP, FX, FX-McDonalds, GP, GX, UX, UXL, UXLS, UXS, UXT, UXTL, UXTLS, UXTS		

TP



1			
GEV No.	370021	Ref. No.	240003
description	solenoid valve double straight 230VAC inlet 3/4" outlet 11.5mm DN10 TP flow regulating valve inlet white		
spare parts for	370021		
	GEV No.	371013	Ref. No. —
	solenoid coil TP 230VAC 50/60Hz		

Table continues overleaf



accessories for 370021		GEV No.	Ref. No.	
	reducer TP flow rate 3l/min red tolerance ±15%	371220		—
	reducer TP flow rate 5.5l/min yellow tolerance ±15%	371221		—
	reducer TP flow rate 6l/min grey tolerance ±15%	371222		—
	reducer TP flow rate 10l/min white tolerance ±15%	371223		—
	reducer TP flow rate 12l/min bronze tolerance ±15%	371224		—
	reducer TP flow rate 16l/min light brown tolerance ±15%	371225		—
	reducer TP flow rate 20l/min red tolerance ±15%	371226		—
	reducer TP flow rate 0.25l/min red tolerance ±25%	371230		—
	reducer TP flow rate 0.35l/min violet tolerance ±25%	371231		—
	reducer TP flow rate 0.5l/min orange tolerance ±25%	371232		—
	reducer TP flow rate 0.8l/min white tolerance ±25%	371233		—
	reducer TP flow rate 1l/min light blue tolerance ±25%	371234		—
	reducer TP flow rate 1.2l/min brown tolerance ±25%	371235		—
	reducer TP flow rate 1.5l/min light brown tolerance ±25%	371236		—
	reducer TP flow rate 2.5l/min yellow tolerance ±25%	371237		—
	reducer TP flow rate 3.4l/min dark green tolerance ±25%	371238		—
	reducer TP flow rate 5l/min black tolerance ±25%	371239		—
	reducer TP flow rate 8l/min blue tolerance ±20%	371240		—













			
1			
GEV No.	370111	Ref. No.	E927001
description	solenoid valve double straight 24VAC inlet 3/4" outlet 11.5mm DN10 TP		
spare parts for	370111		
	GEV No.	371035	Ref. No.
			—
accessories for	370111		
	GEV No.	371220	Ref. No.
			—
	GEV No.	371221	Ref. No.
			—
	GEV No.	371222	Ref. No.
			—
	GEV No.	371223	Ref. No.
			—
	GEV No.	371224	Ref. No.
			—
	GEV No.	371225	Ref. No.
			—
	GEV No.	371226	Ref. No.
			—
	GEV No.	371230	Ref. No.
			—
	GEV No.	371231	Ref. No.
			—
	GEV No.	371232	Ref. No.
			—
	GEV No.	371233	Ref. No.
			—
	GEV No.	371234	Ref. No.
			—
	GEV No.	371235	Ref. No.
			—
	GEV No.	371236	Ref. No.
			—
	GEV No.	371237	Ref. No.
			—

Table continues overleaf



accessories for		370111		
GEV No.		371238	Ref. No.	—
				reducer TP flow rate 3.4l/min dark green tolerance ±25%
				reducer TP flow rate 5l/min black tolerance ±25%
				reducer TP flow rate 8l/min blue tolerance ±20%

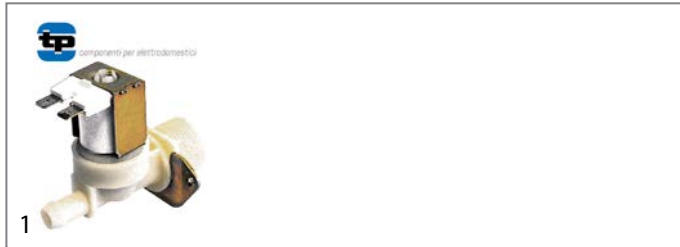

GEV No.	370017	Ref. No.	240011
---------	--------	----------	--------

description solenoid valve single straight 230VAC inlet 3/4" outlet 11.5mm DN10 TP p max 10bar

spare parts for 370017

GEV No.	371013	Ref. No.	—
			solenoid coil TP 230VAC 50/60Hz

accessories for 370017

	GEV No.	371220	Ref. No.	—	reducer TP flow rate 3l/min red tolerance ±15%
	GEV No.	371221	Ref. No.	—	reducer TP flow rate 5.5l/min yellow tolerance ±15%
	GEV No.	371222	Ref. No.	—	reducer TP flow rate 6l/min grey tolerance ±15%
	GEV No.	371223	Ref. No.	—	reducer TP flow rate 10l/min white tolerance ±15%
	GEV No.	371224	Ref. No.	—	reducer TP flow rate 12l/min bronze tolerance ±15%
	GEV No.	371225	Ref. No.	—	reducer TP flow rate 16l/min light brown tolerance ±15%
	GEV No.	371226	Ref. No.	—	reducer TP flow rate 20l/min red tolerance ±15%
	GEV No.	371230	Ref. No.	—	reducer TP flow rate 0.25l/min red tolerance ±25%
	GEV No.	371231	Ref. No.	—	reducer TP flow rate 0.35l/min violet tolerance ±25%
	GEV No.	371232	Ref. No.	—	reducer TP flow rate 0.5l/min orange tolerance ±25%
	GEV No.	371233	Ref. No.	—	reducer TP flow rate 0.8l/min white tolerance ±25%
	GEV No.	371234	Ref. No.	—	reducer TP flow rate 1l/min light blue tolerance ±25%

accessories for		370017		
GEV No.		371235	Ref. No.	—
				reducer TP flow rate 1.2l/min brown tolerance ±25%
				reducer TP flow rate 1.5l/min light brown tolerance ±25%
				reducer TP flow rate 2.5l/min yellow tolerance ±25%
				reducer TP flow rate 3.4l/min dark green tolerance ±25%
				reducer TP flow rate 5l/min black tolerance ±25%
				reducer TP flow rate 8l/min blue tolerance ±20%

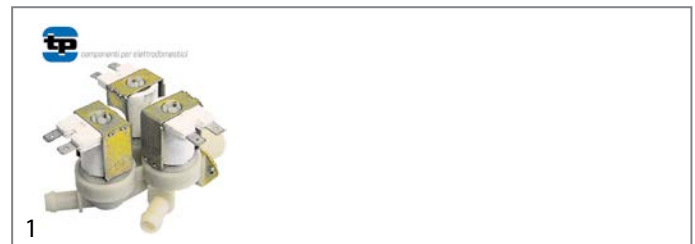

GEV No.	370025	Ref. No.	139321-1
---------	--------	----------	----------

description solenoid valve triple straight 230VAC inlet 3/4" outlet 11.5mm DN10 TP

spare parts for 370025









GEV No.	371013	Ref. No.	—
			solenoid coil TP 230VAC 50/60Hz

accessories for 370025

	GEV No.	371220	Ref. No.	—	reducer TP flow rate 3l/min red tolerance ±15%
	GEV No.	371221	Ref. No.	—	reducer TP flow rate 5.5l/min yellow tolerance ±15%
	GEV No.	371222	Ref. No.	—	reducer TP flow rate 6l/min grey tolerance ±15%
	GEV No.	371223	Ref. No.	—	reducer TP flow rate 10l/min white tolerance ±15%
	GEV No.	371224	Ref. No.	—	reducer TP flow rate 12l/min bronze tolerance ±15%
	GEV No.	371225	Ref. No.	—	reducer TP flow rate 16l/min light brown tolerance ±15%
	GEV No.	371226	Ref. No.	—	reducer TP flow rate 20l/min red tolerance ±15%
	GEV No.	371230	Ref. No.	—	reducer TP flow rate 0.25l/min red tolerance ±25%

Table continues overleaf



accessories for		370025		
	GEV No.	371231	Ref. No.	—
reducer TP flow rate 0.35l/min violet tolerance ±25%				
	GEV No.	371232	Ref. No.	—
reducer TP flow rate 0.5l/min orange tolerance ±25%				
	GEV No.	371233	Ref. No.	—
reducer TP flow rate 0.8l/min white tolerance ±25%				
	GEV No.	371234	Ref. No.	—
reducer TP flow rate 1l/min light blue tolerance ±25%				
	GEV No.	371235	Ref. No.	—
reducer TP flow rate 1.2l/min brown tolerance ±25%				
	GEV No.	371236	Ref. No.	—
reducer TP flow rate 1.5l/min light brown tolerance ±25%				
	GEV No.	371237	Ref. No.	—
reducer TP flow rate 2.5l/min yellow tolerance ±25%				
	GEV No.	371238	Ref. No.	—
reducer TP flow rate 3.4l/min dark green tolerance ±25%				
	GEV No.	371239	Ref. No.	—
reducer TP flow rate 5l/min black tolerance ±25%				
	GEV No.	371240	Ref. No.	—
reducer TP flow rate 8l/min blue tolerance ±20%				

solenoid valves with reducers

	1		
GEV No.	370628	Ref. No.	00-139321-65
description	solenoid valve double straight 230VAC inlet 3/4" input 16l/min DN10 TP plastic outlet 11.5mm		

	1		
GEV No.	370245	Ref. No.	E927242
description	solenoid valve single straight 24VAC inlet 3/4" outlet 11.5mm input 16l/min t.max. 90°C TP plastic flow regulating valve inlet light brown		

various			
	1		
GEV No.	370641	Ref. No.	00-775897-001 775897-1
description	solenoid valve 220-240VAC outlet 10mm plastic inlet 10mm		
For models:	ECOMAX-402, ECOMAX-502, ECOMAX-602S-11, ECOMAX-612S-10, FX, FX-McDonalds		

metal			
ASCO			
2-way			
	1		
GEV No.	370121	Ref. No.	173863
description	solenoid valve 2-ways 230VAC connection 1/2" L 70mm DN 16mm slide-on receptacle DIN -20° up to 85°C Asco type series 210 (positively actuated) coil type 400425-217 membranes NBR (water) p max 9bar valve set A		
For models:	102-G, 103G, 104G, 201G, 202-G, 203G, 204G, 205G, 2222, 2226, 2227, 2228, 301G, 302-G, 303G, 304G, 304T, 305G, AM-12E, AM-12EC, AM-12EF, AM-12ER, AM-600CR, AM-600R, UW-135, UW-135H		

	1		
GEV No.	370200	Ref. No.	296795-1
description	solenoid valve 2-ways 230VAC connection 3/4" L 71mm DN 19mm slide-on receptacle DIN -20° up to 85°C Asco type series 222 (positively actuated) coil type 400425-117 membranes NBR (water) p max 20bar p min 0.35bar valve set F		
For models:	AMX, AMX-E, AMX-ER, AMX-R, AUX_, AUX-E, AUX-ER, AUX-R		



solenoid valves steam (water)

2-way



1

GEV No.	370263	Ref. No.	00-168909-001 168909-1 2967951-1
description	solenoid valve 2-ways 230VAC inlet 3/4" outlet 3/4" connection 3/4" L 72mm DN 19mm slide-on receptacle DIN -20° up to 184°C Asco type series 222 (positively actuated) coil type 400426-117 membranes PTFE (water/steam) p max 9bar valve set H		
For models:	AM-600, AM-600C, AM-600CR, AM-600R, AMX, AMX-E, AMX-ER, AMX-R, AUX, AUX-E, AUX-ER, AUX-R, UW-100, UW-105, UW-135, UW-135H, UX-30, UX-30B, UX-30E, UX-30EB, UX-30ES, UX-30ESB, UX-30S, UX-30SB, UX-60, UX-60B, UX-60E, UX-60EB		

spare parts and accessories

kits



1

GEV No.	371143	Ref. No.	228894-1 228894-11
description	valve insert for solenoid valve with accessories		



1

GEV No.	371110	Ref. No.	173863-11
description	valve insert type A size 1/2" service kit		
For models:	2226, 2227, AM-12E, AM-12EC, AM-12EF, AM-12ER, AM-600, AM-600C, AM-600CR, AM-600R		

drain valves



1

GEV No.	370642	Ref. No.	00-774683-001 774683-1
description	drain solenoid valve 230V 50/60Hz single inlet 40mm outlet 40mm 26 1-ways		
For models:	CN, CNA, CNB, CNR, CSA, EWB-S, FTN		



1

GEV No.	370621	Ref. No.	323785-1 323785-11 378562-1
description	drain solenoid valve 230V 50Hz single inlet 17mm outlet 17mm 11.5		
For models:	FE-W, FX, GX, HX, HX-30, HX-30E, HX-30ES, HX-30S, HX-40, HX-40E, HX-40ES, HX-40S, HX-60-EHL, HX-E, HX-ES, HX-S, UX-30ES, UX-30ESB, UX-30ESH, UX-30-McDonalds, UX-30S, UX-30SB, UX-30SH		



1

GEV No.	370720	Ref. No.	323592-1
description	drain solenoid valve straight 230V 50/60Hz single inlet 17mm outlet 19mm 10 plastic		
For models:	AMX-ER, AMX-R, AUX-ER, AUX-R, CN, CNA, CNB, CNR, CR, CSA, FTN		



1

GEV No.	370721	Ref. No.	323785-12 323785-2
description	drain solenoid valve straight 240V 50Hz single inlet 17mm outlet 19mm 10 plastic		
For models:	FE-W, FX, GX, HX, HX-30, HX-30E, HX-30ES, HX-30S, HX-40, HX-40E, HX-40ES, HX-40S, HX-60-EHL, HX-E, HX-ES, HX-S, UX-30ES, UX-30ESB, UX-30ESH, UX-30-McDonalds, UX-30S, UX-30SB, UX-30SH		

pressure switches

for warewashing

ø 58mm with male faston 6.3mm

with connection horizontal



1

GEV No.	541002	Ref. No.	139321-452
description	pressure control pressure range 110/60mbar connection 6mm ø 58mm pressure connection horizontal warewashing pressure connection ø 6mm		

1

GEV No.	541001	Ref. No.	139321-521
description	pressure control pressure range 35/17mbar connection 6mm ø 58mm pressure connection horizontal warewashing		



1

GEV No.	541003	Ref. No.	139321-23 139321-833
description	pressure control pressure range 55/35mbar connection 6mm ø 58mm pressure connection horizontal warewashing pressure connection ø 6mm		
For models:	GE-400, GF-60, GF-60S, GW-600, GW-600S, GW-601, GW-601S		

ø 79mm with coded plug

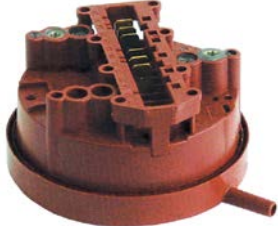

1

GEV No.	541321	Ref. No.	231981-2 231981-6
description	pressure control 2 pressure ranges pressure range 35/20 80/60mbar connection 6mm ø 79mm pressure connection horizontal warewashing suitable for HOBART pressure connection ø 6mm		
For models:	AMX, AMX-R, AUX, AUX_, AUX-R, CN, CNB, FTN, UX-30, UX-30B, UX-30H, UX-30-McDonalds, UX-30S, UX-30SB, UX-30SH, UX-60, UX-60B, UXD-30		

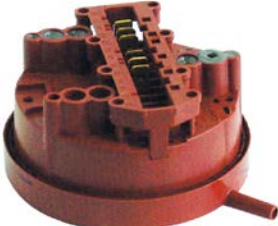

1

GEV No.	541318 ¹	Ref. No.	378758-2 378758-6
description	pressure control 2 pressure ranges pressure range 35/25 80/60mbar connection 6mm ø 79mm with gold contacts for electric machines pressure connection horizontal warewashing suitable for HOBART pressure connection ø 6mm		
For models:	AMX-E, AMX-ER, AUX-E, AUX-ER, CN, CNB, FTN, UX-30E, UX-30EB, UX-30EH, UX-30ES, UX-30ESB, UX-30ESH, UX-30-McDonalds, UX-60E, UX-60EB		

¹with gold contacts for electronically controlled equipment

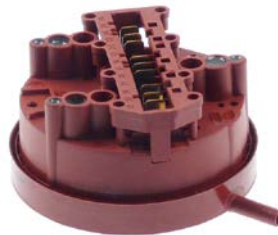

1

GEV No.	541902 ¹	Ref. No.	378760-002 378760-2
description	pressure control 3 pressure ranges pressure range 145/120 230/200 280/250mbar connection 6mm ø 79mm pressure connection horizontal with gold contacts for electric machines warewashing		
For models:	CR, CR-F		

¹with gold contacts for electronically controlled equipment



1

GEV No.	541904	Ref. No.	378758-8
description	pressure control 3 pressure ranges pressure range 145/120 260/230 385/350mbar connection 6mm ø 79mm pressure connection horizontal warewashing pressure connection ø 6mm		
For models:	UX-30E, UX-30EB, UX-30EH, UX-30ES, UX-30ESB, UX-30ESH, UX-30-McDonalds		



1

GEV No.	542151	Ref. No.	378760-6
description	pressure control 3 pressure ranges pressure range 40/25 57/37 125/105mbar connection 6mm ø 78mm pressure connection horizontal warewashing pressure connection ø 6mm		
For models:	FX, GX		

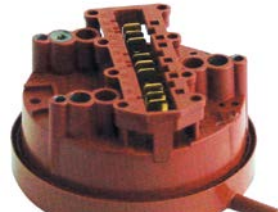

1

GEV No.	541320	Ref. No.	231981-1
description	pressure control 3 pressure ranges pressure range 40/25 57/37 125/105mbar connection 6mm ø 79mm pressure connection horizontal warewashing suitable for HOBART pressure connection ø 6mm		
For models:	AM3, CR-F, FE, FX, GX, HE, HE600-HL, HE-P, HX, HX-30, HX-30E, HX-30S, HX-40, HX-40E, HX-40S, HX-S		

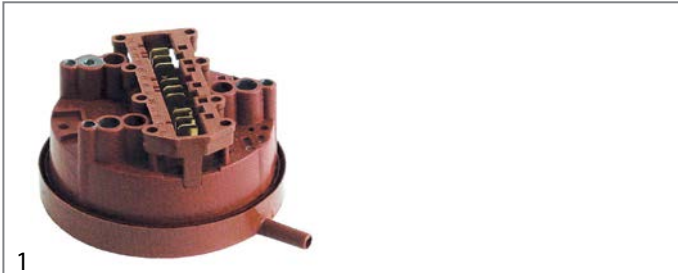

GEV No.	542136 ¹	Ref. No.	00-378758-001 378758-1
description	pressure control 3 pressure ranges pressure range 40/25 57/37 125/105mbar connection 6mm ø 79mm pressure connection horizontal warewashing suitable for HOBART pressure connection ø 6mm		
For models:	FX, HX-30E, HX-30ES, HX-40E, HX-40ES, HX-60-EHL, HX-E, HX-ES		

¹with gold contacts for electronically controlled equipment

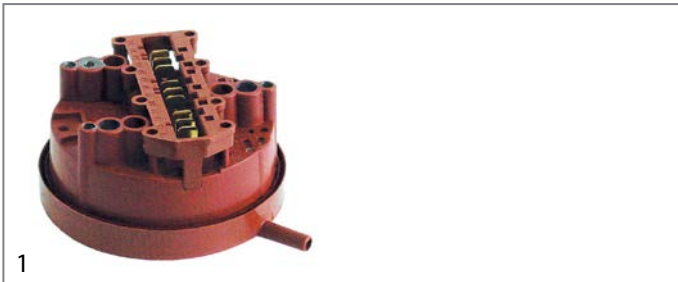

GEV No.	541317 ¹	Ref. No.	378760-1 378760-3
description	pressure control 3 pressure ranges pressure range 40/25 57/42 125/105mbar connection 6mm ø 79mm pressure connection horizontal warewashing suitable for HOBART		
For models:	AMX, AMX-R, AUX, AUX_, AUX-R, UXD-30		

¹with gold contacts for electronically controlled equipment

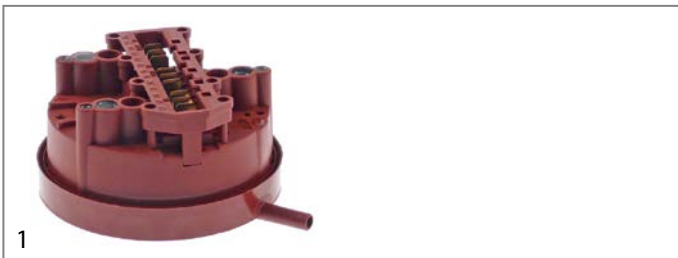

GEV No.	541316 ¹	Ref. No.	378758-4
description	pressure control 3 pressure ranges pressure range 40/25 57/42 125/105mbar connection 6mm ø 79mm pressure connection horizontal with gold contacts for electric machines warewashing		
For models:	AMX-E, AMX-ER, AUX-E, AUX-ER, FX, GX		

¹with gold contacts for electronically controlled equipment



GEV No.	541782 ¹	Ref. No.	00-378758-005 378758-5
description	pressure control 3 pressure ranges pressure range 40/25 92/77 160/140mbar connection 6mm ø 79mm pressure connection horizontal with gold contacts for electric machines warewashing suitable for HOBART pressure connection ø 6mm		
For models:	AM-700, AM900, AMS900, AMX-900, AMXR-900, AMXS-900, AMXX-1300, AMXXR-1300, AMXXS-1300, AMXXT, AUXX-1300, AUXXL, AUXXR-1300, AUXXS-1300, AUXXT, ECOMAX-600, ECOMAX-650, ECOMAX-700, FE-W, UX, UX-30E, UX-30EB, UX-30EH, UX-30ES, UX-30ESB, UX-30ESH, UX-30-McDonalds, UX-60E, UX-60EB, UXL, UXLS, UXS, UXT, UXTH, UXTHL, UXTHLS, UXTHS, UXTL, UXTLH, UXTLHS, UXTS		

¹with gold contacts for electronically controlled equipment

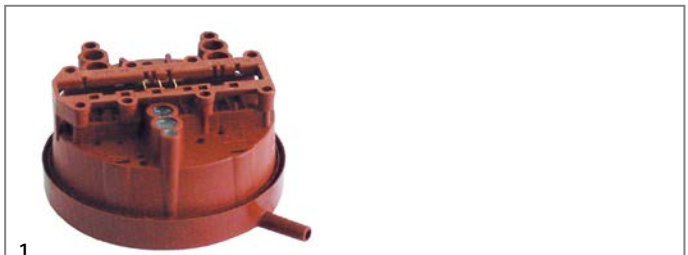

GEV No.	541319	Ref. No.	231981-3
description	pressure control pressure range 35/20mbar connection 6mm ø 79mm pressure connection horizontal warewashing suitable for HOBART pressure connection ø 6mm		
For models:	FX, GX, HX, HX-30, HX-30E, HX-30S, HX-40, HX-40E, HX-40S, HX-5		



GEV No.	541315 ¹	Ref. No.	378758-3
description	pressure control pressure range 35/20mbar connection coded plug ø 79mm pressure connection horizontal with gold contacts for electric machines warewashing suitable for HOBART pressure connection ø 6mm		
For models:	FX, GC41, GC42, GX, HX-30E, HX-30ES, HX-40E, HX-40ES, HX-60-EHL, HX-E, HX-ES		

¹with gold contacts for electronically controlled equipment

1

GEV No.	541322	Ref. No.	378756-3
description	pressure control pressure range 35/20mbar connection coded plug ø 79mm pressure connection horizontal with gold contacts for electric machines warewashing suitable for HOBART pressure connection ø 6mm		

pressure transmitters



1

GEV No.	541149	Ref. No.	00-775866-202 775866-1
description	pressure transmitter pressure range 0-30mbar output voltage 0.5-3.5VDC input voltage 5VDC max 200mbar		
For models:	GC11, GC12, GC31, GC32, GC41, GC42		



1

GEV No.	541786	Ref. No.	00-775866-002 775866-02 775866-2
description	pressure transmitter pressure range 0-50mbar output voltage 0.5-3.5VDC input voltage 5VDC max 200mbar		
For models:	AM-10, AM-11, AM-141, AM900-10N, AM900-90, AMS900-10N, AMX, AMX-10HL, AMX-90, AMXR, AMXS, AMXT, AMXTS, AMXX, AMXXR, AMXXS, AUP, AUP-90, AUPS, AUXX, AUXXL-11N, AUXXLS-11N, AUXXR, AUXXS, AUXXT, AUXXTS, ECOMAX-402, ECOMAX-502, ECOMAX-602-10, ECOMAX-602-11, ECOMAX-602S-11, ECOMAX-612-10, ECOMAX-612S-10, FP, FX, FX-McDonalds, GP, GX		
accessories for	541786		
	GEV No.	520027	Ref. No. 00-324402-005 00-324402-014 139321-126 324402-14 324402-5
	PVC hose ID ø 4mm ED ø 7mm L 10m thickness 1.5mm t.max. 60°C transparent		

accessories



1

GEV No.	541109	Ref. No.	139321-578
description	Y-piece plastic hose ø 8-6-8mm for pressure switch		

electrodes



1

GEV No.	361374	Ref. No.	299956-4
description	conductivity probe with thread		
For models:	AM-600, AM-600C, AM-600CR, AM-600R, FM-400H, FM-400U, FM-500, FM-500H, UW-105, UW-135, UW-135H, UW-55		



1

GEV No.	402986	Ref. No.	845004
description	hose total length 460mm probe Lmm with level sensor connection F6.3 suitable for BOURGEOIS		
For models:	CS-0612E, CS-0612E-A, CS-1012E, CS-1012E-A, CS-1022E, CS-1022E-A, CS-2012E, CS-2012E-A, CS-2022E, CS-2022E-A, CSD-0612E, CSD-0612E-A, CSD-0612ET, CSD-1012E, CSD-1012E-A, CSD-1012ET, CSD-1022E, CSD-1022E-A, CSD-2012E, CSD-2012E-A, CSD-2012ET, CSD-2022E, CSD-2022E-A		



fans

axial fans

import



GEV No.	601510 ¹	Ref. No.	230324-1 492994 895459
description	axial fan L 119mm W 119mm H 38mm 230VAC 50/60Hz 22/21W bearing ball bearing connection male faston 6.3mm SUNON temp.-resist. 70°C		
For models:	CS-0423E, CS-0423EK, CS-0523E, CS-0523EK, CS-0612E, CS-0612E-A, CS-1012E, CS-1012E-A, CS-1012G, CS-1022E, CS-1022E-A, CS-2012E, CS-2012E-A, CS-2012G, CS-2022E, CS-2022E-A, CS-423E, CS-423K, CSD-0612E, CSD-0612E-A, CSD-0612-UC, CSD-1012E, CSD-1012E-A, CSD-1012-UC, CSD-1013G, CSD-1022E, CSD-1022E-A, CSD-1022-UC, CSD-2012E, CSD-2012E-A, CSD-2012-UC, CSD-2013G, CSD-2022E, CSD-2022E-A, CSD-2022-UC, CSL-06E, CSL-10E, CSM-06111E, CSM-0611N, CSM-10111E, CSM-1011N, CSM-10211E, CSM-1021N, CSM-20111E, CSM-2011N, CSM-20211E, CSM-2021N, CX		

¹with ball bearings



GEV No.	601080 ¹	Ref. No.	00-230324-001
description	axial fan L 119mm W 119mm H 38mm 230VAC 50/60Hz 23/20W bearing ball bearing connection male faston 2.8mm metal ADDA fan wheel ø 110mm temp.-resist. 70°C		
accessories for	601080		
	GEV No.	550898	Ref. No. —
	connecting cable cable length 2000mm connection F 2.8 connection distance 7.9mm for axial flow fan		
	GEV No.	692519	Ref. No. —
	guard L 120mm W 120mm plastic		

¹with ball bearings

cross flow fans

cross flow fan with heater battery

roller diameter ø60mm



GEV No.	601027	Ref. No.	301237
description	cross flow fan roller length 180mm roller ø 60mm motor position right 230V 50Hz 17W heat output 2000W bearing silicone cable length 200mm with temperature limiter 125°C		
spare parts for	601027		
	GEV No.	375095	Ref. No. —
	bi-metal thermostat hole distance 18mm switch-off temp. 105°C 1NC 1-pole 16A connection F6.3 2 hole fixing		
	GEV No.	375911	Ref. No. —
	bi-metal thermostat switch-off temp. 125°C 1NC 1-pole for cross flow fan		

hot air motors

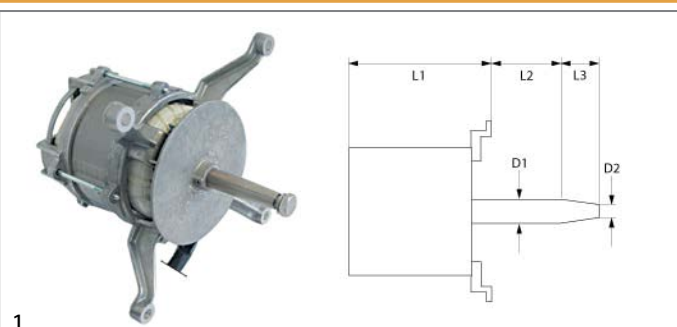

GEV No.	500812	Ref. No.	150443-54 233800-04
description	fan motor 220-240/380-415V 3 phase 50Hz 0.26kW 1440rpm speeds 1 D1 ø 17mm D2 ø 13.5mm		
For models:	CO-0612E, CO-1012E, CS-0612E, CS-1012E		

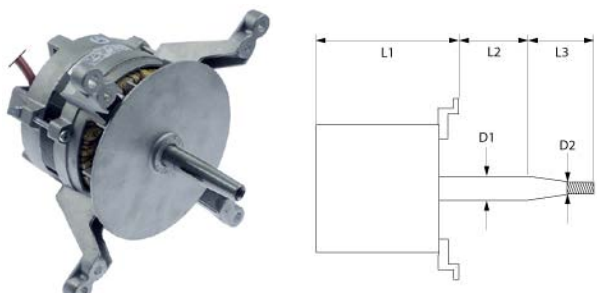



1

GEV No.	601805	Ref. No.	07426 844955-01
description	fan motor 230V 1 phase 50/60Hz 0.185kW 1400/1680rpm speeds 2 L1 130mm L2 27mm L3 37mm D1 ø 17mm D2 ø 13.5mm 1A suitable capacitor 5µF/450V Cos(φ) 0.93 type 1079GA2350		
For models:	CS-0612E, CS-1012E, CS-1022E, CS-2012E, CS-2022E, CSD-0612E, CSD-1012E, CSD-1013G, CSD-1022E, CSD-2012E, CSD-2013G, CSD-2022E, CSL-06E, CSL-10E, CSM-0611IE, CSM-0611N, CSM-1011IE, CSM-1011N, CSM-1021IE, CSM-1021N, CSM-2011IE, CSM-2011N, CSM-2021IE, CSM-2021N		
accessories for	601805		
	GEV No.	511605	Ref. No. 322190-1
		shaft seal	

hot air fans

ebm-papst



1

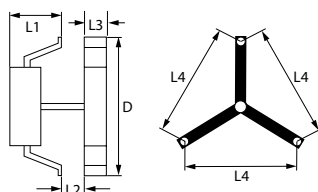

GEV No.	601807	Ref. No.	494069
description	hot air fan kit 230V 50W L1 69mm L4 87mm fan wheel ø 151mm type RRL152/0020A92-3030LH-197 ebm-papst		
For models:	CS-0423E, CS-0423EK, CS-0523E, CS-0523EK, CS-423E, CS-423K, CSL-0423E, CSL-0423EK, CSL-0523E, CSL-0523EK, CSL-423E, CSL-423K		
spare parts for	601807		
	GEV No.	601808	Ref. No. —
		hot air fan 230/240V 50W L1 69mm L2mm L3mm L4 87mm fan wheel ø 150mm type RRL152/0020A92-3030LH-197 ebm-papst	

pumps

wash and rinse pumps

FIR

pumps







1

GEV No.	500598	Ref. No.	139321-490 E929167
description	pump inlet ø 30mm outlet ø 26mm type 5213E2450 230V 50Hz 1 phase 0.22kW 0.1HP L 190mm rotation direction left capacitor 5µF FIR		
For models:	CHH-50, CHH-60D, CHH-70D, EH-60, EH-70		
spare parts for	500598		
	GEV No.	365017	Ref. No. 00-226568-009 01-235398 01-235399 139321-941 226568-9
		operating capacitor capacity 5µF 450V tolerance 5% 50/60Hz ambient temperature max. -25 to +85°C ø 28mm L 54mm M8 plastic connection male faston 6.3mm 16.10.08 protection	
	GEV No.	502265	Ref. No. 139321-976
		pump cover inlet ø 30mm outlet ø 26mm ID ø 89mm inner height 35mm	
	GEV No.	510695	Ref. No. —
		mechanical shaft seal height counter ring 5.5mm ID ø 11mm	
	GEV No.	521203	Ref. No. —
		impellor ø 72mm H 18mm thread M7 shaft ø 11mm shaft length 32mm blades 3	
	GEV No.	532718	Ref. No. —
		O-ring EPDM thickness 4mm ID ø 80mm Qty 1 pcs	
	GEV No.	699372	Ref. No. —
		flange for pump with cover type 5213 L 103mm W 103mm H 69mm	







1

GEV No.	499151	Ref. No.	01-240783-001 01-240783-1	
description	pump inlet \varnothing 45mm outlet \varnothing 40mm type 3910.1421 230V 50Hz 1 phase 0.37kW 0.5HP L 190mm rotation direction right capacitor 10 μ F FIR			
For models:	ECOMAX-502			
spare parts for	499151			
	GEV No.	365015	Ref. No.	00-226568-010 226568-10
	operating capacitor capacity 10 μ F 400V tolerance 5%Hz ambient temperature max. -25 to +85°C \varnothing 35.5mm L 59mm M8 plastic connection male faston 6.3mm protection			
	GEV No.	510508	Ref. No.	—
	pump cover FIR inlet \varnothing 45mm outlet \varnothing 40mm pump type PU 0.5/3911 turn direction right \varnothing 160mm ID \varnothing 125mm inner height 25mm			
	GEV No.	510607	Ref. No.	—
	impellor \varnothing 85mm H 29mm shaft intake \varnothing 9x8mm rotation direction right blades 6			
	GEV No.	510692	Ref. No.	—
	mechanical shaft seal for shaft \varnothing 11mm slide ring ext. \varnothing 24mm slide ring H 13mm counter ring mounting \varnothing 26mm height counter ring 8mm counter ring int. \varnothing 14mm			
	GEV No.	521702	Ref. No.	—
	pump cover gasket thickness 3.5x4.5mm Qty 1 pcs			



1

GEV No.	500400	Ref. No.	774047-1	
description	pump inlet \varnothing 45mm outlet \varnothing 40mm type 4255.1600 230V 50Hz 1 phase 0.55kW 0.75HP L 215mm rotation direction right capacitor 12.5 μ F FIR			
For models:	FE, HE, HE600-HL, HE-P			
spare parts for	500400			
	GEV No.	365014	Ref. No.	—
	operating capacitor capacity 12.5 μ F 450V tolerance 5%Hz ambient temperature max. -25 to +85°C \varnothing 35mm L 70mm M8 plastic connection male faston 6.3mm 45S.C3DS.12.5 protection			
	GEV No.	510692	Ref. No.	—
	mechanical shaft seal for shaft \varnothing 11mm slide ring ext. \varnothing 24mm slide ring H 13mm counter ring mounting \varnothing 26mm height counter ring 8mm counter ring int. \varnothing 14mm			
	GEV No.	521210	Ref. No.	—
	impellor \varnothing 96mm H 30mm shaft intake \varnothing 9/8mm seat \varnothing 16mm blades 6			
	GEV No.	521506	Ref. No.	—
	pump cover FIR inlet \varnothing 45mm outlet \varnothing 40mm turn direction right \varnothing 160mm ID \varnothing 125mm inner height 25mm			
	GEV No.	521702	Ref. No.	—
	pump cover gasket thickness 3.5x4.5mm Qty 1 pcs			



1

GEV No.	499356	Ref. No.	231936-1 775506-1 895499
description	pump type 1314A1910 220/240V 50Hz 1 phase 0.55kW capacitor 12.5µF FIR		
For models:	FE-W, FX, GX, HX, HX-30, HX-30E, HX-30ES, HX-30S, HX-40, HX-40E, HX-40ES, HX-40S, HX-60-EHL, HX-E, HX-ES, HX-S		
accessories for	499356		
	GEV No.	511692	Ref. No. 139321-12 323894-12 734530-12 735530-12 896974
mechanical shaft seal set for shaft ø 12mm ED ø 24mm H 15mm height counter ring 8mm			

HANNING

pumps







1

GEV No.	499094	Ref. No.	324913-1 324913-1V
description	pump inlet ø 28mm outlet ø 26mm 220-240V 50Hz HANNING type UP60-343 L 191mm rotation direction left flow rate 110l/min p max 0.48bar 0.22kW capacitor 5µF 1 phase		
For models:	AMX, AMX-900, AMX-E, AMX-ER, AMX-R, AMXR-900, AMXS-900, AMXX-1300, AMXXR-1300, AMXXS-1300, AMXXT, AUX, AUX-, AUX-E, AUX-ER, AUX-R, AUX-1300, AUXXL, AUXXR-1300, AUXXS-1300, AUXXT, UX, UX-30, UX-30B, UX-30E, UX-30EB, UX-30EH, UX-30H, UX-30-McDonalds, UX-60, UX-60B, UX-60E, UX-60EB, UX-60EH, UX-60EHB, UX-60H, UX-60HB, UXL, UXLs, UXs, UXT, UXTH, UXTHL, UXTHLS, UXTHS, UXTL, UXTLH, UXTLHS, UXTLS, UXTS		



1

GEV No.	499147	Ref. No.	00-775854-001 775854-1
description	pump inlet ø 28mm outlet ø 26mm type UP30-324RU 220-240V 50Hz 1 phase 0.14kW L 170mm rotation direction left capacitor 4µF HANNING		
For models:	AM900-10N, AM900-90, AMS900-10N, AMX, AMX-10HL, AMX-90, AMXR, AMXS, AMXT, AMXTS, AMXX, AMXXR, AMXXS, AUP, AUP-90, AUPS, AUX, AUXXL-11N, AUXXLs-11N, AUXXR, AUXXS, AUXXT, AUXXTS, ECOMAX-402, ECOMAX-502, ECOMAX-602-11, ECOMAX-602S-11, ECOMAX-612-10, ECOMAX-612S-10, FX, FX-McDonalds, GC41, GC42		
spare parts for	499147		
	GEV No.	365031	Ref. No. 00-226568-002 226568-2
operating capacitor capacity 4µF 450V tolerance 5% 50/60Hz ambient temperature max. -25 to +85°C ø 31mm L 58mm M8 plastic connection male faston 6.3mm protection			
	GEV No.	507558	Ref. No. —
mechanical shaft seal for shaft ø 7mm height counter ring 5mm ID ø 6.75mm ED ø 20mm mounting ø counter ring 18.5/slide ring 20mm			
	GEV No.	532644	Ref. No. —
O-ring EPDM thickness 3mm ID ø 78mm Qty 1 pcs			
accessories for	499147		
	GEV No.	507498	Ref. No. 00-883837-001 883837-1
protective plate for wash pump suitable for HOBART L 300mm W 200mm			





1			
GEV No.	499093	Ref. No.	01-240234-001 01-240234-1
description	pump inlet ø 28mm outlet ø 26mm type UP30-379 220-240V 50Hz 1 phase 0.14kW L 161mm rotation direction left capacitor 4µF HANNING		
For models:	FP, FX, FX-McDonalds, GP, GX		



2			
GEV No.	499213	Ref. No.	01-240234-101
description	pump inlet ø 28mm outlet ø 26mm type UP30-439Ru. 220-240V 50Hz 1 phase 0.14kW L 160mm rotation direction left capacitor 4µF HANNING		



1			
GEV No.	500534	Ref. No.	00-324093-021 324093-21
description	pump inlet ø 28mm outlet ø 26mm type UP60-184 230V 50Hz 1 phase 0.27kW 0.37HP L 190mm rotation direction left capacitor 5µF HANNING p max 0.77bar Qmax. 160l/min		
For models:	AM3, AMX, AMX-900, AMX-E, AMX-ER, AMX-R, AMXR-900, AMXS-900, AMXX-1300, AMXXR-1300, AMXXS-1300, AMXXT, AUX, AUX_, AUX-E, AUX-ER, AUX-R, AUXX-1300, AUXXL, AUXXR-1300, AUXXS-1300, AUXXT, ECOMAX-402, ECOMAX-650, ECOMAX-700, UX, UXL, UXLs, UXS, UXT, UXTH, UXTHL, UXTHLS, UXTHS, UXTL, UXTLH, UXTLHS, UXTLs, UXTS		
spare parts for	500534		
	GEV No.	365017	Ref. No. 00-226568-009 01-235398 01-235399 139321-941 226568-9
	operating capacitor capacity 5µF 450V tolerance 5% 50/60Hz ambient temperature max. -25 to +85°C ø 28mm L 54mm M8 plastic connection male faston 6.3mm 16.10.08 protection		
	GEV No.	507558	Ref. No. —
	mechanical shaft seal for shaft ø 7mm height counter ring 5mm ID ø 6.75mm ED ø 20mm mounting ø counter ring 18.5/slide ring 20mm		









1			
GEV No.	499068	Ref. No.	324093-1V
description	pump inlet ø 28mm outlet ø 26mm type UP60-313 230V 50Hz 1 phase 0.25kW 0.34HP L 190mm rotation direction left capacitor 5µF HANNING		
spare parts for	499068		
	GEV No.	365017	Ref. No. 00-226568-009 01-235398 01-235399 139321-941 226568-9
	operating capacitor capacity 5µF 450V tolerance 5% 50/60Hz ambient temperature max. -25 to +85°C ø 28mm L 54mm M8 plastic connection male faston 6.3mm 16.10.08 protection		
	GEV No.	507558	Ref. No. —
	mechanical shaft seal for shaft ø 7mm height counter ring 5mm ID ø 6.75mm ED ø 20mm mounting ø counter ring 18.5/slide ring 20mm		

Table continues overleaf





spare parts for 499068			
	GEV No.	532644	Ref. No. —
O-ring EPDM thickness 3mm ID ø 78mm Qty 1 pcs			



GEV No.	499149	Ref. No.	00-324093-021V 324093-21V
description	pump inlet ø 28mm outlet ø 26mm type UP60-315RU 220-240V 50Hz 1 phase 0.25kW L 185mm rotation direction left capacitor 5µF HANNING countries UK		
spare parts for 499149			
	GEV No.	365017	Ref. No. 00-226568-009 01-235398 01-235399 139321-941 226568-9
operating capacitor capacity 5µF 450V tolerance 5% 50/60Hz ambient temperature max. -25 to +85°C ø 28mm L 54mm M8 plastic connection male faston 6.3mm 16.10.08 protection			
	GEV No.	507558	Ref. No. —
mechanical shaft seal for shaft ø 7mm height counter ring 5mm ID ø 6.75mm ED ø 20mm mounting ø counter ring 18.5/slide ring 20mm			
	GEV No.	532644	Ref. No. —
O-ring EPDM thickness 3mm ID ø 78mm Qty 1 pcs			



GEV No.	499284	Ref. No.	324914-1 324914-1V
description	pump inlet ø 28mm outlet ø 26mm type UP60-321 Ru. 220-240V 50Hz 1 phase 0.27kW L 190mm rotation direction right capacitor 5µF HANNING		
For models:	UX-30, UX-30B, UX-30E, UX-30EB, UX-30EH, UX-30ES, UX-30ESB, UX-30ESH, UX-30H, UX-30-McDonalds, UX-30S, UX-30SB, UX-30SH, UX-60, UX-60B, UX-60E, UX-60EB, UX-60EH, UX-60EHB, UX-60H, UX-60HB		
spare parts for 499284			
	GEV No.	365017	Ref. No. 00-226568-009 01-235398 01-235399 139321-941 226568-9
operating capacitor capacity 5µF 450V tolerance 5% 50/60Hz ambient temperature max. -25 to +85°C ø 28mm L 54mm M8 plastic connection male faston 6.3mm 16.10.08 protection			
	GEV No.	507558	Ref. No. —
mechanical shaft seal for shaft ø 7mm height counter ring 5mm ID ø 6.75mm ED ø 20mm mounting ø counter ring 18.5/slide ring 20mm			
	GEV No.	532644	Ref. No. —
O-ring EPDM thickness 3mm ID ø 78mm Qty 1 pcs			



GEV No.	499112	Ref. No.	774908-108 774908-108V
description	pump inlet ø 32.5mm outlet ø 1" type UP60-341 Ru 220-240/380-415V 50/60Hz 0.16kW HANNING without impellor p max 0.68bar Qmax. 160l/min		



1

GEV No.	499000	Ref. No.	781237 781237-1V
description	pump inlet ø 32mm outlet ø 1" type UP60-334 230V 50Hz 1 phase 0.24kW L 250mm rotation direction left capacitor 5µF HANNING p max 0.35bar Qmax. 85l/min		
For models:	CN, CNA, CNB, CNR, CR, CR-F, CSA, FTN		



1

GEV No.	499040	Ref. No.	781237-2
description	pump inlet ø 32mm outlet ø 1" type UP60-335 230V 50Hz 1 phase 0.27kW L 250mm rotation direction left capacitor 5µF HANNING p max 0.68bar Qmax. 160l/min		
For models:	CNA, CNB, CNR, CR-F, CSA, FTN		



1

GEV No.	499092	Ref. No.	775465-1 897929
description	pump inlet ø outlet ø 26mm type 220-240V 50Hz 1 phase 0.1kW L 135mm capacitor 4µF p max 0.55bar HANNING flange ø 92mm flow rate 45l/min		
For models:	AM900, AMS900, FX, GC, GC31, GC32, GC41, GC42, GX		
accessories for	499092		
	GEV No.	Ref. No.	510427 775465-11
	O-ring EPDM thickness 3mm ID ø 83mm Qty 1 pcs		

LGB



1









GEV No.	500351	Ref. No.	139321-445
description	pump inlet ø 29mm outlet ø 39mm type X5SX 230V 50Hz 1 phase 0.8kW 1.09HP L 210mm rotation direction right capacitor 16µF LGB		
spare parts for	500351		
	GEV No.	Ref. No.	00-226568-013 139321-448 139321-884 226568-13
	operating capacitor capacity 16µF 425V tolerance 5% 50/60Hz ambient temperature max. -25 to +85°C ø 35mm L 73mm single M8 plastic connection male faston 6.3mm 416.10.99 protection		
	GEV No.	Ref. No.	510703 139321-446
	mechanical shaft seal for shaft ø 13mm slide ring H 13mm height counter ring 5.5mm ED ø 26mm		







Table continues overleaf

spare parts for 500351				
	GEV No.	518294	Ref. No.	—
flat gasket rubber ED ø 85mm ID ø 71mm thickness 2mm Qty 1 pcs				
	GEV No.	521234	Ref. No.	139321-662
impellor thread M8L ED ø 93mm W 16mm				
	GEV No.	523509	Ref. No.	139321-661
deep-groove ball bearing type 6201-2RS shaft ø 12mm ED ø 32mm W 10mm with sealing discs deep-groove ball bearing DIN 625-1				
	GEV No.	532537	Ref. No.	139321-469
O-ring EPDM thickness 3.53mm ID ø 113.9mm Qty 1 pcs				







1				
GEV No.	499150	Ref. No.	00-883833-001 883833-1	
description	pump inlet ø 45mm outlet ø 40mm type ZF220SX 230V 50Hz 1 phase 0.4kW L 190mm rotation direction right capacitor 12.5µF LGB			
For models:	AM-10, AM-11, AM-141, ECOMAX-602-10, ECOMAX-602-11, ECO-MAX-602S-11			
spare parts for 499150				
	GEV No.	521036	Ref. No.	00-883833-010 883833-10
service kit for pump type ZF220SX HOBART 50Hz impellor, pump cover gasket, mechanical shaft seal				
accessories for 499150				
	GEV No.	365014	Ref. No.	—
operating capacitor capacity 12.5µF 450V tolerance 5%Hz ambient temperature max. -25 to +85°C ø 35mm L 70mm M8 plastic connection male faston 6.3mm 45S.C3DS.12.5 protection				







1				
GEV No.	500543	Ref. No.	130126 139321-512 E130126	
description	pump inlet ø 50mm outlet ø 50mm type ZF400VSX 230V 50Hz 1 phase 0.85kW 1.2HP L 245mm rotation direction right capacitor 16µF LGB			
For models:	ECOMAX-500			
spare parts for 500543				
	GEV No.	365021	Ref. No.	00-226568-013 139321-448 139321-884 226568-13
operating capacitor capacity 16µF 425V tolerance 5% 50/60Hz ambient temperature max. -25 to +85°C ø 35mm L 73mm single M8 plastic connection male faston 6.3mm 416.10.99 protection				
	GEV No.	509020	Ref. No.	139321-509
impellor ø 104mm H 25mm M8L				
	GEV No.	510703	Ref. No.	139321-446
mechanical shaft seal for shaft ø 13mm slide ring H 13mm height counter ring 5.5mm ED ø 26mm				
	GEV No.	521548	Ref. No.	139321-889
pump cover LGB inlet ø 50mm outlet ø 50mm				
	GEV No.	521734	Ref. No.	139321-887
pump cover bottom part				
	GEV No.	532623	Ref. No.	—
O-ring EPDM thickness 2.62mm ID ø 120.32mm Qty 1 pcs				



GEV No.	500361	Ref. No.	139321-548 139321-963
description	pump inlet ø 60mm outlet ø 49mm type ZF400SX 230V 50Hz 1 phase 0.8kW 1HP L 210mm rotation direction right capacitor 16µF LGB		
For models:	CHH-50		
spare parts for	500361		
	GEV No.	365021	Ref. No. 00-226568-013 139321-448 139321-884 226568-13
	operating capacitor capacity 16µF 425V tolerance 5% 50/60Hz ambient temperature max. -25 to +85°C ø 35mm L 73mm single M8 plastic connection male faston 6.3mm 416.10.99 protection		
	GEV No.	509020	Ref. No. 139321-509
	impellor ø 104mm H 25mm M8L		
	GEV No.	510703	Ref. No. 139321-446
	mechanical shaft seal for shaft ø 13mm slide ring H 13mm height counter ring 5.5mm ED ø 26mm		
	GEV No.	521547	Ref. No. —
	pump cover LGB inlet ø 60mm outlet ø 50mm supporting pressure M8 turn direction right ø 160mm ID ø 127mm inner height 36mm		
	GEV No.	532623	Ref. No. —
	O-ring EPDM thickness 2.62mm ID ø 120.32mm Qty 1 pcs		



GEV No.	499114	Ref. No.	898253-1
description	pump inlet ø 60mm outlet ø 50mm 220-240V 50Hz 1 phase 0.7kW L 245mm rotation direction right capacitor 16µF		
For models:	AM-700, AM900, AMS900, AMX-900, AMXR-900, AMXS-900, ECO-MAX-600, ECOMAX-650		
spare parts for	499114		
	GEV No.	365021	Ref. No. 00-226568-013 139321-448 139321-884 226568-13
	operating capacitor capacity 16µF 425V tolerance 5% 50/60Hz ambient temperature max. -25 to +85°C ø 35mm L 73mm single M8 plastic connection male faston 6.3mm 416.10.99 protection		
	GEV No.	509020	Ref. No. 139321-509
	impellor ø 104mm H 25mm M8L		
	GEV No.	510703	Ref. No. 139321-446
	mechanical shaft seal for shaft ø 13mm slide ring H 13mm height counter ring 5.5mm ED ø 26mm		
	GEV No.	521049	Ref. No. 898253-10
	service kit for pump type ZF400VSX LGB impellor, 2x O-ring, mechanical shaft seal, capacitor capacity 16µF		
	GEV No.	521547	Ref. No. —
	pump cover LGB inlet ø 60mm outlet ø 50mm supporting pressure M8 turn direction right ø 160mm ID ø 127mm inner height 36mm		
	GEV No.	532623	Ref. No. —
	O-ring EPDM thickness 2.62mm ID ø 120.32mm Qty 1 pcs		







OLYMPIA

pumps



1

GEV No.	500535	Ref. No.	371450-2
description	pump inlet \varnothing outlet \varnothing 27mm type T70 230V 50Hz 1 phase 0.3kW 0.4HP L 130mm rotation direction right capacitor 6.3 μ F OLYMPIA		
For models:	GF-60, GF-60S		
spare parts for	500535		
	GEV No.	365012	Ref. No. 206009
	operating capacitor capacity 6.3 μ F 450V tolerance 5% 50Hz ambient temperature max. -25 to +85°C \varnothing 30mm L 61mm M8 plastic connection male faston 6.3mm protection		
	GEV No.	510556	Ref. No. —
	O-ring EPDM thickness 1.78mm ID \varnothing 94.97mm Qty 1 pcs pump type T110		
	GEV No.	510693	Ref. No. 139321-12
	mechanical shaft seal for shaft \varnothing 12mm slide ring ext. \varnothing 24mm slide ring H 15.5mm slide ring int. \varnothing 11mm counter ring mounting \varnothing 24mm height counter ring 8mm counter ring int. \varnothing 13.5mm		
	GEV No.	521254	Ref. No.
	impellor \varnothing 81mm H 11mm thread M8L shaft \varnothing 12mm shaft length 28mm blades 6		

wash pump motors





1

GEV No.	499106	Ref. No.	324818-34
description	pump motor type 1326 1500W 220-240/380-415V 50/60Hz 3 phase L 330mm W 200mm H 240mm 1400/1700rpm shaft \varnothing 22/25mm		
For models:	CR-F		

booster pumps I



1

GEV No.	500359	Ref. No.	139321-651 139321-661
description	pump inlet \varnothing 12 outlet \varnothing 12 type PPL46DX 230V 50Hz 0.33kW capacitor 10 μ F LGB		
For models:	CHF45, CLG-25, EF-40		
spare parts for	500359		
	GEV No.	698663	Ref. No. —
	impellor \varnothing 60mm H 12mm with flute shaft intake \varnothing 12mm W 60mm suitable for LGB		
accessories for	500359		
	GEV No.	365015	Ref. No. 00-226568-010 226568-10
	operating capacitor capacity 10 μ F 400V tolerance 5%Hz ambient temperature max. -25 to +85°C \varnothing 35.5mm L 59mm M8 plastic connection male faston 6.3mm protection		



1

GEV No.	500358	Ref. No.	139321-1085
description	pump inlet \varnothing 3/8" outlet \varnothing 3/8" type PS46 230V 50Hz 0.45kW \varnothing 100mm L 200mm capacitor 10 μ F LGB		
spare parts for	500358		
	GEV No.	510713	Ref. No. —
	slide ring for shaft \varnothing 12mm ED \varnothing 24mm H 16mm		
	GEV No.	510723	Ref. No. —
	counter ring H 8mm ED \varnothing 26mm ID \varnothing 13.5mm for mechanical shaft seal		
	GEV No.	698400	Ref. No. —
	pump cover gasket pump type PS46 thickness 2mm ID \varnothing 66mm Qty 1 pcs		
accessories for	500358		
	GEV No.	365015	Ref. No. 00-226568-010 226568-10
	operating capacitor capacity 10 μ F 400V tolerance 5%Hz ambient temperature max. -25 to +85°C \varnothing 35.5mm L 59mm M8 plastic connection male faston 6.3mm protection		
	GEV No.	511279	Ref. No. —
	hose connector brass straight thread 3/8" hose \varnothing 12mm Qty 1 pcs		
	GEV No.	520202	Ref. No. —
	hose connector nickel-plated brass straight thread 3/8" hose \varnothing 12mm Qty 1 pcs		
	GEV No.	520677	Ref. No. —
	hose connector brass straight thread 3/8" hose \varnothing 13mm Qty 1 pcs		

drain pumps

ASKOLL



1			
GEV No.	500210	Ref. No.	E130123
description	drain pump 230V 40W		



1			
GEV No.	501541	Ref. No.	139321-1110
description	drain pump 40W 220-240V inlet ø 30mm outlet ø 22mm 50Hz ASKOLL type M231 XP		
For models:	CHH-50, CHH-60D, CHH-70D, EH-60, EH-70		



1			
GEV No.	500346	Ref. No.	130105
description	drain pump inlet ø 30mm outlet ø 22mm 230V 40W 50Hz ASKOLL type M231 XP with holder		

GRE



1			
GEV No.	500212	Ref. No.	371450-1
description	drain pump inlet ømm outlet ømm 100W 230V 50Hz GRE without lid		
For models:	GF-60, GF-60S		

HANNING



1			
GEV No.	502290	Ref. No.	00-775854-003 775854-3
description	drain pump 140-160W 220-240V inlet ø 28mm outlet ø 26mm 50-60Hz HANNING type UP30-420 p max 0.65bar Qmax. 115l/min connection coded plug		
For models:	AMXR, AMXXR, AUXXR		



1			
GEV No.	499148	Ref. No.	00-165653-001 00-883993-001 165653-1 883993-1
description	drain pump 80W 220-240V inlet ø 24mm outlet ø 24mm 50Hz HANNING type BE22B3-197 rotation direction right		
For models:	AM-600, AM-600C, AM-600CR, AM-600R, AM-700, AM900, AM900-10N, AM900-90, AMS900, AMS900-10N, AMX, AMX-10HL, AMX-90, AMXR, AMXS, AMXT, AMXTS, AMXX, AMXXR, AMXXS, AUP, AUP-90, AUPS, AUXX, AUXXL-11N, AUXXLS-11N, AUXXR, AUXXS, AUXXT, AUXXTS, ECOMAX-600, ECOMAX-602S-11, ECOMAX-612-10, ECOMAX-612S-10, ECOMAX-650, ECOMAX-700, FE, FM-30U, GC, GC11, GC12, GC31, GC32, GC41, GC42, HE, HE600-HL, HE-P, UW-105, UW-55		



1

GEV No.	499146	Ref. No.	00-883993-012 00-883993-12
description	drain pump inlet ø 24mm outlet ø 24mm 230V 80W 50Hz HANNING type BE22B3-204		
For models:	ECOMAX-402, ECOMAX-502		



1

GEV No.	499319	Ref. No.	01-240010-001 01-240010-1
description	drain pump without lid inlet ømm outlet ømm 230V 65W 50Hz HANNING type BE20B2-083		
For models:	FP, FX, FX-McDonalds, GP, GX		



1

GEV No.	500042	Ref. No.	165653-1 old version
description	drain pump inlet ø 24mm outlet ø 24mm 230V 80W 50Hz HANNING type KD22B3-679		
spare parts for	500042		
	GEV No.	510168	Ref. No. —
	fan wheel shaft intake ø 5mm ø 62mm H 14mm		



1

GEV No.	499094	Ref. No.	324913-1 324913-1V
description	pump inlet ø 28mm outlet ø 26mm 220-240V 50Hz HANNING type UP60-343 L 191mm rotation direction left flow rate 110l/min p max 0.48bar 0.22kW capacitor 5µF 1 phase		
For models:	AMX, AMX-900, AMX-E, AMX-ER, AMX-R, AMXR-900, AMXS-900, AMXX-1300, AMXXR-1300, AMXXS-1300, AMXXT, AUX, AUX_, AUX-E, AUX-ER, AUX-R, AUXR-1300, AUXXL, AUXXR-1300, AUXXS-1300, AUXXT, UX, UX-30, UX-30B, UX-30E, UX-30EB, UX-30EH, UX-30H, UX-30-McDonalds, UX-60, UX-60B, UX-60E, UX-60EB, UX-60EH, UX-60EHB, UX-60H, UX-60HB, UXL, Uxls, Uxs, Uxt, Uxth, UxthL, UxthLS, UxthS, UxTL, UxTLH, UxTLHS, UxTls, UxTls		
spare parts for	499094		
	GEV No.	365017	Ref. No. 00-226568-009 01-235398 01-235399 139321-941 226568-9
	operating capacitor capacity 5µF 450V tolerance 5% 50/60Hz ambient temperature max. -25 to +85°C ø 28mm L 54mm M8 plastic connection male faston 6.3mm 16.10.08 protection		



1

GEV No.	499127	Ref. No.	845548
description	drain pump inlet ø 30mm outlet ø 24mm 220-240V 30W 50Hz HANNING type DPS25-097		
For models:	CS-0612E, CS-0612E-A, CS-1012E, CS-1012E-A, CS-1022E, CS-1022E-A, CS-2012E, CS-2012E-A, CS-2022E, CS-2022E-A, CSD-0612E, CSD-0612E-A, CSD-0612ET, CSD-1012E, CSD-1012E-A, CSD-1012ET, CSD-1013G, CSD-1022E, CSD-1022E-A, CSD-2012E, CSD-2012E-A, CSD-2012ET, CSD-2013G, CSD-2022E, CSD-2022E-A		



booster pumps II

accessories



1			
GEV No.	365015	Ref. No.	00-226568-010 226568-10
description	operating capacitor capacity 10µF 400V tolerance 5%Hz ambient temperature max. -25 to +85°C ø 35.5mm L 59mm M8 plastic connection male faston 6.3mm protection		



1			
GEV No.	365017	Ref. No.	00-226568-009 01-235398 01-235399 139321-941 226568-9
description	operating capacitor capacity 5µF 450V tolerance 5% 50/60Hz ambient temperature max. -25 to +85°C ø 28mm L 54mm M8 plastic connection male faston 6.3mm 16.10.08 protection		
For models:	AMX, AMX-900, AMX-E, AMX-ER, AMX-R, AMXR-900, AMXS-900, AMXX-1300, AMXXR-1300, AMXXS-1300, AMXXT, AUX, AUX_, AUX-E, AUX-ER, AUX-R, AUXX-1300, AUXXL, AUXXR-1300, AUXXS-1300, AUXXT, CHH-70D, ECOMAX-402, ECOMAX-650, ECOMAX-700, EH-70, FE, FE-W, FX, GX, HX-30, HX-30E, HX-30ES, HX-30S, HX-40, HX-40E, HX-40ES, HX-40S, UX, UX-30, UX-30B, UX-30E, UX-30EB, UX-30EH, UX-30ES, UX-30ESB, UX-30H, UX-30-McDonalds, UX-30S, UX-30SB...(Other models you can see in the webshop)		



1			
GEV No.	365012	Ref. No.	206009
description	operating capacitor capacity 6.3µF 450V tolerance 5% 50Hz ambient temperature max. -25 to +85°C ø 30mm L 61mm M8 plastic connection male faston 6.3mm protection		

condensators & interference suppression filters

operating capacitors

plastic



1			
GEV No.	365165	Ref. No.	226568-008 226568-8
description	capacitor capacity 12.5µF 450V tolerance 5% 50Hz ambient temperature max. -25 to +85°C ø 35mm L 60mm M8 plastic connection male faston 6.3mm protection		
For models:	FE, FE-W, FX, GX, HE, HE600-HL, HE-P, HX, HX-30, HX-30E, HX-30ES, HX-30S, HX-40, HX-40E, HX-40ES, HX-40S, HX-60-EHL, HX-E, HX-ES, HX-S		



1			
GEV No.	365167	Ref. No.	226568-3
description	capacitor capacity 6µF 450V tolerance 5% 50Hz ambient temperature max. -25 to +85°C ø 30mm L 58mm M8 plastic connection male faston 6.3mm		
For models:	FE, G10R, G5R, HE-P, HX, HX-60-EHL, HX-E, HX-ES, HX-S, UX-30, UX-30B, UX-30E, UX-30EB, UX-30EH, UX-30ES, UX-30ESB, UX-30ESH, UX-30H, UX-30-McDonalds, UX-30S, UX-30SB, UX-30SH, UX-60, UX-60B, UX-60E, UX-60EB, UX-60EH, UX-60EHB, UX-60H, UX-60HB		



1			
GEV No.	365015	Ref. No.	00-226568-010 226568-10
description	operating capacitor capacity 10µF 400V tolerance 5%Hz ambient temperature max. -25 to +85°C ø 35.5mm L 59mm M8 plastic connection male faston 6.3mm protection		



1			
GEV No.	365021	Ref. No.	00-226568-013 139321-448 139321-884 226568-13
description	operating capacitor capacity 16µF 425V tolerance 5% 50/60Hz ambient temperature max. -25 to +85°C ø 35mm L 73mm single M8 plastic connection male faston 6.3mm 416.10.99 protection		
For models:	AM-700, AM900, AM900-10N, AM900-90, AMS900, AMS900-10N, AMX, AMX-10HL, AMX-90, AMX-900, AMXR, AMXR-900, AMXS, AMXS-900, AMXT, AMXTS, CHF45, ECOMAX-600, ECOMAX-612-10, ECOMAX-612S-10, ECOMAX-650, EF-40		

electric components



			
1			
GEV No.	365031	Ref. No.	00-226568-002 226568-2
description	operating capacitor capacity 4µF 450V tolerance 5% 50/60Hz ambient temperature max. -25 to +85°C ø 31mm L 58mm M8 plastic connection male faston 6.3mm protection		

			
1			
GEV No.	365017	Ref. No.	00-226568-009 01-235398 01-235399 139321-941 226568-9
description	operating capacitor capacity 5µF 450V tolerance 5% 50/60Hz ambient temperature max. -25 to +85°C ø 28mm L 54mm M8 plastic connection male faston 6.3mm 16.10.08 protection		
For models:	AMX, AMX-900, AMX-E, AMX-ER, AMX-R, AMXR-900, AMXS-900, AMXX-1300, AMXXR-1300, AMXXS-1300, AMXXT, AUX, AUX_, AUX-E, AUX-ER, AUX-R, AUXR-1300, AUXXL, AUXXR-1300, AUXXS-1300, AUXXT, CHH-70D, ECOMAX-402, ECOMAX-650, ECOMAX-700, EH-70, FE, FE-W, FX, GX, HX-30, HX-30E, HX-30ES, HX-30S, HX-40, HX-40E, HX-40ES, HX-40S, UX, UX-30, UX-30B, UX-30E, UX-30EB, UX-30EH, UX-30ES, UX-30ESB, UX-30H, UX-30-McDonalds, UX-30S, UX-30SB...(Other models you can see in the webshop)		

			
1			
GEV No.	365012	Ref. No.	206009
description	operating capacitor capacity 6.3µF 450V tolerance 5% 50Hz ambient temperature max. -25 to +85°C ø 30mm L 61mm M8 plastic connection male faston 6.3mm protection		

			
1			
GEV No.	365013	Ref. No.	226568-014 226568-14
description	operating capacitor capacity 8µF 400V tolerance 5%Hz ambient temperature max. -25 to +85°C ø 31.5mm L 55mm M8 plastic connection male faston 6.3mm protection		

metal			
			
1			
GEV No.	365005	Ref. No.	139321-1084
description	operating capacitor capacity 10µF 400V tolerance 5% 50/60Hz ambient temperature max. -25 to +85°C ø 35mm L 90mm M8 aluminium connection cable 300mm MKP protection IP65		

			
1			
GEV No.	365139	Ref. No.	206002
description	operating capacitor capacity 10µF 450V tolerance 5% 60Hz ambient temperature max. -25 up to +70°C ø 40mm L 83mm M8 aluminium connection male faston 6.3mm C.87.8BF2 MKP protection		

filters			
interference suppression filters			
			
1			
GEV No.	365044	Ref. No.	926144
description	interference suppression filter type FC701Y2F 250V 50-60Hz conductor 2 with E connection cable 200mm L 42mm ø 23mm Hmm Wmm plastic Qty 1 pcs		

fuses			
fine fuses			
			
1			
GEV No.	358666	Ref. No.	926283 E926283
description	fine fuse size ø5x20mm 0.315A fast-acting rated 250V Qty 10 pcs		

			
1			
GEV No.	358530	Ref. No.	139321-902
description	fine fuse size ø5x20mm 0.8A fast-acting rated 250V Qty 10 pcs		





			
1			
GEV No.	358677	Ref. No.	139321-690 E228004
description	fine fuse size ø5x20mm 4A fast-acting rated 250V Qty 10 pcs		

			
1			
GEV No.	358594	Ref. No.	228012
description	fine fuse size ø5x20mm 0.16A slow-acting rated 250V Qty 10 pcs		

			
1			
GEV No.	358606	Ref. No.	228010 E228010
description	fine fuse size ø5x20mm 4A slow-acting rated 250V Qty 10 pcs		

			
1			
GEV No.	358792	Ref. No.	H3090506
description	fine fuse size ø6.3x32mm 10A slow-acting rated 250V Qty 10 pcs		

			
1			
GEV No.	358644	Ref. No.	228011
description	fine fuse size ø6.3x32mm 2A slow-acting rated 250V Qty 10 pcs		

			
1			
GEV No.	358742	Ref. No.	775570-2
description	fine fuse size ø6.3x32mm 0.8A fast-acting rated 500V Qty 10 pcs		

			
1			
GEV No.	358752	Ref. No.	3090506
description	fine fuse size ø6.3x32mm 10A fast-acting rated 500V Qty 10 pcs		

			
1			
GEV No.	358751	Ref. No.	00-775570-001 775570-1
description	fine fuse size ø6.3x32mm 6.3A fast-acting rated 500V Qty 10 pcs		
For models:	AMX-900, AMXS-900, AMXX-1300, AMXXT, AUXX-1300, AUXXT, ECO-MAX-650, UX, UXL, UXLS, UXS, UXT, UXTH, UXTHL, UXTHLS, UXTHS, UXTL, UXTLS, UXTS		

fine fuse holders

			
1			
GEV No.	550499	Ref. No.	139321-600
description	fuse holder suitable fuse ø5x20mm 6.3A rated 500V		

			
1			
GEV No.	358026	Ref. No.	00-775548-001 775548-1
description	fuse holder suitable fuse ø6.3x32mm 10A rated 800V L 61mm W 10mm H 65mm cross section 4mm ²		
For models:	AMX-900, AMXS-900, AMXX-1300, AMXXT, AUXX-1300, AUXXT, ECOMAX-402, ECOMAX-502, ECOMAX-650, UX, UXL, UXLS, UXS, UXT, UXTH, UXTHL, UXTHLS, UXTHS, UXTL, UXTLS, UXTS		

			
1			
GEV No.	550519	Ref. No.	139321-601
description	cover plate suitable fuseA ratedV connection for fuse holder		

line circuit breakers

miscellaneous

			
1			
GEV No.	358019	Ref. No.	301777-3
description	line circuit breaker 1-pole 6A rated 230V connection screw clamp nominal 6A		



electric accessories

cables

accessories

cable glands

cable glands



1

GEV No.	551102	Ref. No.	00-227748-001 227748-1
description	cable gland ID ø 10mm mounting ø 12mm Neoprene -30 up to +120°C Qty 1 pcs		
For models:	AM-10, AM-11, AM-141, AM-600, AM-600C, AM-600CR, AM-600R, AM900-10N, AM900-90, AMS900-10N, AMX, AMX-10HL, AMX-90, AMX-E, AMX-ER, AMXR, AMX-R, AMXS, AMXT, AMXTS, AMXX, AMXXR, AMXXS, AUP, AUP-90, AUPS, AUX, AUX_, AUX-E, AUX-ER, AUX-R, AUXX, AUXXL-11N, AUXXLS-11N, AUXXR, AUXXS, AUXXT, AUXXTS, CN-Protronic, CN-Smartronic, CP-Protronic, CS-Easytronic, CX, ECOMAX-602-10, ECOMAX-602-11, ECOMAX-602S-11, ECOMAX-612-10, ECOMAX-612S-10, FM-30, FM-30U...(Other models you can see in the webshop)		

threaded cable glands

screw connections



1

GEV No.	524662	Ref. No.	00-695661-004 695661-4
description	cable gland thread M25 cable ø 16mm mounting ø 25mm Qty 1 pcs plastic WS 33		
For models:	ECOMAX-402, ECOMAX-502		



1

GEV No.	524663	Ref. No.	00-695661-005 695661-5
description	cable gland thread M32 cable ø 21mm mounting ø 32mm Qty 1 pcs plastic WS 42		
For models:	AM-10, AM-11, AM-141, AM-700, AM900-10N, AM900-90, AMS900-10N, AMX, AMX-10HL, AMX-90, AMX-900, AMXR, AMXR-900, AMXS, AMXS-900, AMXT, AMXTS, AMXX, AMXX-1300, AMXXR, AMXXR-1300, AMXXS, AMXXS-1300, AMXXT, AUP, AUP-90, AUPS, AUX, AUX-1300, AUXXL, AUXXL-11N, AUXXLS-11N, AUXXR, AUXXR-1300, AUXXS, AUXXS-1300, AUXXT, AUXXTS, ECOMAX-600, ECOMAX-602-10, ECOMAX-602-11, ECOMAX-602S-11, ECOMAX-612-10, ECOMAX-612S-10, ECOMAX-650, ECOMAX-700, UX, UXL, UXLS, UXS...(Other models you can see in the webshop)		

ribbon cables

group 1



1

GEV No.	402970	Ref. No.	139321-1011
description	ribbon cable 10-pole L 1200mm plug type 2 row coded Qty 1m		



1

GEV No.	400903	Ref. No.	139321-576
description	ribbon cable 10-pole L 2290mm plug type FC-10P raster size 2.54mm		



1

GEV No.	403250	Ref. No.	139321-684
description	ribbon cable 10-pole L 3000mm plug type coded 2 row plug: number of poles 10		

terminals

connection terminals with screw/faston connections



1

GEV No.	550411	Ref. No.	139321-582 774055-1
description	power terminal block 6-pole max. 40A max 450V connection ø6mm ² / F6.3 temp.-resist. 150°C cross section 6mm ²		
For models:	AMX-900, AMXS-900, AMXX-1300, AMXXT, AUXX-1300, AUXXT, CHF45, CHH-50, CHH-60D, CHH-70D, ECOMAX-650, EF-40, EH-60, EH-70, FE, FE-W, FX, GC, GC11, GC12, GC31, GC32, GC41, GC42, GX, HE, HE600-HL, HE-P, UX, UXL, UXLS, UXS, UXT, UXTH, UXTHLS, UXTHS, UXTL, UXTLS, UXTS		

switch boxes



1

GEV No.	524664	Ref. No.	00-229169-007 229169-7
description	gasket for switch box L 415mm W 12mm foam rubber		
For models:	AM-10, AM-11, AM-141, AM900-10N, AM900-90, AMS900-10N, AMX, AMX-10HL, AMX-90, AMXR, AMXS, AMXT, AMXTS, AMXX, AMXXR, AMXXS, AUP, AUP-90, AUPS, AUX, AUXXL-11N, AUXXLS-11N, AUXXR, AUXXS, AUXXT, AUXXTS, ECOMAX-602-10, ECOMAX-602-11, ECOMAX-602S-11, ECOMAX-612-10, ECOMAX-612S-10, RRB		

electronic components

inverter



GEV No.	402902	Ref. No.	916894
description	inverter 200-240V suitable for HOBART		

gas thermostats

PEL

25ST series



GEV No.	101172	Ref. No.	310137 T310137
description	gas thermostat PEL type 25ST 100-300°C gas inlet M16x1.5 (tube ø 10mm) bypass nozzle ø 0.35mm gas outlet M16x1.5 (tube ø 10/8mm) thermocouple connection M9x1 pilot connection M10x1 capillary pipe 1200mm probe ø 6mm probe L 100mm shaft ø 8x6.5mm shaft L 21/15mm shaft flat upper		

spare parts for	101172		
------------------------	--------	--	--

	GEV No.	100259	Ref. No.	—
	description	bypass nozzle type PEL22 bore ø 0.35mm thread M6x0.5		

	GEV No.	101060	Ref. No.	—
	description	magnet unit standard L 39mm D1 ø 15.4mm D2 ø 11mm suitable for PEL20-21/JUNKERS/EGA		

	GEV No.	106200	Ref. No.	—
	description	nut thread M9x1 suitable for PEL 24/255		

accessories for	101172		
------------------------	--------	--	--

	GEV No.	100908	Ref. No.	—
	description	union screw thread M10x1 for pipe ø 4mm Qty 1 pcs		

	GEV No.	100909	Ref. No.	—
	description	union screw thread M10x1 for pipe ø 6mm Qty 1 pcs		

	GEV No.	101246	Ref. No.	—
	description	olive for pipe ø 4mm Qty 1 pcs		



	GEV No.	101278	Ref. No.	—
	description	olive for pipe ø 10mm Qty 1 pcs		

	GEV No.	101286	Ref. No.	—
	description	olive ID ø 6mm Qty 1 pcs		

	GEV No.	101300	Ref. No.	—
	description	union nut thread M16x1.5 tube ø 10mm		

	GEV No.	101450	Ref. No.	—
	description	olive for pipe ø 8mm L 12.7mm Qty 1 pcs ED ø 10mm		

	GEV No.	101451	Ref. No.	—
	description	union nut thread M16x1.5 tube ø 8mm		

accessories for	101172			
	GEV No.	110079	Ref. No.	—
	description	knob dial plate gas thermostat 1-8 silver		
	GEV No.	110081	Ref. No.	—
	description	knob ø 70mm shaft ø 8x6.5mm shaft flat universal		

gas valves and ignition boxes

ignition boxes

SIT



GEV No.	102387	Ref. No.	310197 T310197
description	ignition box SIT type 503EFD electrodes 1 waiting time 1.5s safety time 60s 220/240V 12VA 50-60Hz protection IP20		

ignition parts

ignition units



GEV No.	102388	Ref. No.	308488 T308488
description	ignition unit outputs 4 230VAC dimensions 111x23x34mm mounting distance 100mm inlet F6.3x0.8 outlet F2.8x0.8 type WAC-T4 0.6VA 50/60Hz		

gas burners

bar burners

bar burners



GEV No.	104732	Ref. No.	141610 T141610
description	bar burner ø 50mm Wmm Hmm L 350mm		



auxiliary gas parts

screw connections

olives



1

GEV No.	100898	Ref. No.	MRTCU800183
description	olive for pipe ø 6mm Qty 1 pcs for pilot burner		
accessories for	100898		
	GEV No.	100909	Ref. No.
			—
description	union screw thread M10x1 for pipe ø 6mm Qty 1 pcs		



1

GEV No.	101857	Ref. No.	310275 T310275
description	olive for pipe ø 6mm Qty 1 pcs suitable for 160 series for pilot burner		

equipment-specific units

for slicers

blades

special

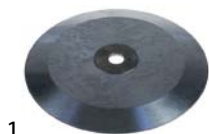

1

GEV No.	697810	Ref. No.	N/A
description	slicing machine blade ED ø 298mm seat ø 25mm 1 hole ID ø 25.4mm H 11.8mm 100Cr6 Spezial suitable for HOBART		

for bandsaws

saw blades

width 16mm



1

GEV No.	699035	Ref. No.	173101-4
description	saw blade L 1750mm W 16mm thickness 0.5mm tooth spacing 6mm		



1

GEV No.	699043	Ref. No.	173101-1
description	saw blade L 2940mm W 16mm thickness 0.5mm tooth spacing 6mm Qty 1 pcs		

GEV No.	699064	Ref. No.	477016-126
description	saw blade L 3200mm W 16mm thickness 0.5mm tooth spacing 6mm		

GEV No.	699065	Ref. No.	290868-1
description	saw blade L 3600mm W 16mm thickness 0.5mm tooth spacing 6mm		

for dough mixers

gear wheels



1

GEV No.	698362	Ref. No.	55614-1
description	gear wheel ø 60mm shaft intake ø 25mm W 16mm teeth 29 fibre		

miscellaneous



1

GEV No.	512413	Ref. No.	012726-02 040991-01 141041
description	bushing L 53mm W 53mm HSM30/HSM40/NCM300/NCM400 mounting distance 41mm		
For models:	A-200N, HSM20, HSM30, HSM40, NCM20, NCM300, NCM400		

for planetary mixers

dough hooks



1

GEV No.	698323	Ref. No.	00-295174
description	dough hook model 60 liters shaft intake ø 35/38mm H 495mm flange ø 185mm		
For models:	H600, H600C, H600D, L800, L800C, L800D, M802, ML-104674, ML-104683, ML-104686, ML-104687, ML-104694, ML-104696, V1401		

1 gas components

			
1			
GEV No.	698324	Ref. No.	00-437701 295171
description	dough hook model 80 liters shaft intake ø 35/38mm H 570mm flange ø 260mm		
For models:	H600, H600C, H600D, L800, L800C, L800D, M802, ML-104674, ML-104683, ML-104686, ML-104687, ML-104694, ML-104696, V1401		

beaters

			
1			
GEV No.	698327	Ref. No.	00-275885
description	beater model 60 liters shaft intake ø 35/38mm W 300mm H 495mm		
For models:	H600, H600C, H600D, L800, L800C, L800D, M802, ML-104674, ML-104683, ML-104686, ML-104687, ML-104694, ML-104696, V1401		

			
1			
GEV No.	698328	Ref. No.	00-275448
description	beater model 80 liters shaft intake ø 35/38mm W 350mm H 525mm		
For models:	H600, H600C, H600D, L800, L800C, L800D, M802, ML-104674, ML-104683, ML-104686, ML-104687, ML-104694, ML-104696, V1401		

mixer bowls

			
1			
GEV No.	698329	Ref. No.	00-66462
description	mixer bowl model 60 liters ø 460mm H 430mm		
For models:	H600		

			
1			
GEV No.	698330	Ref. No.	275690 84920 VML80
description	mixer bowl model 80 liters ø 500mm H 450mm		
For models:	M802, ML-104674, ML-104683, ML-104686, ML-104687, ML-104694, ML-104696, V1401		

beaters

			
1			
GEV No.	698325	Ref. No.	00-295154
description	whisk model 60 liters shaft intake ø 35/38mm ø 270mm H 500mm flange ø 160mm		
For models:	H600, H600C, H600D, L800, L800C, L800D, M802, ML-104674, ML-104683, ML-104686, ML-104687, ML-104694, ML-104696, V1401		

			
1			
GEV No.	698326	Ref. No.	00-295149
description	whisk model 80 liters shaft intake ø 35/38mm ø 320mm H 530mm flange ø 160mm		
For models:	H600, H600C, H600D, L800, L800C, L800D, M802, ML-104674, ML-104683, ML-104686, ML-104687, ML-104694, ML-104696, V1401		

miscellaneous

			
1			
GEV No.	698372	Ref. No.	12749-E
description	guide for spindle suitable for HOBART		



for espresso machines

brewing units

filter holder gaskets

O-rings



1

GEV No.	510409	Ref. No.	00-276903-053 00-67500-016 00-67500-118 276903-53 670500-118 67500-16
description	O-ring EPDM thickness 5.34mm ID ø 56.52mm Qty 1 pcs		
For models:	CR-F, CX, ECW, EWB-S, FTN, FTT, FTX, FUX, ML-104674, ML-104683, ML-104686, UW-135, UW-135H, UWX, UX-60, UX-60B, UX-60E, UX-60EB, UX-60EH, UX-60EHB, UX-60H, UX-60HB, UXT, UXTH, UXTHL, UXTHLS, UXTHS, UXTL, UXTLH, UXTLHS, UXTLS, UXTS, V1401		

for coffee grinders

grinding burrs

screws



1

GEV No.	560067	Ref. No.	140506-27
description	flat-headed bolt thread M5 thread L 10mm SS DIN 7985/ISO 7045 Qty 20 pcs intake Phillips head ø 8mm head thickness 2mm		
For models:	VPU-100, VPU-6		

for convection ovens/combi-steamers

glass panels



1

GEV No.	696425	Ref. No.	844790-2
description	glass panel L 693mm W 613mm for combi-steamer with gasket		

miscellaneous



1

GEV No.	698316	Ref. No.	491760
description	duct for glass plate D1 ø 10mm D2 ø 8mm rubber		
For models:	CO-0612E, CO-1012E, CS-0612E, CS-0612E-A, CS-1012E, CS-1012E-A, CS-1012G, CS-1022E, CS-1022E-A, CS-2012E, CS-2012E-A, CS-2012G, CS-2022E, CS-2022E-A, CSD-0612E, CSD-0612E-A, CSD-0612ET, CSD-0612-UC, CSD-1012E, CSD-1012E-A, CSD-1012ET, CSD-1012-UC, CSD-1013G, CSD-1022E, CSD-1022E-A, CSD-1022-UC, CSD-2012E, CSD-2012E-A, CSD-2012ET, CSD-2012-UC, CSD-2013G, CSD-2022E, CSD-2022E-A, CSD-2022-UC, CSL-0423E, CSL-0423EK, CSL-0523E, CSL-0523EK, CSL-06E, CSL-10E, CSL-423E, CSL-423K, CSM-0611IE, CSM-0611N, CSM-1011IE, CSM-1011N, CSM-1021IE, CSM-1021N, CSM-2011IE, CSM-2011N...(Other models you can see in the webshop)		

for dishwashers

drain and intake components

HOBART

drain /intake bodies



1

GEV No.	524907	Ref. No.	297986-1
description	drain fitting thread 1¼" ED ø 64.5mm ID ø 41mm		
For models:	AM-600, AM-600C, AM-600CR, AM-600R, FM-400H, FM-400U, FM-500, FM-500H, UW-105, UW-135, UW-135H, UW-55		



1

GEV No.	518187	Ref. No.	139321-652
description	drain fitting thread 3/4" ID ø 22mm		
For models:	CHF45, CHH-70D, CLG-25, EF-40, EH-70		





1

GEV No.	518065	Ref. No.	139321-914
description	filter support H 140mm ø 140mm		
For models:	CHH-50, CHH-60D, CHH-70D, EH-60, EH-70		

			
1			
GEV No.	511677	Ref. No.	00-324053-000 00-886639-000
description	flange with gasket ED ø 107mm ID ø 70mm for pump		
For models:	CN-Protronic, CN-Smartronic, CP-Protronic, CR-F, CS-Easytronic, ECOMAX-402, ECOMAX-502, FE-W, FX, GC, GC11, GC12, GC31, GC32, GC41, GC42, GX, HX, HX-30, HX-30E, HX-30ES, HX-30S, HX-40, HX-40E, HX-40ES, HX-40S, HX-60-EHL, HX-E, HX-ES, HX-S		

			
1			
GEV No.	511962	Ref. No.	172986-15
description	flat gasket rubber ED ø 62mm ID ø 44mm thickness 0.9mm Qty 1 pcs		
For models:	AM-600, AM-600C, AM-600CR, AM-600R, FM-400H, FM-400U, FM-500, FM-500H, FTX, FUX, UW-105, UW-120, UW-135, UW-135H, UW-200, UW-55, UWX		

			
1			
GEV No.	507496	Ref. No.	00-324056-000
description	gasket ED ø 100mm ID ø 80mm		
For models:	CN, CNA, CNB, CN-Protronic, CNR, CN-Smartronic, CP-Protronic, CR, CR-F, CS-Easytronic, ECOMAX-402, ECOMAX-502, FE, FE-W, FTN, FX, GC, GC11, GC12, GC31, GC32, GC41, GC42, GX, HE, HE600-HL, HE-P, HX, HX-30, HX-30E, HX-30ES, HX-30S, HX-40, HX-40E, HX-40ES, HX-40S, HX-60-EHL, HX-E, HX-ES, HX-S, UX-60, UX-60B, UX-60E, UX-60EB		

			
1			
GEV No.	524906	Ref. No.	323785-101
description	gasket for drain assembly ø 14mm		
For models:	FX, GX		

			
1			
GEV No.	518060	Ref. No.	139321-913
description	gasket rubber ED ø 132mm ID ø 122mm thickness 5mm		
For models:	CHH-50, CHH-60D, CHH-70D, EH-60, EH-70		

			
1			
GEV No.	518199	Ref. No.	139321-158
description	intake body		
For models:	GE-400, GW-600, GW-600S, GW-601, GW-601S		

			
1			
GEV No.	517404	Ref. No.	00-323802-001 323802-1
description	intake body ED ø 105mm H 110mm ID ø 75mm hose ø 31mm		
For models:	CR, CR-F, ECOMAX-402, ECOMAX-502, FE, GC, GC11, GC12, GC31, GC32, GC41, GC42, HE, HE600-HL, HE-P		

			
1			
GEV No.	518064	Ref. No.	139321-912
description	intake body ED ø 140mm ID ø 102mm hose ø 50/60mm		
For models:	CHH-50, CHH-60D, CHH-70D, EH-60, EH-70		

filters

			
1			
GEV No.	517584	Ref. No.	00-324768-000
description	filter ø 138mm H 86mm		
For models:	AMX, AMX-900, AMX-E, AMX-ER, AMX-R, AMXR-900, AMXS-900, AMXX-1300, AMXXR-1300, AMXXS-1300, AMXXT, AUX, AUX_, AUX-E, AUX-ER, AUX-R, AUXX-1300, AUXXL, AUXXR-1300, AUXXS-1300, AUXXT, UX, UX-30, UX-30B, UX-30E, UX-30EB, UX-30EH, UX-30ES, UX-30ESB, UX-30ESH, UX-30H, UX-30-McDonalds, UX-30S, UX-30SB, UX-30SH, UX-60, UX-60B, UX-60E, UX-60EB, UX-60EH, UX-60EHB, UX-60H, UX-60HB, UXD-30, UXL, UXLs, UXs, UXT, UXTH, UXTHL...(Other models you can see in the webshop)		

			
1			
GEV No.	517586	Ref. No.	01-240051-004 01-240051-4
description	flat filter H 43mm L 525mm W 220mm		
For models:	FX, FX-McDonalds, GX		



			
1			
GEV No.	507499	Ref. No.	00-898189-001 898189-1
description	flat filter L 523mm W 253mm H 15mm		
For models:	AM-10, AM-11, AM-141, AM-700, AM900, AM900-10N, AM900-90, AMS900, AMS900-10N, ECOMAX-600, ECOMAX-602-10, ECOMAX-602-11, ECOMAX-602S-11, ECOMAX-612-10, ECOMAX-612S-10, ECOMAX-650		

			
2			
GEV No.	510647	Ref. No.	323893-1
description	intake filter ø 163mm H 112mm hole ø 33mm		
For models:	FE, HE, HE-P		

			
1			
GEV No.	517581	Ref. No.	229400
description	rectangular filter for dishwasher H 312mm SS L 435mm W 85mm		
For models:	ACW, CX, FTT, FTX, UW-135, UW-135H		

			
1			
GEV No.	510040	Ref. No.	139321-50
description	round filters mounting pos. outer		
For models:	GE-400, GW-600, GW-600S, GW-601, GW-601S		

			
1			
GEV No.	524830	Ref. No.	01-240630-003 01-240630-3
description	round filters ø 136mm H 47mm		

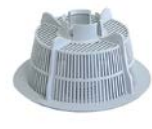
			
1			
GEV No.	510041	Ref. No.	139321-51
description	round filters ø 136mm H 75mm		
For models:	GE-400, GW-600, GW-600S, GW-601, GW-601S		

			
1			
GEV No.	530788	Ref. No.	00-883582-001 01-297817-1 8123 883582-1
description	round filters ø 154mm H 116mm for model AMX/AUX with ring		
For models:	AMX, AMX-10HL, AMX-90, AMXR, AMXS, AMXT, AMXTS, AMXX, AMXXR, AMXXS, AUP, AUP-90, AUPS, AUXX, AUXXL-11N, AUXXLS-11N, AUXXR, AUXXS, AUXXT, AUXXTS		

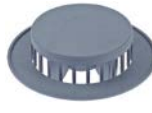
			
1			
GEV No.	524897	Ref. No.	883733-1
description	round filters ø 160mm H 35mm		

			
1			
GEV No.	524681	Ref. No.	324179
description	round filters ø 161mm H 155mm		
For models:	FE-W, FX, GX, HX, HX-30, HX-30E, HX-30ES, HX-30S, HX-40, HX-40E, HX-40ES, HX-40S, HX-60-EHL, HX-E, HX-ES, HX-S		

			
1			
GEV No.	502217	Ref. No.	01-240630-001 01-240630-002 01-240630-1 01-240630-2
description	round filters ø 32.5mm H 49mm		
For models:	ECOMAX-402, ECOMAX-502		

overflow pipes



1

GEV No.	698632	Ref. No.	324231
description	flap for overflow pipe ø 55mm H 13mm		
For models:	AMX, AMX-900, AMX-E, AMX-ER, AMX-R, AMXR-900, AMXS-900, AMXX-1300, AMXXR-1300, AMXXS-1300, AMXXT, AUX, AUX-, AUX-E, AUX-ER, AUX-R, AUX-1300, AUXXL, AUXXR-1300, AUXXS-1300, AUXXT, CR, CR-F, FE-W, FX, GX, HX, HX-30, HX-30E, HX-30ES, HX-30S, HX-40, HX-40E, HX-40ES, HX-40S, HX-60-EHL, HX-E, HX-ES, HX-S, UX, UX-30, UX-30B, UX-30E, UX-30EB, UX-30EH, UX-30ES, UX-30ESB, UX-30ESH, UX-30H, UX-30-McDonalds...(Other models you can see in the webshop)		



2

GEV No.	528919	Ref. No.	139321-49
description	O-ring EPDM thickness 2.62mm ID ø 20.24mm Qty 1 pcs		
For models:	GE-400, GW-600, GW-600S, GW-601, GW-601S		



1

GEV No.	510072	Ref. No.	139321-192
description	O-ring EPDM thickness 3.53mm ID ø 32.93mm Qty 1 pcs		



1

GEV No.	510409	Ref. No.	00-276903-053 00-67500-016 00-67500-118 276903-53 670500-118 67500-16
description	O-ring EPDM thickness 5.34mm ID ø 56.52mm Qty 1 pcs		
For models:	CR-F, CX, ECW, EWB-S, FTN, FTT, FTX, FUX, ML-104674, ML-104683, ML-104686, UW-135, UW-135H, UWX, UX-60, UX-60B, UX-60E, UX-60EB, UX-60EH, UX-60EHB, UX-60H, UX-60HB, UXT, UXTH, UXTHL, UXTHLS, UXTHS, UXTL, UXTLH, UXTLHS, UXTLS, UXTS, V1401		



1

GEV No.	517580	Ref. No.	01-240629-001 01-240629-1 01-240744-001 01-240744-002 01-240744-1 01-240744-2
description	overflow pipe L 160mm ø 90mm		
For models:	ECOMAX-402, ECOMAX-502		



1

GEV No.	510038	Ref. No.	139321-157
description	overflow pipe L 190mm ø 25mm		
For models:	GE-400, GW-600, GW-600S, GW-601, GW-601S		
accessories for	510038		
	GEV No.	Ref. No.	139321-49
	O-ring EPDM thickness 2.62mm ID ø 20.24mm Qty 1 pcs		



1

GEV No.	524480	Ref. No.	323999-1
description	overflow pipe L 250mm ø 32mm		
For models:	CR, CR-F, FE, HE, HE600-HL, HE-P		



1

GEV No.	524660	Ref. No.	00-883737-001 883737-1
description	overflow pipe L 270mm ø 32mm		
For models:	AM-10, AM-11, AM-141, ECOMAX-602-10, ECOMAX-602-11, ECOMAX-602S-11, ECOMAX-612-10, ECOMAX-612S-10		



1



GEV No.	517574	Ref. No.	323534-4
description	overflow pipe L 305mm with filter ø 155mm tube ø 56mm plastic ID ø 28mm		
For models:	AMX-900, AMXR-900, AMXS-900		





1

GEV No.	517579	Ref. No.	898185-1
description	overflow pipe L 323mm ø 86mm tube ø 35mm plastic ID ø 24mm		
For models:	AM-700, ECOMAX-600, ECOMAX-650		





			
1			
GEV No.	524682	Ref. No.	230346 230346-1 230346-1V
description	overflow pipe L 370mm ø 109mm		
For models:	CX, UW-135, UW-135H		
accessories for	524682		
	GEV No.	521120	Ref. No. —
	O-ring EPDM thickness 5.34mm ID ø 37.47mm Qty 1 pcs		

			
1			
GEV No.	517576	Ref. No.	323534-3
description	overflow pipe L 405mm with filter ø 155mm tube ø 36mm ID ø 28mm		
For models:	AMXX-1300, AMXXR-1300, AMXXS-1300, AMXXT, AUXX-1300, AUXXL, AUXXR-1300, AUXXS-1300, AUXXT		

			
1			
GEV No.	517582	Ref. No.	229426-3 229426-3V
description	overflow pipe L 410mm ø 109mm		
For models:	AM-12E, AM-12EC, AM-12EF, AM-12ER, AM-600, AM-600C, AM-600CR, AM-600R, UW-100, UW-105, UWX		

			
1			
GEV No.	517578	Ref. No.	323534-1 774412-1
description	overflow pipe L 458mm with filter ø 155mm tube ø 36mm ID ø 28mm		
For models:	AMX, AMX-E, AMX-ER, AMX-R, AUX, AUX_, AUX-E, AUX-ER, AUX-R, UXD-30		

			
1			
GEV No.	524921	Ref. No.	323534-2 324666-2
description	overflow pipe L 460mm with filter ø 150mm tube ø 36mm plastic ID ø 28mm		
For models:	CR, CR-F, UX-30, UX-30B, UX-30E, UX-30EB, UX-30EH, UX-30ES, UX-30ESB, UX-30ESH, UX-30H, UX-30-McDonalds, UX-30S, UX-30SB, UX-30SH, UX-60, UX-60B, UX-60E, UX-60EB, UX-60EH, UX-60EHB, UX-60H, UX-60HB, UXT, UXTH, UXTHL, UXTHLS, UXTHS, UXTL, UXTLS, UXTS		

			
1			
GEV No.	517577	Ref. No.	323534-6
description	overflow pipe L 467mm with filter ø 155mm tube ø 36mm plastic ID ø 28mm		
For models:	UXT, UXTH, UXTHS, UXTL, UXTLH, UXTLHS, UXTLS, UXTS		

containers

container lids

			
1			
GEV No.	524685	Ref. No.	227883
description	lid ø 29mm for dosing container suitable for HOBART		
For models:	CM1E, FX, GX, WM2E		

			
1			
GEV No.	542091	Ref. No.	00-775530-050 775530-50
description	lid ø 85mm for salt tank suitable for HOBART H 18mm ID ø 58mm		
For models:	AM900, AM900-10N, AM900-90, AMS900, AMS900-10N, AMX, AMX-10HL, AMX-90, AMX-900, AMXR, AMXR-900, AMXS, AMXS-900, AMXT, AMXTS, AMXX, AMXX-1300, AMXXR, AMXXR-1300, AMXXS, AMXXS-1300, AMXXT, AUP, AUP-90, AUPS, AUXX, AUXX-1300, AUXXL, AUXXL-11N, AUXXLS-11N, AUXXR, AUXXR-1300, AUXXS, AUXXS-1300, AUXXT, AUXXTS, FP, FX, FX-McDonalds, GP, GX, UX, UXL, UXLS, UXS, UXT, UXTH, UXTHL, UXTHLS, UXTHS...(Other models you can see in the webshop)		

dosing containers



GEV No.	361881	Ref. No.	231969-1 231969-2
description	container kit L 335mm W 105mm H 25mm for rinse aid		
For models:	FX, GX		



GEV No.	361893	Ref. No.	231969
description	container L 335mm W 105mm H 25mm for rinse aid		
For models:	FX, GX		

salt tanks







GEV No.	524177	Ref. No.	139321-737
description	lid ø 69mm H 20mm for salt tank ID ø 50mm		
accessories for	524177		
	GEV No.	524148	Ref. No. —
	O-ring EPDM thickness 3.53mm ID ø 40.86mm Qty 1 pcs		



GEV No.	510018	Ref. No.	139321-739
description	nut ø 92mm H 10.5mm for salt tank ID ø 64mm		



GEV No.	510032	Ref. No.	139321-740
description	salt tank without gasket new model		
spare parts for	510032		
	GEV No.	506015	Ref. No. 139321-738 371450-64 456052
	O-ring EPDM thickness 3.53mm ID ø 39.69mm Qty 1 pcs		
	GEV No.	510018	Ref. No. 139321-739
	nut ø 92mm H 10.5mm for salt tank ID ø 64mm		
	GEV No.	510071	Ref. No. 139321-597
	flat gasket rubber ED ø 81mm ID ø 68mm thickness 3mm for salt tank Qty 1 pcs		
	GEV No.	524177	Ref. No. 139321-737
	lid ø 69mm H 20mm for salt tank ID ø 50mm		

accessories



GEV No.	510071	Ref. No.	139321-597
description	flat gasket rubber ED ø 81mm ID ø 68mm thickness 3mm for salt tank Qty 1 pcs		





boilers

boilers for dishwashers

 <p>1</p>			
GEV No.	518576	Ref. No.	139321-844
description	boiler		

 <p>1</p>			
GEV No.	504375	Ref. No.	01-240791-001 01-240791-1
description	boiler ø 133mm L 420mm flange 3 hole flange flange ø 47.5mm		
For models:	AM-10, AM-11, AM-141, ECOMAX-502, ECOMAX-602-10		
accessories for	504375		

 <p>GEV No. 504379 Ref. No. 00-774512-001 774512-1</p> <p>plug for draining ø 10mm L 18mm</p>			
 <p>GEV No. 530821 Ref. No. 00-774080-001 774080-1</p> <p>silicone hose ID ø 10mm ED ø 15mm L 1m thickness 2.5mm operating pressure without pressure burst pressure non defined t.max. 200°C transparent Shore 60°</p>			

 <p>1</p>			
GEV No.	519432	Ref. No.	774250-1
description	boiler ø 150mm L 500mm		
For models:	HE, HE600-HL		

accessories

 <p>1</p>			
GEV No.	524908	Ref. No.	00-774808-001 774808-1
description	blind plug for boiler L 69mm W 17mm		
For models:	AM-700, AMX-900, AMXR-900, AMXS-900, AMXX-1300, AMXXR-1300, AMXXS-1300, AMXXT, AUXX-1300, AUXXL, AUXXR-1300, AUXXS-1300, AUXXT, CN, CNA, CNB, CN-Protronic, CNR, CN-Smartronic, CP-Protronic, CR, CR-F, CSA, CS-Easytronic, ECOMAX-600, ECOMAX-650, ECOMAX-700, ECOMAX-800, ECW, FTN, FTX, UX, UXL, UXLS, UXS, UXT, UXTH, UXTHL, UXTHLS, UXTHS, UXTL, UXTLH, UXTLHS, UXTLS, UXTS		

 <p>1</p>			
GEV No.	511654	Ref. No.	230994
description	boiler gasket D1 ø 260mm D2 ø 215mm thickness 2mm 10 holes rubber suitable for HOBART		
For models:	ACW, CR-F, CX, FTN, FTT, FTX, FUX, UWX		

 <p>1</p>			
GEV No.	518121	Ref. No.	226894-1
description	boiler gasket ø 249mm ID ø 235mm thickness 7mm		
For models:	AM-12E, AM-12EC, AM-12EF, AM-12ER, AM-600, AM-600C, AM-600CR, AM-600R, UW-100, UW-105, UW-135, UW-135H		

 <p>1</p>			
GEV No.	524905	Ref. No.	228602
description	gasket for boiler ø 145mm L 187mm W 174mm thickness 7mm hole ø 7mm		
For models:	FM-30, FM-30U, FM-400H, FM-400U, FM-500, FM-500H, UW-55		

 <p>1</p>			
GEV No.	504378	Ref. No.	01-240452-001 01-240452-1
description	hose connector thread 1/8" thread L 44mm hose ø 5mm		
For models:	AM-10, AM-11, AM-141, AM900-10N, AM900-90, AMS900-10N, AMX, AMX-10HL, AMX-90, AMXR, AMXS, AMXT, AMXTS, AMXX, AMXXR, AMXXS, AUP, AUP-90, AUPS, AUXX, AUXXL-11N, AUXXLS-11N, AUXXR, AUXXS, AUXXT, AUXXTS, ECOMAX-602-10, ECOMAX-602-11, ECOMAX-602S-11, ECOMAX-612-10, ECOMAX-612S-10		

 <p>1</p>			
GEV No.	504379	Ref. No.	00-774512-001 774512-1
description	plug for draining ø 10mm L 18mm		
For models:	AM-10, AM-11, AM-141, AM-700, AM900, AM900-10N, AM900-90, AMS900, AMS900-10N, AMX, AMX-10HL, AMX-90, AMX-900, AMXR, AMXR-900, AMXS, AMXS-900, AMXT, AMXTS, AMXX, AMXX-1300, AMXXR, AMXXR-1300, AMXXS, AMXXS-1300, AMXXT, AUP, AUP-90, AUPS, AUXX, AUXX-1300, AUXXL, AUXXL-11N, AUXXLS-11N, AUXXR, AUXXR-1300, AUXXS, AUXXS-1300, AUXXT, AUXXTS, ECOMAX-402, ECOMAX-502, ECOMAX-600, ECOMAX-602-10, ECOMAX-602-11, ECOMAX-602S-11, ECOMAX-612-10, ECOMAX-612S-10, FP, FX...(Other models you can see in the webshop)		

			
GEV No.	530821	Ref. No.	00-774080-001 774080-1
description	silicone hose ID ø 10mm ED ø 15mm L 1m thickness 2.5mm operating pressure without pressure burst pressure non defined t.max. 200°C transparent Shore 60°		
For models:	AM-10, AM-11, AM-141, AM-700, AM900, AM900-10N, AM900-90, AMS900, AMS900-10N, AMX, AMX-10HL, AMX-90, AMX-900, AMXR, AMXR-900, AMXS, AMXS-900, AMXT, AMXTS, AMXX, AMXX-1300, AMXXR, AMXXR-1300, AMXXS, AMXXS-1300, AMXXT, AUP, AUP-90, AUPS, AUXX, AUXX-1300, AUXXL, AUXXL-11N, AUXXLS-11N, AUXXR, AUXXR-1300, AUXXS, AUXXS-1300, AUXXT, AUXXTS, ECOMAX-402, ECOMAX-502, ECOMAX-600, ECOMAX-602-10, ECOMAX-602-11, ECOMAX-602S-11, ECOMAX-612-10, ECOMAX-612S-10, FP, FX...(Other models you can see in the webshop)		

softener cartridges

complete

			
GEV No.	530327	Ref. No.	00-775918-001 00-775918-010 775918-1
description	softener		
For models:	ECOMAX-402, ECOMAX-502, ECOMAX-602S-11, ECOMAX-612S-10		
accessories for	530327		
	GEV No.	530174	Ref. No.
			00-775918-050 775918-150 775918-50
	lid kit for softener		

housing and bezels

miscellaneous

			
GEV No.	513070	Ref. No.	00-886756-004 886756-4
description	duct ID ø 14mm ED ø 19mm		
For models:	AM-10, AM-11, AM-141, AM-700, AM900, AM900-10N, AM900-90, AMS900, AMS900-10N, AMX, AMX-10HL, AMX-90, AMX-900, AMXR, AMXR-900, AMXS, AMXS-900, AMXT, AMXTS, AMXX, AMXX-1300, AMXXR, AMXXR-1300, AMXXS, AMXXS-1300, AMXXT, AUP, AUP-90, AUPS, AUXX, AUXX-1300, AUXXL, AUXXL-11N, AUXXLS-11N, AUXXR, AUXXR-1300, AUXXS, AUXXS-1300, AUXXT, AUXXTS, ECOMAX-402, ECOMAX-502, ECOMAX-602-10, ECOMAX-602-11, ECOMAX-602S-11, ECOMAX-612-10, ECOMAX-612S-10, ECOMAX-650, ECOMAX-700, FP...(Other models you can see in the webshop)		

			
GEV No.	513049	Ref. No.	00-886756-003 886756-3
description	duct ID ø 29mm ED ø 38mm		
For models:	AM-10, AM-11, AM-141, AM-700, AM900-10N, AM900-90, AMS900-10N, AMX, AMX-10HL, AMX-90, AMXR, AMXS, AMXT, AMXTS, AMXX, AMXXR, AMXXS, AUP, AUP-90, AUPS, AUXX, AUXXL-11N, AUXXLS-11N, AUXXR, AUXXS, AUXXT, AUXXTS, ECOMAX-402, ECOMAX-502, ECOMAX-600, ECOMAX-602-10, ECOMAX-602-11, ECOMAX-602S-11, ECOMAX-612-10, ECOMAX-612S-10, ECOMAX-700, GC, GC11, GC12, GC31, GC32, GC41, GC42, UX, UXL, UXLS, UXS, UXT, UXTH, UXTHL...(Other models you can see in the webshop)		

			
GEV No.	513048	Ref. No.	00-886756-001 886756-1
description	duct ID ø 41mm ED ø 50mm		
For models:	AM-10, AM-11, AM-141, AM-700, AM900, AM900-10N, AM900-90, AMS900, AMS900-10N, AMX, AMX-10HL, AMX-90, AMX-900, AMX-E, AMX-ER, AMXR, AMX-R, AMXR-900, AMXS, AMXS-900, AMXT, AMXTS, AMXX, AMXX-1300, AMXXR, AMXXR-1300, AMXXS, AMXXS-1300, AMXXT, AUP, AUP-90, AUPS, AUX, AUX-E, AUX-ER, AUX-R, AUXX, AUXX-1300, AUXXL, AUXXL-11N, AUXXLS-11N, AUXXR, AUXXR-1300, AUXXS, AUXXS-1300, AUXXT, AUXXTS, CN-Protronic, CN-Smartronic, CS-Easytronic...(Other models you can see in the webshop)		

			
GEV No.	513708	Ref. No.	139321-815
description	lid rubber ø 17mm mounting ø 17mm		

hood mechanics for dishwashers

bolts

			
GEV No.	502220	Ref. No.	00-883965-001 883965-1
description	screw bolt ED ø 10mm L 22mm thread M5 kit for roller		
For models:	AM-10, AM-11, AM-141, AM900-10N, AM900-90, AMS900-10N, AMX, AMX-10HL, AMX-90, AMXR, AMXS, AMXT, AMXTS, AMXX, AMXXR, AMXXS, AUP, AUP-90, AUPS, AUXX, AUXXL-11N, AUXXLS-11N, AUXXR, AUXXS, AUXXT, AUXXTS, ECOMAX-602-10, ECOMAX-602-11, ECOMAX-602S-11, ECOMAX-612-10, ECOMAX-612S-10		



spring holders

			
1			
GEV No.	517405	Ref. No.	00-883683-002 883683-2
description	spring holder for hood spring		
For models:	AM-10, AM-11, AM-141, AM900-10N, AM900-90, AMS900-10N, AMX, AMX-10HL, AMX-90, AMXR, AMXS, AMXX, AMXXR, AMXXS, AUP, AUP-90, AUPS, AUXX, AUXXR, AUXXS, ECOMAX-602-10, ECOMAX-602-11, ECOMAX-602S-11, ECOMAX-612-10, ECOMAX-612S-10		

springs

			
1			
GEV No.	511965	Ref. No.	119079-2
description	spring for hood mechanics wire gauge ϕ 5.5mm ϕ 50mm total length 385mm		
For models:	AM-12EC, AM-600C, AM-600CR, AMX, AMX-E, AMX-ER, AMX-R, AUX, AUX_, AUX-E, AUX-ER, AUX-R, FM-30, FM-400H, FM-500H, HE, HE600-HL, HE-P, HX, HX-30, HX-30E, HX-30ES, HX-30S, HX-40, HX-40E, HX-40ES, HX-40S, HX-60-EHL, HX-E, HX-ES, HX-S, UX-30EH, UX-30ESH, UX-30H, UX-30-McDonalds, UX-30SH		

			
1			
GEV No.	517448	Ref. No.	139321-666
description	tension spring ϕ 30mm total length 505mm wire gauge ϕ 5.5mm for hood mechanics Qty 1 pcs		

guide bars

			
1			
GEV No.	511681	Ref. No.	00-883477-001 01-297717-1 883477-1
description	guide L 480mm mounting pos. lower for hood		
For models:	AM-10, AM-11, AM-141, AM900-10N, AM900-90, AMS900-10N, AMX, AMX-10HL, AMX-90, AMXR, AMXS, AMXX, AMXXR, AMXXS, AUP, AUP-90, AUPS, AUXX, AUXXL-11N, AUXXLS-11N, AUXXR, AUXXS, ECOMAX-602-10, ECOMAX-602-11, ECOMAX-602S-11, ECOMAX-612-10, ECOMAX-612S-10		

			
1			
GEV No.	502223	Ref. No.	01-246900-001 01-246900-1
description	spacer for hood L 79mm W 24mm H 10mm		
For models:	AM-10, AM-11, AM-141, AM900-10N, AM900-90, AMS900-10N, AMX, AMX-10HL, AMX-90, AMXR, AMXS, AMXX, AMXXR, AMXXS, AUP, AUP-90, AUPS, AUXX, AUXXL-11N, AUXXLS-11N, AUXXR, AUXXS, ECOMAX-602-10, ECOMAX-602-11, ECOMAX-602S-11, ECOMAX-612-10, ECOMAX-612S-10		

			
1			
GEV No.	502224	Ref. No.	00-886987-001 886987-1
description	spacer kit for hood L 79mm W 24mm H 10mm		
For models:	AM-10, AM-11, AM-141, AM900-10N, AM900-90, AMS900-10N, AMX, AMX-10HL, AMX-90, AMXR, AMXS, AMXX, AMXXR, AMXXS, AUP, AUP-90, AUPS, AUXX, AUXXL-11N, AUXXLS-11N, AUXXR, AUXXR-1300, AUXXS, AUXXS-1300, AUXXT, AMXX, AMXX-1300, AMXXR, AMXXR-1300, AMXXS, AMXXS-1300, AMXXT, AUP, AUP-90, AUPS, AUXX, AUXX-1300, AUXXL-11N, AUXXLS-11N, AUXXR, AUXXR-1300, AUXXS, AUXXS-1300, AUXXT, AUXXTS, ECOMAX-602-10, ECOMAX-602-11, ECOMAX-602S-11, ECOMAX-612-10, ECOMAX-612S-10		

hood handles

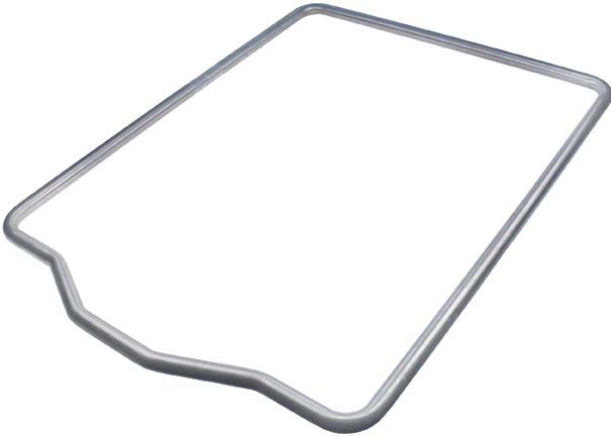
			
1			
GEV No.	513719	Ref. No.	139321-675
description	hood handle		

hood handle supports

			
1			
GEV No.	502222	Ref. No.	00-898024-001 898024-1
description	bearing for hood handle plastic L 47mm W 38mm H 20mm		
For models:	AM-10, AM-11, AM-141, AM900-10N, AM900-90, AMS900-10N, AMX, AMX-10HL, AMX-90, AMXR, AMXS, AMXX, AMXXR, AMXXS, AUP, AUP-90, AUPS, AUXX, AUXXL-11N, AUXXLS-11N, AUXXR, AUXXS, AUXXT, AUXXTS, ECOMAX-602-10, ECOMAX-602-11, ECOMAX-602S-11, ECOMAX-612-10, ECOMAX-612S-10		

rollers



GEV No.	502221	Ref. No.	00-898080-001 898080-1
description	roller ø 29mm for hood mechanics kit hole ø 10mm		
For models:	AM-10, AM-11, AM-141, AM-700, AM900, AM900-10N, AM900-90, AMS900, AMS900-10N, AMX, AMX-10HL, AMX-90, AMX-900, AMX-E, AMX-ER, AMXR, AMX-R, AMXR-900, AMXS, AMXS-900, AMXT, AMXTS, AMXX, AMXX-1300, AMXXR, AMXXR-1300, AMXXS, AMXXS-1300, AMXXT, AUP, AUP-90, AUPS, AUX, AUX-E, AUX-ER, AUX-R, AUXX, AUXX-1300, AUXXL, AUXXL-11N, AUXXLS-11N, AUXXR, AUXXR-1300, AUXXS, AUXXS-1300, AUXXT, AUXXTS, ECOMAX-600, ECOMAX-602-10, ECOMAX-602-11...(Other models you can see in the webshop)		
accessories for	502221		
	GEV No.	502220	Ref. No. 00-883965-001 883965-1
	screw bolt ED ø 10mm L 22mm thread M5 kit for roller		

miscellaneous



GEV No.	508375	Ref. No.	139321-674
description	fixing support		





GEV No.	502226	Ref. No.	00-228828-000
description	rubber pad ED ø 9mm black		
For models:	AM-10, AM-11, AM-141, AM-700, AM900, AM900-10N, AM900-90, AMS900, AMS900-10N, AMX, AMX-10HL, AMX-90, AMX-900, AMX-E, AMX-ER, AMXR, AMX-R, AMXR-900, AMXS, AMXS-900, AMXT, AMXTS, AMXX, AMXX-1300, AMXXR, AMXXR-1300, AMXXS, AMXXS-1300, AMXXT, AUP, AUP-90, AUPS, AUX, AUX, AUX-E, AUX-ER, AUX-R, AUXX, AUXX-1300, AUXXL, AUXXL-11N, AUXXLS-11N, AUXXR, AUXXR-1300, AUXXS, AUXXS-1300, AUXXT, AUXXTS, ECOMAX-600, ECOMAX-602-10...(Other models you can see in the webshop)		



air traps

air traps



GEV No.	518488	Ref. No.	139321-724
description	air trap		
accessories for	518488		
	GEV No.	504618	Ref. No. —
	O-ring EPDM thickness 2.62mm ID ø 15.54mm Qty 1 pcs		

accessories for	518488		
	GEV No.	510075	Ref. No. 139321-725
	flat gasket rubber ED ø 22mm ID ø 13mm thickness 1.5mm Qty 1 pcs		
	GEV No.	510106	Ref. No. 139321-722
	hose connector for air trap		

	GEV No.	503162	Ref. No. 01-240372-001 01-240372-1
description	air trap complete L 77mm W 83mm connection ø 24mm hose ø 6mm		
For models:	AM-10, AM-11, AM-141, AM900-10N, AM900-90, AMS900-10N, AMX, AMX-10HL, AMX-90, AMXR, AMXS, AMXT, AMXTS, AMXX, AMXXR, AMXXS, AUP, AUP-90, AUPS, AUX, AUXXL-11N, AUXXLS-11N, AUXXR, AUXXS, AUXXT, AUXXTS, ECOMAX-402, ECOMAX-502, ECOMAX-602-10, ECOMAX-602-11, ECOMAX-602S-11, ECOMAX-612-10, ECOMAX-612S-10, FP, FX, FX-McDonalds, GP, GX		
accessories for	503162		
	GEV No.	520027	Ref. No. 00-324402-005 00-324402-014 139321-126 324402-14 324402-5
	PVC hose ID ø 4mm ED ø 7mm L 10m thickness 1.5mm t.max. 60°C transparent		

	GEV No.	517575	Ref. No. 324858
description	air trap L 78mm W 40mm H 66mm hose ø 5mm plastic		
For models:	AM3, AMX, AMX-E, AMX-ER, AMX-R, AUX, AUX, AUX-E, AUX-ER, AUX-R, FE, HE, HE600-HL, HE-P, UXD-30		

	GEV No.	510103	Ref. No. 139321-47
description	air trap L 85mm W 20mm H 80mm hose ø 6mm plastic		
For models:	AM-700, AM900, AMS900, AMX-900, AMXR-900, AMXS-900, AMXX-1300, AMXXR-1300, AMXXS-1300, AMXXT, AUXX-1300, AUXXL, AUXXR-1300, AUXXS-1300, AUXXT, ECOMAX-600, ECOMAX-650, ECOMAX-700, FE-W, FX, GC, GC11, GC12, GC31, GC32, GC41, GC42, GE-400, GW-600, GW-600S, GW-601, GW-601S, GX, HX, HX-30, HX-30E, HX-30ES, HX-30S, HX-40, HX-40E, HX-40ES, HX-40S, HX-60-EHL, HX-E, HX-ES, HX-S, UX, UX-30, UX-30B, UX-30E...(Other models you can see in the webshop)		
accessories for	510103		
	GEV No.	505045	Ref. No. —
	O-ring EPDM thickness 1.78mm ID ø 5.28mm Qty 1 pcs		
	GEV No.	505094	Ref. No. —
	air trap		
	GEV No.	510016	Ref. No. 139321-180 897923
	eye bolt for rinse aid container connection		



Table continues overleaf



spare parts for 510103			
	GEV No.	510105	Ref. No. 139321-202 897923
hose connector for air trap			



GEV No.	510111	Ref. No.	139321-550
description	air trap ø 34mm H 130mm hose ø 6mm plastic		
For models:	CHH-50, CHH-60D, CHH-70D, CLG-25, EH-60, EH-70		

spare parts for 510111			
	GEV No.	504618	Ref. No. —
O-ring EPDM thickness 2.62mm ID ø 15.54mm Qty 1 pcs			
	GEV No.	510075	Ref. No. 139321-725
flat gasket rubber ED ø 22mm ID ø 13mm thickness 1.5mm Qty 1 pcs			
	GEV No.	510106	Ref. No. 139321-722
hose connector for air trap			



GEV No.	511993	Ref. No.	107013
description	air trap ø 43mm H 33mm hose ø 6mm plastic		
For models:	H-60		

air trap accessories

	GEV No.	510075	Ref. No. 139321-725
description flat gasket rubber ED ø 22mm ID ø 13mm thickness 1.5mm Qty 1 pcs			



GEV No.	510105	Ref. No.	139321-202 897923
description	hose connector for air trap		
For models:	AM-700, AM900, AMS900, AMX, AMX-900, AMX-E, AMX-ER, AMX-R, AMXR-900, AMXS-900, AMXX-1300, AMXXR-1300, AMXXS-1300, AMXXT, AUX, AUX_, AUX-E, AUX-ER, AUX-R, AUXX-1300, AUXXL, AUXXR-1300, AUXXS-1300, AUXXT, ECOMAX-600, ECOMAX-650, FE, FE-W, FX, GE-400, GW-600, GW-600S, GW-601, GW-601S, GX, HE, HE600-HL, HE-P, HX, HX-30, HX-30E, HX-30ES, HX-30S, HX-40, HX-40E, HX-40ES, HX-40S, HX-60-EHL, HX-E, HX-ES...(Other models you can see in the webshop)		

spare parts for 510105			
	GEV No.	510017	Ref. No. —
union screw			



GEV No.	510106	Ref. No.	139321-722
description	hose connector for air trap		

mechanics for flight type dishwashers



GEV No.	524525	Ref. No.	229326-1
description	bar for transport system L 600mm ø 7mm suitable for HOBART		
For models:	FTX		



GEV No.	524884	Ref. No.	00-154791-000
description	gasket H 35mm ø 66mm ID ø 16mm		
For models:	CN, CNA, CNB, CN-Protronic, CNR, CN-Smartronic, CP-Protronic, CR, CR-F, CSA, CS-Easytronic, ECOMAX-800		



GEV No.	524526	Ref. No.	229319
description	roller for transport system L 24.4mm ID ø 7.4mm ED ø 20/25mm suitable for HOBART		
For models:	FTX		



GEV No.	524527	Ref. No.	774643-1
description	roller for transport system L 26.2mm ID ø 7.2mm ED ø 20/26mm suitable for HOBART		



GEV No.	524879	Ref. No.	302 207-22
description	sliding rail for door L 380mm		
For models:	UX, UXS, UXT, UXTS		



GEV No.	524683	Ref. No.	112378-21 302207-4
description	sliding rail for door L 870mm W 8mm H 11.5mm suitable for HOBART		
For models:	CX, FTX, FUX		



			
1			
GEV No.	524878	Ref. No.	229 102
description	tappet W 70mm H 87mm hole distance 58.5mm		
For models:	FTX		

pipes



			
1			
GEV No.	513047	Ref. No.	00-883512-001 883512-1
description	pipe 14x2.0mm tube ø 14mm L 933mm PE-Xb		
For models:	AM-10, AM-11, AM-141, AM900-10N, AM900-90, AMS900-10N, AMX, AMX-10HL, AMX-90, AMXR, AMXS, AMXT, AMXTS, AMXX, AMXXR, AMXXS, AUP, AUP-90, AUPS, AUX, AUXR, AUXS, AUXXT, AUXXTS, ECOMAX-602-10, ECOMAX-602-11, ECOMAX-602S-11, ECOMAX-612-10, ECOMAX-612S-10		

backflow preventers

backflow preventers

				
1				
GEV No.	511672	Ref. No.	00-775759-001 775759-1	
description	backflow preventer			
For models:	AM-10, AM-11, AM-141, AM-700, AM900-90, AMX-90, AUP-90, CNA, CNB, CNR, CSA, ECOMAX-402, ECOMAX-502, ECOMAX-600, ECOMAX-602-10, ECOMAX-650, ECOMAX-700, ECOMAX-800, FP, FX, FX-McDonalds, GC, GC11, GC12			
accessories for	511672			
	GEV No.	502228	Ref. No.	00-324384-000 324384
	nut for back flow restrictor ø 35mm WS 30			
	GEV No.	507495	Ref. No.	00-775305-001 172513 775305-1
	gasket ED ø 34mm ID ø 25.5mm thickness 2.5mm Qty 1 pcs			

				
1				
GEV No.	511673	Ref. No.	00-883817-001 883817-1	
description	backflow preventer			
For models:	AM900-10N, AM900-90, AMS900-10N, AMX, AMX-10HL, AMX-90, AMXR, AMXS, AMXT, AMXTS, AMXX, AMXXR, AMXXS, AUP, AUP-90, AUPS, AUX, AUXL-11N, AUXLS-11N, AUXR, AUXS, AUXXT, AUXXTS, ECOMAX-602-11, ECOMAX-602S-11, ECOMAX-612-10, ECOMAX-612S-10			
spare parts for	511673			
	GEV No.	511680	Ref. No.	00-324313-002 324313-2
	ball for back flow restrictor ø 8mm			
accessories for	511673			
	GEV No.	511675	Ref. No.	00-775531-001 775531-1
	blind plug for back flow restrictor ø 10mm L 26mm rubber			

				
1				
GEV No.	511674	Ref. No.	01-240142-001 01-240142-1	
description	backflow preventer			
For models:	ECOMAX-402, ECOMAX-502, FP, FX, FX-McDonalds, GP, GX			
spare parts for	511674			
	GEV No.	511680	Ref. No.	00-324313-002 324313-2
	ball for back flow restrictor ø 8mm			
accessories for	511674			
	GEV No.	511675	Ref. No.	00-775531-001 775531-1
	blind plug for back flow restrictor ø 10mm L 26mm rubber			

			
1			
GEV No.	524882	Ref. No.	324091
description	backflow preventer hose ø 12mm		
For models:	ACW, CR-F, FE, FTN, FTT, FTX, FUX, FX, GX, HE, HE600-HL, HX-30ES, HX-30S, HX-40ES, HX-40S, HX-ES, HX-S, UW-135, UW-135H, UX-30ES, UX-30ESB, UX-30ESH, UX-30-McDonalds, UX-30S, UX-30SB, UX-30SH		

1

GEV No.	524513	Ref. No.	324158 886641
description	backflow preventer hose ø 13/18mm		
For models:	AM3, AMX, AMX-E, AMX-ER, AMX-R, AUX, AUX_, AUX-E, AUX-ER, AUX-R, FX, UX-30, UX-30B, UX-30E, UX-30EB, UX-30EH, UX-30H, UX-30-McDonalds, UX-60, UX-60B, UX-60E, UX-60EB, UX-60EH, UX-60EHB, UX-60H, UX-60HB, UXD-30		



1

GEV No.	524457	Ref. No.	00-775540-001 00-775540-011 01-297510-001 01-297510-002 01-297510-2 01-297695-001 01-297695-1 775540-1 775540-11
description	backflow preventer kit		
For models:	AM900, AM900-10N, AM900-90, AMS900, AMS900-10N, AMX, AMX-10HL, AMX-90, AMX-900, AMX-E, AMX-ER, AMXR, AMX-R, AMXR-900, AMXS, AMXS-900, AMXT, AMXTS, AMXX, AMXX-1300, AMXXR, AMXXR-1300, AMXXS, AMXXS-1300, AMXXT, AUP, AUP-90, AUPS, AUX, AUX-E, AUX-ER, AUX-R, AUXX, AUXX-1300, AUXXL, AUXXL-11N, AUXXLS-11N, AUXXR, AUXXR-1300, AUXXS, AUXXS-1300, AUXXT, AUXXTS, ECOMAX-402, ECOMAX-502, ECOMAX-602-11, ECOMAX-602S-11, ECOMAX-612-10, ECOMAX-612S-10, ECOMAX-650... (Other models you can see in the webshop)		
spare parts for	524457		

GEV No.	502228	Ref. No.	00-324384-000 324384
description	nut for back flow restrictor ø 35mm WS 30		

GEV No.	520015	Ref. No.	00-775559-007 00-775559-008 00-775559-013 00-775559-016 139321-125 139321-611 775559-13 775559-16 775559-7 775559-8
description	supply hose ID ø 10mm ED ø 17mm L 5m operating p. 20bar burst p. 60bar t.max. 95°C grey Qty 5m		



GEV No.	511675	Ref. No.	00-775531-001 775531-1
description	blind plug for back flow restrictor ø 10mm L 26mm rubber		
For models:	AM900, AM900-10N, AM900-90, AMS900, AMS900-10N, AMX, AMX-10HL, AMX-90, AMX-900, AMX-E, AMX-ER, AMXR, AMX-R, AMXR-900, AMXS, AMXS-900, AMXT, AMXTS, AMXX, AMXX-1300, AMXXR, AMXXR-1300, AMXXS, AMXXS-1300, AMXXT, AUP, AUP-90, AUPS, AUX, AUX-E, AUX-ER, AUX-R, AUXX, AUXX-1300, AUXXL, AUXXL-11N, AUXXLS-11N, AUXXR, AUXXR-1300, AUXXS, AUXXS-1300, AUXXT, AUXXTS, ECOMAX-402, ECOMAX-502, ECOMAX-602-11, ECOMAX-612-10, ECOMAX-650, FP, FX...(Other models you can see in the webshop)		



1

GEV No.	523077	Ref. No.	01-297695-2
description	backflow preventer kit with cover cap		

non-return valves



1

GEV No.	517573	Ref. No.	146669-1 292909
description	non-return valve thread 1/2" IT		
For models:	AM-600, AM-600C, AM-600CR, AM-600R, CX, FM-400H, FM-500H, UW-105, UWX		

accessories



1

GEV No.	511680	Ref. No.	00-324313-002 324313-2
description	ball for back flow restrictor ø 8mm		
For models:	AMX, AMX-E, AMX-ER, AMX-R, AUX, AUX_, AUX-E, AUX-ER, AUX-R, CR, ECOMAX-402, ECOMAX-502, UX-30, UX-30B, UX-30E, UX-30EB, UX-60, UX-60B, UX-60E, UX-60EB		





1

GEV No.	511675	Ref. No.	00-775531-001 775531-1
description	blind plug for back flow restrictor ø 10mm L 26mm rubber		
For models:	AM900, AM900-10N, AM900-90, AMS900, AMS900-10N, AMX, AMX-10HL, AMX-90, AMX-900, AMX-E, AMX-ER, AMXR, AMX-R, AMXR-900, AMXS, AMXS-900, AMXT, AMXTS, AMXX, AMXX-1300, AMXXR, AMXXR-1300, AMXXS, AMXXS-1300, AMXXT, AUP, AUP-90, AUPS, AUX, AUX-E, AUX-ER, AUX-R, AUXX, AUXX-1300, AUXXL, AUXXL-11N, AUXXLS-11N, AUXXR, AUXXR-1300, AUXXS, AUXXS-1300, AUXXT, AUXXTS, ECOMAX-402, ECOMAX-502, ECOMAX-602-11, ECOMAX-612-10, ECOMAX-650, FP, FX...(Other models you can see in the webshop)		

			
1			
GEV No.	502228	Ref. No.	00-324384-000
description	nut for back flow restrictor ø 35mm WS 30		
For models:	AM-10, AM-11, AM-141, AM-600, AM-600C, AM-600CR, AM-600R, AM-700, AM900, AM900-10N, AM900-90, AMS900, AMS900-10N, AMX, AMX-10HL, AMX-90, AMX-900, AMX-E, AMX-ER, AMXR, AMX-R, AMXR-900, AMXS, AMXS-900, AMXT, AMXTS, AMXX, AMXX-1300, AMXXR, AMXXR-1300, AMXXS, AMXXS-1300, AMXXT, AUP, AUP-90, AUPS, AUX, AUX-, AUX-E, AUX-ER, AUX-R, AUXX, AUXX-1300, AUXXL, AUXXL-11N, AUXXLS-11N, AUXXR, AUXXR-1300, AUXXS, AUXXS-1300...(Other models you can see in the webshop)		

miscellaneous			
			
1			
GEV No.	530469	Ref. No.	325308-1
description	plug for washing arms rubber L 24mm D1 ø 34mm mounting ø 20mm ID ø 15mm		
For models:	CNR, CR, ECW		

			
1			
GEV No.	518129	Ref. No.	136763
description	shaft bearing brass H 32mm D1 ø 38mm D2 ø 32mm ID ø 25.4mm		

			
1			
GEV No.	511676	Ref. No.	00-324097-000 00-883281-001 883281-1
description	water inlet for tank plastic D1 ø 18mm for HOBART		
For models:	AM-600, AM-600C, AM-600CR, AM-600R, AM900, AM900-10N, AM900-90, AMS900, AMS900-10N, AMX, AMX-10HL, AMX-90, AMX-900, AMX-E, AMX-ER, AMXR, AMX-R, AMXR-900, AMXS, AMXS-900, AMXT, AMXTS, AMXX, AMXX-1300, AMXXR, AMXXR-1300, AMXXS, AMXXS-1300, AMXXT, AUP, AUP-90, AUPS, AUX, AUX-E, AUX-ER, AUX-R, AUXX, AUXX-1300, AUXXL, AUXXL-11N, AUXXLS-11N, AUXXR, AUXXR-1300, AUXXS, AUXXS-1300, AUXXT, AUXXTS, ECOMAX-602-11, ECOMAX-602S-11, ECOMAX-612-10...(Other models you can see in the webshop)		

door mechanics			
bolts			
			
1			
GEV No.	502219	Ref. No.	01-240151-001 01-240151-1
description	door bolt ø 8mm L 15mm thread M5 stainless steel		
For models:	ECOMAX-402, ECOMAX-502, FP, FX, FX-McDonalds, GP, GX		

springs			
roller springs			
			
1			
GEV No.	519514	Ref. No.	774749-5
description	roller spring complete W 40mm ID ø 10.5mm lug length 49mm		
For models:	CN, CNA, CNB, CNR, CR, FTN		

			
1			
GEV No.	519492	Ref. No.	774749-2
description	roller spring complete W 40mm ID ø 10.5mm lug length 54mm		
For models:	CN, CNA, CNB, CNR, CR, CR-F, FTN		



1

GEV No.	519496	Ref. No.	774749-6
description	roller spring W 40mm ID ø 10.5mm lug length 52mm		
For models:	CN, CNA, CNB, CNR, CR, FTN		



1

GEV No.	517409	Ref. No.	774749-3
description	roller spring W 40mm ID ø 10.5mm lug length 54mm		
For models:	CSA, FTN		



1

GEV No.	519515	Ref. No.	229277
description	roller spring W 40mm ID ø 35mm lug length 23mm		
For models:	CX, FTT, FTX, FUX		



1

GEV No.	520590	Ref. No.	01-245278-7
description	roller spring W 55mm ID ø 11mm lug length 30mm		



1

GEV No.	694272	Ref. No.	299110 378591
description	roller spring W 65mm ID ø 48mm lug length 24mm		
For models:	UW-100, UW-105, UW-120, UW-125, UW-200, UW-205		

tension springs



1

GEV No.	504424	Ref. No.	00-324773-000
description	tension spring ø 20mm total length 245mm wire gauge ø 2.5mm for door Qty 1 pcs		
For models:	UX-30, UX-30E, UX-30ES, UX-30-McDonalds, UX-30S, UX-60, UX-60E, UXD-30, UXL, UXLS		

linkage



1

GEV No.	518362	Ref. No.	139321-568
description	door pin door pin		
For models:	CHF45, EF-40		



1

GEV No.	518355	Ref. No.	139321-824
description	door pin stop rod		

sliding plates



1

GEV No.	518356	Ref. No.	139321-823
description	sliding plate sliding plate		



1

GEV No.	518353	Ref. No.	E307005
description	stop plastic for door L 60mm W 12.5mm H 10mm		

hinges



1

GEV No.	503501	Ref. No.	324002-2
description	door hinge hinge left mounting pos. left		
For models:	FX, GX		



1

GEV No.	518547	Ref. No.	139321-267
description	door hinge hinge mounting pos. left		
For models:	GE-400, GW-600, GW-600S, GW-601, GW-601S		



1

GEV No.	503500	Ref. No.	324002-1
description	door hinge hinge right mounting pos. right		
For models:	FX, GX		



1

GEV No.	518301	Ref. No.	139321-825
description	door hinge mounting pos. left/right		



1

GEV No.	518122	Ref. No.	139321-560
description	hinge complete for dishwasher L 588mm		

hinge camps



1

GEV No.	502225	Ref. No.	01-294108-001 01-294108-1
description	hinge block plastic T1: M5		
For models:	ECOMAX-402, ECOMAX-502		

accessories for 502225

GEV No.	502219	Ref. No.	01-240151-001 01-240151-1
----------------	--------	-----------------	------------------------------

door bolt ø 8mm L 15mm thread M5 stainless steel

hinge pins



1

GEV No.	518267	Ref. No.	139321-826
description	hinge pin hinge pin		

door guides



1

GEV No.	698702	Ref. No.	325064-4
description	sliding rail L 812mm W 31mm		
For models:	CN, CNA, CNB, CNR, CR		

door bumpers

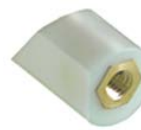

1

GEV No.	518066	Ref. No.	139321-822
description	door bumper end stop		



1

GEV No.	505295	Ref. No.	01-240741-001 01-240741-1
description	door bumper H 7.5mm L 17mm W 10mm		
For models:	ECOMAX-402, ECOMAX-502		



door shafts



1

GEV No. 524883 **Ref. No.** 774495-1

description shaft ø 10mm L 76mm for dishwasher door

For models: CN, CNA, CNB, CNR, CR, CR-F, CSA, ECOMAX-800, FTN

locks



1

GEV No. 512287 **Ref. No.** 01-240763-001
01-510284-1

description door catch L 51mm W 35mm H 13mm

For models: ECOMAX-402, ECOMAX-502



1

GEV No. 513138 **Ref. No.** 139321-817

description door catch with nut door locking catch



1

GEV No. 701126 **Ref. No.** 324221

description snap lock L 33mm with roller thread M12x1.75 for dishwasher

For models: ECOMAX-700, FE, FX, GX, UX-30, UX-30E, UX-30ES, UX-30-McDonalds, UX-30S, UX-60, UX-60E



1

GEV No. 518245 **Ref. No.** 139321-821

description spigot door catch



1

GEV No. 518298 **Ref. No.** 139321-1116

description spigot door catch

miscellaneous



1

GEV No. 503502 **Ref. No.** 228693-1

description bush

For models: FE-W, FM-30U, FM-400U, FM-500, FX, GX, HX, HX-30, HX-30E, HX-30ES, HX-30S, HX-40, HX-40E, HX-40ES, HX-40S, HX-60-EHL, HX-E, HX-ES, HX-S, UW-55



1

GEV No. 698634 **Ref. No.** 324322

description deflector H 30mm L 125mm W 30mm

For models: AMX, AMX-E, AMX-ER, AMX-R, AUX, AUX_, AUX-E, AUX-ER, AUX-R, HE, HE-P, HX, HX-30, HX-30E, HX-30ES, HX-30S, HX-40, HX-40E, HX-40ES, HX-40S, HX-E, HX-ES, HX-S



1

GEV No. 524458 **Ref. No.** 324194
886253-1

description foam rubber gasket for door L 560mm W 19mm thickness 4mm

For models: FX, GX



1

GEV No. 524926 **Ref. No.** 323930-1

description gasket for bearing ID ø 12mm H 23mm L 30mm W 12mm mounting pos. left

For models: FE, FE-W





1

GEV No. 524925 **Ref. No.** 323930-2

description gasket for bearing ID ø 12mm H 23mm L 30mm W 12mm mounting pos. right

For models: FE, FE-W

			
1			
GEV No.	519524	Ref. No.	00-226640-000
description	handle for door mechanism PVC ø 23mm L 122mm		
For models:	AM-10, AM-11, AM-12E, AM-12EC, AM-12ER, AM-141, AM-600, AM-600C, AM-600CR, AM-600R, AMX, AMX-E, AMX-ER, AMX-R, AUX, AUX-E, AUX-ER, AUX-R, ECOMAX-602-10, ECOMAX-602-11, ECOMAX-602S-11, ECOMAX-612-10, ECOMAX-612S-10, FM-400H, FM-500H, HE, HE600-HL, HE-P, HX, HX-60-EHL, HX-E, HX-ES, HX-S, UX-30EH, UX-30ESH, UX-30H, UX-30-McDonalds, UX-30SH		

			
1			
GEV No.	504376	Ref. No.	01-240176-001 01-240176-1
description	slide bearing plastic ED ø 15mm ID ø 8mm D2 ø 10mm		
For models:	ECOMAX-402, ECOMAX-502, FP, FX, FX-McDonalds, GP, GX		

			
1			
GEV No.	502227	Ref. No.	00-883931-001 883931-1
description	spanner for tension spring ø 10mm L 285mm thread M10x1.5		
For models:	AM-10, AM-11, AM-141, AM900-10N, AM900-90, AMS900-10N, AMX, AMX-10HL, AMX-90, AMXR, AMXS, AMXT, AMXTS, AMXX, AMXXR, AMXXS, AUP, AUP-90, AUPS, AUXX, AUXXL-11N, AUXXLS-11N, AUXXR, AUXXS, AUXXT, AUXXTS, ECOMAX-602-10, ECOMAX-602-11, ECOMAX-602S-11, ECOMAX-612-10, ECOMAX-612S-10		

			
1			
GEV No.	502218	Ref. No.	00-883947-001 883947-1
description	spare parts kit for door mechanism door link with door lift handle		
For models:	AM-10, AM-11, AM-141, AM900-10N, AM900-90, AMS900-10N, AMX, AMX-10HL, AMX-90, AMXR, AMXS, AMXT, AMXTS, AMXX, AMXXR, AMXXS, AUP, AUP-90, AUPS, AUXX, AUXXR, AUXXS, AUXXT, AUXXTS, ECOMAX-602-10, ECOMAX-602-11, ECOMAX-602S-11, ECOMAX-612-10, ECOMAX-612S-10		

			
1			
GEV No.	519523	Ref. No.	01-240764-001 01-240764-1
description	spring for door latch L 45mm W 25mm		
For models:	ECOMAX-402, ECOMAX-502		

screw connections			
			
1			
GEV No.	505288	Ref. No.	00-695664-004 695664-4
description	nut thread M25x1.5 H 6mm WS 30 Qty 1 pcs for cable gland		
For models:	CN-Protronic, CN-Smartronic, CP-Protronic, ECOMAX-402, ECOMAX-502		

curtains			
curtains			
			
Image not available			
1			
GEV No.	533133	Ref. No.	229436-5
description	curtain W 1095mm H 210mm warewashing		
For models:	FTX, FUX		

			
1			
GEV No.	533134	Ref. No.	229436-4
description	curtain W 1095mm H 400mm warewashing		
For models:	FTX, FUX		

			
1			
GEV No.	533135	Ref. No.	229436-6
description	curtain W 1095mm H 643mm warewashing		
For models:	FTX, FUX		

			
1			
GEV No.	533139	Ref. No.	230781
description	curtain W 625mm H 420mm warewashing		
For models:	CR-F, CX		



Image not available
1

GEV No.	533137	Ref. No.	231602-2
description	curtain W 640mm H 210mm warewashing		
For models:	CX		

Image not available
1

GEV No.	533130	Ref. No.	229436-2
description	curtain W 740mm H 210mm warewashing		
For models:	FTX		

1

GEV No.	533138	Ref. No.	231602-1
description	curtain W 640mm H 380mm warewashing		
For models:	CX		

1

GEV No.	533131	Ref. No.	229436-1
description	curtain W 740mm H 400mm warewashing		
For models:	FTX, FUX		

Image not available
1

GEV No.	533148	Ref. No.	781284-1
description	curtain W 645mm H 290mm warewashing		
For models:	CN, CNA, CNB, CNR, CR, CSA		

Image not available
1

GEV No.	533132	Ref. No.	229436-3
description	curtain W 740mm H 643mm warewashing		
For models:	FTX, FUX		

Image not available
1

GEV No.	533149	Ref. No.	781033-1
description	curtain W 645mm H 420mm warewashing		
For models:	CN, CNA, CNB, CNR, CR, CSA, ECOMAX-800		

1

GEV No.	533140	Ref. No.	325346-4
description	curtain W 750mm H 365mm warewashing		
For models:	FTN		

1

GEV No.	533150	Ref. No.	781067-1
description	curtain W 645mm H 430mm warewashing		
For models:	CN, CNA, CNB, CNR, CR, CSA, ECOMAX-800		

1

GEV No.	533141	Ref. No.	325346-8
description	curtain W 750mm H 385mm warewashing		
For models:	FTN		



1

GEV No.	533142	Ref. No.	325346-5
description	curtain W 750mm H 480mm warewashing		
For models:	FTN		



2

GEV No.	533143	Ref. No.	325346-1
description	curtain W 750mm H 485mm warewashing		
For models:	FTN		



1

GEV No.	533144	Ref. No.	325346-3
description	curtain W 942mm H 365mm warewashing		
For models:	FTN		



1

GEV No.	533145	Ref. No.	00-325346-007 325346-7
description	curtain W 942mm H 385mm warewashing		
For models:	FTN		



1

GEV No.	533146	Ref. No.	325346-6
description	curtain W 942mm H 480mm warewashing		
For models:	FTN		



1

GEV No.	533147	Ref. No.	325346-2
description	curtain W 942mm H 485mm warewashing		
For models:	FTN		

curtain rods



1

GEV No.	533152	Ref. No.	229924 229924-1
description	curtain rod L 1090mm ø 8mm		
For models:	FTX, FUX		



1

GEV No.	533153	Ref. No.	231540-3
description	curtain rod L 606mm ø 8mm		
For models:	CX		



1

GEV No.	533154	Ref. No.	231540-1
description	curtain rod L 612mm ø 8mm		
For models:	CX		





1

GEV No.	533155	Ref. No.	137143
description	curtain rod L 620mm ø 8mm		





 <p>Image not available</p> <p>1</p>			
GEV No.	533160	Ref. No.	325360-8
description	curtain rod L 645mm ø 8mm		
For models:	ECW		

 <p>Image not available</p> <p>1</p>			
GEV No.	533158	Ref. No.	325360-3
description	curtain rod L 942mm ø 8mm		
For models:	FTN		

 <p>2</p>			
GEV No.	533159	Ref. No.	231540-5 325360-7
description	curtain rod L 655mm ø 8mm		
For models:	CN, CNA, CNB, CNR, CR, CR-F, CSA, ECOMAX-800		

washing and rinsing systems			
 <p>1</p>			
GEV No.	518114	Ref. No.	228643 B228643
description	bush for rinse arm ø 14mm H 21mm		
For models:	AM-12E, AM-12EC, AM-12EF, AM-12ER, AM-600, AM-600C, AM-600CR, AM-600R, FM-30, FM-300U, FM-30U, FM-400H, FM-400U, FM-500, FM-500H, UW-100, UW-105, UW-120, UW-125, UW-135, UW-135H, UW-200, UW-205, UW-55		

 <p>Image not available</p> <p>1</p>			
GEV No.	533156	Ref. No.	231540-2
description	curtain rod L 680mm ø 8mm		
For models:	CX		

 <p>1</p>			
GEV No.	530468	Ref. No.	493414
description	bushing for rinse arm mounting pos. upper/lower ø 15mm ID ø 12mm H 16mm		
For models:	CNR, CR, CR-F		

 <p>Image not available</p> <p>1</p>			
GEV No.	533151	Ref. No.	229214
description	curtain rod L 740mm ø 8mm		
For models:	FTX, FUX		

 <p>1</p>			
GEV No.	510638	Ref. No.	324068
description	clamping ring ID ø 41mm ED ø 45mm thickness 3mm		
For models:	AM-700, AM900, AMS900, AMX-900, AMXR-900, AMXS-900, ECOMAX-600, ECOMAX-650, FE, FE-W, FX, GX, HE, HE600-HL, HE-P, HX, HX-30, HX-30E, HX-30ES, HX-30S, HX-40, HX-40E, HX-40ES, HX-40S, HX-60-EHL, HX-E, HX-ES, HX-S		

 <p>Image not available</p> <p>1</p>			
GEV No.	533157	Ref. No.	325360-2
description	curtain rod L 750mm ø 8mm		
For models:	FTN		

			
1			
GEV No.	694621	Ref. No.	324751
description	clamping ring ID ø 58.5mm ED ø 64mm thickness 3mm		
For models:	AMX, AMX-E, AMX-ER, AMX-R, AMXX-1300, AMXXR-1300, AMXXS-1300, AMXXT, AUX, AUX_, AUX-E, AUX-ER, AUX-R, AUXX-1300, AUXXL, AUXXR-1300, AUXXS-1300, AUXXT, ECOMAX-700, UX, UX-30, UX-30B, UX-30E, UX-30EB, UX-30EH, UX-30ES, UX-30ESB, UX-30ESH, UX-30H, UX-30-McDonalds, UX-30S, UX-30SB, UX-30SH, UX-60, UX-60B, UX-60E, UX-60EB, UX-60EH, UX-60EHB, UX-60H, UX-60HB, UXD-30, UXL, UXLs, UXS, UXT, UXTH, UXTHL, UXTHLS, UXTHS...(Other models you can see in the webshop)		

			
1			
GEV No.	518461	Ref. No.	139321-865
description	flange for wash arm support		

			
1			
GEV No.	517403	Ref. No.	00-172986-035 172986-35
description	flat gasket EPDM ED ø 71mm ID ø 61mm thickness 1.5mm Qty 1 pcs		
For models:	AM-10, AM-11, AM-141, AM900-10N, AM900-90, AMS900-10N, AMX, AMX-10HL, AMX-90, AMXR, AMXS, AMXT, AMXTS, AMXX, AMXXR, AMXXS, AUP, AUP-90, AUPS, AUXX, AUXXL-11N, AUXXLS-11N, AUXXR, AUXXS, AUXXT, AUXXTS, ECOMAX-602-10, ECOMAX-602-11, ECOMAX-602S-11, ECOMAX-612-10, ECOMAX-612S-10		

			
1			
GEV No.	518240	Ref. No.	139321-780
description	flat gasket rubber ED ø 33mm ID ø 17mm thickness 1.5mm Qty 1 pcs		

			
1			
GEV No.	511651	Ref. No.	00-172986-022 172986-22
description	flat gasket rubber ED ø 71mm ID ø 59mm thickness 2mm for wash arm support Qty 1 pcs		
For models:	AMX, AMX-E, AMX-ER, AMX-R, AMXX-1300, AMXXR-1300, AMXXS-1300, AMXXT, AUX, AUX_, AUX-E, AUX-ER, AUX-R, AUXX-1300, AUXXL, AUXXR-1300, AUXXS-1300, AUXXT, CR, ECOMAX-700, UX, UX-30, UX-30B, UX-30E, UX-30EB, UX-30EH, UX-30ES, UX-30ESB, UX-30ESH, UX-30H, UX-30-McDonalds, UX-30S, UX-30SB, UX-30SH, UX-60, UX-60B, UX-60E, UX-60EB, UX-60EH, UX-60EHB, UX-60H, UX-60HB, UXD-30, UXL, UXLs, UXS, UXT, UXTH, UXTHL, UXTHLS...(Other models you can see in the webshop)		

			
1			
GEV No.	524901	Ref. No.	371450-190
description	gasket for pump casing L 45mm W 13mm thickness 1mm rubber Qty 1m		
For models:	GF-60, GF-60S		

			
1			
GEV No.	518071	Ref. No.	139321-915
description	gasket for wash arm support L 109mm W 68mm		

			
2			
GEV No.	511966	Ref. No.	119229
description	compression spring ø 23mm L 22mm wire gauge ø 1.5mm		
For models:	AM-12E, AM-12EC, AM-12EF, AM-12ER, AM-600, AM-600C, AM-600CR, AM-600R, UW-100, UW-105, UW-120, UW-125, UW-135, UW-135H, UW-200, UW-205		

			
1			
GEV No.	507497	Ref. No.	00-883481-001 883481-1
description	connection wash pipe ø 47mm connection 66x36mm		
For models:	AM-10, AM-11, AM-141, AM900-10N, AM900-90, AMS900-10N, AMX, AMX-10HL, AMX-90, AMXR, AMXS, AMXT, AMXTS, AMXX, AMXXR, AMXXS, AUP, AUP-90, AUPS, AUXX, AUXXL-11N, AUXXLS-11N, AUXXR, AUXXS, AUXXT, AUXXTS, ECOMAX-602-10, ECOMAX-602-11, ECOMAX-602S-11, ECOMAX-612-10, ECOMAX-612S-10		

			
1			
GEV No.	510016	Ref. No.	139321-180 897923
description	eye bolt for rinse aid container connection		
For models:	AM-700, AM900, AMS900, AMX, AMX-900, AMX-E, AMX-ER, AMX-R, AMXR-900, AMXS-900, AMXX-1300, AMXXR-1300, AMXXS-1300, AMXXT, AUX, AUX_, AUX-E, AUX-ER, AUX-R, AUXX-1300, AUXXL, AUXXR-1300, AUXXS-1300, AUXXT, ECOMAX-600, ECOMAX-650, FE, FE-W, FX, GE-400, GW-600, GW-600S, GW-601, GW-601S, GX, HE, HE600-HL, HE-P, HX, HX-30, HX-30E, HX-30ES, HX-30S, HX-40, HX-40E, HX-40ES, HX-40S, HX-60-EHL, HX-E, HX-ES...(Other models you can see in the webshop)		





 <p>1</p>			
GEV No.	518116	Ref. No.	00-172986-019 172986-19
description	gasket for wash arm support rubber ø 60mm ID ø 47mm thickness 1mm		
For models:	AMX-900, AMXS-900, ECOMAX-402, ECOMAX-502, ECOMAX-650, FE, FE-W, FP, FX, FX-McDonalds, GC, GC11, GC12, GC31, GC32, GC41, GC42, GP, GX, HE, HE600-HL, HE-P, HX, HX-30, HX-30E, HX-30ES, HX-30S, HX-40, HX-40E, HX-40ES, HX-40S, HX-60-EHL, HX-E, HX-ES, HX-S		

 <p>1</p>			
GEV No.	524924	Ref. No.	226643
description	gasket for wash arm support Tesnit BA-50 ID ø 22mm L 71mm W 45mm thickness 2mm		
For models:	AM-12E, AM-12EC, AM-12EF, AM-12ER, FM-30, FM-30U, FM-400H, FM-400U, FM-500, FM-500H, UW-105, UW-120, UW-125, UW-200, UW-205, UW-55		

 <p>1</p>			
GEV No.	518238	Ref. No.	139321-742
description	manifold ø 12mm L 98mm		

 <p>1</p>			
GEV No.	517454	Ref. No.	308031
description	nut for wash arm ED ø 35mm thickness 11mm plastic		
For models:	ECOMAX-601, H-60		

 <p>1</p>			
GEV No.	518144	Ref. No.	00-883496-001 883496-1
description	nut for wash arm support ED ø 74mm WS 65 hole ø 36mm		
For models:	AM-10, AM-11, AM-141, AM900-10N, AM900-90, AMS900-10N, AMX, AMX-10HL, AMX-90, AMXR, AMXS, AMXT, AMXTS, ECOMAX-602-10, ECOMAX-602-11, ECOMAX-602S-11, ECOMAX-612-10, ECOMAX-612S-10		

 <p>1</p>			
GEV No.	518139	Ref. No.	01-240021-001 01-240021-1
description	nut for wash arm support ø 60mm		
For models:	ECOMAX-402, ECOMAX-502, FP, FX, FX-McDonalds, GP, GX		

 <p>1</p>			
GEV No.	524512	Ref. No.	324698-1
description	nut for wash arm support ø 74mm		
For models:	AMX, AMX-E, AMX-ER, AMX-R, AMXX-1300, AMXXR-1300, AMXXS-1300, AMXXT, AUX, AUX_, AUX-E, AUX-ER, AUX-R, AUXX-1300, AUXXL, AUXXR-1300, AUXXS-1300, AUXXT, ECOMAX-700, UX, UX-30, UX-30B, UX-30E, UX-30EB, UX-30EH, UX-30ES, UX-30ESB, UX-30ESH, UX-30H, UX-30-McDonalds, UX-30S, UX-30SB, UX-30SH, UX-60, UX-60B, UX-60E, UX-60EB, UX-60EH, UX-60EHB, UX-60H, UX-60HB, UXD-30, UXL, UXLS, UXS, UXT, UXTH, UXTHL, UXTHLS, UXTHS...(Other models you can see in the webshop)		

 <p>1</p>			
GEV No.	524684	Ref. No.	885500-1
description	plug for wash arm ø 43mm ID ø 27mm		
For models:	CN, CNA, CNB, CNR, CSA, ECOMAX-800, FTN		

 <p>1</p>			
GEV No.	518443	Ref. No.	139321-766
description	rinse arm support mounting pos. upper		

 <p>1</p>			
GEV No.	511634	Ref. No.	296092
description	rinse arm support mounting pos. upper ø 15mm H 42.5mm		
For models:	AM-12E, AM-12EC, AM-12EF, AM-12ER, AM-600, AM-600C, AM-600CR, AM-600R, UW-100, UW-105, UW-120, UW-125, UW-135, UW-135H, UW-200, UW-205		



GEV No.	518125	Ref. No.	139321-926
description	rinse hose ø 17.5mm		



GEV No.	518148	Ref. No.	01-240097-001 01-240097-1
description	rinse pipe ø 17mm L 60mm		
For models:	ECOMAX-402, ECOMAX-502, FP, FX, FX-McDonalds, GP, GX		



GEV No.	518149	Ref. No.	00-883479-002 883479-2
description	rinse pipe ø 17mm L 69mm		
For models:	AM-10, AM-11, AM-141, ECOMAX-602-10, ECOMAX-602-11, ECOMAX-602S-11, ECOMAX-612-10, ECOMAX-612S-10		



GEV No.	518003	Ref. No.	139321-28 139321-872
description	screw cap		
For models:	GE-400, GW-600, GW-600S, GW-601, GW-601S		



GEV No.	518288	Ref. No.	139321-921
description	screw connection		



GEV No.	524922	Ref. No.	898263-1
description	shim for wash arm support ID ø 49mm ED ø 70mm H 3mm		
For models:	AM-700, AM900, AMS900, AMX-900, AMXR-900, AMXS-900, ECOMAX-600, ECOMAX-650		



GEV No.	518127	Ref. No.	119227 B119227
description	slide ring for wash arm mounting pos. upper/lower ED ø 40mm ID ø 19.4mm thickness 6.2mm		
For models:	AM-12E, AM-12EC, AM-12EF, AM-12ER, LM-12E, UW-100, UW-105, UW-120, UW-125, UW-135, UW-135H, UW-200, UW-205		



GEV No.	518119	Ref. No.	00-774072-001 774072-1
description	slide ring PTFE ED ø 19mm ID ø 14.5mm thickness 0.5mm for rinse arm Qty 1 pcs suitable for HOBART		
For models:	AM-10, AM-11, AM-141, AM-700, AM900, AM900-10N, AM900-90, AMS900, AMS900-10N, AMX, AMX-10HL, AMX-90, AMX-900, AMX-E, AMX-ER, AMXR, AMX-R, AMXR-900, AMXS, AMXS-900, AMXT, AMXTS, AMXX, AMXX-1300, AMXXR, AMXXR-1300, AMXXS, AMXXS-1300, AMXXT, AUP, AUP-90, AUPS, AUX, AUX_, AUX-E, AUX-ER, AUX-R, AUXX, AUXX-1300, AUXXL, AUXXL-11N, AUXXLS-11N, AUXXR, AUXXR-1300, AUXXS, AUXXS-1300, AUXXT, AUXXTS, ECOMAX-402, ECOMAX-502... (Other models you can see in the webshop)		





GEV No.	518120	Ref. No.	00-774072-002 774072-2
description	slide ring PTFE ED ø 21mm ID ø 16mm thickness 0.5mm for rinse arm Qty 1 pcs		
For models:	AM-10, AM-11, AM-141, AM-700, AM900, AM900-10N, AM900-90, AMS900, AMS900-10N, AMX, AMX-10HL, AMX-90, AMX-900, AMX-E, AMX-ER, AMXR, AMX-R, AMXR-900, AMXS, AMXS-900, AMXT, AMXTS, AMXX, AMXX-1300, AMXXR, AMXXR-1300, AMXXS, AMXXS-1300, AMXXT, AUP, AUP-90, AUPS, AUX, AUX_, AUX-E, AUX-ER, AUX-R, AUXX, AUXX-1300, AUXXL, AUXXL-11N, AUXXLS-11N, AUXXR, AUXXR-1300, AUXXS, AUXXS-1300, AUXXT, AUXXTS, ECOMAX-402, ECOMAX-502... (Other models you can see in the webshop)		





GEV No.	511678	Ref. No.	00-774072-007 774072-7
description	slide ring PTFE ED ø 24mm ID ø 13mm thickness 1mm for rinse arm Qty 1 pcs		
For models:	AM-10, AM-11, AM-141, AMX, AMX-10HL, AMX-90, AMXR, AMXS, AMXX, AMXXR, AMXXS, AUP, AUP-90, AUPS, AUXX, AUXXR, AUXXS, ECOMAX-402, ECOMAX-502, ECOMAX-602-10, ECOMAX-602-11, ECOMAX-602S-11, ECOMAX-612-10, ECOMAX-612S-10, FP, FX, FX-McDonalds, GP, GX		







			
1			
GEV No.	513270	Ref. No.	139321-920
description	throttle disc		



			
1			
GEV No.	510112	Ref. No.	139321-107 139321-873
description	Thumb screw thread M10 thread L 10mm ø 22mm H 4.5mm SS		
For models:	GE-400, GW-600, GW-600S, GW-601, GW-601S		

			
1			
GEV No.	511679	Ref. No.	00-324071-000
description	T-piece connection 17.5mm plastic L 80mm W 40mm connection 1: 13.5mm connection 2: 13.5mm suitable for HOBART		
For models:	AM-10, AM-11, AM-141, AM900-10N, AM900-90, AMS900-10N, AMX, AMX-10HL, AMX-90, AMXR, AMXS, AMXT, AMXTS, AMXX, AMXXR, AMXXS, AUP, AUP-90, AUPS, AUXX, AUXXL-11N, AUXXLS-11N, AUXXR, AUXXS, AUXXT, AUXXTS, ECOMAX-402, ECOMAX-602-10, ECOMAX-602-11, ECOMAX-602S-11, ECOMAX-612-10, ECOMAX-612S-10, ECOMAX-700, FE, FP, FX, FX-McDonalds, GC, GC11, GC12, GC31, GC32, GP, GX, UX, UXL, UXLS, UXS, UXT, UXTH...(Other models you can see in the webshop)		
accessories for	511679		
	GEV No.	520573	Ref. No. 00-324510-202 324510-202
	hose clamp ø 20mm wire gauge ø 2mm Qty 1 pcs		



			
1			
GEV No.	524880	Ref. No.	883974-001 883974-1
description	wash arm bearing mounting pos. upper/lower ø 22mm H 37mm thread 3/4"		

			
1			
GEV No.	524831	Ref. No.	01-510702-1 883974-002 883974-2
description	wash arm bearing mounting pos. upper/lower ø 22mm H 53mm with nut thread 3/4"		

			
1			
GEV No.	518079	Ref. No.	734803-1
description	wash arm bearing with nut		
For models:	AM-700, AM900, AMS900, AMX-900, AMXR-900, AMXS-900, ECOMAX-600, ECOMAX-650, FE, FE-W, FX, GX, HE, HE600-HL, HE-P, HX, HX-60-EHL, HX-E, HX-ES, HX-S		
spare parts for	518079		
	GEV No.	510634	Ref. No. 324042
	wash arm bearing ø 22mm H 39mm		
	GEV No.	510637	Ref. No. 324043
	nut for wash arm support		

			
1			
GEV No.	513714	Ref. No.	139321-906
description	wash pipe		
spare parts for	513714		
	GEV No.	518141	Ref. No. —
	wash arm support thread M46x2 ø 44mm ID ø 39mm L 112.5mm W 86mm hole ø 12mm		



			
1			
GEV No.	518633	Ref. No.	139321-643
description	wash pipe		
For models:	CHF45, EF-40		

			
1			
GEV No.	511670	Ref. No.	00-883529-001 883529-1
description	wash pipe ø 28x56mm stainless steel L-shape L1 685mm L2 275mm		
For models:	AM-10, AM-11, AM-141, AM900-10N, AM900-90, AMS900-10N, AMX, AMX-10HL, AMX-90, AMXR, AMXS, AMXT, AMXTS, AMXX, AMXXR, AMXXS, AUP, AUP-90, AUPS, AUXX, AUXXR, AUXXS, AUXXT, AUXXTS, ECOMAX-602-10, ECOMAX-602-11, ECOMAX-602S-11, ECOMAX-612-10, ECOMAX-612S-10		
accessories for	511670		
	GEV No.	507497	Ref. No.
			00-883481-001 883481-1
	connection wash pipe ø 47mm connection 66x36mm		

washing and rinsing systems (sorted by producer)

HOBART

			
1			
GEV No.	513145	Ref. No.	139321-943
description	wash arm L 510mm nozzles 10 mounting ø 16mm mounting pos. upper and bottom		
For models:	CHH-50, CHH-60D, CHH-70D, EH-60, EH-70		

			
1			
GEV No.	503507	Ref. No.	227049 227051 D-227049
description	wash arm L 546mm nozzles 8 mounting ø 19/81mm mounting pos. lower		
For models:	AM-12E, AM-12EC, AM-12EF, AM-12ER, AM-600, AM-600C, AM-600CR, AM-600R, LM-12E, UW-100, UW-105, UW-120, UW-125, UW-135, UW-135H, UW-200, UW-205		
spare parts for	503507		
	GEV No.	518127	Ref. No.
			119227 B119227
	slide ring for wash arm mounting pos. upper/lower ED ø 40mm ID ø 19.4mm thickness 6.2mm		

			
1			
GEV No.	524657	Ref. No.	01-294032-001 01-294032-1
description	wash arm L 390mm nozzles 7 mounting ø 17/45mm		
For models:	ECOMAX-402		
spare parts for	524657		
	GEV No.	524665	Ref. No.
			01-240028-001 01-240028-1
	blank nozzle for cleaning M20		
accessories for	524657		
	GEV No.	518153	Ref. No.
			01-294038-001 01-294038-1
	wash arm support mounting pos. upper		

			
1			
GEV No.	524645	Ref. No.	01-240050-001 01-240050-1
description	wash arm L 515mm nozzles 8 mounting ø 17/45mm mounting pos. upper/lower		
For models:	AM-10, AM-11, AM-141, ECOMAX-502, ECOMAX-602-10, ECOMAX-602-11, ECOMAX-602S-11, ECOMAX-612-10, ECOMAX-612S-10, FP, FX, FX-McDonalds, GP, GX		
spare parts for	524645		
	GEV No.	524665	Ref. No.
			01-240028-001 01-240028-1
	blank nozzle for cleaning M20		

			
1			
GEV No.	524665	Ref. No.	01-240028-001 01-240028-1
description	blank nozzle for cleaning M20		
For models:	AM-10, AM-11, AM-141, ECOMAX-402, ECOMAX-502, ECOMAX-602-10, ECOMAX-602-11, ECOMAX-602S-11, ECOMAX-612-10, ECOMAX-612S-10, FP, FX, FX-McDonalds, GP, GX		



			
1			
GEV No.	518629	Ref. No.	324039 324444 883472-1
description	wash arm L 512mm nozzles 8 mounting ø 16/45.5mm mounting pos. upper and bottom		
For models:	AM-700, AM900, AMS900, AMX-900, AMXR-900, AMXS-900, ECOMAX-600, ECOMAX-650, FE, FE-W, FX, HE, HE600-HL, HE-P, HX, HX-30, HX-30E, HX-30ES, HX-30S, HX-40, HX-40E, HX-40ES, HX-40S, HX-60-EHL, HX-E, HX-ES, HX-S		

			
1			
GEV No.	517587	Ref. No.	00-886898-001 324738 324831 886898-1
description	rinse arm mounting pos. lower L 680mm nozzles 11 thread 1/4"		
For models:	ECOMAX-700, UX, UX-30, UX-30B, UX-30E, UX-30EB, UX-30EH, UX-30ES, UX-30ESB, UX-30ESH, UX-30H, UX-30-McDonalds, UX-30S, UX-30SB, UX-30SH, UX-60, UX-60B, UX-60E, UX-60EB, UX-60EH, UX-60EHB, UX-60H, UX-60HB, UXL, UXLs, UXs, UXT, UXTH, UXTHL, UXTHLS, UXTHS, UXTL, UXTLH, UXTLHS, UXTLS, UXTS		

			
1			
GEV No.	517589	Ref. No.	00-324614-000 324798-1 883453-1
description	wash arm L 535mm nozzles 16		
For models:	AMX, AMX-E, AMX-ER, AMX-R, AMXX-1300, AMXXR-1300, AMXXS-1300, AMXXT, AUX, AUX_, AUX-E, AUX-ER, AUX-R, AUXX-1300, AUXXL, AUXXR-1300, AUXXS-1300, AUXXT, UXD-30		





			
1			
GEV No.	517588	Ref. No.	01-240096-001 01-240096-1 323805 883126
description	rinse arm mounting pos. upper/lower L 520mm nozzles 9 thread 1/4"		
For models:	AM-700, ECOMAX-600, ECOMAX-650, FE, HE, HE600-HL, HE-P		
spare parts for	517588		
	GEV No.	510636	Ref. No. 324172 867429-1 886609
end cap for rinse arm set 4-piece			



			
1			
GEV No.	517590	Ref. No.	00-324691-000 00-324798-002 324798-2
description	wash arm mounting pos. upper/lower L 690mm nozzles 20		
For models:	ECOMAX-700, UX, UX-30, UX-30B, UX-30E, UX-30EB, UX-30EH, UX-30ES, UX-30ESB, UX-30ESH, UX-30H, UX-30-McDonalds, UX-30S, UX-30SB, UX-30SH, UX-60, UX-60B, UX-60E, UX-60EB, UX-60EH, UX-60EHB, UX-60H, UX-60HB, UXL, UXLs, UXs, UXT, UXTH, UXTHL, UXTHLS, UXTHS, UXTL, UXTLH, UXTLHS, UXTLS, UXTS		



			
1			
GEV No.	518112	Ref. No.	324039 324444 883472-1 old
description	wash arm L 512mm nozzles 8 mounting ø 16/45.5mm mounting pos. upper and bottom		
spare parts for	518112		
	GEV No.	510636	Ref. No. 324172 867429-1 886609
end cap for rinse arm set 4-piece			
	GEV No.	518079	Ref. No. 734803-1
wash arm bearing with nut			
accessories for	518112		
	GEV No.	518598	Ref. No. 324067
rinse arm shaft			

			
1			
GEV No.	517585	Ref. No.	00-324785-000 886610
description	end cap for wash arm ø 28mm H 10mm Qty 4 pcs		
For models:	AMX, AMX-E, AMX-ER, AMX-R, AMXX-1300, AMXXR-1300, AMXXS-1300, AMXXT, AUX, AUX_, AUX-E, AUX-ER, AUX-R, AUXX-1300, AUXXL, AUXXR-1300, AUXXS-1300, AUXXT, ECOMAX-700, UX, UX-30, UX-30B, UX-30E, UX-30EB, UX-30EH, UX-30ES, UX-30ESB, UX-30ESH, UX-30H, UX-30-McDonalds, UX-30S, UX-30SB, UX-30SH, UX-60, UX-60B, UX-60E, UX-60EB, UX-60EH, UX-60EHB, UX-60H, UX-60HB, UXD-30, UXL, UXLs, UXs, UXT, UXTH, UXTHL, UXTHLS, UXTHS...(Other models you can see in the webshop)		

			
1			
GEV No.	510636	Ref. No.	324172 867429-1 886609
description	end cap for rinse arm set 4-piece		
For models:	AM-700, AM900, AMS900, AMX, AMX-900, AMX-E, AMX-ER, AMX-R, AMXR-900, AMXS-900, AMXX-1300, AMXXR-1300, AMXXS-1300, AMXXT, AUX, AUX_, AUX-E, AUX-ER, AUX-R, AUXX-1300, AUXXL, AUXXR-1300, AUXXS-1300, AUXXT, ECOMAX-600, ECOMAX-650, ECOMAX-700, FE, FE-W, FX, GX, HE, HE600-HL, HE-P, HX, HX-30, HX-30E, HX-30ES, HX-30S, HX-40, HX-40E, HX-40ES, HX-40S, HX-60-EHL, HX-E, HX-ES, HX-S, UX, UX-30, UX-30B...(Other models you can see in the webshop)		

				
1				
GEV No.	524658	Ref. No.	01-294029-001 01-294029-1	
description	rinse arm L 395mm nozzles 7 mounting ø 14mm with rinse arm shaft			
For models:	ECOMAX-402			
spare parts for	524658			
	GEV No.	511678	Ref. No.	00-774072-007 774072-7
	slide ring PTFE ED ø 24mm ID ø 13mm thickness 1mm for rinse arm Qty 1 pcs			
	GEV No.	518119	Ref. No.	00-774072-001 774072-1
	slide ring PTFE ED ø 19mm ID ø 14.5mm thickness 0.5mm for rinse arm Qty 1 pcs suitable for HOBART			
	GEV No.	518120	Ref. No.	00-774072-002 774072-2
	slide ring PTFE ED ø 21mm ID ø 16mm thickness 0.5mm for rinse arm Qty 1 pcs			







				
1				
GEV No.	524659	Ref. No.	01-240096-003 01-240096-3	
description	rinse arm L 515mm nozzles 8 mounting ø 16mm with rinse arm shaft edition FX			
For models:	AM-10, AM-11, AM-141, ECOMAX-502, ECOMAX-602-10, ECOMAX-602-11, ECOMAX-602S-11, ECOMAX-612-10, ECOMAX-612S-10, FP, FX, FX-McDonalds, GP, GX			
spare parts for	524659			
	GEV No.	511678	Ref. No.	00-774072-007 774072-7
	slide ring PTFE ED ø 24mm ID ø 13mm thickness 1mm for rinse arm Qty 1 pcs			
	GEV No.	518119	Ref. No.	00-774072-001 774072-1
	slide ring PTFE ED ø 19mm ID ø 14.5mm thickness 0.5mm for rinse arm Qty 1 pcs suitable for HOBART			

spare parts for	524659			
	GEV No.	518120	Ref. No.	00-774072-002 774072-2
	slide ring PTFE ED ø 21mm ID ø 16mm thickness 0.5mm for rinse arm Qty 1 pcs			
	GEV No.	518147	Ref. No.	01-240095-001 01-240095-1
	rinse arm shaft			
	GEV No.	518152	Ref. No.	01-240205-001 01-240205-1 324036
	knurled nut thread M12x1 ø 32mm H 3mm mounting pos. upper/lower SS for wash arm ID ø 11.5mm ED ø 32mm thickness 3mm			

			
1			
GEV No.	503183	Ref. No.	01-240096-004 01-240096-4
description	rinse arm L 520mm mounting pos. upper/lower nozzles 8		
For models:	AM900-10N, AM900-90, AMS900-10N, AMX, AMX-10HL, AMX-90, AMXR, AMXS, AMXT, AMXTS, AMXX, AMXXR, AMXXS, AUP, AUP-90, AUPS, AUX, AUXXL-11N, AUXXLS-11N, AUXXR, AUXXS, AUXXT, AUXXTS		

			
1			
GEV No.	503161	Ref. No.	00-324052-000 00-324445-000 01-240096-002 01-240096-2
description	rinse arm L 520mm nozzles 9 mounting ø 16mm		
For models:	AM900, AMS900, AMX, AMX-900, AMX-E, AMX-ER, AMX-R, AMXR-900, AMXS-900, AMXX-1300, AMXXR-1300, AMXXS-1300, AMXXT, AUX, AUX_, AUX-E, AUX-ER, AUX-R, AUXX-1300, AUXXL, AUXXR-1300, AUXXS-1300, AUXXT, ECOMAX-650, FE, FX, GX, HE-P, HX, HX-30, HX-30E, HX-30ES, HX-30S, HX-40, HX-40E, HX-40ES, HX-40S, HX-60-EHL, HX-E, HX-ES, HX-S, UXD-30		





			
1			
GEV No.	503508	Ref. No.	296093-2
description	rinse arm L 515mm nozzles 10 mounting ø 8/19mm mounting pos. upper		
For models:	UW-120, UW-125, UW-135, UW-135H, UW-200, UW-205		
spare parts for	503508		
	GEV No.	504574	Ref. No. 67500-30
	O-ring EPDM thickness 1.78mm ID ø 9.25mm Qty 1 pcs		
	GEV No.	510648	Ref. No. 226800-3
	rinse jet		
	GEV No.	511656	Ref. No. 00-172986-018 172986-18
	flat gasket rubber ED ø 13mm ID ø 7.5mm thickness 0.5mm Qty 1 pcs		
	GEV No.	518114	Ref. No. 228643 B228643
	bush for rinse arm ø 14mm H 21mm		
	GEV No.	520498	Ref. No. 226816
	end cap for rinse arm ø 16mm H 11mm		
	GEV No.	697871	Ref. No. 602309 RR-E-2-38
	retaining ring A D1 ø 14mm D2 ø 12.8mm spring steel DIN 7993 thickness 1mm		



			
1			
GEV No.	520498	Ref. No.	226816
description	end cap for rinse arm ø 16mm H 11mm		
For models:	AM-12E, AM-12EC, AM-12EF, AM-12ER, AM-600, AM-600C, AM-600CR, AM-600R, FM-30, FM-30U, FM-400H, FM-400U, FM-500, FM-500H, UW-100, UW-105, UW-120, UW-125, UW-135, UW-135H, UW-200, UW-205, UW-55		



			
1			
GEV No.	511656	Ref. No.	00-172986-018 172986-18
description	flat gasket rubber ED ø 13mm ID ø 7.5mm thickness 0.5mm Qty 1 pcs		
For models:	CX, FM-400H, FM-400U, FM-500, FM-500H, FTT, UW-105, UW-120, UW-125, UW-135, UW-135H, UW-200, UW-205, UW-55, UWX		



			
1			
GEV No.	510648	Ref. No.	226800-3
description	rinse jet		
For models:	CX, FM-500, FM-500H, UW-100, UW-105, UW-120, UW-125, UW-135, UW-135H, UW-200, UW-205, UW-55, UWX		



			
1			
GEV No.	524829	Ref. No.	775762-1
description	wash and rinse arm mounting pos. upper/lower wash arm L 395mm rinse arm L 395mm w. jets 6 r. jets 6 mounting ø 45/17mm		
For models:	GC, GC11, GC12, GC31, GC32, GC41, GC42		



			
1			
GEV No.	517559	Ref. No.	139321-870 E990109
description	wash arm wash arm L 500mm rinse arm L 495mm w. jets 9 r. jets 5		

			
1			
GEV No.	518419	Ref. No.	139321-784 139321-944
description	end cap for rinse arm		
For models:	CHH-70D, CLG-25, EH-70		
accessories for	518419		
	GEV No.	528485	Ref. No. —
	O-ring EPDM thickness 1.78mm ID ø 6.07mm Qty 1 pcs		

			
1			
GEV No.	518416	Ref. No.	139321-786
description	opposite support for rinse jet		
accessories for	518416		
	GEV No.	560062	Ref. No. 603455
	flat-headed bolt thread M4 thread L 10mm SS DIN 7985/ISO 7045 Qty 20 pcs intake Phillips head ø 8mm head thickness 2mm		
	GEV No.	560131	Ref. No. —
	hexagonal nut thread M4 H 3.2mm WS 7 SS DIN/ISO DIN 934 / ISO 4032/8673 Qty 20 pcs		

			
1			
GEV No.	513055	Ref. No.	139321-785
description	rinse jet		
accessories for	513055		
	GEV No.	560062	Ref. No. 603455
	flat-headed bolt thread M4 thread L 10mm SS DIN 7985/ISO 7045 Qty 20 pcs intake Phillips head ø 8mm head thickness 2mm		
	GEV No.	560131	Ref. No. —
	hexagonal nut thread M4 H 3.2mm WS 7 SS DIN/ISO DIN 934 / ISO 4032/8673 Qty 20 pcs		

			
1			
GEV No.	518333	Ref. No.	139321-871
description	wash arm mounting pos. left L 220mm mounting ø 24mm nozzles 4		
accessories for	518333		
	GEV No.	518004	Ref. No. 139321-32
	wash jet		
	GEV No.	518272	Ref. No. —
	union nut for wash jet		

			
1			
GEV No.	518332	Ref. No.	139321-875
description	wash arm mounting pos. right L 220mm mounting ø 24mm nozzles 5		
accessories for	518332		
	GEV No.	518004	Ref. No. 139321-32
	wash jet		
	GEV No.	518272	Ref. No. —
	union nut for wash jet		



			
1			
GEV No.	510010	Ref. No.	139321-35
description	wash arm boss L1 64mm L2 60mm mounting ø 16.5mm		
For models:	GE-400, GW-600, GW-600S, GW-601, GW-601S		



			
1			
GEV No.	518004	Ref. No.	139321-32
description	wash jet		

			
1			
GEV No.	518117	Ref. No.	226800-1
description	rinse jet ø 7.5mm H 21.5mm		
For models:	AM-12E, AM-12EC, AM-12EF, AM-12ER, FM-30, FM-30U, UW-100		

			
1			
GEV No.	512474	Ref. No.	01-240631-002
description	nut for wash arm support mounting pos. lower ED ø 60mm ID ø 36mm H 72mm connection ø 42mm		

			
1			
GEV No.	518171	Ref. No.	139321-842
description	opposite support mounting pos. lower for wash arm support		

			
1			
GEV No.	518069	Ref. No.	139321-916
description	wash arm support		
accessories for	518069		
	GEV No.	518071	Ref. No. 139321-915
	gasket for wash arm support L 109mm W 68mm		

			
1			
GEV No.	530467	Ref. No.	ML102842
description	wash arm support kit H 56mm D1 ø 50mm ID ø 36mm		
accessories for	530467		
	GEV No.	530468	Ref. No. 493414
	bushing for rinse arm mounting pos. upper/lower ø 15mm ID ø 12mm H 16mm		



			
1			
GEV No.	524680	Ref. No.	324670 886607
description	wash arm support kit mounting pos. upper ø 62mm H 112mm ID ø 51mm		
For models:	AMX, AMX-E, AMX-ER, AMX-R, AMXX-1300, AMXXR-1300, AMXXS-1300, AMXXT, AUX, AUX_, AUX-E, AUX-ER, AUX-R, AUXX-1300, AUXXL, AUXXR-1300, AUXXS-1300, AUXXT, UX-30, UX-30B, UX-30E, UX-30EB, UX-30EH, UX-30ES, UX-30ESB, UX-30ESH, UX-30H, UX-30-McDonalds, UX-30S, UX-30SB, UX-30SH, UX-60, UX-60B, UX-60E, UX-60EB, UX-60EH, UX-60EHB, UX-60H, UX-60HB, UXD-30, UXTH, UXTHL, UXTHLS, UXTHS, UXTLH, UXTLHS		





 <p>1</p>			
GEV No.	518145	Ref. No.	00-883488-001 883488-1
description	wash arm support mounting pos. lower		
For models:	AM-10, AM-11, AM-141, AM900-10N, AM900-90, AMS900-10N, AMX, AMX-10HL, AMX-90, AMXR, AMXS, AMXT, AMXTS, AMXX, AMXXR, AMXXS, AUP, AUP-90, AUPS, AUXX, AUXXL-11N, AUXXLS-11N, AUXXR, AUXXS, AUXXT, AUXXTS, ECOMAX-602-10, ECOMAX-602-11, ECOMAX-602S-11, ECOMAX-612-10, ECOMAX-612S-10		
accessories for	518145		
	GEV No.	517403	Ref. No.
			00-172986-035 172986-35
	flat gasket EPDM ED ø 71mm ID ø 61mm thickness 1.5mm Qty 1 pcs		
	GEV No.	518143	Ref. No.
			00-775933-003 01-515356-001 775933-3
	slide ring for wash arm ED ø 46mm ID ø 41mm thickness 3mm		
	GEV No.	518144	Ref. No.
			00-883496-001 883496-1
	nut for wash arm support ED ø 74mm WS 65 hole ø 36mm		



 <p>1</p>			
GEV No.	524669	Ref. No.	898194-1
description	wash arm support mounting pos. lower		
For models:	AM-700, AM900, AMS900, AMX-900, AMXR-900, AMXS-900, ECOMAX-600, ECOMAX-650		

 <p>1</p>			
GEV No.	518146	Ref. No.	00-883467-001 883467-1
description	wash arm support mounting pos. upper		
For models:	AM-10, AM-11, AM-141, AM900-10N, AM900-90, AMS900-10N, AMX, AMX-10HL, AMX-90, AMXR, AMXS, AMXT, AMXTS, ECOMAX-602-10, ECOMAX-602-11, ECOMAX-602S-11, ECOMAX-612-10, ECOMAX-612S-10		

 <p>1</p>			
GEV No.	518153	Ref. No.	01-294038-001 01-294038-1
description	wash arm support mounting pos. upper		
For models:	ECOMAX-402, ECOMAX-502		
accessories for	518153		
	GEV No.	518116	Ref. No.
			00-172986-019 172986-19
	gasket for wash arm support rubber ø 60mm ID ø 47mm thickness 1mm		
	GEV No.	518139	Ref. No.
			01-240021-001 01-240021-1
	nut for wash arm support ø 60mm		

accessories for	518153		
	GEV No.	518143	Ref. No.
			00-775933-003 01-515356-001 775933-3
	slide ring for wash arm ED ø 46mm ID ø 41mm thickness 3mm		
	GEV No.	518148	Ref. No.
			01-240097-001 01-240097-1
	rinse pipe ø 17mm L 60mm		

 <p>1</p>			
GEV No.	518115	Ref. No.	324268 324480
description	wash arm support mounting pos. upper kit HE, HX suitable for HOBART		
For models:	AM-700, AM900, AMS900, AMX-900, AMXR-900, AMXS-900, ECOMAX-600, ECOMAX-650, HE, HE600-HL, HE-P, HX, HX-30, HX-30E, HX-30ES, HX-30S, HX-40, HX-40E, HX-40ES, HX-40S, HX-60-EHL, HX-E, HX-ES, HX-S		

 <p>1</p>			
GEV No.	510634	Ref. No.	324042
description	wash arm bearing ø 22mm H 39mm		
For models:	FE, FE-W, FX, GX, HE, HX-30, HX-30E, HX-30ES, HX-30S, HX-40, HX-40E, HX-40ES, HX-40S		
accessories for	510634		
	GEV No.	510637	Ref. No.
			324043
	nut for wash arm support		

 <p>1</p>			
GEV No.	505253	Ref. No.	324727 324729+324728+324730 734804.1
description	wash arm bearing ø 24mm H 58mm		
For models:	AMX, AMX-E, AMX-ER, AMX-R, AMXX-1300, AMXXR-1300, AMXXS-1300, AMXXT, AUX, AUX_, AUX-E, AUX-ER, AUX-R, AUXX-1300, AUXXL, AUXXR-1300, AUXXS-1300, AUXXT, ECOMAX-700, UX, UX-30, UX-30B, UX-30E, UX-30EB, UX-30EH, UX-30ES, UX-30ESB, UX-30ESH, UX-30H, UX-30-McDonalds, UX-30S, UX-30SB, UX-30SH, UX-60, UX-60B, UX-60E, UX-60EB, UX-60EH, UX-60EHB, UX-60H, UX-60HB, UXD-30, UXL, UXLS, UXS, UXT, UXTH, UXTHL, UXTHLS, UXTHS... (Other models you can see in the webshop)		



1

GEV No.	510635	Ref. No.	231893-1
description	nut for wash arm support		
For models:	AM-700, AM900, AMS900, AMX-900, AMXR-900, AMXS-900, ECOMAX-600, ECOMAX-650, FE, FE-W, FX, GX, HE, HE600-HL, HE-P, HX, HX-30, HX-30E, HX-30ES, HX-30S, HX-40, HX-40E, HX-40ES, HX-40S, HX-60-EHL, HX-E, HX-ES, HX-S		



1

GEV No.	510637	Ref. No.	324043
description	nut for wash arm support		
For models:	FE, FE-W, FX, GX, HE, HX-30, HX-30E, HX-30ES, HX-30S, HX-40, HX-40E, HX-40ES, HX-40S		

rinse arm shafts



1

GEV No.	518170	Ref. No.	139321-883
description	extension for rinse arm shaft		



1

GEV No.	510108	Ref. No.	139321-113 139321-868
description	rinse arm shaft		
For models:	GE-400, GW-600, GW-600S, GW-601, GW-601S		



1

GEV No.	513159	Ref. No.	139321-947
description	rinse arm shaft		
For models:	CHH-70D, EH-70		



1

GEV No.	513160	Ref. No.	139321-918 E80282
description	rinse arm shaft		



1

GEV No.	518147	Ref. No.	01-240095-001 01-240095-1
description	rinse arm shaft		
For models:	AM-10, AM-11, AM-141, AM900-10N, AM900-90, AMS900-10N, AMX, AMX-10HL, AMX-90, AMXR, AMXS, AMXT, AMXTS, AMXX, AMXXR, AMXXS, AUP, AUP-90, AUPS, AUX, AUXXL-11N, AUXXLS-11N, AUXXR, AUXXS, AUXXT, AUXXTS, ECOMAX-402, ECOMAX-502, ECOMAX-602-10, ECOMAX-602-11, ECOMAX-602S-11, ECOMAX-612-10, ECOMAX-612S-10, FP, FX, FX-McDonalds, GP, GX		



1

GEV No.	518598	Ref. No.	324067
description	rinse arm shaft		
For models:	AM-700, AM900, AMS900, AMX, AMX-900, AMX-E, AMX-ER, AMX-R, AMXR-900, AMXS-900, AMXX-1300, AMXXT, AUX, AUX_, AUX-E, AUX-ER, AUX-R, AUXX-1300, AUXXL, AUXXT, ECOMAX-600, ECOMAX-650, FE, FE-W, FX, GX, HE, HE600-HL, HE-P, HX, HX-30, HX-30E, HX-30ES, HX-30S, HX-40, HX-40E, HX-40ES, HX-40S, HX-60-EHL, HX-E, HX-ES, HX-S, UXD-30		



1

GEV No.	524686	Ref. No.	324040
description	rinse arm shaft ϕ 16mm H 59.5mm thread M16x2 thread L 14mm		
For models:	AM-700, AM900, AMS900, AMX-900, AMXR-900, AMXS-900, ECOMAX-600, ECOMAX-650, FE, FE-W, FX, GX, HE, HE600-HL, HE-P, HX, HX-30, HX-30E, HX-30ES, HX-30S, HX-40, HX-40E, HX-40ES, HX-40S, HX-60-EHL, HX-E, HX-ES, HX-S		

wash pipes

wash pipes



1

GEV No.	513715	Ref. No.	115113 139321-866
----------------	--------	-----------------	----------------------

description	wash pipe		
For models:	ECOMAX-500		

accessories for	513715		
GEV No.	518339	Ref. No.	139321-864



gasket D2 ϕ 50mm thickness 2mm with 3 screw holes wash arm support equiv. no. 437064 suitable for COLGED hole ϕ 50mm hole distance 67mm



GEV No.	518461	Ref. No.	139321-865
----------------	--------	-----------------	------------

flange for wash arm support



locks

snap locks

producer-specific

HOBART



1

GEV No.	701126	Ref. No.	324221
description	snap lock L 33mm with roller thread M12x1.75 for dishwasher		
For models:	ECOMAX-700, FE, FX, GX, UX-30, UX-30E, UX-30ES, UX-30-McDonalds, UX-30S, UX-60, UX-60E		

miscellaneous



1

GEV No.	696420	Ref. No.	03811C
description	door catch with microswitch L 80mm W 46mm mounting distance 60mm		
spare parts for	696420		
	GEV No.	347567	Ref. No.
			—
	momentary push switch mounting ø 12mm white 1NO 250V 4A connection male faston 6.3mm ambient temperature max. 85°C protection IP40		

hinges

door bearing



1

GEV No.	701300	Ref. No.	01-240709-001 01-240709-1
description	door hinge L 90mm W 19mm H 29mm mounting pos. left bottom thickness 3mm		
For models:	ECOMAX-502		



1

GEV No.	701301	Ref. No.	01-240709-002 01-240709-2
description	door hinge L 90mm W 19mm H 29mm mounting pos. right bottom thickness 3mm		
For models:	ECOMAX-502		

accessories

miscellaneous



1

GEV No.	692307	Ref. No.	01-240789-001 01-240789-1
description	plain washer for hinge ID ø 8mm ED ø 18mm plastic thickness 1mm Qty 1 pcs		
For models:	ECOMAX-502		

fittings for catering equipment

drain taps

brass

drain taps



1

GEV No.	541941	Ref. No.	313048
description	drain tap 1 1/2" IT L 124mm conical seal thread 1 1/2"		
accessories for	541941		
	GEV No.	510404	Ref. No.
			—
	flat gasket fibre ED ø 44mm ID ø 34mm thickness 2mm Qty 1 pcs		

equipment feet and end caps

equipment feet

with screw mounting



1

GEV No.	513287	Ref. No.	139321-683
description	equipment foot tube ø 60mm thread M12 thread L 33mm H 155-235mm SS size 2" Qty 1 pcs		

screw-in feet



1

GEV No.	701101	Ref. No.	01-294066-001 01-294066-1
description	equipment foot thread M10 thread L 60mm ø 30mm H 10mm Qty 1 pcs suitable for HOBART		
For models:	ECOMAX-402, ECOMAX-502		



1

GEV No.	513284	Ref. No.	371450-23
description	equipment foot thread M8 thread L 20mm ø 30mm H 12mm Qty 1 pcs		
For models:	GF-60, GF-60S		

baskets

crumb screens



1

GEV No.	970521	Ref. No.	M160036
description	crumb screen L 382mm W 272mm H 130mm suitable for fryer		

warewashing baskets

steel wire baskets square

glass basket



1

GEV No.	971017	Ref. No.	139321-58
description	glass basket L 382mm W 382mm H 170mm number of rows 3 rows spacing 120mm		
For models:	GW-600, GW-600S, GW-601, GW-601S		
spare parts for	971017		
	GEV No.	970001	Ref. No. —
	sliding corner wire gauge ø 5mm L 120mm W 120mm H 12mm L-shape		



1

GEV No.	971018	Ref. No.	139321-57
description	glass basket L 382mm W 382mm H 170mm number of rows 4 rows spacing 85mm inclined bottom		
For models:	GW-600, GW-600S, GW-601, GW-601S		

mix baskets



1

GEV No.	971013 ¹	Ref. No.	139321-54
description	mix basket L 382mm W 382mm H 90mm mesh type wide-meshed		
For models:	GW-600, GW-600S, GW-601, GW-601S		

¹wide-meshed

gaskets

refrigeration gaskets

plug-in gaskets

profile 9793

We offer custom-made gaskets for this profile

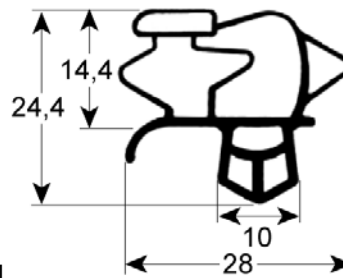

1

GEV No.	900936	Ref. No.	74306
description	refrigeration gasket profile 9793 W 637mm L 1512mm plug size		

gaskets for heated units

door seals

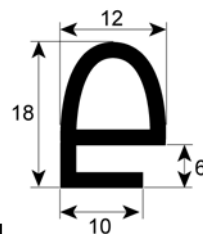

1

GEV No.	901417	Ref. No.	492439 845052
description	door seal profile 2215 L 2010mm suitable for HOBART Qty 1		
For models:	CO-0612E, CS-0612E, CS-0612E-A, CSD-0612E, CSD-0612E-A, CSD-0612-UC, CSL-06E, CSM-0611IE, CSM-0611N		



GEV No.	901366	Ref. No.	492466
description	door seal profile 2215 L 2530mm Qty 1 suitable for HOBART		
For models:	CO-1012E, CS-1012E, CS-1012E-A, CS-1012G, CS-1022E, CS-1022E-A, CSD-1012E, CSD-1012E-A, CSD-1012-UC, CSD-1013G, CSD-1022E, CSD-1022E-A, CSD-1022-UC, CSL-10E, CSM-1011IE, CSM-1011N, CSM-1021IE, CSM-1021N		

GEV No.	902444	Ref. No.	01-235313 1235313 162007
description	door seal profile 2510 W 670mm L 775mm external size		

GEV No.	518126	Ref. No.	492455
description	door seal profile 2980 L 2820mm		
For models:	CO-1012E, CS-1012E, CS-1012E-A, CS-1022E, CS-1022E-A, CSD-1012E, CSD-1012E-A, CSD-1013G, CSD-1022E, CSD-1022E-A, CSL-10E, CSM-1011IE, CSM-1011N, CSM-1021IE, CSM-1021N		

O-rings

EPDM

GEV No.	512500	Ref. No.	01-245340-001 01-245340-1
description	O-ring EPDM thickness 0.2mm ID \varnothing 20mm Qty 1 pcs		
For models:	CN-Protronic, CN-Smartronic, CP-Protronic, CS-Easytronic		

GEV No.	504574	Ref. No.	67500-30
description	O-ring EPDM thickness 1.78mm ID \varnothing 9.25mm Qty 1 pcs		
For models:	AM-12E, AM-12EC, AM-12EF, AM-12ER, AM-600, AM-600C, AM-600CR, AM-600R, CM1E, FM-30, FM-30U, FM-400H, FM-400U, FM-500, FM-500H, FX, GX, UW-100, UW-105, UW-120, UW-125, UW-135, UW-135H, UW-200, UW-205, UW-55, WM2E		

GEV No.	529412	Ref. No.	139321-178
description	O-ring EPDM thickness 2.62mm ID \varnothing 10.78mm Qty 1 pcs		
For models:	AM-700, AM900, AMS900, AMX, AMX-900, AMX-E, AMX-ER, AMX-R, AMXR-900, AMXS-900, AMXX-1300, AMXXR-1300, AMXXS-1300, AMXXT, AUX, AUX_, AUX-E, AUX-ER, AUX-R, AUXX-1300, AUXXL, AUXXR-1300, AUXXS-1300, AUXXT, ECOMAX-600, ECOMAX-650, FE, FE-W, FX, GE-400, GW-600, GW-600S, GW-601, GW-601S, GX, HE, HE600-HL, HE-P, HX, HX-30, HX-30E, HX-30ES, HX-30S, HX-40, HX-40E, HX-40ES, HX-40S, HX-60-EHL, HX-E, HX-ES...(Other models you can see in the webshop)		

GEV No.	518227	Ref. No.	139321-726
description	O-ring EPDM thickness 2.62mm ID \varnothing 12.37mm Qty 1 pcs		

GEV No.	507313	Ref. No.	67500-7
description	O-ring EPDM thickness 2.62mm ID \varnothing 13.95mm Qty 1 pcs		
For models:	AMX, AMX-E, AMX-ER, AMX-R, AUX, AUX_, AUX-E, AUX-ER, AUX-R, M802, ML-104674, ML-104683, ML-104686, ML-104687, ML-104694, ML-104696, UX-30, UX-30B, UX-30E, UX-30EB, UX-30ES, UX-30ESB, UX-30S, UX-30SB, UX-60, UX-60B, UX-60E, UX-60EB, V1401		

GEV No.	528919	Ref. No.	139321-49
description	O-ring EPDM thickness 2.62mm ID \varnothing 20.24mm Qty 1 pcs		
For models:	GE-400, GW-600, GW-600S, GW-601, GW-601S		

GEV No.	518275	Ref. No.	139321-949
description	O-ring EPDM thickness 2.62mm ID \varnothing 6.02mm Qty 1 pcs		

GEV No.	510554	Ref. No.	139321-888
description	O-ring EPDM thickness 2mm ID ø 120mm Qty 1 pcs		

GEV No.	510009	Ref. No.	139321-52
description	O-ring EPDM thickness 3.53mm ID ø 101.2mm Qty 1 pcs		
For models:	GE-400, GW-600, GW-600S, GW-601, GW-601S		

GEV No.	532537	Ref. No.	139321-469
description	O-ring EPDM thickness 3.53mm ID ø 113.9mm Qty 1 pcs		
For models:	CHF45, EF-40		

GEV No.	511322	Ref. No.	67500-72
description	O-ring EPDM thickness 3.53mm ID ø 20.22mm Qty 1 pcs		
For models:	103G, 203G, 2226, 303G, ACW, AM-12E, AM-12EC, AM-12EF, AM-12ER, AM-600, AM-600C, AM-600CR, AM-600R, CN, CNA, CNB, CNR, CR, CR-F, CSA, CX, ECOMAX-800, EWB-S, FTN, FTT, UW-100, UW-105, UW-135, UW-135H, UWX		

GEV No.	517087	Ref. No.	67500-11
description	O-ring EPDM thickness 3.53mm ID ø 23.4mm Qty 1 pcs		
For models:	AMX, AMX-E, AMX-ER, AMX-R, AUX, AUX_, AUX-E, AUX-ER, AUX-R, CN, CNA, CNB, CNR, CR, CR-F, CSA, ECOMAX-800, FTN, UX-30, UX-30B, UX-30E, UX-30EB, UX-30ES, UX-30ESB, UX-30S, UX-30SB, UX-60, UX-60B, UX-60E, UX-60EB		

GEV No.	512501	Ref. No.	00-884505-002 884505-2
description	O-ring EPDM thickness 3.53mm ID ø 24.99mm Qty 1 pcs		
For models:	CN, CNA, CNB, CN-Protronic, CNR, CN-Smartronic, CP-Protronic, CSA, CS-Easytronic, ECOMAX-800, FTN		

GEV No.	511937	Ref. No.	67500-12
description	O-ring EPDM thickness 3.53mm ID ø 28.17mm Qty 1 pcs		
For models:	AM-700, AM900, AMS900, AMX-900, AMXR-900, AMXS-900, ECO-MAX-600, ECOMAX-650, ECW, HE, HE600-HL, HE-P, HX, HX-30, HX-30E, HX-30ES, HX-30S, HX-40, HX-40E, HX-40ES, HX-40S, HX-60-EHL, HX-E, HX-ES, HX-S		

GEV No.	510072	Ref. No.	139321-192
description	O-ring EPDM thickness 3.53mm ID ø 32.93mm Qty 1 pcs		

GEV No.	506015	Ref. No.	139321-738 371450-64 456052
description	O-ring EPDM thickness 3.53mm ID ø 39.69mm Qty 1 pcs		
For models:	CLG-25-NA, ECOMAX-400S-12, GF-60, GF-60S		

GEV No.	505180	Ref. No.	00-233982-001 00-276903-021 233982-1 276903-21
description	O-ring EPDM thickness 3.53mm ID ø 47.22mm Qty 1 pcs		
For models:	CO-0611E, CO-1011E, CO-2011E, CS-0611E, CS-0612E-A, CS-1011E, CS-1012E-A, CS-1022E-A, CS-2011E, CS-2012E-A, CS-2022E-A, CSD-0611E, CSD-0612E-A, CSD-1011E, CSD-1012E-A, CSD-1022E-A, CSD-2011E, CSD-2012E-A, CSD-2022E-A, FX, GX, HX, HX-30, HX-30E, HX-30ES, HX-30S, HX-40, HX-40E, HX-40ES, HX-40S, HX-E, HX-ES, HX-S		

GEV No.	532118	Ref. No.	RTCU700565
description	O-ring EPDM thickness 3.53mm ID ø 55.56mm Qty 10 pcs		

GEV No.	532603	Ref. No.	139321-1041
description	O-ring EPDM thickness 3.53mm ID ø 69.85mm Qty 1 pcs		

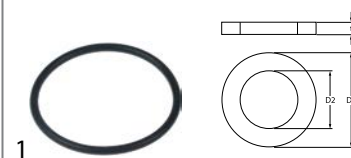

GEV No.	518113	Ref. No.	00-276903-017 276903-17
description	O-ring EPDM thickness 3mm ID ø 46mm Qty 1 pcs		
For models:	FE-W, FX, GX, HX, HX-30, HX-30E, HX-30ES, HX-30S, HX-40, HX-40E, HX-40ES, HX-40S, HX-60-EHL, HX-E, HX-ES, HX-S		

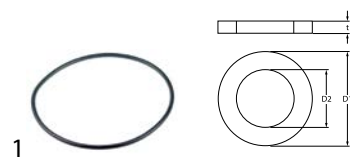

GEV No.	532664	Ref. No.	276903-18
description	O-ring EPDM thickness 3.5mm ID ø 103mm Qty 1 pcs		
For models:	FE-W, FX, GX, HX, HX-30, HX-30E, HX-30ES, HX-30S, HX-40, HX-40E, HX-40ES, HX-40S, HX-60-EHL, HX-E, HX-ES, HX-S		

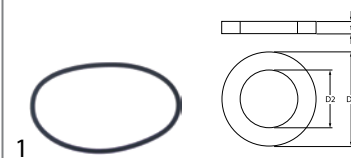

GEV No.	510427	Ref. No.	775465-11
description	O-ring EPDM thickness 3mm ID ø 83mm Qty 1 pcs		
For models:	AM900, AMS900, FX, GC, GC31, GC32, GC41, GC42, GX		

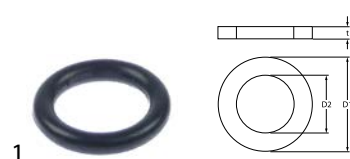

GEV No.	532667	Ref. No.	276903-26
description	O-ring EPDM thickness 3.5mm ID ø 14mm Qty 1 pcs		
For models:	AM-700, AM900, AMS900, AMX, AMX-900, AMX-E, AMX-ER, AMX-R, AMXR-900, AMXS-900, AMXX-1300, AMXXR-1300, AMXXS-1300, AMXXT, AUX, AUX_, AUX-E, AUX-ER, AUX-R, AUXX-1300, AUXXL, AUXXR-1300, AUXXS-1300, AUXXT, ECOMAX-600, ECOMAX-650, HE, HE600-HL, HE-P, HX, HX-30, HX-30E, HX-30ES, HX-30S, HX-40, HX-40E, HX-40ES, HX-40S, HX-60-EHL, HX-E, HX-ES, HX-S, UX-30, UX-30B, UX-30E, UX-30EB, UX-30EH, UX-30ES, UX-30ESB, UX-30ESH...(Other models you can see in the webshop)		

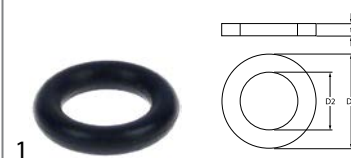

GEV No.	502076	Ref. No.	00-276903-002 276903-2
description	O-ring EPDM thickness 4mm ID ø 12mm Qty 1 pcs		
For models:	AM-600, AM-600C, AM-600CR, AM-600R, UW-105, UW-135, UW-135H		



GEV No.	510419	Ref. No.	00-276903-019 276903-19
description	O-ring EPDM thickness 3mm ID ø 150mm Qty 1 pcs		
For models:	FE-W, FX, GX, HX, HX-30, HX-30E, HX-30ES, HX-30S, HX-40, HX-40E, HX-40ES, HX-40S, HX-60-EHL, HX-E, HX-ES, HX-S		

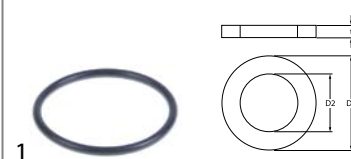

GEV No.	521035	Ref. No.	00-276903-028 276903-28
description	O-ring EPDM thickness 4mm ID ø 137mm Qty 1 pcs		
For models:	AM-10, AM-11, AM-141, AM-700, AM900, AM900-10N, AM900-90, AMS900, AMS900-10N, AMX, AMX-10HL, AMX-90, AMX-900, AMX-E, AMX-ER, AMXR, AMX-R, AMXR-900, AMXS, AMXS-900, AMXT, AMXTS, AMXX, AMXX-1300, AMXXR, AMXXR-1300, AMXXS, AMXXS-1300, AMXXT, AUP, AUP-90, AUPS, AUX, AUX_, AUX-E, AUX-ER, AUX-R, AUXX, AUXX-1300, AUXXL, AUXXL-11N, AUXXLS-11N, AUXXR, AUXXR-1300, AUXXS, AUXXS-1300, AUXXT, AUXXTS, CN, CNA...(Other models you can see in the webshop)		



GEV No.	510563	Ref. No.	276903-9
description	O-ring EPDM thickness 3mm ID ø 28mm Qty 1 pcs		
For models:	AM-12E, AM-12EC, AM-12EF, AM-12ER, FUX, UW-100, UW-105, UW-120, UW-125, UW-135, UW-135H, UW-200, UW-205		



GEV No.	532663	Ref. No.	276903-27
description	O-ring EPDM thickness 4mm ID ø 305mm Qty 1 pcs		
For models:	AMX, AMX-E, AMX-ER, AMX-R, AUX, AUX_, AUX-E, AUX-ER, AUX-R, CN, CNA, CNB, CNR, CR, CR-F, CSA, ECOMAX-800, FTN, UX-30, UX-30B, UX-30E, UX-30EB, UX-30ES, UX-30ESB, UX-30S, UX-30SB, UX-60, UX-60B, UX-60E, UX-60EB		

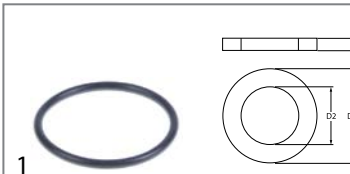

GEV No.	521033	Ref. No.	00-276903-029 276903-29
description	O-ring EPDM thickness 4mm ID ø 50mm Qty 1 pcs		
For models:	AM-10, AM-11, AM-141, AM900-10N, AM900-90, AMS900-10N, AMX, AMX-10HL, AMX-90, AMX-E, AMX-ER, AMXR, AMX-R, AMXS, AMXT, AMXTS, AMXX, AMXX-1300, AMXXR, AMXXR-1300, AMXXS, AMXXS-1300, AMXXT, AUP, AUP-90, AUPS, AUX, AUX_, AUX-E, AUX-ER, AUX-R, AUXX, AUXX-1300, AUXXL, AUXXL-11N, AUXXLS-11N, AUXXR, AUXXR-1300, AUXXS, AUXXS-1300, AUXXT, AUXXTS, ECOMAX-602-10, ECOMAX-602-11, ECOMAX-602S-11, ECOMAX-612-10, ECOMAX-612S-10, UX-30, UX-30B, UX-30E...(Other models you can see in the webshop)		

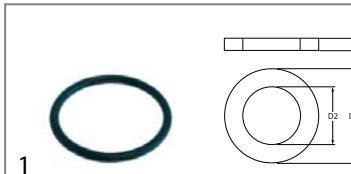

GEV No.	510409	Ref. No.	00-276903-053 00-67500-016 00-67500-118 276903-53 670500-118 67500-16
description	O-ring EPDM thickness 5.34mm ID ø 56.52mm Qty 1 pcs		
For models:	CR-F, CX, ECW, EWB-S, FTN, FTT, FTX, FUX, ML-104674, ML-104683, ML-104686, UW-135, UW-135H, UWX, UX-60, UX-60B, UX-60E, UX-60EB, UX-60EH, UX-60EHB, UX-60H, UX-60HB, UXT, UXTH, UXTHL, UXTHLS, UXTHS, UXTL, UXTLH, UXTLHS, UXTLS, UXTS, V1401		

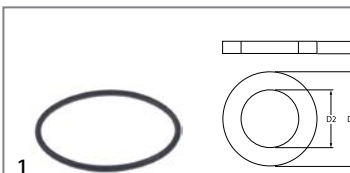

GEV No.	502250	Ref. No.	00-276903-031 276903-31
description	O-ring EPDM thickness 4mm ID ø 74mm Qty 1 pcs		
For models:	AMX, AMX-E, AMX-ER, AMX-R, AUX, AUX_, AUX-E, AUX-ER, AUX-R, CN, CNA, CNB, CNR, CR, CR-F, CSA, ECOMAX-800, ECW, FTN, UX-30, UX-30B, UX-30E, UX-30EB, UX-30EH, UX-30ES, UX-30ESB, UX-30ESH, UX-30H, UX-30-McDonalds, UX-30S, UX-30SB, UX-30SH, UX-60, UX-60B, UX-60E, UX-60EB, UX-60EH, UX-60EHB, UX-60H, UX-60HB, UXD-30		

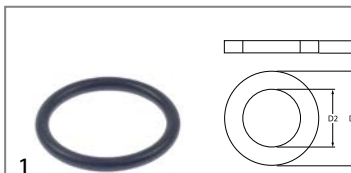

GEV No.	532665	Ref. No.	139321-37 456002
description	O-ring EPDM thickness 6mm ID ø 48mm Qty 1 pcs		
For models:	CHH-70D, ECOMAX-500, ECOMAX-601, EH-70, GE-400, GF-60, GF-60S, GW-600, GW-600S, GW-601, GW-601S, H-60, H66		

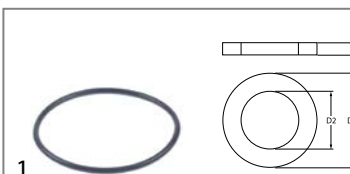

GEV No.	532666	Ref. No.	276903-10
description	O-ring EPDM thickness 4mm ID ø 75mm Qty 1 pcs		
For models:	AM-12E, AM-12EC, AM-12EF, AM-12ER, AM-600, AM-600C, AM-600CR, AM-600R, UW-100, UW-105		

Viton



GEV No.	521034	Ref. No.	00-276903-055 276903-55
description	O-ring Viton thickness 1.5mm ID ø 6mm Qty 1 pcs		
For models:	AM-10, AM-11, AM-141, AM900-10N, AM900-90, AMS900-10N, AMX, AMX-10HL, AMX-90, AMXR, AMXS, AMXT, AMXTS, AMXX, AMXXR, AMXXS, AUP, AUP-90, AUPS, AUXX, AUXXL-11N, AUXXLS-11N, AUXXR, AUXXS, AUXXT, AUXXTS, ECOMAX-602-10, ECOMAX-602-11, ECOMAX-602S-11, ECOMAX-612-10, ECOMAX-612S-10		



GEV No.	505092	Ref. No.	233982-6
description	O-ring EPDM thickness 5.34mm ID ø 43.82mm Qty 1 pcs		
For models:	CS-0612E-A, CS-1012E-A, CS-2012E-A, CSD-0612E-A, CSD-1012E-A, CSD-2012E-A		

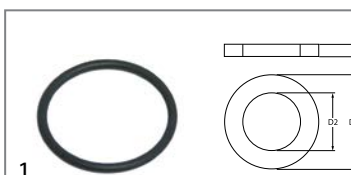

GEV No.	521031	Ref. No.	00-276903-050 276903-50
description	O-ring Viton thickness 2mm ID ø 24mm Qty 1 pcs		
For models:	AMX, AMX-10HL, AMX-90, AMXR, AMXS, AMXT, AMXTS, AMXX, AMXXR, AMXXS, AUP, AUP-90, AUPS, AUXX, AUXXL-11N, AUXXLS-11N, AUXXR, AUXXS, AUXXT, AUXXTS, ECOMAX-402, ECOMAX-502, ECOMAX-602-11, ECOMAX-602S-11, ECOMAX-612-10, ECOMAX-612S-10, FP, FX, FX-McDonalds, GP, GX		

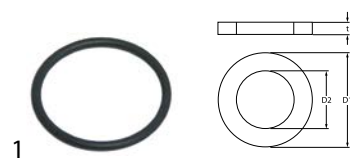

			
GEV No.	521032	Ref. No.	00-276903-056 276903-56
description	O-ring Viton thickness 3mm ID ø 25mm Qty 1 pcs		
For models:	AM-10, AM-11, AM-141, AM900-10N, AM900-90, AMS900-10N, AMX, AMX-10HL, AMX-90, AMXR, AMXS, AMXT, AMXTS, AMXX, AMXXR, AMXXS, AUP, AUP-90, AUPS, AUXX, AUXXL-11N, AUXXLS-11N, AUXXR, AUXXS, AUXXT, AUXXTS, CP-Protronic, ECOMAX-602-10, ECOMAX-602-11, ECOMAX-602S-11, ECOMAX-612-10, ECOMAX-612S-10		

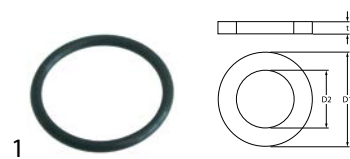
			
GEV No.	521030	Ref. No.	01-240135-011 01-240135-11
description	O-ring Viton thickness 5.34mm ID ø 47mm Qty 1 pcs		
For models:	AM-10, AM-11, AM-141, AM900-10N, AM900-90, AMS900-10N, AMX, AMX-10HL, AMX-90, AMXR, AMXS, AMXT, AMXTS, AMXX, AMXXR, AMXXS, AUP, AUP-90, AUPS, AUXX, AUXXL-11N, AUXXLS-11N, AUXXR, AUXXS, AUXXT, AUXXTS, ECOMAX-402, ECOMAX-502, ECOMAX-602-10, ECOMAX-602-11, ECOMAX-602S-11, ECOMAX-612-10, ECOMAX-612S-10, FP, FX, FX-McDonalds, GP, GX		

miscellaneous

			
GEV No.	510149	Ref. No.	226988
description	O-ring rubber thickness 6.3mm ID ø 45mm Qty 1 pcs		
For models:	AM-12E, AM-12EC, AM-12EF, AM-12ER, AM-600, AM-600C, AM-600CR, AM-600R, UW-100, UW-105, UW-135, UW-135H		

sealing washers

fibre gaskets

			
GEV No.	529349	Ref. No.	139321-21
description	flat gasket FIBER ED ø 22mm ID ø 16.5mm thickness 2mm for thread 3/8" Qty 1 pcs		
For models:	GE-400, GW-600, GW-600S, GW-601, GW-601S		

			
GEV No.	518393	Ref. No.	139321-173
description	flat gasket FIBER ED ø 24mm ID ø 17mm thickness 2mm Qty 1 pcs		
For models:	GF-60S, GW-600, GW-600S, GW-601, GW-601S		

			
GEV No.	524900	Ref. No.	168611-3 300084-1
description	flat gasket FIBER ED ø 30mm ID ø 21mm thickness 1.6mm Qty 1 pcs		
For models:	201G, 301G, AM-12E, AM-12EC, AM-12EF, AM-12ER, AM-600, AM-600C, AM-600CR, AM-600R, CM1E, CN, CNA, CNB, CNR, CO-2011E, CR, CR-F, CS-2011E, CSA, CSD-2011E, ECOMAX-800, FE-W, FTN, FTT, FTX, FX, GX, HX, HX-30, HX-30E, HX-30ES, HX-30S, HX-40, HX-40E, HX-40ES, HX-40S, HX-60-EHL, HX-E, HX-ES, HX-S, UW-105, UW-120, UW-125, UW-135, UW-135H, UW-200, UW-205, UWX, UX-60... (Other models you can see in the webshop)		

			
GEV No.	524898	Ref. No.	168611-11
description	flat gasket FIBER ED ø 35mm ID ø 22mm thickness 2mm Qty 1 pcs		
For models:	AMX-ER, AMX-R, AUX-ER, AUX-R, CN, CNB, CX, ECW, UW-120, UW-125, UW-200, UW-205, UWX		

			
GEV No.	510074	Ref. No.	139321-653
description	flat gasket FIBER ED ø 35mm ID ø 27mm thickness 1.5mm Qty 1 pcs		

rubber gaskets

			
GEV No.	517403	Ref. No.	00-172986-035 172986-35
description	flat gasket EPDM ED ø 71mm ID ø 61mm thickness 1.5mm Qty 1 pcs		
For models:	AM-10, AM-11, AM-141, AM900-10N, AM900-90, AMS900-10N, AMX, AMX-10HL, AMX-90, AMXR, AMXS, AMXT, AMXTS, AMXX, AMXXR, AMXXS, AUP, AUP-90, AUPS, AUXX, AUXXL-11N, AUXXLS-11N, AUXXR, AUXXS, AUXXT, AUXXTS, ECOMAX-602-10, ECOMAX-602-11, ECOMAX-602S-11, ECOMAX-612-10, ECOMAX-612S-10		

			
1			
GEV No.	511657	Ref. No.	324594
description	flat gasket rubber ED ø 12mm ID ø 6.3mm thickness 2.5mm for wash pipe Qty 1 pcs suitable for HOBART		
For models:	AM-700, AM900, AMS900, AMX, AMX-900, AMX-E, AMX-ER, AMX-R, AMXR-900, AMXS-900, AMXX-1300, AMXXR-1300, AMXXS-1300, AMXXT, AUX, AUX_, AUX-E, AUX-ER, AUX-R, AUXX-1300, AUXXL, AUXXR-1300, AUXXS-1300, AUXXT, ECOMAX-600, ECOMAX-650, HX, HX-30, HX-30E, HX-30ES, HX-30S, HX-40, HX-40E, HX-40ES, HX-40S, HX-60-EHL, HX-E, HX-ES, HX-S, UX-30, UX-30B, UX-30E, UX-30EB, UX-30EH, UX-30ES, UX-30ESB, UX-30ESH, UX-30H, UX-30-McDonalds, UX-30S...(Other models you can see in the webshop)		

			
2			
GEV No.	511656	Ref. No.	00-172986-018 172986-18
description	flat gasket rubber ED ø 13mm ID ø 7.5mm thickness 0.5mm Qty 1 pcs		
For models:	CX, FM-400H, FM-400U, FM-500, FM-500H, FTT, UW-105, UW-120, UW-125, UW-135, UW-135H, UW-200, UW-205, UW-55, UWX		

			
1			
GEV No.	519547	Ref. No.	139321-657
description	flat gasket rubber ED ø 14.4mm ID ø 15.5mm thickness 2mm Qty 1 pcs size 3/4"		

			
1			
GEV No.	524055	Ref. No.	229323
description	flat gasket rubber ED ø 18mm ID ø 12mm thickness 2mm Qty 1 pcs		
For models:	CX, UWX		

			
1			
GEV No.	510075	Ref. No.	139321-725
description	flat gasket rubber ED ø 22mm ID ø 13mm thickness 1.5mm Qty 1 pcs		

			
1			
GEV No.	505397	Ref. No.	437083
description	flat gasket rubber ED ø 32mm ID ø 19.5mm thickness 1.5mm Qty 1 pcs		
For models:	H-60		

			
1			
GEV No.	518240	Ref. No.	139321-780
description	flat gasket rubber ED ø 33mm ID ø 17mm thickness 1.5mm Qty 1 pcs		

			
1			
GEV No.	519119	Ref. No.	00-172986-026 172986-26
description	flat gasket rubber ED ø 58mm ID ø 42mm thickness 3mm Qty 1 pcs		
For models:	CN, CNA, CNB, CNR, CR, CR-F, CSA, ECOMAX-800, ECW, FTN		

			
1			
GEV No.	524881	Ref. No.	172 986-33
description	flat gasket rubber ED ø 60mm ID ø 48mm thickness 3mm Qty 1 pcs		
For models:	AM-700, AM900, AMS900, AMX-900, AMXR-900, AMXS-900, ECO-MAX-600		

			
1			
GEV No.	518205	Ref. No.	139321-907
description	flat gasket rubber ED ø 61mm ID ø 47mm thickness 2mm Qty 1 pcs		

			
1			
GEV No.	511962	Ref. No.	172986-15
description	flat gasket rubber ED ø 62mm ID ø 44mm thickness 0.9mm Qty 1 pcs		
For models:	AM-600, AM-600C, AM-600CR, AM-600R, FM-400H, FM-400U, FM-500, FM-500H, FTX, FUX, UW-105, UW-120, UW-125, UW-135H, UW-200, UW-55, UWX		

			
1			
GEV No.	511651	Ref. No.	00-172986-022 172986-22
description	flat gasket rubber ED ø 71mm ID ø 59mm thickness 2mm for wash arm support Qty 1 pcs		
For models:	AMX, AMX-E, AMX-ER, AMX-R, AMXX-1300, AMXXR-1300, AMXXS-1300, AMXXT, AUX, AUX_, AUX-E, AUX-ER, AUX-R, AUXX-1300, AUXXL, AUXXR-1300, AUXXS-1300, AUXXT, CR, ECOMAX-700, UX, UX-30, UX-30B, UX-30E, UX-30EB, UX-30EH, UX-30ES, UX-30ESB, UX-30ESH, UX-30H, UX-30-McDonalds, UX-30S, UX-30SB, UX-30SH, UX-60, UX-60B, UX-60E, UX-60EB, UX-60EH, UX-60EHB, UX-60H, UX-60HB, UXD-30, UXL, UXLS, UXS, UXT, UXTH, UXTHL, UXTHLS...(Other models you can see in the webshop)		





			
1			
GEV No.	510071	Ref. No.	139321-597
description	flat gasket rubber ED ø 81mm ID ø 68mm thickness 3mm for salt tank Qty 1 pcs		

			
1			
GEV No.	507495	Ref. No.	00-775305-001 172513 775305-1
description	gasket ED ø 34mm ID ø 25.5mm thickness 2.5mm Qty 1 pcs		
For models:	AM-10, AM-11, AM-141, AM-700, AM900, AM900-10N, AM900-90, AMS900, AMS900-10N, AMX, AMX-10HL, AMX-90, AMX-900, AMX-E, AMX-ER, AMXR, AMX-R, AMXR-900, AMXS, AMXS-900, AMXT, AMXTS, AMXX, AMXX-1300, AMXXR, AMXXR-1300, AMXXS, AMXXS-1300, AMXXT, AUP, AUP-90, AUPS, AUX, AUX_, AUX-E, AUX-ER, AUX-R, AUXX, AUXX-1300, AUXXL, AUXXL-11N, AUXXLS-11N, AUXXR, AUXXR-1300, AUXXS, AUXXS-1300, AUXXT, AUXXTS, CM1E, CNA...(Other models you can see in the webshop)		

			
1			
GEV No.	518060	Ref. No.	139321-913
description	gasket rubber ED ø 132mm ID ø 122mm thickness 5mm		
For models:	CHH-50, CHH-60D, CHH-70D, EH-60, EH-70		

plastic gaskets			
			
1			
GEV No.	511963	Ref. No.	119038-1
description	flat gasket plastic ED ø 175mm ID ø 136mm thickness 0.125mm for flange Qty 1 pcs		
For models:	AM-12E, AM-12EC, AM-12EF, AM-12ER, AM-600, AM-600C, AM-600CR, AM-600R, UW-100, UW-105		

			
1			
GEV No.	510633	Ref. No.	324521
description	gasket foamed ED ø 93mm ID ø 85mm thickness 3mm Qty 1 pcs		
For models:	FX, GX, HX-30ES, HX-30S, HX-40ES, HX-40S, HX-ES, HX-S, UX-30ES, UX-30ESB, UX-30ESH, UX-30-McDonalds, UX-30S, UX-30SB, UX-30SH		

copper gaskets			
DIN-7603-A			
			
1			
GEV No.	560508	Ref. No.	WA-E-5-29
description	flat gasket copper ED ø 16mm ID ø 8.3mm thickness 1mm Qty 1 pcs		
For models:	104G, 201G, 204G, 301G, 304G, GF-120, UW-100, UW-120, UW-125, UW-200, UW-205		

PTFE gaskets			
			
1			
GEV No.	518346	Ref. No.	437090
description	flat gasket PTFE ED ø 22mm ID ø 9.2mm thickness 1mm Qty 1 pcs equiv. no. 437090 suitable for COLGED		
For models:	H-60		

			
1			
GEV No.	518180	Ref. No.	303018
description	flat gasket PTFE ED ø 40mm ID ø 35mm thickness 3mm Qty 1 pcs equiv. no. 303018/371450-166 suitable for COLGED, HOBART		
For models:	CLG-25, CLG-25-NA, ECOMAX-400-12, ECOMAX-400S-12		

			
1			
GEV No.	518119	Ref. No.	00-774072-001 774072-1
description	slide ring PTFE ED ø 19mm ID ø 14.5mm thickness 0.5mm for rinse arm Qty 1 pcs suitable for HOBART		
For models:	AM-10, AM-11, AM-141, AM-700, AM900, AM900-10N, AM900-90, AMS900, AMS900-10N, AMX, AMX-10HL, AMX-90, AMX-900, AMX-E, AMX-ER, AMXR, AMX-R, AMXR-900, AMXS, AMXS-900, AMXT, AMXTS, AMXX, AMXX-1300, AMXXR, AMXXR-1300, AMXXS, AMXXS-1300, AMXXT, AUP, AUP-90, AUPS, AUX, AUX_, AUX-E, AUX-ER, AUX-R, AUXX, AUXX-1300, AUXXL, AUXXL-11N, AUXXLS-11N, AUXXR, AUXXR-1300, AUXXS, AUXXS-1300, AUXXT, AUXXTS, ECOMAX-402, ECOMAX-502... (Other models you can see in the webshop)		

			
1			
GEV No.	518120	Ref. No.	00-774072-002 774072-2
description	slide ring PTFE ED ø 21mm ID ø 16mm thickness 0.5mm for rinse arm Qty 1 pcs		
For models:	AM-10, AM-11, AM-141, AM-700, AM900, AM900-10N, AM900-90, AMS900, AMS900-10N, AMX, AMX-10HL, AMX-90, AMX-900, AMX-E, AMX-ER, AMXR, AMX-R, AMXR-900, AMXS, AMXS-900, AMXT, AMXTS, AMXX, AMXX-1300, AMXXR, AMXXR-1300, AMXXS, AMXXS-1300, AMXXT, AUP, AUP-90, AUPS, AUX, AUX_, AUX-E, AUX-ER, AUX-R, AUXX, AUXX-1300, AUXXL, AUXXL-11N, AUXXLS-11N, AUXXR, AUXXR-1300, AUXXS, AUXXS-1300, AUXXT, AUXXTS, ECOMAX-402, ECOMAX-502... (Other models you can see in the webshop)		

			
1			
GEV No.	511678	Ref. No.	00-774072-007 774072-7
description	slide ring PTFE ED ø 24mm ID ø 13mm thickness 1mm for rinse arm Qty 1 pcs		
For models:	AM-10, AM-11, AM-141, AMX, AMX-10HL, AMX-90, AMXR, AMXS, AMXX, AMXXR, AMXXS, AUP, AUP-90, AUPS, AUXX, AUXXR, AUXXS, ECOMAX-402, ECOMAX-502, ECOMAX-602-10, ECOMAX-602-11, ECOMAX-602S-11, ECOMAX-612-10, ECOMAX-612S-10, FP, FX, FX-McDonalds, GP, GX		

shaft gaskets

shaft gaskets

			
1			
GEV No.	698317	Ref. No.	OS-E-2-50
description	shaft seal ID ø 25mm ED ø 32mm thickness 4mm		

miscellaneous

			
1			
GEV No.	511605	Ref. No.	322190-1
description	shaft seal		
For models:	CO-0611E, CO-1011E, CO-2011E, CS-0611E, CS-0612E-A, CS-1011E, CS-1012E-A, CS-1022E-A, CS-2011E, CS-2012E-A, CS-2022E-A, CSD-0611E, CSD-0612E-A, CSD-0612ET, CSD-1011E, CSD-1012E-A, CSD-1012ET, CSD-1022E-A, CSD-2011E, CSD-2012E-A, CSD-2012ET, CSD-2022E-A		

special gaskets

door seals for dishwashers

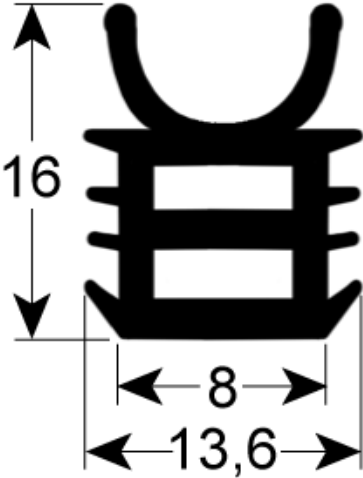
			
1			
GEV No.	518182	Ref. No.	01-240077-001 01-240077-1
description	door seal L 564mm W 493mm Qty 1 for dishwasher 3-sided suitable for HOBART		
For models:	FP, FX, FX-McDonalds, GP, GX		

			
1			
GEV No.	518614	Ref. No.	774063-1
description	door seal L 565mm W 427mm mounting pos. upper for dishwasher 3-sided		
For models:	FE, FE-W		

miscellaneous

			
1			
GEV No.	511600	Ref. No.	844617
description	gasket ED ø 80mm		
For models:	CS-0612E, CS-0612E-A, CS-1012E, CS-1012E-A, CS-1012G, CS-1022E, CS-1022E-A, CS-2012E, CS-2012E-A, CS-2012G, CS-2022E, CS-2022E-A, CSD-0612E, CSD-0612E-A, CSD-1012E, CSD-1012E-A, CSD-1013G, CSD-1022E, CSD-1022E-A, CSD-2012E, CSD-2012E-A, CSD-2013G, CSD-2022E, CSD-2022E-A, CSL-06E, CSL-10E, CSM-0611IE, CSM-0611N, CSM-1011IE, CSM-1011N, CSM-1021IE, CSM-1021N, CSM-2011IE, CSM-2011N, CSM-2021IE, CSM-2021N		





			
1			
GEV No.	524926	Ref. No.	323930-1
description	gasket for bearing ID ø 12mm H 23mm L 30mm W 12mm mounting pos. left		
For models:	FE, FE-W		

			
1			
GEV No.	524925	Ref. No.	323930-2
description	gasket for bearing ID ø 12mm H 23mm L 30mm W 12mm mounting pos. right		
For models:	FE, FE-W		

			
1			
GEV No.	524906	Ref. No.	323785-101
description	gasket for drain assembly ø 14mm		
For models:	FX, GX		

			
1			
GEV No.	524899	Ref. No.	371450-47
description	gasket for in-line particle filter L 71mm W 38mm thickness 1mm rubber hole distance 59mm		
For models:	GF-60, GF-60S		

			
1			
GEV No.	524903	Ref. No.	119054
description	gasket L 147mm W 89mm for pump casing rubber ø 70mm H 2mm		
For models:	AM-12E, AM-12EC, AM-12EF, AM-12ER		

			
1			
GEV No.	524902	Ref. No.	119051
description	gasket L 58mm W 26mm for pump casing FIBER H 2mm		
For models:	AM-12E, AM-12EC, AM-12EF, AM-12ER, AM-600, AM-600C, AM-600CR, AM-600R, UW-100, UW-105		

			
1			
GEV No.	524904	Ref. No.	296709
description	gasket L 99mm W 78mm for pump casing rubber H 6mm		
For models:	ACW, CX, FTT, FTX, FUX, UW-135, UW-135H, UWX		

			
1			
GEV No.	511938	Ref. No.	226556
description	gasket suitable for HOBART external height 10mm ED ø 70mm ID ø 45mm for outflow		
For models:	ACW, AM-12E, AM-12EC, AM-12EF, AM-12ER, CX, ECW, FM-30, FM-30U, FTT, FTX, FUX, UW-100, UWX		

			
1			
GEV No.	524687	Ref. No.	140300 227752
description	gasket suitable for HOBART for dosing pump L 60mm W 48mm thickness 1.55mm hole distance 48mm		
For models:	CM1E, FX, GX, WM2E		

gaskets for wash arm support

			
1			
GEV No.	518025	Ref. No.	139321-840
description	gasket D1 ø 50mm D2 ø 82mm thickness 2mm with 6 holes wash arm support equiv. no. 437014 suitable for COLGED		

			
1			
GEV No.	518339	Ref. No.	139321-864
description	gasket D2 ø 50mm thickness 2mm with 3 screw holes wash arm support equiv. no. 437064 suitable for COLGED hole ø 50mm hole distance 67mm		

evaporators

for fridges

producer-specific



1

GEV No.	750504	Ref. No.	15463031 F15463031
description	evaporator L 700mm W 250mm H 190mm suitable for FOSTER		

transmission technology and ball bearings

drive belts

poly-v belts

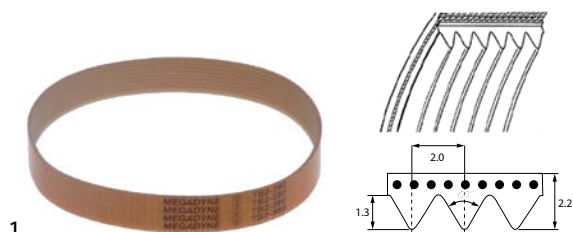

1

GEV No.	697617	Ref. No.	00-479391
description	poly-v belt grooves 10 W 20mm L 360mm profile TB2		

springs

compression springs

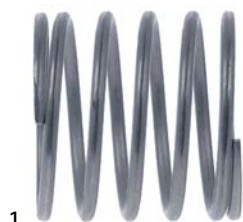

1

GEV No.	511966	Ref. No.	119229
description	compression spring \varnothing 23mm L 22mm wire gauge \varnothing 1.5mm		
For models:	AM-12E, AM-12EC, AM-12EF, AM-12ER, AM-600, AM-600C, AM-600CR, AM-600R, UW-100, UW-105, UW-120, UW-125, UW-135, UW-135H, UW-200, UW-205		



1

GEV No.	519539	Ref. No.	12757-E
description	compression spring \varnothing 36mm wire gauge \varnothing 3.5mm windings 3 for mixer		

spring compressors



1

GEV No.	513119	Ref. No.	139321-678
description	spring compressor		

gas tension springs

gas tension springs



1

GEV No.	701241	Ref. No.	01-240229-001 01-240229-1
description	gas tension spring 50N hub 205mm D1 \varnothing 15mm D2 \varnothing 6mm hole distance 425mm hole \varnothing 5/6mm L 433mm		
For models:	FP, FX, FX-McDonalds, GP, GX		

roller springs

roller springs



1

GEV No.	519618	Ref. No.	01-245278-6
description	roller spring 0.53kg W 55mm ID \varnothing 10.5mm lug length 28mm		



1

GEV No.	519514	Ref. No.	774749-5
description	roller spring complete W 40mm ID \varnothing 10.5mm lug length 49mm		
For models:	CN, CNA, CNB, CNR, CR, FTN		



1

GEV No.	519492	Ref. No.	774749-2
description	roller spring complete W 40mm ID \varnothing 10.5mm lug length 54mm		
For models:	CN, CNA, CNB, CNR, CR, CR-F, FTN		



			
1			
GEV No.	519496	Ref. No.	774749-6
description	roller spring W 40mm ID ø 10.5mm lug length 52mm		
For models:	CN, CNA, CNB, CNR, CR, FTN		

			
1			
GEV No.	517409	Ref. No.	774749-3
description	roller spring W 40mm ID ø 10.5mm lug length 54mm		
For models:	CSA, FTN		

			
1			
GEV No.	519515	Ref. No.	229277
description	roller spring W 40mm ID ø 35mm lug length 23mm		
For models:	CX, FTT, FTX, FUX		

			
1			
GEV No.	520590	Ref. No.	01-245278-7
description	roller spring W 55mm ID ø 11mm lug length 30mm		

			
1			
GEV No.	694272	Ref. No.	299110 378591
description	roller spring W 65mm ID ø 48mm lug length 24mm		
For models:	UW-100, UW-105, UW-120, UW-125, UW-200, UW-205		

accessories

bolts

			
1			
GEV No.	694271	Ref. No.	602812
description	bolt ø 10mm L 95mm		
For models:	UW-105, UW-120, UW-125, UW-200, UW-205		

rollers

			
1			
GEV No.	694270	Ref. No.	299109
description	roller ø 43mm W 75mm		
For models:	UW-105, UW-120, UW-125, UW-200, UW-205		

tension springs

			
1			
GEV No.	511965	Ref. No.	119079-2
description	spring for hood mechanics wire gauge ø 5.5mm ø 50mm total length 385mm		
For models:	AM-12EC, AM-600C, AM-600CR, AMX, AMX-E, AMX-ER, AMX-R, AUX, AUX_, AUX-E, AUX-ER, AUX-R, FM-30, FM-400H, FM-500H, HE, HE600-HL, HE-P, HX, HX-30, HX-30E, HX-30ES, HX-30S, HX-40, HX-40E, HX-40ES, HX-40S, HX-60-EHL, HX-E, HX-ES, HX-S, UX-30EH, UX-30ESH, UX-30H, UX-30-McDonalds, UX-30SH		

			
1			
GEV No.	503504	Ref. No.	00-378622-001 378622-1
description	tension spring		
For models:	FX		

			
1			
GEV No.	518260	Ref. No.	371450-28
description	tension spring ø 10mm total length 145mm wire gauge ø 1mm		
For models:	GF-60, GF-60S		

1 

GEV No.	503503	Ref. No.	227855
description	tension spring ø 13mm total length 147mm wire gauge ø 1.5mm		
For models:	CM1E, FE, FE-W, FM-30U, FM-400U, FM-500, FX, GX, UW-55, WM2E		

1 

GEV No.	504424	Ref. No.	00-324773-000
description	tension spring ø 20mm total length 245mm wire gauge ø 2.5mm for door Qty 1 pcs		
For models:	UX-30, UX-30E, UX-30ES, UX-30-McDonalds, UX-30S, UX-60, UX-60E, UXD-30, UXL, UXLS		

1 

GEV No.	517448	Ref. No.	139321-666
description	tension spring ø 30mm total length 505mm wire gauge ø 5.5mm for hood mechanics Qty 1 pcs		

manometers

1 

GEV No.	542445	Ref. No.	229583-2
description	manometer ø 62mm pressure range 0-1.6bar connection 1/4"		

1 

GEV No.	541788	Ref. No.	229583-1
description	manometer ø 62mm pressure range 0-1bar connection 1/4"		
For models:	ACW, CNA, CNB, CNR, CR-F, CX, ECW, FTN, FTT, FTX, FUX, UWX		

dosing pumps

peristaltic dosing pumps

ASF/THOMAS

built-in version

without control



1

GEV No.	361373	Ref. No.	228022-1
description	dosing pump detergent 230V		
For models:	AM-600, AM-600C, AM-600CR, AM-600R, CM1E, FM-400H, FM-400U, FM-500, FM-500H, UW-105, UW-135, UW-135H, UW-55, WM2E		

SAIER

built-in version

without control



1

GEV No.	361835	Ref. No.	01-240195-002 01-240195-2 028999 AH98299-H0017-2
description	dosing pump without control 3l/h 230VAC detergent hose ø 6x4mm hose type Santoprene 4.9(5.4)W cable length 750mm built-in version counter pressure 0.1bar 50/60Hz		
For models:	FP, FX-McDonalds, GP		
spare parts for	361835		
	GEV No.	361946	Ref. No. 01-240195-012 01-240195-12 01-515268-12 883860-12
service kit SAIER detergent hose type Santoprene hose ø 6x4mm incl. bracket			





spare parts			
			
1			
GEV No.	361946	Ref. No.	01-240195-012 01-240195-12 01-515268-12 883860-12
description	service kit SAIER detergent hose type Santoprene hose ø 6x4mm incl. bracket		
For models:	FP, FX-McDonalds, GP		

			
2			
GEV No.	361947	Ref. No.	01-240195-011 01-240195-11
description	service kit SAIER rinse aid hose type silicone hose ø 6x4mm incl. bracket		
For models:	FP, FX-McDonalds, GP		

SEKO			
built-in version			
without control			
			
1			
GEV No.	361150 ¹	Ref. No.	00-775556-011 775556-11
description	dosing pump SEKO without control 0.4l/h 230VAC rinse aid hose ø 4x6mm hose type D hose Sekobril suction level 1.5m horizontal/vertical type PG dimensions 67x95x52mm		
For models:	ECOMAX-402, ECOMAX-502, FX, FX-McDonalds, GX		
spare parts for	361150		
	GEV No.	361135	Ref. No.
			00-775608-001 775608-1
pump hose SEKO rinse aid hose ø 3x8mm hose ø 4x6mm hose type D hose Sekobril			
	GEV No.	361136	Ref. No.
			—
roller assembly for dosing pump hole ø 4.8x4mm			
	GEV No.	361562	Ref. No.
			—
pump cover for dosing pump yellow			
	GEV No.	361866	Ref. No.
			00-775507-001 775507-1
union nut for hose connector ø 17mm			
accessories for	361150		
	GEV No.	361144	Ref. No.
			—
mounting set rinse aid hose type 4x6mm hose length 2m PVC/nylon hose container filter/non-return valve transparent			

¹with accessories

accessories for	361150		
	GEV No.	570123	Ref. No.
			01-246301-001 01-246301-1
PVC hose ID ø 4mm ED ø 6mm L 3.5m thickness 1mm t.max. 60°C transparent			

			
1			
GEV No.	361867	Ref. No.	00-883828-001 883828-1
description	dosing pump SEKO without control 0.4l/h 230VAC rinse aid hose ø 4x6mm hose type D hose Sekobril suction level 1.5m type NPG 0.4 8W cable length 45mm built-in version counter pressure 1bar		
For models:	AM-10, AM-11, AM-141, AM900-10N, AM900-90, AMS900-10N, AMX, AMX-10HL, AMX-90, AMXR, AMXS, AMXT, AMXTS, AMXX, AMXXR, AMXXS, AUXX, AUXXL-11N, AUXXLS-11N, AUXXR, AUXXS, AUXXT, AUXXTS, ECOMAX-602-10, ECOMAX-602-11, ECOMAX-602S-11, ECOMAX-612-10, ECOMAX-612S-10		
spare parts for	361867		
	GEV No.	361135	Ref. No.
			00-775608-001 775608-1
pump hose SEKO rinse aid hose ø 3x8mm hose ø 4x6mm hose type D hose Sekobril			

			
1			
GEV No.	361869	Ref. No.	00-883828-002 883828-2
description	dosing pump SEKO without control 3l/h 230VAC detergent hose ø 4x6mm hose type K hose Santoprene suction level 1.5m type NPG 3		
For models:	AM-11, AM900-10N, AM900-90, AMS900-10N, AMX, AMX-10HL, AMX-90, AMXR, AMXS, AMXT, AMXTS, AMXX, AMXXR, AMXXS, AUXX, AUXXL-11N, AUXXLS-11N, AUXXR, AUXXS, AUXXT, AUXXTS, ECOMAX-602-11, ECOMAX-602S-11, ECOMAX-612-10, ECOMAX-612S-10		
spare parts for	361869		
	GEV No.	361815	Ref. No.
			00-775608-002 775608-2
pump hose detergent hose ø 6x10mm hose ø 4x6mm hose type K hose Santoprene type SEKO			



1

GEV No.	361868	Ref. No.	00-775556-012 775556-12
description	dosing pump SEKO without control 3l/h 230VAC detergent hose ø 4x6mm hose type K hose Santoprene suction level 1.5m type PG 8W		
For models:	ECOMAX-402, ECOMAX-502, FX, FX-McDonalds, GX		
spare parts for	361868		
	GEV No.	Ref. No.	00-775608-002 775608-2
	pump hose detergent hose ø 6x10mm hose ø 4x6mm hose type K hose Santoprene type SEKO		



1

GEV No.	361896	Ref. No.	775556-2 897931
description	dosing pump SEKO without control 3l/h 230VAC detergent hose ø 4x6mm hose type K hose Santoprene suction level 1.5m type PG 8W cable length 430mm built-in version kit CODE PPG0003A1024		
For models:	AM-700, AM900, AMS900, AMX-900, AMXR-900, AMXS-900, AMXX-1300, AMXXR-1300, AMXXS-1300, AMXXT, AUXX-1300, AUXXL, AUXXR-1300, AUXXS-1300, AUXXT, ECOMAX-600, ECOMAX-650, ECOMAX-700, FX, GC, GC11, GC12, GC31, GC32, GC41, GC42, GX, UX, UXL, UXLS, UXS, UXT, UXTH, UXTHL, UXTHLS, UXTHS, UXTL, UXTLH, UXTLHS, UXTLS, UXTS		

spare parts



1

GEV No.	698712	Ref. No.	143258
description	dosing hose SEKO detergent hose ø 4x8.6mm hose ø 4x6mm hose type H hose Santoprene		



1

GEV No.	362005	Ref. No.	00-775608-003 775608-3
description	dosing hose SEKO rinse aid hose ø 6.25x10.55mm hose length 135mm hose ø 4x6mm hose type M hose Sekobril		



1

GEV No.	361815	Ref. No.	00-775608-002 775608-2
description	pump hose detergent hose ø 6x10mm hose ø 4x6mm hose type K hose Santoprene type SEKO		
For models:	AM-11, AM900-10N, AM900-90, AMS900-10N, AMX, AMX-10HL, AMX-90, AMXR, AMXS, AMXT, AMXTS, AMXX, AMXXR, AMXXS, AUXX, AUXXL-11N, AUXXLS-11N, AUXXR, AUXXS, AUXXT, AUXXTS, ECOMAX-402, ECOMAX-502, ECOMAX-602-11, ECOMAX-602S-11, ECOMAX-612-10, ECOMAX-612S-10, FX, FX-McDonalds, GX		



1

GEV No.	361135	Ref. No.	00-775608-001 775608-1
description	pump hose SEKO rinse aid hose ø 3x8mm hose ø 4x6mm hose type D hose Sekobril		
For models:	AM-10, AM-11, AM-141, AM900-10N, AM900-90, AMS900-10N, AMX, AMX-10HL, AMX-90, AMXR, AMXS, AMXT, AMXTS, AMXX, AMXXR, AMXXS, AUXX, AUXXL-11N, AUXXLS-11N, AUXXR, AUXXS, AUXXT, AUXXTS, ECOMAX-402, ECOMAX-502, ECOMAX-602-10, ECOMAX-602-11, ECOMAX-602S-11, ECOMAX-612-10, ECOMAX-612S-10, FX, FX-McDonalds, GX		
spare parts for	361135		
	GEV No.	Ref. No.	00-775507-001 775507-1
	union nut for hose connector ø 17mm		

various built-in version



1

GEV No.	361828	Ref. No.	00-323772-002 00-324232-002 323772-2 324232-2
description	dosing pump HOBART 230VAC hose ø 6mm CODE C-323 772-2		
For models:	AMX, AMX-E, AMX-ER, AMX-R, AUX, AUX_, AUX-E, AUX-ER, AUX-R, FE-W, FX, GX, HX, HX-30, HX-30E, HX-30ES, HX-30S, HX-40, HX-40E, HX-40ES, HX-40S, HX-60-EHL, HX-E, HX-ES, HX-S, UX-30, UX-30B, UX-30E, UX-30EB, UX-30EH, UX-30ES, UX-30ESB, UX-30ESH, UX-30H, UX-30-McDonalds, UX-30S, UX-30SB, UX-30SH, UX-60, UX-60B, UX-60E, UX-60EB, UX-60EH, UX-60EHB, UX-60H, UX-60HB		
spare parts for	361828		
	GEV No.	Ref. No.	324356-2
	silicone hose rinse aid silicone beige		



piston pumps

dosing pumps



1

GEV No.	361838	Ref. No.	378625-1 378625-1P
description	dosing pump type TTE 200-240V detergent inlet 5.5mm outlet 5.5mm HOBART		
For models:	AMX, AMX-E, AMX-ER, AMX-R, AUX, AUX_, AUX-E, AUX-ER, AUX-R, FE-W, FX, GE-400, GF-60, GF-60S, GX, HX, HX-60-EHL, HX-E, HX-ES, HX-S, UX-30, UX-30B, UX-30E, UX-30EB, UX-30EH, UX-30ES, UX-30ESB, UX-30ESH, UX-30H, UX-30-McDonalds, UX-30S, UX-30SB, UX-30SH		



1

GEV No.	361895	Ref. No.	378625-1P + Zubeh+r 378630
description	dosing pump type TTE service kit 200-240V detergent inlet 5.5mm outlet 5.5mm		
For models:	FX, GX		
spare parts for	361895		
	GEV No.	Ref. No.	378625-1 378625-1P
	dosing pump type TTE 200-240V detergent inlet 5.5mm outlet 5.5mm HOBART		

membrane dosing pumps

electric dosing pumps

Delta



1

GEV No.	361023 ¹	Ref. No.	172927-1
description	dosing pump ASF/THOMAS 230V rinse aid/detergent duty cycle 100% type DELTA valve lips/SS valve		
For models:	AM-600, AM-600C, AM-600CR, AM-600R, UW-105, UW-135, UW-135H		
spare parts for	361023		
	GEV No.	Ref. No.	—
	lip valve type DELTA		
	GEV No.	Ref. No.	—
	membrane type DELTA		
	GEV No.	Ref. No.	—
	valve type DELTA		

¹lip valve SS

spare parts for	361023		
	GEV No.	Ref. No.	—
	hose connector type DELTA		
	GEV No.	Ref. No.	—
	disc type DELTA		
	GEV No.	Ref. No.	—
	flat gasket rubber ID ø 9mm ED ø 14.5mm thickness 1mm type DELTA		

self-priming

SEKO



1

GEV No.	361364 ¹	Ref. No.	139321-1120 139321-499
description	dosing pump type DIB5E self-sucking rinse aid pump rate 0-5cm ³ per stroke pressure connection ø 4x6mm suction connection ø 4x6mm SEKO supporting pressure closed		
For models:	CHF45, CLG-25, EF-40		
spare parts for	361364		
	GEV No.	Ref. No.	—
	hose connector for type DIB3E/DIB5E		
	GEV No.	Ref. No.	—
	valve bush for type DIB3E/DIB5E		
	GEV No.	Ref. No.	—
	O-ring EPDM ID ø 11.11mm thickness 1.78mm Qty 1 pcs for type DIB3E/DIB5E		
	GEV No.	Ref. No.	—
	valve disc for type DIB3E/DIB5E DIB3P/DIB5P		
	GEV No.	Ref. No.	—
	membrane for type DIB3E/DIB5E ø 49mm hole ø 5mm		
	GEV No.	Ref. No.	—
	membrane dosing pump ø 68mm hole ø 6mm for type DIB3P/DIB5P		
	GEV No.	Ref. No.	—
	hose connector ø 6mm for dosing pump		
	GEV No.	Ref. No.	—
	lip valve for type DIB3P/DIB5P DIB3E/DIB5E		
accessories for	361364		
	GEV No.	Ref. No.	—
	hose connector 1-way hose ø 6mm plastic connection M10x1		
	GEV No.	Ref. No.	—
	hose connector 1-way hose ø 9mm plastic connection M10x1		



¹auxiliary pressure connection closed

self-priming with supporting pressure

ELETTROBAR









1

GEV No.	361362	Ref. No.	987023 E999266
description	dosing pump rinse aid pressure connection ø 6mm pressure connection 6		
For models:	CLG-25, CLG-25-NA, ECOMAX-400-12, ECOMAX-400S-12, ECOMAX-500, ECOMAX-601		
spare parts for	361362		
	GEV No.	361363	Ref. No. —
	membrane		
	GEV No.	510298	Ref. No. —
	lip valve dosing pump suitable for DB2/DS5		

SEKO



1

GEV No.	361039	Ref. No.	139321-521 139321-931
description	dosing pump type DIB5P with auxiliary pressure connection rinse aid 0-5cm ³ per stroke/h pressure connection ø 4x6mm suction connection ø 4x6mm auxiliary pressure connection 10mm SEKO		
For models:	CHH-70D, EH-70		
spare parts for	361039		
	GEV No.	361301	Ref. No. —
	hose connector for type DIB3E/DIB5E		
	GEV No.	361302	Ref. No. —
	valve bush for type DIB3E/DIB5E		
	GEV No.	361304	Ref. No. —
	O-ring EPDM ID ø 11.11mm thickness 1.78mm Qty 1 pcs for type DIB3E/DIB5E		
	GEV No.	361305	Ref. No. —
	valve disc for type DIB3E/DIB5E DIB3P/DIB5P		
	GEV No.	361307	Ref. No. —
	membrane dosing pump ø 68mm hole ø 6mm for type DIB3P/DIB5P		
	GEV No.	361481	Ref. No. —
	lip valve for type DIB3P/DIB5P DIB3E/DIB5E		

accessories



1

GEV No.	361141	Ref. No.	139321-594
description	container filter with weight ceramic hose ø 4mm		



1

GEV No.	518372	Ref. No.	00-775239-001 775239-1
description	container filter with weight ceramic hose ø 4mm		
For models:	AM-10, AM-11, AM-141, AM-700, AM900, AM900-10N, AM900-90, AMS900, AMS900-10N, AMX, AMX-10HL, AMX-90, AMX-900, AMXR, AMXR-900, AMXS, AMXS-900, AMXT, AMXTS, AMXX, AMXX-1300, AMXXR, AMXXR-1300, AMXXS, AMXXS-1300, AMXXT, AUP, AUP-90, AUPS, AUX, AUX-1300, AUXXL, AUXXL-11N, AUXXLS-11N, AUXXR, AUXXR-1300, AUXXS, AUXXS-1300, AUXXT, AUXXTS, ECOMAX-402, ECOMAX-502, ECOMAX-600, ECOMAX-602-10, ECOMAX-602-11, ECOMAX-602S-11, ECOMAX-612-10, ECOMAX-612S-10, ECOMAX-650, ECOMAX-700...(Other models you can see in the webshop)		

container filters with non-return valve



1

GEV No.	361839	Ref. No.	227441-1
description	container filter with non-return valve SS hose ø 6mm ø 20mm L 55mm for dosing pump		
For models:	AM-12E, AM-12EC, AM-12EF, AM-12ER, AMX, AMX-E, AMX-ER, AMX-R, AUX, AUX-E, AUX-ER, AUX-R, ECOMAX-600, ECOMAX-700, ECW, FE, FE-W, FX, GE-400, GX, HE, HE600-HL, HX, HX-60-EHL, HX-E, HX-ES, HX-S, UX-30, UX-30B, UX-30E, UX-30EB, UX-30EH, UX-30ES, UX-30ESB, UX-30ESH, UX-30H, UX-30-McDonalds, UX-30S, UX-30SB, UX-30SH, UX-60, UX-60B, UX-60E, UX-60EB, UX-60EH, UX-60EHB, UX-60H, UX-60HB		

hoses

PVC hoses





1

GEV No.	570126	Ref. No.	01-246301-010 01-246301-10
description	PVC hose ID ø 4mm ED ø 6mm L 0.28m thickness 1mm t.max. 60°C transparent		
For models:	AMX, AMX-10HL, AMX-90, AMXR, AMXS, AMXX, AMXXR, AMXXS, AUP, AUP-90, AUPS, AUX, AUXR, AUXXS, ECOMAX-402, ECOMAX-502		



			
GEV No.	570124	Ref. No.	01-246301-008 01-246301-8
description	PVC hose ID ø 4mm ED ø 6mm L 0.5m thickness 1mm t.max. 60°C transparent		
For models:	AM-11, AM900-10N, AM900-90, AMS900-10N, AMX, AMX-10HL, AMX-90, AMXR, AMXS, AMXT, AMXTS, AMXX, AMXXR, AMXXS, AUP, AUP-90, AUPS, AUXX, AUXXL-11N, AUXXLS-11N, AUXXR, AUXXS, AUXXT, AUXXTS, ECOMAX-602-11, ECOMAX-602S-11, ECOMAX-612-10, ECOMAX-612S-10		

			
GEV No.	570123	Ref. No.	01-246301-001 01-246301-1
description	PVC hose ID ø 4mm ED ø 6mm L 3.5m thickness 1mm t.max. 60°C transparent		
For models:	ECOMAX-402, ECOMAX-502, FP, FX, FX-McDonalds, GP, GX, UX, UXL, UXLs, UXs, UXT, UXTL, UXTLS, UXTS		

			
GEV No.	520090	Ref. No.	00-898252-002 00-898252-005 898252-2 898252-5
description	PVC hose ID ø 4mm ED ø 6mm L 2m thickness 1mm t.max. 60°C transparent		
For models:	AM-10, AM-11, AM-141, AM-700, AM900, AM900-10N, AM900-90, AMS900, AMS900-10N, AMX, AMX-10HL, AMX-90, AMX-900, AMXR, AMXR-900, AMXS, AMXS-900, AMXT, AMXTS, AMXX, AMXX-1300, AMXXR, AMXXR-1300, AMXXS, AMXXS-1300, AMXXT, AUP, AUP-90, AUPS, AUXX, AUXX-1300, AUXXL, AUXXL-11N, AUXXLS-11N, AUXXR, AUXXR-1300, AUXXS, AUXXS-1300, AUXXT, AUXXTS, ECOMAX-600, ECOMAX-602-10, ECOMAX-602-11, ECOMAX-602S-11, ECOMAX-602S-10, ECOMAX-602-11, ECOMAX-602S-11, ECOMAX-650, ECOMAX-700, GC, GC11... (Other models you can see in the webshop)		

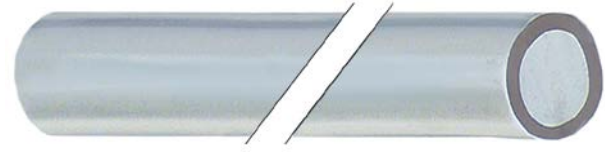
			
GEV No.	570127	Ref. No.	01-246301-011 01-246301-11 01-515410-011
description	PVC hose ID ø 4mm ED ø 6mm L 4m thickness 1mm t.max. 60°C transparent		
For models:	AM-10, AM-11, AM-141, AM900-10N, AM900-90, AMS900-10N, AMX, AMX-10HL, AMX-90, AMXR, AMXS, AMXT, AMXTS, AMXX, AMXXR, AMXXS, AUP, AUP-90, AUPS, AUXX, AUXXL-11N, AUXXLS-11N, AUXXR, AUXXS, AUXXT, AUXXTS, ECOMAX-602-10, ECOMAX-602-11, ECOMAX-602S-11, ECOMAX-612-10, ECOMAX-612S-10, ECOMAX-612S-10		

accessories for	520090		
	GEV No.	361058	Ref. No. —
	container filter with non-return valve SS hose ø 4x6mm ø 20mm L 56mm		
	GEV No.	361066	Ref. No. —
	container filter straight SS hose ø 4x6mm L 37mm non return valve ball valve		
	GEV No.	361106	Ref. No. —
	container filter with weight and non-return valve SS hose ø 4x6mm ø 21mm L 51mm non return valve lip valve		
	GEV No.	361141	Ref. No. 139321-594
	container filter with weight ceramic hose ø 4mm		
	GEV No.	361230	Ref. No. —
	container filter with weight stainless steel hose ø 4x6mm		
	GEV No.	361462	Ref. No. —
	container filter with weight SS hose ø 4x6mm		
	GEV No.	361728	Ref. No. —
	container filter with 4m 4x6 hose SS hose ø 4x6mm hose length 4000mm		

tank inlets			
			
GEV No.	361865	Ref. No.	00-883676-001 883676-1
description	tank inlet stainless steel M10x1 hose ø 5mm		
For models:	AM-11, AM900-10N, AM900-90, AMS900-10N, AMX, AMX-10HL, AMX-90, AMXR, AMXS, AMXT, AMXTS, AMXX, AMXXR, AMXXS, AUP, AUP-90, AUPS, AUXX, AUXXL-11N, AUXXLS-11N, AUXXR, AUXXS, AUXXT, AUXXTS, ECOMAX-402, ECOMAX-502, ECOMAX-602-11, ECOMAX-602S-11, ECOMAX-612-10, ECOMAX-612S-10, FP, FX, FX-McDonalds, GP, GX		

			
GEV No.	361856	Ref. No.	139321-587
description	tank inlet stainless steel M12 hose ø 4/5/6mm		



hoses

supply hoses

stainless steel flexi hoses

universal hoses

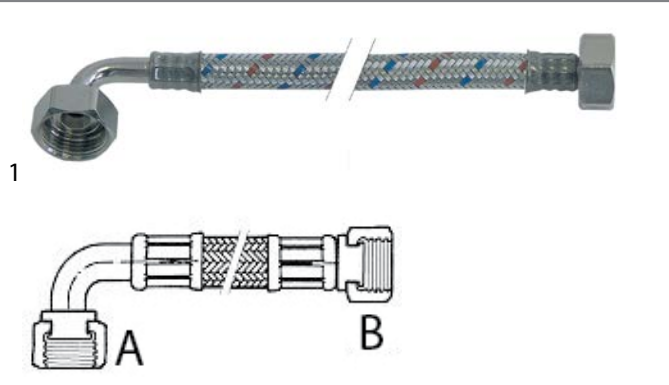

GEV No.	520578	Ref. No.	01-240316-001 01-240316-1
description	flex hose SS braid straight-curved DN10 connection 1: 3/4" connection 2: 3/4" L 2000mm with integrated gasket approval DVGW operating p. 10bar test pressure 32bar burst p. 95bar		
For models:	AM900-10N, AM900-90, AMS900-10N, AMX, AMX-10HL, AMX-90, AMX-900, AMXR, AMXR-900, AMXS, AMXS-900, AMXT, AMXTS, AMXX, AMXX-1300, AMXXR, AMXXR-1300, AMXXS, AMXXS-1300, AMXXT, AUP, AUP-90, AUPS, AUXX, AUXX-1300, AUXXL-11N, AUXXL-11N, AUXXR, AUXXR-1300, AUXXS, AUXXS-1300, AUXXT, AUXXTS, ECOMAX-402, ECOMAX-502, ECOMAX-602-11, ECOMAX-602S-11, ECOMAX-612-10, ECOMAX-612S-10, FP, FX, FX-McDonalds, GP, GX, UX, UXL, UXLS, UXS, UXT, UXTH...(Other models you can see in the webshop)		

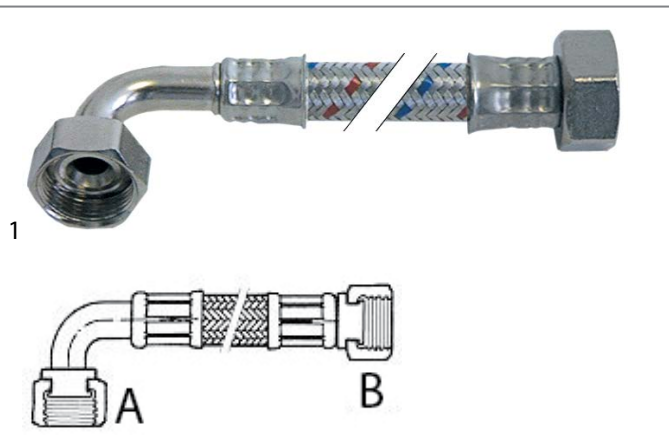

GEV No.	520008	Ref. No.	139321-656
description	flex hose SS braid straight-curved DN12 connection 1: 3/4" connection 2: 3/4" L 1500mm approval DVGW operating p. 10bar test pressure 32bar burst p. 95bar		
accessories for	520008		
	GEV No.	520054	Ref. No. —
	flat gasket rubber ED ø 23.5mm ID ø 14mm thickness 2.3mm Qty 10 pcs		

PVC supply hoses

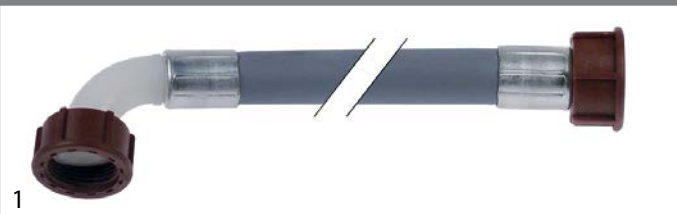

GEV No.	520010	Ref. No.	E143170
description	supply hose PVC straight-curved DN13 connections 3/4" L 1500mm operating p. 10bar burst p. 32bar t.max. 90°C blue approval VDE flat seal		
accessories for	520010		
	GEV No.	520053	Ref. No. —
	screen connection 3/4" D1 ø 26mm D2 ø 15mm Qty 10 pcs rubber thickness 8mm		
	GEV No.	520054	Ref. No. —
	flat gasket rubber ED ø 23.5mm ID ø 14mm thickness 2.3mm Qty 10 pcs		



GEV No.	520011	Ref. No.	139321-1030 139321-1034
description	supply hose PVC straight-curved DN13 connections 3/4" L 2000mm operating p. 10bar burst p. 32bar t.max. 90°C approval VDE flat seal		

pre-rinse hoses

stainless steel spiral tubes with bend relief

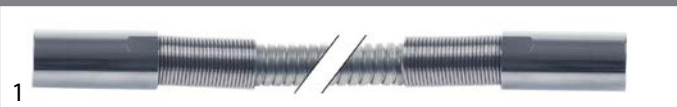

GEV No.	540066 ¹	Ref. No.	170858
description	shower hose connections 1/2" L 1000mm SS operating p. 10bar burst p. 40bar t.max. 90°C approval KTW with integrated gasket DN 8mm		
spare parts for	540066		
	GEV No.	504209	Ref. No. —
	flat gasket FIBER ED ø 18.5mm ID ø 11mm thickness 2mm Qty 1 pcs		

¹brass bush

drain hoses

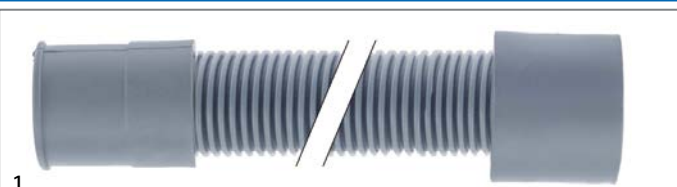

GEV No.	518518	Ref. No.	139321-647
description	drain hose DN19 L 1500mm A int. ø 21mm A ext. ø 27mm B int. ø 29mm B ext. ø 35mm outer hose ø 25mm		

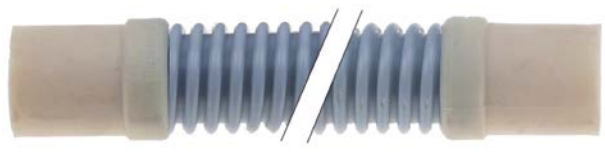
1

GEV No.	530298	Ref. No.	00-324045-000
description	drain hose DN19 L 2100mm A int. ø 19mm A ext. ø 25mm B int. ø 19mm B ext. ø 25mm outer hose ø 24mm		
For models:	AM900, AMS900, AMX-900, AMX-ER, AMX-R, AMXR-900, AMXS-900, AMXX-1300, AMXXR-1300, AMXXS-1300, AMXXT, AUX-ER, AUX-R, AUXX-1300, AUXXL, AUXXR-1300, AUXXS-1300, AUXXT, ECOMAX-402, ECOMAX-502, ECOMAX-650, FE-W, FX, GC, GC11, GC12, GC31, GC32, GC41, GC42, GX, HX, HX-30, HX-30E, HX-30ES, HX-30S, HX-40, HX-40E, HX-40ES, HX-40S, HX-60-EHL, HX-E, HX-ES, HX-S, UX, UXL, UXLS, UXS, UXT, UXTH...(Other models you can see in the webshop)		



1

GEV No.	513258	Ref. No.	139321-850
description	drain hose DN19 L 270mm A int. ø 22mm A ext. ø 28mm B int. ø 24mm B ext. ø 28mm outer hose ø 22mm		



1

GEV No.	518219	Ref. No.	139321-645
description	drain hose DN19 L 630mm A int. ø 20mm A ext. ø 27mm B int. ø 21mm B ext. ø 28mm outer hose ø 24mm		

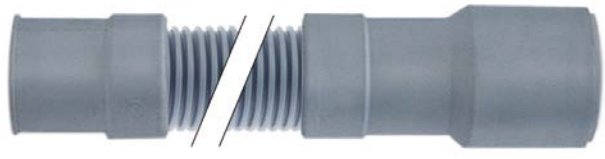

1

GEV No.	530570	Ref. No.	00-323801-001 323801-1
description	drain hose DN21 L 2000mm A int. ø 21mm A ext. ø 25mm B int. ø 20/29mm B ext. ø 27/35mm outer hose ø 25mm		
For models:	AM-10, AM-11, AM-141, AM-700, ECOMAX-402, ECOMAX-502, ECOMAX-600, ECOMAX-602-10, ECOMAX-602-11, ECOMAX-650, ECOMAX-700, FE, HE, HE600-HL, HE-P		



1

GEV No.	530299	Ref. No.	00-883961-001 00-883961-002 01-243347-001 01-243347-1 883961-1 883961-2
description	drain hose DN19 L 2000mm straight ø inside 19mm straight ext. ø 25mm elbow ø inside 21mm elbow ext. ø 27mm outer hose ø 25mm		
For models:	AM-700, AM900-10N, AM900-90, AMS900-10N, AMX, AMX-10HL, AMX-90, AMX-900, AMXR, AMXR-900, AMXS, AMXS-900, AMXT, AMXTS, AMXX, AMXX-1300, AMXXR, AMXXR-1300, AMXXS, AMXXS-1300, AMXXT, AUP, AUP-90, AUPS, AUXX, AUXX-1300, AUXXL-11N, AUXXLS-11N, AUXXR, AUXXR-1300, AUXXS, AUXXS-1300, AUXXT, AUXXTS, ECOMAX-600, ECOMAX-602S-11, ECOMAX-612-10, ECOMAX-612S-10, ECOMAX-700, FP, FX, FX-McDonalds, GP, GX, UX, UXL, UXLS, UXS, UXT, UXTH...(Other models you can see in the webshop)		



1

GEV No.	518103	Ref. No.	139321-911
description	drain hose DN32 L 2000mm straight ø inside 31mm straight ext. ø 35mm elbow ø inside 51mm elbow ext. ø 58mm outer hose ø 38mm polypropylene		
For models:	CHH-50, CHH-60D, CHH-70D, EH-60, EH-70		

industrial hoses

Niplaflex hoses



1

GEV No.	530562	Ref. No.	139321-940
description	pressure hose ID ø 13mm ED ø 21mm L 5m operating p. 10bar burst p. 30bar t.max. 110°C		

pressure control hoses



1

GEV No.	530560	Ref. No.	139321-615
description	pressure control hose ID ø 5mm ED ø 9mm L 5m operating p. 30bar burst p. 90bar temp.-resist. 60°C		

PVC hoses

PVC hoses without fabric



1

GEV No.	570000	Ref. No.	00-775611-004 775611-4
description	PVC hose ID ø 10mm ED ø 14mm L 1.1m thickness 2mm t.max. 60°C transparent		
For models:	ECOMAX-502, UXTH, UXTHS, UXTLH, UXTLHS		



GEV No.	570126	Ref. No.	01-246301-010 01-246301-10
description	PVC hose ID ø 4mm ED ø 6mm L 0.28m thickness 1mm t.max. 60°C transparent		
For models:	AMX, AMX-10HL, AMX-90, AMXR, AMXS, AMXX, AMXXR, AMXXS, AUP, AUP-90, AUPS, AUXX, AUXXR, AUXXS, ECOMAX-402, ECOMAX-502		









GEV No.	570124	Ref. No.	01-246301-008 01-246301-8
description	PVC hose ID ø 4mm ED ø 6mm L 0.5m thickness 1mm t.max. 60°C transparent		
For models:	AM-11, AM900-10N, AM900-90, AMS900-10N, AMX, AMX-10HL, AMX-90, AMXR, AMXS, AMXT, AMXTS, AMXX, AMXXR, AMXXS, AUP, AUP-90, AUPS, AUXX, AUXXL-11N, AUXXLS-11N, AUXXR, AUXXS, AUXXT, AUXXTS, ECOMAX-602-11, ECOMAX-602S-11, ECOMAX-612-10, ECOMAX-612S-10		



GEV No.	520383	Ref. No.	H.775601
description	PVC hose ID ø 4mm ED ø 6mm L 2m thickness 1mm t.max. 60°C blue		
For models:	H-60		
accessories for	520383		
	GEV No.	361058	Ref. No. —
	container filter with non-return valve SS hose ø 4x6mm ø 20mm L 56mm		
	GEV No.	361066	Ref. No. —
	container filter straight SS hose ø 4x6mm L 37mm non return valve ball valve		
	GEV No.	361106	Ref. No. —
	container filter with weight and non-return valve SS hose ø 4x6mm ø 21mm L 51mm non return valve lip valve		
	GEV No.	361141	Ref. No. 139321-594
	container filter with weight ceramic hose ø 4mm		
	GEV No.	361230	Ref. No. —
	container filter with weight stainless steel hose ø 4x6mm		
	GEV No.	361462	Ref. No. —
	container filter with weight SS hose ø 4x6mm		
	GEV No.	361728	Ref. No. —
	container filter with 4m 4x6 hose SS hose ø 4x6mm hose length 4000mm		





GEV No.	520090	Ref. No.	00-898252-002 00-898252-005 898252-2 898252-5
description	PVC hose ID ø 4mm ED ø 6mm L 2m thickness 1mm t.max. 60°C transparent		
For models:	AM-10, AM-11, AM-141, AM-700, AM900, AM900-10N, AM900-90, AMS900, AMS900-10N, AMX, AMX-10HL, AMX-90, AMX-900, AMXR, AMXR-900, AMXS, AMXS-900, AMXT, AMXTS, AMXX, AMXX-1300, AMXXR, AMXXR-1300, AMXXS, AMXXS-1300, AMXXT, AUP, AUP-90, AUPS, AUXX, AUXX-1300, AUXXL, AUXXL-11N, AUXXLS-11N, AUXXR, AUXXR-1300, AUXXS, AUXXS-1300, AUXXT, AUXXTS, ECOMAX-600, ECOMAX-602-10, ECOMAX-602-11, ECOMAX-602S-11, ECOMAX-612-10, ECOMAX-612S-10, ECOMAX-650, ECOMAX-700, GC, GC11...(Other models you can see in the webshop)		
accessories for	520090		
	GEV No.	361058	Ref. No. —
	container filter with non-return valve SS hose ø 4x6mm ø 20mm L 56mm		
	GEV No.	361066	Ref. No. —
	container filter straight SS hose ø 4x6mm L 37mm non return valve ball valve		
	GEV No.	361106	Ref. No. —
	container filter with weight and non-return valve SS hose ø 4x6mm ø 21mm L 51mm non return valve lip valve		
	GEV No.	361141	Ref. No. 139321-594
	container filter with weight ceramic hose ø 4mm		
	GEV No.	361230	Ref. No. —
	container filter with weight stainless steel hose ø 4x6mm		
	GEV No.	361462	Ref. No. —
	container filter with weight SS hose ø 4x6mm		
	GEV No.	361728	Ref. No. —
	container filter with 4m 4x6 hose SS hose ø 4x6mm hose length 4000mm		



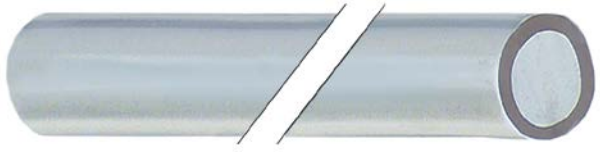

GEV No.	570123	Ref. No.	01-246301-001 01-246301-1
description	PVC hose ID ø 4mm ED ø 6mm L 3.5m thickness 1mm t.max. 60°C transparent		
For models:	ECOMAX-402, ECOMAX-502, FP, FX, FX-McDonalds, GP, GX, UX, UXL, UXLS, UXS, UXT, UXTL, UXTLS, UXTS		





			
1			
GEV No.	570127	Ref. No.	01-246301-011 01-246301-11 01-515410-011
description	PVC hose ID \varnothing 4mm ED \varnothing 6mm L 4m thickness 1mm t.max. 60°C transparent		
For models:	AM-10, AM-11, AM-141, AM900-10N, AM900-90, AMS900-10N, AMX, AMX-10HL, AMX-90, AMXR, AMXS, AMXT, AMXTS, AMXX, AMXXR, AMXXS, AUP, AUP-90, AUPS, AUXX, AUXXL-11N, AUXXLS-11N, AUXXR, AUXXS, AUXXT, AUXXTS, ECOMAX-602-10, ECOMAX-602-11, ECOMAX-602S-11, ECOMAX-612-10, ECOMAX-612S-10		

			
2			
GEV No.	520027	Ref. No.	00-324402-005 00-324402-014 139321-126 324402-14 324402-5
description	PVC hose ID \varnothing 4mm ED \varnothing 7mm L 10m thickness 1.5mm t.max. 60°C transparent		
For models:	CN, CNB, CR, ECOMAX-402, ECOMAX-502, ECW, FTN, GE-400, GF-60, GF-60S, GW-600, GW-600S, GW-601, GW-601S		

			
1			
GEV No.	520029	Ref. No.	00-165168-001
description	PVC hose ID \varnothing 6mm ED \varnothing 9mm L 10m thickness 1.5mm t.max. 60°C transparent		

<h3>extraction and pressure hoses</h3>			
			
1			
GEV No.	530442	Ref. No.	492144-7
description	universal hose ID \varnothing 32mm ED \varnothing 40mm L 1m operating p. 10bar burst p. 30bar temp.-resist. -30 up to +80°C		

<h3>silicone hoses</h3>			
<h4>without fabric</h4>			
			
1			
GEV No.	530821	Ref. No.	00-774080-001 774080-1
description	silicone hose ID \varnothing 10mm ED \varnothing 15mm L 1m thickness 2.5mm operating pressure without pressure burst pressure non defined t.max. 200°C transparent Shore 60°		
For models:	AM-10, AM-11, AM-141, AM-700, AM900, AM900-10N, AM900-90, AMS900, AMS900-10N, AMX, AMX-10HL, AMX-90, AMX-900, AMXR, AMXR-900, AMXS, AMXS-900, AMXT, AMXTS, AMXX, AMXX-1300, AMXXR, AMXXR-1300, AMXXS, AMXXS-1300, AMXXT, AUP, AUP-90, AUPS, AUXX, AUXX-1300, AUXXL, AUXXL-11N, AUXXLS-11N, AUXXR, AUXXR-1300, AUXXS, AUXXS-1300, AUXXT, AUXXTS, ECOMAX-402, ECOMAX-502, ECOMAX-600, ECOMAX-602-10, ECOMAX-602-11, ECOMAX-602S-11, ECOMAX-612-10, ECOMAX-612S-10, FP, FX...(Other models you can see in the webshop)		

<h3>formed hoses</h3>			
<h4>straight</h4>			
			
1			
GEV No.	530278	Ref. No.	00-883776-001 883776-1
description	formed hose D1 \varnothing 24mm L 765mm for boiler ID \varnothing 17.5mm		
For models:	AM900-10N, AM900-90, AMS900-10N, AMX, AMX-10HL, AMX-90, AMXR, AMXS, AMXT, AMXTS, AMXX, AMXXR, AMXXS, AUP, AUP-90, AUPS, AUXX, AUXXL-11N, AUXXLS-11N, AUXXR, AUXXS, AUXXT, AUXXTS, ECOMAX-602-11, ECOMAX-602S-11, ECOMAX-612-10, ECOMAX-612S-10		

			
1			
GEV No.	530276	Ref. No.	00-883721-001 883721-1
description	formed hose D1 \varnothing 25mm D2 \varnothing 17mm L 700mm for wash pump		
For models:	AM900-10N, AM900-90, AMS900-10N, AMX, AMX-10HL, AMX-90, AMXR, AMXS, AMXX, AMXXR, AMXXS, AUP, AUP-90, AUPS, AUXX, AUXXL-11N, AUXXLS-11N, AUXXR, AUXXS, ECOMAX-602-11, ECOMAX-602S-11, ECOMAX-612-10, ECOMAX-612S-10		

			
1			
GEV No.	524228	Ref. No.	774060-1
description	formed hose dishwasher straight equiv. no. 12127		
For models:	EWB-S, FE, HE, HE600-HL, HE-P		

			
1			
GEV No.	518070	Ref. No.	139321-843
description	formed hose dishwasher straight mounting pos. upper equiv. no. 127026		

			
1			
GEV No.	518380	Ref. No.	139321-867
description	formed hose ext. ø 53 ID ø 43mm L 65mm dishwasher straight mounting pos. upper equiv. no. 127036		

			
1			
GEV No.	530290	Ref. No.	00-883775-001 883775-1
description	formed hose hose ext. ø 26mm hose int. ø 19mm L 655mm connection ø 23.5mm		
For models:	AM900-10N, AM900-90, AMS900-10N, AMX, AMX-10HL, AMX-90, AMXR, AMXS, AMXT, AMXTS, AMXX, AMXXR, AMXXS, AUP, AUP-90, AUPS, AUXX, AUXXL-11N, AUXXLS-11N, AUXXR, AUXXS, AUXXT, AUXXTS, ECOMAX-602-11, ECOMAX-602S-11, ECOMAX-612-10, ECOMAX-612S-10		

			
1			
GEV No.	508402	Ref. No.	00-883680-001 883680-1
description	formed hose hose ext. ø 32mm hose int. ø 26mm L 85mm		
For models:	AM900-10N, AM900-90, AMS900-10N, AMX, AMX-10HL, AMX-90, AMXR, AMXS, AMXT, AMXTS, AMXX, AMXXR, AMXXS, AUP, AUP-90, AUPS, AUXX, AUXXL-11N, AUXXLS-11N, AUXXR, AUXXS, AUXXT, AUXXTS, ECOMAX-602-11, ECOMAX-602S-11, ECOMAX-612-10, ECOMAX-612S-10		

form L

			
1			
GEV No.	507494	Ref. No.	00-898247-002 898247-2
description	formed hose end piece A ext. ø 19mm end piece A int. ø 13mm AD2 ø 19mm end piece B 13mm L 485mm for wash pipe		
For models:	AM-10, AM-11, AM-141, AM900-10N, AM900-90, AMS900-10N, AMX, AMX-10HL, AMX-90, AMXR, AMXS, AMXT, AMXTS, AMXX, AMXXR, AMXXS, AUP, AUP-90, AUPS, AUXX, AUXXL-11N, AUXXLS-11N, AUXXR, AUXXS, AUXXT, AUXXTS, ECOMAX-602-10, ECOMAX-602-11, ECOMAX-602S-11, ECOMAX-612-10, ECOMAX-612S-10, UXTH, UXTHL, UXTHLS, UXTHS, UXTLH, UXTLHS		

			
1			
GEV No.	507492	Ref. No.	00-898247-009 898247-9
description	formed hose end piece A ext. ø 20mm end piece A int. ø 13mm AD2 ø 19mm end piece B 12mm L 755mm		
For models:	AM-10, AM-11, AM-141, AM900-10N, AM900-90, AMS900-10N, AMX, AMX-10HL, AMX-90, AMXR, AMXS, AMXT, AMXTS, AMXX, AMXXR, AMXXS, AUP, AUP-90, AUPS, AUXX, AUXXL-11N, AUXXLS-11N, AUXXR, AUXXS, AUXXT, AUXXTS, ECOMAX-502, ECOMAX-602-10, ECOMAX-602-11, ECOMAX-602S-11, ECOMAX-612-10, ECOMAX-612S-10		

			
1			
GEV No.	507493	Ref. No.	00-883524-001 883524-1
description	formed hose end piece A ext. ø 36.5mm end piece A int. ø 29mm AD2 ø 30mm end piece B 22mm L 520mm drain tank - drain pump L-shape		
For models:	AM900-10N, AM900-90, AMS900-10N, AMX, AMX-10HL, AMX-90, AMXR, AMXS, ECOMAX-602-11, ECOMAX-612-10, ECOMAX-612S-10		

			
1			
GEV No.	513254	Ref. No.	139321-910
description	formed hose L 340mm warewashing L-shape equiv. no. 80186 ID ø 60mm		

			
1			
GEV No.	518225	Ref. No.	127041 139321-862
description	formed hose warewashing L-shape equiv. no. 127041		
For models:	ECOMAX-500		



form S



1

GEV No.	510386	Ref. No.	324199
description	formed hose hose ext. ø 21mm hose int. ø 16mm L 195mm Qty 1 S-shape		
For models:	FX, GX, HX, HX-30, HX-30E, HX-30ES, HX-30S, HX-40, HX-40E, HX-40ES, HX-40S, HX-60-EHL, HX-E, HX-ES, HX-S		

form U



1

GEV No.	518517	Ref. No.	139321-851
description	formed hose for drain pump D1 ø 28mm D2 ø 21mm warewashing U-shape		

for dishwashers

miscellaneous



1

GEV No.	570126	Ref. No.	01-246301-010 01-246301-10
description	PVC hose ID ø 4mm ED ø 6mm L 0.28m thickness 1mm t.max. 60°C transparent		
For models:	AMX, AMX-10HL, AMX-90, AMXR, AMXS, AMXX, AMXXR, AMXXS, AUP, AUP-90, AUPS, AUXX, AUXXR, AUXXS, ECOMAX-402, ECOMAX-502		



1

GEV No.	570124	Ref. No.	01-246301-008 01-246301-8
description	PVC hose ID ø 4mm ED ø 6mm L 0.5m thickness 1mm t.max. 60°C transparent		
For models:	AM-11, AM900-10N, AM900-90, AMS900-10N, AMX, AMX-10HL, AMX-90, AMXR, AMXS, AMXT, AMXTS, AMXX, AMXXR, AMXXS, AUP, AUP-90, AUPS, AUXX, AUXXL-11N, AUXXLS-11N, AUXXR, AUXXS, AUXXT, AUXXTS, ECOMAX-602-11, ECOMAX-602S-11, ECOMAX-612-10, ECOMAX-612S-10		



1

GEV No.	520592	Ref. No.	775552-1 895495 898045-1
description	supply hose service kit connections 3/4" L 2000mm SS straight-curved		
For models:	AMX, AMX-900, AMX-E, AMXR-900, AMXS-900, AMXX-1300, AMXXR-1300, AMXXS-1300, AMXXT, AUX, AUX-E, AUXX-1300, AUXXL, AUXXR-1300, AUXXS-1300, AUXXT, ECOMAX-650, FX, GX, UX, UXL, UXLS, UXS, UXT, UXTH, UXTHS, UXTL, UXTLH, UXTLHS, UXTLS, UXTS		

fittings, hose and pipe connectors

hose connectors

without screw connection



1

GEV No.	541109	Ref. No.	139321-578
description	Y-piece plastic hose ø 8-6-8mm for pressure switch		

hose connectors

brass



1

GEV No.	513253	Ref. No.	139321-751
description	hose connector brass angled thread 1/4" hose ø 12mm Qty 1 pcs		



producer-specific



1

GEV No.	504377	Ref. No.	01-240159-001 01-240159-1
description	hose connector grommet ø 23mm grommet length 25mm total length 55mm for water filling		
For models:	AM-10, AM-11, AM-141, AM900-10N, AM900-90, AMS900-10N, AMX, AMX-10HL, AMX-90, AMXR, AMXS, AMXT, AMXTS, AMXX, AMXXR, AMXXS, AUP, AUP-90, AUPS, AUXX, AUXXL-11N, AUXXLS-11N, AUXXR, AUXXS, AUXXT, AUXXTS, ECOMAX-602-10, ECOMAX-602-11, ECOMAX-602S-11, ECOMAX-612-10, ECOMAX-612S-10, ECOMAX-612S-10, FP, FX, FX-McDonalds, GP, GX		

			
1			
GEV No.	520591	Ref. No.	139321-379
description	hose connector thread 1/4" angled grommet ø 12mm grommet length 17mm total length 38mm thread L 12mm brass		
For models:	GE-400, GF-60, GF-60S, GW-600, GW-600S, GW-601, GW-601S		

			
1			
GEV No.	511679	Ref. No.	00-324071-000
description	T-piece connection 17.5mm plastic L 80mm W 40mm connection 1: 13.5mm connection 2: 13.5mm suitable for HOBART		
For models:	AM-10, AM-11, AM-141, AM900-10N, AM900-90, AMS900-10N, AMX, AMX-10HL, AMX-90, AMXR, AMXS, AMXT, AMXTS, AMXX, AMXXR, AMXXS, AUP, AUP-90, AUPS, AUXX, AUXXL-11N, AUXXLS-11N, AUXXR, AUXXS, AUXXT, AUXXTS, ECOMAX-402, ECOMAX-602-10, ECOMAX-602-11, ECOMAX-602S-11, ECOMAX-612-10, ECOMAX-612S-10, ECOMAX-700, FE, FP, FX, FX-McDonalds, GC, GC11, GC12, GC31, GC32, GP, GX, UX, UXL, UXLS, UXS, UXT, UXTH...(Other models you can see in the webshop)		
accessories for	511679		
	GEV No.	520573	Ref. No. 00-324510-202 324510-202
hose clamp ø 20mm wire gauge ø 2mm Qty 1 pcs			

valves and tank inlets

float valves

float valves

			
1			
GEV No.	518118	Ref. No.	897665-1
description	float valve inlet 3/4" outlet 13.5mm input 3.5l/min outputl/min pressure range 0.3-10bar MÜLLER type 21.010.115 for water container flow regulating valve inlet dark blue flow regulating valve outlet		
For models:	CNA, CNB, CNR, CSA, FTN		

water softeners

accessories

			
1			
GEV No.	530174	Ref. No.	00-775918-050 775918-150 775918-50
description	lid kit for softener		
For models:	ECOMAX-402, ECOMAX-502, ECOMAX-602S-11, ECOMAX-612S-10		



water filters

BRITA

water filters

PURITY Clean Extra

full desalination specifically for glasswashers

			
1			
GEV No.	530849	Ref. No.	1008586
description	water filter BRITA type Purity 1200 Clean Extra capacity 5000l flow rate 300l/h operation p max 6bar water temperature +4 up to +60°C ø 288mm H 550mm full desalination for dishwashers		
accessories for	530849		
	GEV No.	520584	Ref. No. —
flex hose SS straight-curved DN12 connection 1: 3/4" connection 2: 3/4" L 2000mm approval DVGW operating p. 10bar test pressure 32bar burst p. 95bar			

water cycle components

supply filters

			
1			
GEV No.	520261	Ref. No.	E927078
description	supply filter thread 1/2" IT - 1/2" IT total length 58mm red brass mesh opening 0.4mm		



ancillary products

clamps

hose clamps

DIN 3017 - W2



GEV No.	520114	Ref. No.	423008
description	hose clamp ø 20-32mm width 9mm Qty 10 pcs DIN 3017		

double wire clamps



GEV No.	520573	Ref. No.	00-324510-202
description	hose clamp ø 20mm wire gauge ø 2mm Qty 1 pcs		
For models:	AMX, AMX-E, AMX-ER, AMX-R, AUX, AUX_, AUX-E, AUX-ER, AUX-R, ECOMAX-402, ECOMAX-502, ECOMAX-700, FE, FE-W, FP, FX, FX-McDonalds, GC41, GC42, GP, GX, HE, HE600-HL, HE-P, HX, HX-30, HX-30E, HX-30ES, HX-30S, HX-40, HX-40E, HX-40ES, HX-40S, HX-60-EHL, HX-E, HX-ES, HX-S, UX, UX-30, UX-30B, UX-30E, UX-30EB, UX-30EH, UX-30ES, UX-30ESB, UX-30ESH, UX-30H, UX-30-McDonalds, UX-30S, UX-30SB... (Other models you can see in the webshop)		



GEV No.	520577	Ref. No.	00-324510-242
description	hose clamp ø 24mm wire gauge ø 2mm Qty 1 pcs		
For models:	AMX, AMX-E, AMX-ER, AMX-R, AMXX-1300, AMXXR-1300, AMXXS-1300, AUX, AUX_, AUX-E, AUX-ER, AUX-R, AUXX-1300, AUXXR-1300, AUXXS-1300, CN, CNA, CNB, CNR, CR, ECOMAX-402, ECOMAX-502, ECOMAX-700, FE, FE-W, FP, FX, FX-McDonalds, GC, GC11, GC12, GC31, GC32, GC41, GC42, GP, GX, HE-P, HX, HX-30, HX-30E, HX-30ES, HX-30S, HX-40, HX-40E, HX-40ES, HX-40S, HX-60-EHL, HX-E, HX-ES... (Other models you can see in the webshop)		



GEV No.	520574	Ref. No.	00-324510-327
description	hose clamp ø 32mm wire gauge ø 3mm Qty 1 pcs		
For models:	AMX, AMX-900, AMX-E, AMX-ER, AMX-R, AMXR-900, AMXS-900, AMXX-1300, AMXXR-1300, AMXXS-1300, AMXXT, AUX, AUX-E, AUX-ER, AUX-R, AUXX-1300, AUXXL, AUXXR-1300, AUXXS-1300, AUXXT, ECOMAX-502, ECOMAX-650, ECOMAX-700, FE, FP, FX, FX-McDonalds, GP, GX, UX, UXD-30, UXL, UXLS, UXS, UXT, UXTH, UXTHL, UXTHLS, UXTHS, UXTL, UXTLH, UXTLHS, UXTLS, UXTS		



GEV No.	513268	Ref. No.	00-303340-008 00-324510-068 139321-580 303340-8 324510-68
description	hose clamp ø 8-10mm wire gauge ø 1mm Qty 1 pcs		
For models:	AM-10, AM-11, AM-141, AM-700, AM900, AM900-10N, AM900-90, AMS900, AMS900-10N, AMX, AMX-10HL, AMX-90, AMX-900, AMXR, AMXR-900, AMXS, AMXS-900, AMXT, AMXTS, AMXX, AMXX-1300, AMXXR, AMXXR-1300, AMXXS, AMXXS-1300, AMXXT, AUP, AUP-90, AUPS, AUXX, AUXX-1300, AUXXL, AUXXL-11N, AUXXLS-11N, AUXXR, AUXXR-1300, AUXXS, AUXXS-1300, AUXXT, AUXXTS, CHF45, ECOMAX-600, ECOMAX-602-10, ECOMAX-602-11, ECOMAX-602S-11, ECOMAX-612-10, ECOMAX-612S-10, ECOMAX-650, ECOMAX-700, EF-40... (Other models you can see in the webshop)		

double wire clamps with screw



GEV No.	505281	Ref. No.	00-323945-015 323945-15
description	hose clamp ø 15mm zinc-coated steel Qty 20 pcs		
For models:	AM-10, AM-11, AM-141, AM-700, AM900, AM900-10N, AM900-90, AMS900, AMS900-10N, AMX, AMX-10HL, AMX-90, AMX-900, AMXR, AMXR-900, AMXS, AMXS-900, AMXT, AMXTS, AMXX, AMXX-1300, AMXXR, AMXXR-1300, AMXXS, AMXXS-1300, AMXXT, AUP, AUP-90, AUPS, AUXX, AUXX-1300, AUXXL, AUXXL-11N, AUXXLS-11N, AUXXR, AUXXR-1300, AUXXS, AUXXS-1300, AUXXT, AUXXTS, ECOMAX-402, ECOMAX-502, ECOMAX-600, ECOMAX-602-10, ECOMAX-602-11, ECOMAX-602S-11, ECOMAX-612-10, ECOMAX-612S-10, FP, FX... (Other models you can see in the webshop)		



GEV No.	505282	Ref. No.	00-323945-016 323945-16
description	hose clamp ø 16mm zinc-coated steel Qty 20 pcs		
For models:	AM-700, AM900, AMS900, AMX, AMX-900, AMX-E, AMX-ER, AMX-R, AMXR-900, AMXS-900, AMXX-1300, AMXXR-1300, AMXXS-1300, AMXXT, AUX, AUX-E, AUX-ER, AUX-R, AUXX-1300, AUXXL, AUXXR-1300, AUXXS-1300, AUXXT, ECOMAX-402, ECOMAX-502, ECOMAX-600, ECOMAX-650, GC, UX, UXL, UXLS, UXS, UXT, UXTH, UXTHL, UXTHLS, UXTHS, UXTL, UXTLH, UXTLHS, UXTLS, UXTS		



1

GEV No.	505283	Ref. No.	00-323945-018 323945-18
description	hose clamp ø 18mm zinc-coated steel Qty 20 pcs		
For models:	AM-10, AM-11, AM-141, AM-700, AM900, AM900-10N, AM900-90, AMS900, AMS900-10N, AMX, AMX-10HL, AMX-90, AMX-900, AMX-E, AMX-ER, AMXR, AMX-R, AMXR-900, AMXS, AMXS-900, AMXT, AMXTS, AMXX, AMXX-1300, AMXXR, AMXXR-1300, AMXXS, AMXXS-1300, AMXXT, AUP, AUP-90, AUPS, AUX, AUX-E, AUX-ER, AUX-R, AUXX, AUXX-1300, AUXXL-11N, AUXXLS-11N, AUXXR, AUXXR-1300, AUXXS, AUXXS-1300, AUXXT, AUXXTS, ECOMAX-402, ECOMAX-502, ECOMAX-600, ECOMAX-602-10...(Other models you can see in the webshop)		



1

GEV No.	505286	Ref. No.	00-323945-029 323945-29
description	hose clamp ø 29mm zinc-coated steel Qty 20 pcs		
For models:	AM900-10N, AM900-90, AMS900-10N, AMX, AMX-10HL, AMX-90, AMX-E, AMX-ER, AMXR, AMX-R, AMXS, AMXT, AMXTS, AMXX, AMXX-1300, AMXXR, AMXXR-1300, AMXXS, AMXXS-1300, AMXXT, AUP, AUP-90, AUPS, AUX, AUX-E, AUX-ER, AUX-R, AUXX, AUXX-1300, AUXXL, AUXXL-11N, AUXXLS-11N, AUXXR, AUXXR-1300, AUXXS, AUXXS-1300, AUXXT, AUXXTS, CR, CR-F, ECOMAX-602-11, ECOMAX-602S-11, ECOMAX-612-10, ECOMAX-612S-10, ECOMAX-700, FE, GC, GC11, GC12, GC31...(Other models you can see in the webshop)		



1

GEV No.	505284	Ref. No.	00-323945-019 00-323945-021 323945-19 -alt- 323945-21
description	hose clamp ø 21mm zinc-coated steel Qty 20 pcs		
For models:	AM-10, AM-11, AM-141, AM-700, AM900-10N, AM900-90, AMS900-10N, AMX, AMX-10HL, AMX-90, AMX-E, AMX-ER, AMXR, AMX-R, AMXS, AMXT, AMXTS, AMXX, AMXX-1300, AMXXR, AMXXR-1300, AMXXS, AMXXS-1300, AMXXT, AUP, AUP-90, AUPS, AUX, AUX-E, AUX-ER, AUX-R, AUXX, AUXX-1300, AUXXL, AUXXL-11N, AUXXLS-11N, AUXXR, AUXXR-1300, AUXXS, AUXXS-1300, AUXXT, AUXXTS, ECOMAX-402, ECOMAX-502, ECOMAX-600, ECOMAX-602-10, ECOMAX-602-11, ECOMAX-602S-11, ECOMAX-612-10, ECOMAX-612S-10...(Other models you can see in the webshop)		



1

GEV No.	505287	Ref. No.	00-323945-033 323945-33
description	hose clamp ø 33mm zinc-coated steel Qty 20 pcs		
For models:	AM-700, AM900, AM900-10N, AM900-90, AMS900, AMS900-10N, AMX, AMX-10HL, AMX-90, AMX-900, AMXR, AMXR-900, AMXS, AMXS-900, AMXX, AMXXR, AMXXS, AUP, AUP-90, AUPS, AUXX, AUXXL-11N, AUXXLS-11N, AUXXR, AUXXS, CN-Protronic, CN-Smartronic, CP-Protronic, CR-F, ECOMAX-402, ECOMAX-502, ECOMAX-600, ECOMAX-602-11, ECOMAX-612-10, ECOMAX-612S-10, ECOMAX-650, ECOMAX-700, FX, GC31, GC32, GC41, GC42, GX		



1

GEV No.	505285	Ref. No.	00-323945-025 323945-25
description	hose clamp ø 25mm zinc-coated steel Qty 20 pcs		
For models:	AM-10, AM-11, AM-141, AM-700, AM900, AM900-10N, AM900-90, AMS900, AMS900-10N, AMX, AMX-10HL, AMX-90, AMX-900, AMX-E, AMX-ER, AMXR, AMX-R, AMXR-900, AMXS, AMXS-900, AMXT, AMXTS, AMXX, AMXX-1300, AMXXR, AMXXR-1300, AMXXS, AMXXS-1300, AMXXT, AUP, AUP-90, AUPS, AUX, AUX-E, AUX-ER, AUX-R, AUXX, AUXX-1300, AUXXL, AUXXL-11N, AUXXLS-11N, AUXXR, AUXXR-1300, AUXXS, AUXXS-1300, AUXXT, AUXXTS, ECOMAX-402, ECOMAX-502, ECOMAX-600...(Other models you can see in the webshop)		





1

GEV No.	505293	Ref. No.	00-323945-035 323945-35
description	hose clamp ø 34-38mm zinc-coated steel Qty 20 pcs		
For models:	AM900-10N, AM900-90, AMS900-10N, AMX, AMX-10HL, AMX-90, AMXR, AMXS, AMXT, AMXTS, AMXX, AMXXR, AMXXS, AUP, AUP-90, AUPS, AUXX, AUXXL-11N, AUXXLS-11N, AUXXR, AUXXS, AUXXT, AUXXTS, CR, CR-F, ECOMAX-402, ECOMAX-502, ECOMAX-602-11, ECOMAX-602S-11, ECOMAX-612-10, ECOMAX-612S-10, ECOMAX-650		



 <p>1</p>			
GEV No.	505290	Ref. No.	00-323945-037 323945-37
description	hose clamp ø 37mm zinc-coated steel Qty 10 pcs		
For models:	AM-700, AM900, AMS900, AMX-900, AMXR-900, AMXS-900, AMXT, AMXTS, AMXX-1300, AMXXR-1300, AMXXS-1300, AMXXT, AUXX-1300, AUXXL, AUXXR-1300, AUXXS-1300, AUXXT, AUXXTS, CR, ECOMAX-402, ECOMAX-502, ECOMAX-600, ECOMAX-700, FP, FX, FX-McDonalds, GC41, GC42, GP, GX, UX, UXL, UXLS, UXS, UXT, UXTH, UXTHL, UXTHLS, UXTHS, UXTL, UXTLH, UXTLHS, UXTLS, UXTS		

 <p>1</p>			
GEV No.	505292	Ref. No.	00-323945-064 323945-64
description	hose clamp ø 64-68mm zinc-coated steel Qty 10 pcs		
For models:	AM-10, AM-11, AM-141, AM900-10N, AM900-90, AMS900-10N, AMX, AMX-10HL, AMX-90, AMXR, AMXS, AMXT, AMXTS, AUXXT, AUXXTS, CN-Protronic, CN-Smartronic, CP-Protronic, CS-Easytronic, ECOMAX-602-10, ECOMAX-602-11, ECOMAX-602S-11, ECOMAX-612-10, ECOMAX-612S-10, ECOMAX-700, UX, UXL, UXLS, UXS, UXT, UXTL, UXTLS, UXTS		

 <p>1</p>			
GEV No.	505294	Ref. No.	00-323945-053 323945-53
description	hose clamp ø 53mm zinc-coated steel Qty 10 pcs		
For models:	CN-Protronic, CN-Smartronic, CP-Protronic, CSA, CS-Easytronic, ECOMAX-402, ECOMAX-502, FE, GC, GC11, GC12, GC31, GC32, GC41, GC42, HE, HE600-HL, HE-P, UX-30, UX-30B, UX-30E, UX-30EB, UX-30EH, UX-30ES, UX-30ESB, UX-30ESH, UX-30H, UX-30-McDonalds, UX-30S, UX-30SB, UX-30SH, UX-60, UX-60B, UX-60E, UX-60EB, UX-60EH, UX-60EHB, UX-60H, UX-60HB		

 <p>1</p>			
GEV No.	505291	Ref. No.	00-323945-056 323945-56
description	hose clamp ø 56mm zinc-coated steel Qty 10 pcs		
For models:	AM-700, AM900, AMS900, AMX-900, AMXR-900, AMXS-900, CR, ECOMAX-402, ECOMAX-502, ECOMAX-600, ECOMAX-650, FE, HE, HE600-HL, HE-P		

 <p>1</p>			
GEV No.	505289	Ref. No.	00-323945-060 323945-60
description	hose clamp ø 60mm zinc-coated steel Qty 10 pcs		
For models:	AM-10, AM-11, AM-141, AM900-10N, AM900-90, AMS900-10N, AMX, AMX-10HL, AMX-90, AMXR, AMXS, AMXT, AMXTS, AMXX, AMXXR, AMXXS, AUP, AUP-90, AUPS, AUXX, AUXXL-11N, AUXXLS-11N, AUXXR, AUXXS, AUXXT, AUXXTS, CSA, ECOMAX-602-10, ECOMAX-602-11, ECOMAX-602S-11, ECOMAX-612-10, ECOMAX-612S-10		

measuring equipment

thermometers

built-in thermometers

 <p>1</p>			
GEV No.	541969	Ref. No.	228720-2 228720-3
description	thermometer mounting measurements 58x25.5mm +30 up to +120°C capillary pipe 3000mm probe ø 8.5mm probe L 35mm		
For models:	AMX, AMX-R, AUX_, AUX-R, CR-F, CSA, ECOMAX-600, ECOMAX-700, ECOMAX-800, ECW, FX, GX, HX-30, HX-30S, HX-40, HX-40S, UW-120, UW-200, UX-30, UX-30B, UX-30S, UX-30SB, UX-60, UX-60B		

fastening material

screws

countersunk screws

 <p>1</p>			
GEV No.	560215	Ref. No.	603182
description	countersunk screw thread M5 L 14mm SS DIN 963/ISO 2009 Qty 20 pcs intake slotted head ø 9.2mm		
For models:	CR, FE, FE-W, FX, GC, GC11, GC12, GC31, GC32, GC41, GC42, GX, HE, HE600-HL, HE-P, HX, HX-30, HX-30E, HX-30ES, HX-30S, HX-40, HX-40E, HX-40ES, HX-40S, HX-60-EHL, HX-E, HX-ES, HX-S, UXD-30		

flat-headed bolts

			
1			
GEV No.	560062	Ref. No.	603455
description	flat-headed bolt thread M4 thread L 10mm SS DIN 7985/ISO 7045 Qty 20 pcs intake Phillips head ø 8mm head thickness 2mm		
For models:	CO-0611E, CO-1011E, CO-2011E, CS-0611E, CS-1011E, CS-2011E, CSD-0611E, CSD-1011E, CSD-2011E, UW-105		

			
1			
GEV No.	560061	Ref. No.	602687
description	flat-headed bolt thread M4 thread L 6mm SS DIN 7985/ISO 7045 Qty 20 pcs intake Phillips head ø 8mm head thickness 2mm		
For models:	AMX, AMX-E, AMX-ER, AMX-R, AUX, AUX_, AUX-E, AUX-ER, AUX-R, ECOMAX-600, ECOMAX-700, FE, FUX, FX, GX, HE, HE600-HL, HE-P, HX, HX-30, HX-30E, HX-30ES, HX-30S, HX-40, HX-40E, HX-40ES, HX-40S, HX-E, HX-ES, HX-S, UX-30, UX-30B, UX-30E, UX-30EB, UX-30EH, UX-30ES, UX-30ESB, UX-30ESH, UX-30H, UX-30-McDonalds, UX-30S, UX-30SB, UX-30SH, UX-60, UX-60B, UX-60E, UX-60EB, UX-60EH, UX-60EHB, UX-60H...(Other models you can see in the webshop)		

			
1			
GEV No.	560067	Ref. No.	140506-27
description	flat-headed bolt thread M5 thread L 10mm SS DIN 7985/ISO 7045 Qty 20 pcs intake Phillips head ø 8mm head thickness 2mm		
For models:	VPU-100, VPU-6		

hexagonal screws

			
1			
GEV No.	550528	Ref. No.	00-609782-000
description	safety screw thread M5 WS 8 Qty 10 pcs L 8mm head ø 11mm		
For models:	AM-10, AM-11, AM-141, AM900-10N, AM900-90, AMS900-10N, AMX, AMX-10HL, AMX-90, AMXR, AMXS, AMXT, AMXTS, AMXX, AMXXR, AMXXS, AUP, AUP-90, AUPS, AUX, AUXXL-11N, AUXXLS-11N, AUXXR, AUXXS, AUXXT, AUXXTS, ECOMAX-602-10, ECOMAX-602-11, ECOMAX-602S-11, ECOMAX-612-10, ECOMAX-612S-10		

grub screws

DIN 913/ISO 4026

			
1			
GEV No.	504733	Ref. No.	VA-261-1
description	grub screw thread M4 L 5mm stainless steel DIN 913 intake internal hexagon WS 2 Qty 1 pcs		

knurled screws

			
1			
GEV No.	510112	Ref. No.	139321-107 139321-873
description	Thumb screw thread M10 thread L 10mm ø 22mm H 4.5mm SS		
For models:	GE-400, GW-600, GW-600S, GW-601, GW-601S		

nuts

knurled nuts

			
1			
GEV No.	518152	Ref. No.	01-240205-001 01-240205-1 324036
description	knurled nut thread M12x1 ø 32mm H 3mm mounting pos. upper/lower SS for wash arm ID ø 11.5mm ED ø 32mm thickness 3mm		
For models:	AM-10, AM-11, AM-141, AM-700, AM900, AM900-10N, AM900-90, AMS900, AMS900-10N, AMX, AMX-10HL, AMX-90, AMX-900, AMX-E, AMX-ER, AMXR, AMX-R, AMXR-900, AMXS, AMXS-900, AMXT, AMXTS, AMXX, AMXX-1300, AMXXR, AMXXR-1300, AMXXS, AMXXS-1300, AMXXT, AUP, AUP-90, AUPS, AUX, AUX_, AUX-E, AUX-ER, AUX-R, AUX, AUX-1300, AUXXL, AUXXL-11N, AUXXLS-11N, AUXXR, AUXXR-1300, AUXXS, AUXXS-1300, AUXXT, AUXXTS, ECOMAX-402, ECOMAX-502...(Other models you can see in the webshop)		

hexagonal nuts

DIN 934 / ISO 4032/8673

			
1			
GEV No.	511212	Ref. No.	602491
description	hexagonal nut thread M6 H 5mm WS 10 SS DIN/ISO DIN 934 / ISO 4032/8673 Qty 1 pcs		
For models:	ACW, AM-600, AM-600C, AM-600CR, AM-600R, AMX, AMX-E, AMX-ER, AMX-R, AMXX-1300, AMXXR-1300, AMXXS-1300, AMXXT, AUX, AUX_, AUX-E, AUX-ER, AUX-R, AUX-1300, AUXXL, AUXXR-1300, AUXXS-1300, AUXXT, CDC, CNA, CNR, CO-0611E, CO-0612E, CO-1011E, CO-1012E, CO-2011E, CS-0611E, CS-0612E, CS-0612E-A, CS-1011E, CS-1012E, CS-1012E-A, CS-1012G, CS-1022E, CS-1022E-A, CS-2011E, CS-2012E, CS-2022E, CSD-0611E, CSD-0612E, CSD-0612E-A, CSD-1011E, CSD-1012E, CSD-1012E-A, CSD-1013G...(Other models you can see in the webshop)		





DIN 985			
			
1			
GEV No.	560460	Ref. No.	602504
description	hexagonal nut thread M10 H 15mm SS WS 17 self-locking Qty 1 pcs DIN/ISO 985		
For models:	AM-600, AM-600C, AM-600CR, AM-600R, AM900, AMS900, AMX-900, AMXR-900, AMXS-900, AMXX-1300, AMXXR-1300, AMXXS-1300, AMXXT, AUXX-1300, AUXXR-1300, AUXXS-1300, AUXXT, CDC, CN, CNA, CNB, CNR, CTC, ECOMAX-700, ECW, FTX, FUX, MS-34R, MS-41R, UW-105, UW-120, UW-125, UW-135, UW-135H, UW-200, UW-205, UX, UXL, UXLs, UXS, UXT, UXTH, UXTHL, UXTHLS, UXTHS, UXTL, UXTLH, UXTLHS, UXTLS, UXTS		

miscellaneous			
			
1			
GEV No.	696438	Ref. No.	00-775460-001 775460-1
description	expanding nut plastic Qty 1 pcs for sheet-metal screw		
For models:	AM-10, AM-11, AM-141, AM-700, AM900, AM900-10N, AM900-90, AMS900, AMS900-10N, AMX, AMX-10HL, AMX-90, AMX-900, AMXR, AMXR-900, AMXS, AMXS-900, AMXT, AMXTS, AMXX, AMXX-1300, AMXXR, AMXXR-1300, AMXXS, AMXXS-1300, AMXXT, AUP, AUP-90, AUPS, AUXX, AUXX-1300, AUXXL, AUXXL-11N, AUXXLS-11N, AUXXR, AUXXR-1300, AUXXS, AUXXS-1300, AUXXT, AUXXTS, ECOMAX-600, ECOMAX-602-10, ECOMAX-602-11, ECOMAX-602S-11, ECOMAX-612-10, ECOMAX-612S-10, ECOMAX-650, ECOMAX-700, FP, FX... (Other models you can see in the webshop)		

washers			
spring rings			
			
1			
GEV No.	560121	Ref. No.	371020-562 602308 VC032-09
description	lock washer ID ø 4.2mm ED ø 8mm SS DIN127 Qty 20 pcs for thread M4		
For models:	AM-600, AM-600C, AM-600CR, AM-600R, AMX, AMX-E, AMX-ER, AMX-R, AUX, AUX_, AUX-E, AUX-ER, AUX-R, CO-0611E, CO-0612E, CO-1011E, CO-1012E, CO-2011E, CS-0423E, CS-0423EK, CS-0523E, CS-0523EK, CS-0611E, CS-0612E, CS-1011E, CS-1012E, CS-1012E-A, CS-1022E, CS-1022E-A, CS-2011E, CS-2012E, CS-2022E, CS-423E, CS-423K, CSD-0611E, CSD-0612E, CSD-0612ET, CSD-1011E, CSD-1012E, CSD-1012E-A, CSD-1012ET, CSD-1013G, CSD-1022E, CSD-1022E-A, CSD-2011E, CSD-2012E, CSD-2012ET, CSD-2013G, CSD-2022E, CSD-0423E... (Other models you can see in the webshop)		

			
1			
GEV No.	560122	Ref. No.	140506-28 602306
description	lock washer ID ø 5.2mm ED ø 9mm SS DIN127 Qty 20 pcs for thread M5		
For models:	AM-600, AM-600C, AM-600CR, AM-600R, CO-0611E, CO-0612E, CO-1011E, CO-1012E, CO-2011E, CS-0611E, CS-0612E, CS-0612E-A, CS-1011E, CS-1012E, CS-1012E-A, CS-1012G, CS-1022E, CS-1022E-A, CS-2011E, CS-2012E, CS-2012G, CS-2022E, CSD-0611E, CSD-0612E, CSD-0612E-A, CSD-1011E, CSD-1012E, CSD-1012E-A, CSD-1013G, CSD-1022E, CSD-1022E-A, CSD-2011E, CSD-2012E, CSD-2013G, CSD-2022E, FE, FE-W, FM-400H, FM-400U, FM-500, FM-500H, FTX, FUX, FX, G10R, G5R, GX, HE-P, HX, HX-30... (Other models you can see in the webshop)		

washers			
DIN 125A			
			
1			
GEV No.	560356	Ref. No.	602288
description	plain washer ID ø 10.5mm ED ø 20mm thickness 2mm SS Qty 1 pcs DIN 125A for thread M10		
For models:	ACW, AM-600, AM-600C, AM-600CR, AM-600R, AM-700, AM900, AMS900, AMX, AMX-900, AMX-E, AMX-ER, AMX-R, AMXR-900, AMXS-900, AMXX-1300, AMXXR-1300, AMXXS-1300, AMXXT, AUX, AUX_, AUX-E, AUX-ER, AUX-R, AUXX-1300, AUXXL, AUXXR-1300, AUXXS-1300, AUXXT, CDC, CN, CNA, CNB, CNR, CO-2011E, CS-2011E, CSD-2011E, CTC, ECOMAX-600, ECOMAX-650, ECOMAX-700, ECW, FE-W, FTN, FTT, FTX, FUX, FX, GC, GC11... (Other models you can see in the webshop)		

miscellaneous			
			
1			
GEV No.	692307	Ref. No.	01-240789-001 01-240789-1
description	plain washer for hinge ID ø 8mm ED ø 18mm plastic thickness 1mm Qty 1 pcs		
For models:	ECOMAX-502		

			
1			
GEV No.	524117	Ref. No.	602286
description	plain washer ID ø 6.4mm ED ø 12mm thickness 1.6mm SS Qty 1 pcs		

tooth lock washers

DIN 6798A



GEV No.	560509	Ref. No.	602316
description	tooth lock washer ID ø 15mm ED ø 24mm SS Qty 1 pcs for thread 1/4"		
For models:	AM-12E, AM-12EC, AM-12EF, AM-12ER, AM-600, AM-600C, AM-600CR, AM-600R, CN, CNA, CNB, CNR, CR, CR-F, CSA, CX, ECOMAX-800, EWB-S, FTN, FTT, FTX, FUX, UW-105, UW-135, UW-135H, UWX		

GEV No.	520577	Ref. No.	00-324510-242
description	hose clamp ø 24mm wire gauge ø 2mm Qty 1 pcs		
For models:	AMX, AMX-E, AMX-ER, AMX-R, AMXX-1300, AMXXR-1300, AMXXS-1300, AUX, AUX_, AUX-E, AUX-ER, AUX-R, AUXX-1300, AUXXR-1300, AUXXS-1300, CN, CNA, CNB, CNR, CR, ECOMAX-402, ECOMAX-502, ECOMAX-700, FE, FE-W, FP, FX, FX-McDonalds, GC, GC11, GC12, GC31, GC32, GC41, GC42, GP, GX, HE-P, HX, HX-30, HX-30E, HX-30ES, HX-30S, HX-40, HX-40E, HX-40ES, HX-40S, HX-60-EHL, HX-E, HX-ES...(Other models you can see in the webshop)		

fasteners

slot nuts



GEV No.	560283	Ref. No.	12430-59 D-12430-59
description	slot nut W 5mm H 5mm L 25mm		
For models:	A-200, A-200DT, A-200FM, A-200FT, A-200N, A-200T, HSM20, NCM20		

GEV No.	520574	Ref. No.	00-324510-327
description	hose clamp ø 32mm wire gauge ø 3mm Qty 1 pcs		
For models:	AMX, AMX-900, AMX-E, AMX-ER, AMX-R, AMXR-900, AMXS-900, AMXX-1300, AMXXR-1300, AMXXS-1300, AMXXT, AUX, AUX-E, AUX-ER, AUX-R, AUXX-1300, AUXXL, AUXXR-1300, AUXXS-1300, AUXXT, ECOMAX-502, ECOMAX-650, ECOMAX-700, FE, FP, FX, FX-McDonalds, GP, GX, UX, UXD-30, UXL, UXLS, UXS, UXT, UXTH, UXTHL, UXTHLS, UXTHS, UXTL, UXTLH, UXTLHS, UXTLS, UXTS		

clamps

hose clamps

DIN 3017 - W2



GEV No.	520114	Ref. No.	423008
description	hose clamp ø 20-32mm width 9mm Qty 10 pcs DIN 3017		

GEV No.	513268	Ref. No.	00-303340-008 00-324510-068 139321-580 303340-8 324510-68
description	hose clamp ø 8-10mm wire gauge ø 1mm Qty 1 pcs		
For models:	AM-10, AM-11, AM-141, AM-700, AM900, AM900-10N, AM900-90, AMS900, AMS900-10N, AMX, AMX-10HL, AMX-90, AMX-900, AMXR, AMXR-900, AMXS, AMXS-900, AMXT, AMXTS, AMXX, AMXX-1300, AMXXR, AMXXR-1300, AMXXS, AMXXS-1300, AMXXT, AUP, AUP-90, AUPS, AUXX, AUXX-1300, AUXXL, AUXXL-11N, AUXXLS-11N, AUXXR, AUXXR-1300, AUXXS, AUXXS-1300, AUXXT, AUXXTS, CHF45, ECOMAX-600, ECOMAX-602-10, ECOMAX-602-11, ECOMAX-602S-11, ECOMAX-612-10, ECOMAX-612S-10, ECOMAX-650, ECOMAX-700, EF-40...(Other models you can see in the webshop)		

double wire clamps



GEV No.	520573	Ref. No.	00-324510-202
description	hose clamp ø 20mm wire gauge ø 2mm Qty 1 pcs		
For models:	AMX, AMX-E, AMX-ER, AMX-R, AUX, AUX_, AUX-E, AUX-ER, AUX-R, ECOMAX-402, ECOMAX-502, ECOMAX-700, FE, FE-W, FP, FX, FX-McDonalds, GC41, GC42, GP, GX, HE, HE600-HL, HE-P, HX, HX-30, HX-30E, HX-30ES, HX-30S, HX-40, HX-40E, HX-40ES, HX-40S, HX-60-EHL, HX-E, HX-ES, HX-S, UX, UX-30, UX-30B, UX-30E, UX-30EB, UX-30EH, UX-30ES, UX-30ESB, UX-30ESH, UX-30H, UX-30-McDonalds, UX-30S, UX-30SB...(Other models you can see in the webshop)		



double wire clamps with screw

1



GEV No.	505281	Ref. No.	00-323945-015 323945-15
description	hose clamp ø 15mm zinc-coated steel Qty 20 pcs		
For models:	AM-10, AM-11, AM-141, AM-700, AM900, AM900-10N, AM900-90, AMS900, AMS900-10N, AMX, AMX-10HL, AMX-90, AMX-900, AMXR, AMXR-900, AMXS, AMXS-900, AMXT, AMXTS, AMXX, AMXX-1300, AMXXR, AMXXR-1300, AMXXS, AMXXS-1300, AMXXT, AUP, AUP-90, AUPS, AUX, AUX-1300, AUXXL, AUXXL-11N, AUXXLS-11N, AUXXR, AUXXR-1300, AUXXS, AUXXS-1300, AUXXT, AUXXTS, ECOMAX-402, ECOMAX-502, ECOMAX-600, ECOMAX-602-10, ECOMAX-602-11, ECOMAX-602S-11, ECOMAX-612-10, ECOMAX-612S-10, FP, FX...(Other models you can see in the webshop)		

1



GEV No.	505284	Ref. No.	00-323945-019 00-323945-021 323945-19 -alt 323945-21
description	hose clamp ø 21mm zinc-coated steel Qty 20 pcs		
For models:	AM-10, AM-11, AM-141, AM-700, AM900-10N, AM900-90, AMS900-10N, AMX, AMX-10HL, AMX-90, AMX-E, AMX-ER, AMXR, AMX-R, AMXS, AMXT, AMXTS, AMXX, AMXX-1300, AMXXR, AMXXR-1300, AMXXS, AMXXS-1300, AMXXT, AUP, AUP-90, AUPS, AUX, AUX-E, AUX-ER, AUX-R, AUX, AUX-1300, AUXXL, AUXXL-11N, AUXXLS-11N, AUXXR, AUXXR-1300, AUXXS, AUXXS-1300, AUXXT, AUXXTS, ECOMAX-402, ECOMAX-502, ECOMAX-600, ECOMAX-602-10, ECOMAX-602-11, ECOMAX-602S-11, ECOMAX-612-10, ECOMAX-612S-10...(Other models you can see in the webshop)		

2



GEV No.	505282	Ref. No.	00-323945-016 323945-16
description	hose clamp ø 16mm zinc-coated steel Qty 20 pcs		
For models:	AM-700, AM900, AMS900, AMX, AMX-900, AMX-E, AMX-ER, AMX-R, AMXR-900, AMXS-900, AMXX-1300, AMXXR-1300, AMXXS-1300, AMXXT, AUX, AUX-E, AUX-ER, AUX-R, AUX-1300, AUXXL, AUXXR-1300, AUXXS-1300, AUXXT, ECOMAX-402, ECOMAX-502, ECOMAX-600, ECOMAX-650, GC, UX, UXL, UXL, UXS, UXT, UXTH, UXTHL, UXTHLS, UXTHS, UXTL, UXTLH, UXTLHS, UXTLS, UXTS		

1



GEV No.	505285	Ref. No.	00-323945-025 323945-25
description	hose clamp ø 25mm zinc-coated steel Qty 20 pcs		
For models:	AM-10, AM-11, AM-141, AM-700, AM900, AM900-10N, AM900-90, AMS900, AMS900-10N, AMX, AMX-10HL, AMX-90, AMX-900, AMX-E, AMX-ER, AMXR, AMX-R, AMXR-900, AMXS, AMXS-900, AMXT, AMXTS, AMXX, AMXX-1300, AMXXR, AMXXR-1300, AMXXS, AMXXS-1300, AMXXT, AUP, AUP-90, AUPS, AUX, AUX-E, AUX-ER, AUX-R, AUX, AUX-1300, AUXXL, AUXXL-11N, AUXXLS-11N, AUXXR, AUXXR-1300, AUXXS, AUXXS-1300, AUXXT, AUXXTS, ECOMAX-402, ECOMAX-502, ECOMAX-600...(Other models you can see in the webshop)		

1



GEV No.	505283	Ref. No.	00-323945-018 323945-18
description	hose clamp ø 18mm zinc-coated steel Qty 20 pcs		
For models:	AM-10, AM-11, AM-141, AM-700, AM900, AM900-10N, AM900-90, AMS900, AMS900-10N, AMX, AMX-10HL, AMX-90, AMX-900, AMX-E, AMX-ER, AMXR, AMX-R, AMXR-900, AMXS, AMXS-900, AMXT, AMXTS, AMXX, AMXX-1300, AMXXR, AMXXR-1300, AMXXS, AMXXS-1300, AMXXT, AUP, AUP-90, AUPS, AUX, AUX-E, AUX-ER, AUX-R, AUX, AUX-1300, AUXXL-11N, AUXXLS-11N, AUXXR, AUXXR-1300, AUXXS, AUXXS-1300, AUXXT, AUXXTS, ECOMAX-402, ECOMAX-502, ECOMAX-600, ECOMAX-602-10...(Other models you can see in the webshop)		

1



GEV No.	505286	Ref. No.	00-323945-029 323945-29
description	hose clamp ø 29mm zinc-coated steel Qty 20 pcs		
For models:	AM900-10N, AM900-90, AMS900-10N, AMX, AMX-10HL, AMX-90, AMX-E, AMX-ER, AMXR, AMX-R, AMXS, AMXT, AMXTS, AMXX, AMXX-1300, AMXXR, AMXXR-1300, AMXXS, AMXXS-1300, AMXXT, AUP, AUP-90, AUPS, AUX, AUX-E, AUX-ER, AUX-R, AUX, AUX-1300, AUXXL, AUXXL-11N, AUXXLS-11N, AUXXR, AUXXR-1300, AUXXS, AUXXS-1300, AUXXT, AUXXTS, CR, CR-F, ECOMAX-602-11, ECOMAX-602S-11, ECOMAX-612-10, ECOMAX-612S-10, ECOMAX-700, FE, GC, GC11, GC12, GC31...(Other models you can see in the webshop)		



1

GEV No.	505287	Ref. No.	00-323945-033 323945-33
description	hose clamp ø 33mm zinc-coated steel Qty 20 pcs		
For models:	AM-700, AM900, AM900-10N, AM900-90, AMS900, AMS900-10N, AMX, AMX-10HL, AMX-90, AMX-900, AMXR, AMXR-900, AMXS, AMXS-900, AMXX, AMXXR, AMXXS, AUP, AUP-90, AUPS, AUXX, AUXXL-11N, AUXXLS-11N, AUXXR, AUXXS, CN-Protronic, CN-Smartronic, CP-Protronic, CR-F, ECOMAX-402, ECOMAX-502, ECOMAX-600, ECOMAX-602-11, ECOMAX-612-10, ECOMAX-612S-10, ECOMAX-650, ECOMAX-700, FX, GC31, GC32, GC41, GC42, GX		



1

GEV No.	505293	Ref. No.	00-323945-035 323945-35
description	hose clamp ø 34-38mm zinc-coated steel Qty 20 pcs		
For models:	AM900-10N, AM900-90, AMS900-10N, AMX, AMX-10HL, AMX-90, AMXR, AMXS, AMXT, AMXTS, AMXX, AMXXR, AMXXS, AUP, AUP-90, AUPS, AUXX, AUXXL-11N, AUXXLS-11N, AUXXR, AUXXS, AUXXT, AUXXTS, CR, CR-F, ECOMAX-402, ECOMAX-502, ECOMAX-602-11, ECOMAX-602S-11, ECOMAX-612-10, ECOMAX-612S-10, ECOMAX-650		



1

GEV No.	505290	Ref. No.	00-323945-037 323945-37
description	hose clamp ø 37mm zinc-coated steel Qty 10 pcs		
For models:	AM-700, AM900, AMS900, AMX-900, AMXR-900, AMXS-900, AMXT, AMXTS, AMXX-1300, AMXXR-1300, AMXXS-1300, AMXXT, AUXX-1300, AUXXL, AUXXR-1300, AUXXS-1300, AUXXT, AUXXTS, CR, ECOMAX-402, ECOMAX-502, ECOMAX-600, ECOMAX-700, FP, FX, FX-McDonalds, GC41, GC42, GP, GX, UX, UXL, UXLS, UXS, UXT, UXTL, UXTLH, UXTLHLS, UXTLS, UXTS		



1

GEV No.	505294	Ref. No.	00-323945-053 323945-53
description	hose clamp ø 53mm zinc-coated steel Qty 10 pcs		
For models:	CN-Protronic, CN-Smartronic, CP-Protronic, CSA, CS-Easytronic, ECOMAX-402, ECOMAX-502, FE, GC, GC11, GC12, GC31, GC32, GC41, GC42, HE, HE600-HL, HE-P, UX-30, UX-30B, UX-30E, UX-30EB, UX-30EH, UX-30ES, UX-30ESB, UX-30ESH, UX-30H, UX-30-McDonalds, UX-30S, UX-30SB, UX-30SH, UX-60, UX-60B, UX-60E, UX-60EB, UX-60EH, UX-60EHB, UX-60H, UX-60HB		



1

GEV No.	505291	Ref. No.	00-323945-056 323945-56
description	hose clamp ø 56mm zinc-coated steel Qty 10 pcs		
For models:	AM-700, AM900, AMS900, AMX-900, AMXR-900, AMXS-900, CR, ECOMAX-402, ECOMAX-502, ECOMAX-600, ECOMAX-650, FE, HE, HE600-HL, HE-P		



1

GEV No.	505289	Ref. No.	00-323945-060 323945-60
description	hose clamp ø 60mm zinc-coated steel Qty 10 pcs		
For models:	AM-10, AM-11, AM-141, AM900-10N, AM900-90, AMS900-10N, AMX, AMX-10HL, AMX-90, AMXR, AMXS, AMXT, AMXTS, AMXX, AMXXR, AMXXS, AUP, AUP-90, AUPS, AUXX, AUXXL-11N, AUXXLS-11N, AUXXR, AUXXS, AUXXT, AUXXTS, CSA, ECOMAX-602-10, ECOMAX-602-11, ECOMAX-602S-11, ECOMAX-612-10, ECOMAX-612S-10		





			
1			
GEV No.	505292	Ref. No.	00-323945-064 323945-64
description	hose clamp ø 64-68mm zinc-coated steel Qty 10 pcs		
For models:	AM-10, AM-11, AM-141, AM900-10N, AM900-90, AMS900-10N, AMX, AMX-10HL, AMX-90, AMXR, AMXS, AMXT, AMXTS, AUXXT, AUXXTS, CN-Protronic, CN-Smartronic, CP-Protronic, CS-Easytronic, ECOMAX-602-10, ECOMAX-602-11, ECOMAX-602S-11, ECOMAX-612-10, ECOMAX-612S-10, ECOMAX-700, UX, UXL, UXLs, UXS, UXT, UXTL, UXTLS, UXTS		

retaining rings

DIN 471

			
1			
GEV No.	507509	Ref. No.	602302 RR-010-13 RR-10-13 RR-E-2-34
description	retaining ring shaft ø 18mm thickness 1.2mm stainless steel DIN 471		
For models:	103G, 203G, 2226, 303G, AM-12E, AM-12EC, AM-12EF, AM-12ER, AM15, AM15F, AM15T, AM-600, AM-600C, AM-600CR, AM-600R, C44A, C44AW, C54A, C64A, CS-2012E, CS-2022E, CSD-2012E, CSD-2022E, CX, FTT, FTX, FUX, ML-110025, ML-110976, ML-110977, ML-32614, ML-32615, UW-105, UW-135, UW-135H, UWX		

DIN 6799

 			
1			
GEV No.	518557	Ref. No.	602980
description	retaining ring E D1 ø 5mm D2 ø 11mm SS DIN 6799 thickness 0.7mm		

DIN 7993

			
1			
GEV No.	697871	Ref. No.	602309 RR-E-2-38
description	retaining ring A D1 ø 14mm D2 ø 12.8mm spring steel DIN 7993 thickness 1mm		
For models:	AM-12E, AM-12EC, AM-12EF, AM-12ER, AM-600, AM-600C, AM-600CR, AM-600R, FM-400H, FM-400U, FM-500, FM-500H, UW-105, UW-120, UW-125, UW-135, UW-135H, UW-200, UW-205, UW-55		

			
1			
GEV No.	518308	Ref. No.	139321-856
description	retaining ring DIN 7993 for drain assembly thickness 3mm ED ø 57mm		

cotter pins

			
1			
GEV No.	694269	Ref. No.	602886
description	cotter pin ø 2.7mm L 18mm		
For models:	FTX, FUX, UW-105, UW-125, UW-205		

consumables

fuses

<h4>fine fuses</h4>			
			
1			
GEV No.	358666	Ref. No.	926283 E926283
description	fine fuse size ø5x20mm 0.315A fast-acting rated 250V Qty 10 pcs		

			
1			
GEV No.	358530	Ref. No.	139321-902
description	fine fuse size ø5x20mm 0.8A fast-acting rated 250V Qty 10 pcs		

			
1			
GEV No.	358677	Ref. No.	139321-690 E228004
description	fine fuse size ø5x20mm 4A fast-acting rated 250V Qty 10 pcs		

			
1			
GEV No.	358594	Ref. No.	228012
description	fine fuse size ø5x20mm 0.16A slow-acting rated 250V Qty 10 pcs		

			
1			
GEV No.	358606	Ref. No.	228010 E228010
description	fine fuse size ø5x20mm 4A slow-acting rated 250V Qty 10 pcs		

ø6.3x32mm 250V

			
1			
GEV No.	358792	Ref. No.	H3090506
description	fine fuse size ø6.3x32mm 10A slow-acting rated 250V Qty 10 pcs		

			
1			
GEV No.	358644	Ref. No.	228011
description	fine fuse size ø6.3x32mm 2A slow-acting rated 250V Qty 10 pcs		

ø6.3x32mm 500V

			
1			
GEV No.	358742	Ref. No.	775570-2
description	fine fuse size ø6.3x32mm 0.8A fast-acting rated 500V Qty 10 pcs		

			
1			
GEV No.	358752	Ref. No.	3090506
description	fine fuse size ø6.3x32mm 10A fast-acting rated 500V Qty 10 pcs		

			
1			
GEV No.	358751	Ref. No.	00-775570-001 775570-1
description	fine fuse size ø6.3x32mm 6.3A fast-acting rated 500V Qty 10 pcs		
For models:	AMX-900, AMXS-900, AMXX-1300, AMXXT, AUXX-1300, AUXXT, ECO-MAX-650, UX, UXL, UXL, UXLS, UXS, UXT, UXTH, UXTHL, UXTHLS, UXTHS, UXTL, UXTLS, UXTS		

fine fuse holders

			
1			
GEV No.	550519	Ref. No.	139321-601
description	cover plate suitable fuseA ratedV connection for fuse holder		

A			
alarm devices	27		
axial fans	46		
B			
bar burners	62		
bi-metal thermostats	13, 13		
booster pumps I	55		
booster pumps II	58		
C			
cable glands	61, 61		
cables	61		
cam switches	19		
clamps	123, 128		
condensators & interference suppression filters	58		
consumables	131		
contactors	27		
container filters	114		
control equipment	23		
control thermostats	13, 15		
cotter pins	131		
countersunk screws	125		
cross flow fans	46		
D			
door seals	98		
door seals for dishwashers	106		
dosing pumps	110		
double wire clamps	123, 128		
double wire clamps with screw	123, 129		
drain hoses	116		
drain pumps	56		
E			
electric accessories	61		
electric timers	26		
electrodes	45		
electronic controllers	30		
energy regulators	12		
evaporators	108		
extraction and pressure hoses	119		
F			
fans	46		
fasteners	128		
fastening material	125		
filters	59		
fine fuses	131		
flat-headed bolts	126		
float switches	18		
float valves	122		
fluorescent lamps	26, 26		
foil heating elements	12		
formed hoses	119		
fuses	59, 131		
G			
gas burners	62		
gas thermostats	62		
gaskets for heated units	98		
gaskets for wash arm support	107		
grub screws	126		
H			
halogen lamp	26		
heating elements	3		
heating elements for convection	11		
hexagonal nuts	126		
hexagonal screws	126		
hose clamps	123, 128		
hose connectors	121, 121		
hoses	116		
hot air fans	47		
hot air motors	46		
I			
ignition boxes	62		
ignition units	62		
immersion heating elements	3		
indicator lights	25		
indicator lights (complete)	25		
industrial hoses	117		
K			
knurled nuts	126		
knurled screws	126		
L			
lamps	25		
light bulbs	26		
M			
magnetic switches	21		
measuring equipment	125		
mechanical timers	27		
microswitches	17		
N			
Niplaflex hoses	117		
nuts	126		
O			
operating capacitors	58		
O-rings	99		

oven lamps 26

P

plug-in gaskets 98
 plunger sockets 16
 position switches 17
 pre-rinse hoses 116
 pressure control hoses 117
 pressure switches 42
 probes 31
 programme timers 26
 pumps 47
 push/momentary push switches 17
 PVC hoses 117
 PVC supply hoses 116

R

refrigeration gaskets 98
 relays 29
 retaining rings 131
 ribbon cables 61
 rocker/momentary rocker switches 17
 rotary switches 20

S

safety bi-metal thermostats 13
 safety thermostats 14
 screws 125
 sealing washers 103
 shaft gaskets 106
 silicone hoses 119
 slot nuts 128
 snap locks 97
 solenoid valves 36
 spring rings 127
 stainless steel flexi hoses 116
 supply filters 122, 122
 supply hoses 116
 switch boxes 61
 switches and momentary switches 17
 system switches (ROLD) 18

T

tank inlets 115
 terminals 61
 thermostats 13
 threaded cable glands 61
 time relays 30
 timers 26
 toggle switches 17
 tooth lock washers 128
 transformers 30

U

universal hoses 116

V

valves and tank inlets 122

W

wash and rinse pumps 47
 wash pump motors 55
 washers 127
 water cycle components 122
 water filters 122
 water softeners 122