



GAS COMPONENTS



ELECTRIC COMPONENTS



WATER TECHNOLOGY



MECHANICAL COMPONENTS



TOOLS

Spare parts suitable for

HORECA-SELECT

Find the complete and up-to-date range of products in our GEV Webshop



Manufacturer catalogue

The most important spare parts and accessories arranged clearly for every manufacturer

- ✓ Complete product range and all appliance data always up to date in the GEV Webshop
- ✓ Alphabetical Index at the end of the catalogue

GEV Webshop

www.gev-online.co.uk

www.gev-online.com



- 🔍 Add to Favourites
- 🔍 Sign In with email address and usual password
- 🔍 Easy-order – place several items in your basket at the same time
- 🔍 Quick Item search – no login needed



induction

induction coils



1

GEV No.	404000	Ref. No.	01058352
description	induction coils 3500W 230V 50Hz L 220mm W 217mm H 12mm suitable for BARTSCHER for induction device		
For models:	GIC2030, GIC2035		



1

GEV No.	404010	Ref. No.	AD100087 GIC3035-04 GIC3035-B04 GIC3500-04 GIC3500-A04 GIC3535-04 GIC3535-D04
description	induction coils ø 220mm H 10mm		
For models:	GIC3500, GIC3535		



1

GEV No.	404009	Ref. No.	GIC4035-04 GIC4035-C04
description	induction coils ø 260mm H 50mm for induction wok		
For models:	GIC4035		

heating elements

heating elements for ovens



1

GEV No.	416969	Ref. No.	01203250 09950327000
description	heating element 1400W 230V heating circuits 1 L 370mm W 400mm L1 45mm L2 325mm W1 184mm W2 30mm flange length 70mm flange width 22mm hole distance 46mm bridge length 420mm hole ø 5mm tube ø 6.3mm connection male faston 6.3mm windings 3 rectangular flange dry heating element		
For models:	GCO1001, GCO2001		
accessories for	416969		
		GEV No.	510368 Ref. No. —
	gasket L 70mm W 23.5mm hole ø 5mm hole distance 56mm FIBER thickness 2mm for heating element		

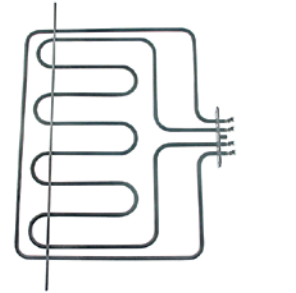

1

GEV No.	416970	Ref. No.	01203240 09950317000
description	heating element 2800W 230V heating circuits 2 L 323mm W 393mm L1 30mm L2 293mm W1 166mm W2 61mm flange length 100mm flange width 22mm hole distance 76mm bridge length 485mm hole ø 5mm tube ø 6.3mm connection male faston 6.3mm rectangular flange dry heating element		
For models:	GCO1001, GCO2001		
accessories for	416970		
		GEV No.	528090 Ref. No. 01000160 01980518000
	gasket L 100mm W 22mm thickness 1mm		



heating elements for fryers

2 hole fixing

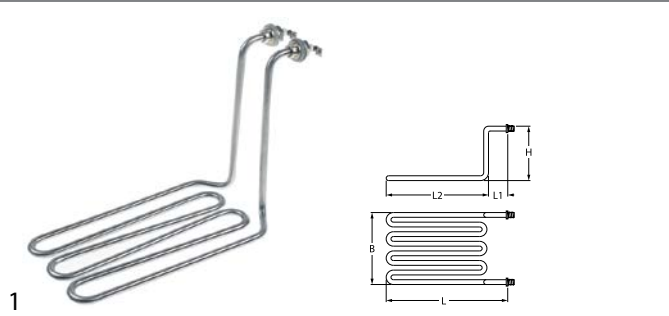

GEV No.	417598	Ref. No.	1.07.HDF4140403 GDF1104-013 GDF2124-013
description	heating element 2500W 230V heating circuits 1 L 290mm W 130mm H 200mm L1 40mm L2 230mm tube ø 8mm		
For models:	GDF1104, GDF2124		

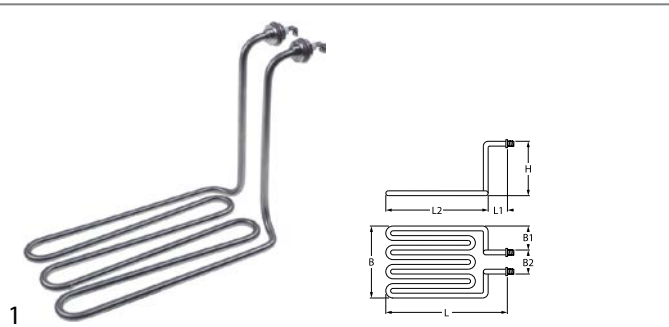

GEV No.	420145	Ref. No.	016240419
description	heating element 2500W 230V heating circuits 1 L 267mm W 127mm H 187mm 2 hole fixing connection M4 immersion heater L1 32mm L2 235mm W1 38mm W2 50mm tube ø 8mm thread M12x1.25 mounting distance 42mm connection length 15mm windings 3		
For models:	GDF1004, GDF2024		

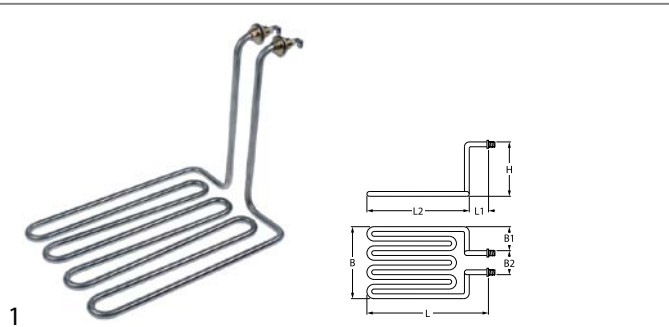

GEV No.	420018	Ref. No.	016210818
description	heating element 3250W 230V heating circuits 1 L 265mm W 185mm H 200mm 2 hole fixing connection M4 immersion heater L1 25mm L2 240mm W1 71mm W2 42mm tube ø 8.1mm thread M12x1 mounting distance 34mm windings 4		
For models:	GDF1008, GDF2028		

spare parts for	420018		
	GEV No.	521131	Ref. No. —
	nut thread M12x1 H 3.5mm WS 17 SS Qty 1 pcs		

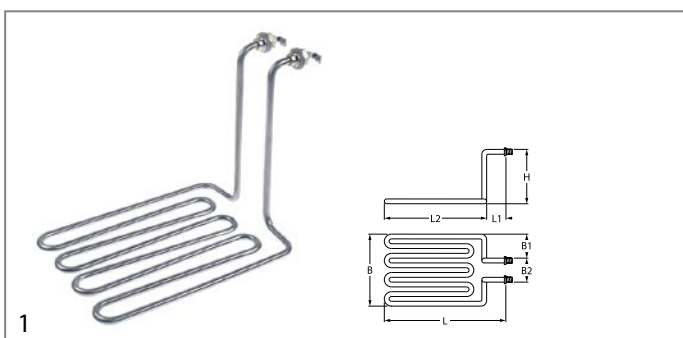

GEV No.	417599	Ref. No.	1.07.HDF8141903 GDF1108-012 GDF2128-012 HDF1108-013 HDF1108-13 HDF2128-013
description	heating element 3250W 230V heating circuits 1 thread M12x1.25 L 280mm W 190mm H 210mm L1 35mm L2 245mm W1 120mm W2 70mm tube ø 8mm connection M4		
For models:	GDF1108, GDF2128		

heating elements for griddles



GEV No.	419177	Ref. No.	D02169
description	heating element 1750W 230V heating circuits 1 L 255mm W 240mm H 60mm tube ø 6.3mm cable length 600mm bain marie connection distance 234mm dry heating element		
For models:	GEG2001		

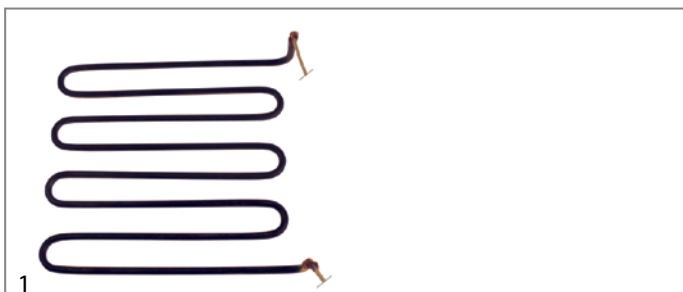

GEV No.	418622	Ref. No.	D02105
description	heating element 3000W 230V heating circuits 1 L 277mm W 245mm H 55mm tube ø 8mm connection cable cable length 600mm connection length 15mm griddle connection distance 237mm dry heating element		
For models:	GEG1001		



heating elements for hot dog machines

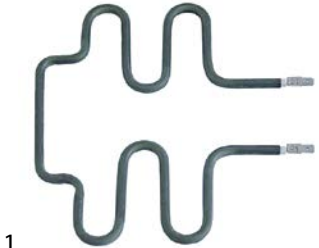

1

GEV No.	416718	Ref. No.	D02002
description	heating element 300W 230V L 170mm W 198mm tube ø 6.3mm L1 50mm L2 120mm W1 68mm W2 62mm connection male faston 6.3mm connection distance 56mm dry heating element heating circuits 1 hot dog machine		
For models:	GHM1001		

heating elements for coffee machine



1

GEV No.	420147	Ref. No.	A0ND010
description	heating element 1200W 230V heating circuits 1 D1 ø 65mm H 42mm D2 ø 54mm windings 3 connection male faston 6.3mm immersion heater tube ø 6.5mm for coffee machine		
For models:	GCM1006, GCM2009		
accessories for	420147		
	GEV No.	Ref. No.	A0ND011
	511646		
	gasket silicone ED ø 63mm ID ø 55mm thickness 2.3mm Qty 1 pcs for heating element		



1

GEV No.	420146	Ref. No.	A0ND012
description	heating element 130W 230V ø 130mm L 130mm H 54mm connection male faston 6.3mm W 130mm heating circuits 1		
For models:	GCM1006, GCM2009, GCM3016		



1

GEV No.	420143	Ref. No.	A0ND037
description	heating element heating circuits 1 D1 ø 65mm H 42mm D2 ø 54mm windings 4 connection male faston 6.3mm immersion heater tube ø 6.5mm for coffee machine		
For models:	GCM3016		
accessories for	420143		
	GEV No.	Ref. No.	A0ND011
	511646		
	gasket silicone ED ø 63mm ID ø 55mm thickness 2.3mm Qty 1 pcs for heating element		

heating elements for refrigeration

miscellaneous



1

GEV No.	420277	Ref. No.	N/A RW40.05
description	heating element 65W 220-240V L 120mm W 20mm H 21mm connection Faston 6.3mm cable length 300mm tube ø 12mm refrigeration		
For models:	GHR1040, GHR2600		

heating elements for contact grills



1

GEV No.	419161	Ref. No.	912171
description	heating element 1100W 415V L 180mm W 180mm H 40mm tube ø 6.5mm connection M4		
For models:	GPG2001		



1

GEV No.	419002	Ref. No.	902028
description	heating element 1400W 230V heating circuits 1 L 175mm W 305mm H 20mm W1 40mm W2 325mm tube ø 6.3mm windings 5		
For models:	GPG1001		



1

GEV No.	419003	Ref. No.	902035
description	heating element 1550W 240V L 175mm W 305mm H 40mm tube ø 6.3mm connection M4 windings 5		
For models:	GPG1001		



1

GEV No.	419160	Ref. No.	912140
description	heating element 900W 400V L 170mm W 180mm H 15mm W1 40mm W2 100mm tube ø 6.5mm windings 3 connection M4		
For models:	GPG2001		

quartz heating elements



1

GEV No.	420089	Ref. No.	D04034
description	quartz heating element 600W 115V L 365mm ø 11mm connection male faston 6.3mm		
For models:	GTO1001, GTO2001		
accessories for	420089		
	GEV No.	551108	Ref. No. B07025
	spring clip stainless steel for quartz heating element L 39mm W 25mm H 13.5mm bore ø 10mm		



1

GEV No.	551108	Ref. No.	B07025
description	spring clip stainless steel for quartz heating element L 39mm W 25mm H 13.5mm bore ø 10mm		
For models:	GTO1001, GTO2001		

immersion heating elements

3 hole flange ø38.5mm



1



GEV No.	416263	Ref. No.	905496
description	heating element 2600W 230V mounting ø 38.5mm heating circuits 1 L 293mm W 26mm H 26mm number of thermostat sleeves 1 thermostat sleeves ø 7mm length thermostat sleeves 260mm thermostat sleeve not clinging tube ø 6.3mm hole distance 57mm hole ø 10mm 3 hole flange connection male faston 6.3mm immersion heater		
For models:	GGW1001, GGW2001		
spare parts for	416263		
	GEV No.	521120	Ref. No. 907981
	O-ring EPDM thickness 5.34mm ID ø 37.47mm Qty 1 pcs		

accessories for 416263

GEV No.	532577	Ref. No.	—
	O-ring EPDM thickness 5.34mm ID ø 40.65mm Qty 1 pcs		



1

GEV No.	416267	Ref. No.	905560
description	heating element 4500W 230V mounting ø 38.5mm heating circuits 3 L 358mm W 32mm H 58mm L1 36mm L2 72mm L3 250mm H1 28mm H2 30mm hole distance 57mm hole ø 10mm tube ø 6.3mm connection male faston 6.3mm immersion heater 3 hole flange		
For models:	GDW1001		
spare parts for	416267		
	GEV No.	521120	Ref. No. 907981
	O-ring EPDM thickness 5.34mm ID ø 37.47mm Qty 1 pcs		
accessories for	416267		
	GEV No.	532577	Ref. No. —
	O-ring EPDM thickness 5.34mm ID ø 40.65mm Qty 1 pcs		

with compression flange 50 x 26mm



1

GEV No.	416209	Ref. No.	904957 905858
description	heating element 2000W 230V heating circuits 1 compression flange flange 50x26mm L 180mm W 90mm H 24mm L1 55mm L2 125mm W1 28mm W2 35mm connection male faston 6.3mm tube ø 8.5mm connection length 28mm immersion heater		
For models:	GDW1001		
accessories for	416209		
	GEV No.	510387	Ref. No. —
	gasket L 46mm W 22mm ømm EPDM for heating element for flange 50x26mm		



1





GEV No.	416259	Ref. No.	905771
description	heating element 1600W 230V heating circuits 1 L 275mm W 38mm H 28mm thread M10x1 mounting distance 27mm tube ø 7.1mm connection male faston 6.3mm 2 hole fixing connection length 26mm immersion heater		
For models:	GGW1001, GGW2001		
accessories for	416259		
	GEV No.	510416	Ref. No. —
	flat gasket fibre ED ø 19mm ID ø 10.5mm thickness 1.5mm for thread M10 Qty 1 pcs		

Table continues overleaf

accessories for		416259	
	GEV No.	510893	Ref. No. —
	O-ring EPDM thickness 2.62mm ID ϕ 9.92mm Qty 1 pcs		
	GEV No.	520231	Ref. No. —
	nut thread M10x1 H 6mm WS 14 zinc-coated steel Qty 1 pcs		
	GEV No.	521129	Ref. No. —
	nut thread M10 H 6mm SS WS 17 Qty 1 pcs DIN/ISO DIN 439		

heating elements for convection

			
1			
GEV No.	418044	Ref. No.	01203260 09950977000
description	heating element 2500W 230V heating circuits 1 ID ϕ 180mm ED ϕ 192mm L 245mm H 28mm L1 45mm W1 30mm H1 3mm H2 25mm flange length 70mm flange width 22mm hole distance 56mm connection male faston 6.3mm tube ϕ 6.3mm convection heating element hole ϕ 5mm rectangular flange		
For models:	GCO1001, GCO2001		
accessories for	418044		
	GEV No.	550937	Ref. No. 01000140 01960368000
	gasket L 71mm W 21mm hole ϕ 5mm hole distance 57mm fibre thickness 1mm for heating element		

accessories

hexagonal nuts

			
1			
GEV No.	519051	Ref. No.	902030
description	nut thread M4 H 3.2mm WS 7 SS DIN/ISO DIN 934 / ISO 4032/8673 Qty 20 pcs		
For models:	GGW2001		

various

			
1			
GEV No.	551108	Ref. No.	B07025
description	spring clip stainless steel for quartz heating element L 39mm W 25mm H 13.5mm bore ϕ 10mm		
For models:	GTO1001, GTO2001		

sealing washers

O-rings

			
1			
GEV No.	510072	Ref. No.	904350
description	O-ring EPDM thickness 3.53mm ID ϕ 32.93mm Qty 1 pcs		
For models:	GGW1001, GGW2001		

			
1			
GEV No.	521120	Ref. No.	907981
description	O-ring EPDM thickness 5.34mm ID ϕ 37.47mm Qty 1 pcs		
For models:	GDW1001, GGW1001, GGW2001		

flange gaskets

			
1			
GEV No.	528090	Ref. No.	01000160 01980518000
description	gasket L 100mm W 22mm thickness 1mm		
For models:	GCO1001, GCO2001		

			
1			
GEV No.	550937	Ref. No.	01000140 01960368000
description	gasket L 71mm W 21mm hole ϕ 5mm hole distance 57mm fibre thickness 1mm for heating element		
For models:	GCO1001, GCO2001		

spring clips

			
1			
GEV No.	692132	Ref. No.	016210820
description	probe clip for pipe ϕ 8.5mm for probe ϕ 4mm Qty 1 pcs L 42mm W 14mm		
For models:	GDF1008, GDF2028		



clamps



1

GEV No.	692185	Ref. No.	016210821
description	probe clip for probe ø 6mm SS Qty 1 pcs L 40mm W 14mm		
For models:	GDF1008, GDF2028		



1

GEV No.	692184	Ref. No.	016240410
description	probe clip for probe ø 6mm SS Qty 1 pcs L 57mm W 20mm		
For models:	GDF1004, GDF2024		

thermostats

bi-metal thermostats

safety bi-metal thermostats



1

GEV No.	390708	Ref. No.	902004
description	bi-metal safety thermostat hole distance 23.5mm switch-off temp. 180°C 1NC 1-pole 16A connection M3 mounting ø 15mm		
For models:	GPG1001		



1

GEV No.	390461	Ref. No.	907243
description	bi-metal safety thermostat hole distance 23.8mm switch-off temp. 95°C 1NC 1-pole 16A connection F6.3 2 hole fixing		
For models:	GGW1001, GGW2001		
accessories for	390461		
	GEV No.	550388	Ref. No.
			—



1

GEV No.	390379	Ref. No.	A040625
description	bi-metal safety thermostat hole distance 23.8mm switch-off temp. 150°C 1NC 1-pole 16A connection F6.3		
For models:	GCM1006, GCM2009, GCM3016		
accessories for	390379		
	GEV No.	550389	Ref. No.
			—



1

GEV No.	390318	Ref. No.	907245
description	bi-metal safety thermostat switch-off temp. 95°C 1-pole 2 hole fixing		
For models:	GDW1001		

bi-metal thermostats



1

GEV No.	390869	Ref. No.	253099000143 GMW1025-C19
description	bi-metal thermostat hole distance 23.5mm switch-off temp. 140°C 1NC 1-pole 10A 250V connection F4.8 Qty 1 pcs		
For models:	GMW1030		



1

GEV No.	390867	Ref. No.	253099000224 GMW1025-C07 GMW1030-C07
description	bi-metal thermostat hole distance 23.5mm switch-off temp. 180°C 1NC 1-pole 10A 250V connection F4.8 Qty 1 pcs		
For models:	GMW1030		



1

GEV No.	390868	Ref. No.	GMW1030-C19
description	bi-metal thermostat hole distance 23.5mm switch-off temp. 180°C 1NC 1-pole 10A 250V connection F4.8 Qty 1 pcs		
For models:	GMW1030		



1

GEV No.	390763	Ref. No.	907244
description	bi-metal thermostat hole distance 23.8mm switch-off temp. 55°C 1NC 1-pole 16A 250V connection F6.3 2 hole fixing for tank		
For models:	GGW1001, GGW2001		



1

GEV No.	390753	Ref. No.	A0ND013
description	bi-metal thermostat hole distance 24mm switch-off temp. 83°C 1NC 1-pole 16A 250V connection F6.3 2 hole fixing for coffee machine		
For models:	GCM1006, GCM2009, GCM3016		



control and safety thermostats

EGO

control thermostats

55.10/19_series

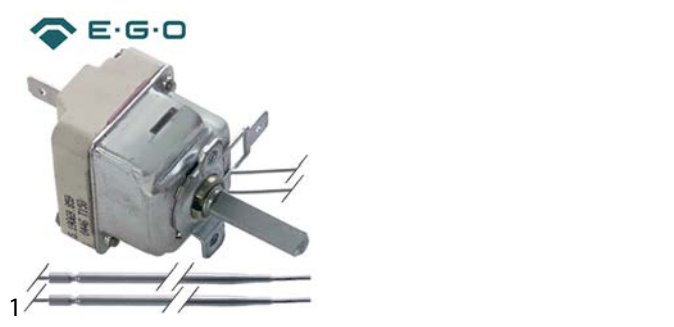

GEV No.	375800	Ref. No.	09952637000
description	thermostat t.max. 308°C temperature range 65-308°C 1-pole 1NO 16A probe ø 3.03mm probe L 120mm capillary pipe 600mm capillary pipe isolatedmm gland nut shaft ø 6x4.6mm shaft L 23mm shaft position upper rotation 270° with 2 probes		
For models:	GCO1001		

55.13_series



GEV No.	375517	Ref. No.	A039882
description	thermostat t.max. 190°C temperature range 60-190°C 1-pole 1NO 16A probe ø 6mm probe L 77mm capillary pipe 870mm capillary pipe isolatedmm gland nut shaft ø 6/4.6mm shaft L 23mm shaft position left° rotation 270°		
For models:	GDF1004, GDF1008, GDF2024, GDF2028		
accessories for	375517		
	GEV No.	512205	Ref. No. 016240433
	gasket for temperature probe ED ø 15mm plastic Qty 1 pcs		



GEV No.	375505	Ref. No.	902011
description	thermostat t.max. 320°C temperature range 50-320°C 1-pole 1NO 16A probe ø 3mm probe L 160mm capillary pipe 870mm capillary pipe isolatedmm gland nut shaft ø 6x4.6mm shaft L 23mm shaft position upper rotation 270°		
For models:	GPG1001, GPG2001		

55.17_series



GEV No.	371320	Ref. No.	A06032
description	thermostat t.max. 280°C temperature range 30-280°C 1-pole 1NO 16A probe ø 3mm probe L 170mm capillary pipe 860mm capillary pipe isolatedmm gland nut shaft L 14mm shaft position upper rotation 270°		
For models:	GEG1001, GEG2001		

safety thermostats

55.32_series



GEV No.	390999	Ref. No.	01202690
description	safety thermostat switch-off temp. 350°C temperature range°C 2-pole NC 20A probe ø 3mm probe L 187mm capillary pipe 690mm capillary pipe isolated 680mm gland nut shaft ømm probe SS		
For models:	GCO2001		

IMIT / TEMPOMATIC / ARTHERMO

control thermostats



GEV No.	390683	Ref. No.	TR0440
description	thermostat t.max. 86°C temperature range 0-86°C 1-pole 1CO 16A probe ø 6.5mm probe L 98mm capillary pipe 1000mm capillary pipe isolated 960mm gland nut shaft ø 6x4.6mm shaft L 20mm shaft position +135° rotation 270° probe material copper		
For models:	GGW1001, GGW2001		

accessories for	390683		
	GEV No.	110100	Ref. No. 903982
	knob thermostat t.max. 90°C 0-90°C ø 42mm shaft ø 6x4.6mm shaft flat -135° black		

CAEM

safety thermostats



GEV No.	375456	Ref. No.	01951367000
description	safety thermostat switch-off temp. 335°C 2-pole 20A probe ø 3mm probe L 200mm capillary pipe 1050mm capillary pipe isolated 650mm gland nut probe SS at 250V 20A at 400V 10A		
For models:	GCO1001		

TECASA

control thermostats



GEV No.	375134	Ref. No.	A06032 (old version)
description	thermostat t.max. 280°C temperature range 30-280°C 1-pole 1NO 16A probe ø 3mm probe L 170mm capillary pipe 860mm capillary pipe isolated 650mm gland nut shaft L 14mm shaft position upper rotation 270°		

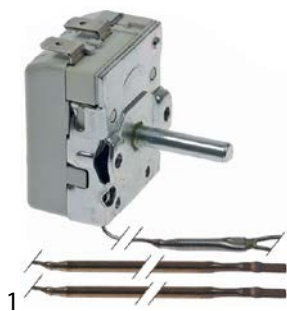

GEV No.	376091	Ref. No.	01201220
description	thermostat t.max. 328°C temperature range 57-328°C 1-pole 1NO 16A probe ø 3mm probe L 98mm capillary pipe 1540mm capillary pipe isolated 650mm gland nut shaft ø 6x4.6mm shaft L 21mm rotation 270° outer switch probe thread disc ømm		
For models:	GCO2001		

various

control thermostats



GEV No.	390871	Ref. No.	1.1.A.A06.02 GGC1078-05 GGC1078-5
description	thermostat t.max. 95°C temperature range 0-95°C 1-pole 1NO 6A probe ø 6mm probe L 95mm capillary pipe 550mm capillary pipe isolated 490mm gland nut shaft ø 6x4mm shaft L 23mm shaft position 45° rotation 270° probe material zinc-coated steel 250V contacts male faston 4.8mm Qty 1 pcs		



GEV No.	390870	Ref. No.	GHR1040-14 RW40.20
description	thermostat t.max. °C temperature range °C 1-pole 1NO 5A probe ø 2mm probe Lmm capillary pipe 750mm capillary pipe isolated 250mm gland nut shaft ø 6x4mm shaft L 12mm shaft position 45° rotation 270° probe material SS 250V Qty 1 pcs		
For models:	GHR1040, GHR2600		



GEV No.	390968	Ref. No.	1.06.1851713 GDF1104-018 GDF1108-008 GDF2124-018 GDF2128-008 HDF1108-018 HDF1108-18 HDF2128-018
description	thermostatcontroller t.max. 185°C temperature range °C 2-pole 1NO 16A probe ø 6mm probe L 77mm capillary pipe 1500mm capillary pipe isolated 650mm gland nut shaft ø 6x4.6mm shaft L 25mm shaft position upper rotation 270° probe material SS		
For models:	GDF1104, GDF1108, GDF2124, GDF2128		



safety thermostats



GEV No.	375523	Ref. No.	016240438
description	safety thermostat switch-off temp. 230°C 1-pole 1NC 16A probe ø 4mm probe L 100mm capillary pipe 900mm capillary pipe isolated 410mm gland nut probe		
For models:	GDF1004, GDF1008, GDF2024, GDF2028		



GEV No.	390970	Ref. No.	1.06.230171301 GDF1104-005 GDF1104-5 GDF1108-023 GDF2124-005 GDF2128-023 HDF1108-005 HDF2128-005
description	safety thermostat switch-off temp. 230°C 2-pole 1NC 16A probe ø 5mm probe L 48mm capillary pipe 440mm capillary pipe isolated 150mm gland nut probe 250V model WQS-230		
For models:	GDF1104, GDF1108, GDF2124, GDF2128		

refrigeration thermostats

universal with housing



GEV No.	698867	Ref. No.	GPC1046-09
description	thermostat probe capillary pipe 650mm 1NO threaded type WPF17C-L2		
For models:	GPC1046		

RANCO

K50 series



GEV No.	390760	Ref. No.	3301323
description	thermostat RANCO type K50-L3210 probe ø 2mm probe Lmm capillary pipe 2500mm temperature range -30 up to -23°C refrigeration		
For models:	GFR1600		
accessories for	390760		
	GEV No.	112654	Ref. No. 3301324
knob ø 22.5mm shaft ø 6x4mm blue for thermostat			



GEV No.	390757	Ref. No.	0225090
description	thermostat RANCO type K50-L3337 probe ø 2mm probe Lmm capillary pipe 1500mm refrigeration		
For models:	GRE1600		

miscellaneous producers





GEV No.	390761	Ref. No.	20-0914-9
description	thermostat probe ø 2mm capillary pipe 1400mm for container		
For models:	GIM1023, GIM1038, GIM2023, GIM2038		



GEV No.	390762	Ref. No.	20-0883-3
description	thermostat probe ø 2mm probe Lmm capillary pipe 2000mm type WPF20.5B-L for evaporator		
For models:	GIM1023, GIM1038, GIM2023, GIM2038		



			
1			
GEV No.	390997	Ref. No.	DQWA0002
description	thermostat probe ø 3.4mm probe Lmm capillary pipe 770mm type WPF11-L for fridge 1NO 230V 50/60Hz		

			
1			
GEV No.	390972	Ref. No.	DQWA0010 HSC360-37
description	thermostat temperature range°C probe ø 10mm probe L 24mm capillary pipe 660mm type WPF-45270 hole distance 55mm		

accessories

axis extensions

			
1			
GEV No.	551215	Ref. No.	RW40.23
description	shaft extension total length 89mm shaft ø 6x4.6mm Qty 1 pcs		
For models:	GHR1040, GHR2600		

probe clips

clamps

for thermostat

			
1			
GEV No.	692185	Ref. No.	016210821
description	probe clip for probe ø 6mm SS Qty 1 pcs L 40mm W 14mm		
For models:	GDF1008, GDF2028		

			
1			
GEV No.	692184	Ref. No.	016240410
description	probe clip for probe ø 6mm SS Qty 1 pcs L 57mm W 20mm		
For models:	GDF1004, GDF2024		



switches and momentary switches

rocker/momentary rocker switches

28x10mm

			
1			
GEV No.	347804	Ref. No.	DQKC0000 GBC1001-21 GBC1002-22 GBC1003-22
description	rocker switch mounting measurements 28x10mm red 1NO 250V 15A 0-I connection male faston 6.3mm ambient temperature max. 85°C protection IP40		

30x11mm



			
1			
GEV No.	301010	Ref. No.	A0ND021
description	rocker switch mounting measurements 30x11mm red 1NO/indicator light 250V 16A 0-I connection male faston 6.3mm ambient temperature max. 85/125°C protection IP40		
For models:	GCM1006, GCM2009, GCM3016		
accessories for	301010		
	GEV No.	301035	Ref. No. —
protective cover mounting measurements 30x11mm			

30x22mm

			
1			
GEV No.	347791	Ref. No.	1.1.A.A07.10 205426 A040573 A07034 E2301GR00001 GCV1600-36 GPS1600-01 GSF1600-01 S900.01
description	rocker switch mounting measurements 30x22mm green 2NO 230V 20A illuminated 0-I connection male faston 6.3mm ambient temperature max. 125/55°C protection IP65 with rubber collar		
For models:	GDF1004, GDF2024, GDS1134, GDS1600, GHM1001, GHS1134, GHS1600, GHS2134, GHS2600, GJU1001, GPG1001, GPS1134, GPS1600, GPS2600, GSA1134, GSA1600, GSA2600, GSD2600, GSF1134, GSF1600, GSF2600		



			
1			
GEV No.	347531	Ref. No.	016210836
description	rocker switch mounting measurements 30x22mm green 2NO 250V 20A illuminated 0-I connection male faston 6.3mm ambient temperature max. 125/55°C protection IP65 with rubber collar		
For models:	GDF1008, GDF2028		



			
1			
GEV No.	301188	Ref. No.	20-0670-9
description	rocker switch mounting measurements 30x22mm black 2NO/2NO 250V 16A I O II connection male faston 6.3mm ambient temperature max. 125/55°C protection IP40		
For models:	GIM1023, GIM1038, GIM2023, GIM2038		
accessories for	301188		
		GEV No.	301036
		Ref. No.	—
	protective cover internal size 30x22mm for rocker switch mounting measurementsmm		

<h3>ø20mm</h3>			
			
1			
GEV No.	347803	Ref. No.	DQKA0000 GSC1100-04
description	rocker switch mounting measurements 20mm red 1NO 250V 15A 0-I connection male faston 4.8mm ambient temperature max. 85°C protection IP40		
For models:	GSC1100, GSC1100G, GSC2336		

			
1			
GEV No.	347802	Ref. No.	GSC1336-05 GSC2336-05 GSC2336-5 HSC360-31
description	rocker switch mounting ø 20mm red 1NO 250V 15A illuminated 0-I connection male faston 4.8mm ambient temperature max. 85°C protection IP40		
For models:	GSC1336		

push/momentary push switches

30x22mm

			
1			
GEV No.	345712	Ref. No.	00000700296
description	push switch mounting measurements 30x22mm red/green 2CO 250V 16A Stop / I connection male faston 6.3mm ambient temperature max. 85°C protection IP40 with indicator		
For models:	GFS1022, GFS1025, GFS1030, GFS2022, GFS2025, HFS2019, HFS2022, HFS2025		
accessories for	345712		
		GEV No.	301127
		Ref. No.	00000000285
	protective cover internal size 30x55mm transparent		

ø22mm

			
1			
GEV No.	301127	Ref. No.	00000000285
description	protective cover internal size 30x55mm transparent		
For models:	GFS1022, GFS1025, GFS1030, GFS2025, HFS2025		

ø25mm

			
1			
GEV No.	345151 ¹	Ref. No.	0202000
description	push switch mounting ø 25mm orange 2NO 250V 16A illuminated connection male faston 6.3mm ambient temperature max. 85°C protection IP40		
For models:	GFR1600		

¹illuminated

			
1			
GEV No.	347537	Ref. No.	0202087
description	push switch mounting ø 25mm green 2NO 250V 16A illuminated main switch connection male faston 6.3mm ambient temperature max. 55/120°C protection IP40		
For models:	GFR1600, GRE1600		



microswitches

pin-plunger actuated



1

GEV No.	347799	Ref. No.	253039000003 GMW1025-C09 GMW1030-C09
description	microswitch with plunger 250V 15A 1CO connection male faston 4.8mm ambient temperature max. 105°C mounting distance 22mm type W-15-102C actuating force: 180g white		
For models:	GMW1030		



1

GEV No.	347798	Ref. No.	253039000010 GMW1025-C10 GMW1025-C11 GMW1030-C10 GMW1030-C11
description	microswitch with plunger 250V 15A 1NO connection male faston 4.8mm L 20mm L2 22mm ambient temperature max. 105°C mounting distance 22mm type W-15-302C actuating force: 200g white		
For models:	GMW1030		

M10



1

GEV No.	347341	Ref. No.	016240435
description	microswitch with plunger thread M10x1 thread L 16mm 250V 10A 1NO connection male faston 6.3mm stroke 5mm mounting distance L 41mm ambient temperature max. 85°C type X3L502K6DD actuating force: 130g		
For models:	GDF1004, GDF1008, GDF2024, GDF2028		

miscellaneous



1

GEV No.	347560	Ref. No.	00000000304
description	microswitch with plunger mounting distance 22mm thread M10 thread L 14mm 250V 12A 1NO connection male faston 6.3mm stroke 3.5mm ambient temperature max. 125°C type VRSR03AA1 actuating force: 135g		
For models:	GFS1025		

miscellaneous



1

GEV No.	348187	Ref. No.	HVS1000-47 YJS820-47
description	microswitch 230V 1NO connection cable 400mm L 58mm L1 38mm		

with push button

switches with snap-fit



1

GEV No.	347801	Ref. No.	RW40.36
description	microswitch with plunger 250V 0.5A 1NC connection male faston 4.8mm L 28x10mm ambient temperature max. 85°C type built-in version actuating force: 150g		
For models:	GHR1040, GHR2600		



1

GEV No.	348192	Ref. No.	0202070 I0202070
description	microswitch with push button 250VA 1NO connection male faston 6.3mm L 26x12mm ambient temperature max. 85°C actuating force: 500g		
For models:	GFR3600, GRE1600, GRE3600		



1

GEV No.	348184	Ref. No.	RC400.23
description	switch 250V 4A 1NO connection F4.8 L 40mm L1 24mm L2 16mm		
For models:	RC400		

accessories



1

GEV No.	347797	Ref. No.	GMW1030-P23
description	bracket for microswitch L 165mm W 65mm Qty 1 pcs		
For models:	GMW1030		

accessories for	347797		
GEV No.	347794	Ref. No.	GMW1030-P247



lever for microswitch L 28mm small ID ø 5mm W 22mm Qty 1 pcs



GEV No.	347795	Ref. No.	GMW1030-P246
----------------	--------	-----------------	--------------

lever for microswitch L 45mm middle ID ø 5mm W 22mm Qty 1 pcs





GEV No.	347796	Ref. No.	GMW1030-P245
----------------	--------	-----------------	--------------

lever for microswitch L 63mm large ID ø 5mm W 22mm Qty 1 pcs





			
1			
GEV No.	347794	Ref. No.	GMW1030-P247
description	lever for microswitch L 28mm small ID ø 5mm W 22mm Qty 1 pcs		
For models:	GMW1030		

			
1			
GEV No.	347795	Ref. No.	GMW1030-P246
description	lever for microswitch L 45mm middle ID ø 5mm W 22mm Qty 1 pcs		
For models:	GMW1030		

			
1			
GEV No.	347796	Ref. No.	GMW1030-P245
description	lever for microswitch L 63mm large ID ø 5mm W 22mm Qty 1 pcs		
For models:	GMW1030		

			
1			
GEV No.	301104	Ref. No.	905312
description	momentary switch unit 1NO 250V 16A connection male faston 6.3mm		
For models:	GGW1001, GGW2001		

			
1			
GEV No.	345621	Ref. No.	909362
description	push button size 17x13mm black		
For models:	GGW1001, GGW2001		

			
1			
GEV No.	345651	Ref. No.	905314
description	switch 2CO 250V 16A connection male faston 6.3mm		
For models:	GGW1001, GGW2001		

position switches

METRO

			
1			
GEV No.	348088	Ref. No.	1.05.035011HDFMS116 GDF1104-006 GDF1104-6 GDF1108-022 GDF2124-006 GDF2128-022 HDF1108-006 HDF2128-006
description	microswitch 1NO 250V 16A L 41mm W 12mm H 44mm actuating force: 250g		
For models:	GDF1104, GDF1108, GDF2124, GDF2128		

system switches (ROLD)

			
1			
GEV No.	345627	Ref. No.	909361
description	element holder mounting measurements 20.6x16.4mm black arched for push buttons 13x17mm		
For models:	GGW1001, GGW2001		

cam switches

4-position

			
1			
GEV No.	300094	Ref. No.	A01001
description	cam switch 4 operating positions 1NO/2CO sequence 0-1-2-3 16A shaft ø 6x4.6mm shaft L 15mm connection screw 4-position ceramic		
For models:	GEG1001, GEG2001		



4 operating positions

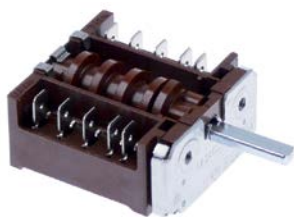

1

GEV No.	300243	Ref. No.	912102
description	cam switch 2 operating positions sequence 0-1 shaft \varnothing 6x4.6mm shaft L 23mm connection male faston 6.3mm 4-pole		
For models:	GPG2001		



1

GEV No.	347101	Ref. No.	A01017
description	cam switch 4 operating positions 1NO/1CO sequence 0-1-2-3 13A shaft \varnothing 6x4.6mm shaft L 23mm connection male faston 6.3mm plastic		
For models:	GTO1001, GTO2001		

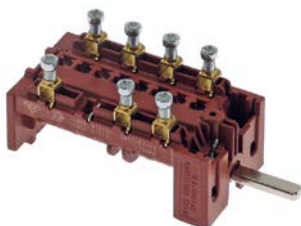

1

GEV No.	348143	Ref. No.	A01001/1
description	cam switch 4 operating positions 5NO sequence 0-1-2-3 16A shaft \varnothing 6x4.6mm shaft L 23mm connection male faston 6.3mm 8410R plastic		
For models:	GEG1001		

10 operating positions



1

GEV No.	301205	Ref. No.	01200040 01950037000
description	cam switch 10 operating positions 5NO/1CO sequence 0-1-2-3-4-5-6-7-8-9 16A shaft \varnothing 6x4.6mm shaft L 23mm connection male faston 6.3mm ceramic		
For models:	GCO1001, GCO2001		

magnetic switches

37x16mm



1

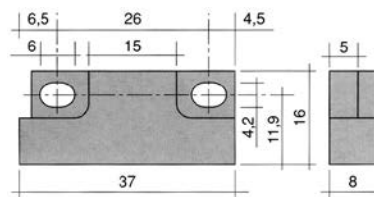

GEV No.	347540	Ref. No.	909289
description	magnetic switch L 37mm W 16mm 1NO 250V 0.04A P max. 10W connection male faston 6.3mm cable length 370mm		
For models:	GGW1001, GGW2001		

accessories

magnets

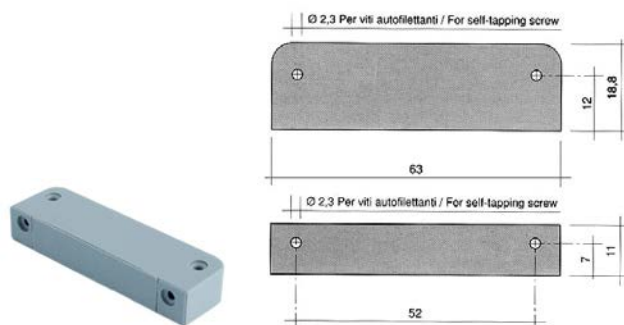

1

GEV No.	519049	Ref. No.	903651
description	magnet \varnothing mm L 63mm H 10.7mm W 18.8mm hole distance 52mm M2 hole \varnothing 2mm		
For models:	GDW1001, GGW1001, GGW2001		
accessories for	519049		
	GEV No.	560095	Ref. No. —
sheet metal screws \varnothing 2.9mm L 9.5mm SS Qty 20 pcs DIN 7981/ISO 7049 head \varnothing 5.6mm oval head			

lamps

indicator lights

indicator lights 2-piece (lens and indicator lamp)

indicator light lenses

 \varnothing 8mm (type RL-2)





1



GEV No.	359819	Ref. No.	00002360 09950388535
description	indicator light lens green Qty 1 pcs \varnothing 8mm		
For models:	GCO1001, GCO2001		



 <p>1</p>			
GEV No.	359820	Ref. No.	00002350 09950368534
description	indicator light lens yellow Qty 1 pcs ø 8mm		
For models:	GCO1001, GCO2001		

indicator lamps for socket type RL

 <p>1</p>			
GEV No.	359818	Ref. No.	01200330 01951177000
description	indicator light 230V clear connection male faston 6.3mm		
For models:	GCO1001, GCO2001		
accessories for	359818		
	GEV No.	359820	Ref. No. 00002350 09950368534
indicator light lens yellow Qty 1 pcs ø 8mm			
	GEV No.	359833	Ref. No. —
indicator light lens red Qty 1 pcs ø 8mm			
	GEV No.	359948	Ref. No. —
indicator light lens clear Qty 1 pcs ø 8mm			

 <p>1</p>			
GEV No.	359817	Ref. No.	01200340 01951187000
description	indicator light 230V green connection male faston 6.3mm		
For models:	GCO1001, GCO2001		
accessories for	359817		
	GEV No.	359819	Ref. No. 00002360 09950388535
indicator light lens green Qty 1 pcs ø 8mm			

indicator lights (complete)

<p>ø 6mm</p>  <p>1</p>			
GEV No.	359004	Ref. No.	903648
description	indicator light ø 6mm 230V green cable length 400mm temp.-resist. 106°C		
For models:	GGW1001, GGW2001		

 <p>1</p>			
GEV No.	359005	Ref. No.	903644
description	indicator light ø 6mm 230V yellow cable length 400mm		
For models:	GGW1001, GGW2001		

ø10mm

<p>with screw socket</p>  <p>1</p>			
GEV No.	359870	Ref. No.	A0ND022
description	indicator light ø 10mm 230V green connection male faston 4.8mm socket screw base		
For models:	GCM1006, GCM2009, GCM3016		

ø12mm

<p>with plug-in socket</p>  <p>1</p>			
GEV No.	359041	Ref. No.	A08009
description	indicator light ø 12mm green 230V connection male faston 6.3mm temp.-resist. 120°C Qty 1 pcs		
For models:	GEG1001, GEG2001		

 <p>1</p>			
GEV No.	359042	Ref. No.	A08003
description	indicator light ø 12mm yellow 230V connection male faston 6.3mm temp.-resist. 120°C Qty 1 pcs		
For models:	GEG1001, GEG2001, GTO1001, GTO2001		

 <p>1</p>			
GEV No.	357110	Ref. No.	912119
description	indicator light ø 12mm green 400V connection male faston 6.3mm temp.-resist. 100°C		
For models:	GPG2001		

 <p>1</p>			
GEV No.	360509	Ref. No.	016240441 912003
description	indicator light ø 12mm yellow 230V connection male faston 6.3mm thermometer		
For models:	GDF1004, GDF1008, GDF2024, GDF2028, GPG1001		



			
1			
GEV No.	357111	Ref. No.	912126
description	indicator light ø 12mm yellow 400V connection male faston 6.3mm thermometer		
For models:	GPG2001		

ø14mm
with screw socket

			
1			
GEV No.	360622	Ref. No.	1.03.00020013 GDF1104-009 GDF1108-021 GDF2124-009 GDF2128-021 GDF2128-21 HDF1108-009 HDF2128-009
description	indicator light ø 14mm green 220V connection male faston 4.8mm plastic		
For models:	GDF1104, GDF1108, GDF2124, GDF2128		

			
1			
GEV No.	360621	Ref. No.	1.03.00020017 GDF1104-008 GDF1108-009 GDF2124-008 GDF2128-009 GDF2128-9 HDF1108-008 HDF2128-008
description	indicator light ø 14mm yellow 220V connection male faston 4.8mm plastic		
For models:	GDF1104, GDF1108, GDF2124, GDF2128		

LED**LED bars**

			
1			
GEV No.	357257	Ref. No.	DQLED007 HSC350DD-23
description	LED bar L 1100mm W 14.4mm H 7.5mm 24VDC white number of lamps 36 cable length 120mm		

			
1			
GEV No.	357256	Ref. No.	DQLED008 GSC1100G-27 HSC360G-21
description	LED bar L 1200mm W 14.4mm H 7.5mm 24VDC white number of lamps 42 cable length 120mm		
For models:	GSC1100G		

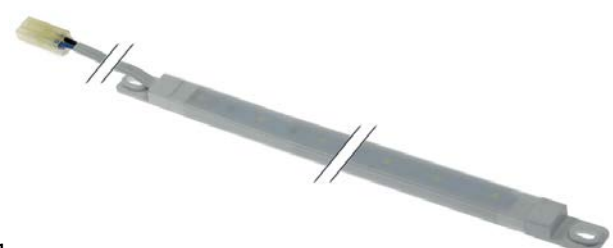
			
1			
GEV No.	357255	Ref. No.	DQLED011 HSC350DD-30
description	LED bar L 400mm W 14.4mm H 7.5mm 24VDC white number of lamps 18 cable length 380mm		

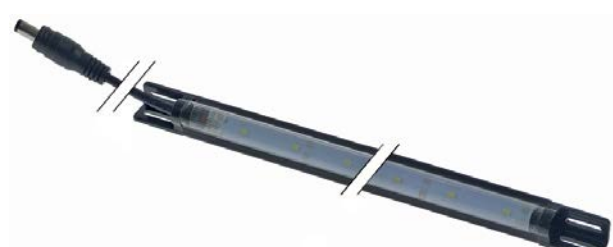
			
1			
GEV No.	357244	Ref. No.	A1.1.A.A01.01.19
description	LED bar L 580mm W 18mm H 13mmV black/transparent number of lamps 25 cable length 210mm		
For models:	GRV1100		

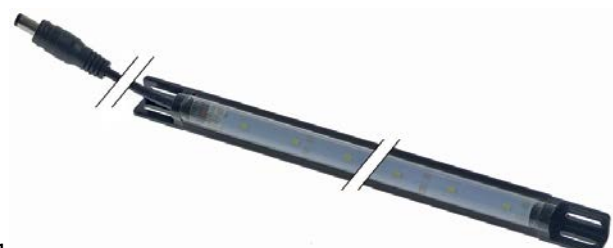
			
1			
GEV No.	357243	Ref. No.	A1.1.A.A01.01.18
description	LED bar L 580mm W 18mm H 13mmV black/transparent number of lamps 25 cable length 850mm		
For models:	GRV1100		





			
1			
GEV No.	357241	Ref. No.	DQLED067
description	LED bar L 600mm W 11.5mm H 12.5mm 24V number of lamps 42 cable length 285mm voltage DC		

			
1			
GEV No.	357138	Ref. No.	1.1.A.A01.03.03 GCV1600-18
description	LED bar L 698mm W 13mm H 13mm 230V number of lamps 27 cable length 800mm		

			
1			
GEV No.	357258	Ref. No.	GSC1100G-29
description	LED bar L 900mm W 14.4mm H 7.5mm 24VDC white number of lamps 30 cable length 120mm		

accessories

			
1			
GEV No.	357152	Ref. No.	1.1.B.B25.20 GCV1600-38
description	power supply for LEDs RT-130-2-24cm Qty 1 pcs		

			
1			
GEV No.	357247	Ref. No.	A1.1.A.A06.01 A1.1.A.A07.01.01
description	power supply with bush primary 85-265V secondary 0.2A		
For models:	GRV1100		

fluorescent lamps

fluorescent lamps

G5

			
1			
GEV No.	357156	Ref. No.	DQDA0009 GBC1001-31
description	fluorescent lamp socket G5 L 285mm 8W ø 16mm 230V T5/865 Qty 1 pcs		
For models:	GBC1001		

			
1			
GEV No.	357148	Ref. No.	DQDA0010 GBC1002-32 GBC1003-32
description	fluorescent lamp socket G5 L 547mm 14W ø 16mm 230V T5/865 Qty 1 pcs		
For models:	GBC1002, GBC1003		

G13

			
1			
GEV No.	357145	Ref. No.	DQDA0012 GSC1336-22 GSC2336-22
description	fluorescent lamp socket G13 L 438mm 15W ø 27mm 230V Qty 1 pcs light colour 865		
For models:	GSC1336, GSC2336		

			
1			
GEV No.	357146	Ref. No.	DQDA0007 GSC1336-18 GSC2336-18 HSC360-26
description	fluorescent lamp socket G13 L 895mm 30W ø 26mm 230V T8/765 Qty 1 pcs		
For models:	GSC1100, GSC1336, GSC2336		

			
1			
GEV No.	357147	Ref. No.	GSC1100-07
description	fluorescent lamp socket G13 L 895mm 30W ø 26mm 230V T8/765 Qty 1 pcs		



accessories

sockets



1

GEV No.	381169	Ref. No.	GSC1100-42 GSC1336-43 GSC2336-43 SLJY2010
description	lamp holder socket G13 L 26.5mm W 24.5mm Qty 1 pcs for fluorescent lamps		
For models:	GSC1100, GSC1336		



1

GEV No.	381447	Ref. No.	GBC1001-30 GBC1002-31 GBC1003-31 SLZA3000
description	lamp socket socket G13 L 33mm W 10mm H 28mm		
For models:	GBC1001, GBC1002, GBC1003		



1

GEV No.	381413	Ref. No.	HSC350-28 HSC360-28 SLZA2000
description	lamp socket socket G13 L 37.5mm W 28.5mm Qty 1 pcs for fluorescent lamps		
For models:	GSC1100, GSC2336		

starter holders



1

GEV No.	381170	Ref. No.	GBC1001-27 GBC1002-28 GBC1003-28 GSC1100-44 GSC1336-21 GSC2336-21 SLZA1000
description	starter holder L 32mm W 24mm housing ø 23mm Qty 1 pcs		
For models:	GBC1001, GBC1002, GBC1003, GSC1100, GSC1336, GSC2336		

starter



1

GEV No.	380464	Ref. No.	DQDF0000 GBC1001-26 GBC1002-27 GBC1003-27 GSC1100-45 GSC1336-20 GSC2336-20
description	starter 4-65W		
For models:	GBC1001, GBC1002, GBC1003, GSC1100, GSC1336, GSC2336		



1

GEV No.	357150	Ref. No.	1.1.A.A01.02.01 GGC1078-33 GGC2270-36
description	starter for fluorescent lamps L 69mm W 38.5mm 11W type HG-YZ11E Qty 1 pcs		
For models:	GGC1270		

ballasts



1

GEV No.	403192	Ref. No.	DQZB0005 GBC1002-18 GBC1003-18
description	electrical ballast 15W 220-240V connection screw clamp for fluorescent lamps type JF-1595M Qty 1 pcs		
For models:	GBC1002, GBC1003		



1

GEV No.	403190	Ref. No.	DQZA0027 GSC1100-35 GSC1336-35
description	electrical ballast 30W 220-240V connection screw clamp for fluorescent lamps type JF-3095W Qty 1 pcs		
For models:	GSC1100, GSC1336		





1

GEV No.	358134	Ref. No.	DQZA0024 GSC1336-23 GSC2336-23 HSC360-06
description	electrical ballast 76W 230V connection screw clamp for fluorescent lamps type JF-1595W Qty 1 pcs		
For models:	GSC1336		



			
1			
GEV No.	403191	Ref. No.	DQZB0029 GBC1001-17
description	electrical ballast 9W 220V connection screw clamp for fluorescent lamps type JF-995M Qty 1 pcs		
For models:	GBC1001		

covers			
			
1			
GEV No.	699314	Ref. No.	GBC1001-32 SLZV0017
description	cover L 510mm W 30mm H 30mm		
For models:	GBC1001		

			
1			
GEV No.	694873	Ref. No.	HSC350-40 SLSE2008
description	cover L 590mm W 280mm H 1mm		
For models:	GSC2336		

			
1			
GEV No.	699312	Ref. No.	GBC1002-33 GBC1003-33 SLZV0018
description	cover L 810mm W 30mm H 30mm transparent		
For models:	GBC1002		

			
1			
GEV No.	694874	Ref. No.	HSC350-38 SLZQ0037
description	cover set mounting pos. left/right W 82mm H 280mm D 34		
For models:	GSC1100, GSC1100G, GSC2336		
spare parts for	694874		
	GEV No.	692393	Ref. No. —
bezel for cover mounting pos. right/left W 82mm H 280mm D 34mm plastic Qty 1 pcs			
	GEV No.	692394	Ref. No. —
bezel for cover mounting pos. left W 82mm H 280mm D 34mm plastic Qty 1 pcs			

			
1			
GEV No.	694872	Ref. No.	HSC350-36 SLJV2040
description	cover support L 610mm W 20mm H 55mm mounting pos. lower		
For models:	GSC2336		

			
1			
GEV No.	694871	Ref. No.	HSC350-41 SLJV2041
description	cover support L 610mm W 20mm H 55mm mounting pos. upper		
For models:	GSC2336		

			
1			
GEV No.	699307	Ref. No.	HSC360-24 SLZE0061
description	end cap L 60mm W 40mm H 10mm for lamp		

			
1			
GEV No.	694870	Ref. No.	HSC350-23 SLJY2016
description	housing L 131.5mm W 45mm H 40mm		
For models:	GSC2336		

fridge lamps

producer-specific fridge lamps

NINGBO ROTOR

			
1			
GEV No.	357143	Ref. No.	RW40.38
description	cover for lamp plastic ø 62mm clear Qty 1 pcs		
For models:	GHR1040, GHR2600		

			
1			
GEV No.	360713	Ref. No.	1.1.A.A01.01.01 GGC1078-31 GGC2270-35
description	halogen lamp 11W 220/240V L 234mm W 32mm H 20mm		
For models:	GGC1270		



GEV No.	357144	Ref. No.	RW40.37
description	lamp holder for LEDs ø 84mm Qty 1 pcs		
For models:	GHR1040, GHR2600		

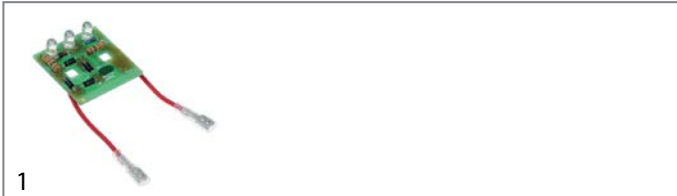

GEV No.	357127	Ref. No.	RW40.35
description	LED refrigerator GHR1040 white 220V PCB voltage AC		
For models:	GHR1040, GHR2600		



GEV No.	357149	Ref. No.	1.1.A.A01.01.03 GGC1078-32 GGC2270-37
description	lamp socket socket T140 250V L 34.5mm H 31mm plastic Qty 1 pcs 500W hole distance 254mm		
For models:	GGC1270		

RWA

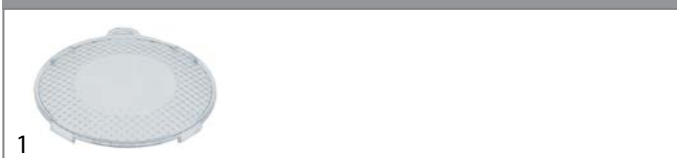

GEV No.	357143	Ref. No.	RW40.38
description	cover for lamp plastic ø 62mm clear Qty 1 pcs		
For models:	GHR1040, GHR2600		



GEV No.	357144	Ref. No.	RW40.37
description	lamp holder for LEDs ø 84mm Qty 1 pcs		
For models:	GHR1040, GHR2600		



GEV No.	357127	Ref. No.	RW40.35
description	LED refrigerator GHR1040 white 220V PCB voltage AC		
For models:	GHR1040, GHR2600		

microwave lamps

sockets

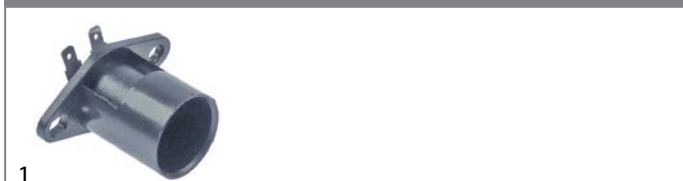

GEV No.	357141	Ref. No.	GMW1030-P21
description	lamp socket socket E14 250V ø 26mm L 37mm connection male faston 4.8mm mounting distance 40mm for microwave holder length 52mm plastic Qty 1 pcs		
For models:	GMW1030		

light bulbs



GEV No.	357142	Ref. No.	GMW1030-C06
description	light bulb socket E14 230V 20W ø 22mm L 58mm Qty 1 pcs lens L 33mm		
For models:	GMW1030		





GEV No.	357175	Ref. No.	253079000039 GMW1025-C06
description	light bulb socket E14 230V 20W ø 25mm L 63mm Qty 1 pcs lens L 37mm		



oven lamps

universal oven lamps

mounting diameter 35.5mm

 <p>1</p>				
GEV No.	359718	Ref. No.	00002330	
description	oven lamp mounting ø 35.5mm 230V 15W socket E14 temp.-resist. 300°C connection male faston 6.3mm hard glas			
For models:	GCO2001			
spare parts for	359718			
	GEV No.	359701	Ref. No.	—
	lamp socket socket E14 220-230V mounting ø 35.5mm connection male faston 6.3mm 15W			
	GEV No.	359740	Ref. No.	—
	light bulb t.max. 300°C socket E14 15W 230V ø 22mm L 48mm lens L 20mm for oven lamp IMPORT			

mounting diameter 47.8mm

 <p>1</p>				
GEV No.	359703	Ref. No.	01950077400	
description	oven lamp mounting ø 47.8mm 230V 15W socket E14 temp.-resist. 300°C connection male faston 6.3mm hard glas			
For models:	GCO1001			
spare parts for	359703			
	GEV No.	359610	Ref. No.	—
	light bulb t.max. 300°C socket E14 15W 230V ø 22mm L 47mm lens L 20mm for oven lamp type Philips			
	GEV No.	359725	Ref. No.	—
	oven lamp glass thread ø 44mm H 43mm ø 54mm hard glas temp.-resist. 350°C			

timers



electric timers

 <p>1</p>			
GEV No.	360513	Ref. No.	20-0978-9
description	timer operation time 5-15min/1-6min time spreadmin 1CO/1NO permanent position no time range 5-15 / 1-6min 10A shaft ømm shaftmm shaft Lmm connection male faston 6.3mm ABB for ice-cube maker 24-240V voltage AC/DC 2-pole		
For models:	GIM1023, GIM1038, GIM2023, GIM2038		

with time spread

 <p>1</p>			
GEV No.	350142	Ref. No.	09952437000
description	timer MS65 with bell operation time 120min time spread 30min 1CO/1NC/2NO at 250V 16A permanent position yes time range 0-120min impulse electric 16A shaft ø 6x4.6mm shaft L 22mm connection male faston 6.3mm Invensys screw/F6.3 230V voltage AC 50Hz		
For models:	GCO1001		

mechanical timers

 <p>1</p>				
GEV No.	350186	Ref. No.	01202980	
description	timer M2 2-pole operation time 120min impulse mechanical 2CO at 250V 16A permanent position yes shaft ø 6x4.6mm shaft 6x4.6mm shaft L 23mm mounting distance 28mm			
For models:	GCO2001			
accessories for	350186			
	GEV No.	112627	Ref. No.	—
	knob time 120min ø 58mm shaft ø 6x4.6mm shaft flat lower			



1

GEV No.	360164	Ref. No.	A02008
description	timer MT49 2-pole operation time 15min impulse mechanical 2NO at 250V 16A permanent position yes shaft 6x4.6mm shaft L 16mm mounting distance 28mm connection lateral		
For models:	GTO1001, GTO2001		

defrost timers

miscellaneous



1

GEV No.	360553	Ref. No.	1.1.A.A05.06 GGC1078-06 GGC1078-6
description	defrost timer SONXIE type DBZF-625-2G2B defrosting interval 6h defrosting time 2minmin fan delaymin 200-240V Qty 1 pcs		

alarm devices

buzzer boards



1

GEV No.	401062	Ref. No.	01201250
description	buzzer board 230VAC L 48mm W 45mm connection Faston 6.3mm		
For models:	GCO2001		

contactors

ISKRA (FANAL)

power contactors



1

GEV No.	380212	Ref. No.	907096
description	power contactor resistive load 20A 230VAC (AC3/400V) 8.5A/5.5kW main contacts 3NO auxiliary contacts 1NC connection screw connection type Fanal K07M 01 type ISKRA DSL7 01		
For models:	GDW1001		

solid state relays

accessories

diodes

high voltage diodes



1

GEV No.	403185	Ref. No.	GMW1030-C45
description	hv diode type RG304 connection F4.8mm / lug M4 for microwave Qty 1 pcs		
For models:	GMW1030		



1

GEV No.	403261	Ref. No.	253089000101 GMW1025-C02
description	hv diode type RG501 connection F6.3mm / lug M4 cable lengthmm for microwave Qty 1 pcs		

relays

power relays

with bracket mounting



1

GEV No.	381252	Ref. No.	1.03.00010026 GDF1108-003 GDF1108-3 GDF2128-003 HDF1108-021 HDF2128-021
description	relay OMRON 230VAC 25A 2NO connection male faston 6.3mm bracket mounting at 250V 25A manuf. no. G7L-2A-TUB 230VAC		
For models:	GDF1108, GDF2128		

1

GEV No.	380867	Ref. No.	DQWBZJ02
description	relay SHANGFANG 12VDC 30A 1NO connection male faston 6.3mm screw mounting at 250V 30A manuf. no. 855AW-1A-C1		
For models:	GSC1100G, GSC2336		



1

GEV No.	403737	Ref. No.	GMW1030-C12 GMW1030-C12 (Kabel lang)
description	HV transformer primary 230-240V 50Hz type 95244XC-7 for micro-waves		
For models:	GMW1030		

magnetrons



1

GEV No.	403173	Ref. No.	253017000051 GMW1025-C08
description	Magnetron type 2M248J(JT)		
For models:	GMW1030		



1

GEV No.	403257	Ref. No.	253029000256 GMW1025-C12
description	HV transformer primary 230-240V 50Hz type GAL-1000E-1G for microwave		



1

GEV No.	403259	Ref. No.	GMW1030-C08
description	Magnetron type M24FB-610A for microwave suitable for GALANZ		
For models:	GMW1030		

miscellaneous



1

GEV No.	403660	Ref. No.	DQLED069 HBC1002-18 HBC2003-18
description	transformer primary 100-240V secondary 24VDC 20VA secondary 0.84A		



1

GEV No.	403867	Ref. No.	DQLED042 DQLED055 GSC1100G-31 GSC1100G-32 HSC350DD-32 HSC350DD-33 HSC360G-06
description	transformer primary 100-240V secondary 24VDC secondary 0.42A H 25mm L 95mm W 40mm		
For models:	GSC1100G		

transformers

HV transformers



1

GEV No.	403258	Ref. No.	GMW1030-C12 (Kabel kurz)
description	HV transformer primary 230-240V 50Hz type 95244XC-5 for micro-waves		



electronic controllers

DIXELL

refrigeration controllers

built-in version



1

GEV No.	378256	Ref. No.	GPS1600-02 GSF1600-02 RC600.34 RN600.27 S900.02
description	electronic controller DIXELL XR02CX-5N0C0 mounting measurements 71x29mm built-in depth 56mm 230V voltage AC NTC relay outputs 1 CO-8A(4) NTC protection IP54 defrosting function/time control -40 up to +110°C display 2½ digit		
For models:	GDS1134, GDS1600, GFR2600, GHS1134, GHS1600, GHS2134, GHS2600, GPS1134, GPS1600, GRE2600, GSA1134, GSA1600, GSF1134, GSF1600		
spare parts for	378256		
	GEV No.	Ref. No.	—
	temperature probe NTC 10kOhm cable thermoplastic probe -40 up to +110°C cable -40 up to +110°C probe ø6x14mm cable length 3m without screw connection 2-wire		
accessories for	378256		
	GEV No.	Ref. No.	—
	temperature probe NTC 10kOhm cable PVC probe -20 up to +80°C cable -10 up to 100°C probe ø7x24.5mm cable length 1.5m without screw connection 2-wire		
	GEV No.	Ref. No.	—
	temperature probe NTC 10kOhm cable PVC probe -20 up to +80°C cable -10 up to 100°C probe ø6x25mm cable length 3m 2-wire		
	GEV No.	Ref. No.	E21010150001 GPS1600-32 GSF1600-32 S900.32
	temperature probe NTC 10kOhm cable thermoplastic probe -40 up to +110°C cable -40 up to +110°C probe ø6x14mm cable length 1.5m without screw connection 2-wire		
	GEV No.	Ref. No.	—
	temperature probe NTC 10kOhm cable thermoplastic probe -40 up to +110°C cable -40 up to +110°C probe ø6x14mm cable length 3m without screw connection 2-wire		
	GEV No.	Ref. No.	0205610
	temperature probe NTC 10kOhm cable silicone probe -40 up to +110°C cable -50 up to +180°C probe ø6x40mm cable length 3m 2-wire		
	GEV No.	Ref. No.	—
	temperature probe NTC 10kOhm cable silicone probe -40 up to +110°C cable -50 up to +180°C probe ø6x40mm cable length 1.5m without screw connection 2-wire		

dixell

71 x 29mm



1

GEV No.	378267	Ref. No.	E20A111C4D00 RC400.21 RN400.25
description	electronic controller DIXELL XR02CX-5N0C1 mounting measurements 71x29mm built-in depth 56mm 230V voltage AC NTC relay outputs 1 NO-20A(8) NTC DI protection IP54 defrosting function/time control -40 up to +110°C display 2½ digit		
For models:	GPS2600, GSA2600, GSD2600, GSF2600, RC400, RN400		
accessories for	378267		
	GEV No.	Ref. No.	—
	temperature probe NTC 10kOhm cable thermoplastic probe -40 up to +110°C cable -40 up to +110°C probe ø6x14mm cable length 3m without screw connection 2-wire		
	GEV No.	Ref. No.	—
	temperature probe NTC 10kOhm cable PVC probe -40 up to +110°C cable -10 up to 100°C connection 2-wire thread probe ø6x14mm cable length 3m		



1

GEV No.	379843 ¹	Ref. No.	1.1.A.A06.03.31 GCV1600-39
description	electronic controller kit DIXELL XR30CX-5N2C1 mounting measurements 71x29mm 230V voltage AC NTC/PTC relay outputs 2 1x NTC probe inclusive -50 up to +150°C display 3½ digits 2 RoomTempIN NTC/PTC DEF Probe DigilN1 DigilN2 DEF Relay fan relay Temp4/Dig1 NTC/PTC/DIGI evaporator probe defr. funct. compressor relay NO-20A(8) light relay alarm relay CO-8A(3) auxiliary relay		
spare parts for	379843		
	GEV No.	Ref. No.	E21010150001 GPS1600-32 GSF1600-32 S900.32
	temperature probe NTC 10kOhm cable thermoplastic probe -40 up to +110°C cable -40 up to +110°C probe ø6x14mm cable length 1.5m without screw connection 2-wire		

¹incl. 1x NTC probe









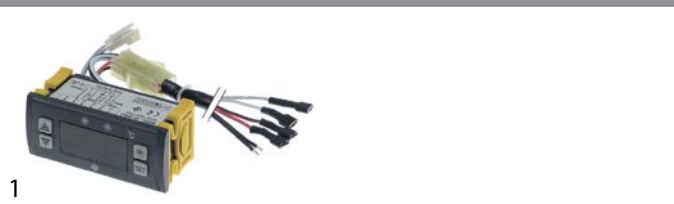

SHANGFANG

refrigeration controllers

built-in version











GEV No.	379799 ¹	Ref. No.	DQWBZX02 GSC1100-22 GSC1336-11 GSC2336-11
description	electronic controller SHANGFANG type SF-104S-2 mounting measurements 71x29mm 12V voltage AC NTC relay outputs 2 12VDC 12VDC NTC front measurements 77x35mm built-in depth 40mm protection IP54 accuracy 1% built-in version alarm without accessories defr. funct. yes -45 up to +45°C display 3 digits		
For models:	GSC1100, GSC1100G, GSC1336, GSC2336		
spare parts for	379799		
	GEV No.	379054	Ref. No. —
	transformer primary 230VAC secondary 12VAC 3VA secondary 0.25A H 40mm L 45mm W 50mm connection screw 50/60Hz type 153/M		
	GEV No.	380867	Ref. No. DQWBZJ02
	relay SHANGFANG 12VDC 30A 1NO connection male faston 6.3mm screw mounting at 250V 30A manuf. no. 855AW-1A-C1		
	GEV No.	381318	Ref. No. —
	temperature probe NTC cable silicone cable colours white cable length 3m probe -40 up to +110°C cable -50 up to +180°C probe ø7x25mm coded plug		
	GEV No.	381319	Ref. No. —
	temperature probe NTC cable silicone cable colours black cable length 3m evaporator probe -40 up to +110°C cable -50 up to +180°C probe ø7x25mm coded plug		
accessories for	379799		
	GEV No.	379054	Ref. No. —
	transformer primary 230VAC secondary 12VAC 3VA secondary 0.25A H 40mm L 45mm W 50mm connection screw 50/60Hz type 153/M		
	GEV No.	380867	Ref. No. DQWBZJ02
	relay SHANGFANG 12VDC 30A 1NO connection male faston 6.3mm screw mounting at 250V 30A manuf. no. 855AW-1A-C1		
	GEV No.	381318	Ref. No. —
	temperature probe NTC cable silicone cable colours white cable length 3m probe -40 up to +110°C cable -50 up to +180°C probe ø7x25mm coded plug		
	GEV No.	381319	Ref. No. —
	temperature probe NTC cable silicone cable colours black cable length 3m evaporator probe -40 up to +110°C cable -50 up to +180°C probe ø7x25mm coded plug		









¹without relay, cable harness, probe and transformer

built-in version 2-piece



GEV No.	379849 ¹	Ref. No.	DQWB0005 GBC1001-18 GBC1002-19 GBC1003-19
description	electronic controller SHANGFANG type SF-101S mounting measurements 71x29mm 230V voltage AC NTC relay outputs 1 NO-30A NTC Comp front measurements 77x35mm built-in depth 40mm protection IP54 accuracy 1% built-in version alarm incl. relay, cable harness, probe and transformer defr. funct. yes -45 up to +45°C display 3 digits		
For models:	GBC1001, GBC1002, GBC1003		
spare parts for	379849		
	GEV No.	379054	Ref. No. —
	transformer primary 230VAC secondary 12VAC 3VA secondary 0.25A H 40mm L 45mm W 50mm connection screw 50/60Hz type 153/M		
	GEV No.	380867	Ref. No. DQWBZJ02
	relay SHANGFANG 12VDC 30A 1NO connection male faston 6.3mm screw mounting at 250V 30A manuf. no. 855AW-1A-C1		
	GEV No.	381318	Ref. No. —
	temperature probe NTC cable silicone cable colours white cable length 3m probe -40 up to +110°C cable -50 up to +180°C probe ø7x25mm coded plug		
	GEV No.	381319	Ref. No. —
	temperature probe NTC cable silicone cable colours black cable length 3m evaporator probe -40 up to +110°C cable -50 up to +180°C probe ø7x25mm coded plug		
accessories for	379849		
	GEV No.	379054	Ref. No. —
	transformer primary 230VAC secondary 12VAC 3VA secondary 0.25A H 40mm L 45mm W 50mm connection screw 50/60Hz type 153/M		
	GEV No.	380867	Ref. No. DQWBZJ02
	relay SHANGFANG 12VDC 30A 1NO connection male faston 6.3mm screw mounting at 250V 30A manuf. no. 855AW-1A-C1		
	GEV No.	381318	Ref. No. —
	temperature probe NTC cable silicone cable colours white cable length 3m probe -40 up to +110°C cable -50 up to +180°C probe ø7x25mm coded plug		
	GEV No.	381319	Ref. No. —
	temperature probe NTC cable silicone cable colours black cable length 3m evaporator probe -40 up to +110°C cable -50 up to +180°C probe ø7x25mm coded plug		

¹incl. relay, cable harness, probe and transformer

 <p>71 x 29mm</p>			
1			
GEV No.	403074 ¹	Ref. No.	DQWB0002 GSC1100-25 GSC1336-12 GSC2336-12
description	electronic controller SHANGFANG type SF-104S-2 mounting measurements 71x29mm 230V voltage AC NTC relay outputs 2 NO-30A NO-30A NTC NTC front measurements 77x35mm built-in depth 38mm protection IP54 accuracy 1% built-in version alarm incl. relay, cable harness, probe and transformer defr. funct. yes -45 up to +45°C display 2½ digit		
For models:	GSC1100, GSC1100G, GSC1336, GSC2336		
spare parts for	403074		
	GEV No.	379054	Ref. No. —
	transformer primary 230VAC secondary 12VAC 3VA secondary 0.25A H 40mm L 45mm W 50mm connection screw 50/60Hz type 153/M		
	GEV No.	380867	Ref. No. DQWBZJ02
	relay SHANGFANG 12VDC 30A 1NO connection male faston 6.3mm screw mounting at 250V 30A manuf. no. 855AW-1A-C1		
	GEV No.	381318	Ref. No. —
	temperature probe NTC cable silicone cable colours white cable length 3m probe -40 up to +110°C cable -50 up to +180°C probe ø7x25mm coded plug		
	GEV No.	381319	Ref. No. —
	temperature probe NTC cable silicone cable colours black cable length 3m evaporator probe -40 up to +110°C cable -50 up to +180°C probe ø7x25mm coded plug		
accessories for	403074		
	GEV No.	379054	Ref. No. —
	transformer primary 230VAC secondary 12VAC 3VA secondary 0.25A H 40mm L 45mm W 50mm connection screw 50/60Hz type 153/M		
	GEV No.	380867	Ref. No. DQWBZJ02
	relay SHANGFANG 12VDC 30A 1NO connection male faston 6.3mm screw mounting at 250V 30A manuf. no. 855AW-1A-C1		
	GEV No.	381318	Ref. No. —
	temperature probe NTC cable silicone cable colours white cable length 3m probe -40 up to +110°C cable -50 up to +180°C probe ø7x25mm coded plug		
	GEV No.	381319	Ref. No. —
	temperature probe NTC cable silicone cable colours black cable length 3m evaporator probe -40 up to +110°C cable -50 up to +180°C probe ø7x25mm coded plug		

¹incl. relay, cable harness, probe and transformer

accessories



1			
GEV No.	380867	Ref. No.	DQWBZJ02
description	relay SHANGFANG 12VDC 30A 1NO connection male faston 6.3mm screw mounting at 250V 30A manuf. no. 855AW-1A-C1		
For models:	GSC1100G, GSC2336		

miscellaneous

refrigeration controllers



1			
GEV No.	379848	Ref. No.	GBC1001-19 GBC1002-20 GBC1003-20
description	electronic controller ZHONGSHAN SHANGFANG INSTRUMENT type SF-101 mounting measurements 71x29mm 12V display 3 digits relay outputs 1		

accessories universal for electronic con-

miscellaneous



1			
GEV No.	692369	Ref. No.	1.1.C.C63.71 GCV1600-47
description	bracket for thermometer W 81mm H 41mm plastic Qty 1 pcs		

probes

universal probes

temperature probes



1			
GEV No.	379343	Ref. No.	0205610
description	temperature probe NTC 10kOhm cable silicone probe -40 up to +110°C cable -50 up to +180°C probe ø6x40mm cable length 3m 2-wire		
For models:	GFR1600, GRE1600		





1			
GEV No.	379160	Ref. No.	E21010150001 GPS1600-32 GSF1600-32 S900.32
description	temperature probe NTC 10kOhm cable thermoplastic probe -40 up to +110°C cable -40 up to +110°C probe ø6x14mm cable length 1.5m without screw connection 2-wire		
For models:	GDS1134, GDS1600, GPS1134, GPS1600, GPS2600, GSA1134, GSA1600, GSA2600, GSD2600, GSF1134, GSF1600, GSF2600		



producer-specific probes

probes

1 			
GEV No.	403910	Ref. No.	I0205805
description	temperature probe NTC 10kOhm cable PVC probe -40 up to +110°C connection 2-wire probe 5x20 cable length 1.475m		
For models:	GFR3600, GRE3600		

1 			
GEV No.	378331	Ref. No.	909364
description	temperature probe NTC cable silicone probe -40 up to +110°C cable -50 up to +180°C connection coded plug thread probe ø6x50mm cable length 2m		
For models:	GDW1001		

sensors

1 			
GEV No.	403155	Ref. No.	AD400009 DQD010010R GIC3035-03 GIC3035-B03 GIC3500-03 GIC3500-A03 GIC3535-03 GIC3535-D03
description	sensor for induction device ø 25mm H 17mm cable length 130mm		
For models:	GIC3500, GIC3535		

1 			
GEV No.	403158	Ref. No.	GIC4035-03 GIC4035-C03
description	sensor for induction wok ø 25mm H 17mm cable length 130mm		
For models:	GIC4035		

accessories

fasteners

1 			
GEV No.	692373	Ref. No.	GPS1600-31 GSF1600-31 S900.31
description	probe clip for temperature probe L 50mm W 31mm H 6mm SS hole ø 5mm hole distance 30mm Qty 1 pcs		
For models:	GDS1134, GDS1600, GPS1134, GPS1600, GSA1134, GSA1600, GSF1134, GSF1600		

electronics

electronics accessories

1 			
GEV No.	551213	Ref. No.	GMW1030-P65
description	bracket for PCB L 125mm W 80mm thickness 3mm plastic Qty 1 pcs		
For models:	GMW1030		

PCBs

1 			
GEV No.	402961	Ref. No.	01059331M
description	control PCB for induction device GIC2030 L 242mm W 69mm with digital display buttons 6		
For models:	GIC2030		

1 			
GEV No.	403324	Ref. No.	01059353M
description	control PCB for induction device GIC2035 L 257mm W 75mm edition until 06/2010 buttons 6		
For models:	GIC2035		

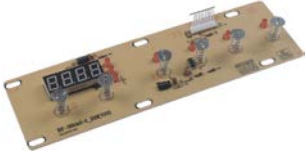

1

GEV No.	402962	Ref. No.	01059353M2
description	control PCB induction device GIC2035 L 257mm W 75mm edition since 06/2010 buttons 6		
For models:	GIC2035		

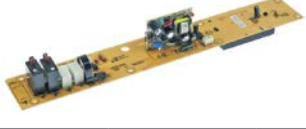

1

GEV No.	403168	Ref. No.	GMW1030-C17 old
description	control PCB microwave GMW1030 L 335mm W 50mm with display		



1

GEV No.	403653	Ref. No.	GMW1030-C17
description	control PCB microwave GMW1030 L 375mm W 50mm with display		
For models:	GMW1030		

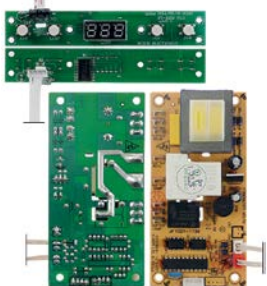

1

GEV No.	361873	Ref. No.	1.1.A.A17.01.01 1.1.A.A17.04.06 1.1.A.A17.04.06+1.1.A.A17.01.01 GGC2270-31 GGC2270-49
description	control PCB refrigerated show case GGC 1270/2270 cable length 225mm 2-piece type KB3150		
For models:	GGC1270		



1

GEV No.	403736	Ref. No.	43845000 I9R00462
description	control PCB refrigeration IARP L 222mm W 40mm		
For models:	GFR3600, GRE3600		



1

GEV No.	403798	Ref. No.	DQA020344R
description	display PCB induction device HIC3500 L 50mm W 48mm		



1

GEV No.	403529	Ref. No.	263019008956 GMW1025-C17
description	display PCB microwave GMW1025 L 160mm W 85mm cable length 200mm for microwave		



1

GEV No.	403212	Ref. No.	909350
description	keypad PCB dishwasher GDW1001/A670		
For models:	GDW1001		



1

GEV No.	403161	Ref. No.	GIC3035-16 old GIC3035-B16 old GIC3535-16 old GIC3535-D16 old
description	keypad PCB for induction device GIC3535/GIC4035 L 247mm W 53mm keypad connection 7 contact pins buttons 8		



1

Image not available



GEV No.	403463	Ref. No.	GIC3500-16 GIC3500-A16
description	keypad PCB for induction device L 247mm W 53mm keypad connection 4 contact pins buttons 8		





1

GEV No.	403462	Ref. No.	GIC4035-16 old GIC4035-C16 old
description	keypad PCB for induction device L 247mm W 53mm keypad connection 7 contact pins buttons 8		





 <p>1</p>											
GEV No.	403154	Ref. No.	DQA020110R GIC3035-16 GIC3035-B16 GIC3535-16 GIC3535-D16								
description	keypad PCB induction device GIC3035 L 247mm W 53mm keypad connection 4 contact pins edition since 2012 buttons 8										
For models:	GIC3535										
accessories for	403154										
 <table border="1"> <tr> <td>GEV No.</td> <td>403156</td> <td>Ref. No.</td> <td>GIC3035-17 GIC3035-B17 GIC3535-17 GIC3535-D17 GIC4035-17 GIC4035-C17 LAC5000003</td> </tr> <tr> <td colspan="4">control panel induction device GIC3535 W 300mm H 58mm</td> </tr> </table>				GEV No.	403156	Ref. No.	GIC3035-17 GIC3035-B17 GIC3535-17 GIC3535-D17 GIC4035-17 GIC4035-C17 LAC5000003	control panel induction device GIC3535 W 300mm H 58mm			
GEV No.	403156	Ref. No.	GIC3035-17 GIC3035-B17 GIC3535-17 GIC3535-D17 GIC4035-17 GIC4035-C17 LAC5000003								
control panel induction device GIC3535 W 300mm H 58mm											
 <table border="1"> <tr> <td>GEV No.</td> <td>403160</td> <td>Ref. No.</td> <td>GIC3535-20 GIC3535-D20</td> </tr> <tr> <td colspan="4">control panel induction device GIC3535 W 300mm mounting pos. right H 58mm</td> </tr> </table>				GEV No.	403160	Ref. No.	GIC3535-20 GIC3535-D20	control panel induction device GIC3535 W 300mm mounting pos. right H 58mm			
GEV No.	403160	Ref. No.	GIC3535-20 GIC3535-D20								
control panel induction device GIC3535 W 300mm mounting pos. right H 58mm											

 <p>1</p>			
GEV No.	403461	Ref. No.	GIC3500-16 old GIC3500-A16 old
description	keypad PCB induction device GIC3500 L 247mm W 53mm keypad connection 7 contact pins buttons 8		

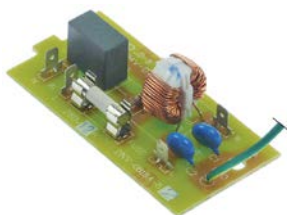
 <p>1</p>			
GEV No.	403184	Ref. No.	GMW1030-C04
description	line filter for microwave type GMW1030 250V 50/60Hz conductor 2 PCB connection male faston 6.3mm L 90mm H 20mm W 70mm PCB Qty 1 pcs cable length 130mm		
For models:	GMW1030		

 <p>1</p>			
GEV No.	403188	Ref. No.	263029001088 GMW1025-C04
description	line filter microwave for GMW1025 250V 50/60Hz conductor 2 PCB connection male faston 4.8mm L 80mm H 20mm W 40mm PCB Qty 1 pcs cable length 120mm type DNV-0818A-5		

 <p>1</p>			
GEV No.	402960	Ref. No.	01059332M
description	main PCB for induction device GIC2030 L 237mm W 231mm		
For models:	GIC2030		

 <p>1</p>			
GEV No.	403325	Ref. No.	010583510M
description	main PCB for induction device GIC2035 L 236mm W 230mm until 06/2010		
For models:	GIC2035		

 <p>1</p>			
GEV No.	403460	Ref. No.	GIC3500-A05 old
description	main PCB for induction device L 265mm W 163mm keypad connection 7 contact pins		

 <p>1</p>			
GEV No.	402959	Ref. No.	010583510M2
description	main PCB induction device GIC2035 L 236mm W 230mm since 06/2010		
For models:	GIC2035		

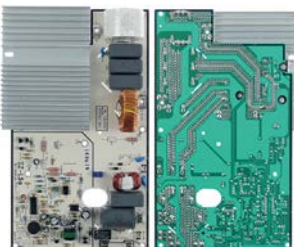

1

GEV No.	403153	Ref. No.	DQA010095R GIC3035-05 GIC3035-B05 GIC3500-05 GIC3500-A05 GIC3535-05 GIC3535-D05 GIC4035-05 GIC4035-C05
description	main PCB induction device GIC3035 L 267mm W 160mm connection male faston 6.3mm vertical keypad connection 4 contact pins SZ-L5		
For models:	GIC3500, GIC3535, GIC4035		
accessories for	403153		

	GEV No.	403154	Ref. No.	DQA020110R GIC3035-16 GIC3035-B16 GIC3535-16 GIC3535-D16
keypad PCB induction device GIC3035 L 247mm W 53mm keypad connection 4 contact pins edition since 2012 buttons 8				

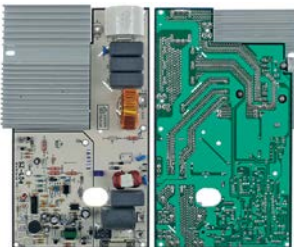

1

GEV No.	403680	Ref. No.	GIC3035-B5 GIC3535-B5 GIC4035-C5
description	main PCB induction device GIC3035 L 267mm W 160mm connection screw keypad connection 4 contact pins SZ-L5a		



1

GEV No.	403159	Ref. No.	GIC3035-05 old GIC3035-B05 old GIC3535-05 old GIC3535-D05 old
description	main PCB induction device GIC3535 L 265mm W 163mm keypad connection 7 contact pins		



1

GEV No.	403799	Ref. No.	DQA010204R
description	main PCB induction device HIC3500 L 265mm W 152mm		



1

GEV No.	403715	Ref. No.	HVS1000-42 YJS820-42
description	main PCB vacuum packing machine HVS1000 L 88mm W 75mm		



1

GEV No.	402915	Ref. No.	909348
description	PCB dishwasher GDW1001 L 143mm W 122mm		
For models:	GDW1001		



1

GEV No.	402965	Ref. No.	907178
description	PCB dishwasher GGW2001 L 122mm W 80mm 50/60Hz 230/240V voltage AC		
For models:	GGW2001		



1

GEV No.	403165	Ref. No.	2852
description	PCB GSM1000 speed control		
For models:	GSM1000		
spare parts for	403165		

	GEV No.	696506	Ref. No.	2858
knob for PCB ø 26mm black Qty 1 pcs				

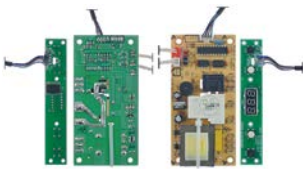
1

GEV No.	403664	Ref. No.	A1.1.A.05.01.09
description	PCB refrigerated show case GRV1100 incl. probe		
For models:	GRV1100		



1

GEV No.	403189	Ref. No.	RW40.21
description	PCB refrigerator GHR1040 L 60mm W 17.5mm Qty 1 pcs		
For models:	GHR1040, GHR2600		



1

GEV No.	403717	Ref. No.	HVS1000-25 YJS820-25
description	PCB vacuum packing machine HVS1000 L 125mm W 100mm		

central units



1

GEV No.	400788	Ref. No.	00000000297
description	control box for slicer 230V		
For models:	GFS1022, GFS1025, GFS1030, GFS2022, GFS2025, HFS2022, HFS2025		



1

GEV No.	403682	Ref. No.	00000001752
description	control box for slicer 230V 50Hz edition since 04/2016		
For models:	HFS2019		



1

GEV No.	401855	Ref. No.	00000009240
description	control box with pressure switch double for slicer 230V		
For models:	GFS1030		

keypads

front foils



1

GEV No.	403156	Ref. No.	GIC3035-17 GIC3035-B17 GIC3535-17 GIC3535-D17 GIC4035-17 GIC4035-C17 LAC5000003
description	control panel induction device GIC3535 W 300mm H 58mm		
For models:	GIC3535, GIC4035		
accessories for	403156		
GEV No.	403154	Ref. No.	DQA020110R GIC3035-16 GIC3035-B16 GIC3535-16 GIC3535-D16
description	keypad PCB induction device GIC3035 L 247mm W 53mm keypad connection 4 contact pins edition since 2012 buttons 8		



1

GEV No.	511647	Ref. No.	909127
description	front foil for dishwasher grey L 409mm W 57mm		
For models:	GGW1001		





1

GEV No.	511648	Ref. No.	909198
description	front foil for dishwasher grey L 409mm W 57mm		
For models:	GGW2001		





membrane keypads

			
1			
GEV No.	403186	Ref. No.	GMW1030-C18
description	membrane keypad microwave buttons 18 Qty 1 pcs L 386mm W 42mm		
For models:	GMW1030		

			
1			
GEV No.	403187	Ref. No.	253069002692 GMW1025-C18
description	membrane keypad microwave GMW1025 2-piece buttons 15 Qty 1 pcs L 164mm W 70mm		

			
1			
GEV No.	403718	Ref. No.	HVS1000-36 YJS820-36
description	membrane keypad vacuum packing machine HVS1000 L 190mm W 55mm		

control panel

			
1			
GEV No.	403160	Ref. No.	GIC3535-20 GIC3535-D20
description	control panel induction device GIC3535 W 300mm mounting pos. right H 58mm		
For models:	GIC3535		
accessories for	403160		
	GEV No.	403154	Ref. No.
			DQA020110R GIC3035-16 GIC3035-B16 GIC3535-16 GIC3535-D16
keypad PCB induction device GIC3035 L 247mm W 53mm keypad connection 4 contact pins edition since 2012 buttons 8			

solenoid valves

solenoid valves (water)

DELTRON

solenoid valves with reducers

			
1			
GEV No.	370662	Ref. No.	000000729
description	solenoid valve single angled 220-240VAC inlet 3/4" outlet 11.5mm DELTRON DSV40-X-2-B-.25-3 plastic flow regulating valve outlet grey		
For models:	GIM1023, GIM2023		

			
1			
GEV No.	370663	Ref. No.	000000887
description	solenoid valve single angled 220-240VAC inlet 3/4" outlet 11.5mm DELTRON DSV40-X-2-B-0.5-3 plastic flow regulating valve outlet blue		
For models:	GIM1038, GIM2038		

TP

















			
1			
GEV No.	370021	Ref. No.	902400
description	solenoid valve double straight 230VAC inlet 3/4" outlet 11.5mm DN10 TP flow regulating valve inlet white		
For models:	GGW2001		
spare parts for	370021		
	GEV No.	371013	Ref. No.
			— solenoid coil TP 230VAC 50/60Hz
accessories for	370021		
	GEV No.	371220	Ref. No.
			— reducer TP flow rate 3l/min red tolerance ±15%
	GEV No.	371221	Ref. No.
			— reducer TP flow rate 5.5l/min yellow tolerance ±15%
	GEV No.	371222	Ref. No.
			— reducer TP flow rate 6l/min grey tolerance ±15%
	GEV No.	371223	Ref. No.
			— reducer TP flow rate 10l/min white tolerance ±15%

Table continues overleaf



accessories for		370021		
	GEV No.	371224	Ref. No.	—
reducer TP flow rate 12l/min bronze tolerance ±15%				
	GEV No.	371225	Ref. No.	—
reducer TP flow rate 16l/min light brown tolerance ±15%				
	GEV No.	371226	Ref. No.	—
reducer TP flow rate 20l/min red tolerance ±15%				
	GEV No.	371230	Ref. No.	—
reducer TP flow rate 0.25l/min red tolerance ±25%				
	GEV No.	371231	Ref. No.	—
reducer TP flow rate 0.35l/min violet tolerance ±25%				
	GEV No.	371232	Ref. No.	—
reducer TP flow rate 0.5l/min orange tolerance ±25%				
	GEV No.	371233	Ref. No.	—
reducer TP flow rate 0.8l/min white tolerance ±25%				
	GEV No.	371234	Ref. No.	—
reducer TP flow rate 1l/min light blue tolerance ±25%				
	GEV No.	371235	Ref. No.	—
reducer TP flow rate 1.2l/min brown tolerance ±25%				
	GEV No.	371236	Ref. No.	—
reducer TP flow rate 1.5l/min light brown tolerance ±25%				
	GEV No.	371237	Ref. No.	—
reducer TP flow rate 2.5l/min yellow tolerance ±25%				
	GEV No.	371238	Ref. No.	—
reducer TP flow rate 3.4l/min dark green tolerance ±25%				
	GEV No.	371239	Ref. No.	—
reducer TP flow rate 5l/min black tolerance ±25%				
	GEV No.	371240	Ref. No.	—
reducer TP flow rate 8l/min blue tolerance ±20%				

accessories for		370017		
	GEV No.	371220	Ref. No.	—
reducer TP flow rate 3l/min red tolerance ±15%				
	GEV No.	371221	Ref. No.	—
reducer TP flow rate 5.5l/min yellow tolerance ±15%				
	GEV No.	371222	Ref. No.	—
reducer TP flow rate 6l/min grey tolerance ±15%				
	GEV No.	371223	Ref. No.	—
reducer TP flow rate 10l/min white tolerance ±15%				
	GEV No.	371224	Ref. No.	—
reducer TP flow rate 12l/min bronze tolerance ±15%				
	GEV No.	371225	Ref. No.	—
reducer TP flow rate 16l/min light brown tolerance ±15%				
	GEV No.	371226	Ref. No.	—
reducer TP flow rate 20l/min red tolerance ±15%				
	GEV No.	371230	Ref. No.	—
reducer TP flow rate 0.25l/min red tolerance ±25%				
	GEV No.	371231	Ref. No.	—
reducer TP flow rate 0.35l/min violet tolerance ±25%				
	GEV No.	371232	Ref. No.	—
reducer TP flow rate 0.5l/min orange tolerance ±25%				
	GEV No.	371233	Ref. No.	—
reducer TP flow rate 0.8l/min white tolerance ±25%				
	GEV No.	371234	Ref. No.	—
reducer TP flow rate 1l/min light blue tolerance ±25%				
	GEV No.	371235	Ref. No.	—
reducer TP flow rate 1.2l/min brown tolerance ±25%				
	GEV No.	371236	Ref. No.	—
reducer TP flow rate 1.5l/min light brown tolerance ±25%				
	GEV No.	371237	Ref. No.	—
reducer TP flow rate 2.5l/min yellow tolerance ±25%				
	GEV No.	371238	Ref. No.	—
reducer TP flow rate 3.4l/min dark green tolerance ±25%				
	GEV No.	371239	Ref. No.	—
reducer TP flow rate 5l/min black tolerance ±25%				
	GEV No.	371240	Ref. No.	—
reducer TP flow rate 8l/min blue tolerance ±20%				

  <p>1</p>				
GEV No.	370017	Ref. No.	902390	
description	solenoid valve single straight 230VAC inlet 3/4" outlet 11.5mm DN10 TP p max 10bar			
For models:	GDW1001, GGW1001			
spare parts for	370017			
	GEV No.	371013	Ref. No.	—
solenoid coil TP 230VAC 50/60Hz				



various



1

GEV No.	374094	Ref. No.	HVS1000-45 YJS820-45
description	solenoid valve angled 2-way inlet 4.5mm outlet 4.5mm cable length 300mm		



1

GEV No.	374093	Ref. No.	HVS1000-41 YJS820-41
description	solenoid valve single 2-way 12VDC inlet 11mm outlet 11mm suitable for exit		

metal

ASCO

spare parts and accessories

O-rings



1

GEV No.	371100	Ref. No.	YJS820-4
description	O-ring silicone thickness 1.78mm ID ø 6.07mm Qty 1 pcs		

solenoid valves (refrigeration)

various

valves



1

GEV No.	370373	Ref. No.	76-0239-3
description	solenoid valve angled DN1.9 connection 6mm soldering connection refrigeration angled 90° 230V		
For models:	GIM1023, GIM1038, GIM2023, GIM2038		

spare parts for 370373



GEV No.	371144	Ref. No.	000001144
solenoid coil 230V 50/60Hz refrigeration			

spare parts and accessories

solenoid coils



1

GEV No.	371144	Ref. No.	000001144
description	solenoid coil 230V 50/60Hz refrigeration		
For models:	GIM1023, GIM1038, GIM2023, GIM2038		

Solenoid valve - accessories



1

GEV No.	371100	Ref. No.	YJS820-4
description	O-ring silicone thickness 1.78mm ID ø 6.07mm Qty 1 pcs		

pressure switches

for warewashing

ø 58mm with male faston 6.3mm

with connection horizontal



1

GEV No.	541330	Ref. No.	905283
description	pressure control pressure range 70/30mbar connection 6mm ø 58mm pressure connection horizontal warewashing pressure connection ø 6mm		
For models:	GDW1001		

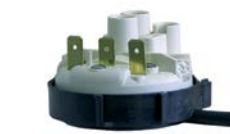

1

GEV No.	541017	Ref. No.	905270
description	pressure control with mounting strap pressure range 40/20mbar connection 6mm ø 58mm pressure connection horizontal warewashing		
For models:	GGW1001, GGW2001		



cooling aggregates

GEV No.	379304***	Ref. No.	123456
description			
For models:			
spare parts for	605145		
	GEV No.	420277	Ref. No.
			N/A RW40.05
heating element 65W 220-240V L 120mm W 20mm H 21mm connection Faston 6.3mm cable length 300mm tube ø 12mm refrigeration			

compressors

ACC/ZEL

R134A

LBP monophase

Lower evaporation temperature below -20°C



1

GEV No.	605126	Ref. No.	S900.41
description	compressor coolant R134a type OF1350A 220-240V 50Hz LBPkg 1/4HP power input 158W cylinder capacity 7.5cm ³ RSIR H 183mmWWWWWWWWW ZEL		
For models:	GDS1134, GDS1600, GHS1134, GHS2134, GPS1134, GSA1134, GSF1134		

MBP monophase

Medium evaporation temperature above -20°C



1

GEV No.	605253	Ref. No.	RN400.08 RN400.09 RN400.10
description	compressor coolant R134a type GTH93AA 220-240V 50Hz MBP 9.8kg 1/4HP cylinder capacity 9.3cm ³ RSIR/RSCR H 184mmWWWWWWW		
For models:	RN400		

R600A

LBP monophase

Lower evaporation temperature below -20°C



1

GEV No.	605141	Ref. No.	DQYD0015 E27B6F1Z0001 GBC1002-15 GBC1003-15 GSC2336-33 S960.01
description	compressor coolant R600a type HPY12AAa 220-240V 50Hz LBP 8.8kg 1/5HP cylinder capacity 12cm ³ RSIR H 200mmWWWWWWWWW		
For models:	GBC1002, GBC1003, GPS1600, GPS2600, GSA1600, GSA2600, GSC2336, GSD2600, GSF1600, GSF2600		



1

GEV No.	605147	Ref. No.	RC600.08
description	compressor coolant R600a type HTH14AA 220-240V 50Hz LBP 9.37kg 1/4HP cylinder capacity 14cm ³ RSIR/RSCR H 183mmWWWWWWWWW		
For models:	GRE2600		



1

GEV No.	605150	Ref. No.	A1.1.A.A02.14 GCV1600-37 GRV1100 HCV1100
description	compressor coolant R600a type HVM10AA 220-240V 50Hz LBP 8.7kg 1/6HP cylinder capacity 10cm ³ RSIR H 180mmWWWWWWWWW		
For models:	GRV1100		

EMBRACO / ASPERA

R290A
LBP monophase

Lower evaporation temperature below -20°C



1	GEV No.	605258	Ref. No.	I0210981
	description	compressor coolant R290 type EMTE2134U 220-240V 50Hz LBP 9kg 3/8HP cylinder capacity 9.5cm ³ CSIR H 187mm 250W 278W 305W 330W 366WWWWW		
	For models:	GFR3600		

R600A
LBP monophase

Lower evaporation temperature below -20°C



1	GEV No.	605257	Ref. No.	45004031
	description	compressor coolant R600a type EMD46CLT 220-240V 50Hz LBP 7.5kg cylinder capacity 7.96cm ³ RSCR H 210mm 88W 118W 154W 196W 246WWWWW		
	For models:	GRE3600		

1			
GEV No.	650150	Ref. No.	VRX1560.01
description	compressor coolant R600a type HVM67AA 220-240V 50Hz LBP 7.5kg 1/8HP cylinder capacity 7cm ³ RSIR H 180mmWWWWW		
For models:	GHS1600, GHS2600		

1			
GEV No.	605142	Ref. No.	1.1.A.A02.04 DQYD0014 GBC1001-14 GGC1078-46
description	compressor coolant R600a type HVM86AA 220-240V 50Hz LBP fully hermetic 7.83kg 1/7HP cylinder capacity 8.6cm ³ RSIR H 174mmWWWWW		
For models:	GBC1001		

1			
GEV No.	605251	Ref. No.	RC400.07 RC400.08 RC400.09
description	compressor coolant R600a type HVT10AA 220-240V 50Hz LBP 7.8kg 1/6HP cylinder capacity 10cm ³ RSCR H 174mmWWWWW		
For models:	RC400		



miscellaneous

R134A



1

GEV No.	605240	Ref. No.	HSC800-07
description	compressor HuaGuang coolant R134a type AN150ML 220-240V 50Hz LBP 10.5kg 1/2HP cylinder capacity 15.1cm ³ CSIR H 180mmWWWWWWWWWW		



1

GEV No.	605239	Ref. No.	DQYA0009 HBC2003-15
description	compressor HuaGuang coolant R134a type ANA90 220-240V 50Hz 10.5kgHP power input 255W cylinder capacitycm ³ H 180mmWWWWWWWWWW		



1

GEV No.	605245	Ref. No.	DQYA0014 HSC350-07 HSC350-7 HSC360-11
description	compressor HuaGuang coolant R134a type ATA72XL 220-240V 50/60Hz 7.2kg 1/5HP cylinder capacity 7cm ³ H 160mmWWWWWWWWWW		



1

GEV No.	605140	Ref. No.	DQYA0087 GSC1100-28 GSC1336-33
description	compressor KONOR type GQR90AA coolant R134a 220-240V 50Hz 10.1kg 1/4HP cylinder capacity 9.1cm ³ RSIR H 186mmWWWWWWWWWW		
For models:	GSC1100, GSC1336		



1

GEV No.	605148	Ref. No.	RN600.06
description	compressor KULTHORN type AEA2415Y coolant R134a 220-240V 50Hz		
For models:	GFR2600		

R600A



1

GEV No.	605143	Ref. No.	1.1.A.A02.25 GGC2270-12
description	compressor DONPER type QD167YU coolant R600a 220-240V 50Hz fully hermetic 11.9kg power input 276W cylinder capacity 16.7cm ³ RSCR H 220mm 169W 199W 236W 280W 334W 391WWWWWW test method ASHRAE capacitor 6µF		
For models:	GGC1270		





1

GEV No.	605272	Ref. No.	DQYD0009 HSC350DD07 HSC360G-08
description	compressor HuaGuang coolant R600 type ETA110 220-240V 50Hz LBP 8kg 1/4HP RSIR		

accessories

starting relays

miscellaneous



1

GEV No.	381450	Ref. No.	RC600.13 RC600.14 RC600.14+RC600.13
description	start relay 230V 16A		
For models:	GRE2600		



1

GEV No.	381449	Ref. No.	RN600.09
description	start relay KULTHORN KME 682-26NT 230V 16A		
For models:	GFR2600		

overload protector (klixon)



1

GEV No.	391044	Ref. No.	RN600.08
description	overload protector for engine protective curcuit breaker Klixon with cable t.max. 105°C		
For models:	GFR2600		

miscellaneous



1

GEV No.	699425	Ref. No.	1.1.C.C41.01 GGC1078-45
description	vibration damper ø 25mm H 10mm		

fans

axial fans

ebm-papst



1

GEV No.	601813 ¹	Ref. No.	RC600.33
description	axial fan L 119mm W 119mm H 38mm 230VAC 50/60Hz 19W bearing ball bearing manuf. no. 4656N/A02 cable length 800mm metal connection plug ebm-papst fan wheel ø 110mm		
For models:	GRE2600		

¹with slide bearings

import



1

GEV No.	601131 ¹	Ref. No.	I0221151	
description	axial fan L 119mm W 119mm H 25mm 230VAC 50/60Hz 19/18W bearing ball bearing connection male faston 2.8mm metal ADDA fan wheel ø 110mm temp.-resist. 70°C			
For models:	GFR3600			
accessories for	601131			
	GEV No.	550898	Ref. No.	I0221181
	connecting cable cable length 2000mm connection F 2.8 connection distance 7.9mm for axial flow fan			

¹with ball bearings



			
1			
GEV No.	601909 ¹	Ref. No.	45003031
description	axial fan L 119mm W 119mm H 38mm 220-240 50/60Hz 31/29W bearing ball bearing connection male faston 2.8mm		
For models:	GFR3600, GRE3600		

¹with ball bearings

			
1			
GEV No.	601834 ¹	Ref. No.	1.1.A.A03.01.31 GCV1600-34
description	axial fan L 119mm W 119mm H 38mm 230VAC 50/60Hz 16/15W bearing ball bearing manuf. no. RAM1238B1 connection cable length 900mm XINRUILIAN fan wheel ø 110mm temp.-resist. -10 up to +70°C input current 0.16A		

¹with ball bearings

			
1			
GEV No.	601604 ¹	Ref. No.	E17A1A010100 GPS1600-34 GSF1600-34 S900.34
description	axial fan L 119mm W 119mm H 38mm 230VAC 50/60Hz 17/15W bearing slide bearing manuf. no. AA1282HS-AT connection cable 300mm fan wheel ø 110mm temp.-resist. 70°C input current 0.1A airflow 130m ³ /h 2600rpm		
For models:	GDS1134, GDS1600, GHS1134, GHS1600, GHS2134, GHS2600, GPS1134, GPS1600, GPS2600, GSA1134, GSA1600, GSA2600, GSD2600, GSF1134, GSF1600, GSF2600		

¹with slide bearings

			
1			
GEV No.	601787 ¹	Ref. No.	DQFA1000 DQFD1000 DQFD1001 GBC1001-07 GBC1001-35 GBC1002-36 GBC1003-36 GSC1100-17 GSC1336-15 GSC2336-15 HSC360-30 HSC800-44
description	axial fan L 119mm W 119mm H 38mm 230VAC 50/60Hz 22/38.4W bearing slide bearing manuf. no. HT-A12038S220 connection plug cable length 300mm HUI TONG fan wheel ø 110mm input current 0.1/0.16A housing aluminium		
For models:	GBC1001, GSC1100, GSC1100G, GSC1336, GSC2336		

¹with slide bearings

			
1			
GEV No.	602136	Ref. No.	DQFD2003
description	axial fan L 119mm W 119mm H 38mm 230VAC 50/60Hz 22/38.4W bearing slide bearing manuf. no. HT-A12038S220 connection with cable 500mm cable length 300mm HUI TONG fan wheel ø 110mm input current 0.1/0.16A housing aluminium		
For models:	GBC1001, GBC1002, GBC1003		

			
1			
GEV No.	601743	Ref. No.	01058355
description	axial fan L 80mm W 80mm H 25mm 18VDC 1.8W connection coded plug cable length 300mm		
For models:	GIC2030, GIC2035		



accessories

fan guards



GEV No.	691104	Ref. No.	GBC1001-36 GBC1002-37 GBC1003-37 GSC1336-13 GSC2336-13 HSC350-43 I0427017 WJFZ0007
description	guard ø 115mm mounting distance 105mm for axial fan 119mm		
For models:	GBC1001, GBC1002, GBC1003, GFR3600, GRE3600, GSC1336, GSC2336		

connecting cables



GEV No.	550898	Ref. No.	I0221181
description	connecting cable cable length 2000mm connection F 2.8 connection distance 7.9mm for axial flow fan		
For models:	GFR3600, GRE3600		

refrigeration fans

refrigeration motors universal

ebm-papst



miscellaneous



GEV No.	601783	Ref. No.	E17A1A050500 GPS1600-37 GSF1600-37 S900.37
description	fan motor 10W 230V 50/60Hz L3 87mm W 67mm cable length 400mm 1300rpm ebm-papst M4Q045-CA03-51/C18 3 mounting options bearing slide bearing for refrigerated counters		
For models:	GDS1134, GDS1600, GPS1134, GPS1600, GPS2600, GSA1134, GSA1600, GSA2600, GSD2600, GSF1134, GSF1600, GSF2600		
spare parts for	601783		
	GEV No.	601413	Ref. No. —
	fixing plate suitable for fanwheel ED ø 32mm shaft ø 7 mounting distance 26mm		

accessories for	601783		
	GEV No.	601385	Ref. No. 30-0566-9 E181A1723401
	fan wheel sucking ø 172mm fan wheel mounting 25.4mm blade angle 34° W 42mm aluminium		

	GEV No.	601737	Ref. No.	20-0021-9
description	fan motor 16W 230V 60Hz L1 43mm L3 87mm W 72mm cable length 500mm 1550rpm ebm-papst M4Q045-CF01-05/S01			
For models:	GIM1038, GIM2038			
spare parts for	601737			
	GEV No.	601413	Ref. No.	—
	fixing plate suitable for fanwheel ED ø 32mm shaft ø 7 mounting distance 26mm			

	GEV No.	601736	Ref. No.	20-0020-9
description	fan motor M4Q045-BD01-05/S01 5W 230V 60Hz L1 45mm L3 75mm W 60mm cable length 300mm 1550rpm ebm-papst double			
For models:	GIM1023, GIM2023			
spare parts for	601736			
	GEV No.	601413	Ref. No.	—
	fixing plate suitable for fanwheel ED ø 32mm shaft ø 7 mounting distance 26mm			



ELCO

N series - standard



1

GEV No.	601735	Ref. No.	0221115
description	fan motor ELCO 5W 230V 50/60Hz bearing slide bearing L3 71mm W 59mm connection Kabel 1430mm cable length 1500mm 1300/1550rpm 3 mounting options VN5-13/249		
For models:	GRE1600		

miscellaneous



1

GEV No.	601789	Ref. No.	1.1.A.A03.01.10 GGC2270-48	
description	fan motor 10W 220-240V 50/60Hz L1 50mm L2 72mm L3 90mm W 84mm cable length 460mm 1300rpm HANGZOU SAIWEI MOTOR YZ10-20			
For models:	GGC1270			
spare parts for	601789			
	GEV No.	601413	Ref. No.	—
	fixing plate suitable for fanwheel ED ø 32mm shaft ø 7 mounting distance 26mm			



1

GEV No.	602164	Ref. No.	GSC1100G-07
description	fan motor 10W 220-240V 50-60Hz L2 65mm L3 81mm W 82mm cable length 1200mm 1300/1500rpm HL-YJF10		

accessories

fan wheels

aluminium

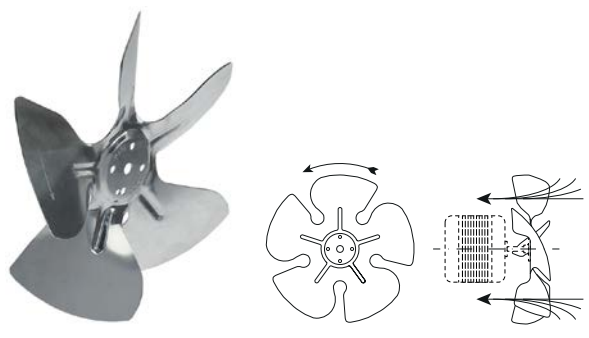

1

GEV No.	601385	Ref. No.	30-0566-9 E181A1723401
description	fan wheel sucking ø 172mm fan wheel mounting 25.4mm blade angle 34° W 42mm aluminium		
For models:	GIM1023, GIM2023, GPS2600, GSA2600, GSD2600, GSF2600		

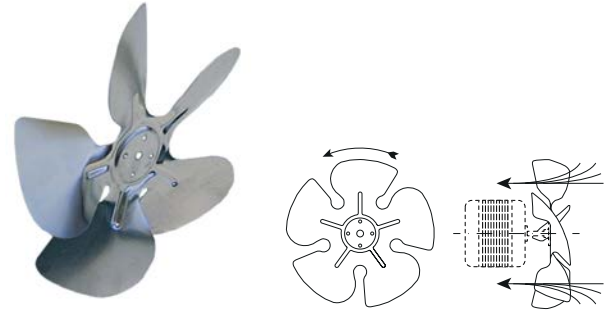

1

GEV No.	601069	Ref. No.	0407004
description	fan wheel sucking ø 172mm turn direction left fan wheel mounting 25.4mm blade angle 25° W 32mm aluminium		
For models:	GRE1600		

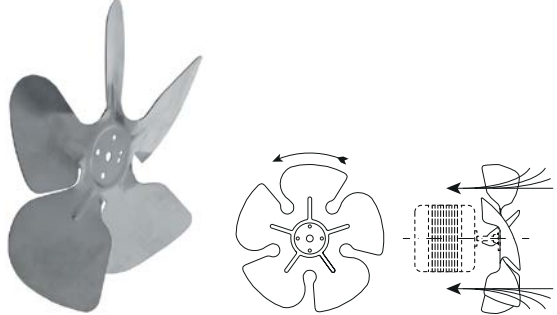

1

GEV No.	601070	Ref. No.	1.1.A.A03.03.05 GGC2270-09 GGC2270-9
description	fan wheel sucking ø 200mm fan wheel mounting 25.4mm blade angle 28° W 38mm aluminium		
For models:	GGC1270		

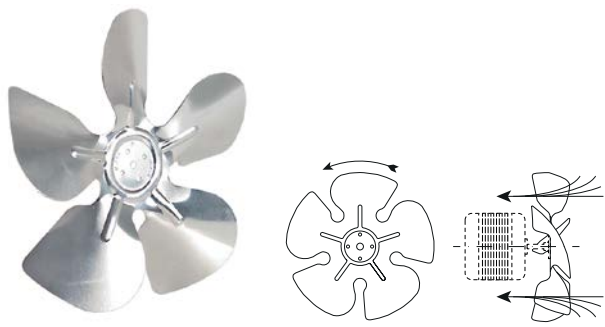

1

GEV No.	601283	Ref. No.	30-0565-9
description	fan wheel sucking \varnothing 230mm fan wheel mounting 25.4mm blade angle 28° W 41mm aluminium		
For models:	GIM1038, GIM2038		



1

GEV No.	602101	Ref. No.	E192A1200300 E192A1723800
description	guard \varnothing 210mm H 35mm mounting distance 1 230mm mounting distance 2 100mm		
For models:	GPS2600, GSA2600, GSD2600, GSF2600		

mounting rings



1

GEV No.	601586	Ref. No.	0221128
description	ring for fan wheel \varnothing 172mm sucking \varnothing 220mm H 49mm mounting distance 1 208mm mounting distance 2 94.5mm		
For models:	GRE1600		

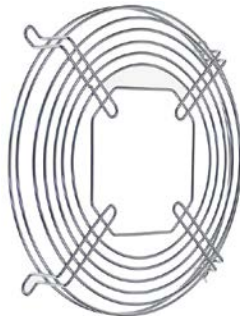

1

GEV No.	699432	Ref. No.	1.1.B.B10.36 GGC2270-10
description	guard \varnothing 215mm mounting distance 230mm		
For models:	GJC1270		

fan guards



1

GEV No.	601738	Ref. No.	GPS1600-38 GSF1600-38 S900.38
description	guard for fan wheel \varnothing 170mm \varnothing 216mm H 30mm mounting distance 1 224 up to 254mm mounting distance 2 94.5mm		
For models:	GDS1134, GDS1600, GPS1134, GPS1600, GSA1134, GSA1600, GSF1134, GSF1600		

cooling motors (complete)



1

GEV No.	601836	Ref. No.	DQJB2004 GBC1002-07 GBC1003-07
description	fan 220V 25/3W 50/60Hz fan wheel \varnothing 172mm L 82mm W 82mm connection spate terminal M4 cable length 1000mm		
For models:	GBC1002, GBC1003		



1

GEV No.	601835	Ref. No.	DQJB2013 GSC1100-26
description	fan 220V 35/5W 50/60Hz L 82mm W 82mm connection spate terminal M4 cable length 1100mm		
For models:	GSC1100		
spare parts for	601835		
	GEV No.	602184	Ref. No. —
	fixing plate suitable for fanwheel ED ø 33mm shaft ø 6 mounting distance 17mm		



1

GEV No.	601791	Ref. No.	1.1.A.A03.02.04 GGC2270-47
description	fan motor pair 220-240V 10W 50Hz fan wheel ø 110mm mounting distance 137mm cable length 800mm		
For models:	GGC1270		

cold air circulating fans

cold air circulating fans



1

GEV No.	602078	Ref. No.	A1.1.A.A03.01.08
description	fan motor 220-240V 50Hz 5W shaft ø 4mm shaft L 15mm L 205mm W 147mm H 80mm		
For models:	GRV1100		
spare parts for	602078		
	GEV No.	698913	Ref. No.
	fan wheel blowing ø 148mm shaft intake ø 3mm blade angle° W 17.5mm plastic Qty 1 pcs blades 4		



1

GEV No.	601845	Ref. No.	1.1.A.A03.01.08 GGC1078-40
description	fan motor 220-240V 50Hz IN 22W / OUT 5W shaft ø 4mm shaft L 20/48mm L 65mm W 66mm H 73mm Qty 1 pcs		
accessories for	601845		
	GEV No.	601846	Ref. No. 1.1.C.C17.04 GGC1078-39
	fan wheel blowing ø 150mm shaft intake ø 4mm W 33mm plastic Qty 1 pcs		

accessories

fan wheels for cold air circulating fans



1

GEV No.	698913	Ref. No.	A1.1.A.A03.01.07
description	fan wheel blowing ø 148mm shaft intake ø 3mm blade angle° W 17.5mm plastic Qty 1 pcs blades 4		
For models:	GRV1100		



1

GEV No.	601846	Ref. No.	1.1.C.C17.04 GGC1078-39
description	fan wheel blowing ø 150mm shaft intake ø 4mm W 33mm plastic Qty 1 pcs		



cross flow fans

IMPORT



1			
GEV No.	601812	Ref. No.	RC400.06 RC600.16
description	cross flow fan YJ61-14A-HZ01 roller ø 60mm roller length 180mm laminated core thickness 18mm motor position left 220-240V/50-60Hz 13W refrigeration bearing rubber connection plug -30 up to +100°C 220V cable length 300mm 50Hz		
For models:	GRE2600, RC400		

EMMEVI - FER GAS

with standard coil



1			
GEV No.	601018	Ref. No.	01202330 15950427000
description	cross flow fan TG 180 roller ø 60mm roller length 180mm motor position right 230V/50Hz 25W universal bearing silicone connection male faston 6.3mm -10 up to +60°C 230V connections 1-2 1950U/min connections 1-4 1500U/min		
For models:	GCO1001, GCO2001		

accessories for cross flow fans

fasteners



1			
GEV No.	692388	Ref. No.	RC600.17
description	bracket for cross flow fan L 295mm W 85mm H 25mm Qty 1 pcs		
For models:	GRE2600		

air ducts



1			
GEV No.	701630	Ref. No.	00012330
description	air duct for cross flow fan for combi-steamer plastic grey		
For models:	GCO2001		

hot air motors



1			
GEV No.	601865	Ref. No.	GMW1030-C05
description	fan motor 220-240V 50/60Hz 0.036kW 2500rpm D1 ø 6mm power input 18W at 50Hz 2600rpm shaft flat length 18mm		
For models:	GMW1030		





hot air fans

miscellaneous

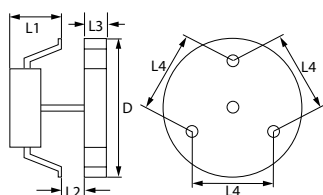

1



GEV No.	601125	Ref. No.	11950057000
description	hot air fan 220-240V 45W 50/60Hz L1 70mm L2 11mm L3 25mm L4 87mm fan wheel ø 150mm FIME type C30R0479CLF		
For models:	GCO1001		
accessories for	601125		
	GEV No.	550879	Ref. No. —
insulation ø 130mm thickness 3mm hole ø 20mm for hot air fan			



1

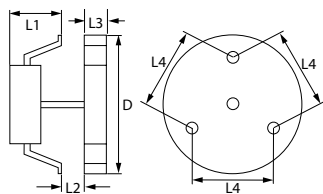

GEV No.	602100	Ref. No.	01203230
description	hot air fan 240V 59W 50/60Hz L1 80mm L2 16mm fan wheel ø 150mm IMS type 138251		
For models:	GCO2001		

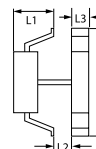

1

GEV No.	601838	Ref. No.	278009000033 GMW1025-C05
description	fan motor 220-240V 18W 2500rpm L1 33mm L2 12mm L3 15mm L4mm fan wheel ø 120mm shaft 2x2.5mm GALANZ type GAL6309E(30)-ZD Qty 1 pcs		

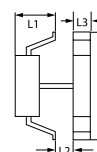

1

GEV No.	602140	Ref. No.	YHWF-110
description	hot air fan 18V 2750rpm L1 6mm L2mm L3 16mm L4mm fan wheel ø 85mm type YHWF-110		

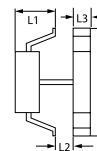

1

GEV No.	601827	Ref. No.	DQB000019R GIC3035-15 GIC3035-B15 GIC3500-15 GIC3500-A15 GIC3535-15 GIC3535-D15 GIC4035-15 GIC4035-C15
description	hot air fan 18V 2750rpm L1 6mm L2mm L3 16mm L4mm fan wheel ø 85mm type YHWF-85		
For models:	GIC3500, GIC3535, GIC4035		



accessories

fan wheels for hot air fans

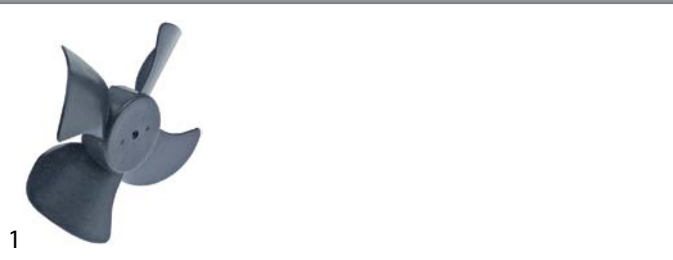

GEV No.	601839	Ref. No.	223149000014 GMW1025-P06
description	fan wheel ø 120mm W 32mm shaft intake ø 2x2.5mm plastic blades 4 Qty 1 pcs		

miscellaneous



GEV No.	601840	Ref. No.	223139000011 GMW1025-P05
description	bracket ø 130mm L 135mm W 130mm for hot air fan Qty 1 pcs		



GEV No.	211088	Ref. No.	09960218715
description	guard L 155mm W 155mm for fan		
For models:	GCO1001		

radial fans

accessories

fan wheels for radial fans



GEV No.	601837	Ref. No.	GMW1030-P272
description	fan wheel for radial fan ø 96mm shaft diameter 4x5mm H 49mm blades 40 plastic Qty 1 pcs		
For models:	GMW1030		

accessories universal



GEV No.	699309	Ref. No.	HSC360-35 WJFZ0008
description	guard ø 194mm hole distance 208mm		

speed controllers

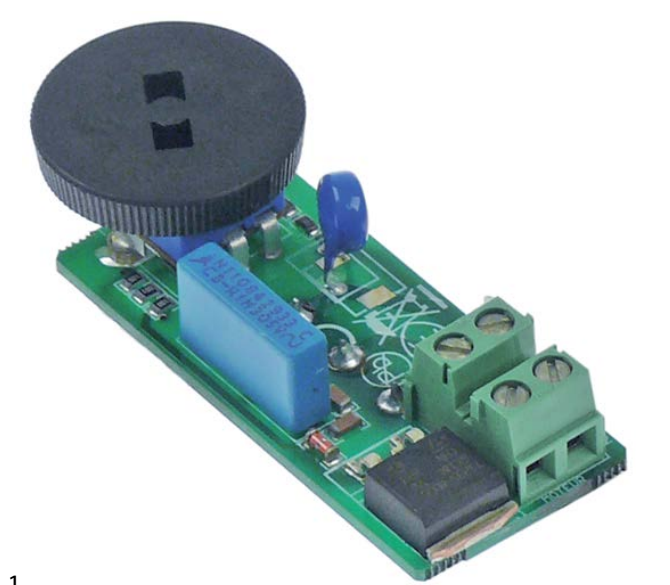

GEV No.	403165	Ref. No.	2852
description	PCB GSM1000 speed control		
For models:	GSM1000		

spare parts for	403165		
GEV No.	696506	Ref. No.	2858
description	knob for PCB ø 26mm black Qty 1 pcs		

motors

gear motors

for microwaves



GEV No.	601867	Ref. No.	278019000017 GMW1025-C100
description	gear motor GALANZ type GAL-33-30-TD(B) 4W 30V voltage AC 50/60Hz 33/40rpm shaft ø 6x3.5mm for microwave Qty 1 pcs		

1

GEV No.	601828	Ref. No.	GMW1030-C100
description	gear motor SYNCHRONOUS MOTOR type SM-16E 3W 220-240V voltage AC 50/60Hz 30/36rpm shaft \varnothing 6x3.5mm		
For models:	GMW1030		



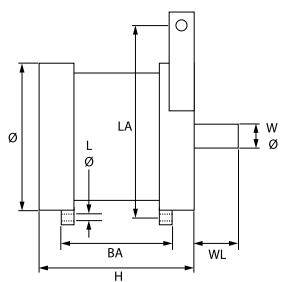

1

GEV No.	501434	Ref. No.	00000000423
description	motor 230V 1 phase 50Hz 1380rpm shaft \varnothing 15mm shaft length 33mm \varnothing 113mm H 91mm mounting distance 49mm hole distance 150mm hole \varnothing 6mm type H40-423 ELETTRMECANICA capacitor 8 μ F		
For models:	GFS1025, GFS2025, HFS2025		

motors

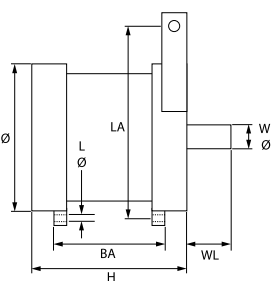
for slicers

1

GEV No.	501530	Ref. No.	00000001753
description	motor 230V 1 phase 50Hz 1380rpm shaft \varnothing 15mm shaft length 25mm \varnothing 195-220 edition since 04/2016		
For models:	HFS2019		

1

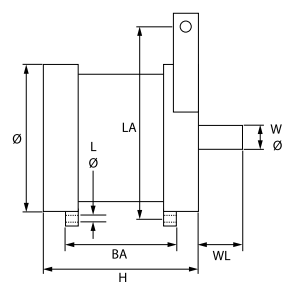
GEV No.	501433	Ref. No.	00000000681
description	motor 230V 1 phase 50Hz 1380rpm shaft \varnothing 15mm shaft length 35mm \varnothing 113mm H 121mm mounting distance 79mm hole distance 150mm hole \varnothing 6mm type H70-681 ELETTRMECANICA capacitor 10 μ F		
For models:	GFS1030		



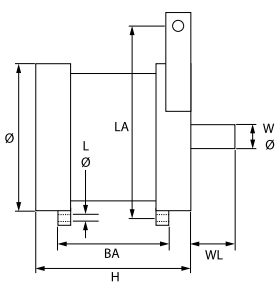

1

GEV No.	501427	Ref. No.	00000700283
description	motor 230V 1 phase 50Hz 1380rpm shaft \varnothing 15mm shaft length 25mm \varnothing 115mm H 86mm mounting distance 44mm hole distance 145mm hole \varnothing 6mm type H35-700283		
For models:	GFS1022, GFS2022, HFS2019, HFS2022		

for hand blenders

motors



1

GEV No.	698378	Ref. No.	2847
description	motor for hand blender 230V 100W shaft \varnothing 6.4mm GSM1000		
For models:	GSM1000		

for citrus juicers



1

GEV No.	501426	Ref. No.	900956
description	motor for citrus juicers 180W 230-240V 50Hz shaft \varnothing 8mm shaft length 40mm type RCJ298252 0.18kW		
For models:	GJU1001		



pumps





wash and rinse pumps

LGB



1			
GEV No.	500567	Ref. No.	902238
description	pump inlet \varnothing 28mm outlet \varnothing 28mm type ZF121DX 230V 50Hz 1 phase 0.25kW L 195mm rotation direction left capacitor 6.3 μ F LGB		
For models:	GGW1001, GGW2001		
spare parts for	500567		
	GEV No.	365012	Ref. No. 0000000149
	operating capacitor capacity 6.3 μ F 450V tolerance 5% 50Hz ambient temperature max. -25 to +85°C \varnothing 30mm L 61mm M8 plastic connection male faston 6.3mm protection		
	GEV No.	510703	Ref. No. —
	mechanical shaft seal for shaft \varnothing 13mm slide ring H 13mm height counter ring 5.5mm ED \varnothing 26mm		
	GEV No.	521098	Ref. No. —
	pump cover LGB inlet \varnothing 28mm outlet \varnothing 26mm auxiliary pressure connection 12mm ID \varnothing 77mm		
	GEV No.	521099	Ref. No. —
	impellor \varnothing 72mm H 17mm thread M7R shaft \varnothing 13mm shaft length 12mm		
	GEV No.	528800	Ref. No. —
	O-ring EPDM thickness 2.62mm ID \varnothing 75.87mm Qty 1 pcs		



1			
GEV No.	500470	Ref. No.	902304
description	pump inlet \varnothing 45mm outlet \varnothing 40mm type ZF270VDX 230V 50Hz 1 phase 0.6kW 0.8HP L 225mm rotation direction left capacitor 12.5 μ F LGB		
For models:	GDW1001		
spare parts for	500470		
	GEV No.	365014	Ref. No. —
	operating capacitor capacity 12.5 μ F 450V tolerance 5%Hz ambient temperature max. -25 to +85°C \varnothing 35mm L 70mm M8 plastic connection male faston 6.3mm 45S.C3DS.12.5 protection		
	GEV No.	510702	Ref. No. —
	mechanical shaft seal height counter ring 5.5mm ID \varnothing 12mm		
	GEV No.	521109	Ref. No. —
	pump cover LGB inlet \varnothing 45mm outlet \varnothing 40mm supporting pressure 12		
	GEV No.	521111	Ref. No. —
	impellor \varnothing 105mm H 29mm thread M8R shaft \varnothing 20mm shaft length 5mm		
	GEV No.	521714	Ref. No. —
	pump cover gasket thickness 4x4mm Qty 1 pcs		

drain pumps

GRE



1			
GEV No.	499121	Ref. No.	902328
description	drain pump inlet \varnothing 24mm outlet \varnothing 22mm 33W 230V 50Hz GRE		
For models:	GGW1001		

1

GEV No.	500959	Ref. No.	902346
description	drain pump inlet ø 30mm outlet ø 23mm 100W 230V 50Hz GRE		
For models:	GDW1001		

booster pumps II

accessories



1

GEV No.	365015	Ref. No.	0000000633
description	operating capacitor capacity 10µF 400V tolerance 5%Hz ambient temperature max. -25 to +85°C ø 35.5mm L 59mm M8 plastic connection male faston 6.3mm protection		
For models:	GFS1030		



1

GEV No.	365012	Ref. No.	0000000149
description	operating capacitor capacity 6.3µF 450V tolerance 5% 50Hz ambient temperature max. -25 to +85°C ø 30mm L 61mm M8 plastic connection male faston 6.3mm protection		
For models:	GFS1022		

pumps for ice machines



1

GEV No.	499125	Ref. No.	040000036
description	pump HANNING type DP025-258 30W 220-240V 50Hz inlet ø 24mm outlet ø 24mm for ice-cube maker kit		
For models:	GIM1023, GIM2032		



Image not available

1

GEV No.	499118	Ref. No.	040000038
description	pump HANNING type DP025-258 30W 220-240V 50Hz inlet ø 24mm outlet ø 24mm L 130mm for ice-cube maker kit		
For models:	GIM1038, GIM2038		

vacuum pumps

vacuum pumps



1

GEV No.	602111	Ref. No.	HVS1000-30 YJS820-30
description	vacuum pump 220/240V 0.32kW 50Hz type OLF400Z		

condensators & interference suppression filters

starting capacitors

starting capacitors



1

GEV No.	365214	Ref. No.	RC600.12
description	starting capacitor 5µF 450V 50/60Hz duty cycle 5% ø 35mm L 60.5mm connection male faston 4.8mm		
For models:	GRE2600		



1

GEV No.	365153	Ref. No.	0210402
description	starting capacitor 52µF 330V 50/60Hz duty cycle 3s 41280A133 2252347 ø 36mm L 83mm M8 plastic connection cable 350mm		
For models:	GRE1600		



operating capacitors

plastic



1

GEV No.	365015	Ref. No.	00000000633
description	operating capacitor capacity 10 μ F 400V tolerance 5%Hz ambient temperature max. -25 to +85°C ϕ 35.5mm L 59mm M8 plastic connection male faston 6.3mm protection		
For models:	GFS1030		



1

GEV No.	365012	Ref. No.	00000000149
description	operating capacitor capacity 6.3 μ F 450V tolerance 5% 50Hz ambient temperature max. -25 to +85°C ϕ 30mm L 61mm M8 plastic connection male faston 6.3mm protection		
For models:	GFS1022		



1

GEV No.	365013	Ref. No.	00000000182
description	operating capacitor capacity 8 μ F 400V tolerance 5%Hz ambient temperature max. -25 to +85°C ϕ 31.5mm L 55mm M8 plastic connection male faston 6.3mm protection		
For models:	GFS1025, GFS2022, GFS2025, HFS2019, HFS2022, HFS2025		

filters

interference suppression filters



1

GEV No.	365168	Ref. No.	902107
description	interference suppression filter type FCP045000 250V 50/60Hz conductor 4 with E connection male faston 6.3mm L 56mm ϕ 38mm Hmm Wmm M8 plastic Qty 1 pcs		
For models:	GDW1001		

line filters

without housing



1

GEV No.	403184	Ref. No.	GMW1030-C04
description	line filter for microwave type GMW1030 250V 50/60Hz conductor 2 PCB connection male faston 6.3mm L 90mm H 20mm W 70mm PCB Qty 1 pcs cable length 130mm		
For models:	GMW1030		



1

GEV No.	403188	Ref. No.	263029001088 GMW1025-C04
description	line filter microwave for GMW1025 250V 50/60Hz conductor 2 PCB connection male faston 4.8mm L 80mm H 20mm W 40mm PCB Qty 1 pcs cable length 120mm type DNV-0818A-5		

HV capacitors



1

GEV No.	365158	Ref. No.	GMW1030-C03
description	HV capacitor for microwave 1.05 μ F type CH85-21105 2100V 50/60Hz double connection male faston 6.3mm L 90mm H 33mm W 52mm dependent on equipment aluminium Qty 1 pcs ϕ mm		
For models:	GMW1030		



1

GEV No.	365159	Ref. No.	253059000142 GMW1025-C03
description	HV capacitor for microwave 1.15 μ F type CH85-21115 2100V 50/60Hz double connection male faston 4.8mm L 105mm H 33mm W 52mm dependent on equipment aluminium Qty 1 pcs		



fuses

fine fuses

 <p>1</p>			
GEV No.	358133	Ref. No.	GIC3035-B06 GIC3500-A06 GIC3535-D06 GIC4035-C06
description	fine fuse size ø6.3x32mm 16A slow-acting rated 250V Qty 1 pcs		
For models:	GIC3500, GIC3535, GIC4035		

 <p>2</p>			
GEV No.	358132	Ref. No.	GIC3035-06 GIC3500-06 GIC3535-06 GIC4035-06
description	fine fuse size ø6.3x32mm 16A slow-acting rated 250V Qty 20 pcs		

 <p>1</p>			
GEV No.	358186	Ref. No.	DZJ020003
description	fuse size ø6.3x32 15A slow-acting rated 250V Qty 1 pcs		

fine fuse holders

 <p>1</p>			
GEV No.	358101	Ref. No.	907116
description	fuse holder suitable fuse ø5x20mm ø 14mm 4A rated 250V connection F6.3 with fuse 4A fast-acting		
For models:	GGW1001, GGW2001		

electric accessories

plugs - couplings - power sockets

appliance sockets/plugs

low temperature appliances 70°C

 <p>1</p>			
GEV No.	551334	Ref. No.	HVS1000-38 YJS820-38
description	plug for box mounting receptacles C14 max 10A/250V F4.8		

cables

power supply cables

 <p>1</p>			
GEV No.	551085	Ref. No.	00000009171 C03013
description	cable CEE7/7 type E+F 3-pole contacts P+N+E 1.5mm ² max. 16A max 230V 2m with plug H05VV-F 3G1.5		
For models:	GFS1022, GFS1025, GFS1030, GFS2022, GFS2025, GTO1001, GTO2001, HFS2019, HFS2022, HFS2025		

 <p>1</p>			
GEV No.	698880	Ref. No.	E25EUB315300
description	connecting cable 3-pole contacts P+N+E 1.5mm ² max. 16A max 250V 2.9m		
For models:	GPS2600, GSA2600, GSD2600, GSF2600		

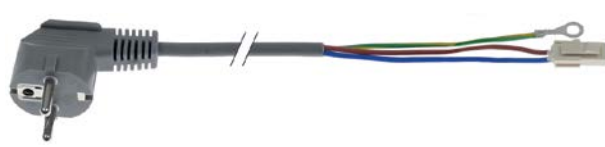
 <p>1</p>			
GEV No.	699313	Ref. No.	RN600.01
description	connecting cable CEE7/7 type E+F 3-pole contacts P+N+E 0.75mm ² max. 16A max 250V 2.87m		
For models:	GFR2600		

 <p>1</p>			
GEV No.	699317	Ref. No.	GPS1600-45 GSF1600-45 S900.47
description	connecting cable CEE7/7 type E+F 3-pole contacts P+N+E 1.5mm ² max. 16A max 250V 2.95m H05VV-F black		
For models:	GDS1134, GDS1600, GHS1134, GHS1600, GHS2134, GHS2600, GPS1134, GPS1600, GSA1134, GSA1600, GSF1134, GSF1600		

 <p>1</p>			
GEV No.	551203	Ref. No.	C03007
description	connecting cable CEE7/7 type E+F 3-pole contacts P+N+E 2.5mm ² max. 16A max 230V 2m H07 RN-F with plug		
For models:	GEG2001		





			
1			
GEV No.	550726	Ref. No.	HVS1000-39 YJS820-39
description	low temperature appliance supply cable CEE7/7 - C15 3-pole contacts P+N+E 1mm ² max. 10A max 250V 2.0m H05VVF T70 2-pole + earthing insulation PVC		

			
1			
GEV No.	551232	Ref. No.	253159002607 GMW1025-C14
description	power lead CEE7/7 1mm ² max 500V 1.5m Qty 1 pcs connection male faston 6.3mm black		

			
1			
GEV No.	551217	Ref. No.	DQXA6002 GBC1001-15 GBC1002-16 GBC1003-16 GSC1100-34 GSC1336-30 GSC2336-30
description	power lead CEE7/7 type E+F 3-pole contacts P+N+E 0.75mm ² max. 16A 2.2m with strain relief 16A Qty 1 pcs white		
For models:	GBC1001, GBC1002, GBC1003, GSC1100, GSC1100G, GSC1336, GSC2336		

			
1			
GEV No.	551218	Ref. No.	1.1.A.A08.02.02 1.1.A.A08.02.79 1.1.A.A08.02.87 A1.1.A.A07.02.01 GCV1600-45 GGC1078-51 GGC2270-53 GGC2270-53-white
description	power lead CEE7/7 type E+F 3-pole contacts P+N+E 0.75mm ² max. 16A max 230V 2m Qty 1 pcs grey		
For models:	GGC1270, GRV1100		

			
1			
GEV No.	551193	Ref. No.	RW40.19
description	power lead CEE7/7 type E+F 3-pole contacts P+N+E 1.5mm ² max. 16A max 230V 1.37m H07RN-F 3G1.50mm ² countries A/B/D/F/I		
For models:	GHR1040, GHR2600		

			
1			
GEV No.	552002	Ref. No.	I3306470
description	power lead CEE7/7 type E+F contacts P+N+E 1mm ² max. 16A max 230V 2.5m		
For models:	GFR3600, GRE3600		

			
1			
GEV No.	551325	Ref. No.	GIC3035-B7 GIC3535-B7 GIC4035-B7 XC0000071R
description	power lead P+N+E 1mm ² max 500V 1.5m Qty 1m connection screw		

accessories

cable glands

threaded cable glands

screw connections

			
1			
GEV No.	530431	Ref. No.	902687
description	cable gland thread PG13.5 cable ø 12mm mounting ø 21mm Qty 1 pcs plastic WS 24		
For models:	GGW1001, GGW2001		

			
1			
GEV No.	551288 ¹	Ref. No.	A10032
description	cable gland thread PG16 cable ø 14mm mounting ø 22.5mm WS 27 plastic Qty 1 pcs		
For models:	GEG1001, GEG2001		

¹incl. fastening nut

strain reliefs

			
1			
GEV No.	506273	Ref. No.	HVS1000-44 YJS820-44
description	strain relief L 20mm W 8mm hole ø 4mm Qty 1 pcs		





			
1			
GEV No.	506235	Ref. No.	1.1.C.C24.03 A1.1.C.C02.02 GGC1078-48
description	strain relief L 28mm W 12mm H 8mm hole ø 3.5mm hole distance 16mm plastic Qty 1 pcs		
For models:	GRV1100		

ribbon cables

group 8			
			
1			
GEV No.	403213	Ref. No.	909352
description	ribbon cable 7-pole L 400mm plug type 1-row		
For models:	GDW1001		

cable harnesses

			
1			
GEV No.	699172	Ref. No.	912089 917089
description	cable harness		
For models:	GPG1001		

			
1			
GEV No.	699173	Ref. No.	912188
description	cable harness		
For models:	GPG2001		

			
1			
GEV No.	694615	Ref. No.	253169000472 GMW1025-C13
description	cable harness for microwave L 800mm Qty 1 pcs		

connection cables

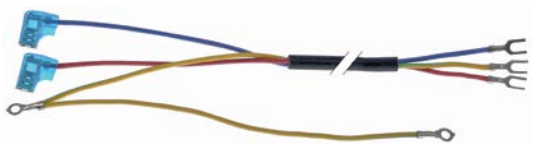
			
1			
GEV No.	699304	Ref. No.	DQXB9019 GBC1001-20 GBC1002-21 GBC1003-21
description	connection cable L 360mm 3-pole		
For models:	GBC1001, GBC1002, GBC1003		

			
1			
GEV No.	699305	Ref. No.	DQXB2003 GSC1336-31 GSC2336-31
description	connection cable L 650mm 3-pole		
For models:	GSC1336, GSC2336		

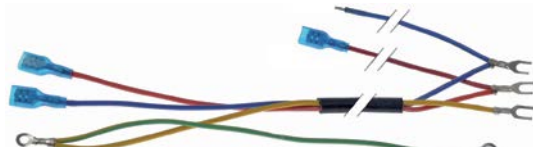
			
1			
GEV No.	699306	Ref. No.	DQXB4003
description	connection cable L 665mm 3-pole		
For models:	GSC1100, GSC1100G		

terminals

connection terminals with screw/faston connections

			
1			
GEV No.	551444	Ref. No.	01200720
description	power terminal block 3-pole max. 25A max 450V connection male faston 6.3mm temp.-resist. 150°C		
For models:	GCO2001		

			
1			
GEV No.	550278	Ref. No.	904140
description	power terminal block 3-pole max. 40A max 400V connection ø6mm ² / F6.3 temp.-resist. 150°C cross section 6mm ²		
For models:	GGW1001, GGW2001		

			
1			
GEV No.	550411	Ref. No.	904150 A16014
description	power terminal block 6-pole max. 40A max 450V connection ø6mm ² / F6.3 temp.-resist. 150°C cross section 6mm ²		
For models:	GDW1001, GEG1001, GEG2001		



connection terminals with screw connection



1

GEV No.	551109	Ref. No.	912041
description	connecting cable 4-pole max. 15A max 500V connection screw temp.-resist. 150°C		
For models:	GPG1001, GPG2001		

connection boxes



1

GEV No.	550755 ¹	Ref. No.	09950047000
description	connecting cable 3-pole contacts P+N+E with strain relief black L 1600mm 2.5mm ²		
For models:	GCO1001		

¹with cable 1600mm

1

GEV No.	550300	Ref. No.	A10007
description	power terminal block 3-pole contacts P+N+E		
For models:	GTO1001, GTO2001		

terminal boxes



1

GEV No.	551214	Ref. No.	S900.48 S960.02
description	terminal box 4-pole L 90mm W 52mm H 28mm with strain relief Qty 1 pcs		
For models:	GDS1134, GDS1600, GHS1134, GHS1600, GHS2134, GHS2600, GSA1134, GSA1600		



1

GEV No.	551216	Ref. No.	GBC1001-16 GBC1002-17 GBC1003-17 GSC2336-35 SLZB3001
description	terminal box 4-pole L 90mm W 52mm H 33mm with strain relief 250V 1mm ² Qty 1 pcs		
For models:	GBC1001, GBC1002, GBC1003, GSC2336		



1

GEV No.	551086	Ref. No.	01009
description	terminal box 6-pole L 117mm W 67mm H 22mm protection IP30		
For models:	GFR1600		

equipment-specific units

for slicers

covers



1

GEV No.	696528	Ref. No.	00000000489
description	blade covering ø 180mm for knife ø 220mm mounting thread M6 fixing dimensions 12x12mm cast aluminium edition since year of construction 2010		
For models:	GFS1022, GFS2022, HFS2022		

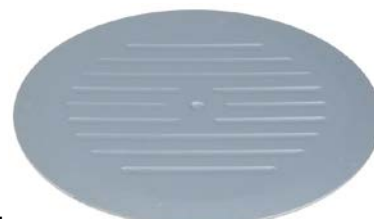

1

GEV No.	697749	Ref. No.	00000000463 00000000490
description	blade covering ø 209mm for knife ø 250mm mounting thread M6 fixing dimensions 12x12mm aluminium		
For models:	GFS1025, GFS2025, HFS2025		



1

GEV No.	697744	Ref. No.	00000000403
description	blade covering ø 248mm for knife ø 300mm mounting thread M6 fixing dimensions 12x12mm aluminium		
For models:	GFS1030		



locking screws

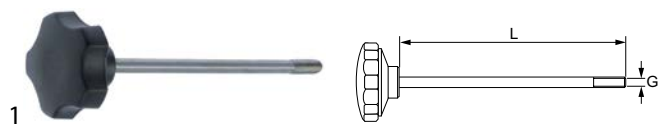

GEV No.	698376	Ref. No.	00000001302 00000701302
description	locking screw thread M6 L 134mm black		
For models:	GFS1022, GFS2022, HFS2022		

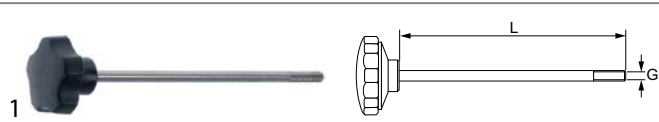

GEV No.	697439	Ref. No.	00000000777
description	locking screw thread M6 L 155mm handle ø 40mm		
For models:	GFS2025, HFS2025		

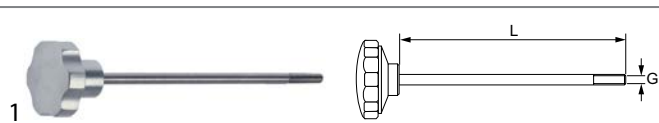

GEV No.	696602	Ref. No.	00000009958
description	locking screw thread M6 L 188mm handle ø 39mm for model 300/S-G, Dolly Verticale VS300		
For models:	GFS1030		

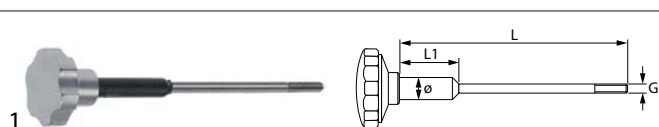

GEV No.	698629	Ref. No.	00000709956
description	locking screw thread M6 L 155mm ø 10mm L1 55mm handle ø 29mm		
For models:	GFS1025		

adjustment knobs



GEV No.	697419	Ref. No.	00000000130 00000700130
description	adjusting knob 0-15 ø 55mm shaft ø 12mm shaft L 28mm handle ø 42mm 250		
For models:	GFS1022, GFS2022, GFS2025, HFS2019, HFS2022, HFS2025		



GEV No.	696522	Ref. No.	00000009503
description	adjusting knob 0-22 ø 68mm shaft ø 18mm shaft L 50mm handle ø 68mm turn direction left		
For models:	GFS1030		

eccentric disc for slice thickness



GEV No.	697470	Ref. No.	00000000830
description	eccentrics for cutting thickness hole ø 12mm groove width 6mm ED ø 52mm thickness 21.5mm		
For models:	GFS2025, HFS2025		



GEV No.	697471	Ref. No.	00000000379
description	eccentrics for cutting thickness hole ø 12mm groove width 6mm ED ø 58mm thickness 21mm		
For models:	GFS1022, GFS1025, GFS2022, HFS2019, HFS2022		

spring washers



GEV No.	697478	Ref. No.	00000000671
description	spring washer ID ø 19mm ED ø 26mm Qty 1 pcs		
For models:	GFS1030		

guiding pieces

for sliding plates



GEV No.	697483	Ref. No.	00000000117
description	guide 195		
For models:	GFS1022, GFS2022, HFS2019, HFS2022		



GEV No.	697448	Ref. No.	00000009177
description	guide 220-250		
For models:	GFS2025, HFS2025		



1

GEV No.	696524	Ref. No.	00000000602 00000009691
description	guide L 117mm W 92mm H 51mm hole ø 18mm shaft intake ø 16mm aluminium		
For models:	GFS1030		



1

GEV No.	697477	Ref. No.	00000000126
description	connection plate L 75mm W 15mm		
For models:	GFS2022, GFS2025, HFS2019, HFS2022, HFS2025		

for carriage



1

GEV No.	696510	Ref. No.	00000009466
description	guide 220		
For models:	GFS1022, GFS2022, HFS2019, HFS2022		

bushes



1

GEV No.	698626	Ref. No.	00000000119
description	bush ED ø 18mm ID ø 16mm H 15mm		
For models:	GFS1030, GFS2025, HFS2025		



1

GEV No.	698627	Ref. No.	00000000611
description	bush ED ø 8mm ID ø 5mm H 10mm		
For models:	GFS1030		

spindles



1

GEV No.	697782	Ref. No.	00000000501
description	spindle for carriage ø 16mm L 390mm thread M8		
For models:	GFS1025		

housings

bottom parts



1

GEV No.	696512	Ref. No.	00000000504
description	bottom plate 220		
For models:	GFS1022, GFS2022, HFS2019, HFS2022		



1

GEV No.	696345	Ref. No.	00000000516
description	bottom plate L 390mm W 190mm plastic 300		
For models:	GFS1025		



1

GEV No.	698393	Ref. No.	00000000701
description	bottom plate L 409mm W 174mm plastic		
For models:	GFS2025, HFS2025		



1

GEV No.	698389	Ref. No.	00000000768
description	cover L 447mm W 180mm plastic		
For models:	GFS1030		

hand guard





1

GEV No.	697754	Ref. No.	00000000784
description	hand protection for knife ø 300mm H 125mm W 60mm thickness 1.2mm hole ø 6.5mm mounting distance 84mm stainless steel		
For models:	GFS1030		





			
1			
GEV No.	696511	Ref. No.	00000000197
description	wiper for knife ø 220/250mm stainless steel		
For models:	GFS1025, GFS2025, HFS2025		

			
1			
GEV No.	697755	Ref. No.	00000000162
description	hand protection for carriage 300 H 180mm W 152mm thickness 5mm hole ø 10mm mounting distance 110mm plastic		
For models:	GFS1030		

			
1			
GEV No.	697826	Ref. No.	00000000924
description	hand protection for slicer		
For models:	GFS1025, GFS2025, HFS2025		

			
1			
GEV No.	698964	Ref. No.	00000000482
description	hand protection for slicer 195-220		
For models:	GFS2022, HFS2019, HFS2022		



accessories			
			
1			
GEV No.	697482	Ref. No.	00000000446
description	screw thread M5 ø 8mm L 15mm		
For models:	GFS1025, GFS1030, GFS2022, GFS2025, HFS2019, HFS2022, HFS2025		

			
1			
GEV No.	697481	Ref. No.	00000000623
description	Thumb screw thread M6 thread L 8mm ø 14mm H 6mm SS		
For models:	GFS1030, GFS2022, GFS2025, HFS2019, HFS2022, HFS2025		

			
1			
GEV No.	698640	Ref. No.	00000009924
description	blade pulley complete with shaft shaft ø 14 shaft length 95mm mounting thread M5 3 hole fixing		
For models:	GFS1022, GFS2022, HFS2022		

			
1			
GEV No.	697747	Ref. No.	00000009920
description	blade pulley with spindle D1 ø 40mm D2 ø 64.3mm D3 ø 67.5mm shaft ø 14 L 33mm shaft length 152mm mounting thread M5 mounting ø 3-hole		
For models:	GFS1025		

			
1			
GEV No.	697746	Ref. No.	00000009469
description	blade pulley with spindle D1 ø 40mm D2 ø 76mm shaft ø 16 L 40mm shaft length 157mm mounting thread M5 mounting ø 3-hole		
For models:	GFS1030		

spare parts for 697746			
	GEV No.	514030	Ref. No. —
retaining ring shaft ø 20mm thickness 1.3mm steel DIN 471			
	GEV No.	523512	Ref. No. 00000000632
deep-groove ball bearing type 6204-2RS shaft ø 20mm ED ø 47mm W 14mm with sealing discs deep-groove ball bearing DIN 625-1			
	GEV No.	692029	Ref. No. —
retaining ring bore ø 47mm thickness 1.8mm steel DIN 472			

food holders

handles



1			
GEV No.	698642	Ref. No.	0000001130
description	handle thread M10 ø 59mm L 100mm aluminium		
For models:	GFS1030		



1			
GEV No.	696515	Ref. No.	0000001242
description	handle thread M10x1.5 ø 34mm L 88mm food holder		
For models:	GFS1025		
accessories for	696515		

	GEV No.	696517	Ref. No.	00000800678 800678
	thread bolt for handle ø 12mm L 64mm thread M6/M10 stainless steel			



1			
GEV No.	697429	Ref. No.	0000000298
description	handle thread M6 ø 25mm L 126mm with hand guard D1 ø 70mm		
For models:	GFS2022, GFS2025, HFS2019, HFS2022, HFS2025		

food holders



1			
GEV No.	698644	Ref. No.	0000000608
description	food holder 300-350 L 290mm hole ø 12mm handle M10 CE		
For models:	GFS1030		
accessories for	698644		

	GEV No.	110703	Ref. No.	—
	cylindrical handle thread M10 ø 28mm L 87mm			



1			
GEV No.	698418	Ref. No.	00000009878
description	food holder L 240mm hole ø 12mm handle M6 with handle		
For models:	GFS1025, GFS2025, HFS2025		

accessories



1			
GEV No.	698630	Ref. No.	0000000827
description	spike food holder ø 3mm L 11.5mm		
For models:	GFS1025, GFS1030, GFS2022, GFS2025, HFS2019, HFS2022, HFS2025		



1			
GEV No.	697480	Ref. No.	0000000151
description	stop bolt food holder ø 7.5mm L 8mm plastic		
For models:	GFS1025, GFS1030, GFS2022, GFS2025, HFS2019, HFS2022, HFS2025		



1			
GEV No.	696517	Ref. No.	00000800678
description	thread bolt for handle ø 12mm L 64mm thread M6/M10 stainless steel		
For models:	GFS1025		
accessories for	696515		

	GEV No.	696515	Ref. No.	0000001242 1242
	handle thread M10x1.5 ø 34mm L 88mm food holder			

blades

standard



1			
GEV No.	697546	Ref. No.	0000000254
description	slicing machine blade ED ø 195mm seat ø 30mm 3-hole ID ø 155mm H 12.8mm C45 standard		
For models:	HFS2019		



1			
GEV No.	697436	Ref. No.	0000000855
description	slicing machine blade ED ø 220mm seat ø 40mm 3-hole ID ø 180mm H 15.5mm C45		
For models:	GFS1022, GFS2022, HFS2022		





			
1			
GEV No.	697365	Ref. No.	00000000142
description	slicing machine blade ED ø 250mm seat ø 40mm 3-hole ID ø 210mm H 17.5mm C45 standard		
For models:	GFS1025, GFS2025, HFS2025		

			
1			
GEV No.	697385	Ref. No.	00000000636
description	slicing machine blade ED ø 300mm seat ø 40mm 3-hole ID ø 250mm H 20mm C45 standard		
For models:	GFS1030		

sharpener units

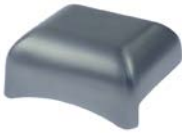
lids

			
1			
GEV No.	696514	Ref. No.	00000000863
description	lid for sharpener units L 116mm W 100mm mounting distance 26mm		
For models:	GFS1025, GFS2022, GFS2025, HFS2022, HFS2025		

			
1			
GEV No.	698643	Ref. No.	00000000596
description	lid for sharpener units L 150mm W 120mm		
For models:	GFS1030		

holders

			
1			
GEV No.	696493	Ref. No.	00000000771
description	bracket for sharpener units L 60mm W 31mm H 78mm hole ø 12mm mounting thread M6 with fastening angle		
For models:	GFS1030		

knobs

			
1			
GEV No.	697441	Ref. No.	00000000854
description	locking screw thread M5 handle ø 25mm black L 30mm		
For models:	GFS2022, GFS2025, HFS2022, HFS2025		

			
1			
GEV No.	696518	Ref. No.	00000009954
description	locking screw thread M5 L 47mm handle ø 25mm silver		
For models:	GFS1025		





			
1			
GEV No.	697428	Ref. No.	00000000138
description	locking screw thread M6 handle ø 25mm black L 15mm		
For models:	HFS2019		

			
1			
GEV No.	696523	Ref. No.	00000009510
description	locking screw thread M6 L 53mm handle ø 34mm silver		
For models:	GFS1030		

sharpener units

			
1			
GEV No.	697397	Ref. No.	00000009864
description	blade sharpener 220/250/275		
For models:	GFS1022, GFS1025, GFS2022, GFS2025, HFS2022, HFS2025		

			
1			
GEV No.	697355	Ref. No.	00000009693
description	blade sharpener 350		
For models:	GFS1030		
spare parts for	697355		
	GEV No.	697377	Ref. No. 0000000720
	grindstone ø 51mm thickness 12mm bore ø 8mm grained coarse without bevel		
	GEV No.	697378	Ref. No. 0000000721
	grindstone ø 51mm thickness 7mm bore ø 8mm grained fine with bevel, without hub		

			
1			
GEV No.	697420	Ref. No.	00000009168
description	blade sharpener PARKER		
For models:	HFS2019		
spare parts for	697420		
	GEV No.	697423	Ref. No. 0000000816
	grindstone ø 40mm thickness 8mm bore ø 6mm grained fine with bevel, with hub		
	GEV No.	697424	Ref. No. 0000000871
	grindstone ø 40mm thickness 8mm bore ø 6mm grained coarse with bevel, with hub		
	GEV No.	697428	Ref. No. 0000000138
	locking screw thread M6 handle ø 25mm black L 15mm		

spindles

			
1			
GEV No.	698633	Ref. No.	00000000778
description	spindle for sharpener units ø 12mm L 95mm thread M5		
For models:	GFS1030		

grindstones

			
1			
GEV No.	697378	Ref. No.	0000000721
description	grindstone ø 51mm thickness 7mm bore ø 8mm grained fine with bevel, without hub		
For models:	GFS1030		

grindstones with hub

			
1			
GEV No.	697424	Ref. No.	0000000871
description	grindstone ø 40mm thickness 8mm bore ø 6mm grained coarse with bevel, with hub		
For models:	HFS2019		

			
1			
GEV No.	697423	Ref. No.	0000000816
description	grindstone ø 40mm thickness 8mm bore ø 6mm grained fine with bevel, with hub		
For models:	HFS2019		

			
1			
GEV No.	697421	Ref. No.	0000000641
description	grindstone ø 45mm thickness 8mm bore ø 6mm grained coarse with bevel, with hub		
For models:	GFS1025, GFS2022, GFS2025, HFS2022, HFS2025		

			
1			
GEV No.	697422	Ref. No.	0000000642
description	grindstone ø 45mm thickness 8mm bore ø 6mm grained fine with bevel, with hub		
For models:	GFS1025, GFS2022, GFS2025, HFS2022, HFS2025		

grindstones cup form

			
1			
GEV No.	697377	Ref. No.	0000000720
description	grindstone ø 51mm thickness 12mm bore ø 8mm grained coarse without bevel		
For models:	GFS1030		



carriages

handles



1

GEV No.	697440	Ref. No.	00000000432
description	handle thread M10 handle ø 66mm H 51mm black		
For models:	GFS1022		

accessories



1

GEV No.	696516	Ref. No.	00000000186
description	bracket for carriage L 56mm aluminium		
For models:	GFS2022, HFS2019, HFS2022		



1

GEV No.	698631	Ref. No.	00000000895
description	spindle for carriage thread M6 L 170mm ø 12mm		
For models:	GFS2025, HFS2025		



1

GEV No.	697827	Ref. No.	00000000678
description	spindle for slicer thread M10 L 95mm thread L 12/15mm total length 122mm ø 16mm stainless steel		
For models:	GFS1030		

miscellaneous



1

GEV No.	697356	Ref. No.	00000000300
description	bracket thread M10x0.75 ø 30mm for microswitch ID ø 14.5mm thickness 13mm mounting thread M5		
For models:	GFS1025		



1

GEV No.	697476	Ref. No.	00000000509
description	bush ø 14mm L 88mm ID ø 12mm		
For models:	GFS1025, GFS2022, GFS2025, HFS2019, HFS2022, HFS2025		



1

GEV No.	698388	Ref. No.	00000000765
description	mounting flange ø 18mm L 128mm W 28mm		
For models:	GFS1030		



1

GEV No.	698392	Ref. No.	00000000828
description	thread bolt thread M6 ø 6mm L 35mm for slicer		
For models:	GFS1025, GFS1030, GFS2022, GFS2025, HFS2019, HFS2022, HFS2025		



1

GEV No.	698628	Ref. No.	00000000774
description	threaded shaft thread M6 L 37mm for slicer		
For models:	GFS1030		

for hand blenders

housings



1

GEV No.	699708	Ref. No.	2840M
description	cover for handle blue GSM1000 L 80mm W 42mm		
For models:	GSM1000		



1

GEV No.	696503	Ref. No.	2851
description	handle for hand blender plastic grey		
For models:	GSM1000		



1

GEV No.	699134	Ref. No.	2849M
description	housing left blue GSM1000		
For models:	GSM1000		
accessories for	699134		
	GEV No.	Ref. No.	
	699133	2843M	
	housing right blue GSM1000		



1

GEV No.	699133	Ref. No.	2843M
description	housing right blue GSM1000		
For models:	GSM1000		
accessories for	699133		
	GEV No.	Ref. No.	
	699134	2849M	
	housing left blue GSM1000		



1

GEV No.	698386	Ref. No.	2848M
description	sticker for hand blender silver L 125mm W 25mm thickness 1mm ON-OFF		
For models:	GSM1000		



1

GEV No.	698387	Ref. No.	2853M
description	sticker for lid silver L 50mm W 27mm		
For models:	GSM1000		

couplings



1

GEV No.	696504	Ref. No.	2846
description	coupling for hand blender D1 ø 19mm int. ø 1 6.3mm L 29.5mm teeth 8 GSM1000		
For models:	GSM1000		



1

GEV No.	696505	Ref. No.	2860
description	coupling with roll pin for hand blender D1 ø 19mm int. ø 1 8mm teeth 8 GSM1000		
For models:	GSM1000		

blender sticks

blades

blades with adaptor (complete)



1

GEV No.	698262	Ref. No.	0551
description	knife ø 39mm hole ø 4mm H 12mm		
For models:	GSM1000		





			
1			
GEV No.	698261	Ref. No.	0550
description	knife ø 39mm hole ø 4mm H 18mm		
For models:	GSM1000		

			
1			
GEV No.	698381	Ref. No.	0552
description	mixer disc ø 36mm hole ø 4mm H 0.8mm GSM1000		
For models:	GSM1000		

			
1			
GEV No.	698382	Ref. No.	0553
description	mixer disc ø 36mm hole ø 4mm H 3.4mm GSM1000		
For models:	GSM1000		

<h3>blender sticks</h3>			
			
1			
GEV No.	698379	Ref. No.	2845M
description	blender stick GSM1000 L 234mm flange ø 66mm		
For models:	GSM1000		

<h3>spindles</h3>			
			
1			
GEV No.	698380	Ref. No.	2844M
description	drive shaft for hand blender with coupling D1 ø 4mm D2 ø 8mm L 214mm SS		
For models:	GSM1000		
spare parts for	698380		
			
GEV No.	696505	Ref. No.	2860
description	coupling with roll pin for hand blender D1 ø 19mm int. ø 18mm teeth 8 GSM1000		

<h3>miscellaneous</h3>			
			
1			
GEV No.	698385	Ref. No.	2841
description	bracket for grab handle L 40mm W 37mm thickness 1.5mm		
For models:	GSM1000		

			
1			
GEV No.	696507	Ref. No.	2854
description	bracket for motor plastic black		
For models:	GSM1000		

			
1			
GEV No.	696506	Ref. No.	2858
description	knob for PCB ø 26mm black Qty 1 pcs		
For models:	GSM1000		

			
1			
GEV No.	532648	Ref. No.	2859
description	O-ring EPDM thickness 1.5mm ID ø 5mm Qty 1 pcs		
For models:	GSM1000		

			
1			
GEV No.	698384	Ref. No.	45710
description	protection cap for grab handle plastic black		
For models:	GSM1000		

			
1			
GEV No.	698383	Ref. No.	0632
description	shaft sealing ID ø 4mm ED ø 12mm for hand blender H 6.3mm		
For models:	GSM1000		

for citrus juicers

spillage trays



1

GEV No.	696502	Ref. No.	900963
description	drain tray for citrus juicers ø 175mm hole ø 42mm H 110mm SS		
For models:	GJU1001		

gaskets



1

GEV No.	532647	Ref. No.	900970
description	O-ring EPDM thickness 1.8mm ID ø 11.8mm Qty 1 pcs		
For models:	GJU1001		



1

GEV No.	511953	Ref. No.	900871
description	seal kit for citrus juicers		
For models:	GJU1001		

motors



1

GEV No.	501426	Ref. No.	900956
description	motor for citrus juicers 180W 230-240V 50Hz shaft ø 8mm shaft length 40mm type RCJ298252 0.18kW		
For models:	GJU1001		

juicer insert



1

GEV No.	650168	Ref. No.	900901
description	filter for citrus juicers ø 155mm H 23mm plastic		
For models:	GJU1001		



1

GEV No.	650167	Ref. No.	221266
description	juicer insert set for citrus juicers ø 57/62/79mm H 45/50/55mm plastic		
For models:	GJU1001		

spindles



1

GEV No.	650170	Ref. No.	900895
description	spindle L 48mm square thread M8x1.25 for citrus juicers WS 12		
For models:	GJU1001		

miscellaneous



1

GEV No.	650171	Ref. No.	900925
description	cover for spindle ø 44mm H 18mm aluminium		
For models:	GJU1001		



1

GEV No.	650169	Ref. No.	221242
description	drip tray for citrus juicers ø 79mm H 20mm plastic black		
For models:	GJU1001		

for fridges

drain systems

drain valves



1

GEV No.	692441	Ref. No.	GSC1100-48
description	drain fitting L 45mm plastic H 38mm W 28mm hose ø 10mm Qty 1 pcs		

control parts



GEV No.	698848	Ref. No.	GPC1088-03
description	lamp with thermostat ø 140mm H 35mm		
For models:	GPC1088		

spare parts and accessories



GEV No.	551346	Ref. No.	I0534005R
description	bush refrigerator compressor ø 9mm ID ø 6.5mm L 17mm Qty 1 pcs		
For models:	GFR3600, GRE3600		



GEV No.	694967	Ref. No.	HSC360G-22 SLCX0002
description	cover L 51mm W 44mm H 12mm plastic mounting distance 30mm		



GEV No.	698849	Ref. No.	GPC1046-03 GPC1088-04
description	cover cap L 96mm W 44mm H 13mm plastic		
For models:	GPC1046, GPC1088		



GEV No.	698878	Ref. No.	WJQZ9000 WJQZ9001
description	guide counterweight for sliding door L 248mm W 20mm H 10mm		



GEV No.	750691	Ref. No.	RN400.11 RN400.12
description	pressure compensation valve L 104mm W 59mm H 87mm		
For models:	RN400		



GEV No.	699232	Ref. No.	I0535012
description	strain relief L 56mm W 14.5mm H 20mm		
For models:	GFR3600, GRE3600		

housing and bezels

covers





GEV No.	694596	Ref. No.	GSC1336-04 GSC2336-04
description	bezel for lighting L 185mm W 72mm H 15mm mounting pos. left Qty 1 pcs		
For models:	GSC1336		

 <p>1</p>			
GEV No.	694595	Ref. No.	GSC1336-02 GSC2336-02
description	bezel for lighting L 185mm W 72mm H 15mm mounting pos. right Qty 1 pcs		
For models:	GSC1336		

 <p>1</p>			
GEV No.	694588	Ref. No.	RC600.31
description	cover for axial flow fan W 663mm H 222mm plate thickness max. 0.7mm plate Qty 1 pcs		
For models:	GRE2600		

 <p>1</p>			
GEV No.	694594	Ref. No.	GSC1336-03 GSC2336-03
description	cover for lighting W 615mm H 180mm plate thickness max. 1mm plexiglas white Qty 1 pcs		
For models:	GSC1336		

 <p>1</p>			
GEV No.	998252	Ref. No.	44037000
description	cover for ventilation L 72mm W 62mm H 10mm Qty 1 pcs		
For models:	GFR3600, GRE3600		

 <p>1</p>			
GEV No.	698890	Ref. No.	PTBP9N88
description	cover L 1350mm W 65mm H 52mm Qty 1 pcs		

 <p>1</p>			
GEV No.	694969	Ref. No.	GSC1100G-28
description	cover L 1420mm W 127mm H 30mm		

 <p>1</p>			
GEV No.	701271	Ref. No.	GHR1040-12 RW40.18
description	cover cap for Phillips screw plastic ø 12mm Qty 1 pcs		
For models:	GHR1040, GHR2600		

 <p>1</p>			
GEV No.	692389	Ref. No.	GHR1040-21 RW40.27
description	deflector L 304mm W 25mm H 125mm aluminium Qty 1 pcs		
For models:	GHR1040, GHR2600		

<p>control panel</p>  <p>1</p>			
GEV No.	699234	Ref. No.	44027000
description	bezel L 780mm W 67mm H 62mm mounting pos. upper		
For models:	GFR3600, GRE3600		

 <p>1</p>			
GEV No.	692381	Ref. No.	RW40.25
description	control panel for fridge W 72mm H 110mm Qty 1 pcs		
For models:	GHR1040, GHR2600		

 <p>1</p>			
GEV No.	699316	Ref. No.	RC400.20 RN400.21
description	front panel L 598mm W 78mm H 52mm		
For models:	RC400, RN400		



lids



1

GEV No.	698864	Ref. No.	GPC1046-05 GPC1088-06
description	cover black L 50mm W 42mm H 7mm		
For models:	GPC1046, GPC1088		

housings



1

GEV No.	692382	Ref. No.	RW40.24
description	housing for thermostat black L 110mm W 70mm H 55mm Qty 1 pcs		
For models:	GHR1040, GHR2600		



1

GEV No.	699233	Ref. No.	I9500323
description	terminal box L 98mm W 74mm H 35mm kit		
For models:	GFR3600, GRE3600		

equipment feet



1

GEV No.	698865	Ref. No.	GPC1088-12
description	equipment foot M8 thread L 15mm ø 29mm		
For models:	GPC1088		

handles



1

GEV No.	692390	Ref. No.	GSC1100-12 GSC1336-45 GSC2336-45 LCCG0005
description	handle rod for door L 380mm W 40mm aluminium Qty 1 pcs		
For models:	GSC1100, GSC1100G, GSC1336		

holders



1

GEV No.	692384	Ref. No.	RN400.22 RN600.21
description	bracket for evaporator mounting pos. left L 98mm W 34mm H 37mm plastic Qty 1 pcs		
For models:	GFR2600, RN400		



1

GEV No.	692383	Ref. No.	RN400.24 RN600.20
description	bracket for evaporator mounting pos. right L 98mm W 34mm H 37mm plastic Qty 1 pcs		
For models:	GFR2600, RN400		

caps





1

GEV No.	692735	Ref. No.	RC400.33 RN400.31
description	cap for evaporator fan grey ø 24mm mounting ø 18mm H 5mm		
For models:	RC400, RN400		

			
1			
GEV No.	692372	Ref. No.	GDS1134-03 GDS1134-3 GDS1600-03 GDS1600-3 GPS1600-03 GPS1600-3 GSA1134-03 GSF1600-03 S900.03
description	cap grey ø 16.5mm mounting ø 12.5mm H 7mm Qty 1 pcs		
For models:	GDS1134, GDS1600, GHS1134, GHS1600, GHS2134, GHS2600, GPS1134, GPS1600, GSA1134, GSA1600, GSF1134, GSF1600		

miscellaneous

			
1			
GEV No.	692392	Ref. No.	GSC1100-02 SLSE4005
description	cover for lighting W 1170mm H 280mm thickness 1mm plastic Qty 1 pcs		
For models:	GSC1100, GSC1100G		

			
1			
GEV No.	694875	Ref. No.	SLZE0026
description	cover for thermostat		

			
1			
GEV No.	692391	Ref. No.	GSC1336-24 GSC2336-24 SLZE0027
description	housing for bulb socket L 150mm W 40mm H 20mm plastic Qty 1 pcs		
For models:	GSC1100G, GSC1336, GSC2336		

			
1			
GEV No.	701268	Ref. No.	RN400.23 RN600.32
description	U profile for evaporator L 635mm W 16mm H 13mm aluminium Qty 1 pcs		
For models:	GFR2600, RN400		

			
1			
GEV No.	701547	Ref. No.	RC400.17 RN400.18
description	ventilation grille H 60mm L 600mm		
For models:	RC400, RN400		

			
1			
GEV No.	701267	Ref. No.	RC600.21 RN600.14
description	ventilation grille white H 61mm L 770mm mounting pos. lower Qty 1 pcs		
For models:	GFR2600, GRE2600		

drawers

drawers

			
1			
GEV No.	699320	Ref. No.	S901-4D.51
description	drawer for fridge L 590mm W 428mm H 255mm stainless steel		
For models:	GDS1134		



doors

doors

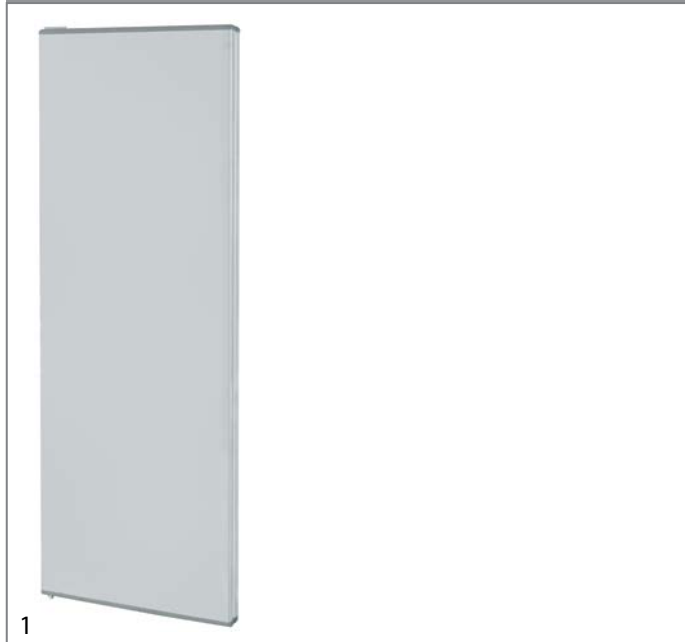

1

GEV No.	699406	Ref. No.	RC400.30 RN400.29
description	door L 1715mm W 600mm H 76mm		
For models:	RC400, RN400		

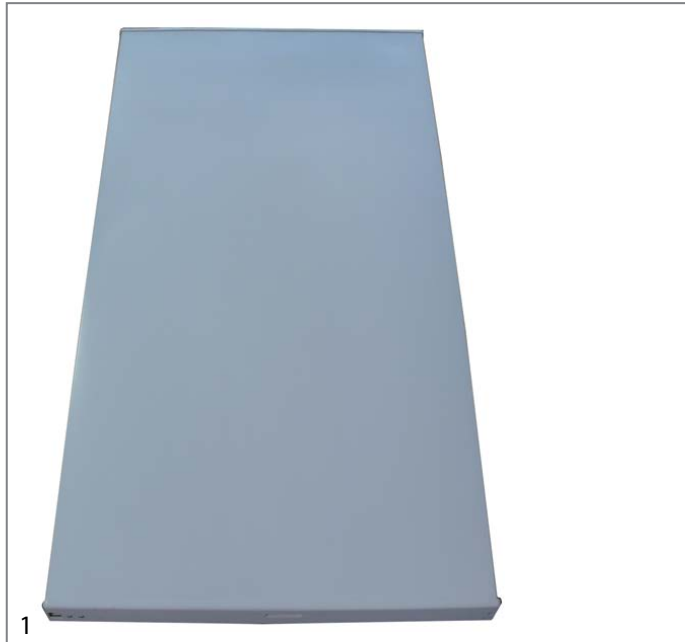

1

GEV No.	694543	Ref. No.	RC600.41 RN600.30
description	door W 765mm H 1740mm thickness 63mm		
For models:	GFR2600, GRE2600		



1

GEV No.	698989	Ref. No.	BLGM2B12 HSC350-46
description	glass door L 1350mm W 620mm		



1

GEV No.	699381	Ref. No.	BLGM4010 GSC1100-15
description	glass door left W 600mm H 1330mm D 40mm		
For models:	GSC1100, GSC1100G		



GEV No.	699382	Ref. No.	BLGM4011 GSC1100-16
description	glass door right W 600mm H 1330mm D 40mm		
For models:	GSC1100, GSC1100G		



GEV No.	699376	Ref. No.	BLGM4161 HSC800-49
description	glass door W 460mm H 1230mm mounting pos. right D 30mm		



GEV No.	699375	Ref. No.	BLGM4160 HSC800-51
description	glass door W 460mm H 1230mm mounting pos. left D 30mm		



GEV No.	699377	Ref. No.	GSC1336-07 GSC2336-07
description	glass door W 620mm H 1380mm with handle D 40mm		
For models:	GSC1336		



GEV No.	699374	Ref. No.	BLPM2033 HSC360-40
description	glass door W 620mm H 1600mm D 40mm		



GEV No.	699493	Ref. No.	BLGM4025 HSC350DD-51
description	glass door with lock W 620mm H 680mm D 38mm mounting pos. lower		

spare parts for	699493		
	GEV No.	902465	Ref. No.
			HSC350DD-46 HSC350DD-49 SLJP2015
	refrigeration gasket profile 9161 W 590mm L 650mm plug size		



GEV No.	699494	Ref. No.	BLGM4024 HSC350DD-47
description	glass door W 620mm H 680mm D 38mm mounting pos. upper		

spare parts for	699494		
	GEV No.	902465	Ref. No.
			HSC350DD-46 HSC350DD-49 SLJP2015
	refrigeration gasket profile 9161 W 590mm L 650mm plug size		

miscellaneous



GEV No.	701431	Ref. No.	HSC360-22 WJLD0000
description	bracket for glass door L 54mm W 42mm H 75mm hole \varnothing 7x12mm Qty 1 pcs		



GEV No.	692731	Ref. No.	RC600.11
description	bracket L 80mm W 58mm D 25mm zinc-plated sheet steel		
For models:	GRE2600		

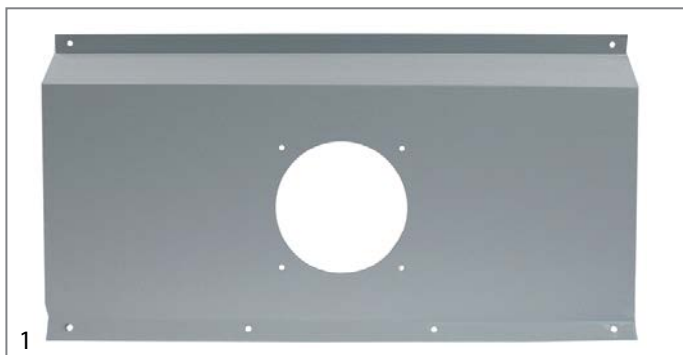

GEV No.	694867	Ref. No.	HSC350-29 PTBP2020
description	cover for evaporator L 525mm W 280mm H 53mm plate Qty 1 pcs		

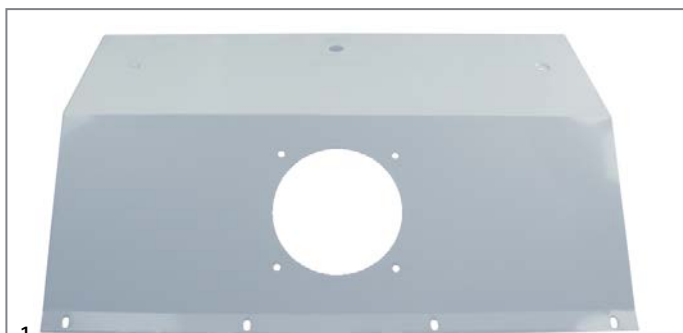

GEV No.	694597	Ref. No.	GSC1336-14 GSC2336-14
description	cover for evaporator L 525mm W 345mm H 115mm plate Qty 1 pcs		
For models:	GSC1336		



GEV No.	692424	Ref. No.	GSC1336-19 GSC2336-19 SLZV0007
description	cover for lighting mounting pos. inner L 1263mm W 56mm H 20mm plastic Qty 1 pcs		
For models:	GSC1336, GSC2336		



GEV No.	698888	Ref. No.	SLZV0019
description	cover transparent for lamp L 810mm W 40mm H 30mm Qty 1 pcs		
For models:	GBC1003		



GEV No.	692426	Ref. No.	GSC1336-38 GSC2336-38 LCCJ2029
description	guide for fridge L 1145mm W 26mm H 4.5mm Qty 1 pcs		
For models:	GSC1100, GSC1100G, GSC1336, GSC2336		



GEV No.	692256	Ref. No.	S900.29
description	opposite support for bolt L 43mm hole ø 6mm hole distance 28.5mm		
For models:	GDS1600, GSA1134, GSA1600		



GEV No.	701272	Ref. No.	GHR1040-22 RW40.28
description	shelf large for fridge W 325mm H 9mm D 145mm plastic Qty 1 pcs		
For models:	GHR1040, GHR2600		





GEV No.	701274	Ref. No.	GHR1040-24 RW40.30
description	shelf set for door W 290mm H 60mm D 103/77mm plastic Qty 1 pcs		
For models:	GHR1040, GHR2600		



GEV No.	701273	Ref. No.	GHR1040-23 RW40.29
description	shelf small for fridge W 325mm H 9mm D 120mm plastic Qty 1 pcs		
For models:	GHR1040, GHR2600		



			
1			
GEV No.	698877	Ref. No.	LCKK0001
description	shelf support L 26.5mm W 8.5mm H 40mm aluminium		
For models:	GSC1100, GSC1100G, GSC2336		

			
1			
GEV No.	694590	Ref. No.	GHR1040-10 GHR2600-10 RW40.16
description	spacer ø 12mm ID ø 7.6mm H 1.4mm plastic Qty 1 pcs		
For models:	GHR1040, GHR2600		

			
1			
GEV No.	694589	Ref. No.	GHR1040-20 RW40.26
description	water container for fridge L 71mm W 58mm H 35mm plastic Qty 1 pcs		
For models:	GHR1040, GHR2600		

for refrigerated counters

housing and bezels

			
1			
GEV No.	699318	Ref. No.	S901-4D.49
description	support for refrigerated counters W 68mm H 364mm		
For models:	GDS1134		

for freezer cabinets

housing and bezels

			
1			
GEV No.	692386	Ref. No.	RC600.35 RN600.26
description	front panel W 770mm H 52mm plastic Qty 1 pcs		
For models:	GFR2600, GRE2600		

for display coolers

control parts

			
1			
GEV No.	692700	Ref. No.	1.1.C.C12.07 GGC2270-18-black
description	door handle L 100mm W 32mm hole distance 68mm black Qty 1 pcs		

			
1			
GEV No.	692409	Ref. No.	1.1.C.C12.06 GGC2270-18 GGC2270-18-white
description	door handle L 100mm W 32mm hole distance 68mm white		
For models:	GGC1270		

			
1			
GEV No.	692402	Ref. No.	1.1.C.C12.14 GGC1078-15-white GGC1078-WHITE-15
description	handle grey for vitrine H 9.5mm L 85mm W 25mm mounting distance 70mm Qty 1 pcs		

			
1			
GEV No.	692401	Ref. No.	1.1.C.C23.01 GGC1078-11
description	knob ø 27mm grey zero mark shaft ø 6x4.6mm shaft flat left for thermostat to clip Qty 1		

spare parts and accessories



1	GEV No.	699422	Ref. No.	1.1.C.C63.61 GCV1600-35
	description	clip for dryer L 90mm W 20mm H 52mm plastic Qty 1 pcs		



1	GEV No.	699436	Ref. No.	A1.1.C.C21.15
	description	rail L 250mm W 24mm H 10mm		
	For models:	GRV1100		



1	GEV No.	694912	Ref. No.	GGC2270-52
	description	strain relief L 40mm W 20mm H 8mm		
	For models:	GGC1270		

housing and bezels

fascias



1	GEV No.	692411	Ref. No.	1.1.C.C40.02 GGC2270-45
	description	base plate for evaporator L 305mm W 241mm thickness 1.5mm plastic Qty 1 pcs		
	For models:	GGC1270		



1	GEV No.	698935	Ref. No.	A1.1.B.B19.07
	description	bezel mounting pos. lower for vitrine H 235mm Qty 1 pcs ø 490mm		
	For models:	GRV1100		



1	GEV No.	698907	Ref. No.	A1.1.B.B19.03
	description	bezel mounting pos. right for vitrine W 34mm D 10mm H 710mm 1 pair chrome-plated steel		
	For models:	GRV1100		



1	GEV No.	692405	Ref. No.	1.1.C.C22.08 GGC1078-10
	description	control panel for vitrine temperature MIN/MAX W 130mm D 23mm H 145mm plastic Qty 1 pcs		



1	GEV No.	692733	Ref. No.	HSC360-27 SLJX2014
	description	cover for lamp W 55mm H 20mm L 1040mm		



1	GEV No.	698914	Ref. No.	A1.1.C.C19.05
	description	cover mounting pos. lower for switch W 135mm D 20mm H 30mm plastic		
	For models:	GRV1100		



1	GEV No.	699158	Ref. No.	A1.1.C.C21.06
	description	cover plate mounting pos. upper/lower for door W 420mm D 110mm H 12mm Qty 1 pcs		
	For models:	GRV1100		



1	GEV No.	699160	Ref. No.	A1.1.C.C21.07
	description	end barrier mounting pos. upper/lateral for door W 420mm D 110mm H 23mm Qty 1 pcs		
	For models:	GRV1100		





			
1			
GEV No.	699181	Ref. No.	A1.1.C21.23
description	filter W 260mm D 90mm H 296mm black Qty 1 pcs		
For models:	GRV1100		

			
1			
GEV No.	699319	Ref. No.	S901-4D.07
description	front panel for drawer W 428mm D 38mm H 255mm stainless steel		
For models:	GDS1134		

			
1			
GEV No.	699410	Ref. No.	1.1.C.C15.03.35 GGC2270-06-black
description	front panel mounting pos. front W 518mm D 35mm H 440mm black		

			
1			
GEV No.	699409	Ref. No.	1.1.C.C15.03.03 GGC2270-06 GGC2270-06-white
description	front panel mounting pos. front W 518mm D 35mm H 440mm white		
For models:	GGC1270		

			
1			
GEV No.	699401	Ref. No.	S24AC21A0001
description	front panel mounting pos. front W 865mm D 15mm H 248mm		
For models:	GPS2600, GSA2600, GSD2600, GSF2600		

			
1			
GEV No.	698854	Ref. No.	1.1.C.C15.01.02 GGC1078-04-black GGC1078-50-black
description	front panel mounting pos. in the front/at the back black W 427mm D 33mm H 190mm plastic Qty 1 pcs for vitrine		

			
1			
GEV No.	692417	Ref. No.	1.1.C.C21.01 GGC1078-09 GGC1078-9
description	housing for control W 130mm D 75mm H 145mm plastic Qty 1 pcs		

			
1			
GEV No.	699415	Ref. No.	1.1.C.C02.02 GGC2270-30-black
description	lamp cover W 310mm D 5mm H 172mm black		

			
1			
GEV No.	699414	Ref. No.	1.1.C.C02.01 GGC2270-30-white
description	lamp cover W 310mm D 5mm H 172mm white		

			
1			
GEV No.	699407	Ref. No.	S24AC20A0005
description	sheet mounting pos. upper for door W 890mm D 115mm H 10mm		
For models:	GPS2600, GSA2600, GSD2600, GSF2600		

lids



1			
GEV No.	698904	Ref. No.	A1.1.C.C21.02
description	lid black W 475mm H 33mm L 355mm		
For models:	GRV1100		



1			
GEV No.	698922	Ref. No.	A1.1.C.C21.01
description	lid for vitrine black W 474mm D 364mm H 24mm Qty 1 pcs		
For models:	GRV1100		



1			
GEV No.	692414	Ref. No.	GGC1078-29-white GGC1078-WHITE-29
description	lid L 313mm W 163mm for lighting Qty 1 pcs		



1			
GEV No.	699403	Ref. No.	S24AC50A0003
description	top for display refrigerator W 910mm D 705mm H 125mm		
For models:	GSD2600		

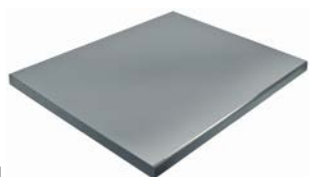

1			
GEV No.	699404	Ref. No.	S24AC30A0003
description	top for display refrigerator W 910mm D 705mm H 55mm		
For models:	GSF2600		

shelf supports



1			
GEV No.	698940	Ref. No.	A1.1.C.C21.16 A1.1.C.C21.18 A1.1.C.C21.19
description	shelf support L 55mm W 18mm H 40mm mounting pos. left/right with ball		
For models:	GRV1100		

housings



1			
GEV No.	698851	Ref. No.	1.1.C.C15.01.06 GGC2270-51-black
description	back panel for vitrine W 515mm D 45mm H 410mm black		



1			
GEV No.	692269	Ref. No.	1.1.C.C15.01.05 GGC2270-51 GGC2270-51-white
description	back panel for vitrine W 515mm D 45mm H 410mm white		
For models:	GGC1270		



1			
GEV No.	698936	Ref. No.	A1.1.C.C21.09
description	base mounting pos. lower H 160mm plastic ø 490mm		
For models:	GRV1100		



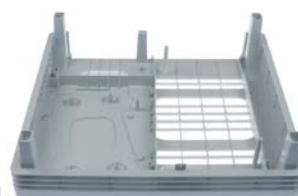

1			
GEV No.	698917	Ref. No.	A1.1.C.C04.15
description	base part mounting pos. for housing W 153mm D 4mm H 85mm plastic Qty 1 pcs white		
For models:	GRV1100		





1			
GEV No.	692416	Ref. No.	1.1.C.C25.15 GGC1078-49
description	bottom for vitrine W 378mm H 115mm L 425mm Qty 1 pcs		



 <p>1</p>			
GEV No.	692419	Ref. No.	1.1.C.C01.15 GGC1078-27-white GGC1078-WHITE-27
description	casing cover for display refrigerator W 425mm L 380mm plastic Qty 1 pcs white		
accessories for	692419		
 <p>1</p>			
GEV No.	692414	Ref. No.	GGC1078-29-white GGC1078-WHITE-29
description	lid L 313mm W 163mm for lighting Qty 1 pcs		

 <p>1</p>			
GEV No.	692437	Ref. No.	1.1.C.C22.07 GGC2270-55
description	casing cover W 130mm D 70mm H 6mm plastic Qty 1 pcs		
For models:	GGC1270		

 <p>1</p>			
GEV No.	692413	Ref. No.	GGC2270-59
description	casing cover W 40mm D 18mm plastic Qty 1 pcs		
For models:	GGC1270		

 <p>1</p>			
GEV No.	692420	Ref. No.	1.1.B.B05.02 GGC1078-08 GGC1078-8
description	cover for condenser W 365mm D 220mm H 130mm plate Qty 1 pcs		

 <p>1</p>			
GEV No.	692422	Ref. No.	1.1.C.C16.02 GGC1078-41
description	cover for evaporator W 280mm D 345mm H 35mm plastic Qty 1 pcs		

 <p>1</p>			
GEV No.	698916	Ref. No.	A1.1.C.C04.14
description	cover mounting pos. for PCB W 140mm D 38mm H 80mm plastic Qty 1 pcs		
For models:	GRV1100		

 <p>1</p>			
GEV No.	692403	Ref. No.	1.1.C.C15.01.01 GGC1078-04-white GGC1078-WHITE-4
description	front panel mounting pos. front for vitrine W 427mm D 33mm H 190mm plastic Qty 1 pcs white		

 <p>1</p>			
GEV No.	698860	Ref. No.	1.1.C.C56.84 GGC1078-18-black
description	guide mounting pos. front for side part W 23mm D 30mm H 635mm Qty 1 pcs		

 <p>1</p>			
GEV No.	698861	Ref. No.	1.1.C.C56.85 GGC1078-38-black
description	guide mounting pos. rear for side part W 30mm D 30mm H 635mm Qty 1 pcs		

 <p>1</p>			
GEV No.	699175	Ref. No.	P04AC21A0003
description	housing for control part W 200mm D 115mm H 95mm		
For models:	GPS2600, GSA2600, GSD2600, GSF2600		

 <p>1</p>			
GEV No.	692415	Ref. No.	1.1.C.C18.04 GGC1078-44
description	housing for evaporator W 370mm H 175mm L 420mm Qty 1 pcs		



1

GEV No.	699323	Ref. No.	VRX1560.2
description	housing for switch W 114mm D 68mm H 100mm		
For models:	GHS1134, GHS1600, GHS2134, GHS2600		



1

GEV No.	692436	Ref. No.	1.1.C.C21.03 GGC2270-54
description	housing W 128mm D 65mm H 38mm plastic Qty 1 pcs		
For models:	GGC1270		



1

GEV No.	692412	Ref. No.	GGC2270-58
description	housing W 40mm H 21mm plastic Qty 1 pcs		
For models:	GGC1270		



1

GEV No.	698937	Ref. No.	A1.1.C.C21.08
description	insert mounting pos. centre for vitrine H 210mm plastic ø 490mm		
For models:	GRV1100		



1

GEV No.	692270	Ref. No.	1.1.C.C15.03.08 1.1.C.C15.03.08+1.1.C.C15.03.09 GGC2270-50 GGC2270-50-white
description	side panel W 418mm H 410mm plastic white		
For models:	GGC1270		

ventilation grilles



1

GEV No.	698855	Ref. No.	1.1.C.C14.02 GGC1078-12-black
description	cover for fan W 425mm D 380mm H 36mm plastic Qty 1 pcs black		



1

GEV No.	699411	Ref. No.	1.1.C.C14.01 GGC1078-12-white
description	cover for fan W 425mm D 380mm H 36mm plastic Qty 1 pcs white		



1

GEV No.	698915	Ref. No.	A1.1.C.C21.20
description	cover mounting pos. for air fan W 270mm D 10mm H 63mm plastic		
For models:	GRV1100		



1

GEV No.	698912	Ref. No.	A1.1.C.C21.21
description	cover mounting pos. for aspiration W 290mm D 10mm H 40mm plastic Qty 1 pcs		
For models:	GRV1100		



1

GEV No.	698911	Ref. No.	A1.1.C.C21.10
description	frame mounting pos. lower for vitrine W 370mm D 75mm H 70mm plastic		
For models:	GRV1100		





			
1			
GEV No.	698853	Ref. No.	1.1.C.C26.02 GGC1078-02-black
description	grid mounting pos. lower for ventilation W 350mm D 12mm H 57mm plastic Qty 1 pcs black		

			
1			
GEV No.	699417	Ref. No.	1.1.C.C26.01 GGC1078-02-white
description	grid mounting pos. lower for ventilation W 350mm D 12mm H 57mm plastic Qty 1 pcs white		

			
1			
GEV No.	701253	Ref. No.	1.1.C.C49.09 GCV1600-33
description	ventilation grille for air fan plastic black H 50mm L 620mm Qty 1 pcs		

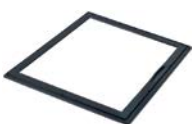
			
1			
GEV No.	701254	Ref. No.	1.1.C.C49.10 GCV1600-32
description	ventilation grille for aspiration plastic black H 50mm L 260mm Qty 1 pcs		

frame			
			
1			
GEV No.	699412	Ref. No.	1.1.C.C63.14 GCV1600-29
description	door frame inner W 378mm D 10mm H 385mm		

			
1			
GEV No.	699413	Ref. No.	1.1.C.C63.13 GCV1600-28
description	door frame outer W 375mm D 10mm H 375mm		

side parts			
			
1			
GEV No.	698862	Ref. No.	1.1.C.C38.19 GGC1078-20-black
description	side panel for door L 590mm thickness 17mm		

			
1			
GEV No.	698906	Ref. No.	A1.1.C.C21.12
description	side panel for door W 47mm D 29mm H 660mm plastic		
For models:	GRV1100		

			
1			
GEV No.	698852	Ref. No.	1.1.C.C15.02.02 GGC1078-01-black
description	side panel mounting pos. left/right black W 316mm D 13.5mm H 190mm plastic Qty 1 pcs for vitrine		

			
1			
GEV No.	692404	Ref. No.	1.1.C.C15.02.01 GGC1078-01-white GGC1078-WHITE-01 GGC1078-WHITE-1
description	side panel mounting pos. left/right white W 316mm D 13.5mm H 190mm plastic Qty 1 pcs for vitrine		

			
1			
GEV No.	699444	Ref. No.	1.1.C.C56.06 GGC2270-40-black
description	side panel mounting pos. vertical W 40mm D 40mm H 1370mm black		

			
1			
GEV No.	699443	Ref. No.	1.1.C.C56.03 GGC2270-40-white
description	side panel mounting pos. vertical W 40mm D 40mm H 1370mm white		

			
1			
GEV No.	699324	Ref. No.	VRX38.12
description	side panel W 390mm D 40mm H 222mm		
For models:	GHS1134, GHS1600, GHS2134, GHS2600		

			
1			
GEV No.	698850	Ref. No.	1.1.C.C15.03.10 GGC2270-50-black
description	side panel W 418mm H 410mm plastic black		

miscellaneous			
			
1			
GEV No.	699427	Ref. No.	1.1.C.C03.01 GGC1078-28-white GGC2270-32-white
description	blank H 5mm ø 12mm		

			
1			
GEV No.	699428	Ref. No.	1.1.C.C03.02 GGC1078-28-black GGC2270-32-black
description	blank H 5mm ø 12mm		

			
1			
GEV No.	692369	Ref. No.	1.1.C.C63.71 GCV1600-47
description	bracket for thermometer W 81mm H 41mm plastic Qty 1 pcs		

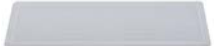
			
1			
GEV No.	692410	Ref. No.	1.1.C.C09.01 GGC1078-26 GGC2270-27 GGC2270-33
description	cover for lighting mounting pos. inner L 230mm W 84mm H 2.5mm plastic Qty 1 pcs		
For models:	GGC1270		

			
1			
GEV No.	698909	Ref. No.	A1.1.B.B19.02
description	fixing plate for condenser L 300mm W 170mm H 55mm thickness 1mm		
For models:	GRV1100		

			
1			
GEV No.	699315	Ref. No.	SLZE0042
description	fixing plate for evaporator L 55mm W 27mm H 6mm		
For models:	GBC1001, GBC1002, GBC1003		

			
1			
GEV No.	692370	Ref. No.	1.1.C.C63.70 GCV1600-06
description	rail for gasket L 740mm W 42mm H 19mm plastic Qty 1 pcs		

			
1			
GEV No.	692380	Ref. No.	RW40.31
description	spacer for bottles L 30mm W 8mm H 17mm plastic Qty 1 pcs		
For models:	GHR1040, GHR2600		

shelf rails			
			
1			
GEV No.	698905	Ref. No.	A1.1.C.C21.14
description	centre web mounting pos. rear for vitrine W 65mm D 26.5mm H 665mm plastic		
For models:	GRV1100		

			
1			
GEV No.	698908	Ref. No.	A1.1.C.C21.13
description	guide mounting pos. left/right for vitrine W 45mm D 38mm H 665mm 1 pair plastic		
For models:	GRV1100		



glass panels

glass panels

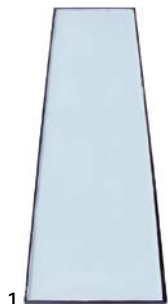

1

GEV No.	692293	Ref. No.	1.1.E.E2.02.44 GGC2270-38
description	glass panel L 1392mm W 376mm thickness 10mm flat mounting pos. lateral for display refrigerator		
For models:	GGC1270		

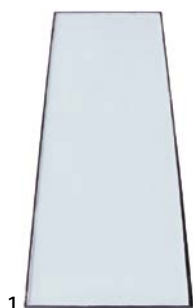

1

GEV No.	699328	Ref. No.	1.1.E.E2.02.45 GGC2270-39
description	glass panel L 1395mm W 464mm thickness 17.5mm mounting pos. rear refrigerated show case GGC2270		
For models:	GGC1270		



1

GEV No.	699330	Ref. No.	1.1.E.E2.02.76 GCV1600-27
description	glass panel L 360mm W 357mm thickness 10.5mm for door GCV1600		

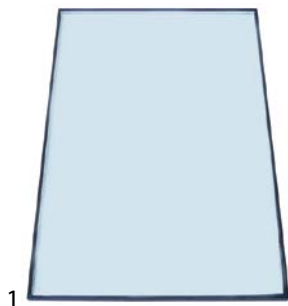

1

GEV No.	692291	Ref. No.	1.1.E.E2.02.64 GGC1078-21
description	glass panel L 635mm W 390mm thickness 10mm flat mounting pos. door for display refrigerator		



1

GEV No.	699326	Ref. No.	1.1.E.E2.02.74 GCV1600-21
description	glass panel L 645mm W 595mm H 16mm thickness 8mm mounting pos. left for display refrigerator GCV1600		



1

GEV No.	699327	Ref. No.	1.1.E.E2.02.75 GCV1600-26
description	glass panel L 645mm W 595mm H 16mm thickness 8mm mounting pos. right for display refrigerator GCV1600		

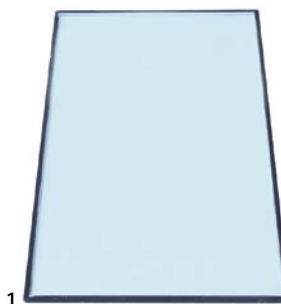

1

GEV No.	692292	Ref. No.	1.1.E.E2.02.12 GGC1078-37
description	glass panel L 655mm W 390mm thickness 10mm flat mounting pos. rear for display refrigerator		

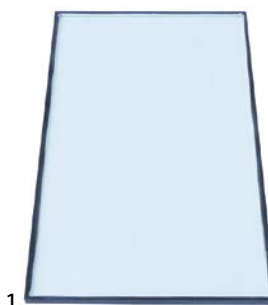

1

GEV No.	692290	Ref. No.	1.1.E.E2.02.11 GGC1078-17
description	glass panel L 660mm W 332mm thickness 10mm flat mounting pos. lateral for fridge		



1

GEV No.	698939	Ref. No.	A1.1.E.E07.09.02
description	glass panel L 715mm W 420mm H 120mm thickness 20mm arched mounting pos. left/right		
For models:	GRV1100		



1

GEV No.	699329	Ref. No.	1.1.E.E2.04.15.A0 GCV1600-16
description	glass panel L 773mm W 710mm thickness 12mm mounting pos. front-side for display refrigerator GCV1600		



1

GEV No.	698923	Ref. No.	A1.1.E.E07.09.03
description	glass panel ø 390mm thickness 6mm		
For models:	GRV1100		

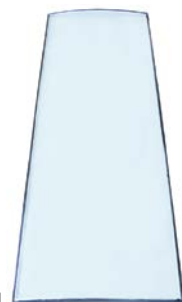

1

GEV No.	692289	Ref. No.	1.1.E.E2.02.65 GGC2270-20
description	glass panel W 460mm H 1360mm thickness 17mm curved for fridge		
For models:	GGC1270		

accessories



1

GEV No.	699159	Ref. No.	A1.1.D.D06.06.02
description	insulation for door L 315mm thickness 19mm W 85mm		
For models:	GRV1100		



1

GEV No.	699431	Ref. No.	1.1.B.B14.05 GCV1600-13
description	rail L 775mm		

doors



1

GEV No.	699176	Ref. No.	S24AC22A0001-LEFT
description	door L 515mm W 425mm H 55mm mounting pos. left		
For models:	GPS2600, GSA2600, GSD2600, GSF2600		



1

GEV No.	699177	Ref. No.	S24AC22A0001-RIGHT
description	door L 515mm W 425mm H 55mm mounting pos. right		
For models:	GPS2600, GSA2600, GSD2600, GSF2600		



1

GEV No.	694541	Ref. No.	RW40.03
description	door W 395mm H 540mm		
For models:	GHR1040, GHR2600		



1

GEV No.	698973	Ref. No.	BLGM9S01 HBC1002-44
description	glass door W 440mm H 770mm mounting pos. right		



1

GEV No.	698859	Ref. No.	1.1.C.C11.02 GGC1078-16-black GGC1078-23-black
description	door frame L 425mm W 15mm H 28mm mounting pos. upper/lower		



1

GEV No.	699378	Ref. No.	GBC1002-47 GBC1003-47
description	glass door W 440mm H 770mm with catch D 25mm		



1

GEV No.	698938	Ref. No.	A1.1.E.E07.09.01
description	glass door L 725mm W 418mm H 122mm for vitrine		
For models:	GRV1100		



1

GEV No.	698972	Ref. No.	BLGM9S00 HBC1002-45
description	glass door W 440mm H 770mm with lock mounting pos. left		
accessories for	698972		
		GEV No.	902210
		Ref. No.	JNMA0000
	gasket L 930mm Qty 1 dimensions 5x6mm		



1

GEV No.	699379	Ref. No.	GBC1002-49 GBC1003-49
description	glass door W 440mm H 770mm D 25mm		



1

GEV No.	698971	Ref. No.	BLGM9S52 HBC2003-50
description	glass door W 440mm H 770mm with lock mounting pos. right		



1

GEV No.	698969	Ref. No.	BLGM9S57 HBC2003-48
description	glass door W 450mm H 770mm mounting pos. left		



1

GEV No.	698970	Ref. No.	BLGM9S5M HBC2003-49
description	glass door W 450mm H 770mm with lock mounting pos. centre		



1

GEV No.	699380	Ref. No.	GBC1001-44
description	glass door W 600mm H 800mm D 30mm		



1

GEV No.	699405	Ref. No.	S24AC50A0004
description	shelf L 255mm W 890mm H 30mm stainless steel		
For models:	GSD2600		

door mechanics

bolts



1

GEV No.	699424	Ref. No.	1.1.B.B09.03 GGC1078-36
description	door bolt H 7mm W 7mm L 20.5mm mounting pos. upper		



1

GEV No.	699433	Ref. No.	A1.1.B.B19.09
description	door bolt L 45.5mm ø 7mm		
For models:	GRV1100		

bushes



1

GEV No.	699161	Ref. No.	A1.1.B.B15.18
description	bush for door H 11.5mm ø 10mm		
For models:	GRV1100		



1

GEV No.	699429	Ref. No.	GGC1078-34-white
description	bush H 15mm ø 10mm		





1

GEV No.	699430	Ref. No.	1.1.C.C13.02 GGC1078-34-black
description	bush H 15mm ø 10mm		



 <p>1</p>			
GEV No.	699435	Ref. No.	A1.1.C.C19.07
description	bush H 17.5mm ø 16.8mm		
For models:	GRV1100		

miscellaneous			
 <p>1</p>			
GEV No.	694928	Ref. No.	WJCX0000
description	door magnet L 46mm W 16mm H 14.5mm		

 <p>1</p>			
GEV No.	694929	Ref. No.	WJXC0000
description	plate for magnet L 45mm W 12mm H 1.5mm mounting distance 32mm		

door bumpers			
 <p>1</p>			
GEV No.	699442	Ref. No.	A1.1.B.B19.05
description	door bumper H 3mm W 14mm L 664mm mounting pos. vertical		
For models:	GRV1100		

 <p>1</p>			
GEV No.	699441	Ref. No.	A1.1.B.B19.06
description	door bumper H 7mm W 9mm L 355mm mounting pos. horizontal		
For models:	GRV1100		

for ice-cube maker

doors

doors

 <p>1</p>			
GEV No.	694417	Ref. No.	40-1245-9
description	door for ice-cube maker W 370mm H 180mm thickness 29mm grey		
For models:	GIM1023, GIM2023		

 <p>1</p>			
GEV No.	694408	Ref. No.	40-0937-9
description	door for ice-cube maker W 475mm H 235mm thickness 28mm grey		
For models:	GIM1038, GIM2038		

curtains

accessories

lamellas

 <p>1</p>			
GEV No.	694426	Ref. No.	40-1258-9
description	lamella for curtain W 38mm H 94mm ø 6.5mm angled		
For models:	GIM1038, GIM2038		

 <p>1</p>			
GEV No.	694422	Ref. No.	40-0882-9
description	lamella for curtain W 38mm H 95mm ø 6.5mm		
For models:	GIM1023, GIM2023		

curtain rods

1 

GEV No.	694466	Ref. No.	30-0570-9
description	curtain rod for ice-cube maker L 316mm ø 6mm		
For models:	GIM1023, GIM2023		

1 

GEV No.	694421	Ref. No.	30-0455-9
description	curtain rod for ice-cube maker L 466mm ø 6mm		
For models:	GIM1038, GIM2038		

refrigeration pipes

1 

GEV No.	694418	Ref. No.	76-0240-3
description	refrigeration pipe with collector		
For models:	GIM1038, GIM2038		

1 

GEV No.	694467	Ref. No.	76-0267-9
description	refrigeration pipe with collector		
For models:	GIM1023, GIM2023		

for pour machines

filter pans

filter pans

BARTSCHER

1 

GEV No.	950000	Ref. No.	A038004
description	filter pan aluminium with percolator tube edition since year of construction 10/2007 ø 205mm H 50mm suitable for PRO 40T		
For models:	GCM1006		

drain taps

drain taps

1 

GEV No.	531128	Ref. No.	A0ND029	
description	outlet tap complete tube ø 19mm pipe length 22mm thread M15x1 black			
For models:	GCM1006, GCM2009, GCM3016			
spare parts for	531128			
	GEV No.	531129	Ref. No.	A0ND032
	gasket for outlet tap H 29mm ø 14.5mm suitable for BARTSCHER			

components

1 

GEV No.	531129	Ref. No.	A0ND032
description	gasket for outlet tap H 29mm ø 14.5mm suitable for BARTSCHER		
For models:	GCM1006, GCM2009, GCM3016		



liquid level pipes

liquid level pipes



1

GEV No.	531131	Ref. No.	A0ND043
description	water level tube ED ø 12mm ID ø 10mm H 202mm for coffee machine		
For models:	GCM1006		
accessories for	531131		
	GEV No.	504297	Ref. No. A0ND036
	gasket for water level tube ED ø 13mm ID ø 6mm silicone		



1

GEV No.	531130	Ref. No.	A039690
description	water level tube ED ø 12mm ID ø 10mm H 262mm for coffee machine		
For models:	GCM2009, GCM3016		
accessories for	531130		
	GEV No.	504297	Ref. No. A0ND036
	gasket for water level tube ED ø 13mm ID ø 6mm silicone		

accessories

gaskets



1

GEV No.	504297	Ref. No.	A0ND036
description	gasket for water level tube ED ø 13mm ID ø 6mm silicone		
For models:	GCM1006, GCM2009, GCM3016		

miscellaneous



1

GEV No.	531308	Ref. No.	A039688 A040627
description	pipe L 335mm W 43mm tube ø 9mm		
For models:	GCM2009, GCM3016		



1

GEV No.	531208	Ref. No.	A0ND038
description	reset pin L 107mm W 33mm suitable for BARTSCHER		
For models:	GCM1006, GCM2009, GCM3016		



for pyroceram ranges

ceramic hobs

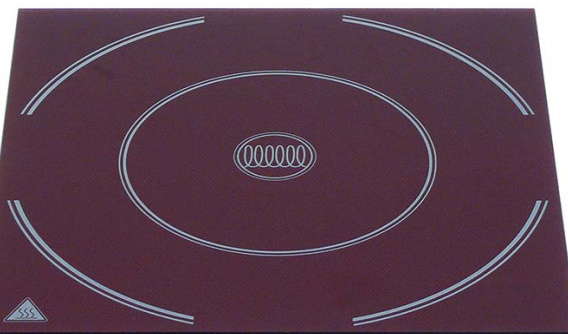
ceramic glass plates



1

GEV No.	694932	Ref. No.	MBA000234
description	ceramic plate for induction device L 274mm W 274mm thickness 4mm		
accessories for	694932		
	GEV No.	890015	Ref. No. —
	high temperature silicone OTTOSEAL S17 t.max. 285°C red/brown cartridge 310ml		
	GEV No.	890060	Ref. No. —
	adhesive PACTAN 6076 310ml 250°C anthracite		

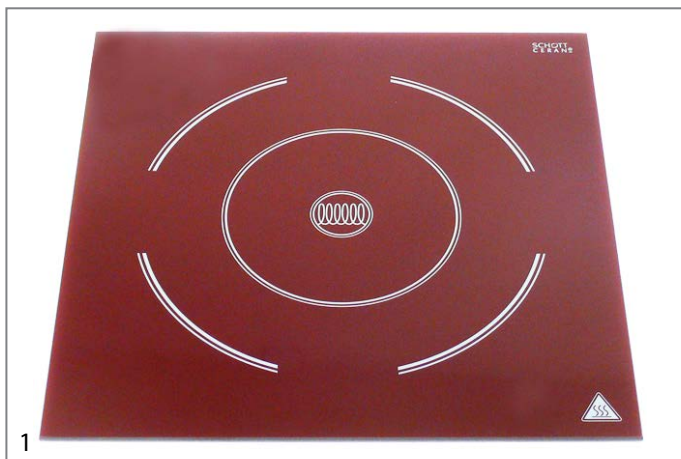

GEV No.	694579	Ref. No.	GIC3035-01 GIC3035-B01 GIC3500-01 GIC3500-A01 MBF000032R
description	ceramic plate L 300mm W 300mm thickness 4mm		
For models:	GIC3500		

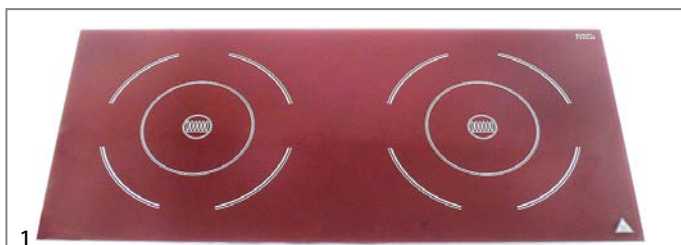

GEV No.	694582	Ref. No.	GIC3535-01 GIC3535-D01
description	ceramic plate L 655mm W 300mm thickness 4mm		
For models:	GIC3535		

for deep fryers

fasteners



GEV No.	692544	Ref. No.	2.02HDF4260701 GDF2124-034 GDF2124-34 GDF2128-025 HDF2128-023
description	mounting strap L 63mm W 25mm H 15mm		
For models:	GDF2124, GDF2128		

lids



GEV No.	970745	Ref. No.	016240415
description	lid for fryer SS L 295mm W 215mm H 7mm		
For models:	GDF1004, GDF2024		



GEV No.	698544	Ref. No.	3.CP0603070100 GDF1104-032 GDF1108-039 GDF2124-032 GDF2128-040 GDF2128-40 HDF1108-035 HDF2128-036
description	mushroom cap handle handle ø 50mm ø 70mm L 36mm plastic black		
For models:	GDF1104, GDF1108, GDF2124, GDF2128		

basket holders





GEV No.	970744	Ref. No.	016240426
description	basket support for fryer L 139mm W 44mm H 8mm suitable for BARTSCHER		
For models:	GDF1004, GDF2024		



miscellaneous

			
1			
GEV No.	694738	Ref. No.	HDF1108-030 HDF2128-031
description	bezel plate L 45mm H 1mm ID ø 30mm		

			
1			
GEV No.	694737	Ref. No.	2.02HDF8A130001 GDF1108-032 GDF1108-32 GDF2128-033
description	bezel plate L 63mm H 15mm ID ø 26mm		
For models:	GDF1108, GDF2128		

			
1			
GEV No.	699212	Ref. No.	2.HDF8A460201 GDF2128-020
description	pipe stainless steel L 30mm W 13mm thread M5		
For models:	GDF1108, GDF2128		

for grills

sumps

			
1			
GEV No.	692237	Ref. No.	263990
description	grease collecting tray L 357mm W 37mm H 29mm		
For models:	GPG1001		

			
1			
GEV No.	692238	Ref. No.	263983
description	grease collecting tray L 497mm W 37mm H 29mm		
For models:	GPG2001		

for convection ovens/combi-steamers



			
1			
GEV No.	692843	Ref. No.	00004380
description	spacer bush ID ø 7mm H 7.5mm ED ø 17.5mm for glass plate white Spacer		
For models:	GCO2001		

spare parts and accessories

			
1			
GEV No.	693043	Ref. No.	F02005
description	guard		
For models:	GTO1001, GTO2001		

glass panels

			
1			
GEV No.	693230	Ref. No.	01981248300
description	glass panel L 430mm W 345mm thickness 4mm rectangular		
For models:	GCO1001		

				
1				
GEV No.	692841	Ref. No.	21100870	
description	glass panel L 447mm mounting pos. inner W 585mm			
For models:	GCO2001			
accessories for	692841			
	GEV No.	692842	Ref. No.	21100880
	glass panel L 450mm mounting pos. outer W 590mm			
	GEV No.	692843	Ref. No.	00004380
	spacer bush ID ø 7mm H 7.5mm ED ø 17.5mm for glass plate white Spacer			





				
1				
GEV No.	692842	Ref. No.	21100880	
description	glass panel L 450mm mounting pos. outer W 590mm			
For models:	GCO2001			
accessories for	692842			
	GEV No.	692841	Ref. No.	21100870
	glass panel L 447mm mounting pos. inner W 585mm			

Table continues overleaf

accessories for	692842		
	GEV No.	692843	Ref. No. 00004380
	spacer bush ID ø 7mm H 7.5mm ED ø 17.5mm for glass plate white Spacer		
	GEV No.	694993	Ref. No. 00011680
	door handle ø 18mm L 350mm stainless steel M5 black matt		

	1		
GEV No.	691811	Ref. No.	09982338418
description	glass panel L 583mm W 450mm mounting pos. outer		
For models:	GCO1001		

Fans - accessories

	1		
GEV No.	701630	Ref. No.	00012330
description	air duct for cross flow fan for combi-steamer plastic grey		
For models:	GCO2001		

for hot dog machines

lids			
	1		
GEV No.	694450	Ref. No.	F05051
description	lid for hot dog machine ø 205mm		
For models:	GHM1001		

glass cylinders			
	1		
GEV No.	693002	Ref. No.	F05009
description	glass cylinder ø 200mm Pyrex glass H 240mm		
For models:	GHM1001		

skewers			
	1		
GEV No.	693018	Ref. No.	F05010
description	bun spikes for hot dog machine		
For models:	GHM1001		

water containers			
	1		
GEV No.	693005	Ref. No.	F05022
description	water container for hot dog machine PTFE/aluminium		
For models:	GHM1001		

for induction devices			
	1		
GEV No.	699334	Ref. No.	WJD000047
description	deflector for induction device L 280mm W 17mm H 14mm		

	1		
GEV No.	699331	Ref. No.	WJD000050
description	grease filter L 125mm W 120mm H 9mm		

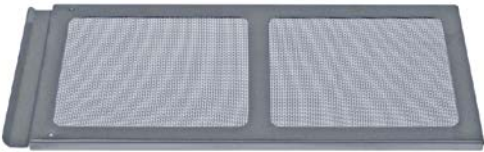

 <p>1</p>			
GEV No.	970790	Ref. No.	AB600022 GIC3035-12 GIC3035-B12 GIC3500-12 GIC3500-A12 GIC3535-12 GIC3535-D12 GIC4035-12 GIC4035-C12
description	grease filter W 323mm H 144mm thickness 8mm SS layers 2 outer grids 1 inner grids 1 for induction device		
For models:	GIC3500, GIC3535, GIC4035		

 <p>1</p>			
GEV No.	699333	Ref. No.	DQA020343R SLA010075 SLA010075DQA020343R
description	housing for knob L 60mm W 58mm H 25.5mm		

 <p>1</p>			
GEV No.	699336	Ref. No.	AB300015
description	insert for PCB L 298mm W 267mm H 60mm		

 <p>1</p>			
GEV No.	699335	Ref. No.	WJD000048
description	sheet L 320mm W 15mm H 29mm		

for tilting bratt pans

miscellaneous

 <p>1</p>			
GEV No.	523510	Ref. No.	00000000860
description	deep-groove ball bearing type 6202-2RS shaft ø 15mm ED ø 35mm W 11mm with sealing discs deep-groove ball bearing DIN 625-1		
For models:	GFS1025, GFS2022, GFS2025, HFS2019, HFS2022, HFS2025		

for panini grill

guiding pieces

 <p>1</p>			
GEV No.	698565	Ref. No.	902097
description	shaft bearing mounting pos. rear L 35mm W 14mm H 12.5mm		
For models:	GPG1001, GPG2001		

for contact grills

miscellaneous

 <p>1</p>			
GEV No.	692241	Ref. No.	902195
description	spindle for contact grill		
For models:	GPG2001		

for microwaves

electric

displays

 <p>1</p>			
GEV No.	692457	Ref. No.	GMW1030-P40
description	disc for display plexiglas W 32mm L 70mm thickness 1.3mm Qty 1 pcs		
For models:	GMW1030		

microswitches

holders



1

GEV No.	347797	Ref. No.	GMW1030-P23
description	bracket for microswitch L 165mm W 65mm Qty 1 pcs		
For models:	GMW1030		
accessories for	347797		



GEV No.	347794	Ref. No.	GMW1030-P247
description	lever for microswitch L 28mm small ID ø 5mm W 22mm Qty 1 pcs		



GEV No.	347795	Ref. No.	GMW1030-P246
description	lever for microswitch L 45mm middle ID ø 5mm W 22mm Qty 1 pcs		



GEV No.	347796	Ref. No.	GMW1030-P245
description	lever for microswitch L 63mm large ID ø 5mm W 22mm Qty 1 pcs		

levers



1

GEV No.	347794	Ref. No.	GMW1030-P247
description	lever for microswitch L 28mm small ID ø 5mm W 22mm Qty 1 pcs		
For models:	GMW1030		



1

GEV No.	347795	Ref. No.	GMW1030-P246
description	lever for microswitch L 45mm middle ID ø 5mm W 22mm Qty 1 pcs		
For models:	GMW1030		



1

GEV No.	347796	Ref. No.	GMW1030-P245
description	lever for microswitch L 63mm large ID ø 5mm W 22mm Qty 1 pcs		
For models:	GMW1030		

line filters



1

GEV No.	403184	Ref. No.	GMW1030-C04
description	line filter for microwave type GMW1030 250V 50/60Hz conductor 2 PCB connection male faston 6.3mm L 90mm H 20mm W 70mm PCB Qty 1 pcs cable length 130mm		
For models:	GMW1030		



1

GEV No.	403188	Ref. No.	263029001088 GMW1025-C04
description	line filter microwave for GMW1025 250V 50/60Hz conductor 2 PCB connection male faston 4.8mm L 80mm H 20mm W 40mm PCB Qty 1 pcs cable length 120mm type DNV-0818A-5		

housings

outer parts



1

GEV No.	692453	Ref. No.	GMW1030-P240
description	frame L 484mm W 72mm H 34mm for microwave Qty 1 pcs		
For models:	GMW1030		

ceramic plates

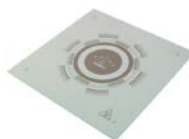



1

GEV No.	692350	Ref. No.	243999000108 GMW1025-P162	
description	ceramic plate L 330mm W 335mm for microwave thickness 3.5mm GMW1025 Qty 1 pcs			
accessories for	692350			
	GEV No.	901698	Ref. No.	593219000016 GMW1025-P161
	gasket L 330mm W 325mm silicone for ceramic plate Qty 1 pcs			

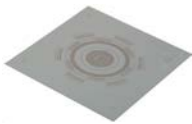

			
1			
GEV No.	692462	Ref. No.	GMW1030-P161
description	ceramic plate L 365mm W 353mm for microwave thickness 4mm GMW1030 suitable for GALANZ		
For models:	GMW1030		

miscellaneous			
			
1			
GEV No.	601869	Ref. No.	213149000023 GMW1025-P04
description	bracket L 78mm W 20mm H 50mm for condenser Qty 1 pcs		

doors			
films			
			
1			
GEV No.	692451	Ref. No.	515059000119 GMW1025-P114
description	film L 287mm W 159mm for door inside thickness 0.1mm transparent suitable for GALANZ plastic Qty 1 pcs		

door hinges			
			
1			
GEV No.	701250	Ref. No.	GMW1030-P377
description	hook lower for door latch L 51mm W 6mm H 28mm hole ø 4.4mm Qty 1 pcs		
For models:	GMW1030		

door catches			
			
1			
GEV No.	347902	Ref. No.	GMW1025-P198
description	door catch L 174mm W 48mm for microwave GMW1025 suitable for GALANZ plastic Qty 1 pcs		

tension springs			
			
1			
GEV No.	701249	Ref. No.	GMW1030-P118
description	tension spring ø 7.3mm total length 25.5mm wire gauge ø 1mm for door latch Qty 1 pcs		
For models:	GMW1030		

for saladettes			
			
1			
GEV No.	692740	Ref. No.	GDS1600-16 GPS1600-16 GSF1134-16 GSF1600-16 S900.16
description	cap for drain pipe ø 20mm mounting ø 15mm H 17.5mm plastic		
For models:	GDS1134, GDS1600, GPS1134, GPS1600, GSA1134, GSA1600, GSF1134, GSF1600		

			
1			
GEV No.	692739	Ref. No.	GDS1600-15 GPS1600-15 GSF1134-15 GSF1600-15 S900.15
description	drain pipe ED ø 19mm ID ø 15mm H 79mm plastic thread M20		
For models:	GDS1134, GDS1600, GPS1134, GPS1600, GSA1134, GSA1600, GSF1134, GSF1600		

			
1			
GEV No.	692742	Ref. No.	GDS1600-14 GPS1600-14 GSF1134-14 GSF1600-14 S900.14
description	nut for drain pipe thread M20 H 18mm WS 26 plastic		
For models:	GDS1134, GDS1600, GPS1134, GPS1600, GSA1134, GSA1600, GSF1134, GSF1600		

housing and bezels



1

GEV No.	692343	Ref. No.	GSD1600-54 PS200.54
description	bridge for saladette L 182mm W 25mm H 13mm Qty 1 pcs		
For models:	GDS1600		



1

GEV No.	692259	Ref. No.	GPS1600-59
description	bridge for saladette mounting pos. inner L 182mm W 23mm H 12.5mm aluminium		
For models:	GPS1134, GPS1600		



1

GEV No.	692260	Ref. No.	GPS1600-60
description	bridge for saladette mounting pos. outer L 207mm W 35mm H 41mm aluminium Qty 2 pcs		
For models:	GPS1134, GPS1600		



1

GEV No.	692692	Ref. No.	KITSR4AC2A00
description	bridge L 168/330/534mm 6 pieces		
For models:	GSA2600		



1

GEV No.	692691	Ref. No.	KITSR4AC4A00
description	bridge set 2-piece for saladette W 25mm D 184mm H 11mm		
For models:	GPS2600, GSD2600		



1

GEV No.	993263	Ref. No.	P04AC20A0006
description	cutting board L 950mm W 130mm H 20mm		
For models:	GSA2600		



1

GEV No.	692257	Ref. No.	VRX.01 VRX.02 VRX.04 VRX.05 VRX.06 VRX33-38
description	mounting set for glass plate for saladette 53-piece Qty 1 pcs 6x mounting clip 7x angle 12x flat-headed bolt 14x bush 14x screw connection		
For models:	GHS1134, GHS1600, GHS2134, GHS2600		



1

GEV No.	692371	Ref. No.	S900.25
description	plug mounting ø 5.5mm ø 10mm H 13mm plastic Qty 1 pcs		
For models:	GSA1134, GSA1600		



doors



1

GEV No.	699325	Ref. No.	GSF1600-49 S900.54
description	door mounting pos. left W 427mm H 520mm D 36mm		
For models:	GDS1600, GSA1134, GSA1600, GSF1134, GSF1600		



1

GEV No.	699321	Ref. No.	GSF1600-07 S900.07
description	door mounting pos. right W 427mm H 520mm D 36mm		
For models:	GDS1600, GSA1134, GSA1600, GSF1134, GSF1600		



1

GEV No.	701546	Ref. No.	S24AC22A0006
description	door bolt L 28mm mounting pos. upper thread L 8mmmm		
For models:	GPS2600, GSA2600, GSD2600, GSF2600		

for salamander grills



1

GEV No.	692240	Ref. No.	30045
description	drain tray for salamander grill L 350mm W 245mm		
For models:	GTO1001, GTO2001		

for dishwashers

containers

container lids



1

GEV No.	524508	Ref. No.	906418
description	lid ø 61mm for salt tank		
For models:	GGW2001		

salt tanks



1

GEV No.	510929	Ref. No.	901770
description	salt tank ø 120mm H 117mm hose ø 10mm mounting ø 70mm overall height 157mm		
For models:	GGW2001		

spare parts for	510929		
GEV No.	506015	Ref. No.	—
	O-ring EPDM thickness 3.53mm ID ø 39.69mm Qty 1 pcs		

Table continues overleaf

spare parts for		510929	
	GEV No.	510018	Ref. No. —
	nut ø 92mm H 10.5mm for salt tank ID ø 64mm		
	GEV No.	524177	Ref. No. —
	lid ø 69mm H 20mm for salt tank ID ø 50mm		
accessories for		510929	
	GEV No.	510071	Ref. No. —
	flat gasket rubber ED ø 81mm ID ø 68mm thickness 3mm for salt tank Qty 1 pcs		
	GEV No.	510654	Ref. No. —
	gasket H 6mm D1 ø 82mm D2 ø 68mm		
	GEV No.	510883	Ref. No. —
	gasket rubber ED ø 86mm ID ø 66mm thickness 2mm for salt tank Qty 1 pcs		

accessories

	1		
GEV No.	524507	Ref. No.	902830
description	nut ø 83mm for salt tank external height 10mm Qty 1 pcs		
For models:	GGW2001		

boilers

boilers for dishwashers

	1		
GEV No.	508429	Ref. No.	900384
description	boiler 3500W 230V ø 127mm L 400mm		
For models:	GDW1001		

	1		
GEV No.	517643	Ref. No.	900368
description	boiler ø 105mm L 340mm inlet ø 12mm		
For models:	GGW1001, GGW2001		

softener cartridges

softening columns

	1		
GEV No.	530000	Ref. No.	902150
description	softener 4-fold L 380mm W 180mm		
For models:	GGW2001		

air traps

air traps

	1		
GEV No.	519250	Ref. No.	907254
description	air trap		
For models:	GDW1001		

	1		
GEV No.	519513	Ref. No.	905266
description	air trap L 40mm W 30mm H 45mm thread M12x1.75 hose ø 5mm plastic		
For models:	GGW1001, GGW2001		

air trap accessories

	1		
GEV No.	511385	Ref. No.	907926
description	flange L 46mm W 32mm for air trap		
For models:	GDW1001		

	1		
GEV No.	511197	Ref. No.	903261
description	gasket L 46mm W 33mm for air trap		
For models:	GDW1001		

backflow preventers

backflow preventers



1

GEV No.	516101	Ref. No.	TR2433
description	backflow preventer dishwasher hose ø 12mm		
For models:	GDW1001		
spare parts for	516101		
	GEV No.	506367	Ref. No. —
	flat gasket rubber ED ø 40mm ID ø 28mm thickness 1.8mm Qty 1 pcs		

miscellaneous



1

GEV No.	850121	Ref. No.	904571
description	bracket for softener L 220mm W 40mm H 40mm for Silanos		
For models:	GGW2001		

door mechanics

hinges



1

GEV No.	519035	Ref. No.	901245
description	door hinge bores 3 hinge		
For models:	GGW1001, GGW2001		



1

GEV No.	502263	Ref. No.	901247
description	hinge mounting pos. left L 94mm N45/N50		
For models:	GDW1001		



1

GEV No.	502262	Ref. No.	901246
description	hinge mounting pos. right L 94mm N45/N50		
For models:	GDW1001		

hinge pins



1

GEV No.	519204	Ref. No.	904795
description	hinge pin hinge pin		
For models:	GGW1001, GGW2001		

locks



1

GEV No.	519247	Ref. No.	906121
description	door catch door locking catch		
For models:	GDW1001, GGW1001, GGW2001		
accessories for	519247		
	GEV No.	519050	Ref. No. 902023
	nut thread M12x1.75 H 4mm WS 16 SS Qty 1 pcs for snap lock		

miscellaneous



1

GEV No.	504435	Ref. No.	908146
description	flat gasket plastic ED ø 18mm ID ø 9.5mm thickness 2.5mm for door hinge Qty 1 pcs		
For models:	GDW1001		

screw connections



1

GEV No.	519054	Ref. No.	902070
description	locknut thread 1"		
For models:	GGW1001, GGW2001		



1

GEV No.	519055	Ref. No.	902080
description	locknut thread 1 1/4"		
For models:	GGW1001		

washing and rinsing systems



1

GEV No.	501351	Ref. No.	908124
description	flange mounting pos. upper ø 91mm H 11mm ID ø 45mm hole ø 5.5mm		
For models:	GDW1001		



1

GEV No.	519122	Ref. No.	903351
description	flat gasket for rinse arm		
For models:	GGW1001, GGW2001		



1

GEV No.	519444	Ref. No.	905449
description	opposite support mounting pos. upper/lower for wash arm support suitable for Silanos		
For models:	GDW1001		
accessories for	519444		



GEV No.	519445	Ref. No.	908141
description	gasket D1 ø 80mm D2 ø 50mm thickness 3mm with 4 screw holes		



1

GEV No.	519238	Ref. No.	906002
description	plain washer ID ø 15mm ED ø 33mm thickness 0.8mm SS Qty 1 pcs		
For models:	GGW2001		



1

GEV No.	519201	Ref. No.	904765
description	rinse pipe		
For models:	GGW1001, GGW2001		



1

GEV No.	519437	Ref. No.	902183
description	spacer piece		
For models:	GDW1001		



1

GEV No.	519085	Ref. No.	902880
description	Thumb screw ø 34mm thread M6		
For models:	GDW1001, GGW1001		



1

GEV No.	519438	Ref. No.	903743
description	wash pipe ø 37mm L 700mm plastic suitable for Silanos		
For models:	GDW1001		

for toasters

spare parts and accessories



1

GEV No.	693043	Ref. No.	F02005
description	guard		
For models:	GTO1001, GTO2001		



miscellaneous

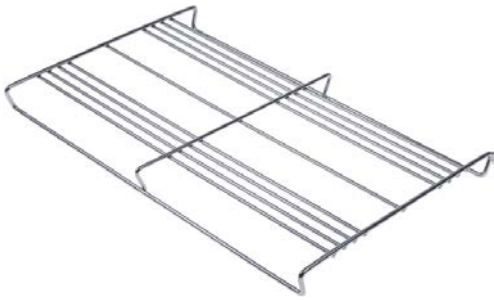

1

GEV No.	694449	Ref. No.	F01069
description	guard L 315mm W 200mm for toaster H 24mm		
For models:	GTO1001, GTO2001		

for vacuum packers

lids



1

GEV No.	699600	Ref. No.	HVS1000-02 YJS820-2
description	lid L 420mm W 350mm HVS1000		

air cylinders

air cylinders



1

GEV No.	692702	Ref. No.	HVS1000-17 YJS820-17
description	air cylinder ø 53mm H 30.5mm shaft length 12.8mm 1 pair		

housing and bezels

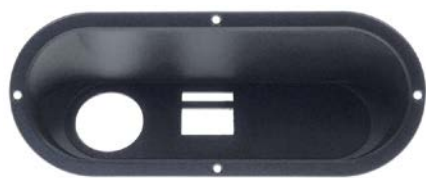

1

GEV No.	699610	Ref. No.	HVS1000-34 YJS820-34
description	front panel for vacuum packing machine W 100mm H 40mm HVS1000 L 250mm		

rubber bumper



1

GEV No.	699607	Ref. No.	HVS1000-31 YJS820-31
description	rubber pad H 3mm L 30mm W 20mm 4 pieces		

sealing bars



1

GEV No.	699601	Ref. No.	HVS1000-07 YJS820-7
description	sealing bar L 295mm W 20mm H 24mm		

base plate



1

GEV No.	699617	Ref. No.	HVS1000-24 YJS820-24
description	base plate L 132mm W 105mm H 0.5mm		



1

GEV No.	699611	Ref. No.	HVS1000-01 YJS820-1
description	base plate L 30mm W 30mm H 2mm 1 pair hole ø 5mm		



1

GEV No.	699445	Ref. No.	HVS1000-43 YJS820-43
description	base plate L 95mm W 90mm H 0.5mm		

miscellaneous



GEV No.	699604	Ref. No.	HVS1000-48 YJS820-48
description	bracket L 38mm W 36mm H 124mm for microswitch		



GEV No.	699605	Ref. No.	HVS1000-14 YJS820-14
description	clamp L 95mm W 34mm H 48mm		



GEV No.	699608	Ref. No.	HVS1000-10 YJS820-10
description	nut for air inlet thread 1/4"		



GEV No.	699613	Ref. No.	HVS1000-13 YJS820-13
description	plug L 9mm W 6mm 1 pair		



GEV No.	699602	Ref. No.	HVS1000-06 YJS820-6
description	rubber rail L 298mm W 23mm H 9.5mm for sealing bar		



GEV No.	699609	Ref. No.	HVS1000-12 YJS820-12
description	spring L 104mm W 32mm to secure		

for woks



GEV No.	694580	Ref. No.	GIC4035-01 GIC4035-C01
description	wok bowl for induction wok ø 310mm H 69mm Ceran		
For models:	GIC4035		

knobs

universal knobs



GEV No.	112733	Ref. No.	3.ZCK165BT19010101MGB GDF1104-020 GDF1108-007 GDF2124-020 GDF2124-20 GDF2128-007 HDF1108-020 HDF2128-020
description	knob zero mark t.max.°C ø 55mm shaft ø 6x4.6mm shaft flat upper black		
For models:	GDF1104, GDF1108, GDF2124, GDF2128		

miscellaneous



GEV No.	696506	Ref. No.	2858
description	knob for PCB ø 26mm black Qty 1 pcs		
For models:	GSM1000		



			
1			
GEV No.	692677	Ref. No.	SLZI0001
description	knob ø 26mm grey zero mark for thermostat shaft diameter 6x4mm Qty 1		

accessories

rosettes

			
1			
GEV No.	111806	Ref. No.	3.ZCK165BT20010101-1 GDF1104-019 GDF1108-006 GDF2124-019 GDF2128-006 GDF2128-6 HDF1108-019 HDF2128-019
description	rosette knob ø 16mm ø 55mm		
For models:	GDF1104, GDF1108, GDF2124, GDF2128		

handles and hand wheels

mushroom cap handles

			
1			
GEV No.	698641	Ref. No.	00000001111
description	mushroom cap handle thread M6 handle ø 34mm L 25mm aluminium		
For models:	GFS1030		

			
1			
GEV No.	111441	Ref. No.	016240439
description	mushroom cap handle with screw thread M4 handle ø 28mm L 24mm black for lid		
For models:	GDF1004, GDF2024		

handle bars

producer-specific handle rails

TECNOEKA

			
1			
GEV No.	694993	Ref. No.	00011680
description	door handle ø 18mm L 350mm stainless steel M5 black matt		
For models:	GCO2001		

handle rails

handle rails

			
1			
GEV No.	699449	Ref. No.	HSC350DD-48 HSC350DD-52 SLZB0020
description	handle rail for fridge L 220mm W 36mm H 23mm grey hole distance 120mm		
For models:	GSC2336		

bracket handles

			
1			
GEV No.	697997	Ref. No.	A0ND006
description	handle L 107mm H 20mm mounting distance 60mm for container ø 20mm W 46mm black		
For models:	GCM1006, GCM2009, GCM3016		

			
1			
GEV No.	699606	Ref. No.	HVS1000-03 YJS820-3
description	handle L 140mm H 38mm mounting distance 120mm hole ø 8.5mm		



1

GEV No.	698580	Ref. No.	A0ND001
description	pull handle L 114mm H 33mm mounting distance 106mm thread M3 W 30mm		
For models:	GCM1006, GCM2009		



1

GEV No.	691510	Ref. No.	016210828
description	pull handle L 130mm H 44mm mounting distance 112mm		
For models:	GDF1008, GDF2028		



1

GEV No.	698563	Ref. No.	A0ND024
description	pull handle L 144mm H 42mm mounting distance 136mm thread M3 W 32mm		
For models:	GCM3016		

folding grill handles



1

GEV No.	692149	Ref. No.	902264
description	handle L 155mm ø 30mm seat ø 10mm for contact grill		
For models:	GPG1001		

recessed handles



1

GEV No.	697995	Ref. No.	016240427
description	recessed handle L 90mm W 60mm H 23.5mm mounting distance 75mm plastic for fryer		
For models:	GDF1004, GDF2024		

door handles

door handles



1

GEV No.	694617	Ref. No.	GMW1030-P34
description	handle rod tube ø 16mm L 235mm aluminium Qty 1 pcs		
For models:	GMW1030		

miscellaneous



1

GEV No.	692409	Ref. No.	1.1.C.C12.06 GGC2270-18 GGC2270-18-white
description	door handle L 100mm W 32mm hole distance 68mm white		
For models:	GGC1270		



1

GEV No.	698858	Ref. No.	1.1.C.C12.15 GGC1078-15-black
description	handle black for vitrine H 9.5mm L 85mm W 25mm mounting distance 70mm Qty 1 pcs		



1

GEV No.	692402	Ref. No.	1.1.C.C12.14 GGC1078-15-white GGC1078-WHITE-15
description	handle grey for vitrine H 9.5mm L 85mm W 25mm mounting distance 70mm Qty 1 pcs		



			
1			
GEV No.	691960	Ref. No.	A15015
description	handle L 100mm W 32mm hole distance 70mm for lid		
For models:	GTO1001, GTO2001		

			
1			
GEV No.	110921	Ref. No.	A15016
description	handle L 130mm W 39mm hole distance 91mm Qty 1 pcs		
For models:	GHM1001		



			
1			
GEV No.	692545	Ref. No.	3.HDF409010101 GDF1104-025 GDF1104-25 GDF2124-025
description	handle L 96mm W 64mm hole distance 73mm mounting pos. side panel black		
For models:	GDF1104, GDF2124		

locks

locking devices

producer-specific

HORECA SELECT

			
1			
GEV No.	692318	Ref. No.	RC600.36 RN600.25
description	key pair for key cylinder 692317		
For models:	GFR2600, GRE2600		
accessories for	692318		
	GEV No.	692317	Ref. No.
			RC600.37 RN600.24
	key cylinder with lever ø 18.4mm rotation 45° cam length 40mm cam width 15mm		

			
1			
GEV No.	692317	Ref. No.	RC600.37 RN600.24
description	key cylinder with lever ø 18.4mm rotation 45° cam length 40mm cam width 15mm		
For models:	GFR2600, GRE2600		
accessories for	692317		
	GEV No.	692318	Ref. No.
			RC600.36 RN600.25
	key pair for key cylinder 692317		

			
1			
GEV No.	348185	Ref. No.	Z04AC21A0002
description	key cylinder with lever ø 18.4mm rotation 45° cam length 40mm cam width 15mm with key		
For models:	GPS2600, GSA2600, GSD2600, GSF2600		

			
1			
GEV No.	699178	Ref. No.	RC400.22 RN400.26 RN400.27
description	key cylinder with lever ø 18.4mm rotation 45° cam length 48mm cam width 16mm with key		
For models:	RC400, RN400		

hinges

spring assisted hinges

producer-specific

RWA

			
1			
GEV No.	701124	Ref. No.	GPS1134-6 GPS1600-06 GSF1600-06
description	spring assisted hinge mounting pos. 22x22 left/right L 76mm W 25mm H 101mm A 11mm B 15mm intake 7.5x7.5 refrigeration units mounting distance 25.4mm		
For models:	GPS1134, GPS1600, GSF1134, GSF1600		



1

GEV No.	701586	Ref. No.	GN2100TN.04 Z04AA02A0007
description	spring assisted hinge mounting pos. left/right L 74.5mm W 25mm H 102mm mounting measurements 8x8mm refrigeration units mounting distance 25mm		
For models:	GDS1600, GSA1134, GSA1600		



1

GEV No.	701145	Ref. No.	RC400.25 RC600.39 RN400.28 RN600.28
description	spring assisted hinge mounting pos. upper L 65mm W 23mm mounting distance 21mm		
For models:	GFR2600, GRE2600, RC400, RN400		

oven hinges



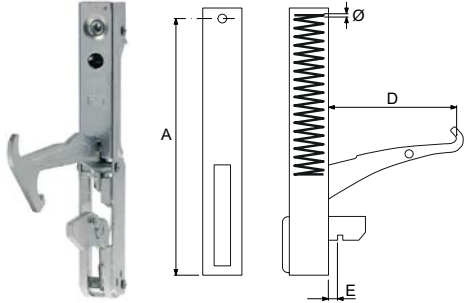

1

GEV No.	701631	Ref. No.	00014600
description	opposite support mounting distance 119mm L 135mm W 12mm		
For models:	GCO2001		
accessories for	701631		
	GEV No.	701573	Ref. No. 00014610
description	oven hinge mounting distance 142mm mounting distance 2mm lug mountingmm lever lengthmm groove distance 12mm spring thickness 3.3mm mounting ear position spring length 116mm L 170mm mounting pos. left/right W 22mm		



1

GEV No.	700000	Ref. No.	01980859512
description	oven hinge mounting distance 142mm mounting distance 2mm lug mountingmm lever length 127mm groove distance 10mm spring thickness 3.7mm mounting ear position L 155mm mounting pos. left/right		
For models:	GCO1001		
accessories for	700000		
	GEV No.	693045	Ref. No. —
description	opposite support L 110mm W 12mm mounting distance 94mm		
	GEV No.	700707	Ref. No. —
description	opposite support mounting distance 94mm L 140mm mounting pos. left W 13mm with welded metal sheet H 110mm for hinge		



1

GEV No.	701573	Ref. No.	00014610
description	oven hinge mounting distance 142mm mounting distance 2mm lug mountingmm lever lengthmm groove distance 12mm spring thickness 3.3mm mounting ear position spring length 116mm L 170mm mounting pos. left/right W 22mm		
For models:	GCO2001		
accessories for	701573		
	GEV No.	701631	Ref. No. 00014600
description	opposite support mounting distance 119mm L 135mm W 12mm		

door bearing





1

GEV No.	692406	Ref. No.	1.1.B.B10.17 GGC1270-42-brass GGC2270-44
description	bolt H 16.5mm ø 10/14mm ID ø 7mm brass for door hinge Qty 1 pcs		
For models:	GGC1270		

 <p>1</p>			
GEV No.	701256	Ref. No.	S900.28
description	bolt L 17mm mounting pos. left/right thread M4 ø 7mm for hinge Qty 1 pcs		
For models:	GDS1600, GSA1134, GSA1600		



 <p>1</p>			
GEV No.	701275	Ref. No.	GRE2600-24 RC400.37 RC600.24 RN400.35
description	bolt L 19mm mounting pos. lower thread M6 ø 7mm for door hinge Qty 1 pcs		
For models:	GRE2600, RC400, RN400		

 <p>1</p>			
GEV No.	701257	Ref. No.	GN2100TN.05 GPS1134-9 GPS1600-09 S900.06
description	bolt L 25mm mounting pos. upper thread M5 ø 7mm complete for door hinge Qty 1 pcs		
For models:	GDS1600, GPS1134, GPS1600, GSA1134, GSA1600		

 <p>1</p>			
GEV No.	701276	Ref. No.	GSF1134-09 GSF1600-09
description	bolt L 31mm mounting pos. upper thread M8 ø 5/7mm for door hinge Qty 1 pcs		
For models:	GSF1134, GSF1600		

 <p>1</p>			
GEV No.	701264	Ref. No.	RN600.16
description	bolt L 32mm mounting pos. lower thread M6 ø 7mm for door hinge Qty 1 pcs		
For models:	GFR2600		

 <p>1</p>			
GEV No.	701562	Ref. No.	44447000
description	bolt L 36mm W 22mm thread M6 bolt 12mm bolt ø 12mm		
For models:	GFR3600, GRE3600		

 <p>1</p>			
GEV No.	701025	Ref. No.	0530022
description	bolt L 45mm mounting pos. upper thread M8x1.25 ø 12mm for hinge		
For models:	GFR1600, GRE1600		
accessories for	701025		
 <p>hinge L 56mm W 50mm mounting pos. upper thickness 3mm</p>			
GEV No.	701026	Ref. No.	0162886

 <p>1</p>			
GEV No.	701265	Ref. No.	RC400.35 RC600.27 RN400.33 RN600.19
description	bush H 12mm mounting pos. lower ø 19mm ID ø 14.5mm plastic for door hinge Qty 1 pcs		
For models:	GFR2600, GRE2600, RC400, RN400		

 <p>1</p>			
GEV No.	692421	Ref. No.	1.1.C.C13.01 GGC1078-34 GGC1270-42-plastic GGC2270-42-plastic
description	bush H 15mm ø 10/13mm ID ø 7mm plastic for door hinge Qty 1 pcs		
For models:	GGC1270		

 <p>1</p>			
GEV No.	701263	Ref. No.	RC400.36 RC600.26 RN400.34 RN600.17
description	bush H 18mm mounting pos. lower ø 14mm ID ø 7.2mm for door hinge Qty 1 pcs		
For models:	GFR2600, GRE2600, RC400, RN400		

			
1			
GEV No.	701567	Ref. No.	41649000
description	bush L 11mm ø 11/15mm thickness 2mm		
For models:	GFR3600, GRE3600		

			
1			
GEV No.	692379	Ref. No.	GPS1134-51 GPS1600-51 GSF1600-51
description	bush L 23mm ø 9.8mm ID ø 7.3mm grey Qty 1 pcs		
For models:	GPS1134, GPS1600, GSF1134, GSF1600		

			
1			
GEV No.	692396	Ref. No.	GSC1100-11
description	bush L 25mm ø 12mm ID ø 9.4mm transparent for door hinge Qty 1 pcs		

			
1			
GEV No.	701572	Ref. No.	I0534002
description	bush ø 18.5mm ID ø 12mm		
For models:	GFR3600, GRE3600		

			
1			
GEV No.	701280	Ref. No.	GSC1100-10 WJMA4002
description	door hinge L 42mm W 33mm H 82mm mounting pos. bottom right/left set Qty 1 pcs		
For models:	GSC1100, GSC1100G		

			
1			
GEV No.	701281	Ref. No.	GSC1100-13 WJMA4005
description	door hinge L 43mm W 82mm H 71mm mounting pos. upper right/left set Qty 1 pcs		
For models:	GSC1100, GSC1100G		

			
1			
GEV No.	698866	Ref. No.	GPC1046-12 GPC1088-13
description	door hinge L 90mm W 40mm H 19mm mounting pos. lower bolt 13mm bolt ø 10.5mm		
For models:	GPC1046, GPC1088		

			
1			
GEV No.	698863	Ref. No.	GPC1046-04 GPC1088-05
description	door hinge L 90mm W 40mm H 19mm mounting pos. upper bolt 13mm bolt ø 10.5mm		
For models:	GPC1046, GPC1088		

			
1			
GEV No.	694927	Ref. No.	HSC360-29
description	hinge L 105mm W 52mm H 34mm bolt 17mm bolt ø 7mm		

			
1			
GEV No.	701260	Ref. No.	RW40.14
description	hinge L 114mm W 50mm H 29mm mounting pos. left/right bottom bolt 16mm shaft ø 7mm Qty 1 pcs		
For models:	GHR1040, GHR2600		

			
1			
GEV No.	701564	Ref. No.	46996000
description	hinge L 130mm W 85mm H 38mm mounting distance 48mm mounting distance 2 33mm thread M6 ø 8mm bolt 13mm bolt ø 8mm		
For models:	GFR3600, GRE3600		





 <p>1</p>			
GEV No.	692258	Ref. No.	GPS1600-50 GSF1600-50 S900.55
description	hinge L 30mm W 30mm H 45mm mounting pos. bottom left thickness 3mm		
For models:	GDS1600, GPS1134, GPS1600, GSA1134, GSA1600, GSF1134, GSF1600		

 <p>1</p>			
GEV No.	692374	Ref. No.	GPS1600-05 GSF1600-05 S900.05
description	hinge L 30mm W 30mm H 45mm mounting pos. bottom right thickness 3mm Qty 1 pcs		
For models:	GDS1600, GPS1134, GPS1600, GSA1134, GSA1600, GSF1134, GSF1600		

 <p>1</p>			
GEV No.	701284	Ref. No.	GBC1001-43 GBC1002-46 GBC1003-46
description	hinge L 39mm W 39mm H 23mm Qty 1 pcs		

 <p>1</p>			
GEV No.	692375	Ref. No.	S900.19.1
description	hinge L 40mm W 43mm mounting pos. left/right for lid Qty 1 pcs		
For models:	GDS1600, GSA1134, GSA1600		

 <p>1</p>			
GEV No.	692690	Ref. No.	S24AC22A0003
description	hinge L 40mm W 70mm H 22mm mounting distance 2 20mm		
For models:	GPS2600, GSA2600, GSD2600, GSF2600		

 <p>1</p>			
GEV No.	701026	Ref. No.	0162886
description	hinge L 56mm W 50mm mounting pos. upper thickness 3mm		
For models:	GFR1600, GRE1600		
accessories for	701026		
	GEV No.	701025	Ref. No. 0530022
	 <p>bolt L 45mm mounting pos. upper thread M8x1.25 ø 12mm for hinge</p>		

 <p>1</p>			
GEV No.	701027	Ref. No.	0415122
description	hinge L 58mm W 28mm H 73mm mounting pos. lower with bolt		
For models:	GFR1600, GRE1600		

 <p>1</p>			
GEV No.	701144	Ref. No.	RC400.16 RC600.20 RN400.17 RN600.12
description	hinge L 59mm W 27mm H 59mm mounting pos. bottom left		
For models:	GFR2600, GRE2600, RC400, RN400		

 <p>1</p>			
GEV No.	701143	Ref. No.	RC600.22 RN400.19 RN600.15
description	hinge L 59mm W 27mm H 59mm mounting pos. bottom right Qty 1 pcs		
For models:	GFR2600, GRE2600, RN400		

 <p>1</p>			
GEV No.	694968	Ref. No.	HSC350DD-25 WJMA2020
description	hinge L 77mm W 19mm H 42mm mounting distance 27mm mounting distance 2 27mm mounting pos. centre thickness 3mm bolt 18/22mm bolt ø 7mm		



GEV No.	694926	Ref. No.	HSC360-23 WJMA2012
description	hinge L 82mm W 42mm H 50mm mounting pos. lower bolt 19mm bolt ø 9mm		



GEV No.	694592	Ref. No.	GSC1336-08 GSC2336-08
description	hinge L 82mm W 42mm H 50mm mounting pos. lower with bolt Qty 1 pcs		
For models:	GSC1336		



GEV No.	701258	Ref. No.	RW40.12
description	hinge L 85mm W 13mm H 20mm mounting pos. upper left Qty 1 pcs		
For models:	GHR1040, GHR2600		



GEV No.	701261	Ref. No.	RW40.13
description	hinge L 85mm W 13mm H 20mm mounting pos. upper right Qty 1 pcs		
For models:	GHR1040, GHR2600		



GEV No.	701563	Ref. No.	43870000
description	hinge L 98mm W 48mm H 38mm mounting distance 40mm mounting distance 2 20mm thread M6		
For models:	GFR3600, GRE3600		



GEV No.	694866	Ref. No.	HSC350-22 WJMA2003
description	hinge mounting pos. lower L 82mm W 53mm H 43mm mounting distance 30mm mounting distance 2 56mm thickness 4mm bolt 20mm bolt ø 7mm		
For models:	GSC2336		



GEV No.	694865	Ref. No.	HSC350-32 WJMA0004
description	hinge mounting pos. upper L 50mm W 33mm H 42mm mounting distance 27mm thickness 3mm bolt 32.5mm bolt ø 9mm Qty 1kg		
For models:	GSC2336		



GEV No.	694593	Ref. No.	GSC1336-06 GSC2336-06 GSC2336-6
description	hinge mounting pos. upper with bolt Qty 1 pcs		
For models:	GSC1336		





GEV No.	699419	Ref. No.	1.1.B.B09.01 GGC1078-25
description	hinge bearing L 55mm W 15mm H 14mm mounting distance 26mm mounting pos. upper		



GEV No.	698918	Ref. No.	A1.1.B.B19.08
description	hinge bearing L 60mm W 37mm H 27mm mounting distance 23mm mounting distance 2 23mm mounting pos. upper right bolt 23mm bolt ø 7mm		
For models:	GRV1100		



			
1			
GEV No.	701565	Ref. No.	48205000
description	hinge bearing L 72mm W 39mm H 30mm mounting distance 25mm mounting distance 2 25mm mounting pos. left		
For models:	GFR3600, GRE3600		

			
1			
GEV No.	701566	Ref. No.	46997000
description	hinge bearing L 72mm W 39mm H 30mm mounting distance 25mm mounting distance 2 25mm mounting pos. right		
For models:	GFR3600, GRE3600		

			
1			
GEV No.	699423	Ref. No.	1.1.B.B09.17 GGC2270-25
description	hinge bearing L 85mm W 17mm H 17mm mounting distance 48mm mounting pos. upper		
For models:	GGC1270		

accessories

base plate

			
1			
GEV No.	701266	Ref. No.	RC400.34 RC600.42 RN400.32 RN600.34
description	base plate L 88mm W 35mm thickness 3mm for door hinge mounting pos. lower Qty 1 pcs		
For models:	GFR2600, GRE2600, RC400, RN400		

pullouts

rollers

			
1			
GEV No.	692376	Ref. No.	S900.24
description	roller rollerø 12mm overall width 5mm A 12mm B 5mm plastic with screw connection bore ø 5.4mm thread M4 thread L 5.5mm Qty 1 pcs		
For models:	GSA1134, GSA1600		

roller with holder

			
1			
GEV No.	692385	Ref. No.	RC600.23 RN600.11
description	roller rollerø 21mm B1 7mm with holder SS/plastic mounting pos. lower bearing ball bearing Qty 1 pcs L 52mm mounting distance 41mm		
For models:	GFR2600, GRE2600		

fittings for catering equipment

outlet taps

universal

 			
1			
GEV No.	541540	Ref. No.	016210829
description	outlet tap nickel-plated brass W 38mm H 40mm thread 3/4" IT		
For models:	GDF1008, GDF2028		
spare parts for	541540		
	GEV No.	697834	Ref. No. —
	cone handle thread M6x1 ø 13mm plastic L 53mm black thread L 6mm		



1

GEV No.	692499	Ref. No.	016210831
description	reducer L 46mm thread 1/2" ET / 3/4" ET ø 26mm		
For models:	GDF1008, GDF2028		



1

GEV No.	541749	Ref. No.	016210830
description	rosette for outlet tap thread D1 ø 63mm D2 ø 25mm		
For models:	GDF1008, GDF2028		

filters

grease filters

grease filter



1

GEV No.	699331	Ref. No.	WJD000050
description	grease filter L 125mm W 120mm H 9mm		

accessories



1

GEV No.	699332	Ref. No.	WJD000049
description	frame SS for filter L 144mm W 152mm		

accessories

fastening material



1

GEV No.	694581	Ref. No.	GIC3035-13 GIC3035-B13 GIC3500-13 GIC3500-A13 GIC3535-13 GIC3535-19 GIC3535-D13 GIC3535-D19 GIC4035-13 GIC4035-C13 WJB000079R
description	frame L 317mm W 170mm H 9mm for filter		
For models:	GIC3500, GIC3535, GIC4035		

equipment feet and end caps

screw-in feet



1

GEV No.	701230	Ref. No.	900888
description	equipment feet kit thread M5 thread L 10mm ø 22mm H 12mm rubber WS Qty 4 pcs bore ø 5/10mm		
For models:	GJU1001		



1

GEV No.	700972	Ref. No.	S900.13
description	equipment foot thread M10 thread L 16mm ø 29mm H 11.5mm Qty 1 pcs for fridge		
For models:	GDS1134, GDS1600, GHS1134, GHS1600, GHS2134, GHS2600, GSA1134, GSA1600		





1

GEV No.	692235	Ref. No.	A13012
description	equipment foot thread M10 thread L 20mm ø 26mm H 6mm Qty 1 pcs		
For models:	GEG1001, GEG2001		





 <p>1</p>			
GEV No.	802156	Ref. No.	00002790 09960058500
description	equipment foot thread M10 thread L 20mm ø 60mm H 50mm Qty 1 pcs		
For models:	GCO1001, GCO2001		

 <p>1</p>			
GEV No.	701262	Ref. No.	RC600.19 RN600.13
description	equipment foot thread M10 thread L 40mm ø 36mm H 15.5mm Qty 1 pcs		
For models:	GFR2600, GRE2600		

 <p>1</p>			
GEV No.	701036	Ref. No.	A13006
description	equipment foot thread M10 thread L 40mm ø 40mm H 52mm Qty 1 pcs		
For models:	GEG1001		

 <p>1</p>			
GEV No.	701112	Ref. No.	0403014 I0403014
description	equipment foot thread M10 thread L 43mm ø 29mm H 52mm plastic WS 35 Qty 1 pcs		
For models:	GFR1600, GFR3600, GRE1600, GRE3600		

 <p>1</p>			
GEV No.	701451	Ref. No.	00000001240
description	equipment foot thread M5 thread L 13mm ø 37.5mm H 25mm conical aluminium WS Qty 1 pcs bore ø 6mm		
For models:	GFS1025		

 <p>1</p>			
GEV No.	701588	Ref. No.	AB300038
description	equipment foot thread M5 thread L 7mm ø 24mm H 20mm		

 <p>1</p>			
GEV No.	701219	Ref. No.	AB300035 GIC3035-11 GIC3035-B11 GIC3500-11 GIC3500-A11 GIC3535-11 GIC3535-D11 GIC4035-11 GIC4035-C11
description	equipment foot thread M5 thread L 9mm ø 33mm H 34mm Qty 1 pcs		
For models:	GIC3500, GIC3535, GIC4035		

 <p>1</p>			
GEV No.	802048	Ref. No.	912058
description	equipment foot thread M6 thread L 14mm ø 30mm H 16mm Qty 4 pcs		
For models:	GPG1001, GPG2001		

 <p>1</p>			
GEV No.	701587	Ref. No.	AB300037
description	equipment foot thread M6 thread L 20mm ø 26mm H 11mm Qty 1 pcs		

 <p>1</p>			
GEV No.	701220	Ref. No.	AB300055 GIC3035-10 GIC3035-B10 GIC3500-10 GIC3500-A10 GIC3535-10 GIC3535-D10 GIC4035-10 GIC4035-C10
description	equipment foot thread M6 thread L 20mm ø 33mm H 20mm WS 12 Qty 1 pcs		
For models:	GIC3500, GIC3535, GIC4035		

			
1			
GEV No.	701324	Ref. No.	GSF1600-13
description	equipment foot thread M8 thread L 22mm Ø 35mm H 29mm Qty 1 pcs L 41mm		
For models:	GSF1134, GSF1600		

			
1			
GEV No.	701270	Ref. No.	GHR1040-09 RW40.15
description	equipment foot Ø 20mm H 12mm plastic bore Ø 5mm Qty 1 pcs GHR1040		
For models:	GHR1040, GHR2600		

			
1			
GEV No.	701279	Ref. No.	GBC1001-23 GBC1002-24 GBC1003-24 HSC360-18 WJLB0008
description	equipment foot thread M8 thread L 22mm Ø 35mm H 38mm Qty 1 pcs		

			
1			
GEV No.	691814	Ref. No.	A13003
description	equipment foot Ø 22mm H 20mm bore Ø 4mm Qty 1 pcs		
For models:	GHM1001, GTO1001, GTO2001		

			
1			
GEV No.	701259	Ref. No.	RW40.42
description	equipment foot thread M8 thread L 31mm Ø 30mm H 12mm Qty 1 pcs		
For models:	GHR1040, GHR2600		

			
1			
GEV No.	697996	Ref. No.	016240431
description	equipment foot Ø 23mm H 23.5mm bore Ø 5mm Qty 1 pcs		
For models:	GDF1004, GDF1008, GDF2024		

			
1			
GEV No.	698495	Ref. No.	00000001251
description	equipment foot thread M8 thread L 9mm Ø 48mm H 43mm conical aluminium WS Qty 1 pcs		
For models:	GFS1030		

			
1			
GEV No.	697998	Ref. No.	01058356
description	equipment foot Ø 24/36mm H 25mm bore Ø 19mm Qty 1 pcs thread M8x1.25		
For models:	GIC2030, GIC2035		

bolting feet

			
1			
GEV No.	701555	Ref. No.	HVS1000-40 YJS820-40
description	equipment feet kit Ø 39mm H 17mm Qty 4 pcs		

			
1			
GEV No.	691509	Ref. No.	A042567
description	equipment foot Ø 28mm H 17.5mm rubber bore Ø 6mm Qty 1 pcs		
For models:	GDF2028		



 <p>1</p>			
GEV No.	698546	Ref. No.	3,0000161 GDF1104-026 GDF1108-025 GDF2124-026 GDF2128-026 GDF2128-26 HDF1108-023 HDF2128-024
description	equipment foot ø 29mm H 16mm rubber bore ø 6mm Qty 1 pcs		
For models:	GDF1104, GDF1108, GDF2124, GDF2128		

 <p>2</p>			
GEV No.	697433	Ref. No.	00000000140 00000700140
description	equipment foot ø 35mm H 26mm bore ø 5mm Qty 1 pcs		
For models:	GFS1022, GFS2022, GFS2025, HFS2019, HFS2022, HFS2025		

equipment feet with stem

 <p>1</p>			
GEV No.	701251	Ref. No.	223189000015 GMW1025-P26
description	equipment foot ø 20mm H 12mm mounting ø 8mm mounting measurements 19mm overall height 19mm plastic Qty 1 pcs		

end caps and plugs

housing plugs

 <p>1</p>			
GEV No.	692371	Ref. No.	S900.25
description	plug mounting ø 5.5mm ø 10mm H 13mm plastic Qty 1 pcs		
For models:	GSA1134, GSA1600		

miscellaneous

with fixing plate

ø30mm

 <p>1</p>			
GEV No.	701277 ¹	Ref. No.	GSC1336-42 GSC2336-42 WJLA1001 WJLA1009
description	swivel castor 2 with & 2 without brake ø 30mm plate fixing housing zinc-plated sheet steel plate size 61x51mm hole distance mm capacity 60kg bearing slide bearing wheel body PVC tread PVC H 44mm wheel width 23.5mm		
For models:	GBC1001, GBC1002, GBC1003, GSC1336, GSC2336		

¹with swivel brake

 <p>1</p>			
GEV No.	701523	Ref. No.	HSC360-17 WJLA2001
description	swivel castor ø 31mm plate fixing H 45mm wheel width 22.5mm Qty 1 pcs		

ø75mm

 <p>1</p>			
GEV No.	701282	Ref. No.	GSC1100-30 HSC800-14 WJLA1002
description	swivel castor set 2 with & 2 without brake ø 75mm plates fixing 102x83mm housing zinc-plated sheet steel hole distance 55/75mm bearing slide bearing H 112mm wheel width 31mm Qty 4 pcs		
For models:	GSC1100, GSC1100G		

with spigot

ø40mm



GEV No.	701120	Ref. No.	1.1.B.B10.95 1.1.B.B10.95+1.1.B.B10.96 GGC2270-03
description	castor set 2 with & 2 without brake ø 40mm with thread bolt housing chrome-plated steel thread L 24mm thread ø M10x1.5mm capacity 60kg bearing ball bearing wheel body nylon tread nylon H 68mm wheel width 20mm Qty 4 pcs		
For models:	GGC1270		

diverse sets



GEV No.	710027	Ref. No.	RC400.14 RC400.15 RN400.15 RN400.16
description	castor set with 2 feet ø 21.5mm threaded plate size 40x58mm hole distance 24/42mm wheel body plastic wheel width 33mm		
For models:	RC400, RN400		

1			
GEV No.	970866	Ref. No.	2.HDF800304 GDF1108-036 GDF2128-037 GDF2128-37
description	fryer basket W1 190mm L1 240mm H1 140mm without handle size 8 litre		
For models:	GDF1108, GDF2128		
accessories for	970866		
GEV No.	694736	Ref. No.	
handle L 143mm W 41mm H 22mm plastic			

1			
GEV No.	970868	Ref. No.	HDF1108-033 HDF2128-034
description	fryer basket W1 200mm L1 250mm H1 140mm hinged handle size 8 litre		
accessories for	970868		
GEV No.	694736	Ref. No.	
handle L 143mm W 41mm H 22mm plastic			
GEV No.	694782	Ref. No.	
handle for fryer basket			
GEV No.	694783	Ref. No.	HDF1108-038 HDF2128-039
handle for fryer basket			

1			
GEV No.	694782	Ref. No.	2.HDF812030609510 GDF1104-033 GDF2124-033
description	handle for fryer basket		
For models:	GDF1104, GDF2124		

baskets

fryer baskets



METRO



GEV No.	970867	Ref. No.	2.HDF403069510 GDF1104-030 GDF1104-30 GDF2124-029
description	fryer basket W1 160mm L1 220mm H1 130mm size 4 litre		
For models:	GDF1104, GDF2124		
accessories for	970867		
GEV No.	694736	Ref. No.	
handle L 143mm W 41mm H 22mm plastic			
GEV No.	694782	Ref. No.	
handle for fryer basket			
GEV No.	694783	Ref. No.	HDF1108-038 HDF2128-039
handle for fryer basket			



			
1			
GEV No.	694783	Ref. No.	HDF1108-038 HDF2128-039
description	handle for fryer basket		

			
1			
GEV No.	694736	Ref. No.	3.HDF818050101 GDF1104-029 GDF1104-29 GDF1108-037 GDF2124-030 GDF2128-038
description	handle L 143mm W 41mm H 22mm plastic		
For models:	GDF1104, GDF1108, GDF2124, GDF2128		
accessories for	694736		
	GEV No.	560270	Ref. No. —
	raised countersunk head screw thread M5 thread L 12mm SS DIN 966/ISO 7047 Qty 20 pcs intake slotted sunk head		

			
1			
GEV No.	970870	Ref. No.	2.HDF812020609510 GDF1108-035 GDF2128-036 HDF1108-032 HDF1108-32 HDF2128-033
description	crumb screen L 245mm W 200mm H 35mm 8 litre		
For models:	GDF1108, GDF2128		

wire baskets for hot dog machines

			
1			
GEV No.	693004	Ref. No.	F04012
description	grid basket for hot dog grill ø 180mm H 210mm		
For models:	GHM1001		

crumb screens

			
1			
GEV No.	970743	Ref. No.	016210816
description	crumb screen L 245mm W 205mm H 5mm chrome-plated steel for fryer		
For models:	GDF1008, GDF2028		

			
1			
GEV No.	970742	Ref. No.	016240418
description	crumb screen L 216mm W 149mm H 37mm chrome-plated steel for fryer		
For models:	GDF1004, GDF2024		

			
1			
GEV No.	970869	Ref. No.	2.HDF405069510 GDF1104-028 GDF2124-028
description	crumb screen L 220mm W 160mm H 35mm 4 litre		
For models:	GDF1104, GDF2124		

shelves and shelf rails

grates

universal

without upstand

			
1			
GEV No.	970801	Ref. No.	GBC1003-43 WJGA9008
description	grate W 345mm D 400mm chrome-plated steel wire gauge frame 6mm lengthwise wires gauge 2.5mm crossing wires 4 Qty 1 pcs		
For models:	GBC1003		



1

GEV No.	970800	Ref. No.	GBC1001-41 WJGA9002
description	grate W 345mm D 500mm chrome-plated steel wire gauge frame 6mm lengthwise wires gauge 2.5mm crossing wires 4 Qty 1 pcs		
For models:	GBC1001		



1

GEV No.	970925	Ref. No.	S14AC29A0001
description	grate W 325mm D 570mm GN 1/1 H 55mm plastic-coated steel wire gauge frame 7.5mm lengthwise wires gauge 4mm crossing wires 3 grey		
For models:	GPS2600, GSA2600, GSD2600, GSF2600		



1

GEV No.	970747	Ref. No.	F01070
description	grate W 350mm D 240mm H 7mm SS for toaster wire gauge frame 4mm lengthwise wires gauge 3mm crossing wires ROLLER GRILL		
For models:	GTO1001, GTO2001		



1

GEV No.	970904	Ref. No.	GPC1088-14-full size
description	grate W 350mm D 295mm H 30mm chrome-plated steel wire gauge frame 4mm lengthwise wires gauge 2mm crossing wires 1 Qty 2 pcs		
For models:	GPC1088		

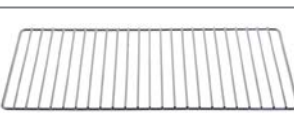

1

GEV No.	970905	Ref. No.	GPC1046-13 GPC1088-14-half size
description	grate W 365mm D 165mm H 7mm wire gauge frame 4mm lengthwise wires gauge 3mm		
For models:	GPC1046, GPC1088		



1

GEV No.	970926	Ref. No.	RC400.31
description	grate W 500mm D 400mm H 47mm plastic-coated steel wire gauge frame 8mm lengthwise wires gauge 4.5mm crossing wires 1 white		
For models:	RC400		



1

GEV No.	970906	Ref. No.	GBC1002-43 GBC1003-43A GBC1003-43C WJGA9005
description	grate W 400mm D 345mm chrome-plated steel wire gauge frame 6mm crossing wires 4		
For models:	GBC1002		



1

GEV No.	970791	Ref. No.	GRE2600-28 RC600.28
description	grate W 650mm D 530mm GN 2/1 H 10mm plastic-coated steel upper wire gauge frame 8mm lengthwise wires gauge 4mm crossing wires 3 white		
For models:	GRE2600		

with upstand



1

GEV No.	750368	Ref. No.	GSD1600-11 GSF1600-11 S900.11
description	grate W 320mm D 560mm plastic-coated steel wire gauge frame 7.5mm lengthwise wires gauge 3.5mm crossing wires 2 grey		
For models:	GDS1600, GSA1134, GSA1600		



1

GEV No.	970874	Ref. No.	0427709
description	grate W 650mm D 540mm GN 2/1 H 30mm plastic-coated steel with hinge camp for fridge wire gauge frame 7.3mm lengthwise wires gauge 3.2mm crossing wires 2 white		
For models:	GRE1600		







			
GEV No.	970795	Ref. No.	1.1.B.B25.15 GCV1600-15
description	grate W 735mm D 235mm H 37mm chrome-plated steel wire gauge frame 8mm lengthwise wires gauge 3mm crossing wires 1		

			
GEV No.	970794	Ref. No.	1.1.B.B25.16 GCV1600-14
description	grate W 735mm D 365mm H 35mm chrome-plated steel wire gauge frame 8mm lengthwise wires gauge 3mm crossing wires 1		

producer-specific

			
GEV No.	971150	Ref. No.	RC600.09
description	chargrill grid W 693mm D 303mm H 6mm plastic-coated steel lengthwise wires gauge 4mm crossing wires 4 white		
For models:	GRE2600		

			
GEV No.	970792	Ref. No.	GRE2600-25 RC600.25
description	grate W 185mm D 640mm plastic-coated steel lower wire gauge frame 7mm lengthwise wires gauge 3.5mm white		
For models:	GRE2600		

			
GEV No.	698856	Ref. No.	1.1.B.B02.01.03 GGC1078-13-black
description	grate W 360mm D 305mm plastic-coated steel		
accessories for	698856		
	GEV No.	692400	Ref. No.
			1.1.C.C10.07 GGC1078-14 GGC1078-14-white
	shelf support L 28.5mm W 14mm H 17.5mm plastic Qty 1 pcs		
	GEV No.	698857	Ref. No.
			1.1.C.C10.08 GGC1078-14-black
	shelf support L 28.5mm W 14mm H 17.5mm plastic Qty 1 pcs		

			
GEV No.	970876	Ref. No.	1.1.B.B02.01.01 GGC1078-13
description	grate W 360mm D 305mm plastic-coated steel		

			
GEV No.	692696	Ref. No.	1.1.B.B02.04.02 GGC2270-41-black
description	grate W 430mm D 390mm H 8mm plastic-coated steel refrigeration wire gauge frame 8mm lengthwise wires gauge 3.6mm crossing wires 5 black		

			
GEV No.	692339	Ref. No.	1.1.B.B02.04.01 GGC2270-41 GGC2270-41-white
description	grate W 430mm D 390mm H 8mm plastic-coated steel refrigeration wire gauge frame 8mm lengthwise wires gauge 3.6mm crossing wires 5 white		
For models:	GGC1270		

			
GEV No.	970927	Ref. No.	RC400.32
description	grate W 500mm D 200mm H 25mm plastic-coated steel wire gauge frame 8mm lengthwise wires gauge 4mm crossing wires 1 white		
For models:	RC400		

			
GEV No.	970921	Ref. No.	GSC1336-40 GSC2336-40 WJGA2010
description	grate W 500mm D 425mm H 38mm plastic-coated steel wire gauge frame 6.5mm lengthwise wires gauge 2.5mm crossing wires 6 white Qty 1kg		
For models:	GSC1336		

			
1			
GEV No.	970910	Ref. No.	HSC360-38
description	grate W 530mm D 380mm H 40mm plastic-coated steel wire gauge frame 6mm lengthwise wires gauge 3mm crossing wires 23		

			
1			
GEV No.	970799	Ref. No.	GSC1100-09 WJGA4078
description	grate W 540mm D 505mm H 41mm plastic-coated steel wire gauge frame 6mm lengthwise wires gauge 3mm crossing wires 3 white Qty 1 pcs		
For models:	GSC1100, GSC1100G		

			
1			
GEV No.	970930	Ref. No.	44714000
description	grate W 650mm D 330mm H 9mm wire gauge frame 7mm lengthwise wires gauge 3mm crossing wires 1		
For models:	GRE3600		

			
1			
GEV No.	970929	Ref. No.	44379000
description	grate W 665mm D 560mm H 30mm wire gauge frame 7mm lengthwise wires gauge 3mm crossing wires 2		
For models:	GFR3600, GRE3600		

			
1			
GEV No.	971149	Ref. No.	RN600.05
description	grate W 715mm H 55mm plastic-coated steel L 365mm lengthwise wires gauge 4mm crossing wires 4 white		
For models:	GFR2600		

accessories			
			
1			
GEV No.	691917	Ref. No.	F03006
description	grid handle L 204mm W 80mm		
For models:	GTO1001, GTO2001		

grid attachments			
			
1			
GEV No.	692368	Ref. No.	1.1.B.B25.27 GCV1600-44
description	rack support L 220mm H 83mm mounting pos. bottom right SS Qty 1 pcs		

			
1			
GEV No.	692365	Ref. No.	1.1.B.B25.28 GCV1600-41
description	rack support L 220mm H 83mm mounting pos. upper left SS Qty 1 pcs		

			
1			
GEV No.	692366	Ref. No.	1.1.B.B25.29 GCV1600-42
description	rack support L 220mm H 83mm mounting pos. upper right SS Qty 1 pcs		

			
1			
GEV No.	692367	Ref. No.	1.1.B.B25.26 GCV1600-43
description	rack support L 320mm H 83mm mounting pos. bottom left SS Qty 1 pcs		

			
1			
GEV No.	701252	Ref. No.	1.1.B.B25.35 GCV1600-46
description	rail for grid attachment L 405mm Hmm mounting pos. left/right W 19mm SS Qty 1 pcs		



shelf rails and supports

universal



1

GEV No.	690332	Ref. No.	I0402138
description	shelf support L 31/28mm W 22mm H 17mm SS with hook Qty 1 pcs		
For models:	GFR3600, GRE3600		
accessories for	690332		
	GEV No.	690330	Ref. No. —
	rack L 1000mm W 22mm H 4mm aperture 3x8mm hole distance 12.5mm stainless steel		

producer-specific



1

GEV No.	698870	Ref. No.	GBC1001-25 GBC1002-26 GBC1003-26 LCCJ2001
description	guide L 390mm W 25mm mounting pos. left/right inner height 4mm		
For models:	GBC1001, GBC1002, GBC1003		



1

GEV No.	699231	Ref. No.	I0402137
description	guide white L 1350mm W 20mm H 5mm Qty 1		
For models:	GFR3600, GRE3600		



1

GEV No.	701585	Ref. No.	GPS1600-12 GSF1600-12 S900.12
description	pair of setting bar L 245mm W 29mm H 15mm		
For models:	GDS1134, GDS1600, GPS1134, GPS1600, GSA1134, GSA1600, GSF1134, GSF1600		



1

GEV No.	696443	Ref. No.	GPS1600-10 GSF1600-10 KITGD4AC2A00 S900.10.1
description	pair of setting bar U-shape L 548mm W 20mm inner height 13mm mounting pos. left/right		
For models:	GDS1600, GPS1134, GPS1600, GPS2600, GSA1134, GSA1600, GSA2600, GSD2600, GSF1134, GSF1600, GSF2600		



1

GEV No.	696388	Ref. No.	S900.10
description	pair of setting bar U-shape L 550mm W 20mm H 17mm mounting pos. left/right		



1

GEV No.	701269	Ref. No.	RC600.29
description	rack L 1172mm W 22mm aluminium hole distance 13mm Qty 1 pcs aperture 3x8mm		
For models:	GRE2600		



1

GEV No.	701278	Ref. No.	GSC1100-37
description	rack L 1290mm W 26mm hole distance 22mm Qty 1 pcs aperture 10x10mm		



1

GEV No.	701550	Ref. No.	S24AC29A0002
description	rack L 244mm W 50mm H 8mm mounting pos. front		
For models:	GPS2600, GSA2600, GSD2600, GSF2600		



1

GEV No.	701548	Ref. No.	GSF1600-48 S24AC29A0004 S900.50
description	rack L 245mm W 40mm H 30mm mounting pos. left		
For models:	GDS1134, GDS1600, GPS2600, GSA1134, GSA1600, GSA2600, GSD2600, GSF1134, GSF1600, GSF2600		



1

GEV No.	701549	Ref. No.	GPS1600-18 GSF1600-18 S24AC29A0005 S900.18
description	rack L 245mm W 40mm H 30mm mounting pos. right		
For models:	GDS1134, GDS1600, GPS1134, GPS1600, GPS2600, GSA1134, GSA1600, GSA2600, GSD2600, GSF1134, GSF1600, GSF2600		



1

GEV No.	692399	Ref. No.	GSC1100-38
description	shelf support L 24mm W 7mm H 28mm aluminium for fridge Qty 1 pcs		



1

GEV No.	692398	Ref. No.	GBC1001-42 GBC1002-44 GBC1003-44 LCCK0002
description	shelf support L 24mm W 9mm H 29mm aluminium for fridge Qty 1 pcs		
For models:	GBC1001, GBC1002, GBC1003		



1

GEV No.	692400	Ref. No.	1.1.C.C10.07 GGC1078-14 GGC1078-14-white
description	shelf support L 28.5mm W 14mm H 17.5mm plastic Qty 1 pcs		



1

GEV No.	698857	Ref. No.	1.1.C.C10.08 GGC1078-14-black
description	shelf support L 28.5mm W 14mm H 17.5mm plastic Qty 1 pcs		



1

GEV No.	692387	Ref. No.	RC600.32
description	shelf support L 31/28mm W 22mm H 19mm Qty 1 pcs		
For models:	GRE2600		



1

GEV No.	694591	Ref. No.	GSC1336-39 GSC2336-39 SLZE0028
description	shelf support L 33mm W 9mm H 27mm aluminium for fridge Qty 1 pcs		
For models:	GSC1336		



1

GEV No.	692408	Ref. No.	1.1.C.C10.09 GGC2270-17 GGC2270-17-white
description	shelf support L 38.5mm W 14mm H 18mm plastic Qty 1 pcs		
For models:	GGC1270		



1

GEV No.	699416	Ref. No.	1.1.C.C10.10 GGC2270-17-black
description	shelf support L 38.5mm W 14mm H 18mm plastic Qty 1 pcs		



gaskets

refrigeration gaskets

plug-in gaskets

profile 9161

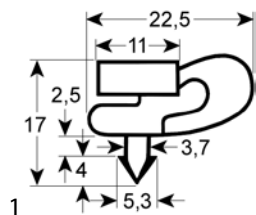

GEV No.	902208	Ref. No.	HSC360-39 SLJP2025
description	refrigeration gasket profile 9161 W 590mm L 1540mm plug size		

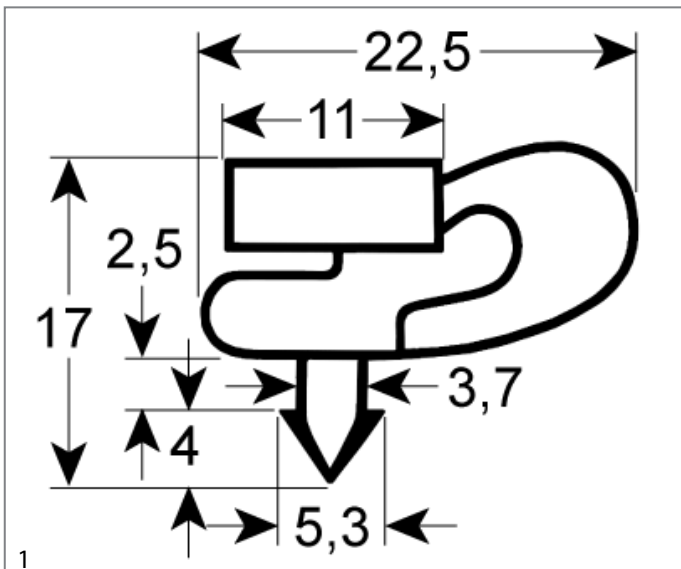

GEV No.	902465	Ref. No.	HSC350DD-46 HSC350DD-49 SLJP2015
description	refrigeration gasket profile 9161 W 590mm L 650mm plug size		

profile 9151

We offer custom-made gaskets for this profile

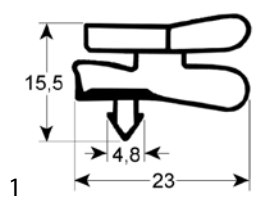

GEV No.	901377	Ref. No.	0313291
description	refrigeration gasket profile 9151 W 715mm L 1674mm plug size L1 1686mm W1 722mm external size		
For models:	GFR1600, GRE1600		

profile 9149

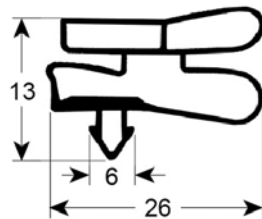

GEV No.	902216	Ref. No.	R04AC22A0002
description	refrigeration gasket profile 9149 W 385mm L 480mm plug size		
For models:	GPS2600, GSA2600, GSD2600, GSF2600		

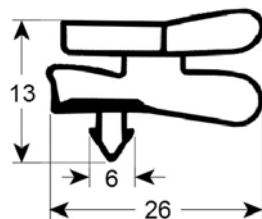

GEV No.	902215	Ref. No.	RC400.29 RN400.30
description	refrigeration gasket profile 9149 W 555mm L 1680mm plug size		
For models:	RC400, RN400		

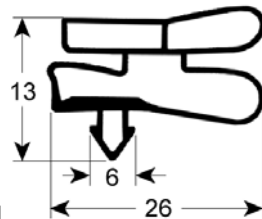

GEV No.	901524	Ref. No.	RC600.40 RN600.29
description	refrigeration gasket profile 9149 W 720mm L 1710mm plug size		
For models:	GFR2600, GRE2600		

profile 9058

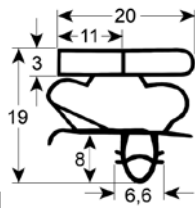

GEV No.	902395	Ref. No.	44404000
description	refrigeration gasket profile 9058 W 770mm L 1810mm plug size Qty 1		
For models:	GFR3600, GRE3600		

profile 9152

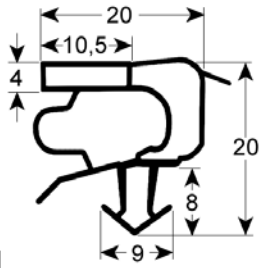

GEV No.	902421	Ref. No.	S901-4D.08
description	refrigeration gasket profile 9152 W 225mm L 390mm plug size		
For models:	GDS1134		

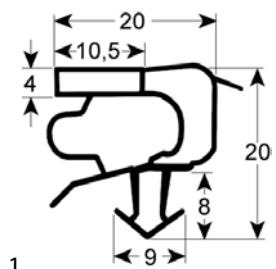

GEV No.	901486	Ref. No.	GPS1600-08 GSF1600-08 S900.08
description	refrigeration gasket profile 9152 W 390mm L 485mm plug size		
For models:	GDS1600, GPS1134, GPS1600, GSA1134, GSA1600, GSF1134, GSF1600		

profile 9156

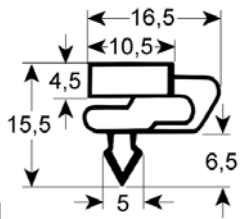

GEV No.	901662	Ref. No.	GSC1100-14 SLJP4007
description	door seal profile 9156 W 569mm L 1295mm plug size Qty 1 pcs		
For models:	GSC1100, GSC1100G		

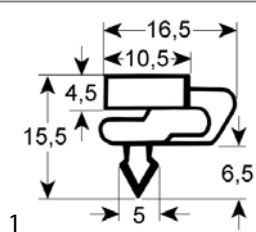

GEV No.	901674	Ref. No.	GBC1002-48
description	refrigeration gasket profile 9156 W 415mm L 775mm plug size Qty 1 pcs		

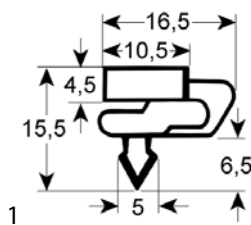

GEV No.	901660	Ref. No.	GBC1001-45
description	refrigeration gasket profile 9156 W 420mm L 785mm plug size Qty 1 pcs		

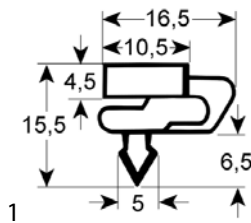

GEV No.	901648	Ref. No.	GSC1336-44 GSC2336-44 SLJP2010
description	refrigeration gasket profile 9156 W 595mm L 1340mm plug size Qty 1 pcs		
For models:	GSC1336, GSC2336		

profile 9314

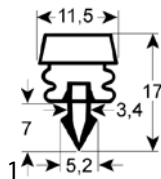

GEV No.	902158	Ref. No.	HSC800-53
description	refrigeration gasket profile 9314 Wmm L 1200mm		

profile 9930

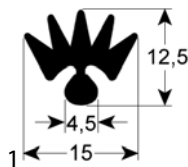

GEV No.	901645	Ref. No.	1.1.C.63.69 GCV1600-07
description	refrigeration gasket profile 9930 Wmm L 746mm plug size		

miscellaneous

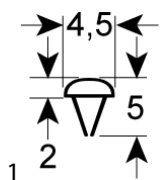

GEV No.	902210	Ref. No.	JNMA0000
description	gasket L 930mm Qty 1 dimensions 5x6mm		



screw-in gaskets

profile 9135

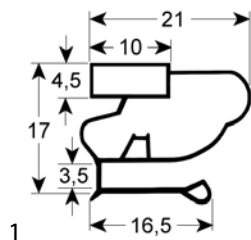

GEV No.	901520	Ref. No.	RW40.02
description	refrigeration gasket profile 9135 W 380mm L 520mm external size Qty 1		
For models:	GHR1040, GHR2600		

profile 9997

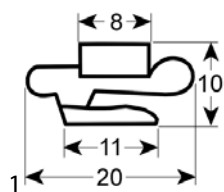

GEV No.	902150	Ref. No.	A1.1.C.C21.17
description	refrigeration gasket profile 9997 W 408mm L 720mm external size		
For models:	GRV1100		

profile 9968

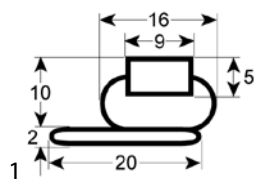

GEV No.	901649	Ref. No.	1.1.E.E1.35 GGC1078-19 GGC1078-19-black
description	refrigeration gasket profile 9968 W 418mm L 658mm external size with metal reinforcement Qty 1 pcs		

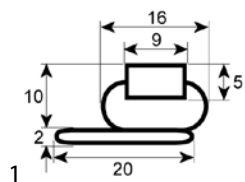

GEV No.	901650	Ref. No.	1.1.E.E1.25 GGC2270-23 GGC2270-23 white
description	refrigeration gasket profile 9968 W 515mm L 1390mm external size with metal reinforcement Qty 1 pcs		
For models:	GGC1270		

profile 9910

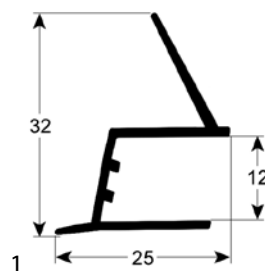

GEV No.	901651	Ref. No.	1.1.C.C63.67 GCV1600-23
description	refrigeration gasket profile 9910 Wmm L 735mm Qty 1 mounting pos. left		

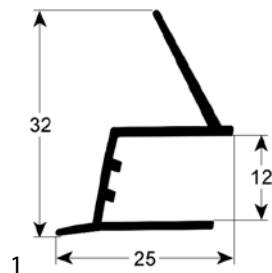

GEV No.	901646	Ref. No.	1.1.C.C63.76 GCV1600-24
description	refrigeration gasket profile 9910 Wmm L 735mm Qty 1 mounting pos. right		

gaskets for heated units

door seals

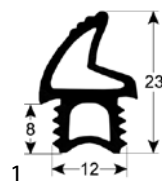

GEV No.	902497	Ref. No.	01000770
description	door seal profile 2764 L 1020mm suitable for TECNOEKA		
For models:	GCO2001		

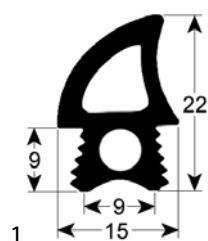

GEV No.	902419	Ref. No.	01000810
description	door seal profile 2767 L 1780mm suitable for TECNOEKA		
For models:	GCO2001		

door seals with fixing hook



GEV No.	900396	Ref. No.	09988928000
description	oven gasket L 440mm W 370mm external size		
For models:	GCO1001		

door gaskets (wire reinforced)

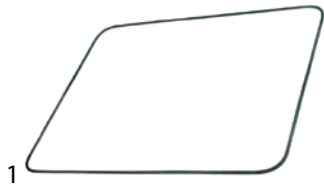

GEV No.	693232	Ref. No.	09980928000
description	oven gasket wire reinforced L 425mm W 350mm		
For models:	GCO1001		

O-rings

EPDM

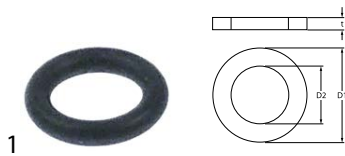

GEV No.	532648	Ref. No.	2859
description	O-ring EPDM thickness 1.5mm ID ø 5mm Qty 1 pcs		
For models:	GSM1000		

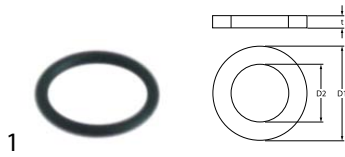

GEV No.	529545	Ref. No.	50-0463-9 904324
description	O-ring EPDM thickness 1.78mm ID ø 10.82mm Qty 1 pcs		
For models:	GDW1001, GGW1001, GGW2001, GIM1023, GIM1038, GIM2023, GIM2038		



GEV No.	532647	Ref. No.	900970
description	O-ring EPDM thickness 1.8mm ID ø 11.8mm Qty 1 pcs		
For models:	GJU1001		

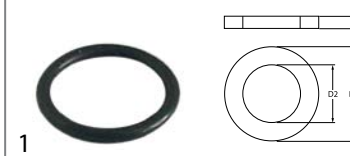

GEV No.	504590	Ref. No.	904330
description	O-ring EPDM thickness 2.62mm ID ø 18.72mm Qty 1 pcs		
For models:	GGW2001		

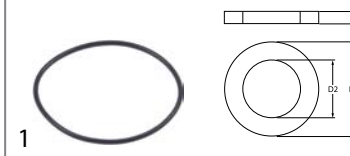

GEV No.	532618	Ref. No.	016240424
description	O-ring EPDM thickness 2mm ID ø 48.5mm Qty 1 pcs		
For models:	GDF1004, GDF1008, GDF2024, GDF2028		

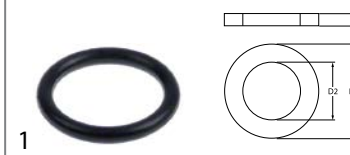

GEV No.	511322	Ref. No.	904430
description	O-ring EPDM thickness 3.53mm ID ø 20.22mm Qty 1 pcs		
For models:	GDW1001, GGW1001, GGW2001		

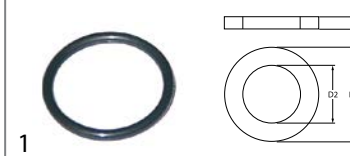

GEV No.	510072	Ref. No.	904350
description	O-ring EPDM thickness 3.53mm ID ø 32.93mm Qty 1 pcs		
For models:	GGW1001, GGW2001		

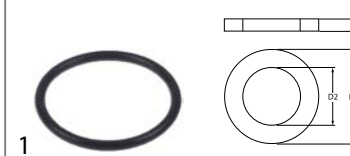

GEV No.	519179	Ref. No.	904380
description	O-ring EPDM thickness 3.53mm ID ø 41.28mm Qty 1 pcs		
For models:	GGW1001		



GEV No.	510955	Ref. No.	00002001
description	O-ring EPDM thickness 3mm ID ø 6mm Qty 1 pcs		
For models:	GCO2001		

GEV No.	521120	Ref. No.	907981
description	O-ring EPDM thickness 5.34mm ID ø 37.47mm Qty 1 pcs		
For models:	GDW1001, GGW1001, GGW2001		

silicone

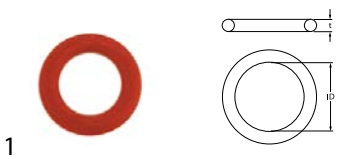

GEV No.	371100	Ref. No.	YJS820-4
description	O-ring silicone thickness 1.78mm ID ø 6.07mm Qty 1 pcs		

sealing washers

rubber gaskets



GEV No.	511649	Ref. No.	903263
description	flat gasket rubber ED ø 20mm ID ø 12mm thickness 2mm Qty 1 pcs		
For models:	GGW1001, GGW2001		



GEV No.	511936	Ref. No.	904991
description	flat gasket rubber ED ø 25mm ID ø 16.5mm thickness 1.8mm Qty 1 pcs warewashing		
For models:	GDW1001		



GEV No.	519117	Ref. No.	903301
description	flat gasket rubber ED ø 60mm ID ø 47mm thickness 3mm Qty 1 pcs		
For models:	GGW1001, GGW2001		



GEV No.	519121	Ref. No.	903340
description	flat gasket rubber ED ø 80mm ID ø 67mm thickness 3mm Qty 1 pcs suitable for Silanos		
For models:	GGW2001		

plastic gaskets



GEV No.	504435	Ref. No.	908146
description	flat gasket plastic ED ø 18mm ID ø 9.5mm thickness 2.5mm for door hinge Qty 1 pcs		
For models:	GDW1001		

paper gasket



GEV No.	511650	Ref. No.	903403
description	flat gasket paper ED ø 24mm ID ø 10.5mm thickness 1mm Qty 1 pcs warewashing		
For models:	GGW1001, GGW2001		

silicone gaskets



GEV No.	504296	Ref. No.	A040382
description	flat gasket silicone ED ø 29mm ID ø 12mm thickness 1.6mm Qty 1 pcs for coffee machine		
For models:	GCM1006, GCM2009, GCM3016		



GEV No.	511646	Ref. No.	A0ND011
description	gasket silicone ED ø 63mm ID ø 55mm thickness 2.3mm Qty 1 pcs for heating element		
For models:	GCM1006, GCM2009, GCM3016		

shaft gaskets

shaft gaskets



GEV No.	697475	Ref. No.	00000012671
description	shaft seal ID ø 20mm ED ø 30mm thickness 5mm		
For models:	GFS1025		



1

GEV No.	698383	Ref. No.	0632
description	shaft sealing ID ø 4mm ED ø 12mm for hand blender H 6.3mm		
For models:	GSM1000		

miscellaneous



1

GEV No.	511953	Ref. No.	900871
description	seal kit for citrus juicers		
For models:	GJU1001		

special gaskets

for vacuum packers



1

GEV No.	699618	Ref. No.	HVS1000-08 YJS820-8
description	lid gasket L 1365mm		

for microwaves



1

GEV No.	901698	Ref. No.	593219000016 GMW1025-P161
description	gasket L 330mm W 325mm silicone for ceramic plate Qty 1 pcs		

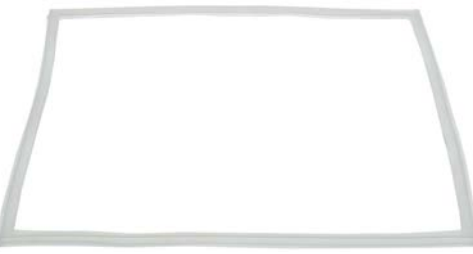

1

GEV No.	902161	Ref. No.	P161
description	gasket L 365mm W 360mm silicone for ceramic plate Qty 1 pcs for GMW1030		

miscellaneous



1

GEV No.	698545	Ref. No.	3,0000404 GDF1108-027 GDF1108-27 GDF2128-028 HDF1108-036 HDF2128-037
description	gasket ED ø 31mm ID ø 21mm		
For models:	GDF1108, GDF2128		



1

GEV No.	698543	Ref. No.	3,0000403 GDF1108-033 GDF2128-034 HDF1108-037 HDF1108-37 HDF2128-038
description	gasket external height 4mm ED ø 25mm ID ø 16mm		
For models:	GDF1108, GDF2128		



1

GEV No.	504297	Ref. No.	A0ND036
description	gasket for water level tube ED ø 13mm ID ø 6mm silicone		
For models:	GCM1006, GCM2009, GCM3016		

thermostat gaskets



1

GEV No.	512205	Ref. No.	016240433
description	gasket for temperature probe ED ø 15mm plastic Qty 1 pcs		
For models:	GDF1004, GDF2024		

gaskets for wash arm support



1

GEV No.	506223	Ref. No.	905257
description	gasket D1 ø 110mm D2 ø 82mm thickness 3mm with 4 screw holes flange		
For models:	GDW1001		





1

GEV No.	519445	Ref. No.	908141
description	gasket D1 ø 80mm D2 ø 50mm thickness 3mm with 4 screw holes		
For models:	GDW1001		

refrigeration cycle components

cooling water regulators

JOHNSON CONTROLS



1

GEV No.	541839	Ref. No.	82-5272-9
description	cooling water regulator 3/8" type V46SA-9952 connection 6mm soldering connection pressure range 5-23bar water pressure max. 18bar water temperature max. 90°C capillary pipe 750mm L 101mm 405kg		
For models:	GIM1023, GIM1038, GIM2023, GIM2038		

valves

Schrader valves

Schrader valves (complete)



1

GEV No.	750636	Ref. No.	C01AA06A0003 GDS1600-36 GDS1600-42 GPS1134-36 GPS1134-42 GPS1600-36 GPS1600-42 GSF1600-36 GSF1600-42 S900.36 S900.42
description	Schrader valve complete connection 1/4"SAE ø 6mm L 120mm		
For models:	GDS1134, GDS1600, GHS1134, GHS1600, GHS2134, GHS2600, GPS1134, GPS1600, GSA1134, GSA1600, GSF1134, GSF1600		

filter driers

accessories

holders



1

GEV No.	699297	Ref. No.	GBC1001-10 GBC1002-10 GBC1003-10 SLJAC008
description	bracket L 40mm W 30mm H 31mm ID ø 18mm ED ø 22mm for dryer		
For models:	GBC1001, GBC1002, GBC1003, GSC1100G, GSC2336		

miscellaneous



1

GEV No.	750381	Ref. No.	A1.1.A.A04.01 GBC1001-09 GBC1002-09 GBC1003-09 GSC1336-32 GSC2336-32 TCGV0002
description	dryer ø 18.5mm L 115.5mm connection 2,4/5,2mm Qty 1 pcs		
For models:	GBC1001, GBC1002, GBC1003, GRV1100, GSC1336, GSC2336		



1

GEV No.	750693	Ref. No.	1.1.A.A04.01 GCV1600-40
description	dryer ø 19mm L 120.5mm connection 2/5mm Qty 1 pcs		



1

GEV No.	750378	Ref. No.	C04AC26A0001 RC400.12 RC600.03 RN400.07 RN600.04
description	dryer ø 19mm L 145mm connection 4,5/8mm type XH9 Qty 1 pcs		
For models:	GFR2600, GPS2600, GRE2600, GSA2600, GSD2600, GSF2600, RC400, RN400		



1

GEV No.	750383	Ref. No.	GGC2270-08 GGC2270-8
description	dryer ø 19mm L 182mm connection 6,5/6,5mm Qty 1 pcs		
For models:	GGC1270		

			
1			
GEV No.	750694	Ref. No.	1.1.A.A04.06 GGC2270-07
description	dryer ø 25mm L 144mm connection 6/8mm Qty 1 pcs		
For models:	GGC1270		

			
1			
GEV No.	750324	Ref. No.	GPS1600-44 GSF1600-44 S900.44
description	dryer size 20g ø 23mm L 117mm connection 4,8/8,3mm		
For models:	GDS1134, GDS1600, GHS1134, GHS1600, GHS2134, GHS2600, GPS1134, GPS1600, GSA1134, GSA1600, GSF1134, GSF1600		

			
1			
GEV No.	750382	Ref. No.	GSC1100-31 TCGV0002 HSC350-10 TCGV0009
description	dryer ø 18.5mm L 120mm connection 4/7mm Qty 1 pcs		
For models:	GSC1100, GSC1100G		
accessories for	750382		
	GEV No.	694868	Ref. No. —
	bracket for dryer L 40mm W 30mm H 31mm Qty 1 pcs		

			
1			
GEV No.	750311	Ref. No.	0145040
description	dryer size 20g ø 19mm L 149mm connection 3,2/6,2mm		
For models:	GFR1600		

			
1			
GEV No.	750310	Ref. No.	0145015
description	dryer size 20g ø 19mm L 150mm connection 3.2/5/6.2mm		
For models:	GRE1600		

refrigeration pipes

copper pipes uninsulated

			
1			
GEV No.	694931	Ref. No.	GPS1600-43 GSF1600-43 S900.43 VRX.15
description	capillary pipe ID ø 0.8mm ED ø 2mm L 2340m		
For models:	GDS1134, GDS1600, GHS1134, GHS1600, GHS2134, GHS2600, GPS1134, GPS1600, GSA1134, GSA1600, GSF1134, GSF1600		

			
1			
GEV No.	692407	Ref. No.	1.1.B.B06.21 GGC2270-57
description	copper pipe copper ID ø 3.8mm ED ø 4.8mm L 0.1m Qty 1 pcs		
For models:	GGC1270		

			
1			
GEV No.	692667	Ref. No.	A1.1.B.B02.07
description	copper pipe ID ø 5mm ED ø 6mm L 0.23m Qty 1		
For models:	GRV1100		

			
1			
GEV No.	692418	Ref. No.	1.1.B.B06.26 GGC2270-56
description	refrigeration pipe copper ID ø 5mm ED ø 6mm L 1m Qty 1		
For models:	GGC1270		

			
1			
GEV No.	692699	Ref. No.	A1.1.B.B02.04
description	refrigeration pipe ID ø 3.5mm ED ø 5mm L 0.1m		
For models:	GRV1100		



copper pipes insulated



GEV No.	699322	Ref. No.	GPS1600-39 GSF1600-39 S900.39
description	refrigeration pipe pipe \varnothing 6 insulation thickness 8mm L 525mm		
For models:	GDS1134, GDS1600, GPS1134, GPS1600, GSA1134, GSA1600, GSF1134, GSF1600		

insulation



GEV No.	694930	Ref. No.	RC600.10
description	insulating hose thickness 8mm model 3/8"x5/8" refrigeration ID \varnothing 20mm		
For models:	GRE2600		

heating tubes

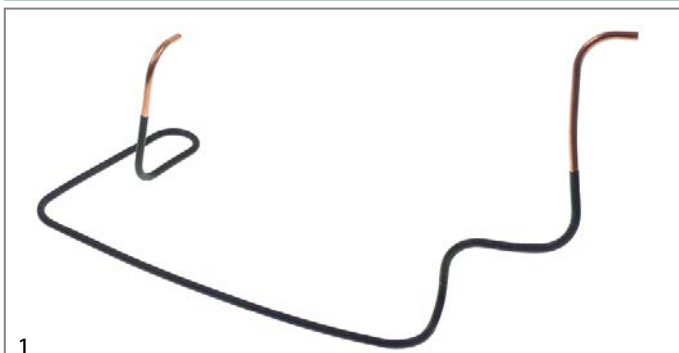

GEV No.	699421	Ref. No.	GCV1600-49
description	heater ED \varnothing 5mm ID \varnothing 3.3mm L 320mm copper Qty 1m		



GEV No.	701583	Ref. No.	C04AC26A0002
description	heater ED \varnothing 6mm ID \varnothing 3mm L 260mm copper		
For models:	GPS2600, GSA2600, GSD2600, GSF2600		



GEV No.	701584	Ref. No.	RC600.07 RC600.15
description	heater ED \varnothing 6mm ID \varnothing 5mm L 330mm copper		
For models:	GRE2600		

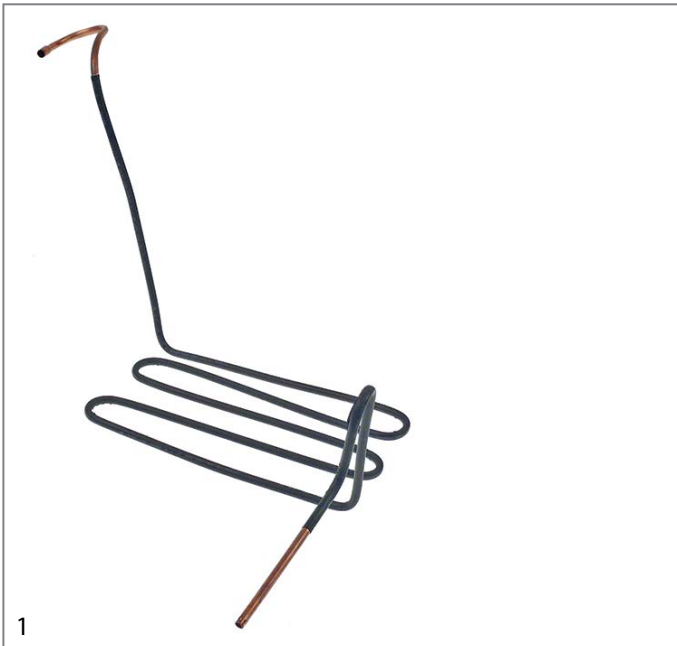

GEV No.	701495	Ref. No.	TCGD4010
description	heater ED ø 6mm ID ø 5mm Qty 1m for evaporator connection ø 6mm		
For models:	GSC1100G		



GEV No.	699400	Ref. No.	RC400.10
description	heater mounting pos. lower ø 6mm L 300mm W 155mm H 170mm		
For models:	RC400		

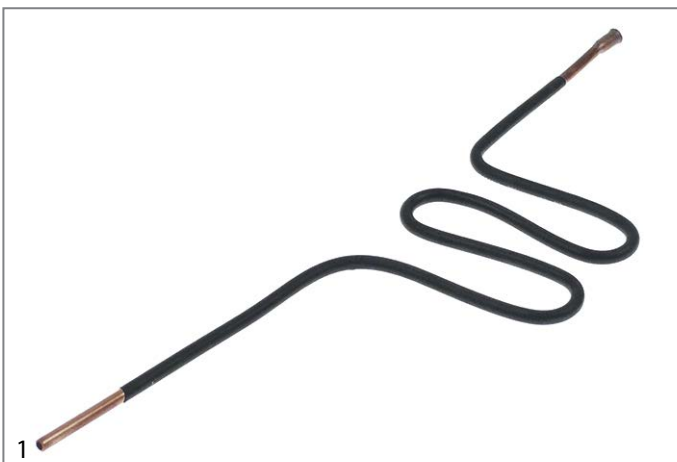

GEV No.	701432	Ref. No.	TCGD2012
description	heater pipe ED ø 5mm ID ø 3mm L 350mm copper Qty 1		

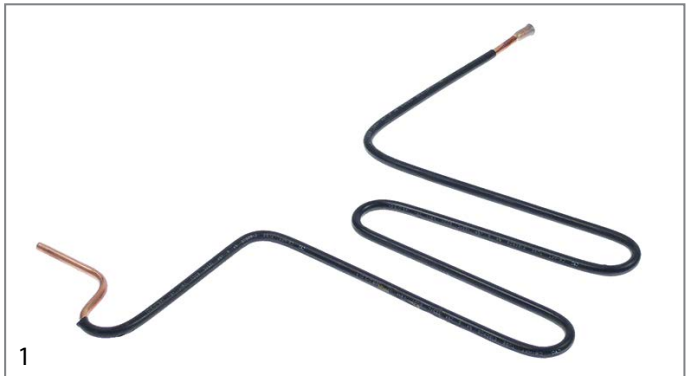

GEV No.	701582	Ref. No.	GBC1001-13 GBC1002-11 GBC1003-11 TCGD2001
description	heater pipe ED ø 5mm ID ø 3mm L 355mm H 250mm		
For models:	GBC1001		

evaporators for fridges

producer-specific



GEV No.	750367	Ref. No.	GFR2600-31 RN600.31
description	evaporator for deep freezer GFR2600 L 600mm W 450mm H 1200mm		
For models:	GFR2600		



GEV No.	750387	Ref. No.	GBC1001-39 TLZA9000
description	evaporator for fridge GBC1001 L 430mm W 500mm		
For models:	GBC1001		

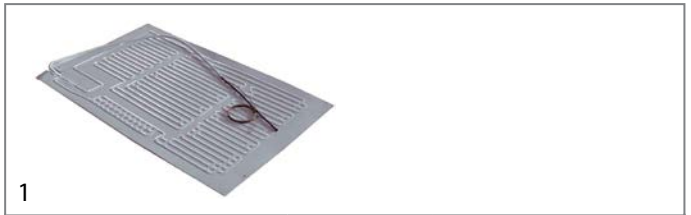

GEV No.	750376	Ref. No.	GBC1002-41 TLZD9001
description	evaporator for fridge GBC1002 L 760mm W 500mm		
For models:	GBC1002		



1

GEV No.	750456	Ref. No.	HSC360-21
description	evaporator for fridge HSC360 L 780mm W 495mm		



1

GEV No.	750361	Ref. No.	RC600.04
description	evaporator for fridge L 1000mm W 471mm		
For models:	GRE2600		



1

GEV No.	750377	Ref. No.	GBC1003-41 TLZD9002
description	evaporator for fridge L 1000mm W 500mm		
For models:	GBC1003		

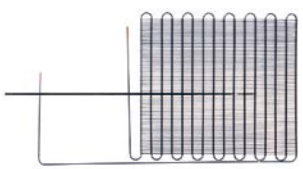

1

GEV No.	750342	Ref. No.	0130010
description	evaporator L 1580mm W 660mm suitable for AB500P		
For models:	GRE1600		



1

GEV No.	750352	Ref. No.	1.1.A.A10.27 GGC1078-43
description	evaporator L 250mm W 50mm H 117mm		



1

GEV No.	750629	Ref. No.	GPC1088-02
description	evaporator L 320mm W 320mm H 5mm		
For models:	GPC1088		



1

GEV No.	750350	Ref. No.	1.1.A.A10.40 GGC2270-15
description	evaporator L 345mm W 100mm H 215mm total length 345mm overall width 100mm overall height 240mm for fridge		
For models:	GGC1270		



1

GEV No.	750345	Ref. No.	GSC1336-16 GSC2336-16
description	evaporator L 520mm W 180mm H 160mm		
For models:	GSC1336		



1

GEV No.	750371	Ref. No.	1.1.A.A10.23 GCV1600-09
description	evaporator L 545mm W 50mm H 110mm total length 600mm overall width 50mm overall height 123mm		



1

GEV No.	750728	Ref. No.	GSC1100G-39
description	evaporator L 610mm W 120mm H 215mm		



1

GEV No.	750660	Ref. No.	HSC800-42 TLZA4003
description	evaporator L 620mm W 225mm H 160mm		



1

GEV No.	750375	Ref. No.	GSC1100-19 TLZA4004
description	evaporator L 760mm W 140mm H 225mm		
For models:	GSC1100		

for display coolers



1

GEV No.	750646	Ref. No.	A1.1.A.A09.03
description	evaporator L 280mm W 82mm H 116mm total length 330mm overall width 120mm		
For models:	GRV1100		



1

GEV No.	750690	Ref. No.	RN400.02
description	evaporator W 430mm D 415mm H 1210mm		
For models:	RN400		

accessories

miscellaneous



1

GEV No.	692425	Ref. No.	GSC1336-28 GSC2336-28
description	bush for evaporator plastic ø 24mm L 34mm Qty 1 pcs		
For models:	GSC1336		



1

GEV No.	699408	Ref. No.	RC400.24
description	clip for evaporator ø 31.5mm		
For models:	RC400		



1

GEV No.	701268	Ref. No.	RN400.23 RN600.32
description	U profile for evaporator L 635mm W 16mm H 13mm aluminium Qty 1 pcs		
For models:	GFR2600, RN400		

condensors

filters



1

GEV No.	694587	Ref. No.	GPS1600-04 GSF1600-04 S900.04
description	air filter for condenser L 218mm W 194mm thickness 6mm Qty 1 pcs		
For models:	GDS1134, GDS1600, GPS1134, GPS1600, GSA1134, GSA1600, GSF1134, GSF1600		

1

GEV No.	699402	Ref. No.	P04AC28A0002
description	filter for condenser L 218mm W 230mm thickness 6mm Qty 1 pcs		
For models:	GPS2600, GSA2600, GSD2600, GSF2600		

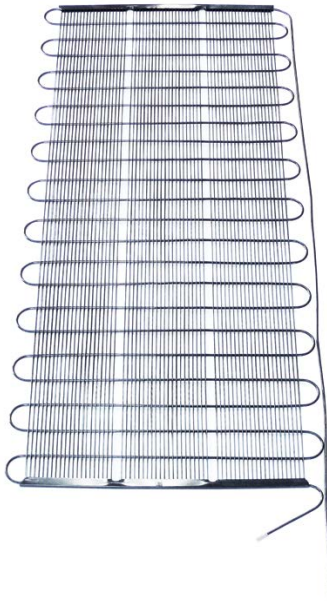

1

GEV No.	750360	Ref. No.	RC600.05
description	condenser for fridge W 500mm H 1170mm Qty 1 pcs		
For models:	GRE2600		

condensers



1

GEV No.	750379	Ref. No.	RN600.03
description	condenser for deep freezer W 640mm H 1165mm Qty 1 pcs		
For models:	GFR2600		



1

GEV No.	750319	Ref. No.	VRX.11
description	condenser for pizza table W 228mm D 77mm H 179mm		
For models:	GHS1134, GHS1600, GHS2134, GHS2600		



1

GEV No.	750647	Ref. No.	A1.1.A06.03
description	condenser for vitrine W 160mm D 312mm H 110mm Qty 1 pcs		
For models:	GRV1100		



1

GEV No.	750373	Ref. No.	DTLA9002 GBC1002-06 HBC2003-06
description	condenser W 190mm D 160mm H 205mm Qty 1 pcs		
For models:	GBC1003		

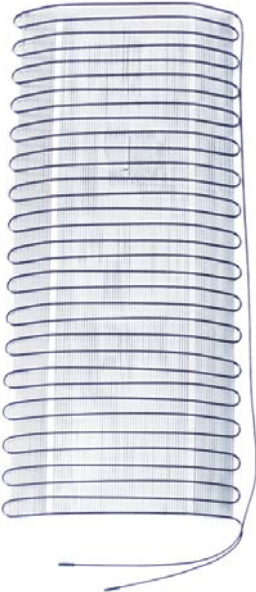

1

GEV No.	750346	Ref. No.	DTLB2004 GSC1336-27 GSC2336-27 HSC360-02
description	condenser L 1430mm W 520mm		
For models:	GSC1336		



1

GEV No.	750372	Ref. No.	DTLA9000 GBC1001-06
description	condenser W 195mm D 80mm H 205mm Qty 1 pcs		
For models:	GBC1001		



1

GEV No.	750347	Ref. No.	C04AC28A0001 GPS1600-35 GSF1600-35 S900.35
description	condenser W 220mm D 100mm H 230mm L 270mm		
For models:	GDS1134, GDS1600, GPS1134, GPS1600, GPS2600, GSA1134, GSA1600, GSA2600, GSD2600, GSF1134, GSF1600, GSF2600		



1

GEV No.	750385	Ref. No.	GBC1003-06
description	condenser W 255mm D 180mm H 205mm Qty 1 pcs		



1

GEV No.	750384	Ref. No.	1.1.A.A09.01 GGC1078-07 GGC1078-7
description	condenser W 220mm D 60mm H 280mm Qty 1 pcs		

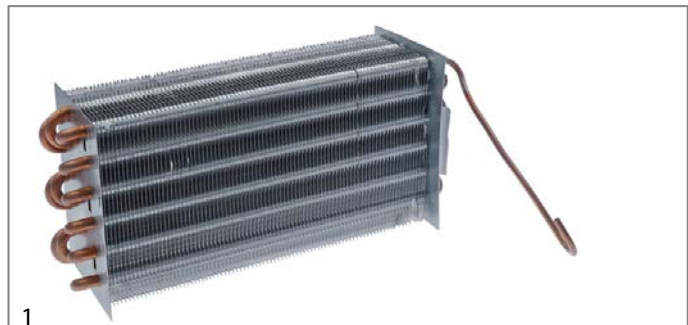

1

GEV No.	750370	Ref. No.	1.1.A.A09.21 GCV1600-30
description	condenser W 265mm D 93mm H 140mm Qty 1 pcs		



1

GEV No.	750351	Ref. No.	1.1.A.A09.09 GGC2270-11
description	condenser W 255mm D 130mm H 235mm		
For models:	GGC1270		



1

GEV No.	750659	Ref. No.	HSC800-06
description	condenser W 290mm D 180mm H 215mm Qty 1 pcs		

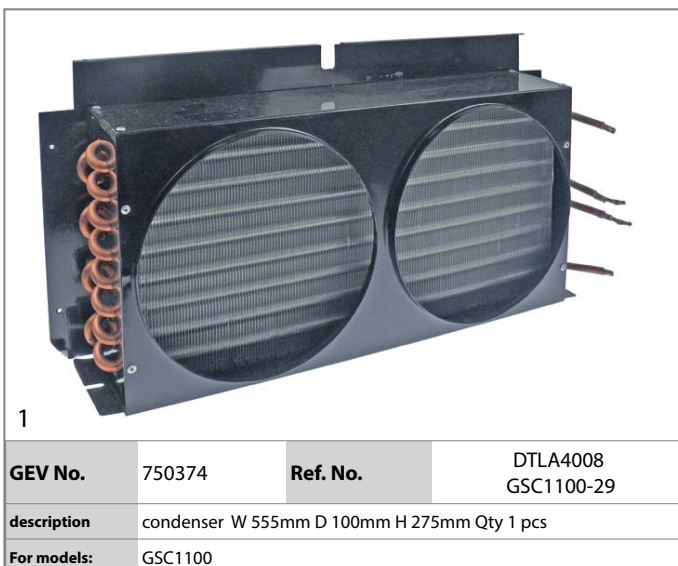
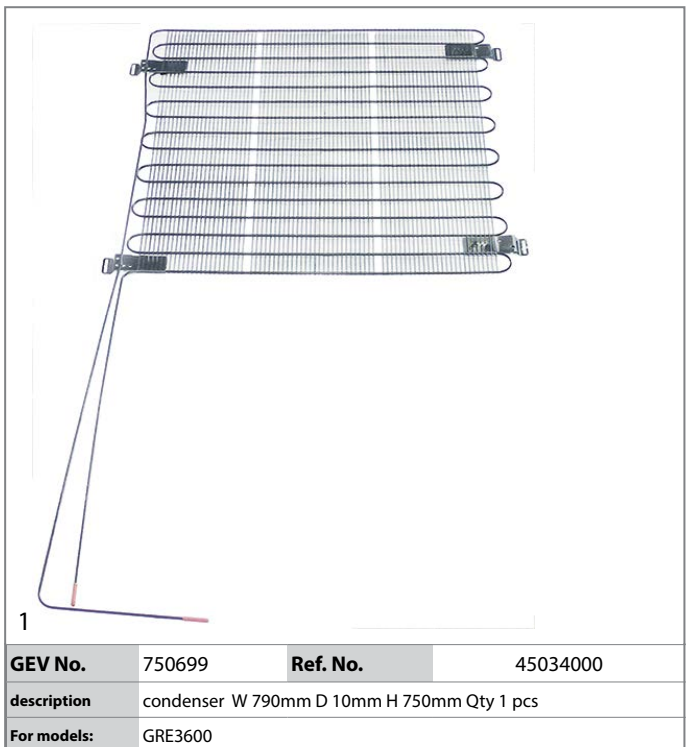
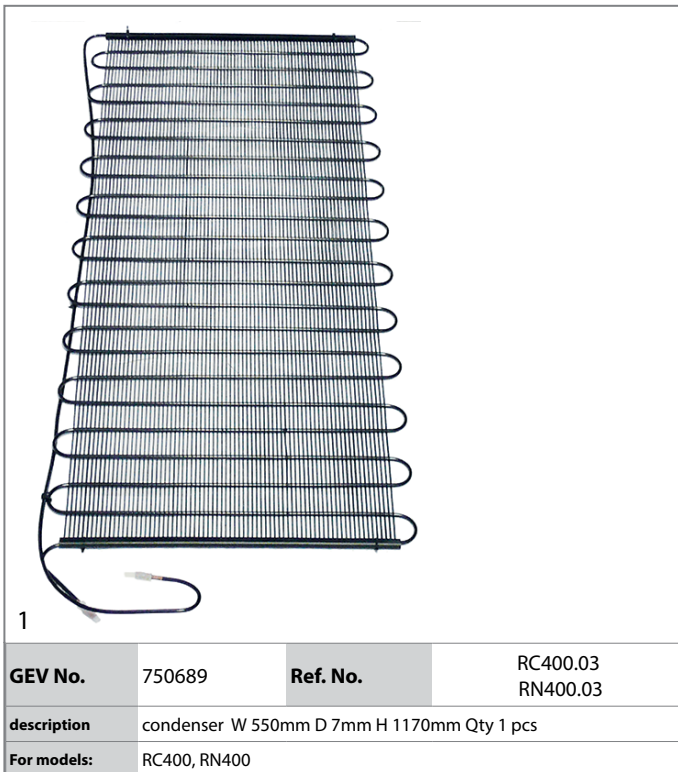
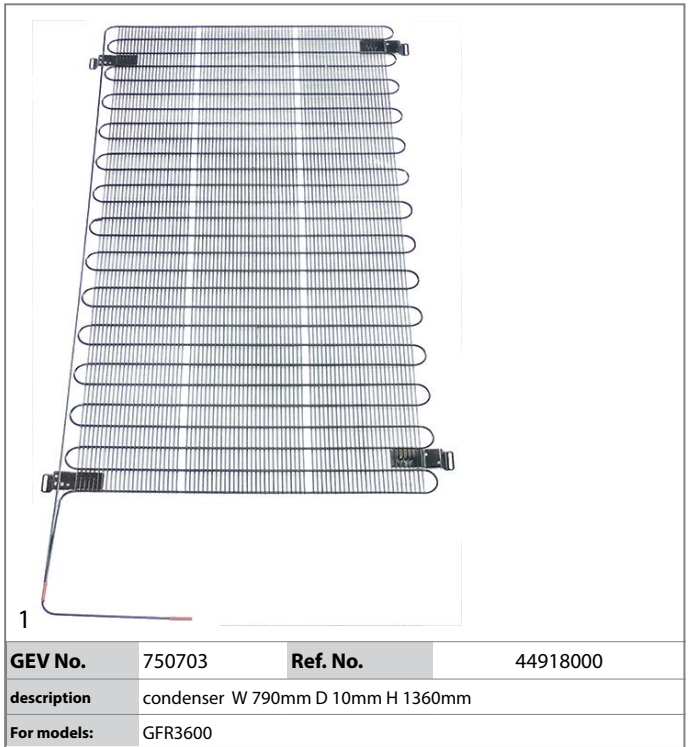





evaporation and condensing trays

evaporation trays

 <p>1</p>			
GEV No.	699308	Ref. No.	GBC1002-14 GBC1003-14
description	evaporation tray L 120mm W 74mm H 58mm Qty 1 pcs		

 <p>1</p>			
GEV No.	699302	Ref. No.	SLZJ0021
description	evaporation tray L 185mm W 130mm H 75mm		
For models:	GBC1001		

 <p>1</p>			
GEV No.	699299	Ref. No.	GSC1336-47 SLZJ0014
description	evaporation tray L 210mm W 105mm H 80mm		
For models:	GSC1336, GSC2336		

 <p>1</p>			
GEV No.	699211	Ref. No.	I0425088
description	evaporation tray L 230mm W 144mm H 45mm		
For models:	GRE3600		

 <p>1</p>			
GEV No.	750380	Ref. No.	RC400.11 RC600.06
description	evaporation tray unheated L 205mm W 155mm H 78mm for deep freezer Qty 1 pcs		
For models:	GRE2600, RC400		

unheated condensing trays

 <p>1</p>			
GEV No.	750630	Ref. No.	GPC1088-08
description	condensing tray L 200mm W 135mm H 30mm plastic		
For models:	GPC1088		

 <p>1</p>			
GEV No.	750632	Ref. No.	SLZJ0022
description	drip tray L 187mm W 128mm H 70mm plastic		
For models:	GBC1002, GBC1003		

 <p>1</p>			
GEV No.	750631	Ref. No.	GSC1100-27 SLZJ0015
description	drip tray L 302mm W 204mm H 85mm plastic		
For models:	GSC1100, GSC1100G		

 <p>1</p>			
GEV No.	699418	Ref. No.	1.1.C.C29.02 GGC2270-04
description	drip tray L 400mm W 144mm H 50mm plastic		
For models:	GGC1270		

transmission technology and ball bearings

ball bearings

deep-groove ball bearings 2RS

 <p>1</p>			
GEV No.	523501	Ref. No.	00000000637
description	deep-groove ball bearing type 608-2RS shaft \varnothing 8mm ED \varnothing 22mm W 7mm with sealing discs deep-groove ball bearing DIN 625-1		
For models:	GFS1030		



1

GEV No.	523510	Ref. No.	00000000860
description	deep-groove ball bearing type 6202-2RS shaft ϕ 15mm ED ϕ 35mm W 11mm with sealing discs deep-groove ball bearing DIN 625-1		
For models:	GFS1025, GFS2022, GFS2025, HFS2019, HFS2022, HFS2025		



1

GEV No.	523512	Ref. No.	00000000632
description	deep-groove ball bearing type 6204-2RS shaft ϕ 20mm ED ϕ 47mm W 14mm with sealing discs deep-groove ball bearing DIN 625-1		
For models:	GFS1030		



1

GEV No.	523504	Ref. No.	00000000862
description	deep-groove ball bearing type 626-2RS shaft ϕ 6mm ED ϕ 19mm W 6mm with sealing discs deep-groove ball bearing DIN 625-1		
For models:	GFS1025, GFS2022, GFS2025, HFS2019, HFS2022, HFS2025		

drive belts

poly-v belts

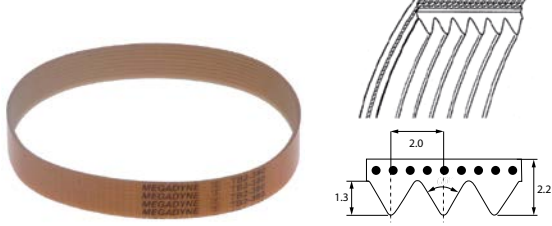

1

GEV No.	698215	Ref. No.	00000000635
description	poly-v belt grooves 10 W 20mm L 400mm profile TB2		
For models:	GFS1030		

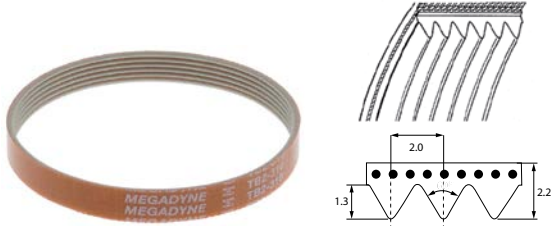

1

GEV No.	698963	Ref. No.	00000000492
description	poly-v belt grooves 5 W 10mm L 310mm profile TB2		
For models:	GFS2022, HFS2022		

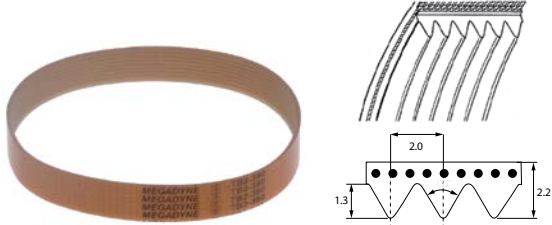

1

GEV No.	698217	Ref. No.	00000000861
description	poly-v belt grooves 7 W 14mm L 330mm profile TB2		
For models:	GFS1025, GFS2025, HFS2025		

springs

torsion springs



1

GEV No.	700569	Ref. No.	901908
description	torsion spring ϕ 21.5mm L2 40mm wire gauge ϕ 3.3mm L1 100mm L3 45mm		
For models:	GPG1001, GPG2001		

gas tension springs

gas tension springs



1

GEV No.	701553	Ref. No.	HVS1000-21 YJS820-21
description	gas tension spring left 80N D1 ϕ 6mm D2 ϕ 15mm L 162mm HVS1000		



1

GEV No.	701554	Ref. No.	HVS1000-46 YJS820-46
description	gas tension spring right 80N D1 ϕ 6mm D2 ϕ 15mm L 162mm HVS1000		

tension springs



1

GEV No.	519443	Ref. No.	908042
description	tension spring ϕ 11.5mm total length 220mm wire gauge ϕ 2mm		
For models:	GDW1001		



			
1			
GEV No.	701249	Ref. No.	GMW1030-P118
description	tension spring ϕ 7.3mm total length 25.5mm wire gauge ϕ 1mm for door latch Qty 1 pcs		
For models:	GMW1030		

kitchen accessories

gastronorm

bridges

			
1			
GEV No.	692377	Ref. No.	S900.20
description	bridge for Gastronorm container L1 180mm L2 200mm SS W 38mm H 12.5mm Qty 1 pcs thickness 0.6mm		
For models:	GSA1134, GSA1600		

			
1			
GEV No.	692378	Ref. No.	S900.21
description	bridge for Gastronorm container L1 325mm L2 295mm SS W 23mm H 14mm Qty 1 pcs thickness 0.9mm		
For models:	GSA1134, GSA1600		

			
1			
GEV No.	692262	Ref. No.	S900.22
description	bridge for Gastronorm container L1 530mm L2 550mm SS W 23mm H 14mm Qty 1 pcs thickness 0.7mm		
For models:	GSA1134, GSA1600		

manometers

			
1			
GEV No.	542340	Ref. No.	HVS1000-35 YJS820-35
description	manometer ϕ 41mm pressure range 0-1bar connection 5mm		

dosing pumps

membrane dosing pumps

self-priming with supporting pressure

GERMAC

type 2001















			
1			
GEV No.	361545	Ref. No.	902013
description	dosing pump type 2001 rinse aid inlet 4x6mm outlet M10x1 suction connection ϕ 4x6mm supporting pressure 11mm rebound ball PTFE 1mm GERMAC CODE VNR/U3		
For models:	GDW1001, GGW1001, GGW2001		
spare parts for	361545		
			
GEV No.	361551	Ref. No.	—
compression spring wire gauge ϕ 1mm			
			
GEV No.	361700	Ref. No.	—
hose connector rotary hose ϕ 4x6mm plastic connection M10x1			
			
GEV No.	361702	Ref. No.	—
hose connector brass hose ϕ 4x6mm			
			
GEV No.	361705	Ref. No.	—
gasket for hose connector M12x1			
			
GEV No.	510298	Ref. No.	—
lip valve dosing pump suitable for DB2/DS5			
accessories for	361545		
			
GEV No.	361142	Ref. No.	—
mounting set detergent hose type 4x6mm hose length 2m PVC 2x hose/container filter/tank intake transparent			
			
GEV No.	361550	Ref. No.	—
hose connector hose ϕ 4x6mm			
			
GEV No.	361553	Ref. No.	—
membrane EPDM			
			
GEV No.	361701	Ref. No.	—
hose connector thread M10x1 grommet ϕ 7.5mm			
			
GEV No.	361703	Ref. No.	—
hose connector thread M10x1 brass pipe connection ϕ 4x6mm			
			
GEV No.	361704	Ref. No.	—
hose connector brass straight thread M12x1 hose ϕ 11mm Qty 1 pcs			
			
GEV No.	510296	Ref. No.	—
membrane silicone			
			
GEV No.	520090	Ref. No.	—
PVC hose ID ϕ 4mm ED ϕ 6mm L 2m thickness 1mm t.max. 60°C transparent			

Table continues overleaf

accessories for	361545		
GEV No.	520091	Ref. No.	—
 nylon hose ID ø 4mm ED ø 6mm L 2m thickness 1mm operating p. 10bar burst p. 50bar t.max. 100°C transparent			

accessories

miscellaneous



GEV No.	513329	Ref. No.	906375
description	bracket for dosing pump L 70mm H 25mm W 40mm spring steel		
For models:	GDW1001, GGW1001		

hoses



supply hoses

PVC supply hoses



GEV No.	520010	Ref. No.	907344
description	supply hose PVC straight-curved DN13 connections 3/4" L 1500mm operating p. 10bar burst p. 32bar t.max. 90°C blue approval VDE flat seal		
For models:	GDW1001, GGW1001, GGW2001		

accessories for

GEV No.	520053	Ref. No.	—
 screen connection 3/4" D1 ø 26mm D2 ø 15mm Qty 10 pcs rubber thickness 8mm			
GEV No.	520054	Ref. No.	—
 flat gasket rubber ED ø 23.5mm ID ø 14mm thickness 2.3mm Qty 10 pcs			

drain hoses

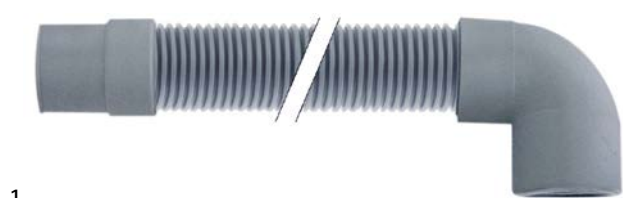

GEV No.	530571	Ref. No.	907440
description	drain hose DN24 L 1500mm straight ø inside 24mm straight ext. ø 29mm elbow ø inside 29mm elbow ext. ø 35mm outer hose ø 28mm		
For models:	GGW2001		

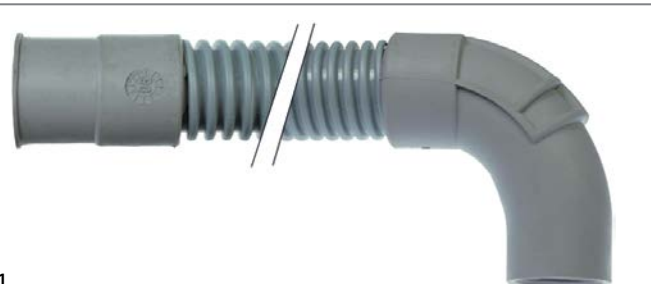

GEV No.	519456	Ref. No.	907439
description	drain hose L 1500mm D1 ø 21mm D2 ø 21mm		
For models:	GDW1001, GGW1001		

industrial hoses

PVC hoses

PVC hoses without fabric



GEV No.	699440	Ref. No.	A1.1.K.K04.08
description	hose ID ø 10mm ED ø 13mm L 196m		
For models:	GRV1100		



GEV No.	699439	Ref. No.	A1.1.E.E06.03
description	hose ID ø 8mm ED ø 10mm L 0.36m		
For models:	GRV1100		



GEV No.	570027	Ref. No.	902046
description	PVC hose ID ø 4mm ED ø 7mm L 100m thickness 1.5mm t.max. 60°C transparent		
For models:	GDW1001, GGW1001, GGW2001		



GEV No.	520637	Ref. No.	RW40.34
description	PVC hose ID ø 6mm ED ø 9mm L 0.4m thickness 1.5mm t.max. 60°C transparent		
For models:	GHR1040, GHR2600		



silicone hoses

without fabric



1

GEV No.	530410	Ref. No.	907279
description	silicone hose ID ø 4mm ED ø 7mm L 2m thickness 1.5mm t.max. 200°C transparent		
For models:	GDW1001, GGW1001, GGW2001		

form S



1

GEV No.	519131	Ref. No.	903668
description	formed hose S-shape warewashing equiv. no. 903668		
For models:	GGW1001, GGW2001		

formed hoses

straight



1

GEV No.	519392	Ref. No.	903756
description	formed hose L 61mm dishwasher straight hose ext. ø 50mm hose int. ø 38mm		
For models:	GDW1001		

miscellaneous



1

GEV No.	699420	Ref. No.	GGC1078-47
description	formed hose ID ø 19mm ED ø 24mm L 150mm		

form L



1

GEV No.	519563	Ref. No.	908136
description	formed hose end piece A ext. ø 56mm end piece A int. ø 45mm AD2 ø 56mm ø end piece B 44mm L 160mm Qty 1 L-shape		
For models:	GDW1001		

for dishwashers

miscellaneous



1

GEV No.	519448	Ref. No.	907295
description	hose D1 ø 12mm D2 ø 19.5mm		
For models:	GDW1001, GGW1001, GGW2001		



1

GEV No.	530432	Ref. No.	907360
description	pressure hose ED ø 17mm ID ø 10mm L 1000mm operating p. 10bar burst p. 25bar temp.-resist. 110°C		
For models:	GGW1001, GGW2001		



1

GEV No.	519132	Ref. No.	903674
description	formed hose warewashing L-shape equiv. no. 903674		
For models:	GGW1001, GGW2001		

fittings, hose and pipe connectors

hose connectors

without screw connection



1

GEV No.	519644	Ref. No.	905434
description	T-piece plastic connection ø12mm - ø5mm - ø12mm		
For models:	GDW1001, GGW1001, GGW2001		



			
1			
GEV No.	519216	Ref. No.	905382
description	T-piece plastic hose ø 12-12-12mm 3-way		
For models:	GDW1001, GGW1001, GGW2001		

			
1			
GEV No.	699612	Ref. No.	HVS1000-15 YJS820-15
description	T-piece plastic hose ø 5-5-5mm		

			
1			
GEV No.	504817	Ref. No.	HVS1000-29 YJS820-29
description	T-piece SS hose ø 10-10-10mm		

			
1			
GEV No.	504823	Ref. No.	HVS1000-28 YJS820-28
description	cross fitting SS hose ø 10-10-10-10mm L 57mm W 57mm		

hose connectors

nickel-plated brass

			
1			
GEV No.	519239	Ref. No.	905452
description	hose connector nickel-plated brass thread 1/4" hose ø 11mm Qty 1 pcs		
For models:	GGW1001, GGW2001		

producer-specific			
			
1			
GEV No.	699615	Ref. No.	HVS1000-11 YJS820-11
description	hose connector for hose ID 10mm connection 1/4"mm L-shape		

ancillary products

clamps

hose clamps

DIN 3017 - W2

			
1			
GEV No.	520115	Ref. No.	902460
description	hose clamp ø 25-40mm width 9mm Qty 10 pcs DIN 3017		
For models:	GDW1001, GGW1001, GGW2001		

			
1			
GEV No.	520116	Ref. No.	902441
description	hose clamp ø 32-50mm width 9mm Qty 5 pcs DIN 3017		
For models:	GDW1001, GGW1001, GGW2001		

DIN 3017 - W4

			
1			
GEV No.	520120	Ref. No.	902440
description	hose clamp SS W4 ø 12-20mm width 9mm Qty 1 pcs DIN 3017		
For models:	GDW1001, GGW1001, GGW2001		

			
1			
GEV No.	520121	Ref. No.	902450
description	hose clamp SS W4 ø 16-27mm width 9mm Qty 1 pcs DIN 3017		
For models:	GGW2001		



measuring equipment

thermometers

built-in thermometers



GEV No.	541080	Ref. No.	3303276
description	thermometer mounting measurements 58x25,5mm -40 up to +40°C capillary pipe 2500mm probe ø 6mm probe L 30mm		
For models:	GFR1600, GRE1600		

external power supply



GEV No.	378274 ¹	Ref. No.	0406046
description	thermometer ARTHERMO type ROF-DIG/230 mounting measurements 58x25,5mm front measurements 64x31mm 230V voltage AC -30 jusqu'à +110°C probe ø6x40mm cable length 2500mm display 3 digits		
For models:	GFR1600, GRE1600		

¹incl. 1x NTC probe

fastening material

screws

flat-headed bolts



GEV No.	560281	Ref. No.	GHR1040-05 RW40.11
description	flat-headed bolt thread M5 thread L 16mm SS DIN 7985/ISO 7045 Qty 1 pcs intake Phillips head ø 10mm head thickness 2mm		
For models:	GHR1040, GHR2600		

hexagonal screws



GEV No.	560309	Ref. No.	907846
description	hexagonal screw thread M10 thread L 16mm SS WS 17 Qty 1 pcs DIN 933 / ISO 4017		
For models:	GGW1001, GGW2001		



GEV No.	560464	Ref. No.	907820
description	hexagonal screw thread M8 thread L 12mm SS WS 13 Qty 1 pcs head thickness 5mm DIN 933 / ISO 4017		
For models:	GDW1001, GGW1001, GGW2001		



GEV No.	699616	Ref. No.	HVS1000-23 YJS820-23
description	screw thread M10 thread L 26mm WS 17 Qty 2 pcs head thickness 7mm L 60mm		

side bolts



GEV No.	560551	Ref. No.	0000000615
description	side bolts thread M10 L 15mm SS Qty 1 pcs intake slotted head ø 24,5mm		
For models:	GFS1030		

knurled screws



GEV No.	697481	Ref. No.	0000000623
description	Thumb screw thread M6 thread L 8mm ø 14mm H 6mm SS		
For models:	GFS1030, GFS2022, GFS2025, HFS2019, HFS2022, HFS2025		

nuts

hexagonal nuts

DIN 934 / ISO 4032/8673



GEV No.	560197	Ref. No.	902025 HVS1000-20 YJS820-20
description	nut thread M10 H 8mm WS 17 SS DIN/ISO DIN 934 / ISO 4032/8673 Qty 1 pcs		
For models:	GGW1001, GGW2001		

			
1			
GEV No.	506166	Ref. No.	HVS1000-16 YJS820-16
description	nut thread M12 H 10mm WS 19 SS DIN/ISO DIN 934 / ISO 4032/8673 Qty 1 pcs		

			
1			
GEV No.	505200	Ref. No.	902037
description	nut thread M12x1.75 H 10mm WS 19 SS DIN/ISO DIN 934 / ISO 4032/8673 Qty 1 pcs		
For models:	GGW1001, GGW2001		

 <p>Image not available</p>			
1			
GEV No.	519051	Ref. No.	902030
description	nut thread M4 H 3.2mm WS 7 SS DIN/ISO DIN 934 / ISO 4032/8673 Qty 20 pcs		
For models:	GGW2001		

hexagonal nuts metric (without norm)

			
1			
GEV No.	692742	Ref. No.	GDS1600-14 GPS1600-14 GSF1134-14 GSF1600-14 S900.14
description	nut for drain pipe thread M20 H 18mm WS 26 plastic		
For models:	GDS1134, GDS1600, GPS1134, GPS1600, GSA1134, GSA1600, GSF1134, GSF1600		

			
1			
GEV No.	519050	Ref. No.	902023
description	nut thread M12x1.75 H 4mm WS 16 SS Qty 1 pcs for snap lock		
For models:	GDW1001, GGW1001, GGW2001		

<p>hexagonal nuts inch thread</p> 			
1			
GEV No.	506024	Ref. No.	902104
description	nut thread 3/8" H 6mm SS WS 22 Qty 1 pcs		
For models:	GDW1001		

washers

spring washers

			
1			
GEV No.	697478	Ref. No.	0000000671
description	spring washer ID ø 19mm ED ø 26mm Qty 1 pcs		
For models:	GFS1030		

washers

DIN 125A

			
1			
GEV No.	560312	Ref. No.	906055
description	plain washer ID ø 10.5mm ED ø 20mm thickness 2mm SS Qty 1 pcs DIN 125A for thread M10		
For models:	GGW1001, GGW2001		

miscellaneous

			
1			
GEV No.	560593	Ref. No.	HVS1000-22 YJS820-22
description	plain washer ID ø 10.5mm ED ø 15.8mm thickness 1mm SS Qty 4 pcs		

			
1			
GEV No.	560486	Ref. No.	0521000
description	plain washer ID ø 14.1mm ED ø 22mm thickness 2mm plastic Qty 1 pcs		
For models:	GFR1600, GRE1600		

			
1			
GEV No.	519238	Ref. No.	906002
description	plain washer ID ø 15mm ED ø 33mm thickness 0.8mm SS Qty 1 pcs		
For models:	GGW2001		



fasteners

mounting clips



1

GEV No.	692865	Ref. No.	00007750
description	mounting clip for bulb socket L 16mm H 19mm		
For models:	GCO2001		

clamps

hose clamps

DIN 3017 - W2



1

GEV No.	520115	Ref. No.	902460
description	hose clamp ø 25-40mm width 9mm Qty 10 pcs DIN 3017		
For models:	GDW1001, GGW1001, GGW2001		



1

GEV No.	520116	Ref. No.	902441
description	hose clamp ø 32-50mm width 9mm Qty 5 pcs DIN 3017		
For models:	GDW1001, GGW1001, GGW2001		

DIN 3017 - W4



1

GEV No.	520120	Ref. No.	902440
description	hose clamp SS W4 ø 12-20mm width 9mm Qty 1 pcs DIN 3017		
For models:	GDW1001, GGW1001, GGW2001		



1

GEV No.	520121	Ref. No.	902450
description	hose clamp SS W4 ø 16-27mm width 9mm Qty 1 pcs DIN 3017		
For models:	GGW2001		

roll pins



1

GEV No.	691637	Ref. No.	0744
description	roll pin ø 3mm L 20mm		
For models:	GSM1000		



1

GEV No.	692236	Ref. No.	902240
description	roll pin ø 4mm L 40mm		
For models:	GPG1001, GPG2001		

consumables

fuses

fine fuses

ø6.3x32mm 250V



1

GEV No.	358133	Ref. No.	GIC3035-B06 GIC3500-A06 GIC3535-D06 GIC4035-C06
description	fine fuse size ø6.3x32mm 16A slow-acting rated 250V Qty 1 pcs		
For models:	GIC3500, GIC3535, GIC4035		



1

GEV No.	358132	Ref. No.	GIC3035-06 GIC3500-06 GIC3535-06 GIC4035-06
description	fine fuse size ø6.3x32mm 16A slow-acting rated 250V Qty 20 pcs		

A			
alarm devices	24	flat-headed bolts	145
appliance sockets/plugs	53	fluorescent lamps	19, 19
axial fans	40	formed hoses	143
		fridge lamps	21
		fuses	53, 147
B			
ballasts	20	G	
bi-metal thermostats	8, 8	gaskets for heated units	125
booster pumps II	51	gaskets for wash arm support	128
		gastronorm	141
		grates	117
C			
cable glands	54	H	
cables	53	heating elements	3
cam switches	15	heating elements for coffee machine	5
castors and bumper angles	115	heating elements for contact grills	5
clamps	12, 144, 147	heating elements for convection	7
cold air circulating fans	45	heating elements for fryers	4
compressors	37	heating elements for griddles	4
condensators & interference suppression filters	51	heating elements for ovens	3
connection cables	55	heating elements for refrigeration	5
consumables	147	hexagonal nuts	145
contactors	24	hexagonal screws	145
control thermostats	9, 9	hose clamps	144, 147
cooling aggregates	37	hose connectors	143, 144
cooling water regulators	129	hoses	142
copper pipes insulated	131	hot air fans	47
copper pipes uninsulated	130	hot air motors	46
cross flow fans	46	HV capacitors	52
D			
defrost timers	24	I	
door gaskets (wire reinforced)	126	immersion heating elements	6
door seals	125	indicator lights	16
door seals with fixing hook	126	indicator lights (complete)	17
dosing pumps	141	induction coils	3
drain hoses	142	industrial hoses	142
drain pumps	50	insulation	131
E			
electric accessories	53	K	
electric timers	23	knurled screws	145
electronic controllers	26	L	
end caps and plugs	115	lamps	16
evaporators	132	LED	18
F			
fans	40	M	
fasteners	147	magnetic switches	16
fastening material	145	magnetrons	25
filter driers	129	measuring equipment	145
filters	52	mechanical timers	23
fine fuses	147	microswitches	14
		microwave lamps	22
		motors	48

mounting clips	147	solid state relays	24
N		speed controllers	48
nuts	145	spring assisted hinges	105
O		spring washers	146
operating capacitors	52	starter	20
O-rings	126	starting capacitors	51
oven hinges	106	strain reliefs	54
oven lamps	23	supply hoses	142
P		switches and momentary switches	12
plug-in gaskets	123	system switches (ROLD)	15
plugs - couplings - power sockets	53	T	
position switches	15	temperature probes	28
power supply cables	53	terminal boxes	56
pressure switches	36	terminals	55
probe clips	12	thermostat gaskets	128
probes	28	thermostats	8
pumps	50	threaded cable glands	54
pumps for ice machines	51	timers	23
push/momentary push switches	13	transformers	25
PVC hoses	142	U	
PVC supply hoses	142	universal probes	28
Q		V	
quartz heating elements	6	vacuum pumps	51
R		W	
radial fans	48	wash and rinse pumps	50
refrigeration cycle components	129	washers	146
refrigeration fans	42		
refrigeration gaskets	123		
refrigeration motors universal	42		
refrigeration pipes	130		
refrigeration thermostats	11		
relays	24		
ribbon cables	55		
rocker/momentary rocker switches	12		
roll pins	147		
S			
safety bi-metal thermostats	8		
safety thermostats	9		
Schrader valves	129		
screw-in gaskets	125		
screws	145		
sealing washers	127		
shaft gaskets	127		
shelves and shelf rails	117		
side bolts	145		
silicone hoses	143		
solenoid valves	34		