



GAS COMPONENTS



ELECTRIC COMPONENTS



WATER TECHNOLOGY



MECHANICAL COMPONENTS



TOOLS

Spare parts suitable for

I-OVENS

Find the complete and up-to-date range of products in our GEV Webshop



Manufacturer catalogue

The most important spare parts and accessories arranged clearly for every manufacturer

- ✓ Complete product range and all appliance data always up to date in the GEV Webshop
- ✓ Alphabetical Index at the end of the catalogue

GEV Webshop

www.gev-online.co.uk

www.gev-online.com



- 🔍 Add to Favourites
- 🔍 Sign In with email address and usual password
- 🔍 Easy-order – place several items in your basket at the same time
- 🔍 Quick Item search – no login needed



heating elements

heating elements for ovens



1

GEV No.	418759	Ref. No.	10645
description	heating element 1800W 230V heating circuits 1 L 360mm W 390mm L1 95mm L2 265mm W1 165mm W2 60mm flange length 100mm flange width 23mm hole distance 86mm bridge length 485mm hole ø 3.3mm tube ø 6.3mm connection male faston 6.3mm connection length 10mm windings 4 rectangular flange dry heating element mounting thread M4		

heating elements for heated cabinets



1



GEV No.	419065	Ref. No.	10602
description	heating element 1400W 230V heating circuits 1 L 375mm W 140mm connection length 30mm connection male faston 6.3mm tube ø 6.3mm 2 hole fixing thread M10x1 dry heating element L1 45mm L2 75mm L3 255mm W1 45mm W2 50mm mounting distance 44mm		

immersion heating elements

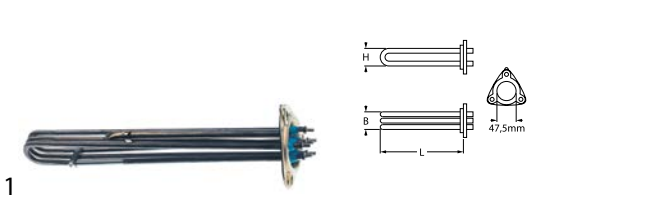
3 hole flange ø47.5mm



1

GEV No.	418136	Ref. No.	3434
description	heating element 4360W 240V mounting ø 47.5mm heating circuits 3 L 310mm W 31mm H 35mm number of thermostat sleeves 1 thermostat sleeves ø 7mm length thermostat sleeves 200mm thermostat sleeve clinging tube ø 6.3mm hole distance 62mm hole ø 8mm connection M4 3 hole flange immersion heater		
spare parts for	418136		
	GEV No.	510408	Ref. No. —
	O-ring EPDM thickness 5.34mm ID ø 47mm Qty 1 pcs		
accessories for	418136		
	GEV No.	510408	Ref. No. —
	O-ring EPDM thickness 5.34mm ID ø 47mm Qty 1 pcs		
	GEV No.	510562	Ref. No. —
	O-ring silicone thickness 5.34mm ID ø 47mm Qty 1 pcs		

with expansion flange 70 x 18mm



1

GEV No.	418137	Ref. No.	10622
description	heating element 3000W 230V heating circuits 1 flange 70x18mm L 220mm W 65mm H connection male faston 6.3mm tube ø 8.5mm immersion heater expansion flange connection length 34mm		



1

GEV No.	418138	Ref. No.	10620
description	heating element 6000W 230V heating circuits 1 flange 70x18mm L 445mm W 68mm connection male faston 6.3mm tube ø 8.5mm immersion heater expansion flange connection length 34mm		

heating elements for convection



1

GEV No.	418129	Ref. No.	10638 40400038
description	heating element 16000W 230V heating circuits 3 ID ø 337mm ED ø 358mm L 450mm H 100mm L1 84mm W1 108mm H1 15mm H2 85mm flange length 142mm flange width 25mm hole distance 64mm connection M4 tube ø 8.5mm convection heating element hole ø 6mm rectangular flange		



1

GEV No.	418127	Ref. No.	10641
description	heating element 16000W 230V heating circuits 3 ID ø 390mm ED ø 410mm L 430mm H 99mm L1 15mm W1 100mm H1 15mm H2 84mm flange length 142mm flange width 25mm hole distance 63mm connection M4 tube ø 8.5mm convection heating element hole ø 6mm rectangular flange		



1

GEV No.	418133	Ref. No.	22
description	heating element 2000W 220V heating circuits 1 ID \varnothing 187mm ED \varnothing 200mm L 215mm H 25mm L1 15mm W1 60mm H1 5mm H2 20mm flange length 100mm flange width 22mm hole distance 86mm connection male faston 6.3mm connection length 37mm tube \varnothing 6.5mm convection heating element hole \varnothing 5mm rectangular flange		



1

GEV No.	416412	Ref. No.	159
description	heating element 2500W 230V heating circuits 1 ID \varnothing 188mm ED \varnothing 200mm L 215mm H 30mm L1 3mm W1 53mm H1 5mm H2 25mm flange length 100mm flange width 22mm hole distance 86mm connection male faston 6.3mm		



1

GEV No.	418134	Ref. No.	508
description	heating element 3300W 240V heating circuits 1 ID \varnothing 185mm ED \varnothing 200mm L 215mm H 30mm W1 60mm H1 5mm H2 25mm flange length 100mm flange width 22mm hole distance 85mm connection male faston 6.3mm connection length 22mm tube \varnothing 6.5mm convection heating element hole \varnothing 5mm rectangular flange		



1

GEV No.	418130	Ref. No.	10601
description	heating element 3900W 230V heating circuits 3 ID \varnothing 175mm ED \varnothing 245mm L 285mm H 32mm L1 60mm W1 62mm H1 10mm H2 26mm flange length 93mm flange width 22mm hole distance 77mm connection male faston 6.3mm connection length 61mm tube \varnothing 6.5mm convection heating element hole \varnothing 5mm rectangular flange		



1

GEV No.	418131	Ref. No.	1023
description	heating element 6000W 230V heating circuits 3 ID \varnothing 217mm ED \varnothing 231mm L 271mm H 90mm L1 41mm W1 103mm H1 24mm H2 66mm flange length 140mm flange width 22mm hole distance 63mm tube \varnothing 6.3mm convection heating element hole \varnothing 5mm rectangular flange		



1

GEV No.	418132	Ref. No.	3016 3016A
description	heating element 7350W 230V heating circuits 3 ID \varnothing 250mm ED \varnothing 265mm L 277mm H 75mm L1 17mm W1 102mm H1 12mm H2 67mm flange length 143mm flange width 25mm hole distance 7mm connection M4 tube \varnothing 6.5mm convection heating element hole \varnothing 63mm rectangular flange		

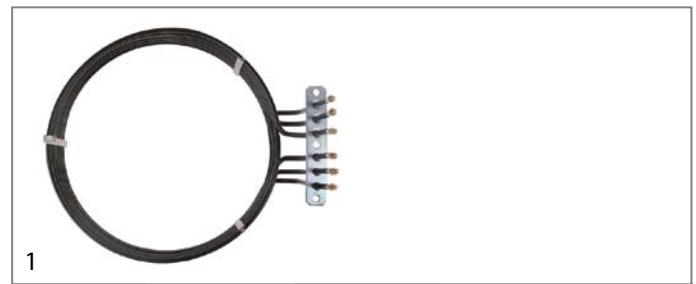

1



GEV No.	418753	Ref. No.	10628
description	heating element 8000W 230V heating circuits 3 ID \varnothing 287mm ED \varnothing 300mm L 345mm H 90mm L1 39mm H1 20mm H2 67mm flange length 142mm flange width 25mm hole distance 12.7mm connection M4 connection length 67mm tube \varnothing 6.5mm convection heating element hole \varnothing 7mm rectangular flange		



1

GEV No.	418128	Ref. No.	10633
description	heating element 9000W 230V heating circuits 3 ID \varnothing 500mm ED \varnothing 515mm L 535mm H 95mm L1 13mm W1 105mm H1 15mm H2 80mm flange length 142mm flange width 25mm hole distance 64mm connection M4 tube \varnothing 8.5mm convection heating element hole \varnothing 6mm rectangular flange		



 <p>1</p>			
GEV No.	418135	Ref. No.	1126
description	heating element 920W 230V heating circuits 1 ID ø 200mm ED ø 215mm L 255mm H 40mm thread 1/4" connection male faston 6.3mm 2 hole fixing mounting distance 24mm tube ø 8.5mm convection heating element		
accessories for	418135		
	GEV No.	361182	Ref. No. —
	nut thread 1/4" H 5mm nickel-plated brass WS 17 Qty 1 pcs		
	GEV No.	510417	Ref. No. —
	flat gasket fibre ED ø 20mm ID ø 14mm thickness 2mm Qty 1 pcs		
	GEV No.	520228	Ref. No. —
	tooth lock washer ID ø 15.3mm ED ø 24mm steel Qty 1 pcs for thread M14		
	GEV No.	550262	Ref. No. —
	flat gasket copper ED ø 20mm ID ø 14mm thickness 2mm		

 <p>1</p>			
GEV No.	418139	Ref. No.	1466
description	heating element 3500W 240V heating circuits 1 L 620mm W 120mm L1 33mm L2 587mm W2 90mm flange length 70mm flange width 22mm hole distance 56mm connection length 100mm connection M4 tube ø 8.5mm hole ø 6mm W1 30mm rectangular flange convection heating element windings 2		

energy regulators

EGO

1-circuit

 <p>1</p>			
GEV No.	380015	Ref. No.	280
description	energy regulator 230V 13A single-circuit turn direction right shaft ø 6x4.6mm shaft L 23mm mounting thread M4 power release 6-100% no. 50.57021.010		

thermostats

control and safety thermostats

EGO

control thermostats

55.10/19_ series

 <p>1</p>			
GEV No.	375647	Ref. No.	10005
description	thermostat t.max. 110°C temperature range 31-110°C 1-pole 1NO 16A probe ø 6mm probe L 133mm capillary pipe 870mm capillary pipe isolated gland nut shaft ø 6x4.6mm shaft L 23mm shaft position upper rotation 318°		

 <p>1</p>			
GEV No.	390068	Ref. No.	283 3529 596
description	thermostat t.max. 269°C temperature range 55-269°C 1-pole 1CO 16A probe ø 3.1mm probe L 219mm capillary pipe 1280mm capillary pipe isolated 1270mm gland nut shaft ø 6x4.6mm shaft L 23mm shaft position upper rotation 318°		

 <p>1</p>			
GEV No.	375002	Ref. No.	26
description	thermostat t.max. 320°C temperature range 55-320°C 1-pole 1NO 16A probe ø 3.1mm probe L 226mm capillary pipe 870mm capillary pipe isolated 850mm gland nut shaft L 23mm shaft position upper rotation 270°		



safety thermostats

55.10/19_ series

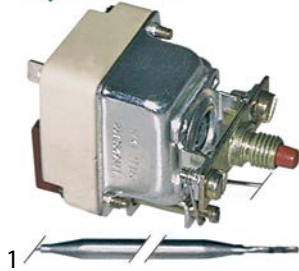

GEV No.	375250	Ref. No.	3528 599
description	safety thermostat capillary pipe 870mm probe ø 6mm 1-pole probe L 129mm 16A capillary pipe isolatedmm gland nut switch-off temp. 130°C probe SS		
spare parts for	375250		
	GEV No.	551083	Ref. No. —
	cap for safety thermostat thread M8x1		



GEV No.	376008	Ref. No.	166
description	safety thermostat switch-off temp. 352°C 1-pole 16A probe ø 3mm probe L 200mm capillary pipe 885mm capillary pipe isolated 780mm gland nut probe		

55.32_ series



GEV No.	375649	Ref. No.	3019 3023
description	safety thermostat switch-off temp. 160°C 3-pole 20A probe ø 6mm probe L 87mm capillary pipe 890mm capillary pipe isolated 880mm gland nut probe SS		

CAEM

control thermostats



GEV No.	375645	Ref. No.	10008
description	thermostat t.max. 120°C temperature range 30-120°C 1-pole 1CO 16A probe ø 6mm probe L 110mm capillary pipe 1600mm capillary pipe isolated 1550mm gland nut shaft ø 6x4.6mm shaft L 22mm shaft position upper rotation 270° probe material copper 250V		

switches and momentary switches

push/momentary push switches

28.5x77.5mm



GEV No.	346365	Ref. No.	10044
description	switch combination momentary/latching mounting measurements 28.5x77.5mm black 2CO/2CO 250V 16A with indicator connection male faston 6.3mm ambient temperature max. 85°C protection IP40		



GEV No.	346363	Ref. No.	10043
description	switch combination with indicator mounting measurements 28.5x77.5mm black 2CO/2CO 250V 16A connection male faston 6.3mm ambient temperature max. 85°C protection IP40		

microswitches

pin-plunger actuated

M10



GEV No.	345032	Ref. No.	1519
description	microswitch with plunger thread M10x1 thread L 12mm 250V 16A 1CO connection male faston 6.3mm stroke 7mm mounting distance 22mm L 28mm ambient temperature max. 125°C type SP9603 actuating force: 180g		



non-standard



1			
GEV No.	348019	Ref. No.	70201
description	microswitch with cable		

system switches (ROLD)



1			
GEV No.	345721	Ref. No.	3471
description	blank cap holder		



1			
GEV No.	345537	Ref. No.	10313
description	element holder mounting measurements 20.6x16.4mm grey arched for push buttons 13x17mm		



1			
GEV No.	345131	Ref. No.	3475
description	element holder mounting measurements 28.5x28.5mm grey single element holder		



1			
GEV No.	346201	Ref. No.	3468
description	element holder mounting measurements 28.5x77.5mm grey three-fold element holder		



1			
GEV No.	345606	Ref. No.	3474
description	momentary switch unit 2CO 250V 16A connection male faston 6.3mm		



1			
GEV No.	345538	Ref. No.	3480
description	push button ø 11.9mm black		



1			
GEV No.	345133	Ref. No.	3470
description	push button ø 23mm grey		



1			
GEV No.	346211	Ref. No.	3469
description	push button ø 23mm grey with lens		



1			
GEV No.	345539	Ref. No.	10312
description	push button size 17x13mm grey		



1			
GEV No.	346364	Ref. No.	3472
description	rotary disc red/white disc ø 20.6mm		



1			
GEV No.	345605	Ref. No.	3473
description	switch 2CO 250V 16A connection male faston 6.3mm		

cam switches

4 operating positions

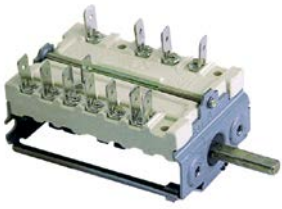

1

GEV No.	300010	Ref. No.	281
description	cam switch 4 operating positions 2NO/2CO sequence 0-1-2-3 16A shaft ø 6x4.6mm shaft L 23mm connection male faston 6.3mm ceramic		

5 operating positions



1

GEV No.	347652	Ref. No.	3018
description	cam switch 5 operating positions 5NO/2CO sequence 0-1-2-3-4 16A shaft ø 6x4.6mm shaft L 23mm connection male faston 6.3mm plastic		

10 operating positions



1

GEV No.	301205	Ref. No.	10027
description	cam switch 10 operating positions 5NO/1CO sequence 0-1-2-3-4-5-6-7-8-9 16A shaft ø 6x4.6mm shaft L 23mm connection male faston 6.3mm ceramic		

operation switches



1

GEV No.	300153	Ref. No.	38
description	cam switch 3 operating positions operation switch 16A sequence 0-1-2 shaft ø 6x4.6mm shaft L 23mm connection male faston 6.3mm plastic ambient temperature max. 240°C		

magnetic switches

accessories

magnets



1

GEV No.	348007	Ref. No.	10420
description	magnet ø 23mm Lmm H 10mm Wmm ID ø 4.5mm ED ø 23mm M3 hole ø 4.5mm		

encoders and potentiometers



1

GEV No.	401592	Ref. No.	10527 10566
description	potentiometer 10KOhm		

lamps

indicator lights

indicator lights (complete)

ø10mm

with plug-in socket



1

GEV No.	359139	Ref. No.	631
description	indicator light ø 10mm green 230V connection male faston 6.3mm Qty 1 pcs		



1

GEV No.	359138	Ref. No.	591
description	indicator light ø 10mm red 230V connection male faston 6.3mm Qty 1 pcs		



1

GEV No.	359140	Ref. No.	592
description	indicator light ø 10mm yellow 230V connection male faston 6.3mm Qty 1 pcs		



screw-on/push-on fit

light bulbs

for ovens

PHILIPS



1

GEV No.	359610	Ref. No.	35.0003.01
description	light bulb t.max. 300°C socket E14 15W 230V ø 22mm L 47mm lens L 20mm for oven lamp type Philips		

PHILIPS

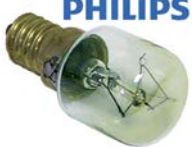

1

GEV No.	359612	Ref. No.	3546
description	light bulb t.max. 300°C socket E14 25W 230V ø 25mm L 56mm lens L 30mm for oven lamp type Philips		

halogen lamp

for socket G4 / G6.35 / G9



1 **500°C**

GEV No.	359599	Ref. No.	10307
description	halogen lamp socket G4 12V 20W temp.-resist. 500°C		





oven lamps

universal oven lamps

mounting diameter 35.5mm





1

GEV No.	359701	Ref. No.	35.0002.01	
description	lamp socket socket E14 220-230V mounting ø 35.5mm connection male faston 6.3mm 15W			
accessories for	359701			
	GEV No.	359705	Ref. No.	—
	oven lamp glass thr.ø 33.5mm ø 52mm hard glas temp.-resist. 350°C			
	GEV No.	359709	Ref. No.	—
	oven lamp glass thr.ø 33.5mm ø 42mm hard glas temp.-resist. 350°C			
	GEV No.	359721	Ref. No.	0812.01
	gasket silicone ED ø 48mm ID ø 39.5mm thickness 5mm Qty 1 pcs			
	GEV No.	359942	Ref. No.	—
	oven lamp glass thr.ø 33.5mm ø 41mm hard glas temp.-resist. 350°C			



1

GEV No.	359661	Ref. No.	35000101	
description	oven lamp glass thread 32.1 ø 58mm hard glas temp.-resist. 350°C			
accessories for	359661			
	GEV No.	359700	Ref. No.	—
	gasket for pizza oven fibre glass ID ø 32.5mm ED ø 55mm thickness 5mm			



1

GEV No.	359721	Ref. No.	0812.01
description	gasket silicone ED ø 48mm ID ø 39.5mm thickness 5mm Qty 1 pcs		

mounting diameter 47.8mm



1

GEV No.	359703	Ref. No.	10340	
description	oven lamp mounting ø 47.8mm 230V 15W socket E14 temp.-resist. 300°C connection male faston 6.3mm hard glas			
spare parts for	359703			
	GEV No.	359610	Ref. No.	35.0003.01
	light bulb t.max. 300°C socket E14 15W 230V ø 22mm L 47mm lens L 20mm for oven lamp type Philips			
	GEV No.	359725	Ref. No.	—
	oven lamp glass thread ø 44mm H 43mm ø 54mm hard glas temp.-resist. 350°C			

55x70mm









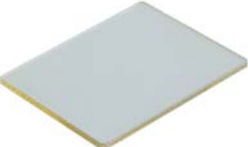



1

GEV No.	359297	Ref. No.	10306	
description	frame L 95mm W 81mm mounting distance 68/83mm thickness 6mm			
accessories for	359297			
	GEV No.	359299	Ref. No.	10304
	gasket L 91mm W 77mm hole ø 3mm for oven lamp			

			
1			
GEV No.	359299	Ref. No.	10304
description	gasket L 91mm W 77mm hole ø 3mm for oven lamp		

			
1			
GEV No.	359296	Ref. No.	10305
description	lamp glass L 74mm W 58mm thickness 3mm		

55x100mm			
			
1			
GEV No.	359698	Ref. No.	3542
description	lamp socket L 100mm W 55mm socket E14 connection male faston 6.3mm		
spare parts for	359698		
	GEV No.	358119	Ref. No. —
	frame L 118mm W 72mm mounting distance 143mm for bulb socket		
	GEV No.	358122	Ref. No. —
	gasket L 112mm W 68mm silicone thickness 3mm for bulb socket		
	GEV No.	358123	Ref. No. —
	lamp glass L 112mm W 68mm		
	GEV No.	359612	Ref. No. 3546
	light bulb t.max. 300°C socket E14 25W 230V ø 25mm L 56mm lens L 30mm for oven lamp type Philips		
	GEV No.	359714	Ref. No. 3543
	gasket for bulb socket		
	GEV No.	359715	Ref. No. 3544
	lamp glass L 110mm W 65mm thickness 5mm		
	GEV No.	359716	Ref. No. 1265A 3545
	frame for bulb socket		
accessories for	359698		
	GEV No.	359612	Ref. No. 3546
	light bulb t.max. 300°C socket E14 25W 230V ø 25mm L 56mm lens L 30mm for oven lamp type Philips		
	GEV No.	359938	Ref. No. —
	borosilicate glass L 115mm W 69mm		

			
1			
GEV No.	359716	Ref. No.	1265A 3545
description	frame for bulb socket		

			
1			
GEV No.	359714	Ref. No.	3543
description	gasket for bulb socket		

			
1			
GEV No.	359715	Ref. No.	3544
description	lamp glass L 110mm W 65mm thickness 5mm		











			
1			
GEV No.	359698	Ref. No.	3542
description	lamp socket L 100mm W 55mm socket E14 connection male faston 6.3mm		
spare parts for	359698		
	GEV No.	358119	Ref. No. —
	frame L 118mm W 72mm mounting distance 143mm for bulb socket		
	GEV No.	358122	Ref. No. —
	gasket L 112mm W 68mm silicone thickness 3mm for bulb socket		
	GEV No.	358123	Ref. No. —
	lamp glass L 112mm W 68mm		
	GEV No.	359612	Ref. No. 3546
	light bulb t.max. 300°C socket E14 25W 230V ø 25mm L 56mm lens L 30mm for oven lamp type Philips		
	GEV No.	359714	Ref. No. 3543
	gasket for bulb socket		
	GEV No.	359715	Ref. No. 3544
	lamp glass L 110mm W 65mm thickness 5mm		
	GEV No.	359716	Ref. No. 1265A 3545
	frame for bulb socket		

Table continues overleaf



accessories for	359698		
	GEV No.	359612	Ref. No. 3546
	light bulb t.max. 300°C socket E14 25W 230V ø 25mm L 56mm lens L 30mm for oven lamp type Philips		
	GEV No.	359938	Ref. No. —
	borosilicate glass L 115mm W 69mm		

lamps

light bulbs

	1		
GEV No.	359610	Ref. No.	35.0003.01
description	light bulb t.max. 300°C socket E14 15W 230V ø 22mm L 47mm lens L 20mm for oven lamp type Philips		

	1		
GEV No.	359612	Ref. No.	3546
description	light bulb t.max. 300°C socket E14 25W 230V ø 25mm L 56mm lens L 30mm for oven lamp type Philips		

halogen lamps

for socket G4 / G6.35 / G9

	1 500°C		
GEV No.	359599	Ref. No.	10307
description	halogen lamp socket G4 12V 20W temp.-resist. 500°C		



sockets

G4 / G5,3 / G6,35

	1		
GEV No.	359646	Ref. No.	10308
description	lamp socket socket G4/G5.3/G6.35 24V ø 17mm H 15mm connection cable 130mm mounting distance 26mm for halogen lamp holder length 31mm cable length 130mm		

timers

programme timers

	1		
GEV No.	360339	Ref. No.	10039 10042
description	timer FIBER P25 engines 1 chambers 1 operation time 20s 230V shaft ø 6x4.6mm shaft L 20mm manif. no. P255J01C1N4 motor type M51BJ0R6400		
spare parts for	360339		
	GEV No.	360673	Ref. No. —
	motor kit pinion ø 6.8mm teeth 15 230V voltage AC 50/60Hz turn direction clockwise motor ø 48mm H 18.5mm motor type UDS-40NE1RNZ165 cable length 150mm with holder		

mechanical timers

	1		
GEV No.	350003	Ref. No.	39
description	timer M2 with bell 2-pole operation time 120min impulse mechanical 2NO at 250V 16A permanent position no shaft ø 6x4.6mm shaft 6x4.6mm shaft L 23mm mounting distance 28mm connection lateral		
accessories for	350003		
	GEV No.	110366	Ref. No. —
	knob switch zero mark t.max. °C ø 44mm shaft ø 6x4.6mm shaft flat upper black		
	GEV No.	111199	Ref. No. —
	dial plate graduation 120min permanent position no rotation 0-330° ø 60mm timers knob ø 45mm		

	1		
GEV No.	350008	Ref. No.	3433 50
description	timer M2 with bell 2-pole operation time 120min impulse mechanical 2NO at 250V 16A permanent position yes shaft ø 6x4.6mm shaft 6x4.6mm shaft L 24mm mounting distance 28mm connection lateral		



alarm devices

alarm units

			
1			
GEV No.	350081	Ref. No.	636
description	alarm device 9-15VDC H 14.5mm wall-mounted version 75dB protection IPx0		

buzzers

			
1			
GEV No.	350050	Ref. No.	1553
description	buzzer 230VAC connection male faston 6.3mm screw mounting thread M4 60dB		

contactors

SIEMENS

power contactors

			
1			
GEV No.	380645	Ref. No.	10004
description	power contactor 230VAC with auxiliary contacts		

			
1			
GEV No.	380389	Ref. No.	10001
description	power contactor resistive load 22A 230VAC (AC3/400V) 9A/4kW main contacts 3NO auxiliary contacts 1NO connection screw connection type 3RT10-16-1AP01		

overload switches





			
1			
GEV No.	381002	Ref. No.	10003
description	overload switch setting range 1.8-2.5A		

relays

power relays

with male contacts

female contact 2.0mm

			
1			
GEV No.	380642	Ref. No.	10504
description	power relays 230VAC connection 2.0 plug-in connection		
accessories for	380642		
	GEV No.	380378	Ref. No. 10509
	relay socket 2-pole 55/85 dimensions 70.5x30x27mm 250V voltage AC 10A FINDER manuf. no. 94.72		
	GEV No.	380384	Ref. No. —
	relay socket 2-pole contacts male faston 2.8mm 250V voltage AC 10A W 23mm for		
	GEV No.	380399	Ref. No. —
	relay socket 4-pole dimensions 76.2x27x86.1mm 250V voltage AC 1A FINDER manuf. no. 94.94.3		







			
			
1			
GEV No.	380377	Ref. No.	10507
description	power relays FINDER 220-240VAC 10A 2CO connection F2 plug-in connection manuf. no. 55.32.8.230.0000 94.92.3 250V		
accessories for	380377		
	GEV No.	380341	Ref. No. —
	relay socket 4-pole contacts 12 300V voltage AC 6A Italiana Relè manuf. no. ZMD4		
	GEV No.	380378	Ref. No. 10509
	relay socket 2-pole 55/85 dimensions 70.5x30x27mm 250V voltage AC 10A FINDER manuf. no. 94.72		

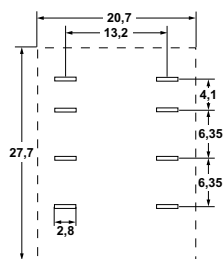
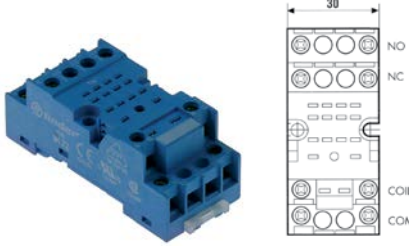

Table continues overleaf



accessories for	380377		
	GEV No.	380384	Ref. No. —
	relay socket 2-pole contacts male faston 2.8mm 250V voltage AC 10A W 23mm for		
	GEV No.	380399	Ref. No. —
	relay socket 4-pole dimensions 76.2x27x86.1mm 250V voltage AC 1A FINDER manuf. no. 94.94.3		

relay sockets

			
1			
GEV No.	380641	Ref. No.	10505
description	relay socket		

			
1			
GEV No.	380378	Ref. No.	10509
description	relay socket 2-pole 55/85 dimensions 70.5x30x27mm 250V voltage AC 10A FINDER manuf. no. 94.72		
accessories for	380378		
	GEV No.	380804	Ref. No. —
	support bracket		

			
1			
GEV No.	380638	Ref. No.	10503
description	relay socket 8-pole dimensions 51x41x23mm 250V 10A FINDER manuf. no. 90.26		



level relays



GICAR

			
1			
GEV No.	401224	Ref. No.	10532
description	level relay 230V connection F6.3 type RL30/3ES/F/G		



time relays

time relays

			
1			
GEV No.	380329	Ref. No.	10508
description	time relay FIBER 85.02.8.240 time range 0.05s - 100h 230-240VAC 10A mounting measurements 20.6x27.7mm 2CO connection 2.0		
accessories for	380329		
	GEV No.	380378	Ref. No. 10509
	relay socket 2-pole 55/85 dimensions 70.5x30x27mm 250V voltage AC 10A FINDER manuf. no. 94.72		
	GEV No.	380803	Ref. No. —
	relay socket 2-pole dimensions 76.2x27x86.1mm 250V voltage AC 10A FINDER manuf. no. 94.92.3		

			
1			
GEV No.	380639	Ref. No.	10501
description	time relay TECNOLOGIC RTR12DS06S time range 6s 230VAC 5A mounting measurements 34x34mm 1CO connection plug-in connection round 8-pole		
accessories for	380639		
	GEV No.	380638	Ref. No. 10503
	relay socket 8-pole dimensions 51x41x23mm 250V 10A FINDER manuf. no. 90.26		



			
1			
GEV No.	380640	Ref. No.	10502
description	time relay TECNOLOGIC RTR12DS60S time range 60s 230VAC 5A 1CO connection plug-in connection round 8-pole		
accessories for	380640		
	GEV No.	380638	Ref. No. 10503
	relay socket 8-pole dimensions 51x41x23mm 250V 10A FINDER manuf. no. 90.26		

transformers

open transformers

with clamp terminal

			
1			
GEV No.	401229	Ref. No.	10323 10324
description	transformer primary 230V secondary 12V 63VA		

encapsulated transformers

PMA

			
1			
GEV No.	379196	Ref. No.	635
description	transformer primary 230VAC secondary 12VAC 10VA secondary 0.8A connection screw 50Hz		





			
1			
GEV No.	379054	Ref. No.	1551
description	transformer primary 230VAC secondary 12VAC 3VA secondary 0.25A H 40mm L 45mm W 50mm connection screw 50/60Hz type 153/M		

electronic controllers

EVCO - EVERY CONTROL

universal controllers

built-in version

			
1			
GEV No.	378131	Ref. No.	1549
description	electronic controller EVERY CONTROL EVK411M mounting measurements 71x29mm 12V voltage AC/DC NTC/PTC/Pt100/Pt1000 relay outputs 1 CO-16A(8) NTC/PTC/Pt100/Pt1000/TC(J,K)/mV/mA yes protection IP65 dependent on probe°C display 3½ digits		
accessories for	378131		
	GEV No.	379050	Ref. No. 634
	temperature probe Pt100 cable Vetrotex probe -200 up to +600°C cable -50 up to +350°C probe ø6x100mm cable length 2.7m without screw connection 3-wire		
	GEV No.	379160	Ref. No. —
	temperature probe NTC 10kOhm cable thermoplastic probe -40 up to +110°C cable -40 up to +110°C probe ø6x14mm cable length 1.5m without screw connection 2-wire		
	GEV No.	379781	Ref. No. —
	temperature probe PTC 1kOhm cable thermoplastic probe -50 up to +150°C cable -40 up to +110°C probe ø6x14mm cable length 1.5m without screw connection 2-wire		
	GEV No.	379944	Ref. No. —
	temperature probe Pt1000 cable Vetrotex probe -70 up to +500°C cable -50 up to +350°C connection 2-wire thread probe ø6x180mm cable length 1.7m		

SHANGFANG

accessories

			
1			
GEV No.	379054	Ref. No.	1551
description	transformer primary 230VAC secondary 12VAC 3VA secondary 0.25A H 40mm L 45mm W 50mm connection screw 50/60Hz type 153/M		



probes

universal probes

temperature probes

			
1			
GEV No.	379050 ¹	Ref. No.	634
description	temperature probe Pt100 cable Vetrotex probe -200 up to +600°C cable -50 up to +350°C probe ø6x100mm cable length 2.7m without screw connection 3-wire		

¹3-wire

			
1			
GEV No.	378067	Ref. No.	70401
description	temperature probe PTC 1kOhm cable silicone probe -50 up to +150°C cable -50 up to +180°C probe ø6x40mm cable length 2m without screw connection 2-wire		

producer-specific probes

probes

			
1			
GEV No.	402154	Ref. No.	10411
description	temperature probe Pt100 cable silicone probe -100 up to 450°C cable -50 up to +180°C connection 3-wire thread 1/8" probe ø6x35mm cable length 1.5m		

core probes

			
1			
GEV No.	379945	Ref. No.	10402
description	core temperature probe Pt100 cable PTFE probe -40 up to +250°C cable -40 up to +250°C connection plug probe ø3.5x100mm thread cable length 0.5m handle ø 10mm handle length 80mm		

			
1			
GEV No.	379946	Ref. No.	10401
description	core temperature probe Pt100 cable PTFE probe -40 up to +250°C cable -40 up to +250°C connection plug probe ø3.5x100mm thread cable length 0.7m handle ø 10mm handle length 80mm		

			
1			
GEV No.	379947	Ref. No.	10405 10406
description	core temperature probe Pt100 cable PTFE probe -40 up to +250°C cable -40 up to +250°C connection plug probe ø3.5x100mm thread cable length 1.2m handle ø 10mm handle length 80mm		

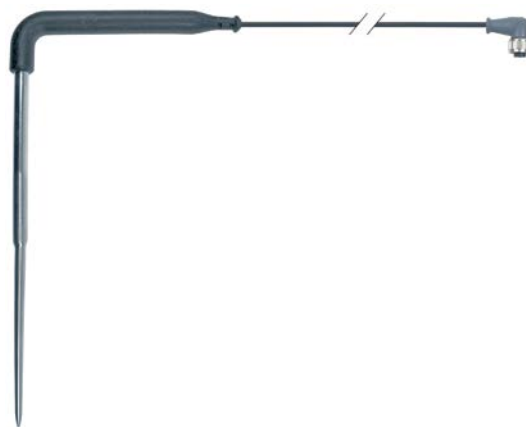
			
1			
GEV No.	379350 ¹	Ref. No.	70404
description	core temperature probe PTC 1kOhm cable silicone probe -40 up to +120°C cable -50 up to +180°C connection plug probe ø4x100mm thread cable length 1.7m handle ø 8mm handle length 120/35mm L1 120mm L2 130mm		

¹ multipoint probe

			
1			
GEV No.	379662 ¹	Ref. No.	70402A
description	core temperature probe PTC 1kOhm cable silicone probe -40 up to +120°C cable -50 up to +180°C connection plug probe ø4x70mm thread cable length 1.3m handle ø 16mm handle length 120mm L1 120mm L2 130mm		

¹ multipoint probe

			
1			
GEV No.	379806 ¹	Ref. No.	70405A
description	core temperature probe PTC 1kOhm cable silicone probe -40 up to +120°C cable -50 up to +180°C connection plug probe ø5x70mm thread cable length 1.2m handle ø 16mm handle length 125mm L1 170mm L2 65mm		

¹ multipoint probe



1 

GEV No.	379948	Ref. No.	3566
description	core temperature probe thermocouple J (Fe-CuNi) cable SS corrugated hose probe -40 up to +250°C cable -40 up to +250°C connection 1/8" probe ø3.5x100mm thread 1/8" cable length 1.8m handle ø 10mm handle length 80mm		

1 

GEV No.	379951	Ref. No.	3567
description	temperature probe thermocouple J (Fe-CuNi) cable SS corrugated hose probe -40 up to +250°C cable -40 up to +250°C connection 2-wire probe ø3.5x100mm thread 1/8" cable length 2.1m handle ø 10mm handle length 80mm		

electronics

EPROMS

1 

GEV No.	403201	Ref. No.	10547
description	EPROM type FOCABO 59		

1 

GEV No.	403062	Ref. No.	10550
description	EPROM type FOCABO P5		

PCBs

1 

GEV No.	401042	Ref. No.	10029
description	display PCB		

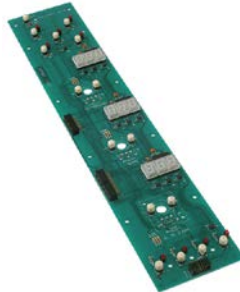
1 

GEV No.	401245	Ref. No.	10536
description	keypad PCB		

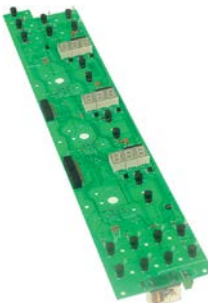
1 

GEV No.	401569	Ref. No.	10563
description	keypad PCB		

1 

GEV No.	403061	Ref. No.	10513
description	keypad PCB		

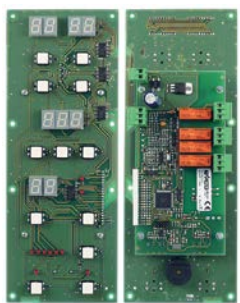
1

GEV No.	401219	Ref. No.	614
description	keypad PCB convection oven FC06/12/20		



1

GEV No.	402318	Ref. No.	10555
description	PCB		



1

GEV No.	402930	Ref. No.	10565
description	PCB combi-steamer LCM06/M100 L 110mm W 80mm Fan Reversal Card		





1

GEV No.	403473	Ref. No.	10672
description	PCB combi-steamer LCM06/M100 L 95mm W 79mm H 43mm Fan Reversal Card		



1

GEV No.	401566	Ref. No.	10524	
description	power PCB without EPROM type CQB 324(02)			
accessories for	401566			
	GEV No.	403062	Ref. No.	10550
	EPROM type FOCABO P5			
	GEV No.	403201	Ref. No.	10547
	EPROM type FOCABO 59			

solenoid valves

solenoid valves (water)

RPE



1

GEV No.	374021	Ref. No.	1363
description	solenoid valve double straight 230VAC inlet 3/4" outlet 10mm DN10 RPE		



1

GEV No.	374017	Ref. No.	282
description	solenoid valve single straight 230VAC inlet 3/4" outlet 10mm input 6l/min DN10 RPE polyamide flow regulating valve inlet white membranes NBR pressure range 0.2-10bar		

reducers

outlet side



1

GEV No.	371269	Ref. No.	13001
description	reducer flow rate 0.07-0.14l/min brown		



1

GEV No.	371266	Ref. No.	289
description	reducer flow rate 0.2l/min red		



1

GEV No.	371268	Ref. No.	290 295
description	reducer flow rate 0.32-0.42l/min green		



solenoid valves with reducers

4-fold



1

GEV No.	374026	Ref. No.	13003
description	solenoid valve 4-fold straight 230VAC inlet 3/4" outlet 11.5mm duty cycle 100% RPE plastic pressure range 0.2-10bar		
spare parts for	374026		
	GEV No.	371015	Ref. No. —
	solenoid coil RPE 230VAC 8.4VA 50/60Hz seat ø 9mm connection male faston 6.3mm		







TP



1

GEV No.	370017	Ref. No.	0282
description	solenoid valve single straight 230VAC inlet 3/4" outlet 11.5mm DN10 TP p max 10bar		
spare parts for	370017		
	GEV No.	371013	Ref. No. —
	solenoid coil TP 230VAC 50/60Hz		
accessories for	370017		
	GEV No.	371220	Ref. No. —
	reducer TP flow rate 3l/min red tolerance ±15%		
	GEV No.	371221	Ref. No. —
	reducer TP flow rate 5.5l/min yellow tolerance ±15%		
	GEV No.	371222	Ref. No. —
	reducer TP flow rate 6l/min grey tolerance ±15%		
	GEV No.	371223	Ref. No. —
	reducer TP flow rate 10l/min white tolerance ±15%		
	GEV No.	371224	Ref. No. —
	reducer TP flow rate 12l/min bronze tolerance ±15%		
	GEV No.	371225	Ref. No. —
	reducer TP flow rate 16l/min light brown tolerance ±15%		
	GEV No.	371226	Ref. No. —
	reducer TP flow rate 20l/min red tolerance ±15%		
	GEV No.	371230	Ref. No. —
	reducer TP flow rate 0.25l/min red tolerance ±25%		
	GEV No.	371231	Ref. No. —
	reducer TP flow rate 0.35l/min violet tolerance ±25%		
	GEV No.	371232	Ref. No. —
	reducer TP flow rate 0.5l/min orange tolerance ±25%		

accessories for 370017

	GEV No.	371233	Ref. No.	—
	reducer TP flow rate 0.8l/min white tolerance ±25%			
	GEV No.	371234	Ref. No.	—
	reducer TP flow rate 1l/min light blue tolerance ±25%			
	GEV No.	371235	Ref. No.	—
	reducer TP flow rate 1.2l/min brown tolerance ±25%			
	GEV No.	371236	Ref. No.	—
	reducer TP flow rate 1.5l/min light brown tolerance ±25%			
	GEV No.	371237	Ref. No.	—
	reducer TP flow rate 2.5l/min yellow tolerance ±25%			
	GEV No.	371238	Ref. No.	—
	reducer TP flow rate 3.4l/min dark green tolerance ±25%			
	GEV No.	371239	Ref. No.	—
	reducer TP flow rate 5l/min black tolerance ±25%			
	GEV No.	371240	Ref. No.	—
	reducer TP flow rate 8l/min blue tolerance ±20%			

metal

CEME

solenoid valves



1

GEV No.	370348	Ref. No.	11022
description	solenoid valve 2-ways 230VAC connection 1/2" L 60mm t.max. 90°C membranes NBR p max 10bar p min 0.25bar brass		

ball valves electric



1

GEV No.	401233	Ref. No.	10036
description	ball valve inlet 1/2" IT outlet 1/2" IT 230V 50/60Hz mode of operation electric W 60mm H 99mm cable 4-pole 2.5W 4-pole duty cycle 50%		



electrodes

1			
GEV No.	401225	Ref. No.	3680
description	level electrode M12 ET - 1/8" ET total length 124/127/139mm probe L 91/95/104mm insulated probe length 42mm set 3-piece connection male faston 6.3mm ø 2.5mm		

1			
GEV No.	401226	Ref. No.	3681
description	level electrode M12x1 total length 150/160/171mm probe L 117/127/138mm insulated probe length 20mm set 3-piece connection male faston 6.3mm ø 2.5mm		

1			
GEV No.	401227	Ref. No.	3683
description	level electrode M12x1 total length 80/86/98mm probe L 48/53/65mm insulated probe length 20mm set 3-piece connection male faston 6.3mm ø 2.5mm		

1			
GEV No.	401228	Ref. No.	3572
description	level electrode total length 175mm connection male faston 6.3mm ø 2.5mm		

fans

axial fans

import

1			
GEV No.	601080 ¹	Ref. No.	10724
description	axial fan L 119mm W 119mm H 38mm 230VAC 50/60Hz 23/20W bearing ball bearing connection male faston 2.8mm metal ADDA fan wheel ø 110mm temp.-resist. 70°C		
accessories for	601080		
	GEV No.	550898	Ref. No. —
	connecting cable cable length 2000mm connection F 2.8 connection distance 7.9mm for axial flow fan		
	GEV No.	692519	Ref. No. —
	guard L 120mm W 120mm plastic		

¹with ball bearings

1			
GEV No.	601130 ¹	Ref. No.	10721
description	axial fan L 80mm W 80mm H 25mm 230VAC 50/60Hz 13/14W bearing ball bearing connection male faston 2.8mm metal ADDA fan wheel ø 75mm temp.-resist. 70°C airflow 30.6m ³ /h		
accessories for	601130		
	GEV No.	550898	Ref. No. —
	connecting cable cable length 2000mm connection F 2.8 connection distance 7.9mm for axial flow fan		

¹with ball bearings

1			
GEV No.	601081 ¹	Ref. No.	10720
description	axial fan L 80mm W 80mm H 38mm 230VAC 50/60Hz 14/13.5W bearing ball bearing connection male faston 2.8mm metal ADDA fan wheel ø 75mm temp.-resist. 70°C		
accessories for	601081		
	GEV No.	691102	Ref. No. —
	guard ø 75mm mounting distance 71mm for axial fan 80mm		

¹with ball bearings

refrigeration fans

cooling motors (complete)

1			
GEV No.	694178	Ref. No.	70701
description	fan 220-240V 16W 50-60Hz fan wheel ø 250mm connection with cable mounting distance 300mm		



cold air circulating fans (complete)

ebm-papst

A4D series

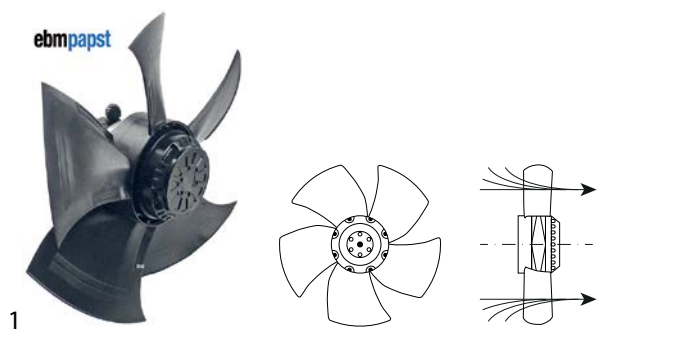

GEV No.	601628	Ref. No.	70705
description	fan A4D500-AM03-01 fan wheel ϕ 500mm blades 5 400V 50Hz 720W 1390rpm cable length 450mm rotation direction left ebm-papst sucking		

A4E series

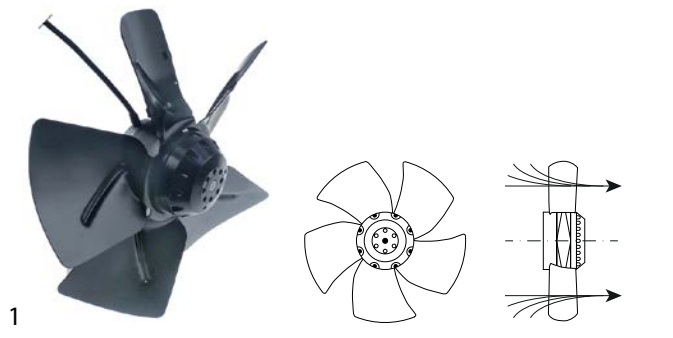

GEV No.	601684	Ref. No.	70702
description	fan A4E350-AA06-54 fan wheel ϕ 350mm blades 5 230V 50/60Hz 145W 1380/1540rpm cable length 450mm ebm-papst blowing suitable capacitor 5 μ F/400V μ F		

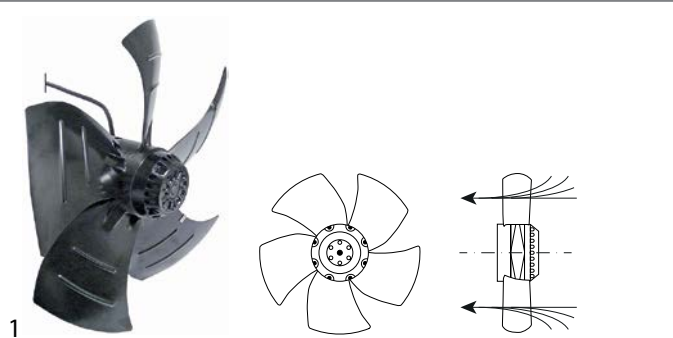

GEV No.	602045	Ref. No.	70704
description	fan A4E450-AP01-01 fan wheel ϕ 450mm blades 5 230V 50/60Hz 245/355W mounting distance 65mm 1400/1600rpm connection 4-wire cable length 500mm rotation direction left ebm-papst sucking suitable capacitor MLR25PRL μ F		

ZIEHL-ABEGG

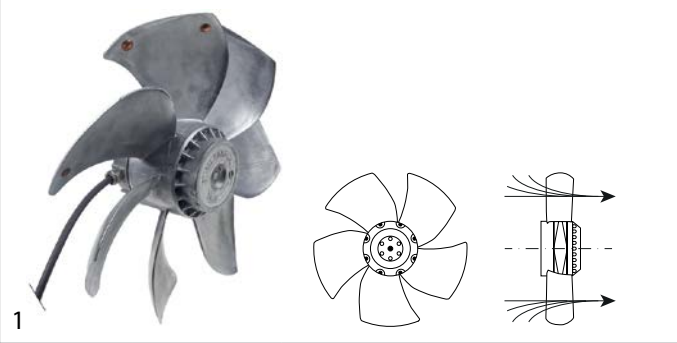

GEV No.	601726	Ref. No.	70706
description	fan fan wheel ϕ 360mm 230V 50/60Hz 200/310W cable length 2600mm ZIEHL-ABEGG complete H 118mm type FE035-4EA.0F.A7		

hot air motors

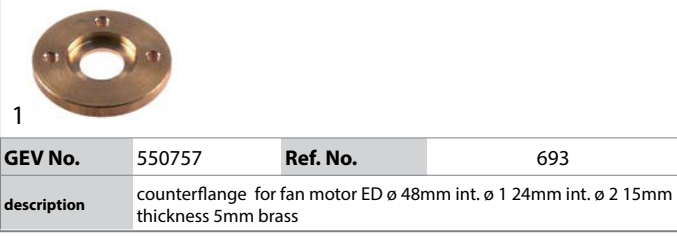

GEV No.	550757	Ref. No.	693
description	counterflange for fan motor ED ϕ 48mm int. ϕ 1 24mm int. ϕ 2 15mm thickness 5mm brass		

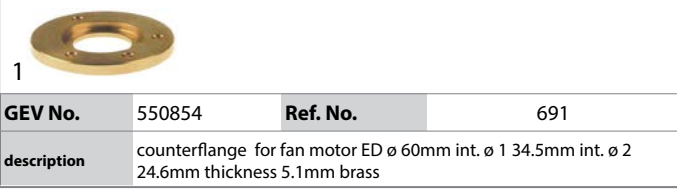

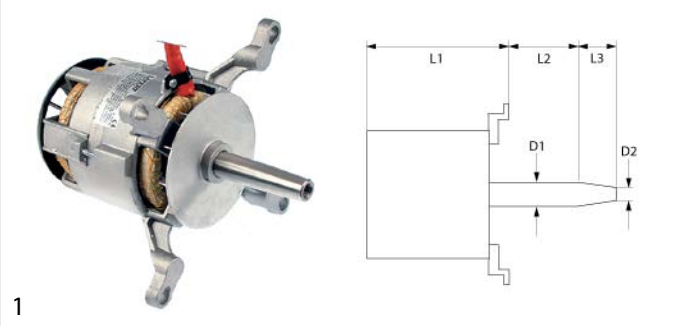

GEV No.	550854	Ref. No.	691
description	counterflange for fan motor ED ϕ 60mm int. ϕ 1 34.5mm int. ϕ 2 24.6mm thickness 5.1mm brass		

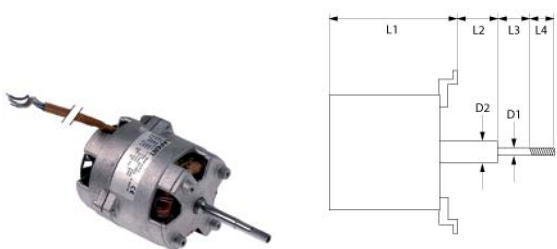

GEV No.	601046	Ref. No.	0840B
description	fan motor 220/380V 3 phase 50/60Hz 0.75kW 1350/1650rpm speeds 1 L1 185mm L2 42mm L3 47mm D1 ϕ 24mm D2 ϕ 20mm M12L IT 1.9/3.3A Cos(fi) 0.83 at 50Hz 200-240/346-415V at 60Hz 200-277/346-480V at 50Hz 1350rpm at 60Hz 1650rpm type ST80/4 no. 661512		



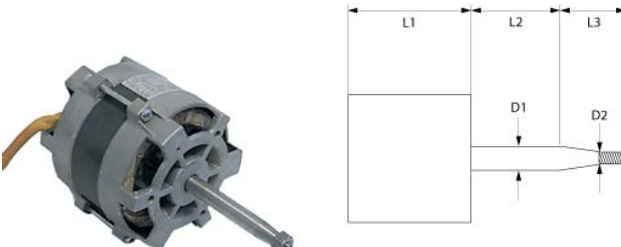

1

GEV No.	601354	Ref. No.	1100C
description	fan motor 220-240V 1 phase 50Hz 0.11kW 2760rpm speeds 1 L1 130mm L2 32mm L3 30mm L4 18mm D1 ø 7/8mm D2 ø 9mm M4R IT 0.9A at 50Hz 230V at 50Hz 2760rpm suitable capacitor 4µF type LM63 shaft flat length 17mm		
accessories for	601354		
	GEV No.	365031	Ref. No. 1103
description	operating capacitor capacity 4µF 450V tolerance 5% 50/60Hz ambient temperature max. -25 to +85°C ø 31mm L 58mm M8 plastic connection male faston 6.3mm protection		
	GEV No.	601061	Ref. No. —
description	fan wheel D1 ø 160mm H1 60mm blades 15 D2 ø 18mm D3 ø 18mm H2 35mm		



1

GEV No.	601043	Ref. No.	764
description	fan motor 220-240V 1 phase 50Hz 0.37/0.07kW 0.1/0.5HP 1400/2700rpm speeds 2 L1 123mm L2 107mm L3 15mm D1 ø 15mm D2 ø 12mm M10L ET 2/0.7A suitable capacitor 20µF/250V at 50Hz 1400/2700rpm type 1057		
accessories for	601043		
	GEV No.	365019	Ref. No. 775
description	operating capacitor capacity 20µF 400V tolerance 5% 50/60Hz ambient temperature max. -25 to +85°C ø 39.5mm L 70mm M8 plastic connection male faston 6.3mm 16.10.25. protection		

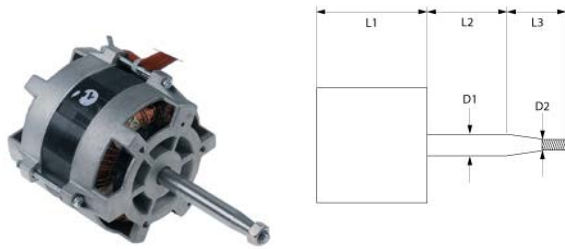

1

GEV No.	601166	Ref. No.	10705
description	fan motor 220-240V 1 phase 50Hz 0.37kW 2700rpm speeds 1 L1 123mm L2 77mm L3 30mm D1 ø 15mm D2 ø 12mm M10L ET 2A suitable capacitor 12.5µF/450V at 50Hz 2700rpm type 1057.2157		
spare parts for	601166		
	GEV No.	365014	Ref. No. 0932
description	operating capacitor capacity 12.5µF 450V tolerance 5%Hz ambient temperature max. -25 to +85°C ø 35mm L 70mm M8 plastic connection male faston 6.3mm 45S.C3DS.12.5 protection		

accessories for 601166

	GEV No.	601165	Ref. No.	1118
description	fan wheel D1 ø 160mm H1 60mm blades 15 D2 ø 16mm D3 ø 16mm H2 29mm			

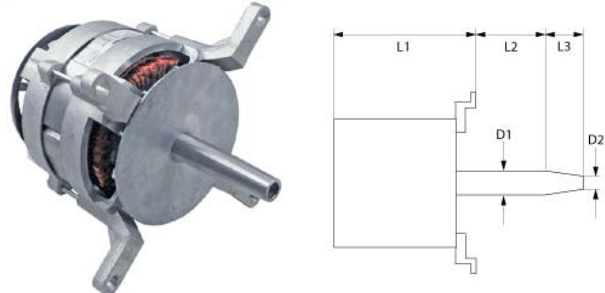

1

GEV No.	499185	Ref. No.	0841B
description	fan motor 380-415V 3 phase 50/60Hz 0.13/0.55kW 700/1350rpm speeds 2 L1 170mm L2 49mm L3 45mm D1 ø 24mm D2 ø 20mm M12x1.75 4P/8P type FB100L		

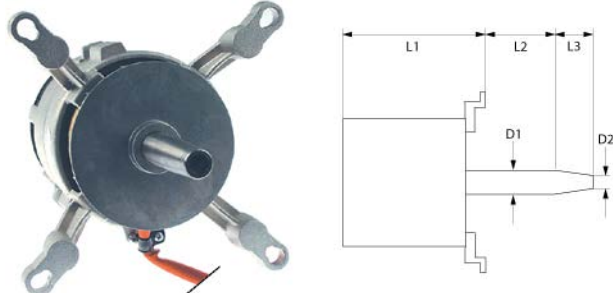

1

GEV No.	500652	Ref. No.	841
description	fan motor 380-415V 3 phase 50Hz 0.13/0.55kW 700/1350rpm speeds 2 L1 188mm L2 44mm L3 48mm D1 ø 24mm D2 ø 20mm M12L ITA Cos(φ) 0.13/0.55 at 50Hz 700/1350rpm 4P/8P type FB80 4/8 no. 390133		



1

GEV No.	514507	Ref. No.	1104
description	fan wheel blades 15 D1 ø 160mm D2 ø 11mm D3 ø 16mm H1 60mm H2 18mm		



1

GEV No.	601067	Ref. No.	15007
description	fan wheel D1 ø 150mm H1 38mm blades 36 D2 ø 6mm D3 ø 6mm H2 14mm		



1

GEV No.	601165	Ref. No.	1118
description	fan wheel D1 ø 160mm H1 60mm blades 15 D2 ø 16mm D3 ø 16mm H2 29mm		



1

GEV No.	601060	Ref. No.	758
description	fan wheel D1 ø 180mm H1 60mm blades 16 D2 ø 11mm D3 ø 16mm H2 30mm		



1

GEV No.	601064	Ref. No.	15016
description	fan wheel D1 ø 220mm H1 78mm blades 20 D2 ø 11.5mm D3 ø 16.5mm H2 30mm		



1

GEV No.	601224	Ref. No.	3196
description	fan wheel D1 ø 300mm H1 100mm blades 24 D2 ø 19.5mm D3 ø 23mm H2 46mm		



1

GEV No.	601063	Ref. No.	759
description	fan wheel D1 ø 350mm H1 100mm blades 24 D2 ø 19.5mm D3 ø 23mm H2 46mm		



1

GEV No.	691810	Ref. No.	692
description	flange for fan motor ED ø 48mm int. ø 1 19.5mm int. ø 2 15mm thickness 3.5mm brass		



1

GEV No.	550852	Ref. No.	690
description	flange for fan motor ED ø 60mm int. ø 1 28.5mm int. ø 2 24.5mm thickness 3.5mm brass		



1

GEV No.	550853	Ref. No.	688
description	gasket for fan motor ID ø 24mm ED ø 29mm thickness 3mm		



hot air fans

miscellaneous

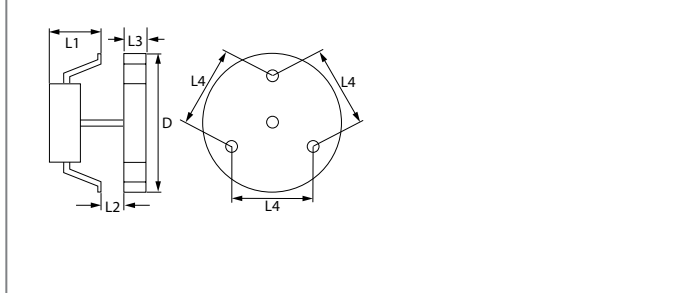

GEV No.	601125	Ref. No.	0016A 10731
description	hot air fan 220-240V 45W 50/60Hz L1 70mm L2 11mm L3 25mm L4 87mm fan wheel ø 150mm FIME type C30R0479CLF		
accessories for	601125		
	GEV No.	Ref. No.	—
	insulation ø 130mm thickness 3mm hole ø 20mm for hot air fan		

pumps

drain pumps

ASKOLL



GEV No.	500565	Ref. No.	3363
description	drain pump 30W		

condensators & interference suppression filters

operating capacitors

plastic



GEV No.	365014	Ref. No.	0932
description	operating capacitor capacity 12.5µF 450V tolerance 5%Hz ambient temperature max. -25 to +85°C ø 35mm L 70mm M8 plastic connection male faston 6.3mm 45S.C3DS.12.5 protection		



GEV No.	365019	Ref. No.	775
description	operating capacitor capacity 20µF 400V tolerance 5% 50/60Hz ambient temperature max. -25 to +85°C ø 39.5mm L 70mm M8 plastic connection male faston 6.3mm 16.10.25. protection		



GEV No.	365031	Ref. No.	1103
description	operating capacitor capacity 4µF 450V tolerance 5% 50/60Hz ambient temperature max. -25 to +85°C ø 31mm L 58mm M8 plastic connection male faston 6.3mm protection		

electric accessories

cables

ribbon cables

group 1

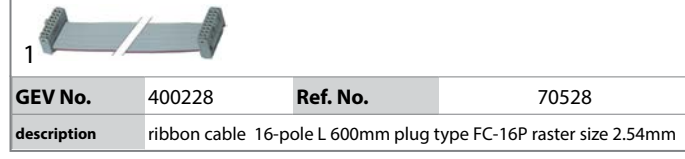

GEV No.	400228	Ref. No.	70528
description	ribbon cable 16-pole L 600mm plug type FC-16P raster size 2.54mm		

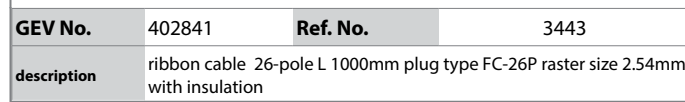

GEV No.	402841	Ref. No.	3443
description	ribbon cable 26-pole L 1000mm plug type FC-26P raster size 2.54mm with insulation		



cable harnesses

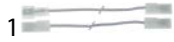

GEV No.	551191	Ref. No.	11029
description	cable harness for thermal fuse 1.5mm ² 2-pole L 100mm white plug type Faston 6.3mm		

terminals

porcelain clamps



GEV No.	550112	Ref. No.	10360
description	porcelain terminal block 2-pole 2.5mm ² max. 10A max 250V t.max. 200°C L 22mm W 17mm H 15mm mounting distancemm Qty 1 pcs		

various



GEV No.	693955	Ref. No.	10220
description	terminal grounding cable		

gas valves and ignition boxes

gas control valves

HONEYWELL



GEV No.	106004	Ref. No.	11017	
description	gas valve type VK4105C 220-240V 50/60Hz gas inlet flange 32x32mm gas outlet flange 32x32mm thermocouple connection pilot connection pressure range 15-60mbar max 60mbar operator type pressure controller type V5306E 1234 1 suitable for HONEYWELL flange 32x32mm			
accessories for	106004			
	GEV No.	102845	Ref. No.	—
	gas connection angled 1/2" flange 32x32mm hole distance 24x24mm Tandem			
	GEV No.	102846	Ref. No.	—
	gas connection straight 1/2" flange 32x32mm hole distance 24x24mm suitable for Tandem			







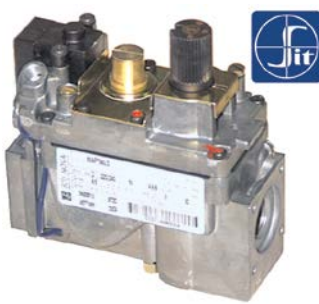

SIT

ELETTROSIT





GEV No.	101127	Ref. No.	766	
description	gas valve SIT type ELETTROSIT 230V gas inlet 3/4" gas outlet 3/4" thermocouple connection M9x1 pilot connection M10x1 lateral equiv. no. 0.810.175			
spare parts for	101127			
	GEV No.	101312	Ref. No.	1119
	microswitch			
	GEV No.	101352	Ref. No.	—
	solenoid coil 230V 50Hz suitable for ELETTROSIT			
accessories for	101127			
	GEV No.	100006	Ref. No.	—
	piezoelectric igniter suitable for ELETTROSIT body plastic blowing connection ø2.4mm ø 14mm			
	GEV No.	100904	Ref. No.	—
	locking screw M10x1 for pipe ø 4mm Qty 1 pcs			
	GEV No.	100905	Ref. No.	0830
	locking screw M10x1 for pipe ø 6mm Qty 1 pcs			
	GEV No.	101301	Ref. No.	—
	gas connection thread 1/2" straight ELETTROSIT screw with O-ring			
	GEV No.	101303	Ref. No.	—
	gas connection straight thread 3/4" ELETTROSIT			
	GEV No.	101309	Ref. No.	—
	extension			





NOVASIT			
			
1			
GEV No.	101162	Ref. No.	3015
description	gas valve SIT series Novasit 820 230V 50Hz gas inlet 1/2" gas outlet 1/2" thermocouple connection M9x1 pilot connection M10x1 ignition pressure 3-5mbar pressure range 3-30mbar pressure regulator connection blind equiv. no. 0.820.010		
spare parts for	101162		
	GEV No.	101065	Ref. No. —
	magnet unit with cable L 44mm D1 ø 30mm D2 ø 20mm suitable for NOVASIT		
	GEV No.	101313	Ref. No. —
	solenoid coil 230V 50Hz		
accessories for	101162		
	GEV No.	100006	Ref. No. —
	piezoelectric igniter suitable for ELETTROSIT body plastic blowing connection ø2.4mm ø 14mm		
	GEV No.	101305	Ref. No. —
	gas connection straight 1/2" flange 45x45mm ELETTROSIT/V4400/4600/4605 suitable for SIT/HONEYWELL hole distance 36x36mm		
	GEV No.	101306	Ref. No. —
	gas connection angled flange 45x45mm hole distance 36x36mm 1/2" ELETTROSIT/V4400/4600/4605 screw with O-ring suitable for SIT/HONEYWELL		
	GEV No.	101307	Ref. No. —
	gas connection straight flange 45x45mm hole distance 36x36mm 3/4" ELETTROSIT/V4400/4600/4605 screw with O-ring suitable for SIT/HONEYWELL		
	GEV No.	101308	Ref. No. —
	gas connection angled flange 45x45mm hole distance 36x36mm 3/4" ELETTROSIT/V4400/4600/4605 screw with O-ring suitable for SIT/HONEYWELL		
	GEV No.	101312	Ref. No. 1119
	microswitch		
	GEV No.	101314	Ref. No. —
	solenoid coil 24V 50Hz		
	GEV No.	101317	Ref. No. —
	plug with cable L 1000mm suitable for NOVASIT		
	GEV No.	101318	Ref. No. —
	cover cap for solenoid coil suitable for NOVASIT		



accessories			
			
1			
GEV No.	101359	Ref. No.	3020
description	knob extension L 75mm suitable for NOVASIT		

			
1			
GEV No.	100905	Ref. No.	0830
description	locking screw M10x1 for pipe ø 6mm Qty 1 pcs		

			
1			
GEV No.	101312	Ref. No.	1119
description	microswitch		

SIGMA			
			
Image not available			
1			
GEV No.	107499	Ref. No.	11140
description	gas valve 230V 50Hz gas inlet 3/4" gas outlet 3/4" SIT equiv. no. 0.848.049		
spare parts for	107499		
	GEV No.	106214	Ref. No. —
	solenoid coil 230V 50Hz Sigma		
accessories for	107499		
	GEV No.	107222	Ref. No. —
	plug for solenoid valve 3-pole cable length 1070mm		



GEV No.	107498	Ref. No.	11009
description	gas valve type Sigma 230V 50Hz gas inlet 1/2" gas outlet 1/2" pressure range 2-50mbar		
spare parts for	107498		
	GEV No.	106214	Ref. No. —
	solenoid coil 230V 50Hz Sigma		
accessories for	107498		
	GEV No.	107222	Ref. No. —
	plug for solenoid valve 3-pole cable length 1070mm		

TANDEM



GEV No.	101984	Ref. No.	11002
description	gas valve 230V 50Hz gas inlet 1/2" gas outlet 1/2" pilot connection level slow ignition ignition times pressure range 2-50mbar power supply for modulator 230VAC rectified Tandem equiv. no. 0.836.010		
spare parts for	101984		
	GEV No.	101379	Ref. No. —
	solenoid coil 230V 50Hz suitable for Tandem		
accessories for	101984		
	GEV No.	101274	Ref. No. —
	olive for pipe ø 16mm Qty 1 pcs		
	GEV No.	101275	Ref. No. —
	union screw thread 1/2" for pipe ø 16mm Qty 1 pcs		
	GEV No.	101925	Ref. No. —
	plug with O-ring thread M10x1 for pilot burner suitable for NOVASIT		
	GEV No.	102845	Ref. No. —
	gas connection angled 1/2" flange 32x32mm hole distance 24x24mm Tandem		
	GEV No.	102846	Ref. No. —
	gas connection straight 1/2" flange 32x32mm hole distance 24x24mm suitable for Tandem		
	GEV No.	102847	Ref. No. —
	O-ring		

ignition boxes

HONEYWELL



GEV No.	101165	Ref. No.	11003 11020
description	ignition box HONEYWELL type S4560A 1008 equiv. no. S4560A 1008 electrodes 1 waiting time 0s safety time 10s 220-240V 10VA 50Hz		
spare parts for	101165		
	GEV No.	358696	Ref. No. —
	fine fuse size ø5x20mm 4A medium lag rated 250V Qty 10 pcs		



GEV No.	102367	Ref. No.	11016
description	ignition box HONEYWELL type S4565A 2092 1 electrodes 3 waiting times safety time 10s 220-240V 4VA 50/60Hz		

SIT



GEV No.	102309	Ref. No.	11010
description	ignition box SIT type 537ABC electrodes 3 waiting time 1.5s safety time 10s 230V 10VA 50-60Hz protection IP44		

1

GEV No.	107497	Ref. No.	11147
description	ignition box SIT type 579DBC electrodes 1 waiting time 1s safety time 5s 220/240V 12VA 50/60Hz		

ignition parts











pilot burners







SIT

100 series



1

GEV No.	106906	Ref. No.	836
description	pilot burner SIT type 100 series 3 flames nozzle \varnothing 0.2mm gas connection 6mm		
spare parts for	106906		
	GEV No.	100245	Ref. No. —
	pilot burner nozzle LPG code 20 bore \varnothing 0.2mm Qty 1 pcs thread M8x0.75		
	GEV No.	100855	Ref. No. —
	pilot burner bracket triple		
	GEV No.	100885	Ref. No. —
	air mixing sleeve for pilot burner Qty 1 pcs		
	GEV No.	100916	Ref. No. —
	compression spring for pilot burner Qty 1 pcs		
	GEV No.	100917	Ref. No. —
	gasket for pilot burner Qty 1 pcs aluminium		
	GEV No.	100918	Ref. No. —
	screw for pilot burner		
	GEV No.	107162	Ref. No. —
	pilot burner cap SIT 3 flames Hmm Lmm Qty 1 pcs		
	GEV No.	107701	Ref. No. —
	pilot burner bottom part SIT 100 series nozzle \varnothing 0.2mm		
accessories for	106906		
	GEV No.	100245	Ref. No. —
	pilot burner nozzle LPG code 20 bore \varnothing 0.2mm Qty 1 pcs thread M8x0.75		
	GEV No.	100246	Ref. No. —
	pilot burner nozzle natural gas bore \varnothing 0.35mm Qty 1 pcs thread M8x0.75		

accessories for	106906		
	GEV No.	100904	Ref. No. —
	locking screw M10x1 for pipe \varnothing 4mm Qty 1 pcs		
	GEV No.	100905	Ref. No. 0830
	locking screw M10x1 for pipe \varnothing 6mm Qty 1 pcs		
	GEV No.	102110	Ref. No. —
	pilot tube copper pipe \varnothing 4mm thickness 1mm L 3000mm		
	GEV No.	102111	Ref. No. —
	pilot tube copper pipe \varnothing 6mm thickness 1mm L 3000mm		
	GEV No.	107171	Ref. No. —
	pilot burner nozzle SIT natural/liquid gas bore \varnothing 0.25mm Qty 1 pcs		
	GEV No.	107700	Ref. No. —
	pilot burner bottom part SIT 100 series nozzle \varnothing 0.25mm		
	GEV No.	107702	Ref. No. —
	pilot burner bottom part SIT 100 series nozzle \varnothing 0.35mm		

accessories

ignition electrodes



1

GEV No.	100706	Ref. No.	832
description	ignition electrode connection M4 Qty 1 pcs		

electrodes



1

GEV No.	100706	Ref. No.	832
description	ignition electrode connection M4 Qty 1 pcs		

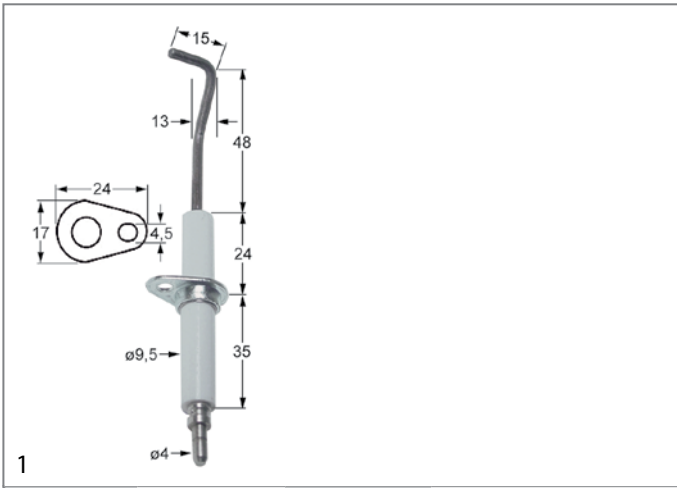

GEV No.	102342	Ref. No.	11001 11007
description	ignition electrode flange length 24mm flange width 17mm D1 ø 9.5mm L1 48mm L2 13mm L3 15mm BL1 24mm BL2 35mm fixing dimensions ø4.5mm with flange connection ø 4mm		

ignition cables

pre-assembled cables



GEV No.	100026	Ref. No.	3958
description	ignition cable cable length 1000mm connection ø4mm / F6.3mm		



GEV No.	102190	Ref. No.	3974
description	ignition cable cable length 1500mm connection ø4mm / F2.8mm		



GEV No.	102270	Ref. No.	3959
description	ignition cable cable length 1500mm connection ø4mm / F6.3mm		



GEV No.	102155	Ref. No.	3973
description	ignition cable cable length 900mm connection ø4mm / F2.8mm		

ignition units



GEV No.	101002	Ref. No.	825
description	ignition unit outputs 2 230VAC dimensions 88x23x34mm mounting distance 73mm inlet F6.3x0.8 outlet F2.8x0.8 0.6VA 50/60Hz		

thermocouples

plug-in thermocouples

plug-in thermocouples standard

with barrel socket ø6(6.5)mm

thermocouples SIT

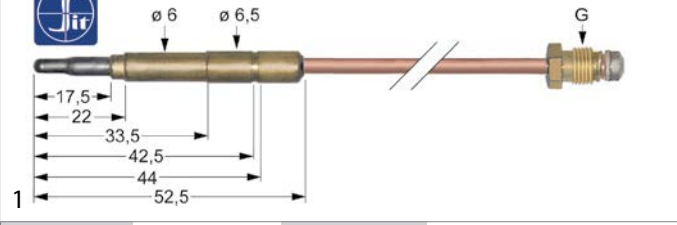

GEV No.	107612	Ref. No.	1668
description	thermocouple SIT M9x1 L 1000mm plug connection ø6.0(6.5)mm		

plug-in thermocouples with interruption

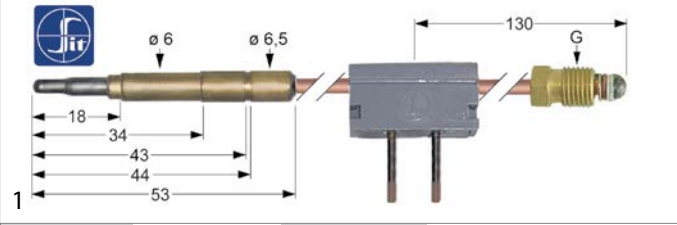

GEV No.	107164	Ref. No.	0831
description	thermocouple SIT with interrupter M9x1 L 1000mm plug connection ø6.0(6.5)mm soldering connection		

gas burners

bar burners

bar burners



GEV No.	105788	Ref. No.	0767A
description	bar burner 1-row ø 50mm Wmm Hmm L 483mm flange width 71mm convection oven flange ø 75mm		



GEV No.	105787	Ref. No.	768
description	bar burner ø 40mm Wmm Hmm L 415mm flange width 43mm flange length 43mm convection oven		



			
1			
GEV No.	105790	Ref. No.	3131
description	bar burner ø 50mm Wmm Hmm L 325mm flange width 57mm flange length 57mm convection oven		

			
1			
GEV No.	105791	Ref. No.	11031 11032
description	bar burner ø 50mm Wmm Hmm L 375mm flange width 57mm flange length 57mm convection oven		

			
1			
GEV No.	105789	Ref. No.	11030 1361
description	bar burner ø 50mm Wmm Hmm L 618mm flange width 71mm convection oven flange ø 75mm		

gas nozzles

main nozzles

gas nozzles M10x1

			
1			
GEV No.	106287	Ref. No.	2142
description	gas injector thread M10x1 WS 11 bore ø 2.2mm inner peaked		

pilot burner nozzles

pilot burner nozzles SIT



100 series

			
1			
GEV No.	107170	Ref. No.	1667
description	pilot burner nozzle SIT natural gas bore ø 0.35mm Qty 1 pcs		

auxiliary gas parts

screw connections

olives

			
1			
GEV No.	101256	Ref. No.	0665
description	olive for pipe ø 16mm Qty 1 pcs		
accessories for	101256		
	GEV No.	101253	Ref. No.
			—
	union nut thread M24x1.5 PEL for pipe ø 16mm		

union screws

			
1			
GEV No.	100905	Ref. No.	0830
description	locking screw M10x1 for pipe ø 6mm Qty 1 pcs		

			
1			
GEV No.	101467	Ref. No.	1107
description	union screw thread M18x1.5 for pipe ø 12mm Qty 1 pcs		

equipment-specific units

for convection ovens/combi-steamers

injection pipes

			
1			
GEV No.	692310	Ref. No.	3872
description	injection pipe for convection oven ED ø 8mm ID ø 6mm L 180mm		

glass panels



1

GEV No.	693985	Ref. No.	15196
description	glass panel L 443mm W 543mm thickness 4mm		



1

GEV No.	691937	Ref. No.	15202 15205
description	glass panel L 543mm W 442mm thickness 4mm		



1

GEV No.	694355	Ref. No.	15146
description	glass panel L 745mm W 355mm thickness 4mm		

for ovens

glass panels



1

GEV No.	691812	Ref. No.	15190
description	glass panel L 432mm W 346mm thickness 4mm		

handles and hand wheels

mushroom cap handles



1

GEV No.	111411	Ref. No.	382
description	mushroom cap handle thread M6 handle ø 26mm ø 17mm L 17mm plastic black matt		

locks

handle latches





universal

outside fixing

locks



1



GEV No.	694065	Ref. No.	90199
description	door handle for headed units L 145mm W 40mm H 62mm spring length 33mm outer black		
spare parts for	694065		
	GEV No.	514390	Ref. No. 15057
	spring for door handle ø 6mm L 54mm W 27.5mm		
	GEV No.	694734	Ref. No. —
	door handle L 165mm W 40mm H 25mm black		
	GEV No.	694735	Ref. No. —
	cap ø 32mm black		
accessories for	694065		
	GEV No.	694066	Ref. No. 3772
	door catch with spigot 2-stage L 28mm W 14mm H 15mm H1 16mm total length 51mm thread M8 thread L 23mm stainless steel		
	GEV No.	694067	Ref. No. —
	door catch with spigot 1-stage L 26mm total length 51mm thread M8		

edgmount latches

handle latches

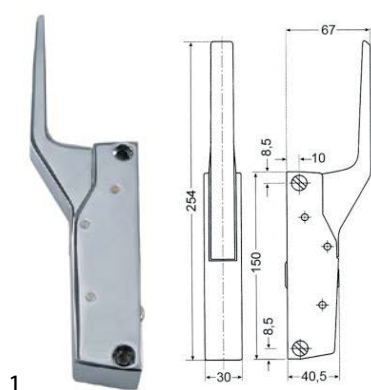
CAFF/FERMOD



GEV No.	700060	Ref. No.	1496
description	handle latch L 150mm mounting distance 133mm non lockable heated units G 791		
accessories for	700060		
	GEV No.	700061	Ref. No. 1500
	door catch L 58mm W 20mm H 35mm mounting distance 42mm chrome-plated brass for headed units		
	GEV No.	700062	Ref. No. —
	handle protection heated units		

door catches



GEV No.	700061	Ref. No.	1500
description	door catch L 58mm W 20mm H 35mm mounting distance 42mm chrome-plated brass for headed units		
accessories for	700061		
	GEV No.	690414	Ref. No. —
	handle latch L 150mm mounting distance 133mm non lockable refrigeration units G 791		

snap locks

universal



GEV No.	690864	Ref. No.	285
description	door catch L 38mm W 13mm H 21mm mounting distance 28mm zamak with spigot		



GEV No.	690863	Ref. No.	0285B
description	snap lock L 60mm W 16mm mounting distance 48mm spring thickness 1.5mm without door catch zamak		



GEV No.	690903	Ref. No.	0117B
description	snap lock L 69mm W 13mm H 20mm mounting distance 57mm complete with door catch nickel-plated brass		

hinges

oven hinges

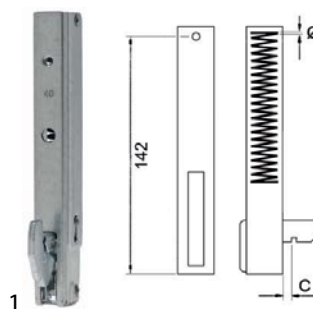

GEV No.	700390	Ref. No.	15062
description	oven hinge mounting distance 142mm mounting distance 2mm lug mountingmm lever lengthmm groove distance 12mm spring thickness 3mm mounting ear position spring length 116mm L 170mm mounting pos. left/right W 22mm		

door bearing





GEV No.	514306	Ref. No.	0045D
description	hinge bearing mounting pos. bottom left without bolt		





GEV No.	514308	Ref. No.	1004A
description	hinge bearing mounting pos. bottom left without bolt		

			
1			
GEV No.	514310	Ref. No.	0321.05
description	hinge bearing mounting pos. bottom left without bolt		

			
1			
GEV No.	514313	Ref. No.	12025
description	hinge bearing mounting pos. lower without bolt		

			
1			
GEV No.	514315	Ref. No.	30082
description	hinge bearing mounting pos. lower without bolt		

			
1			
GEV No.	514305	Ref. No.	0046B
description	hinge bearing mounting pos. upper left without bolt		

			
1			
GEV No.	514307	Ref. No.	1003A 12178
description	hinge bearing mounting pos. upper left without bolt		

			
1			
GEV No.	514309	Ref. No.	0322C
description	hinge bearing mounting pos. upper left without bolt		

			
1			
GEV No.	514311	Ref. No.	15.0007.01
description	hinge bearing mounting pos. upper left without bolt		

			
1			
GEV No.	514312	Ref. No.	12024
description	hinge bearing mounting pos. upper left without bolt		

			
1			
GEV No.	514314	Ref. No.	30083
description	hinge bearing mounting pos. upper left without bolt		

DERBY RUOTE

with fixing plate

chrome-plated steel

			
1			
GEV No.	700210	Ref. No.	15034
description	swivel castor with swivel brake ø 125mm plate fixing housing chrome-plated sheet steel plate size 95x70mm hole distance 50x70mm capacity 100kg bearing ball bearing wheel body polypropylene tread TPE tyres H 162mm wheel width 30mm Qty 1 pcs		



gaskets

refrigeration gaskets

plug-in gaskets

profile 9048

We offer custom-made gaskets for this profile

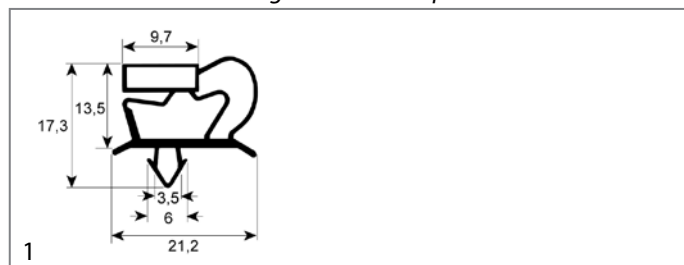

GEV No.	900345	Ref. No.	74001
description	refrigeration gasket profile 9048 W 410mm L 670mm plug size for blast chiller		

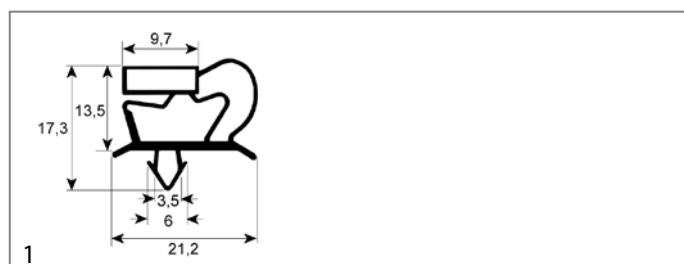

GEV No.	901211	Ref. No.	74002
description	refrigeration gasket profile 9048 W 555mm L 705mm plug size for blast chiller		

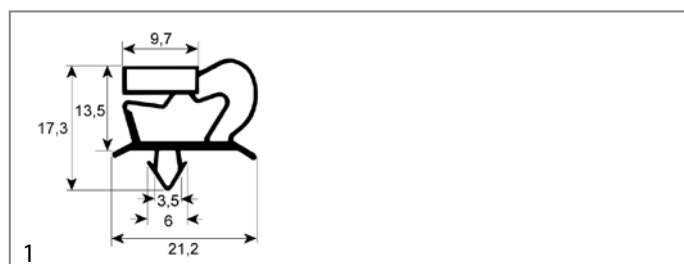

GEV No.	901209	Ref. No.	74003
description	refrigeration gasket profile 9048 W 710mm L 835mm plug size for blast chiller		

gaskets for heated units

window seals

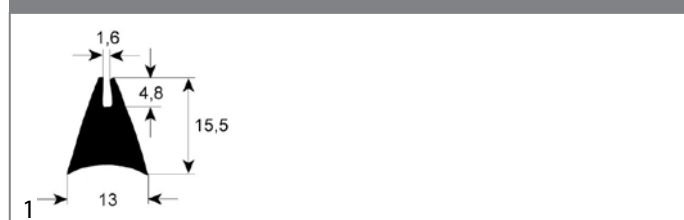

GEV No.	900463	Ref. No.	30093
description	window gasket profile 1650 L 1110mm Qty 1		



GEV No.	900472	Ref. No.	1441 490 498
description	window gasket profile 1650 L 1700mm Qty 1		



GEV No.	900473	Ref. No.	1444 489
description	window gasket profile 1650 L 2250mm Qty 1		



GEV No.	900881	Ref. No.	N/A
description	window gasket profile 1650 Qty supplied by meter		



GEV No.	900469	Ref. No.	14017
description	window gasket profile 1880 L 1385mm Qty 1		

GEV No.	902550	Ref. No.	0032
description	window gasket profile 1880 L 5170mm Qty 1		

GEV No.	902549	Ref. No.	60327
description	window gasket profile 1880 L 730mm Qty 1		

GEV No.	900470	Ref. No.	14018	
description	window gasket profile 1880 L 520mm Qty 1			
accessories for	900470			
	GEV No.	900471	Ref. No.	14019
	window gasket profile 1880 L 680mm Qty 1			

GEV No.	900882	Ref. No.	14002
description	window gasket profile 1880 Qty supplied by meter		

GEV No.	900471	Ref. No.	14019	
description	window gasket profile 1880 L 680mm Qty 1			
accessories for	900471			
	GEV No.	900470	Ref. No.	14018
	window gasket profile 1880 L 520mm Qty 1			

door seals

GEV No.	900461	Ref. No.	30099
description	door seal profile 2400 L 380mm Qty 1		

GEV No.	901325	Ref. No.	1443
description	door seal profile 2400 L 410mm external size		

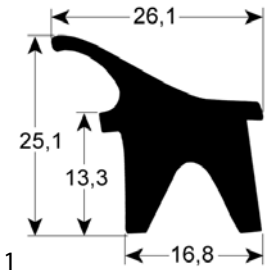
GEV No.	900462	Ref. No.	30098
description	door seal profile 2400 L 410mm Qty 1		

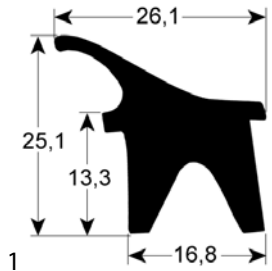

GEV No.	900883	Ref. No.	N/A
description	door seal profile 2400 Qty supplied by meter		

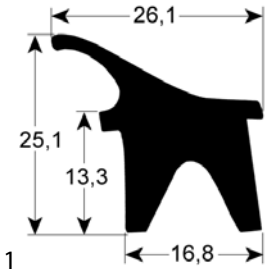

GEV No.	901324	Ref. No.	1442
description	door seal profile 2400 L 620mm external size		

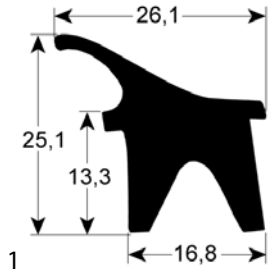

GEV No.	900934	Ref. No.	0271B
description	door seal profile 2400 Qty supplied by meter		

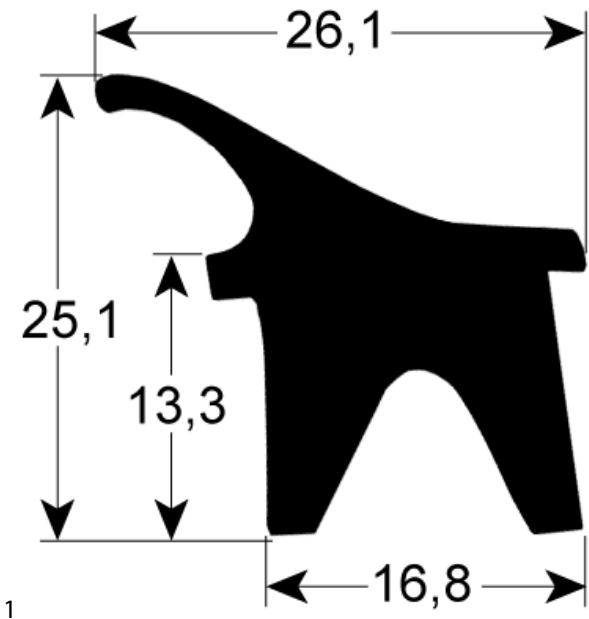

GEV No.	902551	Ref. No.	1446
description	door seal profile 2400 L 695mm Qty 1		

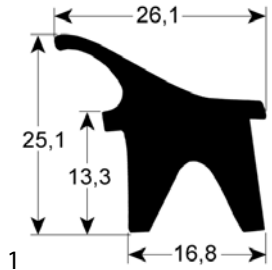

GEV No.	900480	Ref. No.	N/A
description	door seal profile 2400 W 390mm L 400mm external size Qty 1		

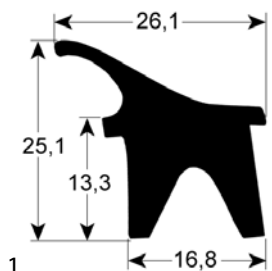

GEV No.	900464	Ref. No.	1093
description	door seal profile 2400 W 420mm L 645mm external size Qty 1		

GEV No.	900683	Ref. No.	3351
description	door seal profile 2400 W 475mm L 645mm Qty 1		

GEV No.	900474	Ref. No.	14014
description	door seal profile 2400 W 685mm L 805mm external size Qty 1		

GEV No.	900465	Ref. No.	323
description	door seal profile 2400 W 480mm L 700mm external size Qty 1		

GEV No.	900466	Ref. No.	324
description	door seal profile 2400 W 700mm L 915mm external size Qty 1		

GEV No.	900468	Ref. No.	1217 3352
description	door seal profile 2400 W 640mm L 800mm external size Qty 1		

GEV No.	900478	Ref. No.	14020
description	door seal profile 2415 L 1465mm mounting pos. left/right Qty 1		
accessories for	900478		
	GEV No.	900479	Ref. No.
			14021
description	door seal profile 2415 L 635mm mounting pos. upper/lower Qty 1		

GEV No.	900475	Ref. No.	14013
description	door seal profile 2400 W 685mm L 1465mm external size Qty 1		

GEV No.	901302	Ref. No.	14029
description	door seal profile 2415 L 543mm mounting pos. left/right Qty 1		
accessories for	901302		
	GEV No.	901300	Ref. No.
			14028
description	door seal profile 2415 L 675mm mounting pos. upper/lower Qty 1		

GEV No.	900479	Ref. No.	14021
description	door seal profile 2415 L 635mm mounting pos. upper/lower Qty 1		
accessories for	900479		
	GEV No.	900478	Ref. No. 14020
	door seal profile 2415 L 1465mm mounting pos. left/right Qty 1		

GEV No.	900477	Ref. No.	14011 14012 14013 14014 14021 14028
description	door seal profile 2415 L 805mm mounting pos. left/right Qty 1		
accessories for	900477		
	GEV No.	900476	Ref. No. 14012
	door seal profile 2415 L 695mm mounting pos. upper/lower Qty 1		

GEV No.	901300	Ref. No.	14028
description	door seal profile 2415 L 675mm mounting pos. upper/lower Qty 1		
accessories for	901300		
	GEV No.	901302	Ref. No. 14029
	door seal profile 2415 L 543mm mounting pos. left/right Qty 1		

GEV No.	902166	Ref. No.	14082
description	door seal profile 2749 W 660mm L 1450mm external size suitable for FOINOX		

GEV No.	900476	Ref. No.	14012
description	door seal profile 2415 L 695mm mounting pos. upper/lower Qty 1		
accessories for	900476		
	GEV No.	900477	Ref. No. 14011 14012 14013 14014 14021 14028
	door seal profile 2415 L 805mm mounting pos. left/right Qty 1		

GEV No.	902548	Ref. No.	61558
description	door seal profile 2768 L 1952mm Qty 1		

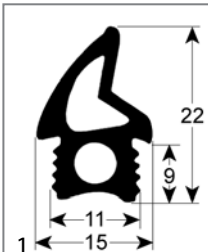

GEV No.	900879	Ref. No.	60320
description	door seal profile 2768 L 2020mm		

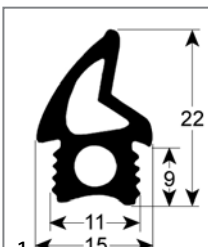

GEV No.	901713	Ref. No.	60321
description	door seal profile 2768 L 2700mm		

door seals with fixing hook



GEV No.	900811	Ref. No.	161
description	door seal L 320mm W 240mm external size		



GEV No.	900810	Ref. No.	162
description	door seal L 360mm W 290mm with 8 mounting clips external size		

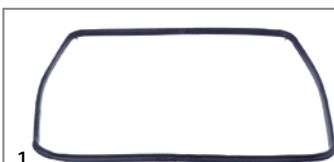

GEV No.	900307	Ref. No.	14070
description	door seal L 480mm W 380mm type ECG Speedy external size		

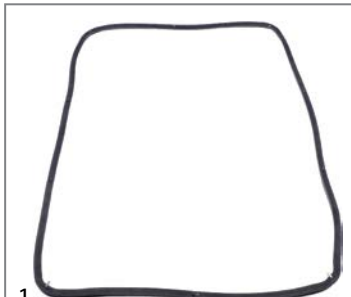

GEV No.	901299	Ref. No.	14076
description	door seal W 620mm with mounting clip H 360mm		

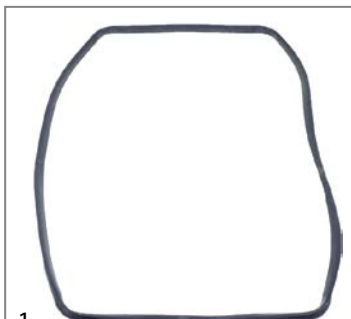

GEV No.	901342	Ref. No.	14073
description	oven gasket L 620mm W 270mm with 10 mounting clips plug size		

sealing washers

silicone gaskets



GEV No.	359721	Ref. No.	0812.01
description	gasket silicone ED ø 48mm ID ø 39.5mm thickness 5mm Qty 1 pcs		

shaft gaskets

shaft gaskets



GEV No.	698247	Ref. No.	689
description	shaft seal ID ø 15mm		



evaporators

for fridges

producer-specific



1

GEV No.	750301	Ref. No.	71041
description	evaporator L 700mm W 440mm H 100mm suitable for FOINOX		

hose reels and spray guns

spray guns



1

GEV No.	691048	Ref. No.	1518.01
description	spray gun for appliances 1/2" ET L 225mm type STAR		

spare parts for 691048

	GEV No.	507309	Ref. No.	—
		O-ring EPDM thickness 2.62mm ID ø 17.13mm Qty 1 pcs		
	GEV No.	510322	Ref. No.	—
		O-ring EPDM thickness 1.78mm ID ø 17.17mm Qty 1 pcs		
	GEV No.	524055	Ref. No.	—
		flat gasket rubber ED ø 18mm ID ø 12mm thickness 2mm Qty 1 pcs		
	GEV No.	528485	Ref. No.	—
		O-ring EPDM thickness 1.78mm ID ø 6.07mm Qty 1 pcs		
	GEV No.	528494	Ref. No.	—
		gasket rubber ED ø 13mm ID ø 4mm thickness 4mm Qty 1 pcs		

valves and tank inlets

ball valves

ball valves electric



1

GEV No.	401233	Ref. No.	10036
description	ball valve inlet 1/2" IT outlet 1/2" IT 230V 50/60Hz mode of operation electric W 60mm H 99mm cable 4-pole 2.5W 4-pole duty cycle 50%		

measuring equipment

thermometers

built-in thermometers

ø52mm



1

GEV No.	541077	Ref. No.	593 594
description	thermometer mounting ø 52mm t.max. 350°C +50 up to +350°C probe ø 6mm probe L 30mm capillary pipe 1000mm built-in depth 28mm		

fastening material

screws

hexagonal screws



1

GEV No.	560083	Ref. No.	17120
description	hexagonal screw thread M5 thread L 10mm SS WS 8 Qty 20 pcs DIN 933 / ISO 4017		

fasteners

roll pins



1

GEV No.	691637	Ref. No.	3780
description	roll pin ø 3mm L 20mm		



1

GEV No.	504003	Ref. No.	17022
description	roll pin ø 3mm L 24mm		

A			
alarm devices	12		
axial fans	19		
B			
ball valves	39		
ball valves electric	18, 39		
bar burners	28		
C			
cables	23		
cam switches	8		
castors and bumper angles	32		
cold air circulating fans (complete)	20		
condensators & interference suppression filters	23		
contactors	12		
control thermostats	5		
D			
door catches	31		
door seals	34		
door seals with fixing hook	38		
drain pumps	23		
E			
edgemount latches	31		
electric accessories	23		
electrodes	19		
electronic controllers	14		
energy regulators	5		
evaporators	39		
F			
fans	19		
fasteners	40		
fastening material	39		
G			
gas burners	28		
gas control valves	24		
gas nozzles	29		
gaskets for heated units	33		
H			
halogen lamp	9		
handle latches	31		
heating elements	3		
heating elements for convection	3		
heating elements for heated cabinets	3		
heating elements for ovens	3		
hexagonal screws	39		
hot air fans	23		
hot air motors	20		
I			
ignition boxes	26		
ignition cables	28		
ignition units	28		
immersion heating elements	3		
indicator lights	8		
indicator lights (complete)	8		
L			
lamps	8		
light bulbs	9		
M			
magnetic switches	8		
measuring equipment	39		
mechanical timers	11		
microswitches	6		
O			
operating capacitors	23		
oven hinges	31		
oven lamps	9		
P			
pilot burners	27		
plug-in gaskets	33		
probes	15		
programme timers	11		
pumps	23		
push/momentary push switches	6		
R			
refrigeration fans	19		
refrigeration gaskets	33		
relays	12		
ribbon cables	23		
roll pins	40		
S			
safety thermostats	6		
screws	39		
sealing washers	38		
shaft gaskets	38		
snap locks	31		
solenoid valves	17		
spray guns	39		
spray guns with external thread	39		
switches and momentary switches	6		
system switches (ROLD)	7		

T

temperature probes	15
terminals	24
thermocouples	28
thermostats	5
time relays	13
timers	11
transformers	14

U

universal probes	15
------------------	----

V

valves and tank inlets	39
------------------------	----

W

window seals	33
--------------	----