



GAS COMPONENTS



ELECTRIC COMPONENTS



WATER TECHNOLOGY



MECHANICAL COMPONENTS



TOOLS

Spare parts suitable for

IARP

Find the complete and up-to-date range of products in our GEV Webshop



Manufacturer catalogue

The most important spare parts and accessories arranged clearly for every manufacturer

- ✓ Complete product range and all appliance data always up to date in the GEV Webshop
- ✓ Alphabetical Index at the end of the catalogue

GEV Webshop

www.gev-online.co.uk

www.gev-online.com



- 🔍 Add to Favourites
- 🔍 Sign In with email address and usual password
- 🔍 Easy-order – place several items in your basket at the same time
- 🔍 Quick Item search – no login needed



heating elements

heating elements for refrigeration

heating elements for defrosting



GEV No.	417669	Ref. No.	0205376
description	heating element 233W 230V L 195mm W 122mm connection male faston 6.3mm cable length 1000mm tube ø 8.5mm defrosting		

heating cables

connection on both sides (metal braided)



GEV No.	417516	Ref. No.	0231005
description	heating cable 40.6W 230V ø 2.6mm L 4600mm 10W/m		

thermostats

refrigeration thermostats

DANFOSS

control thermostats

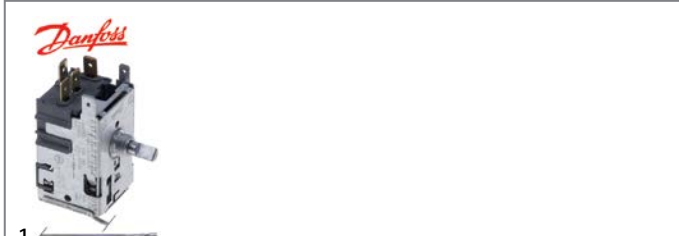

GEV No.	390774	Ref. No.	0225093 0225178
description	thermostat type 077B3317L capillary pipe 2000mm temperature range -13.6 up to -30.0°C probe ø 2mm		

RANCO

K22 series

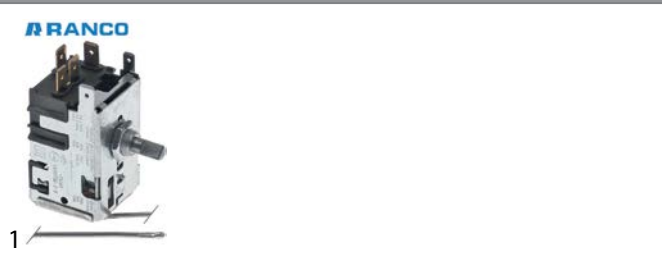

GEV No.	391000	Ref. No.	0225095 3305084 I3305084
description	thermostat RANCO type K22L1067 probe ø 2mm probe L 7mm capillary pipe 1500mm T war 10.5°C T cold -32°C shaft L 11mm shaft 6x4mm		



GEV No.	391003	Ref. No.	0225008
description	thermostat RANCO type K22L1067 probe ø 2mm probe Lmm capillary pipe 1500mm T war -10°C T cold -34°C		



GEV No.	390775	Ref. No.	0225105
description	thermostat RANCO type K22L2088 probe ø 2mm capillary pipe 2500mm temperature range -10 up to -20°C		



GEV No.	391007	Ref. No.	3304241
description	thermostat RANCO type K22-L8103 probe ø 2mm probe L 48mm capillary pipe 1500mm T war 10°C T cold -5°C for fridge		

K50 series



GEV No.	391008	Ref. No.	3304724
description	thermostat RANCO type K50B-S3492 probe ø 2mm probe Lmm capillary pipe 2500mm T war -19°C T cold -26°C ice maker		



GEV No.	390990	Ref. No.	I0225186
description	thermostat RANCO type K50B-S3528 capillary pipe 800mm		



GEV No.	390760	Ref. No.	3301323
description	thermostat RANCO type K50-L3210 probe ø 2mm probe Lmm capillary pipe 2500mm temperature range -30 up to -23°C refrigeration		

accessories for 390760



GEV No.	112654	Ref. No.	3301324
----------------	--------	-----------------	---------

knob ø 22.5mm shaft ø 6x4mm blue for thermostat



GEV No.	391004	Ref. No.	3300683
description	thermostat RANCO type K50-L3313 probe ø 2mm probe Lmm capillary pipe 1500mm for display refrigerator		



GEV No.	391002	Ref. No.	0225088 3306115 I3306115
description	thermostat RANCO type K50-L3319 probe ø 2mm probe L 7mm capillary pipe 1000mm temperature range -4,5 up to +7,5°C shaft L 11mm shaft 6x4mm		



GEV No.	390757	Ref. No.	0225090
description	thermostat RANCO type K50-L3337 probe ø 2mm probe Lmm capillary pipe 1500mm refrigeration		



GEV No.	391005	Ref. No.	3303610
description	thermostat RANCO type K50-L3425 probe ø 2mm probe Lmm capillary pipe 1000mm T war -10°C T cold -30°C for display refrigerator		





GEV No.	391006	Ref. No.	0225081 0225185
description	thermostat RANCO type K50L7201 probe ø 2mm probe L 36mm capillary pipe 900mm for fridge		







K57 series			
			
1			
GEV No.	390665	Ref. No.	3302297 3304195
description	thermostat RANCO type K57-L2852 probe ø 10mm probe L 40mm capillary pipe 1200mm		

switches and momentary switches

rocker/momentary rocker switches

30x22mm			
			
1			
GEV No.	301003	Ref. No.	0202083
description	rocker switch mounting measurements 30x22mm green 2NO 250V 16A illuminated 0-I connection male faston 6.3mm ambient temperature max. 125/55°C protection IP65		
accessories for	301003		
	GEV No.	301036	Ref. No. —
protective cover internal size 30x22mm for rocker switch mounting measurementsmm			

			
1			
GEV No.	301002	Ref. No.	3305916 I3305916
description	rocker switch mounting measurements 30x22mm orange 2NO 250V 16A illuminated 0-I connection male faston 6.3mm ambient temperature max. 85/125°C protection IP65		
accessories for	301002		
	GEV No.	301036	Ref. No. —
protective cover internal size 30x22mm for rocker switch mounting measurementsmm			

			
1			
GEV No.	301009	Ref. No.	0202008 0202030
description	rocker switch mounting measurements 30x22mm white 2NO 250V 16A illuminated 0-I connection male faston 6.3mm ambient temperature max. 125/55°C protection IP65		
For models:	GAYA20-TOP-DOOR		
accessories for	301009		
	GEV No.	301036	Ref. No. —
protective cover internal size 30x22mm for rocker switch mounting measurementsmm			

push/momentary push switches

27.2x22.2mm			
			
1			
GEV No.	348112	Ref. No.	3301934
description	push switch mounting measurements 27.2x22.2mm 2NO 250V 16A without cap connection male faston 6.3mm ambient temperature max. 55°C		

ø25mm			
			
1			
GEV No.	348109	Ref. No.	0202088 3300972
description	push switch mounting ø 25mm white 2NO 250V 16A light connection male faston 6.3mm ambient temperature max. 55°C		

			
1			
GEV No.	347536	Ref. No.	0202007
description	push switch mounting ø 25mm white 2NO 250V 16A connection male faston 6.3mm ambient temperature max. 125°C protection IP40		

			
1			
GEV No.	346003	Ref. No.	0202084
description	momentary push switch mounting ø 25mm red 1NO/indicator light 250V 16A illuminated connection male faston 6.3mm ambient temperature max. 85°C protection IP65		

			
1			
GEV No.	345161 ¹	Ref. No.	3303454
description	push switch mounting ø 25mm green 2NO 250V 16A illuminated connection male faston 6.3mm ambient temperature max. 85°C protection IP40		

			
1			
GEV No.	345151 ¹	Ref. No.	0202000
description	push switch mounting ø 25mm orange 2NO 250V 16A illuminated connection male faston 6.3mm ambient temperature max. 85°C protection IP40		

¹illuminated

¹illuminated



1

GEV No.	347537	Ref. No.	0202087
description	push switch mounting ø 25mm green 2NO 250V 16A illuminated main switch connection male faston 6.3mm ambient temperature max. 55/120°C protection IP40		

microswitches

with push button

switches with snap-fit



1

GEV No.	345249	Ref. No.	020270
description	microswitch with push button 250V 0.25A 1NO connection male faston 6.3mm L 26x12mm ambient temperature max. 85°C actuating force: 500g		



1

GEV No.	348192	Ref. No.	0202070 I0202070
description	microswitch with push button 250VA 1NO connection male faston 6.3mm L 26x12mm ambient temperature max. 85°C actuating force: 500g		

lamps

indicator lights

indicator lights (complete)

30x22mm



1

GEV No.	359157	Ref. No.	0200008	
description	indicator light mounting measurements 30x22mm 230V green connection male faston 6.3mm temp.-resist. 125/55°C type RL2			
For models:	GAYA20-TOP-DOOR			
accessories for	359157			
	GEV No.	301036	Ref. No.	—
	protective cover internal size 30x22mm for rocker switch mounting measurementsmm			



1

GEV No.	359178	Ref. No.	N/A	
description	indicator light mounting measurements 30x22mm 230V green connection male faston 6.3mm temp.-resist. 85°C type Marquardt 1667.. IP44			
accessories for	359178			
	GEV No.	301036	Ref. No.	—
	protective cover internal size 30x22mm for rocker switch mounting measurementsmm			



1

GEV No.	359155	Ref. No.	0200007
description	indicator light mounting measurements 30x22mm 230V red connection male faston 6.3mm temp.-resist. 125°C type RL2		

fluorescent lamps

accessories

ballasts



1

GEV No.	401504	Ref. No.	0206009 3303896
description	electrical ballast 18W 230V Qty 1 pcs		
For models:	GAYA20-TOP-DOOR		



1

GEV No.	401505	Ref. No.	0206012 3303897
description	electrical ballast 36W 230V Qty 1 pcs		
For models:	GAYA20-TOP-DOOR		

timers

programme timers



1

GEV No.	403659	Ref. No.	3306879
description	timer CDC 4901F1 engines 1 chambers 1 operation time 20s 230V 50Hz shaft ø 6x4.6mm shaft Lmm		

defrost timers

BIGATTI



1

GEV No.	360520	Ref. No.	3301867
description	defrost timer BIGATTI type D94.44 defrosting interval 4x per 24h defrosting time 12.5min 230V 50Hz		

CDC



1

GEV No.	403603	Ref. No.	I3306873
description	defrost timer CDC type 4901F1CME000.1000 defrosting interval 4x per 24h defrosting time 12.5min 230V 50/60Hz		

miscellaneous



1

GEV No.	360187	Ref. No.	3300736
description	defrost timer type RZ-2001-21 defrosting interval 4H defrosting time 15min fan delay 5min 230V 50Hz defr. funct. 4x per 24h		

relays

power relays

with bracket mounting

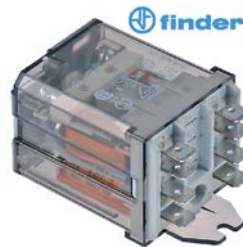

1

GEV No.	380139	Ref. No.	3301894 3301895
description	power relays FINDER 230VAC 16A 2CO connection F6.3 bracket mounting dimensions 68x38.2x35.8mm manuf. no. 62.82.8.230.0000		



1

GEV No.	380687	Ref. No.	3300702
description	power relays FINDER 230VAC 30A 2NO connection F6.3 bracket mounting manuf. no. 66.82.8.230.0300		
For models:	GAYA20-TOP-DOOR		



1

GEV No.	381252	Ref. No.	3301814
description	relay OMRON 230VAC 25A 2NO connection male faston 6.3mm bracket mounting at 250V 25A manuf. no. G7L-2A-TUB 230VAC		



electronic controllers

EUREMA

refrigeration controllers



1

GEV No.	378471	Ref. No.	3304410 3306508 I3306508
description	electronic controller EUREMA type TE11E mounting measurements 58x25mm 230V voltage AC PTC relay outputs 1 NO-16A PTC built-in depth 82mm protection IP65 built-in version -50 up to +50°C display 2 digit		



1

GEV No.	378281	Ref. No.	0233096 3303605
description	electronic controller EUREMA type TE32E mounting measurements 64x32mm 230V voltage AC PTC relay outputs 3 NO-16A NO-8A NO-5A PTC PTC protection IP65 built-in version -50 up to +50°C display 2 digit		



1

GEV No.	378486	Ref. No.	TE32F
description	electronic controller EUREMA type TE32F mounting measurements 58x25mm 230V voltage AC PTC/NTC relay outputs 3 NO-16A CO-10A NO-10A PTC/NTC PTC/NTC DI front measurements 64x32mm built-in depth 82mm protection IP65 accuracy 1% built-in version incl. adaptor 71x29 defr. funct. yes -50 up to +99°C display 2½ digit		

thermometers



1

GEV No.	379778	Ref. No.	0205115 TE01DEF
description	thermometer EUREMA type TE01 mounting measurements 58x25mm 230V voltage AC -10 up to +55°C PTC display 2 digit front measurements 63x32mm protection IP65 accuracy 1%		



1

GEV No.	378472	Ref. No.	3301028 I3301028
description	thermometer EUREMA type TE01DEF mounting measurements 58x25mm 230V voltage AC°C measuring input PTC display 2½ digit front measurements 64x32mm protection IP65 accuracy 1% PTC		

accessories



1

GEV No.	378306	Ref. No.	3303038	
description	load module EUREMA type EWEM036 mounting measurements 115x37mm 230V voltage AC relay outputs 3 CO-20A CO-16A CO-10A front measurementsmm built-in depth 70mm protection IPx0 wall-mounted version defr. funct.°C display			
accessories for	378306			
	GEV No.	403555	Ref. No.	3303049
	ribbon cable 5-pole L 1000mm plug type IDC-AUTOCOM HE14, 90° raster size 2.54mm			

probes

universal probes

temperature probes



1

GEV No.	379343	Ref. No.	0205610
description	temperature probe NTC 10kOhm cable silicone probe -40 up to +110°C cable -50 up to +180°C probe ø6x40mm cable length 3m 2-wire		

producer-specific probes

probes



1

GEV No.	403910	Ref. No.	I0205805
description	temperature probe NTC 10kOhm cable PVC probe -40 up to +110°C connection 2-wire probe 5x20 cable length 1.475m		



electronics

PCBs

			
1			
GEV No.	403736	Ref. No.	43845000 I9R00462
description	control PCB refrigeration IARP L 222mm W 40mm		

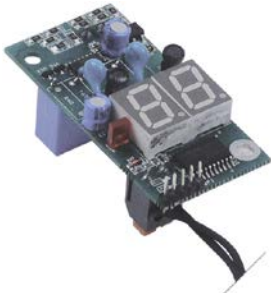
			
1			
GEV No.	402976	Ref. No.	0205600
description	PCB thermometer L 68mm W 33mm cable length 2000mm with probe 230V voltage AC		

keypads

front foils



			
1			
GEV No.	403764	Ref. No.	49357000
description	front foil blast freezer L 165mm W 45mm		

solenoid valves

solenoid valves (refrigeration)

DANFOSS

valve bodies

			
1			
GEV No.	370160	Ref. No.	0189035 I0189035
description	solenoid valve body NC type EVR 3 p max 45.2bar DN 3.2mm connection 6mm soldering connection -40° up to 105°C refrigeration straight DANFOSS		
accessories for	370160		
			
GEV No.	371046	Ref. No.	—
description	console for solenoid valve for EVR2,3,6,10		

compressors

EMBRACO / ASPERA

R134A

HBP monophase

High evaporation temperature above -15°C

			
1			
GEV No.	605181	Ref. No.	0210607
description	compressor coolant R134a type EMT50HDP 220-240V 50Hz HBP 7.8kg 1/6HP cylinder capacity 4.5cm ³ RSIR H 166mmWWW 161 W 207W 261W 324W 396W 476W		

HMBP monophase

High/Medium evaporation temperature above -20/-15 °C

			
1			
GEV No.	605016	Ref. No.	0210611
description	compressor coolant R134a type EM65HHR 220-240V 50Hz HBP fully hermetic 7.62kg 1/6HP cylinder capacity 5.54cm ³ CSIRWWW 287W 389W 499W 617W 742W test method ASHRAE 842W		



R290A

LBP monophase

Lower evaporation temperature below -20°C



1

GEV No.	605258	Ref. No.	I0210981
description	compressor coolant R290 type EMTE2134U 220-240V 50Hz LBP 9kg 3/8HP cylinder capacity 9.5cm ³ CSIR H 187mm 250W 278W 305W 330W 366WWWWW		



1

GEV No.	605274	Ref. No.	0210809
description	compressor coolant R290 type NEK2134U 220-240V 50Hz LBP 11kg 1/2HP cylinder capacity 9.99cm ³ CSIR 351W 441W 552W 682W 833WWWWW test method ASHRAE		



1

GEV No.	605204	Ref. No.	0210951
description	compressor coolant R290 type NEK2160U 220-240V 50Hz LBP 11.9kg 3/4HP cylinder capacity 16.8cm ³ CSR H 206mm 508W 646W 808W 995W 1206WWWWW test method ASHRAE		

R600A

LBP monophase

Lower evaporation temperature below -20°C



1

GEV No.	605257	Ref. No.	45004031
description	compressor coolant R600a type EMD46CLT 220-240V 50Hz LBP 7.5kg cylinder capacity 7.96cm ³ RSCR H 210mm 88W 118W 154W 196W 246WWWWW		

SECOPI DANFOSS

R134A

HMBP monophase

High/Medium evaporation temperature above -20/-15 °C



1

GEV No.	605076	Ref. No.	0210109
description	compressor coolant R134a type SC18G 220-240V 50Hz HMBP fully hermetic 13.7kg 1/2HP power input 495W cylinder capacity 17.7cm ³ CSIR H 219mmW 348W 485W 649W 844W 1074W 1343W 1655W 2014W test method ASHRAE		

spare parts for	605076			
	GEV No.	380058	Ref. No.	—
	start relay DANFOSS 117U6019/F278 HST			



1

GEV No.	605194	Ref. No.	0210107
description	compressor coolant R134a type SC21G 220-240V 50Hz HMBP 13.5kg 5/8HP power input 643W cylinder capacity 20.95cm ³ CSR H 219mmW 410W 558W 746W 977W 1250W 1568W 1931W 2343W test method ASHRAE		



1

GEV No.	601055 ¹	Ref. No.	0221007	
description	axial fan L 92mm W 92mm H 25mm 230VAC 50/60Hz 14.5/14W bearing ball bearing connection male faston 2.8mm metal ADDA fan wheel ø 85mm temp.-resist. 70°C			
accessories for	601055			
	GEV No.	550898	Ref. No.	0221181 I0221181
	connecting cable cable length 2000mm connection F 2.8 connection distance 7.9mm for axial flow fan			
	GEV No.	691103	Ref. No.	—
	guard ø 90mm mounting distance 83mm for axial fan 92mm			

fans

axial fans

import



1

GEV No.	601131 ¹	Ref. No.	0221005 0221151 I0221151	
description	axial fan L 119mm W 119mm H 25mm 230VAC 50/60Hz 19/18W bearing ball bearing connection male faston 2.8mm metal ADDA fan wheel ø 110mm temp.-resist. 70°C			
accessories for	601131			
	GEV No.	550898	Ref. No.	0221181 I0221181
	connecting cable cable length 2000mm connection F 2.8 connection distance 7.9mm for axial flow fan			

¹with ball bearings



1

GEV No.	601909 ¹	Ref. No.	45003031
description	axial fan L 119mm W 119mm H 38mm 220-240 50/60Hz 31/29W bearing ball bearing connection male faston 2.8mm		

¹with ball bearings

¹with ball bearings

accessories

fan guards



1

GEV No.	691104	Ref. No.	0427017 I0427017
description	guard ø 115mm mounting distance 105mm for axial fan 119mm		

connecting cables



1

GEV No.	550898	Ref. No.	0221181 I0221181
description	connecting cable cable length 2000mm connection F 2.8 connection distance 7.9mm for axial flow fan		



refrigeration fans

refrigeration motors universal

ELCO

N series - standard



GEV No.	601442	Ref. No.	0220067 I0220067
description	fan motor ELCO 10W 230V 50-60Hz bearing slide bearing L1 45mm L3 83mm W 83mm cable length 1800mm 1300/1550rpm 3 mounting options VN10-20/507 triple		
spare parts for	601442		
	GEV No.	601413	Ref. No. —
	fixing plate suitable for fanwheel ED ø 32mm shaft ø 7 mounting distance 26mm		



GEV No.	601762	Ref. No.	0221141
description	fan motor ELCO 10W 230V 50Hz bearing ball bearing L1 49mm L2 59mm L3 86.5mm W 83mm connection cable 500mm cable length 500mm 1300/1550rpm 3 mounting options VN10-20/1456		
spare parts for	601762		
	GEV No.	601413	Ref. No. —
	fixing plate suitable for fanwheel ED ø 32mm shaft ø 7 mounting distance 26mm		



GEV No.	601763	Ref. No.	0221140
description	fan motor ELCO 16W 230V 50/60Hz bearing ball bearing L1 48mm L2 64mm L3 91.5mm W 83mm connection cable 500mm cable length 500mm 1300/1550rpm 3 mounting options VN16-25/1457		
spare parts for	601763		
	GEV No.	601413	Ref. No. —
	fixing plate suitable for fanwheel ED ø 32mm shaft ø 7 mounting distance 26mm		



GEV No.	601735	Ref. No.	0221115 3604962
description	fan motor ELCO 5W 230V 50/60Hz bearing slide bearing L3 71mm W 59mm connection Kabel 1430mm cable length 1500mm 1300/1550rpm 3 mounting options VN5-13/249		

IQ series



GEV No.	601886	Ref. No.	0220087
description	fan motor 14W 230V 50/60Hz L2 35-56mm L3 95mm W 80mm cable length 1000mm 1400rpm ELCO IQ motor 3 mounting options bearing ball bearing		



GEV No.	601887	Ref. No.	0220088
description	fan motor 25W 230V 50/60Hz L2 46-66mm L3 115mm W 90mm cable length 1000mm 1400rpm ELCO IQ motor 3 mounting options bearing ball bearing		



FMI



1

GEV No.	601332	Ref. No.	0220072 I0220072
description	fan motor 16W 230V 50Hz L1 65mm L2 54mm L3 94mm W 77mm cable length 500mm 1300/1550rpm ABS12 5 mounting options bearing slide bearing		
For models:	GAYA20-TOP-DOOR		
spare parts for	601332		
	GEV No.	601413	Ref. No. —
description	fixing plate suitable for fanwheel ED ø 32mm shaft ø 7 mounting distance 26mm		

accessories

fan wheels

aluminium

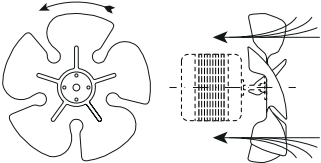
1

GEV No.	601069	Ref. No.	0407004
description	fan wheel sucking ø 172mm turn direction left fan wheel mounting 25.4mm blade angle 25° W 32mm aluminium		

mounting rings



1

GEV No.	601586	Ref. No.	0221128
description	ring for fan wheel ø 172mm sucking ø 220mm H 49mm mounting distance 1 208mm mounting distance 2 94.5mm		



1

GEV No.	601587	Ref. No.	0221116
description	ring for fan wheel ø 200mm sucking ø 246mm H 49mm mounting distance 1 236mm mounting distance 2 94.5mm		

cross flow fans

COPREL

double fans



1

GEV No.	602107	Ref. No.	N/A
description	cross flow fan COPREL TFD roller ø 60mm roller length 2x300mm laminated core thickness 30mm motor position centre 230V/50-60Hz 35W universal bearing silicone connection cable 1600mm airflow 333m ³ /h -10 up to +50°C		

condensators & interference suppression filters

starting capacitors

starting capacitors



1

GEV No.	365153	Ref. No.	0210402
description	starting capacitor 52µF 330V 50/60Hz duty cycle 3s 41280A133 2252347 ø 36mm L 83mm M8 plastic connection cable 350mm		



fuses

line circuit breakers

miscellaneous



1

GEV No.	356000	Ref. No.	I3301770
description	circuit breaker 2 20A with fault current switch		

electric accessories

cables

power supply cables



1

GEV No.	552002	Ref. No.	I3306470
description	power lead CEE7/7 type E+F contacts P+N+E 1mm ² max. 16A max 230V 2.5m		

ribbon cables

group 6



1

GEV No.	403555	Ref. No.	3303049
description	ribbon cable 5-pole L 1000mm plug type IDC-AUTOCOM HE14, 90° raster size 2.54mm		

terminal boxes



1

GEV No.	551086	Ref. No.	01009
description	terminal box 6-pole L 117mm W 67mm H 22mm protection IP30		

equipment-specific units

for fridges

spare parts and accessories



1

GEV No.	551346	Ref. No.	I0534005R
description	bush refrigerator compressor ø 9mm ID ø 6.5mm L 17mm Qty 1 pcs		



1

GEV No.	699232	Ref. No.	I0535012
description	strain relief L 56mm W 14.5mm H 20mm		

housing and bezels

covers



1

GEV No.	998252	Ref. No.	44037000
description	cover for ventilation L 72mm W 62mm H 10mm Qty 1 pcs		

control panel



1

GEV No.	699234	Ref. No.	44027000
description	bezel L 780mm W 67mm H 62mm mounting pos. upper		

housings



1

GEV No.	699233	Ref. No.	I9500323
description	terminal box L 98mm W 74mm H 35mm kit		



knobs

producer-specific knobs

IARP



1

GEV No.	112654	Ref. No.	3301324
description	knob ø 22.5mm shaft ø 6x4mm blue for thermostat		

locks

locking devices

producer-specific

IARP



1

GEV No.	701114	Ref. No.	0423002
description	door catch plastic H 15mm L 40mm W 15mm hole ø 4.2mm mounting distance 14mm for catch		



1

GEV No.	702100	Ref. No.	44373000
description	key cylinder ø 19mm rotation 180° cam length 42.5mm cam width 14mm		



1

GEV No.	701113	Ref. No.	0423001
description	key cylinder rotation 180° cam length 32mm cam width 17mm mounting ø 19mm		

hinges

door bearing



1

GEV No.	701562	Ref. No.	44447000
description	bolt L 36mm W 22mm thread M6 bolt 12mm bolt ø 12mm		



1

GEV No.	701025	Ref. No.	0530022
description	bolt L 45mm mounting pos. upper thread M8x1.25 ø 12mm for hinge		
accessories for	701025		



GEV No.	701026	Ref. No.	0162886
description	hinge L 56mm W 50mm mounting pos. upper thickness 3mm		



1

GEV No.	701567	Ref. No.	41649000
description	bush L 11mm ø 11/15mm thickness 2mm		



1

GEV No.	701572	Ref. No.	I0534002
description	bush ø 18.5mm ID ø 12mm		



1

GEV No.	692537	Ref. No.	0415134 I0415134
description	door hinge L 68mm W 25mm mounting pos. upper right with plunger		





1

GEV No.	701564	Ref. No.	46996000
description	hinge L 130mm W 85mm H 38mm mounting distance 48mm mounting distance 2 33mm thread M6 ø 8mm bolt 13mm bolt ø 8mm		



1

GEV No.	701026	Ref. No.	0162886
description	hinge L 56mm W 50mm mounting pos. upper thickness 3mm		
accessories for	701026		
	GEV No.	701025	Ref. No. 0530022
description	bolt L 45mm mounting pos. upper thread M8x1.25 ø 12mm for hinge		



1

GEV No.	701027	Ref. No.	0415122
description	hinge L 58mm W 28mm H 73mm mounting pos. lower with bolt		



1

GEV No.	701039	Ref. No.	0160434
description	hinge L 67mm W 43mm H 22mm mounting pos. bottom right		



1

GEV No.	701563	Ref. No.	43870000
description	hinge L 98mm W 48mm H 38mm mounting distance 40mm mounting distance 2 20mm thread M6		



1

GEV No.	701565	Ref. No.	48205000
description	hinge bearing L 72mm W 39mm H 30mm mounting distance 25mm mounting distance 2 25mm mounting pos. left		



1

GEV No.	701566	Ref. No.	46997000
description	hinge bearing L 72mm W 39mm H 30mm mounting distance 25mm mounting distance 2 25mm mounting pos. right		

equipment feet and end caps

screw-in feet



1

GEV No.	701112	Ref. No.	0403014 10403014
description	equipment foot thread M10 thread L 43mm ø 29mm H 52mm plastic WS 35 Qty 1 pcs		

shelves and shelf rails

grates

universal

with upstand



1

GEV No.	970824	Ref. No.	0427743
description	grate W 526mm D 418mm plastic-coated steel with hinge camp crossing wires 2		



1







GEV No.	970556	Ref. No.	0427396
description	grate W 530mm D 650mm GN 2/1 plastic-coated steel with hinge camp wire gauge frame 9mm lengthwise wires gauge 5mm crossing wires 2 white suitable for refrigerator		
accessories for	970556		
	GEV No.	690330	Ref. No. —
description	rack L 1000mm W 22mm H 4mm aperture 3x8mm hole distance 12.5mm stainless steel		
	GEV No.	690332	Ref. No. 10402138
description	shelf support L 31/28mm W 22mm H 17mm SS with hook Qty 1 pcs		
	GEV No.	694700	Ref. No. —
description	shelf support L 31/28mm W 22mm H 18mm SS Qty 12 pcs		

Table continues overleaf





accessories for	970556		
	GEV No.	694701	Ref. No. —
shelf support L 31/28mm W 22mm H 17mm SS with hook Qty 12 pcs			

			
GEV No.	970874	Ref. No.	0427709
description	grate W 650mm D 540mm GN 2/1 H 30mm plastic-coated steel with hinge camp for fridge wire gauge frame 7.3mm lengthwise wires gauge 3.2mm crossing wires 2 white		

producer-specific			
			
GEV No.	970930	Ref. No.	44714000
description	grate W 650mm D 330mm H 9mm wire gauge frame 7mm lengthwise wires gauge 3mm crossing wires 1		

			
GEV No.	970929	Ref. No.	44379000
description	grate W 665mm D 560mm H 30mm wire gauge frame 7mm lengthwise wires gauge 3mm crossing wires 2		

shelf rails and supports

universal			
			
GEV No.	690332	Ref. No.	I0402138
description	shelf support L 31/28mm W 22mm H 17mm SS with hook Qty 1 pcs		
accessories for	690332		
	GEV No.	690330	Ref. No. —
rack L 1000mm W 22mm H 4mm aperture 3x8mm hole distance 12.5mm stainless steel			

producer-specific			
			
GEV No.	699231	Ref. No.	I0402137
description	guide white L 1350mm W 20mm H 5mm Qty 1		

			
GEV No.	691835	Ref. No.	0160741
description	shelf support L 28/25mm W 35mm H 19mm		

gaskets

refrigeration gaskets

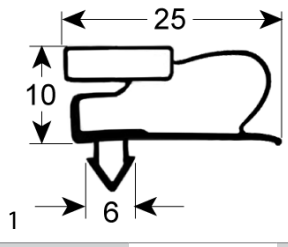
plug-in gaskets			
profile 9050			
			
GEV No.	902152	Ref. No.	0313225
description	refrigeration gasket profile 9050 W 560mm L 1585mm plug size		

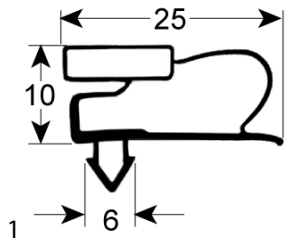
			
GEV No.	902051	Ref. No.	0313220
description	refrigeration gasket profile 9050 W 700mm L 1505mm plug size		

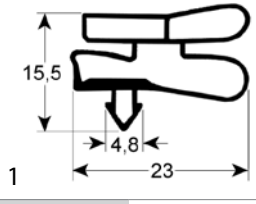
profile 9151			
<i>We offer custom-made gaskets for this profile</i>			
			
GEV No.	901457	Ref. No.	3303310
description	refrigeration gasket profile 9151 W 495mm L 1440mm plug size		

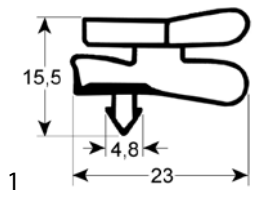
			
GEV No.	901458	Ref. No.	0313223
description	refrigeration gasket profile 9151 W 535mm L 1690mm plug size		

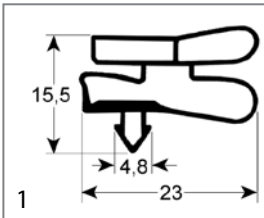

GEV No.	901083	Ref. No.	0313205
description	refrigeration gasket profile 9151 W 550mm L 1722mm plug size L1 1712mm W1 540mm external size		

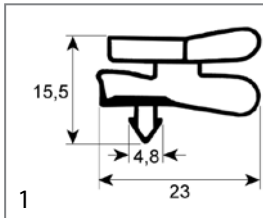

GEV No.	901096	Ref. No.	0313191 3300917
description	refrigeration gasket profile 9151 W 620mm L 890mm plug size		

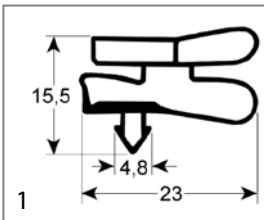

GEV No.	901179	Ref. No.	3302200 I3302200
description	refrigeration gasket profile 9151 W 555mm L 1555mm plug size L1 1545mm W1 545mm external size		

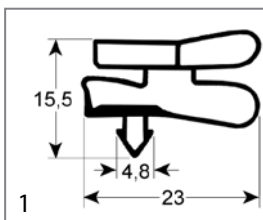

GEV No.	901081	Ref. No.	0313010
description	refrigeration gasket profile 9151 W 634mm L 1391mm external size L1 1381mm W1 624mm plug size		

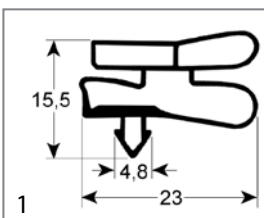

GEV No.	901080	Ref. No.	0313007 I0313007
description	refrigeration gasket profile 9151 W 558mm L 1713mm plug size L1 1703mm W1 548mm external size		

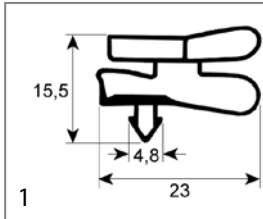

GEV No.	901097	Ref. No.	3300913
description	refrigeration gasket profile 9151 W 637mm L 576mm plug size		

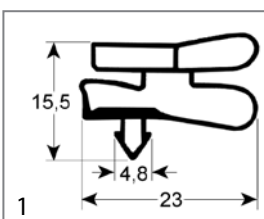

GEV No.	901082	Ref. No.	0313178
description	refrigeration gasket profile 9151 W 585mm L 1390mm plug size L1 1380mm W1 575mm external size		

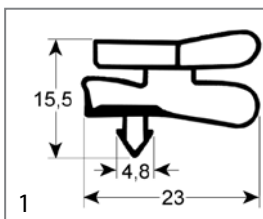

GEV No.	901796	Ref. No.	0313221
description	refrigeration gasket profile 9151 W 655mm L 1534mm		

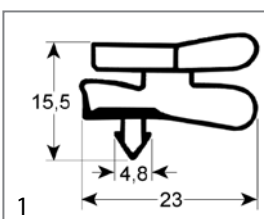

GEV No.	901086	Ref. No.	0313206
description	refrigeration gasket profile 9151 W 620mm L 1522mm plug size L1 1532mm W1 630mm external size		

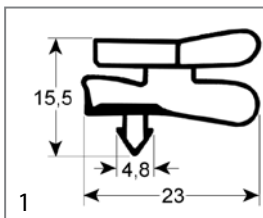

GEV No.	901377	Ref. No.	0313291
description	refrigeration gasket profile 9151 W 715mm L 1674mm plug size L1 1686mm W1 722mm external size		



GEV No.	901322	Ref. No.	0313233
description	refrigeration gasket profile 9151 W 717mm L 1515mm plug size L1 1505mm W1 707mm external size		

GEV No.	901085	Ref. No.	0313200
description	refrigeration gasket profile 9151 W 730mm L 1550mm plug size L1 1540mm W1 720mm external size		

GEV No.	901084	Ref. No.	0313202 0313207
description	refrigeration gasket profile 9151 W 740mm L 1619mm plug size L1 1609mm W1 730mm external size length external size 1625mm width external size 740mm		

profile 9058

GEV No.	902395	Ref. No.	44404000
description	refrigeration gasket profile 9058 W 770mm L 1810mm plug size Qty 1		

refrigeration cycle components

filter driers

miscellaneous

GEV No.	750311	Ref. No.	0145040
description	dryer size 20g ø 19mm L 149mm connection 3,2/6,2mm		

GEV No.	750310	Ref. No.	0145015
description	dryer size 20g ø 19mm L 150mm connection 3.2/5/6.2mm		

evaporators

for fridges

producer-specific

GEV No.	750621	Ref. No.	0119189
description	evaporator for fridge L 390mm W 325mm IARP		

GEV No.	750342	Ref. No.	0130010
description	evaporator L 1580mm W 660mm suitable for AB500P		

condensors

condensors

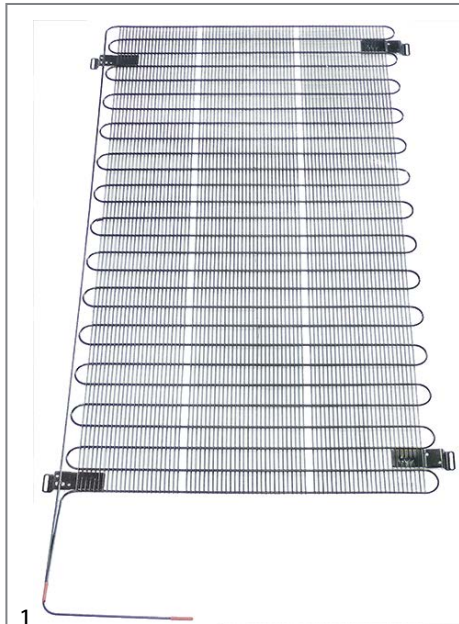

GEV No.	750703	Ref. No.	44918000
description	condenser W 790mm D 10mm H 1360mm		

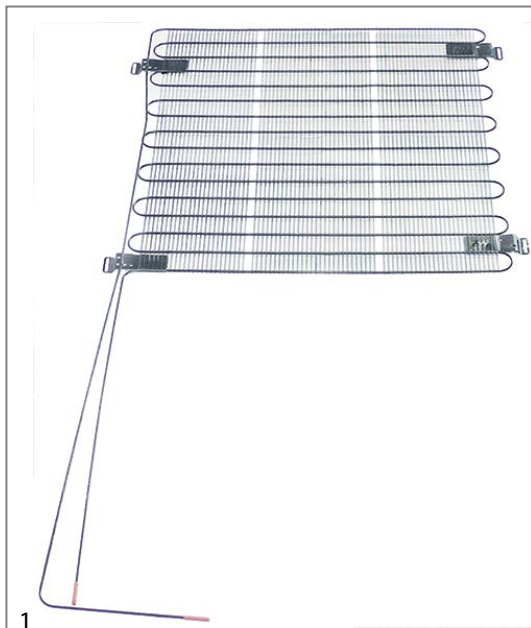

GEV No.	750699	Ref. No.	45034000
description	condenser W 790mm D 10mm H 750mm Qty 1 pcs		

evaporation and condensing trays

evaporation trays



GEV No.	699211	Ref. No.	I0425088
description	evaporation tray L 230mm W 144mm H 45mm		

measuring equipment

thermometers

built-in thermometers



GEV No.	541080	Ref. No.	0406018 3303276
description	thermometer mounting measurements 58x25.5mm -40 up to +40°C capillary pipe 2500mm probe ø 6mm probe L 30mm		
For models:	GAYA20-TOP-DOOR		

external power supply



GEV No.	378274 ¹	Ref. No.	0406046
description	thermometer ARTHERMO type ROF-DIG/230 mounting measurements 58x25.5mm front measurements 64x31mm 230V voltage AC -30 jusqu'à +110°C probe ø6x40mm cable length 2500mm display 3 digits		

¹incl. 1x NTC probe

fastening material

washers

washers

miscellaneous



GEV No.	560486	Ref. No.	0521000
description	plain washer ID ø 14.1mm ED ø 22mm thickness 2mm plastic Qty 1 pcs		
For models:	GAYA20-TOP-DOOR		

A			
axial fans	11		
B			
ballasts	6		
C			
cables	14		
compressors	9		
condensators & interference suppression filters	13		
cross flow fans	13		
D			
defrost timers	7		
E			
electric accessories	14		
electronic controllers	8		
evaporators	19		
F			
fans	11		
fastening material	20		
filter driers	19		
fluorescent lamps	6		
fuses	14		
G			
grates	16		
H			
heating cables	3		
heating elements	3		
heating elements for defrosting	3		
heating elements for refrigeration	3		
I			
indicator lights	6		
indicator lights (complete)	6		
L			
lamps	6		
M			
measuring equipment	20		
microswitches	6		
P			
plug-in gaskets	17		
power supply cables	14		
probes	8		
programme timers	7		
push/momentary push switches	5		
R			
refrigeration cycle components	19		
refrigeration fans	12		
refrigeration gaskets	17		
refrigeration motors universal	12		
refrigeration thermostats	3		
relays	7		
ribbon cables	14		
rocker/momentary rocker switches	5		
S			
shelves and shelf rails	16		
solenoid valves	9		
starting capacitors	13		
switches and momentary switches	5		
T			
temperature probes	8		
terminal boxes	14		
thermostats	3		
timers	7		
U			
universal probes	8		
W			
washers	20		