



**GAS COMPONENTS**



**ELECTRIC COMPONENTS**



**WATER TECHNOLOGY**



**MECHANICAL COMPONENTS**



**TOOLS**

Spare parts suitable for

**ITV**

Find the complete and up-to-date range of products in our GEV Webshop



# Manufacturer catalogue

The most important spare parts and accessories arranged clearly for every manufacturer

- ✓ Complete product range and all appliance data always up to date in the GEV Webshop
- ✓ Alphabetical Index at the end of the catalogue

## GEV Webshop

[www.gev-online.co.uk](http://www.gev-online.co.uk)

[www.gev-online.com](http://www.gev-online.com)



- 🔍 Add to Favourites
- 🔍 Sign In with email address and usual password
- 🔍 Easy-order – place several items in your basket at the same time
- 🔍 Quick Item search – no login needed



## thermostats

### refrigeration thermostats

#### RANCO

##### K22 series

RANCO



|                |        |                 |        |
|----------------|--------|-----------------|--------|
| <b>GEV No.</b> | 390291 | <b>Ref. No.</b> | 100153 |
|----------------|--------|-----------------|--------|

**description** thermostat RANCO type K22 S1096 probe ømm probe Lmm capillary pipe 1500mm

**For models:** Alfa-NDP20A, Alfa-NDP20W, Alfa-NG110A, Alfa-NG110W, Alfa-NG150A, Alfa-NG150W, Alfa-NG35A, Alfa-NG35W, Alfa-NG45A, Alfa-NG45W, Alfa-NG60A, Alfa-NG60W, Alfa-NG80A, Alfa-NG80W, Delta-DP140A, Delta-DP140W, Delta-DP30A, Delta-DP30W, Delta-DP45A, Delta-DP45W, Delta-DP60A, Delta-DP60W, Delta-DP80A, Delta-DP80W, Delta-DP90A, Delta-DP90W, Delta-NG110A, Delta-NG110W, Delta-NG150A, Delta-NG150W, Delta-NG30A, Delta-NG30W, Delta-NG35A, Delta-NG35W, Delta-NG45A, Delta-NG45W, Delta-NG60A, Delta-NG60W, Delta-NG80A, Delta-NG80W, Gala-DP20A, Gala-DP20W, Gala-DP30A, Gala-DP30W, Gala-DP40A, Gala-DP40W, Gala-DP55A, Gala-DP55W, Gala-DP70A, Gala-DP70W... (Other models you can see in the webshop)

RANCO



|                |        |                 |        |
|----------------|--------|-----------------|--------|
| <b>GEV No.</b> | 390577 | <b>Ref. No.</b> | 120273 |
|----------------|--------|-----------------|--------|

**description** thermostat RANCO type K22-L2084 probe ømm probe Lmm capillary pipe 1200mm

**For models:** Pulsar-15A, Pulsar-15W, Pulsar-25A, Pulsar-25W, Pulsar-35A, Pulsar-35W

##### K50 series

RANCO



|                |        |                 |        |
|----------------|--------|-----------------|--------|
| <b>GEV No.</b> | 390290 | <b>Ref. No.</b> | 100274 |
|----------------|--------|-----------------|--------|

**description** thermostat RANCO type K50S3493 probe ø 4.6mm probe L 6mm capillary pipe 2000mm

**For models:** Alfa-NDP20A, Alfa-NDP20W, Alfa-NG110A, Alfa-NG110W, Alfa-NG150A, Alfa-NG150W, Alfa-NG35A, Alfa-NG35W, Alfa-NG45A, Alfa-NG45W, Alfa-NG60A, Alfa-NG60W, Alfa-NG80A, Alfa-NG80W, Delta-DP140A, Delta-DP140W, Delta-DP30A, Delta-DP30W, Delta-DP45A, Delta-DP45W, Delta-DP60A, Delta-DP60W, Delta-DP80A, Delta-DP80W, Delta-DP90A, Delta-DP90W, Delta-NG110A, Delta-NG110W, Delta-NG150A, Delta-NG150W, Delta-NG30A, Delta-NG30W, Delta-NG35A, Delta-NG35W, Delta-NG45A, Delta-NG45W, Delta-NG60A, Delta-NG60W, Delta-NG80A, Delta-NG80W, Gala-DP140A, Gala-DP140W, Gala-DP20A, Gala-DP20W, Gala-DP30A, Gala-DP30W, Gala-DP40A, Gala-DP40W, Gala-DP55A, Gala-DP55W... (Other models you can see in the webshop)

## switches and momentary switches

### microswitches

#### lever actuated



|                |        |                 |        |
|----------------|--------|-----------------|--------|
| <b>GEV No.</b> | 345279 | <b>Ref. No.</b> | 100388 |
|----------------|--------|-----------------|--------|

**description** microswitch with lever 250V 6A 1CO connection male faston 6.3mm L 27mm L1 122mm ambient temperature max. 85°C mounting distance 22.5mm type U831604 actuating force: 12g

**For models:** Quasar-130CA, Quasar-130CW, Quasar-20CA, Quasar-20CW, Quasar-30CA, Quasar-30CW, Quasar-40CA, Quasar-40CW, Quasar-40SCA, Quasar-40SCW, Quasar-50CA, Quasar-50CW, Quasar-60CA, Quasar-60CW, Quasar-90CA, Quasar-90CW, Quasar-MQ200A, Quasar-MQ200W

#### roller-lever actuated

### microswitches



|                |        |                 |        |
|----------------|--------|-----------------|--------|
| <b>GEV No.</b> | 345276 | <b>Ref. No.</b> | 100387 |
|----------------|--------|-----------------|--------|

**description** microswitch with handle with a switch 250V 16A 1CO connection F6.3 L 33mm L1 28mm ambient temperature max. 125°C mounting distance 22.2mm actuating force: 190g black

**For models:** Quasar-130CA, Quasar-130CW, Quasar-20CA, Quasar-20CW, Quasar-30CA, Quasar-30CW, Quasar-40CA, Quasar-40CW, Quasar-40SCA, Quasar-40SCW, Quasar-50CA, Quasar-50CW, Quasar-60CA, Quasar-60CW, Quasar-90CA, Quasar-90CW, Quasar-MQ200A, Quasar-MQ200W

### accessories



|                |        |                 |        |
|----------------|--------|-----------------|--------|
| <b>GEV No.</b> | 345319 | <b>Ref. No.</b> | 100372 |
|----------------|--------|-----------------|--------|

**description** cover for microswitch mounting pos. left

**For models:** Quasar-130CA, Quasar-130CW, Quasar-20CA, Quasar-20CW, Quasar-30CA, Quasar-30CW, Quasar-40CA, Quasar-40CW, Quasar-40SCA, Quasar-40SCW, Quasar-50CA, Quasar-50CW, Quasar-60CA, Quasar-60CW, Quasar-90CA, Quasar-90CW, Quasar-MQ200A, Quasar-MQ200W



|                |        |                 |        |
|----------------|--------|-----------------|--------|
| <b>GEV No.</b> | 345318 | <b>Ref. No.</b> | 100371 |
|----------------|--------|-----------------|--------|

**description** cover for microswitch mounting pos. right

**For models:** Quasar-130CA, Quasar-130CW, Quasar-40SCA, Quasar-40SCW, Quasar-50CA, Quasar-50CW, Quasar-60CA, Quasar-60CW, Quasar-90CA, Quasar-90CW, Quasar-MQ200A, Quasar-MQ200W



## float switches

|   |  |                 |        |
|---|--|-----------------|--------|
|  |  |                 |        |
| 1   |  |                 |        |
| <b>GEV No.</b>  | 347672   | <b>Ref. No.</b> | 505423 |
| <b>description</b>  | float switch thread M12 1NO ø 30mm L 74mm mounting ø 12mm 250V 0.5A cable cable length 500mm   |                 |        |
| <b>For models:</b>  | IceQueen-IQ135A, IceQueen-IQ135W, IceQueen-IQ150A, IceQueen-IQ150W, IceQueen-IQ200A, IceQueen-IQ200W, IQ-45A, IQ-45W, IQ-85A, IQ-85W |                 |        |

|   |  |                 |        |
|---|--|-----------------|--------|
|  |  |                 |        |
| 1   |  |                 |        |
| <b>GEV No.</b>  | 345324   | <b>Ref. No.</b> | 105058 |
| <b>description</b>  | float switch 1CO ømm L 190mm mounting ømm 250V 6A male faston 6.3mm cable lengthmm   |                 |        |
| <b>For models:</b>  | Quasar-130CA, Quasar-130CW, Quasar-20CA, Quasar-20CW, Quasar-30CA, Quasar-30CW, Quasar-40CA, Quasar-40CW, Quasar-40SCA, Quasar-40SCW, Quasar-50CA, Quasar-50CW, Quasar-60CA, Quasar-60CW, Quasar-90CA, Quasar-90CW, Quasar-MQ200A, Quasar-MQ200W |                 |        |

## floats



|  |  |                 |        |
|--|--|-----------------|--------|
|  |  |                 |        |
| 1  |  |                 |        |
| <b>GEV No.</b>   | 695180   | <b>Ref. No.</b> | 105209 |
| <b>description</b>   | float without magnet ø 18.5mm L 85mm W 22mm H 40mm PVC   |                 |        |
| <b>For models:</b>   | Quasar-130CA, Quasar-130CW, Quasar-20CA, Quasar-20CW, Quasar-30CA, Quasar-30CW, Quasar-40CA, Quasar-40CW, Quasar-40SCA, Quasar-40SCW, Quasar-50CA, Quasar-50CW, Quasar-60CA, Quasar-60CW, Quasar-90CA, Quasar-90CW, Quasar-MQ200A, Quasar-MQ200W |                 |        |

## timers

## programme timers

|   |   |                 |       |
|---|---|-----------------|-------|
|  |   |                 |       |
| 1   |   |                 |       |
| <b>GEV No.</b>  | 360695  | <b>Ref. No.</b> | 4864C |
| <b>description</b>  | timer CDC 4902C1 engines 1 chambers 2 operation time 15min manif. no. 4902C10BER000.1000 motor type M48R 230V |                 |       |

|  |   |                 |      |
|--|---|-----------------|------|
|  |   |                 |      |
| 1  |   |                 |      |
| <b>GEV No.</b>   | 360628  | <b>Ref. No.</b> | 380C |
| <b>description</b>   | timer CDC 4902C1 engines 1 chambers 2 operation time 20min 230V shaft ømm shaft Lmm manif. no. 4902C10BGR000.1000 |                 |      |

|  |  |                 |        |
|--|--|-----------------|--------|
|  |  |                 |        |
| 1  |  |                 |        |
| <b>GEV No.</b>   | 360557   | <b>Ref. No.</b> | 304864 |
| <b>description</b>   | timer FIBER P19 engines 1 chambers 2 operation time 15min 230V shaft ømm shaft Lmm manif. no. P195JE2J730 motor type M51B-J0L6400 cable length 250mm voltage AC  |                 |        |
| <b>For models:</b>   | Alfa-NG110A, Alfa-NG110W, Alfa-NG150A, Alfa-NG150W, Alfa-NG35A, Alfa-NG35W, Alfa-NG45A, Alfa-NG45W, Alfa-NG60A, Alfa-NG60W, Alfa-NG80A, Alfa-NG80W, Delta-NG110A, Delta-NG110W, Delta-NG150A, Delta-NG150W, Delta-NG30A, Delta-NG30W, Delta-NG35A, Delta-NG35W, Delta-NG45A, Delta-NG45W, Delta-NG60A, Delta-NG60W, Delta-NG80A, Delta-NG80W, Gala-NG110A, Gala-NG110W, Gala-NG150A, Gala-NG150W, Gala-NG30A, Gala-NG30W, Gala-NG35A, Gala-NG35W, Gala-NG45A, Gala-NG45W, Gala-NG60A, Gala-NG60W, Gala-NG80A, Gala-NG80W, NG110A, NG110W, NG150A, NG150W, NG30A, NG30W, NG35A, NG35W, NG45A, NG45W...(Other models you can see in the webshop) |                 |        |
| <b>spare parts for</b>   | 360557   |                 |        |
|  |   | <b>GEV No.</b>  | 360674 |
|  |  | <b>Ref. No.</b> | —      |
|  | motor kit pinion ø 6.8mm teeth 15 230V voltage AC 50/60Hz turn direction counterclockwise motor ø 48mm H 18.5mm motor type UDS40NE1RNZ165 cable length 150mm with holder   |                 |        |

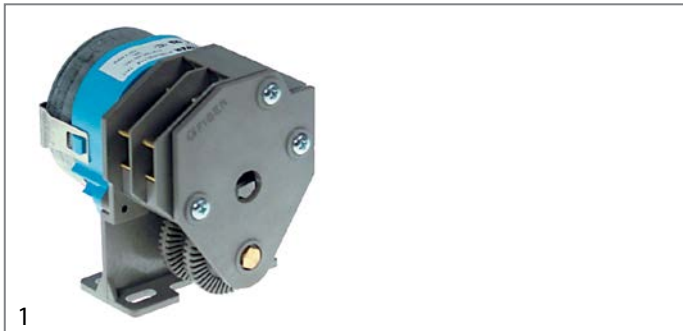

|                    |   |                 |        |
|--------------------|---|-----------------|--------|
| <b>GEV No.</b>     | 360082  | <b>Ref. No.</b> | 100380 |
| <b>description</b> | timer FIBER P19 engines 1 chambers 2 operation time 20min 230V shaft ømm shaft Lmm manuf. no. P195JE2L130   |                 |        |
| <b>For models:</b> | Alfa-NDP20A, Alfa-NDP20W, Alfa-NG110A, Alfa-NG110W, Alfa-NG150A, Alfa-NG150W, Alfa-NG35A, Alfa-NG35W, Alfa-NG45A, Alfa-NG45W, Alfa-NG60A, Alfa-NG60W, Alfa-NG80A, Alfa-NG80W, Delta-DP140A, Delta-DP140W, Delta-DP30A, Delta-DP30W, Delta-DP45A, Delta-DP45W, Delta-DP60A, Delta-DP60W, Delta-DP80A, Delta-DP80W, Delta-DP90A, Delta-DP90W, Delta-NG110A, Delta-NG110W, Delta-NG150A, Delta-NG150W, Delta-NG30A, Delta-NG30W, Delta-NG35A, Delta-NG35W, Delta-NG45A, Delta-NG45W, Delta-NG60A, Delta-NG60W, Delta-NG80A, Delta-NG80W, Gala-DP20A, Gala-DP20W, Gala-DP30A, Gala-DP30W, Gala-DP40A, Gala-DP40W, Gala-DP55A, Gala-DP55W, Gala-DP70A, Gala-DP70W... (Other models you can see in the webshop) |                 |        |

**contactors**

LS Industrial Systems

power contactors



|                    |  |                 |        |
|--------------------|--|-----------------|--------|
| <b>GEV No.</b>     | 381138   | <b>Ref. No.</b> | 300536 |
| <b>description</b> | contactor resistive load 20A 230VAC (AC3/400V) 9A/4kW main contacts 3NO auxiliary contacts 1NO connection screw connection type MC-9a  |                 |        |
| <b>For models:</b> | IceQueen-IQ1100A, IceQueen-IQ1100W, IceQueen-IQ135A, IceQueen-IQ135W, IceQueen-IQ150A, IceQueen-IQ150W, IceQueen-IQ200A, IceQueen-IQ200W, IceQueen-IQ400A, IceQueen-IQ400W, IceQueen-IQ550A, IceQueen-IQ550W, IQ1100, IQ135, IQ150, IQ200, IQ400, IQ550, Remote-IQ |                 |        |

overload switches



|                    |  |                 |      |
|--------------------|--|-----------------|------|
| <b>GEV No.</b>     | 381200   | <b>Ref. No.</b> | 1003 |
| <b>description</b> | motor protection circuit breaker setting range 1.6-2.5A type GTK-12M LS Industrial Systems |                 |      |
| <b>For models:</b> | IQ85A, IQ-85A, IQ85W, IQ-85W   |                 |      |

**relays**

time relays

time relays



|                    |  |                 |                          |
|--------------------|--|-----------------|--------------------------|
| <b>GEV No.</b>     | 381137   | <b>Ref. No.</b> | 201694<br>2471<br>302471 |
| <b>description</b> | time relay OMRON H3DS-XL time range 0.1s-120h 24-230V AC/DC 5mA-0.7A mounting measurements DIN railmm connection screw clamp   |                 |                          |
| <b>For models:</b> | IceQueen-IQ1100A, IceQueen-IQ1100W, IceQueen-IQ135A, IceQueen-IQ135W, IceQueen-IQ150A, IceQueen-IQ150W, IceQueen-IQ200A, IceQueen-IQ200W, IceQueen-IQ400A, IceQueen-IQ400W, IceQueen-IQ550A, IceQueen-IQ550W, IQ1100, IQ135, IQ150, IQ200, IQ400, IQ550, IQ85A, IQ-85A, IQ85W, IQ-85W, Remote-IQ |                 |                          |

**probes**

universal probes

temperature probes

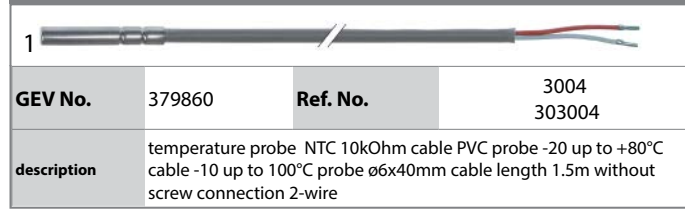

|                    |  |                 |                |
|--------------------|--|-----------------|----------------|
| <b>GEV No.</b>     | 379860   | <b>Ref. No.</b> | 3004<br>303004 |
| <b>description</b> | temperature probe NTC 10kOhm cable PVC probe -20 up to +80°C cable -10 up to 100°C probe ø6x40mm cable length 1.5m without screw connection 2-wire |                 |                |

**solenoid valves**

solenoid valves (water)

ELBI



|                    |  |                 |                             |
|--------------------|--|-----------------|-----------------------------|
| <b>GEV No.</b>     | 370186   | <b>Ref. No.</b> | 100329<br>329 (old version) |
| <b>description</b> | solenoid valve single straight 230VAC inlet 3/4" outlet 11.5mm input/min output 0.25l/min DN10 t.max. 90°C ELBI plastic flow regulating valve inlet pink   |                 |                             |
| <b>For models:</b> | Delta-DP140A, Delta-DP30A, Delta-DP45A, Delta-DP60A, Delta-DP80A, Delta-DP90A, Gala-DP20A, Gala-DP30A, Gala-DP40A, Gala-DP55A, Gala-DP70A, Pulsar-145A, Pulsar-15A, Pulsar-25A, Pulsar-35A, Pulsar-45A, Pulsar-65A, Pulsar-85A, Quasar-130CA, Quasar-20CA, Quasar-30CA, Quasar-40CA, Quasar-40SCA, Quasar-50CA, Quasar-60CA, Quasar-90CA, SuperStar-DP140A, SuperStar-DP45A, SuperStar-DP60A, SuperStar-DP80A, SuperStar-DP90A |                 |                             |

TP



|                    |  |                 |     |
|--------------------|--|-----------------|-----|
| <b>GEV No.</b>     | 370842   | <b>Ref. No.</b> | 329 |
| <b>description</b> | solenoid valve single straight 230VAC inlet 3/4" outlet 11.5mm input/min output 0.25l/min DN10 t.max. 90°C TP plastic flow regulating valve outlet green   |                 |     |
| <b>For models:</b> | Alfa-NG110A, Alfa-NG110W, Alfa-NG150A, Alfa-NG150W, Alfa-NG35A, Alfa-NG35W, Alfa-NG45A, Alfa-NG45W, Alfa-NG60A, Alfa-NG60W, Alfa-NG80A, Alfa-NG80W, Delta-NG110A, Delta-NG110W, Delta-NG150A, Delta-NG150W, Delta-NG35A, Delta-NG35W, Delta-NG45A, Delta-NG45W, Delta-NG60A, Delta-NG60W, Delta-NG80A, Delta-NG80W, Gala-NG110A, Gala-NG110W, Gala-NG150A, Gala-NG150W, Gala-NG35A, Gala-NG35W, Gala-NG40A, Gala-NG40W, Gala-NG45A, Gala-NG45W, Gala-NG55A, Gala-NG55W, Gala-NG60A, Gala-NG60W, Gala-NG70A, Gala-NG70W, Gala-NG80A, Gala-NG80W, Gala-NG90A, Gala-NG90W, NG110A, NG110W, NG150A, NG150W, NG35A, NG35W...(Other models you can see in the webshop) |                 |     |

solenoid valves with reducers



|                    |  |                 |        |
|--------------------|--|-----------------|--------|
| <b>GEV No.</b>     | 370471   | <b>Ref. No.</b> | 101233 |
| <b>description</b> | solenoid valve 4-fold straight 230VAC inlet 3/4" outlet 11.5mm t.max. 90°C TP plastic flow regulating valve inlet white flow regulating valve outlet A light blue flow regulating valve outlet B green flow regulating valve outlet C green flow regulating valve outlet D green |                 |        |
| <b>For models:</b> | Delta-DP90W, Quasar-MQ200W   |                 |        |



|                    |   |                 |        |
|--------------------|---|-----------------|--------|
| <b>GEV No.</b>     | 370187  | <b>Ref. No.</b> | 200928 |
| <b>description</b> | solenoid valve double straight 230VAC inlet 3/4" input 10l/min output ~3.4l/min DN10 t.max. 90°C TP plastic flow regulating valve inlet white outlet 11.5mm output B 3.4l/min flow regulating valve outlet B green output A w/t membrane (constantly open)                      |                 |        |
| <b>For models:</b> | Delta-DP140A, Delta-DP140W, Delta-DP90A, Gala-DP140A, Gala-DP140W, Gala-DP90A, MDP-150A, MDP-150W, Pulsar-MP145A, Pulsar-MP145W, Quasar-130CW, Quasar-50CW, Quasar-60CW, Quasar-90CW, Spika-111A, Spika-200, Spika-33A, Spika-400, Spika-55A, SuperStar-DP140A, SuperStar-DP90A |                 |        |



|                    |  |                 |        |
|--------------------|--|-----------------|--------|
| <b>GEV No.</b>     | 370188   | <b>Ref. No.</b> | 100404 |
| <b>description</b> | solenoid valve double straight 230VAC inlet 3/4" input 10l/min output 1/0.25l/min DN10 t.max. 90°C TP plastic flow regulating valve inlet white outlet 11.5mm output A blue/min output B green/min flow regulating valve outlet A light blue flow regulating valve outlet B green  |                 |        |
| <b>For models:</b> | Delta-DP30W, Delta-DP45W, Delta-DP60W, Delta-DP80W, Gala-DP20W, Gala-DP30W, Gala-DP40W, Gala-DP55W, Gala-DP70W, Pulsar-145W, Pulsar-15W, Pulsar-25W, Pulsar-35W, Pulsar-45W, Pulsar-65W, Pulsar-85W, Quasar-130CW, Quasar-20CW, Quasar-30CW, Quasar-40CW, Quasar-40SCW, Quasar-50CW, Quasar-60CW, Quasar-90CW, SuperStar-DP80W |                 |        |



|                    |  |                 |        |
|--------------------|--|-----------------|--------|
| <b>GEV No.</b>     | 370468   | <b>Ref. No.</b> | 100293 |
| <b>description</b> | solenoid valve double straight 230VAC inlet 3/4" input 10l/min output 3.4/3.4l/min DN10 t.max. 90°C TP plastic flow regulating valve inlet white outlet 11.5mm output A 3.4l/min output B 3.4l/min flow regulating valve outlet A green flow regulating valve outlet B green |                 |        |
| <b>For models:</b> | Delta-DP30A, Delta-DP45A, Delta-DP60A, Delta-DP80A, Quasar-MQ200A  |                 |        |





|                    |   |                 |      |
|--------------------|---|-----------------|------|
| <b>GEV No.</b>     | 370694  | <b>Ref. No.</b> | 1674 |
| <b>description</b> | solenoid valve double straight 230VAC inlet 3/4" TP plastic outlet 11.5mm output A 1l/min output B 1l/min flow regulating valve outlet A light blue flow regulating valve outlet B light blue |                 |      |
| <b>For models:</b> | Alfa-NDP20A, Alfa-NDP20W, Delta-NG30A, Delta-NG30W, Gala-NG30A, Gala-NG30W  |                 |      |



|                    |   |                 |        |
|--------------------|---|-----------------|--------|
| <b>GEV No.</b>     | 370339  | <b>Ref. No.</b> | 204541 |
| <b>description</b> | solenoid valve single angled 230VAC inlet 3/4" outlet 11.5mm output 1l/min t.max. 90°C TP plastic flow regulating valve outlet light blue |                 |        |



|  |  |                 |        |
|--|--|-----------------|--------|
|  <p>1</p> |  |                 |        |
| <b>GEV No.</b>   | 370635   | <b>Ref. No.</b> | 101913 |
| <b>description</b>   | solenoid valve triple straight 230VAC inlet 3/4" outlet 11.5mm input 10l/min output 3.4/1/3.4l/min DN10 t.max. 60°C TP flow regulating valve inlet white medium temp max. 20°C output A 3.4l/min output B 1l/min output C 3.4l/min flow regulating valve outlet A green flow regulating valve outlet B blue flow regulating valve outlet C green |                 |        |
| <b>For models:</b>   | Delta-DP30W, Delta-DP45W, Delta-DP60W, Delta-DP80W, Delta-DP90W  |                 |        |

|  |  |                 |        |
|--|--|-----------------|--------|
|  <p>1</p> |  |                 |        |
| <b>GEV No.</b>   | 370189   | <b>Ref. No.</b> | 101430 |
| <b>description</b>   | solenoid valve triple straight 230VAC inlet 3/4" outlet 11.5mm input 12l/min output 1/3.4/3.4l/min DN10 t.max. 90°C TP plastic flow regulating valve inlet dark blue output A 1l/min output B 3.4l/min output C 3.4l/min flow regulating valve outlet A light blue flow regulating valve outlet B green flow regulating valve outlet C green output A w/t membrane (constantly open) |                 |        |
| <b>For models:</b>   | Delta-DP140A, Delta-DP140W, Delta-DP90A, Delta-DP90W, Gala-DP90W, IceQueen-IQ1100A, IceQueen-IQ1100W, IceQueen-IQ135A, IceQueen-IQ135W, IceQueen-IQ150A, IceQueen-IQ150W, IceQueen-IQ200A, IceQueen-IQ200W, IceQueen-IQ400A, IceQueen-IQ400W, IceQueen-IQ550A, IceQueen-IQ550W, MDP-150A, MDP-150W, SuperStar-DP90W  |                 |        |

|  |   |                 |     |
|--|---|-----------------|-----|
|  <p>1</p> |   |                 |     |
| <b>GEV No.</b>   | 370752  | <b>Ref. No.</b> | 870 |
| <b>description</b>   | solenoid valve triple straight 230VAC inlet 3/4" outlet 11.5mm t.max. 90°C TP plastic flow regulating valve inlet white flow regulating valve outlet A dark green flow regulating valve outlet B light blue flow regulating valve outlet C dark green output A w/t membrane (constantly open) |                 |     |
| <b>For models:</b>   | Spika-33W, Spika-55W  |                 |     |

solenoid valves (refrigeration)

various

valve bodies

|   |  |                 |        |
|---|--|-----------------|--------|
|  <p>1</p> |  |                 |        |
| <b>GEV No.</b>  | 370191   | <b>Ref. No.</b> | 207459 |
| <b>description</b>  | solenoid valve body type CLS 2.5 connection 6mm soldering connection refrigeration angled 90°  |                 |        |
| <b>For models:</b>  | Delta-DP140A, Delta-DP140W, Delta-DP80A, Delta-DP80W, Delta-DP90A, Delta-DP90W, Gala-DP140A, Gala-DP140W, Gala-DP70A, Gala-DP70W, Gala-DP90A, Gala-DP90W, Pulsar-145A, Pulsar-145W, Pulsar-MP145A, Pulsar-MP145W, Quasar-130CA, Quasar-130CW, SuperStar-DP140A, SuperStar-DP80A, SuperStar-DP80W, SuperStar-DP90A, SuperStar-DP90W |                 |        |

|   |   |                 |        |
|---|---|-----------------|--------|
|  <p>1</p> |   |                 |        |
| <b>GEV No.</b>  | 370190  | <b>Ref. No.</b> | 207458 |
| <b>description</b>  | solenoid valve body type ILS 1.5 connection 6mm soldering connection refrigeration angled 90°   |                 |        |
| <b>For models:</b>  | Delta-DP30A, Delta-DP30W, Delta-DP45A, Delta-DP45W, Delta-DP60A, Delta-DP60W, Gala-DP20A, Gala-DP30A, Gala-DP40A, Gala-DP55A, IQ1100, IQ135, IQ150, IQ200, IQ400, IQ550 |                 |        |

|   |  |                 |        |
|---|--|-----------------|--------|
|  <p>1</p> |  |                 |        |
| <b>GEV No.</b>  | 370192   | <b>Ref. No.</b> | 207457 |
| <b>description</b>  | solenoid valve body type RLS 1.9 connection 6mm soldering connection refrigeration angled 90°  |                 |        |
| <b>For models:</b>  | Delta-DP30A, Delta-DP30W, Delta-DP45A, Delta-DP45W, Delta-DP60A, Delta-DP60W, Gala-DP20A, Gala-DP20W, Gala-DP30A, Gala-DP30W, Gala-DP40A, Gala-DP40W, Gala-DP55A, Gala-DP55W, Pulsar-15A, Pulsar-15W, Pulsar-25A, Pulsar-25W, Pulsar-35A, Pulsar-35W, Pulsar-45A, Pulsar-45W, Pulsar-65A, Pulsar-65W, Pulsar-85A, Pulsar-85W, Quasar-130CA, Quasar-130CW, Quasar-20CA, Quasar-20CW, Quasar-30CA, Quasar-30CW, Quasar-40CA, Quasar-40CW, Quasar-40SCA, Quasar-40SCW, Quasar-50CA, Quasar-50CW, Quasar-60CA, Quasar-60CW, Quasar-90CA, Quasar-90CW, Quasar-MQ200A, Quasar-MQ200W, Spika-111A, Spika-111W, Spika-33A, Spika-33W, Spika-55A, Spika-55W...(Other models you can see in the webshop) |                 |        |



spare parts and accessories

solenoid coils



|                    |   |                 |        |
|--------------------|---|-----------------|--------|
| <b>GEV No.</b>     | 371045  | <b>Ref. No.</b> | 105173 |
| <b>description</b> | solenoid coil 230V 50/60Hz PARKER type YB09 with cable  |                 |        |
| <b>For models:</b> | Alfa-NDP20A, Alfa-NDP20W, Alfa-NG110A, Alfa-NG110W, Alfa-NG150A, Alfa-NG150W, Alfa-NG35A, Alfa-NG35W, Alfa-NG45A, Alfa-NG45W, Alfa-NG60A, Alfa-NG60W, Alfa-NG80A, Alfa-NG80W, Delta-DP140A, Delta-DP140W, Delta-DP30A, Delta-DP30W, Delta-DP45A, Delta-DP45W, Delta-DP60A, Delta-DP60W, Delta-DP80A, Delta-DP80W, Delta-DP90A, Delta-DP90W, Delta-NG110A, Delta-NG110W, Delta-NG150A, Delta-NG150W, Delta-NG30A, Delta-NG30W, Delta-NG35A, Delta-NG35W, Delta-NG45A, Delta-NG45W, Delta-NG60A, Delta-NG60W, Delta-NG80A, Delta-NG80W, Gala-DP140A, Gala-DP140W, Gala-DP20A, Gala-DP20W, Gala-DP30A, Gala-DP30W, Gala-DP40A, Gala-DP40W, Gala-DP55A, Gala-DP55W... (Other models you can see in the webshop) |                 |        |



|                    |  |                 |        |
|--------------------|--|-----------------|--------|
| <b>GEV No.</b>     | 541855   | <b>Ref. No.</b> | 300424 |
| <b>description</b> | pressure control reset automatic HTB-3UC57   |                 |        |
| <b>For models:</b> | Quasar-130CA, Quasar-20CA, Quasar-30CA, Quasar-40CA, Quasar-40SCA, Quasar-50CA, Quasar-60CA, Quasar-90CA |                 |        |



|                    |  |                 |                |
|--------------------|--|-----------------|----------------|
| <b>GEV No.</b>     | 541112   | <b>Ref. No.</b> | 2507<br>302507 |
| <b>description</b> | pressure control reset automatic refrigeration type HTB-X3UC29 connection 7/16" UNF (1/4" SAE)   |                 |                |
| <b>For models:</b> | Alfa-NG110A, Alfa-NG110W, Alfa-NG150A, Alfa-NG150W, Alfa-NG35A, Alfa-NG35W, Alfa-NG45A, Alfa-NG45W, Alfa-NG60A, Alfa-NG60W, Alfa-NG80A, Alfa-NG80W, Delta-DP140A, Delta-DP140W, Delta-DP30A, Delta-DP30W, Delta-DP45A, Delta-DP45W, Delta-DP60A, Delta-DP60W, Delta-DP80A, Delta-DP80W, Delta-DP90A, Delta-DP90W, Delta-NG110A, Delta-NG110W, Delta-NG150A, Delta-NG150W, Delta-NG30A, Delta-NG30W, Delta-NG35A, Delta-NG35W, Delta-NG45A, Delta-NG45W, Delta-NG60A, Delta-NG60W, Delta-NG80A, Delta-NG80W, Gala-DP140A, Gala-DP140W, Gala-DP20A, Gala-DP20W, Gala-DP30A, Gala-DP30W, Gala-DP40A, Gala-DP40W, Gala-DP55A, Gala-DP55W, Gala-DP70A, Gala-DP70W...(Other models you can see in the webshop) |                 |                |

pressure switches

for refrigeration

DANFOSS



|                    |  |                 |        |
|--------------------|--|-----------------|--------|
| <b>GEV No.</b>     | 541861   | <b>Ref. No.</b> | 407393 |
| <b>description</b> | pressure control pressure connection 10mm hose connector type LCB-PA22                                 |                 |        |
| <b>For models:</b> | IceQueen-IQ1100A, IceQueen-IQ1100W, IceQueen-IQ400A, IceQueen-IQ400W, IceQueen-IQ550A, IceQueen-IQ550W |                 |        |

SAGI NO MIYA



|                    |  |                 |                |
|--------------------|--|-----------------|----------------|
| <b>GEV No.</b>     | 541113   | <b>Ref. No.</b> | 2683<br>302683 |
| <b>description</b> | pressure control HD reset automatic p max 30bar refrigeration type HTB-X326 connection 7/16" UNF (1/4" SAE) switch-off pressure 29.4bar switch-on pressure 24.5bar -20 to +70°C  |                 |                |
| <b>For models:</b> | Alfa-NG110A, Alfa-NG110W, Alfa-NG150A, Delta-NG110A, Delta-NG110W, Delta-NG150A, Gala-NG110A, Gala-NG110W, Gala-NG150A, Gala-NG90A, Gala-NG90W, MDP-150A, MDP-150W, NG110A, NG110W, NG150A, SuperStar-NG110A, SuperStar-NG110W, SuperStar-NG150A |                 |                |

miscellaneous



|                    |   |                 |        |
|--------------------|---|-----------------|--------|
| <b>GEV No.</b>     | 541118  | <b>Ref. No.</b> | 200334 |
| <b>description</b> | pressure control HD reset automatic type ACB-DBM2142 refrigeration -30 up to +85°C pressure connection soldering connection 6.35mm connection male faston 6.3mm   |                 |        |
| <b>For models:</b> | Delta-DP30A, Delta-DP30W, Delta-DP45A, Delta-DP45W, Gala-DP20A, Gala-DP20W, Gala-DP30A, Gala-DP30W, Gala-DP40A, Gala-DP40W, IQ1100, IQ135, IQ150, IQ200, IQ400, IQ550, IQ85A, IQ85W, Pulsar-15A, Pulsar-15W, Pulsar-25A, Pulsar-25W, Pulsar-35A, Pulsar-35W, Pulsar-45A, Pulsar-45W, Pulsar-65A, Pulsar-65W, Quasar-20CA, Quasar-20CW, Quasar-30CA, Quasar-30CW, Quasar-40CA, Quasar-40CW, Quasar-40SCA, Quasar-40SCW, Quasar-50CA, Quasar-50CW, Quasar-60CA, Quasar-60CW, Spika-33A, Spika-33W, Spika-55A, Spika-55W |                 |        |





|   |   |                 |        |
|---|---|-----------------|--------|
|  |   |                 |        |
| 1   |   |                 |        |
| <b>GEV No.</b>  | 541128  | <b>Ref. No.</b> | 300359 |
| <b>description</b>  | pressure control HD switch-off pressure 27bar switch-on pressure 17bar reset automatic type G63-H3076-000 refrigeration pressure connection soldering connectionmm connection male faston 6.3mm |                 |        |
| <b>For models:</b>  | Delta-DP60A, Delta-DP80A, Gala-DP55A, Gala-DP70A, Pulsar-145A, Pulsar-85A, Quasar-130CA, Quasar-90CA, Quasar-MQ200A, SuperStar-DP60A, SuperStar-DP80A   |                 |        |

|   |   |                 |                 |
|---|---|-----------------|-----------------|
|  |   |                 |                 |
| 2   |   |                 |                 |
| <b>GEV No.</b>  | 542434  | <b>Ref. No.</b> | 507476<br>7476E |
| <b>description</b>  | pressure control switch-off pressure 16bar switch-on pressure 18bar reset automatic type NSDHF10A00101 refrigeration -30 up to +85°C pressure connection soldering connection 6.35mmmm connection male faston 6.3mm |                 |                 |

|  |  |                 |                  |
|--|--|-----------------|------------------|
|  |  |                 |                  |
| 1  |  |                 |                  |
| <b>GEV No.</b>   | 605014   | <b>Ref. No.</b> | 300436<br>302033 |
| <b>description</b>   | compressor coolant R404a/R507 type ML80TB 220-240V 50Hz HMBP fully hermetic 11.4kg 3/8HP cylinder capacity 7.57cm <sup>3</sup> CSIR H 175.5mmW 261W 346W 446W 561W 691W 835W 993W 1167W test method ASHRAE ambient temperature max. 43°C |                 |                  |
| <b>For models:</b>   | Delta-DP45A, Delta-DP45W, Gala-DP40A, Gala-DP40W, Pulsar-45A, Pulsar-45W, Pulsar-65A, Pulsar-65W, Spika-55A, Spika-55W, SuperStar-DP45A  |                 |                  |

**compressors**

ACC/ZEL  
R404a/R507  
HMBP monophase  
*High/Medium evaporation temperature above -20/-15 °C*

|   |   |                 |                |
|---|---|-----------------|----------------|
|  |   |                 |                |
| 1   |   |                 |                |
| <b>GEV No.</b>  | 605020  | <b>Ref. No.</b> | 2030<br>302030 |
| <b>description</b>  | compressor coolant R404a/R507 type ML40TB 220-240V 50Hz HMBP fully hermetic 10kg 1/6HP cylinder capacity 4.04cm <sup>3</sup> CSIR H 175.5mmW 168W 218W 276W 342W 416W 499W 589W 688W test method ASHRAE |                 |                |
| <b>For models:</b>  | Pulsar-15A, Pulsar-15W, Pulsar-25A, Pulsar-25W, Quasar-20CA, Quasar-20CW, Quasar-30CA, Quasar-30CW  |                 |                |

|   |   |                 |                |
|---|---|-----------------|----------------|
|  |   |                 |                |
| 1   |   |                 |                |
| <b>GEV No.</b>  | 605028  | <b>Ref. No.</b> | 2034<br>302034 |
| <b>description</b>  | compressor coolant R404a/R507 type ML90TB 220-240V 50Hz HMBP fully hermetic 11.6kg 3/8HP cylinder capacity 8.85cm <sup>3</sup> CSIR H 175.5mmW 323W 418W 532W 666W 819W 990W 1181W 1391W test method ASHRAE ambient temperature max. 43°C |                 |                |
| <b>For models:</b>  | Delta-DP60A, Delta-DP60W, Gala-DP55A, Gala-DP55W, IQ135, IQ150, Quasar-90CA   |                 |                |

|  |  |                 |                |
|--|--|-----------------|----------------|
|  |  |                 |                |
| 1  |  |                 |                |
| <b>GEV No.</b>   | 605093   | <b>Ref. No.</b> | 2038<br>302038 |
| <b>description</b>   | compressor coolant R404a/R507 type MX21TB 220-240V 50Hz HMBP 17.5kg 1HP cylinder capacity 20.73cm <sup>3</sup> CSR H 221mmW 733W 813W 892W 970W 1046W 1121W 1195W 1268W test method ASHRAE ambient temperature max. 43°C |                 |                |
| <b>For models:</b>   | IQ400, Pulsar-MP145A, Pulsar-MP145W  |                 |                |



## CUBIGEL

R404a/R507

HMBP monophase

*High/Medium evaporation temperature above -20/-15 °C*

1

|                    |   |                 |                |
|--------------------|---|-----------------|----------------|
| <b>GEV No.</b>     | 605013  | <b>Ref. No.</b> | 2032<br>302032 |
| <b>description</b> | compressor coolant R404a/R507 type ML60TB 220-240V 50Hz HMBP fully hermetic 10.1kg 1/4HP power input 647W cylinder capacity 5.68cm <sup>3</sup> CSIR H 175.5mmW 244W 319W 407W 511W 628W 760W 906W 1067W test method ASHRAE |                 |                |



1

|                    |  |                 |                |
|--------------------|--|-----------------|----------------|
| <b>GEV No.</b>     | 605029   | <b>Ref. No.</b> | 2035<br>302035 |
| <b>description</b> | compressor coolant R404a/R507 type MP12RB 220-240V 50Hz HMBP fully hermetic 13.5kg 1/2HP cylinder capacity 12cm <sup>3</sup> CSR H 203.6mmW 561W 734W 933W 1157W 1407W 1681W 1982WW test method ASHRAE ambient temperature max. 43°C |                 |                |
| <b>For models:</b> | Delta-DP80A, Delta-DP80W, Gala-DP70A, Gala-DP70W, Quasar-130CA, Quasar-MQ200A, Quasar-MQ200W   |                 |                |

## accessories



1

|                    |  |                 |        |
|--------------------|--|-----------------|--------|
| <b>GEV No.</b>     | 380061   | <b>Ref. No.</b> | 202919 |
| <b>description</b> | start relay MTRP0027-31 120/240V voltage AC 8A 1NO                         |                 |        |
| <b>For models:</b> | Delta-DP30A, Delta-DP30W, Gala-DP30A, Gala-DP30W, Quasar-50CA, Quasar-60CA |                 |        |

## EMBRACO / ASPERA

R404a/R507

HMBP monophase

*High/Medium evaporation temperature above -20/-15 °C*

1

|                    |   |                 |      |
|--------------------|---|-----------------|------|
| <b>GEV No.</b>     | 605162  | <b>Ref. No.</b> | 6006 |
| <b>description</b> | compressor coolant R404a/R507 type NEK6181GK 220-240V 50Hz HMBP 10.4kg 1/4HP cylinder capacity 7.28cm <sup>3</sup> CSIR H 190mmWW 454W 533W 677W 826W 1000W 1198W 1422W |                 |      |

## L'UNITE HERMETIQUE / TECUMSEH

R404A

HMBP monophase

*High/Medium evaporation temperature above -20/-15 °C*

1

|   |  |                 |                 |                |
|---|--|-----------------|-----------------|----------------|
| <b>GEV No.</b>  | 605025   | <b>Ref. No.</b> | 2032<br>302032  |                |
| <b>description</b>  | compressor coolant R404A type AE4430Z-FZ 220-240V 50Hz HMBP fully hermetic 10.2kg 1/4HP power input 427W cylinder capacity 5.7cm <sup>3</sup> CSIR H 186mmWW 258W 346W 441W 550W 682W 794W test method EN 12900 908W |                 |                 |                |
| <b>For models:</b>  | Delta-DP30A, Delta-DP30W, Gala-DP30A, Gala-DP30W, Quasar-50CA, Quasar-60CA   |                 |                 |                |
| <b>spare parts for</b>  | 605025   |                 |                 |                |
|  | <b>GEV No.</b>   | 380061          | <b>Ref. No.</b> | 202919<br>2919 |
| start relay MTRP0027-31 120/240V voltage AC 8A 1NO                                  |  |                 |                 |                |



|                    |  |                 |                |
|--------------------|--|-----------------|----------------|
| 1                  |  |                 |                |
| <b>GEV No.</b>     | 605023   | <b>Ref. No.</b> | 300437<br>8437 |
| <b>description</b> | compressor coolant R404A type AE4450Z 220-240V 50Hz HMBP fully hermetic 12.5kg 3/8HP cylinder capacity 8.85cm <sup>3</sup> CSIR H 207mmWW 434W 567W 734W 927W 1270W 1367W test method EN 12900 1729W   |                 |                |
| <b>For models:</b> | Alfa-NG60A, Alfa-NG60W, Delta-DP60A, Delta-DP60W, Delta-NG60A, Delta-NG60W, Gala-DP55A, Gala-DP55W, Gala-NG55A, Gala-NG55W, Gala-NG60A, Gala-NG60W, IceQueen-IQ135A, IceQueen-IQ135W, IceQueen-IQ150A, IceQueen-IQ150W, IQ135, IQ150, NG60A, NG60W, Pulsar-85A, Pulsar-85W, Quasar-90CA, Quasar-90CW, SuperStar-NG60A, SuperStar-NG60W |                 |                |



|                    |  |                 |             |
|--------------------|--|-----------------|-------------|
| 1                  |  |                 |             |
| <b>GEV No.</b>     | 605022   | <b>Ref. No.</b> | 436<br>8436 |
| <b>description</b> | compressor coolant R404A type AEZ4440Z 230V 50Hz HMBP fully hermetic 21kg cylinder capacity 7.55cm <sup>3</sup> CSIR H 292mm 415W 517W 637W 772W 919W 1074W test method EN 12900 1234W |                 |             |
| <b>For models:</b> | Alfa-NG45A, Alfa-NG45W, Delta-NG45A, Delta-NG45W, Gala-NG40A, Gala-NG45A, Gala-NG45W, NG45A, NG45W, SuperStar-NG45A, SuperStar-NG45W   |                 |             |



|                    |  |                 |                                  |
|--------------------|--|-----------------|----------------------------------|
| 1                  |  |                 |                                  |
| <b>GEV No.</b>     | 605021   | <b>Ref. No.</b> | 2031<br>220434<br>302031<br>8434 |
| <b>description</b> | compressor coolant R404A type AEZ4425Z 220-240V 50Hz HMBP fully hermetic 9.8kg 1/5HP cylinder capacity 4.5cm <sup>3</sup> CSIR H 186mmWW 198W 263W 341W 432W 537W 629W test method EN 12900 723W |                 |                                  |
| <b>For models:</b> | Alfa-NDP20A, Alfa-NDP20W, Gala-DP20A, Gala-DP20W, Pulsar-35A, Pulsar-35W, Quasar-40CA, Quasar-40CW, Quasar-40SCA, Quasar-40SCW   |                 |                                  |



|                    |  |                 |        |
|--------------------|--|-----------------|--------|
| 1                  |  |                 |        |
| <b>GEV No.</b>     | 605015   | <b>Ref. No.</b> | 300438 |
| <b>description</b> | compressor coolant R404A type CAE9470Z 220-240V 50Hz HMBP fully hermetic 13.7kg 1/2HP cylinder capacity 13.3cm <sup>3</sup> CSR H 207mmWW 549W 711W 897W 1110W 1356W 1637W 1960W test method EN 12900 2327W  |                 |        |
| <b>For models:</b> | Alfa-NG80A, Alfa-NG80W, Delta-DP80A, Delta-DP80W, Delta-NG80A, Delta-NG80W, Gala-DP70W, Gala-NG70A, Gala-NG70W, Gala-NG80A, Gala-NG80W, IceQueen-IQ200A, IceQueen-IQ200W, IQ200, NG80A, NG80W, Pulsar-145A, Pulsar-145W, Quasar-130CA, Quasar-130CW, Quasar-MQ200A, Quasar-MQ200W, Spika-111A, Spika-111W, SuperStar-DP80A, SuperStar-NG80A, SuperStar-NG80W |                 |        |



|                    |  |                 |                       |
|--------------------|--|-----------------|-----------------------|
| <b>GEV No.</b>     | 605027   | <b>Ref. No.</b> | 2039<br>302039<br>441 |
| <b>description</b> | compressor coolant R404A type CAJ4517Z 220-240V 50Hz HMBP fully hermetic 24kg 1.2HP cylinder capacity 25.95cm <sup>3</sup> CSR H 282mm WW 1588W 1987W 2451W 2971W 3536W 4132W test method EN 12900 4742W                                       |                 |                       |
| <b>For models:</b> | Alfa-NG150A, Alfa-NG150W, Delta-DP140A, Delta-DP140W, Delta-NG150A, Delta-NG150W, Gala-DP140A, Gala-DP140W, Gala-NG150A, Gala-NG150W, IceQueen-IQ400A, IceQueen-IQ400W, MDP-150A, MDP-150W, NG150A, NG150W, SuperStar-NG150A, SuperStar-NG150W |                 |                       |



|                    |  |                 |                          |
|--------------------|--|-----------------|--------------------------|
| <b>GEV No.</b>     | 605032   | <b>Ref. No.</b> | 2037<br>300439<br>302037 |
| <b>description</b> | compressor coolant R404A type CAJ9510Z 220-240V 50Hz HMBP fully hermetic 23kg 1HP cylinder capacity 18.3cm <sup>3</sup> CSR H 282mm 527W 732W 970W 1252W 1583W 1972W 2437W 2826W test method EN 12900 3220W  |                 |                          |
| <b>For models:</b> | Alfa-NG110A, Alfa-NG110W, Delta-DP90A, Delta-DP90W, Delta-NG110A, Delta-NG110W, Gala-DP90A, Gala-DP90W, Gala-NG110A, Gala-NG110W, Gala-NG90A, Gala-NG90W, NG110A, NG110W, Pulsar-MP145A, Pulsar-MP145W, SuperStar-DP90A, SuperStar-DP90W, SuperStar-NG110A, SuperStar-NG110W |                 |                          |

accessories

overload protector (klixon)

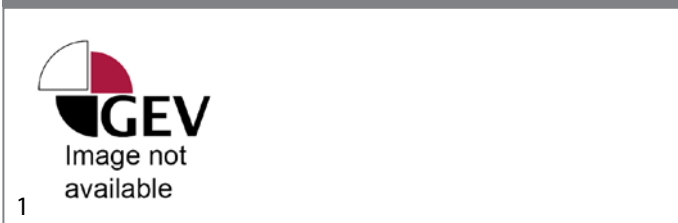

|                    |  |                 |        |
|--------------------|--|-----------------|--------|
| <b>GEV No.</b>     | 390388   | <b>Ref. No.</b> | 202928 |
| <b>description</b> | klixon type DP90   |                 |        |
| <b>For models:</b> | Delta-DP90A, Delta-DP90W, Gala-DP90A, Gala-DP90W, Pulsar-MP145A, Pulsar-MP145W |                 |        |

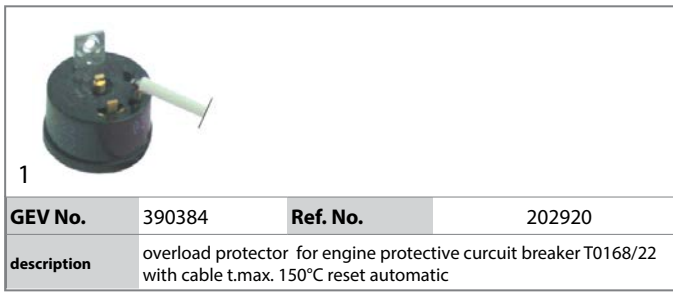

|                    |   |                 |        |
|--------------------|---|-----------------|--------|
| <b>GEV No.</b>     | 390384  | <b>Ref. No.</b> | 202920 |
| <b>description</b> | overload protector for engine protective circuit breaker T0168/22 with cable t.max. 150°C reset automatic |                 |        |

|                    |  |                 |        |
|--------------------|--|-----------------|--------|
| <b>GEV No.</b>     | 390544   | <b>Ref. No.</b> | 202920 |
| <b>description</b> | overload protector for engine protective circuit breaker T0168/22 with cable t.max. 150°C reset automatic  |                 |        |
| <b>For models:</b> | Alfa-NG35A, Alfa-NG35W, Alfa-NG45A, Alfa-NG45W, Delta-DP30A, Delta-DP30W, Delta-NG35A, Delta-NG35W, Delta-NG45A, Delta-NG45W, Gala-DP30A, Gala-DP30W, Gala-NG35A, Gala-NG35W, Gala-NG40A, Gala-NG40W, Gala-NG45A, Gala-NG45W, IQ85A, IQ-85A, IQ85W, IQ-85W, NG35A, NG35W, NG45A, NG45W, Quasar-50CA, Quasar-60CA, SuperStar-NG45A, SuperStar-NG45W |                 |        |

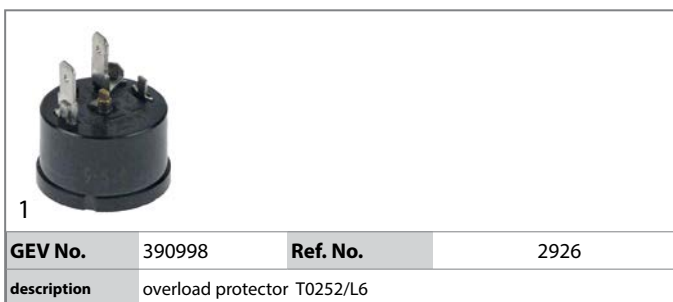

|                    |                             |                 |      |
|--------------------|-----------------------------|-----------------|------|
| <b>GEV No.</b>     | 390998                      | <b>Ref. No.</b> | 2926 |
| <b>description</b> | overload protector T0252/L6 |                 |      |



# fans

## refrigeration fans

### refrigeration motors universal

#### accessories

#### fan wheels

#### aluminium

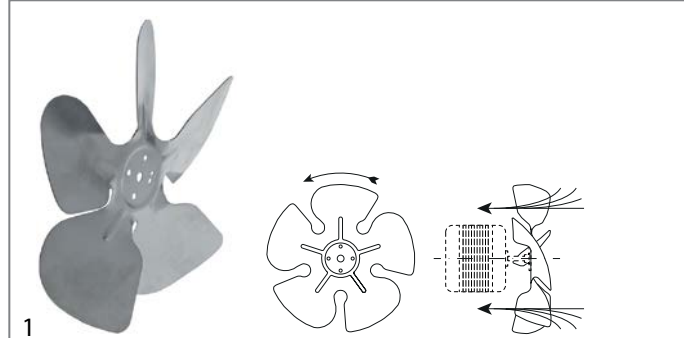

|                    |   |                 |        |
|--------------------|---|-----------------|--------|
| <b>GEV No.</b>     | 601070  | <b>Ref. No.</b> | 204040 |
| <b>description</b> | fan wheel sucking ø 200mm fan wheel mounting 25.4mm blade angle 28° W 38mm aluminium  |                 |        |
| <b>For models:</b> | Alfa-NG110A, Alfa-NG110W, Alfa-NG150A, Alfa-NG35W, Alfa-NG45W, Alfa-NG60W, Alfa-NG80A, Alfa-NG80W, Delta-NG110A, Delta-NG110W, Delta-NG150A, Delta-NG35W, Delta-NG45W, Delta-NG60W, Delta-NG80A, Delta-NG80W, Gala-NG110A, Gala-NG110W, Gala-NG150A, Gala-NG35W, Gala-NG45W, Gala-NG60W, Gala-NG80A, Gala-NG80W, Gala-NG90A, NG110A, SuperStar-NG110A, SuperStar-NG110W, SuperStar-NG150A, SuperStar-NG45W, SuperStar-NG60W, SuperStar-NG80A, SuperStar-NG80W |                 |        |

## cooling motors (complete)



|                    |   |                 |        |
|--------------------|---|-----------------|--------|
| <b>GEV No.</b>     | 601392  | <b>Ref. No.</b> | 240960 |
| <b>description</b> | fan 230V 10W 50/60Hz fan wheel ø 200mm shaft L 20mm feet depth 58mm L 66mm W 83mm H 83mm blade angle 28° connection cable 500mm |                 |        |
| <b>For models:</b> | Delta-DP30A, Gala-DP30A, Spika-33A  |                 |        |



|                    |   |                 |                         |
|--------------------|---|-----------------|-------------------------|
| <b>GEV No.</b>     | 601390  | <b>Ref. No.</b> | 200445<br>200445+404495 |
| <b>description</b> | fan 230V 10W 50/60Hz fan wheel ø 254mm shaft L 14mm feet depth 85mm L 67mm W 83mm H 83mm blade angle 22° connection cable 500mm   |                 |                         |
| <b>For models:</b> | IceQueen-IQ135A, IceQueen-IQ150A, IceQueen-IQ200A, IQ135, IQ150, IQ200, Pulsar-145A, Pulsar-45A, Pulsar-MP401A, Pulsar-MP801A, Quasar-130CA, Quasar-90CA, Quasar-MQ200A |                 |                         |

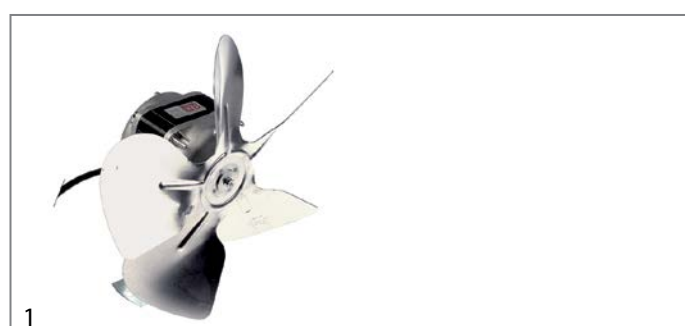



|                    |   |                 |                         |
|--------------------|---|-----------------|-------------------------|
| <b>GEV No.</b>     | 601391  | <b>Ref. No.</b> | 200410<br>200410+504994 |
| <b>description</b> | fan 230V 16W 50/60Hz fan wheel ø 254mm shaft L 16mm feet depth 83mm L 77mm W 83mm H 83mm blade angle 34° connection cable 500mm |                 |                         |
| <b>For models:</b> | IceQueen-IQ200A   |                 |                         |



|                    |  |                 |        |
|--------------------|--|-----------------|--------|
| <b>GEV No.</b>     | 601389   | <b>Ref. No.</b> | 202170 |
| <b>description</b> | fan 230V 5W 50/60Hz fan wheel ø 172mm shaft L 20mm feet depth 53mm L 60mm W 83mm H 83mm blade angle 22° connection cable 500mm   |                 |        |
| <b>For models:</b> | Alfa-NDP20A, Alfa-NG35W, Alfa-NG45W, Delta-NG30W, Delta-NG35W, Delta-NG45W, Gala-DP20A, Gala-DP20W, Gala-NG30W, Gala-NG35W, Gala-NG45W, IQ-45A, IQ-45W, NG30W, SuperStar-NG45W |                 |        |



|   |   |                 |        |
|---|---|-----------------|--------|
|  |   |                 |        |
| 1   |   |                 |        |
| <b>GEV No.</b>  | 601393  | <b>Ref. No.</b> | 200443 |
| <b>description</b>  | fan 230V 5W 50/60Hz fan wheel ø 200mm shaft L 12mm feet depth 58mm L 60mm W 83mm H 83mm blade angle 28°   |                 |        |
| <b>For models:</b>  | Alfa-NG35W, Alfa-NG45W, Delta-DP30W, Delta-DP45W, Delta-NG35W, Delta-NG45W, Gala-DP30W, Gala-DP40W, Gala-NG35W, Gala-NG45W, NG35W, NG45W, Pulsar-15A, Pulsar-15W, Pulsar-25A, Pulsar-25W, Pulsar-35A, Pulsar-35W, Quasar-20CA, Quasar-30CA, Quasar-40CA, SuperStar-DP45W, SuperStar-NG45W |                 |        |

|   |   |                 |                       |
|---|---|-----------------|-----------------------|
|  |   |                 |                       |
| 1   |   |                 |                       |
| <b>GEV No.</b>  | 601394  | <b>Ref. No.</b> | 200444<br>200444+4040 |
| <b>description</b>  | fan 230V 5W 50/60Hz fan wheel ø 200mm shaft L 12mm feet depth 71mm L 60mm W 83mm H 83mm blade angle 28° connection cable 500mm  |                 |                       |
| <b>For models:</b>  | Alfa-NG110A, Alfa-NG110W, Alfa-NG150A, Alfa-NG60W, Alfa-NG80A, Alfa-NG80W, Delta-DP60W, Delta-DP80A, Delta-DP80W, Delta-DP90A, Delta-DP90W, Delta-NG110A, Delta-NG110W, Delta-NG150A, Delta-NG60W, Delta-NG80A, Delta-NG80W, Gala-DP55W, Gala-DP70A, Gala-DP70W, Gala-DP90A, Gala-DP90W, Gala-NG110A, Gala-NG110W, Gala-NG150A, Gala-NG55W, Gala-NG60W, Gala-NG70A, Gala-NG70W, Gala-NG80A, Gala-NG80W, Gala-NG90W, IceQueen-IQ1100W, IceQueen-IQ135W, IceQueen-IQ150W, IceQueen-IQ200W, IceQueen-IQ400W, IceQueen-IQ550W, IQ85A, IQ-85A, IQ85W, IQ-85W, NG110A, NG110W, NG150A, NG60W, NG80A, NG80W, Pulsar-145W, Pulsar-45W...(Other models you can see in the webshop) |                 |                       |

## motors

### gear motors

#### for ice-cube maker

#### for paddles

|   |  |                 |                         |
|---|--|-----------------|-------------------------|
|  |  |                 |                         |
| 1   |  |                 |                         |
| <b>GEV No.</b>  | 499180   | <b>Ref. No.</b> | 212<br>300212<br>306486 |
| <b>description</b>  | gear motor 180W 220V H 155mm L 307mm W 145mm from serial no. 2983092 type MM063-84 ELMOR 50Hz 1300rpm shaft ø 19mm |                 |                         |
| <b>For models:</b>  | IQ85A, IQ-85A, IQ85W, IQ-85W   |                 |                         |

|  |  |                 |        |
|--|--|-----------------|--------|
|  |  |                 |        |
| 1  |  |                 |        |
| <b>GEV No.</b>   | 500792   | <b>Ref. No.</b> | 105291 |
| <b>description</b>   | gear motor 230V H 70mm L 69mm W 69mm KELVIN 50Hz shaft ø 6mm   |                 |        |
| <b>For models:</b>   | Quasar-130CA, Quasar-130CW, Quasar-40SCA, Quasar-40SCW, Quasar-50CA, Quasar-50CW, Quasar-60CA, Quasar-60CW, Quasar-90CA, Quasar-90CW, Quasar-MQ200A, Quasar-MQ200W |                 |        |

|  |   |                 |                  |
|--|---|-----------------|------------------|
|  |   |                 |                  |
| 1  |   |                 |                  |
| <b>GEV No.</b>   | 500422  | <b>Ref. No.</b> | 105364<br>ITV794 |
| <b>description</b>   | gear motor ITV type MT6b-GB5FS 3.5W 230V 50Hz 30rpm shaft ø 6mm L 64mm W 51mm H 40mm for ice-cube maker |                 |                  |
| <b>For models:</b>   | Quasar-20CA, Quasar-20CW, Quasar-30CA, Quasar-30CW, Quasar-40CA, Quasar-40CW                            |                 |                  |

|  |  |                 |        |
|--|--|-----------------|--------|
|  |  |                 |        |
| 1  |  |                 |        |
| <b>GEV No.</b>   | 500424   | <b>Ref. No.</b> | 205201 |
| <b>description</b>   | gear motor KELVIN type K15 230V 50Hz shaft ø 6mm L 178mm W 75mm H 95mm for ice-cube maker with housing   |                 |        |
| <b>For models:</b>   | Quasar-130CA, Quasar-130CW, Quasar-40SCA, Quasar-40SCW, Quasar-50CA, Quasar-50CW, Quasar-60CA, Quasar-60CW, Quasar-90CA, Quasar-90CW, Quasar-MQ200A, Quasar-MQ200W |                 |        |

for sumps



1

|   |  |                 |                       |
|---|--|-----------------|-----------------------|
| <b>GEV No.</b>  | 500425   | <b>Ref. No.</b> | 105200                |
| <b>description</b>  | gear motor 230V 50Hz shaft ø 10mm W 115mm H 100mm tilting motor complete incl. fastening plate L 125mm   |                 |                       |
| <b>For models:</b>  | Quasar-130CA, Quasar-130CW, Quasar-40SCA, Quasar-40SCW, Quasar-50CA, Quasar-50CW, Quasar-60CA, Quasar-60CW, Quasar-90CA, Quasar-90CW, Quasar-MQ200A, Quasar-MQ200W |                 |                       |
| <b>spare parts for</b>  | 500425   |                 |                       |
|   | <b>GEV No.</b>   | <b>Ref. No.</b> | 202<br>205202<br>5202 |
|  | 694257   |                 |                       |
| disc for pan tilting ø 92mm shaft intake ø 8x7mm shaft ø 10 shaft length 15mm     |  |                 |                       |



1

|                    |   |                 |                             |
|--------------------|---|-----------------|-----------------------------|
| <b>GEV No.</b>     | 500423  | <b>Ref. No.</b> | 105363<br>5363+254<br>5363K |
| <b>description</b> | gear motor CROUZET type 80336505 3.5W 230V 50Hz shaft ø 10mm W 110mm H 85mm L 130mm |                 |                             |
| <b>For models:</b> | Quasar-20CA, Quasar-20CW, Quasar-30CA, Quasar-30CW, Quasar-40CA, Quasar-40CW        |                 |                             |

miscellaneous



1

|                    |  |                 |        |
|--------------------|--|-----------------|--------|
| <b>GEV No.</b>     | 499181   | <b>Ref. No.</b> | 207596 |
| <b>description</b> | gear motor LENZE type GSS05-2M HAR071C32 400/480V voltage AC 50/60/87Hz 1410/1710/2520rpm shaft ø 32mm L 415mm W 180mm H 210mm for ice maker 370/450/660W 0.37/0.45/0.66kW |                 |        |



1

|                    |   |                 |        |
|--------------------|---|-----------------|--------|
| <b>GEV No.</b>     | 499175  | <b>Ref. No.</b> | 203201 |
| <b>description</b> | gear motor ROSSI type HBM 63C 230V voltage AC 50Hz shaft ø 24mm L 350mm W 190mm H 160mm for flake ice maker 180W          |                 |        |
| <b>For models:</b> | IceQueen-IQ135A, IceQueen-IQ135W, IceQueen-IQ150A, IceQueen-IQ150W, IceQueen-IQ200A, IceQueen-IQ200W, IQ135, IQ150, IQ200 |                 |        |

motors

for ice-cube maker

complete





1

|  |   |                 |                |
|--|---|-----------------|----------------|
| <b>GEV No.</b>   | 499183  | <b>Ref. No.</b> | 105261         |
| <b>description</b>   | motor for ice maker with holder 115W 220V 50/60Hz 1 phase shaft ø 7mm 1390/1600rpm type RM63/50 ø 93mm REBO 0.115kW |                 |                |
| <b>For models:</b>   | Pulsar-45W  |                 |                |
| <b>spare parts for</b>   | 499183  |                 |                |
|  | <b>GEV No.</b>  | <b>Ref. No.</b> | 205260<br>5260 |
|                                 | 500793  |                 |                |
| motor with belt pulley 120W 230V 50/60Hz 1 phase shaft ø 10mm 1390/1600rpm type RM63/50 ø 90mm H 160mm REBO 0.12kW |   |                 |                |



1

|                    |   |                 |        |
|--------------------|---|-----------------|--------|
| <b>GEV No.</b>     | 499182  | <b>Ref. No.</b> | 205262 |
| <b>description</b> | motor for ice maker with holder 180W 230V 50Hz 1 phase shaft ø 10mm 1300rpm type 3RGM 85-40/1 H 275mm ELCO 0.18kW |                 |        |
| <b>For models:</b> | Pulsar-145A, Pulsar-145W, Pulsar-65A, Pulsar-65W, Pulsar-85A, Pulsar-85W  |                 |        |

|   |   |                 |                               |
|---|---|-----------------|-------------------------------|
|  |   |                 |                               |
| 1   |   |                 |                               |
| <b>GEV No.</b>  | 500793  | <b>Ref. No.</b> | 205260                        |
| <b>description</b>  | motor with belt pulley 120W 230V 50/60Hz 1 phase shaft ø 10mm 1390/1600rpm type RM63/50 ø 90mm H 160mm REBO 0.12kW                          |                 |                               |
| <b>For models:</b>  | Pulsar-15A, Pulsar-15W, Pulsar-25A, Pulsar-25W, Pulsar-35A, Pulsar-35W, Pulsar-45A, Pulsar-45W  |                 |                               |
| <b>spare parts for</b>  | 500793  |                 |                               |
|  | <b>GEV No.</b>  | 695279          | <b>Ref. No.</b> 110607<br>607 |
|   | round belt pulley disc ø 49mm single shaft intake ø 10mm groove depth 5mm disc width 12mm groove width 10mm overall width 19mm shaft ø 18mm |                 |                               |

## pumps

### drain pumps

#### GRE

|  |  |                 |      |
|--|--|-----------------|------|
|  |  |                 |      |
| 1  |  |                 |      |
| <b>GEV No.</b>   | 499323   | <b>Ref. No.</b> | 4556 |
| <b>description</b>   | pump inlet ø 23mm outlet ø 24mm 190W 230V 50Hz GRE |                 |      |

|   |  |                 |        |
|---|--|-----------------|--------|
|  |  |                 |        |
| 1   |  |                 |        |
| <b>GEV No.</b>  | 499178   | <b>Ref. No.</b> | 204556 |
| <b>description</b>  | pump inlet ø 24mm outlet ø 24mm 190W 230V 50Hz GRE |                 |        |

## HANNING

|  |  |                 |        |
|--|--|-----------------|--------|
|  |  |                 |        |
| 1  |  |                 |        |
| <b>GEV No.</b>   | 499179   | <b>Ref. No.</b> | 304769 |
| <b>description</b>   | drain pump 30W 220-240V inlet ø 24mm outlet ø 24mm 50Hz type DPN25-347 HANNING |                 |        |
| <b>For models:</b>   | Alfa-NDP20A, Alfa-NDP20W, Delta-NG30A, Delta-NG30W, Gala-NG30A, Gala-NG30W     |                 |        |

## service kits

|  |   |                 |       |
|--|---|-----------------|-------|
|  |   |                 |       |
| 1  |   |                 |       |
| <b>GEV No.</b>   | 499337  | <b>Ref. No.</b> | 8687K |
| <b>description</b>   | drain pump 40W 220-240V inlet ø 24mm outlet ø 24mm 50Hz HANNING |                 |       |

## pumps for ice machines

|  |  |                 |        |
|--|--|-----------------|--------|
|  |  |                 |        |
| 1  |  |                 |        |
| <b>GEV No.</b>   | 500223   | <b>Ref. No.</b> | 205125 |
| <b>description</b>   | pump COPREL type DP20-30 35W 230V 50/60Hz outlet ø 17mm L 85mm rotation direction left for ice-cube maker  |                 |        |
| <b>For models:</b>   | Delta-DP30A, Delta-DP30W, Gala-DP20A, Gala-DP20W, Gala-DP30A, Gala-DP30W, IceQueen-IQ135A, IceQueen-IQ135W, IceQueen-IQ150A, IceQueen-IQ150W, IceQueen-IQ200A, IceQueen-IQ200W |                 |        |





1

|                    |  |                 |               |
|--------------------|--|-----------------|---------------|
| <b>GEV No.</b>     | 500974   | <b>Ref. No.</b> | 113<br>205113 |
| <b>description</b> | pump COPREL type DP40-55-60-70-80 50W 230V 50/60Hz outlet ø 17mm L 110mm rotation direction left for ice-cube maker  |                 |               |
| <b>For models:</b> | Alfa-NG110A, Alfa-NG110W, Alfa-NG150A, Alfa-NG150W, Alfa-NG35A, Alfa-NG35W, Alfa-NG45A, Alfa-NG45W, Alfa-NG60A, Alfa-NG60W, Alfa-NG80A, Alfa-NG80W, Delta-DP60A, Delta-DP60W, Delta-DP80A, Delta-DP80W, Delta-NG110A, Delta-NG110W, Delta-NG150A, Delta-NG150W, Delta-NG30A, Delta-NG30W, Delta-NG35A, Delta-NG35W, Delta-NG45A, Delta-NG45W, Delta-NG60A, Delta-NG60W, Delta-NG80A, Delta-NG80W, Gala-DP55A, Gala-DP55W, Gala-DP70A, Gala-DP70W, Gala-NG110A, Gala-NG110W, Gala-NG150A, Gala-NG150W, Gala-NG30A, Gala-NG30W, Gala-NG35A, Gala-NG35W, Gala-NG40A, Gala-NG40W, Gala-NG45A, Gala-NG45W, Gala-NG55A, Gala-NG55W, Gala-NG60A, Gala-NG60W...(Other models you can see in the webshop) |                 |               |



2

|                    |  |                 |      |
|--------------------|--|-----------------|------|
| <b>GEV No.</b>     | 499172   | <b>Ref. No.</b> | 5405 |
| <b>description</b> | pump COPREL type NG Gala DP80 50W 230V 50/60Hz inlet ø 20mm outlet ø 17mm L 125mm rotation direction right for ice-cube maker                    |                 |      |
| <b>For models:</b> | Alfa-NG80A, Alfa-NG80W, Delta-NG80A, Delta-NG80W, Gala-NG70A, Gala-NG70W, Gala-NG80A, Gala-NG80W, NG80A, NG80W, SuperStar-NG80A, SuperStar-NG80W |                 |      |



1

|                    |  |                 |        |
|--------------------|--|-----------------|--------|
| <b>GEV No.</b>     | 499177   | <b>Ref. No.</b> | 505494 |
| <b>description</b> | pump COPREL type NG Gala DP90 52W 230V 50Hz inlet ø 20mm outlet ø 17mm L 124mm rotation direction right for ice-cube maker capacitor 2µF                   |                 |        |
| <b>For models:</b> | Alfa-NG110A, Alfa-NG110W, Delta-NG110A, Delta-NG110W, Gala-NG110A, Gala-NG110W, Gala-NG90A, Gala-NG90W, NG110A, NG110W, SuperStar-NG110A, SuperStar-NG110W |                 |        |



1

|                    |   |                 |        |
|--------------------|---|-----------------|--------|
| <b>GEV No.</b>     | 499174  | <b>Ref. No.</b> | 105563 |
| <b>description</b> | pump COPREL type NG55 Girada 50W 230V 50/60Hz inlet ø 20mm outlet ø 17mm L 125mm rotation direction right for ice-cube maker  |                 |        |
| <b>For models:</b> | Alfa-NG35A, Alfa-NG35W, Alfa-NG45A, Alfa-NG45W, Alfa-NG60A, Alfa-NG60W, Delta-NG35A, Delta-NG35W, Delta-NG45A, Delta-NG45W, Delta-NG60A, Delta-NG60W, Gala-NG35A, Gala-NG35W, Gala-NG40A, Gala-NG40W, Gala-NG45A, Gala-NG45W, Gala-NG55A, Gala-NG55W, Gala-NG60A, Gala-NG60W, NG35A, NG35W, NG45A, NG45W, NG60A, SuperStar-NG45A, SuperStar-NG45W, SuperStar-NG60A, SuperStar-NG60W |                 |        |



1

|                    |  |                 |        |
|--------------------|--|-----------------|--------|
| <b>GEV No.</b>     | 500755   | <b>Ref. No.</b> | 205400 |
| <b>description</b> | pump MAVIP type DP140 52W 230V 50Hz outlet ø 17mm L 110mm rotation direction left for ice-cube maker capacitor 1.5µF |                 |        |
| <b>For models:</b> | Delta-DP140A, Delta-DP140W, Gala-DP140A, Gala-DP140W, MDP-150A, MDP-150W, SuperStar-DP140A                           |                 |        |



1

|                    |   |                 |            |
|--------------------|---|-----------------|------------|
| <b>GEV No.</b>     | 500229  | <b>Ref. No.</b> | 205407 old |
| <b>description</b> | pump MAVIP type DP90 52W 230V 50Hz outlet ø 17mm L 110mm rotation direction left for ice-cube maker capacitor 5µF |                 |            |



1

|                    |   |                 |        |
|--------------------|---|-----------------|--------|
| <b>GEV No.</b>     | 499167  | <b>Ref. No.</b> | 205407 |
| <b>description</b> | pump MAVIP type G DP90-D DP90 52W 230V 50Hz inlet ø 20mm outlet ø 17mm L 110mm rotation direction left for ice-cube maker capacitor 2µF |                 |        |
| <b>For models:</b> | Delta-DP90A, Delta-DP90W, Gala-DP90A, Gala-DP90W, SuperStar-DP90A, SuperStar-DP90W  |                 |        |



1

|                    |  |                 |        |
|--------------------|--|-----------------|--------|
| <b>GEV No.</b>     | 499176   | <b>Ref. No.</b> | 505927 |
| <b>description</b> | pump REBO type NG140 75W 208/230V 50/60Hz inlet ø 20mm outlet ø 17mm L 138mm rotation direction right for ice-cube maker capacitor 5µF |                 |        |
| <b>For models:</b> | Alfa-NG150A, Alfa-NG150W, Delta-NG150A, Delta-NG150W, Gala-NG150A, Gala-NG150W, NG150A, NG150W, SuperStar-NG150A, SuperStar-NG150W     |                 |        |



1

|                    |  |                 |        |
|--------------------|--|-----------------|--------|
| <b>GEV No.</b>     | 500222                                 | <b>Ref. No.</b> | 205031 |
| <b>description</b> | pump type DP20 rotation direction left |                 |        |



1

|                    |   |                 |               |
|--------------------|---|-----------------|---------------|
| <b>GEV No.</b>     | 500224  | <b>Ref. No.</b> | 176<br>205176 |
| <b>description</b> | pump type DP40/DP45 50W 230V 50Hz L 110mm rotation direction left   |                 |               |
| <b>For models:</b> | Delta-DP45A, Delta-DP45W, Gala-DP40A, Gala-DP40W, Spika-111A, Spika-111W, Spika-200, Spika-33A, Spika-33W, Spika-55A, Spika-55W, SuperStar-DP45A, SuperStar-DP45W |                 |               |

## electric accessories

### terminals

#### connection terminals with faston connections



1

|                    |   |                 |        |
|--------------------|---|-----------------|--------|
| <b>GEV No.</b>     | 550281  | <b>Ref. No.</b> | 405177 |
| <b>description</b> | connection terminal 1-pole  |                 |        |
| <b>For models:</b> | Alfa-NG110A, Alfa-NG110W, Alfa-NG150A, Alfa-NG150W, Alfa-NG35A, Alfa-NG35W, Alfa-NG45A, Alfa-NG45W, Alfa-NG60A, Alfa-NG60W, Alfa-NG80A, Alfa-NG80W, Delta-DP140A, Delta-DP140W, Delta-DP30A, Delta-DP30W, Delta-DP45A, Delta-DP45W, Delta-DP60A, Delta-DP60W, Delta-DP80A, Delta-DP80W, Delta-DP90A, Delta-DP90W, Delta-NG110A, Delta-NG110W, Delta-NG150A, Delta-NG150W, Delta-NG30A, Delta-NG30W, Delta-NG35A, Delta-NG35W, Delta-NG45A, Delta-NG45W, Delta-NG60A, Delta-NG60W, Delta-NG80A, Delta-NG80W, Gala-DP140A, Gala-DP140W, Gala-DP20A, Gala-DP20W, Gala-DP30A, Gala-DP30W, Gala-DP40A, Gala-DP40W, Gala-DP55A, Gala-DP55W, Gala-DP70A, Gala-DP70W... (Other models you can see in the webshop) |                 |        |

## equipment-specific units

### for ice-cube maker

#### drain systems

##### drain pans



1

|                    |  |                 |        |
|--------------------|--|-----------------|--------|
| <b>GEV No.</b>     | 696448   | <b>Ref. No.</b> | 300593 |
| <b>description</b> | drain pan L 145mm W 65mm H 225mm hole ø 12.5mm   |                 |        |
| <b>For models:</b> | Quasar-130CA, Quasar-130CW, Quasar-20CA, Quasar-20CW, Quasar-30CA, Quasar-30CW, Quasar-40CA, Quasar-40CW, Quasar-40SCA, Quasar-40SCW, Quasar-50CA, Quasar-50CW, Quasar-60CA, Quasar-60CW, Quasar-90CA, Quasar-90CW, Quasar-MQ200A, Quasar-MQ200W |                 |        |

#### overflow pipes



1

|                    |  |                 |                |
|--------------------|--|-----------------|----------------|
| <b>GEV No.</b>     | 695290   | <b>Ref. No.</b> | 1134<br>301134 |
| <b>description</b> | overflow pipe L 115mm ø 18mm thickness 1mm   |                 |                |
| <b>For models:</b> | Alfa-NG150A, Alfa-NG150W, Delta-DP30A, Delta-DP30W, Delta-NG150A, Delta-NG150W, Gala-DP40A, Gala-DP40W, Gala-DP55A, Gala-DP55W, Gala-NG150A, Gala-NG150W, NG150A, NG150W, Spika-33A, Spika-33W, Spika-55A, Spika-55W, SuperStar-NG150A, SuperStar-NG150W |                 |                |



1

|                    |  |                 |                |
|--------------------|--|-----------------|----------------|
| <b>GEV No.</b>     | 695291   | <b>Ref. No.</b> | 2709<br>302709 |
| <b>description</b> | overflow pipe L 130mm ø 18mm thickness 1mm   |                 |                |
| <b>For models:</b> | Delta-DP140A, Delta-DP140W, Delta-DP45A, Delta-DP45W, Delta-DP60A, Delta-DP60W, Delta-DP80A, Delta-DP80W, Delta-DP90A, Delta-DP90W, Gala-DP140A, Gala-DP140W, Gala-DP90A, Gala-DP90W, Spika-200, Spika-400, SuperStar-DP140A, SuperStar-DP45A, SuperStar-DP45W, SuperStar-DP60A, SuperStar-DP60W, SuperStar-DP80A, SuperStar-DP80W, SuperStar-DP90A, SuperStar-DP90W |                 |                |



1

|                    |   |                 |                   |
|--------------------|---|-----------------|-------------------|
| <b>GEV No.</b>     | 696694                                      | <b>Ref. No.</b> | 1103 (Delta DP20) |
| <b>description</b> | overflow pipe L 67mm ø 14mm thickness 1.5mm |                 |                   |



spare parts and accessories



|                    |  |                 |        |
|--------------------|--|-----------------|--------|
| 1                  |  |                 |        |
| <b>GEV No.</b>     | 695288   | <b>Ref. No.</b> | 210618 |
| <b>description</b> | bushing L 60mm W 55mm H 29mm ID ø 12mm   |                 |        |
| <b>For models:</b> | Pulsar-145A, Pulsar-145W, Pulsar-15A, Pulsar-15W, Pulsar-25A, Pulsar-25W, Pulsar-35A, Pulsar-35W, Pulsar-45A, Pulsar-45W, Pulsar-65A, Pulsar-65W, Pulsar-85A, Pulsar-85W, Pulsar-MP145A, Pulsar-MP145W, Pulsar-MP401A, Pulsar-MP401W, Pulsar-MP801A, Pulsar-MP801W |                 |        |

spray systems

ITV

spray arms



Image not available

|                    |   |                 |               |
|--------------------|---|-----------------|---------------|
| 1                  |   |                 |               |
| <b>GEV No.</b>     | 695182  | <b>Ref. No.</b> | 334<br>407334 |
| <b>description</b> | spray arm for ice maker   |                 |               |
| <b>For models:</b> | Alfa-NDP20A, Alfa-NDP20W, Alfa-NG35A, Alfa-NG35W, Alfa-NG45A, Alfa-NG45W, Alfa-NG60A, Alfa-NG60W, Alfa-NG80A, Alfa-NG80W, Delta-DP60A, Delta-DP60W, Delta-NG30A, Delta-NG30W, Delta-NG35A, Delta-NG35W, Delta-NG45A, Delta-NG45W, Delta-NG60A, Delta-NG60W, Delta-NG80A, Delta-NG80W, Gala-DP55A, Gala-DP55W, Gala-NG30A, Gala-NG30W, Gala-NG35A, Gala-NG35W, Gala-NG40A, Gala-NG45A, Gala-NG45W, Gala-NG55A, Gala-NG55W, Gala-NG60A, Gala-NG60W, Gala-NG70A, Gala-NG70W, Gala-NG80A, Gala-NG80W, IceQueen-IQ1100A, IceQueen-IQ1100W, IceQueen-IQ135A, IceQueen-IQ135W, IceQueen-IQ150A, IceQueen-IQ150W, IceQueen-IQ200A, IceQueen-IQ200W, IceQueen-IQ400A, IceQueen-IQ400W, IceQueen-IQ550A...(Other models you can see in the webshop) |                 |               |



Image not available

|                    |  |                 |        |
|--------------------|--|-----------------|--------|
| 1                  |  |                 |        |
| <b>GEV No.</b>     | 695183   | <b>Ref. No.</b> | 407335 |
| <b>description</b> | spray arm for ice maker  |                 |        |
| <b>For models:</b> | Alfa-NG80A, Alfa-NG80W, Delta-DP80A, Delta-DP80W, Delta-NG80A, Delta-NG80W, Gala-DP70A, Gala-DP70W, Gala-NG80A, Gala-NG80W, NG80A, NG80W, SuperStar-DP80A, SuperStar-DP80W, SuperStar-NG80A, SuperStar-NG80W |                 |        |



|                    |  |                 |                     |
|--------------------|--|-----------------|---------------------|
| 1                  |  |                 |                     |
| <b>GEV No.</b>     | 695184   | <b>Ref. No.</b> | 407341<br>7350+2191 |
| <b>description</b> | spray arm for ice maker  |                 |                     |
| <b>For models:</b> | Delta-DP140A, Delta-DP140W, Delta-DP90A, Delta-DP90W, Gala-DP140A, Gala-DP140W, Gala-DP90A, Gala-DP90W, SuperStar-DP140A, SuperStar-DP90A, SuperStar-DP90W |                 |                     |



|                    |  |                 |               |
|--------------------|--|-----------------|---------------|
| 1                  |  |                 |               |
| <b>GEV No.</b>     | 695181   | <b>Ref. No.</b> | 333<br>407333 |
| <b>description</b> | spray arm L 300mm nozzles 6 for ice maker  |                 |               |
| <b>For models:</b> | Alfa-NDP20A, Alfa-NDP20W, Delta-DP30A, Delta-DP30W, Delta-DP45A, Delta-DP45W, Gala-DP20A, Gala-DP20W, Gala-DP30A, Gala-DP30W, Gala-DP40A, Gala-DP40W, SuperStar-DP45A, SuperStar-DP45W |                 |               |

accessories



|                    |  |                 |        |
|--------------------|--|-----------------|--------|
| 1                  |  |                 |        |
| <b>GEV No.</b>     | 695186   | <b>Ref. No.</b> | 300523 |
| <b>description</b> | end cap for spray arm  |                 |        |
| <b>For models:</b> | Delta-DP140A, Delta-DP140W, Delta-DP30A, Delta-DP30W, Delta-DP45A, Delta-DP45W, Delta-DP60A, Delta-DP60W, Delta-DP80A, Delta-DP80W, Delta-DP90A, Delta-DP90W, Gala-DP140A, Gala-DP140W, Gala-DP20A, Gala-DP20W, Gala-DP30A, Gala-DP30W, Gala-DP40A, Gala-DP40W, Gala-DP55A, Gala-DP55W, Gala-DP70A, Gala-DP70W, Gala-DP90A, Gala-DP90W, SuperStar-DP140A, SuperStar-DP45A, SuperStar-DP45W, SuperStar-DP60A, SuperStar-DP60W, SuperStar-DP80A, SuperStar-DP80W, SuperStar-DP90A, SuperStar-DP90W |                 |        |



1

|                    |   |                 |        |
|--------------------|---|-----------------|--------|
| <b>GEV No.</b>     | 695185  | <b>Ref. No.</b> | 100526 |
| <b>description</b> | spray nozzle for ice maker  |                 |        |
| <b>For models:</b> | Alfa-NDP20A, Alfa-NDP20W, Alfa-NG110A, Alfa-NG110W, Alfa-NG150A, Alfa-NG150W, Alfa-NG35A, Alfa-NG35W, Alfa-NG45A, Alfa-NG45W, Alfa-NG60A, Alfa-NG60W, Alfa-NG80A, Alfa-NG80W, Delta-DP140A, Delta-DP140W, Delta-DP30A, Delta-DP30W, Delta-DP45A, Delta-DP45W, Delta-DP60A, Delta-DP60W, Delta-DP80A, Delta-DP80W, Delta-DP90A, Delta-DP90W, Delta-NG110A, Delta-NG110W, Delta-NG150A, Delta-NG150W, Delta-NG30A, Delta-NG30W, Delta-NG35A, Delta-NG35W, Delta-NG45A, Delta-NG45W, Delta-NG60A, Delta-NG60W, Delta-NG80A, Delta-NG80W, Gala-DP140A, Gala-DP140W, Gala-DP20A, Gala-DP20W, Gala-DP30A, Gala-DP30W, Gala-DP40A, Gala-DP40W, Gala-DP55A, Gala-DP55W... (Other models you can see in the webshop) |                 |        |

## doors

## bushes



1

|                    |  |                 |        |
|--------------------|--|-----------------|--------|
| <b>GEV No.</b>     | 695297   | <b>Ref. No.</b> | 101716 |
| <b>description</b> | bush for door  |                 |        |
| <b>For models:</b> | Delta-DP140A, Delta-DP140W, Delta-DP30A, Delta-DP30W, Delta-DP45A, Delta-DP45W, Delta-DP60A, Delta-DP60W, Delta-DP80A, Delta-DP80W, Delta-DP90A, Delta-DP90W, Gala-DP140A, Gala-DP140W, Gala-DP20A, Gala-DP20W, Gala-DP30A, Gala-DP30W, Gala-DP40A, Gala-DP40W, Gala-DP55A, Gala-DP55W, Gala-DP70A, Gala-DP70W, Gala-DP90A, Gala-DP90W, Quasar-130CA, Quasar-130CW, Quasar-20CA, Quasar-20CW, Quasar-30CA, Quasar-30CW, Quasar-40CA, Quasar-40CW, Quasar-40SCA, Quasar-40SCW, Quasar-50CA, Quasar-50CW, Quasar-60CA, Quasar-60CW, Quasar-90CA, Quasar-90CW, Spika-111A, Spika-111W, Spika-33A, Spika-33W, Spika-55A, Spika-55W, SuperStar-DP140A, SuperStar-DP45A... (Other models you can see in the webshop) |                 |        |

## doors



1

|                    |  |                 |               |
|--------------------|--|-----------------|---------------|
| <b>GEV No.</b>     | 695231   | <b>Ref. No.</b> | 100<br>407100 |
| <b>description</b> | door for ice-cube maker  |                 |               |
| <b>For models:</b> | Delta-DP45A, Delta-DP45W, Gala-DP40A, Gala-DP40W, SuperStar-DP45A, SuperStar-DP45W |                 |               |



1

|                    |  |                 |        |
|--------------------|--|-----------------|--------|
| <b>GEV No.</b>     | 695232   | <b>Ref. No.</b> | 407608 |
| <b>description</b> | door for ice-cube maker  |                 |        |
| <b>For models:</b> | Delta-DP60A, Delta-DP60W, Gala-DP55A, Gala-DP55W, Spika-55A, Spika-55W, SuperStar-DP60A, SuperStar-DP60W |                 |        |



1

|                    |  |                 |        |
|--------------------|--|-----------------|--------|
| <b>GEV No.</b>     | 695240   | <b>Ref. No.</b> | 407551 |
| <b>description</b> | door for ice-cube maker                              |                 |        |
| <b>For models:</b> | Quasar-40SCA, Quasar-40SCW, Quasar-50CA, Quasar-50CW |                 |        |



1

|                    |                          |                 |        |
|--------------------|--------------------------|-----------------|--------|
| <b>GEV No.</b>     | 695241                   | <b>Ref. No.</b> | 407552 |
| <b>description</b> | door for ice-cube maker  |                 |        |
| <b>For models:</b> | Quasar-60CA, Quasar-60CW |                 |        |



1

|                    |                          |                 |        |
|--------------------|--------------------------|-----------------|--------|
| <b>GEV No.</b>     | 695242                   | <b>Ref. No.</b> | 407553 |
| <b>description</b> | door for ice-cube maker  |                 |        |
| <b>For models:</b> | Quasar-90CA, Quasar-90CW |                 |        |



1

|                    |                            |                 |        |
|--------------------|----------------------------|-----------------|--------|
| <b>GEV No.</b>     | 695243                     | <b>Ref. No.</b> | 407554 |
| <b>description</b> | door for ice-cube maker    |                 |        |
| <b>For models:</b> | Quasar-130CA, Quasar-130CW |                 |        |





1

|                    |  |                 |        |
|--------------------|--|-----------------|--------|
| <b>GEV No.</b>     | 695230   | <b>Ref. No.</b> | 407555 |
| <b>description</b> | door for ice-cube maker W 320mm H 260mm thickness 18mm                   |                 |        |
| <b>For models:</b> | Delta-DP30A, Delta-DP30W, Gala-DP20A, Gala-DP20W, Gala-DP30A, Gala-DP30W |                 |        |



|   |  |                 |        |
|---|--|-----------------|--------|
|  |  |                 |        |
| 1   |  |                 |        |
| <b>GEV No.</b>  | 695239   | <b>Ref. No.</b> | 407550 |
| <b>description</b>  | door for ice-cube maker W 320mm H 315mm thickness 18mm                       |                 |        |
| <b>For models:</b>  | Quasar-20CA, Quasar-20CW, Quasar-30CA, Quasar-30CW, Quasar-40CA, Quasar-40CW |                 |        |

|   |  |                 |        |
|---|--|-----------------|--------|
|  |  |                 |        |
| 1   |  |                 |        |
| <b>GEV No.</b>  | 695233   | <b>Ref. No.</b> | 407557 |
| <b>description</b>  | door for ice-cube maker W 630mm H 300mm thickness 22mm   |                 |        |
| <b>For models:</b>  | Alfa-NG35A, Alfa-NG35W, Alfa-NG45A, Alfa-NG45W, Alfa-NG60A, Alfa-NG60W, Alfa-NG80A, Alfa-NG80W, Delta-DP140A, Delta-DP140W, Delta-DP80A, Delta-DP80W, Delta-DP90A, Delta-DP90W, Delta-NG35A, Delta-NG35W, Delta-NG45A, Delta-NG45W, Delta-NG60A, Delta-NG60W, Delta-NG80A, Delta-NG80W, Gala-DP140A, Gala-DP140W, Gala-DP70A, Gala-DP70W, Gala-DP90A, Gala-DP90W, Gala-NG35A, Gala-NG35W, Gala-NG40A, Gala-NG40W, Gala-NG45A, Gala-NG45W, Gala-NG55A, Gala-NG55W, Gala-NG60A, Gala-NG60W, Gala-NG80A, Gala-NG80W, NG35A, NG35W, NG45A, NG45W, NG60A, NG60W, NG80A, NG80W, SuperStar-DP140A, SuperStar-DP80A... (Other models you can see in the webshop) |                 |        |

|  |  |                 |                |
|--|--|-----------------|----------------|
|  |  |                 |                |
| 1  |  |                 |                |
| <b>GEV No.</b>   | 695237   | <b>Ref. No.</b> | 1701<br>201701 |
| <b>description</b>   | door guides mounting pos. left L 255/320mm W 35mm                            |                 |                |
| <b>For models:</b>   | Quasar-20CA, Quasar-20CW, Quasar-30CA, Quasar-30CW, Quasar-40CA, Quasar-40CW |                 |                |

|  |  |                 |                |
|--|--|-----------------|----------------|
|  |  |                 |                |
| 1  |  |                 |                |
| <b>GEV No.</b>   | 695238   | <b>Ref. No.</b> | 1707<br>201707 |
| <b>description</b>   | door guides mounting pos. left L 305/370mm W 35mm  |                 |                |
| <b>For models:</b>   | Quasar-130CA, Quasar-130CW, Quasar-40SCA, Quasar-40SCW, Quasar-50CA, Quasar-50CW, Quasar-60CA, Quasar-60CW, Quasar-90CA, Quasar-90CW, Spika-111A, Spika-111W |                 |                |

door guides

|   |  |                 |                |
|---|--|-----------------|----------------|
|  |  |                 |                |
| 1   |  |                 |                |
| <b>GEV No.</b>  | 695228   | <b>Ref. No.</b> | 1703<br>201703 |
| <b>description</b>  | door guides mounting pos. left L 215/280mm W 35mm  |                 |                |
| <b>For models:</b>  | Delta-DP30A, Delta-DP30W, Gala-DP20A, Gala-DP20W, Gala-DP30A, Gala-DP30W, Spika-33A, Spika-33W |                 |                |

|  |  |                 |                |
|--|--|-----------------|----------------|
|  |  |                 |                |
| 1  |  |                 |                |
| <b>GEV No.</b>   | 695227   | <b>Ref. No.</b> | 1704<br>201704 |
| <b>description</b>   | door guides mounting pos. right L 255/320mm W 35mm   |                 |                |
| <b>For models:</b>   | Delta-DP140A, Delta-DP140W, Delta-DP45A, Delta-DP45W, Delta-DP60A, Delta-DP60W, Delta-DP80A, Delta-DP80W, Delta-DP90A, Delta-DP90W, Gala-DP140A, Gala-DP140W, Gala-DP40A, Gala-DP40W, Gala-DP55A, Gala-DP55W, Gala-DP70A, Gala-DP70W, Gala-DP90A, Gala-DP90W, Spika-55A, Spika-55W, SuperStar-DP140A, SuperStar-DP45A, SuperStar-DP45W, SuperStar-DP60A, SuperStar-DP60W, SuperStar-DP80A, SuperStar-DP80W, SuperStar-DP90A, SuperStar-DP90W |                 |                |

|   |  |                 |                |
|---|--|-----------------|----------------|
|  |  |                 |                |
| 1   |  |                 |                |
| <b>GEV No.</b>  | 695229   | <b>Ref. No.</b> | 1705<br>201705 |
| <b>description</b>  | door guides mounting pos. left L 255/320mm W 35mm  |                 |                |
| <b>For models:</b>  | Delta-DP140A, Delta-DP140W, Delta-DP45A, Delta-DP45W, Delta-DP60A, Delta-DP60W, Delta-DP80A, Delta-DP80W, Delta-DP90A, Delta-DP90W, Gala-DP140A, Gala-DP140W, Gala-DP40A, Gala-DP40W, Gala-DP55A, Gala-DP55W, Gala-DP70A, Gala-DP70W, Gala-DP90A, Gala-DP90W, Spika-55A, Spika-55W, SuperStar-DP140A, SuperStar-DP45A, SuperStar-DP45W, SuperStar-DP60A, SuperStar-DP60W, SuperStar-DP80A, SuperStar-DP80W, SuperStar-DP90A, SuperStar-DP90W |                 |                |

|  |  |                 |                |
|--|--|-----------------|----------------|
|  |  |                 |                |
| 1  |  |                 |                |
| <b>GEV No.</b>   | 695235   | <b>Ref. No.</b> | 1700<br>201700 |
| <b>description</b>   | door guides mounting pos. right L 255/320mm W 35mm                           |                 |                |
| <b>For models:</b>   | Quasar-20CA, Quasar-20CW, Quasar-30CA, Quasar-30CW, Quasar-40CA, Quasar-40CW |                 |                |



|                    |  |                 |                |
|--------------------|--|-----------------|----------------|
| <b>GEV No.</b>     | 695226   | <b>Ref. No.</b> | 1702<br>201702 |
| <b>description</b> | door guides mounting pos. right L 280/215mm W 35mm   |                 |                |
| <b>For models:</b> | Alfa-NG110A, Alfa-NG110W, Alfa-NG150A, Alfa-NG150W, Alfa-NG35A, Alfa-NG35W, Alfa-NG45A, Alfa-NG45W, Alfa-NG60A, Alfa-NG60W, Alfa-NG80A, Alfa-NG80W, Delta-DP30A, Delta-DP30W, Delta-NG110A, Delta-NG110W, Delta-NG150A, Delta-NG150W, Delta-NG30A, Delta-NG30W, Delta-NG35A, Delta-NG35W, Delta-NG45A, Delta-NG45W, Delta-NG60A, Delta-NG60W, Delta-NG80A, Delta-NG80W, Gala-DP20A, Gala-DP20W, Gala-DP30A, Gala-DP30W, Gala-NG110A, Gala-NG110W, Gala-NG150A, Gala-NG150W, Gala-NG30A, Gala-NG30W, Gala-NG35A, Gala-NG35W, Gala-NG40A, Gala-NG40W, Gala-NG45A, Gala-NG45W, Gala-NG55A, Gala-NG55W, Gala-NG60A, Gala-NG60W, Gala-NG70A, Gala-NG70W...(Other models you can see in the webshop) |                 |                |



|                    |  |                 |                |
|--------------------|--|-----------------|----------------|
| <b>GEV No.</b>     | 695236   | <b>Ref. No.</b> | 1706<br>201706 |
| <b>description</b> | door guides mounting pos. right L 305/370mm W 35mm   |                 |                |
| <b>For models:</b> | Quasar-130CA, Quasar-130CW, Quasar-40SCA, Quasar-40SCW, Quasar-50CA, Quasar-50CW, Quasar-60CA, Quasar-60CW, Quasar-90CA, Quasar-90CW, Spika-111A, Spika-111W |                 |                |

## door bumpers



|                    |   |                 |        |
|--------------------|---|-----------------|--------|
| <b>GEV No.</b>     | 695618  | <b>Ref. No.</b> | 101715 |
| <b>description</b> | stopper   |                 |        |
| <b>For models:</b> | Delta-DP140A, Delta-DP140W, Delta-DP30A, Delta-DP30W, Delta-DP45A, Delta-DP45W, Delta-DP60A, Delta-DP60W, Delta-DP80A, Delta-DP80W, Delta-DP90A, Delta-DP90W, Gala-DP140A, Gala-DP140W, Gala-DP20A, Gala-DP20W, Gala-DP30A, Gala-DP30W, Gala-DP40A, Gala-DP40W, Gala-DP55A, Gala-DP55W, Gala-DP70A, Gala-DP70W, Gala-DP90A, Gala-DP90W, Quasar-130CA, Quasar-130CW, Quasar-20CA, Quasar-20CW, Quasar-30CA, Quasar-30CW, Quasar-40CA, Quasar-40CW, Quasar-40SCA, Quasar-40SCW, Quasar-50CA, Quasar-50CW, Quasar-60CA, Quasar-60CW, Quasar-90CA, Quasar-90CW, Spika-111A, Spika-111W, Spika-33A, Spika-33W, Spika-55A, Spika-55W, SuperStar-DP140A, SuperStar-DP45A...(Other models you can see in the webshop) |                 |        |

## curtains

### with holder



|                    |  |                 |        |
|--------------------|--|-----------------|--------|
| <b>GEV No.</b>     | 695219   | <b>Ref. No.</b> | 305006 |
| <b>description</b> | curtain for ice maker W 330mm H 200mm with holder shaft length 340mm shaft ø 6mm   |                 |        |
| <b>For models:</b> | Delta-DP30A, Delta-DP30W, Delta-DP45A, Delta-DP45W, Gala-DP20A, Gala-DP20W, Gala-DP30A, Gala-DP30W, Gala-DP40A, Gala-DP40W, SuperStar-DP45A, SuperStar-DP45W |                 |        |



|                    |  |                 |        |
|--------------------|--|-----------------|--------|
| <b>GEV No.</b>     | 695283   | <b>Ref. No.</b> | 305110 |
| <b>description</b> | curtain for ice maker W 338mm H 185mm with holder shaft length 277mm shaft ø 6mm |                 |        |
| <b>For models:</b> | Pulsar-15A, Pulsar-15W, Pulsar-25A, Pulsar-25W, Pulsar-35A, Pulsar-35W           |                 |        |



|                    |  |                 |        |
|--------------------|--|-----------------|--------|
| <b>GEV No.</b>     | 695284   | <b>Ref. No.</b> | 305111 |
| <b>description</b> | curtain for ice maker W 605mm H 207mm with holder shaft length 540mm shaft ø 6mm |                 |        |
| <b>For models:</b> | Pulsar-145A, Pulsar-145W, Pulsar-65A, Pulsar-65W, Pulsar-85A, Pulsar-85W         |                 |        |





|                    |  |                 |        |
|--------------------|--|-----------------|--------|
| <b>GEV No.</b>     | 695285   | <b>Ref. No.</b> | 305112 |
| <b>description</b> | curtain for ice maker W 605mm H 250mm with holder shaft length 540mm shaft ø 6mm |                 |        |
| <b>For models:</b> | Pulsar-45A, Pulsar-45W   |                 |        |





|                    |  |                 |        |
|--------------------|--|-----------------|--------|
| <b>GEV No.</b>     | 695221   | <b>Ref. No.</b> | 305025 |
| <b>description</b> | curtain for ice maker W 640mm H 195mm with holder shaft length 650mm shaft ø 6mm   |                 |        |
| <b>For models:</b> | Delta-DP80A, Delta-DP80W, Gala-DP70A, Gala-DP70W, SuperStar-DP80A, SuperStar-DP80W |                 |        |



|  |  |                 |        |
|--|--|-----------------|--------|
|  <p>Image not available</p> |  |                 |        |
| 1  |  |                 |        |
| <b>GEV No.</b>   | 695220   | <b>Ref. No.</b> | 305026 |
| <b>description</b>   | curtain with holder  |                 |        |
| <b>For models:</b>   | Delta-DP60A, Delta-DP60W, Gala-DP55A, Gala-DP55W, SuperStar-DP60A, SuperStar-DP60W |                 |        |

|  |  |                 |        |
|--|--|-----------------|--------|
|  |  |                 |        |
| 1  |  |                 |        |
| <b>GEV No.</b>   | 695224   | <b>Ref. No.</b> | 110605 |
| <b>description</b>   | lamella for curtain L 110mm W 10mm ID ø 6mm  |                 |        |
| <b>For models:</b>   | Alfa-NG110A, Alfa-NG110W, Alfa-NG150A, Alfa-NG150W, Alfa-NG35A, Alfa-NG35W, Alfa-NG45A, Alfa-NG45W, Alfa-NG60A, Alfa-NG60W, Alfa-NG80A, Alfa-NG80W, Delta-DP140A, Delta-DP140W, Delta-DP30A, Delta-DP30W, Delta-DP45A, Delta-DP45W, Delta-DP60A, Delta-DP60W, Delta-DP80A, Delta-DP80W, Delta-DP90A, Delta-DP90W, Delta-NG110A, Delta-NG110W, Delta-NG150A, Delta-NG150W, Delta-NG35A, Delta-NG35W, Delta-NG45A, Delta-NG45W, Delta-NG60A, Delta-NG60W, Delta-NG80A, Delta-NG80W, Gala-DP140A, Gala-DP140W, Gala-DP20A, Gala-DP20W, Gala-DP30A, Gala-DP30W, Gala-DP40A, Gala-DP40W, Gala-DP55A, Gala-DP55W, Gala-DP70A, Gala-DP70W, Gala-DP90A, Gala-DP90W...(Other models you can see in the webshop) |                 |        |

|  |  |                 |        |
|--|--|-----------------|--------|
|  <p>Image not available</p> |  |                 |        |
| 2  |  |                 |        |
| <b>GEV No.</b>   | 695222   | <b>Ref. No.</b> | 305495 |
| <b>description</b>   | curtain with holder  |                 |        |
| <b>For models:</b>   | Delta-DP90A, Delta-DP90W, Gala-DP90A, Gala-DP90W, SuperStar-DP90A, SuperStar-DP90W |                 |        |

|  |  |                 |        |
|--|--|-----------------|--------|
|  <p>Image not available</p> |  |                 |        |
| 1  |  |                 |        |
| <b>GEV No.</b>   | 695223   | <b>Ref. No.</b> | 305496 |
| <b>description</b>   | curtain with holder  |                 |        |
| <b>For models:</b>   | Delta-DP140A, Delta-DP140W, Gala-DP140A, Gala-DP140W, SuperStar-DP140A |                 |        |

pan mechanics

sumps

|   |   |                 |        |
|---|---|-----------------|--------|
|  |   |                 |        |
| 1   |   |                 |        |
| <b>GEV No.</b>  | 695211  | <b>Ref. No.</b> | 105361 |
| <b>description</b>  | sump complete for ice maker L 234mm W 170mm H 90mm ITV blue for Q40 |                 |        |
| <b>For models:</b>  | Quasar-40CA, Quasar-40CW  |                 |        |

accessories

lamellas

|   |  |                 |        |
|---|--|-----------------|--------|
|  |  |                 |        |
| 1   |  |                 |        |
| <b>GEV No.</b>  | 695225   | <b>Ref. No.</b> | 110606 |
| <b>description</b>  | lamella for curtain L 109mm W 25mm ID ø 6mm outer  |                 |        |
| <b>For models:</b>  | Alfa-NG110A, Alfa-NG110W, Alfa-NG150A, Alfa-NG150W, Alfa-NG35A, Alfa-NG35W, Alfa-NG45A, Alfa-NG45W, Alfa-NG60A, Alfa-NG60W, Alfa-NG80A, Alfa-NG80W, Delta-DP140A, Delta-DP140W, Delta-DP30A, Delta-DP30W, Delta-DP45A, Delta-DP45W, Delta-DP60A, Delta-DP60W, Delta-DP80A, Delta-DP80W, Delta-DP90A, Delta-DP90W, Delta-NG110A, Delta-NG110W, Delta-NG150A, Delta-NG150W, Delta-NG35A, Delta-NG35W, Delta-NG45A, Delta-NG45W, Delta-NG60A, Delta-NG60W, Delta-NG80A, Delta-NG80W, Gala-DP140A, Gala-DP140W, Gala-DP20A, Gala-DP20W, Gala-DP30A, Gala-DP30W, Gala-DP40A, Gala-DP40W, Gala-DP55A, Gala-DP55W, Gala-DP70A, Gala-DP70W, Gala-DP90A, Gala-DP90W...(Other models you can see in the webshop) |                 |        |

|  |   |                 |        |
|--|---|-----------------|--------|
|  |   |                 |        |
| 1  |   |                 |        |
| <b>GEV No.</b>   | 695210  | <b>Ref. No.</b> | 105360 |
| <b>description</b>   | sump complete for ice maker L 240mm W 155mm H 70mm ITV blue |                 |        |
| <b>For models:</b>   | Quasar-20CA, Quasar-20CW, Quasar-30CA, Quasar-30CW          |                 |        |

|  |  |                 |        |
|--|--|-----------------|--------|
|  |  |                 |        |
| 1  |  |                 |        |
| <b>GEV No.</b>   | 695212   | <b>Ref. No.</b> | 105203 |
| <b>description</b>   | sump complete for ice maker L 280mm W 192mm H 64mm ITV blue for Q34,Q40S,Q50 |                 |        |
| <b>For models:</b>   | Quasar-40SCA, Quasar-40SCW, Quasar-50CA, Quasar-50CW                         |                 |        |



1

|                    |   |                 |        |
|--------------------|---|-----------------|--------|
| <b>GEV No.</b>     | 695213  | <b>Ref. No.</b> | 105204 |
| <b>description</b> | sump complete for ice maker L 350mm W 170mm H 60mm ITV blue for Q60 |                 |        |
| <b>For models:</b> | Quasar-60CA, Quasar-60CW  |                 |        |



1

|                    |   |                 |        |
|--------------------|---|-----------------|--------|
| <b>GEV No.</b>     | 695214  | <b>Ref. No.</b> | 105205 |
| <b>description</b> | sump complete for ice maker L 480mm W 220mm H 90mm ITV blue for Q90 |                 |        |
| <b>For models:</b> | Quasar-90CA, Quasar-90CW, Quasar-MQ200A, Quasar-MQ200W              |                 |        |



1

|                    |   |                 |        |
|--------------------|---|-----------------|--------|
| <b>GEV No.</b>     | 695215  | <b>Ref. No.</b> | 105273 |
| <b>description</b> | sump complete ice cube maker L 600mm W 190mm H 70mm blue for Q130 |                 |        |
| <b>For models:</b> | Quasar-130CA, Quasar-130CW  |                 |        |

## tanks with paddle



1

|                    |   |                 |        |
|--------------------|---|-----------------|--------|
| <b>GEV No.</b>     | 695275  | <b>Ref. No.</b> | 105105 |
| <b>description</b> | sump with paddle ITV suitable for PULSAR65-PULSAR85 |                 |        |
| <b>For models:</b> | Pulsar-65A, Pulsar-65W, Pulsar-85A, Pulsar-85W      |                 |        |



1

|                    |  |                 |        |
|--------------------|--|-----------------|--------|
| <b>GEV No.</b>     | 695273   | <b>Ref. No.</b> | 205100 |
| <b>description</b> | sump with paddle L 360mm W 260mm H 400mm ITV suitable for PULSAR15 |                 |        |
| <b>For models:</b> | Pulsar-15A, Pulsar-15W   |                 |        |



1

|                    |  |                 |        |
|--------------------|--|-----------------|--------|
| <b>GEV No.</b>     | 695274   | <b>Ref. No.</b> | 105101 |
| <b>description</b> | sump with paddle L 360mm W 260mm H 400mm ITV suitable for PULSAR25-PULSAR35-PULSAR45 |                 |        |
| <b>For models:</b> | Pulsar-25A, Pulsar-25W, Pulsar-35A, Pulsar-35W, Pulsar-45A, Pulsar-45W               |                 |        |



1

|                    |   |                 |        |
|--------------------|---|-----------------|--------|
| <b>GEV No.</b>     | 695276  | <b>Ref. No.</b> | 105106 |
| <b>description</b> | sump with paddle L 635mm W 395mm H 470mm suitable for PULSAR145 ITV |                 |        |
| <b>For models:</b> | Pulsar-145A, Pulsar-145W  |                 |        |

## spare parts and accessories



1

|                    |  |                 |        |
|--------------------|--|-----------------|--------|
| <b>GEV No.</b>     | 695202   | <b>Ref. No.</b> | 200561 |
| <b>description</b> | adjusting ring for spindle   |                 |        |
| <b>For models:</b> | Quasar-130CA, Quasar-130CW, Quasar-20CA, Quasar-20CW, Quasar-30CA, Quasar-30CW, Quasar-40CA, Quasar-40CW, Quasar-40SCA, Quasar-40SCW, Quasar-50CA, Quasar-50CW, Quasar-60CA, Quasar-60CW, Quasar-90CA, Quasar-90CW, Quasar-MQ200A, Quasar-MQ200W |                 |        |





1



|                    |  |                 |               |
|--------------------|--|-----------------|---------------|
| <b>GEV No.</b>     | 695203   | <b>Ref. No.</b> | 159<br>307159 |
| <b>description</b> | bush   |                 |               |
| <b>For models:</b> | Alfa-NG35A, Alfa-NG35W, Alfa-NG45A, Alfa-NG45W, Alfa-NG60A, Alfa-NG60W, Delta-NG35A, Delta-NG35W, Delta-NG45A, Delta-NG45W, Delta-NG60A, Delta-NG60W, Gala-NG35A, Gala-NG35W, Gala-NG40A, Gala-NG40W, Gala-NG45A, Gala-NG45W, Gala-NG55A, Gala-NG55W, Gala-NG60A, Gala-NG60W, IQ-85A, IQ-85W, NG35A, NG35W, NG45A, NG45W, NG60A, NG60W, Quasar-20CA, Quasar-20CW, Quasar-30CA, Quasar-30CW, Quasar-40CA, Quasar-40CW, SuperStar-NG45A, SuperStar-NG45W, SuperStar-NG60A, SuperStar-NG60W |                 |               |





|   |  |                 |        |
|---|--|-----------------|--------|
|  |  |                 |        |
| 1   |  |                 |        |
| <b>GEV No.</b>  | 695206   | <b>Ref. No.</b> | 300046 |
| <b>description</b>  | bush motor   |                 |        |
| <b>For models:</b>  | Quasar-130CA, Quasar-130CW, Quasar-20CA, Quasar-20CW, Quasar-30CA, Quasar-30CW, Quasar-40CA, Quasar-40CW, Quasar-40SCA, Quasar-40SCW, Quasar-50CA, Quasar-50CW, Quasar-60CA, Quasar-60CW, Quasar-90CA, Quasar-90CW, Quasar-MQ200A, Quasar-MQ200W |                 |        |

|   |  |                 |               |
|---|--|-----------------|---------------|
|  |  |                 |               |
| 2   |  |                 |               |
| <b>GEV No.</b>  | 694257   | <b>Ref. No.</b> | 202<br>205202 |
| <b>description</b>  | disc for pan tilting ø 92mm shaft intake ø 8x7mm shaft ø 10 shaft length 15mm  |                 |               |
| <b>For models:</b>  | Quasar-130CA, Quasar-130CW, Quasar-20CA, Quasar-20CW, Quasar-30CA, Quasar-30CW, Quasar-40CA, Quasar-40CW, Quasar-40SCA, Quasar-40SCW, Quasar-50CA, Quasar-50CW, Quasar-60CA, Quasar-60CW, Quasar-90CA, Quasar-90CW, Quasar-MQ200A, Quasar-MQ200W |                 |               |

|   |  |                 |        |
|---|--|-----------------|--------|
|  |  |                 |        |
| 1   |  |                 |        |
| <b>GEV No.</b>  | 695201   | <b>Ref. No.</b> | 100013 |
| <b>description</b>  | paddle for ice maker ø 125mm shaft intake ø 6mm 1  |                 |        |
| <b>For models:</b>  | Quasar-130CA, Quasar-130CW, Quasar-20CA, Quasar-20CW, Quasar-30CA, Quasar-30CW, Quasar-40CA, Quasar-40CW, Quasar-40SCA, Quasar-40SCW, Quasar-50CA, Quasar-50CW, Quasar-60CA, Quasar-60CW, Quasar-90CA, Quasar-90CW, Quasar-MQ200A, Quasar-MQ200W |                 |        |

|   |   |                 |                 |
|---|---|-----------------|-----------------|
|  |   |                 |                 |
| 1   |   |                 |                 |
| <b>GEV No.</b>  | 695194  | <b>Ref. No.</b> | 105257          |
| <b>description</b>  | paddle for ice maker ø 125mm shaft ø 6mm shaft length 500mm 9 |                 |                 |
| <b>For models:</b>  | Quasar-90CA, Quasar-90CW, Quasar-MQ200A, Quasar-MQ200W        |                 |                 |
| <b>accessories for</b>  | 695194  |                 |                 |
|  | <b>GEV No.</b>  | 695201          | <b>Ref. No.</b> |
|   |   |                 | 100013<br>13    |
|   | paddle for ice maker ø 125mm shaft intake ø 6mm 1             |                 |                 |

|   |  |                 |        |
|---|--|-----------------|--------|
|  |  |                 |        |
| 1   |  |                 |        |
| <b>GEV No.</b>  | 695191   | <b>Ref. No.</b> | 105271 |
| <b>description</b>  | paddle for ice maker shaft length 280mm 4                                    |                 |        |
| <b>For models:</b>  | Quasar-20CA, Quasar-20CW, Quasar-30CA, Quasar-30CW, Quasar-40CA, Quasar-40CW |                 |        |

|  |  |                 |        |
|--|--|-----------------|--------|
|  |  |                 |        |
| 1  |  |                 |        |
| <b>GEV No.</b>   | 695192   | <b>Ref. No.</b> | 105255 |
| <b>description</b>   | paddle for ice maker shaft length 335mm 5            |                 |        |
| <b>For models:</b>   | Quasar-40SCA, Quasar-40SCW, Quasar-50CA, Quasar-50CW |                 |        |

|  |  |                 |        |
|--|--|-----------------|--------|
|  |  |                 |        |
| 1  |  |                 |        |
| <b>GEV No.</b>   | 695286   | <b>Ref. No.</b> | 405098 |
| <b>description</b>   | paddle for ice maker shaft length 380mm 6  |                 |        |
| <b>For models:</b>   | Pulsar-15A, Pulsar-15W, Pulsar-25A, Pulsar-25W, Pulsar-35A, Pulsar-35W, Pulsar-45A, Pulsar-45W |                 |        |

|  |   |                 |        |
|--|---|-----------------|--------|
|  |   |                 |        |
| 1  |   |                 |        |
| <b>GEV No.</b>   | 695193                                    | <b>Ref. No.</b> | 105256 |
| <b>description</b>   | paddle for ice maker shaft length 415mm 7 |                 |        |
| <b>For models:</b>   | Quasar-60CA, Quasar-60CW                  |                 |        |

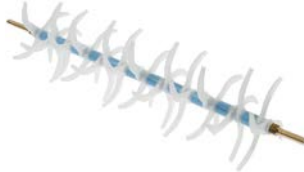
|  |  |                 |        |
|--|--|-----------------|--------|
|  |  |                 |        |
| 1  |  |                 |        |
| <b>GEV No.</b>   | 695578   | <b>Ref. No.</b> | 405099 |
| <b>description</b>   | paddle for ice maker shaft length 640mm 12   |                 |        |
| <b>For models:</b>   | Pulsar-145A, Pulsar-145W, Pulsar-65A, Pulsar-65W, Pulsar-85A, Pulsar-85W, Pulsar-MP145A, Pulsar-MP145W, Pulsar-MP401A, Pulsar-MP401W, Pulsar-MP801A, Pulsar-MP801W |                 |        |

|   |  |                 |        |
|---|--|-----------------|--------|
|  |  |                 |        |
| 1   |  |                 |        |
| <b>GEV No.</b>  | 695195   | <b>Ref. No.</b> | 105272 |
| <b>description</b>  | paddle for ice maker shaft length 655mm 13   |                 |        |
| <b>For models:</b>  | Alfa-NDP20A, Alfa-NDP20W, Alfa-NG110A, Alfa-NG110W, Alfa-NG150A, Alfa-NG150W, Alfa-NG35A, Alfa-NG35W, Alfa-NG45A, Alfa-NG45W, Alfa-NG60A, Alfa-NG60W, Alfa-NG80A, Alfa-NG80W, Delta-NG110A, Delta-NG110W, Delta-NG150A, Delta-NG150W, Delta-NG30A, Delta-NG30W, Delta-NG35A, Delta-NG35W, Delta-NG45A, Delta-NG45W, Delta-NG60A, Delta-NG60W, Delta-NG80A, Delta-NG80W, Gala-NG110A, Gala-NG110W, Gala-NG150A, Gala-NG150W, Gala-NG30A, Gala-NG30W, Gala-NG35A, Gala-NG35W, Gala-NG40A, Gala-NG40W, Gala-NG45A, Gala-NG45W, Gala-NG55A, Gala-NG55W, Gala-NG60A, Gala-NG60W, Gala-NG70A, Gala-NG70W, Gala-NG80A, Gala-NG80W, Gala-NG90A, Gala-NG90W...(Other models you can see in the webshop) |                 |        |

|   |  |                 |        |
|---|--|-----------------|--------|
|  |  |                 |        |
| 2   |  |                 |        |
| <b>GEV No.</b>  | 695196   | <b>Ref. No.</b> | 300563 |
| <b>description</b>  | spindle for paddle   |                 |        |
| <b>For models:</b>  | Quasar-20CA, Quasar-20CW, Quasar-30CA, Quasar-30CW, Quasar-40CA, Quasar-40CW |                 |        |

|  |  |                 |               |
|--|--|-----------------|---------------|
|  |  |                 |               |
| 1  |  |                 |               |
| <b>GEV No.</b>   | 695197   | <b>Ref. No.</b> | 143<br>300143 |
| <b>description</b>   | spindle for paddle                                   |                 |               |
| <b>For models:</b>   | Quasar-40SCA, Quasar-40SCW, Quasar-50CA, Quasar-50CW |                 |               |

|   |                          |                 |               |
|---|--------------------------|-----------------|---------------|
|  |                          |                 |               |
| 1   |                          |                 |               |
| <b>GEV No.</b>  | 695198                   | <b>Ref. No.</b> | 144<br>300144 |
| <b>description</b>  | spindle for paddle       |                 |               |
| <b>For models:</b>  | Quasar-50CA, Quasar-50CW |                 |               |

|   |  |                 |               |
|---|--|-----------------|---------------|
|  |  |                 |               |
| 1   |  |                 |               |
| <b>GEV No.</b>  | 695199   | <b>Ref. No.</b> | 145<br>300145 |
| <b>description</b>  | spindle for paddle                                     |                 |               |
| <b>For models:</b>  | Quasar-90CA, Quasar-90CW, Quasar-MQ200A, Quasar-MQ200W |                 |               |

|   |                                  |                 |                |
|---|----------------------------------|-----------------|----------------|
|  |                                  |                 |                |
| 1   |                                  |                 |                |
| <b>GEV No.</b>  | 695200                           | <b>Ref. No.</b> | 2074<br>302074 |
| <b>description</b>  | spindle for paddle ø 6mm L 665mm |                 |                |
| <b>For models:</b>  | Quasar-130CA, Quasar-130CW       |                 |                |

## drive technology

## round belt pulleys

|  |   |                 |        |
|--|---|-----------------|--------|
|  |   |                 |        |
| 1  |   |                 |        |
| <b>GEV No.</b>   | 695281  | <b>Ref. No.</b> | 110378 |
| <b>description</b>   | round belt pulley disc ø 124mm single shaft intake ø 10x7mm groove depth 5mm disc width 12mm groove width 10mm overall width 32mm ITV suitable for PULSAR65-PULSAR85 shaft ø 17.5mm |                 |        |
| <b>For models:</b>   | Pulsar-145A, Pulsar-145W, Pulsar-65A, Pulsar-65W, Pulsar-85A, Pulsar-85W, Pulsar-MP145A, Pulsar-MP145W, Pulsar-MP401A, Pulsar-MP401W, Pulsar-MP801A, Pulsar-MP801W                  |                 |        |

|  |  |                 |        |
|--|--|-----------------|--------|
|  |  |                 |        |
| 1  |  |                 |        |
| <b>GEV No.</b>   | 695282   | <b>Ref. No.</b> | 110608 |
| <b>description</b>   | round belt pulley disc ø 148mm single shaft intake ø 10x7mm groove depth 6mm disc width 12mm groove width 10mm overall width 30mm shaft ø 17.5mm |                 |        |
| <b>For models:</b>   | Pulsar-15A, Pulsar-15W, Pulsar-25A, Pulsar-25W, Pulsar-35A, Pulsar-35W, Pulsar-45A, Pulsar-45W   |                 |        |

|   |   |                 |        |
|---|---|-----------------|--------|
|  |   |                 |        |
| 1   |   |                 |        |
| <b>GEV No.</b>  | 695279  | <b>Ref. No.</b> | 110607 |
| <b>description</b>  | round belt pulley disc ø 49mm single shaft intake ø 10mm groove depth 5mm disc width 12mm groove width 10mm overall width 19mm shaft ø 18mm |                 |        |
| <b>For models:</b>  | Pulsar-15A, Pulsar-15W, Pulsar-25A, Pulsar-25W, Pulsar-35A, Pulsar-35W, Pulsar-45A, Pulsar-45W  |                 |        |

|   |  |                 |        |
|---|--|-----------------|--------|
|  |  |                 |        |
| 1   |  |                 |        |
| <b>GEV No.</b>  | 695280   | <b>Ref. No.</b> | 110224 |
| <b>description</b>  | round belt pulley disc ø 61mm single shaft intake ø 10mm groove depth 5mm disc width 12mm groove width 10mm overall width 19mm shaft ø 18mm                        |                 |        |
| <b>For models:</b>  | Pulsar-145A, Pulsar-145W, Pulsar-65A, Pulsar-65W, Pulsar-85A, Pulsar-85W, Pulsar-MP145A, Pulsar-MP145W, Pulsar-MP401A, Pulsar-MP401W, Pulsar-MP801A, Pulsar-MP801W |                 |        |



mechanics for evaporators

gear motors

motors

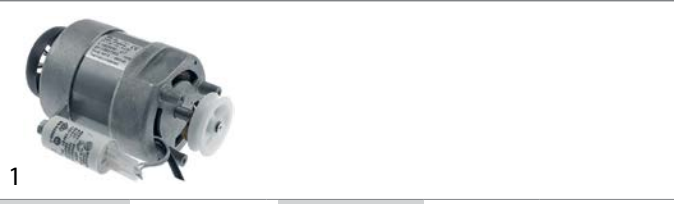

|                |        |                 |        |
|----------------|--------|-----------------|--------|
| <b>GEV No.</b> | 500793 | <b>Ref. No.</b> | 205260 |
|----------------|--------|-----------------|--------|

**description** motor with belt pulley 120W 230V 50/60Hz 1 phase shaft ø 10mm 1390/1600rpm type RM63/50 ø 90mm H 160mm REBO 0.12kW

**For models:** Pulsar-15A, Pulsar-15W, Pulsar-25A, Pulsar-25W, Pulsar-35A, Pulsar-35W, Pulsar-45A, Pulsar-45W

**spare parts for** 500793

|                |        |                 |               |
|----------------|--------|-----------------|---------------|
| <b>GEV No.</b> | 695279 | <b>Ref. No.</b> | 110607<br>607 |
|----------------|--------|-----------------|---------------|

**description** round belt pulley disc ø 49mm single shaft intake ø 10mm groove depth 5mm disc width 12mm groove width 10mm overall width 19mm shaft ø 18mm

hoses

miscellaneous



|                |        |                 |        |
|----------------|--------|-----------------|--------|
| <b>GEV No.</b> | 695188 | <b>Ref. No.</b> | 300993 |
|----------------|--------|-----------------|--------|

**description** hose

**For models:** Alfa-NDP20A, Alfa-NDP20W, Delta-DP30A, Delta-DP30W, Delta-DP45A, Delta-DP45W, Delta-DP60A, Delta-DP60W, Delta-DP80A, Delta-DP80W, Delta-NG30A, Delta-NG30W, Gala-DP20A, Gala-DP20W, Gala-DP30A, Gala-DP30W, Gala-DP40A, Gala-DP40W, Gala-DP55A, Gala-DP55W, Gala-DP70A, Gala-DP70W, Gala-NG30A, Gala-NG30W, SuperStar-DP45A, SuperStar-DP45W, SuperStar-DP60A, SuperStar-DP60W, SuperStar-DP80A, SuperStar-DP80W

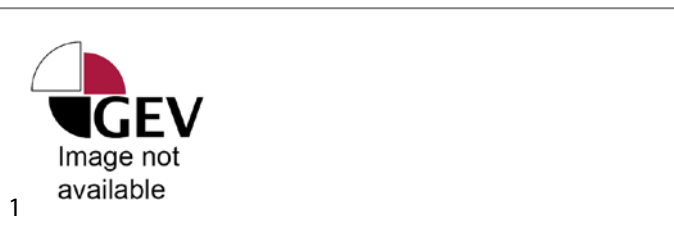

|                |        |                 |                |
|----------------|--------|-----------------|----------------|
| <b>GEV No.</b> | 695189 | <b>Ref. No.</b> | 1328<br>301328 |
|----------------|--------|-----------------|----------------|

**description** hose

**For models:** Delta-DP90A, Delta-DP90W, Gala-DP90A, Gala-DP90W, SuperStar-DP90A, SuperStar-DP90W

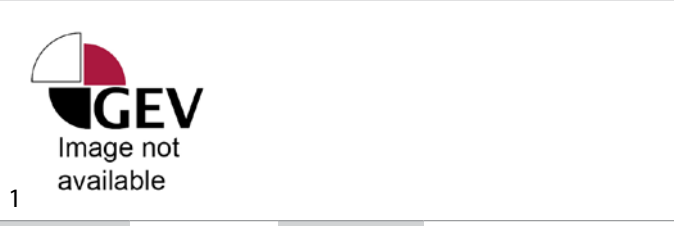

|                |        |                 |                |
|----------------|--------|-----------------|----------------|
| <b>GEV No.</b> | 695190 | <b>Ref. No.</b> | 2317<br>302317 |
|----------------|--------|-----------------|----------------|

**description** hose

**For models:** Delta-DP140A, Delta-DP140W, Gala-DP140A, Gala-DP140W, SuperStar-DP140A



|                |        |                 |        |
|----------------|--------|-----------------|--------|
| <b>GEV No.</b> | 695293 | <b>Ref. No.</b> | 400934 |
|----------------|--------|-----------------|--------|

**description** hose L 100mm ø 24mm thickness 2.5mm

**For models:** Delta-DP30A, Delta-DP30W, Gala-DP20A, Gala-DP20W, Gala-DP30A, Gala-DP30W



|                |        |                 |        |
|----------------|--------|-----------------|--------|
| <b>GEV No.</b> | 695294 | <b>Ref. No.</b> | 300992 |
|----------------|--------|-----------------|--------|

**description** hose L 175mm ø 24mm thickness 2.5mm

**For models:** Delta-DP45A, Delta-DP45W, Delta-DP60A, Delta-DP60W, Gala-DP40A, Gala-DP40W, Gala-DP55A, Gala-DP55W



|                |        |                 |                |
|----------------|--------|-----------------|----------------|
| <b>GEV No.</b> | 695295 | <b>Ref. No.</b> | 1060<br>301060 |
|----------------|--------|-----------------|----------------|

**description** hose L 235mm ø 24mm thickness 2.5mm

**For models:** Delta-DP80A, Delta-DP80W, Gala-DP70A, Gala-DP70W



|                |        |                 |                |
|----------------|--------|-----------------|----------------|
| <b>GEV No.</b> | 695296 | <b>Ref. No.</b> | 1101<br>301101 |
|----------------|--------|-----------------|----------------|

**description** hose L 250mm ø 24mm thickness 2.5mm

**For models:** Delta-DP140A, Delta-DP140W, Delta-DP90A, Delta-DP90W, Gala-DP140A, Gala-DP140W, Gala-DP90A, Gala-DP90W

floats

float containers

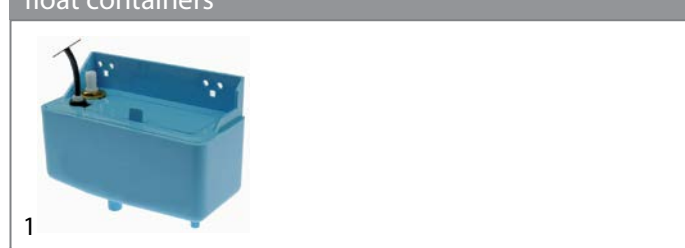

|                |        |                 |        |
|----------------|--------|-----------------|--------|
| <b>GEV No.</b> | 694533 | <b>Ref. No.</b> | 305231 |
|----------------|--------|-----------------|--------|

**description** float container for ice maker L 186mm W 86mm H 120mm with float plastic

**For models:** IceQueen-IQ1100A, IceQueen-IQ1100W, IceQueen-IQ135A, IceQueen-IQ135W, IceQueen-IQ150A, IceQueen-IQ150W, IceQueen-IQ200A, IceQueen-IQ200W, IceQueen-IQ400A, IceQueen-IQ400W, IceQueen-IQ550A, IceQueen-IQ550W, IQ-45A, IQ-45W, IQ-85A, IQ-85W

## miscellaneous



1

|                    |  |                 |        |
|--------------------|--|-----------------|--------|
| <b>GEV No.</b>     | 695208   | <b>Ref. No.</b> | 100169 |
| <b>description</b> | bearing  |                 |        |
| <b>For models:</b> | Quasar-130CA, Quasar-130CW, Quasar-40SCA, Quasar-40SCW, Quasar-50CA, Quasar-50CW, Quasar-60CA, Quasar-60CW, Quasar-90CA, Quasar-90CW, Quasar-MQ200A, Quasar-MQ200W |                 |        |



1

|                    |  |                 |        |
|--------------------|--|-----------------|--------|
| <b>GEV No.</b>     | 695287   | <b>Ref. No.</b> | 110196 |
| <b>description</b> | bearing  |                 |        |
| <b>For models:</b> | Pulsar-145A, Pulsar-145W, Pulsar-15A, Pulsar-15W, Pulsar-25A, Pulsar-25W, Pulsar-35A, Pulsar-35W, Pulsar-45A, Pulsar-45W, Pulsar-65A, Pulsar-65W, Pulsar-85A, Pulsar-85W, Pulsar-MP145A, Pulsar-MP145W, Pulsar-MP401A, Pulsar-MP401W, Pulsar-MP801A, Pulsar-MP801W |                 |        |



1

|                    |  |                 |        |
|--------------------|--|-----------------|--------|
| <b>GEV No.</b>     | 695205   | <b>Ref. No.</b> | 100556 |
| <b>description</b> | bracket  |                 |        |
| <b>For models:</b> | Pulsar-MP401A, Pulsar-MP401W, Pulsar-MP801A, Pulsar-MP801W, Quasar-20CA, Quasar-20CW, Quasar-30CA, Quasar-30CW, Quasar-40CA, Quasar-40CW |                 |        |



1

|                    |  |                 |        |
|--------------------|--|-----------------|--------|
| <b>GEV No.</b>     | 695207   | <b>Ref. No.</b> | 400057 |
| <b>description</b> | bracket  |                 |        |
| <b>For models:</b> | Quasar-130CA, Quasar-130CW, Quasar-40SCA, Quasar-40SCW, Quasar-50CA, Quasar-50CW, Quasar-60CA, Quasar-60CW, Quasar-90CA, Quasar-90CW, Quasar-MQ200A, Quasar-MQ200W |                 |        |



1

|                    |   |                 |        |
|--------------------|---|-----------------|--------|
| <b>GEV No.</b>     | 695216  | <b>Ref. No.</b> | 300363 |
| <b>description</b> | collecting pipe   |                 |        |
| <b>For models:</b> | Alfa-NDP20A, Alfa-NDP20W, Alfa-NG110A, Alfa-NG110W, Alfa-NG150A, Alfa-NG150W, Alfa-NG35A, Alfa-NG35W, Alfa-NG45A, Alfa-NG45W, Alfa-NG60A, Alfa-NG60W, Alfa-NG80A, Alfa-NG80W, Delta-DP140A, Delta-DP140W, Delta-DP30A, Delta-DP30W, Delta-DP45A, Delta-DP45W, Delta-DP60A, Delta-DP60W, Delta-DP80A, Delta-DP80W, Delta-DP90A, Delta-DP90W, Delta-NG110A, Delta-NG110W, Delta-NG150A, Delta-NG150W, Delta-NG30A, Delta-NG30W, Delta-NG35A, Delta-NG35W, Delta-NG45A, Delta-NG45W, Delta-NG60A, Delta-NG60W, Delta-NG80A, Delta-NG80W, Gala-DP140A, Gala-DP140W, Gala-DP20A, Gala-DP20W, Gala-DP30A, Gala-DP30W, Gala-DP40A, Gala-DP40W, Gala-DP55A, Gala-DP55W... (Other models you can see in the webshop) |                 |        |



1

|                    |  |                 |                |
|--------------------|--|-----------------|----------------|
| <b>GEV No.</b>     | 695289   | <b>Ref. No.</b> | 1103<br>301103 |
| <b>description</b> | overflow pipe L 100mm ø 18mm thickness 1mm   |                 |                |
| <b>For models:</b> | Delta-DP140A, Delta-DP140W, Delta-DP30A, Delta-DP30W, Delta-DP45A, Delta-DP45W, Delta-DP60A, Delta-DP60W, Delta-DP80A, Delta-DP80W, Delta-DP90A, Delta-DP90W, Gala-DP20A, Gala-DP20W, Gala-DP30A, Gala-DP30W, SuperStar-DP140A, SuperStar-DP45A, SuperStar-DP45W, SuperStar-DP60A, SuperStar-DP60W, SuperStar-DP80A, SuperStar-DP80W, SuperStar-DP90A, SuperStar-DP90W |                 |                |



1

|                    |  |                 |               |
|--------------------|--|-----------------|---------------|
| <b>GEV No.</b>     | 695292                                     | <b>Ref. No.</b> | 102<br>301102 |
| <b>description</b> | overflow pipe L 150mm ø 18mm thickness 1mm |                 |               |
| <b>For models:</b> | Gala-DP70A, Gala-DP70W                     |                 |               |

## valves

## intake valves



1

|                    |   |                 |        |
|--------------------|---|-----------------|--------|
| <b>GEV No.</b>     | 695218  | <b>Ref. No.</b> | 205404 |
| <b>description</b> | intake valve thread M14x1 L 190mm ø 30mm connection ø 10mm  |                 |        |
| <b>For models:</b> | Alfa-NG110A, Alfa-NG110W, Alfa-NG150A, Alfa-NG150W, Alfa-NG35A, Alfa-NG35W, Alfa-NG45A, Alfa-NG45W, Alfa-NG60A, Alfa-NG60W, Alfa-NG80A, Alfa-NG80W, Delta-DP140A, Delta-DP140W, Delta-DP90A, Delta-DP90W, Delta-NG110A, Delta-NG110W, Delta-NG150A, Delta-NG150W, Delta-NG35A, Delta-NG35W, Delta-NG45A, Delta-NG45W, Delta-NG60A, Delta-NG60W, Delta-NG80A, Delta-NG80W, Gala-DP140A, Gala-DP140W, Gala-DP90A, Gala-DP90W, Gala-NG110A, Gala-NG110W, Gala-NG150A, Gala-NG150W, Gala-NG35A, Gala-NG35W, Gala-NG40A, Gala-NG40W, Gala-NG45A, Gala-NG45W, Gala-NG55A, Gala-NG55W, Gala-NG60A, Gala-NG60W, Gala-NG70A, Gala-NG70W, Gala-NG80A, Gala-NG80W... (Other models you can see in the webshop) |                 |        |



1

|                    |  |                 |        |
|--------------------|--|-----------------|--------|
| <b>GEV No.</b>     | 694534   | <b>Ref. No.</b> | 205340 |
| <b>description</b> | intake valve with float plastic hose ø 10mm  |                 |        |
| <b>For models:</b> | IceQueen-IQ1100A, IceQueen-IQ1100W, IceQueen-IQ135A, IceQueen-IQ135W, IceQueen-IQ150A, IceQueen-IQ150W, IceQueen-IQ200A, IceQueen-IQ200W, IceQueen-IQ400A, IceQueen-IQ400W, IceQueen-IQ550A, IceQueen-IQ550W, IQ-45A, IQ-45W, IQ-85A, IQ-85W |                 |        |



knobs

producer-specific knobs

ITV



|                        |  |                 |                   |
|------------------------|--|-----------------|-------------------|
| <b>GEV No.</b>         | 110888   | <b>Ref. No.</b> | 220272            |
| <b>description</b>     | knob switch zero mark ø 26mm shaft ø 6x4.6mm shaft flat lower black  |                 |                   |
| <b>For models:</b>     | Delta-DP140A, Delta-DP140W, Delta-DP30A, Delta-DP30W, Delta-DP45A, Delta-DP45W, Delta-DP60A, Delta-DP60W, Delta-DP80A, Delta-DP80W, Delta-DP90A, Delta-DP90W, Gala-DP140A, Gala-DP140W, Gala-DP20A, Gala-DP20W, Gala-DP30A, Gala-DP30W, Gala-DP40A, Gala-DP40W, Gala-DP55A, Gala-DP55W, Gala-DP70A, Gala-DP70W, Gala-DP90A, Gala-DP90W, Pulsar-145A, Pulsar-145W, Pulsar-15A, Pulsar-15W, Pulsar-25A, Pulsar-25W, Pulsar-35A, Pulsar-35W, Pulsar-45A, Pulsar-45W, Pulsar-65A, Pulsar-65W, Pulsar-85A, Pulsar-85W, Pulsar-MP145A, Pulsar-MP145W, RA5, RA5-G, RAB20, Spika-111A, Spika-111W, Spika-33A, Spika-33W, Spika-55A...(Other models you can see in the webshop) |                 |                   |
| <b>accessories for</b> | 110888   |                 |                   |
|                        | <b>GEV No.</b>   | 110135          | <b>Ref. No.</b> — |
|                        | rosette knob up to ø 52mm  |                 |                   |



|                    |   |                 |            |
|--------------------|---|-----------------|------------|
| <b>GEV No.</b>     | 110284  | <b>Ref. No.</b> | 220272/OLD |
| <b>description</b> | knob switch zero mark ø 26mm shaft ø 6x4.6mm shaft flat right white |                 |            |

gaskets

O-rings

EPDM

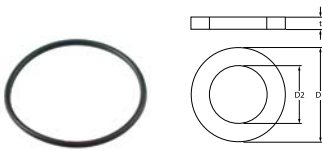

|                    |  |                 |        |
|--------------------|--|-----------------|--------|
| <b>GEV No.</b>     | 532516   | <b>Ref. No.</b> | 210406 |
| <b>description</b> | O-ring EPDM thickness 1.5mm ID ø 30mm Qty 1 pcs  |                 |        |
| <b>For models:</b> | Pulsar-145A, Pulsar-145W, Pulsar-15A, Pulsar-15W, Pulsar-25A, Pulsar-25W, Pulsar-35A, Pulsar-35W, Pulsar-45A, Pulsar-45W, Pulsar-65A, Pulsar-65W, Pulsar-85A, Pulsar-85W, Pulsar-MP145A, Pulsar-MP145W, Pulsar-MP401A, Pulsar-MP401W, Pulsar-MP801A, Pulsar-MP801W |                 |        |

refrigeration cycle components

cooling water regulators

JOHNSON CONTROLS



|                    |  |                 |        |
|--------------------|--|-----------------|--------|
| <b>GEV No.</b>     | 541150   | <b>Ref. No.</b> | 300425 |
| <b>description</b> | cooling water regulator 3/8" type V46AA-9609 connection 7/16" UNF (1/4" SAE) pressure range 5-23bar water pressure max. 10bar water temperature max. 90°C capillary pipe 750mm L 160mm 0.9kg   |                 |        |
| <b>For models:</b> | Delta-DP140W, Gala-DP140W, IceQueen-IQ1100A, IceQueen-IQ1100W, IceQueen-IQ135A, IceQueen-IQ135W, IceQueen-IQ150A, IceQueen-IQ150W, IceQueen-IQ200A, IceQueen-IQ200W, IceQueen-IQ400A, IceQueen-IQ400W, IceQueen-IQ550A, IceQueen-IQ550W, IQ1100, IQ135, IQ150, IQ200, IQ400, IQ550, MDP-150A, MDP-150W, Pulsar-MP145W, Quasar-130CW, Quasar-50CW, Quasar-60CW, Quasar-90CW, Quasar-MQ200W, Spika-111W, Spika-200, Spika-400, Spika-55W |                 |        |

valves

Schrader valves

Schrader valves (complete)



|                    |   |                 |        |
|--------------------|---|-----------------|--------|
| <b>GEV No.</b>     | 750102  | <b>Ref. No.</b> | 300335 |
| <b>description</b> | Schrader valve complete connection 6mm soldering connection   |                 |        |
| <b>For models:</b> | Alfa-NDP20W, Alfa-NG110A, Alfa-NG110W, Alfa-NG150A, Alfa-NG150W, Alfa-NG35A, Alfa-NG35W, Alfa-NG45A, Alfa-NG45W, Alfa-NG60A, Alfa-NG60W, Alfa-NG80A, Alfa-NG80W, Delta-DP140A, Delta-DP140W, Delta-DP30A, Delta-DP30W, Delta-DP45A, Delta-DP45W, Delta-DP60A, Delta-DP60W, Delta-DP80A, Delta-DP80W, Delta-DP90A, Delta-DP90W, Delta-NG110A, Delta-NG110W, Delta-NG150A, Delta-NG150W, Delta-NG30A, Delta-NG30W, Delta-NG35A, Delta-NG35W, Delta-NG45A, Delta-NG45W, Delta-NG60A, Delta-NG60W, Delta-NG80A, Delta-NG80W, Gala-DP140A, Gala-DP140W, Gala-DP20A, Gala-DP20W, Gala-DP30A, Gala-DP30W, Gala-DP40A, Gala-DP40W, Gala-DP55A, Gala-DP55W, Gala-DP70A...(Other models you can see in the webshop) |                 |        |

filter driers

miscellaneous



|                    |  |                 |        |
|--------------------|--|-----------------|--------|
| <b>GEV No.</b>     | 750045   | <b>Ref. No.</b> | 200449 |
| <b>description</b> | dryer size 20g ø 18.8mm L 144mm connection 6,5/6,5mm type Q20-Q50  |                 |        |
| <b>For models:</b> | Alfa-NDP20A, Alfa-NDP20W, IQ-45A, IQ-45W, Pulsar-15A, Pulsar-15W, Pulsar-25A, Pulsar-25W, Quasar-130CA, Quasar-20CA, Quasar-20CW, Quasar-30CA, Quasar-30CW, Quasar-40CA, Quasar-40CW, Quasar-40SCA, Quasar-40SCW, Quasar-50CA, Quasar-50CW, Quasar-60CA, Quasar-90CA, Spika-33A, Spika-33W |                 |        |



|                    |   |                 |                |
|--------------------|---|-----------------|----------------|
| <b>GEV No.</b>     | 750047  | <b>Ref. No.</b> | 1717<br>201717 |
| <b>description</b> | dryer size 30g ø 24mm L 143mm connection 6,5/6,5mm type DP20-DP70,DP140   |                 |                |
| <b>For models:</b> | Alfa-NG35A, Alfa-NG35W, Alfa-NG45A, Alfa-NG45W, Alfa-NG60A, Alfa-NG60W, Alfa-NG80A, Alfa-NG80W, Delta-DP140A, Delta-DP140W, Delta-DP30A, Delta-DP30W, Delta-DP45A, Delta-DP45W, Delta-DP60A, Delta-DP60W, Delta-DP80A, Delta-DP80W, Delta-NG30A, Delta-NG30W, Delta-NG35A, Delta-NG35W, Delta-NG45A, Delta-NG45W, Delta-NG60A, Delta-NG60W, Delta-NG80A, Delta-NG80W, Gala-DP140A, Gala-DP20A, Gala-DP30A, Gala-DP40A, Gala-DP55A, Gala-DP70A, Gala-DP90W, Gala-NG30A, Gala-NG30W, Gala-NG35A, Gala-NG35W, Gala-NG45A, Gala-NG45W, Gala-NG55A, Gala-NG55W, Gala-NG60A, Gala-NG60W, Gala-NG70W, Gala-NG80A, Gala-NG80W, IceQueen-IQ135A, IceQueen-IQ135W...(Other models you can see in the webshop) |                 |                |



|                    |  |                 |                |
|--------------------|--|-----------------|----------------|
| <b>GEV No.</b>     | 750048   | <b>Ref. No.</b> | 1096<br>201096 |
| <b>description</b> | dryer size 40g ø 24mm L 175mm connection 6,5/6,5mm type D90,Q130   |                 |                |
| <b>For models:</b> | Alfa-NG110A, Alfa-NG110W, Delta-DP90A, Delta-DP90W, Delta-NG110A, Delta-NG110W, Gala-DP140W, Gala-DP20W, Gala-DP30W, Gala-DP40W, Gala-DP55W, Gala-DP70W, Gala-DP90A, Gala-NG110A, Gala-NG110W, Gala-NG90A, Gala-NG90W, IceQueen-IQ400A, IceQueen-IQ400W, IQ400, NG110A, NG110W, Pulsar-MP145A, Pulsar-MP145W, Quasar-130CA, Quasar-130CW, Quasar-MQ200A, Quasar-MQ200W, SuperStar-DP90A, SuperStar-DP90W, SuperStar-NG110A, SuperStar-NG110W |                 |                |

evaporators

for ice-cube maker

for ice cube maker



|                    |  |                 |        |
|--------------------|--|-----------------|--------|
| <b>GEV No.</b>     | 750110   | <b>Ref. No.</b> | 407643 |
| <b>description</b> | evaporator for ice-cube maker 12 cubes L 334mm W 115mm H 45mm Gala DP 20 |                 |        |



|                    |  |                 |        |
|--------------------|--|-----------------|--------|
| <b>GEV No.</b>     | 750111   | <b>Ref. No.</b> | 407645 |
| <b>description</b> | evaporator for ice-cube maker 18 cubes L 334mm W 160mm H 45mm Gala DP 30 |                 |        |
| <b>For models:</b> | Gala-DP20A, Gala-DP20W, Gala-DP30A, Gala-DP30W                           |                 |        |



  
Image not available  
1

|                    |   |                 |        |
|--------------------|---|-----------------|--------|
| <b>GEV No.</b>     | 750116                                    | <b>Ref. No.</b> | 407660 |
| <b>description</b> | evaporator for ice-cube maker Gala DP 140 |                 |        |
| <b>For models:</b> | Gala-DP140A, Gala-DP140W                  |                 |        |

  
Image not available  
1

|                    |  |                 |        |
|--------------------|--|-----------------|--------|
| <b>GEV No.</b>     | 750112                                   | <b>Ref. No.</b> | 407648 |
| <b>description</b> | evaporator for ice-cube maker Gala DP 40 |                 |        |
| <b>For models:</b> | Gala-DP40A, Gala-DP40W                   |                 |        |

  
Image not available  
1

|                    |  |                 |        |
|--------------------|--|-----------------|--------|
| <b>GEV No.</b>     | 750113                                   | <b>Ref. No.</b> | 407651 |
| <b>description</b> | evaporator for ice-cube maker Gala DP 55 |                 |        |
| <b>For models:</b> | Gala-DP55A, Gala-DP55W                   |                 |        |

  
Image not available  
1

|                    |  |                 |        |
|--------------------|--|-----------------|--------|
| <b>GEV No.</b>     | 750114                                   | <b>Ref. No.</b> | 407654 |
| <b>description</b> | evaporator for ice-cube maker Gala DP 70 |                 |        |
| <b>For models:</b> | Gala-DP70A, Gala-DP70W                   |                 |        |



1

|                    |  |                 |        |
|--------------------|--|-----------------|--------|
| <b>GEV No.</b>     | 750115                                   | <b>Ref. No.</b> | 407657 |
| <b>description</b> | evaporator for ice-cube maker Gala DP 90 |                 |        |
| <b>For models:</b> | Gala-DP90A, Gala-DP90W                   |                 |        |

  
Image not available  
1

|                    |   |                 |        |
|--------------------|---|-----------------|--------|
| <b>GEV No.</b>     | 750145                                    | <b>Ref. No.</b> | 307094 |
| <b>description</b> | evaporator for ice-cube maker Quasar Q130 |                 |        |
| <b>For models:</b> | Quasar-130CA, Quasar-130CW                |                 |        |



1

|                    |  |                 |        |
|--------------------|--|-----------------|--------|
| <b>GEV No.</b>     | 750140   | <b>Ref. No.</b> | 307106 |
| <b>description</b> | evaporator for ice-cube maker Quasar Q20/Q30 L 270mm W 158mm H 65mm 15 cubes |                 |        |
| <b>For models:</b> | Quasar-20CA, Quasar-20CW, Quasar-30CA, Quasar-30CW                           |                 |        |

  
Image not available  
1

|                    |  |                 |        |
|--------------------|--|-----------------|--------|
| <b>GEV No.</b>     | 750141                                   | <b>Ref. No.</b> | 307108 |
| <b>description</b> | evaporator for ice-cube maker Quasar Q40 |                 |        |
| <b>For models:</b> | Quasar-40CA, Quasar-40CW                 |                 |        |



1

|                    |  |                 |        |
|--------------------|--|-----------------|--------|
| <b>GEV No.</b>     | 750142   | <b>Ref. No.</b> | 307091 |
| <b>description</b> | evaporator for ice-cube maker Quasar Q40S/Q50        |                 |        |
| <b>For models:</b> | Quasar-40SCA, Quasar-40SCW, Quasar-50CA, Quasar-50CW |                 |        |



1

|                    |  |                 |        |
|--------------------|--|-----------------|--------|
| <b>GEV No.</b>     | 750143                                   | <b>Ref. No.</b> | 307092 |
| <b>description</b> | evaporator for ice-cube maker Quasar Q60 |                 |        |
| <b>For models:</b> | Quasar-60CA, Quasar-60CW                 |                 |        |



1

|                    |  |                 |        |
|--------------------|--|-----------------|--------|
| <b>GEV No.</b>     | 750144   | <b>Ref. No.</b> | 307093 |
| <b>description</b> | evaporator for ice-cube maker Quasar Q90               |                 |        |
| <b>For models:</b> | Quasar-90CA, Quasar-90CW, Quasar-MQ200A, Quasar-MQ200W |                 |        |

drive belts

round belts



1

|                    |  |                 |        |
|--------------------|--|-----------------|--------|
| <b>GEV No.</b>     | 695299   | <b>Ref. No.</b> | 110623 |
| <b>description</b> | round belt ø 6mm L 1280mm ITV                    |                 |        |
| <b>For models:</b> | Pulsar-145A, Pulsar-145W, Pulsar-85A, Pulsar-85W |                 |        |



1

|                    |  |                 |        |
|--------------------|--|-----------------|--------|
| <b>GEV No.</b>     | 695277   | <b>Ref. No.</b> | 110629 |
| <b>description</b> | round belt ø 6mm L 720mm   |                 |        |
| <b>For models:</b> | Pulsar-15A, Pulsar-15W, Pulsar-MP145A, Pulsar-MP145W, Pulsar-MP401A, Pulsar-MP401W, Pulsar-MP801A, Pulsar-MP801W |                 |        |



1

|                    |  |                 |        |
|--------------------|--|-----------------|--------|
| <b>GEV No.</b>     | 695278   | <b>Ref. No.</b> | 110622 |
| <b>description</b> | round belt ø 6mm L 850mm                       |                 |        |
| <b>For models:</b> | Pulsar-25A, Pulsar-25W, Pulsar-65A, Pulsar-65W |                 |        |



1

|                    |  |                 |        |
|--------------------|--|-----------------|--------|
| <b>GEV No.</b>     | 695298   | <b>Ref. No.</b> | 110624 |
| <b>description</b> | round belt ø 6mm L 940mm ITV                   |                 |        |
| <b>For models:</b> | Pulsar-35A, Pulsar-35W, Pulsar-45A, Pulsar-45W |                 |        |

transmission technology and ball bearings

ball bearings

miscellaneous



1

|                    |  |                 |        |
|--------------------|--|-----------------|--------|
| <b>GEV No.</b>     | 523544   | <b>Ref. No.</b> | 205097 |
| <b>description</b> | ball bearing shaft ø 12mm ED ø 35mm W 31.5mm with shaft adapter  |                 |        |
| <b>For models:</b> | Pulsar-145A, Pulsar-145W, Pulsar-15A, Pulsar-15W, Pulsar-25A, Pulsar-25W, Pulsar-35A, Pulsar-35W, Pulsar-45A, Pulsar-45W, Pulsar-65A, Pulsar-65W, Pulsar-85A, Pulsar-85W, Pulsar-MP145A, Pulsar-MP145W, Pulsar-MP401A, Pulsar-MP401W, Pulsar-MP801A, Pulsar-MP801W |                 |        |





## fastening material

### screws

#### countersunk screws

|   |  |                 |        |
|---|--|-----------------|--------|
|  |  |                 |        |
| 1   |  |                 |        |
| <b>GEV No.</b>  | 695204   | <b>Ref. No.</b> | 230248 |
| <b>description</b>  | screw thread M5 L 16mm SS DIN 965/ISO 7046 Qty 1 pcs head ø 9mm              |                 |        |
| <b>For models:</b>  | Quasar-20CA, Quasar-20CW, Quasar-30CA, Quasar-30CW, Quasar-40CA, Quasar-40CW |                 |        |

### fasteners

#### cotter pins

|  |  |                 |        |
|--|--|-----------------|--------|
|  |  |                 |        |
| 1  |  |                 |        |
| <b>GEV No.</b>   | 695209   | <b>Ref. No.</b> | 100267 |
| <b>description</b>   | cotter pin ø 2mm L 20mm SS   |                 |        |
| <b>For models:</b>   | Pulsar-145A, Pulsar-145W, Pulsar-15A, Pulsar-15W, Pulsar-25A, Pulsar-25W, Pulsar-35A, Pulsar-35W, Pulsar-45A, Pulsar-45W, Pulsar-65A, Pulsar-65W, Pulsar-85A, Pulsar-85W, Pulsar-MP145A, Pulsar-MP145W, Pulsar-MP401A, Pulsar-MP401W, Pulsar-MP801A, Pulsar-MP801W, Quasar-130CA, Quasar-130CW, Quasar-40SCA, Quasar-40SCW, Quasar-50CA, Quasar-50CW, Quasar-60CA, Quasar-60CW, Quasar-90CA, Quasar-90CW, Quasar-MQ200A, Quasar-MQ200W |                 |        |



**C**

|                          |    |
|--------------------------|----|
| compressors              | 9  |
| contactors               | 5  |
| cooling water regulators | 29 |
| cotter pins              | 33 |
| countersunk screws       | 33 |

**D**

|             |    |
|-------------|----|
| drain pumps | 16 |
|-------------|----|

**E**

|                      |    |
|----------------------|----|
| electric accessories | 18 |
| evaporators          | 30 |

**F**

|                    |    |
|--------------------|----|
| fans               | 13 |
| fasteners          | 33 |
| fastening material | 33 |
| filter driers      | 30 |
| float switches     | 4  |

**M**

|               |    |
|---------------|----|
| microswitches | 3  |
| motors        | 14 |

**O**

|         |    |
|---------|----|
| O-rings | 29 |
|---------|----|

**P**

|                        |    |
|------------------------|----|
| pressure switches      | 8  |
| probes                 | 5  |
| programme timers       | 4  |
| pumps                  | 16 |
| pumps for ice machines | 16 |

**R**

|                                |    |
|--------------------------------|----|
| refrigeration cycle components | 29 |
| refrigeration fans             | 13 |
| refrigeration motors universal | 13 |
| refrigeration thermostats      | 3  |
| relays                         | 5  |

**S**

|                                 |    |
|---------------------------------|----|
| Schrader valves                 | 29 |
| screws                          | 33 |
| solenoid valves                 | 5  |
| switches and momentary switches | 3  |

**T**

|                    |    |
|--------------------|----|
| temperature probes | 5  |
| terminals          | 18 |
| thermostats        | 3  |

|             |   |
|-------------|---|
| time relays | 5 |
| timers      | 4 |

**U**

|                  |   |
|------------------|---|
| universal probes | 5 |
|------------------|---|