



GAS COMPONENTS



ELECTRIC COMPONENTS



WATER TECHNOLOGY



MECHANICAL COMPONENTS



TOOLS

Spare parts suitable for

IBERITAL-MACCHINE

Find the complete and up-to-date range of products in our GEV Webshop



Manufacturer catalogue

The most important spare parts and accessories arranged clearly for every manufacturer

- ✓ Complete product range and all appliance data always up to date in the GEV Webshop
- ✓ Alphabetical Index at the end of the catalogue

GEV Webshop

www.gev-online.co.uk

www.gev-online.com







- 🔍 Add to Favourites
- 🔍 Sign In with email address and usual password
- 🔍 Easy-order – place several items in your basket at the same time
- 🔍 Quick Item search – no login needed





heating elements

heating elements for coffee machine

			
1			
GEV No.	417258	Ref. No.	9938
description	heating element 1800/1960W 230/240V heating circuits 3 mounting \varnothing 38.5mm hole distance 68mm L 184mm W 30mm H 28mm hole \varnothing 11mm length thermostat sleeves 156mm thermostat sleeves \varnothing 6mm number of thermostat sleeves 1 thermostat sleeve centred, adjacent tube \varnothing 8.3mm connection M4 immersion heater 3 hole flange		
			
1			
GEV No.	417496	Ref. No.	2415
description	heating element 2600W 220V heating circuits 2 mounting \varnothing 37mm hole distance 52mm L 415mm W 30mm H 58mm L1 25mm L2 50mm L3 340mm H1 25mm H2 28mm hole \varnothing 10mm tube \varnothing 8mm connection male faston 6.3mm immersion heater		
			
1			
GEV No.	417260	Ref. No.	9939
description	heating element 2600W 230V heating circuits 2 mounting \varnothing 38.5mm hole distance 58mm L 385mm W 40mm H 46mm L1 25mm L2 45mm L3 315mm H1 26mm H2 20mm hole \varnothing 11mm tube \varnothing 8mm thermostat sleeves \varnothing 6.5mm length thermostat sleeves 191mm thermostat sleeve centred, adjacent number of thermostat sleeves 1 connection M6 immersion heater 3 hole flange		
			
1			
GEV No.	417261	Ref. No.	9941
description	heating element 3700W 230V heating circuits 2 mounting \varnothing 38.5mm hole distance 56mm L 580mm W 39mm H 45mm L1 22mm L2 36mm L3 520mm H1 25mm H2 20mm hole \varnothing 11mm tube \varnothing 8mm thermostat sleeves \varnothing 6.5mm length thermostat sleeves 191mm thermostat sleeve centred, adjacent number of thermostat sleeves 1 connection M6 immersion heater 3 hole flange		
			
1			
GEV No.	417259	Ref. No.	9940
description	heating element 3800W 230V heating circuits 3 mounting \varnothing 38.5mm hole distance 58mm L 388mm W 33mm H 34mm hole \varnothing 11mm length thermostat sleeves 195mm thermostat sleeves \varnothing 6mm number of thermostat sleeves 1 thermostat sleeve centred, adjacent tube \varnothing 8mm connection M4 immersion heater 3 hole flange		

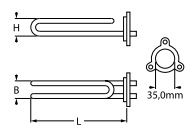

immersion heating elements

3 hole flange \varnothing 35.0mm

 			
1			
GEV No.	416211	Ref. No.	23361
description	heating element 2700W 230V heating circuits 1 mounting \varnothing 35mm L 300mm W 25mm H 24mm tube \varnothing 6.3mm hole distance 44mm hole \varnothing 10mm connection male faston 6.3mm immersion heater 3 hole flange connection length 15mm		
accessories for	416211		
	GEV No.	507048	Ref. No.
			—
description	gasket ID \varnothing 30mm silicone thickness 3mm hole \varnothing 10mm hole distance 41mm for heating element warewashing		

accessories



flange gaskets

			
1			
GEV No.	528013	Ref. No.	11374
description	gasket ID \varnothing 40mm fibre thickness 4mm hole \varnothing 11mm hole distance 57mm for heating element coffee machine parts		
			
1			
GEV No.	528012	Ref. No.	6671
description	gasket suitable for VIBIEMME for heating element		

thermostats

bi-metal thermostats

bi-metal thermostats

			
1			
GEV No.	390450	Ref. No.	5299
description	bi-metal thermostat hole distance 25mm switch-off temp. 66/57°C NC/NO 2-pole 16A connection F6.3		
accessories for	390450		
	GEV No.	505093	Ref. No.
			—
description	gasket for thermostat ED \varnothing 35mm ID \varnothing 24mm thickness 7mm equiv. no. N503017		



control and safety thermostats

EGO

safety thermostats

55.13_ series



1

GEV No.	375898	Ref. No.	19433
description	safety thermostat switch-off temp. 140°C 1-pole 16A probe ø 4mm probe L 125mm capillary pipe 900mm capillary pipe isolated 420mm gland nut probe		



1

GEV No.	390804	Ref. No.	43261
description	safety thermostat switch-off temp. 340°C 1-pole 1NC 16A probe ø 3mm probe L 160mm capillary pipe 870mm capillary pipe isolated 600mm gland nut probe connection male faston 6.3mm		

55.32_ series



1

GEV No.	390324	Ref. No.	10028 16508
description	safety thermostat switch-off temp. 169°C 3-pole 3NC 20A probe ø 4mm probe L 128mm capillary pipe 890mm capillary pipe isolated 210/210mm gland nut probe SS		

switches and momentary switches

rocker/momentary rocker switches

30x22mm



1

GEV No.	301002	Ref. No.	6952
description	rocker switch mounting measurements 30x22mm orange 2NO 250V 16A illuminated 0-I connection male faston 6.3mm ambient temperature max. 85/125°C protection IP65		
accessories for	301002		
	GEV No.	301036	Ref. No. —
	protective cover internal size 30x22mm for rocker switch mounting measurementsmm		



1

GEV No.	301060	Ref. No.	5828
description	rocker switch mounting measurements 30x22mm red 2NO 250V 16A illuminated connection male faston 6.3mm ambient temperature max. 125/55°C protection IP40		

push/momentary push switches

19x13mm



1

GEV No.	347377	Ref. No.	19078
description	momentary push switch mounting measurements 19x13mm red 2NO 250V 16A ambient temperature max. 125°C protection IP40		

ø25mm



1

GEV No.	345151 ¹	Ref. No.	1660
description	push switch mounting ø 25mm orange 2NO 250V 16A illuminated connection male faston 6.3mm ambient temperature max. 85°C protection IP40		

¹illuminated

miscellaneous



1

GEV No.	347317	Ref. No.	9420
description	microswitch mounting measurements 12x15mm black 1NO 240V 4A connection soldering connection ambient temperature max. 85°C protection IP40		



microswitches

roller actuated

roller 90°



GEV No.	345104	Ref. No.	399
description	microswitch with roller plunger 250V 16A 1CO connection male faston 6.3mm L 24mm ambient temperature max. 125°C thread L 12mm thread M10x0.75 mounting distance 22mm actuating force: 280g type EF83161.1		

cam switches

on/off



GEV No.	300021	Ref. No.	40704
description	cam switch 4 operating positions 4NO sequence 0-1-0-1 16A shaft ø 6x4.6mm shaft L 23mm connection screw ceramic		

rotary switches

GIOVENZANA

rotary switches



GEV No.	347975	Ref. No.	9177
description	rotary switch 3 0-1-2 sets of contacts 3 type P106 690V 20A shaft ø 5x5mm shaft L 15mm shaft square connection screw		

GOTTAK



GEV No.	347380	Ref. No.	11255
description	rotary switch 3 0-1-2 sets of contacts 2 400V 16A shaft ø 6x4.6mm shaft L 22mm shaft oval connection male faston 6.3mm		



GEV No.	345148	Ref. No.	2877
description	rotary switch 3 0-1-2 sets of contacts 6 type 4RH 400V 10A shaft ø 4.8x6mm shaft L 21mm shaft oval connection male faston 6.3mm		



GEV No.	347378	Ref. No.	24989
description	rotary switch 4 0-1-2-3 sets of contacts 4 400V 16A shaft ø 6x4.6mm shaft L 22mm shaft oval connection male faston 6.3mm		

TELERGON



GEV No.	347693	Ref. No.	43294
description	rotary switch 2 0-1 sets of contacts 1 type T-0002000011E1N1 300V 20A shaft ø 5x5mm shaft L 15mm shaft square with knob connection screw clamp		



GEV No.	347479	Ref. No.	1430
description	rotary switch 3 0-1-2 sets of contacts 6 type T-0002021589 400V 20A shaft ø 5x5mm shaft L 15mm connection screw TELERGON		

lamps

indicator lights

indicator lights (complete)

ø10mm

with plug-in socket



GEV No.	359139	Ref. No.	19457
description	indicator light ø 10mm green 230V connection male faston 6.3mm Qty 1 pcs		



			
1			
GEV No.	359138	Ref. No.	19458
description	indicator light ø 10mm red 230V connection male faston 6.3mm Qty 1 pcs		

ø13mm
with screw socket

			
1			
GEV No.	357125	Ref. No.	43040
description	indicator light ø 13mm red 400V connection screw clamp		



miscellaneous

			
1			
GEV No.	357124	Ref. No.	43292
description	indicator light green/red 230V connection screw		



1			
GEV No.	360011	Ref. No.	6363
description	timer CEM HH3M16 engines 1 chambers 3 operation time 120s 230V manuf. no. HH3M16 / 120225 motor type UDS40NE1RNZ165		
spare parts for	360011		
	GEV No.	360112	Ref. No. —
	motor SAIA pinion ø 4mm teeth 12 230V turn direction right motor ø 48mm motor type UDS11NE1RHZ for timer		



1			
GEV No.	360271	Ref. No.	14472
description	timer FIBER P25 engines 2 chambers 5 operation time 6s / 2min 230V shaft ømm shaft Lmm manuf. no. P25J05JDN7 motor type M51BJ0R6400 / M51BJ0L6400		
spare parts for	360271		
	GEV No.	360673	Ref. No. —
	motor kit pinion ø 6.8mm teeth 15 230V voltage AC 50/60Hz turn direction clockwise motor ø 48mm H 18.5mm motor type UDS-40NE1RNZ165 cable length 150mm with holder		
	GEV No.	360674	Ref. No. —
	motor kit pinion ø 6.8mm teeth 15 230V voltage AC 50/60Hz turn direction counterclockwise motor ø 48mm H 18.5mm motor type UDS40NE1RNZ165 cable length 150mm with holder		

timers

programme timers





1			
GEV No.	360048	Ref. No.	13588
description	timer CDC 4904DV/4905DV engines 2 chambers 5 operation time 4s / 180s 230V shaft ømm shaft Lmm motor type M48L ATS		
spare parts for	360048		
	GEV No.	360083	Ref. No. —
	motor CDC pinion ø 4.9mm teeth 10 230V turn direction left motor ø 47mm H 19.3mm motor type M48L ATS for timer		



1			
GEV No.	361355	Ref. No.	14343
description	timer CDC 7804DV engines 2 chambers 4 operation time 6s / 3min 230V shaft ømm shaft Lmm motor type M37RN/M37LN		

mechanical timers



1			
GEV No.	350176	Ref. No.	10560
description	timer C20 2-pole operation time 5min 2NO at 250V 16A permanent position no shaft ø 6x4.6mm shaft 6x4.6mm shaft L 20mm mounting distance 28mm		
accessories for	350176		
	GEV No.	110366	Ref. No. —
	knob switch zero mark t.max. °C ø 44mm shaft ø 6x4.6mm shaft flat upper black		
	GEV No.	112138	Ref. No. —
	dial plate graduation 5min permanent position no rotation 0-290° ø 60mm		



contactors

LS Industrial Systems

power contactors



1

GEV No.	380922	Ref. No.	19036
description	power contactor resistive load 20A 230VAC (AC3/400V) 5A/2.2kW main contacts 3NO auxiliary contacts 1NO connection screw connection type GMC-6M		



1

GEV No.	380923	Ref. No.	19428 (old version)
description	power contactor resistive load 25A 230VAC (AC3/400V) 18A/7.5kW main contacts 4NO connection screw connection type GMC-18/4		



1

GEV No.	380924	Ref. No.	13353 19428
description	power contactor resistive load 32A 230VAC (AC3/400V) 22A/11kW main contacts 4NO connection screw connection type UKC1-22/KR4S		

GENERAL ELECTRIC (AEG)

power contactors



1

GEV No.	380846	Ref. No.	8736
description	contactor resistive load 16A 230VAC (AC3/400V) 9A/4kW main contacts 3NO auxiliary contacts 1NC connection male faston 6.3mm type AEG LS05 01A type GE MC1A 301A		

ALLEN BRADLEY

power contactors



1

GEV No.	380458	Ref. No.	8365
description	power contactor resistive load 20A 230VAC (AC3/400V) 9A/4kW main contacts 3NO auxiliary contacts 1NO connection screw connection type 100-K09KF10		

solid state relays

CELDUC



1

GEV No.	400521	Ref. No.	19030
description	solid state relay CELDUC 2 phase 50A 400V 10-30VDC L 58mm W 45mm screw type SCB965600 10-30VDC		

relays

power relays

with DIN rail mounting

lateral



1

GEV No.	380379	Ref. No.	6690
description	power relays SCHRACK 230VAC 25A 2CO connection male faston 6.3mm DIN rail manuf. no. RM809730		



level relays

GICAR



1

GEV No.	402103	Ref. No.	9625
description	level controller 230/240V voltage AC 50/60Hz connection F6.3 type NRL30/1E-2C/F		



1

GEV No.	528636	Ref. No.	13391
description	level controller 230V voltage AC 50/60Hz 16/5A connection F6.3 type RL30 MICRO ST		



1

GEV No.	402623	Ref. No.	21475
description	level controller 230V voltage AC 50/60Hz type 30μZ 3L S.T.		

miscellaneous



1

GEV No.	400264	Ref. No.	7145
description	level relay 230V		

probes

producer-specific probes

probes



1

GEV No.	525376	Ref. No.	13375
description	temperature probe NTC cable PVC probe -40 up to +110°C cable -10 up to 100°C connection plug thread 1/4" probe ø8x20mm cable length 0.37m		

keypads

front foils



1

GEV No.	525373	Ref. No.	19441
description	keypad foil black/silver suitable for IBERITAL L 27mm W 103mm buttons 5		



1

GEV No.	525374	Ref. No.	19092
description	keypad foil black/yellow suitable for FAEMA L 107mm W 51mm buttons 5		



1

GEV No.	525212	Ref. No.	19025
description	keypad foil silver/black suitable for IBERITAL L 103mm W 27mm buttons 5		

membrane keypads



1

GEV No.	400509	Ref. No.	9998
description	membrane keypad coffee machine IBERITAL L 103mm W 27mm		



1

GEV No.	401408	Ref. No.	21934
description	membrane keypad coffee machine parts buttons 6 suitable for FAEMA L 176mm W 49mm		



1

GEV No.	402635	Ref. No.	11641
description	membrane keypad suitable for IBERITAL L 110mm W 30mm		





			
1			
GEV No.	402634	Ref. No.	19093
description	membrane keypad suitable for IBERITAL L 110mm W 55mm		

keypad units

			
1			
GEV No.	400226	Ref. No.	21476 21960
description	keypad unit buttons 5		

			
1			
GEV No.	402628	Ref. No.	11361
description	keypad unit buttons 5 black type TH SMT 1GR+RL lighting LED 230V L 120mm W 50mm		

			
1			
GEV No.	402626	Ref. No.	19424
description	keypad unit buttons 5 black/silver type 1d5e GRCZ NKP S10 lighting LED 230V L 117mm W 46mm		

			
1			
GEV No.	402627	Ref. No.	13349
description	keypad unit buttons 5 black/silver type 1d5e GRCZ NKP S10 lighting LED 230V L 117mm W 46mm with jumpers		

			
1			
GEV No.	402624	Ref. No.	9997
description	keypad unit buttons 5 black/silver type TH SMT 1GR+TEA 230V		

			
1			
GEV No.	402636	Ref. No.	19042
description	keypad unit buttons 5 black/white type TH SMT 1GR+RL 230V L 120mm W 50mm with jumper		

			
1			
GEV No.	402632	Ref. No.	21451
description	keypad unit buttons 5 black/yellow type 1d5e GRCZ NKP S10 no c/m 230V L 120mm W 50mm with jumper		

			
1			
GEV No.	402631	Ref. No.	21981
description	keypad unit buttons 5 black/yellow type 1d5e GRCZ NKP S10 no c/m 230V L 132mm W 64mm		

			
1			
GEV No.	400441	Ref. No.	11440
description	keypad unit buttons 5 L 91mm W 51mm		

			
1			
GEV No.	402630	Ref. No.	19439
description	keypad unit buttons 5 type 1d5e GRCZ NKP S10 230V L 120mm W 50mm with jumper		

			
1			
GEV No.	402629	Ref. No.	13381
description	keypad unit buttons 5 type 1d5e GRCZ NKP S10 lighting LED 230V L 120mm W 50mm		



1

GEV No.	400354	Ref. No.	7633
description	keypad unit coffee machine AIRY/ATLAS/COMBI NOVA/JUNIOR buttons 5		





1

GEV No.	402633	Ref. No.	21769
description	keypad unit temperature controller type CONTROL d, SSR HEATING C/L		

spare parts for 370057

	GEV No.	371029	Ref. No.	—
solenoid coil PARKER 230VAC 9VA coil type ZB09 seat ø 14mm H 33mm W 34mm D 43mm				

accessories for 370057

	GEV No.	371090	Ref. No.	—
power socket plug type DIN 43650A screw				
	GEV No.	371095	Ref. No.	—
O-ring Viton thickness 1.78mm ID ø 6.07mm Qty 1 pcs				
	GEV No.	371100	Ref. No.	—
O-ring silicone thickness 1.78mm ID ø 6.07mm Qty 1 pcs				

pressure switches for coffee machines

ø 38mm



1

GEV No.	541104	Ref. No.	21463
description	pressure control ø 38mm pressure range 0.2-1.2bar 10A 250V connection male faston 6.3mm 1CO pressure connection 1/4"		

electrodes



1

GEV No.	401363	Ref. No.	21480
description	level electrode 1/4" total length 110mm probe L 85mm insulated probe length 26mm connection male faston 6.3mm stainless steel ø 2.5mm		



1

GEV No.	401157	Ref. No.	5277
description	level electrode 1/4" total length 150mm probe L 122mm insulated probe length 26mm connection male faston 6.3mm stainless steel ø 2.5mm		



1

GEV No.	400404	Ref. No.	21479
description	level electrode 1/4" total length 240mm probe L 216mm insulated probe length 209mm PTFE insulated connection angled, male faston 6.3mm stainless steel ø 2.5mm		

solenoid valves

solenoid valves (water)

metal

M&M

2-way

D267 series



1

GEV No.	370598	Ref. No.	19072
description	solenoid valve brass 2-ways 230VAC inlet 1/4" outlet 1/4" connection 1/4" slide-on receptacle DIN -10 up to 180°C M&M type series D267 coil type 7701 membranes PTFE (steam) p max 9bar p min 0bar voltage 50/60		

PARKER

3-way

VE-128 series



1

GEV No.	370057	Ref. No.	8259	
description	solenoid valve 3-ways 230VAC body outer cone DN 1.2mm slide-on receptacle DIN -20° up to 140°C PARKER type series VE-128 coil type ZB09 membranes ruby p max 10bar brass flange 32x32mm			
spare parts for	370057			
	GEV No.	370062	Ref. No.	—
solenoid valve body PARKER 3-ways outer cone				



flow meters and flow sensors

flow meters

GICAR



1

GEV No. 541750 **Ref. No.** 21456

description flow meter hose ø 7mm plastic approval NSF

motors

motors

for ice-cube maker

complete



1

GEV No. 500793 **Ref. No.** 23735

description motor with belt pulley 120W 230V 50/60Hz 1 phase shaft ø 10mm 1390/1600rpm type RM63/50 ø 90mm H 160mm REBO 0.12kW

spare parts for 500793

	GEV No. 695279	Ref. No.	—
round belt pulley disc ø 49mm single shaft intake ø 10mm groove depth 5mm disc width 12mm groove width 10mm overall width 19mm shaft ø 18mm			

pumps

wash and rinse pumps

ALBA (C&A)

pumps







1





GEV No. 500299 **Ref. No.** 17240

description pump inlet ø 28mm outlet ø 28mm type C9035X 230V 50Hz 1 phase 0.11kW 0.15HP L 200mm rotation direction right capacitor 6.3µF ALBA PUMPS (C&A)

spare parts for 500299

	GEV No. 365012	Ref. No.	—
operating capacitor capacity 6.3µF 450V tolerance 5% 50Hz ambient temperature max. -25 to +85°C ø 30mm L 61mm M8 plastic connection male faston 6.3mm protection			
	GEV No. 510692	Ref. No.	—
mechanical shaft seal for shaft ø 11mm slide ring ext. ø 24mm slide ring H 13mm counter ring mounting ø 26mm height counter ring 8mm counter ring int. ø 14mm			
	GEV No. 521222	Ref. No.	—
impellor ø 72mm H 19mm thread M7L shaft ø 11mm shaft length 29mm blades 3			
	GEV No. 521518	Ref. No.	—
pump cover ALBA PUMPS (C&A) inlet ø 28mm outlet ø 28mm turn direction right ø 93mm ID ø 76mm inner height 31mm			
	GEV No. 532490	Ref. No.	—
O-ring EPDM thickness 2.62mm ID ø 72.69mm Qty 1 pcs			







1			
GEV No.	500938	Ref. No.	4603
description	pump inlet \varnothing 30mm outlet \varnothing 30mm type IM1629030 230V 50Hz 1 phase 0.22kW 0.3HP L 175mm rotation direction right capacitor 10 μ F auxiliary pressure connection 10mm supporting pressure open ALBA PUMPS (C&A)		
spare parts for	500938		
	GEV No.	507065	Ref. No. —
	pump cover		
	GEV No.	509018	Ref. No. —
	O-ring EPDM thickness 3.53mm ID \varnothing 107.5mm Qty 1 pcs		
	GEV No.	509028	Ref. No. —
	impellor \varnothing 87mm H 21mm rotation direction right thread M7L shaft \varnothing 12mm		
	GEV No.	510693	Ref. No. —
	mechanical shaft seal for shaft \varnothing 12mm slide ring ext. \varnothing 24mm slide ring H 15.5mm slide ring int. \varnothing 11mm counter ring mounting \varnothing 24mm height counter ring 8mm counter ring int. \varnothing 13.5mm		
accessories for	500938		
	GEV No.	365014	Ref. No. —
	operating capacitor capacity 12.5 μ F 450V tolerance 5%Hz ambient temperature max. -25 to +85°C \varnothing 35mm L 70mm M8 plastic connection male faston 6.3mm 45S.C3DS.12.5 protection		

FIR

pumps



1			
GEV No.	500261	Ref. No.	23481
description	pump inlet \varnothing 30mm outlet \varnothing 30mm type 1267.1405 230V 50Hz 1 phase 0.18kW 0.25HP L 180mm rotation direction right capacitor 10 μ F FIR		
spare parts for	500261		
	GEV No.	365015	Ref. No. —
	operating capacitor capacity 10 μ F 400V tolerance 5%Hz ambient temperature max. -25 to +85°C \varnothing 35.5mm L 59mm M8 plastic connection male faston 6.3mm protection		
	GEV No.	510605	Ref. No. —
	impellor \varnothing 80mm H 21mm M7L		
	GEV No.	510702	Ref. No. —
	mechanical shaft seal height counter ring 5.5mm ID \varnothing 12mm		
	GEV No.	521571	Ref. No. —
	pump cover FIR inlet \varnothing 30mm outlet \varnothing 30mm turn direction right \varnothing 128mm ID \varnothing 100mm inner height 21mm		
	GEV No.	521701	Ref. No. —
	pump cover gasket		





LGB





1	GEV No.	500153	Ref. No.	14812
	description	pump inlet ø outlet ø type W180SX 230V 50Hz 1 phase 0.19kW 0.26HP L 220mm rotation direction right capacitor 5µF LGB		
	spare parts for	500153		
	GEV No.	365017	Ref. No.	—
	description	operating capacitor capacity 5µF 450V tolerance 5% 50/60Hz ambient temperature max. -25 to +85°C ø 28mm L 54mm M8 plastic connection male faston 6.3mm 16.10.08 protection		
	GEV No.	510703	Ref. No.	—
	description	mechanical shaft seal for shaft ø 13mm slide ring H 13mm height counter ring 5.5mm ED ø 26mm		
	GEV No.	513267	Ref. No.	—
	description	end cap for wash pump suitable for pump casing		
	GEV No.	518177	Ref. No.	—
	description	drain unit thread 3/4" ID ø 35mm hose ø 24mm		
	GEV No.	518204	Ref. No.	—
	description	screw connection for filter ø 67mm		
	GEV No.	518205	Ref. No.	—
	description	flat gasket rubber ED ø 61mm ID ø 47mm thickness 2mm Qty 1 pcs		
	GEV No.	521147	Ref. No.	—
	description	flange		
	GEV No.	521221	Ref. No.	—
	description	impellor ø 67mm H 16mm rotation direction right thread M7L shaft ø 13mm shaft length 12mm blades 8		
	GEV No.	528800	Ref. No.	—
	description	O-ring EPDM thickness 2.62mm ID ø 75.87mm Qty 1 pcs		

vibration pumps



1			
GEV No.	520250	Ref. No.	4112
description	by-pass thread 1/8" IT T2: M12x1 IG		





1			
GEV No.	499054	Ref. No.	6072
description	vibration pump type 1108PAALM3N 220/240V 70W 50Hz inlet ø 1/8" outlet ø 1/8" FLUID-O-TECH L 129mm		

1				
GEV No.	500124	Ref. No.	20021	
description	vibration pump type EX 5 230V 48W 50/60Hz inlet ø 6 outlet ø 1/8" IT flat seal ULKA brass L 123mm			
accessories for	500124			
	GEV No.	520152	Ref. No.	—
	description	hose connector Santoprene grommet ø 7mm grommet length 14mm		
	GEV No.	520330	Ref. No.	—
	description	bracket rubber dimensions 69x44x4mm		

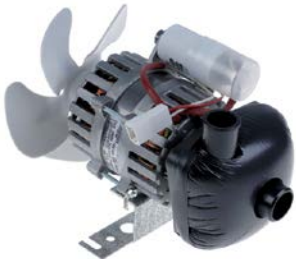

pumps for ice machines

			
1			
GEV No.	500590	Ref. No.	30166
description	pump FIR type 4240.2300 120W 230V 50/60Hz inlet ø 22mm outlet ø 22mm L 240mm rotation direction right for ice-cube maker capacitor 5µF		
spare parts for	500590		
	GEV No.	601412	Ref. No. —
	fan wheel sucking ø 154mm fan wheel mounting 25.4mm blade angle 28° W 34mm plastic		
	GEV No.	601413	Ref. No. —
	fixing plate suitable for fanwheel ED ø 32mm shaft ø 7 mounting distance 26mm		

			
1			
GEV No.	500165	Ref. No.	30165
description	pump REBO type 63/35 120W 230V 50/60Hz inlet ø 28mm outlet ø 26mm L 180mm rotation direction right for ice-cube maker capacitor 5µF		
spare parts for	500165		
	GEV No.	365017	Ref. No. —
	operating capacitor capacity 5µF 450V tolerance 5% 50/60Hz ambient temperature max. -25 to +85°C ø 28mm L 54mm M8 plastic connection male faston 6.3mm 16.10.08 protection		
	GEV No.	601412	Ref. No. —
	fan wheel sucking ø 154mm fan wheel mounting 25.4mm blade angle 28° W 34mm plastic		
	GEV No.	601413	Ref. No. —
	fixing plate suitable for fanwheel ED ø 32mm shaft ø 7 mounting distance 26mm		

electric accessories

cables

ribbon cables







group 5

			
1			
GEV No.	402568	Ref. No.	21477
description	ribbon cable 16-pole L 550mm plug type 2 row coded Qty 1m		

gas thermostats

SIT

630 Eurosit series

			
1			
GEV No.	101188	Ref. No.	40499
description	gas thermostat type 630 Eurosit series t.max. 190°C 110-190°C gas inlet 3/8" gas outlet 3/8" thermocouple connection M9x1 pilot connection M10x1 probe ø 4mm probe L 202mm capillary pipe 1050mm SIT		
accessories for	101188		
	GEV No.	100904	Ref. No. —
	locking screw M10x1 for pipe ø 4mm Qty 1 pcs		
	GEV No.	100905	Ref. No. 42509
	locking screw M10x1 for pipe ø 6mm Qty 1 pcs		
	GEV No.	101273	Ref. No. —
	olive for pipe ø 12mm L 9.5mm brass Qty 1 pcs suitable for universal		
	GEV No.	101276	Ref. No. —
	union screw thread 3/8" tube ø 12mm Qty 1 pcs		
	GEV No.	101333	Ref. No. —
	plug thread 3/8" with O-ring		





			
1			
GEV No.	101125	Ref. No.	40430
description	gas thermostat type 630 Eurosit series t.max. 340°C 100-340°C gas inlet 3/8" gas outlet 3/8" thermocouple connection M9x1 pilot connection M10x1 probe ø 4mm probe L 72mm capillary pipe 1050mm SIT		
accessories for	101125		
	GEV No.	100825	Ref. No. —
	gas tap spindle shaft ø 8x6.5mm shaft L 22/14mm suitable for EUROSIT		
	GEV No.	100904	Ref. No. —
	locking screw M10x1 for pipe ø 4mm Qty 1 pcs		
	GEV No.	100905	Ref. No. 42509
	locking screw M10x1 for pipe ø 6mm Qty 1 pcs		

Table continues overleaf







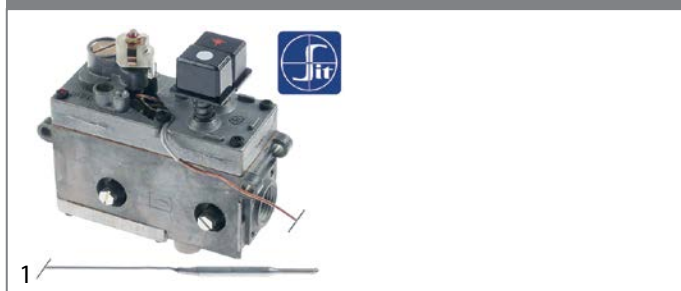

accessories for		101125	
	GEV No.	100949	Ref. No. —
gasket suitable for 630 Eurosit series			
	GEV No.	101273	Ref. No. —
olive for pipe ø 12mm L 9.5mm brass Qty 1 pcs suitable for universal			
	GEV No.	101276	Ref. No. —
union screw thread 3/8" tube ø 12mm Qty 1 pcs			
	GEV No.	101333	Ref. No. —
plug thread 3/8" with O-ring			
	GEV No.	101390	Ref. No. —
gas tap spindle shaft ø 6x4.6mm shaft L 32/15mm gas tap with ignition flame suitable for ZANUSSI, MARENO for gas thermostat EUROSIT			
	GEV No.	101392	Ref. No. —
adapter suitable for 630 Eurosit series			
	GEV No.	110357	Ref. No. —
gas tap spindle shaft ø 8x6.5mm shaft L 36/12mm suitable for 630 Eurosit series			
	GEV No.	110358	Ref. No. —
adapter shaft ø 10x8mm shaft L 29/18mm suitable for 630 Eurosit series			

accessories for		101132	
	GEV No.	101136	Ref. No. —
piezoelectric igniter suitable for Minisit with cover cap ømm connection F6.3x0.8			
	GEV No.	101137	Ref. No. —
cover cap without piezoelectric igniter			
	GEV No.	101267	Ref. No. —
reducer IT 3/8" ET 1/2" L 21mm			
	GEV No.	101268	Ref. No. —
gas connection thread 3/8" angled with O-ring MINISIT 710			
	GEV No.	101269	Ref. No. —
gas connection thread 1/2" angled with O-ring MINISIT 710			
	GEV No.	101270	Ref. No. —
screw connection IT 3/8" ET 3/8" L 28mm			
	GEV No.	101272	Ref. No. —
screw connection IT 1/2" ET 3/8" L 57mm			
	GEV No.	101273	Ref. No. —
olive for pipe ø 12mm L 9.5mm brass Qty 1 pcs suitable for universal			
	GEV No.	101274	Ref. No. —
olive for pipe ø 16mm Qty 1 pcs			
	GEV No.	101275	Ref. No. —
union screw thread 1/2" for pipe ø 16mm Qty 1 pcs			
	GEV No.	101276	Ref. No. —
union screw thread 3/8" tube ø 12mm Qty 1 pcs			
	GEV No.	110068	Ref. No. —
knob suitable for Minisit ø 37mm			

710 Minisit series



GEV No.	101132	Ref. No.	40495
description	gas thermostat SIT type MINISIT 710 t.max. 340°C 100-340°C gas inlet 1/2" gas outlet 3/8" thermocouple connection M9x1 pilot connection M10x1 probe ø 5mm probe L 68mm capillary pipe 1050mm probe type type B1 pressure controller no pressure regulator mbar gland nut ignition gas no		
spare parts for	101132		
	GEV No.	101053	Ref. No. —
magnet unit T1: M9x1 T2: M24x1 L 45mm ø 17mm suitable for Minisit			
	GEV No.	102102	Ref. No. —
probe 100-340°C probe ø 5mm probe L 68mm capillary pipe 1750mm t.max. 340°C oven/grill probe type type B1 suitable for MINISIT 710			
accessories for	101132		
	GEV No.	100809	Ref. No. —
O-ring EPDM thickness 2mm ID ø 21mm Qty 1 pcs			
	GEV No.	100904	Ref. No. —
locking screw M10x1 for pipe ø 4mm Qty 1 pcs			
	GEV No.	100905	Ref. No. 42509
locking screw M10x1 for pipe ø 6mm Qty 1 pcs			
	GEV No.	101054	Ref. No. —
magnet unit T1: M10x1 T2: M24x1 L 45mm ø 17mm suitable for Minisit			

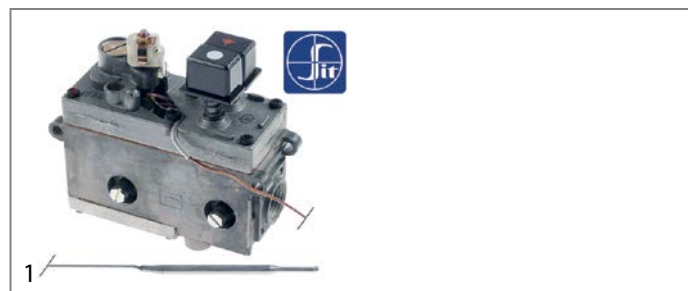



GEV No.	101131	Ref. No.	40494
description	gas thermostat without cap, button and angle SIT type MINISIT 710 t.max. 190°C 50-190°C gas inlet 1/2" gas outlet 3/8" thermocouple connection M9x1 pilot connection M10x1 probe ø 5mm probe L 98mm capillary pipe 1200mm probe type type A2 pressure controller no pressure regulator mbar gland nut		
spare parts for	101131		
	GEV No.	101053	Ref. No. —
magnet unit T1: M9x1 T2: M24x1 L 45mm ø 17mm suitable for Minisit			
	GEV No.	102103	Ref. No. —
probe 60-200°C probe ø 5mm probe L 98mm capillary pipe 1050mm t.max. 200°C fryer probe type type A2 suitable for MINISIT 710			

Table continues overleaf

accessories for		101131	
	GEV No.	100809	Ref. No. —
O-ring EPDM thickness 2mm ID ø 21mm Qty 1 pcs			
	GEV No.	100820	Ref. No. —
gland duct ET M14x1.5 IT M10x0.75 probe ø max. 6.5mm WS 22			
	GEV No.	100904	Ref. No. —
locking screw M10x1 for pipe ø 4mm Qty 1 pcs			
	GEV No.	100905	Ref. No. 42509
locking screw M10x1 for pipe ø 6mm Qty 1 pcs			
	GEV No.	101054	Ref. No. —
magnet unit T1: M10x1 T2: M24x1 L 45mm ø 17mm suitable for Minisit			
	GEV No.	101136	Ref. No. —
piezoelectric igniter suitable for Minisit with cover cap ømm connection F6.3x0.8			
	GEV No.	101137	Ref. No. —
cover cap without piezoelectric igniter			
	GEV No.	101267	Ref. No. —
reducer IT 3/8" ET 1/2" L 21mm			
	GEV No.	101268	Ref. No. —
gas connection thread 3/8" angled with O-ring MINISIT 710			
	GEV No.	101269	Ref. No. —
gas connection thread 1/2" angled with O-ring MINISIT 710			
	GEV No.	101270	Ref. No. —
screw connection IT 3/8" ET 3/8" L 28mm			
	GEV No.	101272	Ref. No. —
screw connection IT 1/2" ET 3/8" L 57mm			
	GEV No.	101273	Ref. No. —
olive for pipe ø 12mm L 9.5mm brass Qty 1 pcs suitable for universal			
	GEV No.	101274	Ref. No. —
olive for pipe ø 16mm Qty 1 pcs			
	GEV No.	101275	Ref. No. —
union screw thread 1/2" for pipe ø 16mm Qty 1 pcs			
	GEV No.	101276	Ref. No. —
union screw thread 3/8" tube ø 12mm Qty 1 pcs			
	GEV No.	110068	Ref. No. —
knob suitable for Minisit ø 37mm			

accessories			
probes			
			
1			
GEV No.	106225 ¹	Ref. No.	40973
description	probe 120-200°C probe ø 6mm probe L 102mm capillary pipe 1050mm t.max. 200°C fryer probe type type D1 suitable for MINISIT 710		

¹gland box M14x1,5

PEL

24STS series















			
1			
GEV No.	101161	Ref. No.	41264
description	gas thermostat PEL type 24STS 120-320°C gas inlet M20x1.5 (tube ø 12/10mm) bypass nozzle ø 0.35mm gas outlet M20x1.5 (tube ø 12/10mm) thermocouple connection M9x1 pilot connection M10x1 capillary pipe 1200mm probe ø 6mm probe L 100mm shaft ø 10x8mm shaft L 27/17mm shaft flat upper		
spare parts for	101161		
	GEV No.	101058	Ref. No. —
magnet unit L 39mm D1 ø 15.4mm D2 ø 13.5mm suitable for PEL22/ EGA24197 standard			
accessories for	101161		
	GEV No.	101235	Ref. No. —
gas connection thread M20x1.5 tube ø 12/10mm for PEL gas taps horizontal			
	GEV No.	101236	Ref. No. —
gas connection thread M20x1.5 tube ø 12/10mm for PEL gas taps vertical			
	GEV No.	101240	Ref. No. —
gas connection thread M20x1.5 tube ø 12/10mm for PEL gas taps with gasket and screws horizontal			
	GEV No.	101241	Ref. No. —
gas connection thread M20x1.5 tube ø 12/10mm for PEL gas taps vertical			
	GEV No.	101248	Ref. No. —
olive for pipe ø 12mm Qty 1 pcs suitable for PEL			
	GEV No.	101249	Ref. No. —
olive for pipe ø 10mm Qty 1 pcs			
	GEV No.	101250	Ref. No. —
union nut thread M20x1.5 for pipe ø 10mm			
	GEV No.	101251	Ref. No. —
union nut thread M20x1.5 for pipe ø 12mm			
	GEV No.	101365	Ref. No. —
gas connection thread M20x1.5 tube ø 12mm for PEL gas taps horizontal			

Table continues overleaf



accessories for	101161		
	GEV No.	101460	Ref. No. —
	O-ring ø 12.37mm D1 ø 2.62mm suitable for PEL22		
	GEV No.	101461	Ref. No. —
	screw kit suitable for PEL22 Qty 4 pcs		
	GEV No.	110079	Ref. No. —
	knob dial plate gas thermostat 1-8 silver		
	GEV No.	110080	Ref. No. —
	knob ø 70mm shaft ø 10x8mm shaft flat universal		

gas valves and ignition boxes









gas control valves

SIT

ELETTROSIT



1

GEV No.	101123	Ref. No.	40492
description	gas valve SIT type ELETTROSIT 230V gas inlet 3/4" gas outlet 3/4" thermocouple connection M9x1 pilot connection M10x1 bottom equiv. no. 0.810.138		
spare parts for	101123		
	GEV No.	101312	Ref. No. —
	microswitch		
	GEV No.	101352	Ref. No. —
	solenoid coil 230V 50Hz suitable for ELETTROSIT		
accessories for	101123		
	GEV No.	100006	Ref. No. —
	piezoelectric igniter suitable for ELETTROSIT body plastic blowing connection ø2.4mm ø 14mm		
	GEV No.	100904	Ref. No. —
	locking screw M10x1 for pipe ø 4mm Qty 1 pcs		
	GEV No.	100905	Ref. No. 42509
	locking screw M10x1 for pipe ø 6mm Qty 1 pcs		
	GEV No.	101301	Ref. No. —
	gas connection thread 1/2" straight ELETTROSIT screw with O-ring		
	GEV No.	101303	Ref. No. —
	gas connection straight thread 3/4" ELETTROSIT		
	GEV No.	101309	Ref. No. —
	extension		









1

GEV No.	101127	Ref. No.	40422
description	gas valve SIT type ELETTROSIT 230V gas inlet 3/4" gas outlet 3/4" thermocouple connection M9x1 pilot connection M10x1 lateral equiv. no. 0.810.175		
spare parts for	101127		
	GEV No.	101312	Ref. No. —
	microswitch		
	GEV No.	101352	Ref. No. —
	solenoid coil 230V 50Hz suitable for ELETTROSIT		
accessories for	101127		
	GEV No.	100006	Ref. No. —
	piezoelectric igniter suitable for ELETTROSIT body plastic blowing connection ø2.4mm ø 14mm		
	GEV No.	100904	Ref. No. —
	locking screw M10x1 for pipe ø 4mm Qty 1 pcs		
	GEV No.	100905	Ref. No. 42509
	locking screw M10x1 for pipe ø 6mm Qty 1 pcs		
	GEV No.	101301	Ref. No. —
	gas connection thread 1/2" straight ELETTROSIT screw with O-ring		
	GEV No.	101303	Ref. No. —
	gas connection straight thread 3/4" ELETTROSIT		
	GEV No.	101309	Ref. No. —
	extension		

NOVASIT











1

GEV No.	101187	Ref. No.	40498
description	gas valve SIT series Novasit 820 0.17VHz gas inlet 1/2" gas outlet 1/2" thermocouple connection M9x1 pilot connection M10x1 ignition pressurebar pressure range 5-50mbar pressure regulator connection blind equiv. no. 0.820.301 supply Operator millivolt		
spare parts for	101187		
	GEV No.	101065	Ref. No. —
	magnet unit with cable L 44mm D1 ø 30mm D2 ø 20mm suitable for NOVASIT		
accessories for	101187		
	GEV No.	100110	Ref. No. —
	pilot burner SIT type 190 series 3 flames nozzle ømm gas connectionmm		
	GEV No.	101305	Ref. No. —
	gas connection straight 1/2" flange 45x45mm ELETTROSIT/V4400/4600/4605 suitable for SIT/HONEYWELL hole distance 36x36mm		
	GEV No.	101306	Ref. No. —
	gas connection angled flange 45x45mm hole distance 36x36mm 1/2" ELETTROSIT/V4400/4600/4605 screw with O-ring suitable for SIT/HONEYWELL		
	GEV No.	101307	Ref. No. —
	gas connection straight flange 45x45mm hole distance 36x36mm 3/4" ELETTROSIT/V4400/4600/4605 screw with O-ring suitable for SIT/HONEYWELL		
	GEV No.	101308	Ref. No. —
	gas connection angled flange 45x45mm hole distance 36x36mm 3/4" ELETTROSIT/V4400/4600/4605 screw with O-ring suitable for SIT/HONEYWELL		
	GEV No.	102116	Ref. No. —
	thermopile ROBERTSHAW L 900mm probe ø 9mm probe L 57mm 250-750mV screw connection 7/16"		





1

GEV No.	101914	Ref. No.	40421
description	gas valve SIT series Novasit 822 230V 50Hz gas inlet 1/2" gas outlet 1/2" thermocouple connection pilot connection closed ignition pressurebar pressure range 3-30mbar pressure regulator connection blind equiv. no. 0.822.144		
spare parts for	101914		
	GEV No.	101313	Ref. No. 42623
	solenoid coil 230V 50Hz		

spare parts for	101914		
	GEV No.	101542	Ref. No. —
	solenoid coil 50Hz NOVA 822/826/827 suitable for NOVASIT 230V		
accessories for	101914		
	GEV No.	101305	Ref. No. —
	gas connection straight 1/2" flange 45x45mm ELETTROSIT/V4400/4600/4605 suitable for SIT/HONEYWELL hole distance 36x36mm		
	GEV No.	101306	Ref. No. —
	gas connection angled flange 45x45mm hole distance 36x36mm 1/2" ELETTROSIT/V4400/4600/4605 screw with O-ring suitable for SIT/HONEYWELL		
	GEV No.	101307	Ref. No. —
	gas connection straight flange 45x45mm hole distance 36x36mm 3/4" ELETTROSIT/V4400/4600/4605 screw with O-ring suitable for SIT/HONEYWELL		
	GEV No.	101308	Ref. No. —
	gas connection angled flange 45x45mm hole distance 36x36mm 3/4" ELETTROSIT/V4400/4600/4605 screw with O-ring suitable for SIT/HONEYWELL		
	GEV No.	101503	Ref. No. —
	O-ring EPDM thickness 2mm ID ø 32mm Qty 1 pcs		
	GEV No.	101924	Ref. No. —
	plug with cable L 1090mm suitable for NOVA 822/826/827		

accessories			
	1		
GEV No.	100905	Ref. No.	42509
description	locking screw M10x1 for pipe ø 6mm Qty 1 pcs		

	1		
GEV No.	101313	Ref. No.	42623
description	solenoid coil 230V 50Hz		
accessories for	101313		
	GEV No.	550896	Ref. No. —
	gasket with screw gas valves NOVASIT		



ignition parts









pilot burners

SIT

100 series







1

GEV No.	106901	Ref. No.	40471
description	pilot burner SIT type 100 series 1 flame nozzle \varnothing 0.2mm gas connection 6mm		
spare parts for	106901		
	GEV No.	100854	Ref. No. —
	pilot burner bracket double		
	GEV No.	100916	Ref. No. —
	compression spring for pilot burner Qty 1 pcs		
	GEV No.	100917	Ref. No. —
	gasket for pilot burner Qty 1 pcs aluminium		
	GEV No.	100918	Ref. No. —
	screw for pilot burner		
accessories for	106901		
	GEV No.	100904	Ref. No. —
	locking screw M10x1 for pipe \varnothing 4mm Qty 1 pcs		
	GEV No.	100905	Ref. No. 42509
	locking screw M10x1 for pipe \varnothing 6mm Qty 1 pcs		
	GEV No.	102110	Ref. No. —
	pilot tube copper pipe \varnothing 4mm thickness 1mm L 3000mm		
	GEV No.	102111	Ref. No. —
	pilot tube copper pipe \varnothing 6mm thickness 1mm L 3000mm		
	GEV No.	102742	Ref. No. —
	pilot burner nozzle LPG code 25 bore \varnothing 0.25mm Qty 1 pcs		





1

GEV No.	106902	Ref. No.	40014
description	pilot burner SIT type 100 series 2 flames nozzle \varnothing 0.2mm gas connection 6mm		
spare parts for	106902		
	GEV No.	100245	Ref. No. —
	pilot burner nozzle LPG code 20 bore \varnothing 0.2mm Qty 1 pcs thread M8x0.75		

spare parts for	106902		
	GEV No.	100842	Ref. No. —
	pilot burner cap 2 flames Qty 1 pcs		
	GEV No.	100885	Ref. No. —
	air mixing sleeve for pilot burner Qty 1 pcs		
	GEV No.	100916	Ref. No. —
	compression spring for pilot burner Qty 1 pcs		
	GEV No.	100917	Ref. No. —
	gasket for pilot burner Qty 1 pcs aluminium		
	GEV No.	100918	Ref. No. —
	screw for pilot burner		
	GEV No.	107161	Ref. No. —
	pilot burner cap SIT 2 flames Hmm Lmm Qty 1 pcs		
	GEV No.	107701	Ref. No. —
	pilot burner bottom part SIT 100 series nozzle \varnothing 0.2mm		
accessories for	106902		
	GEV No.	100246	Ref. No. —
	pilot burner nozzle natural gas bore \varnothing 0.35mm Qty 1 pcs thread M8x0.75		
	GEV No.	100904	Ref. No. —
	locking screw M10x1 for pipe \varnothing 4mm Qty 1 pcs		
	GEV No.	100905	Ref. No. 42509
	locking screw M10x1 for pipe \varnothing 6mm Qty 1 pcs		
	GEV No.	102110	Ref. No. —
	pilot tube copper pipe \varnothing 4mm thickness 1mm L 3000mm		
	GEV No.	102111	Ref. No. —
	pilot tube copper pipe \varnothing 6mm thickness 1mm L 3000mm		
	GEV No.	107171	Ref. No. —
	pilot burner nozzle SIT natural/liquid gas bore \varnothing 0.25mm Qty 1 pcs		
	GEV No.	107700	Ref. No. —
	pilot burner bottom part SIT 100 series nozzle \varnothing 0.25mm		
	GEV No.	107702	Ref. No. —
	pilot burner bottom part SIT 100 series nozzle \varnothing 0.35mm		



			
1			
GEV No.	106903	Ref. No.	41703
description	pilot burner SIT type 100 series 3 flames nozzle ø 0.2mm gas connection 6mm		
spare parts for	106903		
	GEV No.	100245	Ref. No. —
	pilot burner nozzle LPG code 20 bore ø 0.2mm Qty 1 pcs thread M8x0.75		
	GEV No.	100854	Ref. No. —
	pilot burner bracket double		
	GEV No.	100885	Ref. No. —
	air mixing sleeve for pilot burner Qty 1 pcs		
	GEV No.	100916	Ref. No. —
	compression spring for pilot burner Qty 1 pcs		
	GEV No.	100917	Ref. No. —
	gasket for pilot burner Qty 1 pcs aluminium		
	GEV No.	100918	Ref. No. —
	screw for pilot burner		
	GEV No.	107162	Ref. No. —
	pilot burner cap SIT 3 flames Hmm Lmm Qty 1 pcs		
	GEV No.	107701	Ref. No. —
	pilot burner bottom part SIT 100 series nozzle ø 0.2mm		
accessories for	106903		
	GEV No.	100245	Ref. No. —
	pilot burner nozzle LPG code 20 bore ø 0.2mm Qty 1 pcs thread M8x0.75		
	GEV No.	100246	Ref. No. —
	pilot burner nozzle natural gas bore ø 0.35mm Qty 1 pcs thread M8x0.75		
	GEV No.	100904	Ref. No. —
	locking screw M10x1 for pipe ø 4mm Qty 1 pcs		
	GEV No.	100905	Ref. No. 42509
	locking screw M10x1 for pipe ø 6mm Qty 1 pcs		
	GEV No.	102110	Ref. No. —
	pilot tube copper pipe ø 4mm thickness 1mm L 3000mm		
	GEV No.	102111	Ref. No. —
	pilot tube copper pipe ø 6mm thickness 1mm L 3000mm		
	GEV No.	107171	Ref. No. —
	pilot burner nozzle SIT natural/liquid gas bore ø 0.25mm Qty 1 pcs		
	GEV No.	107700	Ref. No. —
	pilot burner bottom part SIT 100 series nozzle ø 0.25mm		

accessories for	106903		
	GEV No.	107702	Ref. No. —
	pilot burner bottom part SIT 100 series nozzle ø 0.35mm		





















			
1			
GEV No.	106906	Ref. No.	40016
description	pilot burner SIT type 100 series 3 flames nozzle ø 0.2mm gas connection 6mm		
spare parts for	106906		
	GEV No.	100245	Ref. No. —
	pilot burner nozzle LPG code 20 bore ø 0.2mm Qty 1 pcs thread M8x0.75		
	GEV No.	100855	Ref. No. —
	pilot burner bracket triple		
	GEV No.	100885	Ref. No. —
	air mixing sleeve for pilot burner Qty 1 pcs		
	GEV No.	100916	Ref. No. —
	compression spring for pilot burner Qty 1 pcs		
	GEV No.	100917	Ref. No. —
	gasket for pilot burner Qty 1 pcs aluminium		
	GEV No.	100918	Ref. No. —
	screw for pilot burner		
	GEV No.	107162	Ref. No. —
	pilot burner cap SIT 3 flames Hmm Lmm Qty 1 pcs		
	GEV No.	107701	Ref. No. —
	pilot burner bottom part SIT 100 series nozzle ø 0.2mm		
accessories for	106906		
	GEV No.	100245	Ref. No. —
	pilot burner nozzle LPG code 20 bore ø 0.2mm Qty 1 pcs thread M8x0.75		
	GEV No.	100246	Ref. No. —
	pilot burner nozzle natural gas bore ø 0.35mm Qty 1 pcs thread M8x0.75		
	GEV No.	100904	Ref. No. —
	locking screw M10x1 for pipe ø 4mm Qty 1 pcs		
	GEV No.	100905	Ref. No. 42509
	locking screw M10x1 for pipe ø 6mm Qty 1 pcs		
	GEV No.	102110	Ref. No. —
	pilot tube copper pipe ø 4mm thickness 1mm L 3000mm		
	GEV No.	102111	Ref. No. —
	pilot tube copper pipe ø 6mm thickness 1mm L 3000mm		













Table continues overleaf



accessories for		106906	
GEV No.	107171	Ref. No.	—
	pilot burner nozzle SIT natural/liquid gas bore ø 0.25mm Qty 1 pcs		
GEV No.	107700	Ref. No.	—
	pilot burner bottom part SIT 100 series nozzle ø 0.25mm		
GEV No.	107702	Ref. No.	—
	pilot burner bottom part SIT 100 series nozzle ø 0.35mm		



accessories for		107114	
GEV No.	100909	Ref. No.	—
	union screw thread M10x1 for pipe ø 6mm Qty 1 pcs		
GEV No.	102110	Ref. No.	—
	pilot tube copper pipe ø 4mm thickness 1mm L 3000mm		
GEV No.	102111	Ref. No.	—
	pilot tube copper pipe ø 6mm thickness 1mm L 3000mm		

140 - 145 -150 series

			
1			
GEV No.	107114 ¹	Ref. No.	40472
description	pilot burner SIT type 140 series 2 flames nozzle ømm gas connecti- onmm		
spare parts for	107114		
	GEV No.	100907	Ref. No.
			—
	screw connection thread M10x1 Qty 1 pcs type SEF 1 ømm for thermocouple		
accessories for		107114	
GEV No.	100204	Ref. No.	41007
	pilot burner nozzle SIT LPG code 14 bore ø 0.18/0.20mm Qty 1 pcs suitable for 140 series		
GEV No.	100205	Ref. No.	—
	pilot burner nozzle SIT LPG code 19 bore ø 0.23/0.26mm Qty 1 pcs suitable for SIT 150 series		
GEV No.	100206	Ref. No.	—
	pilot burner nozzle SIT natural gas code 36 bore ø 0.60/0.55mm Qty 1 pcs suitable for SIT 150 series		
GEV No.	100207	Ref. No.	40292
	pilot burner nozzle SIT natural gas code 27 bore ø 0.40/0.38mm suitable for SIT 140 series		
GEV No.	100216	Ref. No.	—
	pilot burner nozzle SIT natural gas code 38 bore ø 0.45mm Qty 1 pcs suitable for SIT 150 series		
GEV No.	100701	Ref. No.	9611
	ignition electrode connection M4 Qty 1 pcs		
GEV No.	100801	Ref. No.	—
	gasket for pilot burner Qty 1 pcs		
GEV No.	100897	Ref. No.	—
	olive for pipe ø 4mm Qty 1 pcs for pilot burner		
GEV No.	100898	Ref. No.	—
	olive for pipe ø 6mm Qty 1 pcs for pilot burner		
GEV No.	100906	Ref. No.	—
	screw connection thread M10x1 for ignition electrode brass Qty 1 pcs WS 10		
GEV No.	100908	Ref. No.	—
	union screw thread M10x1 for pipe ø 4mm Qty 1 pcs		

¹incl. thermocouple fitting

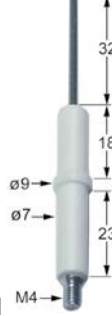
electrodes

			
1			
GEV No.	100701	Ref. No.	9611
description	ignition electrode connection M4 Qty 1 pcs		
accessories for		100701	
GEV No.	100906	Ref. No.	—
	screw connection thread M10x1 for ignition electrode brass Qty 1 pcs WS 10		

ignition cables

pre-assembled cables

			
1			
GEV No.	102155	Ref. No.	41698
description	ignition cable cable length 900mm connection ø4mm / F2.8mm		

piezoelectric igniters

mounting diameter 18mm





			
1			
GEV No.	100009	Ref. No.	4182 70473
description	piezoelectric igniter body plastic blowing mounting ø 18mm con- nection ø2.4mm front measurements 26mm M18x1.5		
accessories for		100009	
GEV No.	101339	Ref. No.	—
	cover cap for piezoelectric igniter		
GEV No.	106869	Ref. No.	—
	cover cap for piezoelectric igniter ID ø 22mm ED ø 35mm H 25mm		

Table continues overleaf



accessories for	100009		
	GEV No.	107931	Ref. No. —
cover cap for piezoelectric igniter ID \varnothing 21mm ED \varnothing 36mm			

miscellaneous

	1		
GEV No.	nla ¹	Ref. No.	41192
description	piezoelectric igniter suitable for Minisit connection F6.3x0.8 \varnothing mm		

¹no longer available

thermocouples

plug-in thermocouples

plug-in thermocouples standard

with barrel socket \varnothing 6(6.5)mm

thermocouples SIT

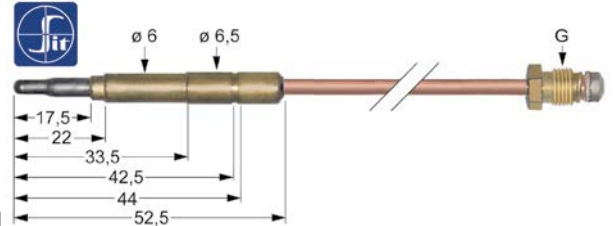
	1		
GEV No.	107612	Ref. No.	41550
description	thermocouple SIT M9x1 L 1000mm plug connection \varnothing 6.0(6.5)mm		

GEV No.	107612	Ref. No.	41550
description	thermocouple SIT M9x1 L 1000mm plug connection \varnothing 6.0(6.5)mm		

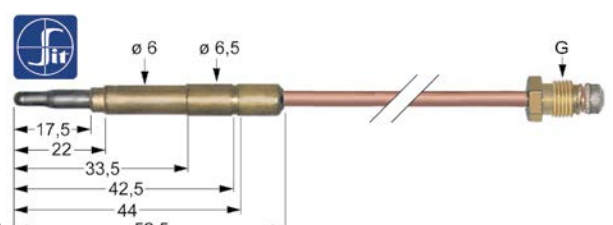
	1		
GEV No.	107613	Ref. No.	40535
description	thermocouple SIT M9x1 L 1200mm plug connection \varnothing 6.0(6.5)mm		

GEV No.	107613	Ref. No.	40535
description	thermocouple SIT M9x1 L 1200mm plug connection \varnothing 6.0(6.5)mm		

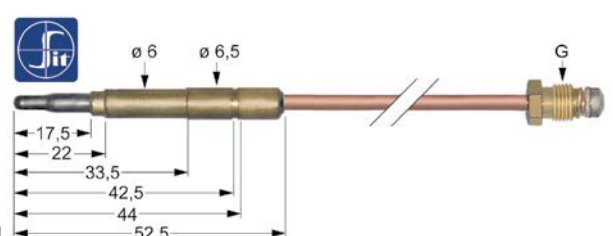
	1		
GEV No.	107614	Ref. No.	40362
description	thermocouple SIT M9x1 L 1500mm plug connection \varnothing 6.0(6.5)mm		

GEV No.	107614	Ref. No.	40362
description	thermocouple SIT M9x1 L 1500mm plug connection \varnothing 6.0(6.5)mm		

thermocouples with aluminised tip

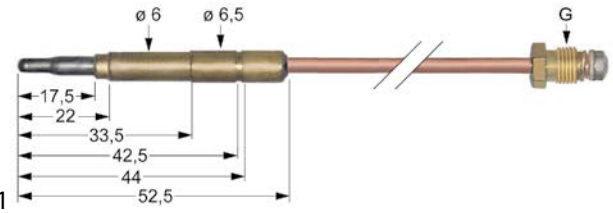
	1		
GEV No.	102036	Ref. No.	70551
description	thermocouple M8x1 L 1000mm plug connection \varnothing 6.0(6.5)mm		

GEV No.	102036	Ref. No.	70551
description	thermocouple M8x1 L 1000mm plug connection \varnothing 6.0(6.5)mm		

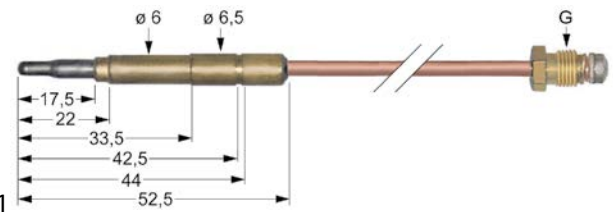
	1		
GEV No.	102035	Ref. No.	43057
description	thermocouple M8x1 L 850mm plug connection \varnothing 6.0(6.5)mm		

GEV No.	102035	Ref. No.	43057
description	thermocouple M8x1 L 850mm plug connection \varnothing 6.0(6.5)mm		

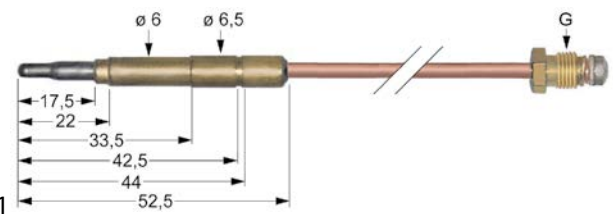
	1		
GEV No.	102041	Ref. No.	40534
description	thermocouple M9x1 L 600mm plug connection \varnothing 6.0(6.5)mm		

GEV No.	102041	Ref. No.	40534
description	thermocouple M9x1 L 600mm plug connection \varnothing 6.0(6.5)mm		

accessories

nuts

	1		
GEV No.	102067	Ref. No.	40540
description	nut thread M8x1 H 3mm brass Qty 1 pcs type SEF 1		

GEV No.	102067	Ref. No.	40540
description	nut thread M8x1 H 3mm brass Qty 1 pcs type SEF 1		

	1		
GEV No.	102500	Ref. No.	40540
description	nut thread M8x1 Qty 10 pcs		

GEV No.	102500	Ref. No.	40540
description	nut thread M8x1 Qty 10 pcs		



gas burners

hob burners

accessories

reducers for pan supports



1

GEV No.	104499	Ref. No.	43158
description	reducer for pan support L 175mm W 114mm		

gas nozzles

main nozzles

gas nozzles M9x1



1

GEV No.	107345	Ref. No.	43081
description	gas injector thread M9x1 WS 10 bore ø 0.9mm		



1

GEV No.	107347	Ref. No.	43192
description	gas injector thread M9x1 WS 10 bore ø 2.4mm		

pilot burner nozzles

pilot burner nozzles SIT

140/150 series



1

GEV No.	100204	Ref. No.	41007
description	pilot burner nozzle SIT LPG code 14 bore ø 0.18/0.20mm Qty 1 pcs suitable for 140 series		



1

GEV No.	100207	Ref. No.	40292
description	pilot burner nozzle SIT natural gas code 27 bore ø 0.40/0.38mm suitable for SIT 140 series		

160 series



1

GEV No.	107650	Ref. No.	41009
description	pilot burner nozzle SIT LPG code 30 Qty 1 pcs		

auxiliary gas parts

screw connections

union screws



1

GEV No.	100905	Ref. No.	42509
description	locking screw M10x1 for pipe ø 6mm Qty 1 pcs		

angle pieces



1

GEV No.	104490	Ref. No.	43167
description	angle piece T1: 1/2" IT T2: 1/2" ET grommet ø 13.5mm grommet length 22mm WS 24 brass		



1

GEV No.	104489	Ref. No.	43168
description	angle piece T1: 3/4" IT T2: 1/2" ET grommet ø 13.5mm grommet length 22mm WS 24 brass		

tools

reamers

reamer set



1

GEV No.	800050	Ref. No.	70565
description	nozzle reamers set size 0.5/0.6/0.7/0.8/0.9mm size 1 1.0/1.1/1.2/1.4/1.6/1.8/2.0mm 12-piece with holder		
description	reamer set with holder 12-piece 0.5mm / 0.6mm / 0.7mm / 0.8mm / 0.9mm / 1.0mm 1.1mm / 1.2mm / 1.4mm / 1.6mm / 1.8mm / 2.0mm		

equipment-specific units

for ice-cube maker

mechanics for evaporators

gear motors

motors



1

GEV No.	500793	Ref. No.	23735
description	motor with belt pulley 120W 230V 50/60Hz 1 phase shaft \varnothing 10mm 1390/1600rpm type RM63/50 \varnothing 90mm H 160mm REBO 0.12kW		
spare parts for	500793		
	GEV No.	695279	Ref. No.
			—
description	round belt pulley disc \varnothing 49mm single shaft intake \varnothing 10mm groove depth 5mm disc width 12mm groove width 10mm overall width 19mm shaft \varnothing 18mm		

for espresso machines

filter holders

filter holders standard

filter holder without spout



1

GEV No.	525997	Ref. No.	N/A
description	filter holder suitable for IBERITAL without outlet mounting \varnothing 83mm hole \varnothing 7.5mm outlet 3/8" ID \varnothing 56.5mm wedge height 8mm wedge position horizontal number of wedges 3 lever inclined chrome-plated brass		



1

GEV No.	525998	Ref. No.	N/A
description	filter holder suitable for IBERITAL without outlet mounting \varnothing 83mm hole \varnothing 7.5mm outlet 3/8" ID \varnothing 62mm wedge height 10.2mm wedge position horizontal number of wedges 2 lever straight chrome-plated brass		

filter holders short



1

GEV No.	525231	Ref. No.	19412
description	filter holder mounting \varnothing 83mm outlet 3/8" ID \varnothing 56.5mm handle M12x1.75 wedge height 8mm wedge position horizontal number of wedges 2 lever inclined chrome-plated brass		



1

GEV No.	525230	Ref. No.	2966 9699
description	filter holder mounting \varnothing 83mm outlet 3/8" ID \varnothing 62mm handle M12x1.75 wedge height 10.2mm wedge position horizontal number of wedges 2 lever straight chrome-plated brass		

filters

for 1 cup



1

GEV No.	525234	Ref. No.	19786
description	coffee filter \varnothing 66mm mounting \varnothing 55mm H 23mm cups 1 perforation \varnothing 0.45mm		



1

GEV No.	525235	Ref. No.	19787
description	coffee filter \varnothing 66mm mounting \varnothing 55mm H 25mm cups 1 perforation \varnothing 0.45mm		

for 2 cups



1

GEV No.	529030	Ref. No.	19788
description	coffee filter \varnothing 65mm mounting \varnothing 55mm H 27.5mm cups 2 amount of coffee 14g		



blind filters			
			
1			
GEV No.	525232	Ref. No.	6551
description	blind filter ø 65mm mounting ø 55.2mm H 25.5mm		

with upstand			
			
1			
GEV No.	529132	Ref. No.	288
description	shower screen ø 58mm H 18mm		

brewing units			
shower screens			
flat			
			
1			
GEV No.	529088	Ref. No.	2181
description	shower screen ø 48mm hole ø 5.5mm flat		

			
1			
GEV No.	529084	Ref. No.	1194
description	shower screen ø 52mm hole ø 6.4mm		

with upstand and central hole			
			
1			
GEV No.	525233	Ref. No.	19079
description	shower screen ø 52mm H 5mm hole ø 5mm		

 <p>Image not available</p>			
1			
GEV No.	531287	Ref. No.	ID-103
description	shower screen ø 57.5mm		

filter holder gaskets			
flat			
with internal notch			
			
1			
GEV No.	525385	Ref. No.	19077
description	filter holder gasket inner cone D1 ø 73.5mm D2 ø 55.5mm H 10.5mm with inside notch Qty 1 pcs		

standard			
			
1			
GEV No.	528030	Ref. No.	142
description	filter holder gasket D1 ø 72.7mm D2 ø 57.2mm H 8mm Qty 1 pcs		

			
1			
GEV No.	528060	Ref. No.	1280
description	filter holder gasket D1 ø 73.5mm D2 ø 59.5mm H 7.5mm Qty 1 pcs		

			
1			
GEV No.	525607	Ref. No.	142 30260
description	filter holder gasket D1 ø 73mm D2 ø 57mm H 8.2mm Qty 1 pcs		

			
1			
GEV No.	525371	Ref. No.	145
description	filter holder gasket D1 ø 73mm D2 ø 57mm H 9.2mm Qty 1 pcs		

brewing units with solenoid valve

filters

filters

			
1			
GEV No.	526738	Ref. No.	22042
description	filter set for brewing unit		

brewing units manual

components

gaskets

			
1			
GEV No.	526856	Ref. No.	2243
description	gasket D1 ø 13mm ID ø 4mm thickness 4mm Viton		

			
1			
GEV No.	525368	Ref. No.	172
description	gasket ED ø 13mm ID ø 4mm H 4mm Qty 1 pcs EPDM		

			
1			
GEV No.	525369	Ref. No.	163
description	gasket ED ø 15.5mm ID ø 7.5mm H 4mm Qty 1 pcs EPDM		

			
1			
GEV No.	525378	Ref. No.	449
description	gasket ED ø 15.5mm ID ø 7.5mm H 4mm Qty 1 pcs Viton		

			
1			
GEV No.	528494	Ref. No.	2243
description	gasket rubber ED ø 13mm ID ø 4mm thickness 4mm Qty 1 pcs		

miscellaneous

			
1			
GEV No.	528531	Ref. No.	216
description	bolt square brass thread M3 L 12mm W 6mm H 6mm thread L 10mm		

levers

levers

			
1			
GEV No.	525398	Ref. No.	21541 7090
description	lever for IBERITAL		

camshafts

			
1			
GEV No.	525763	Ref. No.	151 2518
description	camshaft shaft ø 8mm shaft intake ø 10mm L 78.3mm W 19.6mm H 16.7mm thread M6 brass suitable for IBERITAL		

valves

			
1			
GEV No.	525761	Ref. No.	180
description	valve for brewing unit L 57.7mm round ED ø 16mm shaft ø 4mm		



			
1			
GEV No.	525759	Ref. No.	178
description	valve for drain unit L 20.5mm ED ø 16mm shaft 5x5		

			
1			
GEV No.	525760	Ref. No.	179
description	valve for drain unit L 59.5mm square ED ø 16mm shaft 5x5		

components

nozzles

with thread

			
1			
GEV No.	526441	Ref. No.	21609
description	nozzle bore ø 0.5mm thread M6x0.75 L 9mm		

			
1			
GEV No.	528486	Ref. No.	267
description	nozzle bore ø 0.7mm thread M6x0.75 L 9mm WS 7		

water dispersions

water dispersions

group 2

			
1			
GEV No.	525756	Ref. No.	175
description	water distributor ø 30mm hole ø 1.5mm H 15mm ET M10x1 grooves 6 2.6mm brass 2 holes perforation ø 1mm		

			
1			
GEV No.	525757	Ref. No.	19449
description	water distributor ø 30mm hole ø 3mm H 14.5mm ET M10x1 IT M5 grooves 6 2.8mm brass 2 holes perforation ø 1mm		

safety valves

safety valves

3/8"

			
1			
GEV No.	529302	Ref. No.	3596
description	safety valve connection 3/8" triggering pressure 1.8bar		

			
1			
GEV No.	529312	Ref. No.	1314
description	safety valve connection 3/8" triggering pressure 1.8bar		

expansion valves

gaskets

			
1			
GEV No.	526692	Ref. No.	160
description	gasket ED ø 15mm seat ø 6mm H 4mm overall height 9mm		

drain pans

drain pans

			
1			
GEV No.	525217	Ref. No.	9937
description	drain pan L 78mm W 70mm H 54mm hose ø 12mm suitable for IBERITAL		

			
1			
GEV No.	525214	Ref. No.	6000
description	drain pan L 85mm ø 65mm hose ø 19mm suitable for IBERITAL		



			
1			
GEV No.	525216	Ref. No.	23891
description	drain pan L 90mm W 70mm H 43mm hole ø 27mm hose ø 12mm		

accessories

			
1			
GEV No.	525215	Ref. No.	22116 9188 9435
description	drain hose L 290mm ID ø 6mm ED ø 9mm		

aerators and air bleeders

			
1			
GEV No.	529326	Ref. No.	3319
description	aerator and air bleeder		

			
1			
GEV No.	529303	Ref. No.	3319
description	aerator and air bleeder connection 1/4" only steam		
spare parts for	529303		
	GEV No.	528687	Ref. No. —
	O-ring Viton thickness 1.78mm ID ø 3.69mm Qty 1 pcs		

boilers

pipes

			
1			
GEV No.	525762	Ref. No.	9242
description	aspiration tube tube ø 8mm pipe length 135mm T1: 1/4" T2: 1/4" copper conical seal		

steam/water taps

steam/water taps

steam/water taps

			
1			
GEV No.	525389	Ref. No.	11300
description	steam/water tap swing lever inlet 1/4" outlet 3/8" suitable for IBERITAL		

steam taps

steam taps (complete)

			
1			
GEV No.	525392	Ref. No.	11017
description	steam tap with steam pipe inlet 1/4" suitable for IBERITAL		

components

gaskets

			
1			
GEV No.	526856	Ref. No.	2243
description	gasket D1 ø 13mm ID ø 4mm thickness 4mm Viton		

gasket supports

			
1			
GEV No.	525175	Ref. No.	1973
description	valve ø hexagon 16mm L 14mm brass		



valve bodies

 <p>1</p>			
GEV No.	525764	Ref. No.	6783
description	valve body for steam-/water-tap		

water taps

<p>water taps</p>  <p>1</p>			
GEV No.	525391	Ref. No.	11277
description	water tap with pipe inlet 1/4" suitable for IBERITAL		

steam/water pipes

<p>steam pipes</p>  <p>1</p>			
GEV No.	525396	Ref. No.	8302
description	steam pipe thread 3/8" H 175mm L 210mm ø 14.2mm tube ø 10mm suitable for FAEMA		

 <p>1</p>			
GEV No.	525395	Ref. No.	19084
description	steam pipe thread 3/8" H 225mm L 255mm ø 14.2mm tube ø 10mm suitable for IBERITAL		

water pipes

 <p>1</p>			
GEV No.	525397	Ref. No.	19085
description	water pipe thread 3/8" ø 14.2mm L 65mm suitable for IBERITAL		

accessories

<p>bushes</p>  <p>1</p>			
GEV No.	528786	Ref. No.	7506
description	bush		

 <p>1</p>			
GEV No.	525324	Ref. No.	19051
description	bush D1 ø 14.3mm D2 ø 11.4mm H 6mm PTFE ID ø 7.1mm		

 <p>1</p>			
GEV No.	525357	Ref. No.	7321
description	bush D1 ø 15mm D2 ø 10.4mm H 10.3mm PTFE ID ø 7.6mm		

tube handles

 <p>1</p>			
GEV No.	525152	Ref. No.	10493
description	handle for pipe ø 10mm L 40mm rubber		

fine filters

<p>fine filters</p>  <p>1</p>			
GEV No.	529911	Ref. No.	10971 263
description	fine filter flat ø 11mm H 0.25mm		

 <p>1</p>			
GEV No.	528946	Ref. No.	5232
description	fine filter pipe ø 8.5mm H 22mm		

intake valves

intake valves



1

GEV No.	525394	Ref. No.	19065
----------------	--------	-----------------	-------

description intake valve centre for IBERITAL



1

GEV No.	525390	Ref. No.	10001
----------------	--------	-----------------	-------

description intake valve front for IBERITAL



1

GEV No.	525393	Ref. No.	11646
----------------	--------	-----------------	-------

description intake valve rear for IBERITAL

accessories

bushes



1

GEV No.	525758	Ref. No.	4075
----------------	--------	-----------------	------

description bush for filling valve D1 ø 15mm int. ø 1 12.9mm int. ø 2 10.8mm H 12.8mm brass

gaskets



1

GEV No.	528596	Ref. No.	316
----------------	--------	-----------------	-----

description gasket ED ø 12mm ID ø 4mm overall height 4mm conical

level glasses

level glasses

gaskets



1

GEV No.	525379	Ref. No.	19794
----------------	--------	-----------------	-------

description gasket D1 ø 15mm D2 ø 10mm ID ø 6mm

pressure rings



1

GEV No.	525238	Ref. No.	2501
----------------	--------	-----------------	------

description press ring D1 ø 15mm D2 ø 11.5mm thickness 1.5mm brass for level glass

level glass pipes



1

GEV No.	525218	Ref. No.	9602
----------------	--------	-----------------	------

description water level tube ø 11mm H 140mm ID ø 6.5mm marking Min/Max red/blue



1

GEV No.	529351	Ref. No.	95
----------------	--------	-----------------	----

description water level tube ø 12mm H 135mm

non-return valves

balls



1

GEV No.	528419	Ref. No.	158
----------------	--------	-----------------	-----

description ball ø 11mm SS

for coffee grinders

grinding burrs

grinding burrs conical



1

GEV No.	526890	Ref. No.	709
----------------	--------	-----------------	-----

description grinding burrs pair turn direction right D1 ø 38mm D2 ø 30mm H 18/20mm shaft ø 7mm suitable for IBERITAL

miscellaneous



1

GEV No.	530534	Ref. No.	14572
----------------	--------	-----------------	-------

description equipment foot rectangular L 30mm plastic for coffee grinder



dosing containers

dosing container lids



1

GEV No. 527458 **Ref. No.** 4186

description lid for dosing container ø 126mm

automatic grinding

automatic grinding



1

GEV No. 698757 **Ref. No.** 23621

description housing for microswitch H 26mm L 102mm

accessories for 698757

GEV No. 698756 **Ref. No.** 23620

description lid for microswitch H 20mm



1

GEV No. 698756 **Ref. No.** 23620

description lid for microswitch H 20mm

miscellaneous



1

GEV No. 526541 **Ref. No.** 8161

description frame for lid L 73.5mm W 44mm H 8mm mounting pos. lower plastic

support for filter holder



1

GEV No. 527891 **Ref. No.** 5854

description filter holder support for dosing unit L 71mm W 98mm H 25mm plastic

for dishwashers

air traps

air traps



1

GEV No. 517171 **Ref. No.** 16147

description air trap L 90mm W 55mm H 31mm

accessories for 517171

GEV No. 517173 **Ref. No.** —

description flat gasket FIBER ED ø 14mm ID ø 8mm thickness 1.5mm Qty 1 pcs

GEV No. 517174 **Ref. No.** —

description nut thread M8 H 6.5mm WS 13 SS DIN/ISO DIN 934 / ISO 4032/8673 Qty 1 pcs

door mechanics

miscellaneous



1

GEV No. 528224 **Ref. No.** 3163

description gasket PTFE gasket

washing and rinsing systems



1

GEV No. 505040 **Ref. No.** 6277

description bush for wash arm



1

GEV No. 517103 **Ref. No.** 16152

description cover

knobs

steam/water taps

steam/water taps



1			
GEV No.	111109	Ref. No.	2163
description	knob ø 46mm shaft ø lead: 2mm black		



1			
GEV No.	111372	Ref. No.	9468
description	knob ø 50mm L 32mm shaft 8mm black		

knob dial plates



1			
GEV No.	111376	Ref. No.	9472
description	knob dial plate for water filling ø 24mm black		

handles and hand wheels

miscellaneous



1			
GEV No.	111373	Ref. No.	10930
description	handle for sliding valve shaft ø 6x5mm black suitable for IBERITAL		

accessories



1			
GEV No.	525213	Ref. No.	11010
description	bezel for sliding valve steam suitable for IBERITAL		



1			
GEV No.	525399	Ref. No.	11009
description	bezel for sliding valve water suitable for IBERITAL		

hinges

oven hinges



1			
GEV No.	701137	Ref. No.	43037
description	cover mounting distance 95mm L 112mm W 26mm thickness 1mm cut-out 9x66mm for oven hinge		



1			
GEV No.	701135	Ref. No.	43033
description	opposite support mounting distance 94mm L 110mm W 19mm for oven hinge		



1			
GEV No.	701134	Ref. No.	43032
description	oven hinge mounting distance 173mm mounting distance 2mm lug mounting 14mm lever length 123mm groove distance 10mm spring thickness 3.5mm mounting ear position left/right spring length 112mm L 207mm W 25mm		



gaskets

O-rings

EPDM

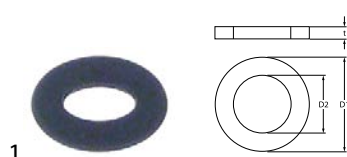

1

GEV No.	525310	Ref. No.	330
description	O-ring EPDM thickness 1.9mm ID ø 4.2mm Qty 1 pcs		

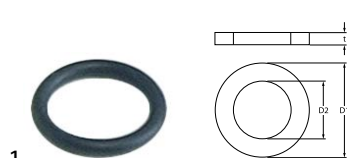

1

GEV No.	529251	Ref. No.	19426
description	O-ring EPDM thickness 2.62mm ID ø 15.08mm Qty 1 pcs		



1

GEV No.	528583	Ref. No.	1293
description	O-ring EPDM thickness 2.62mm ID ø 9.13mm Qty 1 pcs		



1

GEV No.	510951	Ref. No.	176
description	O-ring EPDM thickness 3.53mm ID ø 18.64mm Qty 1 pcs		

silicone

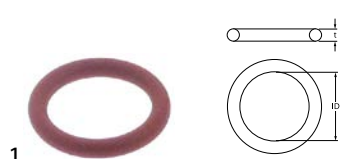

1

GEV No.	525388	Ref. No.	2350
description	O-ring silicone thickness 1.78mm ID ø 9.25mm Qty 1 pcs		

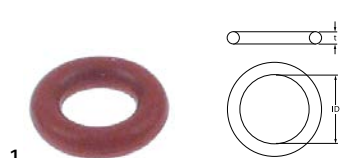

1

GEV No.	525384	Ref. No.	2179
description	O-ring silicone thickness 1.9mm ID ø 4.2mm Qty 1 pcs		



1

GEV No.	528222	Ref. No.	1019
description	O-ring silicone thickness 2.62mm ID ø 10.78mm Qty 1 pcs		

Viton



1

GEV No.	528226	Ref. No.	1287
description	O-ring Viton thickness 2.62mm ID ø 9.92mm Qty 1 pcs		



1

GEV No.	528525	Ref. No.	10242
description	O-ring Viton thickness 3.53mm ID ø 18.64mm Qty 1 pcs		

sealing washers

rubber gaskets



1

GEV No.	528494	Ref. No.	2243
description	gasket rubber ED ø 13mm ID ø 4mm thickness 4mm Qty 1 pcs		

copper gaskets

DIN-7603-A



1

GEV No.	525386	Ref. No.	1565
description	flat gasket copper ED ø 26mm ID ø 21mm thickness 1mm Qty 1 pcs		

DIN-7603-C



1

GEV No.	528520	Ref. No.	270
description	gasket copper ED ø 22mm ID ø 16mm thickness 2mm		





			
1			
GEV No.	525381	Ref. No.	10622
description	gasket copper ED ø 27mm ID ø 21mm thickness 3mm Qty 1 pcs		

PTFE gaskets

			
1			
GEV No.	525380	Ref. No.	11345
description	flat gasket PTFE ED ø 14mm ID ø 9.5mm thickness 0.5mm Qty 1 pcs		

			
1			
GEV No.	526661	Ref. No.	10002
description	flat gasket PTFE ED ø 17mm ID ø 13mm thickness 2mm Qty 1 pcs		

			
1			
GEV No.	525611	Ref. No.	4216 9559
description	flat gasket PTFE ED ø 22mm ID ø 17mm thickness 2mm Qty 1 pcs		

			
1			
GEV No.	528683	Ref. No.	4215
description	flat gasket PTFE ED ø 26mm ID ø 21mm thickness 2mm Qty 1 pcs suitable for GAGGIA, SPAZIALE		

			
1			
GEV No.	528918	Ref. No.	4199
description	flat gasket PTFE ED ø 36mm ID ø 30mm thickness 2mm Qty 1 pcs suitable for VIBIEMME		

special gaskets

group gaskets

			
1			
GEV No.	525377	Ref. No.	9193
description	group gasket L 77mm W 66mm thickness 2mm aperture 24x6mm fibre		

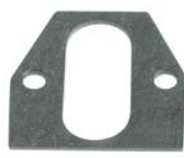
			
1			
GEV No.	528943	Ref. No.	7685
description	group gasket L 77mm W 74mm thickness 2mm aperture 27x66mm hole distance 56mm fibre		

springs

compression springs

			
1			
GEV No.	525359	Ref. No.	10415
description	compression spring ø 10.7mm L 30mm wire gauge ø 1.2mm windings 8		

			
1			
GEV No.	525360	Ref. No.	11050
description	compression spring ø 11.5mm L 26mm wire gauge ø 2mm windings 7		

			
1			
GEV No.	525370	Ref. No.	248
description	compression spring ø 13.5mm L 40.5mm wire gauge ø 1.1mm windings 7		

			
1			
GEV No.	525236	Ref. No.	156
description	compression spring ø 14.5mm L 31.5mm wire gauge ø 2mm windings 7		

			
1			
GEV No.	525372	Ref. No.	162
description	compression spring ø 15mm L 27.5mm wire gauge ø 1.8mm windings 4		

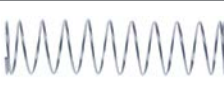
			
1			
GEV No.	525361	Ref. No.	148
description	compression spring ø 8.3mm L 32mm wire gauge ø 0.4mm windings 10		





coffee accessories

supports for filter holders

			
1			
GEV No.	531293	Ref. No.	—
description	bracket for filter holder W 90mm D 70mm H 65mm SS/rubber		

manometers

			
1			
GEV No.	541763	Ref. No.	9679
description	manometer double scale ø 58mm pressure range 0-2.5 / 0-16bar connection on the backside thread 1/8"		

			
1			
GEV No.	541223	Ref. No.	21731
description	manometer double scale ø 60mm pressure range 0-2.5 / 0-16bar connection on the backside thread 1/8"		

			
1			
GEV No.	541764	Ref. No.	11267
description	manometer ø 39mm pressure range 0-16bar thread 1/8" marking 0.8-9 connection on the backside		

			
1			
GEV No.	525375	Ref. No.	11268
description	manometer ø 39mm pressure range 0-3bar thread 1/8" marking 0.8-1 connection on the backside		

			
1			
GEV No.	525645	Ref. No.	24976
description	manometer ø 57mm pressure range 0-16bar CARIMALI connection 1/8"		

			
1			
GEV No.	525644	Ref. No.	24975
description	manometer ø 57mm pressure range 0-2.5bar without glass connection 1/8"		

dosing pumps

membrane dosing pumps

self-priming

LANG











			
1			
GEV No.	361221	Ref. No.	4211
description	dosing pump type N6 rinse aid pressure connection ø 4x6mm suction connection ø 6x8mm LANG		
spare parts for	361221		
	GEV No.	361079	Ref. No. —
	spring for type N5/N6 for ball		
	GEV No.	361080	Ref. No. —
	O-ring EPDM thickness 2mm ID ø 16mm Qty 1 pcs		
	GEV No.	361085	Ref. No. —
	O-ring EPDM thickness 2mm ID ø 8mm Qty 1 pcs		
	GEV No.	361309	Ref. No. —
	ball for type N5/N6		
	GEV No.	361310	Ref. No. —
	bracket for type N6 ball guide		
	GEV No.	361311	Ref. No. —
	O-ring EPDM thickness 2mm ID ø 6mm Qty 1 pcs for type N6		
	GEV No.	361314	Ref. No. —
	valve ring for type N6 holder for O-ring		

Table continues overleaf



spare parts for		361221	
	GEV No.	361317	Ref. No. —
sealing disc for type N6			
	GEV No.	361886	Ref. No. —
non-return valve inletmm outletmm outlet ø 12.4mm L 12.7mm			
	GEV No.	505228	Ref. No. —
spacer bush ID ø 4.5mm ED ø 10mm L 16mm for dosing pump			

hoses

supply hoses

stainless steel flexi hoses

universal hoses



1



GEV No.	520602	Ref. No.	351
description	flex hose SS braid straight-straight DN8 connections 3/8" L 1500mm conical seal approval DVGW operating p. 10bar test pressure 32bar burst p. 95bar		



1



GEV No.	520572	Ref. No.	3052
description	flex hose SS braid straight-straight DN8 connections 3/8" L 500mm conical seal approval DVGW operating p. 10bar test pressure 32bar burst p. 95bar		

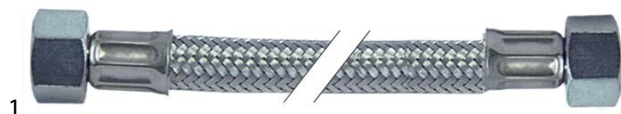

1



GEV No.	520600	Ref. No.	520600
description	flex hose SS braid straight-straight DN8 connections 3/8" L 750mm conical seal approval DVGW operating p. 10bar test pressure 32bar burst p. 95bar		

industrial hoses

hoses wire reinforced

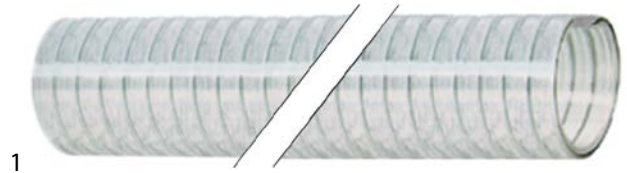

1

GEV No.	520489	Ref. No.	7074
description	drain hose ID ø 14mm ED ø 20mm L 1.5m wire reinforced		

fittings, hose and pipe connectors

hose connectors

without screw connection



1

GEV No.	510843	Ref. No.	22975
description	T-piece plastic hose ø 10-6-10mm		

fittings

double nipples



1

GEV No.	520164	Ref. No.	959
description	double nipple nickel-plated brass thread 1/4" - 3/8" Qty 1 pcs		

valves and tank inlets

ball valves

universal

mini ball valves



1

GEV No.	520723	Ref. No.	8263
description	ball valve connection 3/8" IT - 3/8" ET DN8 total length 40mm brass		



tools

machining

reamers

reamer set

			
1			
GEV No.	800050	Ref. No.	70565
description	nozzle reamers set size 0.5/0.6/0.7/0.8/0.9mm size 1 1.0/1.1/1.2/1.4/1.6/1.8/2.0mm 12-piece with holder		
description	reamer set with holder 12-piece 0.5mm / 0.6mm / 0.7mm / 0.8mm / 0.9mm / 1.0mm 1.1mm / 1.2mm / 1.4mm / 1.6mm / 1.8mm / 2.0mm		

fastening material

screws

hexagonal screws

			
1			
GEV No.	560085	Ref. No.	11270
description	hexagonal screw thread M5 thread L 20mm SS WS 8 Qty 20 pcs DIN 933 / ISO 4017		

nuts

hexagonal nuts

hexagonal nuts metric (without norm)

			
1			
GEV No.	102067	Ref. No.	40540
description	nut thread M8x1 H 3mm brass Qty 1 pcs type SEF 1		

washers

washers

miscellaneous

			
1			
GEV No.	525382	Ref. No.	8978
description	plain washer ID ø 14.5mm ED ø 18.5mm thickness 1.5mm Qty 1 pcs		

			
1			
GEV No.	525383	Ref. No.	21582
description	plain washer ID ø 7mm ED ø 15mm thickness 0.5mm brass Qty 1 pcs		

			
1			
GEV No.	525387	Ref. No.	11079
description	plain washer ID ø 8mm ED ø 14mm thickness 0.5mm brass Qty 1 pcs		

B			
ball valves	36		
bi-metal thermostats	3, 3		
C			
cables	14		
cam switches	5		
contactors	7		
D			
dosing pumps	35		
double nipples	36		
E			
electric accessories	14		
electrodes	10		
F			
fastening material	37		
fittings	36		
flow meters	11		
G			
gas burners	23		
gas control valves	17		
gas nozzles	23		
gas thermostats	14		
H			
heating elements	3		
heating elements for coffee machine	3		
hexagonal nuts	37		
hexagonal screws	37		
hob burners	23		
hose connectors	36		
hoses	36		
hoses wire reinforced	36		
I			
ignition cables	21		
immersion heating elements	3		
indicator lights	5		
indicator lights (complete)	5		
industrial hoses	36		
L			
lamps	5		
M			
machining	37		
mechanical timers	6		
microswitches	5		
motors		11	
N			
nuts		37	
O			
O-rings		33	
oven hinges		32	
P			
piezoelectric igniters		21	
pilot burners		19	
pressure switches		10	
probes		8	
programme timers		6	
pumps		11	
pumps for ice machines		14	
push/momentary push switches		4	
R			
reamers		23, 37	
relays		7	
ribbon cables		14	
rocker/momentary rocker switches		4	
rotary switches		5	
S			
safety thermostats		4	
screws		37	
sealing washers		33	
solenoid valves		10	
solid state relays		7	
stainless steel flexi hoses		36	
supply hoses		36	
switches and momentary switches		4	
T			
thermocouples		22	
thermostats		3	
timers		6	
tools		37	
U			
universal hoses		36	
V			
valves and tank inlets		36	
vibration pumps		13	
W			
wash and rinse pumps		11	
washers		37	