



**GAS COMPONENTS**



**ELECTRIC COMPONENTS**



**WATER TECHNOLOGY**



**MECHANICAL COMPONENTS**



**TOOLS**

Spare parts suitable for

**ICEMATIC**

Find the complete and up-to-date range of products in our GEV Webshop



# Manufacturer catalogue

The most important spare parts and accessories arranged clearly for every manufacturer

- ✓ Complete product range and all appliance data always up to date in the GEV Webshop
- ✓ Alphabetical Index at the end of the catalogue

## GEV Webshop

[www.gev-online.co.uk](http://www.gev-online.co.uk)

[www.gev-online.com](http://www.gev-online.com)



- 🔍 Add to Favourites
- 🔍 Sign In with email address and usual password
- 🔍 Easy-order – place several items in your basket at the same time
- 🔍 Quick Item search – no login needed



## heating elements

### heating cables

#### drain heating cables

|   |   |                 |                            |
|---|---|-----------------|----------------------------|
|  |   |                 |                            |
| <b>GEV No.</b>  | 417615  | <b>Ref. No.</b> | 33575155/0<br>CM33575155/0 |
| <b>description</b>  | drain heating cable 25W 230V 50Hz ø 6.3mm L 3000mm L1 (unheated) 1300mm L2 (heated) 1700mm silicone |                 |                            |

## thermostats

### control and safety thermostats

#### RANCO

##### safety thermostats

|  |  |                 |              |
|--|--|-----------------|--------------|
|  |  |                 |              |
| <b>GEV No.</b>   | 375832   | <b>Ref. No.</b> | CMNM62044300 |
| <b>description</b>   | safety thermostat t.max. 70°C temperature range 0-70°C 1-pole 1N0 16A probe ø 8mm probe L 60mm capillary pipe 870mm capillary pipe isolatedmm gland nut shaft ømm shaft Lmm shaft position rotation° probe material copper switch-off temp. 70°C |                 |              |

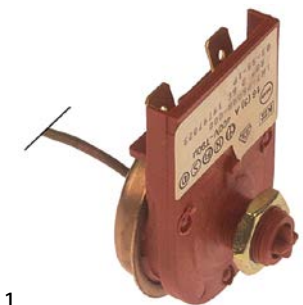
|   |   |                 |                            |
|---|---|-----------------|----------------------------|
|  |   |                 |                            |
| <b>GEV No.</b>  | 390583  | <b>Ref. No.</b> | 19797023/0<br>CM19797023/0 |
| <b>description</b>  | safety thermostat t.max. 80°C temperature range°C 1-pole 1NC 16A probe ø 9mm probe L 50mm capillary pipe 800mm capillary pipe isolatedmm gland nut shaft ømm shaft Lmm shaft position rotation° probe material copper with coiled probe screw connection M10x0.75 switch-off temp. 80°C |                 |                            |
| <b>For models:</b>  | N21S, N25SW, N45L, N45S, N45SW, N70SW, N90SW  |                 |                            |

### refrigeration thermostats

#### DANFOSS

##### service thermostats DANFOSS

All Danfoss thermostats are supplied with fastening material application:  
 390552 - \*\*fridges  
 390553 - \*\*Refrigerators with defrosting push button  
 390554 - \*\*/\*\*Refrigerators with automatic defrosting  
 390555 - absorption refrigerators  
 390557 - Deep cooler with active signal  
 390558 - Freezing with passive signal  
 390559 - bottle cooler 390559

|   |   |                 |  |
|---|---|-----------------|--|
|  |   |                 |  |
| <b>GEV No.</b>  | 390559  | <b>Ref. No.</b> | 077B7008<br>19797007/0<br>19797012/0<br>CM19797007/0<br>CM19797012/0 |
| <b>description</b>  | thermostat type 077B7008 capillary pipe 2000mm temperature range -8.5 up to +11.5°C probe ømm probe Lmm |                 |  |

##### control thermostats

|   |   |                 |                            |
|---|---|-----------------|----------------------------|
|  |   |                 |                            |
| <b>GEV No.</b>  | 390268  | <b>Ref. No.</b> | 19797012/0<br>CM19797012/0 |
| <b>description</b>  | thermostat type 077B0070L capillary pipe 2000mm |                 |                            |

|   |  |                 |                            |
|---|--|-----------------|----------------------------|
|  |  |                 |                            |
| <b>GEV No.</b>  | 390269   | <b>Ref. No.</b> | 19797011/0<br>CM19797011/0 |
| <b>description</b>  | thermostat type 077B2033 capillary pipe 2000mm temperature range -34 up to -15°C |                 |                            |

**RANCO**

**K22 series**



1 

|                    |   |                 |                            |
|--------------------|---|-----------------|----------------------------|
| <b>GEV No.</b>     | 390582  | <b>Ref. No.</b> | 19797025/0<br>CM19797025/0 |
| <b>description</b> | thermostat RANCO type K22-L1529 probe ø 7mm probe L 108mm capillary pipe 1400mm   |                 |                            |
| <b>For models:</b> | N25L, N25LBI, N25LW, N35BI, N35S, N35SW, N45L, N45S, N45SW, N55L, N55LW, N55S, N55SW, N70S, N70SW, N90L, N90LW, N90S, N90SW |                 |                            |



1 

|                    |  |                 |                     |
|--------------------|--|-----------------|---------------------|
| <b>GEV No.</b>     | 390646   | <b>Ref. No.</b> | nicht in Preisliste |
| <b>description</b> | thermostat RANCO type K22-L1075 capillary pipe 2900mm probe ø9.5x107mm |                 |                     |



1 

|                    |  |                 |                     |
|--------------------|--|-----------------|---------------------|
| <b>GEV No.</b>     | 390644   | <b>Ref. No.</b> | nicht in Preisliste |
| <b>description</b> | thermostat RANCO type A22-1297-000 capillary pipe 1500mm probe ø10x100mm |                 |                     |



1 

|                    |  |                 |                            |
|--------------------|--|-----------------|----------------------------|
| <b>GEV No.</b>     | 390209   | <b>Ref. No.</b> | 19797009/0<br>CM19797009/0 |
| <b>description</b> | thermostat RANCO type K22L1020 probe ø 9mm probe L 40mm capillary pipe 2000mm temperature range -20.5 up to -1.5°C |                 |                            |
| <b>For models:</b> | N21S   |                 |                            |



1 

|                    |   |                 |  |
|--------------------|---|-----------------|--|
| <b>GEV No.</b>     | 390737  | <b>Ref. No.</b> | 62020101<br>CMCS62020101<br>CMNM62020101<br>CMNX62020101 |
| <b>description</b> | thermostat RANCO type K22-L1074 probe ø 9mm probe L 42mm capillary pipe 1450mm temperature range -19 up to -1°C |                 |  |



1 

|                    |   |                 |     |
|--------------------|---|-----------------|-----|
| <b>GEV No.</b>     | 390279  | <b>Ref. No.</b> | N/A |
| <b>description</b> | thermostat RANCO type K22L3022 probe ø 9mm probe L 35mm capillary pipe 1600mm |                 |     |

**K50 series**



1 

|                    |  |                 |                            |
|--------------------|--|-----------------|----------------------------|
| <b>GEV No.</b>     | 390642   | <b>Ref. No.</b> | 19797019/0<br>CM19797019/0 |
| <b>description</b> | thermostat RANCO type K50-L3218 probe ø 2mm probe Lmm capillary pipe 1230mm refrigeration 1NO M10x0.75 |                 |                            |





1 

|                    |   |                 |                                    |
|--------------------|---|-----------------|------------------------------------|
| <b>GEV No.</b>     | 390581  | <b>Ref. No.</b> | 19797026/0<br>CM19797026/0<br>I-35 |
| <b>description</b> | thermostat RANCO type K50-S3595 probe ø 2mm probe Lmm capillary pipe 2000mm |                 |                                    |
| <b>For models:</b> | N21S  |                 |                                    |

|   |   |                 |     |
|---|---|-----------------|-----|
|  |   |                 |     |
| <b>GEV No.</b>  | 390444  | <b>Ref. No.</b> | N/A |
| <b>description</b>  | thermostat RANCO type K50-L3074 probe ø 9mm probe L 40mm capillary pipe 560mm |                 |     |

|   |  |                 |         |
|---|--|-----------------|---------|
| <p>K55 series</p>  |  |                 |         |
| <b>GEV No.</b>  | 390210   | <b>Ref. No.</b> | 3824917 |
| <b>description</b>  | thermostat RANCO type K55L1042 capillary pipe 1100mm temperature range +1.7 up to +9.5°C probe ø10x110mm |                 |         |

|  |  |                 |  |
|--|--|-----------------|--|
|  |  |                 |  |
| <b>GEV No.</b>   | 390283   | <b>Ref. No.</b> | 19797017/0<br>19797302/0<br>CM19797017/0<br>CM19797302/0 |
| <b>description</b>   | thermostat RANCO type K55L5081 capillary pipe 1100mm temperature range°C probe ø10x110mm   |                 |  |
| <b>For models:</b>   | N140, N20L, N20WL, N25BI, N25L, N25LBI, N25LW, N25S, N25SW, N35BI, N35S, N35SW, N45L, N45S, N45SW, N50BI, N50BIW, N55L, N55LW, N55S, N55SW |                 |  |

|   |  |                 |  |
|---|--|-----------------|--|
|  |  |                 |  |
| <b>GEV No.</b>  | 390284   | <b>Ref. No.</b> | 19797018/0<br>19797303<br>CM19797018/0 |
| <b>description</b>  | thermostat RANCO type K55L5082 capillary pipe 1500mm temperature range°C probe ø10x110mm |                 |  |
| <b>For models:</b>  | N70S, N70SW, N90L, N90LW, N90S, N90SW  |                 |  |

|   |   |                 |                            |
|---|---|-----------------|----------------------------|
| <p>K61 series</p>  |   |                 |                            |
| <b>GEV No.</b>  | 390212  | <b>Ref. No.</b> | 29090002/0<br>CM29090002/0 |
| <b>description</b>  | thermostat RANCO type K61L1500 probe ømm probe Lmm capillary pipe 750mm T war -11.5°C T cold 22°C |                 |                            |

|  |   |                 |                            |
|--|---|-----------------|----------------------------|
|  |   |                 |                            |
| <b>GEV No.</b>   | 390586  | <b>Ref. No.</b> | 19797031/0<br>CM19797031/0 |
| <b>description</b>   | thermostat RANCO type K61L1504 probe ø 2mm probe Lmm capillary pipe 1800mm T war 11.5°C T cold 22°C |                 |                            |

|  |  |                 |  |
|--|--|-----------------|--|
|  |  |                 |  |
| <b>GEV No.</b>   | 379516   | <b>Ref. No.</b> | 62026416<br>CF62026416<br>CMCF62026416<br>CMNM62026416 |
| <b>description</b>   | thermostat RANCO type K61L1508 probe ø 2mm probe Lmm capillary pipe 1800mm |                 |  |

|  |            |                 |                     |
|--|------------|-----------------|---------------------|
| <p>miscellaneous producers</p>  |            |                 |                     |
| <b>GEV No.</b>   | 390485     | <b>Ref. No.</b> | nicht in Preisliste |
| <b>description</b>   | thermostat |                 |                     |



|   |  |                 |                     |
|---|--|-----------------|---------------------|
|  |  |                 |                     |
| 1   |  |                 |                     |
| <b>GEV No.</b>  | 390659                                       | <b>Ref. No.</b> | nicht in Preisliste |
| <b>description</b>  | thermostat probe ø 2.5mm capillary pipe 90mm |                 |                     |

accessories

probe clips

clamps

for thermostat

|   |  |                 |                            |
|---|--|-----------------|----------------------------|
|  |  |                 |                            |
| 1   |  |                 |                            |
| <b>GEV No.</b>  | 695672   | <b>Ref. No.</b> | 25726140/0<br>CM25726140/0 |
| <b>description</b>  | probe clip L 12mm W 27mm H 18mm hole ø 9.5mm   |                 |                            |
| <b>For models:</b>  | N140, N25L, N25LBI, N25LW, N35BI, N35S, N35SW, N45S, N45SW, N50BI, N50BIW, N55L, N55LW, N55S, N55SW, N70S, N70SW, N90L, N90LW, N90S, N90SW |                 |                            |

|  |  |                 |                            |
|--|--|-----------------|----------------------------|
|  |  |                 |                            |
| 1  |  |                 |                            |
| <b>GEV No.</b>   | 695661   | <b>Ref. No.</b> | 25726141/0<br>CM25726141/0 |
| <b>description</b>   | probe clip L 40mm W 25mm H 18mm hole ø 9.5mm   |                 |                            |
| <b>For models:</b>   | N140, N25L, N25LBI, N25LW, N35BI, N35S, N35SW, N45S, N45SW, N50BI, N50BIW, N55L, N55LW, N55S, N55SW, N70S, N70SW, N90L, N90LW, N90S, N90SW |                 |                            |

switches and momentary switches

rocker/momentary rocker switches

25.5x25mm

|   |   |                 |                            |
|---|---|-----------------|----------------------------|
|  |   |                 |                            |
| 1   |   |                 |                            |
| <b>GEV No.</b>  | 347115 <sup>1</sup>   | <b>Ref. No.</b> | 33400044/0<br>CM33400044/0 |
| <b>description</b>  | rocker switch mounting measurements 25.5x25mm clear 2CO 250V 16A illuminated connection male faston 6.3mm ambient temperature max. 85°C protection IP40 |                 |                            |

<sup>1</sup>illuminated

30x11mm

|   |   |                 |                            |
|---|---|-----------------|----------------------------|
|  |   |                 |                            |
| 1   |   |                 |                            |
| <b>GEV No.</b>  | 348107  | <b>Ref. No.</b> | 33400046/0<br>CM33400046/0 |
| <b>description</b>  | momentary rocker switch mounting measurements 30x11mm black 1NO 250V 16A I connection male faston 6.3mm ambient temperature max. 85/125°C protection IP40 |                 |                            |
| <b>For models:</b>  | N401M, N501M  |                 |                            |

30x11mm

|   |   |                 |  |
|---|---|-----------------|--|
|  |   |                 |  |
| 1   |   |                 |  |
| <b>GEV No.</b>  | 301013  | <b>Ref. No.</b> | 33400049/0<br>62024202<br>CM33400049/0 |
| <b>description</b>  | rocker switch mounting measurements 30x11mm black 1CO 250V 16A connection male faston 6.3mm ambient temperature max. 85/125°C protection IP40 |                 |  |
| <b>For models:</b>  | N21S  |                 |  |



30x11mm

|   |   |                 |                            |
|---|---|-----------------|----------------------------|
|  |   |                 |                            |
| 1   |   |                 |                            |
| <b>GEV No.</b>  | 301012  | <b>Ref. No.</b> | 33400053/0<br>CM33400053/0 |
| <b>description</b>  | rocker switch mounting measurements 30x11mm green 1NO/indicator light 250V 16A 0-I connection male faston 6.3mm ambient temperature max. 85/125°C protection IP40 |                 |                            |
| <b>For models:</b>  | N21S, N25L, N25LW, N25S, N25SW, N35S, N35SW, N45L, N45S, N45SW, N55L, N55LW, N55S, N55SW, N70S, N70SW, N90L, N90LW, N90S, N90SW                                   |                 |                            |

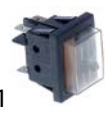
30x22mm

|   |  |                 |                     |
|---|--|-----------------|---------------------|
|  |  |                 |                     |
| 1   |  |                 |                     |
| <b>GEV No.</b>  | 347074   | <b>Ref. No.</b> | nicht in Preisliste |
| <b>description</b>  | rocker switch mounting measurements 30x22mm black/orange 1NO/indicator light 250V 16A cold connection male faston 6.3mm ambient temperature max. 125/55°C protection IP65 with cover cap |                 |                     |

miscellaneous

|   |  |                 |                     |
|---|--|-----------------|---------------------|
|  |  |                 |                     |
| 1   |  |                 |                     |
| <b>GEV No.</b>  | 347064   | <b>Ref. No.</b> | nicht in Preisliste |
| <b>description</b>  | rocker switch mounting measurements 40x18mm black 1CO 250V 10A |                 |                     |
| <b>accessories for</b>  | 347064   |                 |                     |
|  | <b>GEV No.</b>   | 694188          | <b>Ref. No.</b> —   |
| cable harness 3-pole L 170mm permanent temperature 105°C plug type Faston 6.3mm     |  |                 |                     |



push/momentary push switches

19x13mm



1

|                    |   |                 |                     |
|--------------------|---|-----------------|---------------------|
| <b>GEV No.</b>     | 347079 <sup>1</sup>   | <b>Ref. No.</b> | nicht in Preisliste |
| <b>description</b> | push switch mounting measurements 19x13mm green 2NO 250V 16A illuminated connection male faston 6.3mm ambient temperature max. 125°C protection IP65 with cover cap |                 |                     |

<sup>1</sup>illuminated

20.6x16.4mm



1

|                    |  |                 |                            |
|--------------------|--|-----------------|----------------------------|
| <b>GEV No.</b>     | 348108   | <b>Ref. No.</b> | 33400060/0<br>CM33400060/0 |
| <b>description</b> | push switch mounting measurements 20.6x16.4mm chrome 1NO 250V 16A connection male faston 6.3mm ambient temperature max. 85°C protection IP40 |                 |                            |



1

|                    |  |                 |                            |
|--------------------|--|-----------------|----------------------------|
| <b>GEV No.</b>     | 347205   | <b>Ref. No.</b> | 33400060/0<br>CM33400060/0 |
| <b>description</b> | push switch mounting measurements 20.6x16.4mm chrome 2NO 250V 16A connection male faston 6.3mm ambient temperature max. 85°C protection IP40 |                 |                            |

ø 7mm



1

|                    |   |                 |        |
|--------------------|---|-----------------|--------|
| <b>GEV No.</b>     | 347069  | <b>Ref. No.</b> | I-1682 |
| <b>description</b> | momentary push switch mounting ø 7mm red 1NO 24V 4A with cable 500mm connection cable ambient temperature max. 85°C protection IP40 for ice maker |                 |        |

toggle switches

M12x0.75



1

|                    |  |                 |  |
|--------------------|--|-----------------|--|
| <b>GEV No.</b>     | 347068   | <b>Ref. No.</b> | 33400019/0<br>33400027/0<br>81453376/0<br>CM33400019/0<br>CM33400027/0<br>CM81453376/0 |
| <b>description</b> | toggle switch thread M12x0.75 2NO 250V 16A ON-OFF-ON male faston 6.3mm with neutral position |                 |  |

microswitches

lever actuated



1

|                    |  |                 |                            |
|--------------------|--|-----------------|----------------------------|
| <b>GEV No.</b>     | 347063   | <b>Ref. No.</b> | 25474581/0<br>CM25474581/0 |
| <b>description</b> | microswitch 250V 15A 1CO connection male faston 6.3mm ambient temperature max. 105°C lever length 37mm |                 |                            |



1

|                    |  |                 |                            |
|--------------------|--|-----------------|----------------------------|
| <b>GEV No.</b>     | 345345   | <b>Ref. No.</b> | 19410207/0<br>CM19410207/0 |
| <b>description</b> | microswitch with lever 250V 16A 1CO connection male faston 6.3mm L 78mm ambient temperature max. 85°C mounting distance 22mm type X662-88-J27 actuating force: 40g lever length 69mm |                 |                            |



1

|                    |   |                 |                            |
|--------------------|---|-----------------|----------------------------|
| <b>GEV No.</b>     | 346875  | <b>Ref. No.</b> | 19410200/0<br>CM19410200/0 |
| <b>description</b> | microswitch 3 with lever 250V 15A 1CO connection screw L 112mm L1 49mm ambient temperature max. 125°C mounting distance 25mm type Z-15HW24-B actuating force: 5g lever length 125mm |                 |                            |



1

|                    |   |                 |                            |
|--------------------|---|-----------------|----------------------------|
| <b>GEV No.</b>     | 345270  | <b>Ref. No.</b> | 19410200/0<br>CM19410200/0 |
| <b>description</b> | microswitch with lever 250V 16A 1CO connection male faston 6.3mm ambient temperature max. 85°C mounting distance 25mm type C99ZP3 actuating force: 30g lever length 140mm |                 |                            |



1

|                    |   |                 |                     |
|--------------------|---|-----------------|---------------------|
| <b>GEV No.</b>     | 346887  | <b>Ref. No.</b> | nicht in Preisliste |
| <b>description</b> | microswitch with lever 250V 15A 1NC connection male faston 6.3mm ambient temperature max. 125°C lever length 60mm |                 |                     |



|   |  |                 |                     |
|---|--|-----------------|---------------------|
|  |  |                 |                     |
| 1   |  |                 |                     |
| <b>GEV No.</b>  | 347077   | <b>Ref. No.</b> | nicht in Preisliste |
| <b>description</b>  | microswitch with lever 250V 15A 2CO connection male faston 6.3mm ambient temperature max. 85°C lever length 62mm |                 |                     |

|   |  |                 |                            |
|---|--|-----------------|----------------------------|
|  |  |                 |                            |
| 1   |  |                 |                            |
| <b>GEV No.</b>  | 345361   | <b>Ref. No.</b> | 19410205/0<br>CM19410205/0 |
| <b>description</b>  | microswitch with lever 250V 5A 1NO/1NC connection soldering connection ambient temperature max. 85°C type 83109004 lever length 43mm |                 |                            |

## roller-lever actuated

## microswitches

|   |  |                 |  |
|---|--|-----------------|--|
|  |  |                 |  |
| 1   |  |                 |  |
| <b>GEV No.</b>  | 345253   | <b>Ref. No.</b> | 19410201/0<br>19410209/0<br>CM19410201/0<br>CM19410209/0 |
| <b>description</b>  | microswitch with handle with a switch 250V 15A 1CO connection male faston 6.3mm L 28mm L1 37mm ambient temperature max. 125°C mounting distance 22mm type RL6-1-F-GE-P12-5-L actuating force: 80g grey lever length 28mm |                 |  |
| <b>For models:</b>  | N140, N20L, N20WL, N25BI, N25L, N25LBI, N25LW, N25S, N25SW, N35BI, N35S, N35SW, N45L, N45S, N45SW, N50BI, N50BIW, N55L, N55LW, N55S, N55SW, N70S, N70SW, N90L, N90LW, N90S, N90SW  |                 |  |

## heavy duty version

|   |   |                 |                            |
|---|---|-----------------|----------------------------|
|  |   |                 |                            |
| 1   |   |                 |                            |
| <b>GEV No.</b>  | 346874  | <b>Ref. No.</b> | 19410300/0<br>CM19410300/0 |
| <b>description</b>  | microswitch with handle with a switch 250V 16A 1CO connection screw L 29mm L1 49mm ambient temperature max. 85°C mounting distance 26mm type Z-15GW22-B actuating force: 120g lever length 25mm |                 |                            |

## with mounting components



|   |   |                 |  |
|---|---|-----------------|--|
|  |   |                 |  |
| 1   |   |                 |  |
| <b>GEV No.</b>  | 346876  | <b>Ref. No.</b> | 19410208/0<br>81401140<br>CM19410208/0 |
| <b>description</b>  | microswitch with handle with a switch 250V 16A 1CO connection male faston L 35mm L1 28mm ambient temperature max. 125°C mounting distance 22mm type V-166-1CR5 actuating force: 86g |                 |  |
| <b>For models:</b>  | N20L, N20WL, N25BI, N25L, N25LBI, N25LW, N25S, N25SW, N35BI, N35S, N35SW  |                 |  |

## roller actuated

## roller 0°

|   |   |                 |                            |
|---|---|-----------------|----------------------------|
|  |   |                 |                            |
| 1   |   |                 |                            |
| <b>GEV No.</b>  | 347080  | <b>Ref. No.</b> | 33400026/0<br>CM33400026/0 |
| <b>description</b>  | microswitch with roller plunger 10A 1CO connection screw ambient temperature max. 85°C thread M12x1 |                 |                            |

## float switches

|  |                               |                 |                            |                            |
|--|-------------------------------|-----------------|----------------------------|----------------------------|
|  |                               |                 |                            |                            |
| 1  |                               |                 |                            |                            |
| <b>GEV No.</b>   | 403551                        | <b>Ref. No.</b> | 81300027/0<br>CM81300027/0 |                            |
| <b>description</b>   | float switch 1CO 250V 4A F6.3 |                 |                            |                            |
| <b>accessories for</b>   | 403551                        |                 |                            |                            |
|   | <b>GEV No.</b>                | 403552          | <b>Ref. No.</b>            | 25725558/0<br>CM25725558/0 |
| bracket for float switch L 100mm W 37mm H 41mm stainless steel thickness 2mm         |                               |                 |                            |                            |

|  |   |                 |  |
|--|---|-----------------|--|
|  |   |                 |  |
| 1  |   |                 |  |
| <b>GEV No.</b>   | 345365  | <b>Ref. No.</b> | 81404080/0<br>81409179/0<br>CM81404080/0<br>CM81409179/0 |
| <b>description</b>   | float switch 250V 16A 1CO male faston 6.3mm L 150mm ambient temperature max. 125°C mounting distance 23mm type EF83161.5 actuating force: 5g black                          |                 |  |
| <b>For models:</b>   | N20L, N20WL, N25BI, N25L, N25LBI, N25LW, N25S, N25SW, N35BI, N35S, N35SW, N45L, N45S, N45SW, N50BI, N50BIW, N55L, N55LW, N55S, N55SW, N70S, N70SW, N90L, N90LW, N90S, N90SW |                 |  |





1



|                    |   |                 |                            |
|--------------------|---|-----------------|----------------------------|
| <b>GEV No.</b>     | 347088  | <b>Ref. No.</b> | 81449091/0<br>CM81449091/0 |
| <b>description</b> | float switch with plunger 250V 16A 1CO male faston 6.3mm L 130mm ambient temperature max. 125°C mounting distance 23mm type EF83161.5 actuating force: 5g black |                 |                            |
| <b>For models:</b> | N140  |                 |                            |

floats

1



|                    |   |                 |  |
|--------------------|---|-----------------|--|
| <b>GEV No.</b>     | 695036  | <b>Ref. No.</b> | 29025013/0<br>CF66058500<br>CF78312700<br>CM29025013/0<br>CMCF66058500<br>CMCF78312700 |
| <b>description</b> | float for ice maker ø 75mm L 115mm H 40mm plastic                     |                 |  |
| <b>For models:</b> | F100, F120, F125C, F200, F80C, F80WC, SF300, SF500, SFN1000, SFN1000W |                 |  |

1



|                    |  |                 |                            |
|--------------------|--|-----------------|----------------------------|
| <b>GEV No.</b>     | 696637   | <b>Ref. No.</b> | 25360110/3<br>CM25360110/3 |
| <b>description</b> | float without magnet ø 18.5mm L 77mm W 19mm H 34mm PVC suitable for ICEMATIC |                 |                            |

centrifugal switches

1



|                    |                    |                 |                     |
|--------------------|--------------------|-----------------|---------------------|
| <b>GEV No.</b>     | 346986             | <b>Ref. No.</b> | nicht in Preisliste |
| <b>description</b> | centrifugal switch |                 |                     |

1

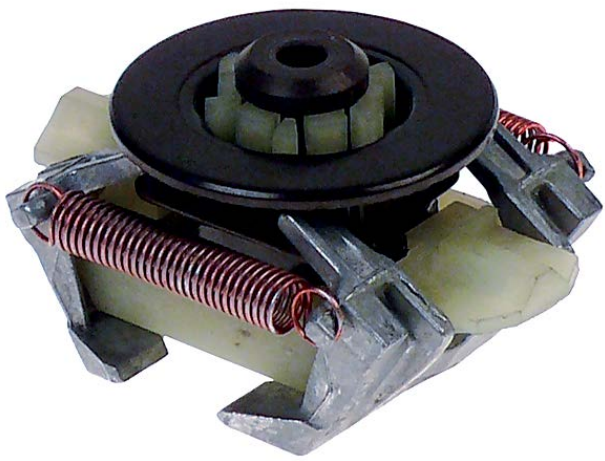

|                    |                    |                 |                     |
|--------------------|--------------------|-----------------|---------------------|
| <b>GEV No.</b>     | 347062             | <b>Ref. No.</b> | nicht in Preisliste |
| <b>description</b> | centrifugal switch |                 |                     |

touch sensitive light switches

1



|                    |                                     |                 |                     |
|--------------------|-------------------------------------|-----------------|---------------------|
| <b>GEV No.</b>     | 402018                              | <b>Ref. No.</b> | nicht in Preisliste |
| <b>description</b> | light barrier for ice thickness set |                 |                     |

1



|                    |   |                 |                            |
|--------------------|---|-----------------|----------------------------|
| <b>GEV No.</b>     | 402043  | <b>Ref. No.</b> | CF65067402<br>CMCF65067402 |
| <b>description</b> | light barrier L 180mm W 35mm H 46mm               |                 |                            |
| <b>For models:</b> | F100, F120, F200, SF300, SF500, SFN1000, SFN1000W |                 |                            |





1

|                    |                                     |                 |  |
|--------------------|-------------------------------------|-----------------|--|
| <b>GEV No.</b>     | 402009                              | <b>Ref. No.</b> | 29040018<br>29040018/0<br>33580175/0<br>CF65067400<br>CM29040018/0<br>CM33580175/0<br>CMCF65067400 |
| <b>description</b> | light barrier L 310mm W 35mm H 47mm |                 |  |
| <b>For models:</b> | F80C, F80WC                         |                 |  |

magnetic switches

26x12.5mm



1

|                    |  |                 |                            |
|--------------------|--|-----------------|----------------------------|
| <b>GEV No.</b>     | 348110 <sup>1</sup>  | <b>Ref. No.</b> | 33210022/0<br>CM33210022/0 |
| <b>description</b> | magnetic switch L 26mm W 12.5mm 1NO 300V 0.5A P max. 10W connection coded plug cable length 1500mm |                 |                            |

<sup>1</sup>with coded connector

36x13mm



1

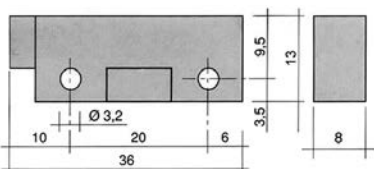

|   |  |                 |  |                            |
|---|--|-----------------|--|----------------------------|
| <b>GEV No.</b>  | 345118 <sup>1</sup>  | <b>Ref. No.</b> | 33210018/0<br>33210019/0<br>CM33210018/0<br>CM33210019/0 |                            |
| <b>description</b>  | magnetic switch L 36mm W 13mm 1NO 250V 1A P max. 50W connection cable length 980mm |                 |  |                            |
| <b>For models:</b>  | N131M, N200M, N200MW, N201M, N300M, N300MW, N301M, N401M, N500M, N501M             |                 |  |                            |
| <b>accessories for</b>  | 345118   |                 |  |                            |
|  | <b>GEV No.</b>   | 345399          | <b>Ref. No.</b>  | 19355004/0<br>CM19355004/0 |
|   | magnet ø 3.3mm L 40mm H 8mm W 13mm hole distance 30mm M3                           |                 |  |                            |

<sup>1</sup>with coded connector

M10x0.75



1

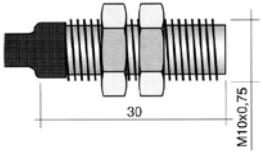

|   |  |                 |                            |   |
|---|--|-----------------|----------------------------|---|
| <b>GEV No.</b>  | 345632   | <b>Ref. No.</b> | 33580132/0<br>CM33580132/0 |   |
| <b>description</b>  | magnetic switch thread M10x0.75 1NO 250V 0.5A P max. 50W connection cable length 2000mm type 102 |                 |                            |   |
| <b>For models:</b>  | T20, T20C, T20R  |                 |                            |   |
| <b>accessories for</b>  | 345632   |                 |                            |   |
|  | <b>GEV No.</b>   | 100779          | <b>Ref. No.</b>            | — |
|   | nut thread M10x0.75 H 3mm WS 14 SS Qty 2 pcs   |                 |                            |   |

accessories

magnets

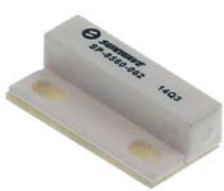

1

|                    |   |                 |  |
|--------------------|---|-----------------|--|
| <b>GEV No.</b>     | 348111  | <b>Ref. No.</b> | 19355010/0<br>193550101/0<br>CM19355010/0<br>CM193550101/0 |
| <b>description</b> | magnet L 26mm H 7.45mm W 12.45mm hole distance 17.5mm M3 hole ø 3.2mm |                 |  |



1

|                    |   |                 |                            |
|--------------------|---|-----------------|----------------------------|
| <b>GEV No.</b>     | 347059  | <b>Ref. No.</b> | 19355007/0<br>CM19355007/0 |
| <b>description</b> | magnet L 40mm H 8mm W 13.2mm hole distance 30mm |                 |                            |
| <b>For models:</b> | N131M, N201M, N301M, N401M, N501M               |                 |                            |



1

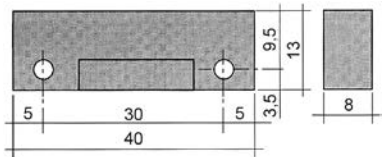

|                    |  |                 |                            |
|--------------------|--|-----------------|----------------------------|
| <b>GEV No.</b>     | 345399   | <b>Ref. No.</b> | 19355004/0<br>CM19355004/0 |
| <b>description</b> | magnet ø 3.3mm L 40mm H 8mm W 13mm hole distance 30mm M3 |                 |                            |
| <b>For models:</b> | N200M, N200MW, N300M, N300MW                             |                 |                            |



miscellaneous



1

|                    |                                      |                 |                     |
|--------------------|--------------------------------------|-----------------|---------------------|
| <b>GEV No.</b>     | 347066                               | <b>Ref. No.</b> | nicht in Preisliste |
| <b>description</b> | safety switch 250V ø 58mm H 40mm 15A |                 |                     |

lamps

indicator lights

indicator lights (complete)

ø10mm

with screw socket



1

|                    |   |                 |                            |
|--------------------|---|-----------------|----------------------------|
| <b>GEV No.</b>     | 359380  | <b>Ref. No.</b> | 33470507/0<br>CM33470507/0 |
| <b>description</b> | indicator light ø 10mm 230V red connection male faston 6.3mm socket screw base  |                 |                            |
| <b>For models:</b> | N21S, N25L, N25LW, N25S, N25SW, N35S, N35SW, N45L, N45S, N45SW, N55L, N55LW, N55S, N55SW, N70S, N70SW, N90L, N90LW, N90S, N90SW |                 |                            |

ø13mm

with plug-in socket



1

|                    |  |                 |          |
|--------------------|--|-----------------|----------|
| <b>GEV No.</b>     | 359141   | <b>Ref. No.</b> | 33576295 |
| <b>description</b> | indicator light ø 13mm red 230V connection male faston 6.3mm temp.-resist. 120°C Qty 1 pcs |                 |          |

30x22mm



1

|                    |  |                 |  |
|--------------------|--|-----------------|--|
| <b>GEV No.</b>     | 359155   | <b>Ref. No.</b> | 33400002<br>33400002/0<br>CM33400002/0 |
| <b>description</b> | indicator light mounting measurements 30x22mm 230V red connection male faston 6.3mm temp.-resist. 125°C type RL2 |                 |  |

timers

programme timers



1

|                    |        |                 |                     |
|--------------------|--------|-----------------|---------------------|
| <b>GEV No.</b>     | 360377 | <b>Ref. No.</b> | nicht in Preisliste |
| <b>description</b> | timer  |                 |                     |



1

|                    |  |                 |            |
|--------------------|--|-----------------|------------|
| <b>GEV No.</b>     | 360754   | <b>Ref. No.</b> | 19800012/0 |
| <b>description</b> | timer CDC engines 1 chambers 2 operation time 12min 230V 50-60Hz shaft ømm shaft Lmm motor type 4902F1 |                 |            |



1

|                    |  |                 |  |
|--------------------|--|-----------------|--|
| <b>GEV No.</b>     | 360665 <sup>1</sup>  | <b>Ref. No.</b> | 81414561/0<br>81414562/0<br>CM19800012/0<br>CM81414561/0<br>CM81414562/0 |
| <b>description</b> | timer CDC kit engines 1 chambers 2 operation time 12min 230V 50-60Hz shaft ømm shaft Lmm motor type 4902F1 |                 |  |

<sup>1</sup>with cable kit

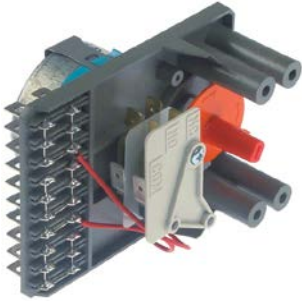

1

|   |  |                 |                            |
|---|--|-----------------|----------------------------|
| <b>GEV No.</b>  | 360370   | <b>Ref. No.</b> | 19800001/0<br>CM19800001/0 |
| <b>description</b>  | timer FIBER P36 engines 1 chambers 2 operation time 12min 230V 50-60Hz shaft ømm shaft Lmm manuf. no. P365JR2J536 motor type M51BJ0R6400                           |                 |                            |
| <b>For models:</b>  | N215   |                 |                            |
| <b>spare parts for</b>  | 360370   |                 |                            |
|  | <b>GEV No.</b>   | 360673          | <b>Ref. No.</b> —          |
|   | motor kit pinion ø 6.8mm teeth 15 230V voltage AC 50/60Hz turn direction clockwise motor ø 48mm H 18.5mm motor type UDS-40NE1RNZ165 cable length 150mm with holder |                 |                            |



1

|                    |   |                 |  |
|--------------------|---|-----------------|--|
| <b>GEV No.</b>     | 380888  | <b>Ref. No.</b> | 33730712<br>33730712/0<br>CM33730712/0 |
| <b>description</b> | power contactor resistive load 20A 230VAC (AC3/400V) 12A/5.7kW main contacts 3NO auxiliary contacts 1NC connection screw connection type 11BG1201A230 |                 |  |
| <b>For models:</b> | N131M, N201M, N301M, N401M  |                 |  |



1

|                    |  |                 |                     |
|--------------------|--|-----------------|---------------------|
| <b>GEV No.</b>     | 380574   | <b>Ref. No.</b> | nicht in Preisliste |
| <b>description</b> | power contactor resistive load 25A 230VAC (AC3/400V) 12A/5.7kW main contacts 3NO auxiliary contacts 1NO connection screw connection type B12 |                 |                     |

### miscellaneous

#### power contactors



1

|                    |  |                 |                     |
|--------------------|--|-----------------|---------------------|
| <b>GEV No.</b>     | 380578   | <b>Ref. No.</b> | nicht in Preisliste |
| <b>description</b> | power contactor 208/240V resistive load 30A main contacts 2NO connection male faston 6.3mm |                 |                     |

## contactors

### GENERAL ELECTRIC (AEG)

#### power contactors



1

|                    |   |                 |                            |
|--------------------|---|-----------------|----------------------------|
| <b>GEV No.</b>     | 380859  | <b>Ref. No.</b> | 33730609/0<br>CM33730609/0 |
| <b>description</b> | power contactor resistive load 25A 230VAC (AC3/400V) 12A/5.5kW main contacts 3NO auxiliary contacts 1NC connection screw connection type AEG LS701E |                 |                            |

### LOVATO

#### power contactors



1

|                    |  |                 |        |
|--------------------|--|-----------------|--------|
| <b>GEV No.</b>     | 380579   | <b>Ref. No.</b> | I-1673 |
| <b>description</b> | power contactor resistive load 16A 230VAC (AC3/400V) 9A/4kW main contacts 3NO auxiliary contacts 1NO connection screw connection type 11MC9102205060 |                 |        |



relays

power relays

with bracket mounting



1

|                    |   |                 |                            |
|--------------------|---|-----------------|----------------------------|
| <b>GEV No.</b>     | 380312  | <b>Ref. No.</b> | 19620107/0<br>CM19620107/0 |
| <b>description</b> | power relays FINDER 230VAC 10A 3CO connection male faston 4.8mm bracket mounting dimensions 52x32.2x36.5mm manuf. no. 60.63.8.230.0000  |                 |                            |
| <b>For models:</b> | N140, N20L, N20WL, N25BI, N25L, N25LBI, N25LW, N25S, N25SW, N35BI, N35S, N35SW, N45L, N45S, N45SW, N50BI, N50BIW, N55L, N55LW, N55S, N55SW, N70S, N70SW, N90L, N90LW, N90S, N90SW |                 |                            |



1



|                    |  |                 |                            |
|--------------------|--|-----------------|----------------------------|
| <b>GEV No.</b>     | 380185   | <b>Ref. No.</b> | 19620103/0<br>CM19620103/0 |
| <b>description</b> | power relays Italiana Relè 230VAC 30A 1NO connection F6.3 bracket mounting dimensions 36.5x32.2x51.8mm manuf. no. A10-230AC-FA |                 |                            |
| <b>For models:</b> | T14, T5  |                 |                            |

with male contacts

bullet connectors, 8 contacts



1

|   |   |                 |                            |                            |
|---|---|-----------------|----------------------------|----------------------------|
| <b>GEV No.</b>  | 380134  | <b>Ref. No.</b> | 19620100/0<br>CM19620100/0 |                            |
| <b>description</b>  | power relays Italiana Relè 230VAC 10A 2CO connection plug-in connection round 8-pole manuf. no. C42-230VAC 90.26/ZVE8 250V              |                 |                            |                            |
| <b>accessories for</b>  | 380134  |                 |                            |                            |
|  | <b>GEV No.</b>  | 380137          | <b>Ref. No.</b>            | —                          |
|   | relay socket 8-pole connection plug-in connection round 8-pole dimensions: 65x28x40mm 380V voltage AC 10A Italiana Relè manuf. no. ZVE8 |                 |                            |                            |
|  | <b>GEV No.</b>  | 380638          | <b>Ref. No.</b>            | 19050010/0<br>CM19050010/0 |
|   | relay socket 8-pole dimensions 51x41x23mm 250V 10A FINDER manuf. no. 90.26  |                 |                            |                            |

relay sockets



1

|                    |  |                 |                            |
|--------------------|--|-----------------|----------------------------|
| <b>GEV No.</b>     | 380638   | <b>Ref. No.</b> | 19050010/0<br>CM19050010/0 |
| <b>description</b> | relay socket 8-pole dimensions 51x41x23mm 250V 10A FINDER manuf. no. 90.26 |                 |                            |

time relays

time relays



1

|                    |   |                 |                     |
|--------------------|---|-----------------|---------------------|
| <b>GEV No.</b>     | 350129  | <b>Ref. No.</b> | nicht in Preisliste |
| <b>description</b> | time relay FIBER R11B52307F0 time range 6s-30min 230VAC 2x6A 1NO/1CO connection male faston 6.3mm |                 |                     |



1

|                    |  |                 |                     |
|--------------------|--|-----------------|---------------------|
| <b>GEV No.</b>     | 380584   | <b>Ref. No.</b> | nicht in Preisliste |
| <b>description</b> | time relay SYRELEC BAR.F time range 0-10min 220-240VAC 5A 1CO connection screw |                 |                     |

miscellaneous



1

|                    |                                      |                 |                            |
|--------------------|--------------------------------------|-----------------|----------------------------|
| <b>GEV No.</b>     | 380580                               | <b>Ref. No.</b> | 33580057/0<br>CM33580057/0 |
| <b>description</b> | relay connection with cable for pump |                 |                            |



## transformers

### open transformers

#### with plug connection



1

|                    |   |                 |                     |
|--------------------|---|-----------------|---------------------|
| <b>GEV No.</b>     | 401827  | <b>Ref. No.</b> | nicht in Preisliste |
| <b>description</b> | transformer primary 230V secondary 24V 75VA 50/60Hz |                 |                     |

## electronic controllers

### CAREL

#### refrigeration controllers

##### built-in version



1

|                    |   |                 |                            |
|--------------------|---|-----------------|----------------------------|
| <b>GEV No.</b>     | 381365  | <b>Ref. No.</b> | 26118434/0<br>CM26118434/0 |
| <b>description</b> | electronic controller CAREL IR3350EN00 mounting measurements 71x29mm built-in depth 56mm 230V voltage AC relay outputs 1 CO-8A(4) NTC NTC DI yes yes yes yes yes protection IP65 display 3 digits |                 |                            |

### miscellaneous

#### refrigeration controllers



1

|                    |  |                 |                            |
|--------------------|--|-----------------|----------------------------|
| <b>GEV No.</b>     | 378230   | <b>Ref. No.</b> | 26117881/0<br>CM26117881/0 |
| <b>description</b> | electronic controller type HTW311 mounting measurements 71x29mm 12V voltage AC sensor 1 NTC/RTC AC1 (R1) 10A |                 |                            |

## probes

### universal probes

#### temperature probes



1

|                    |   |                 |  |
|--------------------|---|-----------------|--|
| <b>GEV No.</b>     | 379557  | <b>Ref. No.</b> | 33580115/0<br>33580116/0<br>CM33580115/0<br>CM33580116/0 |
| <b>description</b> | temperature probe NTC 10kOhm cable silicone probe -40 up to +110°C cable -50 up to +180°C probe ø6x35mm cable length 1.5m without screw connection 2-wire |                 |  |

|                    |   |                 |                            |
|--------------------|---|-----------------|----------------------------|
| 1                  |   |                 |                            |
| <b>GEV No.</b>     | 379162  | <b>Ref. No.</b> | 33580099/0<br>CM33580099/0 |
| <b>description</b> | temperature probe NTC 10kOhm cable thermoplastic probe -40 up to +110°C cable -40 up to +110°C probe ø6x14mm cable length 6m 2-wire |                 |                            |
| <b>For models:</b> | T14, T20, T20C, T20R, T5  |                 |                            |

|                    |  |                 |                            |
|--------------------|--|-----------------|----------------------------|
| 1                  |  |                 |                            |
| <b>GEV No.</b>     | 381343   | <b>Ref. No.</b> | 33580099/1<br>CM33580099/1 |
| <b>description</b> | temperature probe PTC 1kOhm cable thermoplastic probe -50 up to +150°C cable -40 up to +110°C probe ø6x14mm cable length 4.8m 2-wire |                 |                            |

### core probes



1

|                    |   |                 |  |
|--------------------|---|-----------------|--|
| <b>GEV No.</b>     | 379549  | <b>Ref. No.</b> | 33580149<br>33580149/0<br>CM33580149/0 |
| <b>description</b> | core temperature probe PTC 1kOhm cable PVC probe -50 up to +150°C cable -10 up to 100°C probe ø6x110mm cable length 3.5m handle ø 8mm handle length 120x35mm 2-wire L1 120mm L2 130mm |                 |  |
| <b>For models:</b> | T14, T20, T20C, T20R, T5  |                 |  |

### producer-specific probes

#### probes

|                    |  |                 |  |
|--------------------|--|-----------------|--|
| 1                  |  |                 |  |
| <b>GEV No.</b>     | 381339   | <b>Ref. No.</b> | 33580298/0<br>CF62051900<br>CM33580298/0<br>CMCF62051900 |
| <b>description</b> | probe NTC 10kOhm cable PVC probe -40 up to +110°C cable -10 up to 100°C connection plug thread probe ø5x50mm cable length 1.2m |                 |  |

|   |   |                 |                            |
|---|---|-----------------|----------------------------|
| 1  |   |                 |                            |
| <b>GEV No.</b>  | 381338  | <b>Ref. No.</b> | 33580135/0<br>CM33580135/0 |
| <b>description</b>  | probe NTC 2.2kOhm cable PVC probe -40 up to +110°C cable -10 up to 100°C connection plug thread probe ø5x50mm cable length 2m |                 |                            |
| <b>For models:</b>  | N500M   |                 |                            |

|   |  |                 |                            |
|---|--|-----------------|----------------------------|
| 1  |  |                 |                            |
| <b>GEV No.</b>  | 381336   | <b>Ref. No.</b> | 33580265/0<br>CM33580265/0 |
| <b>description</b>  | probe NTC 2kOhm cable PVC probe -40 up to +110°C cable -10 up to 100°C connection plug probe ø6x60mm cable length 1.5m |                 |                            |

|   |  |                 |                            |
|---|--|-----------------|----------------------------|
| 1  |  |                 |                            |
| <b>GEV No.</b>  | 381344   | <b>Ref. No.</b> | CF62040411<br>CMCF62040411 |
| <b>description</b>  | probe PTC 2kOhm cable PVC probe -50 up to +150°C cable -10 up to 100°C connection plug probe ø5x50mm cable length 1.7m |                 |                            |
| <b>For models:</b>  | SFN1000, SFN1000W  |                 |                            |

|   |   |                 |                     |
|---|---|-----------------|---------------------|
| 1  |   |                 |                     |
| <b>GEV No.</b>  | 379628  | <b>Ref. No.</b> | nicht in Preisliste |
| <b>description</b>  | temperature probe 2x NTC 10K cable PVC probe -40 up to +110°C cable -10 up to 100°C connection coded plug thread probe ø6.5x45mm cable length 0.4/0.55m |                 |                     |

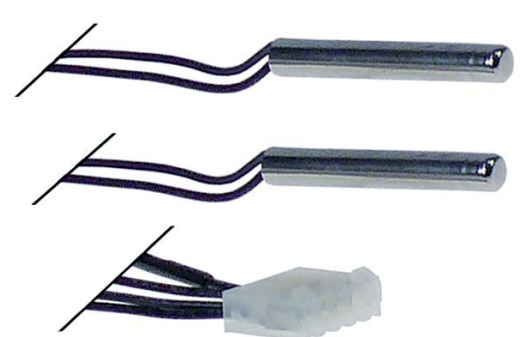
|   |  |                 |                     |
|---|--|-----------------|---------------------|
| 1  |  |                 |                     |
| <b>GEV No.</b>  | 379564   | <b>Ref. No.</b> | nicht in Preisliste |
| <b>description</b>  | temperature probe 2x NTC 10K cable PVC probe -40 up to +110°C cable -10 up to 100°C connection coded plug thread probe ø6.5x45mm cable length 0.7/1.3m |                 |                     |

|   |  |                 |  |
|---|--|-----------------|--|
| 1  |  |                 |  |
| <b>GEV No.</b>  | 381337   | <b>Ref. No.</b> | 33580297/0<br>CF62051901<br>CM33580297/0<br>CMCF62051901 |
| <b>description</b>  | temperature probe NTC 10kOhm cable PVC probe -40 up to +110°C cable -10 up to 100°C connection plug thread probe ø5x40mm cable length 1.5m |                 |  |

|  |   |                 |                            |
|--|---|-----------------|----------------------------|
| 1  |   |                 |                            |
| <b>GEV No.</b>   | 402139  | <b>Ref. No.</b> | 33580101/0<br>CM33580101/0 |
| <b>description</b>   | temperature probe NTC 2.2kOhm cable PVC probe -40 up to +110°C cable -10 up to 100°C connection plug thread probe ø5x60mm cable length 1m |                 |                            |
| <b>For models:</b>   | N131M, N200M, N200MW, N201M, N300M, N300MW, N301M, N401M, N501M   |                 |                            |

|  |   |                 |  |
|--|---|-----------------|--|
| 1  |   |                 |  |
| <b>GEV No.</b>   | 402006  | <b>Ref. No.</b> | 29070010<br>33580065/0<br>33580065/1<br>CM33580065/0<br>CM33580065/1 |
| <b>description</b>   | temperature probe PTC 2kOhm cable PVC probe -50 up to +150°C cable -10 up to 100°C connection plug thread probe ø5x60mm cable length 1.5m |                 |  |

|  |   |                 |                            |
|--|---|-----------------|----------------------------|
| 1  |   |                 |                            |
| <b>GEV No.</b>   | 378231  | <b>Ref. No.</b> | 33580066/1<br>CM33580066/1 |
| <b>description</b>   | temperature probe PTC 2kOhm cable PVC probe -50 up to +150°C cable -10 up to 100°C connection plug thread probe ø5x60mm cable length 1.9m |                 |                            |

|  |  |                 |  |
|--|--|-----------------|--|
| 1  |  |                 |  |
| <b>GEV No.</b>   | 402191   | <b>Ref. No.</b> | 29070014/0<br>CF62040401<br>CM29070014/0<br>CMCF62040401 |
| <b>description</b>   | temperature probe PTC 2kOhm cable TPE probe -50 up to +150°C cable -40 up to +110°C connection plug thread probe ø5x20mm cable length 1.8m |                 |  |
| <b>For models:</b>   | F100, F100C, F120, F125C, F200, F80C, F80WC, SF300, SF500  |                 |  |

|  |  |                 |   |
|--|--|-----------------|---|
| 1  |  |                 |   |
| <b>GEV No.</b>   | 402005   | <b>Ref. No.</b> | 29070013<br>29070013/0<br>620404.10<br>CF62040410<br>CM29070013/0<br>CMCF62040410 |
| <b>description</b>   | temperature probe PTC 2kOhm cable TPE probe -50 up to +150°C cable -40 up to +110°C connection plug thread probe ø6x50mm cable length 1.6m |                 |   |
| <b>For models:</b>   | F100, F100C, F120, F125C, F200, F80C, F80WC, SF300, SF500, SFN1000, SFN1000W   |                 |   |

core probes

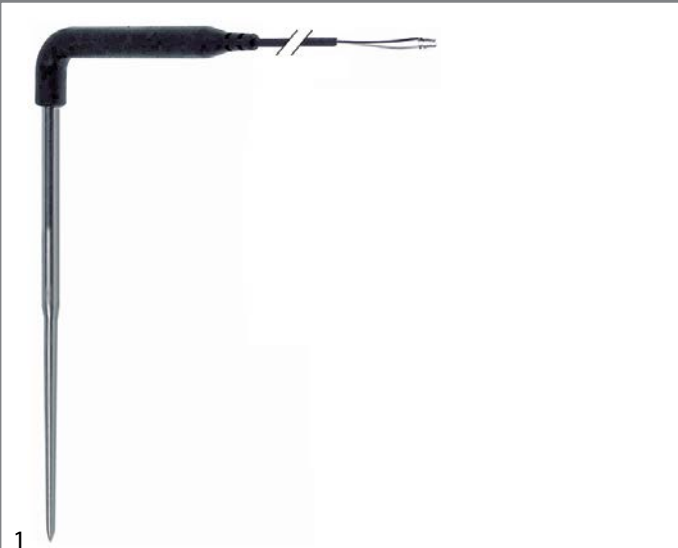

|                    |   |                 |  |
|--------------------|---|-----------------|--|
| <b>GEV No.</b>     | 379549  | <b>Ref. No.</b> | 33580149<br>33580149/0<br>CM33580149/0 |
| <b>description</b> | core temperature probe PTC 1k0hm cable PVC probe -50 up to +150°C cable -10 up to 100°C probe ø6x110mm cable length 3.5m handle ø 8mm handle length 120x35mm 2-wire L1 120mm L2 130mm |                 |  |
| <b>For models:</b> | T14, T20, T20C, T20R, T5  |                 |  |

Hall sensors

|                    |                                |                 |        |
|--------------------|--------------------------------|-----------------|--------|
| <b>GEV No.</b>     | 402141                         | <b>Ref. No.</b> | I-1636 |
| <b>description</b> | Hall sensor cable length 550mm |                 |        |

|                    |   |                 |        |
|--------------------|---|-----------------|--------|
| <b>GEV No.</b>     | 402140  | <b>Ref. No.</b> | I-1637 |
| <b>description</b> | Hall sensor double L 29mm W 26mm H 26mm mounting distance 10mm cable length 700mm |                 |        |

|                    |  |                 |  |
|--------------------|--|-----------------|--|
| <b>GEV No.</b>     | 402044   | <b>Ref. No.</b> | 29070015/0<br>CF62040403<br>CM29070015/0<br>CMCF62040403 |
| <b>description</b> | Hall sensor L 29mm W 26mm H 26mm mounting distance 10mm cable length 1250mm  |                 |  |
| <b>For models:</b> | F100, F100C, F120, F125C, F200, F80C, F80WC, SF300, SF500, SFN1000, SFN1000W |                 |  |

|                    |  |                 |        |
|--------------------|--|-----------------|--------|
| <b>GEV No.</b>     | 402146   | <b>Ref. No.</b> | I-1638 |
| <b>description</b> | Hall sensor L 29mm W 26mm H 26mm mounting distance 10mm cable length 700mm |                 |        |

accessories

miscellaneous

|                    |  |                 |  |
|--------------------|--|-----------------|--|
| <b>GEV No.</b>     | 402040   | <b>Ref. No.</b> | 29015055<br>29015055/0<br>29070016<br>CF62040404<br>CM29015055/0<br>CMCF62040404 |
| <b>description</b> | cable for level electrode cable length 1800mm            |                 |  |
| <b>For models:</b> | F100, F120, F125C, F200, SF300, SF500, SFN1000, SFN1000W |                 |  |

electronics

housing for PCBs

|                    |                                    |                 |  |
|--------------------|------------------------------------|-----------------|--|
| <b>GEV No.</b>     | 695663                             | <b>Ref. No.</b> | 29070021/0<br>CF66054600<br>CM29070021/0<br>CMCF66054600 |
| <b>description</b> | housing PCB L 230mm W 142mm H 57mm |                 |  |
| <b>For models:</b> | F100C                              |                 |  |







|   |                                    |                 |  |
|---|------------------------------------|-----------------|--|
|  |                                    |                 |  |
| 1   |                                    |                 |  |
| <b>GEV No.</b>  | 694206                             | <b>Ref. No.</b> | 19190397/0<br>CF66054700<br>CM19190397/0<br>CMCF66054700 |
| <b>description</b>  | lid PCB L 180mm W 110mm H 9mm      |                 |  |
| <b>For models:</b>  | F100, F120, F200, SF300, SF500     |                 |  |
| <b>accessories for</b>  | 694206                             |                 |  |
|  |                                    |                 |  |
| <b>GEV No.</b>  | 694205                             | <b>Ref. No.</b> | —  |
| <b>description</b>  | housing PCB L 180mm W 110mm H 40mm |                 |  |

|   |  |                 |                            |
|---|--|-----------------|----------------------------|
|  |  |                 |                            |
| 1   |  |                 |                            |
| <b>GEV No.</b>  | 694796                                 | <b>Ref. No.</b> | 29015057/0<br>CM29015057/0 |
| <b>description</b>  | lid PCB L 205mm W 125mm H 14mm plastic |                 |                            |

PCBs

|   |   |                 |                            |
|---|---|-----------------|----------------------------|
|  |   |                 |                            |
| 1   |   |                 |                            |
| <b>GEV No.</b>  | 403455  | <b>Ref. No.</b> | 33580167/0<br>CM33580167/0 |
| <b>description</b>  | auxiliary PCB blast freezer T14 suitable for ICEMATIC |                 |                            |
| <b>For models:</b>  | T14, T20, T20C, T20R, T5                              |                 |                            |

|   |  |                 |                            |
|---|--|-----------------|----------------------------|
|  |  |                 |                            |
| 1   |  |                 |                            |
| <b>GEV No.</b>  | 403454   | <b>Ref. No.</b> | 33580168/0<br>CM33580168/0 |
| <b>description</b>  | control PCB blast freezer T5 suitable for ICEMATIC |                 |                            |
| <b>For models:</b>  | T14, T5  |                 |                            |

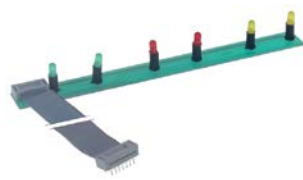
|  |             |                 |        |
|--|-------------|-----------------|--------|
|  |             |                 |        |
| 1  |             |                 |        |
| <b>GEV No.</b>   | 401806      | <b>Ref. No.</b> | I-1666 |
| <b>description</b>   | display PCB |                 |        |

|  |  |                 |                            |
|--|--|-----------------|----------------------------|
|  |  |                 |                            |
| 1  |  |                 |                            |
| <b>GEV No.</b>   | 402145   | <b>Ref. No.</b> | 33580084/0<br>CM33580084/0 |
| <b>description</b>   | display PCB for ice maker cable length 1500mm with LED |                 |                            |

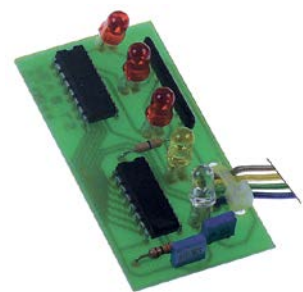
|   |  |                 |                            |
|---|--|-----------------|----------------------------|
|  |  |                 |                            |
| 1   |  |                 |                            |
| <b>GEV No.</b>  | 401803   | <b>Ref. No.</b> | 33580174/0<br>CM33580174/0 |
| <b>description</b>  | display PCB ice maker F80C cable length 900mm with LED |                 |                            |
| <b>For models:</b>  | F80C, F80WC  |                 |                            |

|  |  |                 |                            |
|--|--|-----------------|----------------------------|
|  |  |                 |                            |
| 1  |  |                 |                            |
| <b>GEV No.</b>   | 401805   | <b>Ref. No.</b> | 33580151/0<br>CM33580151/0 |
| <b>description</b>   | display PCB ice maker N201/N301//N501 L 170mm W 25mm |                 |                            |
| <b>For models:</b>   | N131M, N201M, N301M, N401M, N501M                    |                 |                            |

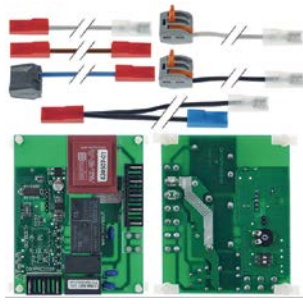
|  |  |                 |              |
|--|--|-----------------|--------------|
|  |  |                 |              |
| 1  |  |                 |              |
| <b>GEV No.</b>   | 403687   | <b>Ref. No.</b> | CMCS62044100 |
| <b>description</b>   | electronic timer for ice maker Simag mounting measurements 90x70mm 230 |                 |              |

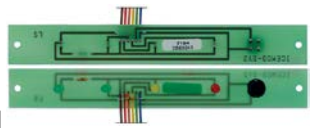

|   |                       |                                     |                            |
|---|-----------------------|-------------------------------------|----------------------------|
| 1 | <b>GEV No.</b> 401801 | <b>Ref. No.</b>                     | 33580024/0<br>CM33580024/0 |
|   | <b>description</b>    | keypad PCB ice maker N200/N300/N500 |                            |
|   | <b>For models:</b>    | N200M, N200MW, N300M, N300MW, N500M |                            |



|   |                       |                 |                            |
|---|-----------------------|-----------------|----------------------------|
| 1 | <b>GEV No.</b> 401824 | <b>Ref. No.</b> | 33580123/0<br>CM33580123/0 |
|   | <b>description</b>    | PCB             |                            |



|   |                       |                 |                     |
|---|-----------------------|-----------------|---------------------|
| 1 | <b>GEV No.</b> 401825 | <b>Ref. No.</b> | nicht in Preisliste |
|   | <b>description</b>    | PCB             |                     |



|   |                       |                 |                     |
|---|-----------------------|-----------------|---------------------|
| 1 | <b>GEV No.</b> 401826 | <b>Ref. No.</b> | nicht in Preisliste |
|   | <b>description</b>    | PCB             |                     |



|   |                       |                 |          |
|---|-----------------------|-----------------|----------|
| 1 | <b>GEV No.</b> 402034 | <b>Ref. No.</b> | 62045602 |
|   | <b>description</b>    | PCB             |          |



|   |                       |                                      |  |
|---|-----------------------|--------------------------------------|--|
| 1 | <b>GEV No.</b> 403499 | <b>Ref. No.</b>                      | 33580173<br>33580173/0<br>CM33580173/0 |
|   | <b>description</b>    | PCB 230V L 90mm W 60mm for ice maker |  |
|   | <b>For models:</b>    | N401M, N501M                         |  |



|   |                       |   |                            |
|---|-----------------------|---|----------------------------|
| 1 | <b>GEV No.</b> 402815 | <b>Ref. No.</b>                         | 33580166/0<br>CM33580166/0 |
|   | <b>description</b>    | PCB blast chiller suitable for ICEMATIC |                            |
|   | <b>For models:</b>    | T14, T20, T20C, T20R, T5                |                            |



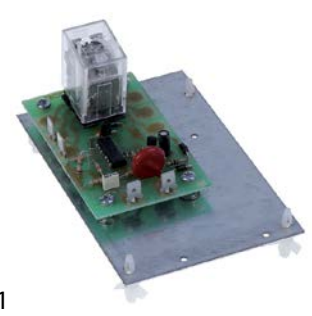

|   |                       |   |                            |
|---|-----------------------|---|----------------------------|
| 1 | <b>GEV No.</b> 403564 | <b>Ref. No.</b>   | 33580166/4<br>CM33580166/4 |
|   | <b>description</b>    | PCB for blast chiller L 145mm W 120mm suitable for ICEMATIC CT1MA0802100 50/60Hz voltage input 230V |                            |



|   |                       |                                   |                     |
|---|-----------------------|-----------------------------------|---------------------|
| 1 | <b>GEV No.</b> 401833 | <b>Ref. No.</b>                   | nicht in Preisliste |
|   | <b>description</b>    | PCB for ice maker with holder 24V |                     |





|   |                                |                 |                     |
|---|--------------------------------|-----------------|---------------------|
|  |                                |                 |                     |
| 1   |                                |                 |                     |
| <b>GEV No.</b>  | 401828                         | <b>Ref. No.</b> | nicht in Preisliste |
| <b>description</b>  | PCB for ice maker with housing |                 |                     |

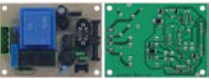

|   |                        |                 |                            |
|---|------------------------|-----------------|----------------------------|
|  |                        |                 |                            |
| 1   |                        |                 |                            |
| <b>GEV No.</b>  | 401823                 | <b>Ref. No.</b> | 33580056/0<br>CM33580056/0 |
| <b>description</b>  | PCB for ice-cube maker |                 |                            |

|   |                         |                 |              |
|---|-------------------------|-----------------|--------------|
|  |                         |                 |              |
| 1   |                         |                 |              |
| <b>GEV No.</b>  | 402003                  | <b>Ref. No.</b> | CMXP62040316 |
| <b>description</b>  | PCB ice maker AC045/055 |                 |              |

|   |                           |                 |                            |
|---|---------------------------|-----------------|----------------------------|
|  |                           |                 |                            |
| 1   |                           |                 |                            |
| <b>GEV No.</b>  | 400055                    | <b>Ref. No.</b> | CF62047000<br>CMCF62047000 |
| <b>description</b>  | PCB ice maker ECO 45 230V |                 |                            |

|   |   |                 |  |
|---|---|-----------------|--|
|  |   |                 |  |
| 1   |   |                 |  |
| <b>GEV No.</b>  | 401799  | <b>Ref. No.</b> | 33580150/0<br>33580250/0<br>CM33580150/0<br>CM33580250/0 |
| <b>description</b>  | PCB ice maker N201/N301//N501 230V  |                 |  |
| <b>For models:</b>  | N131M, N201M, N301M, N401M, N501M   |                 |  |
| <b>accessories for</b>  | 401799  |                 |  |
|  |   |                 |  |
| <b>GEV No.</b>  | 701450  | <b>Ref. No.</b> | 81455102/0<br>CM81455102/0                               |
| <b>description</b>  | connection cable L 1300mm 2-pole level sensor suitable for ice maker connection plug plug type coded plug |                 |  |

|  |                    |                 |                            |
|--|--------------------|-----------------|----------------------------|
|  |                    |                 |                            |
| 1  |                    |                 |                            |
| <b>GEV No.</b>   | 403548             | <b>Ref. No.</b> | 33580191/0<br>CM33580191/0 |
| <b>description</b>   | PCB L 140mm W 92mm |                 |                            |

|   |   |                 |                            |
|---|---|-----------------|----------------------------|
|   |   |                 |                            |
| 1   |   |                 |                            |
| <b>GEV No.</b>  | 403485  | <b>Ref. No.</b> | 81400124/0<br>CM81400124/0 |
| <b>description</b>  | PCB L 160mm W 95mm 230V H 45mm  |                 |                            |
| <b>accessories for</b>  | 403485  |                 |                            |
|    |   |                 |                            |
| <b>GEV No.</b>  | 381336  | <b>Ref. No.</b> | 33580265/0<br>CM33580265/0 |
| <b>description</b>  | probe NTC 2kOhm cable PVC probe -40 up to +110°C cable -10 up to 100°C connection plug probe ø6x60mm cable length 1.5m        |                 |                            |
|  |   |                 |                            |
| <b>GEV No.</b>  | 381338  | <b>Ref. No.</b> | 33580135/0<br>CM33580135/0 |
| <b>description</b>  | probe NTC 2.2kOhm cable PVC probe -40 up to +110°C cable -10 up to 100°C connection plug thread probe ø5x50mm cable length 2m |                 |                            |

|  |                          |                 |                            |
|--|--------------------------|-----------------|----------------------------|
|  |                          |                 |                            |
| 1  |                          |                 |                            |
| <b>GEV No.</b>   | 402035                   | <b>Ref. No.</b> | 33580103/0<br>CM33580103/0 |
| <b>description</b>   | PCB L 190mm W 110mm 230V |                 |                            |

|  |   |                 |                            |
|--|---|-----------------|----------------------------|
|  |   |                 |                            |
| 1  |   |                 |                            |
| <b>GEV No.</b>   | 403021                                  | <b>Ref. No.</b> | 33580064/0<br>CM33580064/0 |
| <b>description</b>   | PCB suitable for Scotsman type WSCM0252 |                 |                            |



central units



|                |        |                 |  |
|----------------|--------|-----------------|--|
| <b>GEV No.</b> | 402004 | <b>Ref. No.</b> | 29070012/0<br>81469134/0<br>CM29070012/0<br>CM81469134/0 |
|----------------|--------|-----------------|--|

**description** control box

**For models:** F100, F100C, F120, F125C, F200, F80C, F80WC, SF300, SF500, SFN1000, SFN1000W

**accessories for** 402004

|                |        |                 |   |
|----------------|--------|-----------------|---|
| <b>GEV No.</b> | 402005 | <b>Ref. No.</b> | 29070013<br>29070013/0<br>620404.10<br>CF62040410<br>CM29070013/0<br>CMCF62040410 |
|----------------|--------|-----------------|---|

temperature probe PTC 2kOhm cable TPE probe -50 up to +150°C cable -40 up to +110°C connection plug thread probe ø6x50mm cable length 1.6m

|                |        |                 |  |
|----------------|--------|-----------------|--|
| <b>GEV No.</b> | 402044 | <b>Ref. No.</b> | 29070015/0<br>CF62040403<br>CM29070015/0<br>CMCF62040403 |
|----------------|--------|-----------------|--|

Hall sensor L 29mm W 26mm H 26mm mounting distance 10mm cable length 1250mm

|                |        |                 |  |
|----------------|--------|-----------------|--|
| <b>GEV No.</b> | 402191 | <b>Ref. No.</b> | 29070014/0<br>CF62040401<br>CM29070014/0<br>CMCF62040401 |
|----------------|--------|-----------------|--|

temperature probe PTC 2kOhm cable TPE probe -50 up to +150°C cable -40 up to +110°C connection plug thread probe ø5x20mm cable length 1.8m



|                |        |                 |                          |
|----------------|--------|-----------------|--------------------------|
| <b>GEV No.</b> | 403028 | <b>Ref. No.</b> | 62040318<br>CMXG62040318 |
|----------------|--------|-----------------|--------------------------|

**description** control box



|                |        |                 |                     |
|----------------|--------|-----------------|---------------------|
| <b>GEV No.</b> | 401841 | <b>Ref. No.</b> | nicht in Preisliste |
|----------------|--------|-----------------|---------------------|

**description** control box for ice-cube maker 24V 50-60Hz



|                |        |                 |                            |
|----------------|--------|-----------------|----------------------------|
| <b>GEV No.</b> | 401842 | <b>Ref. No.</b> | 33580122/0<br>CM33580122/0 |
|----------------|--------|-----------------|----------------------------|

**description** control box for ice-cube maker 24V 50-60Hz



|                |        |                 |  |
|----------------|--------|-----------------|--|
| <b>GEV No.</b> | 403836 | <b>Ref. No.</b> | 81414543/0<br>CF62046213<br>CF62046215<br>CM81414543/0<br>CMCF62046213<br>CMCF62046215 |
|----------------|--------|-----------------|--|

**description** control box ice maker suitable for ICEMATIC/SCOTSMAN/SIMAG



|                |        |                 |                            |
|----------------|--------|-----------------|----------------------------|
| <b>GEV No.</b> | 403837 | <b>Ref. No.</b> | 81400264/0<br>CM81400264/0 |
|----------------|--------|-----------------|----------------------------|

**description** control box ice maker suitable for ICEMATIC/SCOTSMAN/SIMAG

1

|                    |                 |                 |                            |
|--------------------|-----------------|-----------------|----------------------------|
| <b>GEV No.</b>     | 403604          | <b>Ref. No.</b> | 81449089/0<br>CM81449089/0 |
| <b>description</b> | control box kit |                 |                            |



1

|                    |                                  |                 |              |
|--------------------|----------------------------------|-----------------|--------------|
| <b>GEV No.</b>     | 402042                           | <b>Ref. No.</b> | CMXG06071100 |
| <b>description</b> | control box suitable for SFT 012 |                 |              |



1

|                    |  |                 |                            |
|--------------------|--|-----------------|----------------------------|
| <b>GEV No.</b>     | 401829                                 | <b>Ref. No.</b> | CF62040409<br>CMCF62040409 |
| <b>description</b> | control box with housing for ice maker |                 |                            |



1

|                    |  |                 |                     |
|--------------------|--|-----------------|---------------------|
| <b>GEV No.</b>     | 401832   | <b>Ref. No.</b> | nicht in Preisliste |
| <b>description</b> | control box with housing for ice-cube maker 230V |                 |                     |

## keypads

### front foils



1

|                    |                                   |                 |  |
|--------------------|-----------------------------------|-----------------|--|
| <b>GEV No.</b>     | 403447                            | <b>Ref. No.</b> | 33489551<br>33489551/0<br>CM33489551/0<br>CM33489553/0 |
| <b>description</b> | front foil blast chiller ICEMATIC |                 |  |
| <b>For models:</b> | T14, T5                           |                 |  |

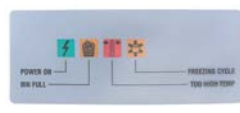

1

|                    |  |                 |                               |
|--------------------|--|-----------------|-------------------------------|
| <b>GEV No.</b>     | 694118                                       | <b>Ref. No.</b> | nicht in Preisliste enthalten |
| <b>description</b> | front foil for ice-cube maker L 134mm W 52mm |                 |                               |

## solenoid valves

### solenoid valves (water)

#### ELBI

#### straight



1

|                        |  |                 |                     |
|------------------------|--|-----------------|---------------------|
| <b>GEV No.</b>         | 370529   | <b>Ref. No.</b> | nicht in Preisliste |
| <b>description</b>     | solenoid valve single straight 120VAC inlet 3/4" outlet 11.5mm DN10 t.max. 60°C ELBI |                 |                     |
| <b>spare parts for</b> | 370529   |                 |                     |
| <b>GEV No.</b>         | 370467   | <b>Ref. No.</b> | —                   |
| <b>description</b>     | solenoid valve filter suitable for ELBI  |                 |                     |



1

|                        |   |                 |                            |
|------------------------|---|-----------------|----------------------------|
| <b>GEV No.</b>         | 373000  | <b>Ref. No.</b> | 19865537/0<br>CM19865537/0 |
| <b>description</b>     | solenoid valve single straight 24V inlet 3/4" outlet 11.5mm DN10 t.max. 90°C ELBI plastic |                 |                            |
| <b>spare parts for</b> | 373000  |                 |                            |
| <b>GEV No.</b>         | 370467  | <b>Ref. No.</b> | —                          |
| <b>description</b>     | solenoid valve filter suitable for ELBI   |                 |                            |

#### angled





1

|                        |  |                 |                     |
|------------------------|--|-----------------|---------------------|
| <b>GEV No.</b>         | 370530   | <b>Ref. No.</b> | nicht in Preisliste |
| <b>description</b>     | solenoid valve single angled 120VAC inlet 3/4" outlet 11.5mm input 16l/min DN10 t.max. 60°C ELBI plastic |                 |                     |
| <b>spare parts for</b> | 370530   |                 |                     |
| <b>GEV No.</b>         | 370467   | <b>Ref. No.</b> | —                   |
| <b>description</b>     | solenoid valve filter suitable for ELBI  |                 |                     |

|   |  |                 |                            |
|---|--|-----------------|----------------------------|
|  |  |                 |                            |
| 1   |  |                 |                            |
| <b>GEV No.</b>  | 374072   | <b>Ref. No.</b> | 19863019/0<br>CM19863019/0 |
| <b>description</b>  | solenoid valve single angled 24VAC inlet 3/4" outlet 11.5mm input/ min flow regulating valve outlet blue |                 |                            |

|  |  |                 |                            |
|--|--|-----------------|----------------------------|
|  |  |                 |                            |
| 1  |  |                 |                            |
| <b>GEV No.</b>   | 374073   | <b>Ref. No.</b> | 19865534/0<br>CM19865534/0 |
| <b>description</b>   | solenoid valve single straight 24VAC inlet 3/4" outlet 13.5mm flow regulating valve inlet yellow |                 |                            |

|   |   |                 |                            |
|---|---|-----------------|----------------------------|
|  |   |                 |                            |
| 1   |   |                 |                            |
| <b>GEV No.</b>  | 374074  | <b>Ref. No.</b> | 19865507/0<br>CM19865507/0 |
| <b>description</b>  | solenoid valve single straight 220-240VAC inlet 3/4" outlet 11.5mm flow regulating valve outlet red |                 |                            |
| <b>For models:</b>  | N25LBI, N35BI   |                 |                            |

|  |  |                 |                     |
|--|--|-----------------|---------------------|
|  |  |                 |                     |
| 1  |  |                 |                     |
| <b>GEV No.</b>   | 370499   | <b>Ref. No.</b> | nicht in Preisliste |
| <b>description</b>   | solenoid valve 2-fold, with reducer straight 230VAC inlet 3/4" outlet 11.5mm t.max. 60°C output A 2.5 orange/min output B 2 whitel/min |                 |                     |

|  |  |                 |                     |
|--|--|-----------------|---------------------|
|  |  |                 |                     |
| 1  |  |                 |                     |
| <b>GEV No.</b>   | 373001   | <b>Ref. No.</b> | nicht in Preisliste |
| <b>description</b>   | solenoid valve single straight 230VAC inlet 3/4" outlet 11.5mm input/min output 2l/min 50/60Hz DN10 t.max. 90°C duty cycle 100% ELBI plastic |                 |                     |

|   |  |                 |                            |
|---|--|-----------------|----------------------------|
|  |  |                 |                            |
| 1   |  |                 |                            |
| <b>GEV No.</b>  | 370461   | <b>Ref. No.</b> | 19865509/0<br>CM19865509/0 |
| <b>description</b>  | solenoid valve double straight 230VAC inlet 3/4" outlet 11.5mm input/min output -/4,7l/min DN10 t.max. 90°C ELBI plastic output B 4.7l/min flow regulating valve outlet B grey output A w/t membrane (constantly open) |                 |                            |
| <b>For models:</b>  | N140, N20L, N20WL, N45S, N45SW, N50BI, N50BIW, N55SW, N70SW, N90LW, N90SW  |                 |                            |

|   |  |                 |                            |
|---|--|-----------------|----------------------------|
|  |  |                 |                            |
| 1   |  |                 |                            |
| <b>GEV No.</b>  | 370431   | <b>Ref. No.</b> | 19865518/0<br>CM19865518/0 |
| <b>description</b>  | solenoid valve single straight 230VAC inlet 3/4" outlet 11.5mm input/min output 2l/min DN10 t.max. 90°C ELBI plastic |                 |                            |
| <b>For models:</b>  | N21S   |                 |                            |

|  |   |                 |                            |
|--|---|-----------------|----------------------------|
|  |   |                 |                            |
| 1  |   |                 |                            |
| <b>GEV No.</b>   | 370462  | <b>Ref. No.</b> | 19865538/0<br>CM19865538/0 |
| <b>description</b>   | solenoid valve double straight 230VAC inlet 3/4" outlet 11.5mm input/min output 0,5/-l/min DN10 plastic output A 0.5l/min |                 |                            |
| <b>For models:</b>   | F80C, F80WC, N21S, N45S, N45SW, N55LW   |                 |                            |

|   |   |                 |                            |
|---|---|-----------------|----------------------------|
|  |   |                 |                            |
| 1   |   |                 |                            |
| <b>GEV No.</b>  | 370414  | <b>Ref. No.</b> | 19865502/0<br>CM19865502/0 |
| <b>description</b>  | solenoid valve single straight 230VAC inlet 3/4" outlet 11.5mm output 2l/min 50/60Hz t.max. 90°C ELBI plastic flow regulating valve outlet white  |                 |                            |
| <b>For models:</b>  | N131M, N140, N201M, N20L, N20WL, N25BI, N25L, N25LW, N25S, N25SW, N301M, N35S, N35SW, N401M, N45S, N45SW, N501M, N50BI, N50BIW, N55L, N55LW, N55S, N55SW, N70S, N70SW, N90L, N90LW, N90S, N90SW |                 |                            |

|  |   |                 |          |
|--|---|-----------------|----------|
|  |   |                 |          |
| 1  |   |                 |          |
| <b>GEV No.</b>   | 370433  | <b>Ref. No.</b> | 65010551 |
| <b>description</b>   | solenoid valve double straight 230VAC inlet 3/4" outlet 11.5mm input/min output 2/2.5l/min DN10 t.max. 90°C ELBI plastic output A 2l/min output B 2.5l/min flow regulating valve outlet A white flow regulating valve outlet B orange |                 |          |

1

|                    |  |                 |                     |
|--------------------|--|-----------------|---------------------|
| <b>GEV No.</b>     | 370526   | <b>Ref. No.</b> | nicht in Preisliste |
| <b>description</b> | solenoid valve double straight 230VAC inlet 3/4" outlet 11.5mm input/min output 2.2l/min DN10 t.max. 60°C ELBI output A 2 whitel/min output B 2 whitel/min |                 |                     |



1

|                    |  |                 |                     |
|--------------------|--|-----------------|---------------------|
| <b>GEV No.</b>     | 370494   | <b>Ref. No.</b> | nicht in Preisliste |
| <b>description</b> | solenoid valve single angled 240VAC outlet 14.5mm inlet 1/4"mm |                 |                     |

**ROBERTSHAW/INVENSYS**

medium temperature: 90°C 90°C 60°C  
 ambient temperature: 60°C 25°C 60°C  
 duty cycle: 40% 100% 100%

**various**



1

|                    |  |                 |                     |
|--------------------|--|-----------------|---------------------|
| <b>GEV No.</b>     | 371105   | <b>Ref. No.</b> | nicht in Preisliste |
| <b>description</b> | solenoid valve angled 240VAC inlet 3/8" outlet 3/8" EATON (INVENSYS) type K-63314-12 |                 |                     |



1

|                    |  |                 |                     |
|--------------------|--|-----------------|---------------------|
| <b>GEV No.</b>     | 371104   | <b>Ref. No.</b> | nicht in Preisliste |
| <b>description</b> | solenoid valve angled 240VAC inlet 3/8" outlet 3/8" SINGER |                 |                     |



1

|                    |  |                 |                     |
|--------------------|--|-----------------|---------------------|
| <b>GEV No.</b>     | 371259   | <b>Ref. No.</b> | nicht in Preisliste |
| <b>description</b> | solenoid valve single angled 230VAC inlet 11.5 outlet 11.5mm DN7 plastic |                 |                     |

**RPE**

**special outlet**



1

|                    |  |                 |  |
|--------------------|--|-----------------|--|
| <b>GEV No.</b>     | 370453   | <b>Ref. No.</b> | 19865532/0<br>19865598/0<br>CM19865532/0<br>CM19865598/0 |
| <b>description</b> | solenoid valve single angled 230VAC inlet 11.5mm outlet 11.5mm RPE |                 |  |
| <b>For models:</b> | N131M, N200M, N200MW, N300M, N300MW                                |                 |  |

**solenoid valves with reducers**

**single**



1

|                    |  |                 |                            |
|--------------------|--|-----------------|----------------------------|
| <b>GEV No.</b>     | 374075   | <b>Ref. No.</b> | 400UMIVALV<br>CM400UMIVALV |
| <b>description</b> | solenoid valve single angled 230VAC inlet 3/4" outlet 10mm input 18.5-20l/min output 1.0-1.25l/min DN10 RPE flow regulating valve outlet white flow regulating valve inlet white |                 |                            |

**TP**

**solenoid valves with reducers**



1

|                    |  |                 |                            |
|--------------------|--|-----------------|----------------------------|
| <b>GEV No.</b>     | 370416   | <b>Ref. No.</b> | 19865530/0<br>CM19865530/0 |
| <b>description</b> | solenoid valve double straight 230VAC inlet 3/4" input/min output 1.2/1.2l/min DN10 t.max. 90°C TP plastic outlet 11.5mm output A 1.2l/min output B 1.2l/min flow regulating valve outlet A dark brown flow regulating valve outlet B dark brown |                 |                            |
| <b>For models:</b> | N20L, N20WL, N25LW, N25SW, N35SW   |                 |                            |

1

|                    |  |                 |                               |
|--------------------|--|-----------------|-------------------------------|
| <b>GEV No.</b>     | 370422   | <b>Ref. No.</b> | nicht in Preisliste enthalten |
| <b>description</b> | solenoid valve double straight 230VAC inlet 3/4" t.max. 90°C TP plastic outlet 11.5mm output A 2.5l/min flow regulating valve outlet A yellow flow regulating valve outlet B brown |                 |                               |



1

|                    |  |                 |                     |
|--------------------|--|-----------------|---------------------|
| <b>GEV No.</b>     | 370527   | <b>Ref. No.</b> | nicht in Preisliste |
| <b>description</b> | solenoid valve single straight 220-240VAC inlet 3/4" outlet 11.5mm output 0.8l/min TP plastic flow regulating valve outlet white 8VA |                 |                     |

various



1

|                    |   |                 |                     |
|--------------------|---|-----------------|---------------------|
| <b>GEV No.</b>     | 370491  | <b>Ref. No.</b> | nicht in Preisliste |
| <b>description</b> | solenoid valve single 240VAC inlet 3/4" outlet 11.5mm |                 |                     |



1

|                    |  |                 |                     |
|--------------------|--|-----------------|---------------------|
| <b>GEV No.</b>     | 370493   | <b>Ref. No.</b> | nicht in Preisliste |
| <b>description</b> | solenoid valve single angled 24V outlet 11.5mm EATON (INVENSYS) plastic inlet 5/8" UNFmm |                 |                     |



1

|                    |   |                 |                            |
|--------------------|---|-----------------|----------------------------|
| <b>GEV No.</b>     | 370496  | <b>Ref. No.</b> | 19865525/0<br>CM19865525/0 |
| <b>description</b> | solenoid valve straight 220VAC outlet 14mm plastic inlet 14mm |                 |                            |
| <b>For models:</b> | N401M, N501M  |                 |                            |

metal

PARKER

spare parts and accessories

solenoid coils



1

|                    |  |                 |                            |
|--------------------|--|-----------------|----------------------------|
| <b>GEV No.</b>     | 371098   | <b>Ref. No.</b> | CF62030648<br>CMCF62030648 |
| <b>description</b> | solenoid coil 220-230VAC 50/60Hz seat ø 14mm cable length 1000mm 14W |                 |                            |



1

|  |   |                 |                            |   |
|--|---|-----------------|----------------------------|---|
| <b>GEV No.</b>   | 371029  | <b>Ref. No.</b> | 19053102/0<br>CM19053102/0 |   |
| <b>description</b>   | solenoid coil PARKER 230VAC 9VA coil type ZB09 seat ø 14mm H 33mm W 34mm D 43mm |                 |                            |   |
| <b>For models:</b>   | N21S, N25BI   |                 |                            |   |
| <b>accessories for</b>   | 371029  |                 |                            |   |
|  | <b>GEV No.</b>  | 371090          | <b>Ref. No.</b>            | — |
|  | power socket plug type DIN 43650A screw   |                 |                            |   |

drain valves



1

|                    |  |                 |                     |
|--------------------|--|-----------------|---------------------|
| <b>GEV No.</b>     | 371106   | <b>Ref. No.</b> | nicht in Preisliste |
| <b>description</b> | drain solenoid valve 208/230V single inlet 17.5mm outlet 16mm EATON (INVENSYS) plastic |                 |                     |



1

|                    |   |                 |  |
|--------------------|---|-----------------|--|
| <b>GEV No.</b>     | 370790 <sup>1</sup>   | <b>Ref. No.</b> | 19863018/0<br>CM19863018/0<br>KITVSCOMPO |
| <b>description</b> | drain solenoid valve 24V 50/60Hz inlet 12.5mm outlet 15.5mm t.max. 40°C CEME brass L 110mm 1/1-ways DN 8mm voltage AC coil type 5704 kit p max 0.2bar p min 0bar slide-on receptacle compact 20°C body plastic incl. hose clamp and mounting screws |                 |  |

<sup>1</sup>with accessories





|   |   |                 |                            |
|---|---|-----------------|----------------------------|
|  |   |                 |                            |
| 1   |   |                 |                            |
| <b>GEV No.</b>  | 370620  | <b>Ref. No.</b> | 19865597/0<br>CM19865597/0 |
| <b>description</b>  | solenoid valve 220-240V inlet 17.5mm outlet 15.5mm EATON (INVENSYS) |                 |                            |

|   |   |                 |  |
|---|---|-----------------|--|
|  |   |                 |  |
| 1   |   |                 |  |
| <b>GEV No.</b>  | 370691  | <b>Ref. No.</b> | 19865525<br>19865597<br>19865597/0<br>81454760/0<br>CM19865597/0<br>CM81454760/0 |
| <b>description</b>  | solenoid valve angled 220-240V kit inlet 17.5mm outlet 16mm |                 |  |
| <b>For models:</b>  | N201M, N301M, N500M, N501M                                  |                 |  |

|  |   |                 |                     |
|--|---|-----------------|---------------------|
|  |   |                 |                     |
| 1  |   |                 |                     |
| <b>GEV No.</b>   | 370540  | <b>Ref. No.</b> | nicht in Preisliste |
| <b>description</b>   | solenoid valve angled 240V 50/60Hz outlet 9/16" UNF plastic inlet 9/16" UNF |                 |                     |

**solenoid valves (refrigeration)**

**ALCO**

valves

with pipe clamp

|   |                    |                 |                     |
|---|--------------------|-----------------|---------------------|
|  |                    |                 |                     |
| 1   |                    |                 |                     |
| <b>GEV No.</b>  | 370492             | <b>Ref. No.</b> | nicht in Preisliste |
| <b>description</b>  | solenoid valve 24V |                 |                     |

|  |   |                 |                     |
|--|---|-----------------|---------------------|
|  |   |                 |                     |
| 1  |   |                 |                     |
| <b>GEV No.</b>   | 370535  | <b>Ref. No.</b> | nicht in Preisliste |
| <b>description</b>   | solenoid valve straight type 200RB5T4 230V p max 34.5bar connection 12.7mm soldering connection |                 |                     |

|  |  |                 |                     |
|--|--|-----------------|---------------------|
|  |  |                 |                     |
| 1  |  |                 |                     |
| <b>GEV No.</b>   | 370534   | <b>Ref. No.</b> | nicht in Preisliste |
| <b>description</b>   | solenoid valve type 200RB3T3 230V tube ø 9.5mm L 118mm hot gas |                 |                     |

**CASTEL**

valves

|   |   |                 |                            |
|---|---|-----------------|----------------------------|
|  |   |                 |                            |
| 1   |   |                 |                            |
| <b>GEV No.</b>  | 370403  | <b>Ref. No.</b> | 19863034/0<br>CM19863034/0 |
| <b>description</b>  | solenoid valve NC CASTEL 230V p max 45bar connection 10mm soldering connection -35 up to +105°C refrigeration |                 |                            |
| <b>For models:</b>  | N131M, N200M, N200MW, N201M, N300M, N300MW, N301M, N401M, N500M, N501M  |                 |                            |



## valve bodies

## STANDARD series

suitable for refrigerants R22, R134a, R404A, R407C, R410A, R507



|   |  |                 |  |
|---|--|-----------------|--|
| <b>GEV No.</b>  | 370382   | <b>Ref. No.</b> | 19863034/0<br>19863037/0<br>CM19863034/0<br>CM19863037/0 |
| <b>description</b>  | solenoid valve body NC type 1028/M105 p max 45bar connection 10mm soldering connection DN 3mm -35 up to +105°C L 125mm refrigeration straight CASTEL |                 |  |
| <b>For models:</b>  | T14  |                 |  |
| <b>accessories for</b>  | 370382   |                 |  |
|    | <b>GEV No.</b>   | 371084          | <b>Ref. No.</b> —  |
|   | solenoid coil CASTEL 230VAC 8VA 50/60Hz connection cable 1000mm type CM2   |                 |  |
|    | <b>GEV No.</b>   | 371090          | <b>Ref. No.</b> —  |
|   | power socket plug type DIN 43650A screw  |                 |  |
|   | <b>GEV No.</b>   | 371301          | <b>Ref. No.</b> —  |
|   | solenoid coil CASTEL 110VAC 8VA 50/60Hz seat ø 11.5mm connection DIN 43650A type HF2   |                 |  |
|  | <b>GEV No.</b>   | 371314          | <b>Ref. No.</b> —  |
|   | solenoid coil CASTEL 240VAC 8VA 50/60Hz seat ø 11.5mm  |                 |  |
|  | <b>GEV No.</b>   | 371321          | <b>Ref. No.</b> —  |
|   | solenoid coil CASTEL 12/24VAC 50/60Hz seat ø 11.5mm connection DIN 43650A type HF2   |                 |  |

## PARKER

## valves



|                    |  |                 |  |
|--------------------|--|-----------------|--|
| <b>GEV No.</b>     | 370415   | <b>Ref. No.</b> | 19053101/0<br>19863032/0<br>19863033/0<br>19863033/0+19053101/0<br>CM19053101/0<br>CM19863032/0<br>CM19863033/0<br>CM19863033/0+CM19053101/0 |
| <b>description</b> | solenoid valve straight 230V pressure range 0-10bar DN2.5 connection 4mm soldering connection PARKER refrigeration   |                 |  |
| <b>For models:</b> | N140, N20L, N20WL, N25BI, N25L, N25LBI, N25LW, N25S, N25SW, N35BI, N35S, N35SW, N45L, N45S, N45SW, N55L, N55LW, N55S, N55SW, N70S, N70SW, N90L, N90LW, N90S, N90SW |                 |  |

|                    |   |                 |                            |
|--------------------|---|-----------------|----------------------------|
| <b>GEV No.</b>     | 370490  | <b>Ref. No.</b> | 19870611/0<br>CM19870611/0 |
| <b>description</b> | solenoid valve type VE-145 230V 8 refrigeration |                 |                            |

|                    |  |                 |                            |
|--------------------|--|-----------------|----------------------------|
| <b>GEV No.</b>     | 370495   | <b>Ref. No.</b> | 19863031/0<br>CM19863031/0 |
| <b>description</b> | solenoid valve type VE-145 230V p max 10bar pressure range 0-10bar 8 PARKER straight |                 |                            |

## valve bodies

|   |   |                 |  |
|---|---|-----------------|--|
| <b>GEV No.</b>  | 370536  | <b>Ref. No.</b> | nicht in Preisliste                        |
| <b>description</b>  | solenoid valve body p max 35bar connection 3/8" US PARKER for ice maker tube ø 10mm hot gas |                 |  |
| <b>accessories for</b>  | 370536  |                 |  |
|  | <b>GEV No.</b>  | 371098          | <b>Ref. No.</b> CF62030648<br>CMCF62030648 |
|   | solenoid coil 220-230VAC 50/60Hz seat ø 14mm cable length 1000mm 14W                        |                 |  |

|                    |   |                 |                     |
|--------------------|---|-----------------|---------------------|
| <b>GEV No.</b>     | 370539  | <b>Ref. No.</b> | nicht in Preisliste |
| <b>description</b> | solenoid valve body straight p max 35bar pressure range 21bar connection 10mm soldering connection PARKER tube ø 10mm L 150mm hot gas |                 |                     |



various

valve bodies



1

|   |   |                 |  |
|---|---|-----------------|--|
| <b>GEV No.</b>  | 370429  | <b>Ref. No.</b> | CF62030627<br>CMCF62030627<br>CMNM62030627 |
| <b>description</b>  | solenoid valve body angled DN 2.5mm connection 6mm soldering connection refrigeration |                 |  |
| <b>accessories for</b>  | 370429  |                 |  |
|  | <b>GEV No.</b>  | 371098          | <b>Ref. No.</b> CF62030648<br>CMCF62030648 |
|   | solenoid coil 220-230VAC 50/60Hz seat ø 14mm cable length 1000mm 14W                  |                 |  |



1

|                    |  |                 |                     |
|--------------------|--|-----------------|---------------------|
| <b>GEV No.</b>     | 370430   | <b>Ref. No.</b> | nicht in Preisliste |
| <b>description</b> | solenoid valve body connection 6mm soldering connection refrigeration angled 90° |                 |                     |



1

|                    |  |                 |                     |
|--------------------|--|-----------------|---------------------|
| <b>GEV No.</b>     | 370458   | <b>Ref. No.</b> | nicht in Preisliste |
| <b>description</b> | solenoid valve body connection 6mm soldering connection refrigeration angled 90° |                 |                     |



1

|                    |   |                 |                            |
|--------------------|---|-----------------|----------------------------|
| <b>GEV No.</b>     | 370463  | <b>Ref. No.</b> | 19863041/0<br>CM19863041/0 |
| <b>description</b> | solenoid valve body DN 1.6mm connection 4mm soldering connection refrigeration angled 90° |                 |                            |
| <b>For models:</b> | N21S  |                 |                            |



1

|                    |   |                 |                            |
|--------------------|---|-----------------|----------------------------|
| <b>GEV No.</b>     | 370424  | <b>Ref. No.</b> | CF62030622<br>CMCF62030622 |
| <b>description</b> | solenoid valve body DN 1.9mm connection 6mm soldering connection refrigeration angled 90° |                 |                            |
| <b>For models:</b> | F100C   |                 |                            |



1

|   |   |                 |                   |
|---|---|-----------------|-------------------|
| <b>GEV No.</b>  | 370454  | <b>Ref. No.</b> | CMNM62030646      |
| <b>description</b>  | solenoid valve body DN 3mm connection 6mm soldering connection refrigeration angled 90° |                 |                   |
| <b>accessories for</b>  | 370454  |                 |                   |
|  | <b>GEV No.</b>  | 371033          | <b>Ref. No.</b> — |
|   | solenoid coil PARKER 230VAC 9VA coil type YB09 with cable seat ø 14mm                   |                 |                   |

### Solenoid valve - accessories

filters



1

|                    |   |                 |                     |
|--------------------|---|-----------------|---------------------|
| <b>GEV No.</b>     | 371101  | <b>Ref. No.</b> | nicht in Preisliste |
| <b>description</b> | solenoid valve filter ø 20mm H 17mm suitable for ELBI |                 |                     |



1

|                    |                                  |                 |                     |
|--------------------|----------------------------------|-----------------|---------------------|
| <b>GEV No.</b>     | 371108                           | <b>Ref. No.</b> | nicht in Preisliste |
| <b>description</b> | body for reducer H 10mm ø 15.7mm |                 |                     |



1

|                    |                            |                 |                            |
|--------------------|----------------------------|-----------------|----------------------------|
| <b>GEV No.</b>     | 371296                     | <b>Ref. No.</b> | 19190202/0<br>CM19190202/0 |
| <b>description</b> | reducer flow rate 1.8l/min |                 |                            |



|   |  |                 |                     |
|---|--|-----------------|---------------------|
|  |  |                 |                     |
| 1   |  |                 |                     |
| <b>GEV No.</b>  | 371087   | <b>Ref. No.</b> | nicht in Preisliste |
| <b>description</b>  | solenoid coil cable length 1100mm seat ø 6.5mm |                 |                     |

|  |  |                 |                            |
|--|--|-----------------|----------------------------|
|  |  |                 |                            |
| 1  |  |                 |                            |
| <b>GEV No.</b>   | 541626   | <b>Ref. No.</b> | 19550623/0<br>CM19550623/0 |
| <b>description</b>   | pressure control switching diff. 30bar reset manual pressure connection 6mm soldering connection 250V cable length 1500mm 1NC 6A |                 |                            |
| <b>For models:</b>   | T14, T5  |                 |                            |

## pressure switches

### for refrigeration

#### DANFOSS

|   |   |                 |  |
|---|---|-----------------|--|
|  |   |                 |  |
| 1   |   |                 |  |
| <b>GEV No.</b>  | 541462  | <b>Ref. No.</b> | 19550371/0<br>19550372/0<br>CM19550371/0<br>CM19550372/0 |
| <b>description</b>  | pressure control DANFOSS type KP5 60-1171 pressure connection vertical HD refrigeration reset automatic switching diff. 1.8-6bar pressure range 8-32bar connection 7/16" UNF (1/4" SAE) |                 |  |
| <b>For models:</b>  | F80C, F80WC, N140, N20L, N20WL, N21S, N25LW, N25SW, N35SW, N45L, N45S, N45SW, N50BI, N50BIW, N55LW, N55S, N55SW, N70S, N70SW, N90S, N90SW   |                 |  |

#### SAGI NO MIYA

|  |   |                 |                            |
|--|---|-----------------|----------------------------|
|  |   |                 |                            |
| 1  |   |                 |                            |
| <b>GEV No.</b>   | 541610  | <b>Ref. No.</b> | 81453749/0<br>CM81453749/0 |
| <b>description</b>   | pressure control p max 45bar type ACB-2UB135MW switch-off pressure 30bar switch-on pressure 22bar |                 |                            |
| <b>For models:</b>   | N131M   |                 |                            |

#### JOHNSON CONTROLS

|   |   |                 |              |
|---|---|-----------------|--------------|
|  |   |                 |              |
| 1   |   |                 |              |
| <b>GEV No.</b>  | 541116  | <b>Ref. No.</b> | CMXP62007500 |
| <b>description</b>  | pressure control HD switch pressure 10bar reset automatic switching diff. 1.1bar pressure range 7-29bar p max 38bar refrigeration type P20EA-9950C connection soldering connection 6.35mm CO JOHNSON CONTROLS pressure connection soldering connection 6.35mm |                 |              |

|   |   |                 |                            |
|---|---|-----------------|----------------------------|
|  |   |                 |                            |
| 1   |   |                 |                            |
| <b>GEV No.</b>  | 694092  | <b>Ref. No.</b> | 19550618/0<br>CM19550618/0 |
| <b>description</b>  | pressure control DANFOSS type KP5 60-5133 pressure connection vertical refrigeration reset manual switching diff. 3bar pressure range 8-32bar connection 7/16" UNF (1/4" SAE) |                 |                            |
| <b>For models:</b>  | T20, T20C, T20R   |                 |                            |

|  |  |                 |                              |
|--|--|-----------------|------------------------------|
|  |  |                 |                              |
| 1  |  |                 |                              |
| <b>GEV No.</b>   | 541117   | <b>Ref. No.</b> | CMCF62023101<br>CMCS62023101 |
| <b>description</b>   | pressure control HD switch pressure 24bar reset manual switching diff. 4.7bar pressure range 7-29bar p max 38bar refrigeration type P20GA-9950T connection male faston 6.3mm CO JOHNSON CONTROLS pressure connection soldering connection 6.35mm |                 |                              |

#### miscellaneous

|   |  |                 |                            |
|---|--|-----------------|----------------------------|
|  |  |                 |                            |
| 1   |  |                 |                            |
| <b>GEV No.</b>  | 542178   | <b>Ref. No.</b> | 19550628/0<br>CM19550628/0 |
| <b>description</b>  | pressure control DANFOSS pressure range 45bar pressure connection 6mm soldering connection reset low pressure 23.5 high pressure 32.5bar type ACB-2UB178 6A 250V |                 |                            |

|  |   |                 |                            |
|--|---|-----------------|----------------------------|
|  |   |                 |                            |
| 1  |   |                 |                            |
| <b>GEV No.</b>   | 542135  | <b>Ref. No.</b> | 25474402/0<br>CM25474402/0 |
| <b>description</b>   | pressure control reset manual pressure connection 6mm soldering connection switching diff. 45bar 250V cable length 230mm 1NC 6A |                 |                            |
| <b>For models:</b>   | N201M, N301M, N401M, N501M  |                 |                            |



## electrodes



1

|                    |   |                 |                            |
|--------------------|---|-----------------|----------------------------|
| <b>GEV No.</b>     | 403562  | <b>Ref. No.</b> | 81455065/0<br>CM81455065/0 |
| <b>description</b> | level electrode push-in type A39030-21 total length 120mm probe L 95mm triple connection male faston 6.3mm SS |                 |                            |

## compressors

### ACC/ZEL

R134A

HMBP monophase

High/Medium evaporation temperature above -20/-15 °C



1

|                    |  |                 |                            |
|--------------------|--|-----------------|----------------------------|
| <b>GEV No.</b>     | 605012   | <b>Ref. No.</b> | 19165497/0<br>CM19165497/0 |
| <b>description</b> | compressor coolant R134a type GL45TB 220-240V 50Hz HMBP fully hermetic 8.4kg 1/6HP power input 342W cylinder capacity 4.5cm <sup>3</sup> CSIR H 175.5mmW 76W 101W 134W 175W 223W 278W 342W 413W test method ASHRAE ambient temperature max. 43°C |                 |                            |
| <b>For models:</b> | N20L, N20WL, N25SW   |                 |                            |



1

|                    |  |                 |              |
|--------------------|--|-----------------|--------------|
| <b>GEV No.</b>     | 605008   | <b>Ref. No.</b> | CM19165851/0 |
| <b>description</b> | compressor coolant R134a type GL80TB 220-240V 50Hz HMBP fully hermetic 9.5kg 1/5HP power input 554W cylinder capacity 7.6cm <sup>3</sup> CSIR H 175.5mm 165W 215W 290W 390W 500W 615W 727W 840W test method ASHRAE ambient temperature max. 43°C |                 |              |



1

|                    |  |                 |                            |
|--------------------|--|-----------------|----------------------------|
| <b>GEV No.</b>     | 605009   | <b>Ref. No.</b> | 19165548/0<br>CM19165548/0 |
| <b>description</b> | compressor coolant R134a type GL90TB 220-240V 50Hz HMBP fully hermetic 10.8kg 1/4HP power input 293W cylinder capacity 8.8cm <sup>3</sup> CSIR H 175.5mmW 143W 194W 259W 339W 432W 539W 661W 796W test method ASHRAE |                 |                            |
| <b>For models:</b> | F100C, F80C, F80WC, N35BI, N35S, N35SW, N45L, N45S, N45SW  |                 |                            |

### CUBIGEL

#### accessories



1

|                    |             |                 |                            |
|--------------------|-------------|-----------------|----------------------------|
| <b>GEV No.</b>     | 380576      | <b>Ref. No.</b> | CF62005731<br>CMCF62005731 |
| <b>description</b> | start relay |                 |                            |
| <b>For models:</b> | F100, F120  |                 |                            |



1

|                    |  |                 |                            |
|--------------------|--|-----------------|----------------------------|
| <b>GEV No.</b>     | 380586                                 | <b>Ref. No.</b> | CM62005732<br>CMCM62005732 |
| <b>description</b> | start relay 120/240V voltage AC 8A 1NO |                 |                            |
| <b>For models:</b> | N21S, N25L, N25LBI, N25LW              |                 |                            |



1

|                    |  |                 |                     |
|--------------------|--|-----------------|---------------------|
| <b>GEV No.</b>     | 380822                                 | <b>Ref. No.</b> | nicht in Preisliste |
| <b>description</b> | start relay 120/240V voltage AC 8A 1NO |                 |                     |



1

|                    |                      |                 |                     |
|--------------------|----------------------|-----------------|---------------------|
| <b>GEV No.</b>     | 380575               | <b>Ref. No.</b> | nicht in Preisliste |
| <b>description</b> | start relay MTRP5631 |                 |                     |

**EMBRACO / ASPERA**

R404a/R507

LBP monophase

Lower evaporation temperature below -20°C



1

|                    |  |                 |              |
|--------------------|--|-----------------|--------------|
| <b>GEV No.</b>     | 605174   | <b>Ref. No.</b> | CM19165559/0 |
| <b>description</b> | compressor coolant R404a/R507 type NJ2192GK 220-240V 50Hz LBP 20.4kg 1 1/4HP cylinder capacity 26.2cm <sup>3</sup> CSR H 265mm 685W 989W 1342W 1745W 2196W 2196WWWWW |                 |              |



1

|                    |   |                 |              |
|--------------------|---|-----------------|--------------|
| <b>GEV No.</b>     | 605081  | <b>Ref. No.</b> | CM19166082/0 |
| <b>description</b> | compressor coolant R404a/R507 type NJ2212GK 220-240V 50Hz LBP fully hermetic 21.5kg 1 1/2HP power input 1150W cylinder capacity 34cm <sup>3</sup> CSR H 277mm 880W 1269W 1738W 2289W 2921W 2921WWWWW test method ASHRAE |                 |              |



1

|                    |   |                 |              |
|--------------------|---|-----------------|--------------|
| <b>GEV No.</b>     | 605164  | <b>Ref. No.</b> | CM19166086/0 |
| <b>description</b> | compressor coolant R404a/R507 type NT2178GK 220-240V 50Hz LBP 17kg 1HP cylinder capacity 17.4cm <sup>3</sup> CSR H 220mm 442W 610W 808W 1032W 1285W 1565WWWWW |                 |              |

HMBP monophase

High/Medium evaporation temperature above -20/-15 °C



1

|                    |  |                 |              |
|--------------------|--|-----------------|--------------|
| <b>GEV No.</b>     | 605139   | <b>Ref. No.</b> | CM19166076/0 |
| <b>description</b> | compressor coolant R404a/R507 type EMT6165GK 220-240V 50Hz HMBP 7.92kg 1/4HP cylinder capacity 5.19cm <sup>3</sup> CSIR H 180mmWW 315W 384W 477W 570W 689W 808W test method ASHRAE |                 |              |

**L'UNITE HERMETIQUE / TECUMSEH**

R134A

HBP monophase

High evaporation temperature above -15°C



1

|                    |  |                 |  |
|--------------------|--|-----------------|--|
| <b>GEV No.</b>     | 605095   | <b>Ref. No.</b> | 19165556/0<br>19165643/0<br>CM19165643/0 |
| <b>description</b> | compressor coolant R134a type AE4450Y-FZ 220-240V 50Hz HBP fully hermetic 11.5kg 3/8HP cylinder capacity 13.2cm <sup>3</sup> CSIR H 206mmWWW 526W 672W 843W 1042W 1273W 1540W test method EN 12900 |                 |  |
| <b>For models:</b> | N55L, N55LW, N55S, N55SW, N70S, N70SW  |                 |  |



1

|                    |   |                 |              |
|--------------------|---|-----------------|--------------|
| <b>GEV No.</b>     | 605184  | <b>Ref. No.</b> | CM19165587/0 |
| <b>description</b> | compressor coolant R134a type THB4419YFZ 220-240V 50Hz HBP fully hermetic 7kg 1/6HP power input 227W cylinder capacity 5.2cm <sup>3</sup> CSIR H 228mmWWW 195W 245W 300W 362W 408W 499W ambient temperature max. 32°C |                 |              |



HMBP monophase

High/Medium evaporation temperature above -20/-15 °C



1

|                    |   |                 |              |
|--------------------|---|-----------------|--------------|
| <b>GEV No.</b>     | 605173  | <b>Ref. No.</b> | CM19165636/0 |
| <b>description</b> | compressor coolant R134a type AE4430Y-FZ1A 220-240V 50Hz HMBP 9.7kg 1/4HP cylinder capacity 8cm <sup>3</sup> CSIR H 200mmWW 294W 382W 488W 613W 760W 930W 1127W |                 |              |



1

|   |   |                 |                 |
|---|---|-----------------|-----------------|
| <b>GEV No.</b>  | 605172  | <b>Ref. No.</b> | CM19165569/0    |
| <b>description</b>  | compressor coolant R134a type CAJ4492Y-F 220-240V 50Hz HMBP 22kg 3/4HP cylinder capacity 25.95cm <sup>3</sup> CSIR H 271mmWW 584W 871W 1215W 1617W 2078WW |                 |                 |
| <b>spare parts for</b>  | 605172  |                 |                 |
|  | <b>GEV No.</b>  | 501548          | <b>Ref. No.</b> |
|   |   |                 | —               |
|   | terminal box for compressor   |                 |                 |



1

|                    |  |                 |                            |
|--------------------|--|-----------------|----------------------------|
| <b>GEV No.</b>     | 605098   | <b>Ref. No.</b> | 19165570/0<br>CM19165570/0 |
| <b>description</b> | compressor coolant R134a type AE4460Y-FZ 220-240V 50Hz HMBP fully hermetic 12.2kg 1/2HP cylinder capacity 15.09cm <sup>3</sup> CSR H 211mmWWW 660W 838W 1040W 1280W 1540W 1840W test method EN 12900 |                 |                            |
| <b>For models:</b> | N90L, N90LW, N90S, N90SW   |                 |                            |

R404A

HMBP monophase

High/Medium evaporation temperature above -20/-15 °C



1

|                    |   |                 |              |
|--------------------|---|-----------------|--------------|
| <b>GEV No.</b>     | 605158  | <b>Ref. No.</b> | CM19165644/0 |
| <b>description</b> | compressor coolant R404A type AE4470Z 220-240V 50Hz HMBP fully hermetic 13.7kg 1/2HP cylinder capacity 12cm <sup>3</sup> CSR H 207mmW 670W 843W 1035W 1251W 1495W 1773W 2088W 2447W |                 |              |



1

|                    |  |                 |                            |
|--------------------|--|-----------------|----------------------------|
| <b>GEV No.</b>     | 605137   | <b>Ref. No.</b> | 19165591/0<br>CM19165591/0 |
| <b>description</b> | compressor coolant R134a type AEZ4430Y 220-240V 50Hz HMBP fully hermetic 10.2kg 1/4HP power input 330W cylinder capacity 8.8cm <sup>3</sup> CSIR H 199mmWW 245W 328W 432W 558W 698WW |                 |                            |



1

|                    |  |                 |              |
|--------------------|--|-----------------|--------------|
| <b>GEV No.</b>     | 605027   | <b>Ref. No.</b> | CM19165630/0 |
| <b>description</b> | compressor coolant R404A type CAJ4517Z 220-240V 50Hz HMBP fully hermetic 24kg 1.2HP cylinder capacity 25.95cm <sup>3</sup> CSIR H 282mmWW 1588W 1987W 2451W 2971W 3536W 4132W test method EN 12900 4742W |                 |              |



|                    |   |                 |  |
|--------------------|---|-----------------|--|
| <b>GEV No.</b>     | 605065  | <b>Ref. No.</b> | 81453661<br>81453661/0<br>CF67009905<br>CM19165594/0<br>CM81453661/0<br>CMCF67009905 |
| <b>description</b> | compressor coolant R404A type CAJ4519Z 220-240V 50Hz HMBP 24kg 1.5HP cylinder capacity 34.4cm <sup>3</sup> CSR H 282mmWWW 1769W 2353W 3009W 3756W 4360W 5200W |                 |  |
| <b>For models:</b> | N301M, SF500  |                 |  |



|                    |  |                 |              |
|--------------------|--|-----------------|--------------|
| <b>GEV No.</b>     | 605070   | <b>Ref. No.</b> | CM19165631/0 |
| <b>description</b> | compressor coolant R404A type CAJ9513Z 220-240V 50Hz HMBP fully hermetic 23kg 1.1HP cylinder capacity 24.2cm <sup>3</sup> CSR H 282mmW 930W 1269W 1654W 2086W 2568W 3096W 3671W test method EN 12900 4278W |                 |              |



|                    |   |                 |              |
|--------------------|---|-----------------|--------------|
| <b>GEV No.</b>     | 605026  | <b>Ref. No.</b> | CM19165632/0 |
| <b>description</b> | compressor coolant R404A type CAJ9480Z 220-240V 50Hz HMBP fully hermetic 22kg 3/4HP cylinder capacity 15.2cm <sup>3</sup> CSR H 271mm 393W 571W 774W 1009W 1284W 1607W 1989W 2334W test method EN 12900 2699W |                 |              |

### accessories

#### starting relays

##### klixons



|                    |   |                 |                     |
|--------------------|---|-----------------|---------------------|
| <b>GEV No.</b>     | 380582                                  | <b>Ref. No.</b> | nicht in Preisliste |
| <b>description</b> | start relay Klixon 131 15A series 9660B |                 |                     |



|                    |   |                 |                              |
|--------------------|---|-----------------|------------------------------|
| <b>GEV No.</b>     | 605032  | <b>Ref. No.</b> | CM19165554/0<br>CM19165596/0 |
| <b>description</b> | compressor coolant R404A type CAJ9510Z 220-240V 50Hz HMBP fully hermetic 23kg 1HP cylinder capacity 18.3cm <sup>3</sup> CSR H 282mm 527W 732W 970W 1252W 1583W 1972W 2437W 2826W test method EN 12900 3220W |                 |                              |

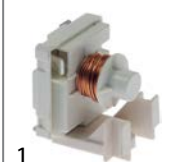

|                    |                                     |                 |                     |
|--------------------|-------------------------------------|-----------------|---------------------|
| <b>GEV No.</b>     | 380583                              | <b>Ref. No.</b> | nicht in Preisliste |
| <b>description</b> | start relay Klixon 145 series 9660B |                 |                     |



|                    |   |                 |                     |
|--------------------|---|-----------------|---------------------|
| <b>GEV No.</b>     | 380586                                  | <b>Ref. No.</b> | nicht in Preisliste |
| <b>description</b> | start relay Klixon 170 15A series 9660A |                 |                     |

#### RBM



|                    |                               |                 |                     |
|--------------------|-------------------------------|-----------------|---------------------|
| <b>GEV No.</b>     | 380595                        | <b>Ref. No.</b> | nicht in Preisliste |
| <b>description</b> | start relay RBM 128306-1645PB |                 |                     |







|   |                               |                 |                     |
|---|-------------------------------|-----------------|---------------------|
|  |                               |                 |                     |
| 1   |                               |                 |                     |
| <b>GEV No.</b>  | 380594                        | <b>Ref. No.</b> | nicht in Preisliste |
| <b>description</b>  | start relay RBM 128306-1653VB |                 |                     |

miscellaneous

|   |   |                 |                     |
|---|---|-----------------|---------------------|
|  |   |                 |                     |
| 1   |   |                 |                     |
| <b>GEV No.</b>  | 380587  | <b>Ref. No.</b> | nicht in Preisliste |
| <b>description</b>  | start relay 230V 1NC connection male faston 6.3mm |                 |                     |

|   |  |                 |                     |
|---|--|-----------------|---------------------|
|  |  |                 |                     |
| 1   |  |                 |                     |
| <b>GEV No.</b>  | 380581   | <b>Ref. No.</b> | nicht in Preisliste |
| <b>description</b>  | start relay 230V 1NO/1NC connection male faston 6.3mm with strap dimensions 45x50x42mm |                 |                     |

overload protector (klixon)

|   |                    |                 |                     |
|---|--------------------|-----------------|---------------------|
|  |                    |                 |                     |
| 1   |                    |                 |                     |
| <b>GEV No.</b>  | 390654             | <b>Ref. No.</b> | nicht in Preisliste |
| <b>description</b>  | overload protector |                 |                     |

|   |  |                 |                     |
|---|--|-----------------|---------------------|
|  |  |                 |                     |
| 1   |  |                 |                     |
| <b>GEV No.</b>  | 390651   | <b>Ref. No.</b> | nicht in Preisliste |
| <b>description</b>  | overload protector for engine protective circuit breaker MRA38031-3007 with cable t.max. 145°C reset automatic |                 |                     |

|   |   |                 |                     |
|---|---|-----------------|---------------------|
|  |   |                 |                     |
| 1   |   |                 |                     |
| <b>GEV No.</b>  | 390544  | <b>Ref. No.</b> | nicht in Preisliste |
| <b>description</b>  | overload protector for engine protective circuit breaker T0168/22 with cable t.max. 150°C reset automatic |                 |                     |

|   |   |                 |                     |
|---|---|-----------------|---------------------|
|  |   |                 |                     |
| 1   |   |                 |                     |
| <b>GEV No.</b>  | 390608  | <b>Ref. No.</b> | nicht in Preisliste |
| <b>description</b>  | overload protector for engine protective circuit breaker T0418/A4 |                 |                     |

|  |   |                 |                            |
|--|---|-----------------|----------------------------|
|  |   |                 |                            |
| 1  |   |                 |                            |
| <b>GEV No.</b>   | 390640  | <b>Ref. No.</b> | CF62005878<br>CMCF62005878 |
| <b>description</b>   | overload protector for engine protective circuit breaker with cable reset automatic |                 |                            |
| <b>For models:</b>   | SF300   |                 |                            |

|  |  |                 |                     |
|--|--|-----------------|---------------------|
|  |  |                 |                     |
| 1  |  |                 |                     |
| <b>GEV No.</b>   | 390666   | <b>Ref. No.</b> | nicht in Preisliste |
| <b>description</b>   | overload protector for engine protective circuit breaker L140-20F 8926 cable length 90mm |                 |                     |



fans

refrigeration fans

refrigeration motors universal

ELCO

N series - multi fit



1

|   |  |                 |  |
|---|--|-----------------|--|
| <b>GEV No.</b>  | 601427   | <b>Ref. No.</b> | 18562496/0<br>29020001<br>29020003<br>CF62041902<br>CM18562496/0<br>CMCF62041902 |
| <b>description</b>  | fan motor ELCO 10W 230V 50/60Hz bearing slide bearing L1 49mm L2 59mm L3 86.5mm W 83mm connection cable 500mm 1300/1550rpm 5 mounting options VNT10-20/028 |                 |  |
| <b>For models:</b>  | F100, F100C, F120, F200, N35S, N35SW, N45L   |                 |  |
| <b>spare parts for</b>  | 601427   |                 |  |
|  | <b>GEV No.</b>   | 560140          | <b>Ref. No.</b> —  |
|   | hexagonal nut thread M4 H 4.8mm SS WS 7 Qty 20 pcs DIN/ISO DIN 985 self-locking  |                 |  |
|  | <b>GEV No.</b>   | 560332          | <b>Ref. No.</b> —  |
|   | plain washer ID ø 4.3mm ED ø 9mm thickness 0.8mm SS Qty 1 pcs  |                 |  |
|  | <b>GEV No.</b>   | 560340          | <b>Ref. No.</b> —  |
|   | hexagonal nut thread M4 H 3.2mm WS 7 SS DIN/ISO DIN 934 / ISO 4032/8673 Qty 1 pcs  |                 |  |
|  | <b>GEV No.</b>   | 601413          | <b>Ref. No.</b> —  |
|   | fixing plate suitable for fanwheel ED ø 32mm shaft ø 7 mounting distance 26mm  |                 |  |



1

|   |  |                 |                            |
|---|--|-----------------|----------------------------|
| <b>GEV No.</b>  | 601528   | <b>Ref. No.</b> | CF62041904<br>CMCF62041904 |
| <b>description</b>  | fan motor ELCO 16W 230V 50/60Hz bearing slide bearing L1 48mm L2 64mm L3 91.5mm W 83mm connection cable 500mm 1300/1550rpm 5 mounting options VNT16-25/029 |                 |                            |
| <b>For models:</b>  | SF300  |                 |                            |
| <b>spare parts for</b>  | 601528   |                 |                            |
|  | <b>GEV No.</b>   | 601413          | <b>Ref. No.</b> —          |
|   | fixing plate suitable for fanwheel ED ø 32mm shaft ø 7 mounting distance 26mm  |                 |                            |



1

|   |   |                 |                   |
|---|---|-----------------|-------------------|
| <b>GEV No.</b>  | 601530  | <b>Ref. No.</b> | 29020005          |
| <b>description</b>  | fan motor ELCO 34W 230V 50/60Hz bearing slide bearing L1 55.5mm L2 91.5mm L3 119mm W 83mm connection cable 500mm 1300/1550rpm 5 mounting options VNT34-45/031 |                 |                   |
| <b>spare parts for</b>  | 601530  |                 |                   |
|  | <b>GEV No.</b>  | 601413          | <b>Ref. No.</b> — |
|   | fixing plate suitable for fanwheel ED ø 32mm shaft ø 7 mounting distance 26mm   |                 |                   |

N series - standard



1

|                    |   |                 |                            |
|--------------------|---|-----------------|----------------------------|
| <b>GEV No.</b>     | 601527  | <b>Ref. No.</b> | 18562058/0<br>CM18562058/0 |
| <b>description</b> | fan motor 16W 230V 50/60Hz W 84mm 1300rpm VN16-38 |                 |                            |
| <b>For models:</b> | N200M, N200MW, N300M, N300MW                      |                 |                            |

miscellaneous



1

|                    |                    |                 |  |
|--------------------|--------------------|-----------------|--|
| <b>GEV No.</b>     | 601431             | <b>Ref. No.</b> | 29020005<br>CF62041906<br>CMCF62041906 |
| <b>description</b> | fan motor 35W 230V |                 |  |
| <b>For models:</b> | SF500              |                 |  |





1

|                    |   |                 |  |
|--------------------|---|-----------------|--|
| <b>GEV No.</b>     | 601524  | <b>Ref. No.</b> | 18562524<br>18562524/0<br>CM18562524/0 |
| <b>description</b> | fan motor 35W 230V 50/60Hz L3 153mm W 83mm cable length 1600mm 1300rpm with capacitor capacitor 2.5µF |                 |  |
| <b>For models:</b> | N131M, N201M, N301M, N401M, N501M   |                 |  |



1

|   |   |                 |                   |
|---|---|-----------------|-------------------|
| <b>GEV No.</b>  | 601545  | <b>Ref. No.</b> | I-1013            |
| <b>description</b>  | fan motor 7W 220-240V 50-60Hz L3 101mm W 85mm                                 |                 |                   |
| <b>spare parts for</b>  | 601545  |                 |                   |
|  | <b>GEV No.</b>  | 601413          | <b>Ref. No.</b> — |
|   | fixing plate suitable for fanwheel ED ø 32mm shaft ø 7 mounting distance 26mm |                 |                   |

accessories

fan wheels

aluminium

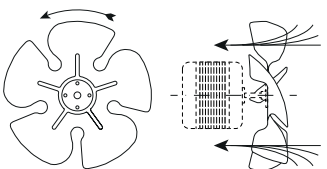



1

|                    |  |                 |                            |
|--------------------|--|-----------------|----------------------------|
| <b>GEV No.</b>     | 601282   | <b>Ref. No.</b> | 18740031/0<br>CM18740031/0 |
| <b>description</b> | fan wheel sucking ø 200mm fan wheel mounting 25.4mm blade angle 34° W 44mm aluminium |                 |                            |

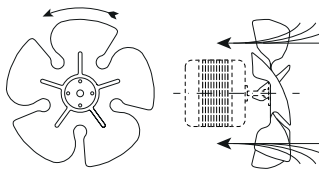

1

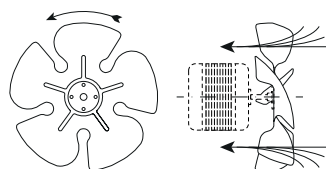

|                    |  |                 |          |
|--------------------|--|-----------------|----------|
| <b>GEV No.</b>     | 601387   | <b>Ref. No.</b> | 62041934 |
| <b>description</b> | fan wheel sucking ø 254mm fan wheel mounting 25.4mm blade angle 34° W 50mm aluminium |                 |          |

1

|                    |  |                 |  |
|--------------------|--|-----------------|--|
| <b>GEV No.</b>     | 601555   | <b>Ref. No.</b> | CF62000001<br>CF62041936<br>CMCF62000001<br>CMCF62041936 |
| <b>description</b> | fan wheel sucking ø 300mm fan wheel mounting 25.4mm blade angle 25° W 45mm aluminium |                 |  |
| <b>For models:</b> | SF500  |                 |  |

1

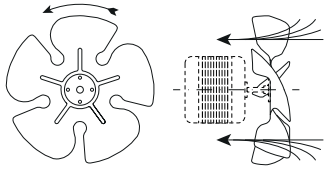
|                    |  |                 |                            |
|--------------------|--|-----------------|----------------------------|
| <b>GEV No.</b>     | 601410   | <b>Ref. No.</b> | 18740032/0<br>CM18740032/0 |
| <b>description</b> | fan wheel sucking ø 300mm fan wheel mounting 25.4mm blade angle 28° W 45mm aluminium |                 |                            |
| <b>For models:</b> | N401M, N501M   |                 |                            |

aluminium

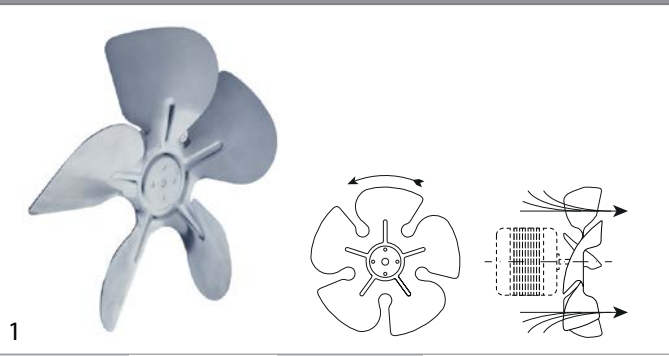

|                    |  |                 |                            |
|--------------------|--|-----------------|----------------------------|
| <b>GEV No.</b>     | 601556   | <b>Ref. No.</b> | 18740040/0<br>CM18740040/0 |
| <b>description</b> | fan wheel blowing ø 254mm fan wheel mounting 25.4mm blade angle 31° W 46mm aluminium |                 |                            |

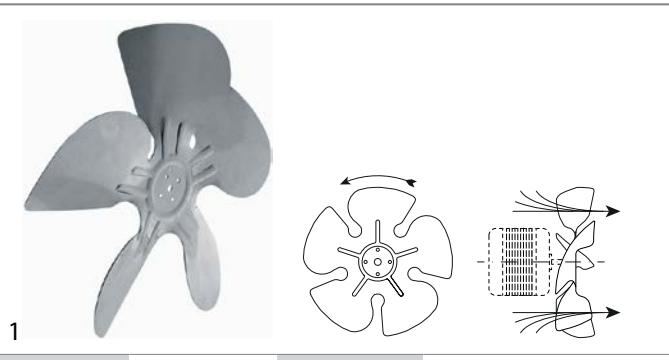

|                    |  |                 |                            |
|--------------------|--|-----------------|----------------------------|
| <b>GEV No.</b>     | 602041   | <b>Ref. No.</b> | 18740042/0<br>CM18740042/0 |
| <b>description</b> | fan wheel blowing ø 300mm fan wheel mounting 25.4mm blade angle 31° W 58mm aluminium |                 |                            |

cooling motors (complete)



|                        |  |                 |                            |
|------------------------|--|-----------------|----------------------------|
| <b>GEV No.</b>         | 601526   | <b>Ref. No.</b> | 18562065/0<br>CM18562065/0 |
| <b>description</b>     | fan 230V 10W 50Hz fan wheel ø 200mm shaft L 13mm L 76mm W 83mm connection cable cable length 500mm |                 |                            |
| <b>For models:</b>     | N500M  |                 |                            |
| <b>spare parts for</b> | 601526   |                 |                            |

|   |  |        |                 |   |
|---|--|--------|-----------------|---|
|  | <b>GEV No.</b>   | 601070 | <b>Ref. No.</b> | — |
|   | fan wheel sucking ø 200mm fan wheel mounting 25.4mm blade angle 28° W 38mm aluminium |        |                 |   |



|                    |   |                 |       |
|--------------------|---|-----------------|-------|
| <b>GEV No.</b>     | 601557  | <b>Ref. No.</b> | I-160 |
| <b>description</b> | fan 230V 5W 50-60Hz fan wheel ø 200mm feet depth 60mm L 83mm W 92mm H 66mm blade angle 28° connection with cable mounting distance 75mm |                 |       |
| <b>For models:</b> | N1, N1W, N2, N2W, N3, N3S, N3W, N4, N5  |                 |       |



|                    |  |                 |                            |
|--------------------|--|-----------------|----------------------------|
| <b>GEV No.</b>     | 694178   | <b>Ref. No.</b> | 18562517/0<br>CM18562517/0 |
| <b>description</b> | fan 220-240V 16W 50-60Hz fan wheel ø 250mm connection with cable mounting distance 300mm |                 |                            |
| <b>For models:</b> | N140, T5   |                 |                            |

cold air circulating fans (complete)

ebm-papst

A4E series

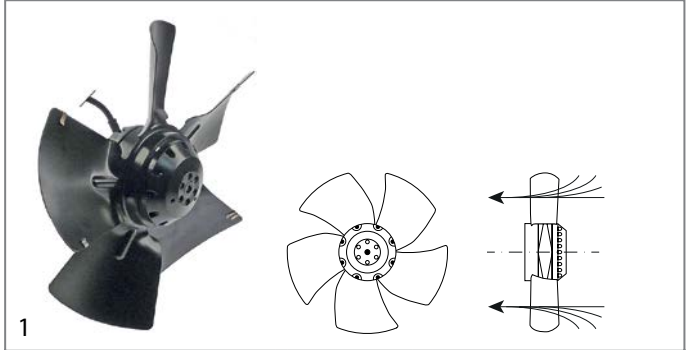

|                        |  |                 |                            |
|------------------------|--|-----------------|----------------------------|
| <b>GEV No.</b>         | 602026   | <b>Ref. No.</b> | 18562532/0<br>CM18562532/0 |
| <b>description</b>     | fan A4E300-AA01-57 fan wheel ø 300mm blades 5 230V 50/60Hz 95/105W 1350/1450rpm cable length 2030mm ebm-papst sucking suitable capacitor 3µF |                 |                            |
| <b>For models:</b>     | T14, T20, T20C, T20R, T5   |                 |                            |
| <b>spare parts for</b> | 602026   |                 |                            |

|   |   |        |                 |   |
|---|---|--------|-----------------|---|
|  | <b>GEV No.</b>  | 365137 | <b>Ref. No.</b> | — |
|   | capacitor capacity 3µF 450V tolerance 5% 50/60Hz ambient temperature max. -25 to +85°C ø 25mm L 56mm M8 plastic connection cable 250mm 416.17.77GF protection |        |                 |   |

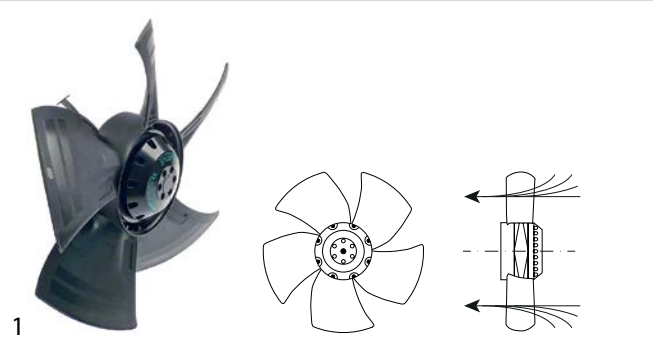



|   |   |                 |                            |
|---|---|-----------------|----------------------------|
| <b>GEV No.</b>  | 602024  | <b>Ref. No.</b> | 18562576/0<br>CM18562576/0 |
| <b>description</b>  | fan A4E300-AS72-07 fan wheel ø 300mm blades 5 230V 50/60Hz 72/90W 1320/1500rpm cable length 2030mm ebm-papst sucking suitable capacitor 2µF                 |                 |                            |
| <b>spare parts for</b>  | 602024  |                 |                            |
|   | <b>GEV No.</b>  | 365170          | <b>Ref. No.</b> —          |
|  | capacitor capacity 2µF 425V tolerance 5% 50/60Hz ambient temperature max. -25 to +85°C ø 25mm L 49mm M8 plastic connection cable 250mm 416.17.74 protection |                 |                            |

### HIDRIA

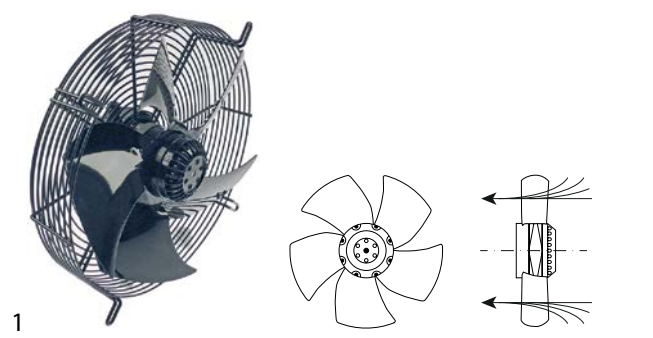

|                    |  |                 |  |
|--------------------|--|-----------------|--|
| <b>GEV No.</b>     | 602029   | <b>Ref. No.</b> | 18562559/2<br>CM18562559/2<br>CM18562559/3 |
| <b>description</b> | fan type R09R-30SPB-4M-3509 fan wheel ø 300mm 230V 50/60Hz 80W ø 105mm suitable capacitor 2.5µF HIDRIA suitable for blast chiller 1370rpm H 90mm cable length 1800mm mounting distance 255mm |                 |  |



|                    |   |                 |                            |
|--------------------|---|-----------------|----------------------------|
| <b>GEV No.</b>     | 602009  | <b>Ref. No.</b> | 18562519/0<br>CM18562519/0 |
| <b>description</b> | fan type R09R-3530HA-4M-4237 fan wheel ø 350mm 230V 50/60Hz 130/165W HIDRIA 1290/1380rpm sucking H 155mm cable lengthmm mounting distance 315mm |                 |                            |
| <b>For models:</b> | T14, T20, T20C, T20R  |                 |                            |

### COPREL

#### MAP series

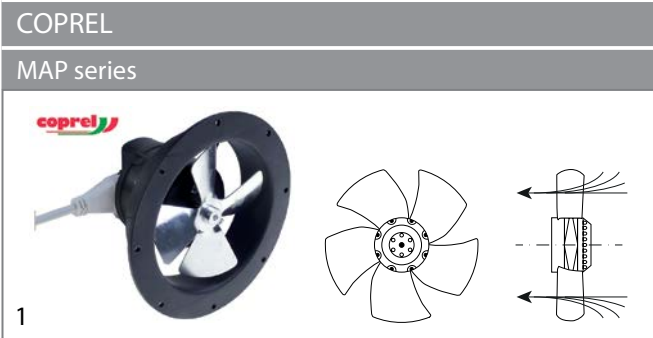

|                    |   |                 |           |
|--------------------|---|-----------------|-----------|
| <b>GEV No.</b>     | 601039  | <b>Ref. No.</b> | 185602055 |
| <b>description</b> | fan sucking 230V 9W 50/60Hz fan wheel ø 96mm shaft L 20mm connection with cable for saladette |                 |           |

### cold air circulating fans (other)



|                    |  |                 |  |
|--------------------|--|-----------------|--|
| <b>GEV No.</b>     | 601554   | <b>Ref. No.</b> | 29020006/0<br>CF62027300<br>CM29020006/0<br>CMCF62027300 |
| <b>description</b> | fan motor 230V 50-60Hz 100W W 105mm H 105mm D 220mm shaft L 80mm shaft ø 12mm EURO MOTORS type 10111-40100 cable length 1500mm 1100rpm |                 |  |
| <b>For models:</b> | SFN1000, SFN1000W  |                 |  |

### cooling fans



|                    |  |                 |                            |
|--------------------|--|-----------------|----------------------------|
| <b>GEV No.</b>     | 602025   | <b>Ref. No.</b> | 18562012/0<br>CM18562012/0 |
| <b>description</b> | fan 230V 50Hz 27.5W W 110mm H 125mm D 110mm Emmevi type 202001 |                 |                            |



radial fans

miscellaneous



1

|                    |  |                 |                            |
|--------------------|--|-----------------|----------------------------|
| <b>GEV No.</b>     | 601523   | <b>Ref. No.</b> | 18562480/0<br>CM18562480/0 |
| <b>description</b> | radial fan 230V voltage AC 50Hz 50W H1 175mm L1 165mm D1 ø 83mm W1 160mm W2 73mm H2 60mm W3 82mm H3 96mm |                 |                            |
| <b>For models:</b> | N50BI, N50BIW  |                 |                            |



1

|   |   |                 |   |
|---|---|-----------------|---|
| <b>GEV No.</b>  | 500786  | <b>Ref. No.</b> | 81404024/0<br>CM81404024/0                    |
| <b>description</b>  | float motor LIP 11W 230V 50Hz 1rpm shaft ø 8mm W 100mm H 90mm for ice maker L 130mm |                 |   |
| <b>For models:</b>  | N20L, N20WL, N25BI, N25L, N25LBI, N25LW, N25S, N25SW, N35BI, N35S, N35SW, N45L      |                 |   |
| <b>spare parts for</b>  | 500786  |                 |   |
|  | <b>GEV No.</b>  | 695670          | <b>Ref. No.</b><br>25260000/0<br>CM25260000/0 |
| disc for pan tilting ø 100mm shaft intake ø 7mm                                   |   |                 |   |

motors

gear motors

for ice-cube maker

for paddles



1

|                    |   |                 |  |
|--------------------|---|-----------------|--|
| <b>GEV No.</b>     | 500407  | <b>Ref. No.</b> | 19440059/0<br>19440059/1<br>CM19440059/0<br>CM19440059/1 |
| <b>description</b> | gear motor LIP type 123MR 8W 220/240V voltage AC 50/60Hz 50rpm turn direction counterclockwise shaft ø 4mm shaft intake ø 6.2mm groove width 2.3mm shaft L 8mm shaft ø 4mm W 74mm |                 |  |
| <b>For models:</b> | N140, N20L, N20WL, N25BI, N25L, N25LBI, N25LW, N25S, N25SW, N35BI, N35S, N35SW, N45L, N45S, N45SW, N50BI, N50BIW, N55L, N55LW, N55S, N55SW, N70S, N70SW, N90L, N90LW, N90S, N90SW |                 |  |



1

|                    |  |                 |  |
|--------------------|--|-----------------|--|
| <b>GEV No.</b>     | 500409   | <b>Ref. No.</b> | 19440058<br>19440063/0<br>19440069/0<br>81404001/0<br>CM19440063/0<br>CM19440069/0<br>CM81404001/0 |
| <b>description</b> | float motor LIP type 001 11W 220/240V voltage 50/60 0.7rpm shaft ø 7mm shaft length 20mm W 71mm H 62mm L 110mm |                 |  |

for sumps



1

|                    |   |                 |                            |
|--------------------|---|-----------------|----------------------------|
| <b>GEV No.</b>     | 500410  | <b>Ref. No.</b> | 19440065/0<br>CM19440065/0 |
| <b>description</b> | float motor LIP 11W 230V 50Hz 0.7rpm shaft ø 7mm shaft length 20mm W 72mm H 110mm 010 |                 |                            |
| <b>For models:</b> | N140, N70S, N70SW, N90L, N90LW, N90S, N90SW   |                 |                            |



1

|                    |   |                 |                            |
|--------------------|---|-----------------|----------------------------|
| <b>GEV No.</b>     | 500411  | <b>Ref. No.</b> | 19440057/0<br>CM19440057/0 |
| <b>description</b> | gear motor BITRON type 97103 11W 230V 50Hz 0.7rpm shaft ø 7mm shaft length 30mm W 72mm H 60mm L 116mm |                 |                            |

|   |  |                 |                            |
|---|--|-----------------|----------------------------|
|  |  |                 |                            |
| 1   |  |                 |                            |
| <b>GEV No.</b>  | 500412   | <b>Ref. No.</b> | 19440073/0<br>CM19440073/0 |
| <b>description</b>  | gear motor LIP type 021B 11W 230V 50Hz 1rpm shaft ø 7mm shaft length 20mm W 74mm D 67mm H 110mm for sump |                 |                            |

|   |  |                 |                            |
|---|--|-----------------|----------------------------|
|  |  |                 |                            |
| 1   |  |                 |                            |
| <b>GEV No.</b>  | 499089   | <b>Ref. No.</b> | 81413011/0<br>CM81413011/0 |
| <b>description</b>  | gear motor LIP type 10 11W 220/240V 50/60Hz 0.7rpm shaft ø 8mm for ice maker |                 |                            |

|  |  |                 |                            |
|--|--|-----------------|----------------------------|
|  |  |                 |                            |
| 1  |  |                 |                            |
| <b>GEV No.</b>   | 500756   | <b>Ref. No.</b> | 81442072/0<br>CM81442072/0 |
| <b>description</b>   | gear motor LIP type 10 11W 220/240V voltage AC 50/60Hz 0.7rpm shaft ø 8mm W 118mm H 88mm for ice maker L 130mm |                 |                            |
| <b>For models:</b>   | N140   |                 |                            |

|   |   |                 |                            |
|---|---|-----------------|----------------------------|
|  |   |                 |                            |
| 1   |   |                 |                            |
| <b>GEV No.</b>  | 501480  | <b>Ref. No.</b> | 81400006/0<br>CM81400006/0 |
| <b>description</b>  | gear motor type ST0676 11W 220/240V voltage AC 50/60Hz 1rpm shaft ø 8mm W 80mm D 93mm H 112mm for ice maker |                 |                            |

|  |  |                 |                            |
|--|--|-----------------|----------------------------|
| miscellaneous  |  |                 |                            |
|  |  |                 |                            |
| 1  |  |                 |                            |
| <b>GEV No.</b>   | 601539   | <b>Ref. No.</b> | 81401520/0<br>CM81401520/0 |
| <b>description</b>   | gear motor LIP type 049E 80W 230V 50Hz 13rpm shaft ø 18mm L 160mm W 74mm H 160mm for auger |                 |                            |

|  |  |                 |   |
|--|--|-----------------|---|
|  |  |                 |   |
| 1  |  |                 |   |
| <b>GEV No.</b>   | 499077   | <b>Ref. No.</b> | 29030005/0<br>79422513<br>79422513R<br>CF79422513<br>CF79422513R<br>CM29030005/0<br>CMCF79422513<br>CMCF79422513R |
| <b>description</b>   | gear motor type 794225 220V voltage AC 50/60Hz shaft ø 22.2mm L 260mm W 150mm H 245mm for ice maker 120W |                 |   |
| <b>For models:</b>   | F100, F100C, F120, F125C, F200, F80C, F80WC  |                 |   |

motors

for ice-cube maker

|  |  |                 |                                |
|--|--|-----------------|--------------------------------|
| rotors   |  |                 |                                |
|  |  |                 |                                |
| 1  |  |                 |                                |
| <b>GEV No.</b>   | 500751   | <b>Ref. No.</b> | nicht in Preislisten enthalten |
| <b>description</b>   | rotor ø 65mm shaft ø 13mm shaft length 180mm for flake ice maker |                 |                                |



stators



1

|                    |   |                 |  |
|--------------------|---|-----------------|--|
| <b>GEV No.</b>     | 695826  | <b>Ref. No.</b> | 29000010/0<br>CF62029500<br>CM29000010/0<br>CMCF62029500 |
| <b>description</b> | stator 230V 50/60Hz 1 phase ø 135mm ID ø 80mm H 45mm with housing |                 |  |
| <b>For models:</b> | SF300, SF500, SFN1000, SFN1000W                                   |                 |  |

pumps

drain pumps

HANNING



1

|                    |   |                 |                            |
|--------------------|---|-----------------|----------------------------|
| <b>GEV No.</b>     | 500757  | <b>Ref. No.</b> | 95005643/0<br>CM95005643/0 |
| <b>description</b> | drain pump inlet ø 18mm outlet ø 20mm 230V 50Hz HANNING |                 |                            |

miscellaneous



1

|                    |                                       |                 |              |
|--------------------|---------------------------------------|-----------------|--------------|
| <b>GEV No.</b>     | 501490                                | <b>Ref. No.</b> | CMUMPOMPA943 |
| <b>description</b> | drain pump inlet ø 24mm outlet ø 24mm |                 |              |

pumps for ice machines



1

|                    |   |                 |        |
|--------------------|---|-----------------|--------|
| <b>GEV No.</b>     | 500781  | <b>Ref. No.</b> | I-1029 |
| <b>description</b> | fan motor 11W 230V 50-60Hz L 83mm W 83mm H 75mm shaft ø 7mm |                 |        |



1

|                    |   |                 |                            |
|--------------------|---|-----------------|----------------------------|
| <b>GEV No.</b>     | 501491  | <b>Ref. No.</b> | 18562001/0<br>CM18562001/0 |
| <b>description</b> | pump 230V 50/60Hz connection cable TRIAL L 218mm W 60mm H 60mm shaft ø 6mm shaft length 155mm |                 |                            |



1

|                    |   |                 |                               |
|--------------------|---|-----------------|-------------------------------|
| <b>GEV No.</b>     | 500759  | <b>Ref. No.</b> | nicht in Preisliste enthalten |
| <b>description</b> | pump GRE 30W 230V 60Hz outlet ø 12.5mm L 137mm rotation direction right for ice maker |                 |                               |



1

|                    |  |                 |  |
|--------------------|--|-----------------|--|
| <b>GEV No.</b>     | 500597   | <b>Ref. No.</b> | 19550109<br>19550109/0<br>CM19550109/0<br>CMXG62043003 |
| <b>description</b> | pump GRE type MH50F 60W 230V 50Hz outlet ø 21mm L 110mm rotation direction right for ice maker |                 |  |







1

|                    |   |                 |                     |
|--------------------|---|-----------------|---------------------|
| <b>GEV No.</b>     | 500763  | <b>Ref. No.</b> | nicht in Preisliste |
| <b>description</b> | pump HARTELL type U21B 25W 230V 50/60Hz outlet ø 19mm L 120mm for ice maker 0.33HP capacitor 12.5µF |                 |                     |



1

|                    |   |                 |                     |
|--------------------|---|-----------------|---------------------|
| <b>GEV No.</b>     | 499005  | <b>Ref. No.</b> | nicht in Preisliste |
| <b>description</b> | pump HARTELL type U21B 75W 240V 50/60Hz outlet ø 12mm L 120mm for ice maker |                 |                     |



1

|                    |   |                 |  |
|--------------------|---|-----------------|--|
| <b>GEV No.</b>     | 500047  | <b>Ref. No.</b> | 19550113/0<br>CM19550113/0<br>CMCS62043300<br>CMNM62043300<br>CMXG62043300 |
| <b>description</b> | pump REBO type MH30F1 30W 230V 50Hz outlet ø 12.7mm L 135mm rotation direction left |                 |  |
| <b>For models:</b> | N131M, N201M, N21S, N301M, N401M, N501M   |                 |  |



1

|                    |  |                 |  |
|--------------------|--|-----------------|--|
| <b>GEV No.</b>     | 500761   | <b>Ref. No.</b> | 19535157<br>19535157/0<br>CM19535157/0 |
| <b>description</b> | pump REBO type MH30F1 30W 230V 50Hz outlet ø 13mm L 135mm rotation direction right for ice maker |                 |  |
| <b>For models:</b> | N200M, N200MW, N300M, N300MW   |                 |  |



1

|                    |  |                 |                            |
|--------------------|--|-----------------|----------------------------|
| <b>GEV No.</b>     | 500754   | <b>Ref. No.</b> | 19580001/0<br>CM19580001/0 |
| <b>description</b> | pump REBO type MH50F 50W 230V 50Hz outlet ø 18mm L 135mm for ice maker |                 |                            |
| <b>For models:</b> | N500M  |                 |                            |



1

|                    |   |                 |                            |
|--------------------|---|-----------------|----------------------------|
| <b>GEV No.</b>     | 500048  | <b>Ref. No.</b> | 19550112/0<br>CM19550112/0 |
| <b>description</b> | pump REBO type MH50F 60W 230V 50Hz outlet ø 18mm L 137mm rotation direction right for ice maker |                 |                            |



1

|                    |   |                 |                                 |
|--------------------|---|-----------------|---------------------------------|
| <b>GEV No.</b>     | 500203  | <b>Ref. No.</b> | 67000212<br>nicht in Preisliste |
| <b>description</b> | pump REBO type MH50F 60W 230V 50Hz outlet ø 21mm L 110mm rotation direction right for ice maker |                 |                                 |



1

|                    |   |                 |                            |
|--------------------|---|-----------------|----------------------------|
| <b>GEV No.</b>     | 501481  | <b>Ref. No.</b> | 81452001/0<br>CM81452001/0 |
| <b>description</b> | pump REBO type NR40 40W 220/240V 50Hz outlet ø 12.7mm L 275mm rotation direction left |                 |                            |



1

|                    |   |                 |                     |
|--------------------|---|-----------------|---------------------|
| <b>GEV No.</b>     | 500046  | <b>Ref. No.</b> | nicht in Preisliste |
| <b>description</b> | pump REBO type NR40 40W 230V 50Hz inlet ø 12mm outlet ø 12mm L 75mm rotation direction right for ice-cube maker |                 |                     |



pumps for drink dispensers

pump motors



|                    |   |                 |        |
|--------------------|---|-----------------|--------|
| <b>GEV No.</b>     | 500781  | <b>Ref. No.</b> | I-1029 |
| <b>description</b> | fan motor 11W 230V 50-60Hz L 83mm W 83mm H 75mm shaft ø 7mm |                 |        |

|                    |  |                 |                            |
|--------------------|--|-----------------|----------------------------|
| <b>GEV No.</b>     | 365153   | <b>Ref. No.</b> | CF62016729<br>CMCF62016729 |
| <b>description</b> | starting capacitor 52µF 330V 50/60Hz duty cycle 3s 41280A133 2252347 ø 36mm L 83mm M8 plastic connection cable 350mm |                 |                            |
| <b>For models:</b> | F100, F120   |                 |                            |

|                    |                              |                 |                     |
|--------------------|------------------------------|-----------------|---------------------|
| <b>GEV No.</b>     | 365096                       | <b>Ref. No.</b> | nicht in Preisliste |
| <b>description</b> | starting capacitor 88µF 330V |                 |                     |

condensators & interference suppression filters

starting capacitors

starting capacitors

|                    |  |                 |                            |
|--------------------|--|-----------------|----------------------------|
| <b>GEV No.</b>     | 365102   | <b>Ref. No.</b> | 19180567/0<br>CM19180567/0 |
| <b>description</b> | starting capacitor 330V 50Hz with resistor duty cycle 3/1.7% capacity 88µF |                 |                            |

|                    |   |                 |                     |
|--------------------|---|-----------------|---------------------|
| <b>GEV No.</b>     | 365098  | <b>Ref. No.</b> | nicht in Preisliste |
| <b>description</b> | starting capacitor 320V 50/60Hz electrolytic capacity 125µF |                 |                     |

|                    |                                       |                 |                     |
|--------------------|---------------------------------------|-----------------|---------------------|
| <b>GEV No.</b>     | 365094                                | <b>Ref. No.</b> | nicht in Preisliste |
| <b>description</b> | starting capacitor 330V capacity 64µF |                 |                     |

|                    |   |                 |  |
|--------------------|---|-----------------|--|
| <b>GEV No.</b>     | 365031  | <b>Ref. No.</b> | 29015023/0<br>CF62029204<br>CM29015023/0<br>CMCF62029204 |
| <b>description</b> | operating capacitor capacity 4µF 450V tolerance 5% 50/60Hz ambient temperature max. -25 to +85°C ø 31mm L 58mm M8 plastic connection male faston 6.3mm protection |                 |  |
| <b>For models:</b> | F100, F120, F125C, F200, F80C, F80WC  |                 |  |

|                    |  |                 |                     |
|--------------------|--|-----------------|---------------------|
| <b>GEV No.</b>     | 365101   | <b>Ref. No.</b> | nicht in Preisliste |
| <b>description</b> | starting capacitor 330V duty cycle 1.7% capacity 125µF |                 |                     |

|                    |  |                 |                            |
|--------------------|--|-----------------|----------------------------|
| <b>GEV No.</b>     | 365204   | <b>Ref. No.</b> | 19180501/0<br>CM19180501/0 |
| <b>description</b> | operating capacitor capacity 15µF 400V tolerance 10% 50-60Hz ambient temperature max. -40 up to +85°C ø 35mm L 135mm M8 aluminium connection cable 630mm |                 |                            |

|                    |   |                 |                                    |
|--------------------|---|-----------------|------------------------------------|
| <b>GEV No.</b>     | 365095  | <b>Ref. No.</b> | CF62016729 old<br>CMCF62016729 old |
| <b>description</b> | starting capacitor 43µF 330V 50/60Hz duty cycle 3 60A1D-330043NXET ø 36mm L 80mm M8 plastic connection cable 350mm 04P.5523CM |                 |                                    |



|   |  |                 |                     |
|---|--|-----------------|---------------------|
|  |  |                 |                     |
| 1   |  |                 |                     |
| <b>GEV No.</b>  | 365099   | <b>Ref. No.</b> | nicht in Preisliste |
| <b>description</b>  | operating capacitor capacity 15µF 440V with metal case |                 |                     |

|   |  |                 |                            |
|---|--|-----------------|----------------------------|
|  |  |                 |                            |
| 1   |  |                 |                            |
| <b>GEV No.</b>  | 365097   | <b>Ref. No.</b> | 19180593/0<br>CM19180593/0 |
| <b>description</b>  | operating capacitor capacity 35µF 450V with metal case 50/60Hz |                 |                            |
| <b>For models:</b>  | N301M  |                 |                            |

## fuses

### fine fuses

|  |   |                 |              |
|--|---|-----------------|--------------|
|  |   |                 |              |
| 1  |   |                 |              |
| <b>GEV No.</b>   | 358509  | <b>Ref. No.</b> | CMXP63001511 |
| <b>description</b>   | fine fuse size ø5x20mm 0.05A slow-acting rated 250V Qty 1 pcs |                 |              |

## electric accessories

### cables

#### ribbon cables

##### group 1

|   |                               |                 |                            |
|---|-------------------------------|-----------------|----------------------------|
|  |                               |                 |                            |
| 1   |                               |                 |                            |
| <b>GEV No.</b>  | 403565                        | <b>Ref. No.</b> | 33580172/0<br>CM33580172/0 |
| <b>description</b>  | ribbon cable 26-pole L 1000mm |                 |                            |
| <b>For models:</b>  | T14, T20, T20C, T20R, T5      |                 |                            |

##### group 7

|   |                                      |                 |                            |
|---|--------------------------------------|-----------------|----------------------------|
|  |                                      |                 |                            |
| 1   |                                      |                 |                            |
| <b>GEV No.</b>  | 694212                               | <b>Ref. No.</b> | 29015064/0<br>CM29015064/0 |
| <b>description</b>  | ribbon cable 3-pole L 150mm for test |                 |                            |

|   |                              |                 |                     |
|---|------------------------------|-----------------|---------------------|
|  |                              |                 |                     |
| 1   |                              |                 |                     |
| <b>GEV No.</b>  | 401818                       | <b>Ref. No.</b> | nicht in Preisliste |
| <b>description</b>  | ribbon cable 4-pole L 1000mm |                 |                     |

### cable harnesses

|   |                          |                 |            |
|---|--------------------------|-----------------|------------|
|  |                          |                 |            |
| 1   |                          |                 |            |
| <b>GEV No.</b>  | 551435                   | <b>Ref. No.</b> | 81414570/0 |
| <b>description</b>  | cable harness for 360665 |                 |            |

### connection cables

|  |   |                 |                     |
|--|---|-----------------|---------------------|
|  |   |                 |                     |
| 1  |   |                 |                     |
| <b>GEV No.</b>   | 401796  | <b>Ref. No.</b> | nicht in Preisliste |
| <b>description</b>   | connecting cable L 690mm connection male faston 6.3mm |                 |                     |

|  |   |                 |                            |
|--|---|-----------------|----------------------------|
|  |   |                 |                            |
| 1  |   |                 |                            |
| <b>GEV No.</b>   | 701450  | <b>Ref. No.</b> | 81455102/0<br>CM81455102/0 |
| <b>description</b>   | connection cable L 1300mm 2-pole level sensor suitable for ice maker connection plug plug type coded plug |                 |                            |

## terminals and connectors

### not insulated

#### protective coverings

|   |  |                 |                     |
|---|--|-----------------|---------------------|
|  |  |                 |                     |
| 1   |  |                 |                     |
| <b>GEV No.</b>  | 358002   | <b>Ref. No.</b> | nicht in Preisliste |
| <b>description</b>  | protective covering size 6.3mm for male faston plastic |                 |                     |

## electronic components

### photo cells

|   |  |                 |                            |
|---|--|-----------------|----------------------------|
|  |  |                 |                            |
| 1   |  |                 |                            |
| <b>GEV No.</b>  | 541608   | <b>Ref. No.</b> | 33580091/0<br>CM33580091/0 |
| <b>description</b>  | photo cell left square connection black L 40mm W 25mm H 40mm for ice maker |                 |                            |



|   |  |                 |                            |
|---|--|-----------------|----------------------------|
|  |  |                 |                            |
| 1   |  |                 |                            |
| <b>GEV No.</b>  | 541611   | <b>Ref. No.</b> | 33580092/0<br>CM33580092/0 |
| <b>description</b>  | photo cell right square connection blue L 40mm W 25mm H 40mm for ice maker |                 |                            |

## equipment-specific units

### for fridges

#### housing and bezels

#### handles

|   |   |                 |                            |
|---|---|-----------------|----------------------------|
|  |   |                 |                            |
| 1   |   |                 |                            |
| <b>GEV No.</b>  | 692590  | <b>Ref. No.</b> | 26116360/0<br>CM26116360/0 |
| <b>description</b>  | handle rod L 265mm W 16mm H 5.6mm inner part SS Qty 1 pcs |                 |                            |

#### miscellaneous

|   |   |                 |                            |
|---|---|-----------------|----------------------------|
|  |   |                 |                            |
| 1   |   |                 |                            |
| <b>GEV No.</b>  | 694821                                      | <b>Ref. No.</b> | 26104012/0<br>CM26104012/0 |
| <b>description</b>  | guide bar mounting pos. left L 400mm W 45mm |                 |                            |

|   |  |                 |                            |
|---|--|-----------------|----------------------------|
|  |  |                 |                            |
| 1   |  |                 |                            |
| <b>GEV No.</b>  | 694822                                       | <b>Ref. No.</b> | 26104013/0<br>CM26104013/0 |
| <b>description</b>  | guide bar mounting pos. right L 400mm W 45mm |                 |                            |

|   |   |                 |                            |
|---|---|-----------------|----------------------------|
|  |   |                 |                            |
| Image not available   |   |                 |                            |
| 1   |   |                 |                            |
| <b>GEV No.</b>  | 695802  | <b>Ref. No.</b> | 81502101/0<br>CM81502101/0 |
| <b>description</b>  | sump for fridge W 585mm H 150mm D 440mm stainless steel |                 |                            |

### for ice-cube maker

#### drain systems

#### drain fittings

|   |  |                 |  |
|---|--|-----------------|--|
|  |  |                 |  |
| 1   |  |                 |  |
| <b>GEV No.</b>  | 696583   | <b>Ref. No.</b> | 25685310/0<br>25685311/0<br>25685313/0<br>CM25685310/0<br>CM25685311/0<br>CM25685313/0 |
| <b>description</b>  | drain fitting ø 50mm thread 3/4 hose ø 21mm L 55mm straight for ice-cube maker |                 |  |

#### drain pans

|   |  |                 |                            |
|---|--|-----------------|----------------------------|
|  |  |                 |                            |
| 1   |  |                 |                            |
| <b>GEV No.</b>  | 696616                                   | <b>Ref. No.</b> | 25820129/0<br>CM25820129/0 |
| <b>description</b>  | drain pan L 160mm W 55mm H 200mm plastic |                 |                            |

#### filters

|   |  |                 |  |
|---|--|-----------------|--|
|  |  |                 |  |
| 1   |  |                 |  |
| <b>GEV No.</b>  | 695769                                 | <b>Ref. No.</b> | 25339002/0<br>CM25339002/0<br>CMNX66021101<br>CMXG66021101 |
| <b>description</b>  | drain filter thread 7/8" ø 32mm H 10mm |                 |  |

#### overflow pipes

|  |  |                 |                            |
|--|--|-----------------|----------------------------|
|  |  |                 |                            |
| 1  |  |                 |                            |
| <b>GEV No.</b>   | 695735   | <b>Ref. No.</b> | 25780153/0<br>CM25780153/0 |
| <b>description</b>   | PVC hose ID ø 10mm ED ø 14mm L 165mm chamfered |                 |                            |
| <b>For models:</b>   | N20L, N20WL, N25BI, N25S, N25SW                |                 |                            |

ice breakers



|                    |  |                 |                            |
|--------------------|--|-----------------|----------------------------|
| <b>GEV No.</b>     | 695629                                       | <b>Ref. No.</b> | CF75400102<br>CMCF75400102 |
| <b>description</b> | ice breaker ID ø 26mm ED ø 51mm H 59mm brass |                 |                            |
| <b>For models:</b> | F100, F100C, F120, F125C, F200, F80C, F80WC  |                 |                            |



|                    |  |                 |  |
|--------------------|--|-----------------|--|
| <b>GEV No.</b>     | 696436   | <b>Ref. No.</b> | 29015001<br>29060000<br>CF06072000<br>CMCF06072000 |
| <b>description</b> | ice breaker ID ø 26mm ED ø 51mm H 59mm brass with ball bearing |                 |  |



|                    |  |                 |                            |
|--------------------|--|-----------------|----------------------------|
| <b>GEV No.</b>     | 694788   | <b>Ref. No.</b> | CF00102807<br>CMCF00102807 |
| <b>description</b> | ice breaker ID ø 26mm ED ø 51mm H 59mm brass with ball bearing and shaft sealing |                 |                            |
| <b>For models:</b> | F100, F120, F125C, F200, F80C, F80WC   |                 |                            |

ice chutes

ice chutes



|                    |  |                 |  |
|--------------------|--|-----------------|--|
| <b>GEV No.</b>     | 695595                                   | <b>Ref. No.</b> | 25250099/0<br>25260462/0<br>CM25250099/0<br>CM25260462/0 |
| <b>description</b> | ice chute for door L 345mm W 205mm white |                 |  |
| <b>For models:</b> | N20L, N20WL, N25BI, N25S, N25SW          |                 |  |



|                    |                                    |                 |                            |
|--------------------|------------------------------------|-----------------|----------------------------|
| <b>GEV No.</b>     | 695596                             | <b>Ref. No.</b> | 25250106/0<br>CM25250106/0 |
| <b>description</b> | ice chute for door L 423mm W 205mm |                 |                            |



|                    |  |                 |                            |
|--------------------|--|-----------------|----------------------------|
| <b>GEV No.</b>     | 694193   | <b>Ref. No.</b> | 81480086/0<br>CM81480086/0 |
| <b>description</b> | ice chute for evaporator L 170mm W 100mm H 160mm stainless steel |                 |                            |
| <b>For models:</b> | SF300, SF500   |                 |                            |



|                    |  |                 |                            |
|--------------------|--|-----------------|----------------------------|
| <b>GEV No.</b>     | 694915   | <b>Ref. No.</b> | 25250186/0<br>CM25250186/0 |
| <b>description</b> | ice chute for ice maker L 255mm W 205mm H 85mm plastic |                 |                            |





|                    |  |                 |                            |
|--------------------|--|-----------------|----------------------------|
| <b>GEV No.</b>     | 694790   | <b>Ref. No.</b> | 25250185/0<br>CM25250185/0 |
| <b>description</b> | ice chute for ice maker L 320mm W 205mm H 85mm plastic white |                 |                            |



|                    |  |                 |                            |
|--------------------|--|-----------------|----------------------------|
| <b>GEV No.</b>     | 694792   | <b>Ref. No.</b> | 25250187/0<br>CM25250187/0 |
| <b>description</b> | ice chute for ice maker L 370mm W 205mm H 85mm plastic white |                 |                            |

|   |   |                 |                            |
|---|---|-----------------|----------------------------|
|  |   |                 |                            |
| 1   |   |                 |                            |
| <b>GEV No.</b>  | 695179  | <b>Ref. No.</b> | 25260459/0<br>CM25260459/0 |
| <b>description</b>  | ice chute for ice maker L 530mm W 200mm H 150mm |                 |                            |

|   |  |                 |  |
|---|--|-----------------|--|
|  |  |                 |  |
| 1   |  |                 |  |
| <b>GEV No.</b>  | 694282   | <b>Ref. No.</b> | 25260472/0<br>25260473/0<br>CM25260472/0<br>CM25260473/0 |
| <b>description</b>  | ice chute for ice-cube maker L 210mm W 365mm H 90mm white  |                 |  |
| <b>For models:</b>  | F80C, F80WC, N25L, N25LBI, N25LW, N35BI, N35S, N35SW, N45L, N45S, N45SW, N50BI, N50BIW, N55L, N55LW, N55S, N55SW |                 |  |

|  |   |                 |  |
|--|---|-----------------|--|
|  |   |                 |  |
| 1  |   |                 |  |
| <b>GEV No.</b>   | 695665  | <b>Ref. No.</b> | 25260470/0<br>25260471/0<br>CM25260470/0<br>CM25260471/0 |
| <b>description</b>   | inner door for ice maker L 595mm W 210mm H 95mm white |                 |  |
| <b>For models:</b>   | F100C, F125C, N70S, N70SW, N90L, N90LW, N90S, N90SW   |                 |  |

## slide grates

|   |   |                 |  |
|---|---|-----------------|--|
|  |   |                 |  |
| 1   |   |                 |  |
| <b>GEV No.</b>  | 695684                                    | <b>Ref. No.</b> | 25700405/0<br>81403025/0<br>CM25700401/0<br>CM25700405/0<br>CM81403025/0 |
| <b>description</b>  | slide grate for ice maker L 170mm W 150mm |                 |  |
| <b>For models:</b>  | N35BI, N35S, N35SW                        |                 |  |

|  |  |                 |                            |
|--|--|-----------------|----------------------------|
|  |  |                 |                            |
| 1  |  |                 |                            |
| <b>GEV No.</b>   | 695686   | <b>Ref. No.</b> | 81413031/0<br>CM81413031/0 |
| <b>description</b>   | slide grate for ice maker L 170mm W 260mm                  |                 |                            |
| <b>For models:</b>   | N45L, N45S, N45SW, N50BI, N50BIW, N55L, N55LW, N55S, N55SW |                 |                            |

|  |   |                 |                            |
|--|---|-----------------|----------------------------|
|  |   |                 |                            |
| 1  |   |                 |                            |
| <b>GEV No.</b>   | 695687                                    | <b>Ref. No.</b> | 81423063/0<br>CM81423063/0 |
| <b>description</b>   | slide grate for ice maker L 170mm W 440mm |                 |                            |
| <b>For models:</b>   | N70S, N70SW, N90L, N90LW, N90S, N90SW     |                 |                            |

|  |   |                 |                            |
|--|---|-----------------|----------------------------|
|  |   |                 |                            |
| 1  |   |                 |                            |
| <b>GEV No.</b>   | 696384  | <b>Ref. No.</b> | 81403045/0<br>CM81403045/0 |
| <b>description</b>   | slide grate for ice-cube maker L 195mm W 114mm H 83mm |                 |                            |
| <b>For models:</b>   | N20L, N20WL, N25BI, N25S, N25SW                       |                 |                            |





|   |   |                 |                            |
|---|---|-----------------|----------------------------|
|  |   |                 |                            |
| 1   |   |                 |                            |
| <b>GEV No.</b>  | 694145  | <b>Ref. No.</b> | 19680501/0<br>CM19680501/0 |
| <b>description</b>  | slide grate for ice-cube maker L 250mm W 170mm H 25mm |                 |                            |
| <b>For models:</b>  | N21S  |                 |                            |

|   |                                 |                 |                            |
|---|---------------------------------|-----------------|----------------------------|
| <p>ice scoops</p>  |                                 |                 |                            |
| 1   |                                 |                 |                            |
| <b>GEV No.</b>  | 694819                          | <b>Ref. No.</b> | 19500099/0<br>CM19500099/0 |
| <b>description</b>  | ice scoop L 155mm W 80mm H 55mm |                 |                            |

|  |                                  |                 |                            |
|--|----------------------------------|-----------------|----------------------------|
|  |                                  |                 |                            |
| 1  |                                  |                 |                            |
| <b>GEV No.</b>   | 694820                           | <b>Ref. No.</b> | 19500101/0<br>CM19500101/0 |
| <b>description</b>   | ice scoop L 240mm W 150mm H 90mm |                 |                            |

|   |   |                 |                            |
|---|---|-----------------|----------------------------|
|  |   |                 |                            |
| 1   |   |                 |                            |
| <b>GEV No.</b>  | 691802  | <b>Ref. No.</b> | 19500102/0<br>CM19500102/0 |
| <b>description</b>  | ice scoop L 240mm W 150mm H 92mm                                |                 |                            |
| <b>For models:</b>  | N131M, N200M, N200MW, N201M, N300M, N300MW, N301M, N401M, N501M |                 |                            |

|  |  |                 |                            |
|--|--|-----------------|----------------------------|
|  |  |                 |                            |
| 1  |  |                 |                            |
| <b>GEV No.</b>   | 692591   | <b>Ref. No.</b> | 19500100/0<br>CM19500100/0 |
| <b>description</b>   | ice scoop middle L 220mm W 112mm H 70mm plastic Qty 1  |                 |                            |
| <b>For models:</b>   | F100C, F125C, F80C, F80WC, N140, N20L, N20WL, N25L, N25LW, N25S, N25SW, N35S, N35SW, N45L, N45S, N45SW, N50BI, N50BIW, N55L, N55LW, N55S, N55SW, N70S, N70SW, N90L, N90LW, N90S, N90SW |                 |                            |

|  |   |                 |                            |
|--|---|-----------------|----------------------------|
| <p>spare parts and accessories</p>  |   |                 |                            |
| 1  |   |                 |                            |
| <b>GEV No.</b>   | 695020  | <b>Ref. No.</b> | 25654016/0<br>CM25654016/0 |
| <b>description</b>   | disc for pan tilting  |                 |                            |
| <b>For models:</b>   | N140, N20L, N20WL, N25S, N25SW, N45S, N45SW, N50BI, N50BIW, N55L, N55LW, N55S, N55SW, N70S, N70SW |                 |                            |

|   |  |                 |                            |
|---|--|-----------------|----------------------------|
| <p>probes</p>  |  |                 |                            |
| 1   |  |                 |                            |
| <b>GEV No.</b>  | 694555   | <b>Ref. No.</b> | 25725450/0<br>CM25725450/0 |
| <b>description</b>  | bracket for probe L 60mm W 56mm H 18mm zinc-plated sheet steel thickness 1mm |                 |                            |
| <b>For models:</b>  | N131M, N200M, N200MW, N201M, N300M, N300MW, N301M, N401M, N500M, N501M       |                 |                            |

|  |   |                 |                            |
|--|---|-----------------|----------------------------|
|  |   |                 |                            |
| 1  |   |                 |                            |
| <b>GEV No.</b>   | 698720  | <b>Ref. No.</b> | 81400044/0<br>CM81400044/0 |
| <b>description</b>   | probe for ice maker 1-pole cable length 350mm |                 |                            |

|  |  |                 |  |
|--|--|-----------------|--|
|  |  |                 |  |
| 1  |  |                 |  |
| <b>GEV No.</b>   | 401764   | <b>Ref. No.</b> | 81453007<br>81453114/0<br>81453434/0<br>CM81453114/0<br>CM81453434/0 |
| <b>description</b>   | probe for ice thickness  |                 |  |
| <b>For models:</b>   | N131M, N200M, N200MW, N201M, N300M, N300MW, N301M, N401M, N500M, N501M |                 |  |

|   |                         |                 |                            |
|---|-------------------------|-----------------|----------------------------|
|  |                         |                 |                            |
| 1   |                         |                 |                            |
| <b>GEV No.</b>  | 401800                  | <b>Ref. No.</b> | 81453860/0<br>CM81453860/0 |
| <b>description</b>  | probe for ice thickness |                 |                            |

|   |                         |                 |                            |
|---|-------------------------|-----------------|----------------------------|
|  |                         |                 |                            |
| 1   |                         |                 |                            |
| <b>GEV No.</b>  | 695707                  | <b>Ref. No.</b> | 81453782/0<br>CM81453782/0 |
| <b>description</b>  | probe for ice thickness |                 |                            |

|   |  |                 |                            |
|---|--|-----------------|----------------------------|
|  |  |                 |                            |
| 1   |  |                 |                            |
| <b>GEV No.</b>  | 401837   | <b>Ref. No.</b> | 81453796/0<br>CM81453796/0 |
| <b>description</b>  | probe for water level 2-pole cable length 85mm |                 |                            |
| <b>For models:</b>  | N401M, N501M                                   |                 |                            |

|   |                      |                 |                            |
|---|----------------------|-----------------|----------------------------|
|  |                      |                 |                            |
| 1   |                      |                 |                            |
| <b>GEV No.</b>  | 696613               | <b>Ref. No.</b> | 81455094/0<br>CM81455094/0 |
| <b>description</b>  | sensor for ice maker |                 |                            |

spray systems

ICEMATIC

spray arms

|   |   |                 |                            |
|---|---|-----------------|----------------------------|
|  |   |                 |                            |
| 1   |   |                 |                            |
| <b>GEV No.</b>  | 695705                                    | <b>Ref. No.</b> | 25791456/0<br>CM25791456/0 |
| <b>description</b>  | spray arm L 240mm nozzles 6 for ice maker |                 |                            |
| <b>For models:</b>  | N21S                                      |                 |                            |

|  |  |                 |                            |
|--|--|-----------------|----------------------------|
|  |  |                 |                            |
| 1  |  |                 |                            |
| <b>GEV No.</b>   | 694793                                     | <b>Ref. No.</b> | 81453460/0<br>CM81453460/0 |
| <b>description</b>   | spray arm L 335mm nozzles 15 for ice maker |                 |                            |
| <b>For models:</b>   | N131M                                      |                 |                            |

|  |   |                 |  |
|--|---|-----------------|--|
|  |   |                 |  |
| 1  |   |                 |  |
| <b>GEV No.</b>   | 694313  | <b>Ref. No.</b> | 81453009/0<br>81453575/0<br>CM81453009/0<br>CM81453575/0 |
| <b>description</b>   | spray arm L 490mm nozzles 18 for ice maker                      |                 |  |
| <b>For models:</b>   | N200M, N200MW, N201M, N300M, N300MW, N301M, N401M, N500M, N501M |                 |  |

accessories

|   |  |                 |                            |
|---|--|-----------------|----------------------------|
|  |  |                 |                            |
| 1   |  |                 |                            |
| <b>GEV No.</b>  | 695068                                       | <b>Ref. No.</b> | 25728011/0<br>CM25728011/0 |
| <b>description</b>  | end cap for ice maker insertion size 13x13mm |                 |                            |
| <b>For models:</b>  | N21S   |                 |                            |

|   |                      |                 |                            |
|---|----------------------|-----------------|----------------------------|
|  |                      |                 |                            |
| 1   |                      |                 |                            |
| <b>GEV No.</b>  | 695714               | <b>Ref. No.</b> | 25799001/0<br>CM25799001/0 |
| <b>description</b>  | nozzle for ice maker |                 |                            |
| <b>For models:</b>  | N21S                 |                 |                            |

doors

bushes

|   |   |                 |              |
|---|---|-----------------|--------------|
|  |   |                 |              |
| 1   |   |                 |              |
| <b>GEV No.</b>  | 695782  | <b>Ref. No.</b> | CMNX66028600 |
| <b>description</b>  | bush for door ED ø 12.5mm ID ø 8.2mm L 10.8mm plastic |                 |              |







|   |   |                 |                            |
|---|---|-----------------|----------------------------|
|  |   |                 |                            |
| 1   |   |                 |                            |
| <b>GEV No.</b>  | 694190  | <b>Ref. No.</b> | 25110805/0<br>CM25110805/0 |
| <b>description</b>  | bush for door ED $\phi$ 15.6mm ID $\phi$ 6mm L 10.8mm plastic |                 |                            |
| <b>For models:</b>  | N140  |                 |                            |

|   |   |                 |                            |
|---|---|-----------------|----------------------------|
|  |   |                 |                            |
| 1   |   |                 |                            |
| <b>GEV No.</b>  | 695700  | <b>Ref. No.</b> | 25110919/0<br>CM25110919/0 |
| <b>description</b>  | bush for door ED $\phi$ 8mm ID $\phi$ 4.4mm L 9mm plastic |                 |                            |

|   |  |                 |                            |
|---|--|-----------------|----------------------------|
|  |  |                 |                            |
| 1   |  |                 |                            |
| <b>GEV No.</b>  | 696639   | <b>Ref. No.</b> | 19060311/0<br>CM19060311/0 |
| <b>description</b>  | bush for door hinge ED $\phi$ 14mm ID $\phi$ 7.2mm L 4mm plastic |                 |                            |

|  |  |                 |                            |
|--|--|-----------------|----------------------------|
|  |  |                 |                            |
| 1  |  |                 |                            |
| <b>GEV No.</b>   | 696638   | <b>Ref. No.</b> | 19060310/0<br>CM19060310/0 |
| <b>description</b>   | bush for door hinge ED $\phi$ 16.8mm ID $\phi$ 6.5mm L 9.5mm plastic |                 |                            |

|   |  |                 |                            |
|---|--|-----------------|----------------------------|
|  |  |                 |                            |
| 1   |  |                 |                            |
| <b>GEV No.</b>  | 696640   | <b>Ref. No.</b> | 25725554/0<br>CM25725554/0 |
| <b>description</b>  | bush for door hinge ID $\phi$ 6mm L 22mm W 22mm H 14mm plastic |                 |                            |

|   |  |                 |                            |
|---|--|-----------------|----------------------------|
|  |  |                 |                            |
| 1   |  |                 |                            |
| <b>GEV No.</b>  | 695883   | <b>Ref. No.</b> | 25110114/0<br>CM25110114/0 |
| <b>description</b>  | spacer ring for door L 3.6mm stainless steel D1 $\phi$ 8mm D2 $\phi$ 10mm M4 with thread |                 |                            |
| <b>For models:</b>  | N140   |                 |                            |

|  |                                    |                 |                            |
|--|------------------------------------|-----------------|----------------------------|
| inner doors  |                                    |                 |                            |
|  |                                    |                 |                            |
| Image not available  |                                    |                 |                            |
| 1  |                                    |                 |                            |
| <b>GEV No.</b>   | 695596                             | <b>Ref. No.</b> | 25250106/0<br>CM25250106/0 |
| <b>description</b>   | ice chute for door L 423mm W 205mm |                 |                            |

|  |   |                 |                            |
|--|---|-----------------|----------------------------|
|  |   |                 |                            |
| 1  |   |                 |                            |
| <b>GEV No.</b>   | 695702  | <b>Ref. No.</b> | 25260475/0<br>CM25260475/0 |
| <b>description</b>   | inner door for ice maker L 256mm W 159mm H 65mm |                 |                            |
| <b>For models:</b>   | N21S  |                 |                            |

|   |   |                 |                            |
|---|---|-----------------|----------------------------|
| magnets   |   |                 |                            |
|  |   |                 |                            |
| 1   |   |                 |                            |
| <b>GEV No.</b>  | 691806  | <b>Ref. No.</b> | 19354010/0<br>CM19354010/0 |
| <b>description</b>  | door magnet $\phi$ 22mm Lmm thread M5 thread L 10mm |                 |                            |
| <b>For models:</b>  | N140  |                 |                            |

|   |   |                 |                            |
|---|---|-----------------|----------------------------|
|  |   |                 |                            |
| 1   |   |                 |                            |
| <b>GEV No.</b>  | 694787  | <b>Ref. No.</b> | 19355002/0<br>CM19355002/0 |
| <b>description</b>  | door magnet $\phi$ mm L 35mm W 12mm H 15mm mounting distance 26mm thread thread Lmm |                 |                            |
| <b>For models:</b>  | N25BI   |                 |                            |

|   |   |                 |                            |
|---|---|-----------------|----------------------------|
|  |   |                 |                            |
| 1   |   |                 |                            |
| <b>GEV No.</b>  | 691808  | <b>Ref. No.</b> | 41109519/0<br>CM41109519/0 |
| <b>description</b>  | door magnet with disc ø 12mm L 13mm thread thread Lmm   |                 |                            |
| <b>For models:</b>  | F100C, F125C, F80C, F80WC, N20L, N20WL, N25L, N25LBI, N25LW, N25S, N25SW, N35BI, N35S, N35SW, N45L, N45S, N45SW, N50BI, N50BIW, N55L, N55LW, N55S, N55SW, N70S, N70SW, N90L, N90LW, N90S, N90SW |                 |                            |

|   |                                    |                 |                            |
|---|------------------------------------|-----------------|----------------------------|
|  |                                    |                 |                            |
| 2   |                                    |                 |                            |
| <b>GEV No.</b>  | 691809                             | <b>Ref. No.</b> | 19355005/0<br>CM19355005/0 |
| <b>description</b>  | door magnet with disc ø 9mm L 11mm |                 |                            |
| <b>For models:</b>  | N21S                               |                 |                            |

## hinges

|   |  |                 |                             |
|---|--|-----------------|-----------------------------|
|  |  |                 |                             |
| 1   |  |                 |                             |
| <b>GEV No.</b>  | 694221   | <b>Ref. No.</b> | 81566732/0<br>CM181566732/0 |
| <b>description</b>  | hinge mounting pos. right shaft ø 6mm L 45mm W 40mm H 22mm |                 |                             |

|   |  |                 |                            |
|---|--|-----------------|----------------------------|
|  |  |                 |                            |
| 1   |  |                 |                            |
| <b>GEV No.</b>  | 694189                                       | <b>Ref. No.</b> | 25130124/0<br>CM25130124/0 |
| <b>description</b>  | hinge mounting pos. upper shaft ø 4mm L 81mm |                 |                            |
| <b>For models:</b>  | D310   |                 |                            |

## doors

|   |  |                 |  |
|---|--|-----------------|--|
|  |  |                 |  |
| 1   |  |                 |  |
| <b>GEV No.</b>  | 694325   | <b>Ref. No.</b> | 81400692/R<br>81400699/0<br>81400699/R<br>81401649/0<br>CM81400692/R<br>CM81400699/0<br>CM81400699/R<br>CM81401649/0 |
| <b>description</b>  | door complete for ice maker W 400mm H 347mm thickness 25mm |                 |  |
| <b>For models:</b>  | N20L, N20WL, N25S, N25SW                                   |                 |  |

|  |  |                 |  |
|--|--|-----------------|--|
|  |  |                 |  |
| 1  |  |                 |  |
| <b>GEV No.</b>   | 695679   | <b>Ref. No.</b> | 81401572/0<br>81401650/0<br>CM81401650/0 |
| <b>description</b>   | door complete for ice-cube maker W 448mm H 347mm thickness 20mm                    |                 |  |
| <b>For models:</b>   | F80C, F80WC, N25L, N25LW, N35S, N35SW, N45L, N45S, N45SW, N55L, N55LW, N55S, N55SW |                 |  |

|  |  |                 |  |
|--|--|-----------------|--|
|  |  |                 |  |
| 1  |  |                 |  |
| <b>GEV No.</b>   | 695743   | <b>Ref. No.</b> | 81460184/0<br>81460326/0<br>CM81460184/0<br>CM81460326/0 |
| <b>description</b>   | door for ice maker W 1080mm H 275mm thickness 16mm |                 |  |

|   |   |                 |  |
|---|---|-----------------|--|
|  |   |                 |  |
| 1   |   |                 |  |
| <b>GEV No.</b>  | 696654  | <b>Ref. No.</b> | 81420505/0<br>81420527/0<br>81420528/0<br>CM81420528/0 |
| <b>description</b>  | door for ice maker W 680mm H 345mm thickness 20mm |                 |  |
| <b>For models:</b>  | N70S, N70SW, N90L, N90LW, N90S, N90SW             |                 |  |

|  |  |                 |                            |
|--|--|-----------------|----------------------------|
|  |  |                 |                            |
| 1  |  |                 |                            |
| <b>GEV No.</b>   | 695793   | <b>Ref. No.</b> | 81420524/0<br>CM81420524/0 |
| <b>description</b>   | door for ice maker W 680mm H 350mm thickness 20mm complete |                 |                            |
| <b>For models:</b>   | F100C, F125C   |                 |                            |

1



|                    |  |                 |  |
|--------------------|--|-----------------|--|
| <b>GEV No.</b>     | 695794   | <b>Ref. No.</b> | 81440455/1<br>81440456/0<br>CM81440455/1<br>CM81440456/0 |
| <b>description</b> | door for ice maker W 880mm H 310mm thickness 20mm complete |                 |  |
| <b>For models:</b> | N140   |                 |  |

1



|                    |  |                 |                            |
|--------------------|--|-----------------|----------------------------|
| <b>GEV No.</b>     | 695669   | <b>Ref. No.</b> | 25600186/0<br>CM25600186/0 |
| <b>description</b> | door for ice-cube maker W 335mm H 210mm thickness 20mm |                 |                            |
| <b>For models:</b> | N21S   |                 |                            |

1



|                    |  |                 |                               |
|--------------------|--|-----------------|-------------------------------|
| <b>GEV No.</b>     | 695458   | <b>Ref. No.</b> | nicht in Preisliste enthalten |
| <b>description</b> | door for ice-cube maker W 345mm H 195mm thickness 14mm |                 |                               |

1



|                    |  |                 |                     |
|--------------------|--|-----------------|---------------------|
| <b>GEV No.</b>     | 695462   | <b>Ref. No.</b> | nicht in Preisliste |
| <b>description</b> | door for ice-cube maker W 395mm H 215mm thickness 18mm |                 |                     |

1



|                    |  |                 |  |
|--------------------|--|-----------------|--|
| <b>GEV No.</b>     | 695695   | <b>Ref. No.</b> | 25600141/0<br>25600174/0<br>25600187/0<br>CM25600141/0<br>CM25600174/0<br>CM25600187/0 |
| <b>description</b> | door for ice-cube maker W 398mm H 345mm thickness 25mm suitable for N25S |                 |  |
| <b>For models:</b> | N20L, N20WL  |                 |  |

1



|                    |  |                 |                     |
|--------------------|--|-----------------|---------------------|
| <b>GEV No.</b>     | 695457   | <b>Ref. No.</b> | nicht in Preisliste |
| <b>description</b> | door for ice-cube maker W 505mm H 270mm thickness 21mm |                 |                     |

1



|                    |   |                 |                            |
|--------------------|---|-----------------|----------------------------|
| <b>GEV No.</b>     | 695716                                  | <b>Ref. No.</b> | 81460325/0<br>CM81460325/0 |
| <b>description</b> | door for ice-cube maker W 805mm H 295mm |                 |                            |

1



|                    |   |                 |  |
|--------------------|---|-----------------|--|
| <b>GEV No.</b>     | 695717                                  | <b>Ref. No.</b> | 81440455/1<br>81440456/0<br>CM81440455/1<br>CM81440456/0 |
| <b>description</b> | door for ice-cube maker W 880mm H 310mm |                 |  |

|   |  |                 |                               |
|---|--|-----------------|-------------------------------|
|  |  |                 |                               |
| 1   |  |                 |                               |
| <b>GEV No.</b>  | 695461   | <b>Ref. No.</b> | nicht in Preisliste enthalten |
| <b>description</b>  | door kit for ice-cube maker W 655mm H 260mm thickness 19mm |                 |                               |

|   |  |                 |  |
|---|--|-----------------|--|
|  |  |                 |  |
| 1   |  |                 |  |
| <b>GEV No.</b>  | 696611   | <b>Ref. No.</b> | 28180009/0<br>CM28180009<br>CM28180009/0<br>CMCM28180009 |
| <b>description</b>  | drip rail for ice maker W 590mm H 690mm thickness 25mm |                 |  |

|  |                      |                 |                            |
|--|----------------------|-----------------|----------------------------|
|  |                      |                 |                            |
| 1  |                      |                 |                            |
| <b>GEV No.</b>   | 694283               | <b>Ref. No.</b> | 81460172/0<br>CM81460172/0 |
| <b>description</b>   | flap W 500mm H 295mm |                 |                            |

door frames

|   |                             |                 |                            |
|---|-----------------------------|-----------------|----------------------------|
|  |                             |                 |                            |
| 1   |                             |                 |                            |
| <b>GEV No.</b>  | 694328                      | <b>Ref. No.</b> | 81460057/0<br>CM81460057/0 |
| <b>description</b>  | door frame W 1082mm H 442mm |                 |                            |
| <b>For models:</b>  | D310                        |                 |                            |

|   |  |                 |                            |
|---|--|-----------------|----------------------------|
|  |  |                 |                            |
| 1   |  |                 |                            |
| <b>GEV No.</b>  | 695668   | <b>Ref. No.</b> | 25165499/0<br>CM25165499/0 |
| <b>description</b>  | door frame W 430mm H 440mm thickness 30mm  |                 |                            |
| <b>For models:</b>  | F80C, F80WC, N25L, N25LBI, N25LW, N35BI, N35S, N35SW, N45L, N45S, N45SW, N50BI, N50BIW, N55L, N55LW, N55S, N55SW |                 |                            |

|  |                            |                 |                            |
|--|----------------------------|-----------------|----------------------------|
|  |                            |                 |                            |
| 1  |                            |                 |                            |
| <b>GEV No.</b>   | 694327                     | <b>Ref. No.</b> | 81460359/0<br>CM81460359/0 |
| <b>description</b>   | door frame W 502mm H 770mm |                 |                            |
| <b>For models:</b>   | D201                       |                 |                            |

|  |   |                 |                            |
|--|---|-----------------|----------------------------|
|  |   |                 |                            |
| 1  |   |                 |                            |
| <b>GEV No.</b>   | 694160                                    | <b>Ref. No.</b> | 25165550/0<br>CM25165550/0 |
| <b>description</b>   | door frame W 565mm H 510mm thickness 60mm |                 |                            |

|  |   |                 |                            |
|--|---|-----------------|----------------------------|
|  |   |                 |                            |
| 1  |   |                 |                            |
| <b>GEV No.</b>   | 695682  | <b>Ref. No.</b> | 25165494/0<br>CM25165494/0 |
| <b>description</b>   | frame W 655mm H 440mm thickness 30mm                |                 |                            |
| <b>For models:</b>   | F100C, F125C, N70S, N70SW, N90L, N90LW, N90S, N90SW |                 |                            |

door shafts

|  |                                 |                 |                            |
|--|---------------------------------|-----------------|----------------------------|
|  |                                 |                 |                            |
| 1  |                                 |                 |                            |
| <b>GEV No.</b>   | 695701                          | <b>Ref. No.</b> | 25085096/0<br>CM25085096/0 |
| <b>description</b>   | door shaft                      |                 |                            |
| <b>For models:</b>   | N20L, N20WL, N25BI, N25S, N25SW |                 |                            |

|  |   |                 |                            |
|--|---|-----------------|----------------------------|
|  |   |                 |                            |
| 1  |   |                 |                            |
| <b>GEV No.</b>   | 695667  | <b>Ref. No.</b> | 25560141/0<br>CM25560141/0 |
| <b>description</b>   | door shaft for ice maker ø 4mm L 1025mm stainless steel |                 |                            |
| <b>For models:</b>   | D310  |                 |                            |



1

|                    |  |                 |                            |
|--------------------|--|-----------------|----------------------------|
| <b>GEV No.</b>     | 695706   | <b>Ref. No.</b> | 25560142/0<br>CM25560142/0 |
| <b>description</b> | door shaft for ice maker ø 4mm L 485mm stainless steel |                 |                            |

1

|                    |  |                 |                            |
|--------------------|--|-----------------|----------------------------|
| <b>GEV No.</b>     | 695710   | <b>Ref. No.</b> | 25560135/0<br>CM25560135/0 |
| <b>description</b> | door shaft for ice maker ø 4mm L 755mm stainless steel |                 |                            |

1

|                    |  |                 |                            |
|--------------------|--|-----------------|----------------------------|
| <b>GEV No.</b>     | 695703   | <b>Ref. No.</b> | 25030019/0<br>CM25030019/0 |
| <b>description</b> | door shaft for ice maker ø 6mm L 360mm stainless steel   |                 |                            |
| <b>For models:</b> | F80C, F80WC, N25L, N25LBI, N25LW, N35BI, N35S, N35SW, N45L, N45S, N45SW, N50BI, N50BIW, N55L, N55LW, N55S, N55SW |                 |                            |

1

|                    |  |                 |                            |
|--------------------|--|-----------------|----------------------------|
| <b>GEV No.</b>     | 695704   | <b>Ref. No.</b> | 25030020/0<br>CM25030020/0 |
| <b>description</b> | door shaft for ice maker ø 6mm L 585mm stainless steel |                 |                            |
| <b>For models:</b> | F125C, N70S, N70SW, N90L, N90LW, N90S, N90SW           |                 |                            |

1

|                    |  |                 |                            |
|--------------------|--|-----------------|----------------------------|
| <b>GEV No.</b>     | 695711   | <b>Ref. No.</b> | 25560285/0<br>CM25560285/0 |
| <b>description</b> | door shaft for ice maker ø 6mm L 890mm thread M4 stainless steel |                 |                            |
| <b>For models:</b> | N140   |                 |                            |

curtains

without holder

1

|                    |   |                 |                            |
|--------------------|---|-----------------|----------------------------|
| <b>GEV No.</b>     | 695726  | <b>Ref. No.</b> | 81401600/0<br>CM81401600/0 |
| <b>description</b> | curtain for ice maker W 250mm H 70mm shaft length 270mm shaft ø 6mm |                 |                            |
| <b>For models:</b> | N21S  |                 |                            |

1

|                    |   |                 |                               |
|--------------------|---|-----------------|-------------------------------|
| <b>GEV No.</b>     | 695429  | <b>Ref. No.</b> | nicht in Preisliste enthalten |
| <b>description</b> | curtain for ice maker W 250mm H 70mm shaft length 280mm shaft ø 6mm |                 |                               |

1

|                    |  |                 |                     |
|--------------------|--|-----------------|---------------------|
| <b>GEV No.</b>     | 695440   | <b>Ref. No.</b> | nicht in Preisliste |
| <b>description</b> | curtain for ice maker W 283mm H 115mm shaft length 305mm shaft ø 6mm |                 |                     |

1

|                    |                                      |                 |                               |
|--------------------|--------------------------------------|-----------------|-------------------------------|
| <b>GEV No.</b>     | 695076                               | <b>Ref. No.</b> | nicht in Preisliste enthalten |
| <b>description</b> | curtain for ice maker W 284mm H 83mm |                 |                               |

1

|                    |  |                 |                     |
|--------------------|--|-----------------|---------------------|
| <b>GEV No.</b>     | 695075   | <b>Ref. No.</b> | nicht in Preisliste |
| <b>description</b> | curtain for ice maker W 305mm H 115mm shaft length 323mm shaft ø 6mm |                 |                     |

1

|                    |   |                 |                               |
|--------------------|---|-----------------|-------------------------------|
| <b>GEV No.</b>     | 695439  | <b>Ref. No.</b> | nicht in preisliste enthalten |
| <b>description</b> | curtain for ice maker W 407mm H 84mm shaft length 458mm shaft ø 6mm |                 |                               |

1



|                    |  |                 |                     |
|--------------------|--|-----------------|---------------------|
| <b>GEV No.</b>     | 695441   | <b>Ref. No.</b> | nicht in Preisliste |
| <b>description</b> | curtain for ice maker W 574mm H 115mm shaft length 610mm shaft ø 6mm |                 |                     |

## accessories

## holders

1



|                    |   |                 |  |
|--------------------|---|-----------------|--|
| <b>GEV No.</b>     | 695080  | <b>Ref. No.</b> | 19797108/0<br>19797111/0<br>CM19797108/0<br>CM19797111/0 |
| <b>description</b> | curtain holder for ice maker W 15mm H 80mm left |                 |  |
| <b>For models:</b> | N21S  |                 |  |

1



|                    |  |                 |  |
|--------------------|--|-----------------|--|
| <b>GEV No.</b>     | 695079   | <b>Ref. No.</b> | 19797109/0<br>19797112/0<br>CM19797109/0<br>CM19797112/0<br>CMXP66038801 |
| <b>description</b> | curtain holder for ice maker W 15mm H 80mm right |                 |  |
| <b>For models:</b> | N21S   |                 |  |

## pan mechanics

## sumps

1



|                    |   |                 |  |
|--------------------|---|-----------------|--|
| <b>GEV No.</b>     | 695014  | <b>Ref. No.</b> | 25098060/0<br>81403005/0<br>CM25098060/0<br>CM81403005/0 |
| <b>description</b> | sump complete for ice maker L 180mm W 125mm H 80mm shaft L 205mm N20 blue |                 |  |
| <b>For models:</b> | N20L, N20WL, N25S, N25SW  |                 |  |

1



|                    |   |                 |                            |
|--------------------|---|-----------------|----------------------------|
| <b>GEV No.</b>     | 696414  | <b>Ref. No.</b> | 81401621/0<br>CM81401621/0 |
| <b>description</b> | sump complete for ice maker L 180mm W 125mm H 80mm shaft L 210mm N25 blue |                 |                            |
| <b>For models:</b> | N25BI, N25L, N25LBI, N25LW, N25S, N25SW                                   |                 |                            |

1



|                    |  |                 |              |
|--------------------|--|-----------------|--------------|
| <b>GEV No.</b>     | 696751   | <b>Ref. No.</b> | CM81400064/0 |
| <b>description</b> | sump complete for ice maker L 182mm W 160mm ICEMATIC white |                 |              |

1

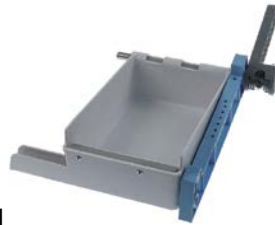

|                    |   |                 |                            |
|--------------------|---|-----------------|----------------------------|
| <b>GEV No.</b>     | 696649  | <b>Ref. No.</b> | 81400004/0<br>CM81400004/0 |
| <b>description</b> | sump complete for ice maker L 220mm W 130mm H 80mm white/blue |                 |                            |

1



|                    |  |                 |                            |
|--------------------|--|-----------------|----------------------------|
| <b>GEV No.</b>     | 696650   | <b>Ref. No.</b> | 25098057/0<br>CM25098057/0 |
| <b>description</b> | sump complete for ice maker L 220mm W 167mm H 80mm white |                 |                            |

1



|                    |   |                 |                            |
|--------------------|---|-----------------|----------------------------|
| <b>GEV No.</b>     | 695015  | <b>Ref. No.</b> | 81403007/0<br>CM81403007/0 |
| <b>description</b> | sump complete for ice maker L 225mm W 165mm H 80mm shaft L 255mm for modell N30/N35 white |                 |                            |
| <b>For models:</b> | N35BI, N35S, N35SW  |                 |                            |



|   |   |                 |                            |
|---|---|-----------------|----------------------------|
|  |   |                 |                            |
| 1   |   |                 |                            |
| <b>GEV No.</b>  | 699148  | <b>Ref. No.</b> | 81414467/0<br>CM81414467/0 |
| <b>description</b>  | sump complete for ice maker L 275mm W 200mm H 60mm grey |                 |                            |
| <b>For models:</b>  | N45L  |                 |                            |

|  |  |                 |                            |
|--|--|-----------------|----------------------------|
|  |  |                 |                            |
| 1  |  |                 |                            |
| <b>GEV No.</b>   | 699147   | <b>Ref. No.</b> | 81426054/0<br>CM81426054/0 |
| <b>description</b>   | sump complete for ice maker L 630mm W 355mm H 100mm grey |                 |                            |
| <b>For models:</b>   | N90L, N90LW  |                 |                            |

|   |   |                 |                            |
|---|---|-----------------|----------------------------|
|  |   |                 |                            |
| 1   |   |                 |                            |
| <b>GEV No.</b>  | 695017  | <b>Ref. No.</b> | 81413001/0<br>CM81413001/0 |
| <b>description</b>  | sump complete for ice maker L 275mm W 220mm H 75mm ICEMATIC white |                 |                            |
| <b>For models:</b>  | N45S, N45SW, N50BI, N50BIW, N55S, N55SW                           |                 |                            |

|  |   |                 |                            |
|--|---|-----------------|----------------------------|
|  |   |                 |                            |
| 1  |   |                 |                            |
| <b>GEV No.</b>   | 695019  | <b>Ref. No.</b> | 81442008/0<br>CM81442008/0 |
| <b>description</b>   | sump complete for ice maker L 690mm W 230mm H 65mm ICEMATIC |                 |                            |

|   |   |                 |  |
|---|---|-----------------|--|
|  |   |                 |  |
| 1   |   |                 |  |
| <b>GEV No.</b>  | 695016  | <b>Ref. No.</b> | 81414519/0<br>81423003/0<br>CM81414519/0<br>CM81423003/0 |
| <b>description</b>  | sump complete for ice maker L 275mm W 220mm white |                 |  |
| <b>For models:</b>  | N55L, N55LW                                       |                 |  |

|  |   |                 |                            |
|--|---|-----------------|----------------------------|
|  |   |                 |                            |
| 1  |   |                 |                            |
| <b>GEV No.</b>   | 694818  | <b>Ref. No.</b> | 81400278/0<br>CM81400278/0 |
| <b>description</b>   | sump complete for ice-cube maker L 275mm W 223mm H 80mm white |                 |                            |

|   |   |                 |                            |
|---|---|-----------------|----------------------------|
|  |   |                 |                            |
| 1   |   |                 |                            |
| <b>GEV No.</b>  | 699146  | <b>Ref. No.</b> | 81400154/0<br>CM81400154/0 |
| <b>description</b>  | sump complete for ice maker L 450mm W 200mm H 60mm grey |                 |                            |

|  |   |                 |                            |
|--|---|-----------------|----------------------------|
|  |   |                 |                            |
| 1  |   |                 |                            |
| <b>GEV No.</b>   | 695018  | <b>Ref. No.</b> | 81423002/0<br>CM81423002/0 |
| <b>description</b>   | sump complete L 455mm W 180mm H 60mm ICEMATIC |                 |                            |
| <b>For models:</b>   | N70S, N70SW, N90S, N90SW                      |                 |                            |

|   |   |                 |                            |
|---|---|-----------------|----------------------------|
|  |   |                 |                            |
| 1   |   |                 |                            |
| <b>GEV No.</b>  | 699149  | <b>Ref. No.</b> | 81453705/0<br>CM81453705/0 |
| <b>description</b>  | sump complete for ice maker L 490mm W 150mm H 260mm white |                 |                            |
| <b>For models:</b>  | N131M   |                 |                            |

|  |   |                 |  |
|--|---|-----------------|--|
|  |   |                 |  |
| 1  |   |                 |  |
| <b>GEV No.</b>   | 696618  | <b>Ref. No.</b> | 81300066<br>81300066/0<br>81300067<br>81300067/0<br>CM81300066/0<br>CM81300067/0 |
| <b>description</b>   | sump for ice maker L 360mm W 175mm H 70mm white |                 |  |

|   |   |                 |  |
|---|---|-----------------|--|
|  |   |                 |  |
| 1   |   |                 |  |
| <b>GEV No.</b>  | 696619  | <b>Ref. No.</b> | 81300090/0<br>81300091/0<br>CM81300090/0<br>CM81300091/0 |
| <b>description</b>  | sump for ice maker L 450mm W 185mm H 70mm white |                 |  |

|   |  |                 |                            |
|---|--|-----------------|----------------------------|
|  |  |                 |                            |
| 1   |  |                 |                            |
| <b>GEV No.</b>  | 696648   | <b>Ref. No.</b> | 25820132/0<br>CM25820132/0 |
| <b>description</b>  | sump for ice maker L 490mm W 235mm H 160mm white |                 |                            |

|  |  |                 |                            |
|--|--|-----------------|----------------------------|
|  |  |                 |                            |
| 1  |  |                 |                            |
| <b>GEV No.</b>   | 696647   | <b>Ref. No.</b> | 25820130/0<br>CM25820130/0 |
| <b>description</b>   | sump for ice maker L 680mm W 240mm H 150mm white |                 |                            |

|   |   |                 |                            |
|---|---|-----------------|----------------------------|
|  |   |                 |                            |
| 1   |   |                 |                            |
| <b>GEV No.</b>  | 695657                                    | <b>Ref. No.</b> | 81442008/0<br>CM81442008/0 |
| <b>description</b>  | sump for ice maker L 690mm W 230mm H 75mm |                 |                            |
| <b>For models:</b>  | N140                                      |                 |                            |

|   |  |                 |                            |
|---|--|-----------------|----------------------------|
|  |  |                 |                            |
| 1   |  |                 |                            |
| <b>GEV No.</b>  | 696682   | <b>Ref. No.</b> | 81453588/0<br>CM81453588/0 |
| <b>description</b>  | sump for ice maker L 697mm W 230mm H 150mm white |                 |                            |

|  |   |                 |                            |
|--|---|-----------------|----------------------------|
|  |   |                 |                            |
| 1  |   |                 |                            |
| <b>GEV No.</b>   | 695662  | <b>Ref. No.</b> | 25820125/0<br>CM25820125/0 |
| <b>description</b>   | water container for ice maker L 697mm W 260mm H 148mm white |                 |                            |
| <b>For models:</b>   | N201M, N301M, N401M, N501M                                  |                 |                            |

spare parts and accessories

|   |   |                 |                            |
|---|---|-----------------|----------------------------|
|  |   |                 |                            |
| 1   |   |                 |                            |
| <b>GEV No.</b>  | 695376  | <b>Ref. No.</b> | 25110924/0<br>CM25110924/0 |
| <b>description</b>  | adjusting ring for spindle H 7mm ID ø 6mm ED ø 12mm thread M4 stainless steel |                 |                            |

|  |   |                 |                            |
|--|---|-----------------|----------------------------|
|  |   |                 |                            |
| 1  |   |                 |                            |
| <b>GEV No.</b>   | 695720  | <b>Ref. No.</b> | 25725429/0<br>CM25725429/0 |
| <b>description</b>   | bracket for float motor L 92mm W 92mm metal   |                 |                            |
| <b>For models:</b>   | N20L, N20WL, N25L, N25LBI, N25LW, N35BI, N35S, N35SW, N45L, N45S, N45SW, N50BI, N50BIW, N55L, N55LW, N55S, N55SW, N70S, N70SW, N90L, N90LW, N90S, N90SW |                 |                            |

|   |   |                 |  |
|---|---|-----------------|--|
|  |   |                 |  |
| 1   |   |                 |  |
| <b>GEV No.</b>  | 695646  | <b>Ref. No.</b> | 25726279/0<br>25726478/0<br>CM25726279/0<br>CM25726478/0 |
| <b>description</b>  | bracket for inner door L 44mm W 20mm H 18mm shaft intake ø 6.3mm mounting distance 30mm   |                 |  |
| <b>For models:</b>  | F125C, F80C, F80WC, N20L, N20WL, N25BI, N25L, N25LBI, N25LW, N25S, N25SW, N35BI, N35S, N35SW, N45L, N45S, N45SW, N50BI, N50BIW, N55L, N55LW, N55S, N55SW, N70S, N70SW, N90L, N90LW, N90S, N90SW |                 |  |

|   |   |                 |                            |
|---|---|-----------------|----------------------------|
|  |   |                 |                            |
| 1   |   |                 |                            |
| <b>GEV No.</b>  | 695651  | <b>Ref. No.</b> | 25525419/0<br>CM25525419/0 |
| <b>description</b>  | bracket for pulser L 34mm W 15mm H 60mm   |                 |                            |
| <b>For models:</b>  | N140, N20L, N20WL, N25BI, N25L, N25LBI, N25LW, N25S, N25SW, N35BI, N35S, N35SW, N45L, N45S, N45SW, N50BI, N50BIW, N55L, N55LW, N55S, N55SW, N70S, N70SW, N90L, N90LW, N90S, N90SW |                 |                            |







|  |   |                 |  |
|--|---|-----------------|--|
|  <p>1</p> |   |                 |  |
| <b>GEV No.</b>   | 695414  | <b>Ref. No.</b> | 25726121/0<br>CM25726121/0<br>CM25726123/0 |
| <b>description</b>   | bracket for sump mounting pos. left L 237mm W 15mm H 50mm ICEMATIC  |                 |  |
| <b>For models:</b>   | N140, N20L, N20WL, N25BI, N25L, N25LBI, N25LW, N25S, N25SW, N35BI, N35S, N35SW, N45L, N45S, N45SW, N50BI, N50BIW, N55L, N55LW, N55S, N55SW, N70S, N70SW, N90L, N90LW, N90S, N90SW |                 |  |

|  |   |                 |  |
|--|---|-----------------|--|
|  <p>1</p> |   |                 |  |
| <b>GEV No.</b>   | 695415  | <b>Ref. No.</b> | 25726122/0<br>25726124/0<br>CM25726122/0<br>CM25726124/0 |
| <b>description</b>   | bracket for sump mounting pos. right ICEMATIC   |                 |  |
| <b>For models:</b>   | N140, N20L, N20WL, N25BI, N25L, N25LBI, N25LW, N25S, N25SW, N35BI, N35S, N35SW, N45L, N45S, N45SW, N50BI, N50BIW, N55L, N55LW, N55S, N55SW, N70S, N70SW, N90L, N90LW, N90S, N90SW |                 |  |

|  |   |                 |  |
|--|---|-----------------|--|
|  <p>1</p> |   |                 |  |
| <b>GEV No.</b>   | 695009  | <b>Ref. No.</b> | 25726115<br>25726115/3<br>CM25726115/3 |
| <b>description</b>   | bracket paddle L 50mm W 17mm H 23mm shaft intake ø 6.5mm mounting distance 30mm   |                 |  |
| <b>For models:</b>   | N140, N20L, N20WL, N25BI, N25L, N25LBI, N25LW, N25S, N25SW, N35BI, N35S, N35SW, N45L, N45S, N45SW, N50BI, N50BIW, N55L, N55LW, N55S, N55SW, N70S, N70SW, N90L, N90LW, N90S, N90SW |                 |  |

|  |   |                 |  |
|--|---|-----------------|--|
|  <p>1</p> |   |                 |  |
| <b>GEV No.</b>   | 695681  | <b>Ref. No.</b> | 19800179/0<br>25110914/0<br>CM19800179/0<br>CM25110914/0 |
| <b>description</b>   | bush for spindle ED ø 10mm ID ø 6.2mm L 20mm plastic ICEMATIC   |                 |  |
| <b>For models:</b>   | N20L, N20WL, N25L, N25LW, N25S, N25SW, N35S, N35SW, N45L, N45S, N45SW, N50BI, N50BIW, N55L, N55LW, N55S, N55SW, N70S, N70SW, N90L, N90LW, N90S, N90SW |                 |  |

|  |  |                 |                            |
|--|--|-----------------|----------------------------|
|  <p>1</p> |  |                 |                            |
| <b>GEV No.</b>   | 695670   | <b>Ref. No.</b> | 25260000/0<br>CM25260000/0 |
| <b>description</b>   | disc for pan tilting ø 100mm shaft intake ø 7mm                                |                 |                            |
| <b>For models:</b>   | N20L, N20WL, N25BI, N25L, N25LBI, N25LW, N25S, N25SW, N35BI, N35S, N35SW, N45L |                 |                            |

|  |   |                 |                            |
|--|---|-----------------|----------------------------|
|  <p>1</p> |   |                 |                            |
| <b>GEV No.</b>   | 695479  | <b>Ref. No.</b> | 81413043/0<br>CM81413043/0 |
| <b>description</b>   | disc for pan tilting ø 100mm shaft ø 7mm  |                 |                            |
| <b>For models:</b>   | N140, N45S, N45SW, N50BI, N50BIW, N55L, N55LW, N55S, N55SW, N70S, N70SW, N90L, N90LW, N90S, N90SW |                 |                            |

|  |  |                 |                            |
|--|--|-----------------|----------------------------|
|  <p>1</p> |  |                 |                            |
| <b>GEV No.</b>   | 695671                                   | <b>Ref. No.</b> | 25260001/1<br>CM25260001/1 |
| <b>description</b>   | disc for pan tilting ø 100mm shaft ø 7mm |                 |                            |

|  |   |                 |  |
|--|---|-----------------|--|
|  <p>1</p> |   |                 |  |
| <b>GEV No.</b>   | 695023  | <b>Ref. No.</b> | 25325953<br>25325953/1<br>CM25325953/1 |
| <b>description</b>   | guide for lever L 30mm W 12mm H 15mm  |                 |  |
| <b>For models:</b>   | N140, N20L, N20WL, N25L, N25LW, N25S, N25SW, N35S, N35SW, N45S, N45SW, N50BI, N50BIW, N55L, N55LW, N55S, N55SW, N70S, N70SW, N90L, N90LW, N90S, N90SW |                 |  |

|   |   |                 |  |
|---|---|-----------------|--|
|  <p>1</p> |   |                 |  |
| <b>GEV No.</b>  | 695025  | <b>Ref. No.</b> | 25440110/0<br>81403011/0<br>CM25440110/0<br>CM81403011/0 |
| <b>description</b>  | lever for sump L 143mm W 29mm H 37mm shaft intake ø 10mm plastic ICEMATIC   |                 |  |
| <b>For models:</b>  | N20L, N20WL, N25BI, N25L, N25LBI, N25LW, N25S, N25SW, N35BI, N35S, N35SW, N45L, N45S, N45SW, N50BI, N50BIW, N55L, N55LW, N55S, N55SW, N70S, N70SW, N90L, N90LW, N90S, N90SW |                 |  |

|   |   |                 |                            |
|---|---|-----------------|----------------------------|
|  <p>1</p> |   |                 |                            |
| <b>GEV No.</b>  | 695645                                  | <b>Ref. No.</b> | 81442071/0<br>CM81442071/0 |
| <b>description</b>  | lever for sump L 143mm W 38mm H 29mm SS |                 |                            |
| <b>For models:</b>  | N140                                    |                 |                            |

|  |  |                 |                            |
|--|--|-----------------|----------------------------|
|  <p>1</p> |  |                 |                            |
| <b>GEV No.</b>   | 695653   | <b>Ref. No.</b> | 81443045/2<br>CM81443045/2 |
| <b>description</b>   | lever for sump L 90mm W 20mm shaft intake ø 10mm |                 |                            |
| <b>For models:</b>   | N140   |                 |                            |

|  |   |                 |                            |
|--|---|-----------------|----------------------------|
|  |   |                 |                            |
| 1  |   |                 |                            |
| <b>GEV No.</b>   | 696612  | <b>Ref. No.</b> | 25545509/0<br>CM25545509/0 |
| <b>description</b>   | paddle for ice maker ø 150mm shaft intake ø 6mm 1 |                 |                            |

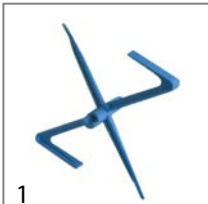
|  |   |                 |  |
|--|---|-----------------|--|
|  |   |                 |  |
| 1  |   |                 |  |
| <b>GEV No.</b>   | 695027  | <b>Ref. No.</b> | 24555520<br>24555522<br>25545520/2<br>25545522<br>CM25545520/2 |
| <b>description</b>   | paddle ø 145mm shaft intake ø 6mm   |                 |  |
| <b>For models:</b>   | N140, N20L, N20WL, N25BI, N25L, N25LBI, N25LW, N25S, N25SW, N35BI, N35S, N35SW, N45L, N45S, N45SW, N50BI, N50BIW, N55L, N55LW, N55S, N55SW, N70S, N70SW, N90L, N90LW, N90S, N90SW |                 |  |

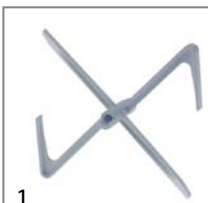
|   |  |                 |                            |
|---|--|-----------------|----------------------------|
|  |  |                 |                            |
| 1   |  |                 |                            |
| <b>GEV No.</b>  | 696527   | <b>Ref. No.</b> | 25545521/0<br>CM25545521/0 |
| <b>description</b>  | paddle ø 145mm shaft intake ø 6mm shaft lengthmm 1 |                 |                            |

|  |   |                 |  |
|--|---|-----------------|--|
|  |   |                 |  |
| 1  |   |                 |  |
| <b>GEV No.</b>   | 695026  | <b>Ref. No.</b> | 25560254/1<br>25560256/0<br>CM25560254/1<br>CM25560256/0 |
| <b>description</b>   | pin for lever L 38mm ø 4.5mm metal  |                 |  |
| <b>For models:</b>   | N140, N20L, N20WL, N25BI, N25L, N25LBI, N25LW, N25S, N25SW, N35BI, N35S, N35SW, N45L, N45S, N45SW, N50BI, N50BIW, N55L, N55LW, N55S, N55SW, N70S, N70SW, N90L, N90LW, N90S, N90SW |                 |  |

|  |   |                 |  |
|--|---|-----------------|--|
|  |   |                 |  |
| 1  |   |                 |  |
| <b>GEV No.</b>   | 695024  | <b>Ref. No.</b> | 25110910<br>25110910/0<br>25110911/0<br>CM25110910/0<br>CM25110911/0 |
| <b>description</b>   | roller for pan tilting ø 26.7mm shaft intake ø 8.1mm  |                 |  |
| <b>For models:</b>   | N140, N20L, N20WL, N25S, N25SW, N45S, N45SW, N50BI, N50BIW, N55L, N55LW, N55S, N55SW, N70S, N70SW |                 |  |

|  |  |                 |                            |
|--|--|-----------------|----------------------------|
|  |  |                 |                            |
| 1  |  |                 |                            |
| <b>GEV No.</b>   | 697880   | <b>Ref. No.</b> | 25030004/0<br>CM25030004/0 |
| <b>description</b>   | shaft for sump for ice-cube maker L 205mm ø 10mm |                 |                            |
| <b>For models:</b>   | N20L, N20WL, N25BI, N25S, N25SW                  |                 |                            |

|   |   |                 |  |
|---|---|-----------------|--|
|  |   |                 |  |
| 1   |   |                 |  |
| <b>GEV No.</b>  | 695035  | <b>Ref. No.</b> | 25725433/0<br>25725439/0<br>CM25725433/0<br>CM25725439/0 |
| <b>description</b>  | shaft intake for paddle motor L 30mm W 17mm H 60mm shaft intake ø 4mm mounting distance 17mm  |                 |  |
| <b>For models:</b>  | N140, N20L, N20WL, N25BI, N25L, N25LBI, N25LW, N25S, N25SW, N35BI, N35S, N35SW, N45L, N45S, N45SW, N50BI, N50BIW, N55L, N55LW, N55S, N55SW, N70S, N70SW, N90L, N90LW, N90S, N90SW |                 |  |

|   |   |                 |                            |
|---|---|-----------------|----------------------------|
|  |   |                 |                            |
| 1   |   |                 |                            |
| <b>GEV No.</b>  | 695882  | <b>Ref. No.</b> | 19644000/0<br>CM19644000/0 |
| <b>description</b>  | spacer ring for spindle ED ø 12mm ID ø 6.2mm L 2mm rubber |                 |                            |

|   |  |                 |                            |
|---|--|-----------------|----------------------------|
|  |  |                 |                            |
| 1   |  |                 |                            |
| <b>GEV No.</b>  | 695004                                 | <b>Ref. No.</b> | 25030006/0<br>CM25030006/0 |
| <b>description</b>  | spindle for ice maker ø 6mm L 165mm SS |                 |                            |
| <b>For models:</b>  | N20L, N20WL, N25BI, N25S, N25SW        |                 |                            |

|  |                                     |                 |                            |
|--|-------------------------------------|-----------------|----------------------------|
|  |                                     |                 |                            |
| 1  |                                     |                 |                            |
| <b>GEV No.</b>   | 695005                              | <b>Ref. No.</b> | 25030007/0<br>CM25030007/0 |
| <b>description</b>   | spindle for ice maker ø 6mm L 206mm |                 |                            |
| <b>For models:</b>   | N35BI, N35S, N35SW                  |                 |                            |

|  |  |                 |                            |
|--|--|-----------------|----------------------------|
|  |  |                 |                            |
| 1  |  |                 |                            |
| <b>GEV No.</b>   | 695006   | <b>Ref. No.</b> | 25030010/0<br>CM25030010/0 |
| <b>description</b>   | spindle for ice maker ø 6mm L 315mm SS               |                 |                            |
| <b>For models:</b>   | N45S, N45SW, N50BI, N50BIW, N55L, N55LW, N55S, N55SW |                 |                            |

|  |                                       |                 |                            |
|--|---------------------------------------|-----------------|----------------------------|
|  |                                       |                 |                            |
| 1  |                                       |                 |                            |
| <b>GEV No.</b>   | 695007                                | <b>Ref. No.</b> | 25030011/0<br>CM25030011/0 |
| <b>description</b>   | spindle for paddle L 495mm            |                 |                            |
| <b>For models:</b>   | N70S, N70SW, N90L, N90LW, N90S, N90SW |                 |                            |



|   |                            |                 |                            |
|---|----------------------------|-----------------|----------------------------|
| 1  |                            |                 |                            |
| <b>GEV No.</b>  | 695008                     | <b>Ref. No.</b> | 25085011/0<br>CM25085011/0 |
| <b>description</b>  | spindle for paddle L 740mm |                 |                            |
| <b>For models:</b>  | N140                       |                 |                            |

|   |   |                 |                            |
|---|---|-----------------|----------------------------|
| 1  |   |                 |                            |
| <b>GEV No.</b>  | 695674  | <b>Ref. No.</b> | 25475400/0<br>CM25475400/0 |
| <b>description</b>  | tension spring for sump ø 13mm wire gauge ø 1.7mm L1 80mm |                 |                            |
| <b>For models:</b>  | N140  |                 |                            |

|   |  |                 |                            |
|---|--|-----------------|----------------------------|
| 1  |  |                 |                            |
| <b>GEV No.</b>  | 695021   | <b>Ref. No.</b> | 25474600/0<br>CM25474600/0 |
| <b>description</b>  | torsion spring ø 20.8mm L1 23.2mm L2 37mm wire gauge ø 2.3mm for ice maker |                 |                            |
| <b>For models:</b>  | N20L, N20WL, N25BI, N25L, N25LBI, N25LW, N25S, N25SW, N35BI, N35S, N35SW   |                 |                            |

|   |   |                 |                            |
|---|---|-----------------|----------------------------|
| 1  |   |                 |                            |
| <b>GEV No.</b>  | 695022  | <b>Ref. No.</b> | 25474602/0<br>CM25474602/0 |
| <b>description</b>  | torsion spring ø 21.2mm L1 26mm L2 37mm wire gauge ø 2.6mm for ice maker                          |                 |                            |
| <b>For models:</b>  | N45L, N45S, N45SW, N50BI, N50BIW, N55L, N55LW, N55S, N55SW, N70S, N70SW, N90L, N90LW, N90S, N90SW |                 |                            |

|   |  |                 |                            |
|---|--|-----------------|----------------------------|
| 1  |  |                 |                            |
| <b>GEV No.</b>  | 695676   | <b>Ref. No.</b> | 25474601/0<br>CM25474601/0 |
| <b>description</b>  | torsion spring ø 23.5mm L1 29mm L2 38mm wire gauge ø 3mm for ice maker |                 |                            |
| <b>For models:</b>  | N140   |                 |                            |

|   |   |                 |                            |
|---|---|-----------------|----------------------------|
| <b>gear wheels</b>  |   |                 |                            |
| 1  |   |                 |                            |
| <b>GEV No.</b>  | 698584  | <b>Ref. No.</b> | CF65115700<br>CMCF65115700 |
| <b>description</b>  | gear wheel ø 101mm shaft intake ø 12.72mm transmission 16/94 double for ice maker |                 |                            |
| <b>For models:</b>  | SF300, SF500, SFN1000, SFN1000W   |                 |                            |

|  |   |                 |          |
|--|---|-----------------|----------|
| 1  |   |                 |          |
| <b>GEV No.</b>   | 691787  | <b>Ref. No.</b> | 29028004 |
| <b>description</b>   | gear wheel ø 27/101mm shaft intake ø 13mm teeth 15/94 |                 |          |

|   |  |                 |  |
|---|--|-----------------|--|
| <b>suction system</b>   |  |                 |  |
| <b>drain pans</b>   |  |                 |  |
| 1  |  |                 |  |
| <b>GEV No.</b>  | 695666   | <b>Ref. No.</b> | 25820080/0<br>CM25820080/0<br>CM25820115/0 |
| <b>description</b>  | sump for ice maker L 220mm W 34mm H 290mm  |                 |  |
| <b>For models:</b>  | N25L, N25LBI, N25LW, N35BI, N35S, N35SW, N45L, N45S, N45SW, N50BI, N50BIW, N55L, N55LW, N55S, N55SW, N70S, N70SW, N90L, N90LW, N90S, N90SW |                 |  |
| <b>accessories for</b>  | 695666   |                 |  |
|    | <b>GEV No.</b>   | 695713          | <b>Ref. No.</b> 81443002/0<br>CM81443002/0 |
|   | guard for drain pan  |                 |  |

|  |  |                 |                            |
|--|--|-----------------|----------------------------|
| <b>intake pans</b>   |  |                 |                            |
| 1  |  |                 |                            |
| <b>GEV No.</b>   | 695732   | <b>Ref. No.</b> | 81453116/0<br>CM81453116/0 |
| <b>description</b>   | water container for ice maker L 698mm W 195mm H 93mm |                 |                            |
| <b>For models:</b>   | N200M, N200MW, N300M, N300MW                         |                 |                            |

## drive technology

## gear wheels



1

|                    |   |                 |  |
|--------------------|---|-----------------|--|
| <b>GEV No.</b>     | 694780  | <b>Ref. No.</b> | 29028005<br>65115800<br>CF65115800<br>CMCF65115800 |
| <b>description</b> | gear wheel $\varnothing$ 135mm shaft $\varnothing$ 25mm W 19mm teeth 83 |                 |  |
| <b>For models:</b> | SF300, SF500, SFN1000, SFN1000W   |                 |  |



1

|                    |  |                 |                            |
|--------------------|--|-----------------|----------------------------|
| <b>GEV No.</b>     | 695586   | <b>Ref. No.</b> | CF65116000<br>CMCF65116000 |
| <b>description</b> | gear wheel $\varnothing$ 21.3mm teeth 18-41 D1 $\varnothing$ 58mm shaft $\varnothing$ 8 shaft L 55mm |                 |                            |
| <b>For models:</b> | F100, F100C, F120, F125C, F200, F80C, F80WC  |                 |                            |



1

|                    |  |                 |                            |
|--------------------|--|-----------------|----------------------------|
| <b>GEV No.</b>     | 697919   | <b>Ref. No.</b> | CF65116100<br>CMCF65116100 |
| <b>description</b> | gear wheel $\varnothing$ 62/20mm shaft $\varnothing$ 9.5mm teeth 56/10 for gearbox |                 |                            |
| <b>For models:</b> | F100, F100C, F120, F125C, F200, F80C, F80WC  |                 |                            |



1

|                    |  |                 |   |
|--------------------|--|-----------------|---|
| <b>GEV No.</b>     | 695582   | <b>Ref. No.</b> | 290286006<br>CF65115600<br>CMCF65115600 |
| <b>description</b> | gear wheel teeth 65 tooth width 14.5mm ED $\varnothing$ 74mm H 72mm shaft $\varnothing$ 12.7mm |                 |   |
| <b>For models:</b> | SF300, SF500, SFN1000, SFN1000W  |                 |   |

## gaskets

## shaft gaskets



1

|                    |  |                 |                            |
|--------------------|--|-----------------|----------------------------|
| <b>GEV No.</b>     | 694191   | <b>Ref. No.</b> | CF13070902<br>CMCF13070902 |
| <b>description</b> | gasket for evaporator ED $\varnothing$ 48mm ID $\varnothing$ 23mm H 7mm rubber |                 |                            |
| <b>For models:</b> | SF300, SF500, SFN1000, SFN1000W  |                 |                            |



1

|                    |   |                 |  |
|--------------------|---|-----------------|--|
| <b>GEV No.</b>     | 696651  | <b>Ref. No.</b> | CF02001607<br>CF02160701<br>CMCF02001607<br>CMCF02160701 |
| <b>description</b> | shaft bearing for ice maker ED $\varnothing$ 33.5mm ID $\varnothing$ 25.7mm H 3mm for shaft bearing metal |                 |  |
| <b>For models:</b> | SF300, SF500, SFN1000, SFN1000W   |                 |  |



1

|                    |  |                 |  |
|--------------------|--|-----------------|--|
| <b>GEV No.</b>     | 695589   | <b>Ref. No.</b> | 29000003/0<br>CF64004000<br>CM29000003/0<br>CMCF64004000 |
| <b>description</b> | shaft sealing ED $\varnothing$ 48mm ID $\varnothing$ 25mm H 22mm suitable for augers |                 |  |
| <b>For models:</b> | F100, F100C, F120, F125C, F200, F80C, F80WC  |                 |  |



1

|                    |   |                 |                            |
|--------------------|---|-----------------|----------------------------|
| <b>GEV No.</b>     | 695428  | <b>Ref. No.</b> | CF65040200<br>CMCF65040200 |
| <b>description</b> | shaft sealing for auger ED $\varnothing$ 45mm ID $\varnothing$ 30mm |                 |                            |
| <b>For models:</b> | SF300, SF500, SFN1000, SFN1000W                                     |                 |                            |

## miscellaneous

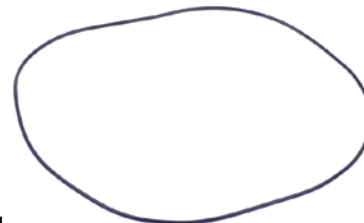

1

|                    |  |                 |                            |
|--------------------|--|-----------------|----------------------------|
| <b>GEV No.</b>     | 697879   | <b>Ref. No.</b> | 1300061738<br>CM1300061738 |
| <b>description</b> | O-ring NBR thickness 2.62mm ID $\varnothing$ 219mm Qty 1 pcs |                 |                            |
| <b>For models:</b> | SF300, SF500   |                 |                            |

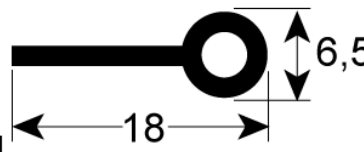

1

|                    |  |                 |                            |
|--------------------|--|-----------------|----------------------------|
| <b>GEV No.</b>     | 900912   | <b>Ref. No.</b> | 38581100/0<br>CM38581100/0 |
| <b>description</b> | refrigeration gasket W 18mm for door Qty supplied by meter |                 |                            |
| <b>For models:</b> | N140   |                 |                            |

housing and bezels

fascias

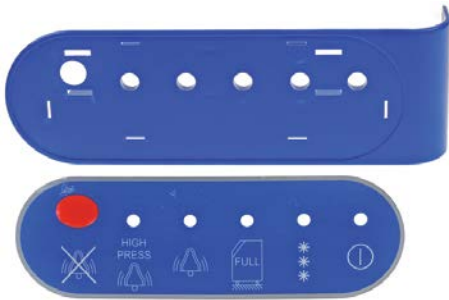

1

|                    |   |                 |                            |
|--------------------|---|-----------------|----------------------------|
| <b>GEV No.</b>     | 696581  | <b>Ref. No.</b> | 81453604/0<br>CM81453604/0 |
| <b>description</b> | bezel for LEDs H 75mm suitable for ICEMATIC N501M L 240mm |                 |                            |
| <b>For models:</b> | N131M, N201M, N301M, N401M, N501M                         |                 |                            |



1

|                    |                             |                 |                            |
|--------------------|-----------------------------|-----------------|----------------------------|
| <b>GEV No.</b>     | 692219                      | <b>Ref. No.</b> | 81453613/0<br>CM81453613/0 |
| <b>description</b> | bezel W 180mm H 46mm D 48mm |                 |                            |

housings



1

|                    |   |                 |                            |
|--------------------|---|-----------------|----------------------------|
| <b>GEV No.</b>     | 696653                                      | <b>Ref. No.</b> | 25165522/0<br>CM25165522/0 |
| <b>description</b> | frame for ice maker L 610mm W 405mm H 100mm |                 |                            |



1

|                    |  |                 |                            |
|--------------------|--|-----------------|----------------------------|
| <b>GEV No.</b>     | 696685   | <b>Ref. No.</b> | 25702906/0<br>CM25702906/0 |
| <b>description</b> | frame for ice maker L 765mm W 495mm H 110mm plastic anthracite |                 |                            |



1

|                    |  |                 |  |
|--------------------|--|-----------------|--|
| <b>GEV No.</b>     | 696646                                     | <b>Ref. No.</b> | 25161164/0<br>CM25161143<br>CM25161164/0 |
| <b>description</b> | housing for contol L 245mm W 245mm H 140mm |                 |  |



1

|                    |   |                 |                            |
|--------------------|---|-----------------|----------------------------|
| <b>GEV No.</b>     | 696635                                    | <b>Ref. No.</b> | 25160731/0<br>CM25160731/0 |
| <b>description</b> | housing for contol L 255mm W 225mm H 98mm |                 |                            |



1

|                    |  |                 |                            |
|--------------------|--|-----------------|----------------------------|
| <b>GEV No.</b>     | 696656   | <b>Ref. No.</b> | 25161138/0<br>CM25161138/0 |
| <b>description</b> | lid for contol L 99mm W 38.4mm H 9mm plastic model N25 silver  |                 |                            |
| <b>For models:</b> | F80C, F80WC, N21S, N25L, N25LW, N25S, N25SW, N35S, N35SW, N45L, N45S, N45SW, N55L, N55LW, N55S, N55SW, N70S, N70SW, N90L, N90LW, N90S, N90SW |                 |                            |

ventilation grilles



1

|                    |   |                 |                            |
|--------------------|---|-----------------|----------------------------|
| <b>GEV No.</b>     | 694142                                    | <b>Ref. No.</b> | 25547146/0<br>CM25547146/0 |
| <b>description</b> | ventilation grille L 335mm W 20mm H 335mm |                 |                            |



1

|                    |  |                 |                            |
|--------------------|--|-----------------|----------------------------|
| <b>GEV No.</b>     | 696655   | <b>Ref. No.</b> | 25295030/0<br>CM25295030/0 |
| <b>description</b> | ventilation grille plastic black H 233mm L 233mm |                 |                            |

model name plates



1

|                    |  |                 |                            |
|--------------------|--|-----------------|----------------------------|
| <b>GEV No.</b>     | 696636   | <b>Ref. No.</b> | 19262800/0<br>CM19262800/0 |
| <b>description</b> | model name plate Scotsman MV 1000 L 265mm W 76mm self-adhesive |                 |                            |



1

|                    |  |                 |                            |
|--------------------|--|-----------------|----------------------------|
| <b>GEV No.</b>     | 694824   | <b>Ref. No.</b> | 19263215/0<br>CM19263215/0 |
| <b>description</b> | type plate ICEMATIC self-adhesive blue/white L 120mm W 120mm |                 |                            |

insulation



1

|                    |  |                 |  |
|--------------------|--|-----------------|--|
| <b>GEV No.</b>     | 694112   | <b>Ref. No.</b> | CF06055101<br>CF6055101<br>CMCF06055101<br>CMCF6055101 |
| <b>description</b> | insulation for discharge chute L 190mm W 200mm H 175mm |                 |  |



1

|                    |  |                 |                            |
|--------------------|--|-----------------|----------------------------|
| <b>GEV No.</b>     | 695989                                   | <b>Ref. No.</b> | CF06055104<br>CMCF06055104 |
| <b>description</b> | insulation for ice maker H 230mm ø 117mm |                 |                            |

flaps



1

|                    |                                    |                 |  |
|--------------------|------------------------------------|-----------------|--|
| <b>GEV No.</b>     | 695728                             | <b>Ref. No.</b> | 25260474/0<br>25260485/0<br>CM25260474/0<br>CM25260485/0 |
| <b>description</b> | flap for ice maker W 265mm H 130mm |                 |  |
| <b>For models:</b> | N21S                               |                 |  |



1

|   |   |                 |                            |                            |
|---|---|-----------------|----------------------------|----------------------------|
| <b>GEV No.</b>  | 696644  | <b>Ref. No.</b> | 81453466/0<br>CM81453466/0 |                            |
| <b>description</b>  | flap for ice maker W 365mm L 410mm for evaporator |                 |                            |                            |
| <b>spare parts for</b>  | 696644  |                 |                            |                            |
|  | <b>GEV No.</b>                                    | 347059          | <b>Ref. No.</b>            | 19355007/0<br>CM19355007/0 |
|   | magnet L 40mm H 8mm W 13.2mm hole distance 30mm   |                 |                            |                            |



1

|   |   |                 |  |
|---|---|-----------------|--|
| <b>GEV No.</b>  | 696641  | <b>Ref. No.</b> | 81453692/0<br>CM81453692/0                 |
| <b>description</b>  | flap for ice maker W 365mm L 420mm for evaporator |                 |  |
| <b>For models:</b>  | N131M   |                 |  |
| <b>spare parts for</b>  | 696641  |                 |  |
|  | <b>GEV No.</b>                                    | 347059          | <b>Ref. No.</b> 19355007/0<br>CM19355007/0 |
| magnet L 40mm H 8mm W 13.2mm hole distance 30mm                                   |   |                 |  |



1

|                    |   |                 |  |
|--------------------|---|-----------------|--|
| <b>GEV No.</b>     | 696392  | <b>Ref. No.</b> | 25820114/0<br>81453008/0<br>81453130/0<br>CM25820114/0<br>CM81453008/0<br>CM81453130/0 |
| <b>description</b> | flap for ice maker W 493mm L 423mm for evaporator |                 |  |



1

|                    |   |                 |                            |
|--------------------|---|-----------------|----------------------------|
| <b>GEV No.</b>     | 696645  | <b>Ref. No.</b> | 25550400/0<br>CM25550400/0 |
| <b>description</b> | flap for ice maker W 473mm L 420mm for evaporator |                 |                            |



1

|   |   |                 |  |
|---|---|-----------------|--|
| <b>GEV No.</b>  | 696642  | <b>Ref. No.</b> | 25820126/0<br>CM25820126/0                 |
| <b>description</b>  | flap for ice maker W 493mm L 423mm for evaporator |                 |  |
| <b>For models:</b>  | N201M, N301M                                      |                 |  |
| <b>accessories for</b>  | 696642  |                 |  |
|  | <b>GEV No.</b>                                    | 347059          | <b>Ref. No.</b> 19355007/0<br>CM19355007/0 |
| magnet L 40mm H 8mm W 13.2mm hole distance 30mm                                     |   |                 |  |



1

|   |   |                 |  |
|---|---|-----------------|--|
| <b>GEV No.</b>  | 695693  | <b>Ref. No.</b> | 81453630/0<br>CM81453630/0                 |
| <b>description</b>  | flap for ice maker W 493mm L 423mm for evaporator |                 |  |
| <b>For models:</b>  | N201M, N301M                                      |                 |  |
| <b>spare parts for</b>  | 695693  |                 |  |
|  | <b>GEV No.</b>                                    | 347059          | <b>Ref. No.</b> 19355007/0<br>CM19355007/0 |
| magnet L 40mm H 8mm W 13.2mm hole distance 30mm                                     |   |                 |  |



1

|                    |   |                 |                            |
|--------------------|---|-----------------|----------------------------|
| <b>GEV No.</b>     | 695697  | <b>Ref. No.</b> | 81453261/0<br>CM81453261/0 |
| <b>description</b> | flap for ice maker W 495mm H 560mm thickness 38mm |                 |                            |
| <b>For models:</b> | N500M   |                 |                            |

|   |   |                 |                            |
|---|---|-----------------|----------------------------|
|  |   |                 |                            |
| 1   |   |                 |                            |
| <b>GEV No.</b>  | 695698  | <b>Ref. No.</b> | 81453262/0<br>CM81453262/0 |
| <b>description</b>  | flap for ice maker W 495mm H 560mm thickness 38mm |                 |                            |
| <b>For models:</b>  | N500M   |                 |                            |

|   |   |                 |  |
|---|---|-----------------|--|
|    |   |                 |  |
| 1   |   |                 |  |
| <b>GEV No.</b>  | 696643  | <b>Ref. No.</b> | 81453651/0<br>CM81453651/0                 |
| <b>description</b>  | flap for ice maker W 525mm L 640mm for evaporator |                 |  |
| <b>For models:</b>  | N501M   |                 |  |
| <b>spare parts for</b>  | 696643  |                 |  |
|  | <b>GEV No.</b>                                    | 347059          | <b>Ref. No.</b> 19355007/0<br>CM19355007/0 |
| magnet L 40mm H 8mm W 13.2mm hole distance 30mm                                     |   |                 |  |

|   |  |                 |  |
|---|--|-----------------|--|
|  |  |                 |  |
| 1   |  |                 |  |
| <b>GEV No.</b>  | 696610   | <b>Ref. No.</b> | 81453072<br>81453131/0<br>CM81453131/0 |
| <b>description</b>  | sump for ice maker W 500mm H 70mm L 540mm for evaporator |                 |  |

## mechanics for evaporators

## screw conveyors

|  |   |                 |                            |
|--|---|-----------------|----------------------------|
|  |   |                 |                            |
| 1  |   |                 |                            |
| <b>GEV No.</b>   | 691788                                    | <b>Ref. No.</b> | CF72405207<br>CMCF72405207 |
| <b>description</b>   | screw conveyor $\varnothing$ 46mm L 260mm |                 |                            |
| <b>For models:</b>   | F100, F100C, F120, F125C, F80C, F80WC     |                 |                            |

|  |   |                 |                            |
|--|---|-----------------|----------------------------|
|  |   |                 |                            |
| 1  |   |                 |                            |
| <b>GEV No.</b>   | 691789                                    | <b>Ref. No.</b> | CF72405206<br>CMCF72405206 |
| <b>description</b>   | screw conveyor $\varnothing$ 46mm L 330mm |                 |                            |
| <b>For models:</b>   | F200                                      |                 |                            |

## holders

|  |  |                 |  |
|--|--|-----------------|--|
|  |  |                 |  |
| 1  |  |                 |  |
| <b>GEV No.</b>   | 694437   | <b>Ref. No.</b> | 06068800<br>29015012<br>29070002<br>65105900<br>CF06052700<br>CF06068800<br>CF65105900<br>CF75400801<br>CMCF06052700<br>CMCF06068800<br>CMCF65105900<br>CMCF75400801 |
| <b>description</b>   | bearing block for evaporator kit with holder mounting pos. lower |                 |  |
| <b>For models:</b>   | SF300, SF500   |                 |  |





miscellaneous



1

|                    |  |                 |                            |
|--------------------|--|-----------------|----------------------------|
| <b>GEV No.</b>     | 694598   | <b>Ref. No.</b> | CF78447601<br>CMCF78447601 |
| <b>description</b> | magnet holder with magnet H 37mm ED ø 42mm plastic |                 |                            |
| <b>For models:</b> | SFN1000, SFN1000W                                  |                 |                            |



1

|                    |  |                 |  |
|--------------------|--|-----------------|--|
| <b>GEV No.</b>     | 560568   | <b>Ref. No.</b> | CF02167900<br>CF02168100<br>CMCF02001681<br>CMCF02167900<br>CMCF02168100 |
| <b>description</b> | plain washer ID ø 25.6mm ED ø 39mm thickness 0.85mm SS Qty 1 pcs |                 |  |
| <b>For models:</b> | SF300, SF500, SFN1000, SFN1000W                                  |                 |  |

gear motors

gearboxes



1

|                    |   |                 |                            |
|--------------------|---|-----------------|----------------------------|
| <b>GEV No.</b>     | 694352                                      | <b>Ref. No.</b> | CF00101501<br>CMCF00101501 |
| <b>description</b> | housing for gearbox                         |                 |                            |
| <b>For models:</b> | F100, F100C, F120, F125C, F200, F80C, F80WC |                 |                            |



1

|                    |                                 |                 |  |
|--------------------|---------------------------------|-----------------|--|
| <b>GEV No.</b>     | 695607                          | <b>Ref. No.</b> | 29070007<br>CFA3123001<br>CMCFA3123001 |
| <b>description</b> | housing for gearbox             |                 |  |
| <b>For models:</b> | SF300, SF500, SFN1000, SFN1000W |                 |  |

hoses

formed hoses

form S



1

|                    |  |                 |                               |
|--------------------|--|-----------------|-------------------------------|
| <b>GEV No.</b>     | 694093   | <b>Ref. No.</b> | nicht in Preisliste enthalten |
| <b>description</b> | formed hose S-shape for ice-cube maker ID ø 18mm ED ø 22mm L 300mm W 100mm |                 |                               |



1

|                    |   |                 |                            |
|--------------------|---|-----------------|----------------------------|
| <b>GEV No.</b>     | 695885  | <b>Ref. No.</b> | 25778366/0<br>CM25778366/0 |
| <b>description</b> | formed hose S-shape for ice-cube maker ID ø 20mm ED ø 25mm L 800mm W 130mm H 80mm |                 |                            |
| <b>For models:</b> | N140  |                 |                            |

miscellaneous



1

|                    |   |                 |                            |
|--------------------|---|-----------------|----------------------------|
| <b>GEV No.</b>     | 695813  | <b>Ref. No.</b> | 29090034/0<br>CM29090034/0 |
| <b>description</b> | formed hose ID ø 11mm ED ø 15mm L 500mm W 110mm |                 |                            |



1

|                    |   |                 |                               |
|--------------------|---|-----------------|-------------------------------|
| <b>GEV No.</b>     | 694104  | <b>Ref. No.</b> | nicht in Preisliste enthalten |
| <b>description</b> | formed hose ID ø 16mm ED ø 20mm L 440mm W 210mm PVC |                 |                               |

## hose connectors

## with thread



1

|                    |   |                 |  |
|--------------------|---|-----------------|--|
| <b>GEV No.</b>     | 695045  | <b>Ref. No.</b> | CF66022400<br>CM25631035<br>CMCF66022400 |
| <b>description</b> | hose connector 3-way ID $\varnothing$ 15mm ED $\varnothing$ 21mm L 91mm |                 |  |
| <b>For models:</b> | F100, F120, F125C, F200, F80C, F80WC, SF300, SF500                      |                 |  |



1

|                    |                                   |                 |                               |
|--------------------|-----------------------------------|-----------------|-------------------------------|
| <b>GEV No.</b>     | 695048                            | <b>Ref. No.</b> | nicht in Preisliste enthalten |
| <b>description</b> | hose connector for ice-cube maker |                 |                               |



1

|                    |  |                 |                     |
|--------------------|--|-----------------|---------------------|
| <b>GEV No.</b>     | 361796   | <b>Ref. No.</b> | nicht in Preisliste |
| <b>description</b> | hose connector thread 3/4" ET grommet $\varnothing$ 13.5mm ID $\varnothing$ 10mm grommet length 20mm WS 27 thread L 22mm |                 |                     |

## without thread



1

|                    |  |                 |                            |
|--------------------|--|-----------------|----------------------------|
| <b>GEV No.</b>     | 696615   | <b>Ref. No.</b> | 25631050/0<br>CM25631050/0 |
| <b>description</b> | drain connection hose $\varnothing$ 25mm L 100mm plastic for ice maker |                 |                            |



1

|                    |   |                 |                            |
|--------------------|---|-----------------|----------------------------|
| <b>GEV No.</b>     | 695737  | <b>Ref. No.</b> | 25631035/0<br>CM25631035/0 |
| <b>description</b> | hose connector straight plastic L 60mm $\varnothing$ 20mm |                 |                            |
| <b>For models:</b> | N215  |                 |                            |



1

|                    |   |                 |  |
|--------------------|---|-----------------|--|
| <b>GEV No.</b>     | 695050  | <b>Ref. No.</b> | 25690803<br>25690806/0<br>CM25690806/0 |
| <b>description</b> | hose connector straight plastic L 70mm $\varnothing$ 21mm   |                 |  |
| <b>For models:</b> | F100C, F125C, F80C, F80WC, N200M, N200MW, N20L, N20WL, N25BI, N25L, N25LW, N25S, N25SW, N300M, N300MW, N35S, N35SW, N45L, N45S, N45SW, N500M, N55L, N55LW, N55S, N55SW, N70S, N70SW, N90L, N90LW, N90S, N90SW |                 |  |

## water dispersions



1

|                    |                                    |                 |  |
|--------------------|------------------------------------|-----------------|--|
| <b>GEV No.</b>     | 694823                             | <b>Ref. No.</b> | 25790075/0<br>81454208/0<br>CM25790075/0<br>CM81454208/0 |
| <b>description</b> | hose T-piece L 580mm for ice maker |                 |  |



1

|                    |                     |                 |                            |
|--------------------|---------------------|-----------------|----------------------------|
| <b>GEV No.</b>     | 694791              | <b>Ref. No.</b> | 81453791/0<br>CM81453791/0 |
| <b>description</b> | hose T-piece L 80mm |                 |                            |
| <b>For models:</b> | N501M               |                 |                            |



1

|                    |  |                 |                            |
|--------------------|--|-----------------|----------------------------|
| <b>GEV No.</b>     | 696617   | <b>Ref. No.</b> | 81453698/0<br>CM81453698/0 |
| <b>description</b> | hose set for ice maker ID $\varnothing$ 12mm ED $\varnothing$ 16mm L 600mm W 20mm rubber H 116mm |                 |                            |

## miscellaneous



1

|                    |  |                 |  |
|--------------------|--|-----------------|--|
| <b>GEV No.</b>     | 520447   | <b>Ref. No.</b> | 73320400<br>CF73320400<br>CMCF73320400 |
| <b>description</b> | double nipple thread 3/8" - 3/4" L1 24mm L2 12mm |                 |  |
| <b>For models:</b> | F100, F120, F200, SF300, SF500, SFN1000W         |                 |  |

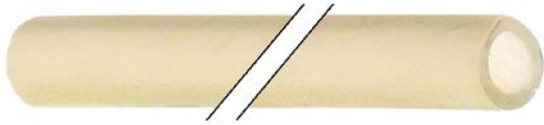

|   |   |                 |                            |
|---|---|-----------------|----------------------------|
|  |   |                 |                            |
| 1   |   |                 |                            |
| <b>GEV No.</b>  | 530768  | <b>Ref. No.</b> | 25791018/0<br>CM25791018/0 |
| <b>description</b>  | hose for ice-cube maker ID ø 10mm ED ø 16mm L 800mm |                 |                            |
| <b>For models:</b>  | N20L, N20WL, N25BI, N25S, N25SW                     |                 |                            |

|   |  |                 |                            |
|---|--|-----------------|----------------------------|
|  |  |                 |                            |
| 1   |  |                 |                            |
| <b>GEV No.</b>  | 530769   | <b>Ref. No.</b> | 25790880/0<br>CM25790880/0 |
| <b>description</b>  | silicone hose for ice-cube maker ID ø 14mm ED ø 20mm L 650mm |                 |                            |

floats

container lids

|  |   |                 |                            |
|--|---|-----------------|----------------------------|
|  |   |                 |                            |
| 1  |   |                 |                            |
| <b>GEV No.</b>   | 695038  | <b>Ref. No.</b> | CF66036300<br>CMCF66036300 |
| <b>description</b>   | lid L 150mm W 102mm for float container                               |                 |                            |
| <b>For models:</b>   | F100, F120, F125C, F200, F80C, F80WC, SF300, SF500, SFN1000, SFN1000W |                 |                            |

float containers

|   |   |                 |  |
|---|---|-----------------|--|
|  |   |                 |  |
| 1   |   |                 |  |
| <b>GEV No.</b>  | 695037  | <b>Ref. No.</b> | 29087022/0<br>79312601<br>CF79312601<br>CM29087022/0<br>CMCF79312601 |
| <b>description</b>  | float container for ice maker plastic                   |                 |  |
| <b>For models:</b>  | F100, F120, F125C, F200, F80C, F80WC, SFN1000, SFN1000W |                 |  |

miscellaneous

|   |  |                 |  |
|---|--|-----------------|--|
|  |  |                 |  |
| 1   |  |                 |  |
| <b>GEV No.</b>  | 691665   | <b>Ref. No.</b> | 25726470/0<br>25726473/0<br>CM25726470/0<br>CM25726473/0 |
| <b>description</b>  | bracket for evaporator flap  |                 |  |
| <b>For models:</b>  | N131M, N200M, N200MW, N201M, N300M, N300MW, N301M, N401M, N500M, N501M |                 |  |

|  |                                      |                 |                            |
|--|--------------------------------------|-----------------|----------------------------|
|  |                                      |                 |                            |
| 1  |                                      |                 |                            |
| <b>GEV No.</b>   | 695715                               | <b>Ref. No.</b> | 25620289/0<br>CM25620289/0 |
| <b>description</b>   | bracket for ice maker L 515mm W 70mm |                 |                            |

|  |                                       |                 |                            |
|--|---------------------------------------|-----------------|----------------------------|
|  |                                       |                 |                            |
| 1  |                                       |                 |                            |
| <b>GEV No.</b>   | 694815                                | <b>Ref. No.</b> | 25725607/0<br>CM25725607/0 |
| <b>description</b>   | bracket L 128mm W 90mm H 30mm plastic |                 |                            |

|  |  |                 |                            |
|--|--|-----------------|----------------------------|
|  |  |                 |                            |
| 1  |  |                 |                            |
| <b>GEV No.</b>   | 694816                                 | <b>Ref. No.</b> | 25725606/0<br>CM25725606/0 |
| <b>description</b>   | bracket L 243mm W 149mm H 40mm plastic |                 |                            |

|   |   |                 |                            |
|---|---|-----------------|----------------------------|
|  |   |                 |                            |
| 1   |   |                 |                            |
| <b>GEV No.</b>  | 696620  | <b>Ref. No.</b> | 25110913/0<br>CM25110913/0 |
| <b>description</b>  | bush for ice maker L 13mm W 8mm H 9mm ID ø 4mm ED ø 8mm plastic |                 |                            |
| <b>For models:</b>  | N21S, N45S, N45SW, N50BI, N50BIW                                |                 |                            |

|   |  |                 |                            |
|---|--|-----------------|----------------------------|
|  |  |                 |                            |
| 1   |  |                 |                            |
| <b>GEV No.</b>  | 696684   | <b>Ref. No.</b> | 25702875/0<br>CM25702875/0 |
| <b>description</b>  | bush ID ø 4.4mm D1 ø 28mm D2 ø 12.75mm L1 25mm |                 |                            |



1

|                    |   |                 |  |
|--------------------|---|-----------------|--|
| <b>GEV No.</b>     | 696621  | <b>Ref. No.</b> | 25560151/0<br>25560152/0<br>CM25560151/0<br>CM25560152/0 |
| <b>description</b> | bush L 9mm W 14mm H 19mm ID ø 4.5mm plastic                     |                 |  |
| <b>For models:</b> | N55L, N55LW, N55S, N55SW, N70S, N70SW, N90L, N90LW, N90S, N90SW |                 |  |



1

|                    |   |                 |  |
|--------------------|---|-----------------|--|
| <b>GEV No.</b>     | 695588  | <b>Ref. No.</b> | CF06052700<br>CF65015900<br>CMCF06052700<br>CMCF65015900 |
| <b>description</b> | bushing complete H 31.5mm ID ø 30mm ED ø 89mm mounting pos. lower |                 |  |
| <b>For models:</b> | SF300, SF500, SFN1000, SFN1000W                                   |                 |  |



1

|                    |  |                 |                            |
|--------------------|--|-----------------|----------------------------|
| <b>GEV No.</b>     | 695733                                       | <b>Ref. No.</b> | CF66050700<br>CMCF66050700 |
| <b>description</b> | cap for ice maker H 18mm ID ø 56mm ED ø 61mm |                 |                            |
| <b>For models:</b> | SF300, SF500, SFN1000, SFN1000W              |                 |                            |



1

|                    |   |                 |                            |
|--------------------|---|-----------------|----------------------------|
| <b>GEV No.</b>     | 695630                                      | <b>Ref. No.</b> | CF06035900<br>CMCF06035900 |
| <b>description</b> | coupling set ø 37mm                         |                 |                            |
| <b>For models:</b> | F100, F100C, F120, F125C, F200, F80C, F80WC |                 |                            |



1

|                    |   |                 |                            |
|--------------------|---|-----------------|----------------------------|
| <b>GEV No.</b>     | 695709  | <b>Ref. No.</b> | 81462028/0<br>CM81462028/0 |
| <b>description</b> | discharge chute for ice maker L 135mm W 80mm H 80mm |                 |                            |
| <b>For models:</b> | F100C   |                 |                            |



1

|                    |   |                 |                            |
|--------------------|---|-----------------|----------------------------|
| <b>GEV No.</b>     | 696652  | <b>Ref. No.</b> | 25260525/0<br>CM25260525/0 |
| <b>description</b> | distance washer for ice maker H 1.5mm ID ø 4mm ED ø 10mm SS Qty 1 pcs |                 |                            |
| <b>For models:</b> | N140, N20L, N20WL   |                 |                            |



1

|                    |   |                 |                            |
|--------------------|---|-----------------|----------------------------|
| <b>GEV No.</b>     | 695675  | <b>Ref. No.</b> | 25730502/0<br>CM25730502/0 |
| <b>description</b> | end cap for water dispersion H 19mm ID ø 16mm ED ø 27mm mounting pos. right |                 |                            |



1

|                    |   |                 |                            |
|--------------------|---|-----------------|----------------------------|
| <b>GEV No.</b>     | 695731  | <b>Ref. No.</b> | 81453015/0<br>CM81453015/0 |
| <b>description</b> | flow regulating valve L 42mm W 14mm                             |                 |                            |
| <b>For models:</b> | N131M, N200M, N200MW, N201M, N300M, N300MW, N301M, N401M, N501M |                 |                            |



1

|                    |   |                 |        |
|--------------------|---|-----------------|--------|
| <b>GEV No.</b>     | 695719                                      | <b>Ref. No.</b> | I-1611 |
| <b>description</b> | gasket for ice maker L 80mm W 36mm silicone |                 |        |



1

|                    |   |                 |                            |
|--------------------|---|-----------------|----------------------------|
| <b>GEV No.</b>     | 695673  | <b>Ref. No.</b> | 25730501/0<br>CM25730501/0 |
| <b>description</b> | gasket for water dispersion H 19mm ID ø 16mm ED ø 27mm mounting pos. left |                 |                            |



1

|                    |                     |                 |                            |
|--------------------|---------------------|-----------------|----------------------------|
| <b>GEV No.</b>     | 695713              | <b>Ref. No.</b> | 81443002/0<br>CM81443002/0 |
| <b>description</b> | guard for drain pan |                 |                            |
| <b>For models:</b> | N140                |                 |                            |



1

|                    |   |                 |                            |
|--------------------|---|-----------------|----------------------------|
| <b>GEV No.</b>     | 696624  | <b>Ref. No.</b> | 19120415/0<br>CM19120415/0 |
| <b>description</b> | hinge for ice maker L 78mm W 38mm H 57mm mounting pos. left |                 |                            |



|  |  |                 |                            |
|--|--|-----------------|----------------------------|
|  <p>1</p> |  |                 |                            |
| <b>GEV No.</b>   | 696623   | <b>Ref. No.</b> | 19120414/0<br>CM19120414/0 |
| <b>description</b>   | hinge for ice maker L 78mm W 38mm H 57mm mounting pos. right |                 |                            |

|  |   |                 |                            |
|--|---|-----------------|----------------------------|
|  <p>1</p> |   |                 |                            |
| <b>GEV No.</b>   | 695660  | <b>Ref. No.</b> | 25300000/0<br>CM25300000/0 |
| <b>description</b>   | inlet spout for ice maker ICEMATIC  |                 |                            |
| <b>For models:</b>   | N20L, N20WL, N25BI, N25L, N25LBI, N25LW, N25S, N25SW, N35BI, N35S, N35SW, N45L, N45S, N45SW, N50BI, N50BIW, N55L, N55LW, N55S, N55SW, N70S, N70SW, N90L, N90LW, N90S, N90SW |                 |                            |

|  |   |                 |                            |
|--|---|-----------------|----------------------------|
|  <p>1</p> |   |                 |                            |
| <b>GEV No.</b>   | 695723  | <b>Ref. No.</b> | 25410055/0<br>CM25410055/0 |
| <b>description</b>   | insulation for control valve L 120mm W 52mm H 105mm |                 |                            |

|  |   |                 |                            |
|--|---|-----------------|----------------------------|
|  <p>1</p> |   |                 |                            |
| <b>GEV No.</b>   | 696683  | <b>Ref. No.</b> | 25410096/0<br>CM25410096/0 |
| <b>description</b>   | insulation for control valve L 85mm W 50mm H 70mm |                 |                            |

|  |  |                 |  |
|--|--|-----------------|--|
|  <p>1</p> |  |                 |  |
| <b>GEV No.</b>   | 695744                                       | <b>Ref. No.</b> | CF66013200<br>CMCF65088700<br>CMCF66013200 |
| <b>description</b>   | insulation L 150mm W 100mm H 140mm ID ø 55mm |                 |  |
| <b>For models:</b>   | F100, F120, F200                             |                 |  |

|  |                                |                 |                            |
|--|--------------------------------|-----------------|----------------------------|
|  <p>1</p> |                                |                 |                            |
| <b>GEV No.</b>   | 692612                         | <b>Ref. No.</b> | 19690418/0<br>CM19690418/0 |
| <b>description</b>   | lid H 12mm ID ø 38mm ED ø 44mm |                 |                            |

|   |  |                 |            |
|---|--|-----------------|------------|
|  <p>1</p> |  |                 |            |
| <b>GEV No.</b>  | 692840   | <b>Ref. No.</b> | 81414560/0 |
| <b>description</b>  | mounting plate L 62mm W 60mm H 10mm for 360665 |                 |            |

|  |  |                 |   |
|--|--|-----------------|---|
|  <p>1</p> |  |                 |   |
| <b>GEV No.</b>   | 695046   | <b>Ref. No.</b> | 19305022/0<br>CF66053500<br>CM19305022/0<br>CMCF66053500<br>nicht in Preisliste |
| <b>description</b>   | nut H 5mm thread M24x1.5 plastic                         |                 |   |
| <b>For models:</b>   | F100, F120, F125C, F200, F80C, F80WC, N21S, SF300, SF500 |                 |   |

|   |  |                 |                            |
|---|--|-----------------|----------------------------|
|  <p>1</p> |  |                 |                            |
| <b>GEV No.</b>  | 691807   | <b>Ref. No.</b> | 25730503/0<br>CM25730503/0 |
| <b>description</b>  | outflow plug for water container L 12mm ø 12mm                         |                 |                            |
| <b>For models:</b>  | N131M, N200M, N200MW, N201M, N300M, N300MW, N301M, N401M, N500M, N501M |                 |                            |

|   |   |                 |  |
|---|---|-----------------|--|
|  <p>1</p> |   |                 |  |
| <b>GEV No.</b>  | 696614  | <b>Ref. No.</b> | 25728007/0<br>CM25728007/0<br>CMNM66074100 |
| <b>description</b>  | plug for ice maker H 40mm ID ø 83mm ED ø 88mm |                 |  |

|   |  |                 |                            |
|---|--|-----------------|----------------------------|
|  <p>1</p> |  |                 |                            |
| <b>GEV No.</b>  | 696622   | <b>Ref. No.</b> | 19270501/0<br>CM19270501/0 |
| <b>description</b>  | plunger for ice maker L 63mm W 48mm H 88mm 230VAC for model N202M/N302M/M192/M202/M302 |                 |                            |

|   |   |                 |                            |
|---|---|-----------------|----------------------------|
|  |   |                 |                            |
| 1   |   |                 |                            |
| <b>GEV No.</b>  | 698719  | <b>Ref. No.</b> | 19270502/0<br>CM19270502/0 |
| <b>description</b>  | plunger for ice maker L 63mm W 48mm H 88mm 230VAC for model N402M/N502M/M402/M502 |                 |                            |

|   |  |                 |  |
|---|--|-----------------|--|
|  |  |                 |  |
| 1   |  |                 |  |
| <b>GEV No.</b>  | 695764   | <b>Ref. No.</b> | 29070018/0<br>CF72421506<br>CM29070018/0<br>CMCF72421506 |
| <b>description</b>  | probe L 100mm ED $\varnothing$ 4mm thread M3                                 |                 |  |
| <b>For models:</b>  | F100, F100C, F120, F125C, F200, F80C, F80WC, SF300, SF500, SFN1000, SFN1000W |                 |  |

|   |  |                 |                            |
|---|--|-----------------|----------------------------|
|  |  |                 |                            |
| 1   |  |                 |                            |
| <b>GEV No.</b>  | 695672   | <b>Ref. No.</b> | 25726140/0<br>CM25726140/0 |
| <b>description</b>  | probe clip L 12mm W 27mm H 18mm hole $\varnothing$ 9.5mm   |                 |                            |
| <b>For models:</b>  | N140, N25L, N25LBI, N25LW, N35BI, N35S, N35SW, N45S, N45SW, N50BI, N50BIW, N55L, N55LW, N55S, N55SW, N70S, N70SW, N90L, N90LW, N90S, N90SW |                 |                            |

|   |  |                 |                            |
|---|--|-----------------|----------------------------|
|  |  |                 |                            |
| 1   |  |                 |                            |
| <b>GEV No.</b>  | 695661   | <b>Ref. No.</b> | 25726141/0<br>CM25726141/0 |
| <b>description</b>  | probe clip L 40mm W 25mm H 18mm hole $\varnothing$ 9.5mm   |                 |                            |
| <b>For models:</b>  | N140, N25L, N25LBI, N25LW, N35BI, N35S, N35SW, N45S, N45SW, N50BI, N50BIW, N55L, N55LW, N55S, N55SW, N70S, N70SW, N90L, N90LW, N90S, N90SW |                 |                            |

|   |   |                 |                            |
|---|---|-----------------|----------------------------|
|  |   |                 |                            |
| 1   |   |                 |                            |
| <b>GEV No.</b>  | 695753  | <b>Ref. No.</b> | 29090049/0<br>CM29090049/0 |
| <b>description</b>  | rubber sleeve L 25mm W 18mm H 18mm ID $\varnothing$ 7mm ED $\varnothing$ 18mm |                 |                            |

|  |  |                 |                     |
|--|--|-----------------|---------------------|
|  |  |                 |                     |
| 1  |  |                 |                     |
| <b>GEV No.</b>   | 695584   | <b>Ref. No.</b> | nicht in Preisliste |
| <b>description</b>   | spring clip L 28mm W 10mm hole $\varnothing$ 4.5mm tube $\varnothing$ 31mm |                 |                     |

|  |   |                 |  |
|--|---|-----------------|--|
|  |   |                 |  |
| 1  |   |                 |  |
| <b>GEV No.</b>   | 695585  | <b>Ref. No.</b> | CF72418000<br>CF72418002<br>CMCF72418000<br>CMCF72418002 |
| <b>description</b>   | threaded rod thread M4 L1 130mm L2 22mm           |                 |  |
| <b>For models:</b>   | F100, F120, F200, SF300, SF500, SFN1000, SFN1000W |                 |  |

|   |                             |                 |                     |
|---|-----------------------------|-----------------|---------------------|
|  |                             |                 |                     |
| 1   |                             |                 |                     |
| <b>GEV No.</b>  | 694438                      | <b>Ref. No.</b> | nicht in Preisliste |
| <b>description</b>  | tray L 205mm W 100mm H 19mm |                 |                     |

|   |  |                 |                            |
|---|--|-----------------|----------------------------|
|  |  |                 |                            |
| 1   |  |                 |                            |
| <b>GEV No.</b>  | 695734                                 | <b>Ref. No.</b> | 25360200/0<br>CM25360200/0 |
| <b>description</b>  | union nut H 15mm ED $\varnothing$ 46mm |                 |                            |

|   |  |                 |                            |
|---|--|-----------------|----------------------------|
|  |  |                 |                            |
| 1   |  |                 |                            |
| <b>GEV No.</b>  | 695730   | <b>Ref. No.</b> | 29090000/0<br>CM29090000/0 |
| <b>description</b>  | water level tube for ice maker L 20mm W 19mm H 130mm |                 |                            |

valves

intake valves



1

|                    |  |                 |  |
|--------------------|--|-----------------|--|
| <b>GEV No.</b>     | 695685   | <b>Ref. No.</b> | 19864010/0<br>19864011/0<br>CM19864010/0<br>CM19864011/0 |
| <b>description</b> | intake valve thread M11 L 130mm ø 37mm plastic |                 |  |
| <b>For models:</b> | N200M, N200MW, N300M, N300MW, N500M            |                 |  |



1

|                    |  |                 |  |
|--------------------|--|-----------------|--|
| <b>GEV No.</b>     | 696389                                       | <b>Ref. No.</b> | 81430351/0<br>81460351/0<br>CM81430351/0<br>CM81460351/0 |
| <b>description</b> | lid for ice container L 720mm W 300mm H 23mm |                 |  |
| <b>For models:</b> | D201   |                 |  |

for ice containers

lids

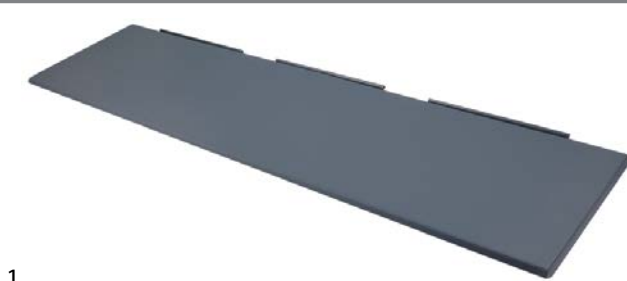

1

|                    |   |                 |                            |
|--------------------|---|-----------------|----------------------------|
| <b>GEV No.</b>     | 696382  | <b>Ref. No.</b> | 81460239/0<br>CM81460239/0 |
| <b>description</b> | lid for ice container for model D 310 L 1050mm W 280mm H 30mm |                 |                            |
| <b>For models:</b> | D310  |                 |                            |

frame



1

|                    |  |                 |                            |
|--------------------|--|-----------------|----------------------------|
| <b>GEV No.</b>     | 696657   | <b>Ref. No.</b> | 81460378/0<br>CM81460378/0 |
| <b>description</b> | frame for ice container for model D 101 L 570mm W 500mm H 70mm |                 |                            |
| <b>For models:</b> | D101   |                 |                            |

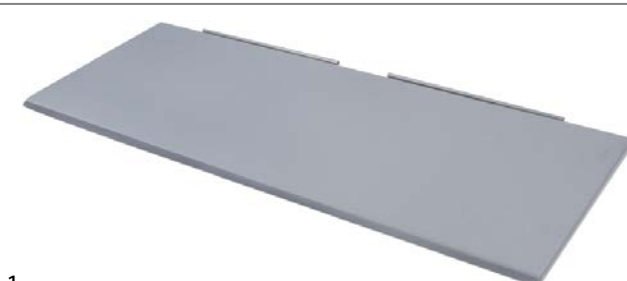

1

|                    |   |                 |                            |
|--------------------|---|-----------------|----------------------------|
| <b>GEV No.</b>     | 696426  | <b>Ref. No.</b> | 81460183/0<br>CM81460183/0 |
| <b>description</b> | lid for ice container for model D200 L 768mm W 294mm H 25mm |                 |                            |



1

|                    |  |                 |                            |
|--------------------|--|-----------------|----------------------------|
| <b>GEV No.</b>     | 695664   | <b>Ref. No.</b> | 81460341/0<br>CM81460341/0 |
| <b>description</b> | frame for ice container L 565mm W 465mm H 70mm for model D 100 |                 |                            |



1

|                    |  |                 |                            |
|--------------------|--|-----------------|----------------------------|
| <b>GEV No.</b>     | 696381   | <b>Ref. No.</b> | 81460056/0<br>CM81460056/0 |
| <b>description</b> | frame for ice container L 810mm W 465mm H 70mm for model D 200 |                 |                            |

## doors



1

|   |  |                 |                            |
|---|--|-----------------|----------------------------|
| <b>GEV No.</b>  | 696582   | <b>Ref. No.</b> | 81460355/0<br>CM81460355/0 |
| <b>description</b>  | door for model B390/B393 L 767mm W 28mm H 310mm              |                 |                            |
| <b>accessories for</b>  | 696582   |                 |                            |
|  | <b>GEV No.</b>   | <b>Ref. No.</b> | 19350201/0<br>CM19350201/0 |
|   | foam rubber gasket W 15mm thickness 8mm self-adhesive Qty 1m |                 |                            |

## for proving cabinets

## drain hose systems



1

|                    |  |                 |                            |
|--------------------|--|-----------------|----------------------------|
| <b>GEV No.</b>     | 698602   | <b>Ref. No.</b> | 400UMSIF01<br>CM400UMSIF01 |
| <b>description</b> | U-bend PVC flexible $\varnothing$ 20mm L 33/21mm elbow |                 |                            |

## steam generators



1

|                    |  |                 |                          |
|--------------------|--|-----------------|--------------------------|
| <b>GEV No.</b>     | 698572   | <b>Ref. No.</b> | 400UMCL04<br>CM400UMCL04 |
| <b>description</b> | humidifier type 400UMCL04 H 195mm $\varnothing$ 209mm conductivity 250-1300 $\mu$ S/cm <sup>2</sup> 3 phase incl. gasket |                 |                          |



1

|                    |   |                 |                          |
|--------------------|---|-----------------|--------------------------|
| <b>GEV No.</b>     | 698570  | <b>Ref. No.</b> | 400UMCL01<br>CM400UMCL01 |
| <b>description</b> | humidifier type 400UMIVALV H 245mm $\varnothing$ 201mm conductivity 250-1300 $\mu$ S/cm <sup>2</sup> 3 phase incl. gasket |                 |                          |





1

|                    |   |                 |  |
|--------------------|---|-----------------|--|
| <b>GEV No.</b>     | 698569  | <b>Ref. No.</b> | 19120427/0<br>CM19120427/0<br>F401TA0000 |
| <b>description</b> | humidifier type F401TA0000 H 300mm ø 150mm conductivity 125-1250µS/cm <sup>2</sup> 1 phase incl. gasket |                 |  |



1

|                    |  |                 |  |
|--------------------|--|-----------------|--|
| <b>GEV No.</b>     | 698568   | <b>Ref. No.</b> | 19120431/0<br>CM19120431/0<br>L401TA0000 |
| <b>description</b> | humidifier type L401TA0000 H 28mm ø 160mm conductivity 125-1250µS/cm <sup>2</sup> 1 phase incl. gasket |                 |  |



1

|                    |  |                 |  |
|--------------------|--|-----------------|--|
| <b>GEV No.</b>     | 698567   | <b>Ref. No.</b> | 19120429/0<br>CM19120429/0<br>L201MA0000 |
| <b>description</b> | humidifier type L201MA0000 H 28mm ø 160mm conductivity 125-1250µS/cm <sup>2</sup> 1 phase incl. gasket |                 |  |

## handles and hand wheels

### star handles

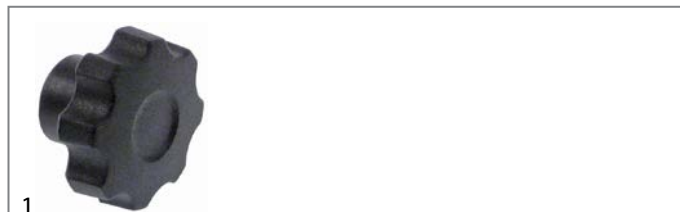

1

|                    |   |                 |                            |
|--------------------|---|-----------------|----------------------------|
| <b>GEV No.</b>     | 698606  | <b>Ref. No.</b> | 19950003/0<br>CM19950003/0 |
| <b>description</b> | star handle thread M4 ø 25.3mm L 16.5mm black |                 |                            |

### bracket handles



1

|                    |   |                 |                            |
|--------------------|---|-----------------|----------------------------|
| <b>GEV No.</b>     | 700989  | <b>Ref. No.</b> | 28190005/0<br>CM28190005/0 |
| <b>description</b> | pull handle L 325mm H 16mm mounting distance 254mm W 36.5mm chrome-plated |                 |                            |

|   |                          |        |                 |  |
|---|--------------------------|--------|-----------------|--|
| <b>accessories for</b>  | 700989                   |        |                 |  |
|  | <b>GEV No.</b>           | 692526 | <b>Ref. No.</b> | 28040018<br>28040018/0<br>CM28040018/0 |
|   | cover for handle plastic |        |                 |  |

## covers



|                    |                          |                 |  |
|--------------------|--------------------------|-----------------|--|
| 1                  |                          |                 |  |
| <b>GEV No.</b>     | 692526                   | <b>Ref. No.</b> | 28040018<br>28040018/0<br>CM28040018/0 |
| <b>description</b> | cover for handle plastic |                 |  |

## fasteners

### locking screws



|                    |  |                 |                            |
|--------------------|--|-----------------|----------------------------|
| 1                  |  |                 |                            |
| <b>GEV No.</b>     | 697742   | <b>Ref. No.</b> | 19950006/0<br>CM19950006/0 |
| <b>description</b> | locking screw thread M4 handle ø 17mm black L 10mm |                 |                            |



|                    |  |                 |                            |
|--------------------|--|-----------------|----------------------------|
| 1                  |  |                 |                            |
| <b>GEV No.</b>     | 697519   | <b>Ref. No.</b> | 19950004/0<br>CM19950004/0 |
| <b>description</b> | locking screw thread M5 handle ø 21mm black L 10mm |                 |                            |

## recessed handles

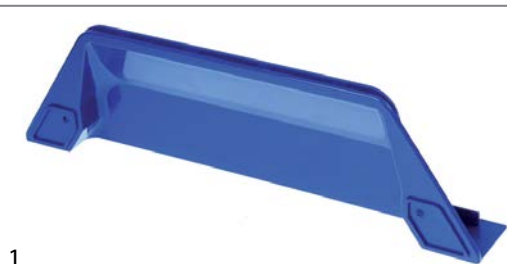

|                    |                                  |                 |                            |
|--------------------|----------------------------------|-----------------|----------------------------|
| 1                  |                                  |                 |                            |
| <b>GEV No.</b>     | 695721                           | <b>Ref. No.</b> | 28000096/0<br>CM28000096/0 |
| <b>description</b> | grip shell L 330mm W 44mm H 96mm |                 |                            |

## hinges

### piano hinges

#### producer-specific

#### CASTEL



|                    |   |                 |                            |
|--------------------|---|-----------------|----------------------------|
| 1                  |   |                 |                            |
| <b>GEV No.</b>     | 701030  | <b>Ref. No.</b> | 19120045/0<br>CM19120045/0 |
| <b>description</b> | hinge controllable L 43mm W 37mm hole ø 4mm for ice container mounting distance 26/32mm plastic |                 |                            |

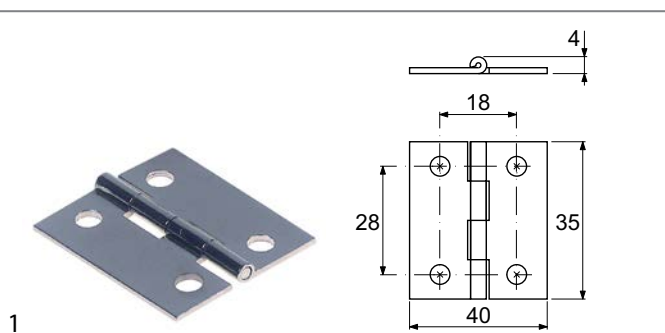

|                    |  |                 |                            |
|--------------------|--|-----------------|----------------------------|
| 1                  |  |                 |                            |
| <b>GEV No.</b>     | 691804   | <b>Ref. No.</b> | 19120050/0<br>CM19120050/0 |
| <b>description</b> | hinge L 40mm W 35mm H 4mm mounting distance 28mm hole ø 5mm thickness 1.3mm brass ICEMATIC   |                 |                            |
| <b>For models:</b> | F100C, F125C, F80C, F80WC, N20L, N20WL, N25BI, N25L, N25LBI, N25LW, N25S, N25SW, N35BI, N35S, N35SW, N45L, N45S, N45SW, N50BI, N50BIW, N55L, N55LW, N55S, N55SW, N70S, N70SW, N90L, N90LW, N90S, N90SW |                 |                            |

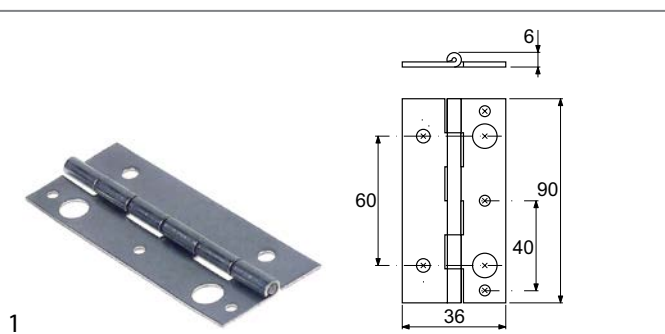

|                    |   |                 |                            |
|--------------------|---|-----------------|----------------------------|
| 1                  |   |                 |                            |
| <b>GEV No.</b>     | 691805  | <b>Ref. No.</b> | 25130137/0<br>CM25130137/0 |
| <b>description</b> | hinge L 90mm W 36mm H 6mm mounting distance 60mm mounting distance 1 40mm mounting distance 2 40mm hole ø 3/5mm thickness 1.2mm stainless steel |                 |                            |
| <b>For models:</b> | D101, D201  |                 |                            |



spring assisted hinges

universal

CAFF/FERMOD

group 2



1

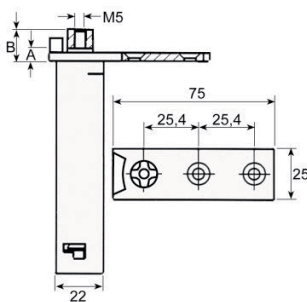

|                    |  |                 |                            |
|--------------------|--|-----------------|----------------------------|
| <b>GEV No.</b>     | 690494   | <b>Ref. No.</b> | 19120054/0<br>CM19120054/0 |
| <b>description</b> | spring assisted hinge series 175 mounting pos. left/right torx L 75mm W 25.6mm H 100mm A 4mm B 11mm mounting measurements 22x22mm intake torx refrigeration units mounting distance 25mm |                 |                            |

door bearing



1

|                    |                            |                 |  |
|--------------------|----------------------------|-----------------|--|
| <b>GEV No.</b>     | 690583                     | <b>Ref. No.</b> | 28294982/0<br>28294990/0<br>CM28294982/0<br>CM28294990/0 |
| <b>description</b> | hinge bearing without bolt |                 |  |

miscellaneous



1

|                    |        |                 |                            |
|--------------------|--------|-----------------|----------------------------|
| <b>GEV No.</b>     | 695727 | <b>Ref. No.</b> | 25130130/0<br>CM25130130/0 |
| <b>description</b> | hinge  |                 |                            |

filters

air filters

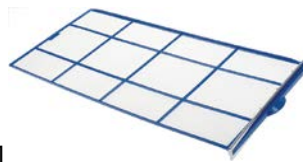

1

|                    |                                  |                 |                            |
|--------------------|----------------------------------|-----------------|----------------------------|
| <b>GEV No.</b>     | 970890                           | <b>Ref. No.</b> | 81400187/0<br>CM81400187/0 |
| <b>description</b> | air filter L 540mm W 250mm H 6mm |                 |                            |
| <b>For models:</b> | N25LBI, N35BI                    |                 |                            |

device filters

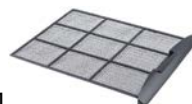

1

|                    |  |                 |                            |
|--------------------|--|-----------------|----------------------------|
| <b>GEV No.</b>     | 970877   | <b>Ref. No.</b> | 25339013/0<br>CM25339013/0 |
| <b>description</b> | air filter L 335mm W 238mm H 3mm plastic for ice maker |                 |                            |

equipment feet and end caps

equipment feet

with screw mounting

universal



1

|                    |   |                 |                            |
|--------------------|---|-----------------|----------------------------|
| <b>GEV No.</b>     | 701458  | <b>Ref. No.</b> | 25570707/0<br>CM25570707/0 |
| <b>description</b> | equipment foot tube ø 52mm thread M10 thread L 25mm H 104-115mm stainless steel size 2" Qty 1 pcs |                 |                            |

components



1

|                    |  |                 |                            |
|--------------------|--|-----------------|----------------------------|
| <b>GEV No.</b>     | 701093   | <b>Ref. No.</b> | 25570880/0<br>CM25570880/0 |
| <b>description</b> | equipment foot tube ø 47mm H 68mm plastic thread 1¼" ET  |                 |                            |
| <b>For models:</b> | F100C, F125C, N140, N45L, N45S, N45SW, N55L, N55LW, N55S, N55SW, N70S, N70SW, N90L, N90LW, N90S, N90SW |                 |                            |

components



1

|                    |  |                 |                            |
|--------------------|--|-----------------|----------------------------|
| <b>GEV No.</b>     | 701093   | <b>Ref. No.</b> | 25570880/0<br>CM25570880/0 |
| <b>description</b> | equipment foot tube ø 47mm H 68mm plastic thread 1¼" ET  |                 |                            |
| <b>For models:</b> | F100C, F125C, N140, N45L, N45S, N45SW, N55L, N55LW, N55S, N55SW, N70S, N70SW, N90L, N90LW, N90S, N90SW |                 |                            |



1

|                    |  |                 |  |
|--------------------|--|-----------------|--|
| <b>GEV No.</b>     | 700103   | <b>Ref. No.</b> | 19490020/0<br>81502140/0<br>CM19490020/0<br>CM81502140/0 |
| <b>description</b> | equipment foot tube ø 56mm plate size mm hole distance mm H 130mm SS size 2" Qty 1 pcs |                 |  |
| <b>For models:</b> | D101, D201, D310   |                 |  |



1

|                    |  |                 |  |
|--------------------|--|-----------------|--|
| <b>GEV No.</b>     | 700103   | <b>Ref. No.</b> | 19490020/0<br>81502140/0<br>CM19490020/0<br>CM81502140/0 |
| <b>description</b> | equipment foot tube ø 56mm plate size mm hole distance mm H 130mm SS size 2" Qty 1 pcs |                 |  |
| <b>For models:</b> | D101, D201, D310   |                 |  |

with fixing plate



1

|                    |   |                 |                            |
|--------------------|---|-----------------|----------------------------|
| <b>GEV No.</b>     | 700823  | <b>Ref. No.</b> | 81502140/0<br>CM81502140/0 |
| <b>description</b> | equipment foot tube ø 64mm plate size 80x100mm hole distance 56x78mm H 130-185mm SS size 2 1/2" Qty 1 pcs |                 |                            |



1

|                    |  |                 |  |
|--------------------|--|-----------------|--|
| <b>GEV No.</b>     | 691803   | <b>Ref. No.</b> | 81400690/0<br>95000100/0<br>CM81400690/0<br>CM95000100/0 |
| <b>description</b> | equipment foot tube ø 68mm plate size 45x50mm hole distance mm H 175-190mm plastic Qty 1 pcs |                 |  |



1

|                    |   |                 |                            |
|--------------------|---|-----------------|----------------------------|
| <b>GEV No.</b>     | 695917  | <b>Ref. No.</b> | 25460020/0<br>CM25460020/0 |
| <b>description</b> | equipment foot tube ø 63mm plate size mm hole distance mm H 100mm plastic size 2 1/3" Qty 1 pcs   |                 |                            |
| <b>For models:</b> | F100C, F125C, N140, N25L, N25LBI, N25LW, N35BI, N35S, N35SW, N45S, N45SW, N55L, N55LW, N55S, N55SW, N70S, N70SW, N90L, N90LW, N90S, N90SW |                 |                            |



miscellaneous



1

|                    |   |                 |                            |
|--------------------|---|-----------------|----------------------------|
| <b>GEV No.</b>     | 695677  | <b>Ref. No.</b> | 25570870/0<br>CM25570870/0 |
| <b>description</b> | equipment foot tube ø 46/68mm H 175-190mm plastic thread 1¼" IT |                 |                            |
| <b>For models:</b> | N25L, N25LBI, N25LW, N35BI, N35S, N35SW                         |                 |                            |

screw-in feet



1

|                    |  |                 |                            |
|--------------------|--|-----------------|----------------------------|
| <b>GEV No.</b>     | 695738   | <b>Ref. No.</b> | 81502119/0<br>CM81502119/0 |
| <b>description</b> | equipment foot thread M8 thread L 27mm ø 30mm H 12mm Qty 1 pcs |                 |                            |
| <b>For models:</b> | F80C, F80WC, N25L, N25LBI, N25LW, N35BI, N35S, N35SW, N45L     |                 |                            |

end caps and plugs

for square pipes

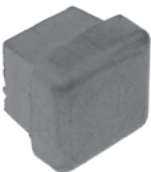

1

|                    |  |                 |                            |
|--------------------|--|-----------------|----------------------------|
| <b>GEV No.</b>     | 695068                                       | <b>Ref. No.</b> | 25728011/0<br>CM25728011/0 |
| <b>description</b> | end cap for ice maker insertion size 13x13mm |                 |                            |
| <b>For models:</b> | N21S   |                 |                            |

miscellaneous



1

|                    |   |                 |                            |
|--------------------|---|-----------------|----------------------------|
| <b>GEV No.</b>     | 695722  | <b>Ref. No.</b> | 81400690/0<br>CM81400690/0 |
| <b>description</b> | mounting plate thread 1¼" L 55mm W 50mm H 27mm hole ø 9.5mm |                 |                            |
| <b>For models:</b> | N25L, N25LBI, N25LW, N35BI, N35S, N35SW                     |                 |                            |

shelves and shelf rails

grates

universal

without upstand



1

|                    |  |                 |                            |
|--------------------|--|-----------------|----------------------------|
| <b>GEV No.</b>     | 970689                                       | <b>Ref. No.</b> | 26107225/0<br>CM26107225/0 |
| <b>description</b> | grate W 325mm D 530mm GN 1/1 stainless steel |                 |                            |

with upstand



1

|                    |  |                 |  |
|--------------------|--|-----------------|--|
| <b>GEV No.</b>     | 970556   | <b>Ref. No.</b> | 28174022<br>28174028<br>28174028/0<br>CM28174028/0 |
| <b>description</b> | grate W 530mm D 650mm GN 2/1 plastic-coated steel with hinge camp wire gauge frame 9mm lengthwise wires gauge 5mm crossing wires 2 white suitable for refrigerator |                 |  |

|                        |        |  |  |
|------------------------|--------|--|--|
| <b>accessories for</b> | 970556 |  |  |
|------------------------|--------|--|--|

|                |        |                 |   |
|----------------|--------|-----------------|---|
| <b>GEV No.</b> | 690330 | <b>Ref. No.</b> | — |
|----------------|--------|-----------------|---|

|                    |  |  |  |
|--------------------|--|--|--|
| <b>description</b> | rack L 1000mm W 22mm H 4mm aperture 3x8mm hole distance 12.5mm stainless steel |  |  |
|--------------------|--|--|--|

|                |        |                 |   |
|----------------|--------|-----------------|---|
| <b>GEV No.</b> | 690332 | <b>Ref. No.</b> | — |
|----------------|--------|-----------------|---|

|                    |  |  |  |
|--------------------|--|--|--|
| <b>description</b> | shelf support L 31/28mm W 22mm H 17mm SS with hook Qty 1 pcs |  |  |
|--------------------|--|--|--|

|                |        |                 |   |
|----------------|--------|-----------------|---|
| <b>GEV No.</b> | 694700 | <b>Ref. No.</b> | — |
|----------------|--------|-----------------|---|

|                    |   |  |  |
|--------------------|---|--|--|
| <b>description</b> | shelf support L 31/28mm W 22mm H 18mm SS Qty 12 pcs |  |  |
|--------------------|---|--|--|

|                |        |                 |   |
|----------------|--------|-----------------|---|
| <b>GEV No.</b> | 694701 | <b>Ref. No.</b> | — |
|----------------|--------|-----------------|---|

|                    |   |  |  |
|--------------------|---|--|--|
| <b>description</b> | shelf support L 31/28mm W 22mm H 17mm SS with hook Qty 12 pcs |  |  |
|--------------------|---|--|--|

shelf rails and supports

producer-specific



1

|                |        |                 |                            |
|----------------|--------|-----------------|----------------------------|
| <b>GEV No.</b> | 695908 | <b>Ref. No.</b> | 98000700/1<br>CM98000700/1 |
|----------------|--------|-----------------|----------------------------|

|                    |  |  |  |
|--------------------|--|--|--|
| <b>description</b> | pair of setting bar U-shape L 620mm W 15mm inner height 22mm |  |  |
|--------------------|--|--|--|

**gaskets**

**refrigeration gaskets**

**plug-in gaskets**

**profile 9048**

We offer custom-made gaskets for this profile

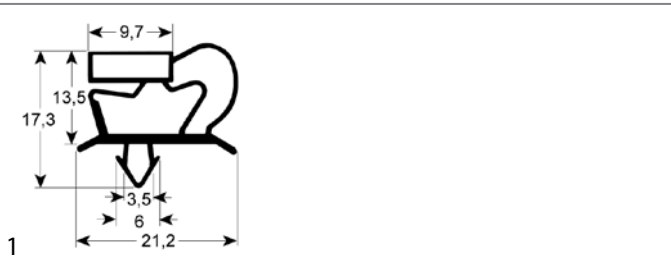

|                    |  |                 |                            |
|--------------------|--|-----------------|----------------------------|
| <b>GEV No.</b>     | 901970   | <b>Ref. No.</b> | 26100379/0<br>CM26100379/0 |
| <b>description</b> | refrigeration gasket profile 9048 W 1130mm L 755mm plug size |                 |                            |

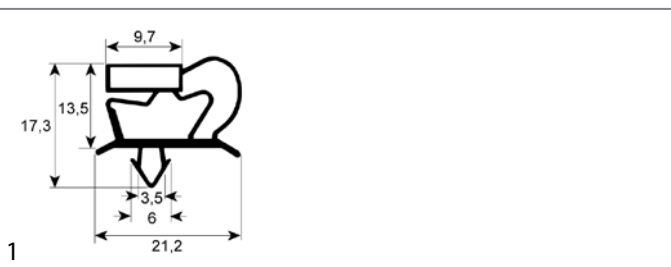

|                    |   |                 |  |
|--------------------|---|-----------------|--|
| <b>GEV No.</b>     | 901218  | <b>Ref. No.</b> | 19352024<br>19352024/0<br>CM19352024/0 |
| <b>description</b> | refrigeration gasket profile 9048 W 301mm L 367mm plug size for blast chiller |                 |  |

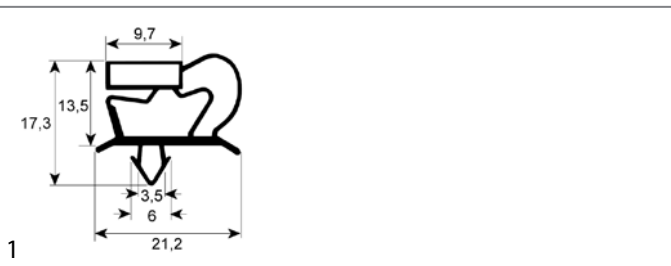

|                    |   |                 |  |
|--------------------|---|-----------------|--|
| <b>GEV No.</b>     | 901217  | <b>Ref. No.</b> | 26107202<br>26107202/0<br>CM26107202/0 |
| <b>description</b> | refrigeration gasket profile 9048 W 395mm L 711mm plug size for blast chiller |                 |  |
| <b>For models:</b> | T5  |                 |  |

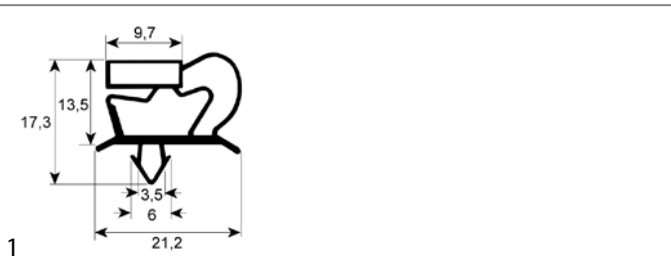

|                    |  |                 |  |
|--------------------|--|-----------------|--|
| <b>GEV No.</b>     | 901216   | <b>Ref. No.</b> | 26107203<br>26107203/0<br>CM26107203/0 |
| <b>description</b> | refrigeration gasket profile 9048 W 705mm L 1030mm plug size for blast chiller |                 |  |
| <b>For models:</b> | T14  |                 |  |

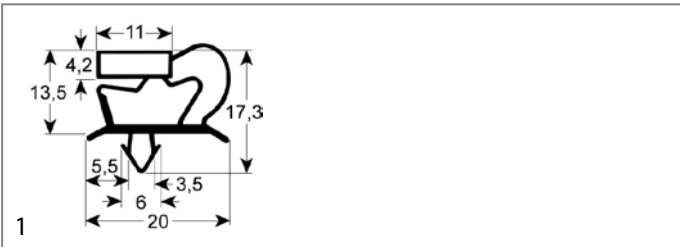

|                    |   |                 |              |
|--------------------|---|-----------------|--------------|
| <b>GEV No.</b>     | 902442  | <b>Ref. No.</b> | CM26100291/0 |
| <b>description</b> | refrigeration gasket profile 9048 W 751mm L 766mm plug size Qty 1 blast freezer |                 |              |

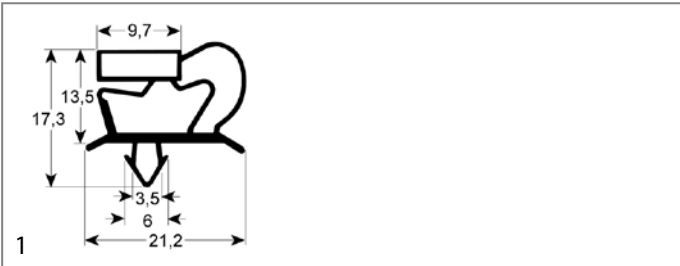

|                    |   |                 |                            |
|--------------------|---|-----------------|----------------------------|
| <b>GEV No.</b>     | 901969  | <b>Ref. No.</b> | 26103838/0<br>CM26103838/0 |
| <b>description</b> | refrigeration gasket profile 9048 W 752mm L 395mm plug size |                 |                            |

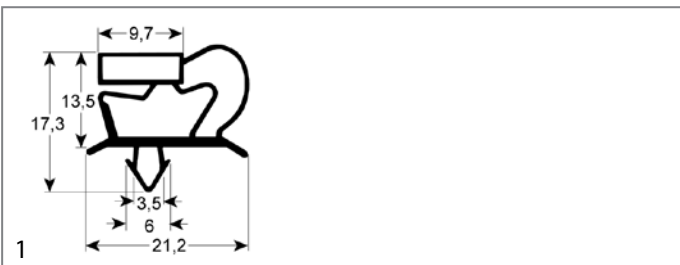

|                    |   |                 |                            |
|--------------------|---|-----------------|----------------------------|
| <b>GEV No.</b>     | 901973  | <b>Ref. No.</b> | 19350510/0<br>CM19350510/0 |
| <b>description</b> | refrigeration gasket profile 9048 W 875mm L 715mm plug size |                 |                            |

**profile 9773**

We offer custom-made gaskets for this profile

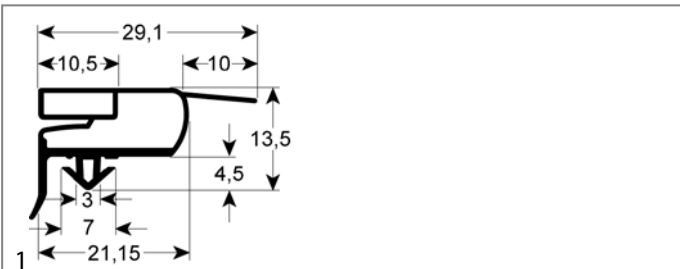

|                    |   |                 |           |
|--------------------|---|-----------------|-----------|
| <b>GEV No.</b>     | 901089  | <b>Ref. No.</b> | CM4612038 |
| <b>description</b> | refrigeration gasket profile 9773 W 640mm L 1540mm external size W1 627mm L1 1527mm plug size |                 |           |

mechanical components, equipment accessories

profile 9704

We offer custom-made gaskets for this profile

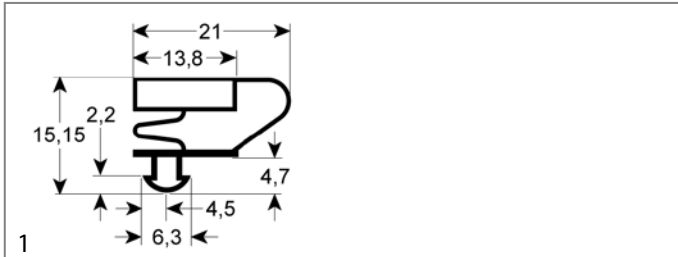

|                    |   |                 |                            |
|--------------------|---|-----------------|----------------------------|
| <b>GEV No.</b>     | 901974  | <b>Ref. No.</b> | 19352010/0<br>CM19352010/0 |
| <b>description</b> | refrigeration gasket profile 9704 W 605mm L 475mm plug size |                 |                            |

profile 9151

We offer custom-made gaskets for this profile

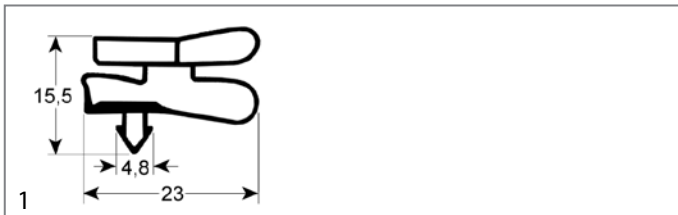

|                    |   |                 |                            |
|--------------------|---|-----------------|----------------------------|
| <b>GEV No.</b>     | 900878  | <b>Ref. No.</b> | 28175018/0<br>CM28175018/0 |
| <b>description</b> | refrigeration gasket profile 9151 W 705mm L 770mm rectangular |                 |                            |

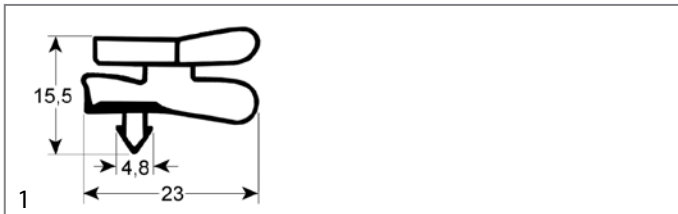

|                    |   |                 |                            |
|--------------------|---|-----------------|----------------------------|
| <b>GEV No.</b>     | 900368  | <b>Ref. No.</b> | 28175017/0<br>CM28175017/0 |
| <b>description</b> | refrigeration gasket profile 9151 W 715mm L 1580mm plug size L1 1570mm W1 705mm external size |                 |                            |

profile 9251

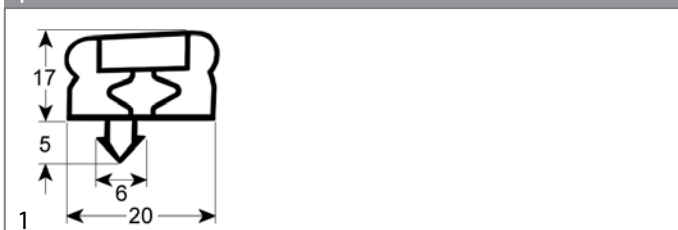

|                    |   |                 |                            |
|--------------------|---|-----------------|----------------------------|
| <b>GEV No.</b>     | 901972  | <b>Ref. No.</b> | 19350506/0<br>CM19350506/0 |
| <b>description</b> | refrigeration gasket profile 9251 W 1000mm L 2750mm plug size 3-sided |                 |                            |



|                    |   |                 |                            |
|--------------------|---|-----------------|----------------------------|
| <b>GEV No.</b>     | 901971  | <b>Ref. No.</b> | 19350157/0<br>CM19350157/0 |
| <b>description</b> | refrigeration gasket profile 9251 W 850mm L 662mm plug size |                 |                            |

miscellaneous



|                    |                                 |                 |                            |
|--------------------|---------------------------------|-----------------|----------------------------|
| <b>GEV No.</b>     | 902010                          | <b>Ref. No.</b> | 19550126/0<br>CM19550126/0 |
| <b>description</b> | gasket plug-in gasket size 7x13 |                 |                            |

O-rings

EPDM

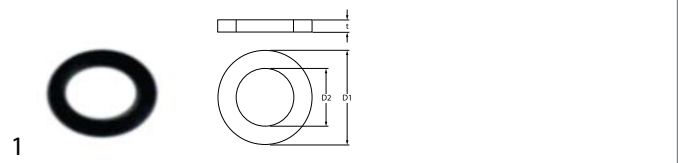

|                    |   |                 |                            |
|--------------------|---|-----------------|----------------------------|
| <b>GEV No.</b>     | 528485  | <b>Ref. No.</b> | CF64010000<br>CMCF64010000 |
| <b>description</b> | O-ring EPDM thickness 1.78mm ID ø 6.07mm Qty 1 pcs                    |                 |                            |
| <b>For models:</b> | F100, F120, F125C, F200, F80C, F80WC, SF300, SF500, SFN1000, SFN1000W |                 |                            |

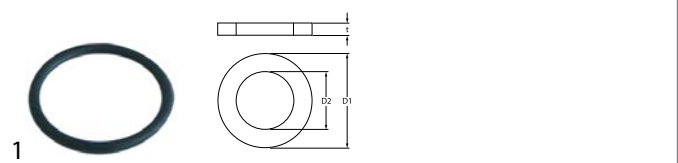

|                    |   |                 |                            |
|--------------------|---|-----------------|----------------------------|
| <b>GEV No.</b>     | 510769  | <b>Ref. No.</b> | CF64004101<br>CMCF64004101 |
| <b>description</b> | O-ring EPDM thickness 2.62mm ID ø 25.07mm Qty 1 pcs |                 |                            |
| <b>For models:</b> | F100, F100C, F120, F125C, F200, F80C, F80WC         |                 |                            |

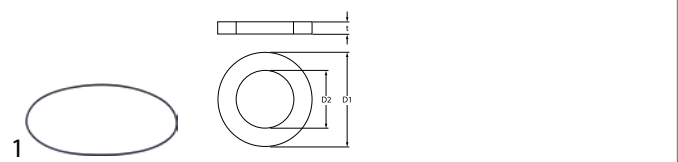

|                    |  |                 |                            |
|--------------------|--|-----------------|----------------------------|
| <b>GEV No.</b>     | 528094   | <b>Ref. No.</b> | CF64008400<br>CMCF64008400 |
| <b>description</b> | O-ring EPDM thickness 2mm ID ø 171mm Qty 1 pcs |                 |                            |
| <b>For models:</b> | F100, F100C, F120, F125C, F80C, F80WC          |                 |                            |



|                    |  |                 |  |
|--------------------|--|-----------------|--|
| <b>GEV No.</b>     | 361085                                       | <b>Ref. No.</b> | 41020448<br>41020448/0<br>CM41020448/0 |
| <b>description</b> | O-ring EPDM thickness 2mm ID ø 8mm Qty 1 pcs |                 |  |
| <b>For models:</b> | N200M, N200MW, N300M, N300MW, N500M          |                 |  |

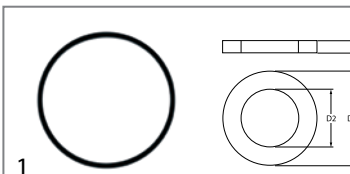

|                    |   |                 |                            |
|--------------------|---|-----------------|----------------------------|
| <b>GEV No.</b>     | 510009  | <b>Ref. No.</b> | CF64009303<br>CMCF64009303 |
| <b>description</b> | O-ring EPDM thickness 3.53mm ID ø 101.2mm Qty 1 pcs |                 |                            |
| <b>For models:</b> | SF300, SF500, SFN1000, SFN1000W                     |                 |                            |

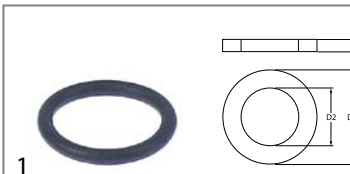

|                    |  |                 |                            |
|--------------------|--|-----------------|----------------------------|
| <b>GEV No.</b>     | 517087   | <b>Ref. No.</b> | 19035151/0<br>CM19035151/0 |
| <b>description</b> | O-ring EPDM thickness 3.53mm ID ø 23.4mm Qty 1 pcs |                 |                            |
| <b>For models:</b> | N21S   |                 |                            |

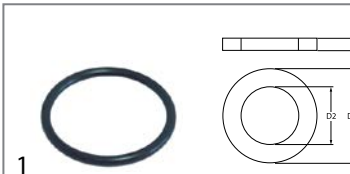

|                    |   |                 |  |
|--------------------|---|-----------------|--|
| <b>GEV No.</b>     | 510895  | <b>Ref. No.</b> | 29000023<br>CF64009302<br>CMCF64009302 |
| <b>description</b> | O-ring EPDM thickness 3.53mm ID ø 34.52mm Qty 1 pcs |                 |  |
| <b>For models:</b> | SF300, SF500, SFN1000, SFN1000W                     |                 |  |

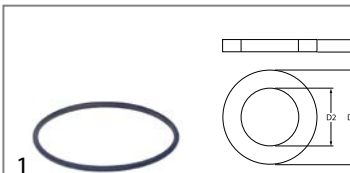

|                    |   |                 |                            |
|--------------------|---|-----------------|----------------------------|
| <b>GEV No.</b>     | 532534  | <b>Ref. No.</b> | 29000002/0<br>CM29000002/0 |
| <b>description</b> | O-ring EPDM thickness 3.53mm ID ø 82.14mm Qty 1 pcs |                 |                            |

### silicone



|                    |   |                 |  |
|--------------------|---|-----------------|--|
| <b>GEV No.</b>     | 695064  | <b>Ref. No.</b> | 29000022<br>CF64004120<br>CMCF64004120 |
| <b>description</b> | O-ring silicone thickness 2mm ID ø 66.4mm Qty 1 pcs |                 |  |

### Viton



|                    |   |                 |        |
|--------------------|---|-----------------|--------|
| <b>GEV No.</b>     | 528250  | <b>Ref. No.</b> | I-1087 |
| <b>description</b> | O-ring Viton thickness 2mm ID ø 8mm Qty 1 pcs |                 |        |

### NBR



|                    |  |                 |                            |
|--------------------|--|-----------------|----------------------------|
| <b>GEV No.</b>     | 697879   | <b>Ref. No.</b> | 1300061738<br>CM1300061738 |
| <b>description</b> | O-ring NBR thickness 2.62mm ID ø 219mm Qty 1 pcs |                 |                            |
| <b>For models:</b> | SF300, SF500                                     |                 |                            |

## sealing washers

### rubber gaskets



|                    |  |                 |                            |
|--------------------|--|-----------------|----------------------------|
| <b>GEV No.</b>     | 510764   | <b>Ref. No.</b> | 19350158/0<br>CM19350158/0 |
| <b>description</b> | flat gasket rubber ED ø 24mm ID ø 12mm thickness 2mm Qty 1 pcs   |                 |                            |
| <b>For models:</b> | N20L, N20WL, N25L, N25LW, N25SW, N35S, N35SW, N45L, N45S, N45SW, N55L, N55LW, N55S, N55SW, N70S, N70SW, N90L, N90LW, N90S, N90SW |                 |                            |

### foam rubber gaskets





|                    |   |                 |                            |
|--------------------|---|-----------------|----------------------------|
| <b>GEV No.</b>     | 691329  | <b>Ref. No.</b> | 19535169/0<br>CM19535169/0 |
| <b>description</b> | foam rubber gasket W 10mm thickness 5mm self-adhesive Qty supplied by meter |                 |                            |





|   |  |                 |                            |
|---|--|-----------------|----------------------------|
|  |  |                 |                            |
| 1   |  |                 |                            |
| <b>GEV No.</b>  | 508418   | <b>Ref. No.</b> | 19350201/0<br>CM19350201/0 |
| <b>description</b>  | foam rubber gasket W 15mm thickness 8mm self-adhesive Qty 1m |                 |                            |

|   |   |                 |                     |
|---|---|-----------------|---------------------|
|  |   |                 |                     |
| 1   |   |                 |                     |
| <b>GEV No.</b>  | 695758  | <b>Ref. No.</b> | nicht in Preisliste |
| <b>description</b>  | foam rubber gasket W 15mm thickness 8mm self-adhesive Qty 3m profile half-round |                 |                     |

|   |   |                 |                               |
|---|---|-----------------|-------------------------------|
|  |   |                 |                               |
| 1   |   |                 |                               |
| <b>GEV No.</b>  | 901292  | <b>Ref. No.</b> | nicht in Preisliste enthalten |
| <b>description</b>  | foam rubber gasket W 15mm thickness 8mm self-adhesive Qty supplied by meter |                 |                               |

|   |  |                 |                            |
|---|--|-----------------|----------------------------|
|  |  |                 |                            |
| 1   |  |                 |                            |
| <b>GEV No.</b>  | 693787   | <b>Ref. No.</b> | 19352049/0<br>CM19352049/0 |
| <b>description</b>  | foam rubber gasket ø 6mm Qty supplied by meter |                 |                            |

shaft gaskets

shaft gaskets

|   |  |                 |                                       |
|---|--|-----------------|---------------------------------------|
|  |  |                 |                                       |
| 1   |  |                 |                                       |
| <b>GEV No.</b>  | 698239   | <b>Ref. No.</b> | 2904001<br>CF64008300<br>CMCF64008300 |
| <b>description</b>  | shaft seal ID ø 11.91mm ED ø 18.24mm thickness 5mm |                 |                                       |
| <b>For models:</b>  | F100, F100C, F120, F125C, F80C, F80WC              |                 |                                       |

|  |   |                 |  |
|--|---|-----------------|--|
|  |   |                 |  |
| 1  |   |                 |  |
| <b>GEV No.</b>   | 511532  | <b>Ref. No.</b> | CF02160600<br>CM02001606<br>CMCF02160600 |
| <b>description</b>   | shaft seal ID ø 15mm ED ø 25.5mm thickness 6.5mm for ice-cube maker |                 |  |
| <b>For models:</b>   | SF300, SF500, SFN1000, SFN1000W                                     |                 |  |

|  |  |                 |  |
|--|--|-----------------|--|
|  |  |                 |  |
| 1  |  |                 |  |
| <b>GEV No.</b>   | 511534   | <b>Ref. No.</b> | 64001901<br>CF02160700<br>CF64001901<br>CMCF02160700<br>CMCF64001901 |
| <b>description</b>   | shaft seal ID ø 22mm ED ø 32mm thickness 5.5mm |                 |  |
| <b>For models:</b>   | F100, F100C, F120, F125C, F200, F80C, F80WC    |                 |  |

|  |  |                 |  |
|--|--|-----------------|--|
|  |  |                 |  |
| 1  |  |                 |  |
| <b>GEV No.</b>   | 511533   | <b>Ref. No.</b> | CF02285301<br>CMCF02002853<br>CMCF02285301 |
| <b>description</b>   | shaft seal ID ø 25mm ED ø 34mm thickness 5mm for ice maker |                 |  |
| <b>For models:</b>   | SF300, SF500, SFN1000, SFN1000W                            |                 |  |

special gaskets

for ice cube maker

|  |   |                 |                            |
|--|---|-----------------|----------------------------|
|  |   |                 |                            |
| 1  |   |                 |                            |
| <b>GEV No.</b>   | 901968  | <b>Ref. No.</b> | 19350507/0<br>CM19350507/0 |
| <b>description</b>   | door seal for ice-cube maker L 515mm W 45mm thickness 10mm silicone |                 |                            |

for vacuum packers

|   |  |                 |                            |
|---|--|-----------------|----------------------------|
|  |  |                 |                            |
| 1   |  |                 |                            |
| <b>GEV No.</b>  | 693787   | <b>Ref. No.</b> | 19352049/0<br>CM19352049/0 |
| <b>description</b>  | foam rubber gasket ø 6mm Qty supplied by meter |                 |                            |

## refrigeration cycle components

### cooling water regulators

#### JOHNSON CONTROLS



|                    |  |                 |                            |
|--------------------|--|-----------------|----------------------------|
| <b>GEV No.</b>     | 541189   | <b>Ref. No.</b> | 19865611/0<br>CM19865611/0 |
| <b>description</b> | cooling water regulator 3/8" type V46AA-9608 connection 7/16" UNF (1/4" SAE) pressure range 5-18bar water pressure max. 10bar water temperature max. 90°C capillary pipe 750mm L 160mm 0.9kg |                 |                            |
| <b>For models:</b> | F100C, F125C, N131M, N140, N200MW, N201M, N300MW, N301M, N401M, N45S, N45SW, N500M, N501M, N50BI, N50BIW, N70SW, N90LW, N90SW  |                 |                            |



|                    |  |                 |  |
|--------------------|--|-----------------|--|
| <b>GEV No.</b>     | 541483   | <b>Ref. No.</b> | 19870815/0<br>29087021/0<br>CF62011100<br>CM19870815/0<br>CM29087021/0<br>CMCF62011100 |
| <b>description</b> | cooling water regulator 3/8" type V46AA-9950 connection 6mm soldering connection pressure range 5-18bar water pressure max. 10bar water temperature max. 90°C capillary pipe 750mm L 160mm 0.9kg |                 |  |
| <b>For models:</b> | F100, F120, F200, N20L, N20WL, SF300, SF500, SFN1000W  |                 |  |

### valves

#### expansion valves

#### DANFOSS

#### valves

#### type TS2/TE52



|                    |  |                 |                            |
|--------------------|--|-----------------|----------------------------|
| <b>GEV No.</b>     | 750178   | <b>Ref. No.</b> | 19870826/0<br>CM19870826/0 |
| <b>description</b> | expansion valve DANFOSS type TS2 coolant R404a/R507 angled 90° inlet 3/8" SAE outlet 1/2" SAE p max 28bar -40 up to -5°C capillary pipe 1500mm |                 |                            |
| <b>For models:</b> | N200M, N200MW, N300M, N300MW   |                 |                            |



|                    |   |                 |                            |
|--------------------|---|-----------------|----------------------------|
| <b>GEV No.</b>     | 750530  | <b>Ref. No.</b> | 81453620/0<br>CM81453620/0 |
| <b>description</b> | expansion valve DANFOSS type TS2 coolant R404a/R507 angled nozzle 068-2006 inlet 3/8" SAE outlet 1/2" SAE p max 34bar -30 up to +10°C capillary pipe 1500mm |                 |                            |
| <b>For models:</b> | N201M, N301M, N500M   |                 |                            |



|                    |   |                 |                            |
|--------------------|---|-----------------|----------------------------|
| <b>GEV No.</b>     | 750545  | <b>Ref. No.</b> | 81453840/0<br>CM81453840/0 |
| <b>description</b> | expansion valve DANFOSS type TS2 coolant R404a/R507 angled nozzle 068-2008 inlet 3/8" SAE outlet 1/2" SAE p max 34bar -30 up to +10°C capillary pipe 1500mm |                 |                            |
| <b>For models:</b> | N501M   |                 |                            |



|                    |   |                 |                            |
|--------------------|---|-----------------|----------------------------|
| <b>GEV No.</b>     | 750529  | <b>Ref. No.</b> | 81453621/0<br>CM81453621/0 |
| <b>description</b> | expansion valve DANFOSS type TS2 coolant R404a/R507 angled nozzle 068-2015 inlet 3/8" SAE outlet 1/2" SAE p max 34bar -30 up to +10°C capillary pipe 1500mm |                 |                            |
| <b>For models:</b> | N131M   |                 |                            |

#### type TUA/TUB/TUC



|                    |   |                 |                            |
|--------------------|---|-----------------|----------------------------|
| <b>GEV No.</b>     | 750531  | <b>Ref. No.</b> | 19870401/0<br>CM19870401/0 |
| <b>description</b> | expansion valve DANFOSS type TUC coolant R404a/R507 straight inlet 6mm soldering connection outlet 10mm soldering connection p max 34bar -30 up to +10°C capillary pipe 800mm |                 |                            |



|                    |   |                 |                            |
|--------------------|---|-----------------|----------------------------|
| <b>GEV No.</b>     | 750532  | <b>Ref. No.</b> | 19870312/0<br>CM19870312/0 |
| <b>description</b> | expansion valve DANFOSS type TUC coolant R404a/R507 straight inlet 6mm soldering connection outlet 13mm soldering connection p max 34bar -25 up to +10°C capillary pipe 800mm |                 |                            |



nozzle inserts

|   |  |                 |                            |
|---|--|-----------------|----------------------------|
| 1  |  |                 |                            |
| <b>GEV No.</b>  | 750484   | <b>Ref. No.</b> | 19470964/0<br>CM19470964/0 |
| <b>description</b>  | nozzle insert size 05 type 068-2008 T2/TE2 DANFOSS |                 |                            |

HONEYWELL

valves

|   |  |                 |  |
|---|--|-----------------|--|
| 1  |  |                 |  |
| <b>GEV No.</b>  | 750425   | <b>Ref. No.</b> | 19870622/0<br>19870627<br>19870627/0<br>CM19870622/0<br>CM19870627/0 |
| <b>description</b>  | expansion valve HONEYWELL type TMV-00001 coolant R22 angled 90° thermostatically controlled inlet 5/8" UNF (3/8" SAE) outlet 3/4" UNF (1/2" SAE) -45 up to +15°C |                 |  |

filter driers

GMC

|   |  |                 |                            |
|---|--|-----------------|----------------------------|
| 1  |  |                 |                            |
| <b>GEV No.</b>  | 750086   | <b>Ref. No.</b> | 19300357/0<br>CM19300357/0 |
| <b>description</b>  | dryer type SC032S connection ODF 1/4"-ODM 3/8" 50cm <sup>3</sup> p max 45bar -40 up to +80°C 261g total length 95mm ø 57.5mm |                 |                            |
| <b>For models:</b>  | N131M, N140, N201M, N301M  |                 |                            |

|   |  |                 |                            |
|---|--|-----------------|----------------------------|
| 1  |  |                 |                            |
| <b>GEV No.</b>  | 750525   | <b>Ref. No.</b> | 19301257/0<br>CM19301257/0 |
| <b>description</b>  | dryer type SC053M10S connection ODF 10mm-ODM 12mm 80cm <sup>3</sup> p max 45bar -40 up to +80°C 325g total length 109mm ø 57.5mm |                 |                            |
| <b>For models:</b>  | N200M, N200MW, N300M, N300MW, N301M  |                 |                            |

|  |   |                 |                            |
|--|---|-----------------|----------------------------|
| 1  |   |                 |                            |
| <b>GEV No.</b>   | 750526  | <b>Ref. No.</b> | 19300355/0<br>CM19300355/0 |
| <b>description</b>   | dryer type SC083M10S connection ODF 10mm-ODM 12mm 130cm <sup>3</sup> p max 45bar -40 up to +85°C 399g total length 134mm ø 57.5mm |                 |                            |
| <b>For models:</b>   | N200M, N200MW, N300M, N300MW, N401M, N500M, N501M   |                 |                            |

miscellaneous

|  |  |                 |          |
|--|--|-----------------|----------|
| 1  |  |                 |          |
| <b>GEV No.</b>   | 750068   | <b>Ref. No.</b> | 63000303 |
| <b>description</b>   | dryer size 25g ø 24mm L 140mm connection 3.5/7mm |                 |          |

evaporators

for fridges

producer-specific

|  |            |                 |            |
|--|------------|-----------------|------------|
| 1  |            |                 |            |
| <b>GEV No.</b>   | 750698     | <b>Ref. No.</b> | 19270072/0 |
| <b>description</b>   | evaporator |                 |            |
| <b>For models:</b>   | T5         |                 |            |

|  |                                   |                 |                              |
|--|-----------------------------------|-----------------|------------------------------|
| 1  |                                   |                 |                              |
| <b>GEV No.</b>   | 694180                            | <b>Ref. No.</b> | 191477077/0<br>CM191477077/0 |
| <b>description</b>   | evaporator L 525mm W 50mm H 442mm |                 |                              |

for ice-cube maker

for ice cube maker



1

|                    |   |                 |                            |
|--------------------|---|-----------------|----------------------------|
| <b>GEV No.</b>     | 750127  | <b>Ref. No.</b> | 81402037/0<br>CM81402037/0 |
| <b>description</b> | evaporator for ice-cube maker 15 cubes L 185mm W 155mm H 60mm total length 400mm overall width 225mm overall height 115mm |                 |                            |
| <b>For models:</b> | N20L, N20WL   |                 |                            |



1

|                    |  |                 |                            |
|--------------------|--|-----------------|----------------------------|
| <b>GEV No.</b>     | 750128   | <b>Ref. No.</b> | 81412031/0<br>CM81412031/0 |
| <b>description</b> | evaporator for ice-cube maker 35 cubes L 295mm W 185mm H 60mm overall height 130mm |                 |                            |
| <b>For models:</b> | N45L, N45S, N45SW, N50BI, N50BIW, N55L, N55LW, N55S, N55SW                         |                 |                            |

for flake ice maker



1

|                    |   |                 |        |
|--------------------|---|-----------------|--------|
| <b>GEV No.</b>     | 695712  | <b>Ref. No.</b> | I-1721 |
| <b>description</b> | evaporator for flake ice maker W 180mm H 225mm ø 90mm |                 |        |
| <b>For models:</b> | F100  |                 |        |



1

|                    |   |                 |   |
|--------------------|---|-----------------|---|
| <b>GEV No.</b>     | 695751  | <b>Ref. No.</b> | CF79423704<br>CF79423706<br>CMCF79423704<br>CMCF79423705<br>CMCF79423706<br>CMCF79423706R |
| <b>description</b> | evaporator for flake ice maker Wmm H 375mm ø 73mm |                 |   |
| <b>For models:</b> | F200  |                 |   |

accessories

housings



1

|                    |  |                 |                            |
|--------------------|--|-----------------|----------------------------|
| <b>GEV No.</b>     | 696383   | <b>Ref. No.</b> | 25820123/0<br>CM25820123/0 |
| <b>description</b> | lid for evaporator for ice maker for N120 L 422mm W 336mm H 60mm |                 |                            |
| <b>For models:</b> | N131M  |                 |                            |

condensors

filters



1

|                    |  |                 |                     |
|--------------------|--|-----------------|---------------------|
| <b>GEV No.</b>     | 691796                                   | <b>Ref. No.</b> | nicht in Preisliste |
| <b>description</b> | air filter for condenser L 495mm W 270mm |                 |                     |



1

|                    |  |                 |                            |
|--------------------|--|-----------------|----------------------------|
| <b>GEV No.</b>     | 692589   | <b>Ref. No.</b> | 25339007/0<br>CM25339007/0 |
| <b>description</b> | air filter for condenser L 510mm W 313mm H 6mm |                 |                            |
| <b>For models:</b> | N131M  |                 |                            |



1

|                    |  |                 |                            |
|--------------------|--|-----------------|----------------------------|
| <b>GEV No.</b>     | 695736                                     | <b>Ref. No.</b> | 25339006/0<br>CM25339006/0 |
| <b>description</b> | filter for condenser L 510mm W 410mm H 6mm |                 |                            |
| <b>For models:</b> | N201M, N301M                               |                 |                            |

condensors

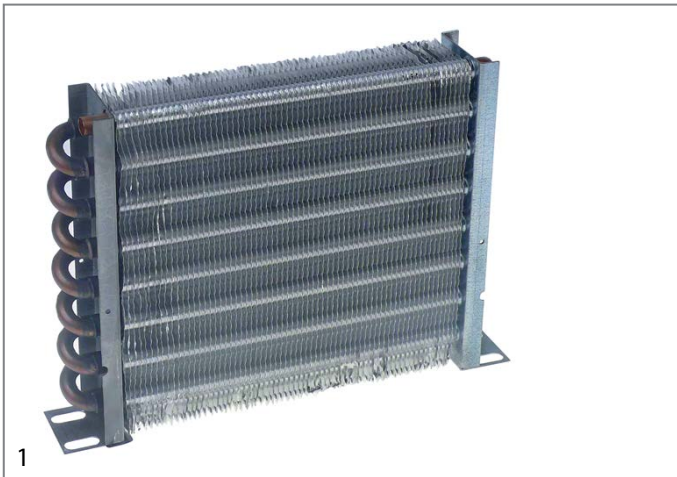

|                    |  |                 |  |
|--------------------|--|-----------------|--|
| <b>GEV No.</b>     | 750089   | <b>Ref. No.</b> | 29015033/0<br>CF62027602<br>CM29015033/0<br>CMCF62027602 |
| <b>description</b> | condenser for ice maker W 280mm D 46mm H 230mm |                 |  |
| <b>For models:</b> | F100, F120                                     |                 |  |



|                    |  |                 |                            |
|--------------------|--|-----------------|----------------------------|
| <b>GEV No.</b>     | 750451   | <b>Ref. No.</b> | 19177072/0<br>CM19177072/0 |
| <b>description</b> | condenser for ice maker W 530mm D 80mm H 550mm |                 |                            |
| <b>For models:</b> | N301M  |                 |                            |



|                    |  |                 |                            |
|--------------------|--|-----------------|----------------------------|
| <b>GEV No.</b>     | 750527   | <b>Ref. No.</b> | 19177073/0<br>CM19177073/0 |
| <b>description</b> | condenser for ice maker W 525mm D 62mm H 490mm |                 |                            |
| <b>For models:</b> | N201M  |                 |                            |



|                    |  |                 |                            |
|--------------------|--|-----------------|----------------------------|
| <b>GEV No.</b>     | 750092   | <b>Ref. No.</b> | 19177507/0<br>CM19177507/0 |
| <b>description</b> | condenser for ice maker W 550mm D 70mm H 455mm |                 |                            |
| <b>For models:</b> | N200M, N200MW, N300M, N300MW                   |                 |                            |



1

|                    |   |                 |                            |
|--------------------|---|-----------------|----------------------------|
| <b>GEV No.</b>     | 750090  | <b>Ref. No.</b> | 19177058/0<br>CM19177058/0 |
| <b>description</b> | condenser for ice maker W 665mm D 113mm H 285mm |                 |                            |
| <b>For models:</b> | N140  |                 |                            |

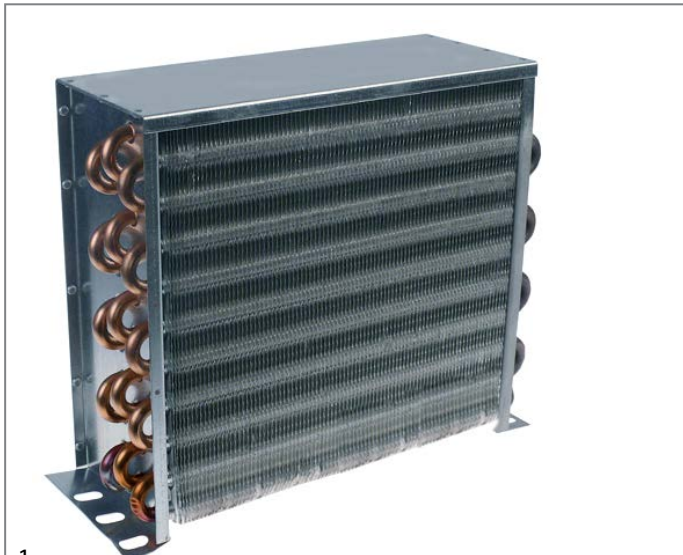

1

|                    |                                   |                 |  |
|--------------------|-----------------------------------|-----------------|--|
| <b>GEV No.</b>     | 750122                            | <b>Ref. No.</b> | 29015035/0<br>62040500<br>CF62040500<br>CM29015035/0<br>CMCF62040500 |
| <b>description</b> | condenser W 290mm D 120mm H 270mm |                 |  |
| <b>For models:</b> | F200                              |                 |  |



1

|                    |                                  |                 |                            |
|--------------------|----------------------------------|-----------------|----------------------------|
| <b>GEV No.</b>     | 750087                           | <b>Ref. No.</b> | 19177509/0<br>CM19177509/0 |
| <b>description</b> | condenser W 190mm D 60mm H 200mm |                 |                            |
| <b>For models:</b> | N20L, N20WL, N25BI, N25S, N25SW  |                 |                            |

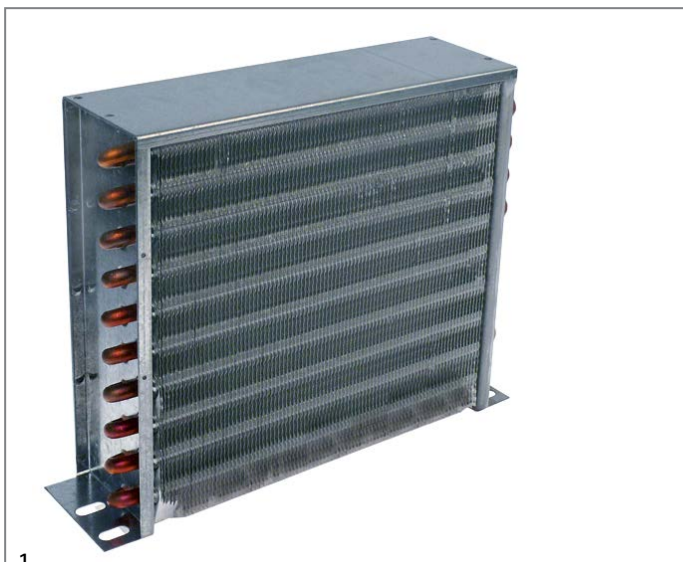

1

|                    |                                  |                 |                            |
|--------------------|----------------------------------|-----------------|----------------------------|
| <b>GEV No.</b>     | 750125                           | <b>Ref. No.</b> | CF62043900<br>CMCF62043900 |
| <b>description</b> | condenser W 290mm D 85mm H 260mm |                 |                            |
| <b>For models:</b> | F100, F120                       |                 |                            |

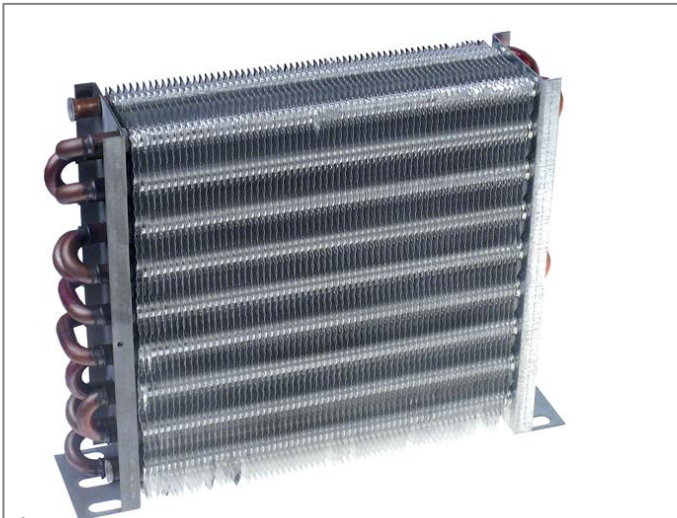

1

|                    |                                  |                 |                            |
|--------------------|----------------------------------|-----------------|----------------------------|
| <b>GEV No.</b>     | 750088                           | <b>Ref. No.</b> | 19180085/0<br>CM19180085/0 |
| <b>description</b> | condenser W 280mm D 70mm H 230mm |                 |                            |



condensers water-cooled



1

|                    |   |                 |                            |
|--------------------|---|-----------------|----------------------------|
| <b>GEV No.</b>     | 695718  | <b>Ref. No.</b> | 81407536/0<br>CM81407536/0 |
| <b>description</b> | condenser for ice maker W 190mm H 220mm L 100mm |                 |                            |
| <b>For models:</b> | N25SW   |                 |                            |



1

|                    |   |                 |                            |
|--------------------|---|-----------------|----------------------------|
| <b>GEV No.</b>     | 695022  | <b>Ref. No.</b> | 25474602/0<br>CM25474602/0 |
| <b>description</b> | torsion spring ø 21.2mm L1 26mm L2 37mm wire gauge ø 2.6mm for ice maker                          |                 |                            |
| <b>For models:</b> | N45L, N45S, N45SW, N50BI, N50BIW, N55L, N55LW, N55S, N55SW, N70S, N70SW, N90L, N90LW, N90S, N90SW |                 |                            |



1

|                    |  |                 |                            |
|--------------------|--|-----------------|----------------------------|
| <b>GEV No.</b>     | 695676   | <b>Ref. No.</b> | 25474601/0<br>CM25474601/0 |
| <b>description</b> | torsion spring ø 23.5mm L1 29mm L2 38mm wire gauge ø 3mm for ice maker |                 |                            |
| <b>For models:</b> | N140   |                 |                            |

evaporation and condensing trays

evaporation trays



1

|                    |  |                 |                            |
|--------------------|--|-----------------|----------------------------|
| <b>GEV No.</b>     | 695916   | <b>Ref. No.</b> | 28300013/0<br>CM28300013/0 |
| <b>description</b> | evaporation tray for fridge L 680mm W 325mm H 40mm |                 |                            |



1

|                    |   |                 |                            |
|--------------------|---|-----------------|----------------------------|
| <b>GEV No.</b>     | 694179  | <b>Ref. No.</b> | 26105003/0<br>CM26105003/0 |
| <b>description</b> | evaporation tray L 520mm W 320mm H 50mm for blast freezer |                 |                            |
| <b>For models:</b> | T14, T5   |                 |                            |

springs

torsion springs



1

|                    |  |                 |                            |
|--------------------|--|-----------------|----------------------------|
| <b>GEV No.</b>     | 695021   | <b>Ref. No.</b> | 25474600/0<br>CM25474600/0 |
| <b>description</b> | torsion spring ø 20.8mm L1 23.2mm L2 37mm wire gauge ø 2.3mm for ice maker |                 |                            |
| <b>For models:</b> | N20L, N20WL, N25BI, N25L, N25LBI, N25LW, N25S, N25SW, N35BI, N35S, N35SW   |                 |                            |

tension springs



1

|                    |   |                 |                            |
|--------------------|---|-----------------|----------------------------|
| <b>GEV No.</b>     | 695674  | <b>Ref. No.</b> | 25475400/0<br>CM25475400/0 |
| <b>description</b> | tension spring for sump ø 13mm wire gauge ø 1.7mm L1 80mm |                 |                            |
| <b>For models:</b> | N140  |                 |                            |

hoses

drain hoses



1

|                    |  |                 |                            |
|--------------------|--|-----------------|----------------------------|
| <b>GEV No.</b>     | 530473   | <b>Ref. No.</b> | 19810114/0<br>CM19810114/0 |
| <b>description</b> | drain hose DN19 L 1900mm straight ø inside 19mm straight ext. ø 25mm elbow ø inside 23mm elbow ext. ø 27mm outer hose ø 24mm for ice maker   |                 |                            |
| <b>For models:</b> | F100C, F125C, F80WC, N131M, N140, N200M, N200MW, N201M, N20L, N20WL, N25BI, N25SW, N300M, N300MW, N301M, N401M, N501M, N55L, N55LW, N55S, N55SW, N70S, N70SW, N90L, N90LW, N90S, N90SW |                 |                            |



## industrial hoses

### silicone hoses

#### without fabric

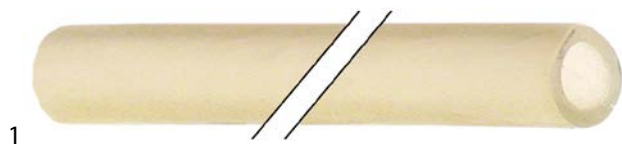

|                    |  |                 |                            |
|--------------------|--|-----------------|----------------------------|
| <b>GEV No.</b>     | 530769   | <b>Ref. No.</b> | 25790880/0<br>CM25790880/0 |
| <b>description</b> | silicone hose for ice-cube maker ID ø 14mm ED ø 20mm L 650mm |                 |                            |



|                    |   |                 |  |
|--------------------|---|-----------------|--|
| <b>GEV No.</b>     | 695050  | <b>Ref. No.</b> | 25690803<br>25690806/0<br>CM25690806/0 |
| <b>description</b> | hose connector straight plastic L 70mm ø 21mm   |                 |  |
| <b>For models:</b> | F100C, F125C, F80C, F80WC, N200M, N200MW, N20L, N20WL, N25BI, N25L, N25LW, N25S, N25SW, N300M, N300MW, N35S, N35SW, N45L, N45S, N45SW, N500M, N55L, N55LW, N55S, N55SW, N70S, N70SW, N90L, N90LW, N90S, N90SW |                 |  |

## fittings, hose and pipe connectors

### fittings

#### double nipples



|                    |  |                 |  |
|--------------------|--|-----------------|--|
| <b>GEV No.</b>     | 520447   | <b>Ref. No.</b> | 73320400<br>CF73320400<br>CMCF73320400 |
| <b>description</b> | double nipple thread 3/8" - 3/4" L1 24mm L2 12mm |                 |  |
| <b>For models:</b> | F100, F120, F200, SF300, SF500, SFN1000W         |                 |  |



|                    |  |                 |                     |
|--------------------|--|-----------------|---------------------|
| <b>GEV No.</b>     | 361796   | <b>Ref. No.</b> | nicht in Preisliste |
| <b>description</b> | hose connector thread 3/4" ET grommet ø 13.5mm ID ø 10mm grommet length 20mm WS 27 thread L 22mm |                 |                     |

### hose connectors

#### producer-specific



|                    |   |                 |                            |
|--------------------|---|-----------------|----------------------------|
| <b>GEV No.</b>     | 501340  | <b>Ref. No.</b> | 25690807/0<br>CM25690807/0 |
| <b>description</b> | connecting piece straight plastic ø 22mm                      |                 |                            |
| <b>For models:</b> | F80C, F80WC, N131M, N201M, N25LBI, N301M, N35BI, N401M, N501M |                 |                            |



|                    |   |                 |                            |
|--------------------|---|-----------------|----------------------------|
| <b>GEV No.</b>     | 695737  | <b>Ref. No.</b> | 25631035/0<br>CM25631035/0 |
| <b>description</b> | hose connector straight plastic L 60mm ø 20mm |                 |                            |
| <b>For models:</b> | N21S  |                 |                            |

### push-in fittings

#### JOHN GUEST



|   |  |                 |                          |   |
|---|--|-----------------|--------------------------|---|
| <b>GEV No.</b>  | 440561   | <b>Ref. No.</b> | CM2521375<br>CMCM2521375 |   |
| <b>description</b>  | push-in fitting John Guest straight thread 1/8" BSP pipe connection ø8mm |                 |                          |   |
| <b>accessories for</b>  | 440561   |                 |                          |   |
|  | <b>GEV No.</b>   | 520972          | <b>Ref. No.</b>          | — |
| hose John Guest thickness 1mm LLDPE blue ID ø 6mm ED ø 8mm                          |  |                 |                          |   |



|                    |  |                 |                          |
|--------------------|--|-----------------|--------------------------|
| <b>GEV No.</b>     | 520452   | <b>Ref. No.</b> | CM2521366<br>CMCM2521366 |
| <b>description</b> | push-in fitting John Guest straight thread 7/16" UNS pipe connection 5/16" sealing conical |                 |                          |





## ancillary products

### clamps

#### hose clamps

DIN 3017 - W4



1

|                    |   |                 |                               |
|--------------------|---|-----------------|-------------------------------|
| <b>GEV No.</b>     | 520444  | <b>Ref. No.</b> | nicht in Preisliste enthalten |
| <b>description</b> | hose clamp SS W4 ø 11-19mm width 9mm Qty 1 pcs DIN 3017 |                 |                               |

#### double wire clamps



1

|                    |  |                 |                         |
|--------------------|--|-----------------|-------------------------|
| <b>GEV No.</b>     | 520449                                       | <b>Ref. No.</b> | nicht in der Preisliste |
| <b>description</b> | hose clamp ø 22mm wire gauge ø 3mm Qty 1 pcs |                 |                         |



1

|                    |  |                 |                            |
|--------------------|--|-----------------|----------------------------|
| <b>GEV No.</b>     | 520407   | <b>Ref. No.</b> | 19281324/0<br>CM19281324/0 |
| <b>description</b> | hose clamp ø 26mm wire gauge ø 2.5mm Qty 1 pcs                                     |                 |                            |
| <b>For models:</b> | N45L, N45S, N45SW, N55L, N55LW, N55S, N55SW, N70S, N70SW, N90L, N90LW, N90S, N90SW |                 |                            |



1

|                    |   |                 |                            |
|--------------------|---|-----------------|----------------------------|
| <b>GEV No.</b>     | 520406  | <b>Ref. No.</b> | 19281332/0<br>CM19281332/0 |
| <b>description</b> | hose clamp ø 28mm wire gauge ø 2.5mm Qty 1 pcs  |                 |                            |
| <b>For models:</b> | N45S, N45SW, N50BI, N50BIW, N55L, N55LW, N55S, N55SW, N70S, N70SW, N90L, N90LW, N90S, N90SW |                 |                            |

#### locking clamps



1

|                    |  |                 |                               |
|--------------------|--|-----------------|-------------------------------|
| <b>GEV No.</b>     | 520443   | <b>Ref. No.</b> | nicht in Preisliste enthalten |
| <b>description</b> | hose clamp ø 14-18mm plastic Qty 1 pcs width 7mm for ice maker |                 |                               |

## fastening material

### screws

#### sheet metal screws



1

|                    |  |                 |                            |
|--------------------|--|-----------------|----------------------------|
| <b>GEV No.</b>     | 560108   | <b>Ref. No.</b> | 12728106/0<br>CM12728106/0 |
| <b>description</b> | sheet metal screws ø 4.2mm L 13mm SS Qty 20 pcs DIN 7981/ISO 7049 head ø 8.2mm oval head |                 |                            |
| <b>For models:</b> | N140, N20L, N20WL, N90L, N90LW, N90S, N90SW  |                 |                            |



1

|                    |  |                 |                            |
|--------------------|--|-----------------|----------------------------|
| <b>GEV No.</b>     | 560109   | <b>Ref. No.</b> | 12728101/0<br>CM12728101/0 |
| <b>description</b> | sheet metal screws ø 4.2mm L 16mm SS Qty 20 pcs DIN 7981/ISO 7049 head ø 8.2mm oval head |                 |                            |
| <b>For models:</b> | N20L, N20WL  |                 |                            |



1

|                    |   |                 |                            |
|--------------------|---|-----------------|----------------------------|
| <b>GEV No.</b>     | 560059  | <b>Ref. No.</b> | 12726235/0<br>CM12726235/0 |
| <b>description</b> | sheet-metal screw ø 4.2mm L 38mm SS Qty 20 pcs 7983 |                 |                            |
| <b>For models:</b> | N140  |                 |                            |

#### flat-headed bolts



1

|                    |  |                 |                            |
|--------------------|--|-----------------|----------------------------|
| <b>GEV No.</b>     | 560063   | <b>Ref. No.</b> | 12726408/0<br>CM12726408/0 |
| <b>description</b> | flat-headed bolt thread M4 thread L 16mm SS DIN 7985/ISO 7045 Qty 20 pcs intake Phillips head ø 8mm head thickness 2mm |                 |                            |
| <b>For models:</b> | N140   |                 |                            |



1

|                    |  |                 |                            |
|--------------------|--|-----------------|----------------------------|
| <b>GEV No.</b>     | 560058   | <b>Ref. No.</b> | 12727301/0<br>CM12727301/0 |
| <b>description</b> | flat-headed bolt thread M4 thread L 45mm SS Qty 20 pcs intake Phillips |                 |                            |
| <b>For models:</b> | N20L, N20WL, N90L, N90LW, N90S, N90SW                                  |                 |                            |

## hexagonal screws



1

|                    |   |                 |                            |
|--------------------|---|-----------------|----------------------------|
| <b>GEV No.</b>     | 560453  | <b>Ref. No.</b> | CF42391500<br>CMCF42391500 |
| <b>description</b> | hexagonal screw thread M12x1.25 thread L 31mm SS WS 19 Qty 1 pcs DIN 933 / ISO 4017 |                 |                            |
| <b>For models:</b> | SF300, SF500, SFN1000, SFN1000W   |                 |                            |

## grub screws

## miscellaneous



1

|                    |   |                 |                            |
|--------------------|---|-----------------|----------------------------|
| <b>GEV No.</b>     | 560458  | <b>Ref. No.</b> | 12712002/0<br>CM12712002/0 |
| <b>description</b> | grub screw thread M4 L 5mm intake slotted Qty 1 pcs |                 |                            |
| <b>For models:</b> | N20L, N20WL, N25S, N25SW                            |                 |                            |

## washers

## washers

## miscellaneous



1

|                    |  |                 |                            |
|--------------------|--|-----------------|----------------------------|
| <b>GEV No.</b>     | 560093   | <b>Ref. No.</b> | CF44180008<br>CMCF44180008 |
| <b>description</b> | plain washer ID ø 10mm ED ø 19mm thickness 0.3mm steel Qty 1 pcs |                 |                            |
| <b>For models:</b> | F100, F100C, F120, F125C, F80C, F80WC                            |                 |                            |



1

|                    |  |                 |                            |
|--------------------|--|-----------------|----------------------------|
| <b>GEV No.</b>     | 560092   | <b>Ref. No.</b> | CF44180007<br>CMCF44180007 |
| <b>description</b> | plain washer ID ø 10mm ED ø 19mm thickness 0.8mm steel Qty 1 pcs |                 |                            |
| <b>For models:</b> | F100, F100C, F120, F125C, F80C, F80WC                            |                 |                            |



1

|                    |  |                 |                            |
|--------------------|--|-----------------|----------------------------|
| <b>GEV No.</b>     | 560144   | <b>Ref. No.</b> | CF03140824<br>CMCF03140824 |
| <b>description</b> | plain washer ID ø 13mm ED ø 22mm thickness 0.8mm steel Qty 1 pcs |                 |                            |
| <b>For models:</b> | SF300, SF500, SFN1000, SFN1000W                                  |                 |                            |



1

|                    |   |                 |                               |
|--------------------|---|-----------------|-------------------------------|
| <b>GEV No.</b>     | 560166  | <b>Ref. No.</b> | nicht in Preisliste enthalten |
| <b>description</b> | plain washer ID ø 16.2mm ED ø 21mm thickness 0.8mm SS Qty 1 pcs |                 |                               |



1

|                    |  |                 |                            |
|--------------------|--|-----------------|----------------------------|
| <b>GEV No.</b>     | 560152   | <b>Ref. No.</b> | CF44180800<br>CMCF44180800 |
| <b>description</b> | plain washer ID ø 23mm ED ø 29mm thickness 1.5mm steel Qty 1 pcs |                 |                            |
| <b>For models:</b> | F100, F100C, F120, F125C, F200, F80C, F80WC                      |                 |                            |



1

|                    |  |                 |  |
|--------------------|--|-----------------|--|
| <b>GEV No.</b>     | 560568   | <b>Ref. No.</b> | CF02167900<br>CF02168100<br>CMCF02001681<br>CMCF02167900<br>CMCF02168100 |
| <b>description</b> | plain washer ID ø 25.6mm ED ø 39mm thickness 0.85mm SS Qty 1 pcs |                 |  |
| <b>For models:</b> | SF300, SF500, SFN1000, SFN1000W                                  |                 |  |



1

|                    |   |                 |                            |
|--------------------|---|-----------------|----------------------------|
| <b>GEV No.</b>     | 560074  | <b>Ref. No.</b> | CF44180005<br>CMCF44180005 |
| <b>description</b> | plain washer ID ø 8.5mm ED ø 14mm thickness 0.3mm steel Qty 1 pcs |                 |                            |
| <b>For models:</b> | F100, F100C, F120, F125C, F80C, F80WC                             |                 |                            |



1

|                    |   |                 |                            |
|--------------------|---|-----------------|----------------------------|
| <b>GEV No.</b>     | 560091  | <b>Ref. No.</b> | CF44180006<br>CMCF44180006 |
| <b>description</b> | plain washer ID ø 8.5mm ED ø 14mm thickness 0.8mm steel Qty 1 pcs |                 |                            |
| <b>For models:</b> | F100, F100C, F120, F125C, F80C, F80WC                             |                 |                            |

## fasteners

## mounting clips



1

|                    |  |                 |                            |
|--------------------|--|-----------------|----------------------------|
| <b>GEV No.</b>     | 524029   | <b>Ref. No.</b> | 19430104/0<br>CM19430104/0 |
| <b>description</b> | mounting clip nominal-ø 3mm L 26mm W 12mm mounting distance 18mm |                 |                            |



mounting spigots



|                    |   |                 |                               |
|--------------------|---|-----------------|-------------------------------|
| 1                  |   |                 |                               |
| <b>GEV No.</b>     | 524030                                    | <b>Ref. No.</b> | nicht in Preisliste enthalten |
| <b>description</b> | spigot nominal-ø 7mm thread M4x0.8 L 13mm |                 |                               |

pipe clips



|                    |  |                 |                     |
|--------------------|--|-----------------|---------------------|
| 1                  |  |                 |                     |
| <b>GEV No.</b>     | 695584   | <b>Ref. No.</b> | nicht in Preisliste |
| <b>description</b> | spring clip L 28mm W 10mm hole ø 4.5mm tube ø 31mm |                 |                     |

clamps

hose clamps

DIN 3017 - W4



|                    |   |                 |                               |
|--------------------|---|-----------------|-------------------------------|
| 1                  |   |                 |                               |
| <b>GEV No.</b>     | 520444  | <b>Ref. No.</b> | nicht in Preisliste enthalten |
| <b>description</b> | hose clamp SS W4 ø 11-19mm width 9mm Qty 1 pcs DIN 3017 |                 |                               |

double wire clamps



|                    |  |                 |                         |
|--------------------|--|-----------------|-------------------------|
| 1                  |  |                 |                         |
| <b>GEV No.</b>     | 520449                                       | <b>Ref. No.</b> | nicht in der Preisliste |
| <b>description</b> | hose clamp ø 22mm wire gauge ø 3mm Qty 1 pcs |                 |                         |



|                    |  |                 |                            |
|--------------------|--|-----------------|----------------------------|
| 1                  |  |                 |                            |
| <b>GEV No.</b>     | 520407   | <b>Ref. No.</b> | 19281324/0<br>CM19281324/0 |
| <b>description</b> | hose clamp ø 26mm wire gauge ø 2.5mm Qty 1 pcs                                     |                 |                            |
| <b>For models:</b> | N45L, N45S, N45SW, N55L, N55LW, N55S, N55SW, N70S, N70SW, N90L, N90LW, N90S, N90SW |                 |                            |



|                    |   |                 |                            |
|--------------------|---|-----------------|----------------------------|
| 1                  |   |                 |                            |
| <b>GEV No.</b>     | 520406  | <b>Ref. No.</b> | 19281332/0<br>CM19281332/0 |
| <b>description</b> | hose clamp ø 28mm wire gauge ø 2.5mm Qty 1 pcs  |                 |                            |
| <b>For models:</b> | N45S, N45SW, N50BI, N50BIW, N55L, N55LW, N55S, N55SW, N70S, N70SW, N90L, N90LW, N90S, N90SW |                 |                            |

locking clamps



|                    |  |                 |                               |
|--------------------|--|-----------------|-------------------------------|
| 1                  |  |                 |                               |
| <b>GEV No.</b>     | 520443   | <b>Ref. No.</b> | nicht in Preisliste enthalten |
| <b>description</b> | hose clamp ø 14-18mm plastic Qty 1 pcs width 7mm for ice maker |                 |                               |

retaining rings

DIN 472



|                    |  |                 |                                      |
|--------------------|--|-----------------|--------------------------------------|
| 1                  |  |                 |                                      |
| <b>GEV No.</b>     | 523002   | <b>Ref. No.</b> | CF65029700<br>CMCF65029700<br>I-1684 |
| <b>description</b> | retaining ring bore ø 45mm thickness 1.6mm steel DIN 472 |                 |                                      |
| <b>For models:</b> | F100, F100C, F120, F125C, F200, F500, F80C, F80WC        |                 |                                      |

DIN 6799



|                    |  |                 |                            |
|--------------------|--|-----------------|----------------------------|
| 1                  |  |                 |                            |
| <b>GEV No.</b>     | 507015   | <b>Ref. No.</b> | CF46003802<br>CMCF46003802 |
| <b>description</b> | retaining ring E D1 ø 7mm D2 ø 14mm SS DIN 6799 thickness 0.9mm for shaft ø 8-11mm |                 |                            |
| <b>For models:</b> | F100, F120, F125C, F200, F80C, F80WC, SF300, SF500, SFN1000, SFN1000W              |                 |                            |

roll pins



|                    |   |                 |                            |
|--------------------|---|-----------------|----------------------------|
| 1                  |   |                 |                            |
| <b>GEV No.</b>     | 692013  | <b>Ref. No.</b> | 12639300/0<br>CM12639300/0 |
| <b>description</b> | roll pin ø 3mm L 16mm   |                 |                            |
| <b>For models:</b> | N140, N20L, N20WL, N25BI, N25L, N25LBI, N25LW, N25S, N25SW, N35BI, N35S, N35SW, N45L, N45S, N45SW, N50BI, N50BIW, N55L, N55LW, N55S, N55SW, N70S, N70SW, N90L, N90LW, N90S, N90SW |                 |                            |

## consumables

### lubricants

#### machine lubricants



1

|                    |   |                 |                            |
|--------------------|---|-----------------|----------------------------|
| <b>GEV No.</b>     | 890003  | <b>Ref. No.</b> | CF06029401<br>CMCF06029401 |
| <b>description</b> | machine lubricant 1000g   |                 |                            |
| <b>description</b> |   |                 |                            |
| <b>For models:</b> | F100, F120, F125C, F200, F80C, F80WC, SF300, SF500, SFN1000, SFN1000W |                 |                            |



1

|                    |  |                 |                            |
|--------------------|--|-----------------|----------------------------|
| <b>GEV No.</b>     | 890029   | <b>Ref. No.</b> | CF06029404<br>CMCF06029404 |
| <b>description</b> | machine lubricant Mobilux EP004 can 500g for gearbox -25 up to +120°C  |                 |                            |
| <b>description</b> | <p>Mobilux EP004 - can 500g</p> <p>Suitable for lubricating enclosed gears and bearings in poorly sealed gear cases with the exception of electric motor bearings. Can also be used for many other industrial applications, e.g. gear cases and chains, in which conventional gear oils would escape due to leaks caused by worn or missing seals. Meets requirements of SEW 1008 hour gear test, DR.EM.2003 mod.</p> <p>Temperature resistance: -25°C to +120°C</p> |                 |                            |



1

|                    |   |                 |  |
|--------------------|---|-----------------|--|
| <b>GEV No.</b>     | 890002  | <b>Ref. No.</b> | 31415301/0<br>CF26361200<br>CM31415301/0<br>CMCF26361200 |
| <b>description</b> | machine lubricant White Food Grade food-safe -25 up to +150°C approval NSF 200g |                 |  |
| <b>description</b> |   |                 |  |
| <b>For models:</b> | F100, F120, F125C, F200, F80C, F80WC, SF300, SF500, SFN1000, SFN1000W           |                 |  |

### cleaning agents

#### descalers



1

|                    |   |                 |                               |
|--------------------|---|-----------------|-------------------------------|
| <b>GEV No.</b>     | 802164                                      | <b>Ref. No.</b> | nicht in Preisliste enthalten |
| <b>description</b> | descaler 4.8l phosphoric acid for ice maker |                 |                               |

### fuses

#### fine fuses



1

|                    |   |                 |              |
|--------------------|---|-----------------|--------------|
| <b>GEV No.</b>     | 358509  | <b>Ref. No.</b> | CMXP63001511 |
| <b>description</b> | fine fuse size ø5x20mm 0.05A slow-acting rated 250V Qty 1 pcs |                 |              |

|   |           |  |  |
|---|-----------|--|--|
| <b>C</b>  |           |  |  |
| cables  | 43        |  |  |
| centrifugal switches                            | 9         |  |  |
| clamps  | 6, 89, 91 |  |  |
| cleaning agents                                 | 92        |  |  |
| cold air circulating fans (complete)            | 36        |  |  |
| compressors                                     | 29        |  |  |
| condensators & interference suppression filters | 42        |  |  |
| connection cables                               | 43        |  |  |
| consumables                                     | 92        |  |  |
| contactors                                      | 12        |  |  |
| cooling fans                                    | 37        |  |  |
| cooling water regulators                        | 82        |  |  |
| core probes                                     | 14        |  |  |
| <b>D</b>  |           |  |  |
| descalers                                       | 92        |  |  |
| double nipples                                  | 88        |  |  |
| double wire clamps                              | 89, 91    |  |  |
| drain hoses                                     | 87        |  |  |
| drain pumps                                     | 40        |  |  |
| <b>E</b>  |           |  |  |
| electric accessories                            | 43        |  |  |
| electrodes                                      | 29        |  |  |
| electronic controllers                          | 14        |  |  |
| end caps and plugs                              | 77        |  |  |
| evaporators                                     | 83        |  |  |
| expansion valves                                | 82        |  |  |
| <b>F</b>  |           |  |  |
| fans  | 34        |  |  |
| fasteners                                       | 90        |  |  |
| fastening material                              | 89        |  |  |
| filter driers                                   | 83        |  |  |
| fine fuses                                      | 92        |  |  |
| fittings  | 88        |  |  |
| flat-headed bolts                               | 89        |  |  |
| float switches                                  | 8         |  |  |
| foam rubber gaskets                             | 80        |  |  |
| fuses   | 43, 92    |  |  |
| <b>G</b>  |           |  |  |
| grates  | 77        |  |  |
| grub screws                                     | 90        |  |  |
| <b>H</b>  |           |  |  |
| Hall sensors                                    | 16        |  |  |
| heating cables                                  | 3         |  |  |
| heating elements                                | 3         |  |  |
| hexagonal screws                                | 90        |  |  |
| hose clamps                                     | 89, 91    |  |  |
| hose connectors                                 | 88        |  |  |
| hoses   | 87        |  |  |
| <b>I</b>  |           |  |  |
| indicator lights                                | 11        |  |  |
| indicator lights (complete)                     | 11        |  |  |
| industrial hoses                                | 88        |  |  |
| <b>L</b>  |           |  |  |
| lamps   | 11        |  |  |
| locking clamps                                  | 89, 91    |  |  |
| lubricants                                      | 92        |  |  |
| <b>M</b>  |           |  |  |
| machine lubricants                              | 92        |  |  |
| magnetic switches                               | 10        |  |  |
| microswitches                                   | 7         |  |  |
| motors  | 38        |  |  |
| mounting clips                                  | 90        |  |  |
| mounting spigots                                | 91        |  |  |
| <b>O</b>  |           |  |  |
| operating capacitors                            | 42        |  |  |
| O-rings   | 79        |  |  |
| <b>P</b>  |           |  |  |
| piano hinges                                    | 74        |  |  |
| pipe clips                                      | 91        |  |  |
| plug-in gaskets                                 | 78        |  |  |
| pressure switches                               | 28        |  |  |
| probe clips                                     | 6         |  |  |
| probes  | 14        |  |  |
| programme timers                                | 11        |  |  |
| protective coverings                            | 43        |  |  |
| pumps   | 40        |  |  |
| pumps for drink dispensers                      | 42        |  |  |
| pumps for ice machines                          | 40        |  |  |
| push/momentary push switches                    | 7         |  |  |
| push-in fittings                                | 88        |  |  |
| <b>R</b>  |           |  |  |
| radial fans                                     | 38        |  |  |
| refrigeration cycle components                  | 82        |  |  |
| refrigeration fans                              | 34        |  |  |
| refrigeration gaskets                           | 78        |  |  |
| refrigeration motors universal                  | 34        |  |  |
| refrigeration thermostats                       | 3         |  |  |
| relays  | 13        |  |  |
| retaining rings                                 | 91        |  |  |
| ribbon cables                                   | 43        |  |  |
| rocker/momentary rocker switches                | 6         |  |  |
| roll pins                                       | 91        |  |  |

**S**

|                                 |    |
|---------------------------------|----|
| screws                          | 89 |
| sealing washers                 | 80 |
| shaft gaskets                   | 81 |
| sheet metal screws              | 89 |
| shelves and shelf rails         | 77 |
| silicone hoses                  | 88 |
| solenoid valves                 | 21 |
| spring assisted hinges          | 75 |
| starting capacitors             | 42 |
| switches and momentary switches | 6  |

**T**

|                                |    |
|--------------------------------|----|
| temperature probes             | 14 |
| terminals and connectors       | 43 |
| thermostats                    | 3  |
| time relays                    | 13 |
| timers                         | 11 |
| toggle switches                | 7  |
| touch sensitive light switches | 9  |
| transformers                   | 14 |

**U**

|                  |    |
|------------------|----|
| universal probes | 14 |
|------------------|----|

**W**

|         |    |
|---------|----|
| washers | 90 |
|---------|----|