



GAS COMPONENTS



ELECTRIC COMPONENTS



WATER TECHNOLOGY



MECHANICAL COMPONENTS



TOOLS

Spare parts suitable for

ICOS

Find the complete and up-to-date range of products in our GEV Webshop



Manufacturer catalogue

The most important spare parts and accessories arranged clearly for every manufacturer

- ✓ Complete product range and all appliance data always up to date in the GEV Webshop
- ✓ Alphabetical Index at the end of the catalogue

GEV Webshop

www.gev-online.co.uk

www.gev-online.com



- 🔍 Add to Favourites
- 🔍 Sign In with email address and usual password
- 🔍 Easy-order – place several items in your basket at the same time
- 🔍 Quick Item search – no login needed



heating elements



immersion heating elements

with round flange ø57.5mm



GEV No.	418040	Ref. No.	10062 39.802.01557
description	heating element 6000W 230V heating circuits 3 L 385mm W 32mm H 42mm tube ø 6.3mm thermostat sleeves ø 7mm length thermostat sleeves 275mm number of thermostat sleeves 1 thermostat sleeve clinging connection male faston 6.3mm connection length 27mm immersion heater round flange mounting ø 57.5mm		
accessories for	418040		
		GEV No.	550002 Ref. No. —
	tension strap H 10mm L 21mm W 10mm hole ø 6.5mm for heating element		



GEV No.	418041	Ref. No.	16600
description	heating element 8000W 230V heating circuits 3 L 470mm W 42mm H 31mm tube ø 6.4mm thermostat sleeves ø 7mm length thermostat sleeves 278mm number of thermostat sleeves 1 thermostat sleeve clinging connection male faston 6.3mm connection length 27mm immersion heater round flange mounting ø 57.5mm		
spare parts for	418041		
		GEV No.	510409 Ref. No. —
	O-ring EPDM thickness 5.34mm ID ø 56.52mm Qty 1 pcs		
accessories for	418041		
		GEV No.	550002 Ref. No. —
	tension strap H 10mm L 21mm W 10mm hole ø 6.5mm for heating element		



GEV No.	416078	Ref. No.	R55100090
description	heating element 8000W 230V heating circuits 3 L 305mm W 39mm H 43mm tube ø 8.5mm thermostat sleeves ø 5mm length thermostat sleeves 285mm number of thermostat sleeves 1 thermostat sleeve clinging connection M4 connection length 48mm immersion heater flange with thread 2"		
accessories for	416078		
		GEV No.	510407 Ref. No. —
	flat gasket fibre ED ø 78mm ID ø 60mm thickness 2mm for heating element for thread 2" Qty 1 pcs		

accessories

sealing washers

fibre gaskets

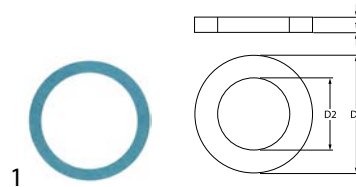

GEV No.	510406	Ref. No.	09387 109387
description	flat gasket fibre ED ø 60mm ID ø 48mm thickness 3mm for thread 1½" Qty 1 pcs		

energy regulators

EGO

1-circuit



GEV No.	380015	Ref. No.	07931
description	energy regulator 230V 13A single-circuit turn direction right shaft ø 6x4.6mm shaft L 23mm mounting thread M4 power release 6-100% no. 50.57021.010		

thermostats

control and safety thermostats

EGO

safety thermostats

55.32_series



GEV No.	375622	Ref. No.	110064
description	safety thermostat switch-off temp. 147°C 1-pole 20A probe ø 6mm probe L 89mm capillary pipe 900mm capillary pipe isolated 800mm gland nut probe		



lamps

indicator lights

indicator lights (complete)

ø12mm

with screw socket



1

GEV No.	359048	Ref. No.	13205 39.665.01360 I13205
description	indicator light ø 12mm 230V yellow connection male faston 6.3mm		



1

GEV No.	359291	Ref. No.	13218 39.665.01571 I13218
description	indicator light ø 12mm 400V green connection male faston 6.3mm		

contactors

BENEDIKT & JÄGER

power contactors



1

GEV No.	381471	Ref. No.	39.815.01371
description	power contactor resistive load 110A 230 (AC3/400V) 22kW main contacts 3NO connection screw type K3-50A00		

GENERAL ELECTRIC (AEG)

power contactors



1

GEV No.	380261	Ref. No.	13042
description	power contactor resistive load 32A 230VAC (AC3/400V) 17A/7.5kW main contacts 3NO auxiliary contacts 1NO connection screw connection type AEG LS7K 10A type GE CL02A 310		

miscellaneous

power contactors



1

GEV No.	380391	Ref. No.	09313 I09313
description	power contactor 230V resistive load 110A (AC3/400V) 55/30kW main contacts 3NO connection screw		

pressure switches

for steam control



1

GEV No.	541350	Ref. No.	16994 39.332.01600
description	pressure control pressure range adjustable 0.3-0.8bar connection 1/4" CO 250V 10A ambient temperature max. 60°C pressure connection 1/4"		



gas taps





PEL

23S/O series



1

GEV No.	101091	Ref. No.	10038 39.785.02164
description	gas tap PEL type 23S/O gas inlet M28x1.5 (tube ø 20mm) bypass nozzle ø 0.35mm gas outlet M24x1.5 (tube ø 16mm) thermocouple connection M9x1 pilot connection M10x1 shaft ø 10x8mm shaft L 35/19mm shaft flat upper		
spare parts for	101091		
	GEV No.	100455	Ref. No. —
	bypass nozzle type PEL23/24 bore ø 0.35mm thread M8x0.5		
	GEV No.	101045	Ref. No. —
	magnet unit T1: M9x1 T2: M22x1 L 46mm ø 18mm suitable for PEL23S M9x1		
	GEV No.	101244	Ref. No. —
	gas connection thread M24x1.5 tube ø 12/16mm horizontal for PEL gas taps		
	GEV No.	101336	Ref. No. —
	gas tap front part shaft ø 10x8mm shaft L 35/17mm shaft flat upper/lower suitable for PEL23S		
	GEV No.	101463	Ref. No. —
	screw suitable for PEL23S Qty 4 pcs		
	GEV No.	528455	Ref. No. —
	O-ring Viton thickness 2.62mm ID ø 18.72mm Qty 1 pcs		
accessories for	101091		
	GEV No.	100908	Ref. No. —
	union screw thread M10x1 for pipe ø 4mm Qty 1 pcs		
	GEV No.	100909	Ref. No. —
	union screw thread M10x1 for pipe ø 6mm Qty 1 pcs		
	GEV No.	101246	Ref. No. —
	olive for pipe ø 4mm Qty 1 pcs		
	GEV No.	101252	Ref. No. —
	union nut thread M24x1.5 for pipe ø 12mm		
	GEV No.	101253	Ref. No. —
	union nut thread M24x1.5 PEL for pipe ø 16mm		
	GEV No.	101254	Ref. No. —
	union nut thread M28x1.5 tube ø 20mm		
	GEV No.	101255	Ref. No. —
	olive for pipe ø 12mm Qty 1 pcs		
	GEV No.	101256	Ref. No. —
	olive for pipe ø 16mm Qty 1 pcs		

accessories for	101091		
	GEV No.	101257	Ref. No. —
	olive for pipe ø 20mm Qty 1 pcs		
	GEV No.	101286	Ref. No. —
	olive ID ø 6mm Qty 1 pcs		
	GEV No.	110080	Ref. No. 15738 39.054.01598
	knob ø 70mm shaft ø 10x8mm shaft flat universal		
	GEV No.	112206	Ref. No. —
	knob dial plate silver gas tap PEL21/22/23 t.max.°C ED ø 63mm ID ø 45.5mm		

ignition parts

pilot burners

SIT

100 series

accessories

ignition electrodes

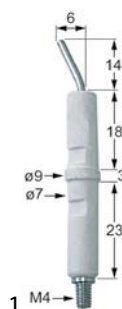

GEV No.	100706	Ref. No.	101050 39.085.01563
description	ignition electrode connection M4 Qty 1 pcs		

POLIDORO

pilot burners



1



















GEV No.	102800	Ref. No.	08122 39.200.02815
description	pilot burner POLIDORO 3 flames code gas connection 6mm		
spare parts for	102800		
	GEV No.	100906	Ref. No. —
	screw connection thread M10x1 for ignition electrode brass Qty 1 pcs WS 10		
	GEV No.	100907	Ref. No. —
	screw connection thread M10x1 Qty 1 pcs type SEF 1 ømm for thermocouple		
	GEV No.	100909	Ref. No. —
	union screw thread M10x1 for pipe ø 6mm Qty 1 pcs		

Table continues overleaf

spare parts for 102800	
	GEV No. 101287 Ref. No. — olive for pipe ø 6mm Qty 1 pcs
accessories for 102800	
	GEV No. 100208 Ref. No. — pilot burner nozzle POLIDORO LPG code 20 bore ø 0.2mm Qty 1 pcs
	GEV No. 100209 Ref. No. — pilot burner nozzle POLIDORO natural gas code 40 bore ø 0.4mm Qty 1 pcs
	GEV No. 100701 Ref. No. — ignition electrode connection M4 Qty 1 pcs
	GEV No. 100908 Ref. No. — union screw thread M10x1 for pipe ø 4mm Qty 1 pcs
	GEV No. 101280 Ref. No. — olive for pipe ø 4mm Qty 1 pcs

	
1	
GEV No.	102876 Ref. No. 10042
description	pilot burner POLIDORO 3 flames code gas connection 6mm

	
1	
GEV No.	100148 Ref. No. 10042
description	pilot burner POLIDORO type A 3 flames LPG code 20 gas connectionmm
accessories for 100148	
	GEV No. 100000 Ref. No. — pilot burner nozzle POLIDORO LPG code 22 bore ø 0.22mm Qty 1 pcs
	GEV No. 100208 Ref. No. — pilot burner nozzle POLIDORO LPG code 20 bore ø 0.2mm Qty 1 pcs
	GEV No. 100209 Ref. No. — pilot burner nozzle POLIDORO natural gas code 40 bore ø 0.4mm Qty 1 pcs
	GEV No. 100701 Ref. No. — ignition electrode connection M4 Qty 1 pcs
	GEV No. 100906 Ref. No. — screw connection thread M10x1 for ignition electrode brass Qty 1 pcs WS 10
	GEV No. 100907 Ref. No. — screw connection thread M10x1 Qty 1 pcs type SEF 1 ømm for thermocouple
	GEV No. 100908 Ref. No. — union screw thread M10x1 for pipe ø 4mm Qty 1 pcs

accessories for 100148	
	GEV No. 100909 Ref. No. — union screw thread M10x1 for pipe ø 6mm Qty 1 pcs
	GEV No. 102110 Ref. No. — pilot tube copper pipe ø 4mm thickness 1mm L 3000mm
	GEV No. 102111 Ref. No. — pilot tube copper pipe ø 6mm thickness 1mm L 3000mm
	GEV No. 102699 Ref. No. — pilot burner nozzle POLIDORO natural gas code 25.2 bore ø 2x0.25mm Qty 1 pcs 2 bores
	GEV No. 102795 Ref. No. — olive for pipe ø 4mm Qty 1 pcs
	GEV No. 102797 Ref. No. — olive for pipe ø 6mm Qty 1 pcs
	GEV No. 106703 Ref. No. — pilot burner nozzle POLIDORO natural gas code 27.2 bore ø 2x0.27mm Qty 1 pcs
	GEV No. 106704 Ref. No. — pilot burner nozzle POLIDORO LPG code 16.2 bore ø 2x0.16mm Qty 1 pcs
	GEV No. 106763 Ref. No. — pilot burner nozzle POLIDORO natural gas code 27.2A bore ø 2x 0.27mm Qty 1 pcs
	GEV No. 106859 Ref. No. — pilot burner nozzle POLIDORO LPG code 24 bore ø 0.24mm Qty 1 pcs

electrodes

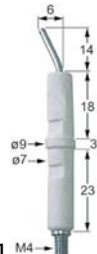
	
1	
GEV No.	100706 Ref. No. 101050 39.085.01563
description	ignition electrode connection M4 Qty 1 pcs

ignition cables

pre-assembled cables	
	
1	
GEV No.	100175 Ref. No. 08053 39.662.01619
description	ignition cable cable length 1750mm connection ø2.4mm / ø4mm



piezoelectric igniters

mounting diameter 18mm



GEV No.	102877	Ref. No.	10041
description	piezoelectric igniter body plastic blowing mounting ø 18mm connection F2.8x0.8		



GEV No.	100009	Ref. No.	16132 39.200.02618 113919
description	piezoelectric igniter body plastic blowing mounting ø 18mm connection ø2.4mm front measurements 26mm M18x1.5		

accessories for 100009

	GEV No.	101339	Ref. No.	—
	cover cap for piezoelectric igniter			

	GEV No.	106869	Ref. No.	—
	cover cap for piezoelectric igniter ID ø 22mm ED ø 35mm H 25mm			

	GEV No.	107931	Ref. No.	—
	cover cap for piezoelectric igniter ID ø 21mm ED ø 36mm			

thermocouples

plug-in thermocouples

plug-in thermocouples standard

with barrel socket ø6(6.5)mm

thermocouples SIT

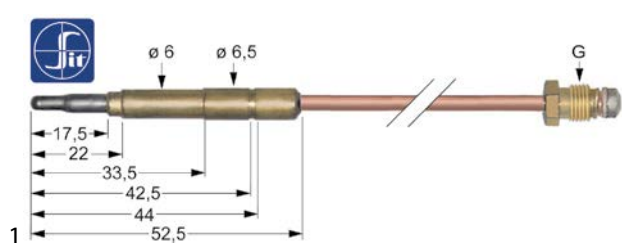

GEV No.	107621	Ref. No.	10070 39.335.01559
description	thermocouple SIT M10x1 L 1500mm plug connection ø6.0(6.5)mm		

gas burners

bar burners

bar burners



GEV No.	105319	Ref. No.	52500200
description	bar burner 4 row L 390mm W 270mm ømm H 60mm kettle		



GEV No.	105330	Ref. No.	052500000 052500000/110053 100000
description	bar burner ø 40mm Wmm Hmm L 500mm mounting thread with bolt M5x12 flange width 43mm flange length 43mm bain marie		



GEV No.	105920	Ref. No.	10053 39.083.00516 39.083.00516-100 110053
description	bar burner ø 50mm Wmm Hmm L 450mm flange with bolt M4 flange width 65mm flange length 71mm kettle		



GEV No.	105697	Ref. No.	09485 39.083.00510 39.083.00510-00
description	bar burner ø 50mm Wmm Hmm L 450mm with bolt M5x12 flange width 65mm flange length 71mm kettle		

equipment-specific units

for espresso machines

level glasses

level glasses

level glass pipes

1



GEV No.	514345	Ref. No.	09833 109833
description	water level tube ø 10mm H 100mm		

for deep fryers

glass panels

1



GEV No.	693397	Ref. No.	10043
description	glass panel L 29mm W 29mm thickness 3.5mm square		

for convection ovens/combi-steamers

glass panels

1



GEV No.	693397	Ref. No.	10043
description	glass panel L 29mm W 29mm thickness 3.5mm square		

frame

1



GEV No.	693398	Ref. No.	10100 39.201.01562
description	frame for level glass		

for tilting bratt pans

glass panels

1



GEV No.	693397	Ref. No.	10043
description	glass panel L 29mm W 29mm thickness 3.5mm square		

for boiling pans

lids

1



GEV No.	514128	Ref. No.	E30600420
description	distance washer for handle		

filters

1



GEV No.	514338	Ref. No.	E32300340
description	drain filter size 12,5x24mm for kettle		

glass panels

1



GEV No.	693397	Ref. No.	10043
description	glass panel L 29mm W 29mm thickness 3.5mm square		

fittings for catering equipment

aerators and air bleeders

1



GEV No.	540825	Ref. No.	14945 39.302.02286
description	aerator and air bleeder thread 3/8" ET WS 24 chrome-plated L 37mm		



lid hinges

type RUBINETTERIE DEL FRIULI

for circular lids

spare parts



GEV No.	540855	Ref. No.	08052
description	torsion spring ø 50.8mm wire gauge ø 5.1mm L1 34mm L2 104mm L3 29mm mounting pos. left		



GEV No.	540854	Ref. No.	08051
description	torsion spring ø 50.8mm wire gauge ø 5.1mm L1 34mm L2 104mm L3 29mm mounting pos. right		

FIREX

spare parts



GEV No.	540855	Ref. No.	08052
description	torsion spring ø 50.8mm wire gauge ø 5.1mm L1 34mm L2 104mm L3 29mm mounting pos. left		



GEV No.	540854	Ref. No.	08051
description	torsion spring ø 50.8mm wire gauge ø 5.1mm L1 34mm L2 104mm L3 29mm mounting pos. right		

ICOS



GEV No.	514129	Ref. No.	16158 35.809.02539 E30900140 I16158
description	adjusting bush L 100mm ø 70/60mm		



GEV No.	514136	Ref. No.	02282 10018 39.302.02445 I02282 I10018
description	bracket for lid hinge		



GEV No.	514131	Ref. No.	10005 39.302.02299 I10005
description	lid hinge body lid radius 320mm		



GEV No.	514132	Ref. No.	10006 39.302.02440 I10006
description	lid hinge body lid radius 395mm		



GEV No.	514133	Ref. No.	10007 39.302.02538 I10007
description	lid hinge body lid radius 500mm		



1

GEV No.	514134	Ref. No.	10008 39.302.02537 I10008
description	lid hinge body lid radius 545mm		



1

GEV No.	514137	Ref. No.	35.161.01603 E30600470
description	spring guide for lid hinge ID ø 28mm ED ø 32mm L 225mm zinc-coated steel		



1

GEV No.	540855	Ref. No.	08052
description	torsion spring ø 50.8mm wire gauge ø 5.1mm L1 34mm L2 104mm L3 29mm mounting pos. left		

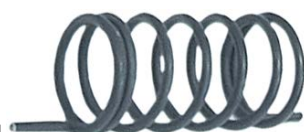

1

GEV No.	540854	Ref. No.	08051
description	torsion spring ø 50.8mm wire gauge ø 5.1mm L1 34mm L2 104mm L3 29mm mounting pos. right		



1

GEV No.	514346	Ref. No.	08008 I08008
description	torsion spring ø 51.5mm wire gauge ø 4.1mm L1 21mm L2 110mm L3 21mm mounting pos. left		



1

GEV No.	514339	Ref. No.	08007 I08007
description	torsion spring ø 51.8mm wire gauge ø 4.1mm L1 20mm L2 106mm L3 20mm mounting pos. right		



1

GEV No.	514526	Ref. No.	08007+08008 32.400.03398-00
description	torsion spring ø 51mm set wire gauge ø 4mm L1 20mm L2 106mm L3 20mm mounting pos. right and left		



1

GEV No.	514352	Ref. No.	08093 I08093
description	torsion spring ø 51mm wire gauge ø 6.5mm L1 28mm L2 101mm L3 28mm mounting pos. left		



1

GEV No.	514351	Ref. No.	08083 I08083
description	torsion spring ø 51mm wire gauge ø 6.5mm L1 28mm L2 101mm L3 28mm mounting pos. right		



1

GEV No.	514350	Ref. No.	08055 I08055
description	torsion spring ø 51mm wire gauge ø 6mm L1 28mm L2 95mm L3 28mm mounting pos. left		



1

GEV No.	514349	Ref. No.	08054 I08054
description	torsion spring ø 51mm wire gauge ø 6mm L1 28mm L2 95mm L3 28mm mounting pos. right		

1

GEV No.	514343	Ref. No.	35.802.02504 E30900570
description	adjusting bush		



1

GEV No.	514135	Ref. No.	09131 109131
description	handle H 270mm L 890mm W 400mm for kettle		



1

GEV No.	514340	Ref. No.	35.802.02506 E30800180
description	bracket mounting pos. left		



1

GEV No.	514342	Ref. No.	09484 109484
description	lid for holder		

lid catches



1

GEV No.	514341	Ref. No.	35.802.02505 E30800170
description	bracket right		

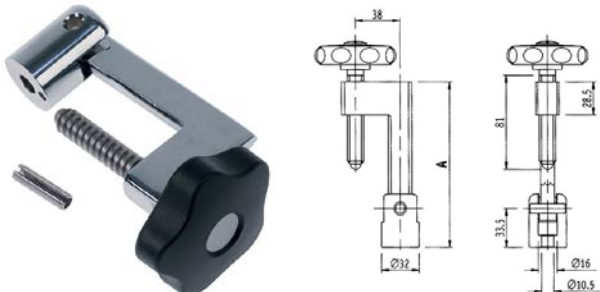

1

GEV No.	514127	Ref. No.	10030 14939 39.302.02292
description	lid lock handle ø 70mm L 143mm		



1



GEV No.	514128	Ref. No.	E30600420
description	distance washer for handle		

drain taps

brass

drain taps



1				
GEV No.	540275	Ref. No.	10027 39.302.01275	
description	drain tap 2" IT with union nut A 90mm B 151mm B1 80mm chrome-plated brass			
spare parts for	540275			
	GEV No.	540214	Ref. No.	—
	handle ID ø 6mm L 145mm			
accessories for	540275			
	GEV No.	529484	Ref. No.	—
	flat gasket fibre ED ø 58mm ID ø 50mm thickness 2mm Qty 1 pcs			
	GEV No.	542448	Ref. No.	—
	gasket silicone 60x49x2 for drain tap 2"			

test taps

test taps

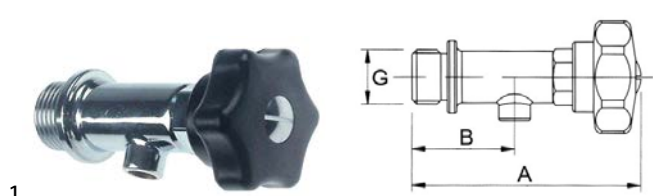

1				
GEV No.	540818	Ref. No.	10044	
description	test tap thread 1/2" ET W 88mm W1 38mm			

safety fittings

safety fittings



1				
GEV No.	514276	Ref. No.	11032 39.392.01566	
description	safety fitting thread 3/4" 0.45bar H 165mm ø 65mm			
spare parts for	514276			
	GEV No.	514094	Ref. No.	—
	angle piece thread 3/8"			
	GEV No.	514276	Ref. No.	11032 39.392.01566
	safety fitting thread 3/4" 0.45bar H 165mm ø 65mm			
	GEV No.	540825	Ref. No.	14945 39.302.02286
	aerator and air bleeder thread 3/8" ET WS 24 chrome-plated L 37mm			
	GEV No.	540828	Ref. No.	10023 39.302.02269
	manometer siphon thread 3/8"			
	GEV No.	541579	Ref. No.	10022 39.302.02450
	manometer ø 52mm pressure range 0 up to 1bar connection marking 0.5 thread 1/4"			











1				
GEV No.	514275	Ref. No.	17054 39.302.02290	
description	safety fitting thread 3/4" 0.45bar with manometer and aerator/air bleeder 3.3kg H 200mm W 150mm			
spare parts for	514275			
	GEV No.	514094	Ref. No.	—
	angle piece thread 3/8"			
	GEV No.	514276	Ref. No.	11032 39.392.01566
	safety fitting thread 3/4" 0.45bar H 165mm ø 65mm			
	GEV No.	540825	Ref. No.	14945 39.302.02286
	aerator and air bleeder thread 3/8" ET WS 24 chrome-plated L 37mm			
	GEV No.	540828	Ref. No.	10023 39.302.02269
	manometer siphon thread 3/8"			

Table continues overleaf



spare parts for 514275			
	GEV No.	541579	Ref. No.
			10022 39.302.02450
manometer ø 52mm pressure range 0 up to 1bar connection marking 0.5 thread 1/4"			

accessories			
	1		
	GEV No.	540817	Ref. No.
			10014 39.302.02482
description fitting support thread 1/2" ET suitable for manometer			

	1		
	GEV No.	540835	Ref. No.
			10013
description screw cap thread 3/4"			
spare parts for 540835			
	GEV No.	513016	Ref. No.
			—
O-ring EPDM thickness 3.53mm ID ø 26.58mm Qty 1 pcs			
accessories for 540835			
	GEV No.	513016	Ref. No.
			—
O-ring EPDM thickness 3.53mm ID ø 26.58mm Qty 1 pcs			

	1		
	GEV No.	540828	Ref. No.
			10023 39.302.02269
description manometer siphon thread 3/8"			

safety valves			
	1		
	GEV No.	540722	Ref. No.
			10004 39.302.02291
description safety valve with outlet for lid			

gaskets

gaskets for heated units

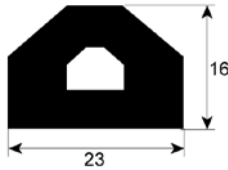
boiling pan gaskets			
	1		
	GEV No.	900510	Ref. No.
			E30100010
description boiling pan gasket profile 3020 L 2000mm			

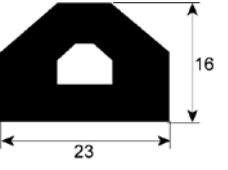
	1		
	GEV No.	900513	Ref. No.
			E30100020
description boiling pan gasket profile 3020 L 2500mm			

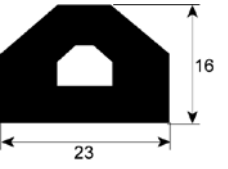
	1		
	GEV No.	900514	Ref. No.
			E30100030
description boiling pan gasket profile 3020 L 3200mm			

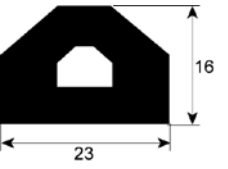
	1		
	GEV No.	900515	Ref. No.
			E30100040
description boiling pan gasket profile 3020 L 3500mm			

sealing washers

fibre gaskets			
	1		
	GEV No.	510406	Ref. No.
			09387 109387
description flat gasket fibre ED ø 60mm ID ø 48mm thickness 3mm for thread 1½" Qty 1 pcs			

springs

torsion springs



GEV No.	540855	Ref. No.	08052
description	torsion spring \varnothing 50.8mm wire gauge \varnothing 5.1mm L1 34mm L2 104mm L3 29mm mounting pos. left		



GEV No.	540854	Ref. No.	08051
description	torsion spring \varnothing 50.8mm wire gauge \varnothing 5.1mm L1 34mm L2 104mm L3 29mm mounting pos. right		



GEV No.	514346	Ref. No.	08008 I08008
description	torsion spring \varnothing 51.5mm wire gauge \varnothing 4.1mm L1 21mm L2 110mm L3 21mm mounting pos. left		



GEV No.	514339	Ref. No.	08007 I08007
description	torsion spring \varnothing 51.8mm wire gauge \varnothing 4.1mm L1 20mm L2 106mm L3 20mm mounting pos. right		

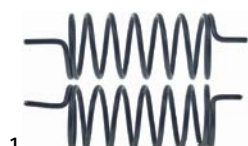

GEV No.	514526	Ref. No.	08007+08008 32.400.03398-00
description	torsion spring \varnothing 51mm set wire gauge \varnothing 4mm L1 20mm L2 106mm L3 20mm mounting pos. right and left		



GEV No.	514352	Ref. No.	08093 I08093
description	torsion spring \varnothing 51mm wire gauge \varnothing 6.5mm L1 28mm L2 101mm L3 28mm mounting pos. left		



GEV No.	514351	Ref. No.	08083 I08083
description	torsion spring \varnothing 51mm wire gauge \varnothing 6.5mm L1 28mm L2 101mm L3 28mm mounting pos. right		



GEV No.	514350	Ref. No.	08055 I08055
description	torsion spring \varnothing 51mm wire gauge \varnothing 6mm L1 28mm L2 95mm L3 28mm mounting pos. left		



GEV No.	514349	Ref. No.	08054 I08054
description	torsion spring \varnothing 51mm wire gauge \varnothing 6mm L1 28mm L2 95mm L3 28mm mounting pos. right		

manometers



GEV No.	541579	Ref. No.	10022 39.302.02450
description	manometer \varnothing 52mm pressure range 0 up to 1bar connection marking 0.5 thread 1/4"		

hoses

supply hoses

stainless steel flexi hoses

tap tubes



GEV No.	514337	Ref. No.	I07817
description	flex hose SS braid DN8 connections 1/2" - 3/8" L 800mm operating p. 10bar test pressure 32bar burst p. 95bar approval DVGW		



fittings, hose and pipe connectors

fittings

angle pieces



1

GEV No.	514344	Ref. No.	14238 114238
description	angle piece for level glass		

B

bar burners	7
boiling pan gaskets	13

C

contactors	4
------------	---

E

energy regulators	3
-------------------	---

F

fittings	15
----------	----

G

gas burners	7
gas taps	5
gaskets for heated units	13

H

heating elements	3
hoses	14

I

ignition cables	6
immersion heating elements	3
indicator lights	4
indicator lights (complete)	4

L

lamps	4
-------	---

P

piezoelectric igniters	7
pilot burners	5
pressure switches	4

S

safety thermostats	3
sealing washers	13
stainless steel flexi hoses	14
supply hoses	14

T

tap tubes	14
thermocouples	7
thermostats	3