



**GAS COMPONENTS**



**ELECTRIC COMPONENTS**



**WATER TECHNOLOGY**



**MECHANICAL COMPONENTS**



**TOOLS**

Spare parts suitable for

**IMPERIAL-USA**

Find the complete and up-to-date range of products in our GEV Webshop



# Manufacturer catalogue

The most important spare parts and accessories arranged clearly for every manufacturer

- ✓ Complete product range and all appliance data always up to date in the GEV Webshop
- ✓ Alphabetical Index at the end of the catalogue

## GEV Webshop

[www.gev-online.co.uk](http://www.gev-online.co.uk)

[www.gev-online.com](http://www.gev-online.com)



- 🔍 Add to Favourites
- 🔍 Sign In with email address and usual password
- 🔍 Easy-order – place several items in your basket at the same time
- 🔍 Quick Item search – no login needed



## thermostats

### control and safety thermostats

#### INVENSYS / ROBERTSHAW

##### control thermostats



<b>GEV No.</b>	390636	<b>Ref. No.</b>	0319 1175
<b>description</b>	thermostat t.max. 204°C temperature range 93-204°C 1-pole 1NO 0.67A probe ø 9.5mm probe L 123mm capillary pipe 915mm capillary pipe isolatedmm gland nut 1/4" NPT shaft ø 6x4.6mm shaft L 21mm shaft position lower rotation 315° probe material nickel-plated probe thread 1/4" US		
<b>For models:</b>	Fryer-Filter-System-Series, IF-25-Series-Fryers, IF-75-Series-Fryers, IF-BL-Basketlift-System-Series-Fryers, IF-Counter-Fryer, IF-Series-Fryers		



<b>GEV No.</b>	390637	<b>Ref. No.</b>	1160
<b>description</b>	thermostat t.max. 260°C temperature range 93-260°C 1-pole 1NOA probe ø 4.5mm probe L 310mm capillary pipe 900mm capillary pipe isolatedmm gland nut shaft ø 6.5x4.7mm shaft L 32.5mm shaft position lower rotation 270° probe material SS		
<b>For models:</b>	ICV-and-ICVD-Series, IDR-Series, IR-Series-mediu-duty-Range, ISAE-Griddle		

##### safety thermostats



<b>GEV No.</b>	390638	<b>Ref. No.</b>	33497
<b>description</b>	safety thermostat switch-off temp. 218°C temperature range°C 1-pole 1COA probe ø 8mm probe L 77mm capillary pipe 940mm capillary pipe isolatedmm gland nut 1/4" NPT shaft ømm probe SS		

<b>GEV No.</b>	390639	<b>Ref. No.</b>	0328 1177
<b>description</b>	safety thermostat switch-off temp. 232°C 1-pole 1COA probe ø 7.9mm probe L 77mm capillary pipe 914mm capillary pipe isolatedmm gland nut 3/8" NPT shaft ømm probe SS 450°F		
<b>For models:</b>	Fryer-Filter-System-Series, IF-25-Series-Fryers, IF-75-Series-Fryers, IF-BL-Basketlift-System-Series-Fryers, IF-Counter-Fryer, IF-Series-Fryers		

<b>GEV No.</b>	390965	<b>Ref. No.</b>	36942
<b>description</b>	safety thermostat switch-off temp. 232°C 1-poleA probe ø 7.93mm probe L 77mm capillary pipe 760mm capillary pipe isolatedmm gland nut shaft ømm probe SS		

## solenoid valves

### solenoid valves (gas)

<b>GEV No.</b>	106366	<b>Ref. No.</b>	1134 513-1
<b>description</b>	solenoid valve gas 2-ways 110V inlet 3/8" outlet 3/8" L 50mm		
<b>For models:</b>	ICV-and-ICVD-Series, IDR-Series, IR-Series-mediu-duty-Range, ISAE-Griddle, ISCE-Griddle		



# gas taps

## TEDDINGTON

1 gas components



<b>GEV No.</b>	106370	<b>Ref. No.</b>	0252-1 1651-R
<b>description</b>	gas tap TEDDINGTON gas inlet flange (tube ø 1/4") left gas outlet 3/8"x27 UNF pilot connection 1/4" CCT thermocouple connection ASA 11/32 shaft ø 8.7x6.2mm shaft L 17/9mm shaft flat right ignition gas no		



<b>GEV No.</b>	106717	<b>Ref. No.</b>	1660-L 38101 TESA2394/15L
<b>description</b>	gas tap TEDDINGTON type TESA2394/15L without ignition flame gas inlet flange (tube ø 1/4") left bypass nozzle ømm gas outlet 3/8"x27 UNF pilot connection thermocouple connection ASA 11/32 shaft ø 8.7x6.2mm shaft L 17/9mm shaft flat left		



<b>GEV No.</b>	106377	<b>Ref. No.</b>	0276 1660-R 38102 TESA2394/15R
<b>description</b>	gas tap TEDDINGTON type TESA2394/15R gas inlet flange (tube ø 1/4") right bypass nozzle ømm gas outlet 3/8"x27 UNF pilot connection thermocouple connection ASA 11/32 shaft ø 8.7x6.2mm shaft L 17/9mm shaft flat right		



<b>GEV No.</b>	106369	<b>Ref. No.</b>	1651-L 38099 TESA2394/8L
<b>description</b>	gas tap TEDDINGTON type TESA2394/8L gas inlet flange (tube ø 1/4") left bypass nozzle ømm gas outlet 3/8"x27 UNF pilot connection 1/4" CCT thermocouple connection ASA 11/32 shaft ø 8.7x6.2mm shaft L 17/9mm shaft flat left		



<b>GEV No.</b>	106941	<b>Ref. No.</b>	1651-R 38100 TESA2394/8R
<b>description</b>	gas tap TEDDINGTON type TESA2394/8R gas inlet flange (tube ø 1/4") right bypass nozzle ømm gas outlet 3/8"x27 UNF pilot connection 1/4" CCT thermocouple connection ASA 11/32 shaft ø 8.7x6.2mm shaft L 17/9mm shaft flat right ignition gas 1/4" pipe US		

## miscellaneous





<b>GEV No.</b>	107845	<b>Ref. No.</b>	1610 1651-L
<b>description</b>	gas tap GARLAND gas inlet 1/8" bypass nozzle ømm gas outlet 1/8" pilot connection thermocouple connection shaft L 31/12mm		
<b>For models:</b>	EBA-Series-Char-Rock-Broilers, GD-Series-Char-Rock-Broilers, IAB-Series-Steakhouse-Broiler, ICB-Chicken-Broiler, ICMA-Series-Cheese-melter, ICRA-Series-chinese-range, IHPA-Series-Hot-Plate, IHR-Series-with-standard-oven, IMGAs-Series-Manually-controlled-Griddles, IPRA-and-IPR-Series-Pork-Roaster, IR2000-Series, IRB-Series-Radiant-Char-Broilers, IR-Series-Medium-Duty-Ranges, ISB-Series-Salamander-Broiler, ISPA-Series-stock-Pot, MSQ-Mesquite-Wood-Broiler		





## gas thermostats

### ROBERTSHAW



<b>GEV No.</b>	106371	<b>Ref. No.</b>	1150 2019
<b>description</b>	gas thermostat type BJWA25PB t.max. 287°C 93-287°C 200-550°F gas inlet flange (tube ø 5/16") bypass nozzle ø 0mm gas outlet 1/4" NPT thermocouple connection pilot connection capillary pipe 48" - 1220mm probe ø 3/16" - 4.7mm probe L 11 1/4" - 285mm gland nut shaft ø 17mm shaft L 13mm shaft flat upper		
<b>For models:</b>	IR2000-Series, IR-Serie-Medium-Duty-Ranges		
<b>accessories for</b>	106371		
	<b>GEV No.</b>	106659	<b>Ref. No.</b> 1104
	gas connection suitable for thermostat		
	<b>GEV No.</b>	112547	<b>Ref. No.</b> 1151 2131
	knob gas thermostat t.max. 500°F 200-500°F ø 49mm shaft ømm shaft flat ROBERTSHAW black		
	<b>GEV No.</b>	112735	<b>Ref. No.</b> 1101
	knob gas thermostat t.max. 400°F 150-400°F ø 49mm shaft ø 17mm black		



<b>GEV No.</b>	106657	<b>Ref. No.</b>	1100
<b>description</b>	gas thermostat type BJWA25PBD0324 65-204°C 150-400°F gas inlet flange (tube ø 5/16") bypass nozzle ø 0mm gas outlet 2x 1/4" NPT thermocouple connection pilot connection capillary pipe 24" - 610mm probe ø 3/16" - 4.7mm probe L 7 3/4" - 195mm shaft ø 17mm shaft L 13mm shaft flat upper		
<b>For models:</b>	IHR-Series-with-standard-oven, IR2000-Series, IR-Serie-Medium-Duty-Ranges, ITG24, ITG36, ITG-Series-Thermostatically-controlled		
<b>accessories for</b>	106657		
	<b>GEV No.</b>	106659	<b>Ref. No.</b> 1104
	gas connection suitable for thermostat		
	<b>GEV No.</b>	112548	<b>Ref. No.</b> 1106 2011
	knob gas thermostat t.max. 400°F 150-400°F ø 49mm shaft ømm shaft flat ROBERTSHAW		

### TEDDINGTON

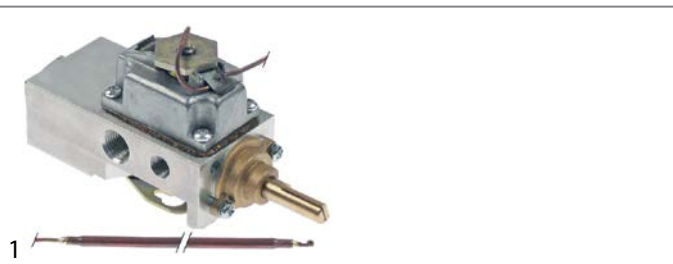

<b>GEV No.</b>	106372	<b>Ref. No.</b>	1179 36014
<b>description</b>	gas thermostat type COMSA006 t.max. 260°C gas inlet flange (tube ø 7.5mm) bypass nozzle ø 1.3mm gas outlet 1/4" NPTmm thermocouple connection ASA 11/32 pilot connection 1/8" capillary pipe 1100mm probe ø 4.8mm probe L 198mm shaft ø 8.8x6.3mm shaft L 28/19mm shaft flat lower		

## gas valves and ignition boxes

### gas control valves

#### HONEYWELL



<b>GEV No.</b>	106361 <sup>1</sup>	<b>Ref. No.</b>	0365-2 1173-HW 1173-WR
<b>description</b>	gas valve type VS820A natural gas 0.75VHz gas inlet 3/4" NPT gas outlet 3/4" NPT thermocouple connection pilot connection 1/4" CCT pressure range 7.5-12.5mbar 3-5"W.C. operator type VS824A pressure controller type V5306A		
<b>spare parts for</b>	106361		
	<b>GEV No.</b>	101408	<b>Ref. No.</b> —
	operator suitable for HONEYWELL supply Operator millivolt		

<sup>1</sup>incl. reducer fittings 2x 1/2" NPT and 1x 3/8" NPT



<b>ROBERTSHAW</b>			
millivolt controlled valves			
1			
<b>GEV No.</b>	580031	<b>Ref. No.</b>	0365-2 1173 1173-HW 1173-WR
<b>description</b>	gas valve supply Operator millivolt gas inlet 3/4" NPT gas outlet 3/4" NPT thermocouple connection pilot connection 1/4" CCT type 7000BMVR pressure controller natural gas 3.5" W.C. suitable for ROBERTSHAW		
<b>For models:</b>	Fryer-Filter-System-Series, IF-25-Series-Fryers, IF-75-Series-Fryers, IF-BL-Basketlift-System-Series-Fryers, IF-Series-Fryers		
<b>spare parts for</b>	580031		
	<b>GEV No.</b>	101422	<b>Ref. No.</b> —
	<b>GEV No.</b>	106109	<b>Ref. No.</b> 28282
	<b>GEV No.</b>	106121	<b>Ref. No.</b> —
	<b>GEV No.</b>	580033	<b>Ref. No.</b> 28328

1			
<b>GEV No.</b>	106792	<b>Ref. No.</b>	1173 1173-RS
<b>description</b>	gas valve supply Operator millivolt gas inlet 3/4" NPT gas outlet 3/4" NPT thermocouple connection pilot connection 1/4" CCT type 7000BMVR pressure controller natural gas 4.0" W.C. natural gas output pressure 4"W.C. operator type 82266 output pressure 10mbar		
<b>spare parts for</b>	106792		
	<b>GEV No.</b>	101422	<b>Ref. No.</b> —
	<b>GEV No.</b>	106109	<b>Ref. No.</b> 28282

<b>spare parts for</b>	106792		
	<b>GEV No.</b>	580033	<b>Ref. No.</b> 28328



1			
<b>GEV No.</b>	106726	<b>Ref. No.</b>	1174 1174-RS
<b>description</b>	gas valve supply Operator millivolt gas inlet 3/4" NPT gas outlet 3/4" NPT thermocouple connection pilot connection 1/4" CCT type 7000BMVR-LP pressure controller LPG 10"W.C. ROBERTSHAW operator type 82266 output pressure 24.9mbar 700mV		
<b>For models:</b>	Fryer-Filter-System-Series, IF-25-Series-Fryers, IF-75-Series-Fryers, IF-BL-Basketlift-System-Series-Fryers, IF-Series-Fryers		
<b>spare parts for</b>	106726		
	<b>GEV No.</b>	101393	<b>Ref. No.</b> —
	<b>GEV No.</b>	101421	<b>Ref. No.</b> —
	<b>GEV No.</b>	106109	<b>Ref. No.</b> 28282
	<b>GEV No.</b>	580033	<b>Ref. No.</b> 28328

safety valves

miscellaneous



1			
<b>GEV No.</b>	106368	<b>Ref. No.</b>	1110-1
<b>description</b>	safety valve BASO type H15HR-3 pressure range 34.5mbar gas inlet 9/16" UNEF (tube ø 9/16") gas outlet 3/8x27 UNF (tube ø 1/4") thermocouple connection 5/32" UNEF 1/2PSI pilot connection 2x 1/4" CCT		

1

<b>GEV No.</b>	106367	<b>Ref. No.</b>	1110
<b>description</b>	safety valve ROBERTSHAW type TS11J pressure range 34.5mbar gas inlet 1/4" NPT gas outlet 1/4" NPT thermocouple connection ASA 11/32 1/2PSI pilot connection 2x 3/8" UNF		
<b>For models:</b>	IHR-Series-with-standard-oven, IPRA-and-IPR-Series-Pork-Roaster, IR2000-Series, IR-Serie-Medium-Duty-Ranges		



1

<b>GEV No.</b>	106348	<b>Ref. No.</b>	1018 1291 1291.018 1292
<b>description</b>	pilot burner ROBERTSHAW type 5CL-2.2 flames natural gas code 18 for pipe ø 3/16" CCT gas connection 3/16" CCTmm nozzle ømm		
<b>For models:</b>	ICMA-Series-Cheesemelter, IDR-Series, IF-Counter-Fryer, IHR-Series-with-standard-oven, IPRA-and-IPR-Series-Pork-Roaster, IR2000-Series, IR-Serie-Medium-Duty-Ranges, ISAE-Griddle, ISB-Series-Salamander-Broiler, ISCE-Griddle		

## ignition parts

### pilot burners

#### ROBERTSHAW

#### pilot burners

#### universal series - type 5



1

<b>GEV No.</b>	106345	<b>Ref. No.</b>	0316 0316.011 1325
<b>description</b>	pilot burner ROBERTSHAW type 5CHL-6.2 flames LPG code 11 for pipe ø 1/4" CCT gas connection 1/4" CCTmm		
<b>For models:</b>	IF-Counter-Fryer		



1

<b>GEV No.</b>	106344	<b>Ref. No.</b>	0316 0316.018 1325
<b>description</b>	pilot burner ROBERTSHAW type 5CHL-6.2 flames natural gas code 18 for pipe ø 1/4" CCT gas connection 1/4" CCTmm		

#### universal series - type 6

*Width of caps:*  
 6CH10 = 1" (25,4mm)  
 6CH14 = 1½" (38,1mm)  
 6CH24 = 2½" (63,5mm)  
 6CH30 = 3" (76,2mm)



1

<b>GEV No.</b>	106347	<b>Ref. No.</b>	1095-16 1095-16.011
<b>description</b>	pilot burner ROBERTSHAW type 6CH14-10 3 flames LPG code 11 for pipe ø 1/4" CCT gas connection 1/4" CCTmm		



1

<b>GEV No.</b>	106375	<b>Ref. No.</b>	1095-16 1095-16.016
<b>description</b>	pilot burner ROBERTSHAW type 6CH14-10 3 flames LPG code 16 for pipe ø 1/4" CCT gas connection 1/4" CCTmm		
<b>For models:</b>	IF-25-Series-Fryers, IF-75-Series-Fryers, IF-BL-Basketlift-System-Series-Fryers, IF-Series-Fryers		



<b>GEV No.</b>	106346	<b>Ref. No.</b>	0310 0310.022 1095-26
<b>description</b>	pilot burner ROBERTSHAW type 6CH14-10 3 flames natural gas code 22 for pipe ø 1/4" CCT gas connection 1/4" CCTmm		
<b>For models:</b>	IF-25-Series-Fryers, IF-75-Series-Fryers, IF-BL-Basketlift-System-Series-Fryers, IF-Series-Fryers		

universal series with electrodes



<b>GEV No.</b>	106349	<b>Ref. No.</b>	1120 1120.018 2139 2139.018
<b>description</b>	pilot burner ROBERTSHAW type 5SL-2 2 flames natural gas code 18 for pipe ø 3/16" CCT		
<b>For models:</b>	IR2000-Series, IR-Serie-Medium-Duty-Ranges, ISAE-Griddle, IS-CE-Griddle		

miscellaneous



<b>GEV No.</b>	102539	<b>Ref. No.</b>	25001
<b>description</b>	pilot burner IMPERIAL USA 4 complete		
<b>For models:</b>	IHR-Series-with-standard-oven		

electrodes

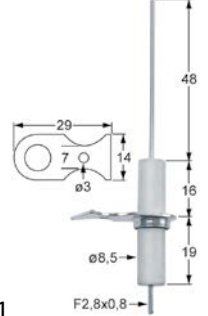

<b>GEV No.</b>	106350	<b>Ref. No.</b>	1256
<b>description</b>	ignition electrode flange length 29mm flange width 14mm flange width 2.7mm D1 ø 8mm L1 48mm BL1 16mm BL2 19mm connection F2.8x0.8 fixing dimensions ø3mm		

ignition cables

pre-assembled cables



<b>GEV No.</b>	100197	<b>Ref. No.</b>	1285
<b>description</b>	ignition cable cable length 600mm connection F2.8mm / ø2.4mm		

piezoelectric igniters

mounting diameter 18mm



<b>GEV No.</b>	100009	<b>Ref. No.</b>	1075 2080	
<b>description</b>	piezoelectric igniter body plastic blowing mounting ø 18mm connection ø2.4mm front measurements 26mm M18x1.5			
<b>For models:</b>	IR2000-Series, IR-Serie-Medium-Duty-Ranges			
<b>accessories for</b>	100009			
	<b>GEV No.</b>	101339	<b>Ref. No.</b>	—
	cover cap for piezoelectric igniter			
	<b>GEV No.</b>	106869	<b>Ref. No.</b>	—
	cover cap for piezoelectric igniter ID ø 22mm ED ø 35mm H 25mm			
	<b>GEV No.</b>	107931	<b>Ref. No.</b>	—
	cover cap for piezoelectric igniter ID ø 21mm ED ø 36mm			





thermocouples

thermocouple sets universal

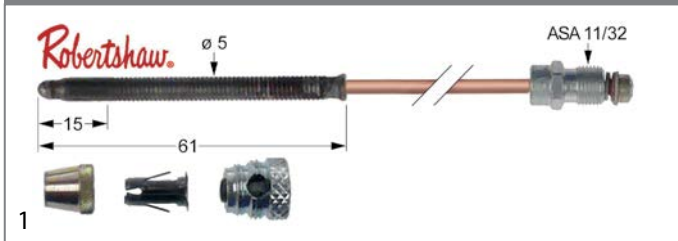

<b>GEV No.</b>	107705	<b>Ref. No.</b>	1121-1
<b>description</b>	thermocouple ROBERTSHAW 5-piece L 18" - 455mm ASA 11/32		

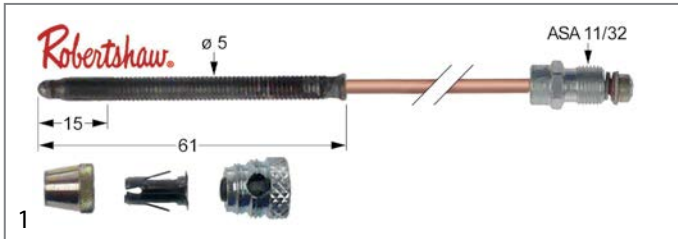

<b>GEV No.</b>	107707	<b>Ref. No.</b>	1138
<b>description</b>	thermocouple ROBERTSHAW 5-piece L 30" - 760mm ASA 11/32		
<b>For models:</b>	IHR-Series-with-standard-oven, IR-Serie-Medium-Duty-Ranges		

plug-in thermocouples

plug-in thermocouples standard

ROBERTSHAW

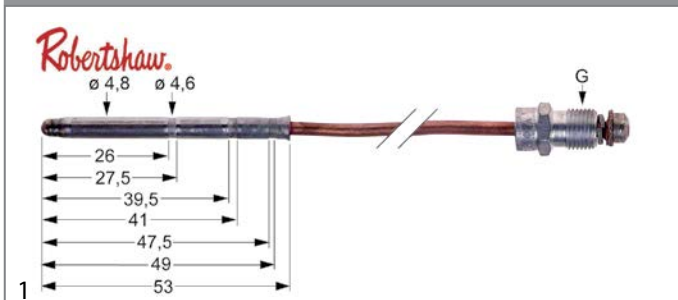

<b>GEV No.</b>	102456	<b>Ref. No.</b>	1121 2140
<b>description</b>	thermocouple ASA 11/32 L 12" - 305mm plug connection ø4.8mm		
<b>For models:</b>	IR2000-Series, IR-Serie-Medium-Duty-Ranges		

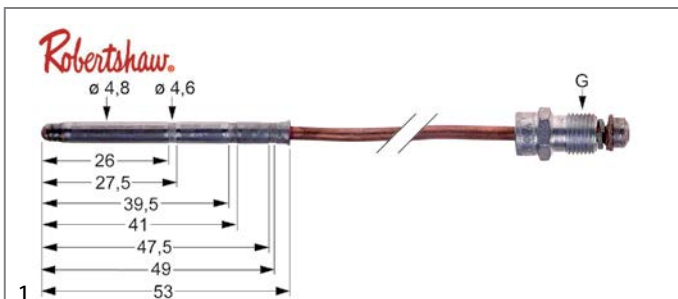

<b>GEV No.</b>	102457	<b>Ref. No.</b>	32167
<b>description</b>	thermocouple ASA 11/32 L 30" - 760mm plug connection ø4.8mm		

threaded thermocouples (miscellaneous)



<b>GEV No.</b>	102458	<b>Ref. No.</b>	1149 old version
<b>description</b>	thermocouple ASA 11/32 L 24" - 610mm plug connection ø4.8mm		



<b>GEV No.</b>	102459	<b>Ref. No.</b>	0230 1265
<b>description</b>	thermocouple ASA 11/32 L 72" - 1825mm plug connection ø4.8mm		



<b>GEV No.</b>	103266	<b>Ref. No.</b>	1149
<b>description</b>	thermocouple L 695mm plug connection ø4.8mm		

thermopiles

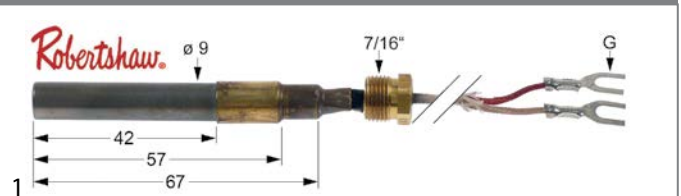

<b>GEV No.</b>	102116	<b>Ref. No.</b>	1096
<b>description</b>	thermopile ROBERTSHAW L 900mm probe ø 9mm probe L 57mm 250-750mV screw connection 7/16"		
<b>For models:</b>	IF-25-Series-Fryers, IF-75-Series-Fryers, IF-BL-Basketlift-System-Series-Fryers, IF-Counter-Fryer, IF-Series-Fryers		

gas burners

hob burners

producer-specific hob burners

IMPERIAL USA



<b>GEV No.</b>	103027	<b>Ref. No.</b>	2119 2680
<b>description</b>	burner cap ø 117mm with central hole		
<b>For models:</b>	IHPA-Series-Hot-Plate, IR2000-Series		

1

<b>GEV No.</b>	104274	<b>Ref. No.</b>	25050
<b>description</b>	burner head ø 155mm front suitable for IHR		
<b>For models:</b>	IHR-Series-with-standard-oven		



1

<b>GEV No.</b>	104279	<b>Ref. No.</b>	25051
<b>description</b>	burner head ø 155mm rear suitable for IHR		
<b>For models:</b>	IHR-Series-with-standard-oven		

bar burners

bar burners



1

<b>GEV No.</b>	103019	<b>Ref. No.</b>	11350
<b>description</b>	bar burner L 355mm W 155mm ømm H 75mm chargrill		
<b>For models:</b>	EBA-Series-Char-Rock-Broilers		



1

<b>GEV No.</b>	103028	<b>Ref. No.</b>	2092-1 2099
<b>description</b>	bar burner L 510mm W 150mm ø 32mm Hmm griddle		



1

<b>GEV No.</b>	210023	<b>Ref. No.</b>	1206 5001
<b>description</b>	chargrill grid L 530mm W 127mm H 20mm chargrill		
<b>For models:</b>	EBA-Series-Char-Rock-Broilers, IAB-Series-Steakhouse-Broiler		



1

<b>GEV No.</b>	210024	<b>Ref. No.</b>	1207 5003
<b>description</b>	lava rock grid L 385mm W 205mm H 25mm		
<b>For models:</b>	EBA-Series-Char-Rock-Broilers		

chargrill grids



1

<b>GEV No.</b>	210023	<b>Ref. No.</b>	1206 5001
<b>description</b>	chargrill grid L 530mm W 127mm H 20mm chargrill		
<b>For models:</b>	EBA-Series-Char-Rock-Broilers, IAB-Series-Steakhouse-Broiler		

lava rock grids



1

<b>GEV No.</b>	210024	<b>Ref. No.</b>	1207 5003
<b>description</b>	lava rock grid L 385mm W 205mm H 25mm		
<b>For models:</b>	EBA-Series-Char-Rock-Broilers		

tube burners



1

<b>GEV No.</b>	105561	<b>Ref. No.</b>	0305 1225
<b>description</b>	tubular burner L 330mm W 65mm H 56mm fryer oval		
<b>For models:</b>	Fryer-Filter-System-Series, IF-25-Series-Fryers, IF-75-Series-Fryers, IF-BL-Basketlift-System-Series-Fryers, IF-Series-Fryers		



## gas nozzles

### main nozzles

#### gas nozzles 3/8" UNF



1

<b>GEV No.</b>	106353	<b>Ref. No.</b>	2062
<b>description</b>	gas injector code 39 thread 3/8" UNF bore ø 2.5mm ø 11mm total length 18.5mm WS 13		



1

<b>GEV No.</b>	106351	<b>Ref. No.</b>	2059
<b>description</b>	gas injector code 41 thread 3/8" UNF bore ø 2.4mm ø 11mm total length 18.5mm WS 13		



1

<b>GEV No.</b>	106376	<b>Ref. No.</b>	1700-43 2062-1
<b>description</b>	gas injector code 43 thread 3/8" UNF bore ø 2.2mm ø 11mm total length 18.5mm WS 13		
<b>For models:</b>	IAB-Series-Steakhouse-Broiler, IHPA-Series-Hot-Plate, IPRA-and-IPR-Series-Pork-Roaster, IR-Series-Elite-Range-Series, ISB-Series-Salamander-Broiler		



1

<b>GEV No.</b>	106352	<b>Ref. No.</b>	2067
<b>description</b>	gas injector code 52 thread 3/8" UNF bore ø 1.5mm ø 11mm total length 18.5mm WS 13		

#### gas nozzles (other)



1

<b>GEV No.</b>	102535	<b>Ref. No.</b>	162536
<b>description</b>	gas injector thread 9/16" UNF code 36 WS 9/16" L 55mm natural gas for fryer		
<b>For models:</b>	Fryer-Filter-System-Series, IF-25-Series-Fryers, IF-75-Series-Fryers, IF-BL-Basketlift-System-Series-Fryers, IF-Series-Fryers		



1

<b>GEV No.</b>	102529	<b>Ref. No.</b>	162551
<b>description</b>	gas injector thread 9/16" UNF code 51 WS 9/16" bore ø 1.6mm L 42mm LPG for fryer		
<b>For models:</b>	Fryer-Filter-System-Series, IF-25-Series-Fryers, IF-75-Series-Fryers, IF-BL-Basketlift-System-Series-Fryers, IF-Series-Fryers		

## pilot burner nozzles

### pilot burner nozzles ROBERTSHAW



1

<b>GEV No.</b>	100275	<b>Ref. No.</b>	1018 1292 2151
<b>description</b>	pilot burner nozzle LPG code 10 bore ø 0.1mm suitable for ROBERTSHAW		

## auxiliary gas parts

### screw connections

#### olives



1

<b>GEV No.</b>	101481	<b>Ref. No.</b>	1633 30270
<b>description</b>	olive for pipe ø 1/4" CCT Qty 1 pcs		



1

<b>GEV No.</b>	106374	<b>Ref. No.</b>	30280
<b>description</b>	olive for pipe ø 3/16" CCT Qty 1 pcs		



1

<b>GEV No.</b>	106355	<b>Ref. No.</b>	30272
<b>description</b>	olive for pipe ø 3/8" CCT Qty 1 pcs		

#### union nuts



1

<b>GEV No.</b>	106354	<b>Ref. No.</b>	30266
<b>description</b>	union nut thread 3/8" CCT WS 16		



1

<b>GEV No.</b>	101483	<b>Ref. No.</b>	1633 30735
<b>description</b>	union nut thread 1/4" CCT short		



**union screws**



1			
<b>GEV No.</b>	106109	<b>Ref. No.</b>	28282
<b>description</b>	locking screw thread 7/16"-24 UNS for pipe ø 1/4" L 16mm brass Qty 1 pcs WS 7/16" (11.113mm) hole ø 6.4mm		

**gas pressure regulators**

*Standard pressure according to country:*  
 Germany 50mbar  
 France 37mbar  
 Italy 30mbar  
 Spain 37/50mbar  
 UK 20mbar



1			
<b>GEV No.</b>	106360	<b>Ref. No.</b>	1051 2144 38734
<b>description</b>	gas pressure regulator RV48L input pressure max. 34.5bar output pressure 12.5-29.9mbar input pressure max. 1/2PSI output pressure 5-12"W.C.		
<b>For models:</b>	EBA-Series-Char-Rock-Broilers, GD-Series-Char-Rock-Broilers, ICB-Chicken-Broiler, ICMA-Series-Cheesemelter, ICRA-Series-chinese-range, ICV-and-ICVD-Series, IHR-Series-with-standard-oven, IMGA-Series-Manually-controlled-Griddles, IPRA-and-IPR-Series-Pork-Roaster, IR2000-Series, IRB-Series-Radiant-Char-Broilers, IR-Series-Medium-Duty-Ranges, ISAE-Griddle, ISB-Series-Salamander-Broiler, ISCE-Griddle, ISPA-Series-stock-Pot, ISP-J-Series-Wok, ITG24, ITG36, ITG-Series-Thermostatically-controlled, MSQ-Mesquite-Wood-Broiler		



1			
<b>GEV No.</b>	106359	<b>Ref. No.</b>	1050 2143 38733
<b>description</b>	gas pressure regulator RV48LS input pressure max. 34.5bar output pressure 7.5-15mbar input pressure max. 1/2PSI output pressure 3-6"W.C. natural gas thread 3/4" NPT		
<b>For models:</b>	EBA-Series-Char-Rock-Broilers, GD-Series-Char-Rock-Broilers, ICB-Chicken-Broiler, ICMA-Series-Cheesemelter, ICRA-Series-chinese-range, ICV-and-ICVD-Series, IHPA-Series-Hot-Plate, IHR-Series-with-standard-oven, IMGA-Series-Manually-controlled-Griddles, IPRA-and-IPR-Series-Pork-Roaster, IR2000-Series, IRB-Series-Radiant-Char-Broilers, IR-Series-Medium-Duty-Ranges, ISAE-Griddle, ISB-Series-Salamander-Broiler, ISCE-Griddle, ISPA-Series-stock-Pot, ISP-J-Series-Wok, ITG24, ITG36, ITG-Series-Thermostatically-controlled, MSQ-Mesquite-Wood-Broiler		

**gas ball valves**

**miscellaneous**



1			
<b>GEV No.</b>	106365	<b>Ref. No.</b>	0344 1623
<b>description</b>	ball valve straight lever handle inlet 1 1/4"NPT outlet 1 1/4"NPT DN32 L 84mm gas IT 1 1/4"NPT		
<b>For models:</b>	IF-25-Series-Fryers, IF-75-Series-Fryers, IF-BL-Basketlift-System-Series-Fryers, IF-Series-Fryers		



1			
<b>GEV No.</b>	106364	<b>Ref. No.</b>	0345 0353 1281
<b>description</b>	ball valve straight lever handle inlet 1"NPT outlet 1"NPT DN25 L 70mm gas		
<b>For models:</b>	IF-Counter-Fryer		



gas lines

pilot tubes

universal



**GEV No.** 106358 **Ref. No.** 2102

**description** gas line aluminium pipe ø 3/8" CCT L 285mm



**GEV No.** 106357 **Ref. No.** 2105  
3061

**description** pilot tube aluminium pipe ø 1/4" CCT L 300mm



**GEV No.** 106356<sup>1</sup> **Ref. No.** 2101  
2101-35  
3058

**description** pilot tube aluminium pipe ø 3/16" CCT Lmm

<sup>1</sup>by the meter

consumables

lava rocks / ceramic briquettes



**GEV No.** 211003 **Ref. No.** 8092

**description** lava rocks size ca.40-120mm Qty 9kg

equipment-specific units

for deep fryers

lids



**GEV No.** 695177 **Ref. No.** 28085

**description** lid suitable for for fryer L 620mm W 390mm

**For models:** IF-BL-Basketlift-System-Series-Fryers, IF-Series-Fryers

spare parts and accessories



**GEV No.** 691771 **Ref. No.** 0308  
28026

**description** diffuser SS L 390mm W 110mm H 50mm

**For models:** Fryer-Filter-System-Series, IF-25-Series-Fryers, IF-BL-Basketlift-System-Series-Fryers, IF-Series-Fryers

door magnets



**GEV No.** 690424 **Ref. No.** 0335  
1830

**description** door magnet L 57mm W 21mm H 9mm

**For models:** Fryer-Filter-System-Series, IF-25-Series-Fryers, IF-75-Series-Fryers, IF-Series-Fryers

sumps



**GEV No.** 691776 **Ref. No.** 28005

**description** sump for fryer suitable for IMPERIAL USA IF-series with 3 burner chambers

**For models:** IF-BL-Basketlift-System-Series-Fryers, IF-Series-Fryers

## miscellaneous



1

<b>GEV No.</b>	691779	<b>Ref. No.</b>	28269
<b>description</b>	bridge for fryer L 600mm W 37mm H 39mm		
<b>For models:</b>	IF-25-Series-Fryers		



1

<b>GEV No.</b>	691778	<b>Ref. No.</b>	28210
<b>description</b>	bridge for fryer SS L 620mm W 48mm H 50mm		
<b>For models:</b>	Fryer-Filter-System-Series		



1

<b>GEV No.</b>	541601	<b>Ref. No.</b>	24119 30864
<b>description</b>	drain pipe L 177mm thread 1"NPT		
<b>For models:</b>	IF-Counter-Fryer		



1

<b>GEV No.</b>	541602	<b>Ref. No.</b>	30647M
<b>description</b>	drain pipe ø 1¼"NPTmm L 127mm		

## for ovens

## doors



1

<b>GEV No.</b>	691773	<b>Ref. No.</b>	2688
<b>description</b>	oven door W 750mm H 455mm thickness 50mm		
<b>For models:</b>	IR2000-Series		

## knobs

## producer-specific knobs

## IMPERIAL USA



1

<b>GEV No.</b>	112317	<b>Ref. No.</b>	2730
<b>description</b>	knob gas tap with ignition flame t.max.°F°F ø 63mm shaft ø 9x6mm shaft flat lower blue		





1

<b>GEV No.</b>	112318	<b>Ref. No.</b>	0260-1 2733
<b>description</b>	knob gas tap with ignition flame t.max.°F°F ø 63mm shaft ø 9x6mm shaft flat lower blue		





			
1			
<b>GEV No.</b>	112302	<b>Ref. No.</b>	2731
<b>description</b>	knob gas tap with ignition flame t.max.°F°F ø 64mm shaft ø 9x6mm shaft flat lower blue		

			
1			
<b>GEV No.</b>	112554	<b>Ref. No.</b>	1151L/S
<b>description</b>	knob gas thermostat t.max. 500°F 250-500°F ø 49mm shaft ømm shaft flat ROBERTSHAW black		

			
1			
<b>GEV No.</b>	112605	<b>Ref. No.</b>	1107
<b>description</b>	knob gas thermostat t.max. 400°F 150-400°F ø 49mm shaft ø 17mm black		
<b>For models:</b>	IHR-Series-with-standard-oven		

			
1			
<b>GEV No.</b>	112297	<b>Ref. No.</b>	1008 2720 36330
<b>description</b>	knob graduated t.max.°F°F ø 70mm shaft ø 9x6mm shaft flat lower blue		
<b>For models:</b>	IAB-Series-Steakhouse-Broiler, ICMA-Series-Cheesemelter, ICRA-Series-chinese-range, IHPA-Series-Hot-Plate, IHR-Series-with-standard-oven, IMGGA-Series-Manually-controlled-Griddles, IPRA-and-IPR-Series-Pork-Roaster, IR2000-Series, IRB-Series-Radiant-Char-Broilers, IR-Series-Medium-Duty-Ranges, IR-Series-Elite-Range-Series, ISB-Series-Salamander-Broiler, ISPA-Series-stock-Pot		

			
1			
<b>GEV No.</b>	112735	<b>Ref. No.</b>	1101
<b>description</b>	knob gas thermostat t.max. 400°F 150-400°F ø 49mm shaft ø 17mm black		
<b>For models:</b>	IR2000-Series, IR-Series-Medium-Duty-Ranges		

			
1			
<b>GEV No.</b>	112553	<b>Ref. No.</b>	1009 27051 2721 4054
<b>description</b>	knob ON-OFF t.max.°F°F ø 61mm shaft ø 9x6mm shaft flat upper		
<b>For models:</b>	EBA-Series-Char-Rock-Broilers, GD-Series-Char-Rock-Broilers, ICB-Chicken-Broiler, IHR-Series-with-standard-oven, MSQ-Mesquite-Wood-Broiler		

			
1			
<b>GEV No.</b>	112548	<b>Ref. No.</b>	1106 2011
<b>description</b>	knob gas thermostat t.max. 400°F 150-400°F ø 49mm shaft ømm shaft flat ROBERTSHAW		
<b>For models:</b>	ITG24, ITG36, ITG-Series-Thermostatically-controlled		

			
1			
<b>GEV No.</b>	112319	<b>Ref. No.</b>	0319-1 1176
<b>description</b>	knob thermostat t.max. 400°F 200-400°F ø 57mm shaft ø 6x5mm shaft flat lower black		
<b>For models:</b>	Fryer-Filter-System-Series, IF-25-Series-Fryers, IF-75-Series-Fryers, IF-BL-Basketlift-System-Series-Fryers, IF-Counter-Fryer, IF-Series-Fryers		

			
1			
<b>GEV No.</b>	112547	<b>Ref. No.</b>	1151 2131
<b>description</b>	knob gas thermostat t.max. 500°F 200-500°F ø 49mm shaft ømm shaft flat ROBERTSHAW black		
<b>For models:</b>	IPRA-and-IPR-Series-Pork-Roaster, IR2000-Series, IR-Series-Medium-Duty-Ranges		

accessories

rosettes



<b>GEV No.</b>	112549	<b>Ref. No.</b>	1103
<b>description</b>	rosette for knob ø 60mm up to ø 50mm		
<b>For models:</b>	IPRA-and-IPR-Series-Pork-Roaster, IR2000-Series, IR-Serie-Medium-Duty-Ranges		



<b>GEV No.</b>	112555	<b>Ref. No.</b>	1103L/S
<b>description</b>	rosette for knob ø 60mm up to ø 50mm		

hinges

oven hinges



<b>GEV No.</b>	691772	<b>Ref. No.</b>	20161
<b>description</b>	oven hinge W 700mm		
<b>For models:</b>	IDR-Series, IHR-Series-with-standard-oven, IR2000-Series, IR-Serie-Medium-Duty-Ranges		

door bearing



<b>GEV No.</b>	691769	<b>Ref. No.</b>	28050
<b>description</b>	hinge L 20mm W 15mm H 52mm mounting pos. left		
<b>For models:</b>	IF-25-Series-Fryers, IF-75-Series-Fryers, IF-BL-Basketlift-System-Series-Fryers, IF-Counter-Fryer, IF-Series-Fryers		



<b>GEV No.</b>	691770	<b>Ref. No.</b>	28048
<b>description</b>	hinge L 20mm W 15mm H 52mm mounting pos. right		
<b>For models:</b>	IF-25-Series-Fryers, IF-75-Series-Fryers, IF-BL-Basketlift-System-Series-Fryers, IF-Counter-Fryer, IF-Series-Fryers		

filters

deep fryer filters



<b>GEV No.</b>	691774	<b>Ref. No.</b>	28209 3056-1
<b>description</b>	paper filter W 315mm L 595mm Qty 100 pcs for fryer		
<b>For models:</b>	Fryer-Filter-System-Series		



<b>GEV No.</b>	691775	<b>Ref. No.</b>	28370 3056
<b>description</b>	paper filter W 410mm L 695mm Qty 100 pcs for fryer		

miscellaneous

with fixing plate

ø125mm



<b>GEV No.</b>	700012	<b>Ref. No.</b>	1060 2502
<b>description</b>	swivel castor ø 125mm plates fixing 93x61mm housing steel plate size 92x60mm hole distance 73x43mm capacity 100kg bearing ball bearing wheel body polypropylene tread TPE tyres H 152mm wheel width 30mm -20 up to +60°C Qty 1 pcs		
<b>For models:</b>	IDR-Series, IHR-Series-with-standard-oven, IR2000-Series, IR-Serie-Medium-Duty-Ranges		



<b>GEV No.</b>	700819 <sup>1</sup>	<b>Ref. No.</b>	1061
<b>description</b>	swivel castor with brake ø 125mm plates fixing 93x61mm housing steel hole distance 73x43mm wheel width 30mm		
<b>For models:</b>	IDR-Series, IHR-Series-with-standard-oven, IR2000-Series, IR-Serie-Medium-Duty-Ranges		

<sup>1</sup>with swivel brake





## baskets

### fryer baskets

#### US producers



1

<b>GEV No.</b>	970637	<b>Ref. No.</b>	2036 3079
<b>description</b>	fryer basket L1 330mm W1 315mm H1 135mm L2 275mm H2 210mm H3 240mm		
<b>For models:</b>	Fryer-Filter-System-Series, IF-BL-Basketlift-System-Series-Fryers, IF-Series-Fryers		



1

<b>GEV No.</b>	970636	<b>Ref. No.</b>	0362 2035 2050
<b>description</b>	fryer basket L1 340mm W1 170mm H1 150mm L2 295mm H2 240mm H3 300mm		
<b>For models:</b>	Fryer-Filter-System-Series, IF-25-Series-Fryers, IF-BL-Basketlift-System-Series-Fryers, IF-Series-Fryers		

### crumb screens

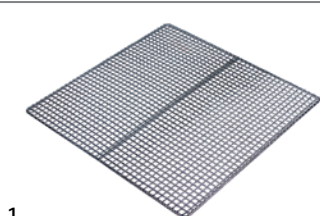

1

<b>GEV No.</b>	970640	<b>Ref. No.</b>	2038
<b>description</b>	crumb screen L 335mm W 342mm		
<b>For models:</b>	Fryer-Filter-System-Series, IF-BL-Basketlift-System-Series-Fryers, IF-Series-Fryers		

## shelves and shelf rails

### chargrill grids



1

<b>GEV No.</b>	210023	<b>Ref. No.</b>	1206 5001
<b>description</b>	chargrill grid L 530mm W 127mm H 20mm chargrill		
<b>For models:</b>	EBA-Series-Char-Rock-Broilers, IAB-Series-Steakhouse-Broiler		

### grates

#### universal

#### with upstand



1

<b>GEV No.</b>	970639	<b>Ref. No.</b>	2021
<b>description</b>	grate W 530mm D 670mm chrome-plated steel for oven crossing wires 1		
<b>For models:</b>	IR-Serie-Medium-Duty-Ranges		

#### producer-specific



1

<b>GEV No.</b>	970638	<b>Ref. No.</b>	2120 4037-3
<b>description</b>	grate W 550mm D 640mm chrome-plated steel for oven		
<b>For models:</b>	IR2000-Series		



consumables

lava rocks / ceramic briquetts

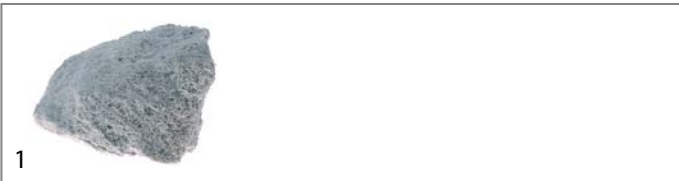

1

<b>GEV No.</b>	211003	<b>Ref. No.</b>	8092
<b>description</b>	lava rocks size ca.40-120mm Qty 9kg		

**B**

bar burners 10

**C**

castors and bumper angles 16

consumables 18

**G**

gas ball valves 12

gas burners 9

gas control valves 5

gas lines 13

gas nozzles 11

gas pressure regulators 12

gas taps 4

gas thermostats 5

grates 17

**H**

hob burners 9

**I**

ignition cables 8

**L**

lava rocks / ceramic briquetts 13, 18

**O**

oven hinges 16

**P**

piezoelectric igniters 8

pilot burners 7

**S**

safety valves 6

shelves and shelf rails 17

solenoid valves 3

**T**

thermocouples 9

thermostats 3

tube burners 10