



GAS COMPONENTS



ELECTRIC COMPONENTS



WATER TECHNOLOGY



MECHANICAL COMPONENTS



TOOLS

Spare parts suitable for

INOXTREND

Find the complete and up-to-date range of products in our GEV Webshop



Manufacturer catalogue

The most important spare parts and accessories arranged clearly for every manufacturer

- ✓ Complete product range and all appliance data always up to date in the GEV Webshop
- ✓ Alphabetical Index at the end of the catalogue

GEV Webshop

www.gev-online.co.uk

www.gev-online.com



- 🔍 Add to Favourites
- 🔍 Sign In with email address and usual password
- 🔍 Easy-order – place several items in your basket at the same time
- 🔍 Quick Item search – no login needed



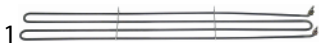

heating elements

heating elements for bain maries

			
GEV No.	419285	Ref. No.	FX0161-00
description	heating element 2660/2900W 230-240V heating circuits 1 L 1160mm W 130mm connection M5 tube ø 8.5mm 2 hole fixing thread M14x1 immersion heater bain marie H 20mm mounting distance 122mm		

heater battery

			
GEV No.	419034	Ref. No.	FX0058-00 FX0063-00 RRFX0063-00
description	heater battery mounting distance 95mm W 116mm H 45mm 800W 230V temperature restriction 90°C heating circuits 1 connection male faston 6.3mm cable length 220mm L 105mm for cross flow fan		
accessories for	419034		
			
GEV No.	601722	Ref. No.	FX0062-00 RRFX0062-00
description	cross flow fan TAS09B-002 roller ø 60mm roller length 94mm laminated core thickness 12mm motor position right 230V/50-60Hz connection male faston 6.3mm		

contact heaters

			
GEV No.	419036	Ref. No.	C2063-00
description	contact heater 1100W 230V heating circuits 1 L 137mm W 120mm H 10mm for combi-steamer connection distance 44mm hole ø 7.5mm		

			
GEV No.	418024	Ref. No.	C5451-00 RRC5451-00
description	hot plate 2200W 230V heating circuits 2 L 194mm H 27mm ø 170mm steam generator dry heating element		

immersion heating elements

3 hole flange ø57.5mm

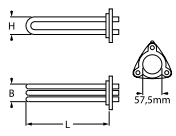
 			
GEV No.	420584	Ref. No.	C5854-00 RRC5854-00
description	heating element 12000W 230V mounting ø 57.5mm heating circuits 3 L 470mm W 34mm H 40mm tube ø 8.5mm hole distance 73mm connection screw flange boiler with gasket combi-steamer		

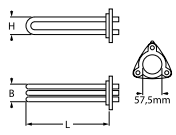
 			
GEV No.	420583	Ref. No.	C5853-00
description	heating element 16000W 230V mounting ø 57.5mm heating circuits 3 L 370mm W 47mm H 47mm tube ø 8.5mm hole distance 73mm connection screw flange boiler with gasket INCOLOY-800 combi-steamer		

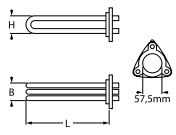
 			
GEV No.	420581	Ref. No.	C5851-00
description	heating element 3900W 230V heating circuits 3 mounting ø 57.5mm L 150mm W 47mm H 47mm round flange connection screw immersion heater tube ø 8.5mm boiler combi-steamer with gasket		

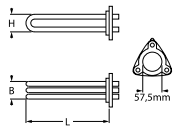
 			
GEV No.	420580	Ref. No.	C5852-00 C5852-12 RRC5852-12
description	heating element 8000W 230V heating circuits 3 L 335mm W 38mm H 42mm round flange connection M5 for boiler tube ø 8.5mm connection length 20mm with gasket		



heating elements for convection



1

GEV No.	418021	Ref. No.	C2431-00 C2538-00 RRC2431-00 RRC2538-00
description	heating element 11000W 230V heating circuits 3 ID ø 298mm ED ø 314mm L 355mm H 105mm L1 34mm W1 104mm H1 28mm H2 87mm flange length 142mm flange width 25mm hole distance 64mm connection M4 tube ø 8.5mm convection heating element hole ø 6mm rectangular flange		



1

GEV No.	418023	Ref. No.	C7172-00 RRC7172-00
description	heating element 12000W 230V heating circuits 3 ID ø 408mm ED ø 425mm L 451mm H 134mm L1 18mm W1 105mm H1 46mm H2 88mm flange length 142mm flange width 25mm hole distance 63mm connection M4 tube ø 8.5mm convection heating element hole ø 6mm flange 142 x 25mm		



1

GEV No.	418022	Ref. No.	C7170-00 RRC7170-00
description	heating element 14000W 230V heating circuits 3 ID ø 368mm ED ø 388mm L 420mm H 128mm L1 35mm W1 105mm H1 38mm H2 90mm flange length 142mm flange width 25mm hole distance 126mm connection M4 connection length 80mm tube ø 6.3mm dry heating element hole ø 6mm rectangular flange		



1

GEV No.	420578	Ref. No.	LC-003
description	heating element 16000W 230V heating circuits 3 ID ø 340mm ED ø 385mm L 425mm H 72mm L1 30mm W1 105mm H1 13mm H2 55mm flange length 142mm flange width 25mm hole distance 63mm connection screw connection length 20mm tube ø 8.5mm convection heating element hole ø 6mm combi-steamer		



1

GEV No.	420579	Ref. No.	LC-004 LC-004G
description	heating element 22500W 400V heating circuits 3 ID ø 495mm ED ø 515mm L 550mm H 85mm L1 70mm W1 105mm H2 58mm flange length 142mm flange width 25mm hole distance 63mm connection screw connection length 20mm tube ø 10mm convection heating element mounting thread M4 hole ø 6mm combi-steamer		



1

GEV No.	420577	Ref. No.	X1280-12
description	heating element 25000W 400V heating circuits 3 ID ø 405mm ED ø 450mm L 490mm H 105mm L1 50mm W1 105mm H1 35mm H2 72mm flange length 142mm flange width 25mm hole distance 63mm connection screw connection length 20mm tube ø 10mm convection heating element combi-steamer		





1

GEV No.	418018	Ref. No.	C6015-00 RRC6015-00
description	heating element 2800W 230V heating circuits 1 ID ø 192mm L 290mm H 37mm L1 85mm W1 59mm flange length 100mm flange width 22mm hole distance 86mm ED ø 210mm connection M4 connection length 22mm tube ø 6.3mm convection heating element hole ø 5mm rectangular flange		



			
1			
GEV No.	418019	Ref. No.	C3616-00 RRC3616-00
description	heating element 3900W 230V heating circuits 3 ID ø 206mm ED ø 218mm L 275mm H 40mm L1 48mm W1 104mm H1 10mm H2 24mm flange length 142mm flange width 25mm hole distance 62.5mm connection M4 connection length 62mm tube ø 6mm convection heating element hole ø 6.5mm rectangular flange		
For models:	CS-5		

			
1			
GEV No.	418020	Ref. No.	C2036-00 C3090-00 LC-001 RRC2036-00 RRC3090-00
description	heating element 7800W 230V heating circuits 3 ID ø 264mm ED ø 277mm L 315mm H 100mm L1 35mm W1 101mm H1 29mm H2 67mm flange length 142mm flange width 23mm hole distance 63mm connection M4 connection length 75mm tube ø 6.3mm convection heating element mounting thread M4 rectangular flange		
For models:	CVE-10 +KTE		

			
1			
GEV No.	420585	Ref. No.	C7560-00 LC-005 LC-005-12
description	heating element 4900W 230V heating circuits 3 ID ø 275mm ED ø 290mm L 315mm H 50mm W1 105mm H1 48mm H2 34mm flange length 142mm flange width 25mm hole distance 63mm connection screw connection length 20mm tube ø 8.5mm convection heating element flange combi-steamer INCOLOY-800		

			
1			
GEV No.	418905	Ref. No.	C9013-00 LC-002 LC-002-22 RRC9013-00 RRLC-002
description	heating element 8000W 230V heating circuits 3 ID ø 302mm ED ø 319mm L 370mm H 60mm L1 54mm W1 104mm H1 22mm H2 38mm flange length 142mm flange width 25mm hole distance 63mm connection M4 connection length 58mm tube ø 8.5mm convection heating element		

			
1			
GEV No.	420586	Ref. No.	C7558-00
description	heating element 5800W 230V heating circuits 3 ID ø 275mm ED ø 290mm L 318mm H 48mm W1 104.5mm H1 15mm H2 34mm flange length 142mm flange width 25mm hole distance 63mm connection screw connection length 20mm tube ø 8.5mm convection heating element mounting thread M4 hole ø 6mm combi-steamer INCOLOY-800		

energy regulators

EGO

1-circuit



1			
GEV No.	380015	Ref. No.	C2192-00 RRC2192-00
description	energy regulator 230V 13A single-circuit turn direction right shaft ø 6x4.6mm shaft L 23mm mounting thread M4 power release 6-100% no. 50.57021.010		



thermostats

bi-metal thermostats

bi-metal thermostats



1

GEV No.	391053	Ref. No.	FX0182-00
description	bi-metal thermostat hole distance 24mm 1NC 16.5A 240V connection F6.3x0.8 t.max. 204°C		



1

GEV No.	375611	Ref. No.	C2065-00 RRC2065-00
description	bi-metal thermostat hole distance 34mm switch-off temp. 180°C 2NC 2-pole 16A connection F6.3 2 hole fixing		

control and safety thermostats

EGO

control thermostats

55.10/19_ series



1

GEV No.	375607	Ref. No.	C2218-00 Alt RRC2218-00 alt
description	thermostat t.max. 110°C temperature range fixed 110°C 1-pole 1CO 16A probe ø 3mm probe L 219mm capillary pipe 900mm capillary pipe isolated 800mm gland nut M9x1		



1

GEV No.	375608	Ref. No.	C2190-00 RRC2190-00
description	thermostat t.max. 265°C temperature range 50-265°C 1-pole 1NO 16A probe ø 3mm probe L 219mm capillary pipe 900mm capillary pipe isolated 800mm gland nut M9x1 shaft ø 6x4.6mm shaft L 23mm shaft position upper rotation 270°		



1

GEV No.	390815	Ref. No.	LC352
description	thermostat t.max. 273°C temperature range 57-273°C 1-pole 1NO 16A probe ø 3.1mm probe L 226mm capillary pipe 1470mm capillary pipe isolated 1250mm gland nut M9x1 shaft ø 6x4.6mm shaft L 23mm shaft position upper rotation 270°		



1

GEV No.	375231	Ref. No.	FX0187-00
description	thermostat t.max. 90°C temperature range 30-90°C 1-pole 1NO 16A probe ø 6mm probe L 130mm capillary pipe 900mm capillary pipe isolated 600mm gland nut M9x1 shaft L 18mm shaft position upper rotation 270°		

55.13_ series



1

GEV No.	375954	Ref. No.	C2218-00 RRC2218-00
description	thermostat t.max. 109°C 1-pole 1CO 16A probe ø 3.03mm probe L 198mm capillary pipe 900mm capillary pipe isolated 610mm gland nut M9x1 shaft ø 6mm shaft Lmm shaft position° shaft position rotation°		

safety thermostats

55.14_series

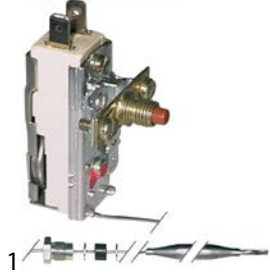

GEV No.	375610	Ref. No.	C2198-00 RRC2198-00
description	safety thermostat switch-off temp. 340°C 1-pole 16A probe ø 3.03mm probe L 144mm capillary pipe 880mm capillary pipe isolated 750mm gland nut M9x1 probe		
For models:	CVE 10-R, MDP-6G		

55.32_series

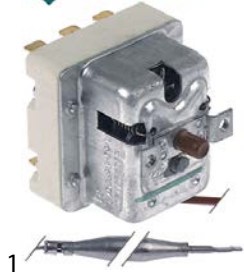

GEV No.	375649	Ref. No.	LC-351 RRLC-351
description	safety thermostat switch-off temp. 160°C 3-pole 20A probe ø 6mm probe L 87mm capillary pipe 890mm capillary pipe isolated 880mm gland nut probe SS		

CAEM

control thermostats

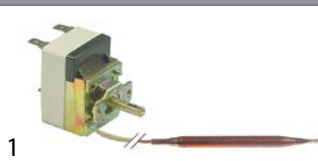

GEV No.	375609	Ref. No.	C2185-00 RRC2185-00
description	thermostat t.max. 90°C temperature range 30-90°C 1-pole 1CO 16A probe ø 6mm probe L 95mm capillary pipe 1600mm capillary pipe isolated 1550mm shaft ø 6x4.6mm rotation 270°		
For models:	MDP-6G		

safety thermostats



GEV No.	376093	Ref. No.	LC-354
description	safety thermostat switch-off temp. 368°C 2-pole 10A probe ø 3mm probe L 140mm capillary pipe 1000mm capillary pipe isolated 750mm 400V at 250V 20A at 400V 10A		

various

safety thermostats



GEV No.	375633	Ref. No.	C2242-00 RRC2242-00
description	safety thermostat		

switches and momentary switches

rocker/momentary rocker switches

30x11mm



GEV No.	301013	Ref. No.	C2206-00 RRC2206-00
description	rocker switch mounting measurements 30x11mm black 1CO 250V 16A connection male faston 6.3mm ambient temperature max. 85/125°C protection IP40		



push/momentary push switches

ø16mm



1

GEV No.	346320	Ref. No.	C5420-00 RRC5420-00
description	momentary push switch mounting ø 16mm red 1NO/indicator light 250V 3A ignition connection male faston 6.3mm ambient temperature max. 85°C protection IP40		
For models:	MDP-6G		

ø25mm



1

GEV No.	346094	Ref. No.	AZ129-00 C8252-00 RRC8252-00
description	push switch mounting ø 25mm orange 2NO/indicator light 250V 16A with rubber collar connection male faston 6.3mm ambient temperature max. 85°C protection IP65		

microswitches

pin-plunger actuated

M10



1

GEV No.	345032	Ref. No.	C2207-00 C6018-00 RRC2207-00 RRC6018-00
description	microswitch with plunger thread M10x1 thread L 12mm 250V 16A 1CO connection male faston 6.3mm stroke 7mm mounting distance 22mm L 28mm ambient temperature max. 125°C type SP9603 actuating force: 180g		
For models:	MDP-6G		

M12



1

GEV No.	345360	Ref. No.	C2911-00 RRC2911-00
description	microswitch with plunger mounting distance 25.4mm thread M12x1 thread L 15mm 250V 10A 1CO connection screw stroke 5mm ambient temperature max. 125°C type Highly D5000 actuating force: 200g		

cam switches

on/off



1

GEV No.	301115	Ref. No.	FX0189-12
description	cam switch 2 operating positions 2NO sequence 0-1 16A shaft ø 6x4.6mm shaft L 23mm connection male faston 6.3mm		

4 operating positions

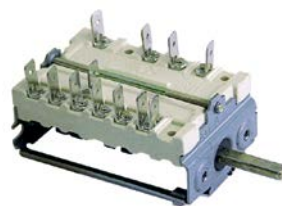

1

GEV No.	300010	Ref. No.	C2214-00 RRC2214-00
description	cam switch 4 operating positions 2NO/2CO sequence 0-1-2-3 16A shaft ø 6x4.6mm shaft L 23mm connection male faston 6.3mm ceramic		

5 operating positions



1

GEV No.	301297	Ref. No.	C8160-00 RRC8160-00
description	cam switch 5 operating positions 1-0-2-3-4 sequence 8NO 16A shaft ø 6x4.6mm shaft L 23mm connection male faston 6.3mm plastic		

rotary switches

TECNOMATIC





1

GEV No.	346301	Ref. No.	C6070-00 RRC6070-00
description	rotary switch 0-1-2-4 groups type HD16X148R000 600V 16A shaft ø 4x5mm shaft L 23mm shaft square connection male faston 6.3mm 3 operating positions		





			
1			
GEV No.	346306	Ref. No.	C5500-00 RRC5500-00
description	rotary switch 0-1-2-3 sets of contacts 6 type HD16X143AR000 600V 16A shaft ø 5x5mm shaft L 23mm shaft square connection male faston 6.3mm 4 operating positions		

			
1			
GEV No.	300274	Ref. No.	C8161-00 RRC8161-00
description	rotary switch 12 operating positions 2NO/2NC shaft ø 6x4.6mm shaft L 24mm connection F6.3x0.8 HD12X256R000 N.TECNOMATIC		

			
1			
GEV No.	346304	Ref. No.	C6074-00 RRC6074-00
description	rotary switch 2 0-1 momentary sets of contacts 1 type HD1201RR000 600V 12A shaft ø 6x6mm shaft L 23mm shaft round momentary connection male faston 6.3mm		

			
1			
GEV No.	346302	Ref. No.	C6200-00 RRC6200-00
description	rotary switch 2-1-0-1-2 8 groups type HD16X167AR000 600V 16A shaft ø 5x5mm shaft L 23mm shaft square connection male faston 6.3mm 5 operating positions		

			
1			
GEV No.	347369	Ref. No.	C6070-12 RRC6070-12
description	rotary switch 3 0-1-2 sets of contacts 4 type HD16X148R000 600V 16A shaft ø 6mm shaft L 22mm shaft round connection male faston 6.3mm		

			
1			
GEV No.	346305	Ref. No.	C2241-00 RRC2241-00
description	rotary switch 3 1-0-1 sets of contacts 2 type HD1241ER000 600V 12A shaft ø 6x5mm shaft L 22mm shaft square connection screw		

			
1			
GEV No.	300275	Ref. No.	C8047-00
description	rotary switch 3 operating positions 16A shaft ø 6x4.6mm N.TECNOMATIC HD16		

			
1			
GEV No.	347610	Ref. No.	C5500-12
description	rotary switch 4 0-1-2-3 sets of contacts 6 type HD16X143AR000 600V 16A shaft ø 6mm shaft L 22mm shaft round connection male faston 6.3mm		

			
1			
GEV No.	346303	Ref. No.	C3652-00 RRC3652-00
description	rotary switch 5 0-1-2-3-4 sets of contacts 6 type HD12X167R000 600V 12A shaft ø 5x5mm shaft L 23mm shaft square connection male faston 6.3mm		

			
1			
GEV No.	347993	Ref. No.	C3652-12 RRC3652-12
description	rotary switch 5 0-1-2-3-4 sets of contacts 6 type HD12X167R000 600V 12A shaft ø 6x4.6mm shaft L 21mm connection male faston 6.3mm 5 operating positions		

			
1			
GEV No.	346307	Ref. No.	C5390-00 C5390-12 RRC5390-00
description	rotary switch 5 0-1-2-3-4 sets of contacts 8 type HD12X152R000 600V 12A shaft ø 6mm shaft L 22mm shaft round connection male faston 6.3mm		

			
1			
GEV No.	347598	Ref. No.	C6200-12
description	rotary switch 5 8 groups sets of contacts 8 type HD16X167AR000 600V 16A shaft ø 6mm shaft L 22mm shaft round connection male faston 6.3mm		





			
1			
GEV No.	346308	Ref. No.	C5395-00 C5395-01 C5395A-00 RRC5395-00
description	rotary switch 6 1-0-1-2-3-4 sets of contacts 16 type HD16X173R000 600V 16A shaft \varnothing 6mm shaft L 21mm shaft square connection male faston 6.3mm		

			
1			
GEV No.	346102	Ref. No.	C8162-00 RRC8162-00
description	rotary switch 6 2-1-0-3-4-5 sets of contacts 10 type HD12X303R000 600V 12A shaft \varnothing 6mm shaft L 22mm shaft round connection male faston 6.3mm		

magnetic switches

37x16mm

			
1			
GEV No.	345600	Ref. No.	C8310-00
description	magnetic switch L 37mm W 16mm 1NO 250V 0.2A P max. 50W connection cable length 960mm		
accessories for	345600		
	GEV No.	519049	Ref. No. —
	magnet \varnothing 6mm L 63mm H 10.7mm W 18.8mm hole distance 52mm M2 hole \varnothing 2mm		

encoders and potentiometers

			
1			
GEV No.	300276	Ref. No.	MC-803
description	encoder 5-pole for combi-steamer rotation 360° shaft \varnothing 6x4.6mm cable length 1550mm		

			
1			
GEV No.	403908	Ref. No.	MC-802
description	encoder shaft \varnothing 6x4.6mm shaft L 10mm connection coded cable length 980mm		

lamps

indicator lights

indicator lights (complete)

 \varnothing 9mm

			
1			
GEV No.	359136	Ref. No.	C5410-00 RRC5410-00
description	indicator light \varnothing 9mm 230V green connection male faston 6.3mm temp.-resist. 120°C		

			
1			
GEV No.	359137	Ref. No.	C5411-00 RRC5411-00
description	indicator light \varnothing 9mm 230V yellow connection male faston 6.3mm temp.-resist. 120°C with lens		

 \varnothing 12mm

with screw socket

			
1			
GEV No.	359048	Ref. No.	C2189-00 RRC2189-00
description	indicator light \varnothing 12mm 230V yellow connection male faston 6.3mm		

			
1			
GEV No.	359027	Ref. No.	C2205-00 RRC2205-00
description	indicator light \varnothing 12mm 250V green connection male faston 6.3mm		



screw-on/push-on fit

light bulbs

for ovens



1

GEV No.	359610	Ref. No.	C6085-05 RRC6085-05
description	light bulb t.max. 300°C socket E14 15W 230V ø 22mm L 47mm lens L 20mm for oven lamp type Philips		



1

GEV No.	359612	Ref. No.	C2104-03 C6073E-00 RRC2104-03 RRC6073E-00
description	light bulb t.max. 300°C socket E14 25W 230V ø 25mm L 56mm lens L 30mm for oven lamp type Philips		

halogen lamp

for socket G4 / G6.35 / G9



1 **500°C**

GEV No.	359074	Ref. No.	C5252-00 RRC5252-00
description	halogen lamp socket G6.35 12V 35W temp.-resist. 500°C		



1

GEV No.	359946	Ref. No.	LC-051
description	halogen lamp socket G9 230V 40W temp.-resist. 300°C		



1

GEV No.	359370	Ref. No.	C5253-00 RRC5253-00
description	halogen lamp socket G6.35 12V 50W temp.-resist. 300°C ø 10mm L 44mm clear		
For models:	MDP-6G		

oven lamps

universal oven lamps





mounting diameter 35.5mm



1

GEV No.	359701	Ref. No.	C6085-01 RRC6085-01
description	lamp socket socket E14 220-230V mounting ø 35.5mm connection male faston 6.3mm 15W		

accessories for 359701

	GEV No.	359705	Ref. No.	—
oven lamp glass thr.ø 33.5mm ø 52mm hard glas temp.-resist. 350°C				
	GEV No.	359709	Ref. No.	C6085-20 RRC6085-20
oven lamp glass thr.ø 33.5mm ø 42mm hard glas temp.-resist. 350°C				
	GEV No.	359721	Ref. No.	—
gasket silicone ED ø 48mm ID ø 39.5mm thickness 5mm Qty 1 pcs				
	GEV No.	359942	Ref. No.	—
oven lamp glass thr.ø 33.5mm ø 41mm hard glas temp.-resist. 350°C				



1

GEV No.	359709	Ref. No.	C6085-20 RRC6085-20
description	oven lamp glass thr.ø 33.5mm ø 42mm hard glas temp.-resist. 350°C		





55x70mm





1

GEV No.	357159	Ref. No.	C6073B-00
description	lamp socket socket E14 mounting measurements 55x70mm connection male faston 6.3mm Qty 1 pcs		

1

GEV No.	357105	Ref. No.	LC-050
description	lamp socket socket G9 250V mounting measurements 55x70mm connection male faston 6.3mm H 32mm		
accessories for	357105		
	GEV No.	359297	Ref. No. C6073D-00
	frame L 95mm W 81mm mounting distance 68/83mm thickness 6mm		
	GEV No.	359299	Ref. No. C6073F-00 RRC6073F-00
	gasket L 91mm W 77mm hole ø 3mm for oven lamp		
	GEV No.	359937	Ref. No. —
	lamp glass L 80mm W 65mm mounting measurements 52x67mm		
	GEV No.	359945	Ref. No. —
	halogen lamp socket G9 230V 25W temp.-resist. 300°C		

1

	GEV No.	359297	Ref. No.	C6073D-00
	description frame L 95mm W 81mm mounting distance 68/83mm thickness 6mm			
accessories for	359297			
	GEV No.	359299	Ref. No.	C6073F-00 RRC6073F-00
	description gasket L 91mm W 77mm hole ø 3mm for oven lamp			

1

	GEV No.	359299	Ref. No.	C6073F-00 RRC6073F-00
	description gasket L 91mm W 77mm hole ø 3mm for oven lamp			

1

	GEV No.	359368	Ref. No.	C6085-20 RRC6085-20
	description lamp glass			





1









	GEV No.	359296	Ref. No.	C6073C-00 RRC6073C-00
	description lamp glass L 74mm W 58mm thickness 3mm			

1

	GEV No.	357159	Ref. No.	C6073B-00
	description lamp socket socket E14 mounting measurements 55x70mm connection male faston 6.3mm Qty 1 pcs			

1

	GEV No.	357105	Ref. No.	LC-050
	description lamp socket socket G9 250V mounting measurements 55x70mm connection male faston 6.3mm H 32mm			
accessories for	357105			
	GEV No.	359297	Ref. No.	C6073D-00
	description frame L 95mm W 81mm mounting distance 68/83mm thickness 6mm			
	GEV No.	359299	Ref. No.	C6073F-00 RRC6073F-00
	description gasket L 91mm W 77mm hole ø 3mm for oven lamp			
	GEV No.	359937	Ref. No.	—
	description lamp glass L 80mm W 65mm mounting measurements 52x67mm			
	GEV No.	359945	Ref. No.	—
	description halogen lamp socket G9 230V 25W temp.-resist. 300°C			

55x100mm			
			
1			
GEV No.	359698	Ref. No.	C2272-01 RRC2272-01
description	lamp socket L 100mm W 55mm socket E14 connection male faston 6.3mm		
spare parts for	359698		
	GEV No.	358119	Ref. No. —
	frame L 118mm W 72mm mounting distance 143mm for bulb socket		
	GEV No.	358122	Ref. No. —
	gasket L 112mm W 68mm silicone thickness 3mm for bulb socket		
	GEV No.	358123	Ref. No. —
	lamp glass L 112mm W 68mm		
	GEV No.	359612	Ref. No. C2104-03 C6073E-00 RRC2104-03 RRC6073E-00
	light bulb t.max. 300°C socket E14 25W 230V ø 25mm L 56mm lens L 30mm for oven lamp type Philips		
	GEV No.	359714	Ref. No. C2104-32 RRC2104-32
	gasket for bulb socket		
	GEV No.	359715	Ref. No. C2104-22 RRC2104-22
	lamp glass L 110mm W 65mm thickness 5mm		
	GEV No.	359716	Ref. No. C2104-12 RRC2104-12
	frame for bulb socket		
accessories for	359698		
	GEV No.	359612	Ref. No. C2104-03 C6073E-00 RRC2104-03 RRC6073E-00
	light bulb t.max. 300°C socket E14 25W 230V ø 25mm L 56mm lens L 30mm for oven lamp type Philips		
	GEV No.	359938	Ref. No. —
	borosilicate glass L 115mm W 69mm		

			
1			
GEV No.	359716	Ref. No.	C2104-12 RRC2104-12
description	frame for bulb socket		

			
1			
GEV No.	359714	Ref. No.	C2104-32 RRC2104-32
description	gasket for bulb socket		

			
1			
GEV No.	359715	Ref. No.	C2104-22 RRC2104-22
description	lamp glass L 110mm W 65mm thickness 5mm		



			
1			
GEV No.	359698	Ref. No.	C2272-01 RRC2272-01
description	lamp socket L 100mm W 55mm socket E14 connection male faston 6.3mm		
spare parts for	359698		
	GEV No.	358119	Ref. No. —
	frame L 118mm W 72mm mounting distance 143mm for bulb socket		
	GEV No.	358122	Ref. No. —
	gasket L 112mm W 68mm silicone thickness 3mm for bulb socket		
	GEV No.	358123	Ref. No. —
	lamp glass L 112mm W 68mm		
	GEV No.	359612	Ref. No. C2104-03 C6073E-00 RRC2104-03 RRC6073E-00
	light bulb t.max. 300°C socket E14 25W 230V ø 25mm L 56mm lens L 30mm for oven lamp type Philips		
	GEV No.	359714	Ref. No. C2104-32 RRC2104-32
	gasket for bulb socket		
	GEV No.	359715	Ref. No. C2104-22 RRC2104-22
	lamp glass L 110mm W 65mm thickness 5mm		
	GEV No.	359716	Ref. No. C2104-12 RRC2104-12
	frame for bulb socket		
accessories for	359698		
	GEV No.	359612	Ref. No. C2104-03 C6073E-00 RRC2104-03 RRC6073E-00
	light bulb t.max. 300°C socket E14 25W 230V ø 25mm L 56mm lens L 30mm for oven lamp type Philips		

Table continues overleaf



accessories for	359698		
	GEV No.	359938	Ref. No. —
	borosilicate glass L 115mm W 69mm		

lamps

light bulbs

			
1			
GEV No.	359610	Ref. No.	C6085-05 RRC6085-05
description	light bulb t.max. 300°C socket E14 15W 230V ø 22mm L 47mm lens L 20mm for oven lamp type Philips		

			
1			
GEV No.	359612	Ref. No.	C2104-03 C6073E-00 RRC2104-03 RRC6073E-00
description	light bulb t.max. 300°C socket E14 25W 230V ø 25mm L 56mm lens L 30mm for oven lamp type Philips		

halogen lamps

for socket G4 / G6.35 / G9

			
1 500°C			
GEV No.	359074	Ref. No.	C5252-00 RRC5252-00
description	halogen lamp socket G6.35 12V 35W temp.-resist. 500°C		

			
1			
GEV No.	359946	Ref. No.	LC-051
description	halogen lamp socket G9 230V 40W temp.-resist. 300°C		

sockets

G4 / G5,3 / G6,35

			
1			
GEV No.	359369	Ref. No.	C5251-00 C5259-00 C5259-00A RRC5251-00
description	lamp socket socket G4/G5.3/G6.35 24V ø 17mm H 10mm connection cable 120mm mounting distance 11.5mm for halogen lamp cable length 730mm		
For models:	MDP-6G		

timers

programme timers

			
1			
GEV No.	360752	Ref. No.	C3056-00
description	timer CDC 4902F1 engines 1 chambers 2 operation time 8min 230V shaft ømm shaft Lmm		

electric timers

			
1			
GEV No.	350015	Ref. No.	C5371-00
description	timer MS65 without bell operation time 120min time spreadmin 1CO/1NO at 250V 16A permanent position yes impulse electric shaft ø 6x4.6mm shaft L 23mm mounting distance 28mm connection lateral 2-pole		
accessories for	350015		
	GEV No.	110366	Ref. No. —
	knob switch zero mark t.max. °C ø 44mm shaft ø 6x4.6mm shaft flat upper black		
	GEV No.	111206	Ref. No. —
	dial plate graduation 120min permanent position no rotation 10-300° ø 60mm timers knob ø 45mm		

with time spread

			
1			
GEV No.	350074	Ref. No.	C5365-00 RRC5365-00
description	timer MS65 operation time 120min time spread 30min 1CO/2NO/1NC at 250V 16A permanent position yes impulse electric shaft ø 6x4.6mm shaft L 22mm mounting distance 28mm connection lateral Invensys 4-pole shaft position lower°		



mechanical timers

 <p>1</p>			
GEV No.	350040	Ref. No.	C2191-00 RRC2191-00
description	timer M2 with bell 2-pole operation time 60min impulse mechanical 2NO at 250V 16A permanent position yes shaft ø 6x4.6mm shaft 6x4.6mm shaft L 23mm mounting distance 28mm connection lateral		
accessories for	350040		
	GEV No.	110366	Ref. No. —
	knob switch zero mark t.max.°C ø 44mm shaft ø 6x4.6mm shaft flat upper black		
	GEV No.	111202	Ref. No. —
	dial plate graduation 60min permanent position yes rotation 0-300° ø 60mm timers knob ø 45mm with permanent position		

spare parts and accessories

<p>miscellaneous</p>  <p>1</p>			
GEV No.	560658	Ref. No.	C5367-00
description	bracket W 34mm H 30mm L 51mm for timer combi-steamer		

alarm devices

buzzer boards

 <p>1</p>			
GEV No.	401062	Ref. No.	C5366-00 RRC5366-00
description	buzzer board 230VAC L 48mm W 45mm connection Faston 6.3mm		



buzzers



 <p>1</p>			
GEV No.	350225	Ref. No.	TS4003-00
description	buzzer 12VAC connection coded with PCB screw 91dB mounting ø 23mm		

contactors

LOVATO

power contactors

 <p>1</p>			
GEV No.	380705	Ref. No.	LC-310 RRLC-310
description	power contactor resistive load 20A 230VAC (AC3/400V) 9A/4kW main contacts 3NO auxiliary contacts 1NO connection screw connection type 11BG0910A230		
accessories for	380705		
	GEV No.	380057	Ref. No. LC-315 RRLC-315
	auxiliary contact contacts 1NO/1NC AC1 10A for contactors BG series connection screw type BGX1011		

 <p>1</p>			
GEV No.	380855	Ref. No.	C2201-00 RRC2201-00
description	power contactor resistive load 25A 230VAC (AC3/400V) 4.2kW main contacts 3NO auxiliary contacts 1NO		
For models:	CVE 10-R		
accessories for	380855		
	GEV No.	380055	Ref. No. LC-313 RRLC-313
	RC circuit voltage AC/DC suitable for BF09-32 rated 240V		
	GEV No.	380118	Ref. No. C3618-00 RRC3618-00
	auxiliary contact contacts 1NO/1NC AC1 10A for contactors BF series connection screw type G480/11		

auxiliary contacts

 <p>1</p>			
GEV No.	380118	Ref. No.	C3618-00 RRC3618-00
description	auxiliary contact contacts 1NO/1NC AC1 10A for contactors BF series connection screw type G480/11		



1			
GEV No.	380057	Ref. No.	LC-315 RRLC-315
description	auxiliary contact contacts 1NO/1NC AC1 10A for contactors BG series connection screw type BGX1011		

miscellaneous

RC circuits



1			
GEV No.	380056	Ref. No.	MC-800 RRMC-800
description	RC circuit 250V		
For models:	MDP-6G		

relays

power relays

with male contacts

female contact 2.0mm



1			
GEV No.	381516	Ref. No.	AZ003-00 RRAZ003-00
description	power relays SCHRACK 230VAC 6A 2NO/2NC connection plug-in connection manuf. no. PT570730 with socket PYF-14BE		

plug-in/print relays



1			
GEV No.	381153	Ref. No.	AZ019-00
description	print relay 230VAC 2CO at 250V 8A raster size 5mm with socket		
spare parts for	381153		
	GEV No.	381168	Ref. No. —
	print relay 230VAC 2CO 2-pole at 250V 8A connection pins raster size 5mm SCHRACK manuf. no. RT424730 95.65/95.75		



1			
GEV No.	381540	Ref. No.	AZ004-00 RRAZ004-00
description	print relay with socket 2CO 230VAC 2-pole at 250V 8A connection pins raster size 5mm SCHRACK manuf. no. RT424730 ES50		

level relays

GICAR



1			
GEV No.	400018	Ref. No.	HC-055 RRHC-055
description	level relay 230V voltage AC connection F6.3 type RL30/3ES/F/G		

miscellaneous



1			
GEV No.	401138	Ref. No.	HC-050 RRHC-050
description	level relay		



transformers

open transformers

with clamp terminal



1

GEV No.	401128	Ref. No.	LC-434 RRLC-434
description	transformer primary 230V secondary 12V 100VA		



1

GEV No.	401135	Ref. No.	LC-436 RRLC-436
description	transformer primary 230V secondary 12V 120VA secondary 10A ambient temperature max. 50°C		



1

GEV No.	401065	Ref. No.	LC-449 RRLC-449
description	transformer primary 230V secondary 12V 120VA secondary 7.5A+2.5A connection screw 50/60Hz		



1

GEV No.	401229	Ref. No.	C2469-00 LC-488 RRC2469-00
description	transformer primary 230V secondary 12V 63VA		
For models:	MDP-6G		



1

GEV No.	401129	Ref. No.	LC-436 LC-437 RRLC-436 RRLC-437
description	transformer primary 230V secondary 12V secondary 10A ambient temperature max. 50°C		



1

GEV No.	403915	Ref. No.	LC-477
description	transformer primary 230VAC secondary 12VAC 30VA H 77mm L 78mm W 76mm connection screw 50/60Hz type T1Q		



1

GEV No.	403117	Ref. No.	LC-493
description	transformer primary 440V secondary 254V 1000VA connection screw clamp 50/60Hz		



1

GEV No.	403118	Ref. No.	LC-494
description	transformer primary 440V secondary 254V 500VA connection screw clamp 50/60Hz		



encapsulated transformers

multiple connections



1

GEV No.	401137	Ref. No.	C2563-00 LC-442 RRC2563-00 RRLC-442
description	transformer primary 230V secondary 12V 12VA		



1

GEV No.	401108	Ref. No.	C2469-00 RRC2469-00
description	transformer primary 230V secondary 12V 30VA		



1

GEV No.	401136	Ref. No.	LC-444 RRLC-444
description	transformer primary 230V secondary 12V 60VA		



1

GEV No.	401087	Ref. No.	LC-445 RRLC-445
description	transformer primary 230V secondary 24V 60VA secondary 2.5A connection male faston 6.3mm 50/60Hz		

PMA



1

GEV No.	379054	Ref. No.	FX0149-00 RRFX149-00
description	transformer primary 230VAC secondary 12VAC 3VA secondary 0.25A H 40mm L 45mm W 50mm connection screw 50/60Hz type 153/M		

for lighting



1

GEV No.	401197	Ref. No.	C5250-00 RRC5250-00
description	transformer primary 230V secondary 12V type RN1521		
For models:	MDP-6G		

electronic controllers

EKTRON

refrigeration controllers

built-in version



1

GEV No.	379397	Ref. No.	C2196-00 RRC2196-00
description	electronic controller EKTRON type DEK31-1000A mounting measurements 71x29mm 12V voltage AC/DC Pt100 relay outputs 2 CO-8A(4) NO-8A(4) Pt100 built-in depth 71mm -99 to +999°C display 3½ digits		



SHANGFANG

accessories



1			
GEV No.	379054	Ref. No.	FX0149-00 RRFX149-00
description	transformer primary 230VAC secondary 12VAC 3VA secondary 0.25A H 40mm L 45mm W 50mm connection screw 50/60Hz type 153/M		

1			
GEV No.	379505	Ref. No.	C8250-22
description	core temperature probe Pt1000 cable PTFE probe -40 up to +250°C cable -40 up to +250°C connection 2-wire probe ø4x100mm thread cable length 1.7m handle ø 10mm handle length 80mm		

1			
GEV No.	379003	Ref. No.	C8250-00 C8250-12 RRC8250-00 RRC8250-12
description	core temperature probe Pt1000 cable PTFE probe -40 up to +250°C cable -40 up to +250°C connection 2-wire probe ø4x100mm thread M12x1 cable length 2.7m handle ø 15mm handle length 80mm		

probes

producer-specific probes

probes

1			
GEV No.	378047	Ref. No.	C8248-00 C8248-12 RRC8248-00
description	temperature probe NTC 100kOhm cable TPE probe -40 up to +110°C cable -40 up to +110°C connection male faston thread probe ø5x-20mm cable length 0.9m		

1			
GEV No.	381517	Ref. No.	C8278-11
description	core temperature probe Pt1000 cable silicone connection 6-pin connector probe ø4x100mm cable length 1200m handle ø 10mm handle length 80mm		

electronics

EPROMS

1			
GEV No.	401107	Ref. No.	C2474-00 RRC2474-00
description	micro processor		
For models:	MDP-6G		

1			
GEV No.	379596	Ref. No.	C2471-00 RRC2471-00
description	temperature probe Pt100 cable PTFE probe -100 up to 450°C cable -40 up to +250°C connection 2-wire thread probe ø4x60mm cable length 0.6m		
For models:	MDP-6G		

frequency converters

1			
GEV No.	403916	Ref. No.	X0070-00
description	frequency converter with heat sink for combi-steamer L 142mm W 135mm H 79mm for motor 0.75kW		

core probes

1			
GEV No.	379597	Ref. No.	C2209-00 C2209-22 RRC2209-00
description	core temperature probe Pt100 cable PTFE probe -40 up to +250°C cable -40 up to +250°C connection 2-wire probe ø4x100mm thread cable length 1.7m handle ø 10mm handle length 80mm		
For models:	MDP-6G		

1 electric components



PCBs



1			
GEV No.	401063	Ref. No.	C8165-00 RRC8165-00
description	keypad PCB		



1			
GEV No.	401103	Ref. No.	C2561-00 RRC2561-00
description	keypad PCB		



1			
GEV No.	401104	Ref. No.	C2467-00 RRC2467-00
description	keypad PCB		
For models:	MDP-6G		



1			
GEV No.	401101	Ref. No.	C2560-00 RRC2560-00
description	keypad PCB L 200mm W 95mm		



1			
GEV No.	403597	Ref. No.	C8164-00 RRC8164-00
description	keypad PCB L 310mm W 105mm		



1			
GEV No.	401064	Ref. No.	C8166-00 RRC8166-00
description	keypad PCB programmable key pad F-Series encoder		



1			
GEV No.	401105	Ref. No.	C2468-00 RRC2468-00
description	keypad PCB with display		
For models:	MDP-6G		

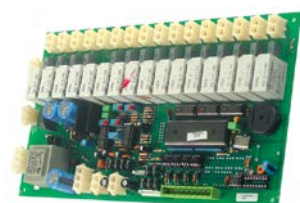

1			
GEV No.	401106	Ref. No.	MC-865 RRC8166-00
description	keypad PCB with display		

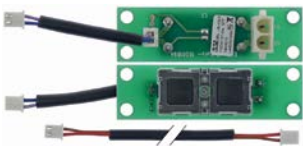

1			
GEV No.	403917	Ref. No.	TS4002-00
description	PCB for combi-steamer L 293mm W 99mm suitable for INOXTREND		

1

GEV No.	403833	Ref. No.	TS4018-00
description	PCB for combi-steamer L 74mm W 22mm		



1

GEV No.	401061	Ref. No.	C5956-00 RRC5956-00
description	PCB for fan		



1

GEV No.	401058	Ref. No.	C8167-00 RRC8167-00
description	PCB suitable for programmable key pad F-Series controller		

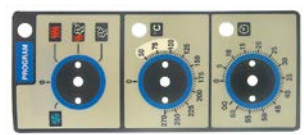

1

GEV No.	401099	Ref. No.	C3654-00/B RRC3654-00/B
description	front foil		



1

GEV No.	401112	Ref. No.	C5521-00/B RRC5521-00/B
description	front foil		



1

GEV No.	401113	Ref. No.	C5506-00/B RRC5506-00/B
description	front foil		

keypads

front foils



1

GEV No.	401097	Ref. No.	C6054-00/BI RRC6054-00/BI
description	front foil		



1

GEV No.	401098	Ref. No.	C6057-00/BI RRC6057-00/BI
description	front foil		



1

GEV No.	401114	Ref. No.	C5508-00/B RRC5508-00/B
description	front foil		



1

GEV No.	401115	Ref. No.	C5278-00/B RRC5278-00/B
description	front foil		



1

GEV No.	401116	Ref. No.	C5298-00/B RRC5298-00/B
description	front foil		



1

GEV No.	401124	Ref. No.	C5704-00/R RRC5704-00/R
description	front foil		



1

GEV No.	401125	Ref. No.	C5706-00/R RRC5706-00/R
description	front foil		



1

GEV No.	403826	Ref. No.	C2245-00 RRC2245-00
description	front foil		



1

GEV No.	403019	Ref. No.	C5278-00/B
description	front foil blue suitable for INOXTREND L 496mm W 115mm		



1

GEV No.	401100	Ref. No.	C3655-00/B RRC3655-00/B
description	keypad foil		



1

GEV No.	401117	Ref. No.	C5510-00/B RRC5510-00/B
description	keypad foil		



1

GEV No.	401118	Ref. No.	C5512-00/B RRC5512-00/B
description	keypad foil		



1

GEV No.	401119	Ref. No.	C5273-00/B RRC5273-00/B
description	keypad foil		



1

GEV No.	401120	Ref. No.	C5293-00/B RRC5293-00/B
description	keypad foil		



1

GEV No.	401121	Ref. No.	C5272-00/B RRC5272-00/B
description	keypad foil		
For models:	MDP-6G		



1

GEV No.	401122	Ref. No.	C5527-00/B RRC5527-00/B
description	keypad foil		



1

GEV No.	401123	Ref. No.	C5292-00/A C5292-00/B RRC5292-00/A RRC5292-00/B
description	keypad foil		



1

GEV No.	401126	Ref. No.	C5700-00/R RRC5700-00/R
description	keypad foil		

			
1			
GEV No.	401127	Ref. No.	C5702-00/R RRC5702-00/R
description	keypad foil		

keypad units

			
1			
GEV No.	401110	Ref. No.	MC-852 RRMC-852
description	keypad unit		

control panel

			
1			
GEV No.	504872	Ref. No.	C2246-00
description	control panel for combi-steamer L 250mm W 100mm thickness 0.5mm		

solenoid valves

solenoid valves (water)

ROBERTSHAW/INVENSYS

medium temperature: 90°C 90°C 60°C
 ambient temperature: 60°C 25°C 60°C
 duty cycle: 40% 100% 100%

			
1			
GEV No.	372025	Ref. No.	C2088-00 RRC2088-00
description	solenoid valve triple straight 230VAC inlet 3/4" outlet 11.5mm DN10 EATON (INVENSYS)		
For models:	MDP-6G		

spare parts and accessories

reducers

outlet side

			
1			
GEV No.	371250	Ref. No.	C1707-00
description	reducer type EATON (INVENSYS) flow rate 0.25l/min pressure range 0 up to 10bar tolerance ±15/25% white		

RPE

			
1			
GEV No.	374021	Ref. No.	C2087-00 RRC2087-00
description	solenoid valve double straight 230VAC inlet 3/4" outlet 10mm DN10 RPE		

			
1			
GEV No.	374017	Ref. No.	C3057-00 RRC3057-00
description	solenoid valve single straight 230VAC inlet 3/4" outlet 10mm input 6l/min DN10 RPE polyamide flow regulating valve inlet white membranes NBR pressure range 0.2-10bar		

			
1			
GEV No.	374027	Ref. No.	C2089-00 RRC2089-00
description	solenoid valve 4-fold angled 230VAC inlet 3/4" outlet 10mm DN10 RPE		

solenoid valves with reducers







2-fold

			
1			
GEV No.	374035	Ref. No.	C2082-00 RRC2082-00
description	solenoid valve double straight 230VAC inlet 3/4" outlet 11.5mm input 10-12l/min t.max. 60°C duty cycle 100% plastic		





4-fold			
			
1			
GEV No.	374111	Ref. No.	C3065-00
description	solenoid valve 4-fold straight 230VAC inlet 3/4" outlet 10.5 duty cycle 100% RPE type H pressure range 0.2-10bar		

TP			
			
1			
GEV No.	370017	Ref. No.	AZ005-00
description	solenoid valve single straight 230VAC inlet 3/4" outlet 11.5mm DN10 TP p max 10bar		
spare parts for	370017		
	GEV No.	371013	Ref. No. —
solenoid coil TP 230VAC 50/60Hz			
accessories for	370017		
	GEV No.	371220	Ref. No. —
reducer TP flow rate 3l/min red tolerance ±15%			
	GEV No.	371221	Ref. No. —
reducer TP flow rate 5.5l/min yellow tolerance ±15%			
	GEV No.	371222	Ref. No. —
reducer TP flow rate 6l/min grey tolerance ±15%			
	GEV No.	371223	Ref. No. —
reducer TP flow rate 10l/min white tolerance ±15%			
	GEV No.	371224	Ref. No. —
reducer TP flow rate 12l/min bronze tolerance ±15%			
	GEV No.	371225	Ref. No. —
reducer TP flow rate 16l/min light brown tolerance ±15%			
	GEV No.	371226	Ref. No. —
reducer TP flow rate 20l/min red tolerance ±15%			
	GEV No.	371230	Ref. No. —
reducer TP flow rate 0.25l/min red tolerance ±25%			
	GEV No.	371231	Ref. No. —
reducer TP flow rate 0.35l/min violet tolerance ±25%			
	GEV No.	371232	Ref. No. —
reducer TP flow rate 0.5l/min orange tolerance ±25%			
	GEV No.	371233	Ref. No. —
reducer TP flow rate 0.8l/min white tolerance ±25%			

accessories for	370017		
	GEV No.	371234	Ref. No. —
reducer TP flow rate 1l/min light blue tolerance ±25%			
	GEV No.	371235	Ref. No. —
reducer TP flow rate 1.2l/min brown tolerance ±25%			
	GEV No.	371236	Ref. No. —
reducer TP flow rate 1.5l/min light brown tolerance ±25%			
	GEV No.	371237	Ref. No. —
reducer TP flow rate 2.5l/min yellow tolerance ±25%			
	GEV No.	371238	Ref. No. —
reducer TP flow rate 3.4l/min dark green tolerance ±25%			
	GEV No.	371239	Ref. No. —
reducer TP flow rate 5l/min black tolerance ±25%			
	GEV No.	371240	Ref. No. —
reducer TP flow rate 8l/min blue tolerance ±20%			

various			
			
1			
GEV No.	370861	Ref. No.	TS0016-00
description	solenoid valve 6-fold straight 230VAC inlet 3/4" outlet 10.5 t.max. 60°C duty cycle 100% plastic suitable for INOXTREND		

metal			
solenoid valves (various)			
			
1			
GEV No.	370338	Ref. No.	C2072-00 RRC2072-00
description	solenoid valve 2-ways 230VAC connection 1/8" DN 6mm		

			
1			
GEV No.	370319	Ref. No.	LC-455 RRLC-455
description	solenoid valve 2-ways 230VAC inlet 1/4" outlet 1/4" p max 13bar p min 0.1 bar 50Hz 230V brass		
spare parts for	370319		
	GEV No.	371188	Ref. No. —
solenoid coil 50Hz 230V H 35mm seat ø 13mm type H 17VA series 688			



ball valves electric

 <p>1</p>			
GEV No.	401085	Ref. No.	LC-500 RRLC-500
description	ball valve inlet 1/2" IT outlet 1/2" IT 230V L 60mm 50/60Hz closed off-current mode of operation electric connection cable 400mm cable 3-pole		

for combi-steamers

 <p>1</p>			
GEV No.	542446	Ref. No.	C2050-00
description	pressure control ø 31mm pressure range 0.2-3.0bar connection 1/8" MA-TER 230V 0.1/16/21A p max 10bar ambient temperature max. 85°C		

pressure switches

for coffee machines

ø 38mm

 <p>1</p>			
GEV No.	541340	Ref. No.	C2074-00 RRC2074-00
description	pressure control ø 38mm pressure range 0.5-1.2bar pressure connection vertical preset at 0.9bar coffee machine parts connection male faston 6.3mm pressure connection 1/8"		

electrodes



 <p>1</p>			
GEV No.	401086	Ref. No.	HC-054 RRHC-054
description	level electrode 1/4" total length 70mm probe L 44mm insulated probe length 39mm PTFE insulated connection male faston 6.3mm stainless steel ø 2.5mm		

 <p>1</p>			
GEV No.	541341	Ref. No.	C2076-00 RRC2076-00
description	pressure control ø 38mm pressure range 1.5-4bar pressure connection vertical preset at 3bar 16A 250V coffee machine parts connection 1/8" pressure connection 1/8"		

fans

axial fans

import

 <p>1</p>			
GEV No.	601080 ¹	Ref. No.	FX0068-00 RRFX0068-00
description	axial fan L 119mm W 119mm H 38mm 230VAC 50/60Hz 23/20W bearing ball bearing connection male faston 2.8mm metal ADDA fan wheel ø 110mm temp.-resist. 70°C		
For models:	MDP-6G		
accessories for	601080		
		GEV No.	550898
		Ref. No.	—
		connecting cable cable length 2000mm connection F 2.8 connection distance 7.9mm for axial flow fan	
		GEV No.	692519
		Ref. No.	—
		guard L 120mm W 120mm plastic	

¹with ball bearings

for steam control

 <p>1</p>			
GEV No.	541581	Ref. No.	C2075-00 RRC2075-00
description	pressure control ø 38mm pressure range fixed 1.6bar connection 1/8" 1CO 16A preset at 1.6barbar pressure connection 1/8" ET		



cross flow fans

TRIAL



1

GEV No.	601722	Ref. No.	FX0062-00 RRFX0062-00
description	cross flow fan TAS09B-002 roller ϕ 60mm roller length 94mm laminated core thickness 12mm motor position right 230V/50-60Hz connection male faston 6.3mm		
accessories for	601722		
	GEV No.	419034	Ref. No. FX0058-00 FX0063-00 RRFX0063-00
	heater battery mounting distance 95mm W 116mm H 45mm 800W 230V temperature restriction 90°C heating circuits 1 connection male faston 6.3mm cable length 220mm L 105mm for cross flow fan		

hot air motors



1

GEV No.	550049	Ref. No.	C2029-00 RRC2029-00
description	counterflange for fan motor ED ϕ 60mm int. ϕ 1 27.3mm int. ϕ 2 18.5mm thickness 5.8mm brass		



1

GEV No.	511585	Ref. No.	C2027-00 RRC2027-00
description	engine shaft gasket ID ϕ 17mm ED ϕ 21.5mm thickness 3.5mm conical		
For models:	MDP-6G		



1

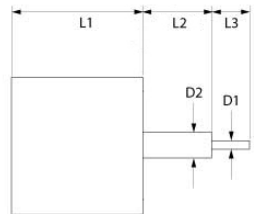

GEV No.	500629	Ref. No.	C3610-00 RRC3610-00
description	fan motor 220-240V 1 phase 50/60Hz 0.045/0.0765kW 2800/3400rpm speeds 1 L1 95mm L2 33mm L3 19mm D1 ϕ 8mm D2 ϕ 10mm 0.35A suitable capacitor 2.5 μ F/400V type 1048		

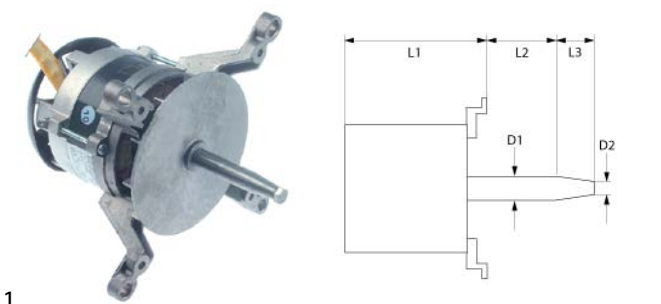

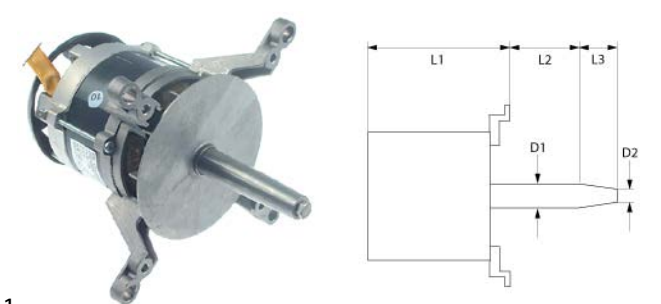

GEV No.	500630	Ref. No.	C2015-00 C2901-00 RRC2901-00
description	fan motor 230/400V 3 phase 50Hz 0.37kW 2600rpm speeds 1 L1 175mm L2 50mm L3 28mm D1 ϕ 17mm D2 ϕ 12mm M8R IT 1.1/1.9A Cos(f) 0.75 at 50Hz 2600rpm type 1020.5450		
For models:	CVE-10E		



GEV No.	500631	Ref. No.	C7160-00 C7161-00 RRC7160-00
description	fan motor 230/400V 3 phase 50Hz 0.55kW 2800rpm speeds 1 L1 185mm L2 45mm L3 47mm D1 ϕ 24mm D2 ϕ 20mm M8L IT 2.6/1.5A Cos(f) 0.8 at 50Hz 2800rpm type 3011B4050		



GEV No.	602177	Ref. No.	C9116-00 C9116-12 C9116-22
description	fan motor 230V 1 phase 50/60Hz 0.1/0.2kW 2700-2200-3300/2600rpm L1 108mm L2 30mm L3 25mm D1 ϕ 12mm D2 ϕ 9.5mm M6 1.2/1.05A suitable capacitor 12.5 μ F/450V Cos(f) 0.98 no. 3013A2355		
accessories for	602177		
	GEV No.	601817	Ref. No. C7535-00 C7535-00K
	fan wheel D1 ϕ 240mm H1 43mm blades 55 D2 ϕ 9mm D3 ϕ 11mm H2 23mm		
	GEV No.	696847	Ref. No. C9153-00 RRC9153-00
	gasket for motor shaft conical ED ϕ 21.5mm ID ϕ 11.8mm plastic		

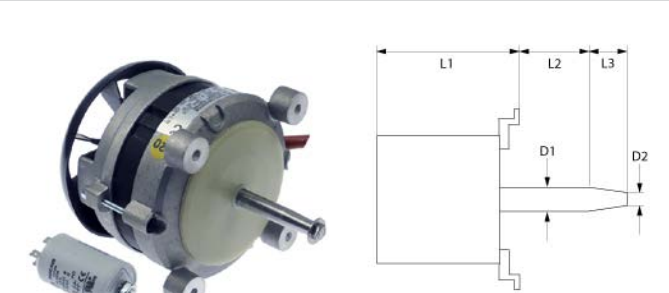

1

GEV No.	601816	Ref. No.	C9011-00 C9011-12 RRC9011-00
description	fan motor 230V 1 phase 50Hz 0.25kW 2600rpm speeds 1 L1 90mm L2 38mm L3 24mm D1 ø 12mm D2 ø 10mm M6 1.5A Cos(fi) 0.98 suitable capacitor 10µF/450V		



1

GEV No.	514261	Ref. No.	C2030-00 C2037-00 RRC2030-00
description	fan wheel D1 ø 210mm H1 100mm blades 20 D2 ø 11mm D3 ø 16mm H2 30mm		
For models:	MDP-6G		

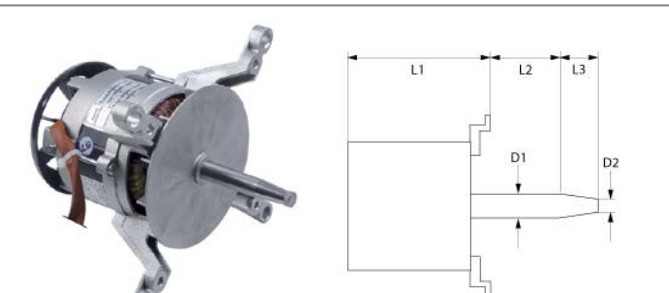

1

GEV No.	601721	Ref. No.	C2900-00
description	fan motor 230V 1 phase 50Hz 0.37kW 2800rpm L1 172mm L2 53mm L3 33mm D1 ø 17mm D2 ø 12mm M8x1.25 2.5A suitable capacitor 10 Cos(fi) 0.95 type 1020.2350		



1

GEV No.	514265	Ref. No.	C3067-00 C3068-00 RRC3068-00
description	fan wheel D1 ø 210mm H1 100mm blades 20 D2 ø 11mm D3 ø 16mm H2 30mm		



1

GEV No.	602179	Ref. No.	C9012-00 C9012-00K RRC9012-00
description	fan wheel blades 55 D1 ø 240mm D2 ø 9mm D3 ø 11mm H1 60mm H2 24mm		



1

GEV No.	601817	Ref. No.	C7535-00 C7535-00K
description	fan wheel D1 ø 240mm H1 43mm blades 55 D2 ø 9mm D3 ø 11mm H2 23mm		



1

GEV No.	514257	Ref. No.	C3612-00 RRC3612-00
description	fan wheel D1 ø 164mm H1 38mm blades 36 D2 ø 8mm D3 ø 8mm H2 28mm		



1

GEV No.	541580	Ref. No.	C2430-11 RRC2430-11
description	fan wheel D1 ø 250mm H1 120mm blades 26 D2 ø 11.5mm D3 ø 16.5mm H2 29mm		



1

GEV No.	514262	Ref. No.	C2430-00 C2430-11 C2430-11K RRC2430-00 RRC2430-11
description	fan wheel D1 ϕ 250mm H1 120mm blades 26 D2 ϕ 11mm D3 ϕ 16mm H2 30mm		



1

GEV No.	514264	Ref. No.	C7167-00 RRC7167-00
description	fan wheel D1 ϕ 270mm H1 120mm blades 24 D2 ϕ 19.5mm D3 ϕ 23mm H2 46mm		



1

GEV No.	514263	Ref. No.	C7165-00 C7168-00 RRC7165-00
description	fan wheel D1 ϕ 300mm H1 120mm blades 24 D2 ϕ 19.5mm D3 ϕ 23.5mm H2 46mm		



1

GEV No.	552008	Ref. No.	C2028-00 RRC2028-00
description	flange for fan motor ED ϕ 60mm int. ϕ 1 21.5mm int. ϕ 2 18.5mm thickness 4mm brass		

radial fans

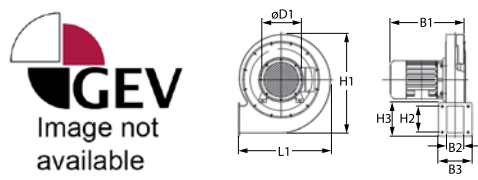

1

GEV No.	601245	Ref. No.	C5950-00
description	radial fan 24V voltage DC 50Hz 45W H1 170mm L1 170mm D1 ϕ 50mm W1 90mm W2 44mm H2 57mm W3 83mm H3 83mm		
accessories for	601245		
	GEV No.	104309	Ref. No. —
description	gasket L 106mm W 100mm H 3mm 4 holes		

pumps
vibration pumps



1

GEV No.	500564	Ref. No.	C5770-00 RRC5770-00
description	vibration pump type EP 5 230V 48W 50Hz inlet ϕ 6 outlet ϕ 1/8" IT ULKA L 123mm		



1

GEV No.	500173	Ref. No.	C5770-00 RRC5770-00
description	vibration pump type EP 5 230V 48W 50Hz inlet ϕ 6 outlet ϕ 1/8" IT ULKA outlet flat plastic L 123mm		



1

GEV No.	500563	Ref. No.	C6115-00 C6175-00 RRC6115-00 RRC6175-00
description	vibration pump type NME Typ2 230V 16W 50Hz inlet ϕ 4 outlet ϕ 6 ULKA L 76mm 110cc/min		

condensators & interference suppression filters

filters

interference suppression filters

			
1			
GEV No.	365090	Ref. No.	C2470-00 LC-317 RRC2470-00
description	interference suppression filter 250V 50/60Hz capacity 0.47µF(X2)+2X0.027µF(Y2)+2x1mH+0.68MµF		
For models:	MDP-6G		

RC circuits

			
1			
GEV No.	380056	Ref. No.	MC-800 RRMC-800
description	RC circuit 250V		
For models:	MDP-6G		

			
1			
GEV No.	380738	Ref. No.	LC-312 RRLC-312
description	RC circuit type 11BGX79240 suitable for BG series rated 125-240VACV		

			
1			
GEV No.	380055	Ref. No.	LC-313 RRLC-313
description	RC circuit voltage AC/DC suitable for BF09-32 rated 240V		

fuses

fine fuses

			
1			
GEV No.	358532	Ref. No.	LC-422
description	fine fuse size ø5x20mm 2A fast-acting rated 250V Qty 10 pcs		

			
1			
GEV No.	358594	Ref. No.	LC-426
description	fine fuse size ø5x20mm 0.16A slow-acting rated 250V Qty 10 pcs		

fine fuse holders

			
1			
GEV No.	358195	Ref. No.	LC-485
description	fuse holder for Fuse ø10x38mm 1-pole 32A rated 690V for DIN rail 35mm		

electric accessories

cables

ribbon cables

group 1

			
1			
GEV No.	401111	Ref. No.	MC-853 RRMC-853
description	ribbon cable 16-pole L 600mm plug type FC-16P raster size 2.54mm		

connection cables

			
1			
GEV No.	579008	Ref. No.	X0311-00
description	connection cable L 1000mm plug type USB A/B		



terminals

connection terminals with screw/faston connections



1

GEV No.	550411	Ref. No.	FX0144-00
description	power terminal block 6-pole max. 40A max 450V connection $\phi 6\text{mm}^2$ / F6.3 temp.-resist. 150°C cross section 6mm ²		

rail-mounted terminals

miscellaneous

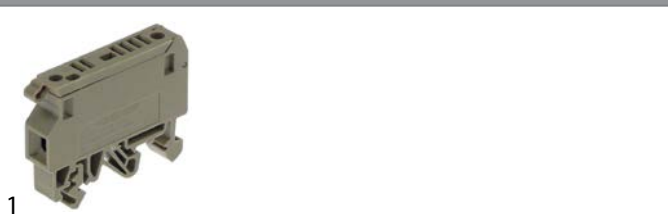

1

GEV No.	551453	Ref. No.	LC-420
description	rail-mounted terminal CONTA CLIP type STK2 4mm ² W 38mm L 48mm max. 6.3A max 500V		

electronic magnets



1

GEV No.	691625	Ref. No.	LC-370 RRLC-370
description	electronic magnet 230V 50Hz duty cycle 100% L 57mm W 46mm H 32mm		

electronic components

miscellaneous

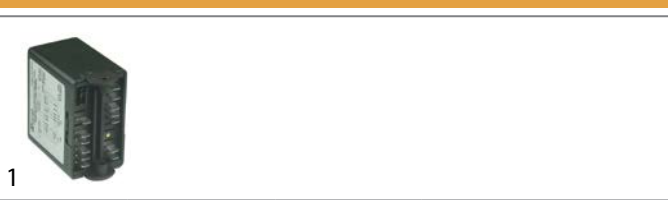

1

GEV No.	401109	Ref. No.	MC-851 RRMC-851
description	control box		

gas valves and ignition boxes

gas control valves

HONEYWELL



1

GEV No.	106012	Ref. No.	C5960-00
description	gas valve type VK4115V 220-240V 50/60Hz gas inlet flange 32x32mm gas outlet flange 32x32mm thermocouple connection pilot connection pressure range 15-60mbar max 60mbar operator type HONEYWELL flange 32x32mm		
accessories for	106012		
	GEV No.	102845	Ref. No. —
	gas connection angled 1/2" flange 32x32mm hole distance 24x24mm Tandem		
	GEV No.	102846	Ref. No. —
	gas connection straight 1/2" flange 32x32mm hole distance 24x24mm suitable for Tandem		



1

GEV No.	106280	Ref. No.	C5960-00 RRC5960-00
description	gas valve type VK4115V 230V 50Hz gas inlet 3/8" gas outlet $\phi 14\text{mm}$, edgewise max 60mbar HONEYWELL		
accessories for	106280		
	GEV No.	101305	Ref. No. —
	gas connection straight 1/2" flange 45x45mm ELETROSIT/V4400/4600/4605 suitable for SIT/HONEYWELL hole distance 36x36mm		
	GEV No.	101306	Ref. No. —
	gas connection angled flange 45x45mm hole distance 36x36mm 1/2" ELETROSIT/V4400/4600/4605 screw with O-ring suitable for SIT/HONEYWELL		
	GEV No.	101307	Ref. No. —
	gas connection straight flange 45x45mm hole distance 36x36mm 3/4" ELETROSIT/V4400/4600/4605 screw with O-ring suitable for SIT/HONEYWELL		
	GEV No.	101308	Ref. No. —
	gas connection angled flange 45x45mm hole distance 36x36mm 3/4" ELETROSIT/V4400/4600/4605 screw with O-ring suitable for SIT/HONEYWELL		







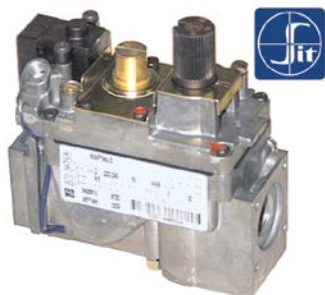





SIT

NOVASIT



1







GEV No.	101162	Ref. No.	C2225-00 RRC2225-00
description	gas valve SIT series Novasit 820 230V 50Hz gas inlet 1/2" gas outlet 1/2" thermocouple connection M9x1 pilot connection M10x1 ignition pressure 3-5mbar pressure range 3-30mbar pressure regulator connection blind equiv. no. 0.820.010		
spare parts for	101162		
	GEV No.	101065	Ref. No. —
	magnet unit with cable L 44mm D1 ø 30mm D2 ø 20mm suitable for NOVASIT		
	GEV No.	101313	Ref. No. —
	solenoid coil 230V 50Hz		
accessories for	101162		
	GEV No.	100006	Ref. No. —
	piezoelectric igniter suitable for ELETTROSIT body plastic blowing connection ø2.4mm ø 14mm		
	GEV No.	101305	Ref. No. —
	gas connection straight 1/2" flange 45x45mm ELETTROSIT/V4400/4600/4605 suitable for SIT/HONEYWELL hole distance 36x36mm		
	GEV No.	101306	Ref. No. —
	gas connection angled flange 45x45mm hole distance 36x36mm 1/2" ELETTROSIT/V4400/4600/4605 screw with O-ring suitable for SIT/HONEYWELL		
	GEV No.	101307	Ref. No. —
	gas connection straight flange 45x45mm hole distance 36x36mm 3/4" ELETTROSIT/V4400/4600/4605 screw with O-ring suitable for SIT/HONEYWELL		
	GEV No.	101308	Ref. No. —
	gas connection angled flange 45x45mm hole distance 36x36mm 3/4" ELETTROSIT/V4400/4600/4605 screw with O-ring suitable for SIT/HONEYWELL		
	GEV No.	101312	Ref. No. —
	microswitch		
	GEV No.	101314	Ref. No. —
	solenoid coil 24V 50Hz		
	GEV No.	101317	Ref. No. —
	plug with cable L 1000mm suitable for NOVASIT		
	GEV No.	101318	Ref. No. —
	cover cap for solenoid coil suitable for NOVASIT		



1

GEV No.	101967	Ref. No.	C5350-00 RRC5350-00
description	gas valve SIT series Novasit 822 230V 50Hz gas inlet 1/2" gas outlet 1/2" thermocouple connection pilot connection M10x1 ignition pressure 3-5mbar pressure range 3-30mbar pressure regulator connection perforated equiv. no. 0.822.110		
spare parts for	101967		
	GEV No.	101313	Ref. No. —
	solenoid coil 230V 50Hz		
	GEV No.	101542	Ref. No. —
	solenoid coil 50Hz NOVA 822/826/827 suitable for NOVASIT 230V		
accessories for	101967		
	GEV No.	100904	Ref. No. —
	locking screw M10x1 for pipe ø 4mm Qty 1 pcs		
	GEV No.	100905	Ref. No. —
	locking screw M10x1 for pipe ø 6mm Qty 1 pcs		
	GEV No.	101305	Ref. No. —
	gas connection straight 1/2" flange 45x45mm ELETTROSIT/V4400/4600/4605 suitable for SIT/HONEYWELL hole distance 36x36mm		
	GEV No.	101306	Ref. No. —
	gas connection angled flange 45x45mm hole distance 36x36mm 1/2" ELETTROSIT/V4400/4600/4605 screw with O-ring suitable for SIT/HONEYWELL		
	GEV No.	101307	Ref. No. —
	gas connection straight flange 45x45mm hole distance 36x36mm 3/4" ELETTROSIT/V4400/4600/4605 screw with O-ring suitable for SIT/HONEYWELL		
	GEV No.	101308	Ref. No. —
	gas connection angled flange 45x45mm hole distance 36x36mm 3/4" ELETTROSIT/V4400/4600/4605 screw with O-ring suitable for SIT/HONEYWELL		
	GEV No.	101503	Ref. No. —
	O-ring EPDM thickness 2mm ID ø 32mm Qty 1 pcs		
	GEV No.	101924	Ref. No. —
	plug with cable L 1090mm suitable for NOVA 822/826/827		



GEV No.	106001	Ref. No.	C2226-00 RRC2226-00
description	gas valve SIT series Novasit 826 230V 50Hz gas inlet 1/2" gas outlet 1/2" thermocouple connection pilot connection closed ignition pressure 3-5mbar pressure range 2-50mbar pressure regulator connection standard equiv. no. 0.826.011 power supply for modulator 230VAC rectified		
For models:	MDP-6G		
spare parts for	106001		
	GEV No.	101542	Ref. No. —
	solenoid coil 50Hz NOVA 822/826/827 suitable for NOVASIT 230V		
accessories for	106001		
	GEV No.	101305	Ref. No. —
	gas connection straight 1/2" flange 45x45mm ELETTROSIT/V4400/4600/4605 suitable for SIT/HONEYWELL hole distance 36x36mm		
	GEV No.	101306	Ref. No. —
	gas connection angled flange 45x45mm hole distance 36x36mm 1/2" ELETTROSIT/V4400/4600/4605 screw with O-ring suitable for SIT/HONEYWELL		
	GEV No.	101307	Ref. No. —
	gas connection straight flange 45x45mm hole distance 36x36mm 3/4" ELETTROSIT/V4400/4600/4605 screw with O-ring suitable for SIT/HONEYWELL		
	GEV No.	101308	Ref. No. —
	gas connection angled flange 45x45mm hole distance 36x36mm 3/4" ELETTROSIT/V4400/4600/4605 screw with O-ring suitable for SIT/HONEYWELL		
	GEV No.	101859	Ref. No. C2226-01 RRC2226-01
	panel-mounted inlet with cable L 1000mm for rectifier suitable for NOVASIT		

accessories

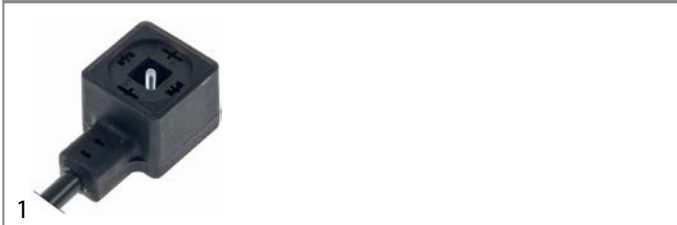

GEV No.	101859	Ref. No.	C2226-01 RRC2226-01
description	panel-mounted inlet with cable L 1000mm for rectifier suitable for NOVASIT		
For models:	MDP-6G		

ignition boxes

HONEYWELL



GEV No.	102367	Ref. No.	C5965-00 C5965-12 RRC5965-00
description	ignition box HONEYWELL type S4565A 2092 1 electrodes 3 waiting times safety time 10s 220-240V 4VA 50/60Hz		

ignition parts
electrodes



GEV No.	109209	Ref. No.	C5942-13
description	gasket for ignition electrode combi-steamer L 56mm W 25mm		

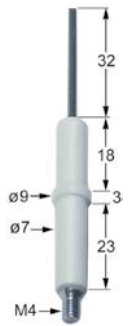

GEV No.	100701	Ref. No.	C2235-00
description	ignition electrode connection M4 Qty 1 pcs		
accessories for	100701		

	GEV No.	100906	Ref. No. —
	screw connection thread M10x1 for ignition electrode brass Qty 1 pcs WS 10		

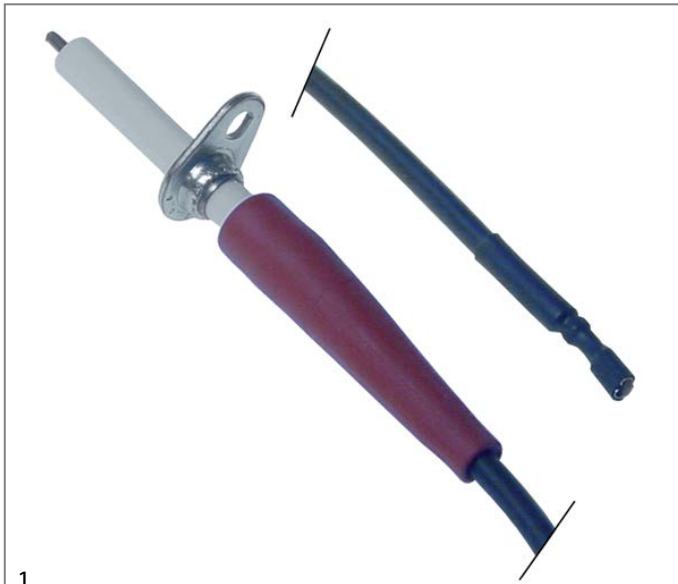

1

GEV No.	102315	Ref. No.	C2497-00 RRC2497-00
description	ignition electrode flange length 23mm flange width 15mm D1 ø 7mm L1 5mm BL1 30mm BL2 23mm connection F 2.8x0.8mm fixing dimensions ø5x4mm with flange		
For models:	MDP-6G		

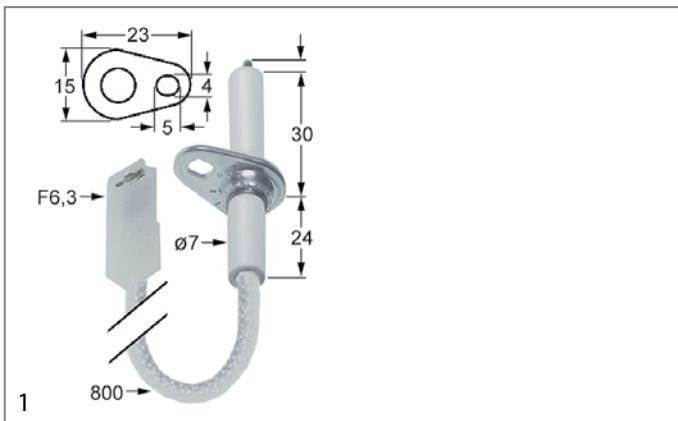

1

GEV No.	102316	Ref. No.	C2494-00 RRC2494-00
description	ignition electrode flange length 23mm flange width 15mm D1 ø 7mm L1 5mm BL1 30mm BL2 24mm connection F 6.3 cable length 800mm fixing dimensions ø5x4mm with flange		
For models:	MDP-6G		



1

GEV No.	102293	Ref. No.	C5907-00 RRC5907-00
description	ignition electrode flange length 51mm flange width 23mm cable length 440mm		

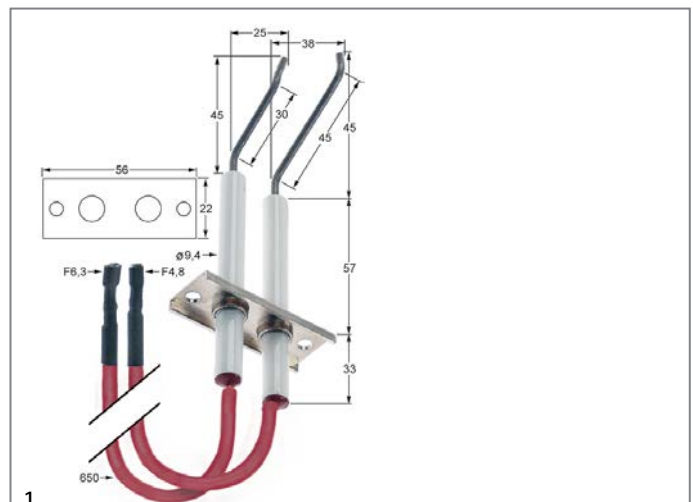

1

GEV No.	107657	Ref. No.	C9309-13 C9309-32 RRC9309-13
description	ignition electrode flange length 56mm flange width 22mm D1 ø 9.4mm L1 45mm L2 38/25mm L3 45/30mm BL1 57mm BL2 33mm connection male faston 4.8mm/6.3mm cable length 650mm screw		

gas burners

bar burners

bar burners



GEV No.	105663	Ref. No.	C2297-00 RRC2297-00
description	bar burner ø 40mm Wmm Hmm L 458mm flange width 43mm flange length 43mm combi-steamer		
For models:	MDP-6G		



GEV No.	105664	Ref. No.	C2480-00 RRC2480-00
description	bar burner ø 50mm Wmm Hmm L 548mm flange width 57mm flange length 57mm combi-steamer		



GEV No.	105665	Ref. No.	C7188-00 RRC7188-00
description	bar burner ø 60mm Wmm Hmm L 548mm flange width 67mm flange length 67mm combi-steamer		

gas nozzles

main nozzles

gas nozzles M10x1



GEV No.	100639	Ref. No.	C1866-00
description	gas injector thread M10x1 WS 11 bore ø 1.25mm inner peaked		



GEV No.	106291	Ref. No.	C1770-00 RRC1770-00
description	gas injector thread M10x1 WS 11 bore ø 1.95mm inner peaked		

pilot burner nozzles

pilot burner nozzles SIT

140/150 series



GEV No.	100205	Ref. No.	C2231-00
description	pilot burner nozzle SIT LPG code 19 bore ø 0.23/0.26mm Qty 1 pcs suitable for SIT 150 series		



GEV No.	100206	Ref. No.	C2232-00
description	pilot burner nozzle SIT natural gas code 36 bore ø 0.60/0.55mm Qty 1 pcs suitable for SIT 150 series		

equipment-specific units for convection ovens/combi-steamers



GEV No.	696841	Ref. No.	C9010-00
description	bush ED ø 7.8mm L 18mm IT M6		



GEV No.	696844	Ref. No.	C1043-00 RRC1043-00
description	bush for pivot bearing combi-steamer ID ø 10mm ED ø 14mm L 18mm		



GEV No.	696840	Ref. No.	C9034-00
description	spacer bush ID ø 8.5mm ED ø 20mm L 11.5mm		

steam generators

steam generators



1

GEV No.	693319	Ref. No.	C5450-90 RRC5450-00
----------------	--------	-----------------	------------------------

description steam generator complete ø 215mm 2200W 240V

injection nozzles



1

GEV No.	691627	Ref. No.	C1715-00 C1715-13 RRC1715-00
----------------	--------	-----------------	------------------------------------

description injection nozzle bore ø 0.4mm D1 ø 6mm D2 ø 11.5mm L 35mm WS 14 brass



1

GEV No.	691628	Ref. No.	C1717-00 C1717-12 RRC1717-00
----------------	--------	-----------------	------------------------------------

description injection nozzle bore ø 0.5mm D1 ø 6mm D2 ø 10.5mm L 35mm WS 14 brass



1

GEV No.	691629	Ref. No.	C1418-00 C1418-12 C1418-21 RRC1418-00 RRC1418-12
----------------	--------	-----------------	--

description injection nozzle bore ø 0.7mm D1 ø 6mm D2 ø 11.5mm L 38mm WS 14 brass thread 1/8"

injection pipes



1

GEV No.	696837	Ref. No.	C5068-00 RRC5068-00
----------------	--------	-----------------	------------------------

description injection pipe for combi-steamer ED ø 8mm ID ø 6mm L 210mm W 53mm hole distance 36mm

spare parts and accessories



1

GEV No.	560658	Ref. No.	C5367-00
----------------	--------	-----------------	----------

description bracket W 34mm H 30mm L 51mm for timer combi-steamer



1

GEV No.	551458	Ref. No.	C8136-00
----------------	--------	-----------------	----------

description connecting piece L 45mm W 15mm H 38mm

filters



1

GEV No.	701652	Ref. No.	C2125-00
----------------	--------	-----------------	----------

description drain filter ø 86mm H 30mm for combi-steamer spout ø 34mm

cleaning system

nozzles



1

GEV No.	510000	Ref. No.	C7285-00 RRC7285-00
----------------	--------	-----------------	------------------------

description nozzle ø 1.5/2.8mm H 13mm thread 1/8" ET WS 13

door mechanics

locking mechanism



1	GEV No. 692900	Ref. No. C7095-00 RRC7095-00
description espagnolette lock ø 10mm L 1165mm		

accessories



1	GEV No. 692901	Ref. No. C8112-00
description base plate for door catch W 21mm hole ø 6mm L 70mm		



1	GEV No. 696845	Ref. No. C2094-00 RRC2094-00
description base plate W 38mm hole ø 7mm stainless steel L 192mm		



1	GEV No. 696842	Ref. No. C9037-00
description bush hole ø 5mm stainless steel L 16mm		



1	GEV No. 696833	Ref. No. C8308-00
description door magnet ø 20mm hole ø 4mm L 10mm		



1	GEV No. 696838	Ref. No. C8305-00
description nut thread M10x1 WS 14 brass Qty 1 pcs serrated for door hinge		



1	GEV No. 696839	Ref. No. C7569-00
description spring for glass plate W 20mm spring steel L 24mm		

for dishwashers

washing and rinsing systems



1	GEV No. 510000	Ref. No. C7285-00 RRC7285-00
description nozzle ø 1.5/2.8mm H 13mm thread 1/8" ET WS 13		

knobs

universal knobs



1	GEV No. 112871	Ref. No. C2188-00
description knob switch zero mark ø 38mm shaft ø 6x4.6mm black		

producer-specific knobs

INOXTREND





1	GEV No. 111000	Ref. No. C5779B-00 RRC5779B-00
description knob ø 60mm shaft ø 18.5x18.5mm for safety valve		



			
1			
GEV No.	112871	Ref. No.	C2188-00
description	knob switch zero mark ø 38mm shaft ø 6x4.6mm black		

			
1			
GEV No.	111683	Ref. No.	C5385-00 RRC5385-00
description	knob switch zero mark ø 40mm shaft ø 6x4.6mm shaft flat upper black		

			
1			
GEV No.	111072	Ref. No.	C8119-00 C8119-22 RRC8119-00
description	knob switch zero mark ø 55mm shaft ø 6x4.6mm shaft flat upper silver		

			
1			
GEV No.	111003 ¹	Ref. No.	C8124-00 RRC8124-00
description	knob switch zero mark ø 55mm shaft ø 6x4.6mm shaft flat upper silver deepend shaft intake		

¹deepend shaft intake

handles and hand wheels

bracket handles

			
1			
GEV No.	691626	Ref. No.	C2417-00 RRC2417-00
description	pull handle L 140mm H 73mm handle M5		

locks

handle latches

producer-specific

INOXTREND

			
1			
GEV No.	692898	Ref. No.	C7557-00
description	door handle for combi-steamer L 220mm H 40mm spring length 54.5mm black plastic/metal mounting thread M5		

edgemount latches

handle latches

CAFF/FERMOD

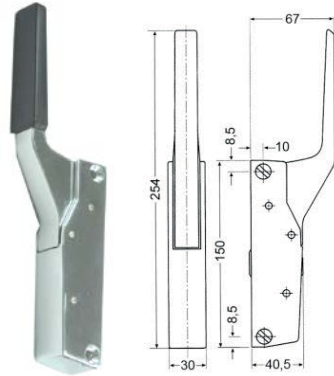
			
1			
GEV No.	690488	Ref. No.	C2210-01 RRC2210-01
description	catch		



			
1			
GEV No.	700060	Ref. No.	C2210-01
description	handle latch L 150mm mounting distance 133mm non lockable heated units G 791		
accessories for	700060		
			
GEV No.	700061	Ref. No.	C2210-02
description	door catch L 58mm W 20mm H 35mm mounting distance 42mm chrome-plated brass for headed units		

Table continues overleaf

accessories for	700060		
	GEV No.	700062	Ref. No. —
	handle protection heated units		

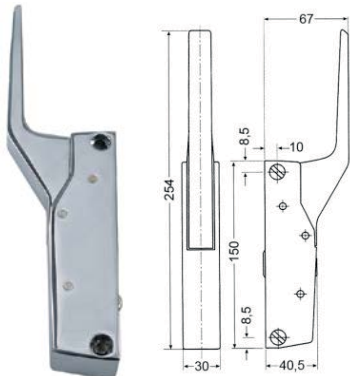

producer-specific

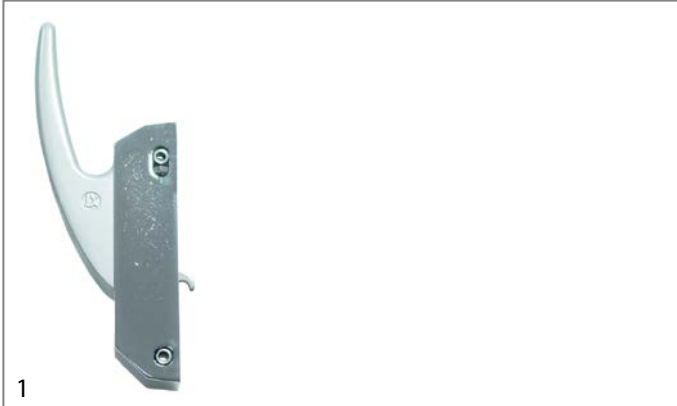
INOXTREND





GEV No.	690536	Ref. No.	C8118-00 C8118-00CR RRC8118-00
description	catch L 172mm mounting distance 133mm non lockable chrome-plated 6200 total length 248mm		
accessories for	690536		
	GEV No.	690123	Ref. No. —
	door catch with roller		



GEV No.	690146	Ref. No.	C2211-01 RRC2211-01
description	handle latch L 172mm mounting distance 134mm non lockable heated units 6200 H 65mm type DUPLO total length 248mm		
For models:	MDP-6G		
accessories for	690146		
	GEV No.	690123	Ref. No. —
	door catch with roller		
	GEV No.	693777	Ref. No. —
	gasket H 6.6mm L 105mm W 45mm L1 78mm W1 25mm for handle		
	GEV No.	693778	Ref. No. —
	door catch		

MODULAR





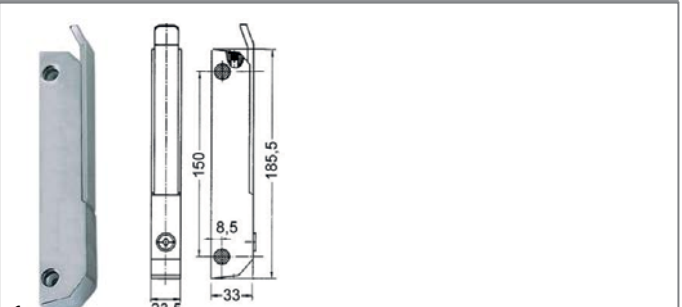

GEV No.	690146	Ref. No.	C2211-01 RRC2211-01
description	handle latch L 172mm mounting distance 134mm non lockable heated units 6200 H 65mm type DUPLO total length 248mm		
For models:	MDP-6G		
accessories for	690146		
	GEV No.	690123	Ref. No. —
	door catch with roller		
	GEV No.	693777	Ref. No. —
	gasket H 6.6mm L 105mm W 45mm L1 78mm W1 25mm for handle		
	GEV No.	693778	Ref. No. —
	door catch		

RAHRBACH

6188 ERGO series



GEV No.	700081	Ref. No.	C8050-00 RRC8050-00
description	handle latch L 185mm mounting distance 150mm chrome-plated non lockable refrigeration units 6188		
accessories for	700081		
	GEV No.	690110	Ref. No. —
	base plate H 1mm L 38mm W 11mm mounting distance 26mm plastic		
	GEV No.	690111	Ref. No. —
	base plate H 2mm L 38mm W 11mm mounting distance 26mm plastic		
	GEV No.	690114	Ref. No. —
	base plate H 3.5mm L 185mm W 30mm mounting distance 150mm with inclination thread M5		
	GEV No.	700082	Ref. No. C1447-00
	door catch L 38mm W 18mm mounting distance 26mm		

door catches



1

GEV No.	690487	Ref. No.	C2211-02 RRC2211-02
description	door catch H 41mm L 70mm W 21mm mounting distance 40mm nickel-plated brass with roller rollerø 8mm		
For models:	MDP-6G		



1

GEV No.	700082	Ref. No.	C1447-00
description	door catch L 38mm W 18mm mounting distance 26mm		



1

GEV No.	700061	Ref. No.	C2210-02	
description	door catch L 58mm W 20mm H 35mm mounting distance 42mm chrome-plated brass for headed units			
accessories for	700061			
	GEV No.	690414	Ref. No.	—
	handle latch L 150mm mounting distance 133mm non lockable refrigeration units G 791			



1

GEV No.	700435	Ref. No.	C2210-02 RRC2210-02
description	door catch L 58mm W 20mm H 35mm mounting distance 42mm zamak for refrigeration units		

snap locks

universal



1

GEV No.	700428	Ref. No.	C4038-00 RRC4038-00
description	snap lock L 60mm W 14mm H 30mm mounting distance 47/25mm spring thickness 1mm complete with door catch zamak		



1

GEV No.	690596	Ref. No.	C4038-00
description	snap lock L 60mm W 15mm H 36mm mounting distance 48/28mm spring thickness 1.5mm complete with door catch zamak		



1

GEV No.	690903	Ref. No.	C8110-00
description	snap lock L 69mm W 13mm H 20mm mounting distance 57mm complete with door catch nickel-plated brass		

espagnolette locks

universal



1

GEV No.	690041	Ref. No.	HC-027
description	cam L 148mm mounting distance 32mm		



1

GEV No.	690040	Ref. No.	HC-029
description	door catch with roller H 42mm L 40mm W 40mm zinc die cast mounting distance 26mm type 0751 series		





1

GEV No.	692900	Ref. No.	C7095-00 RRC7095-00
description	espagnolette lock ø 10mm L 1165mm		

hinges

door bearing

 <p>1</p>			
GEV No.	519631	Ref. No.	C9021-00 C9521
description	hinge bearing L 112mm W 35mm H 6mm mounting pos. upper without bolt		

 <p>1</p>			
GEV No.	519633	Ref. No.	C9022-00 C9522-00
description	hinge bearing L 151mm W 35mm mounting pos. lower thickness 6mm without bolt		

 <p>1</p>			
GEV No.	519634	Ref. No.	C6040-00
description	hinge bearing L 41mm W 32mm H 25mm mounting pos. upper thickness 4mm bolt 19mm bolt ø 10mm		

 <p>1</p>			
GEV No.	519635	Ref. No.	C8311-00
description	hinge bearing L 60mm W 36mm H 22mm thickness 3mm bolt 12mm		

 <p>1</p>			
GEV No.	692899	Ref. No.	C5175-00 RRC5175-00
description	hinge bearing L 62mm W 55mm H 35mm mounting distance 31mm mounting distance 2 18mm mounting pos. upper thickness 6mm bolt 16.5mm bolt ø 10mm		

 <p>1</p>			
GEV No.	519632	Ref. No.	C5180-00 RRC5180-00
description	hinge bearing L 62mm W 55mm mounting pos. lower thickness 6mm bolt 17mm bolt ø 10mm with bolt		

accessories

bushes

 <p>1</p>			
GEV No.	696844	Ref. No.	C1043-00 RRC1043-00
description	bush for pivot bearing combi-steamer ID ø 10mm ED ø 14mm L 18mm		

pullouts

rollers

 <p>1</p>			
GEV No.	690692	Ref. No.	C2418-00 RRC2418-00
description	roller rollersø 55mm B1 10mm overall width 14mm A 55mm B 10mm C 14mm SS bore ø 12mm		

equipment feet and end caps

equipment feet

with screw mounting

 <p>1</p>			
GEV No.	701092	Ref. No.	C2407-00
description	equipment foot tube ø 50mm thread M10 thread L 23mm H 113/160mm stainless steel Qty 1 pcs		

bullet feet

plastic



1

GEV No.	700108	Ref. No.	C1446-00 RRC1446-00
description	equipment foot pipe type 40x40 thickness 1-1.2mm H 17-55mm plastic Qty 1 pcs		
spare parts for	700108		
	GEV No.	511512	Ref. No. —
	O-ring EPDM thickness 2.62mm ID ø 18.72mm Qty 10 pcs		

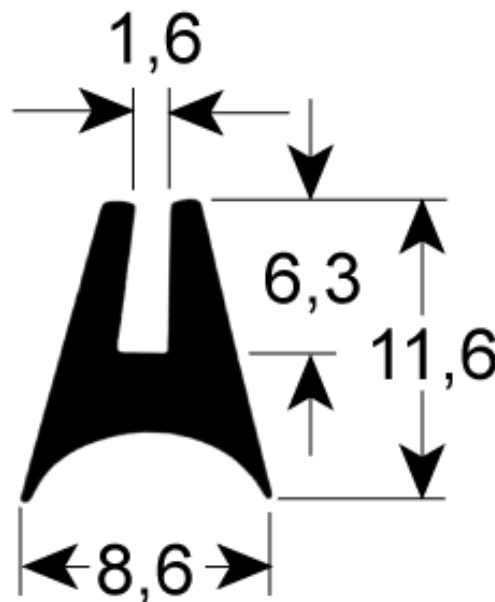

1

GEV No.	902541	Ref. No.	C2183-02 RRC2183-02
description	window gasket profile 1577 L 2100mm Qty 2		

gaskets

gaskets for heated units

window seals

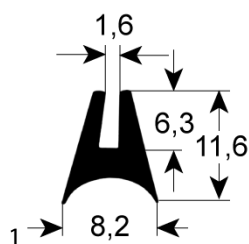

GEV No.	901315	Ref. No.	C7572-00
description	window gasket profile 1577 L 1420mm Qty 1		

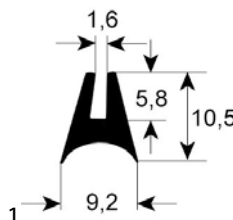

GEV No.	900416	Ref. No.	C5214-00 C5218-00 C5223-00 RRC5214-00 RRC5218-00 RRC5223-00
description	window gasket profile 1580 L 1800mm Qty 1 mounting pos. inner		
For models:	MDP-6G		

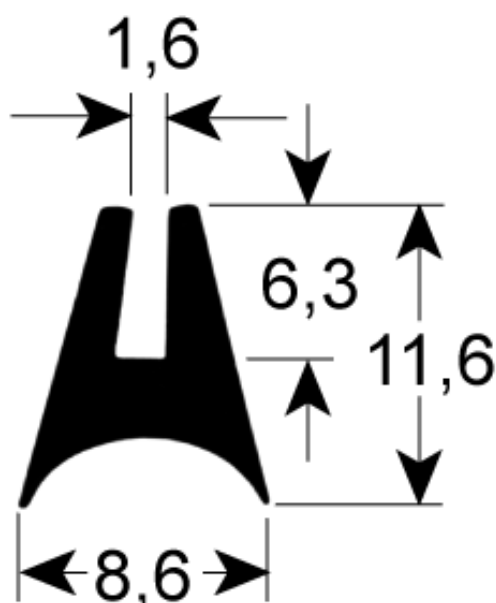

1

GEV No.	902539	Ref. No.	C2183-01 RRC2183-01
description	window gasket profile 1577 L 1550mm Qty 2		

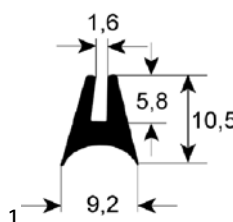

GEV No.	900419	Ref. No.	C5219-00 RRC5219-00
description	window gasket profile 1580 L 2500mm Qty 1 mounting pos. inner		

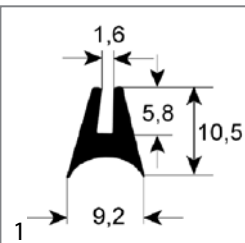

GEV No.	900427	Ref. No.	C6515-00 RRC6515-00
description	window gasket profile 1580 L 2900mm Qty 1 mounting pos. inner		

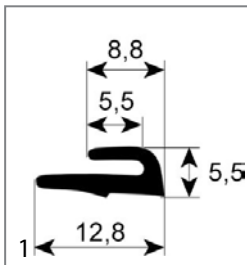

GEV No.	900828	Ref. No.	C5572-00 RRC5572-00
description	window gasket profile 1885 L 2430mm Qty 1		

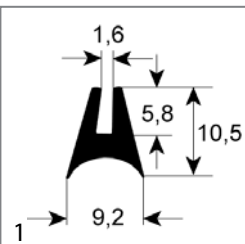

GEV No.	900797	Ref. No.	C5216-00 C5227-00 RRC5216-00 RRC5227-00
description	window gasket profile 1580 L 450mm Qty 1		
For models:	MDP-6G		

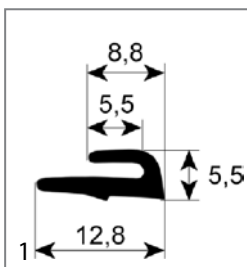

GEV No.	900430	Ref. No.	C7117-00 RRC7117-00
description	window gasket profile 1885 L 3250mm Qty 1		

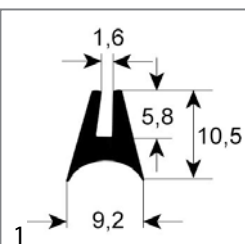

GEV No.	900827	Ref. No.	C5247-00 RRC5247-00
description	window gasket profile 1580 L 990mm Qty 1		

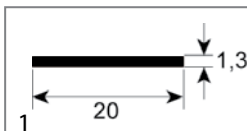

GEV No.	900826	Ref. No.	C6516-00 RRC6516-00
description	window gasket profile 1886 L 600mm Qty 1 external size mounting pos. horizontal		

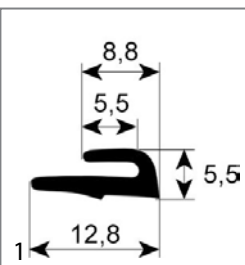

GEV No.	900426	Ref. No.	C6513-00 RRC6513-00
description	window gasket profile 1885 L 2300mm Qty 1		

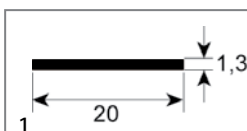

GEV No.	900825	Ref. No.	C6517-00 RRC6517-00
description	window gasket profile 1886 L 800mm Qty 1 external size mounting pos. vertical		

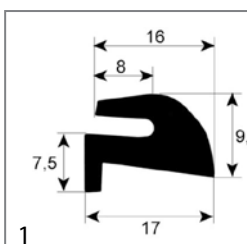

GEV No.	900425	Ref. No.	C6512-00 RRC6512-00
description	window gasket profile 1890 L 2370mm Qty 1 mounting pos. outer		

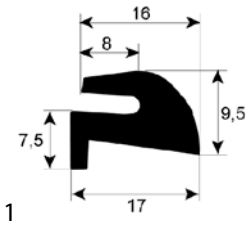
			
GEV No.	900429	Ref. No.	C7121-01 RRC7121-01
description	window gasket profile 1890 L 3500mm Qty 1 mounting pos. outer		

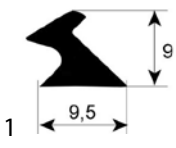
			
GEV No.	900415	Ref. No.	C5209-00 RRC5209-00
description	window gasket profile 1895 L 3000mm Qty 1 mounting pos. outer		

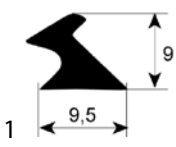
			
GEV No.	900421	Ref. No.	C5735-00 RRC5735-00
description	window gasket profile 1895 L 3000mm Qty 1 mounting pos. outer		

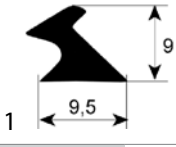
			
GEV No.	900423	Ref. No.	C5736-00 RRC5736-00
description	window gasket profile 1895 L 3500mm Qty 1 mounting pos. outer		

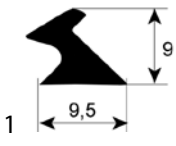
			
GEV No.	900824	Ref. No.	C5211-00 RRC5211-00
description	window gasket profile 1895 L 3570mm Qty 1 mounting pos. inner		

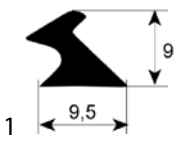
			
GEV No.	900418	Ref. No.	C5217-00 RRC5217-00
description	window gasket profile 1895 L 3700mm Qty 1 mounting pos. outer		

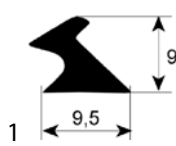
			
GEV No.	900431	Ref. No.	C7116-00 RRC7116-00
description	window gasket profile 1895 L 4600mm Qty 1 mounting pos. inner		

door seals

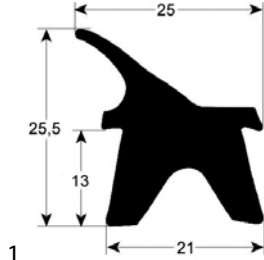
			
GEV No.	900348	Ref. No.	C2215-03
description	door seal profile 2402 Qty supplied by meter		

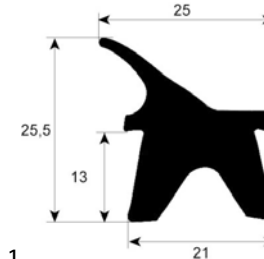
			
GEV No.	900414	Ref. No.	C2215-06 RRC2215-06
description	door seal profile 2402 W 385mm L 425mm external size Qty 1		

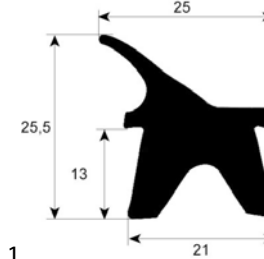
			
GEV No.	901541	Ref. No.	C2215-04
description	door seal profile 2402 W 430mm L 665mm external size Qty 1 suitable for INOXTREND 4-piece		

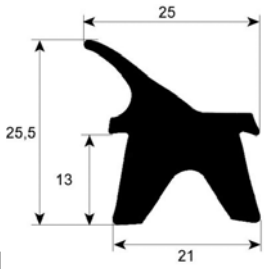

GEV No.	901311	Ref. No.	C2215-01 RRC2215-01
description	door seal profile 2402 W 555mm L 395mm plug size Qty 1 4-piece		
For models:	CVE 6-E		

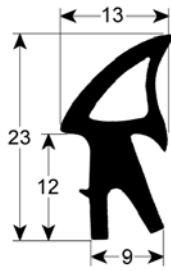

GEV No.	901449	Ref. No.	C7562-00 RRC7562-00
description	door seal profile 2458 L 1600mm		

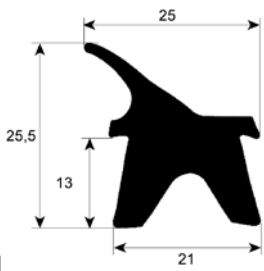

GEV No.	901129	Ref. No.	C2215-02 RRC2215-02
description	door seal profile 2402 W 580mm L 765mm Qty 1 4-piece		

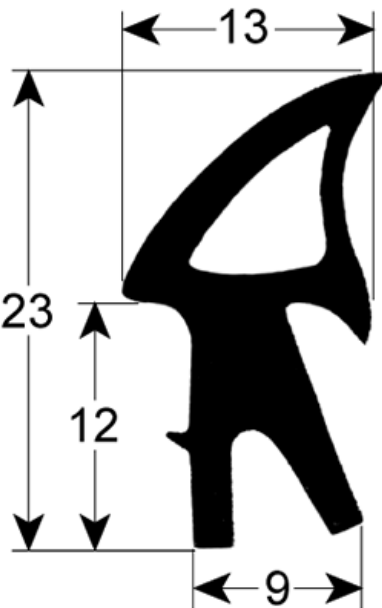

GEV No.	902543	Ref. No.	S0712-00
description	door seal profile 2458 L 1880mm Qty 1 suitable for INOXTREND		

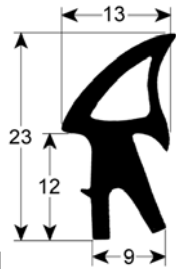

GEV No.	900412	Ref. No.	C6013-00 RRC6013-00
description	door seal profile 2458 L 1400mm Qty 1		

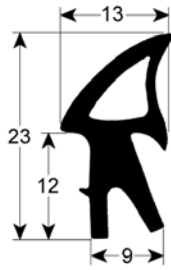

GEV No.	901540	Ref. No.	C7625-00
description	door seal profile 2458 L 2225mm Qty 1 suitable for INOXTREND		

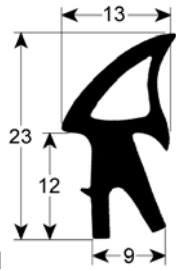

GEV No.	900413	Ref. No.	C6090-00 RRC6090-00
description	door seal profile 2458 L 1400mm Qty 1		



1

GEV No.	900432	Ref. No.	C7115-00 RRC7115-00
description	door seal profile 2460 L 4560mm Qty 1		

1

GEV No.	902544	Ref. No.	C9029-00
description	door seal profile 2470 L 2570mm		

1

GEV No.	901384	Ref. No.	C9031-00 RRC9031-00
description	door seal profile 2470 L 2100mm Qty 1		

1

GEV No.	900422	Ref. No.	C5737-00 RRC5737-00
description	door seal profile 2470 L 2630mm Qty 1		

1

GEV No.	900417	Ref. No.	C5220-00 RRC5220-00
description	door seal profile 2470 L 2300mm Qty 1		
For models:	MDP-6G		

1

GEV No.	900420	Ref. No.	C5221-00 RRC5221-00
description	door seal profile 2470 L 2850mm Qty 1		

GEV No.	900424	Ref. No.	C5738-00 RRC5738-00
description	door seal profile 2470 L 3250mm Qty 1		

GEV No.	900428	Ref. No.	C6510-00 RRC6510-00
description	door seal profile 2470 L 3600mm Qty 1		

door seals with fixing hook

GEV No.	901310	Ref. No.	C1608-00
description	door seal L 330mm W 450mm with 4 mounting clips external size		

gaskets for tray rack trolleys

GEV No.	902545	Ref. No.	C5207-00
description	tray rack trolley gasket L 715mm suitable for INOXTREND Qty 1		

gaskets for control panels

GEV No.	696849	Ref. No.	C5246-00
description	gasket suitable for INOXTREND profile 1577 for control panel L 650mm		



O-rings

silicone

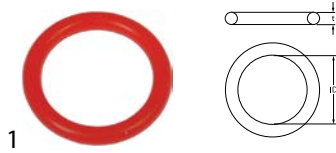

GEV No.	532251	Ref. No.	S0296-00
description	O-ring silicone thickness 2.62mm ID ø 17.86mm Qty 10 pcs		

special gaskets

for combi-steamers



GEV No.	696846	Ref. No.	C5940-00
description	gasket ED ø 85mm ID ø 60mm thickness 1.5mm hole distance 50mm		



GEV No.	696847	Ref. No.	C9153-00 RRC9153-00
description	gasket for motor shaft conical ED ø 21.5mm ID ø 11.8mm plastic		

sealing discs



GEV No.	901539	Ref. No.	C9032-00
description	gasket ø 16mm thickness 2.7mm rubber Qty 1 pcs		

hose reels and spray guns

spray guns



GEV No.	549332	Ref. No.	C2380-00
description	spray gun for appliances 1/2" IT L 215mm type ZANUSSI		
accessories for	549332		



GEV No.	520168	Ref. No.	—
description	double nipple nickel-plated brass thread 1/2" - 1/2" Qty 1 pcs		

hoses

for dishwashers

miscellaneous



GEV No.	511467	Ref. No.	C2181-00
description	pressure hose L 1000mm		

fittings, hose and pipe connectors

fittings

T-pieces

nickel-plated brass



GEV No.	520812	Ref. No.	HR-040
description	T-piece thread 1/8" ET - 1/8" IT - 1/8" IT nickel-plated brass L 37mm		

hose connectors

producer-specific



GEV No.	520336	Ref. No.	HR-598 RRHR-598
description	hose connector thread 1/4" grommet ø 12mm ID ø 8mm grommet length 19mm WS 14 total length 35mm thread L 10mm		



GEV No.	520337	Ref. No.	HR-595 RRHR-595
description	hose connector thread 1/4" grommet ø 7mm ID ø 4.5mm grommet length 19mm WS 14 total length 35mm thread L 10mm		

valves and tank inlets

ball valves

universal

ball valves with butterfly handle

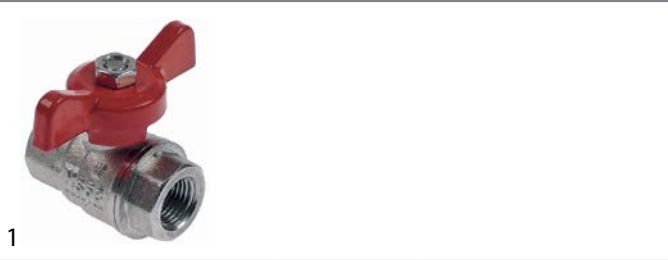

GEV No.	101895	Ref. No.	C2219-00
description	ball valve connection 1/4" IT - 1/4" IT DN10 total length 45mm		

ball valves electric

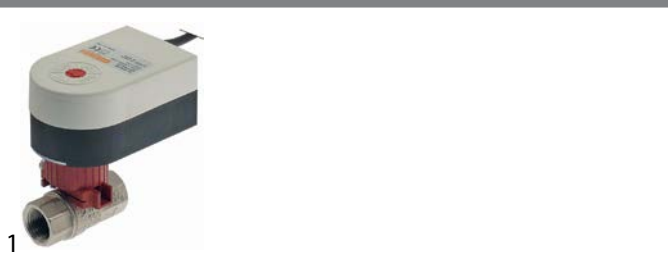

GEV No.	401085	Ref. No.	LC-500 RRLC-500
description	ball valve inlet 1/2" IT outlet 1/2" IT 230V L 60mm 50/60Hz closed off-current mode of operation electric connection cable 400mm cable 3-pole		

water cycle components

pressure reduction valves

pressure reduction valves

producer-specific



GEV No.	520329	Ref. No.	C2090-00 RRC2090-00
description	pressure reduction valve connection 1/2" brass		
For models:	MDP-6G		

measuring equipment

thermometers

built-in thermometers

ø60mm



GEV No.	379855	Ref. No.	C2186-00 RRC2186-00
description	thermometer mounting ø 60mm t.max. 350°C +50 up to +350°C probe ø 6mm probe L 20mm capillary pipe 1030mm		
For models:	CE 5, CE10, CE20, CG 5, CG10, CG20, CVE 5, CVE10, CVE20, CVG 5, CVG10, CVG20		

fastening material

screws

hexagonal screws

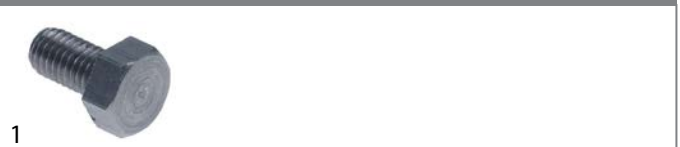

GEV No.	550682	Ref. No.	C3069-00 RRC3069-00
description	hexagonal screw thread M8 thread L 20mm SS WS 13 Qty 1 pcs DIN 933 / ISO 4017		
For models:	MDP-6G		

nuts

miscellaneous



GEV No.	696838	Ref. No.	C8305-00
description	nut thread M10x1 WS 14 brass Qty 1 pcs serrated for door hinge		



consumables

fuses

fine fuses



1

GEV No.	358532	Ref. No.	LC-422
description	fine fuse size ø5x20mm 2A fast-acting rated 250V Qty 10 pcs		



1

GEV No.	358594	Ref. No.	LC-426
description	fine fuse size ø5x20mm 0.16A slow-acting rated 250V Qty 10 pcs		

A		H	
alarm devices	15	halogen lamp	11
axial fans	25	handle latches	37
B		heater battery	3
ball valves	48	heating elements	3
ball valves electric	25, 48	heating elements for bain maries	3
bar burners	34	heating elements for convection	4
bi-metal thermostats	6, 6	hexagonal screws	48
C		hose connectors	47
cables	29	hoses	47
cam switches	8	hot air motors	26
condensators & interference suppression filters	29	I	
connection cables	29	ignition boxes	32
consumables	49	immersion heating elements	3
contact heaters	3	indicator lights	10
contactors	15	indicator lights (complete)	10
control thermostats	6	L	
cross flow fans	26	lamps	10
D		light bulbs	11
door catches	39	M	
door seals	43	magnetic switches	10
door seals with fixing hook	46	measuring equipment	48
E		mechanical timers	15
edgemount latches	37	microswitches	8
electric accessories	29	N	
electric timers	14	nuts	48
electrodes	25	O	
electronic controllers	18	O-rings	47
electronic magnets	30	oven lamps	11
energy regulators	5	P	
espagnolette locks	39	pressure reduction valves	48, 48
F		pressure switches	25
fans	25	probes	19
fastening material	48	programme timers	14
filters	29	pumps	28
fine fuses	49	push/momentary push switches	8
fittings	47	R	
fuses	29, 49	radial fans	28
G		relays	16
gas burners	34	ribbon cables	29
gas control valves	30	rocker/momentary rocker switches	7
gas nozzles	34	rotary switches	8
gaskets for control panels	46	S	
gaskets for heated units	41	safety thermostats	7
gaskets for tray rack trolleys	46		

screws	48
sealing discs	47
snap locks	39
solenoid valves	23
spray guns	47
switches and momentary switches	7

T

terminals	30
thermostats	6
timers	14
transformers	17

V

valves and tank inlets	48
vibration pumps	28

W

water cycle components	48
window seals	41