



GAS COMPONENTS



ELECTRIC COMPONENTS



WATER TECHNOLOGY



MECHANICAL COMPONENTS



TOOLS

Spare parts suitable for

ISA

Find the complete and up-to-date range of products in our GEV Webshop



Manufacturer catalogue

The most important spare parts and accessories arranged clearly for every manufacturer

- ✓ Complete product range and all appliance data always up to date in the GEV Webshop
- ✓ Alphabetical Index at the end of the catalogue

GEV Webshop

www.gev-online.co.uk

www.gev-online.com



- 🔍 Add to Favourites
- 🔍 Sign In with email address and usual password
- 🔍 Easy-order – place several items in your basket at the same time
- 🔍 Quick Item search – no login needed



heating elements

heating cartridges

1 

GEV No.	419216	Ref. No.	41850002800 418500028000
description	heating cartridge 250W 230V ø 11mm L 116mm cable length 2000mm connection male faston 6.3mm refrigeration		

1 

GEV No.	419218	Ref. No.	418500030100
description	heating cartridge 400W 230V ø 11mm L 240mm thread 3/8" cable length 550mm connection female faston 6.3mm refrigeration		

1 

GEV No.	419217	Ref. No.	418500020000
description	heating cartridge 700W 230V ø 11mm L 355mm cable length 1500mm connection female faston 6.3mm		

thermostats

bi-metal thermostats

bi-metal thermostats

1 

GEV No.	390930	Ref. No.	50501404000
description	bi-metal thermostat switch-off temp. 10°C 1-pole starting temperature -1°C cable length 2500mm		

timers

programme timers

1 

GEV No.	360590	Ref. No.	50502800200
description	timer EI30/15.5 engines chambers operation time 25s 230V 50/60Hz shaft ømm shaft Lmm RITARDAT.RT-123/00		

relays

power relays

with bracket mounting

1 

GEV No.	380687	Ref. No.	30506030 50500601400
description	power relays FINDER 230VAC 30A 2NO connection F6.3 bracket mounting manuf. no. 66.82.8.230.0300		

electronic controllers

CAREL

refrigeration controllers

built-in version

1 

71 x 29mm

GEV No.	378491	Ref. No.	418200090000
description	electronic controller CAREL PZIAC0H010K mounting measurements 71x29mm built-in depth 59mm 230V voltage AC NTC relay outputs 3 NO-12A CO-8A NO-8A NTC NTC protection IP65 ISA-TASSELLI -40 up to +99°C display 3½ digits		

DIXELL

refrigeration controllers

built-in version

1 

71 x 29mm

GEV No.	378492	Ref. No.	41825755200
description	electronic controller DIXELL XR72CX mounting measurements 71x29mm built-in depth 59mm 12V voltage AC/DC NTC/PTC relay outputs 4 NO-16A NO-8A NO-8A NO-5A DI NTC/PTC NTC/PTC yes protection IP65 dependend on probe°C display 3½ digits		



built-in version 2-piece



1

GEV No.	378490	Ref. No.	418249561100 418249561200
description	power PCB DIXELL XM470K-510C1 mounting measurements 132x152mm built-in depth 40mm 230V voltage AC NTC relay outputs 5 NO-20A NO-16A NO-8A NO-8A NTC NTC NTC digital digital yes protection°C display		
accessories for	378490		
	GEV No.	378278	Ref. No. —
	keypad unit DIXELL T640 mounting measurements 150x30mm built-in depth 23mmV voltage relay outputs°C display 3½ digits		







ELIWELL











refrigeration controllers

built-in version



1

GEV No.	381403	Ref. No.	418200073000 418200073100
description	electronic controller ELIWELL type EWPlus 974 mounting measurements 71x29mm 230V voltage AC NTC relay outputs 4 NO-12A(8) NO-8A(4) NC-6A(3) NO-5A(2) NTC NTC DI defr. funct. yes -50 up to +110°C display 3½ digits		
accessories for	381403		
	GEV No.	379052	Ref. No. —
	temperature probe PTC 1kOhm cable silicone probe -50 up to +150°C cable -50 up to +180°C probe ø6x40mm cable length 1.5m without screw connection 2-wire		
	GEV No.	379053	Ref. No. —
	temperature probe PTC 1kOhm cable PVC probe -50 up to +150°C cable -10 up to 100°C probe ø6x30mm cable length 3m without screw connection 2-wire		
	GEV No.	379064	Ref. No. —
	temperature probe PTC 1kOhm cable silicone probe -50 up to +150°C cable -50 up to +180°C probe ø6x40mm cable length 3m without screw connection 2-wire		
	GEV No.	379142	Ref. No. —
	temperature probe PTC 1kOhm cable PVC probe -50 up to +150°C cable -10 up to 100°C probe ø6x30mm cable length 1.5m without screw connection 2-wire		
	GEV No.	379160	Ref. No. —
	temperature probe NTC 10kOhm cable thermoplastic probe -40 up to +110°C cable -40 up to +110°C probe ø6x14mm cable length 1.5m without screw connection 2-wire		
	GEV No.	379161	Ref. No. —
	temperature probe NTC 10kOhm cable thermoplastic probe -40 up to +110°C cable -40 up to +110°C probe ø6x14mm cable length 3m without screw connection 2-wire		

accessories for	381403		
	GEV No.	379162	Ref. No. —
	temperature probe NTC 10kOhm cable thermoplastic probe -40 up to +110°C cable -40 up to +110°C probe ø6x14mm cable length 6m 2-wire		
	GEV No.	379169	Ref. No. —
	temperature probe NTC 10kOhm cable thermoplastic probe -40 up to +110°C cable -40 up to +110°C probe ø6x14mm cable length 2m without screw connection 2-wire		
	GEV No.	379199	Ref. No. —
	temperature probe PTC 1kOhm cable PVC probe -50 up to +150°C cable -10 up to 100°C probe ø6x30mm cable length 5m without screw connection 2-wire		
	GEV No.	379343	Ref. No. —
	temperature probe NTC 10kOhm cable silicone probe -40 up to +110°C cable -50 up to +180°C probe ø6x40mm cable length 3m 2-wire		
	GEV No.	379458	Ref. No. —
	temperature probe NTC 10kOhm cable silicone probe -40 up to +110°C cable -50 up to +180°C probe ø6x40mm cable length 1.5m without screw connection 2-wire		
	GEV No.	379630	Ref. No. —
	temperature probe NTC 10kOhm cable thermoplastic probe -40 up to +110°C cable -40 up to +110°C probe ø6x14mm cable length 2.5m without screw connection 2-wire resistor 10kOhm		
	GEV No.	379804	Ref. No. —
	protector for electronic controller 71x29 L 93mm W 65mm plexiglas		
	GEV No.	381407	Ref. No. —
	temperature probe Pt1000 probe -50 up to +110°C cable silicone°C probe ø5x20mm cable length 3m protection IP68		
	GEV No.	550802	Ref. No. —
	PCB terminal block 4-pole raster size 5mm		
	GEV No.	550805	Ref. No. —
	PCB terminal block 7-pole raster size 5mm		

probes

universal probes

temperature probes



1

GEV No.	381222	Ref. No.	418303463100
description	temperature probe PTC 1kOhm cable silicone probe -50 up to +150°C cable -50 up to +180°C probe ø6x30mm cable length 3m cable colours grey 2-wire		



1

GEV No.	381221	Ref. No.	418316740000
description	temperature probe PTC 1kOhm cable silicone probe -50 up to +150°C cable -50 up to +180°C probe ø6x40mm cable length 1.5m 2-wire		



electronics

PCBs



1

GEV No.	360636	Ref. No.	418221547100
description	PCB ON-OFF L 120mm W 40mm suitable for ISA		

keypads

keypad units



1

GEV No.	403576	Ref. No.	418294090000
description	keypad PCB buttons 12 grey suitable for ISA		

compressors

EMBRACO / ASPERA

R290A

LBP monophase

Lower evaporation temperature below -20°C



1

GEV No.	605202	Ref. No.	452500000000
description	compressor coolant R290 type NT2170U 220-240V 50Hz LBP 17kg 3/4HP cylinder capacity 20.44cm ³ CSR H 220mm 544W 698W 883W 1097W 1340WWWWWW test method ASHRAE		

R404a/R507

LBP monophase

Lower evaporation temperature below -20°C



1

GEV No.	605152	Ref. No.	452500001000
description	compressor coolant R404a/R507 type NEK2134GK 220-240V 50Hz LBP 11kg 1/2HP cylinder capacity 8.77cm ³ CSR H 180mm 227W 302W 394W 501W 621W 753WWWWWW test method ASHRAE		



1

GEV No.	605144	Ref. No.	452400001000
description	compressor coolant R404a/R507 type NEK2168GK 220-240V 50Hz LBP 22.9kg 3/4HP cylinder capacity 14.28cm ³ CSR H 200mm 345W 454W 587W 742W 921W 1123WWWWWW		



1

GEV No.	605174	Ref. No.	452400055000 452452284000
description	compressor coolant R404a/R507 type NJ2192GK 220-240V 50Hz LBP 20.4kg 1 1/4HP cylinder capacity 26.2cm ³ CSR H 265mm 685W 989W 1342W 1745W 2196W 2196WWWWWW		



1

GEV No.	605081	Ref. No.	452447789000 452452285000 452452286000
description	compressor coolant R404a/R507 type NJ2212GK 220-240V 50Hz LBP fully hermetic 21.5kg 1 1/2HP power input 1150W cylinder capacity 34cm ³ CSR H 277mm 880W 1269W 1738W 2289W 2921W 2921W test method ASHRAE		

HMBP monophase

High/Medium evaporation temperature above -20/-15 °C



1

GEV No.	605161	Ref. No.	452500003000
description	compressor coolant R404a/R507 type NEK6210GK 220-240V 50Hz HMBP fully hermetic 8.5kg 3/8HP cylinder capacity 8.78cm ³ CSIR H 200mmW 566W 674W 815W 988W 1195W 1435W 1707W		



1

GEV No.	605177	Ref. No.	452447774000
description	compressor coolant R404a/R507 type NJ9238GK 220-240V 50Hz HMBP 22.1kg 1 1/2HP cylinder capacity 32.7cm ³ CSR H 277mmW 2016W 2640W 3315W 4045W 4830W 5668W 6560W		

fans

refrigeration fans

cold air circulating fans (complete)

ELCO



1

GEV No.	602030	Ref. No.	41812963100
description	fan fan wheel ø 100mm 230V 50-60Hz 10W 2500rpm connection Faston without fan wheel		
spare parts for	602030		
	GEV No.	601563	Ref. No. —
	fan wheel sucking ø 96mm shaft intake ø 4mm blade angle 26° W 18mm aluminium suitable for 601039		
	GEV No.	601564	Ref. No. —
	fan wheel blowing ø 96mm shaft intake ø 4mm blade angle 26° W 18mm aluminium suitable for 601056		
accessories for	602030		
	GEV No.	602062	Ref. No. —
	connector cable ELCO cable length 1500mm 0.75mm ² protection IP44 for Plug-In		

miscellaneous



1

GEV No.	601857	Ref. No.	30413698 4152.0518 52A-20001/16 R400002486000 R400064297000
description	fan 230V 50/60Hz 15W ø 96mm type 52A-20001/16 2500rpm blowing fan wheel ø 96mm cable length 3000mm connection with cable mounting ø 110mm built-in depth 98mm		



equipment-specific units

for refrigerated counters

lid hinges



1

GEV No.	696667	Ref. No.	442700041005
description	bracket aluminium for hinge for door mounting pos. left		



1

GEV No.	696668	Ref. No.	442700042005
description	bracket aluminium for hinge for door mounting pos. left		



1

GEV No.	696665	Ref. No.	442700044005
description	bracket aluminium for hinge for door mounting pos. right		



1

GEV No.	696666	Ref. No.	442700043005
description	bracket aluminium for hinge for door mounting pos. right		

handles and hand wheels

bracket handles



1

GEV No.	701479	Ref. No.	491094841000
description	pull handle L1 320mm L2 230mm H 43mm mounting distance 275mm W 30mm grey/white		

locks

snap locks

producer-specific

ISA



1

GEV No.	692857	Ref. No.	50230200300
description	snap lock L 82mm W 38mm H 35mm mounting distance 27mm spring thickness 1.6mm		

hinges

edgemoount hinges

miscellaneous



1

GEV No.	692599	Ref. No.	50230102300
description	edgemoount hinge L 102mm W 19mm mounting distance 62mm hinging left/right without lift plastic grey refrigeration units centre of rotation 24mm		

spring assisted hinges

universal

INTERKLIMAT

hinges



1

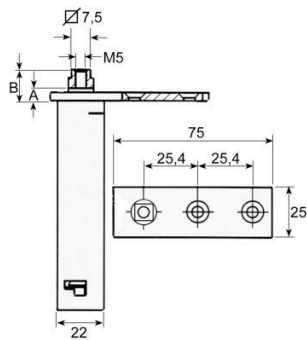

GEV No. 690622 **Ref. No.** 24563

description spring assisted hinge series 28L mounting pos. left/right L 75mm W 25mm H 103mm A 13mm B 18mm mounting measurements 22x22mm intake 7.5x7.5 refrigeration units

producer-specific

ISA



1

GEV No. 692600 **Ref. No.** 24563

description spring assisted hinge right/left L 73mm W 24mm H 100mm refrigeration units mounting distance 26mm

door bearing

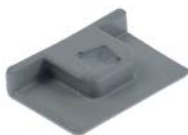

1

GEV No. 692601 **Ref. No.** 442700045005

description hinge L 40mm W 25mm mounting pos. bottom left thickness 7mm



1

GEV No. 692598 **Ref. No.** 442700040005

description hinge L 40mm W 25mm mounting pos. bottom right thickness 7mm Qty 1 pcs

gaskets

refrigeration gaskets

plug-in gaskets

profile 9048

We offer custom-made gaskets for this profile

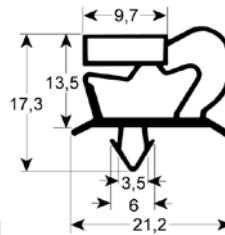

1

GEV No. 901619 **Ref. No.** 42403329900

description refrigeration gasket profile 9048 W 675mm L 1535mm plug size

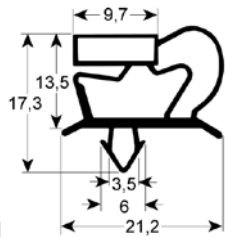

1

GEV No. 902258 **Ref. No.** N/A

description refrigeration gasket profile 9048 Wmm L 2500mm

profile 9703

We offer custom-made gaskets for this profile

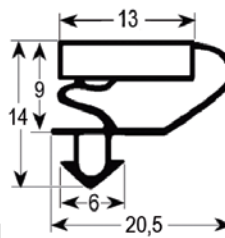

1

GEV No. 970884 **Ref. No.** 29013

description refrigeration gasket profile 9703 W 172mm L 426mm plug size

GEV No.	970819	Ref. No.	29011
description	refrigeration gasket profile 9703 W 281mm L 424mm plug size		

GEV No.	970885	Ref. No.	29014
description	refrigeration gasket profile 9703 W 390mm L 424mm plug size		

GEV No.	900933	Ref. No.	29012 30546
description	refrigeration gasket profile 9703 W 436mm L 616mm plug size L1 606mm W1 426mm external size		

GEV No.	901058	Ref. No.	424019211000
description	refrigeration gasket profile 9703 W 632mm L 1320mm plug size L1 1314mm W1 626mm external size		

GEV No.	901056	Ref. No.	N/A
description	refrigeration gasket profile 9703 W 685mm L 1560mm plug size		

GEV No.	901057	Ref. No.	29010
description	refrigeration gasket profile 9703 W 685mm L 756mm plug size		

GEV No.	901668	Ref. No.	424000017000
description	refrigeration gasket profile 9703 W 755mm L 910mm plug size		

profile 9704

We offer custom-made gaskets for this profile

GEV No.	901978	Ref. No.	29015
description	refrigeration gasket profile 9704 W 398mm L 278mm plug size equiv. no. 29015		

GEV No.	901680	Ref. No.	29017
description	refrigeration gasket profile 9704 W 525mm L 615mm plug size L1 606mm W1 516mm external size		

GEV No.	901976	Ref. No.	29009
description	refrigeration gasket profile 9704 W 689mm L 1565mm plug size L1 1555mm W1 675mm external size suitable for ISA		

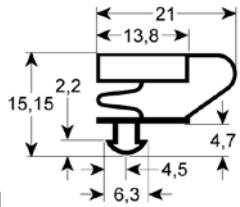

GEV No.	902299	Ref. No.	N/A
description	refrigeration gasket profile 9704 Wmm L 2500mm		

profile 9753

We offer custom-made gaskets for this profile

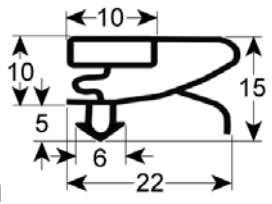

GEV No.	900875	Ref. No.	N/A
description	refrigeration gasket profile 9753 Wmm L 2500mm		

profile 9333

We offer custom-made gaskets for this profile

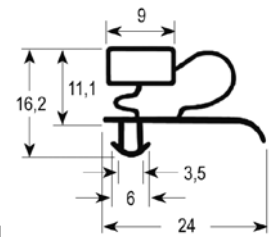

GEV No.	900992	Ref. No.	N/A
description	refrigeration gasket profile 9333 W 612mm L 1457mm plug size		

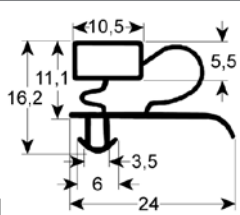

GEV No.	902167	Ref. No.	N/A
description	refrigeration gasket profile 9333 Wmm L 2500mm		

profile 9012

We offer custom-made gaskets for this profile

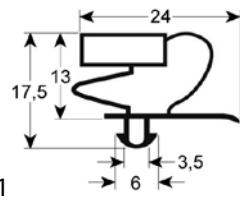

GEV No.	901620	Ref. No.	28047721
description	refrigeration gasket profile 9012 W 625mm L 1595mm plug size		

screw-in gaskets

profile 9106

We offer custom-made gaskets for this profile

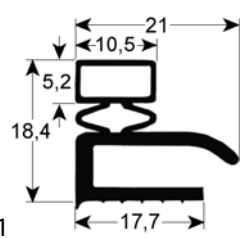

GEV No.	902262	Ref. No.	N/A
description	refrigeration gasket profile 9106 Wmm L 2500mm		

O-rings

EPDM

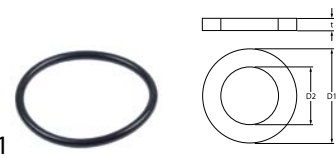

GEV No.	528632	Ref. No.	18025
description	O-ring EPDM thickness 3.53mm ID ø 44.04mm Qty 1 pcs		





refrigeration cycle components

valves

reversing valves



1

GEV No.	370791	Ref. No.	50600401200
description	reversing valve 4-way RANCO type V2-408060200 inlet 1/2" (12.84mm) outlet 3/8" (9.67mm) power range (R407C) 2.81-6.33 kW power range (R410A) 3.17-7.74 kW power range (R134A) 2.46-4.92 kW		
accessories for	370791		
	GEV No.	371302	Ref. No. 50504200500
	solenoid coil RANCO model LDK-41 230 50/60Hz 5/4W cable length 1200mm green		
	GEV No.	371306	Ref. No. —
	solenoid coil RANCO model LDK-41 208/240VAC 50/60Hz 5/4W cable length 2000mm		

spare parts and accessories



1

GEV No.	371302 ¹	Ref. No.	50504200500
description	solenoid coil RANCO model LDK-41 230 50/60Hz 5/4W cable length 1200mm green		

¹incl. cable 1200mm

evaporators

for fridges

producer-specific



1

GEV No.	750590	Ref. No.	420081399000
description	evaporator L 345mm W 120mm D 280mm total length 390mm suitable for ISA-TASSELLI		



1

GEV No.	750544	Ref. No.	420181938000
description	evaporator L 390mm W 355mm H 100mm suitable for ISA		

evaporation and condensing trays

unheated condensing trays



1

GEV No.	750542	Ref. No.	442254412000
description	condensing tray L 400mm W 290mm H 88mm plastic		



1

GEV No.	750541	Ref. No.	442241872100
description	condensing tray L 475mm W 265mm H 90mm plastic		

B

bi-metal thermostats 3,3

C

cold air circulating fans (complete) 6

compressors 5

E

edgemount hinges 7

electronic controllers 3

evaporators 11

F

fans 6

H

heating cartridges 3

heating elements 3

O

O-rings 10

P

plug-in gaskets 8

probes 4

programme timers 3

R

refrigeration cycle components 11

refrigeration fans 6

refrigeration gaskets 8

relays 3

reversing valves 11

S

screw-in gaskets 10

snap locks 7

spring assisted hinges 8

T

temperature probes 4

thermostats 3

timers 3

U

universal probes 4