



GAS COMPONENTS



ELECTRIC COMPONENTS



WATER TECHNOLOGY



MECHANICAL COMPONENTS



TOOLS

Spare parts suitable for

JEMI

Find the complete and up-to-date range of products in our GEV Webshop



Manufacturer catalogue

The most important spare parts and accessories arranged clearly for every manufacturer

- ✓ Complete product range and all appliance data always up to date in the GEV Webshop
- ✓ Alphabetical Index at the end of the catalogue

GEV Webshop

www.gev-online.co.uk

www.gev-online.com



- 🔍 Add to Favourites
- 🔍 Sign In with email address and usual password
- 🔍 Easy-order – place several items in your basket at the same time
- 🔍 Quick Item search – no login needed









heating elements

dry heating elements for dishwashers



GEV No.	420321	Ref. No.	2001302
description	heating element 1100W 240V heating circuits 1 L 185mm W 220mm tube ø 6.5mm connection male faston 6.3mm for drying warewashing 2 hole fixing thread 1/4" mounting distance 214mm		
For models:	A-1500-T, A-1500-TDI, A-1500-TDICV, A-1500-TID, A-1500-TIDCV, A-2460-T, MA-MC		











GEV No.	418756	Ref. No.	2001211 2001225
description	heating element 2600W 240V heating circuits 1 mounting ø 47.5mm L 185mm W 43mm H 35mm round flange connection male faston 6.3mm immersion heater tube ø 6.5mm H1 20mm H2 15mm connection length 25mm		
For models:	GS-1, GS-16, GS-18, GS-19, GS-2, GS-3, GS-4-2, GS-4-2AF, GS-5AF, GS-6, GS-6AF, GS-7, GS-8-2, GS-9		
accessories for	418756		
	GEV No.	510408	Ref. No. 2514180
	O-ring EPDM thickness 5.34mm ID ø 47mm Qty 1 pcs		
	GEV No.	510562	Ref. No. —
	O-ring silicone thickness 5.34mm ID ø 47mm Qty 1 pcs		
	GEV No.	520235	Ref. No. —
	3 hole flange hole distance 70.5mm perforation ø 6.5mm ID ø 53.5mm		
	GEV No.	520236	Ref. No. —
	flange for heating element ID ø 50mm ED ø 90mm hole ø 6.5mm 3 holes		
	GEV No.	550002	Ref. No. —
	tension strap H 10mm L 21mm W 10mm hole ø 6.5mm for heating element		
	GEV No.	550362	Ref. No. —
	blind flange ø 64mm mounting ø 47.5mm		

immersion heating elements

with round flange ø47.5mm







GEV No.	418076	Ref. No.	2001120 2001121
description	heating element 2400W 230V heating circuits 1 mounting ø 47.5mm L 245mm W 33mm H 29mm round flange connection male faston 6.3mm immersion heater tube ø 6.5mm thermostat sleeves ø 6mm number of thermostat sleeves 1 length thermostat sleeves 210mm		
For models:	GS-1, GS-16, GS-18, GS-19, GS-2, GS-3, GS-4-2, GS-4-2AF, GS-5AF, GS-6, GS-6AF, GS-7, GS-8-2, GS-9		
spare parts for	418076		
	GEV No.	510408	Ref. No. 2514180
	O-ring EPDM thickness 5.34mm ID ø 47mm Qty 1 pcs		
accessories for	418076		
	GEV No.	510408	Ref. No. 2514180
	O-ring EPDM thickness 5.34mm ID ø 47mm Qty 1 pcs		
	GEV No.	510562	Ref. No. —
	O-ring silicone thickness 5.34mm ID ø 47mm Qty 1 pcs		
	GEV No.	520235	Ref. No. —
	3 hole flange hole distance 70.5mm perforation ø 6.5mm ID ø 53.5mm		
	GEV No.	520236	Ref. No. —
	flange for heating element ID ø 50mm ED ø 90mm hole ø 6.5mm 3 holes		
	GEV No.	550002	Ref. No. —
	tension strap H 10mm L 21mm W 10mm hole ø 6.5mm for heating element		
	GEV No.	550362	Ref. No. —
	blind flange ø 64mm mounting ø 47.5mm		





GEV No.	420546	Ref. No.	2001182
description	heating element 4500W 240V heating circuits 3 mounting ø 47.5mm L 285mm W 30mm H 35mm tube ø 6.5mm thermostat sleeves ø 6mm number of thermostat sleeves 1 thermostat sleeve 215		
For models:	A-1200, A-1200DI, A-1200DICV, A-1200ID, A-1200IDCV, A-1500-T, A-1500-TDI, A-1500-TDICV, A-1500-TID, A-1500-TIDCV, A-2160, A-2460-T, GS-100, GS-102, GS-19, GS-20, GS-43, GS-7, GS-82, GS-82M, GS-83H, GS-83M, GS-9		











GEV No.	420547	Ref. No.	2001188
description	heating element 6000W 254V heating circuits 3 mounting ø 47.5mm L 284mm W 30mm H 45mm cable length 2000mm tube ø 6.5mm L1 30mm L2 70mm L3 165mm thermostat sleeves ø 6mm number of thermostat sleeves 1		
For models:	A-1200, A-1500-T, A-2160, A-2460-T, GS-100, GS-102, GS-30, GS-82, GS-82M, GS-83H, GS-83M, GSP-45, GSP-46, MA-MC		

			
GEV No.	415493	Ref. No.	2001187
description	heating element 6600W 240V heating circuits 3 mounting \varnothing 47.5mm L 282mm W 35mm H 57mm round flange connection male faston 6.3mm immersion heater H1 35mm H2 22mm L1 20mm L2 52mm L3 210mm thermostat sleeves \varnothing 7mm number of thermostat sleeves 1 length thermostat sleeves 215mm thermostat sleeve eccentric, non clinging		
For models:	A-1200, A-1200DI, A-1200DICV, A-1200ID, A-1200IDCV, A-1500-T, A-1500-TDI, A-1500-TDICV, A-1500-TID, A-1500-TIDCV, A-2160, A-2460-T, A-2980-TDI, A-2980-TDICV, A-2980-TID, A-2980-TIDCV, GS-100, GS-102, GS-30, GS-82, GS-82M, GS-83H, GS-83M, GSP-45, GSP-46, MA-MC		
accessories for	415493		
	GEV No.	510562	Ref. No. —
	O-ring silicone thickness 5.34mm ID \varnothing 47mm Qty 1 pcs		
	GEV No.	520235	Ref. No. —
	3 hole flange hole distance 70.5mm perforation \varnothing 6.5mm ID \varnothing 53.5mm		
	GEV No.	520236	Ref. No. —
	flange for heating element ID \varnothing 50mm ED \varnothing 90mm hole \varnothing 6.5mm 3 holes		
	GEV No.	550002	Ref. No. —
	tension strap H 10mm L 21mm W 10mm hole \varnothing 6.5mm for heating element		
	GEV No.	550362	Ref. No. —
	blind flange \varnothing 64mm mounting \varnothing 47.5mm		

			
GEV No.	417743	Ref. No.	2001192
description	heating element 9000W 240V heating circuits 3 mounting \varnothing 47.5mm L 425mm W 25mm H 50mm round flange connection male faston 6.3mm tube \varnothing 6.5mm H1 30mm H2 20mm L1 30mm L2 70mm L3 325mm thermostat sleeves \varnothing 7.5mm number of thermostat sleeves 1 length thermostat sleeves 217mm		
For models:	A-2980-TDI, A-2980-TDICV, A-2980-TID, A-2980-TIDCV, GS-102, GS-83H, GS-83M, GSP-45, MA-MC		
spare parts for	417743		
	GEV No.	510408	Ref. No. 2514180
	O-ring EPDM thickness 5.34mm ID \varnothing 47mm Qty 1 pcs		

with round flange \varnothing 60.0mm			
			
GEV No.	418840	Ref. No.	2001232
description	heating element 4800W 240V heating circuits 3 mounting \varnothing 60mm L 295mm W 58mm tube \varnothing 6.3mm		
For models:	GS-19, GS-20, GS-30, GS-43, GS-7, GS-9		

			
GEV No.	420114	Ref. No.	240001
description	heating element 500W 230V heating circuits 1 L 365mm W 40mm thread M12x1 mounting distance 31.5mm tube \varnothing 8.5mm connection length 18mm immersion heater connection M4 for bain marie		
accessories for	420114		
	GEV No.	520229	Ref. No. —
	nut thread M12x1 H 4mm WS 16 zinc-coated steel Qty 1 pcs		
	GEV No.	521110	Ref. No. —
	flat gasket fibre ED \varnothing 20mm ID \varnothing 13mm thickness 2mm Qty 1 pcs		
	GEV No.	521131	Ref. No. —
	nut thread M12x1 H 3.5mm WS 17 SS Qty 1 pcs		

			
GEV No.	420115	Ref. No.	240002
description	heating element 750W 230V heating circuits 1 L 533mm W 40mm thread M12x1 mounting distance 31.5mm tube \varnothing 8.5mm connection length 18mm immersion heater connection M4 for bain marie		
accessories for	420115		
	GEV No.	520229	Ref. No. —
	nut thread M12x1 H 4mm WS 16 zinc-coated steel Qty 1 pcs		
	GEV No.	521110	Ref. No. —
	flat gasket fibre ED \varnothing 20mm ID \varnothing 13mm thickness 2mm Qty 1 pcs		
	GEV No.	521131	Ref. No. —
	nut thread M12x1 H 3.5mm WS 17 SS Qty 1 pcs		

accessories

sealing washers

O-rings

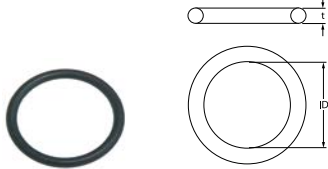
			
GEV No.	510408	Ref. No.	2514180
description	O-ring EPDM thickness 5.34mm ID \varnothing 47mm Qty 1 pcs		
For models:	A-1200, A-1200DI, A-1200DICV, A-1200ID, A-1200IDCV, A-1500-T, A-1500-TDI, A-1500-TDICV, A-1500-TID, A-1500-TIDCV, A-2160, A-2460-T, A-2980-TDI, A-2980-TDICV, A-2980-TID, A-2980-TIDCV, GS-1, GS-100, GS-102, GS-16, GS-18, GS-19, GS-2, GS-20, GS-3, GS-30, GS-4-2, GS-4-2AF, GS-43, GS-5AF, GS-6, GS-6AF, GS-7, GS-80, GS-82, GS-8-2, GS-82M, GS-83H, GS-83M, GS-9, GSP-45, GSP-46, MA-MC		

hot plates

round

with radiused edge

for domestic and commercial kitchens



1

GEV No.	490016	Ref. No.	240023
description	hot plate ø 180mm 2000W 230V connection 4 screw clamps with 8mm spill ring		



1

GEV No.	490020	Ref. No.	240044	
description	hot plate ø 220mm 2600W 230V connection 4 screw clamps with 8mm spill ring			
accessories for	490020			
	GEV No.	550796	Ref. No.	—
	fixing plate for hot plate ø220mm			

thermostats

control and safety thermostats

EGO

control thermostats

55.13_series



1

GEV No.	375527	Ref. No.	2006001 2006005
description	thermostat t.max. 200°C temperature range 60-200°C 1-pole 1NO 16A probe ø 6mm probe L 77mm capillary pipe 870mm capillary pipe isolatedmm gland nut M9x1 shaft L 23mm shaft position upper rotation 270°		



1

GEV No.	375505	Ref. No.	2006061
description	thermostat t.max. 320°C temperature range 50-320°C 1-pole 1NO 16A probe ø 3mm probe L 160mm capillary pipe 870mm capillary pipe isolatedmm gland nut shaft ø 6x4.6mm shaft L 23mm shaft position upper rotation 270°		
For models:	A-1500-T, A-1500-TDI, A-1500-TDICV, A-1500-TID, A-1500-TIDCV, A-2460-T, A-2980-TDI, A-2980-TDICV, A-2980-TID, A-2980-TIDCV, MA-MC		



1

GEV No.	375526	Ref. No.	2006053
description	thermostat t.max. 93°C temperature range 31-93°C 1-pole 1CO 16A probe ø 6mm probe L 98mm capillary pipe 2380mm capillary pipe isolatedmm gland nut M9x1 shaft L 23mm shaft position upper rotation 270°		
For models:	A-1200, A-1200DI, A-1200DICV, A-1200ID, A-1200IDCV, A-1500-T, A-1500-TDI, A-1500-TDICV, A-1500-TID, A-1500-TIDCV, A-2160, A-2460-T, A-2980-TDI, A-2980-TDICV, A-2980-TID, A-2980-TIDCV, GS-1, GS-100, GS-102, GS-16, GS-18, GS-19, GS-2, GS-20, GS-3, GS-30, GS-4-2, GS-4-2AF, GS-5AF, GS-6, GS-6AF, GS-7, GS-80, GS-82, GS-8-2, GS-82M, GS-83H, GS-83M, GS-9, GSP-45, GSP-46, MA-MC		

safety thermostats

55.13_series



1

GEV No.	375214	Ref. No.	2006062
description	safety thermostat switch-off temp. 140°C 1-pole 16A probe ø 6mm probe L 77mm capillary pipe 1540mm capillary pipe isolated 1350mm gland nut probe SS		
For models:	A-1200, A-1200DI, A-1200DICV, A-1200ID, A-1200IDCV, A-1500-T, A-1500-TDI, A-1500-TDICV, A-1500-TID, A-1500-TIDCV, A-2160, A-2460-T, A-2980-TDI, A-2980-TDICV, A-2980-TID, A-2980-TIDCV, GS-1, GS-100, GS-102, GS-16, GS-18, GS-19, GS-2, GS-20, GS-30, GS-5AF, GS-6, GS-6AF, GS-7, GS-82, GS-82M, GS-83H, GS-83M, GSP-45, GSP-46, MA-MC		



accessories

gland nut accessories

ducts

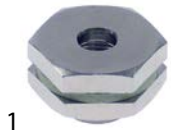

1

GEV No.	551229	Ref. No.	2037051
description	gland duct ET M14x1 IT M9x1 probe ø max. 7mm WS 22 FIBER SS L 15mm		
For models:	A-1200, A-1200DI, A-1200DICV, A-1200ID, A-1200IDCV, A-1500-T, A-1500-TDI, A-1500-TDICV, A-1500-TID, A-1500-TIDCV, A-2160, A-2460-T, A-2980-TDI, A-2980-TDICV, A-2980-TID, A-2980-TIDCV, GS-100, GS-102, GS-18, GS-19, GS-3, GS-4-2, GS-4-2AF, GS-6, GS-6AF, GS-80, GS-82, GS-8-2, GS-82M, GSP-46, MA-MC		

washers with slot



1

GEV No.	510241	Ref. No.	1502060
description	washer with slot ED ø 7.8mm slit width 1.3mm Qty 10		
For models:	A-1500-T, A-2460-T, MA-MC		

gaskets





1

GEV No.	510655	Ref. No.	2519002
description	gasket silicone ø 7.8mm L 5mm blue Shore 55° Qty 10 pcs		
For models:	A-1500-T, A-2460-T, MA-MC		

bolts with slot



1

GEV No.	520243	Ref. No.	2037050	
description	bolt with slot thread M9x1 Qty 10 pcs nickel-plated brass			
For models:	A-1500-T, A-2460-T, GS-30, GS-43, MA-MC			
accessories for	520243			
	GEV No.	510591	Ref. No.	—
	description	washer with slot ED ø 8.8mm slit width 1.2mm Qty 10		
	GEV No.	510592	Ref. No.	—
	description	gasket ø 8x8.7mm Qty 10 pcs slotted silicone		

switches and momentary switches

rocker/momentary rocker switches

25.5x25mm



1

GEV No.	346869 ¹	Ref. No.	2002048 2002049	
description	rocker switch mounting measurements 25.5x25mm green 2NO 250V 16A illuminated main switch connection male faston 6.3mm ambient temperature max. 85°C protection IP40			
For models:	A-1200, A-1500-T, A-2160, A-2460-T, GS-100, GS-18, GS-19, GS-2, GS-20, GS-3, GS-6, GS-6AF, GS-7, GS-82, GS-82M			
accessories for	346869			
	GEV No.	301323	Ref. No.	—
	description	protective cover external size 35x35mm H 11mm transparent suitable for rocker switch mounting measurements 25.5x25mm L 35mm W 35mm		

¹illuminated

27.8x25mm



1

GEV No.	347868	Ref. No.	2003046
description	momentary rocker switch mounting measurements 27.8x25mm white 1NO/indicator light 250V 16A drain pump connection male faston 6.3mm ambient temperature max. 85°C protection IP40		
For models:	GS-18, GS-2		

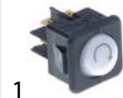

1

GEV No.	347173 ¹	Ref. No.	2003049
description	momentary rocker switch mounting measurements 27.8x25mm white 2NO 250V 16A illuminated programme connection male faston 6.3mm ambient temperature max. 85°C protection IP40		
For models:	A-1200, A-1500-T, A-2160, A-2460-T, GS-100, GS-18, GS-19, GS-2, GS-20, GS-3, GS-6, GS-6AF, GS-7, GS-82		

¹illuminated

1

GEV No.	510281	Ref. No.	4030009
description	blank black mounting measurements 27.8x25mm		
For models:	GS-18, GS-19, GS-2, GS-20, GS-3, GS-30, GS-43, GS-6, GS-6AF, GS-7		



push/momentary push switches

30x22mm



1

GEV No.	347024	Ref. No.	2003302
description	momentary push switch mounting measurements 30x22mm white 1NO/indicator light 250V 16A connection male faston 6.3mm ambient temperature max. 85/55°C protection IP40		
For models:	A-1200, A-1500-T, A-2160, A-2460-T, GS-102, GS-83H, GS-83M		



1

GEV No.	345235 ¹	Ref. No.	2002423
description	push switch mounting measurements 30x22mm green 2NO 250V 16A illuminated connection male faston 6.3mm ambient temperature max. 85°C protection IP40		
For models:	A-1200, A-1500-T, A-2160, A-2460-T, GS-1, GS-102, GS-16, GS-5AF, GS-83H, GS-83M, GSP-45, GSP-46		

¹illuminated

cam switches

on/off



1

GEV No.	301281	Ref. No.	2004051
description	cam switch 2 operating positions 2NO sequence 0-1 25A shaft \varnothing 6x4.6mm shaft L 23mm connection male faston 6.3mm plastic		
For models:	GS-18, GS-19, GS-30, GS-4-2, GS-4-2AF, GS-6, GS-6AF, GS-82, GS-8-2, GS-82M, GS-9		

4-position



1

GEV No.	300023	Ref. No.	240045
description	cam switch 4 operating positions 1NO/2CO sequence 0-1-2-3 16A shaft \varnothing 6x4.6mm shaft L 23mm connection screw 4-position ceramic		

rotary switches

accessories

levers



1

GEV No.	347866	Ref. No.	2016102
description	lever ON-OFF lever length 115mm L 90mm W 90mm shaft 8x8mm mounting distance 68mm		
For models:	A-2980-TDI, A-2980-TDICV, A-2980-TID, A-2980-TIDCV, MA-MC		

magnetic switches

29x19mm

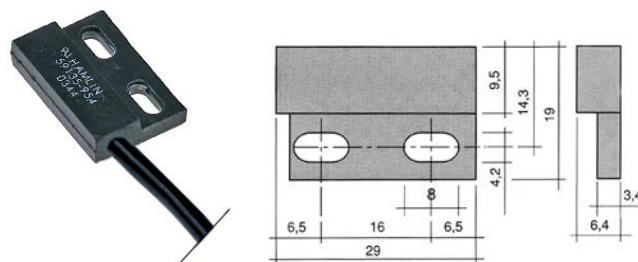

1

GEV No.	347025	Ref. No.	2019118 2019119
description	magnetic switch with holder L 29mm W 19mm 1NO 250V 0.04A P max. 10W cable length 1000mm		
For models:	GS-1, GS-16, GS-18, GS-19, GS-2, GS-20, GS-5AF, GS-6, GS-6AF, GS-7		
spare parts for	347025		
	GEV No.	345117	Ref. No. —
	magnetic switch L 28.5mm W 19mm 1NO 250V 0.04A P max. 10W connection cable cable length 1000mm		

36x13mm



1

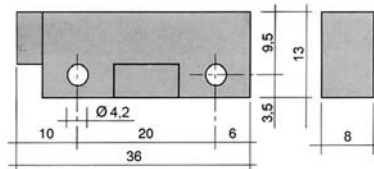

GEV No.	347867	Ref. No.	2019183
description	magnetic switch complete incl. holder L 29mm W 19mm 1NO 250V 0.4A P max. 100W connection cable cable length 1000mm STEM		
For models:	GS-102, GS-83H, GS-83M		
spare parts for	347867		
	GEV No.	345398	Ref. No. —
	magnet \varnothing mm L 36mm H 8mm W 13mm hole distance 20mm M3 hole \varnothing 3mm		



65x20mm

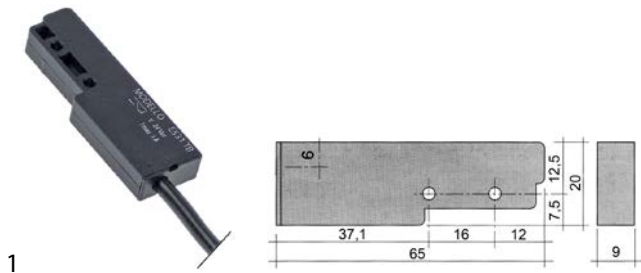

1

GEV No.	347911	Ref. No.	2019101
description	magnetic switch L 65mm W 20mm 1NO 24V 3A P max. 72W connection cable cable length 2000mm		
For models:	A-1200DI, A-1200DICV, A-1200ID, A-1200IDCV, A-1500-TDI, A-1500-TDICV, A-1500-TID, A-1500-TIDCV, A-2980-TDI, A-2980-TDICV, A-2980-TID, A-2980-TIDCV, MA-MC		

accessories

magnets

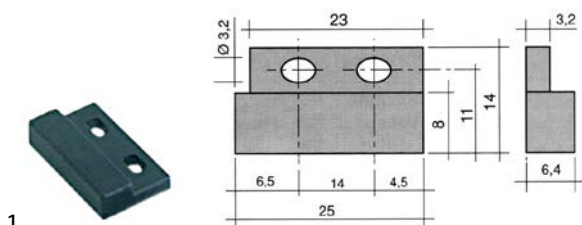

1

GEV No.	345432	Ref. No.	2019120
description	magnet ømm L 25mm H 6.4mm W 14mm hole distance 13mm M3 hole ø 3.2mm		
For models:	GS-1, GS-16, GS-18, GS-19, GS-2, GS-20, GS-5AF, GS-6, GS-6AF, GS-7		

lamps

indicator lights

indicator lights (complete)

ø13mm

with screw socket



1

GEV No.	357076	Ref. No.	240048
description	indicator light ø 13mm 400V green connection screw		



1

GEV No.	357077	Ref. No.	240049
description	indicator light ø 13mm 400V yellow connection screw		

26.5x25.6mm



1

GEV No.	358102	Ref. No.	2014030
description	indicator light mounting measurements 27.8x25mm green 220-250V connection male faston 6.3mm temp.-resist. 85°C		
For models:	GS-18, GS-19, GS-30, GS-43, GS-6, GS-6AF		



1

GEV No.	345796	Ref. No.	2014025 2014032
description	indicator light mounting measurements 27.8x25mm white 230V connection male faston 6.3mm		
For models:	GS-100, GS-18, GS-19, GS-2, GS-20, GS-3, GS-30, GS-4-2, GS-4-2AF, GS-43, GS-6, GS-6AF, GS-7, GS-82, GS-8-2, GS-82M, GS-9		



1

GEV No.	347869	Ref. No.	2014031
description	indicator light mounting measurements 27.8x25mm white 250V connection male faston 6.3mm type cycle		
For models:	GS-18, GS-19, GS-30, GS-43, GS-6, GS-6AF, GS-82, GS-82M		

30x22mm



1

GEV No.	357011	Ref. No.	2014146
description	indicator light mounting measurements 30x22mm 230V white connection male faston 6.3mm temp.-resist. 85°C type Marquardt 1667..		
For models:	A-1200, A-1500-T, A-2160, A-2460-T, GS-1, GS-102, GS-16, GS-5AF, GS-83H, GS-83M, GSP-45		

timers

programme timers



1

GEV No.	360430	Ref. No.	2005003 old
description	timer AKO-DIEHL 514 chambers 3 240V shaft \varnothing 6x4.6mm shaft L 13mm manuf. no. 514028		



1

GEV No.	360412	Ref. No.	2005003 2005103
description	timer CDC 11804 engines 1 chambers 4 operation time 120s 230V shaft \varnothing 6x4.6mm shaft L 23mm manuf. no. 11804F1PMD run-time 120s		
For models:	GS-1, GS-100, GS-16, GS-18, GS-19, GS-2, GS-20, GS-3, GS-30, GS-4-2, GS-4-2AF, GS-43, GS-5AF, GS-6, GS-6AF, GS-7, GS-80, GS-82, GS-8-2, GS-82M, GS-9, GSP-45, GSP-46		

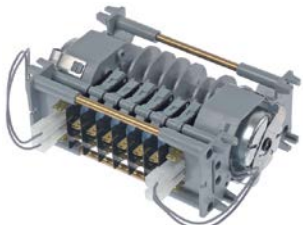

1

GEV No.	360561	Ref. No.	2005083
description	timer CDC 7806DV engines 2 chambers 6 operation time 6s / 2min 230V 50Hz shaft \varnothing mm shaft Lmm manuf. no. 7806DV motor type M37R/M37L voltage AC		
For models:	GS-102, GS-83H, GS-83M		



1

GEV No.	360764	Ref. No.	2005107
description	timer CROUZET 600 engines 1 chambers 3 operation time 20min 230V shaft \varnothing 6x4.6mm shaft L 13mm manuf. no. 2030/2555T7588233679		



1

GEV No.	360429	Ref. No.	2005007	
description	timer FIBER P25 engines 1 chambers 3 operation time 20min 230V shaft \varnothing mm shaft Lmm manuf. no. P255J03L193			
For models:	GS-18, GS-19, GS-2, GS-20, GS-3, GS-4-2, GS-4-2AF, GS-6, GS-6AF, GS-7, GS-8-2, GS-9			
spare parts for	360429			
	GEV No.	360673	Ref. No.	—
	motor kit pinion \varnothing 6.8mm teeth 15 230V voltage AC 50/60Hz turn direction clockwise motor \varnothing 48mm H 18.5mm motor type UDS-40NE1RNZ165 cable length 150mm with holder			

contactors

TELEMECANIQUE (Schneider Electric)

power contactors



1

GEV No.	380967	Ref. No.	2008321
description	power contactor resistive load 20A 230VAC (AC3/400V) 9A/4kW main contacts 3NO auxiliary contacts 1NO connection screw connection type LC1K0910M7		
For models:	GS-19, GS-20, GS-3, GS-30, GS-4-2, GS-4-2AF, GS-6, GS-6AF, GS-7, GS-8-2, GS-9		



1

GEV No.	380479	Ref. No.	2008325
description	power contactor resistive load 25A 230VAC (AC3/400V) 9A/4kW main contacts 3NO auxiliary contacts 1NO/1NC connection screw connection type LC1D09P7		
For models:	GS-100, GS-102, GS-43, GS-82, GS-82M, GS-83H, GS-83M, GSP-45, GSP-46		



relays

power relays

with male contacts

female contact 2.0mm

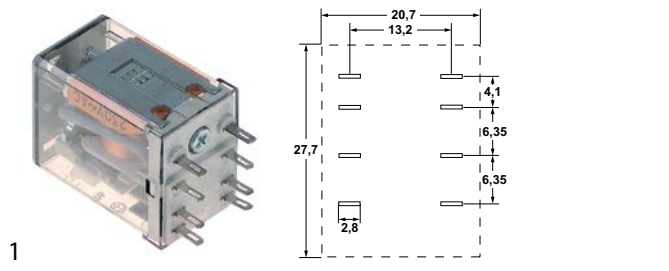

GEV No.	380377	Ref. No.	2054010
description	power relays FINDER 220-240VAC 10A 2CO connection F2 plug-in connection manuf. no. 55.32.8.230.0000 94.92.3 250V		
For models:	A-1200, A-1500-T, A-2160, A-2460-T, GS-102, GS-83H, GS-83M, GSP-45, GSP-46		
accessories for	380377		
	GEV No.	380341	Ref. No. —
	relay socket 4-pole contacts 12 300V voltage AC 6A Italiana Relè manuf. no. ZMD4		
	GEV No.	380378	Ref. No. —
	relay socket 2-pole 55/85 dimensions 70.5x30x27mm 250V voltage AC 10A FINDER manuf. no. 94.72		
	GEV No.	380384	Ref. No. —
	relay socket 2-pole contacts male faston 2.8mm 250V voltage AC 10A W 23mm for		
	GEV No.	380399	Ref. No. —
	relay socket 4-pole dimensions 76.2x27x86.1mm 250V voltage AC 1A FINDER manuf. no. 94.94.3		

plug-in/print relays

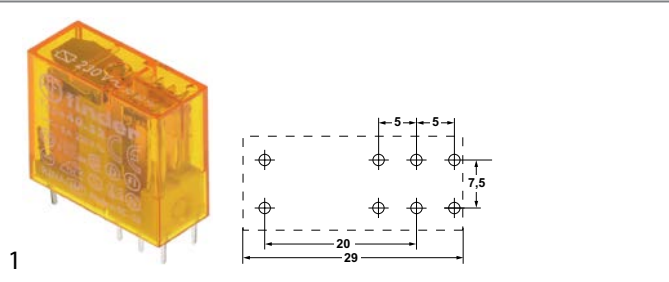

GEV No.	380333	Ref. No.	2054012
description	print relay 230VAC 2CO at 250V 8A connection pins raster size 5mm FINDER manuf. no. 40.52.8.230.0000 95.65/95.75		
For models:	GS-1, GS-16, GS-18, GS-19, GS-2, GS-20, GS-5AF, GS-6, GS-6AF, GS-7		
accessories for	380333		
	GEV No.	380340	Ref. No. —
	relay socket dimensions 62x36x15mm 250V voltage AC 10A Italiana Relè manuf. no. ZMEM/5		
	GEV No.	380505	Ref. No. —
	relay socket 2CO 40.52 dimensions 81.9x15.5x75mm 250V voltage AC 10A FINDER manuf. no. 95.95.3		
	GEV No.	381181	Ref. No. 2054013
	relay socket 2-pole 40.51/40.52/40.61 connection screw clamp dimensions 15.8x78.6mm 250V voltage AC 10A FINDER manuf. no. 95.75		

relay sockets

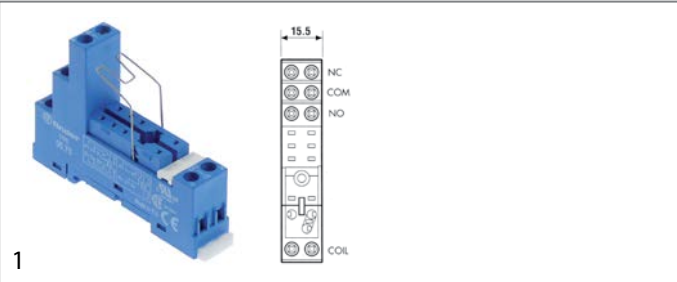

GEV No.	381181	Ref. No.	2054013
description	relay socket 2-pole 40.51/40.52/40.61 connection screw clamp dimensions 15.8x78.6mm 250V voltage AC 10A FINDER manuf. no. 95.75		
For models:	GS-16, GS-18, GS-19, GS-2, GS-20, GS-5AF, GS-6, GS-6AF, GS-7		
accessories for	381181		
	GEV No.	381455	Ref. No. —
	support bracket		

time relays

time relays

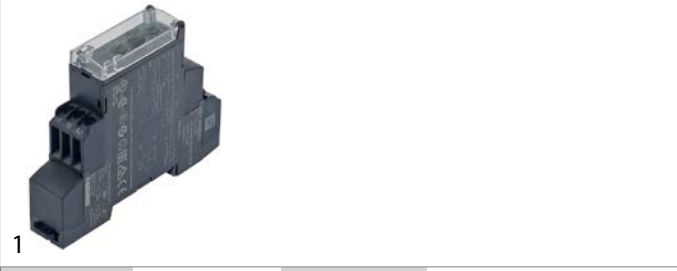

GEV No.	360554	Ref. No.	2054101
description	time relay TELEMECANIQUE RE17RMMU time range 0.1s-100h 24-240VAC/24VDC 8A mounting measurements DIN railmm 1CO connection screw connection		
For models:	A-1200, A-1200DI, A-1200DICV, A-1200ID, A-1200IDCV, A-1500-T, A-1500-TDI, A-1500-TDICV, A-1500-TID, A-1500-TIDCV, A-2160, A-2460-T, A-2980-TDI, A-2980-TDICV, A-2980-TID, A-2980-TIDCV, GS-18, GS-19, GS-2, GS-20, GS-43, GS-6, GS-6AF, GS-7, GS-83H, GS-83M, GSP-45, GSP-46, MA-MC		

probes

producer-specific probes

probes

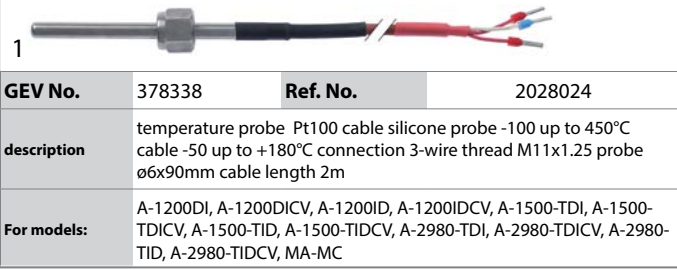

GEV No.	378338	Ref. No.	2028024
description	temperature probe Pt100 cable silicone probe -100 up to 450°C cable -50 up to +180°C connection 3-wire thread M11x1.25 probe ø6x90mm cable length 2m		
For models:	A-1200DI, A-1200DICV, A-1200ID, A-1200IDCV, A-1500-TDI, A-1500-TDICV, A-1500-TID, A-1500-TIDCV, A-2980-TDI, A-2980-TDICV, A-2980-TID, A-2980-TIDCV, MA-MC		



solenoid valves

solenoid valves (water)

ROBERTSHAW/INVENSYS

medium temperature: 90°C 90°C 60°C

ambient temperature: 60°C 25°C 60°C

duty cycle: 40% 100% 100%

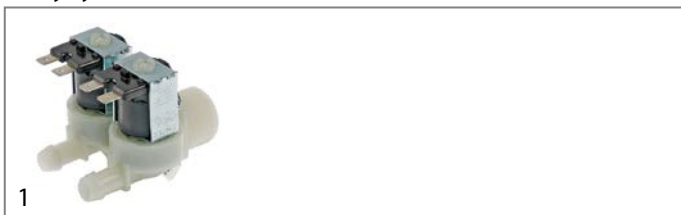

1

GEV No.	372021	Ref. No.	2017022
description	solenoid valve double straight 230VAC inlet 3/4" outlet 11.5mm DN10 EATON (INVENSYS)		
For models:	A-1200, A-1500-T, A-2160, A-2460-T, GS-100, GS-102, GS-18, GS-19, GS-2, GS-20, GS-3, GS-4-2, GS-4-2AF, GS-6, GS-6AF, GS-7, GS-82, GS-8-2, GS-83H, GS-9, GSP-45, MA-MC		



1

GEV No.	370724	Ref. No.	2017024
description	solenoid valve double straight 24VAC inlet 3/4" outlet 11.5mm DN10 t.max. 90°C Invensys plastic		
For models:	A-1200DI, A-1200DICV, A-1200ID, A-1200IDCV, A-1500-TDI, A-1500-TDICV, A-1500-TID, A-1500-TIDCV, A-2980-TDI, A-2980-TDICV, A-2980-TID, A-2980-TIDCV, MA-MC		



1

GEV No.	372017	Ref. No.	2017007
description	solenoid valve single straight 230VAC inlet 3/4" outlet 11.5mm DN10 EATON (INVENSYS)		
For models:	A-2160, A-2460-T, GS-100, GS-102, GS-18, GS-19, GS-2, GS-20, GS-3, GS-30, GS-4-2, GS-4-2AF, GS-6, GS-6AF, GS-7, GS-82, GS-8-2, GS-82M, GS-83H, GS-83M, GS-9, GSP-45, GSP-46		



1

GEV No.	370723	Ref. No.	2017010
description	solenoid valve single straight 24VAC/DC inlet 3/4" outlet 11.5mm DN10 Invensys plastic		
For models:	A-2160, A-2460-T, A-2980-TDI, A-2980-TDICV, A-2980-TID, A-2980-TIDCV, MA-MC		

spare parts and accessories

reducers

outlet side



1

GEV No.	371327	Ref. No.	1026001
description	reducer Invensys ø 8mm mounting measurements 8mm dark blue		
For models:	GS-18, GS-19, GS-2, GS-20, GS-3, GS-4-2, GS-4-2AF, GS-6, GS-6AF, GS-7, GS-8-2, GS-9		

pressure switches

for warewashing

ø 58mm with male faston 6.3mm

with connection horizontal



1

GEV No.	541911	Ref. No.	2007004
description	pressure control pressure range 108/78mbar connection 6mm ø 58mm pressure connection horizontal warewashing pressure connection ø 6mm		
For models:	A-2160, A-2460-T, A-2980-TDI, A-2980-TDICV, A-2980-TID, A-2980-TIDCV, MA-MC		



1

GEV No.	541569	Ref. No.	2007001
description	pressure control pressure range 35/15mbar connection 6mm ø 58mm pressure connection horizontal warewashing		
For models:	GS-1, GS-100, GS-16, GS-18, GS-19, GS-2, GS-20, GS-3, GS-30, GS-4-2, GS-4-2AF, GS-5AF, GS-6, GS-6AF, GS-7, GS-82, GS-8-2, GS-82M, GS-9		



ø 84mm with coded plug



GEV No.	541990	Ref. No.	2007106
description	pressure control 2 pressure ranges pressure range 62/20 105/25mbar connection 6mm ø 84mm pressure connection horizontal warewashing suitable for JEMI pressure connection ø 6mm		
For models:	A-1200DI, A-1200DICV, A-1200ID, A-1200IDCV, A-1500-TDI, A-1500-TDICV, A-1500-TID, A-1500-TIDCV, A-2980-TDI, A-2980-TDICV, A-2980-TID, A-2980-TIDCV		



GEV No.	541910	Ref. No.	2007006
description	pressure control pressure range 62/25 - 90/50mbar connection coded plug ø 84mm pressure connection horizontal warewashing suitable for JEMI pressure connection ø 6mm		
For models:	A-1200, A-1500-T, A-2160, A-2460-T, MA-MC		

compressors

accessories

starting relays

miscellaneous



GEV No.	381177	Ref. No.	2042010
description	start relay AL6S/5A 230V voltage AC 5A		
For models:	GS-18, GS-6, GS-6AF		

pumps





wash and rinse pumps

FIR

pumps



GEV No.	500948	Ref. No.	2011003
description	pump inlet ø 28mm outlet ø 26mm type 2214.1600 230V 50Hz 1 phase 0.11kW 0.15HP L 197mm rotation direction right capacitor 6.3µF FIR		
For models:	GS-1, GS-2, GS-3		

spare parts for	500948			
	GEV No.	365012	Ref. No.	2013002
	operating capacitor capacity 6.3µF 450V tolerance 5% 50Hz ambient temperature max. -25 to +85°C ø 30mm L 61mm M8 plastic connection male faston 6.3mm protection			
	GEV No.	510510	Ref. No.	—
	pump cover pump type 2212/2228/2229/2211			
	GEV No.	510695	Ref. No.	—
	mechanical shaft seal height counter ring 5.5mm ID ø 11mm			
	GEV No.	521203	Ref. No.	—
	impellor ø 72mm H 18mm thread M7 shaft ø 11mm shaft length 32mm blades 3			
	GEV No.	521703	Ref. No.	—
	pump cover gasket EPDM thickness 2.5mm ID ø 75mm Qty 1 pcs			



1

GEV No.	501401	Ref. No.	2011002
description	pump inlet ø 45mm outlet ø 40mm type 5283 230V 50Hz 1 phase 0.37kW L 205mm FIR		
For models:	GS-4-2, GS-5AF, GS-6, GS-6AF		
spare parts for	501401		
	GEV No.	365014	Ref. No. —
	operating capacitor capacity 12.5µF 450V tolerance 5%Hz ambient temperature max. -25 to +85°C ø 35mm L 70mm M8 plastic connection male faston 6.3mm 45S.C3DS.12.5 protection		
	GEV No.	510608	Ref. No. —
	impellor ø 93mm H 32mm shaft intake ø 9/8mm blades 6 inner high 11mm		
	GEV No.	510692	Ref. No. 2041003
	mechanical shaft seal for shaft ø 11mm slide ring ext. ø 24mm slide ring H 13mm counter ring mounting ø 26mm height counter ring 8mm counter ring int. ø 14mm		
	GEV No.	521506	Ref. No. —
	pump cover FIR inlet ø 45mm outlet ø 40mm turn direction right ø 160mm ID ø 125mm inner high 25mm		
	GEV No.	521702	Ref. No. 2514600
	pump cover gasket thickness 3.5x4.5mm Qty 1 pcs		







1

GEV No.	501400	Ref. No.	2011008
description	pump inlet ø 45mm outlet ø 40mm type B206.1500 230V 50Hz 1 phase 0.55kW L 235mm FIR		
For models:	GS-18, GS-19, GS-7, GS-8-2		
spare parts for	501400		
	GEV No.	365014	Ref. No. —
	operating capacitor capacity 12.5µF 450V tolerance 5%Hz ambient temperature max. -25 to +85°C ø 35mm L 70mm M8 plastic connection male faston 6.3mm 45S.C3DS.12.5 protection		
	GEV No.	510508	Ref. No. —
	pump cover FIR inlet ø 45mm outlet ø 40mm pump type PU 0.5/3911 turn direction right ø 160mm ID ø 125mm inner high 25mm		
	GEV No.	510600	Ref. No. 4042003
	impellor ø 102mm H 29mm shaft intake ø 9/8mm rotation direction right blades 6		
	GEV No.	510692	Ref. No. 2041003
	mechanical shaft seal for shaft ø 11mm slide ring ext. ø 24mm slide ring H 13mm counter ring mounting ø 26mm height counter ring 8mm counter ring int. ø 14mm		
	GEV No.	521023	Ref. No. —
	fanwheel cover ED ø 150mm H 70mm for wash pump		
	GEV No.	521702	Ref. No. 2514600
	pump cover gasket thickness 3.5x4.5mm Qty 1 pcs		







1

GEV No.	499231	Ref. No.	2011125
description	pump inlet ø 60mm outlet ø 50mm type 2233A2350 230V 50Hz 1 phase 0.75kW L 255mm rotation direction right capacitor 16µF FIR inlet ø 60mm outlet ø 50mm		
For models:	GS-20		
spare parts for	499231		
	GEV No.	365021	Ref. No. —
	operating capacitor capacity 16µF 425V tolerance 5% 50/60Hz ambient temperature max. -25 to +85°C ø 35mm L 73mm single M8 plastic connection male faston 6.3mm 416.10.99 protection		
	GEV No.	510529	Ref. No. —
	impeller ø 103mm H 30mm shaft intake ø 9/8mm rotation direction right blades 6		
	GEV No.	510552	Ref. No. —
	pump cover gasket pump type 1292-2/3942/3981/3911/3983		
	GEV No.	510692	Ref. No. 2041003
	mechanical shaft seal for shaft ø 11mm slide ring ext. ø 24mm slide ring H 13mm counter ring mounting ø 26mm height counter ring 8mm counter ring int. ø 14mm		
	GEV No.	521512	Ref. No. —
	pump cover FIR inlet ø 60mm outlet ø 50mm		

LGB



1

GEV No.	500586	Ref. No.	2011004
description	pump inlet ø 45mm outlet ø 39mm type FM4023SX 230V 50Hz 1 phase 0.8kW 1.09HP L 297mm rotation direction right capacitor 16µF LGB		
For models:	GS-19, GS-9		
spare parts for	500586		
	GEV No.	365021	Ref. No. —
	operating capacitor capacity 16µF 425V tolerance 5% 50/60Hz ambient temperature max. -25 to +85°C ø 35mm L 73mm single M8 plastic connection male faston 6.3mm 416.10.99 protection		
	GEV No.	510703	Ref. No. —
	mechanical shaft seal for shaft ø 13mm slide ring H 13mm height counter ring 5.5mm ED ø 26mm		
	GEV No.	521246	Ref. No. —
	impeller ø 103mm H 26mm thread M8L shaft ø 20mm shaft length 7mm seat ø 8.2mm blades 6		
	GEV No.	521542	Ref. No. —
	pump cover LGB inlet ø 45mm outlet ø 40mm auxiliary pressure connection 13mm supporting pressure open ø 150mm ID ø 120mm inner height 25mm		
	GEV No.	521714	Ref. No. —
	pump cover gasket thickness 4x4mm Qty 1 pcs		

drain pumps

HANNING



1

GEV No.	500573	Ref. No.	2030002
description	drain pump 30W 4-piece 230V inlet ø 24/30mm outlet ø 24mm 50Hz HANNING type DPS25-032 1x pump, 3x pump cover		
For models:	GS-18, GS-19, GS-2, GS-20, GS-3, GS-4-2, GS-4-2AF, GS-6, GS-6AF, GS-7, GS-8-2, GS-9		



service kits



GEV No.	500573	Ref. No.	2030002
description	drain pump 30W 4-piece 230V inlet ø 24/30mm outlet ø 24mm 50Hz HANNING type DPS25-032 1x pump, 3x pump cover		
For models:	GS-18, GS-19, GS-2, GS-20, GS-3, GS-4-2, GS-4-2AF, GS-6, GS-6AF, GS-7, GS-8-2, GS-9		

booster pumps II

accessories



GEV No.	365012	Ref. No.	2013002
description	operating capacitor capacity 6.3µF 450V tolerance 5% 50Hz ambient temperature max. -25 to +85°C ø 30mm L 61mm M8 plastic connection male faston 6.3mm protection		
For models:	GS-1, GS-2, GS-3		

accessories

pump cover gaskets



GEV No.	521063	Ref. No.	2514380
description	pump cover gasket		
For models:	A-1200, A-1200DI, A-1200DICV, A-1200ID, A-1200IDCV, A-1500-T, A-1500-TDI, A-1500-TDICV, A-1500-TID, A-1500-TIDCV, A-2160, A-2460-T, A-2980-TDI, A-2980-TDICV, A-2980-TID, A-2980-TIDCV, GS-100, GS-102, GS-30, GS-43, GS-82, GS-82M, GS-83H, GS-83M		

condensators & interference suppression filters

operating capacitors

plastic



GEV No.	365150	Ref. No.	2013003
description	operating capacitor capacity 20µF 425V tolerance 5% 50Hz ambient temperature max. -25 to +85°C ø 40mm L 70mm M8 plastic connection male faston 6.3mm 416.10.25 protection		
For models:	GS-18, GS-9		



GEV No.	365012	Ref. No.	2013002
description	operating capacitor capacity 6.3µF 450V tolerance 5% 50Hz ambient temperature max. -25 to +85°C ø 30mm L 61mm M8 plastic connection male faston 6.3mm protection		
For models:	GS-1, GS-2, GS-3		

gas taps

PEL

21S series









GEV No.	106523	Ref. No.	998026	
description	gas tap PEL type 21S gas inlet M16x1.5 (tube ø 10mm) bypass nozzle ø 0mm gas outlet M16x1.5 (tube ø 10/8mm) thermocouple connection M8x1 pilot connection M10x1 shaft ø 8x6.5mm shaft L 22/15mm shaft flat left			
spare parts for	106523			
	GEV No.	101060	Ref. No.	—
	magnet unit standard L 39mm D1 ø 15.4mm D2 ø 11mm suitable for PEL20-21/JUNKERS/EGA			
	GEV No.	101206	Ref. No.	—
	gas tap front part shaft ø 8x6.5mm shaft L 22/15mm shaft flat upper/lower suitable for PEL21			
	GEV No.	101231	Ref. No.	—
	thermocouple nut T1: M9x1 T2: M18x1			
	GEV No.	106202	Ref. No.	—
	bypass nozzle type PEL20/21 bore ø 0mm thread M5x0.5			

Table continues overleaf

accessories for		106523		
	GEV No.	100908	Ref. No.	—
union screw thread M10x1 for pipe ø 4mm Qty 1 pcs				
	GEV No.	100909	Ref. No.	—
union screw thread M10x1 for pipe ø 6mm Qty 1 pcs				
	GEV No.	101246	Ref. No.	—
olive for pipe ø 4mm Qty 1 pcs				
	GEV No.	101278	Ref. No.	—
olive for pipe ø 10mm Qty 1 pcs				
	GEV No.	101286	Ref. No.	—
olive ID ø 6mm Qty 1 pcs				
	GEV No.	101300	Ref. No.	—
union nut thread M16x1.5 tube ø 10mm				
	GEV No.	101450	Ref. No.	—
olive for pipe ø 8mm L 12.7mm Qty 1 pcs ED ø 10mm				
	GEV No.	101451	Ref. No.	—
union nut thread M16x1.5 tube ø 8mm				
	GEV No.	110081	Ref. No.	—
knob ø 70mm shaft ø 8x6.5mm shaft flat universal				
	GEV No.	112206	Ref. No.	—
knob dial plate silver gas tap PEL21/22/23 t.max.°C ED ø 63mm ID ø 45.5mm				

GAI











	1		
GEV No.	106565	Ref. No.	998132
description	gas tap GAI gas inlet pipe flange ø30mm gas outlet 3/8" (tube ø 10mm) thermocouple connection M9x1 pilot connection M10x1 shaft ø 10x8mm shaft L 39/15mm shaft flat right		

	1		
GEV No.	106506	Ref. No.	508005
description	gas tap GAI type G-1 ADB gas inlet pipe flange ø23mm bypass nozzle ø 0mm gas outlet 3/8" (tube ø 5mm) thermocouple connection 2x M8x1 pilot connection shaft ø 8x6.5mm shaft L 36/12mm shaft flat upper		

	1		
GEV No.	106855	Ref. No.	578007
description	gas tap GAI type G-1 ASB-D gas inlet pipe flange ø23mm gas outlet M16x1.25 / M7x0.75 front fixing thermocouple connection M8x1 pilot connection shaft ø 8x6.5mm shaft L 36/12mm shaft flat upper tube ø 8mm		

gas thermostats

PEL

25ST series				
	1			
GEV No.	101332	Ref. No.	998130	
description	gas thermostat PEL type 25ST 120-320°C gas inlet M16x1.5 (tube ø 10mm) bypass nozzle ø 0mm gas outlet M16x1.5 (tube ø 10/8mm) thermocouple connection M9x1 pilot connection M10x1 capillary pipe 1200mm probe ø 6mm probe L 100mm shaft ø 8x6.5mm shaft L 21/15mm shaft flat upper			
accessories for	101332			
	GEV No.	101060	Ref. No.	—
magnet unit standard L 39mm D1 ø 15.4mm D2 ø 11mm suitable for PEL20-21/JUNKERS/EGA				
	GEV No.	106191	Ref. No.	—
bypass nozzle type PEL22 bore ø 0mm thread M6x0.5				
	GEV No.	106200	Ref. No.	—
nut thread M9x1 suitable for PEL 24/25S				
accessories for	101332			
	GEV No.	101278	Ref. No.	—
olive for pipe ø 10mm Qty 1 pcs				
	GEV No.	101300	Ref. No.	—
union nut thread M16x1.5 tube ø 10mm				
	GEV No.	101450	Ref. No.	—
olive for pipe ø 8mm L 12.7mm Qty 1 pcs ED ø 10mm				
	GEV No.	101451	Ref. No.	—
union nut thread M16x1.5 tube ø 8mm				
	GEV No.	110079	Ref. No.	—
knob dial plate gas thermostat 1-8 silver				
	GEV No.	110081	Ref. No.	—
knob ø 70mm shaft ø 8x6.5mm shaft flat universal				



gas valves and ignition boxes







gas control valves

SIT

NOVASIT



1

GEV No.	101187	Ref. No.	998161
description	gas valve SIT series Novasit 820 0.17VHz gas inlet 1/2" gas outlet 1/2" thermocouple connection M9x1 pilot connection M10x1 ignition pressure bar pressure range 5-50mbar pressure regulator connection blind equiv. no. 0.820.301 supply Operator millivolt		
spare parts for	101187		
	GEV No.	101065	Ref. No. —
	magnet unit with cable L 44mm D1 ø 30mm D2 ø 20mm suitable for NOVASIT		
accessories for	101187		
	GEV No.	100110	Ref. No. —
	pilot burner SIT type 190 series 3 flames nozzle ømm gas connectionmm		
	GEV No.	101305	Ref. No. —
	gas connection straight 1/2" flange 45x45mm ELETTROSIT/V4400/4600/4605 suitable for SIT/HONEYWELL hole distance 36x36mm		
	GEV No.	101306	Ref. No. —
	gas connection angled flange 45x45mm hole distance 36x36mm 1/2" ELETTROSIT/V4400/4600/4605 screw with O-ring suitable for SIT/HONEYWELL		
	GEV No.	101307	Ref. No. —
	gas connection straight flange 45x45mm hole distance 36x36mm 3/4" ELETTROSIT/V4400/4600/4605 screw with O-ring suitable for SIT/HONEYWELL		
	GEV No.	101308	Ref. No. —
	gas connection angled flange 45x45mm hole distance 36x36mm 3/4" ELETTROSIT/V4400/4600/4605 screw with O-ring suitable for SIT/HONEYWELL		
	GEV No.	102116	Ref. No. —
	thermopile ROBERTSHAW L 900mm probe ø 9mm probe L 57mm 250-750mV screw connection 7/16"		

ignition parts

pilot burners

SIT

100 series



1















GEV No.	106906	Ref. No.	998137 998142
description	pilot burner SIT type 100 series 3 flames nozzle ø 0.2mm gas connection 6mm		
spare parts for	106906		
	GEV No.	100245	Ref. No. —
	pilot burner nozzle LPG code 20 bore ø 0.2mm Qty 1 pcs thread M8x0.75		
	GEV No.	100855	Ref. No. —
	pilot burner bracket triple		
	GEV No.	100885	Ref. No. —
	air mixing sleeve for pilot burner Qty 1 pcs		
	GEV No.	100916	Ref. No. —
	compression spring for pilot burner Qty 1 pcs		
	GEV No.	100917	Ref. No. —
	gasket for pilot burner Qty 1 pcs aluminium		
	GEV No.	100918	Ref. No. —
	screw for pilot burner		
	GEV No.	107162	Ref. No. —
	pilot burner cap SIT 3 flames Hmm Lmm Qty 1 pcs		
	GEV No.	107701	Ref. No. —
	pilot burner bottom part SIT 100 series nozzle ø 0.2mm		
accessories for	106906		
	GEV No.	100245	Ref. No. —
	pilot burner nozzle LPG code 20 bore ø 0.2mm Qty 1 pcs thread M8x0.75		
	GEV No.	100246	Ref. No. —
	pilot burner nozzle natural gas bore ø 0.35mm Qty 1 pcs thread M8x0.75		
	GEV No.	100904	Ref. No. —
	locking screw M10x1 for pipe ø 4mm Qty 1 pcs		
	GEV No.	100905	Ref. No. —
	locking screw M10x1 for pipe ø 6mm Qty 1 pcs		
	GEV No.	102110	Ref. No. —
	pilot tube copper pipe ø 4mm thickness 1mm L 3000mm		
	GEV No.	102111	Ref. No. —
	pilot tube copper pipe ø 6mm thickness 1mm L 3000mm		

Table continues overleaf

accessories for 106906				
	GEV No.	107171	Ref. No.	—
pilot burner nozzle SIT natural/liquid gas bore ø 0.25mm Qty 1 pcs				
	GEV No.	107700	Ref. No.	—
pilot burner bottom part SIT 100 series nozzle ø 0.25mm				
	GEV No.	107702	Ref. No.	—
pilot burner bottom part SIT 100 series nozzle ø 0.35mm				

160 series

				
GEV No.	100056	Ref. No.	998166	
description	pilot burner SIT type 160 series 3 flames nozzle ømm gas connecti- onmm			
spare parts for 100056				
	GEV No.	100907	Ref. No.	—
screw connection thread M10x1 Qty 1 pcs type SEF 1 ømm for thermocouple				
accessories for 100056				
	GEV No.	100202	Ref. No.	—
pilot burner nozzle natural gas code 41 Qty 1 pcs nozzle ø 0.41mm				
	GEV No.	100203	Ref. No.	—
pilot burner nozzle LPG code 25 Qty 1 pcs nozzle ø 0.25mm				
	GEV No.	100701	Ref. No.	—
ignition electrode connection M4 Qty 1 pcs				
	GEV No.	100801	Ref. No.	—
gasket for pilot burner Qty 1 pcs				
	GEV No.	100869	Ref. No.	—
pilot burner nozzle natural gas code 51 Qty 1 pcs suitable for 160 series nozzle ø 0.51mm				
	GEV No.	100870	Ref. No.	997048
olive for pipe ø 4mm Qty 1 pcs suitable for 160 series for pilot burner				
	GEV No.	100906	Ref. No.	—
screw connection thread M10x1 for ignition electrode brass Qty 1 pcs WS 10				
	GEV No.	100908	Ref. No.	—
union screw thread M10x1 for pipe ø 4mm Qty 1 pcs				
	GEV No.	100909	Ref. No.	—
union screw thread M10x1 for pipe ø 6mm Qty 1 pcs				
	GEV No.	101287	Ref. No.	—
olive for pipe ø 6mm Qty 1 pcs				
	GEV No.	102110	Ref. No.	—
pilot tube copper pipe ø 4mm thickness 1mm L 3000mm				
	GEV No.	102111	Ref. No.	—
pilot tube copper pipe ø 6mm thickness 1mm L 3000mm				

accessories for 100056				
	GEV No.	107650	Ref. No.	—
pilot burner nozzle SIT LPG code 30 Qty 1 pcs				

producer-specific pilot burners

JEMI

				
GEV No.	106511	Ref. No.	998141	
description	pilot burner 1 flame LPG code 0.2			

				
GEV No.	106513	Ref. No.	990040	
description	pilot burner 1 flame LPG code 0.2 M4x0.5			

				
GEV No.	106509	Ref. No.	998177	
description	pilot burner 1 flame natural gas code 0.4			

				
GEV No.	106512	Ref. No.	990084	
description	pilot burner 1 flame natural gas code 0.4			

1

GEV No.	106507	Ref. No.	090036
description	pilot burner SIT type 100 series 3 flames LPG nozzle ϕ 0.21mm gas connection 4mm		



1

GEV No.	106508	Ref. No.	090037
description	pilot burner SIT type 100 series 3 flames LPG nozzle ϕ 0.21mm gas connection 4mm		

electrodes



1

GEV No.	106505	Ref. No.	210067
description	ignition electrode D1 ϕ 7mm D2 ϕ 8.5mm connection male faston 2.8mm L1 16mm BL1 18mm BL2 3mm BL3 23mm to clip		

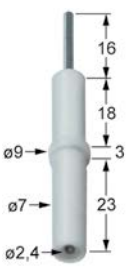

1

GEV No.	102330	Ref. No.	210202
description	ignition electrode D1 ϕ 7mm D2 ϕ 9mm L1 16mm BL1 18mm BL2 3mm BL3 23mm to clip connection ϕ 2.4mm		

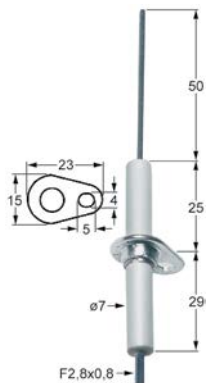

1

GEV No.	100711	Ref. No.	210003
description	ignition electrode flange length 23mm flange width 15mm D1 ϕ 7mm L1 50mm BL1 25mm BL2 29mm connection F 2.8x0.8mm fixing dimensions ϕ 5x4mm with flange		

ignition cables

pre-assembled cables



1



GEV No.	100014	Ref. No.	241116
description	ignition cable cable length 300mm connection ϕ 2.4mm / ϕ 2.4mm		

piezoelectric igniters

mounting diameter 18mm



1

GEV No.	100009	Ref. No.	210075	
description	piezoelectric igniter body plastic blowing mounting ϕ 18mm connection ϕ 2.4mm front measurements 26mm M18x1.5			
accessories for	100009			
	GEV No.	101339	Ref. No.	—
	cover cap for piezoelectric igniter			
	GEV No.	106869	Ref. No.	—
	cover cap for piezoelectric igniter ID ϕ 22mm ED ϕ 35mm H 25mm			
	GEV No.	107931	Ref. No.	—
	cover cap for piezoelectric igniter ID ϕ 21mm ED ϕ 36mm			



thermocouples

plug-in thermocouples

plug-in thermocouples standard

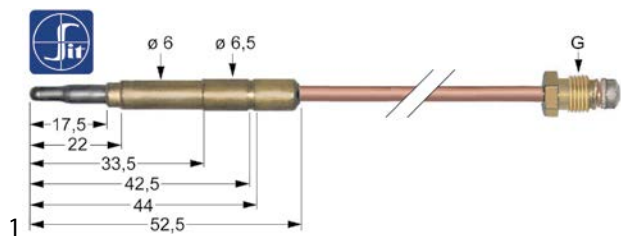

with barrel socket ø6(6.5)mm

thermocouples SIT





GEV No.	107613	Ref. No.	998022
description	thermocouple SIT M9x1 L 1200mm plug connection ø6.0(6.5)mm		

			
1			
GEV No.	104671	Ref. No.	998218
description	burner cap ø 150mm		
accessories for	104671		
	GEV No.	104669	Ref. No. 998208
burner head for burner cap ø 150mm			

			
1			
GEV No.	104249	Ref. No.	590406
description	burner cap ø 155mm		
accessories for	104249		
	GEV No.	104239	Ref. No. 590404
burner head for burner cap ø 155mm			

			
1			
GEV No.	104237	Ref. No.	590403
description	burner head for burner cap ø 125mm		

			
1			
GEV No.	104238	Ref. No.	070414
description	burner head for burner cap ø 125mm		

			
1			
GEV No.	104669	Ref. No.	998208
description	burner head for burner cap ø 150mm		
accessories for	104669		
	GEV No.	104670	Ref. No. 998216
burner cap ø 150mm			
	GEV No.	104671	Ref. No. 998218
burner cap ø 150mm			

gas burners

hob burners

producer-specific hob burners



JEMI

universal





GEV No.	104270	Ref. No.	990909 999035
description	air mixing tube ø 19mm		

			
1			
GEV No.	104248	Ref. No.	990405
description	burner cap ø 125mm		

			
1			
GEV No.	104670	Ref. No.	998216
description	burner cap ø 150mm		
accessories for	104670		
	GEV No.	104669	Ref. No. 998208
burner head for burner cap ø 150mm			



			
1			
GEV No.	104239	Ref. No.	590404
description	burner head for burner cap ø 155mm		
accessories for	104239		
	GEV No.	104249	Ref. No. 590406
	burner cap ø 155mm		

gas nozzles

pilot burner nozzles

pilot burner nozzles SIT

160 series

			
1			
GEV No.	107175	Ref. No.	998168
description	pilot burner nozzle SIT natural gas code 51 Qty 1 pcs suitable for 160 series		

auxiliary gas parts

screw connections

olives

			
1			
GEV No.	100870	Ref. No.	997048
description	olive for pipe ø 4mm Qty 1 pcs suitable for 160 series for pilot burner		

equipment-specific units

for dishwashers

drain and intake components

JEMI

drain /intake bodies

			
1			
GEV No.	502074	Ref. No.	1009020
description	drain fitting ID ø 37mm L 58mm hose ø 28mm with nut		
For models:	GS-1, GS-100, GS-18, GS-19, GS-2, GS-3, GS-30, GS-4-2, GS-4-2AF, GS-43, GS-6, GS-6AF, GS-82, GS-8-2, GS-82M, GS-9		

			
1			
GEV No.	506240	Ref. No.	2510168
description	flat gasket rubber ED ø 56mm ID ø 47mm thickness 2mm Qty 1 pcs		
For models:	A-2980-TDI, A-2980-TDICV, A-2980-TID, A-2980-TIDCV, GS-1, GS-18, GS-19, GS-2, GS-3, GS-4-2, GS-4-2AF, GS-6, GS-6AF, GS-8-2, GS-9		

			
1			
GEV No.	511556	Ref. No.	2510325
description	gasket rubber ED ø 142mm ID ø 112mm thickness 3mm Qty 1 pcs		
For models:	A-1200DI, A-1200DICV, A-1200ID, A-1200IDCV, A-1500-TDI, A-1500-TDICV, A-1500-TID, A-1500-TIDCV, A-2980-TDI, A-2980-TDICV, A-2980-TID, A-2980-TIDCV, GS-102, GS-16, GS-18, GS-19, GS-20, GS-5AF, GS-7, GS-83H, GS-83M		

			
1			
GEV No.	524994	Ref. No.	1014270
description	inlet valve ø 57mm H 55mm hose ø 45mm		
For models:	GS-1, GS-18, GS-19, GS-2, GS-3, GS-4-2, GS-4-2AF, GS-6, GS-6AF, GS-8-2, GS-9		
spare parts for	524994		
	GEV No.	506240	Ref. No. 2510168
	flat gasket rubber ED ø 56mm ID ø 47mm thickness 2mm Qty 1 pcs		

			
1			
GEV No.	511974	Ref. No.	1009254
description	intake body ED ø 150mm outlet ø 36 H 150mm		
For models:	A-1200DI, A-1200DICV, A-1200ID, A-1200IDCV, A-1500-TDI, A-1500-TDICV, A-1500-TID, A-1500-TIDCV, A-2980-TDI, A-2980-TDICV, A-2980-TID, A-2980-TIDCV, GS-102, GS-83H, GS-83M		

			
1			
GEV No.	511555	Ref. No.	1009257
description	intake/drain body ED ø 150mm ID ø 100mm hose ø 45/30mm		
For models:	GS-16, GS-18, GS-19, GS-20, GS-5AF, GS-7		

filters



1

GEV No.	511554	Ref. No.	0522119
description	combi filter ø 130mm H 60mm		
For models:	GS-16, GS-18, GS-19, GS-20, GS-5AF, GS-7		



1

GEV No.	511975	Ref. No.	0522080
description	round filters ø 125mm H 59mm SS		
For models:	GS-19, GS-8-2, GS-9		

overflow pipes



1

GEV No.	502075	Ref. No.	1016003
description	overflow pipe L 113mm ø 37mm		
For models:	GS-1, GS-18, GS-19, GS-2, GS-3, GS-4-2, GS-4-2AF, GS-6, GS-6AF, GS-8-2, GS-9		



1

GEV No.	511553	Ref. No.	1016119
description	overflow pipe L 200mm ø 37mm		
For models:	GS-16, GS-18, GS-19, GS-20, GS-5AF		



1

GEV No.	694946	Ref. No.	1016101
description	overflow pipe L 235mm with chain ø 35mm		
For models:	A-2160, A-2460-T, MA-MC		



1

GEV No.	507530	Ref. No.	1016083
description	overflow pipe L 500mm ø 37mm		
For models:	A-2980-TDI, A-2980-TDICV, A-2980-TID, A-2980-TIDCV, GS-102, GS-83H, GS-83M		

boilers

boilers for dishwashers



1

GEV No.	524984	Ref. No.	1405091
description	boiler left 12000W ø 180mm L 500mm inlet ø 1/2" ET		
For models:	A-2980-TDI, A-2980-TDICV, A-2980-TID, A-2980-TIDCV, MA-MC		



1

GEV No.	524983	Ref. No.	0502083
description	boiler ø 135mm L 465mm inlet ø 11		
For models:	GS-102, GS-83H, GS-83M		



1

GEV No.	524985	Ref. No.	1405092
description	boiler right 12000W ø 180mm L 500mm inlet ø 1/2" ET		
For models:	A-2980-TDI, A-2980-TDICV, A-2980-TID, A-2980-TIDCV, MA-MC		

softener cartridges

softening columns





1

GEV No.	530065	Ref. No.	1024001
description	softener 4-fold L 380mm W 180mm		
For models:	GS-18, GS-19, GS-2, GS-20, GS-3, GS-4-2, GS-4-2AF, GS-6, GS-6AF, GS-7, GS-8-2, GS-9		

hood mechanics for dishwashers			
springs			
			
1			
GEV No.	531212	Ref. No.	2521082
description	compression spring ø 19mm L 33mm wire gauge ø 3mm steel		
For models:	GS-82M		



air traps			
air traps			
			
1			
GEV No.	518435	Ref. No.	4055001
description	air trap L 80mm W 36mm ø 25mm H 68mm thread 3/4" hose ø 7mm plastic		
For models:	A-1200, A-1200DI, A-1200DICV, A-1200ID, A-1200IDCV, A-1500-T, A-1500-TDI, A-1500-TDICV, A-1500-TID, A-1500-TIDCV, A-2160, A-2460-T, A-2980-TDI, A-2980-TDICV, A-2980-TID, A-2980-TIDCV, GS-100, GS-102, GS-16, GS-18, GS-19, GS-2, GS-20, GS-3, GS-30, GS-4-2, GS-4-2AF, GS-43, GS-5AF, GS-6, GS-6AF, GS-7, GS-80, GS-82, GS-8-2, GS-82M, GS-83H, GS-83M, GS-9, MA-MC		

door mechanics			
springs			
tension springs			
			
1			
GEV No.	524518	Ref. No.	2521120
description	tension spring ø 10mm wire gauge ø 2mm total length 125mm for door mechanism		
For models:	GS-18, GS-19, GS-20, GS-6, GS-6AF, GS-7		

door guides			
			
1			
GEV No.	524828	Ref. No.	4038019
description	guide L 50mm W 10mm H 6mm for dishwasher JEMI		
For models:	GS-18, GS-19, GS-2, GS-20, GS-6, GS-6AF, GS-7		

locks			
			
1			
GEV No.	508417	Ref. No.	0814030
description	door opener model GS-30 JEMI		
For models:	GS-30		

washing and rinsing systems			
			
1			
GEV No.	524516	Ref. No.	4047001
description	bearing for rinse arm ø 26mm H 34.5mm		
For models:	GS-30, GS-4-2, GS-4-2AF, GS-43, GS-82, GS-82M, GS-83H, GS-83M		

			
1			
GEV No.	524530	Ref. No.	4050119
description	bush for wash arm mounting pos. upper/lower ø 37mm H 27mm thread 3/4" with gasket		
For models:	A-1200DI, A-1200DICV, A-1200ID, A-1200IDCV, A-1500-TDI, A-1500-TDICV, A-1500-TID, A-1500-TIDCV, A-2980-TDI, A-2980-TDICV, A-2980-TID, A-2980-TIDCV, GS-1, GS-102, GS-16, GS-18, GS-19, GS-2, GS-20, GS-3, GS-30, GS-5AF, GS-6, GS-6AF, GS-7, GS-82, GS-82M, GS-83H, GS-83M, GSP-45, GSP-46, MA-MC		
spare parts for	524530		
	GEV No.	532621	Ref. No.
			2514090
	 O-ring EPDM thickness 2.5mm ID ø 28mm Qty 1 pcs		

			
1			
GEV No.	524993	Ref. No.	4030002
description	end cap for wash distributor thickness 19mm ED ø 63mm		
For models:	A-1200DI, A-1200DICV, A-1200ID, A-1200IDCV, A-1500-TDI, A-1500-TDICV, A-1500-TID, A-1500-TIDCV, A-2980-TDI, A-2980-TDICV, A-2980-TID, A-2980-TIDCV, GS-18, GS-19, GS-20, GS-30, GS-4-2, GS-4-2AF, GS-43, GS-6, GS-6AF, GS-7, GS-8-2, GS-83H, GS-83M, GS-9, MA-MC		

			
1			
GEV No.	506239	Ref. No.	2510020
description	flat gasket rubber ED ø 35.5mm ID ø 24mm thickness 4mm Qty 1 pcs		
For models:	GS-1, GS-102, GS-2, GS-3, GS-4-2, GS-4-2AF, GS-6, GS-6AF, GS-8-2, GS-83H, GS-83M, GS-9, MA-MC		



1

GEV No.	524517	Ref. No.	1515608
description	screw internal hexagon thread M10x1 thread L 10mm WS 6 for rinse arm		
For models:	GS-1, GS-102, GS-16, GS-18, GS-19, GS-2, GS-20, GS-3, GS-30, GS-4-2, GS-4-2AF, GS-43, GS-5AF, GS-6, GS-6AF, GS-7, GS-82, GS-8-2, GS-82M, GS-83H, GS-83M, GS-9, GSP-45, GSP-46		



1

GEV No.	518436	Ref. No.	4047002
description	screw connection thread 1/2" thread L 8mm WS 23 for rinse arm		
For models:	GS-1, GS-102, GS-16, GS-18, GS-19, GS-2, GS-20, GS-5AF, GS-6, GS-6AF, GS-7, GS-8-2, GS-83H, GS-83M, GS-9, GSP-45, GSP-46		



1

GEV No.	524990	Ref. No.	4035051
description	wash distributor mounting pos. lower ø 48mm L 425mm plastic		
For models:	GS-18, GS-19, GS-20, GS-30, GS-4-2AF, GS-6AF, GS-7, GS-8-2, GS-9		

spare parts for 524990



GEV No.	524993	Ref. No.	4030002
description	end cap for wash distributor thickness 19mm ED ø 63mm		

washing and rinsing systems (sorted by producer)

JEMI



1

GEV No.	524989	Ref. No.	8040014
description	wash arm complete mounting pos. upper/lower L 545mm W 42mm H 44mm nozzles 6		
For models:	GS-100, GS-80		



1

GEV No.	511568	Ref. No.	8040001
description	wash arm L 360mm W 28mm H 45mm nozzles 4		
For models:	GS-3		



1

GEV No.	511569	Ref. No.	8040002
description	wash arm L 363mm W 55mm H 45mm nozzles 4		
For models:	GS-8-2		



1

GEV No.	502032	Ref. No.	2521268
description	D-lock		
For models:	A-1200, A-1500-T, A-2160, A-2460-T, GS-100, GS-3, GS-4-2, GS-4-2AF, GS-80, GS-8-2, GS-9, MA-MC		



1

GEV No.	502034	Ref. No.	2521248
description	D-lock		
For models:	GS-100, GS-4-2, GS-4-2AF, GS-80, GS-8-2, GS-9		



1

GEV No.	511570	Ref. No.	4033002 4033002+4032001+4051001
description	end piece for wash arm L 112mm W 22mm H 47mm nozzles 1		
For models:	GS-100, GS-80, GS-8-2		





1

GEV No.	511572	Ref. No.	2514130
description	O-ring EPDM thickness 4.5mm ID ø 25mm Qty 1 pcs		
For models:	A-1200, A-1500-T, A-2160, A-2460-T, GS-100, GS-3, GS-4-2, GS-4-2AF, GS-80, GS-8-2, GS-9, GSP-45, MA-MC		



			
1			
GEV No.	511956	Ref. No.	4051001
description	wash jet body 2 bores thread M20x1.75		
For models:	GS-100, GS-4-2AF, GS-80		

			
1			
GEV No.	511957	Ref. No.	4051003
description	wash jet body helix form thread M20x1.75		
For models:	GS-3, GS-4-2AF, GS-43, GS-8-2, GS-9, GSP-45, GSP-46		

			
1			
GEV No.	511958	Ref. No.	4032001
description	wash jet cap hole ø 5mm thread M20x1.75		
For models:	GS-100, GS-3, GS-4-2AF, GS-8-2, GS-9		

			
1			
GEV No.	524872	Ref. No.	8040103
description	wash arm L 348mm W 37mm H 44mm nozzles 4		
For models:	GS-1, GS-2, GS-3		

				
1				
GEV No.	524528	Ref. No.	8040183	
description	wash arm L 570mm W 37mm H 41mm nozzles 6 mounting ø 32mm mounting pos. upper/lower H 44mm W 37mm			
For models:	GS-102, GS-83H, GS-83M			
spare parts for	524528			
	GEV No.	511466	Ref. No.	4032122
	description	swirl hole ø 2.5mm H 11mm ø 17mm		
	GEV No.	511976	Ref. No.	4032119
	description	wash jet mounting pos. upper/lower thread 1/2" H 12mm WS 25		
accessories for	524528			
	GEV No.	524529	Ref. No.	4050120
	description	wash arm support mounting pos. upper/lower ø 49mm H 28mm		
	GEV No.	524530	Ref. No.	4050119
	description	bush for wash arm mounting pos. upper/lower ø 37mm H 27mm thread 3/4" with gasket		

			
1			
GEV No.	524986	Ref. No.	8040119
description	wash arm mounting pos. upper/lower L 500mm W 38mm H 44mm nozzles 6		
For models:	GS-102, GS-16, GS-18, GS-19, GS-20, GS-30, GS-7, GS-83H, GS-83M		

GEV No.	524986	Ref. No.	8040119
description	wash arm mounting pos. upper/lower L 500mm W 38mm H 44mm nozzles 6		
For models:	GS-102, GS-16, GS-18, GS-19, GS-20, GS-30, GS-7, GS-83H, GS-83M		

			
1			
GEV No.	524987	Ref. No.	8040182
description	wash arm mounting pos. upper/lower L 550mm W 38mm H 44mm nozzles 6		
For models:	GS-82, GS-82M		
spare parts for	524987		

GEV No.	524987	Ref. No.	8040182	
description	wash arm mounting pos. upper/lower L 550mm W 38mm H 44mm nozzles 6			
For models:	GS-82, GS-82M			
spare parts for	524987			
	GEV No.	511976	Ref. No.	4032119
	description	wash jet mounting pos. upper/lower thread 1/2" H 12mm WS 25		

			
1			
GEV No.	524988	Ref. No.	4028183
description	wash arm mounting pos. upper/lower L 570mm W 37mm H 41mm nozzles 6		
For models:	A-1200DI, A-1200DICV, A-1200ID, A-1200IDCV, A-1500-TDI, A-1500-TDICV, A-1500-TID, A-1500-TIDCV, A-2980-TDI, A-2980-TDICV, A-2980-TID, A-2980-TIDCV, GS-102, GS-83H, GS-83M		

GEV No.	524988	Ref. No.	4028183
description	wash arm mounting pos. upper/lower L 570mm W 37mm H 41mm nozzles 6		
For models:	A-1200DI, A-1200DICV, A-1200ID, A-1200IDCV, A-1500-TDI, A-1500-TDICV, A-1500-TID, A-1500-TIDCV, A-2980-TDI, A-2980-TDICV, A-2980-TID, A-2980-TIDCV, GS-102, GS-83H, GS-83M		

			
1			
GEV No.	511466	Ref. No.	4032122
description	swirl hole ø 2.5mm H 11mm ø 17mm		
For models:	GS-1, GS-102, GS-16, GS-18, GS-19, GS-2, GS-20, GS-3, GS-30, GS-5AF, GS-6, GS-6AF, GS-7, GS-82, GS-82M, GS-83H, GS-83M		

			
1			
GEV No.	511976	Ref. No.	4032119
description	wash jet mounting pos. upper/lower thread 1/2" H 12mm WS 25		
For models:	GS-1, GS-102, GS-16, GS-18, GS-19, GS-2, GS-20, GS-3, GS-30, GS-5AF, GS-6, GS-6AF, GS-7, GS-82, GS-82M, GS-83H, GS-83M		





1

GEV No.	531316	Ref. No.	0807083
description	rinse arm L 530mm mounting pos. lower r. jets 8 1/2"		
For models:	GS-102, GS-83H, GS-83M		





1

GEV No.	524992	Ref. No.	0807001
description	rinse arm mounting pos. lower L 370mm nozzles 4 1/2"		
For models:	GS-4-2, GS-4-2AF, GS-6, GS-6AF		
spare parts for	524992		
	GEV No.	518436	Ref. No. 4047002
	screw connection thread 1/2" thread L 8mm WS 23 for rinse arm		



1

GEV No.	524991	Ref. No.	0807004
description	rinse arm mounting pos. lower L 420mm nozzles 8 1/2"		
For models:	GS-18, GS-19, GS-8-2, GS-9		
spare parts for	524991		
	GEV No.	518436	Ref. No. 4047002
	screw connection thread 1/2" thread L 8mm WS 23 for rinse arm		



1

GEV No.	531318	Ref. No.	0841040
description	rinse jet thread M6 thread L 6.5mm stainless steel WS M10		
For models:	A-1200DI, A-1200DICV, A-1200ID, A-1200IDCV, A-1500-TDI, A-1500-TDICV, A-1500-TID, A-1500-TIDCV, A-2980-TDI, A-2980-TDICV, A-2980-TID, A-2980-TIDCV, GS-1, GS-102, GS-16, GS-18, GS-19, GS-2, GS-20, GS-3, GS-30, GS-4-2, GS-4-2AF, GS-43, GS-5AF, GS-6, GS-6AF, GS-7, GS-82, GS-8-2, GS-82M, GS-83H, GS-83M, GS-9		



1

GEV No.	524531	Ref. No.	0843007
description	rinse jet mounting pos. upper/lower ø 14mm H 21mm thread M11x1		
For models:	GS-1, GS-100, GS-102, GS-16, GS-18, GS-19, GS-2, GS-20, GS-30, GS-5AF, GS-6, GS-6AF, GS-7, GS-82, GS-82M, GS-83H, GS-83M, GSP-45, GSP-46		



1

GEV No.	524532	Ref. No.	0832006
description	swirl for rinse jet mounting pos. upper/lower H 16mm ø 8mm 2.4mm		
For models:	GS-1, GS-100, GS-102, GS-16, GS-18, GS-19, GS-2, GS-20, GS-30, GS-43, GS-5AF, GS-6, GS-6AF, GS-7, GS-82, GS-82M, GS-83H, GS-83M, GSP-45, GSP-46		



1

GEV No.	531317	Ref. No.	4034102
description	wash jet ø 23mm L 54mm bore ø 6x12mm 1/2"		
For models:	A-1200, A-1500-T, A-2160, A-2460-T		



1

GEV No.	531320	Ref. No.	4033120
description	end piece thread 1/2" ø 12.5mm L 42mm		
For models:	A-1200DI, A-1200DICV, A-1200ID, A-1200IDCV, A-1500-TDI, A-1500-TDICV, A-1500-TID, A-1500-TIDCV, A-2980-TDI, A-2980-TDICV, A-2980-TID, A-2980-TIDCV, GS-102, GS-82, GS-82M, GS-83H, GS-83M		



1

GEV No.	524529	Ref. No.	4050120
description	wash arm support mounting pos. upper/lower ø 49mm H 28mm		
For models:	A-1200DI, A-1200DICV, A-1200ID, A-1200IDCV, A-1500-TDI, A-1500-TDICV, A-1500-TID, A-1500-TIDCV, A-2980-TDI, A-2980-TDICV, A-2980-TID, A-2980-TIDCV, GS-1, GS-102, GS-16, GS-18, GS-19, GS-2, GS-20, GS-3, GS-30, GS-5AF, GS-6, GS-6AF, GS-7, GS-82, GS-82M, GS-83H, GS-83M, GSP-46, MA-MC		

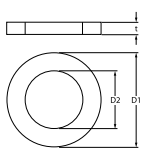

			
GEV No.	531319	Ref. No.	4080183
description	wash arm support ø 20mm H 20mm L 35mm		
For models:	GS-102, GS-16, GS-18, GS-19, GS-20, GS-30, GS-7, GS-83H, GS-83M		

			
GEV No.	511572	Ref. No.	2514130
description	O-ring EPDM thickness 4.5mm ID ø 25mm Qty 1 pcs		
For models:	A-1200, A-1500-T, A-2160, A-2460-T, GS-100, GS-3, GS-4-2, GS-4-2AF, GS-80, GS-8-2, GS-9, GSP-45, MA-MC		

handles and hand wheels

accessories

end caps

			
GEV No.	518077	Ref. No.	4030021
description	end cap oval ø 15x42mm		
For models:	GS-18, GS-19, GS-3, GS-6, GS-6AF		

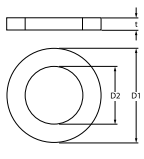
			
GEV No.	532732	Ref. No.	2514142
description	O-ring EPDM thickness 4mm ID ø 42mm Qty 1 pcs		
For models:	A-1200DI, A-1200DICV, A-1200ID, A-1200IDCV, A-1500-TDI, A-1500-TDICV, A-1500-TID, A-1500-TIDCV, A-2980-TDI, A-2980-TDICV, A-2980-TID, A-2980-TIDCV, GS-18, GS-19, GS-20, GS-4-2, GS-4-2AF, GS-6, GS-6AF, GS-7, GS-8-2, GS-83H, GS-83M, GS-9, MA-MC		

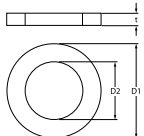
			
GEV No.	510408	Ref. No.	2514180
description	O-ring EPDM thickness 5.34mm ID ø 47mm Qty 1 pcs		
For models:	A-1200, A-1200DI, A-1200DICV, A-1200ID, A-1200IDCV, A-1500-T, A-1500-TDI, A-1500-TDICV, A-1500-TID, A-1500-TIDCV, A-2160, A-2460-T, A-2980-TDI, A-2980-TDICV, A-2980-TID, A-2980-TIDCV, GS-1, GS-100, GS-102, GS-16, GS-18, GS-19, GS-2, GS-20, GS-3, GS-30, GS-4-2, GS-4-2AF, GS-43, GS-5AF, GS-6, GS-6AF, GS-7, GS-80, GS-82, GS-8-2, GS-82M, GS-83H, GS-83M, GS-9, GSP-45, GSP-46, MA-MC		

hinges

oven hinges

			
GEV No.	694397 ¹	Ref. No.	920600
description	oven hinge mounting distance 173mm lug mounting 14mm lever length 117mm groove distance 9mm spring thickness 3.5mm mounting ear position left/right spring length 113mm L 206mm W 26mm with opposite support		

¹with opposite support

sealing washers

			
GEV No.	506237	Ref. No.	2511187
description	flat gasket FIBER ED ø 28mm ID ø 21mm thickness 2mm Qty 1 pcs		
For models:	GS-102, GS-18, GS-19, GS-2, GS-20, GS-6, GS-6AF, GS-7, GS-83H, GS-83M, GSP-45, GSP-46		

gaskets

O-rings

EPDM

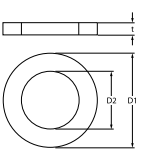
			
GEV No.	532621	Ref. No.	2514090
description	O-ring EPDM thickness 2.5mm ID ø 28mm Qty 1 pcs		
For models:	GS-102, GS-18, GS-19, GS-2, GS-20, GS-3, GS-30, GS-6, GS-6AF, GS-7, GS-82, GS-82M, GS-83H, GS-83M, MA-MC		

			
GEV No.	524898	Ref. No.	2411121 2511121
description	flat gasket FIBER ED ø 35mm ID ø 22mm thickness 2mm Qty 1 pcs		
For models:	GS-102, GS-18, GS-19, GS-2, GS-20, GS-6, GS-6AF, GS-7, GS-83H, GS-83M, GSP-45, GSP-46		

			
1			
GEV No.	506238	Ref. No.	2511250
description	flat gasket FIBER ED ø 38mm ID ø 32mm thickness 2mm Qty 1 pcs		
For models:	MA-MC		

rubber gaskets

			
1			
GEV No.	506239	Ref. No.	2510020
description	flat gasket rubber ED ø 35.5mm ID ø 24mm thickness 4mm Qty 1 pcs		
For models:	GS-1, GS-102, GS-2, GS-3, GS-4-2, GS-4-2AF, GS-6, GS-6AF, GS-8-2, GS-83H, GS-83M, GS-9, MA-MC		

			
1			
GEV No.	506240	Ref. No.	2510168
description	flat gasket rubber ED ø 56mm ID ø 47mm thickness 2mm Qty 1 pcs		
For models:	A-2980-TDI, A-2980-TDICV, A-2980-TID, A-2980-TIDCV, GS-1, GS-18, GS-19, GS-2, GS-3, GS-4-2, GS-4-2AF, GS-6, GS-6AF, GS-8-2, GS-9		

			
1			
GEV No.	511556	Ref. No.	2510325
description	gasket rubber ED ø 142mm ID ø 112mm thickness 3mm Qty 1 pcs		
For models:	A-1200DI, A-1200DICV, A-1200ID, A-1200IDCV, A-1500-TDI, A-1500-TDICV, A-1500-TID, A-1500-TIDCV, A-2980-TDI, A-2980-TDICV, A-2980-TID, A-2980-TIDCV, GS-102, GS-16, GS-18, GS-19, GS-20, GS-5AF, GS-7, GS-83H, GS-83M		

			
1			
GEV No.	560631	Ref. No.	2510012
description	gasket rubber ED ø 19mm ID ø 10mm thickness 2mm Qty 1 pcs		
For models:	A-1200DI, A-1200DICV, A-1200ID, A-1200IDCV, A-1500-TDI, A-1500-TDICV, A-1500-TID, A-1500-TIDCV, A-2980-TDI, A-2980-TDICV, A-2980-TID, A-2980-TIDCV, GS-1, GS-100, GS-102, GS-83H, GS-83M, GSP-46		

			
1			
GEV No.	560632	Ref. No.	2510145
description	gasket rubber ED ø 57mm ID ø 42mm thickness 2mm Qty 1 pcs white		
For models:	A-1200, A-1500-T, A-2160, A-2460-T, GS-1, GS-100, GS-18, GS-19, GS-2, GS-3, GS-30, GS-4-2, GS-4-2AF, GS-43, GS-6, GS-6AF, GS-80, GS-82, GS-8-2, GS-82M, GS-9, MA-MC		

springs

compression springs

			
1			
GEV No.	531212	Ref. No.	2521082
description	compression spring ø 19mm L 33mm wire gauge ø 3mm steel		
For models:	GS-82M		

tension springs







			
1			
GEV No.	524518	Ref. No.	2521120
description	tension spring ø 10mm wire gauge ø 2mm total length 125mm for door mechanism		
For models:	GS-18, GS-19, GS-20, GS-6, GS-6AF, GS-7		

dosing pumps

membrane dosing pumps

electric dosing pumps

Delta



				
1				
GEV No.	361003	Ref. No.	2031001	
description	dosing pump 220V rinse aid duty cycle 25% type EL-1 valve lip valve			
For models:	GS-100, GS-18, GS-19, GS-3, GS-30, GS-4-2, GS-4-2AF, GS-80, GS-82, GS-8-2, GS-82M, GS-83H, GS-83M, GS-9, GSP-45, GSP-46			
spare parts for	361003			
	GEV No.	361122	Ref. No.	—
	lip valve type DELTA			
	GEV No.	361123	Ref. No.	—
	membrane type DELTA			
	GEV No.	361169	Ref. No.	—
	hose connector type DELTA			
	GEV No.	361188	Ref. No.	—
	disc type DELTA			
	GEV No.	361319	Ref. No.	—
	flat gasket rubber ID ø 9mm ED ø 14.5mm thickness 1mm type DELTA			



self-priming

various



GEV No.	361370	Ref. No.	2031101
description	dosing pump type model 2 rinse aid inlet 4x6mm outlet 4x6mm pressure connection ø 4x6mm suction connection ø 4x6mm		
For models:	GS-1, GS-102, GS-16, GS-18, GS-19, GS-2, GS-20, GS-3, GS-30, GS-5AF, GS-6, GS-6AF, GS-7, GS-83H, GS-83M		
spare parts for	361370		
	GEV No.	361307	Ref. No. —
	membrane dosing pump ø 68mm hole ø 6mm for type DIB3P/DIB5P		
	GEV No.	361459	Ref. No. —
	hose connector ø 6mm for dosing pump		

hoses

drain hoses

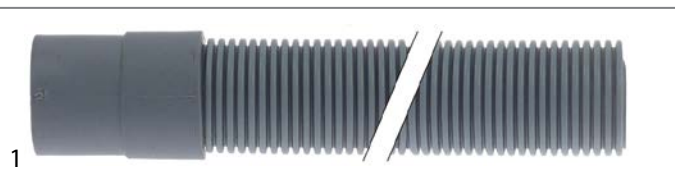

GEV No.	517825	Ref. No.	1010291
description	drain hose DN28 L 1500mm straight ø inside 28mm straight ext. ø 35mm outer hose ø 33mm		
For models:	A-1200, A-1500-T, A-2160, A-2460-T, GS-100, GS-16, GS-18, GS-19, GS-2, GS-20, GS-3, GS-30, GS-4-2, GS-4-2AF, GS-43, GS-5AF, GS-6, GS-6AF, GS-7, GS-82, GS-8-2, GS-82M, GS-83H, GS-83M, GS-9, GSP-46, MA-MC		

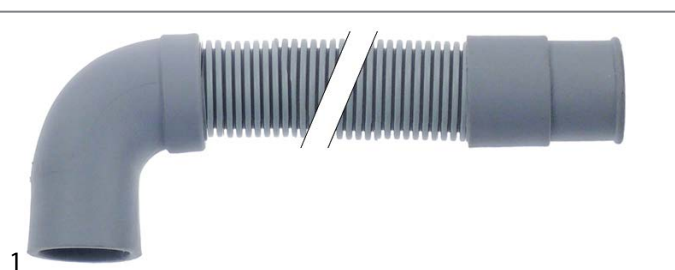

GEV No.	518600	Ref. No.	1010292
description	drain hose DN19 L 1500mm straight ø inside 19mm straight ext. ø 24mm elbow ø inside 22mm elbow ext. ø 27mm outer hose ø 24mm		
For models:	GS-18, GS-19, GS-2, GS-20, GS-3, GS-30, GS-4-2, GS-4-2AF, GS-43, GS-6, GS-6AF, GS-7, GS-8-2, GS-83H, GS-83M, GS-9		

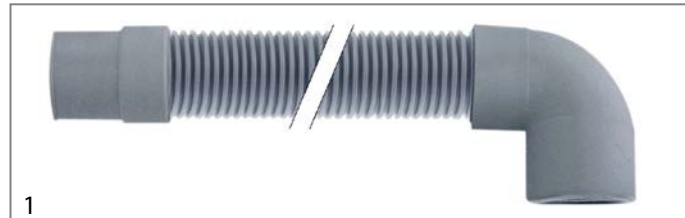

GEV No.	530571	Ref. No.	1010294
description	drain hose DN24 L 1500mm straight ø inside 24mm straight ext. ø 29mm elbow ø inside 29mm elbow ext. ø 35mm outer hose ø 28mm		
For models:	GS-1, GS-18, GS-19, GS-2, GS-20, GS-3, GS-30, GS-4-2, GS-4-2AF, GS-43, GS-6, GS-6AF, GS-7, GS-8-2, GS-9		

measuring equipment

thermometers

built-in thermometers



GEV No.	541063	Ref. No.	2028022
description	thermometer mounting measurements 58x25.5mm 0 up to +120°C capillary pipe 1500mm probe ø 6.5mm probe L 23mm		
For models:	A-1200, A-1500-T, A-2160, A-2460-T, GS-100, GSP-45, GSP-46		



GEV No.	541305	Ref. No.	2028016
description	thermometer mounting measurements 62x11mm +20 up to +120°C capillary pipe 1500mm probe ø 6.5mm probe L 16mm		
For models:	GS-18, GS-19, GS-20, GS-30, GS-43, GS-6AF, GS-7, GS-82, GS-82M, GS-83H, GS-83M		

B

booster pumps II 15

C

cam switches 7

compressors 12

condensators & interference suppression filters 15

contactors 9

control thermostats 5

D

dosing pumps 28

drain hoses 29

drain pumps 14

G

gas burners 20

gas control valves 17

gas nozzles 21

gas taps 15

gas thermostats 16

H

heating elements 3

hob burners 20

hoses 29

hot plates 5

I

ignition cables 19

immersion heating elements 3

indicator lights 8

indicator lights (complete) 8

L

lamps 8

M

magnetic switches 7

measuring equipment 29

O

operating capacitors 15

O-rings 27

oven hinges 27

P

piezoelectric igniters 19

pilot burners 17

pressure switches 11

probes 10

programme timers 9

pumps 12

push/momentary push switches 7

R

relays 10

rocker/momentary rocker switches 6

rotary switches 7

S

safety thermostats 5

sealing washers 27

solenoid valves 11

switches and momentary switches 6

T

thermocouples 20

thermostats 5

time relays 10

timers 9

W

wash and rinse pumps 12