



GAS COMPONENTS



ELECTRIC COMPONENTS



WATER TECHNOLOGY



MECHANICAL COMPONENTS



TOOLS

Spare parts suitable for

JUNO

Find the complete and up-to-date range of products in our GEV Webshop



Manufacturer catalogue

The most important spare parts and accessories arranged clearly for every manufacturer

- ✓ Complete product range and all appliance data always up to date in the GEV Webshop
- ✓ Alphabetical Index at the end of the catalogue

GEV Webshop

www.gev-online.co.uk

www.gev-online.com





- 🔍 Add to Favourites
- 🔍 Sign In with email address and usual password
- 🔍 Easy-order – place several items in your basket at the same time
- 🔍 Quick Item search – no login needed





heating elements









heating elements for ovens

			
1			
GEV No.	417340	Ref. No.	0700214613
description	heating element 2000W 400V L 430mm W 150mm L1 50mm L2 380mm W1 60mm W2 30mm windings 3 connection plug-in connection heating circuits 1 tube ø 6.3mm dry heating element hole distance 56mm flange length 70mm flange width 22mm hole ø 3mm		

			
1			
GEV No.	415499	Ref. No.	0H6178
description	heating element 1500W 230V heating circuits 1 L 437mm W 227mm L1 37mm L2 400mm W1 147mm W2 80mm connection male faston 6.3mm connection distance 140mm tube ø 6.5mm dry heating element		

heating elements for bain maries

			
1			
GEV No.	415051	Ref. No.	0H6163
description	heating element 1500W 230V heating circuits 1 L 390mm W 36mm connection male faston 6.3mm tube ø 6.5mm 2 hole fixing thread M10x1 immersion heater mounting distance 30mm		
accessories for	415051		
	GEV No.	510893	Ref. No. —
	O-ring EPDM thickness 2.62mm ID ø 9.92mm Qty 1 pcs		
	GEV No.	521129	Ref. No. —
	nut thread M10 H 6mm SS WS 17 Qty 1 pcs DIN/ISO DIN 439		

			
1			
GEV No.	415212	Ref. No.	0H6201 214678
description	heating element 2000W 400V heating circuits 1 L 320mm W 96mm connection M4 tube ø 8.5mm flange with thread thread 1" immersion heater L1 75mm L2 245mm H1 24mm H 40mm thermostat sleeves ø 5mm number of thermostat sleeves 1 length thermostat sleeves 133mm thermostat sleeve clinging		
accessories for	415212		
	GEV No.	510404	Ref. No. —
	flat gasket fibre ED ø 44mm ID ø 34mm thickness 2mm Qty 1 pcs		
	GEV No.	510422	Ref. No. —
	gasket copper ED ø 37.7mm ID ø 32.5mm thickness 2.7mm for thread 1"		
	GEV No.	520233	Ref. No. —
	nut thread 1" H 6mm brass WS 47 Qty 1 pcs		
	GEV No.	521103	Ref. No. —
	nut thread M4 H 3mm WS 7 brass Qty 20 pcs		
	GEV No.	521104	Ref. No. —
	washer ID ø 4.3mm ED ø 8mm thickness 0.5mm brass Qty 20 pcs for thread M4		
	GEV No.	560111	Ref. No. —
	plain washer ID ø 4.3mm ED ø 9mm thickness 0.8mm SS Qty 20 pcs DIN 125A for thread M4		
	GEV No.	560131	Ref. No. —
	hexagonal nut thread M4 H 3.2mm WS 7 SS DIN/ISO DIN 934 / ISO 4032/8673 Qty 20 pcs		

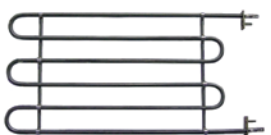
			
1			
GEV No.	415596	Ref. No.	0G2290
description	heating element 1500W 230V heating circuits 1 L 395mm W 198mm tube ø 6.5mm lug length 31mm lug width 16mm connection length 30mm connection male faston 6.3mm dry heating element bracket mounting hole distance 160mm mounting thread M4		

			
1			
GEV No.	415353	Ref. No.	050933
description	heating element 1500W 230V heating circuits 1 L 395mm W 205mm H 25mm L1 50mm L2 345mm connection M4 connection distance 198mm tube ø 8.5mm connection length 20mm dry heating element		





			
1			
GEV No.	415908	Ref. No.	0G5201
description	heating element 2500W 230V heating circuits 1 L 385mm W 96mm connection M4 tube ø 8.5mm flange with thread thread 1" immersion heater L1 75mm L2 310mm H1 10mm H 40mm thermostat sleeves ø 5mm number of thermostat sleeves 1 length thermostat sleeves 133mm thermostat sleeve clinging		
accessories for	415908		
	GEV No.	510404	Ref. No. —
	flat gasket fibre ED ø 44mm ID ø 34mm thickness 2mm Qty 1 pcs		
	GEV No.	510422	Ref. No. —
	gasket copper ED ø 37.7mm ID ø 32.5mm thickness 2.7mm for thread 1"		



Table continues overleaf



accessories for	415908		
	GEV No.	520233	Ref. No.
			—
	nut thread 1" H 6mm brass WS 47 Qty 1 pcs		



GEV No.	415481	Ref. No.	OK0566
description	heating element 2500W 400V heating circuits 1 L 385mm W 96mm connection M4 flange with thread thread 1" immersion heater L1 75mm L2 310mm H1 20mm H 40mm thermostat sleeves ø 5mm number of thermostat sleeves 1 length thermostat sleeves 133mm thermostat sleeve clinging		

accessories for	415481		
	GEV No.	510404	Ref. No.
			—
	flat gasket fibre ED ø 44mm ID ø 34mm thickness 2mm Qty 1 pcs		
	GEV No.	510422	Ref. No.
			—
	gasket copper ED ø 37.7mm ID ø 32.5mm thickness 2.7mm for thread 1"		
	GEV No.	520233	Ref. No.
			—
	nut thread 1" H 6mm brass WS 47 Qty 1 pcs		



GEV No.	415650	Ref. No.	OK0593
description	heating element 6000W 230V heating circuits 3 L 255mm W 250mm connection length 43mm connection M4 flange with thread thread 1 1/4" immersion heater H1 13mm H 25mm		

spare parts for	415650		
	GEV No.	510405	Ref. No.
			—
	flat gasket fibre ED ø 56mm ID ø 42mm thickness 2mm for thread 1 1/4" Qty 1 pcs		

accessories for	415650		
	GEV No.	520232	Ref. No.
			—
	nut thread 1 1/4" H 5mm nickel-plated brass WS 47 Qty 1 pcs		

heating elements for frying pans

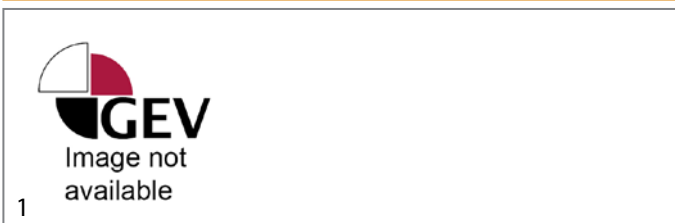

GEV No.	416974	Ref. No.	OH6156
description	heating element 1100W 230V		

heating elements for fryers

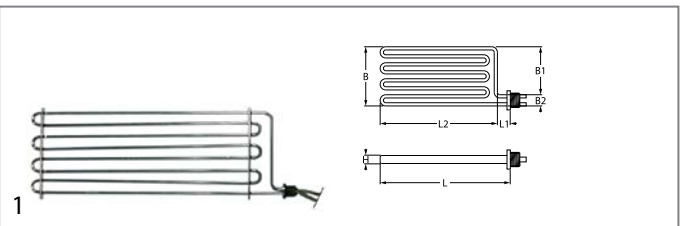

GEV No.	415371	Ref. No.	OH6194 214576
description	heating element 8000W 230/400V heating circuits 3 mounting pos. left thread M26x1.5 L 555mm W 177mm H 27mm L1 20mm L2 535mm W1 160mm W2 15mm mounting ø 26mm tube ø 17x6mm cable length 600mm flange ø 33mm fryer 1 hole fixing connection length 12mm		

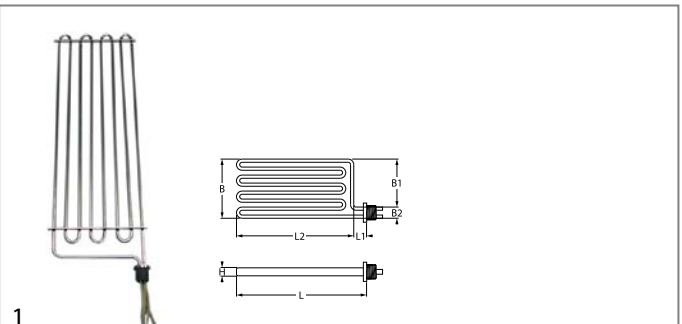

GEV No.	415370	Ref. No.	OK0621
description	heating element 8000W 230/400V heating circuits 3 mounting pos. right thread M26x1.5 L 555mm W 177mm H 27mm L1 20mm L2 535mm W1 160mm W2 15mm mounting ø 26mm tube ø 17x6mm cable length 600mm flange ø 33mm 1 hole fixing connection length 12mm fryer		

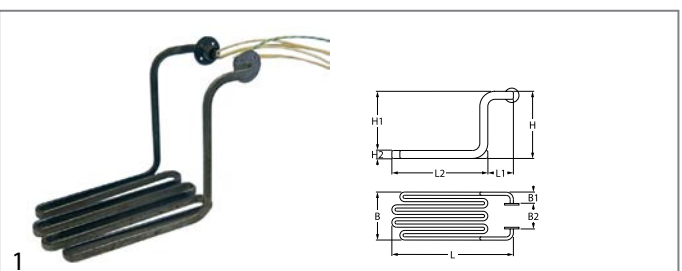

GEV No.	415684	Ref. No.	OK0583
description	heating element 5010W 400V heating circuits 3 L 384mm W 225mm H 245mm L1 84mm L2 300mm H1 227mm H2 18mm W1 31mm W2 148mm windings 4 cable length 860mm rotation flange		

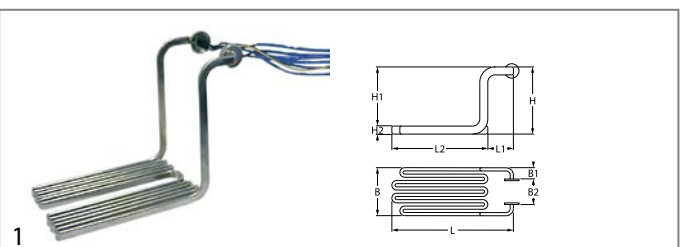

GEV No.	415490	Ref. No.	OH6192
description	heating element 5100W 230/400V heating circuits 3 L 345mm W 168mm H 246mm L1 70mm L2 275mm H1 229mm H2 17mm W1 21mm W2 104mm windings 6 flange ø 39mm connection cable rotation flange immersion heater		



GEV No.	415611	Ref. No.	0H6203
description	heating element 7200W 230/400V heating circuits 3 L 350mm W 168mm H 249mm L1 62mm L2 288mm H1 232mm H2 17mm W1 34mm W2 100mm windings 6 flange ø 42mm tube ø 17x6mm cable length 1730mm rotation flange immersion heater		

GEV No.	415667	Ref. No.	OK0526
description	heating element 4220W 230V heating circuits 1 L 507mm W 45mm H 345mm L1 17mm L2 490mm H1 308mm H2 37mm thread M12x1 mounting distance 37mm tube ø 8.5mm 2 hole fixing connection M4 fryer windings 5		

2 hole fixing

GEV No.	415498	Ref. No.	OK0569
description	heating element 2500W 230V heating circuits 1 L 315mm W 40mm H 275mm L1 35mm L2 280mm H1 235mm H2 40mm thread M12x1 mounting distance 25mm tube ø 8.5mm 2 hole fixing connection M4 connection length 18mm fryer windings 4		
spare parts for	415498		
	GEV No.	521110	Ref. No. —
	flat gasket fibre ED ø 20mm ID ø 13mm thickness 2mm Qty 1 pcs		
accessories for	415498		
	GEV No.	520229	Ref. No. —
	nut thread M12x1 H 4mm WS 16 zinc-coated steel Qty 1 pcs		
	GEV No.	521103	Ref. No. —
	nut thread M4 H 3mm WS 7 brass Qty 20 pcs		
	GEV No.	521104	Ref. No. —
	washer ID ø 4.3mm ED ø 8mm thickness 0.5mm brass Qty 20 pcs for thread M4		
	GEV No.	521131	Ref. No. —
	nut thread M12x1 H 3.5mm WS 17 SS Qty 1 pcs		
	GEV No.	528110	Ref. No. —
	O-ring EPDM thickness 2.62mm ID ø 12.37mm Qty 1 pcs		
	GEV No.	560111	Ref. No. —
	plain washer ID ø 4.3mm ED ø 9mm thickness 0.8mm SS Qty 20 pcs DIN 125A for thread M4		
	GEV No.	560131	Ref. No. —
	hexagonal nut thread M4 H 3.2mm WS 7 SS DIN/ISO DIN 934 / ISO 4032/8673 Qty 20 pcs		

accessories for 415667

	GEV No.	521103	Ref. No. —
	nut thread M4 H 3mm WS 7 brass Qty 20 pcs		
	GEV No.	521104	Ref. No. —
	washer ID ø 4.3mm ED ø 8mm thickness 0.5mm brass Qty 20 pcs for thread M4		
	GEV No.	560111	Ref. No. —
	plain washer ID ø 4.3mm ED ø 9mm thickness 0.8mm SS Qty 20 pcs DIN 125A for thread M4		
	GEV No.	560131	Ref. No. —
	hexagonal nut thread M4 H 3.2mm WS 7 SS DIN/ISO DIN 934 / ISO 4032/8673 Qty 20 pcs		

GEV No.	415470	Ref. No.	0H6180
description	heating element 2000W 230V heating circuits 1 L 320mm W 36mm H 265mm L1 36mm L2 280mm H1 215mm H2 40mm thread M12x1 tube ø 8.5mm 2 hole fixing connection M4 fryer windings 3		
accessories for	415470		
	GEV No.	521103	Ref. No. —
	nut thread M4 H 3mm WS 7 brass Qty 20 pcs		
	GEV No.	521104	Ref. No. —
	washer ID ø 4.3mm ED ø 8mm thickness 0.5mm brass Qty 20 pcs for thread M4		
	GEV No.	560111	Ref. No. —
	plain washer ID ø 4.3mm ED ø 9mm thickness 0.8mm SS Qty 20 pcs DIN 125A for thread M4		
	GEV No.	560131	Ref. No. —
	hexagonal nut thread M4 H 3.2mm WS 7 SS DIN/ISO DIN 934 / ISO 4032/8673 Qty 20 pcs		



heating elements for griddles

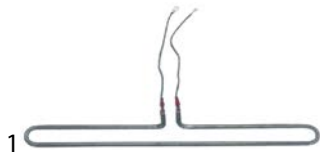

GEV No.	415480	Ref. No.	0H6182
description	heating element 1000W 220V heating circuits 1 L 457mm W 40mm H 70mm tube ø 8.5mm W1 212mm W2 33mm cable length 270mm griddle connection distance 24mm dry heating element		

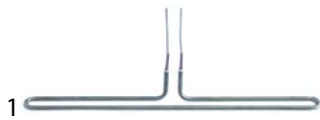

GEV No.	415482	Ref. No.	0H6155
description	heating element 1100W 400V heating circuits 1 L 538mm W 45mm H 67mm tube ø 8.5mm W1 252mm W2 34mm cable length 265mm griddle connection distance 25mm dry heating element		



GEV No.	415079	Ref. No.	053614
description	heating element 1250W 230V heating circuits 1 L 473mm W 52mm H 43mm tube ø 8.5mm griddle connection distance 44mm dry heating element		



GEV No.	415098	Ref. No.	0A2247
description	heating element 2250W 220V heating circuits 1 L 533mm W 75mm H 123mm tube ø 14mm L1 78mm L2 456mm connection cable cable length 2000mm dry heating element		



GEV No.	415479	Ref. No.	0H6183
description	heating element 750W 230V heating circuits 1 L 471mm W 30mm H mm tube ø 6.35mm rectangular flange connection male faston 6.3mm hole distance 36mm flange length 44mm flange width 20mm hole ø 4.5mm connection length 30mm dry heating element		

heating elements for large hobs

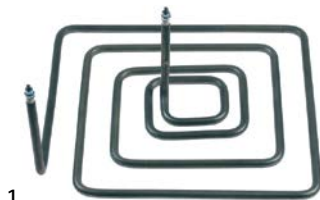

GEV No.	418697	Ref. No.	0K0618
description	heating element 2000W 400V L 270mm W 230mm H 115mm tube ø 8.5mm mounting pos. inner connection M4		

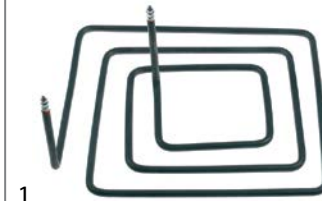

GEV No.	418698	Ref. No.	0K0617
description	heating element 2000W 400V L 300mm W 260mm H 115mm tube ø 8.5mm mounting pos. outer connection M4		

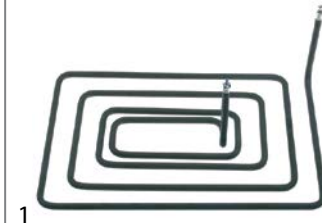

GEV No.	418699	Ref. No.	0H6206
description	heating element 2000W 400V L 345mm W 230mm H 110mm tube ø 8.5mm mounting pos. inner connection M4		

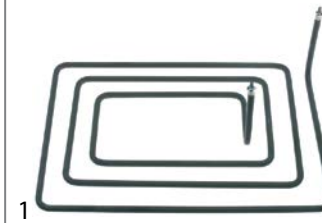

GEV No.	418700	Ref. No.	0H6205
description	heating element 2000W 400V L 380mm W 265mm H 110mm tube ø 8.5mm mounting pos. outer connection M4		

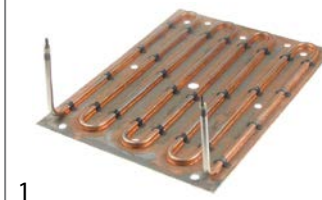

GEV No.	418009	Ref. No.	0K0563
description	heating element 4000W 400V heating circuits 1 L 380mm W 287mm H 116mm tube ø 8.5mm mounting pos. connection M4 dry heating element		

heating elements for tilting bratt pan

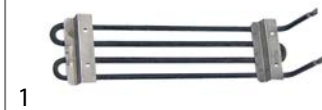



GEV No.	415273	Ref. No.	058345
description	heating element 1500W 220V L 373mm W 82mm H 78mm connection M5 dry heating element heating circuits 1 tube ø 8.5mm with holder connection distance 80mm		



			
GEV No.	415098	Ref. No.	0A2247
description	heating element 2250W 220V heating circuits 1 L 533mm W 75mm H 123mm tube ø 14mm L1 78mm L2 456mm connection cable cable length 2000mm dry heating element		

			
GEV No.	415822	Ref. No.	0H6707 0K2189 249213
description	heating element tilting bratt pan 1800W 230V L 540mm W 105mm Hmm connection male faston dry heating element heating circuits 1 tube ø 8.5mm L1 50mm L2 490mm W1 65mm W2 40mm connection length 10mm		

heating elements for pasta cookers

			
GEV No.	415597	Ref. No.	0C5347
description	heating element 3000W 230V heating circuits 3 L 255mm W 38mm H 26mm 3 hole flange connection male faston tube ø 6.3mm thermostat sleeves ø 7.5mm length thermostat sleeves 199mm hole distance 63mm mounting ø 47.5mm hole ø 8/10mm connection length 15mm immersion heater		
accessories for	415597		
	GEV No.	510408	Ref. No. 067620
	O-ring EPDM thickness 5.34mm ID ø 47mm Qty 1 pcs		
	GEV No.	510562	Ref. No. —
	O-ring silicone thickness 5.34mm ID ø 47mm Qty 1 pcs		

heating elements for chargrills

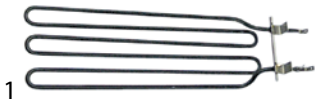
			
GEV No.	415352	Ref. No.	053613
description	heating element 2750W 240V L 480mm W 125mm H 41mm L1 70mm L2 40mm L3 370mm W1 23mm W2 79mm connection M4 connection distance 72mm tube ø 8.5mm heating circuits 1 dry heating element		

heating elements for salamanders/toast-

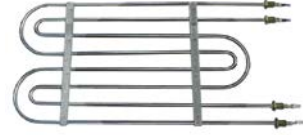

			
GEV No.	415559	Ref. No.	0K4777
description	heating element 2100W 400V heating circuits 1 L 260mm W 217mm H 20mm thread M14x1.25 mounting distance 210mm connection length 14mm tube ø 6.5mm 2 hole fixing dry heating element		

			
GEV No.	415537	Ref. No.	0H6169
description	heating element 3200W 230V heating circuits 2 L 493mm W 250mm thread M14x1.5 mounting distance 35mm connection length 45mm connection male faston 6.3mm tube ø 8.5mm dry heating element 4 hole fixing		

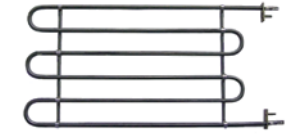
heating elements for heated trolleys

			
GEV No.	415596	Ref. No.	0G2290
description	heating element 1500W 230V heating circuits 1 L 395mm W 198mm tube ø 6.5mm lug length 31mm lug width 16mm connection length 30mm connection male faston 6.3mm dry heating element bracket mounting hole distance 160mm mounting thread M4		





pilot heating elements

			
GEV No.	415460	Ref. No.	0H6199
description	heating element 1000W 230V heating circuits 1 flange 70x18mm L 230mm W 65mm connection male faston 6.3mm tube ø 8.5mm immersion heater expansion flange connection length 20mm silicone TD ø 8mm		
accessories for	415460		
	GEV No.	375044	Ref. No. 0H6141
	safety thermostat switch-off temp. 178°C 1-pole 16A probe ø 4mm probe L 91mm capillary pipe 1730mm capillary pipe isolated 1600mm gland nut probe with sealing sleeve screw connection M8x1 sealing sleeve 8.6x32mm		





immersion heating elements

3 hole flange ø47.5mm

			
GEV No.	415690	Ref. No.	002835
description	heating element 9000W 230V mounting ø 47.5mm heating circuits 3 L 290mm W 32mm H 38mm number of thermostat sleeves 1 thermostat sleeves ø 5mm length thermostat sleeves 175mm thermostat sleeve centre tube ø 8.5mm hole distance 63mm hole ø 10mm connection M5 3 hole flange immersion heater		
spare parts for	415690		
	GEV No.	510408	Ref. No. 067620
	O-ring EPDM thickness 5.34mm ID ø 47mm Qty 1 pcs		
accessories for	415690		
	GEV No.	510408	Ref. No. 067620
	O-ring EPDM thickness 5.34mm ID ø 47mm Qty 1 pcs		
	GEV No.	510562	Ref. No. —
	O-ring silicone thickness 5.34mm ID ø 47mm Qty 1 pcs		

with expansion flange 70 x 18mm

			
GEV No.	415460	Ref. No.	0H6199
description	heating element 1000W 230V heating circuits 1 flange 70x18mm L 230mm W 65mm connection male faston 6.3mm tube ø 8.5mm immersion heater expansion flange connection length 20mm silicone TD ø 8mm		
accessories for	415460		
	GEV No.	375044	Ref. No. 0H6141
	safety thermostat switch-off temp. 178°C 1-pole 16A probe ø 4mm probe L 91mm capillary pipe 1730mm capillary pipe isolated 1600mm gland nut probe with sealing sleeve screw connection M8x1 sealing sleeve 8.6x32mm		

			
GEV No.	415461	Ref. No.	0H6170
description	heating element 4000W 230V heating circuits 2 flange 80x28mm L 237mm W 64mm connection male faston 6.3mm tube ø 8.5mm immersion heater expansion flange		

			
GEV No.	415462	Ref. No.	0H6202
description	heating element 4000W 400V heating circuits 2 flange 70x18mm L 256mm W 65mm connection male faston 6.3mm tube ø 8.5mm immersion heater expansion flange silicone		

			
GEV No.	415459	Ref. No.	0H6146
description	heating element 5600W 230V heating circuits 2 flange 70x18mm L 272mm W 64mm connection male faston 6.3mm tube ø 8.5mm immersion heater expansion flange H 19mm		

			
GEV No.	415557	Ref. No.	0H6164
description	heating element 5600W 400V heating circuits 2 L 272mm W 64mm tube ø 8.5mm connection male faston 6.3mm immersion heater expansion flange flange 70x18mm		

			
GEV No.	415463	Ref. No.	0H6171
description	heating element 6000W 230V heating circuits 2 flange 70x18mm L 385mm W 59mm connection male faston 6.3mm tube ø 8.5mm immersion heater expansion flange		

			
GEV No.	415464	Ref. No.	0H6198
description	heating element 6000W 400V heating circuits 2 flange 70x18mm L 380mm W 65mm connection male faston 6.3mm tube ø 8.5mm immersion heater expansion flange		

			
GEV No.	415345	Ref. No.	OK0551 214095
description	heating element 6000W 400V heating circuits 2 flange 70x18mm L 534mm W 65mm connection male faston 6.3mm tube ø 6.3mm immersion heater expansion flange connection length 22mm		

special flanges



1

GEV No.	416975	Ref. No.	OK0516
description	heating element 15000W 400V heating circuits 6 L 263mm W 240mm H 80mm tube ø 6.5mm connection cable cable length 1500mm immersion heater special fixing hole distance 48/56mm flange length 335mm flange width 125mm hole ø 10mm		
accessories for	416975		
	GEV No.	510560	Ref. No. OK5577
	gasket EPDM thickness 6mm ID ø 200mm dimensions 280x70mm Qty 1 pcs for heating element		



1

GEV No.	415797	Ref. No.	OK0517
description	heating element 18000W 400V heating circuits 6 L 325mm W 240mm H 45mm tube ø 6.5mm connection cable cable length 1250mm immersion heater rectangular flange hole distance 62mm flange length 336mm flange width 126mm hole ø 10mm		
accessories for	415797		
	GEV No.	510560	Ref. No. OK5577
	gasket EPDM thickness 6mm ID ø 200mm dimensions 280x70mm Qty 1 pcs for heating element		



1

GEV No.	415798	Ref. No.	OK0521
description	heating element 22500W 400V heating circuits 6 immersion heater rectangular flange		
accessories for	415798		
	GEV No.	510560	Ref. No. OK5577
	gasket EPDM thickness 6mm ID ø 200mm dimensions 280x70mm Qty 1 pcs for heating element		





1

GEV No.	415799	Ref. No.	OH6153
description	heating element 25200W 400V heating circuits 6 L 470mm W 235mm H 90mm connection cable cable length 1500mm immersion heater special fixing hole distance 48/56mm hole ø 10mm		
accessories for	415799		
	GEV No.	510560	Ref. No. OK5577
	gasket EPDM thickness 6mm ID ø 200mm dimensions 280x70mm Qty 1 pcs for heating element		

3/4"





1

GEV No.	415580	Ref. No.	OG0334
description	heating element 5000W 400V heating circuits 1 L 404mm W 23mm H 80mm cable length 400mm connection length 85mm immersion heater flange with thread H1 52mm H2 28mm thread 3/4"		
accessories for	415580		
	GEV No.	510403	Ref. No. —
	flat gasket fibre ED ø 36.5mm ID ø 27mm thickness 2mm Qty 1 pcs		
	GEV No.	510421	Ref. No. —
	gasket copper ED ø 31.8mm ID ø 26.4mm thickness 2.2mm for thread 3/4"		
	GEV No.	520234	Ref. No. —
	nut thread 3/4" H 5mm brass WS 30 Qty 1 pcs		







1 1/4"





1

GEV No.	415390	Ref. No.	OH6173
description	heating element 7500W 230V heating circuits 3 thread 1 1/4" L 410mm W 35mm H 28mm tube ø 6.5mm immersion heater flange with thread		
accessories for	415390		
	GEV No.	510405	Ref. No. —
	flat gasket fibre ED ø 56mm ID ø 42mm thickness 2mm for thread 1 1/4" Qty 1 pcs		
	GEV No.	520232	Ref. No. —
	nut thread 1 1/4" H 5mm nickel-plated brass WS 47 Qty 1 pcs		
	GEV No.	528021	Ref. No. —
	flat gasket PTFE ED ø 53mm ID ø 42.5mm thickness 3mm Qty 1 pcs equiv. no. 12001/02286 suitable for Astoria/Aurora/Brasilia/Wega		





1 1/2"			
			
GEV No.	415403	Ref. No.	0H6160
description	heating element 7500W 230V heating circuits 3 thread 1 1/2" L 495mm W 36mm H 33mm thermostat sleeves ø 9mm length thermostat sleeves 400mm thermostat sleeve centre not clinging tube ø 8.5mm connection M4 immersion heater connection length 35mm flange with thread number of thermostat sleeves 1		
accessories for	415403		
	GEV No.	510406	Ref. No. —
	flat gasket fibre ED ø 60mm ID ø 48mm thickness 3mm for thread 1 1/2" Qty 1 pcs		
	GEV No.	510424	Ref. No. —
	gasket copper ED ø 55mm ID ø 48mm thickness 2.2mm Centellen for thread 1 1/2"		
	GEV No.	520211	Ref. No. —
	reducer thread 2" ET - 1 1/2" IT brass		
	GEV No.	520212	Ref. No. —
	hexagonal nut thread 1 1/2" brass WS 60 H 8mm		
	GEV No.	550361	Ref. No. —
	blind flange ø 58mm thread 1 1/2"		

heating elements for convection

			
GEV No.	415123	Ref. No.	0H6212 214759
description	heating element 1750W 220V heating circuits 1 ID ø 186mm ED ø 199mm L 222mm H 29mm L1 14mm W1 30mm H1 9mm H2 20mm flange length 70mm flange width 22mm hole distance 56mm connection male faston 6.3mm tube ø 6.3mm convection heating element hole ø 5mm rectangular flange		
accessories for	415123		
	GEV No.	510368	Ref. No. —
	gasket L 70mm W 23.5mm hole ø 5mm hole distance 56mm FIBER thickness 2mm for heating element		



			
GEV No.	418468	Ref. No.	0H6210
description	heating element 2000W 230V heating circuits 1 ID ø 192mm ED ø 203mm L 215mm H 32mm L1 8mm H1 12mm H2 18mm flange length 70mm flange width 22mm hole distance 56mm connection male faston 6.3mm tube ø 6.5mm convection heating element hole ø 6.5mm rectangular flange		



			
GEV No.	415116	Ref. No.	0H6157
description	heating element 2600W 230V heating circuits 1 ID ø 190mm ED ø 210mm L 220mm H 28mm L1 10mm W1 31mm H1 5mm H2 23mm flange length 70mm flange width 22mm hole distance 56mm connection male faston 6.3mm tube ø 6.5mm convection heating element hole ø 5mm rectangular flange		
accessories for	415116		
	GEV No.	510368	Ref. No. —
	gasket L 70mm W 23.5mm hole ø 5mm hole distance 56mm FIBER thickness 2mm for heating element		



			
GEV No.	418470	Ref. No.	0H6168
description	heating element 3000W 230V heating circuits 2 ID ø 350mm ED ø 365mm L 390mm H 118mm W1 62mm H1 34mm H2 84mm flange length 85mm flange width 30mm connection length 90mm tube ø 6.5mm dry heating element hole ø 6.5mm rectangular flange L1 40mm		



			
GEV No.	418487	Ref. No.	OK3049 293688
description	heating element 3150W 230V heating circuits 3 ID ø 201mm ED ø 218mm L 275mm H 41mm L1 54mm W1 63mm H1 3mm H2 38mm flange length 93mm flange width 22mm hole distance 78mm connection male faston 6.3mm connection length 65mm tube ø 8.5mm convection heating element hole ø 5mm rectangular flange		





 <p>1</p>			
GEV No.	415657	Ref. No.	002757
description	heating element 4500W 230V heating circuits 3 L 534mm W 350mm H 70mm L1 96mm L2 438mm W1 160mm W2 33mm H1 37mm H2 33mm flange length 76mm flange width 50mm hole distance 60mm hole ø 6mm tube ø 8.5mm convection heating element connection male faston 6.3mm connection length 103mm rectangular flange		
accessories for	415657		
	GEV No.	550256	Ref. No. 055327
	gasket L 75mm W 50mm hole ø 5mm hole distance 59.5mm rubber thickness 3mm for heating element suitable for JUNO equiv. no. 55327		
	GEV No.	550257	Ref. No. 002689
	gasket L 137mm W 79mm thickness 3.5mm for heating element suitable for JUNO equiv. no. 02689		



 <p>1</p>			
GEV No.	415654	Ref. No.	002688
description	heating element 5666W 230V heating circuits 2 ID ø 465mm ED ø 480mm L 580mm H 65mm L1 90mm W1 32mm H1 34mm H2 31mm flange length 80mm flange width 45mm hole distance 56mm connection M5 connection length 108mm tube ø 8.5mm convection heating element hole ø 6mm rectangular flange		
accessories for	415654		
	GEV No.	550256	Ref. No. 055327
	gasket L 75mm W 50mm hole ø 5mm hole distance 59.5mm rubber thickness 3mm for heating element suitable for JUNO equiv. no. 55327		
	GEV No.	550257	Ref. No. 002689
	gasket L 137mm W 79mm thickness 3.5mm for heating element suitable for JUNO equiv. no. 02689		

 <p>1</p>			
GEV No.	415656	Ref. No.	0A5330
description	heating element 8000W 400V heating circuits 2 ID ø 560mm ED ø 580mm L 630mm H 68mm L1 50mm W1 33mm H1 37mm H2 29mm flange length 80mm flange width 45mm hole distance 60mm connection M5 connection length 15mm tube ø 8.5mm convection heating element hole ø 6mm rectangular flange		
accessories for	415656		
	GEV No.	550256	Ref. No. 055327
	gasket L 75mm W 50mm hole ø 5mm hole distance 59.5mm rubber thickness 3mm for heating element suitable for JUNO equiv. no. 55327		
	GEV No.	550257	Ref. No. 002689
	gasket L 137mm W 79mm thickness 3.5mm for heating element suitable for JUNO equiv. no. 02689		

 <p>1</p>			
GEV No.	415487	Ref. No.	OK0601
description	heating element 1000W 230V heating circuits 1 L 445mm W 65mm flange length 70mm flange width 22mm hole distance 28mm connection length 25mm connection male faston 6.3mm tube ø 6.5mm hole ø 3mm W1 30mm rectangular flange convection heating element		
accessories for	415487		
	GEV No.	510368	Ref. No. —
	gasket L 70mm W 23.5mm hole ø 5mm hole distance 56mm FIBER thickness 2mm for heating element		

 <p>1</p>			
GEV No.	415488	Ref. No.	0H6195
description	heating element 1500W 230V heating circuits 1 L 435mm W 175mm L1 55mm L2 380mm W2 30mm flange length 70mm flange width 22mm hole distance 56mm connection length 36mm connection male faston 6.3mm tube ø 6.3mm hole ø 3mm W1 72mm rectangular flange for hot air oven		
accessories for	415488		
	GEV No.	510368	Ref. No. —
	gasket L 70mm W 23.5mm hole ø 5mm hole distance 56mm FIBER thickness 2mm for heating element		

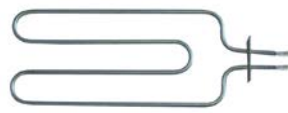
 <p>1</p>			
GEV No.	418469	Ref. No.	0H6208 214728
description	heating element 1500W 240V heating circuits 1 L 350mm W 95mm L1 30mm L2 320mm W2 80mm flange length 70mm flange width 22mm hole distance 56.5mm connection length 15mm connection male faston 6.3mm tube ø 6.3mm hole ø 3.5mm W1 15mm rectangular flange convection heating element windings 2		

 <p>1</p>			
GEV No.	415485	Ref. No.	0H6197
description	heating element 2000W 230V heating circuits 1 L 360mm W 155mm L1 35mm L2 325mm W2 30mm flange length 70mm flange width 22mm hole distance 28mm connection length 63mm connection male faston 6.3mm tube ø 6.3mm W1 62mm rectangular flange convection heating element mounting thread M4		
spare parts for	415485		
	GEV No.	510368	Ref. No. —
	gasket L 70mm W 23.5mm hole ø 5mm hole distance 56mm FIBER thickness 2mm for heating element		







1

GEV No.	415242	Ref. No.	0H6213
description	heating element 2x3500W 230V heating circuits 2 L 240mm W 390mm H 30mm W2 50mm flange length 70mm flange width 22mm hole distance 56mm connection length 20mm connection male faston 6.3mm tube ø 6.5mm hole ø 5mm W1 290mm rectangular flange convection heating element		
accessories for	415242		
	GEV No.	510368	Ref. No. —
	gasket L 70mm W 23.5mm hole ø 5mm hole distance 56mm FIBER thickness 2mm for heating element		





1

GEV No.	415457	Ref. No.	0H6166
description	heating element 3000W 230V heating circuits 2 L 330mm W 135mm L1 60mm L2 270mm H 30mm W2 110mm flange length 85mm flange width 30mm connection length 105mm connection male faston 6.3mm tube ø 6.5mm hole ø 6.5mm W1 25mm rectangular flange hot air		
accessories for	415457		
	GEV No.	510561	Ref. No. 0H7021
	O-ring silicone thickness 3mm ID ø 55mm Qty 1 pcs		
	GEV No.	520239	Ref. No. 0H6648
	counterflange L 110mm W 35mm		
	GEV No.	521142	Ref. No. 0H6665
	gasket L 68mm W 13mm for heating element		
	GEV No.	528203	Ref. No. —
	gasket rubber ED ø 18mm ID ø 12mm thickness 3mm Qty 1 pcs		





1

GEV No.	415458	Ref. No.	0H6188
description	heating element 3000W 230V heating circuits 2 L 575mm W 150mm W2 125mm flange length 70mm flange width 22mm hole distance 55mm connection length 20mm connection male faston 6.3mm tube ø 6.5mm hole ø 3mm W1 25mm rectangular flange convection heating element		
spare parts for	415458		
	GEV No.	510368	Ref. No. —
	gasket L 70mm W 23.5mm hole ø 5mm hole distance 56mm FIBER thickness 2mm for heating element		



1

GEV No.	415616	Ref. No.	0H6189
description	heating element 3000W 380V heating circuits 2 L 575mm W 150mm W2 125mm flange length 70mm flange width 22mm hole distance 28mm connection length 20mm connection male faston 6.3mm tube ø 6.3mm hole ø 4mm W1 25mm rectangular flange dry heating element		
accessories for	415616		
	GEV No.	510368	Ref. No. —
	gasket L 70mm W 23.5mm hole ø 5mm hole distance 56mm FIBER thickness 2mm for heating element		



1

GEV No.	415806	Ref. No.	0H6176
description	heating element 5200W 230V heating circuits 2 L 240mm W 390mm H 30mm W2 50mm flange length 70mm flange width 22mm hole distance 56mm connection male faston 6.3mm tube ø 6.5mm hole ø 5mm W1 290mm rectangular flange convection heating element		
accessories for	415806		
	GEV No.	510368	Ref. No. —
	gasket L 70mm W 23.5mm hole ø 5mm hole distance 56mm FIBER thickness 2mm for heating element		

radiation heaters

square



1

GEV No.	490159	Ref. No.	0C2128
description	radiation heater L 300mm W 300mm 3500W 230V connections 3 square without pan detection EGO		
spare parts for	490159		
	GEV No.	499157	Ref. No. —
	protection pipe for temperature probe ceramic L 297mm ED ø 7mm ID ø 5mm		

1

GEV No.	490008	Ref. No.	OK0589
description	radiation heater L 300mm W 300mm 4000W 400V heating circuits 2 connections 3 square connection type male faston 6.3mm without pan detection EGO		
spare parts for	490008		
	GEV No.	499157	Ref. No.
	protection pipe for temperature probe ceramic L 297mm ED ø 7mm ID ø 5mm		

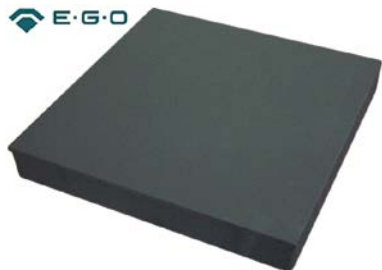

1

GEV No.	490086	Ref. No.	0H6083
description	hot plate dimensions 300x300mm 2500W 400V with cast edge tilt boiling plate connection 3 screw clamps H 43mm square		

hot plates

square & rectangular

with radiused edge



1

GEV No.	490128 ¹	Ref. No.	OK0339
description	hot plate dimensions 300x300mm 2500W 400V with spill ring connection 4 screw clamps protector yes square		

¹incl. protector



1

GEV No.	490074 ¹	Ref. No.	052200
description	hot plate dimensions 300x300mm 4000W 400V with spill ring connection 4 screw clamps protector yes square		

¹incl. protector

tiltable



1

GEV No.	490085	Ref. No.	OK9761
description	hot plate dimensions 300x300mm 2500W 230V with cast edge tilt boiling plate connection 3 screw clamps H 43mm square		

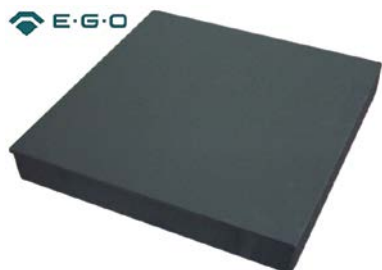

1

GEV No.	490088	Ref. No.	0H6079
description	hot plate dimensions 300x300mm 2500W 400V with cast edge tilt boiling plate connection 4 screw clamps H 43mm square		

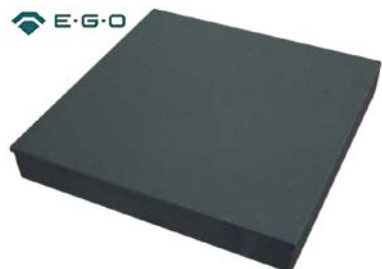

1

GEV No.	490089	Ref. No.	OK0371
description	hot plate dimensions 300x300mm 4000W 230V with cast edge tilt boiling plate connection 4 screw clamps H 43mm square		

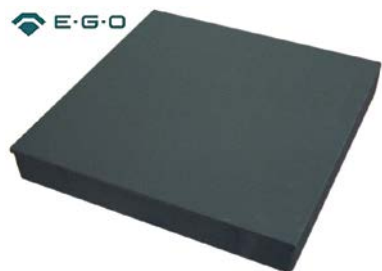

1

GEV No.	490090	Ref. No.	OK0381
description	hot plate dimensions 300x300mm 4000W 400V with cast edge tilt boiling plate connection 4 screw clamps H 43mm square		



round

with radiused edge

for domestic and commercial kitchens



GEV No.	490012	Ref. No.	053406
description	hot plate ø 145mm 1500W 230V connection 4 screw clamps with 8mm spill ring		



GEV No.	490014	Ref. No.	0G6313
description	hot plate ø 180mm 1500W 230V connection 4 screw clamps with 8mm spill ring		



GEV No.	490016	Ref. No.	0K0350
description	hot plate ø 180mm 2000W 230V connection 4 screw clamps with 8mm spill ring		



GEV No.	490017	Ref. No.	0K0343
description	hot plate ø 180mm 2000W 400V connection 4 screw clamps with 8mm spill ring		



GEV No.	490018	Ref. No.	0K0334
description	hot plate ø 220mm 2000W 230V connection 4 screw clamps with 8mm spill ring		

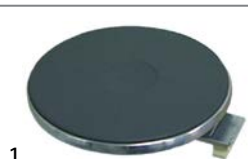

GEV No.	490019	Ref. No.	0K0356
description	hot plate ø 220mm 2000W 400V connection 4 screw clamps with 8mm spill ring		



GEV No.	490020	Ref. No.	053407
description	hot plate ø 220mm 2600W 230V connection 4 screw clamps with 8mm spill ring		
accessories for	490020		
	GEV No.	550796	Ref. No.
			—
	fixing plate for hot plate ø220mm		



GEV No.	490061	Ref. No.	0K0578
description	hot plate ø 300mm 2500W 230V connection 4 screw clamps with 8mm spill ring		



GEV No.	490063	Ref. No.	0H6080
description	hot plate ø 300mm 2500W 400V connection 4 screw clamps with 8mm spill ring		

with cast brim

with screw connection



GEV No.	490100	Ref. No.	0K0374
description	hot plate ø 400mm 5000W 230V connection 2x 3 screw clamps with cast edge H 42mm		

miscellaneous



GEV No.	490158	Ref. No.	0K0362
description	hot plate dimensions 300x300mm 2500W 230V		



accessories

fasteners

			
1			
GEV No.	550129	Ref. No.	OG4300
description	bearing screw for tilt boiling plate straight thread M12x80		

energy regulators

EGO

1-circuit

			
1			
GEV No.	380015	Ref. No.	OC1605
description	energy regulator 230V 13A single-circuit turn direction right shaft ø 6x4.6mm shaft L 23mm mounting thread M4 power release 6-100% no. 50.57021.010		

thermostats

control and safety thermostats

EGO

control thermostats

55.10/19_ series

			
1			
GEV No.	375568	Ref. No.	OH6126
description	thermostat t.max. 140°C temperature range 50-140°C 1-pole 1NO 0.5A probe ø 6mm probe L 107mm capillary pipe 860mm capillary pipe isolatedmm gland nut shaft ø 6x4.6mm shaft L 23mm shaft position° shaft position rotation 270°		

			
1			
GEV No.	390156	Ref. No.	051360
description	thermostat t.max. 260°C temperature range 50-260°C 1-pole 1NO 16A probe ø 4mm probe L 115mm capillary pipe 1300mm capillary pipe isolated 1300mm gland nut shaft ø 6x4.6mm shaft L 23mm shaft position upper rotation 270°		

			
1			
GEV No.	375667	Ref. No.	056384
description	thermostat t.max. 300°C temperature range 68-300°C 1-pole 1NO 16A probe ø 3.1mm probe L 226mm capillary pipe 980mm capillary pipe isolated 980mm gland nut shaft ø 6x4.6mm shaft L 23mm shaft position upper rotation 318°		

			
1			
GEV No.	375809	Ref. No.	OK3061
description	thermostat t.max. 90°C temperature range 30-90°C 1-pole 1NO 16A probe ø 6mm probe L 130mm capillary pipe 1800mm capillary pipe isolated 1800mm gland nut shaft ø 6x4.6mm shaft L 23mm shaft position upper rotation 270°		

			
1			
GEV No.	375042	Ref. No.	OH6440 232909
description	thermostat t.max. 98°C temperature range 50-98°C 1-pole 1CO 16A probe ø 3.1mm probe L 334mm capillary pipe 2410mm capillary pipe isolated 1400mm gland nut M9x1 shaft L 23mm shaft position upper rotation 270° probe material SS		

55.13_series

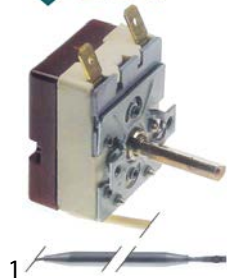

GEV No.	375567	Ref. No.	OK0659
description	thermostat t.max. 110°C temperature range 30-110°C 1-pole 1NO 16A probe ø 6mm probe L 115mm capillary pipe 1130mm capillary pipe isolated 800mm gland nut shaft ø 6x4.6mm shaft L 23mm shaft position upper rotation 270°		



GEV No.	375067	Ref. No.	OK0673
description	thermostat t.max. 125°C temperature range fixed 125°C 1-pole probe ø 3.03mm probe L 147mm capillary pipe 830mm capillary pipe isolatedmm gland nut probe material SS		

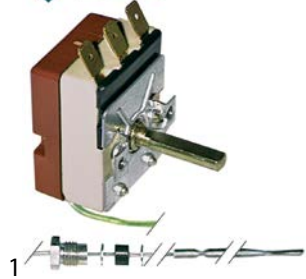

GEV No.	375041	Ref. No.	0H6439
description	thermostat t.max. 250°C temperature range 50-250°C 1-pole 1CO 16A probe ø 3.1mm probe L 160mm capillary pipe 1430mm capillary pipe isolated 800mm gland nut M9x1 shaft L 23mm shaft position upper rotation 270°		

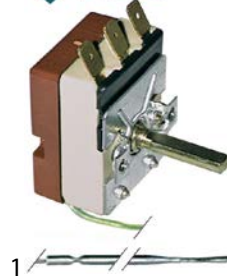

GEV No.	375069	Ref. No.	OK0634
description	thermostat t.max. 255°C temperature range 50-255°C 1-pole 1CO 16A probe ø 3.03mm probe L 160mm capillary pipe 1430mm capillary pipe isolated 800mm gland nut shaft L 23mm probe material SS		

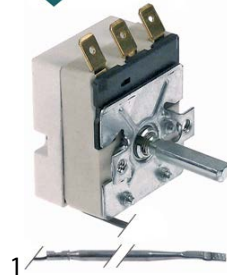

GEV No.	375835	Ref. No.	0H6241
description	thermostat t.max. 280°C temperature range 50-280°C 1-pole 1CO 16A probe ø 3.1mm probe L 160mm capillary pipe 1430mm capillary pipe isolated 800mm gland nut shaft ø 6x4.6mm shaft L 23mm shaft position upper rotation 270°		



GEV No.	375505	Ref. No.	0H2049
description	thermostat t.max. 320°C temperature range 50-320°C 1-pole 1NO 16A probe ø 3mm probe L 160mm capillary pipe 870mm capillary pipe isolatedmm gland nut shaft ø 6x4.6mm shaft L 23mm shaft position upper rotation 270°		



GEV No.	375810	Ref. No.	0H9843
description	thermostat t.max. 80°C temperature range fixed 80°C 1-pole 1NC 16A probe ø 7.5mm probe L 30.5mm capillary pipe 810mm capillary pipe isolatedmm gland nut shaft L 23mm		



55.22_series

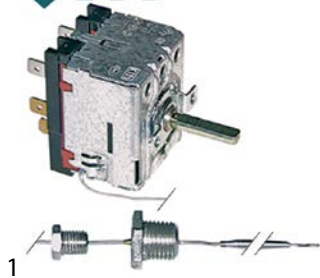

GEV No.	375080	Ref. No.	0H6242 212795
description	thermostat t.max. 102°C temperature range 30-90 / 50-102°C 2-pole 2CO 16A probe ø 3.1mm probe L 334mm capillary pipe 1440mm capillary pipe isolated 1400mm gland nut shaft ø 6x4.6mm shaft L 23mm shaft position upper rotation 270° probe thread 1/4"		

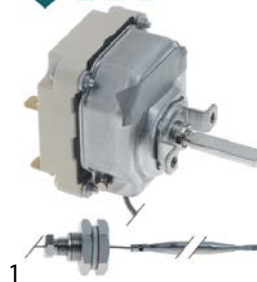

GEV No.	375957	Ref. No.	0H6233 215076
description	thermostat t.max. 180°C temperature range 100-180°C 3-pole 3NO 16A probe ø 6mm probe L 133mm capillary pipe 910mm capillary pipe isolated 770mm gland nut M9x1 shaft ø 6x4.6mm shaft L 23mm shaft position upper rotation 270°		

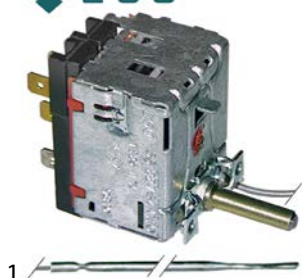

GEV No.	375147	Ref. No.	0H6138
description	thermostat t.max. 255°C temperature range 30-255°C 2-pole 2CO 16A probe ø 3.03mm probe L 147mm capillary pipe 1440mm capillary pipe isolated 1250mm gland nut shaft ø 6x4.6mm shaft L 23mm shaft position right rotation 270°		



GEV No.	375022	Ref. No.	0H6127 212698
description	thermostat t.max. 180°C temperature range 95-180°C 3-pole 3NO 16A probe ø 6mm probe L 133mm capillary pipe 1780mm capillary pipe isolated 1400mm gland nut M9x1 shaft ø 6x4.6mm shaft L 23mm rotation 270°		

55.34_series

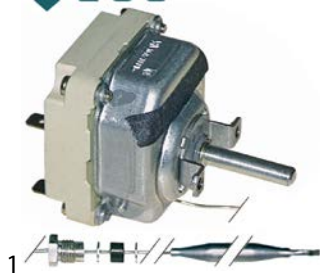

GEV No.	375143	Ref. No.	004911 214948
description	thermostat t.max. 110°C temperature range 32-110°C 3-pole 3NO 16A probe ø 6mm probe L 138mm capillary pipe 1480mm capillary pipe isolated 1100mm gland nut M9x1 shaft ø 6x4.6mm shaft L 23mm shaft position upper rotation 270°		



GEV No.	375043	Ref. No.	0H6221 214840
description	thermostat t.max. 200°C temperature range 65-200°C 3-pole 3NO 16A probe ø 6mm probe L 77mm capillary pipe 880mm capillary pipe isolated 800mm gland nut M9x1 shaft ø 6x4.6mm shaft L 23mm shaft position upper rotation 270°		



GEV No.	375038	Ref. No.	0H6217
description	thermostat t.max. 300°C temperature range 50-300°C 3-pole 3NO 16A probe ø 6mm probe L 79mm capillary pipe 1740mm capillary pipe isolated 800mm gland nut shaft ø 6x4.6mm shaft L 23mm shaft position upper rotation 270°		
accessories for	375038		
	GEV No.	110123	Ref. No. —
	knob thermostat t.max. 300°C ø 50mm shaft ø 6x4.6mm shaft flat upper black temperature range 50-300°C rotation 270°		



GEV No.	375412	Ref. No.	0A2206
description	thermostat t.max. 320°C temperature range 50-320°C 3-pole 3NO 16A probe ø 3.1mm probe L 226mm capillary pipe 1480mm capillary pipe isolated 1400mm gland nut shaft ø 6x4.6mm shaft L 23mm shaft position upper rotation 318°		



GEV No.	375569	Ref. No.	0H6218
description	thermostat t.max. 300°C temperature range 60-300°C 3-pole 3NO 16A probe ø 3.1mm probe L 263mm capillary pipe 1180mm capillary pipe isolated 800mm gland nut shaft ø 6x4.6mm shaft L 23mm shaft position upper rotation 270°		



GEV No.	390038	Ref. No.	0KI260
description	thermostat t.max. 90°C temperature range 30-90°C 3-pole 3CO 16A probe ø 6mm probe L 215mm capillary pipe 900mm capillary pipe isolatedmm gland nut shaft Lmm		



GEV No.	375420	Ref. No.	0H6216
description	thermostat t.max. 320°C temperature range 110-320°C 3-pole 3NO 16A probe ø 6mm probe L 96mm capillary pipe 1780mm capillary pipe isolated 1600mm gland nut shaft ø 6x4.6mm shaft L 23mm shaft position upper rotation 270°		



GEV No.	375411	Ref. No.	052000
description	thermostat t.max. 93°C temperature range 30-93°C 3-pole 3NO 16A probe ø 6mm probe L 129mm capillary pipe 1480mm capillary pipe isolated 1100mm gland nut M10x1 shaft ø 6x4.6mm shaft L 23mm shaft position upper rotation 270°		



safety thermostats

51._ series





GEV No.	375078	Ref. No.	0H6145
description	safety thermostat switch-off temp. 313°C 1-pole 0.5A probe ø 3.1mm probe L 160mm capillary pipe 830mm capillary pipe isolatedmm gland nut probe SS		

55.13_ series

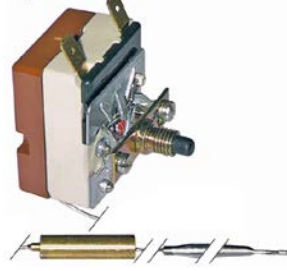

GEV No.	375157	Ref. No.	0K0649
description	safety thermostat switch-off temp. 140°C 1-pole 16A probe ø 5mm probe L 96mm capillary pipe 1470mm capillary pipe isolatedmm gland nut probe		



GEV No.	375044	Ref. No.	0H6141	
description	safety thermostat switch-off temp. 178°C 1-pole 16A probe ø 4mm probe L 91mm capillary pipe 1730mm capillary pipe isolated 1600mm gland nut probe with sealing sleeve screw connection M8x1 sealing sleeve 8.6x32mm			
accessories for	375044			
	GEV No.	102067	Ref. No.	—
	nut thread M8x1 H 3mm brass Qty 1 pcs type SEF 1			
	GEV No.	551083	Ref. No.	—
	cap for safety thermostat thread M8x1			



GEV No.	375106	Ref. No.	0H6142
description	safety thermostat switch-off temp. 190°C 1-pole 16A probe ø 3.1mm probe L 178mm capillary pipe 350mm capillary pipe isolatedmm gland nut M9x1 probe SS		



GEV No.	375156	Ref. No.	0K1877
description	safety thermostat switch-off temp. 291°C 1-pole 16A probe ø 5mm probe L 90mm capillary pipe 870mm capillary pipe isolatedmm gland nut probe SS		



GEV No.	375076	Ref. No.	0H6243
description	safety thermostat switch-off temp. 350°C 1-pole 1NO 16A probe ø 3.03mm probe L 141mm capillary pipe 830mm capillary pipe isolated 450mm gland nut probe SS		

55.31_ series



GEV No.	390165	Ref. No.	051644
description	safety thermostat switch-off temp. 140°C 3-pole 20A probe ø 6mm probe L 173mm capillary pipe 830mm capillary pipe isolated 800mm gland nut probe SS		



GEV No.	375641	Ref. No.	054932
description	safety thermostat switch-off temp. 250°C 3-pole 20A probe ø 6mm probe L 239mm capillary pipe 2530mm capillary pipe isolated 1600/210mm gland nut probe SS		



GEV No.	375047	Ref. No.	0H6136
description	safety thermostat switch-off temp. 320°C 3-pole 20A probe ø 6mm probe L 177mm capillary pipe 1430mm capillary pipe isolated 800mm gland nut M9x1 probe SS		



GEV No.	375571	Ref. No.	051454
description	safety thermostat switch-off temp. 350°C 3-pole 20A probe ø 6mm probe L 157mm capillary pipe 940mm capillary pipe isolated 890mm gland nut probe SS		



GEV No.	375377	Ref. No.	051643
description	safety thermostat switch-off temp. 350°C 3-pole 3NC 1x20/2x0.5A probe ø 6mm probe L 157mm capillary pipe 1230mm capillary pipe isolated 1100mm gland nut probe		

55.32_ series



GEV No.	375394	Ref. No.	0K3967
description	safety thermostat switch-off temp. 135°C 3-pole 1CO/2NC 20A probe ø 6mm probe L 73mm capillary pipe 1490mm capillary pipe isolated 1350mm gland nut M9x1 probe SS		

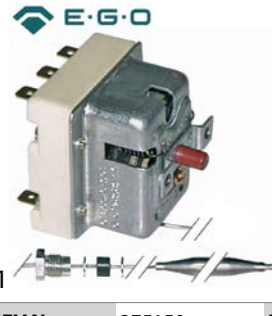

GEV No.	375150	Ref. No.	0H6219
description	safety thermostat switch-off temp. 145°C 3-pole 20A probe ø 3mm probe L 178mm capillary pipe 1790mm capillary pipe isolated 800mm gland nut M9x1 probe		



GEV No.	375170	Ref. No.	002711
description	safety thermostat switch-off temp. 150°C 1-pole 20A probe ø 6mm probe L 74mm capillary pipe 1700mm capillary pipe isolated 1100mm gland nut probe		



GEV No.	375657	Ref. No.	0C1147
description	safety thermostat switch-off temp. 150°C 2-pole 1x20/1x0.5A probe ø 6mm probe L 74mm capillary pipe 1700mm capillary pipe isolated 1100mm gland nut probe SS		



GEV No.	375045	Ref. No.	0H6215 213149 214803
description	safety thermostat switch-off temp. 315°C 3-pole 3NC 20A probe ø 6mm probe L 77mm capillary pipe 1490mm capillary pipe isolated 1100mm gland nut M9x1 probe SS		



GEV No.	375579	Ref. No.	003594
description	safety thermostat switch-off temp. 360°C 1-pole 0.5A probe ø 6mm probe L 74mm capillary pipe 1500mm capillary pipe isolated 1500mm gland nut probe		



GEV No.	375789	Ref. No.	005680
description	safety thermostat switch-off temp. 338°C 2-pole 20A probe ø 11mm probe L 16mm capillary pipe 900mm capillary pipe isolated 900mm gland nut screw-in probe probe thread M14x1		



GEV No.	390142	Ref. No.	004919
description	safety thermostat switch-off temp. 360°C 3-pole 20A probe ø 3.1mm probe L 188mm capillary pipe 1490mm capillary pipe isolated 800mm gland nut probe SS		



GEV No.	375455	Ref. No.	002730
description	safety thermostat switch-off temp. 350°C 1-pole 16A probe ø 11mm probe L 16mm capillary pipe 900mm capillary pipe isolated 900mm gland nut probe screw-in probe probe thread M14x1		

control thermostats with operation switch

55.10/19_ series



GEV No.	390052	Ref. No.	052330
description	thermostat t.max. 185°C temperature range 90-185°C 1-pole 1NO 15A probe ø 4mm probe L 229mm capillary pipe 2500mm capillary pipe isolated 1200/200mm gland nut shaft ø 6x4.6mm shaft L 23mm shaft position upper° rotation 270° outer switch 2NO		



GEV No.	390141	Ref. No.	006826
description	safety thermostat switch-off temp. 350°C 3-pole 3NC 20A probe ø 6mm probe L 77mm capillary pipe 1490mm capillary pipe isolated 800mm gland nut probe SS		

55.34_series



GEV No.	375570	Ref. No.	OK0662
description	thermostat t.max. 470°C temperature range 100-470°C 1-pole 1NO 16A probe ø 3.9mm probe L 228mm capillary pipe 1110mm capillary pipe isolated 600mm gland nut shaft ø 6x4.6mm shaft L 24mm shaft position upper rotation 270° outer switch 2NO		



GEV No.	375877	Ref. No.	OG2529
description	thermostat t.max. 530°C temperature range 100-530°C 3-pole 3NO 16A probe ø 3.9mm probe L 228mm capillary pipe 1110mm capillary pipe isolated 1000mm gland nut shaft ø 6x4.6mm shaft L 23mm shaft position shaft position 90° rotation 270° outer switch 0-1 with operation switch		

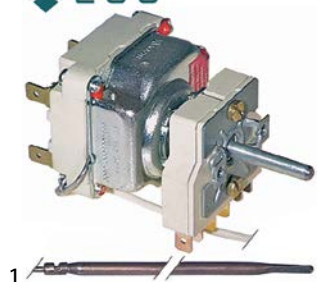

GEV No.	375246	Ref. No.	OK0496
description	thermostat t.max. 645°C temperature range 100-615/645°C 2-pole 2NO 16A probe ø 4mm probe L 230mm capillary pipe 1100mm capillary pipe isolated 600mm gland nut shaft ø 6x4.6mm shaft L 25mm shaft position lower rotation 270° outer switch 2NO probe material copper		

63._series

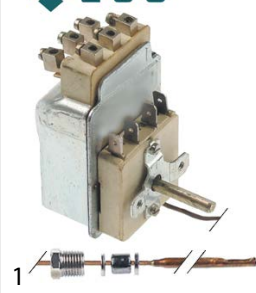

GEV No.	390514	Ref. No.	OK0492
description	thermostat t.max. 300°C temperature range 50-300°C 3-pole 3NO 15A probe ø 4.76mm probe L 293.5mm capillary pipe 1800mm shaft ø 6x4.6mm shaft L 23mm shaft position upper rotation 318° outer switch 2NO		

various

control thermostats with operation switch



GEV No.	375425	Ref. No.	OH6123
description	thermostat t.max. 360°C temperature range 130-400°C 2-pole probe L 228mm		

control thermostats with actual value



GEV No.	379035	Ref. No.	OH6479
description	thermostat t.max. 120°C temperature range 0-120°C 1-pole 1CO 5A probe ø 10mm probe L 32mm capillary pipe 1500mm capillary pipe isolated 1500mm gland nut M10x1 mounting ø 80mm		

accessories

probe clips

spring clips

for safety thermostat



GEV No.	550005	Ref. No.	OH6907
description	probe clip for pipe ø 17x6mm for probe ø 6mm Qty 1 pcs for flat tube heating element		



capillary tube clips			
1			
GEV No.	550004	Ref. No.	0H6906
description	capillary tube clip for pipe ø 17x6mm for flat tube heating element		

1			
GEV No.	550138	Ref. No.	052262
description	capillary tube clip for pipe ø 8.5mm for circular tube heating elements		

connecting bows			
1			
GEV No.	550060	Ref. No.	054376
description	connecting bow long for thermostat Qty 1 pcs		

1			
GEV No.	550059	Ref. No.	0A2205 253566
description	connecting bow short for switch Qty 1 pcs		

switches and momentary switches

rocker/momentary rocker switches

30x22mm			
blank			
1			
GEV No.	346297	Ref. No.	056880
description	rocker switch mounting measurements 30x22mm orange 2NO 230V 16A illuminated connection male faston 6.3mm ambient temperature max. 125/55°C protection IP65		
accessories for	346297		
		GEV No.	301036
		Ref. No.	—
	protective cover internal size 30x22mm for rocker switch mounting measurementsmm		

1			
GEV No.	346298	Ref. No.	056879
description	rocker switch mounting measurements 30x22mm yellow 2NO 230V 16A illuminated II connection male faston 6.3mm ambient temperature max. 125/55°C protection IP65 with cover cap		
accessories for	346298		
		GEV No.	301036
		Ref. No.	—
	protective cover internal size 30x22mm for rocker switch mounting measurementsmm		

push/momentary push switches

30x22mm			
1			
GEV No.	301040 ¹	Ref. No.	0H6697
description	push switch mounting measurements 30x22mm green 2NO 250V 16A illuminated connection male faston 6.3mm ambient temperature max. 85°C protection IP40		

	illuminated		
ø16mm			
1			
GEV No.	346287 ¹	Ref. No.	002418
description	momentary push switch mounting ø 16mm red 1NO 250V 3A illuminated connection male faston 2.8mm ambient temperature max. 125/55°C protection IP65 with cover cap		

	illuminated		
ø25mm			
1			
GEV No.	345161 ¹	Ref. No.	054518
description	push switch mounting ø 25mm green 2NO 250V 16A illuminated connection male faston 6.3mm ambient temperature max. 85°C protection IP40		

	illuminated		
1			
GEV No.	345039	Ref. No.	053979
description	protective cover round ED ø 33mm external size 23mm internal size 21mm H 12mm clear mounting ø 25mm		
accessories for	345039		
		GEV No.	345001
		Ref. No.	—
	momentary push switch mounting ø 25mm yellow 1NO/indicator light 250V 16A cover connection male faston 6.3mm ambient temperature max. 85°C protection IP65		



accessories

protective covers



GEV No.	346577	Ref. No.	0H6588
description	protective cover		

microswitches

lever actuated



GEV No.	346362	Ref. No.	0K2976
description	microswitch with lever connection cable		



GEV No.	345254	Ref. No.	046286
description	microswitch with lever 250V 16A 1CO connection male faston 6.3mm ambient temperature max. 120°C mounting distance 22mm actuating force: 60g lever length 58mm		



GEV No.	345757	Ref. No.	0K1003
description	microswitch with plunger 250V 16A 1CO connection male faston 6.3mm L 28mm ambient temperature max. 125°C mounting distance 22mm type EF83161.3 actuating force: 75g blue/black		

roller-lever actuated

microswitches

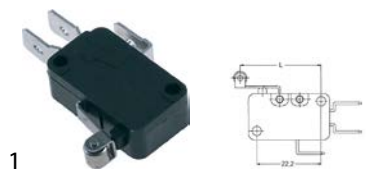

GEV No.	345041	Ref. No.	0H6597 245536
description	microswitch with handle with a switch 250V 16A 1CO connection male faston 6.3mm ambient temperature max. 85°C black lever length 20.5mm		

pin-plunger actuated

M10



GEV No.	345032	Ref. No.	0K1395 245040
description	microswitch with plunger thread M10x1 thread L 12mm 250V 16A 1CO connection male faston 6.3mm stroke 7mm mounting distance 22mm L 28mm ambient temperature max. 125°C type SP9603 actuating force: 180g		

miscellaneous



GEV No.	346289	Ref. No.	0G1767
description	microswitch with plunger thread M12 thread L 14mm 250V 4A 1CO connection cable stroke 5mm ambient temperature max. 85°C cable 5500mm type 101055425 actuating force: 250g		

roller actuated

roller 90°



GEV No.	346574	Ref. No.	0K2153
description	microswitch with roller plunger 250V 10A connection cable ambient temperature max. 85°C		



GEV No.	346290	Ref. No.	0H6583
description	microswitch with roller plunger 250V 6A 1CO connection cable L1 31mm ambient temperature max. 85°C thread L 20mm thread M10 mounting distance 22mm actuating force: 220g MP320 protection IP67		

non-standard

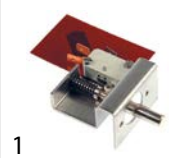

GEV No.	346389	Ref. No.	0G1829
description	microswitch connection male faston		

position switches

BERNSTEIN



1

GEV No.	346296	Ref. No.	0H6698
description	position switch with handle with a switch 1NO/1NC protection IP65 BERNSTEIN		

PIZZATO

FD series



1

GEV No.	345057	Ref. No.	0H6689
description	position switch cast aluminum 1NO/1NC 400V 3A L 98mm W 40mm H 35mm protection IP67 actuating force: 450g screw connection PG13.5 mounting distance 30x60mm		

SIEMENS

3SE3 series

switches (complete)



1

GEV No.	346288	Ref. No.	0K2158
description	position switch		

TELEMECANIQUE (EFA)



1

GEV No.	346807	Ref. No.	0K4382
description	position switch plastic 1NO/1NC 400V 3A L 116.7mm W 40mm H 36mm protection IP67 actuating force: 1800g screw connection M19 mounting distance 30x60mm		

system switches (ROLD)



1

GEV No.	345651	Ref. No.	003766
description	switch 2CO 250V 16A connection male faston 6.3mm		

cam switches

on/off



1

GEV No.	300017	Ref. No.	0A2241
description	cam switch 4 operating positions 4NO sequence 0-1-0-1 16A shaft ø 6x4.6mm shaft L 23mm connection male faston 6.3mm ceramic		



1

GEV No.	300102	Ref. No.	050857 0H6682 247200
description	cam switch 4 operating positions 4NO sequence 0-1-0-1 32A shaft ø 6x4.6mm shaft L 23mm connection screw ceramic		

4-position

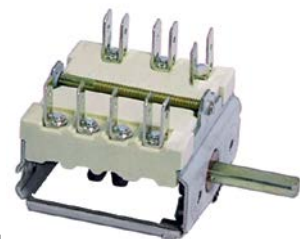

1

GEV No.	300007	Ref. No.	0H6602
description	cam switch 4 operating positions 1NO/2CO sequence 0-1-2-3 16A shaft ø 6x4.6mm shaft L 23mm connection male faston 6.3mm 4-position ceramic		



1

GEV No.	300103	Ref. No.	0H6598
description	cam switch 4 operating positions 1NO/2CO sequence 0-1-2-3 32A shaft ø 6x4.6mm shaft L 23mm connection screw ceramic		

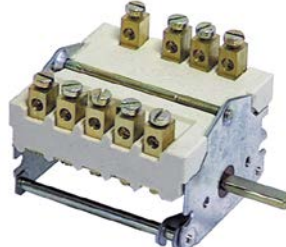
1

GEV No.	300104	Ref. No.	0H6683 247202
description	cam switch 4 operating positions 3NO/1CO sequence 0-1-2-3 32A shaft ø 6x4.6mm shaft L 23mm connection screw ceramic		



1

GEV No.	300106	Ref. No.	0A2022
description	cam switch 7 operating positions 1NO/2CO sequence 0-1-2-3-4-5-6 32A shaft ø 6x4.6mm shaft L 23mm connection screw 7-position shaft flat upper		

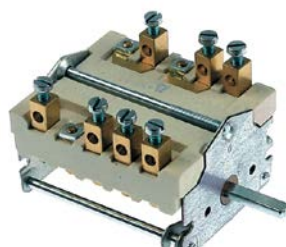

1

GEV No.	300194	Ref. No.	0K2034
description	cam switch 4 operating positions 4NO sequence 0-1-2-3 16A shaft ø 6x4.6mm shaft L 23mm connection screw 4-position ceramic		

2 operating positions



1

GEV No.	300054	Ref. No.	0H6604
description	cam switch 2 operating positions speed sequence 0-1 shaft ø 6x4.6mm connection male faston 9-pole		

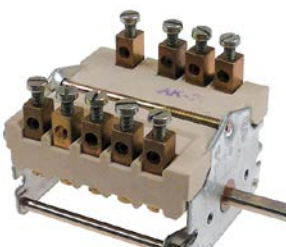

1

GEV No.	300224	Ref. No.	0K1380
description	cam switch 4 operating positions sequence 0-1-2-3 3-pole		

3 operating positions



1

GEV No.	300039	Ref. No.	0H6590
description	cam switch 3 operating positions main + selector switch sequence 1-2-3 16A shaft ø 6x4.6mm connection male faston 6-pole		

7-position



1

GEV No.	300004	Ref. No.	0K6627 247243
description	cam switch 7 operating positions 1NO/2CO sequence 0-1-2-3-4-5-6 16A shaft ø 6x4.6mm shaft L 23mm connection male faston 6.3mm 7-position ceramic		

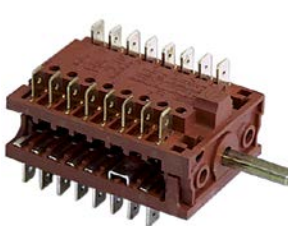

1

GEV No.	300042	Ref. No.	0H6101
description	cam switch 3 operating positions speed/power sequence 1-2-3 shaft ø 6x4.6mm connection male faston 16-pole		

1

GEV No.	300036	Ref. No.	0H6392
description	cam switch 3 operating positions steaming manual sequence 0-1-2 shaft ø 6x4.6mm connection male faston 2-pole		

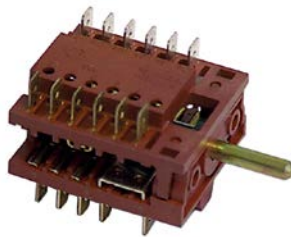

1

GEV No.	300041	Ref. No.	0H6100
description	cam switch 4 operating positions programme 16A shaft ø 6x4.6mm connection male faston 12-pole		

4 operating positions



1

GEV No.	300037	Ref. No.	0H6387
description	cam switch 4 operating positions 4NO sequence 0-1-2-3 16A shaft ø 6x4.6mm shaft L 23mm connection male faston 6.3mm		

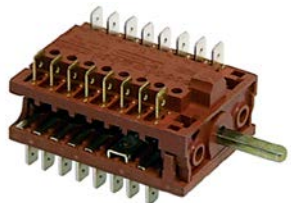

1

GEV No.	300066	Ref. No.	0K1007
description	cam switch 4 operating positions programme shaft ø 6x4.6mm connection male faston 16-pole		

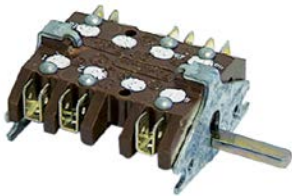

1

GEV No.	300035	Ref. No.	0H6391
description	cam switch 4 operating positions main + selector switch sequence 0-1-2-3 16A shaft ø 6x4.6mm shaft L 23mm connection male faston plastic		



1

GEV No.	345750	Ref. No.	0H6291
description	cam switch 4 operating positions shaft ø 6x4.6mm connection male faston 16-pole		

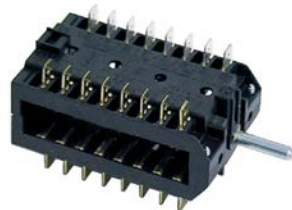

1

GEV No.	300043	Ref. No.	0H6098
description	cam switch 4 operating positions motor performance shaft ø 6x4.6mm connection male faston 16-pole		

5 operating positions

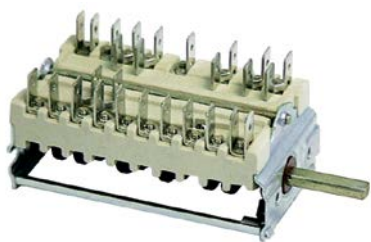

1

GEV No.	300009	Ref. No.	051647
description	cam switch 5 operating positions changeover switch sequence 0-1-2-3-4 16A shaft ø 6x4.6mm connection male faston 8-pole		

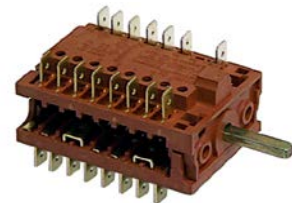

1

GEV No.	300065	Ref. No.	0K2032
description	cam switch 4 operating positions power/ program shaft ø 6x4.6mm connection male faston 16-pole		



7 operating positions

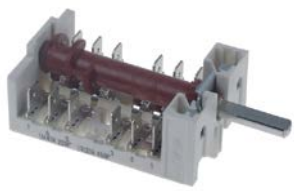

1			
GEV No.	300233	Ref. No.	002661
description	cam switch 7 operating positions shaft ø 6x4.6mm shaft L 23mm 5-pole		

8 operating positions

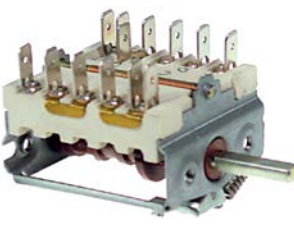

1			
GEV No.	301238	Ref. No.	003761
description	cam switch 8 operating positions shaft ø 6x4.6mm connection male faston 4-pole		

operation switches



1			
GEV No.	300002	Ref. No.	0A2134
description	cam switch 2 operating positions 4NO 16A sequence 0-1 shaft ø 6x4.6mm shaft L 23mm connection male faston 6.3mm ceramic		



1			
GEV No.	300080	Ref. No.	026945
description	cam switch 2 operating positions 4NO 16A sequence 0-1 shaft ø 6x4.6mm shaft L 23mm connection screw operation switch ceramic ambient temperature max. 150°C		

accessories for	300080		
	GEV No.	Ref. No.	
	551456	—	
	gasket for switch ED ø 14mm ID ø 2.5mm thickness 3.5mm white		

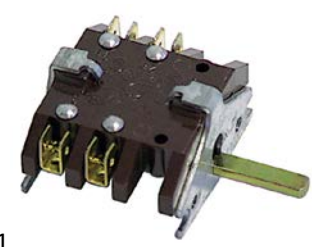

1			
GEV No.	300040	Ref. No.	OK2151
description	cam switch 2 operating positions operation switch 16A sequence 0-1 shaft ø 6x4.6mm connection male faston 2-pole ambient temperature max. 270°C		

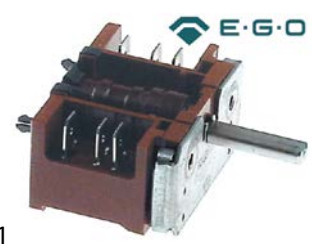

1			
GEV No.	301214	Ref. No.	OK1004
description	cam switch 2 operating positions operation switch 16A sequence 0-1 shaft ø 6x4.6mm shaft L 33mm connection male faston 6.3mm plastic ambient temperature max. 150°C		





1			
GEV No.	300181	Ref. No.	0H6599 245555
description	cam switch 3 operating positions operation switch 32A sequence 0-1-2 shaft ø 6x4.6mm connection screw clamp 4-pole ambient temperature max. 330°C		



1			
GEV No.	345764	Ref. No.	0H6102
description	cam switch 5 operating positions operation switch sequence 0-1-2-3-4 shaft ø 6x4.6mm 5-pole ambient temperature max. 270°C		

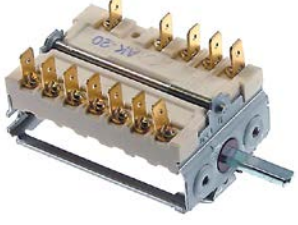

 			
1			
GEV No.	300200	Ref. No.	054375 247318
description	operation switch 2 operating positions 2NO 16A sequence 0-1 shaft ø 6x4.6mm shaft L 23mm connection male faston 6.3mm operation switch ceramic		

			
1			
GEV No.	300178	Ref. No.	0H6284 220909
description	operation switch 3 operating positions 3NO/2CO 16A sequence 0-1-2 shaft ø 6x4.6mm shaft L 23mm connection male faston 6.3mm ceramic ambient temperature max. 270°C		

rotary switches

KRAUS & NAIMER

rotary switches

			
1			
GEV No.	301206	Ref. No.	0K4923
description	rotary switch 4 0-1-2-3 sets of contacts 8 type CA11-AT08A188 690V 7.5A shaft ø 4.8x6mm shaft L 18mm shaft round connection screw code 37/000100 marking 7BC540		

miscellaneous

			
1			
GEV No.	346390	Ref. No.	0K4925
description	rotary switch sets of contacts 1 2 0-1 250V 16A illuminated connection male faston 6.3mm mounting measurements 25x25mm		

control equipment

MOELLER/EATON

push buttons - signal lamps

			
1			
GEV No.	346294	Ref. No.	0K2149
description	push button mounting measurements ø22mm red		

switch blocks

			
1			
GEV No.	346292	Ref. No.	0K2181
description	contact block screw 1NO		

switches (complete)

push/momentary push switches

			
1			
GEV No.	346291	Ref. No.	0KX188
description	momentary push switch mounting measurements ø22mm red 1NO		

			
1			
GEV No.	346340	Ref. No.	0A2196
description	switch mounting measurements ø22mm red complete EMERGENCY SHUT-DOWN		

SCHLEGEL

symbol plates

			
1			
GEV No.	345752	Ref. No.	0H6290
description	symbol plate white operating temperature		





			
1			
GEV No.	345756	Ref. No.	0K1006
description	symbol plate white reset		

GEV special

ø16mm push buttons

			
1			
GEV No.	345754	Ref. No.	005139
description	push button square clear ø 16mm		

			
1			
GEV No.	345265	Ref. No.	0H6287
description	contact block 1NC/1NO 250V 6A equiv. no. 51.971.022		

			
1			
GEV No.	345751	Ref. No.	005138
description	contact block 2NO/2NC		

switches

			
1			
GEV No.	345753	Ref. No.	005137
description	switch mounting measurements ø16mm latching		

			
1			
GEV No.	345755	Ref. No.	0K1005
description	switch mounting measurements ø16mm momentary		

ø22mm

key lock switches

			
1			
GEV No.	345244	Ref. No.	0H6694
description	key lock switch mounting measurements ø22mm latching sequence 0-1		

rotary switches

			
1			
GEV No.	345263	Ref. No.	0K2156
description	rotary selector mounting measurements ø22mm black momentary sequence 0-1		

			
1			
GEV No.	345260	Ref. No.	0H6692
description	rotary selector mounting measurements ø22mm black momentary sequence 1-0-2		

switch blocks

			
1			
GEV No.	345272	Ref. No.	0H6695
description	contact block 1NC/1NO 660V max. 16(4)A connection screw		

			
1			
GEV No.	345261	Ref. No.	0H6693
description	contact block 2NO 660V max. 16(4)A connection screw		



RAFI

Lumotast series

momentary push switches



1

GEV No.	346576	Ref. No.	0H6587
description	momentary push switch mounting measurements ø16mm 230V 3NC/3NO		

TELEMECANIQUE (EFA)

XB2 series

switches (complete)



1

GEV No.	346575	Ref. No.	0H6687
description	momentary push switch mounting measurements ø22mm green 1NC/1NO		

miscellaneous



1

GEV No.	346300	Ref. No.	0K3365
description	indicator socket socket Ba9s		

lamps



1

GEV No.	359606	Ref. No.	0K2043
description	neon light bulb socket Ba9s 220V 2W clear ø 10mm L 28mm		
accessories for	359606		

	GEV No.	359832	Ref. No.	—
	lamp socket mounting measurements ø16.2mm socket Ba9s connection male faston 6.3mm			

	GEV No.	359853	Ref. No.	—
	lamp socket mounting measurements ø18.2mm socket Ba9s connection male faston 6.3mm			

encoders and potentiometers



1

GEV No.	400178	Ref. No.	0H7178
description	potentiometer 47KOhm		

lamps

indicator lights

indicator lights 2-piece (lens and indicator lamp)

indicator light lenses

ø 6mm (type SQ-20)



1

GEV No.	359803	Ref. No.	054151
description	indicator light lens green Qty 1 pcs ø 6mm		

indicator lamps for socket type SQ



1

GEV No.	359109	Ref. No.	054150
description	indicator lamp 230V green connection male faston 6.3mm no lens ø 6mm		

accessories for 359109



GEV No.	359806	Ref. No.	—
description	indicator light lens clear Qty 1 pcs ø 6mm		

indicator lights 3-piece (housing, lens and bulb)

ø19.2mm



1

GEV No.	359108	Ref. No.	0H6110 212569
description	indicator light ø 19.2mm green		









1

GEV No.	359107	Ref. No.	0H6111 212570
description	indicator light ø 19.2mm yellow socket E14		

lamps

neon light bulbs

			
1			
GEV No.	359606	Ref. No.	OK2043
description	neon light bulb socket Ba9s 220V 2W clear ø 10mm L 28mm		
accessories for	359606		
	GEV No.	359832	Ref. No. —
	lamp socket mounting measurements ø16.2mm socket Ba9s connection male faston 6.3mm		
	GEV No.	359853	Ref. No. —
	lamp socket mounting measurements ø18.2mm socket Ba9s connection male faston 6.3mm		

			
1			
GEV No.	359585	Ref. No.	846804
description	neon light bulb socket E10 230V green ø 10mm L 28mm		
accessories for	359585		
	GEV No.	359060	Ref. No. —
	lamp socket mounting measurements ø16.2mm socket E10 connection screw		
	GEV No.	359685	Ref. No. —
	lamp socket mounting measurements ø16.2mm socket E10		

			
1			
GEV No.	359602	Ref. No.	0H7036
description	neon light bulb socket E14 230V clear ø 14mm L 30mm		

			
1			
GEV No.	359603	Ref. No.	0H7037 565628
description	neon light bulb socket E14 380V clear ø 14mm L 30mm		

indicator lights (complete)

ø10mm

with screw socket

			
1			
GEV No.	359378	Ref. No.	0A2224
description	indicator light ø 10mm 230V green connection male faston 6.3mm socket screw base		

with plug-in socket



			
1			
GEV No.	359232	Ref. No.	0H6106
description	indicator light ø 10mm clear 230V connection male faston 2.8mm Qty 1 pcs		



			
1			
GEV No.	359139	Ref. No.	058544
description	indicator light ø 10mm green 230V connection male faston 6.3mm Qty 1 pcs		

			
1			
GEV No.	359231	Ref. No.	OK2047
description	indicator light ø 10mm yellow 230V connection male faston 2.8mm Qty 1 pcs		

ø13mm

with screw socket

			
1			
GEV No.	359145	Ref. No.	0H6619
description	indicator light ø 13mm 230V green t.max. 120°C		
accessories for	359145		
	GEV No.	510302	Ref. No. —
	O-ring EPDM ID ø 12.42mm thickness 1.78mm Qty 1 pcs		
	GEV No.	511505	Ref. No. —
	O-ring EPDM thickness 1.78mm ID ø 12.42mm Qty 10 pcs		

			
1			
GEV No.	359144	Ref. No.	005012
description	indicator light ø 13mm 230V red		
accessories for	359144		
	GEV No.	510302	Ref. No. —
	O-ring EPDM ID ø 12.42mm thickness 1.78mm Qty 1 pcs		
	GEV No.	511505	Ref. No. —
	O-ring EPDM thickness 1.78mm ID ø 12.42mm Qty 10 pcs		







			
1			
GEV No.	359146	Ref. No.	0H6618
description	indicator light ø 13mm 230V yellow		
accessories for	359146		
	GEV No.	510302	Ref. No. —
	O-ring EPDM ID ø 12.42mm thickness 1.78mm Qty 1 pcs		

Table continues overleaf

accessories for	359146		
	GEV No.	511505	Ref. No. —
	O-ring EPDM thickness 1.78mm ID ø 12.42mm Qty 10 pcs		

with plug-in socket			
1			
GEV No.	359364	Ref. No.	005010
description	indicator light ø 13mm green 230V		

ø16mm			
with plug-in socket			
1			
GEV No.	359518	Ref. No.	006849 245888
description	indicator light ø 16mm 230V green		

ø19mm			
1			
GEV No.	345767	Ref. No.	0700212545
description	indicator light ø 19mm 230V green		

1			
GEV No.	345768	Ref. No.	0H6107
description	indicator light ø 19mm 230V red		

ø20mm			
1			
GEV No.	359514	Ref. No.	0K4900
description	indicator light ø 20mm 230V green connection male faston 6.3mm ambient temperature max. 125°C		



31x10mm			
1			
GEV No.	359306	Ref. No.	0H6581
description	indicator light mounting measurements 31x10mm 230V white/red/green		



34x12mm			
1			
GEV No.	359311	Ref. No.	0H6614
description	indicator light mounting measurements 34x12mm 230V green/red		

miscellaneous			
1	 Image not available		
GEV No.	359301	Ref. No.	0K3357
description	indicator light		

1	 Image not available		
GEV No.	359758	Ref. No.	0K3095
description	indicator light yellow		

screw-on/push-on fit

neon light bulbs			
1			
GEV No.	359606	Ref. No.	0K2043
description	neon light bulb socket Ba9s 220V 2W clear ø 10mm L 28mm		
accessories for	359606		
	GEV No.	359832	Ref. No. —
	lamp socket mounting measurements ø16.2mm socket Ba9s connection male faston 6.3mm		
	GEV No.	359853	Ref. No. —
	lamp socket mounting measurements ø18.2mm socket Ba9s connection male faston 6.3mm		

1			
GEV No.	359585	Ref. No.	846804
description	neon light bulb socket E10 230V green ø 10mm L 28mm		
accessories for	359585		
	GEV No.	359060	Ref. No. —
	lamp socket mounting measurements ø16.2mm socket E10 connection screw		
	GEV No.	359685	Ref. No. —
	lamp socket mounting measurements ø16.2mm socket E10		



			
1			
GEV No.	359602	Ref. No.	0H7036
description	neon light bulb socket E14 230V clear ø 14mm L 30mm		

			
1			
GEV No.	359603	Ref. No.	0H7037 565628
description	neon light bulb socket E14 380V clear ø 14mm L 30mm		

light bulbs
for ovens

			
1			
GEV No.	359610	Ref. No.	0H7035
description	light bulb t.max. 300°C socket E14 15W 230V ø 22mm L 47mm lens L 20mm for oven lamp type Philips		

			
1			
GEV No.	359612	Ref. No.	054840
description	light bulb t.max. 300°C socket E14 25W 230V ø 25mm L 56mm lens L 30mm for oven lamp type Philips		



halogen lamp
for socket G4 / G6.35 / G9

			
1			
GEV No.	357191	Ref. No.	565729
description	halogen lamp socket G4 12V 10W temp.-resist. 300°C OSRAM HALOSTAR OVEN		

			
1			
GEV No.	359596	Ref. No.	0H7038
description	halogen lamp socket G4 12V 10W temp.-resist. 500°C		



oven lamps

universal oven lamps
mounting diameter 28.5mm



			
1			
GEV No.	359317	Ref. No.	0H7040
description	oven lamp mounting ø 28.5mm 12V 5W socket G4 temp.-resist. 300°C cable length 300mm		
spare parts for	359317		
	GEV No.	359308	Ref. No. 0H6582
	oven lamp glass		

			
1			
GEV No.	359308	Ref. No.	0H6582
description	oven lamp glass		

mounting diameter 35.5mm

			
1			
GEV No.	359718	Ref. No.	0H6105
description	oven lamp mounting ø 35.5mm 230V 15W socket E14 temp.-resist. 300°C connection male faston 6.3mm hard glas		
spare parts for	359718		
	GEV No.	359701	Ref. No. —
	lamp socket socket E14 220-230V mounting ø 35.5mm connection male faston 6.3mm 15W		
	GEV No.	359740	Ref. No. —
	light bulb t.max. 300°C socket E14 15W 230V ø 22mm L 48mm lens L 20mm for oven lamp IMPORT		

55x70mm

			
1			
GEV No.	359298	Ref. No.	0K3363
description	lamp socket 230V 25W socket E14 mounting measurements 70x55mm connection male faston 6.3mm		
accessories for	359298		
	GEV No.	359937	Ref. No. —
	lamp glass L 80mm W 65mm mounting measurements 52x67mm		

55x100mm			
			
1			
GEV No.	359716	Ref. No.	0H7118
description	frame for bulb socket		

			
1			
GEV No.	359714	Ref. No.	055022
description	gasket for bulb socket		

			
1			
GEV No.	359715	Ref. No.	0H6989
description	lamp glass L 110mm W 65mm thickness 5mm		

			
1			
GEV No.	101372	Ref. No.	0K7521
description	oven lamp complete L 100mm W 55mm 230V 25W socket E14 rectangular temp.-resist. 300°C connection male faston 6.3mm		
spare parts for	101372		
	GEV No.	359612	Ref. No. 054840
	light bulb t.max. 300°C socket E14 25W 230V ø 25mm L 56mm lens L 30mm for oven lamp type Philips		
	GEV No.	359698	Ref. No. —
	lamp socket L 100mm W 55mm socket E14 connection male faston 6.3mm		
	GEV No.	359714	Ref. No. 055022
	gasket for bulb socket		
	GEV No.	359715	Ref. No. 0H6989
	lamp glass L 110mm W 65mm thickness 5mm		
	GEV No.	359716	Ref. No. 0H7118
	frame for bulb socket		

50x75.5mm			
			
1			
GEV No.	359309	Ref. No.	0K2044
description	oven lamp L 75mm W 50mm 230V 40W socket E14 temp.-resist. 300°C connection male faston 6.3mm		

lamps			
light bulbs			
			
1			
GEV No.	359610	Ref. No.	0H7035
description	light bulb t.max. 300°C socket E14 15W 230V ø 22mm L 47mm lens L 20mm for oven lamp type Philips		

			
1			
GEV No.	359612	Ref. No.	054840
description	light bulb t.max. 300°C socket E14 25W 230V ø 25mm L 56mm lens L 30mm for oven lamp type Philips		

halogen lamps			
for socket G4 / G6.35 / G9			
			
1			
GEV No.	357191	Ref. No.	565729
description	halogen lamp socket G4 12V 10W temp.-resist. 300°C OSRAM HALOSTAR OVEN		

			
1			
GEV No.	359596	Ref. No.	0H7038
description	halogen lamp socket G4 12V 10W temp.-resist. 500°C		

sockets			
G4 / G5,3 / G6,35			
			
1			
GEV No.	359304	Ref. No.	0K3362
description	lamp socket socket G4 24V ø 17mm H 9mm connection cable 120mm mounting distance 12mm with 2 hole fixing mounting thread M3 cable length 120mm Qty 1 pcs		



E14



1

GEV No.	359307	Ref. No.	OK2016
description	lamp socket socket E14 L 28mm with 2 hole fixing		

lamp accessories

gaskets



1

GEV No.	359766	Ref. No.	OK2106
description	gasket L 100mm W 76mm		

timers

programme timers



1

GEV No.	350017	Ref. No.	0H6755
description	timer		



1

GEV No.	360334	Ref. No.	003833	
description	timer FIBER P04 engines 1 chambers 2 operation time 120min 230V shaft \varnothing 6x4.6mm shaft L 20mm manuf. no. P045J02W401 motor type M51BJ0R6400 impulse electric			
spare parts for	360334			
	GEV No.	360673	Ref. No.	—
	motor kit pinion \varnothing 6.8mm teeth 15 230V voltage AC 50/60Hz turn direction clockwise motor \varnothing 48mm H 18.5mm motor type UDS-40NE1RNZ165 cable length 150mm with holder			



1

GEV No.	360065	Ref. No.	0700124090
description	timer operation time 85s		

electric timers



1

GEV No.	350007	Ref. No.	0H6118
description	timer CR5 operation time 120min time spreadmin 2CO at 250V 16A permanent position no impulse electric shaft \varnothing 6x4.6mm shaft L 24mm mounting distance 28mm connection lateral 2-pole		



1

GEV No.	350005	Ref. No.	212622
description	timer MS65 without bell operation time 30min time spreadmin 2CO at 250V 16A permanent position no impulse electric shaft \varnothing 6x4.6mm shaft L 23mm mounting distance 28mm connection lateral 2-pole		

accessories for 350005

GEV No.	110366	Ref. No.	—
description	knob switch zero mark t.max. °C \varnothing 44mm shaft \varnothing 6x4.6mm shaft flat upper black		



GEV No.	111207	Ref. No.	—
description	dial plate graduation 30min permanent position no rotation 30-300° \varnothing 60mm timers knob \varnothing 45mm		



1

GEV No.	350143	Ref. No.	0H6117
description	timer MS65 without bell operation time 60min time spreadmin 2CO at 250V 16A permanent position no time range 0-60min impulse electric shaft \varnothing 6x4.6mm shaft L 22mm EATON (INVENSYS) ambient temperature max. 85°C 50Hz 2-pole 230V		



mechanical timers



1

GEV No.	350170	Ref. No.	0H6114
description	timer 600 2-pole operation time 60min impulse mechanical 2NO at 250V 16A permanent position no shaft ø 6x4.6mm shaft L 21mm mounting distance 28mm		



1

GEV No.	350169	Ref. No.	0H6116 212599
description	timer 601 2-pole operation time 60min impulse mechanical 2CO at 250V 16A permanent position no shaft ø 6x4.6mm shaft L 21mm mounting distance 28mm connection lateral		



1

GEV No.	350012	Ref. No.	0K2269
description	timer 601 with bell 2-pole operation time 120min impulse mechanical 2CO at 250V 16A permanent position yes shaft ø 6x4.6mm shaft L 22mm mounting distance 28mm connection lateral		



1

GEV No.	350105	Ref. No.	0H6757
description	timer 601 with bell 2-pole operation time 90min impulse mechanical 1CO/1NO at 250V 16A permanent position yes shaft ø 6x4.6mm shaft L 22mm mounting distance 28mm connection rear		



1

GEV No.	350030	Ref. No.	0K3053
description	timer M2 2-pole operation time 120min impulse mechanical 2NO at 250V 16A permanent position no shaft ø 6x4.6mm shaft L 23mm mounting distance 28mm connection lateral		
accessories for	350030		
	GEV No.	110366	Ref. No. —
	knob switch zero mark t.max.°C ø 44mm shaft ø 6x4.6mm shaft flat upper black		
	GEV No.	111199	Ref. No. —
	dial plate graduation 120min permanent position no rotation 0-330° ø 60mm timers knob ø 45mm		



1

GEV No.	350018	Ref. No.	0H6684
description	timer M2 2-pole operation time 60min impulse mechanical 2CO at 250V 16A permanent position yes shaft ø 6x4.6mm shaft L 23mm mounting distance 28mm connection lateral		
accessories for	350018		
	GEV No.	110366	Ref. No. —
	knob switch zero mark t.max.°C ø 44mm shaft ø 6x4.6mm shaft flat upper black		
	GEV No.	111202	Ref. No. —
	dial plate graduation 60min permanent position yes rotation 0-300° ø 60mm timers knob ø 45mm with permanent position		

alarm devices

buzzers



1

GEV No.	350050	Ref. No.	0H6572 0K2031 244123
description	buzzer 230VAC connection male faston 6.3mm screw mounting thread M4 60dB		



1	GEV No. 350085	Ref. No. 0G1993
description buzzer connection plug-in connection		



1	GEV No. 380675	Ref. No. 0K3383
description power contactor resistive load 25A 230VAC (AC3/400V) 12A/5.5kW main contacts 3NO auxiliary contacts 1NC connection screw connection type K2-12A01230		

contactors

ABB

auxiliary contactors



1	GEV No. 380122	Ref. No. 0H6545
description auxiliary contactor 230VAC AC1 10A AC15 3A connection screw connection contacts 2NO/2NC N2E		



1	GEV No. 380679	Ref. No. 003598 7511209
description power contactor resistive load 25A 230VAC (AC3/400V) 12A/5.5kW main contacts 3NO auxiliary contacts 1NO connection screw connection type K2-12A01230		

BENEDIKT & JÄGER

power contactors



1	GEV No. 380672	Ref. No. 0H7049
description power contactor resistive load 25A 230VAC (AC3/400V) 10A/4kW main contacts 3NO auxiliary contacts 1NC connection screw connection type K2-09A01230		



1	GEV No. 380674	Ref. No. 0H7051 582310
description power contactor resistive load 25A 230VAC (AC3/400V) 12A/5.5kW main contacts 4NO connection screw connection type K2-12A0040230		



1	GEV No. 380772	Ref. No. 088477
description power contactor resistive load 25A 230VAC (AC3/400V) 10A/4kW main contacts 3NO auxiliary contacts 1NO connection screw connection type K3-10A10230		



1	GEV No. 380673	Ref. No. 0K3384
description power contactor resistive load 45A 230VAC (AC3/400V) 11kW		



1

GEV No.	380521	Ref. No.	0K3385
description	power contactor resistive load 45A 230VAC (AC3/400V) 23A/11kW main contacts 4NO connection screw connection type K2-23A0040230		



1

GEV No.	380676	Ref. No.	OTRA70
description	power contactor resistive load 80A 230VAC (AC3/400V) 45A/20kW main contacts 3NO connection screw connection type K2-45A00230		

auxiliary contacts



1

GEV No.	380677	Ref. No.	047046
description	auxiliary contact contacts 1NC AC15 10A for contactors K2/K3 connection screw type HN01 AC1 25A		



1

GEV No.	380678	Ref. No.	046995
description	auxiliary contact contacts 1NO AC15 10A for contactors K2/K3 connection screw type HN10 AC1 25A		

GENERAL ELECTRIC (AEG)

power contactors



1

GEV No.	380262	Ref. No.	0K3374
description	power contactor resistive load 32A 230VAC (AC3/400V) 17A/7.5kW main contacts 3NO auxiliary contacts 1NC connection screw connection type AEG LS7K01A type GE CL02A 301 H 85mm		

MOELLER/EATON

power contactors



1

GEV No.	380493	Ref. No.	0K3375
description	contactor resistive load 55A 230VAC main contacts 3NO		



1

GEV No.	380511	Ref. No.	0H6623
description	power contactor resistive load 16A 230VAC main contacts 3NO auxiliary contacts 1NC		



1

GEV No.	380518	Ref. No.	0K3371 582250
description	power contactor resistive load 20A 230VAC		

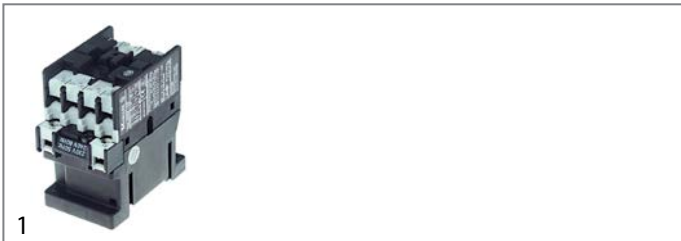

GEV No.	380515	Ref. No.	0H7047
description	power contactor resistive load 20A 230VAC (AC3/400V) 4kW main contacts 4		



GEV No.	380171	Ref. No.	0H7046 582249
description	power contactor resistive load 20A 230VAC (AC3/400V) 9A/4kW main contacts 3NO auxiliary contacts 1NO connection screw connection type DILEM 10		

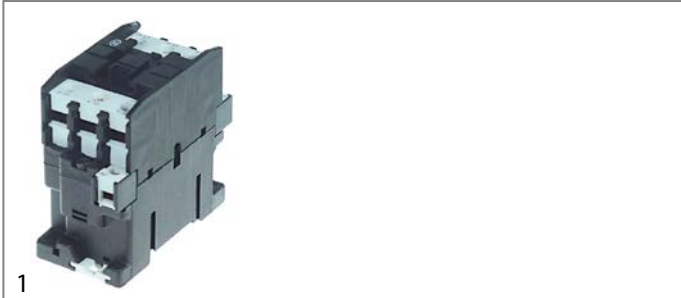

GEV No.	380519	Ref. No.	0K3373
description	power contactor resistive load 35A 230VAC		



GEV No.	380516	Ref. No.	0H7048
description	power contactor resistive load 35A 230VAC (AC3/400V) 7.5kW main contacts 3NO auxiliary contacts NC/NO connection screw connection type DIL00M/11		

auxiliary contactors

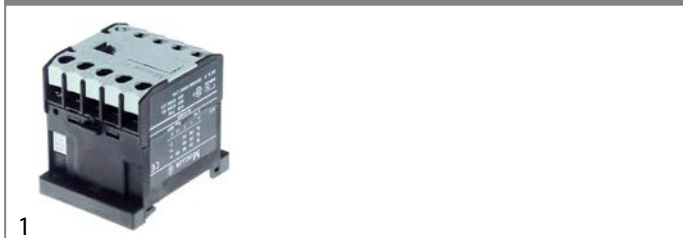

GEV No.	380669	Ref. No.	0H6543
description	power contactor resistive load 10A 230VAC main contacts 3NO auxiliary contacts 1NC		

TELEMECANIQUE (Schneider Electric)

power contactors



GEV No.	380479	Ref. No.	0K2051
description	power contactor resistive load 25A 230VAC (AC3/400V) 9A/4kW main contacts 3NO auxiliary contacts 1NO/1NC connection screw connection type LC1D09P7		

ALLEN BRADLEY

power contactors

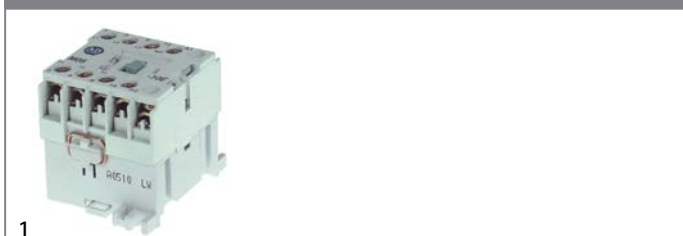

GEV No.	380517	Ref. No.	0H6547
description	power contactor resistive load 20A 230VAC (AC3/400V) 5.3A/2.2kW main contacts 3NO auxiliary contacts 1NO connection screw connection type 100-M05NKF3S		



TRIPUS (Eichhoff)

small relay switches

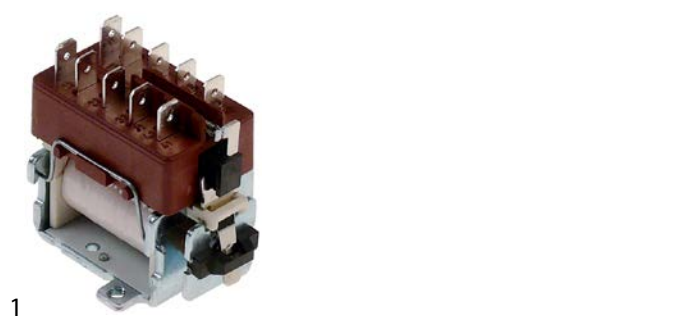

1	GEV No.	380120	Ref. No.	0H6541
description small relay switch 230V AC1 16A main contacts 4NO connection Faston 6.3mm type 307P002 resistive load 16A				

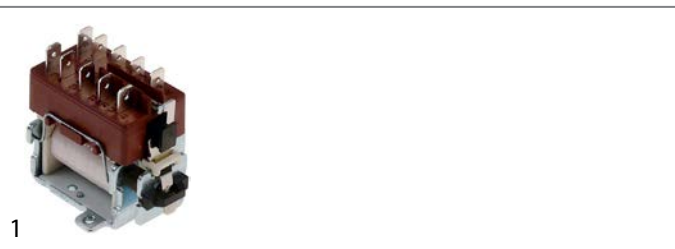

1	GEV No.	380119	Ref. No.	0H7194
description small relay switch 230V main contacts 2NO/2NC connection Faston 6.3mm resistive load 16A				

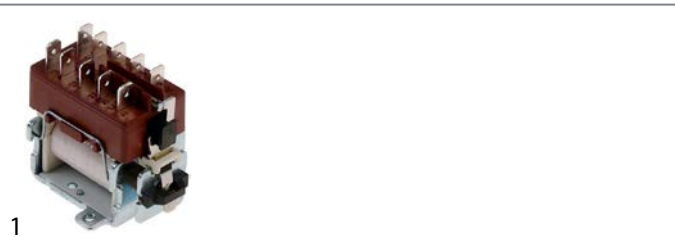

1	GEV No.	380121	Ref. No.	0H6544
description small relay switch 230V main contacts 3NO/1NC auxiliary contacts knob ø70mm (227-piece) connection Faston 6.3mm type E3250 resistive load 16A				

miscellaneous

accessories

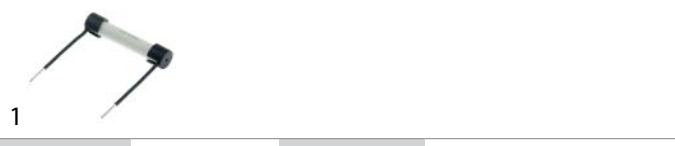

1	GEV No.	400699	Ref. No.	0G1781 249035
description switching delay SV3/50 3s 50VA type 52159 suitable for JUNO				

power contactors



1	GEV No.	380157	Ref. No.	0K2053
description power contactor resistive load 32A				

relays

power relays

with bracket mounting



1	GEV No.	380312	Ref. No.	056466
description power relays FINDER 230VAC 10A 3CO connection male faston 4.8mm bracket mounting dimensions 52x32.2x36.5mm manuf. no. 60.63.8.230.0000				

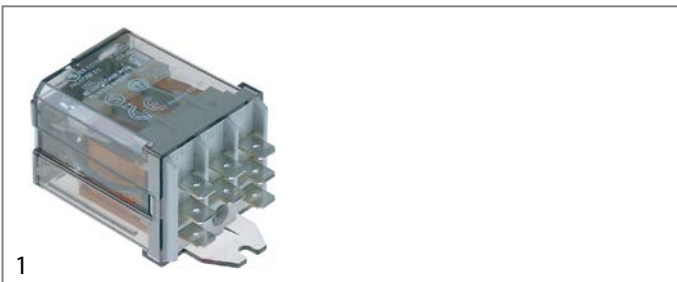

1	GEV No.	380702	Ref. No.	005033
description power relays FINDER 230VAC 16A 3NO connection male faston 6.3mm flange dimensions 36x38x68mm manuf. no. 62.83.8.230.0300 230V				

with male contacts

bullet connectors, 11 contacts

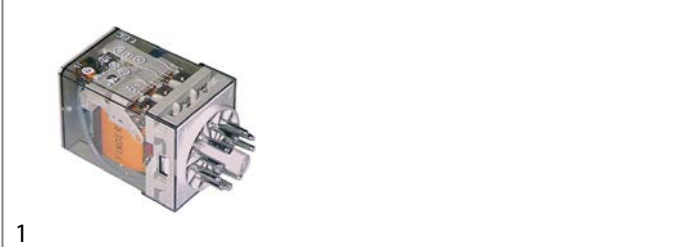

1	GEV No.	380132	Ref. No.	0K3700
description power relays Italiana Relè 230VAC 10A 3CO connection plug-in connection round 11-pole manuf. no. C43-230AC ZVE11 250V 11-pole				

accessories for 380132				
	GEV No.	380136	Ref. No.	—
relay socket 11-pole connection plug-in connection round 11-pole dimensions 65x28x40mm 250V voltage AC 10A Italiana Relè manuf. no. ZVE11				



level relays

GICAR



1

GEV No.	400018	Ref. No.	055458
description	level relay 230V voltage AC connection F6.3 type RL30/3ES/F/G		

miscellaneous



1

GEV No.	400743	Ref. No.	0H6240
description	level relay		



1

GEV No.	400176	Ref. No.	0G1804
description	level relay 1CO 230V voltage AC		



1

GEV No.	400002	Ref. No.	0H6222
description	level relay type FTL 160		

time relays

time relays



1

GEV No.	380682	Ref. No.	0H6817
description	time relay CROUZET time range 1s-100h 24VDC		



1

GEV No.	380381	Ref. No.	0H6818
description	time relay DOLD MK7614.32 time range 0.15s-30min 230VAC 2x4A 2CO connection grip connection		



1

GEV No.	380681	Ref. No.	0K2401
description	time relay TESCH E67.3x105 time range 3-60s 230VAC 5A		



1

GEV No.	360357	Ref. No.	0H6122
description	time relay TESCH V333x01 time range 0s-60h 220-240VAC 4x4A 4CO		



transformers

encapsulated transformers

multiple connections



1

GEV No.	401346	Ref. No.	0H6808
description	transformer 20VA		



1

GEV No.	401546	Ref. No.	0K2761
description	transformer primary 230V secondary 12V 10VA		

for lighting



1

GEV No.	401547	Ref. No.	002856
description	transformer primary 230V secondary 11.5V 50W		

electronic controllers

DOLD

universal controllers

mounting measurements 92x92mm



1

GEV No.	379919	Ref. No.	0H6246 A215696
description	electronic controller DOLD DPG 96 C mounting measurements 90x90mm 230V voltage AC Pt100/TC(J/K/S) 0-10V/4-20mA -150 up to +1700°C display 2x 4 digits relay outputs 4 relays 8A 8A 8A 8A TempIn1 yes TempIn2 yes TempIn3 yes DigiIn1 yes DigiIn2 yes DigiIn3 yes built-in depth 140mm		

JUMO

universal controllers

built-in version



1

GEV No.	400989	Ref. No.	0H6501 236163
description	electronic controller JUMO type iTRON 04 mounting measurements 92x92mm 110-240V voltage AC Pt100/TC(J/K/S)/V/mA relay outputs 2 relays defr. funct. no -200 up to +1300°C display 4 digits TempIn1 yes 3A 3A		

STÖRK-TRONIC

universal controllers

built-in version



1

GEV No.	379339	Ref. No.	0K1206
description	electronic controller STÖRK-TRONIK type ST73-31.10 mounting measurements 60mm 230V voltage AC Pt100 relay outputs 1 NO-12A(6) Pt100 front measurements 72x72mm built-in depth 64mm defr. funct. -60 up to +400°C display 3 digits		

refrigeration controllers

built-in version



1

GEV No.	379339	Ref. No.	0K1206
description	electronic controller STÖRK-TRONIK type ST73-31.10 mounting measurements 60mm 230V voltage AC Pt100 relay outputs 1 NO-12A(6) Pt100 front measurements 72x72mm built-in depth 64mm defr. funct. -60 up to +400°C display 3 digits		



miscellaneous

universal controllers



GEV No.	379084	Ref. No.	0H6244
description	electronic controller Pt100 electronic thermostat		

probes

producer-specific probes

probes



GEV No.	379147	Ref. No.	0H6229
description	temperature probe NTC 10kOhm cable silicone probe -40 up to +110°C cable -50 up to +180°C connection F6.3 thread M10x1 probe ø10x10mm cable length 0.08m		



GEV No.	379049	Ref. No.	0H6482
description	temperature probe Pt100 cable PTFE probe -100 up to 450°C cable -40 up to +250°C connection 2-wire thread 1/4" probe ø5x100mm cable length 2m		



GEV No.	379090	Ref. No.	0H6491
description	temperature probe Pt100 cable PTFE probe -70 up to +500°C cable -40 up to +250°C connection 2-wire thread probe ø3x100mm cable length 1.9m		





GEV No.	379144	Ref. No.	0H6481
description	temperature probe Pt100 cable silicone probe -100 up to 450°C cable -50 up to +180°C connection 2-wire thread probe ø3/3.5x40/180mm cable length 1.9m		



GEV No.	401398	Ref. No.	0H6477
description	temperature probe Pt100 cable silicone probe -50 up to +250°C cable -50 up to +180°C connection male faston 6.3mm thread M10x1 probe ø10x10mm cable length 0.07m		



GEV No.	379100	Ref. No.	0C5342 0K0681 215727
description	temperature probe Pt1000 cable silicone probe -70 up to +500°C cable -50 up to +180°C connection male faston 4.8mm thread probe ø4x235mm cable length 1.8m		
accessories for	379100		
	GEV No.	693745	Ref. No. 002624
	gasket PTFE ED ø 20mm ID ø 15mm thickness 1mm Qty 1 pcs		
	GEV No.	697993	Ref. No. —
	sleeve for temperature probe ø 11mm ID ø 4.3mm H 22.4mm		



GEV No.	378012	Ref. No.	0K5047
description	temperature probe PTC 2kOhm cable probe -50 up to +150°C cable°C connection F6.3 thread M10x1 cable lengthm		



GEV No.	379146	Ref. No.	0H6247
description	temperature probe thermocouple J (Fe-CuNi) cable Vetrotex probe -50 up to +750°C cable -50 up to +350°C connection 2-wire thread 1/2" probe ø6x5mm cable length 2m		



GEV No.	379148	Ref. No.	0H6267
description	temperature probe thermocouple K (NiCr-Ni) cable Vetrotex probe -50 up to 1150°C cable -50 up to +350°C connection 2-wire thread M8 probe ø8x70mm cable length 1.6m		



GEV No.	379145	Ref. No.	0H6269
description	temperature probe thermocouple K (NiCr-Ni) cable Vetrotex probe -50 up to 1150°C cable -50 up to +350°C connection 2-wire thread probe ø3x100mm cable length 2m		



GEV No.	102272	Ref. No.	0H6237
description	thermocouple		

core probes





GEV No.	379108	Ref. No.	0H6131
description	core temperature probe Pt100 cable PTFE probe -100 up to 450°C cable -40 up to +250°C connection 2-wire probe ø3.5x100mm thread cable length 1.3m handle ø 9mm handle length 85mm		





			
GEV No.	401549	Ref. No.	0H6131
description	core temperature probe Pt100 cable PTFE probe -100 up to 450°C cable -40 up to +250°C connection 2-wire probe ø4.5x80mm thread cable length 1.8m handle ø 8mm handle length 70mm		

			
GEV No.	379091	Ref. No.	0H6492
description	core temperature probe Pt100 cable PTFE probe -40 up to +250°C cable -40 up to +250°C connection 2-wire probe ø4.5x80mm thread cable length 1.3m handle ø 8mm handle length 70mm		

			
GEV No.	379096	Ref. No.	0H6493
description	core temperature probe Pt100 cable PTFE probe -40 up to +250°C cable -40 up to +250°C connection 2-wire probe ø4.5x80mm thread cable length 1.5m handle ø 8mm handle length 70mm		

			
GEV No.	379095	Ref. No.	055472
description	core temperature probe Pt100 cable SS corrugated hose probe -40 up to +250°C cable -40 up to +250°C connection coded plug probe ø4x100mm thread M12 cable length 1.45m handle ø 9mm handle length 85mm		

			
GEV No.	379979	Ref. No.	0H6262
description	core temperature probe Pt100 cable SS tube probe -40 up to +250°C cable -40 up to +250°C connection 2-wire probe ø5x100mm thread cable length 2m handle ø 9mm handle length 45mm		

			
GEV No.	379978	Ref. No.	0H6494
description	core temperature probe Pt100 cable SS/plastic probe -40 up to +250°C cable -40 up to +250°C connection 2-wire probe ø5x100mm thread cable length 1.6m handle ø 9mm handle length 45mm		

			
GEV No.	379061	Ref. No.	003853
description	core temperature probe Pt1000 cable SS corrugated hose probe -40 up to +250°C cable -40 up to +250°C connection 2-wire probe ø4x100mm thread M8 cable length 2.5m handle ø 10mm handle length 45mm		

			
GEV No.	379060	Ref. No.	002673
description	core temperature probe Pt1000 cable SS corrugated hose probe -40 up to +250°C cable -40 up to +250°C connection 2-wire probe ø4x100mm thread M8 cable length 2m handle ø 10mm handle length 45mm		

			
GEV No.	379406	Ref. No.	006192
description	core temperature probe Pt1000 cable SS corrugated hose probe -40 up to +250°C cable -40 up to +250°C connection 2-wire probe ø4x100mm thread M8 cable length 2m handle ø 10mm handle length 50mm		

			
GEV No.	379967	Ref. No.	0C0225
description	core temperature probe thermocouple K (NiCr-Ni) cable PTFE probe -40 up to +250°C cable -40 up to +250°C connection plug probe ø3.5x90mm thread cable length 3.1m handle ø 9mm handle length 45/50mm		

accessories

fasteners

			
GEV No.	693748	Ref. No.	002674
description	bracket for core temperature probe		





electronics

PCBs

			
1			
GEV No.	401527	Ref. No.	0H6957
description	control PCB		

			
1			
GEV No.	400179	Ref. No.	0C3758
description	control PCB combi-steamer FCV/G 101/1 102/1		

			
1			
GEV No.	400188	Ref. No.	002725
description	control PCB combi-steamer FCV/G 101/1 102/1		

			
1			
GEV No.	401526	Ref. No.	0H6128 212766
description	control PCB suitable for JUNO		

			
1			
GEV No.	400184	Ref. No.	0C3765
description	control PCB with keypad		

			
1			
GEV No.	401525	Ref. No.	0H6130
description	keypad PCB		

			
1			
GEV No.	401531	Ref. No.	0K2759
description	keypad PCB		

			
1			
GEV No.	401667	Ref. No.	0C3759
description	keypad PCB		

			
Image not available			
1			
GEV No.	401586	Ref. No.	006673
description	main PCB		



1

GEV No.	400189	Ref. No.	006674
description	main PCB combi-steamer 260200-245		

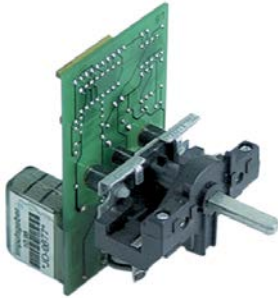

1

GEV No.	400003	Ref. No.	0H6601
description	PCB combi-steamer JUNO		



1

GEV No.	400742	Ref. No.	0K1791
description	PCB		



1

GEV No.	400990	Ref. No.	0K2758
description	PCB for stirrer complete		



1

GEV No.	400744	Ref. No.	003763
description	PCB		



1

GEV No.	400177	Ref. No.	0H6144
description	PCB range JUN90133		



1

GEV No.	401524	Ref. No.	0H6129
description	PCB		



1

GEV No.	401573	Ref. No.	0K4882
description	power PCB		



1

GEV No.	401572	Ref. No.	0C3762
description	power PCB combi-steamer FCV/G 101/1 102/1		

Triacs



1

GEV No.	400079	Ref. No.	0H7060
description	Triac		

keypads front foils



1

GEV No.	401347	Ref. No.	0K2622
description	keypad foil		



1

GEV No.	401354	Ref. No.	0K2637
description	keypad foil		



1

GEV No.	401518	Ref. No.	0K1581
description	keypad foil		



1

GEV No.	401519	Ref. No.	0K1582
description	keypad foil		



1

GEV No.	401520	Ref. No.	0K1583
description	keypad foil		



1

GEV No.	401521	Ref. No.	0K1584
description	keypad foil		



1

GEV No.	401522	Ref. No.	0K1585
description	keypad foil		



1

GEV No.	401523	Ref. No.	0K1586
description	keypad foil		



1

GEV No.	401532	Ref. No.	0K2620
description	keypad foil		





1

GEV No.	401533	Ref. No.	0K2617
description	keypad foil		



1 			
GEV No.	401534	Ref. No.	0H6893
description	keypad foil		

1 			
GEV No.	401544	Ref. No.	006050
description	keypad foil		

1 			
GEV No.	401535	Ref. No.	0K2618
description	keypad foil		

1 			
GEV No.	401545	Ref. No.	005418
description	keypad foil		

1 			
GEV No.	401536	Ref. No.	0K2619
description	keypad foil		

1 			
GEV No.	401551	Ref. No.	005101
description	keypad foil		

1 			
GEV No.	401537	Ref. No.	0H6894
description	keypad foil		

1 			
GEV No.	401552	Ref. No.	005287
description	keypad foil		

1 			
GEV No.	401538	Ref. No.	0K2621
description	keypad foil		

1 			
GEV No.	401553	Ref. No.	005278
description	keypad foil		

1 			
GEV No.	401539	Ref. No.	0H6895
description	keypad foil		

1 			
GEV No.	401554	Ref. No.	005416
description	keypad foil		

1 			
GEV No.	401541	Ref. No.	006054
description	keypad foil		

1 			
GEV No.	401555	Ref. No.	006058
description	keypad foil		

1 			
GEV No.	401543	Ref. No.	005417
description	keypad foil		





			
1			
GEV No.	401556	Ref. No.	005452
description	keypad foil		

			
1			
GEV No.	401574	Ref. No.	0K4333
description	keypad foil		

			
1			
GEV No.	401577	Ref. No.	005459
description	keypad foil		

			
1			
GEV No.	401578	Ref. No.	005457
description	keypad foil		

			
1			
GEV No.	401579	Ref. No.	005449
description	keypad foil		

			
1			
GEV No.	401580	Ref. No.	005455
description	keypad foil		

			
1			
GEV No.	401581	Ref. No.	005453
description	keypad foil		

			
1			
GEV No.	401582	Ref. No.	005276
description	keypad foil		

			
1			
GEV No.	401583	Ref. No.	006048
description	keypad foil		

accessories

			
1			
GEV No.	400997	Ref. No.	002670
description	push button		

solenoid valves

solenoid valves (water)

ELBI

			
1			
GEV No.	373020	Ref. No.	049056
description	solenoid valve double angled 230VAC inlet 3/4" outlet 14mm input 10l/min DN10 t.max. 90°C duty cycle 100% ELBI flow regulating valve inlet white		

MÜLLER

medium temperature: 90°C
duty cycle: 100%











				
1				
GEV No.	370117	Ref. No.	0G2196	
description	solenoid valve single straight 230VAC inlet 3/4" outlet 11.5mm DN10 t.max. 90°C duty cycle 100% MÜLLER			
spare parts for	370117			
	GEV No.	370133	Ref. No.	—
	solenoid valve body single straight inlet 3/4" outlet 11.5mm DN10 t.max. 90°C duty cycle 100% MÜLLER 230V			
	GEV No.	371002	Ref. No.	—
	solenoid valve holder MÜLLER flange support			
	GEV No.	371009	Ref. No.	—
	compression spring for solenoid coil			
	GEV No.	371011	Ref. No.	—
	spare parts kit membrane with long star star high 8mm MÜLLER			
	GEV No.	371017	Ref. No.	—
	solenoid coil MÜLLER 230VAC connection male faston 6.3mm			
	GEV No.	371122	Ref. No.	—
	solenoid valve filter ø 19mm H 10mm suitable for MÜLLER			
	GEV No.	501161	Ref. No.	—
	tap head for solenoid valve holder for solenoid coils			
accessories for	370117			
	GEV No.	371010	Ref. No.	—
	solenoid coil 230VAC connection with cable cable length 2000mm			
	GEV No.	371037	Ref. No.	—
	solenoid coil 24VAC 50/60Hz connection male faston 6.3mm			

Table continues overleaf





accessories for	370117		
	GEV No.	371038	Ref. No. —
	solenoid coil 230VAC connection appliance plug		

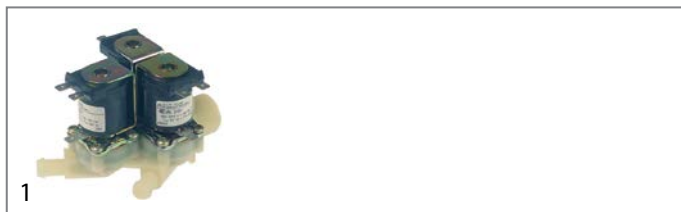



GEV No.	370172	Ref. No.	OH6404
description	solenoid valve triple straight 230VAC inlet 3/4" outlet 11.5mm DN10 t.max. 90°C duty cycle 100% MÜLLER		

spare parts for	370172		
------------------------	--------	--	--

	GEV No.	370132	Ref. No. —
	solenoid valve body triple straight inlet 3/4" outlet 11.5mm DN10 t.max. 90°C duty cycle 100% MÜLLER 230V		

	GEV No.	371002	Ref. No. —
	solenoid valve holder MÜLLER flange support		

	GEV No.	371009	Ref. No. —
	compression spring for solenoid coil		

	GEV No.	371011	Ref. No. —
	spare parts kit membrane with long star star high 8mm MÜLLER		

	GEV No.	371017	Ref. No. —
	solenoid coil MÜLLER 230VAC connection male faston 6.3mm		

	GEV No.	371122	Ref. No. —
	solenoid valve filter ø 19mm H 10mm suitable for MÜLLER		

	GEV No.	501161	Ref. No. —
	tap head for solenoid valve holder for solenoid coils		

accessories for	370172		
------------------------	--------	--	--

	GEV No.	371010	Ref. No. —
	solenoid coil 230VAC connection with cable cable length 2000mm		

	GEV No.	371037	Ref. No. —
	solenoid coil 24VAC 50/60Hz connection male faston 6.3mm		

	GEV No.	371038	Ref. No. —
	solenoid coil 230VAC connection appliance plug		

ROBERTSHAW/INVENSYS

medium temperature: 90°C 90°C 60°C
 ambient temperature: 60°C 25°C 60°C
 duty cycle: 40% 100% 100%



GEV No.	372016	Ref. No.	OK3088
description	solenoid valve single angled 230VAC inlet 3/4" outlet 14mm DN10 EATON (INVENSYS)		

solenoid valves with reducers

3-fold



GEV No.	370345	Ref. No.	0C1934
description	solenoid valve triple straight 230VAC inlet 3/4" outlet 11.5mm t.max. 90°C EATON (INVENSYS) plastic output B 0.25l/min output C 1.2l/min flow regulating valve outlet B white flow regulating valve outlet C blue		

TP

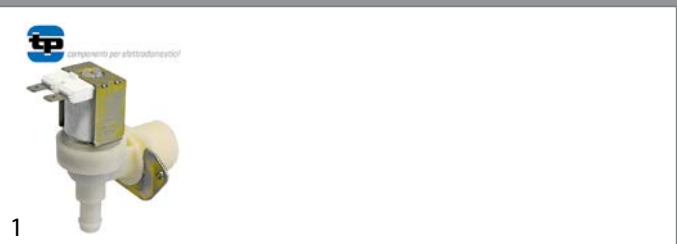



GEV No.	370015	Ref. No.	002613
description	solenoid valve single angled 230VAC inlet 3/4" outlet 11.5mm DN10 TP		

accessories for	370015		
------------------------	--------	--	--

	GEV No.	371220	Ref. No. —
	reducer TP flow rate 3l/min red tolerance ±15%		

	GEV No.	371221	Ref. No. —
	reducer TP flow rate 5.5l/min yellow tolerance ±15%		

	GEV No.	371222	Ref. No. —
	reducer TP flow rate 6l/min grey tolerance ±15%		

	GEV No.	371223	Ref. No. —
	reducer TP flow rate 10l/min white tolerance ±15%		

	GEV No.	371224	Ref. No. —
	reducer TP flow rate 12l/min bronze tolerance ±15%		







	GEV No.	371225	Ref. No. —
	reducer TP flow rate 16l/min light brown tolerance ±15%		

Table continues overleaf

accessories for		370015	
	GEV No.	371226	Ref. No. —
reducer TP flow rate 20l/min red tolerance ±15%			
	GEV No.	371230	Ref. No. —
reducer TP flow rate 0.25l/min red tolerance ±25%			
	GEV No.	371231	Ref. No. —
reducer TP flow rate 0.35l/min violet tolerance ±25%			
	GEV No.	371232	Ref. No. —
reducer TP flow rate 0.5l/min orange tolerance ±25%			
	GEV No.	371233	Ref. No. —
reducer TP flow rate 0.8l/min white tolerance ±25%			
	GEV No.	371234	Ref. No. —
reducer TP flow rate 1l/min light blue tolerance ±25%			
	GEV No.	371235	Ref. No. —
reducer TP flow rate 1.2l/min brown tolerance ±25%			
	GEV No.	371236	Ref. No. —
reducer TP flow rate 1.5l/min light brown tolerance ±25%			
	GEV No.	371237	Ref. No. —
reducer TP flow rate 2.5l/min yellow tolerance ±25%			
	GEV No.	371238	Ref. No. —
reducer TP flow rate 3.4l/min dark green tolerance ±25%			
	GEV No.	371239	Ref. No. —
reducer TP flow rate 5l/min black tolerance ±25%			
	GEV No.	371240	Ref. No. —
reducer TP flow rate 8l/min blue tolerance ±20%			

solenoid valves with reducers			
	1		
GEV No.	374034	Ref. No.	0K3047
description	solenoid valve single angled 230VAC inlet 3/4" outlet 11.5mm input 10l/min output 0.25l/min t.max. 90°C RPE plastic flow regulating valve outlet red flow regulating valve inlet white		

	1		
GEV No.	370344	Ref. No.	002712
description	solenoid valve triple angled 230VAC inlet 3/4" outlet 11.5mm t.max. 90°C TP plastic output B 0.25l/min output C 1l/min flow regulating valve outlet B red flow regulating valve outlet C light blue		

	1		
GEV No.	370375	Ref. No.	0F0001
description	solenoid valve triple straight 230VAC inlet 3/4" outlet 11.5mm t.max. 90°C TP plastic output A 2.5l/min output C 0.25l/min flow regulating valve outlet A yellow flow regulating valve outlet C red		

metal			
BÜRKERT			
2-way			
6213 series			
	1		
GEV No.	370335	Ref. No.	0K0670
description	solenoid valve 2-ways 230VAC connection 3/8" DN 10mm slide-on receptacle DIN -30 up to 120°C BÜRKERT type series 6213 membranes EPDM p max 10bar 50Hz		





solenoid valves steam (water)			
2-way			
0407 series			
			
1			
GEV No.	370334	Ref. No.	OK1425
description	solenoid valve 2-ways 230VAC connection 1" DN 25mm slide-on receptacle DIN 180°C BÜRKERT type series 0407 membranes PTFE p max 10bar		

MÜLLER			
2-way			
			
1			
GEV No.	370035	Ref. No.	0H6405
description	solenoid valve 2-ways 230VAC inlet 3/4" ET outlet 1/2" IT L 57mm water MÜLLER		

			
1			
GEV No.	370036	Ref. No.	OK1420
description	solenoid valve 2-ways 230VAC inlet 3/4" ET outlet 1/2" IT L 57mm water MÜLLER		

solenoid valves (various)			
			
1			
GEV No.	370376	Ref. No.	0H6377 231015
description	solenoid valve double 230V		

			
1			
GEV No.	370377	Ref. No.	0H6376
description	solenoid valve inlet 2" outlet 2"		

solenoid valves (gas)			
KROMSCHRÖDER			
			
1			
GEV No.	101472 ¹	Ref. No.	0H6411
description	solenoid valve 230VAC connection M12x1 L 52mm KROMSCHRÖDER p max 0.36bar p min 0bar reg. no. CE-0085AP0975		
<i>¹aluminium housing</i>			

ball valves electric			
			
1			
GEV No.	401140	Ref. No.	005026
description	ball valve inlet 1" IT outlet 1" IT with plug 230V L 152mm 50/60Hz closed off-current mode of operation electric connection cable 200mm size DN25		

			
1			
GEV No.	401139	Ref. No.	0C0882
description	ball valve inlet 3/4" IT outlet 3/4" IT with plug 230V L 65mm 50/60Hz closed off-current mode of operation electric connection cable 200mm		



pressure switches

for warewashing

ø 58mm with male faston 6.3mm

with connection horizontal



1

GEV No.	541179	Ref. No.	548267
description	pressure control pressure range 240/130mbar connection 6mm ø 58mm pressure connection horizontal warewashing pressure connection ø 6mm		

for gas equipment



1

GEV No.	541182	Ref. No.	0K1397
description	pressure control		



1

GEV No.	541073	Ref. No.	002635
description	pressure control ø 45mm pressure range adjustable 5-20mbar pressure connection vertical gas technology connection 1/4" pressure connection ø 1/4"mm		



1

GEV No.	541446	Ref. No.	005029
description	pressure control pressure range 10-50mbar connection 1/4"		



1

GEV No.	541075	Ref. No.	003772
description	pressure control pressure range adjustable 0.44-0.8mbar gas technology connection 6mm suitable for ZANUSSI		

for steam control



1

GEV No.	541043	Ref. No.	0H6696
description	pressure control ø 45mm pressure connection vertical steam control pressure range 0.44/0.38bar connection 1/4" pressure connection 1/4"		



1

GEV No.	541035	Ref. No.	0H6699
description	pressure control ø 45mm pressure range 0.9mbar pressure connection vertical steam control pressure range 0.75bar connection 1/4" difference 0.16bar pressure connection 1/4"		



1

GEV No.	541026	Ref. No.	0H6402
description	pressure control pressure connection vertical steam control pressure range adjustable 0.1-1.1bar pressure connection ø 3/8" ETmm		



1

GEV No.	541022	Ref. No.	0K1396
description	pressure control steam control pressure connection vertical pressure range adjustable 0.25-4.5bar connection 1/4" pressure connection 1/4" IT		





for boiling pans

			
1			
GEV No.	541459	Ref. No.	0G2935
description	pressure control with cable		

electrodes

			
1			
GEV No.	400698	Ref. No.	0H6629
description	level electrode 1/2" probe L 123mm insulated probe length 107mm		

			
1			
GEV No.	401258	Ref. No.	0A2838
description	level electrode 1/4" total length 120mm probe L 94mm insulated probe length 90mm PTFE insulated connection angled, male faston 6.3mm stainless steel ø 2.5mm		

			
1			
GEV No.	400121	Ref. No.	055346
description	level electrode 1/4" total length 121mm probe L 94mm insulated probe length 90mm PTFE insulated connection angled, male faston 6.3mm stainless steel		

			
1			
GEV No.	401261	Ref. No.	003878
description	level electrode 1/4" total length 138mm probe L 112mm insulated probe length 108mm PTFE insulated connection angled, male faston 6.3mm stainless steel ø 2.5mm		

			
1			
GEV No.	400402	Ref. No.	0H6624
description	level electrode 1/4" total length 193mm probe L 166mm insulated probe length 161mm PTFE insulated connection angled, male faston 6.3mm stainless steel ø 2.5mm		

			
1			
GEV No.	400403	Ref. No.	0H6625
description	level electrode 1/4" total length 210mm probe L 183mm insulated probe length 172mm PTFE insulated connection angled, male faston 6.3mm stainless steel ø 2.5mm		

			
1			
GEV No.	400404	Ref. No.	0H6635
description	level electrode 1/4" total length 240mm probe L 216mm insulated probe length 209mm PTFE insulated connection angled, male faston 6.3mm stainless steel ø 2.5mm		

			
1			
GEV No.	400405	Ref. No.	0H6626 246024
description	level electrode 1/4" total length 345mm probe L 320mm insulated probe length 310mm PTFE insulated connection F6.3 stainless steel ø 2.5mm		

			
1			
GEV No.	400120	Ref. No.	056449
description	level electrode 1/4" total length 83mm probe L 62mm insulated probe length 57mm PTFE insulated connection angled, male faston 6.3mm stainless steel ø 2.5mm		

			
1			
GEV No.	400012	Ref. No.	0H7090
description	level electrode probe L 35/20/11mm insulated probe length 11mm with 3 probes connection M4		

			
1			
GEV No.	400124	Ref. No.	002694
description	level electrode push-in total length 128mm probe L 103mm insulated probe length 93mm PTFE insulated connection F6.3 ø 2.5mm		

			
1			
GEV No.	401548	Ref. No.	005235
description	level electrode push-in total length 175mm probe L 151mm insulated probe length 142mm PTFE insulated connection F6.3 ø 2.5mm		

			
1			
GEV No.	378013	Ref. No.	0K4871
description	level electrode to clip		

			
1			
GEV No.	400011	Ref. No.	0H7101
description	level electrode total length 46mm insulated probe length 40mm with 3 probes connection M4		

			
1			
GEV No.	401260	Ref. No.	002632
description	level electrode total length 75mm probe L 50mm insulated probe length 46mm PTFE insulated connection angled, male faston 6.3mm ø 2.5mm		

			
1			
GEV No.	400123	Ref. No.	002633
description	spacer piece for level electrode		

			
1			
GEV No.	693744	Ref. No.	055435
description	spacer piece for level electrode size 5mm		

			
1			
GEV No.	693743	Ref. No.	055347
description	spacer piece for level electrode size 9mm		

fans



axial fans

ebm-papst

			
1			
GEV No.	601715 ¹	Ref. No.	002690
description	axial fan L 119mm W 119mm H 38mm 230VAC 50Hz 18W bearing ball bearing manuf. no. 4656ZW metal connection cable 310mm ebm-papst fan wheel ø 110mm temp.-resist. 75°C		

¹with ball bearings

import

			
1			
GEV No.	601080 ¹	Ref. No.	0C4423
description	axial fan L 119mm W 119mm H 38mm 230VAC 50/60Hz 23/20W bearing ball bearing connection male faston 2.8mm metal ADDA fan wheel ø 110mm temp.-resist. 70°C		
accessories for	601080		
		GEV No.	550898
		Ref. No.	—
		description	connecting cable cable length 2000mm connection F 2.8 connection distance 7.9mm for axial flow fan
		GEV No.	692519
		Ref. No.	—
		description	guard L 120mm W 120mm plastic

¹with ball bearings

cross flow fans

ebm-papst



1			
GEV No.	601047	Ref. No.	0H6923
description	cross flow fan ebm-papst QLZ06/0600-2513 roller ϕ 60mm roller length 60mm laminated core thickness 13mm motor position right 230V/50Hz 17W refrigeration bearing rubber connection male faston 6.3mm airflow 40m ³ /h 0 up to +60°C		



1			
GEV No.	601505	Ref. No.	0K5059
description	cross flow fan QLN65/2400A17-3030L roller ϕ 65mm roller length 240mm laminated core thickness 29mm motor position right 230V/50Hz 22W refrigeration bearing silicone connection F 6.3 0 up to +60°C 230V throughput 200m ³ /h 50Hz		

cross flow fan with heater battery

roller diameter ϕ 60mm



1			
GEV No.	601191	Ref. No.	0H6474
description	cross flow fan roller length 180mm roller ϕ 60mm motor position right 230V 50Hz 17W heat output 2000W bearing silicone with temperature limiter		

hot air motors

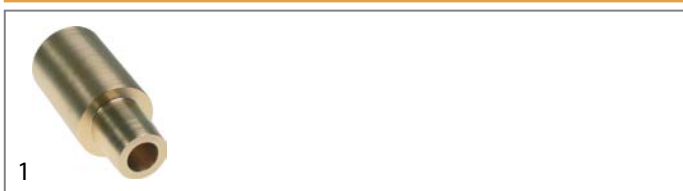

1			
GEV No.	511313	Ref. No.	005132
description	centring piece for fan motor		



1			
GEV No.	511302	Ref. No.	0H6643
description	engine shaft gasket ID ϕ 16mm ED ϕ 40mm for 55/56 series		

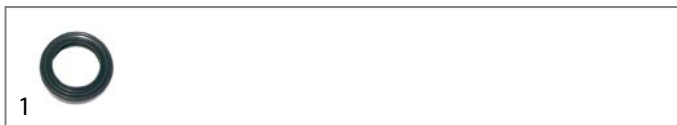

1			
GEV No.	511314	Ref. No.	0H6862
description	engine shaft gasket ID ϕ 19mm ED ϕ 30mm for 54 series		



1			
GEV No.	511303	Ref. No.	0H6644
description	engine shaft gasket ID ϕ 27mm ED ϕ 40mm for 55/56 series		



1			
GEV No.	511315	Ref. No.	0H6513
description	engine shaft gasket ID ϕ 29mm ED ϕ 40mm for 54 series		

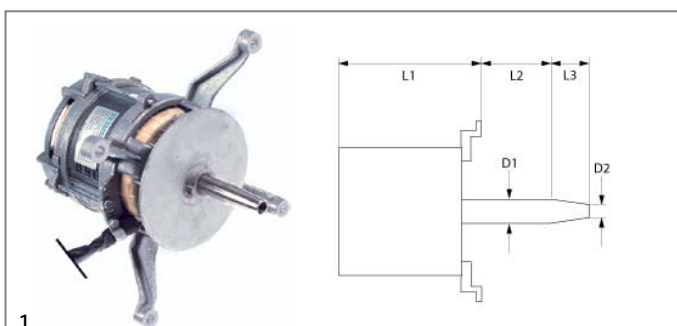

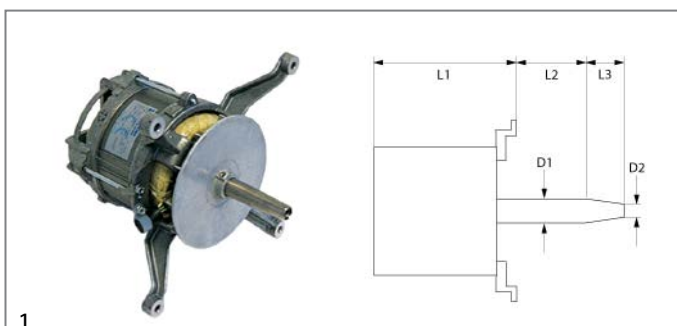

1			
GEV No.	601351	Ref. No.	0K1912
description	fan motor 220-230V 3 phase 50Hz 0.02/0.16kW 710/1390rpm speeds 2 L1 150mm L2 27mm L3 35mm M10R IT 0.35/0.9A power input 60/250W at 50Hz 710/1390rpm type L7mw84D-149 no. R2 D1 ϕ 17mm D2 ϕ 13mm		

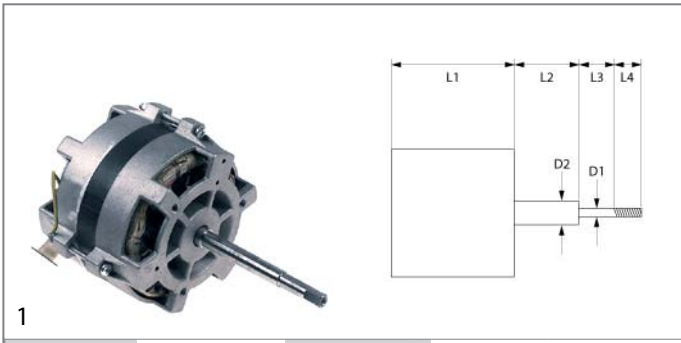

1			
GEV No.	500103	Ref. No.	0H6929
description	fan motor 220-240/380-415V 3 phase 50/60Hz 0.25kW 1400rpm speeds 1 L1 150mm L2 32mm L3 40mm ϕ 125mm M10R IT at 50Hz 1400rpm at 60Hz 1700rpm type L7Aw4D-099 no. X3 D1 ϕ 17mm D2 ϕ 14mm		



GEV No.	601449	Ref. No.	058667
description	fan motor 220-240/380-415V 3 phase 50Hz 0.19kW 1350rpm speeds 1 L1 105mm L2 74mm L3 35mm L4 12mm D1 \varnothing 9x10mm D2 \varnothing 12mm M6R IT 0.58/1A type FIR1092 no. 1092 shaft flat length 9mm		

accessories for	601449			
	GEV No.	693846	Ref. No.	—
	spacer piece for fan motor			
	GEV No.	693847	Ref. No.	—
	fixing plate for hot air motors ED \varnothing 230mm H 2.5mm ID \varnothing 16mm			
	GEV No.	694297	Ref. No.	—
	flange for hot air motors ED \varnothing 270mm H 3.5mm ID \varnothing 16mm			

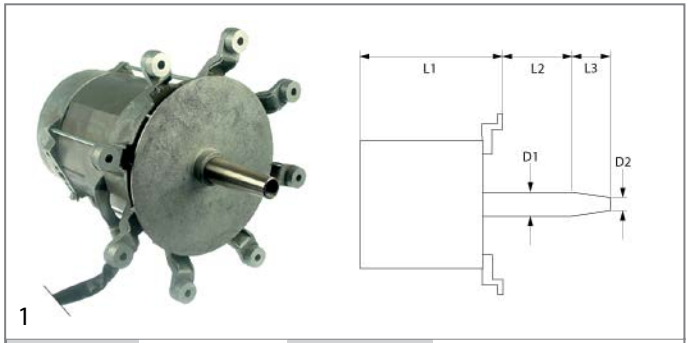

GEV No.	601370	Ref. No.	0K2716
description	fan motor 220-240V 3 phase 50HzkWrpm speeds 2 L1 221mm L2 27mm L3 50mm D1 \varnothing 25mm D2 \varnothing 20mm M14R IT Y/YY type L9UWID-13		

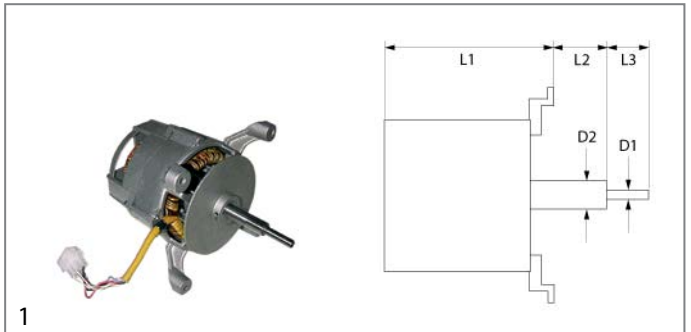

GEV No.	500141	Ref. No.	0F0007
description	fan motor 230V 1 phase 50/60Hz 0.19kW 1450/1750rpm speeds 1 L1 150mm L2 52mm L3 35mm D1 \varnothing 9/10mm D2 \varnothing 14mm M6R IT 1.3A Cos(fi) 0.91 at 50Hz 1450rpm at 60Hz 1750rpm type LM80/4 no. 596477 shaft flat length 12mm		

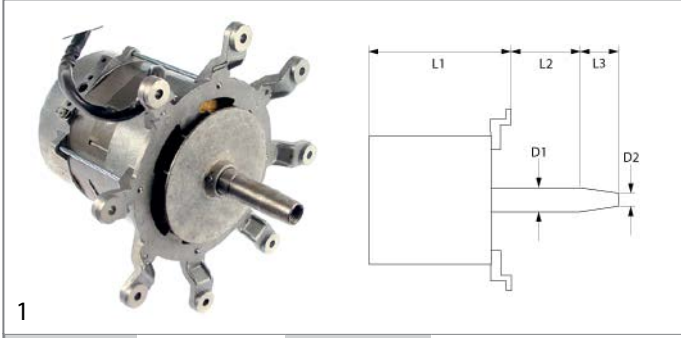

GEV No.	500836	Ref. No.	0H6925 280125
description	fan motor 220-240/380-415V 3 phase 50Hz 0.37kW 1400rpm speeds 1 L1 175mm L2 47mm L3 31mm M14R IT 2.85/1.65A power input 580W Cos(fi) 0.55 at 50Hz 1400rpm type L9Cw4D-037 no. S2 D1 \varnothing 23mm D2 \varnothing 20mm		

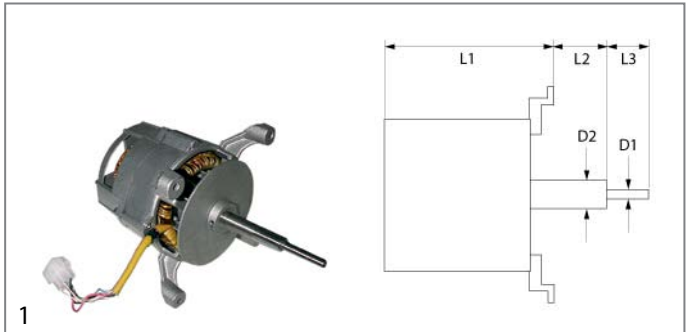

GEV No.	500143	Ref. No.	002739
description	fan motor 230V 1 phase 50/60Hz 0.35kW 1400/1700rpm speeds 1 L1 165mm L2 91mm L3 35mm D1 \varnothing 9/10mm D2 \varnothing 16mm M6R IT 2.7A Cos(fi) 0.9 at 50Hz 230V at 60Hz 230V at 50Hz 1400rpm at 60Hz 1700rpm suitable capacitor 16 μ F/450V type LM80/4 no. 556749 shaft flat length 13mm		

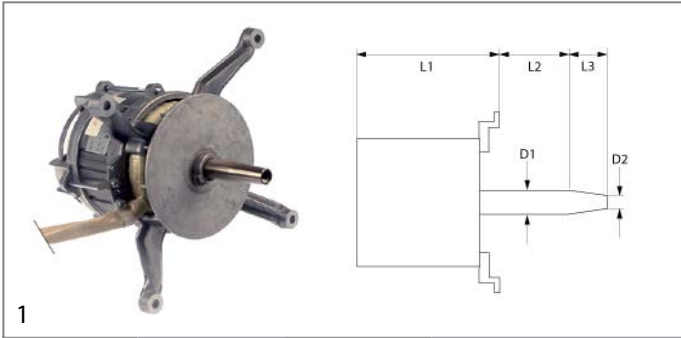

GEV No.	601366	Ref. No.	0K2720 280159
description	fan motor 220-240V 3 phase 50/60HzkW speeds 1 L1 140mm L2 27mm L3 35mm M10R IT Y/YY type L7mw84D-098 no. RD D1 \varnothing 17mm D2 \varnothing 13mm		



1

GEV No.	500142	Ref. No.	005028
description	fan motor 230V 1 phase 50Hz 0.06/0.19kW 930/1380rpm speeds 2 L1 160mm L2 52mm L3 35mm D1 ø 9/10mm D2 ø 16mm M6R IT 1.5/0.7A Cos(φ) 0.9 at 50Hz 930/1380rpm at 60Hz 1100/1700rpm suitable capacitor 12.5µF/400V 4P/6P type LM/FB80 no. 552059 shaft flat length 12mm		

1

GEV No.	500108	Ref. No.	0H6930
description	fan motor 380-415V 3 phase 50/60Hz 0.03/0.2kWrpm speeds 2 L1 155mm L2 30mm L3 31mm M10R IT Y/YY type L7mw84D-097 no. V5 D1 ø 17mm D2 ø 13mm		

2

GEV No.	500144	Ref. No.	002748
description	fan motor 230V 1 phase 50Hz 0.11/0.35kW 900/1400rpm speeds 2 L1 165mm L2 91mm L3 35mm D1 ø 9/10mm D2 ø 16mm M6R IT 2.7/1.3A at 50Hz 230V at 60Hz 230V at 50Hz 900/1400rpm at 60Hz 1080/1680rpm suitable capacitor 16µF/450V 4P/6P type LM/FB80 no. 358008 shaft flat length 12mm		

1

GEV No.	601367	Ref. No.	0H6933
description	fan motor 380-415V 3 phase 50/60HzkWrpm speeds 2 L1 175mm L2 25mm L3 48mm M14R IT Y/YY type L9rw84D-094 no. U3 D1 ø 25mm D2 ø 20mm		

1

GEV No.	601352	Ref. No.	0H6555
description	fan motor 380-400V 3 phase 50Hz 0.02/0.16kW 710/1390rpm speeds 2 L1 140mm L2 27mm L3 35mm M10R IT 0.2/0.5A power input 60/250W at 50Hz 710/1390rpm Y/YY type L7mw84D-148 no. T1 D1 ø 17mm D2 ø 13mm		

1

GEV No.	602139	Ref. No.	0H6932	
description	fan motor 440-480V 3 phase 60Hz 0.37kW 1600rpm L1 185mm L2 26mm L3 50mm type L9Cw4D-157 D1 ø 25mm D2 ø 20mm			
accessories for	602139			
	GEV No.	510574	Ref. No.	—
	shaft sealing type 20 for fan motor			



1

GEV No.	601365	Ref. No.	0G1989
description	fan wheel D1 ø 225mm H1 60mm blades 12 D2 ø 19,5mm D3 ø 23mm H2 25,5mm		



1

GEV No.	601220	Ref. No.	0C6462
description	fan wheel D1 ø 280mm H1 100mm blades 6 D2 ø 10mm D3 ø 10mm H2 37mm H3 22mm		



1

GEV No.	601371	Ref. No.	002871 0C8325
description	fan wheel D1 ø 280mm H1 100mm blades 6 D2 ø 10mm D3 ø 10mm H2 37mm H3 23mm		



1

GEV No.	601344	Ref. No.	0H6507
description	fan wheel D1 ø 280mm H1 127mm blades 12 D2 ø 13mm D3 ø 16mm H2 37mm		



1

GEV No.	601343	Ref. No.	0H6510 237146
description	fan wheel D1 ø 350mm H1 127mm blades 6 D2 ø 13mm D3 ø 16mm H2 37mm		



1

GEV No.	601342	Ref. No.	0H6947
description	fan wheel D1 ø 450mm H1 178mm blades 6 D2 ø 19,5mm D3 ø 23,5mm H2 45mm		



1

GEV No.	511300	Ref. No.	002873
description	O-ring Viton thickness 3.53mm ID ø 28.17mm for 57 series for motor shaft		



1

GEV No.	511301	Ref. No.	002699
description	shaft seal ID ø 16mm ED ø 38mm thickness 18mm		

hot air fans

HEIDOLPH



1

GEV No.	500147	Ref. No.	0H6926
description	hot air fan 230V 37W D 85mm distance fan wheel - fixing 40mm mounting distance 28mm HEIDOLPH type 113.30.000431B		



miscellaneous

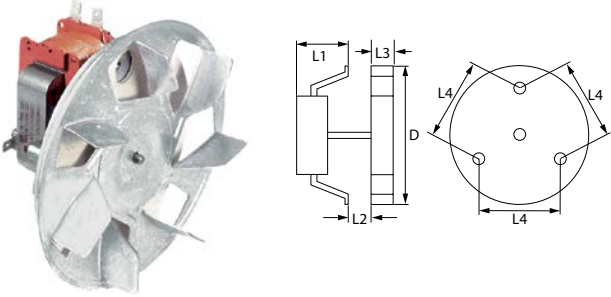

1

GEV No.	601273	Ref. No.	OK3048
description	hot air fan 220-240V 32W 50/60Hz L1 60mm L2 10mm L3 25mm L4 87mm fan wheel ø 155mm FIME type C20X0E01/15CLH		

accessories

fan wheels for hot air fans



1

GEV No.	601346	Ref. No.	0H6951
description	fan wheel ø 180mm W 27mm shaft intake ø 7mm blades 8		

radial fans

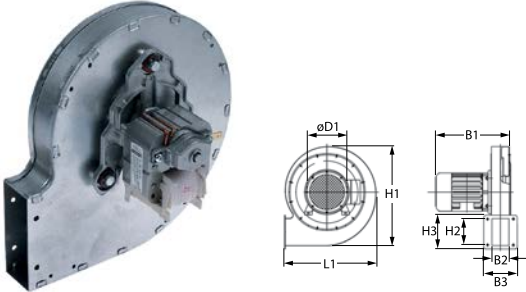

1

GEV No.	601238	Ref. No.	002639
description	radial fan 230V voltage AC 50Hz 40W H1 205mm L1 205mm D1 ø 150mm W1 103mm W2 32mm H2 83mm W3 34mm H3 86mm		

motors

gear motors

for tilting bratt pans



1

GEV No.	500618	Ref. No.	OK2747 280793
description	gear motor for tilting bratt pan		

miscellaneous



1

GEV No.	500620	Ref. No.	OK4843
description	gear motor for kettle		

spindle motors

MAGNETIC



1

GEV No.	500672	Ref. No.	0H6953
description	spindle motor type DSP4550-200-01 280W 400V 50Hz 3 phase shaft ø 30mm for tilting bratt pan L 450mm W 100mm H 185mm hub 200mm MAGNETIC		

condensators & interference suppression filters

operating capacitors

metal



1

GEV No.	365140	Ref. No.	047541
description	operating capacitor capacity 12.5µF 450V tolerance 5% 60Hz ambient temperature max. -25 up to +70°C ø 40mm L 83mm M8 aluminium connection male faston 6.3mm C.87.8BF2 MKP protection		



1

GEV No.	365003	Ref. No.	OK2387
description	operating capacitor capacity 6µF 400V tolerance 5% 50/60Hz ambient temperature max. -25 to +85°C ø 30mm L 85mm M8 aluminium connection cable 300mm MKP protection IP65		



fuses

fine fuses

1			
GEV No.	358610	Ref. No.	058869
description	fine fuse size ø5x20mm 10A fast-acting rated 250V Qty 10 pcs		

1			
GEV No.	358611	Ref. No.	005136
description	fine fuse size ø5x20mm 16A fast-acting rated 250V Qty 10 pcs		

1			
GEV No.	358695	Ref. No.	005032
description	fine fuse size ø5x20mm 3.15A medium lag rated 250V Qty 10 pcs		

1			
GEV No.	358594	Ref. No.	002820
description	fine fuse size ø5x20mm 0.16A slow-acting rated 250V Qty 10 pcs		

1			
GEV No.	358596	Ref. No.	002920
description	fine fuse size ø5x20mm 0.25A slow-acting rated 250V Qty 10 pcs		

fine fuse holders

1			
GEV No.	358396	Ref. No.	056582
description	fuse holder suitable fuse ø5x20mm ø 15mm mounting ø 12.5mm 16A rated 250V L 46mm connection male faston 4.8mm		

1			
GEV No.	358394	Ref. No.	0H6523
description	fuse holder suitable fuse ø5x30mm mounting ø 18.3mm 6.3A rated 500V connection F2.8		

1			
GEV No.	358395	Ref. No.	0H6526
description	screw cap suitable fuse ø 14.5mm mounting ømm thread M9x1 6.3A rated 250V connection suitable for fuse holder		

overload switches

1			
GEV No.	358519	Ref. No.	0H6691
description	overload switch drop-away current 0.05A		

1			
GEV No.	358523	Ref. No.	0H6104
description	overload switch drop-away current 0.6A		

electric accessories

cables

copper wire

up to 200°C

1			
GEV No.	550081	Ref. No.	0K3285
description	copper wire 1.5mm ² permanent temperature -60 up to +200°C conductor nickel-plated copper wire insulation glass fibre braiding/silicone rubber Qty 10m green/yellow t.max. 250°C rated 300/500V test voltage 2000V		

cable harnesses

1			
GEV No.	401849	Ref. No.	002763
description	connecting cable		



terminals and connectors

insulated

ring terminals



1			
GEV No.	550166	Ref. No.	OK2459
description	ring terminal size M6 ø6.5mm 1.5-2.5mm ² Qty 100 pcs insulation PVC Cu gal Sn blue t.max. 75°C		

not insulated

bullet connectors



1			
GEV No.	550334	Ref. No.	0H7029
description	plug connector size 3.5mm 0.25-1.5mm ² Cu gal Sn t.max. 125°C Qty 1 pcs		

plug connectors



1			
GEV No.	550328	Ref. No.	0H7030
description	female bullet ø 3.5mm		



1			
GEV No.	550330	Ref. No.	0H7027
description	plug connector 12-pole		



1			
GEV No.	550333	Ref. No.	0H7028
description	plug connector 12-pole		



1			
GEV No.	550334	Ref. No.	0H7029
description	plug connector size 3.5mm 0.25-1.5mm ² Cu gal Sn t.max. 125°C Qty 1 pcs		

electronic components

resistors













1			
GEV No.	359929	Ref. No.	058872
description	resistor 100Ohm		

gas taps

PEL

20S series





1			
GEV No.	101094	Ref. No.	054109
description	gas tap PEL type 20S gas inlet M16x1.5 (tube ø 10mm) bypass nozzle ø 0.35mm gas outlet M16x1.5 (tube ø 10/8mm) thermocouple connection M8x1 pilot connection shaft ø 8x6.5mm shaft L 22/15mm shaft flat lower		
spare parts for	101094		
	GEV No.	100408	Ref. No.
			—
	bypass nozzle type PEL20/21 bore ø 0.35mm thread M5x0.5		
	GEV No.	101060	Ref. No.
			056595
	magnet unit standard L 39mm D1 ø 15.4mm D2 ø 11mm suitable for PEL20-21/JUNKERS/EGA		
	GEV No.	101205	Ref. No.
			—
	gas tap front part shaft ø 8x6.5mm shaft L 22/15mm shaft flat upper/lower suitable for PEL20		
	GEV No.	101230	Ref. No.
			—
	thermocouple nut T1: M8x1 T2: M18x1 aluminium		
accessories for	101094		
	GEV No.	101278	Ref. No.
			060325
	olive for pipe ø 10mm Qty 1 pcs		
	GEV No.	101300	Ref. No.
			—
	union nut thread M16x1.5 tube ø 10mm		
	GEV No.	101450	Ref. No.
			—
	olive for pipe ø 8mm L 12.7mm Qty 1 pcs ED ø 10mm		
	GEV No.	101451	Ref. No.
			—
	union nut thread M16x1.5 tube ø 8mm		
	GEV No.	110081	Ref. No.
			—
	knob ø 70mm shaft ø 8x6.5mm shaft flat universal		
	GEV No.	110083	Ref. No.
			—
	knob dial plate gas tap without ignition flame silver		



22S/V series



GEV No.	101087	Ref. No.	053192
description	gas tap PEL type 22S/V gas inlet M20x1.5 (tube ø 12mm) bypass nozzle ø 0.35mm gas outlet M20x1.5 (tube ø 12/10mm) thermocouple connection M9x1 pilot connection M10x1 shaft ø 10x8mm shaft L 25/17mm shaft flat upper		
spare parts for	101087		
	GEV No.	100259	Ref. No. —
	bypass nozzle type PEL22 bore ø 0.35mm thread M6x0.5		
	GEV No.	101058	Ref. No. 056594
	magnet unit L 39mm D1 ø 15.4mm D2 ø 13.5mm suitable for PEL22/EGA24197 standard		
	GEV No.	101201	Ref. No. —
	gas tap front part shaft ø 10x8mm shaft L 25/17mm shaft flat upper/lower suitable for PEL22		
	GEV No.	101231	Ref. No. —
	thermocouple nut T1: M9x1 T2: M18x1		
	GEV No.	101241	Ref. No. —
	gas connection thread M20x1.5 tube ø 12/10mm for PEL gas taps vertical		
	GEV No.	101460	Ref. No. —
	O-ring ø 12.37mm D1 ø 2.62mm suitable for PEL22		
	GEV No.	101461	Ref. No. —
	screw kit suitable for PEL22 Qty 4 pcs		
accessories for	101087		
	GEV No.	100908	Ref. No. 052125
	union screw thread M10x1 for pipe ø 4mm Qty 1 pcs		
	GEV No.	100909	Ref. No. —
	union screw thread M10x1 for pipe ø 6mm Qty 1 pcs		
	GEV No.	101240	Ref. No. —
	gas connection thread M20x1.5 tube ø 12/10mm for PEL gas taps with gasket and screws horizontal		
	GEV No.	101246	Ref. No. —
	olive for pipe ø 4mm Qty 1 pcs		
	GEV No.	101248	Ref. No. 050682
	olive for pipe ø 12mm Qty 1 pcs suitable for PEL		
	GEV No.	101249	Ref. No. —
	olive for pipe ø 10mm Qty 1 pcs		
	GEV No.	101250	Ref. No. —
	union nut thread M20x1.5 for pipe ø 10mm		
	GEV No.	101251	Ref. No. —
	union nut thread M20x1.5 for pipe ø 12mm		

accessories for	101087		
	GEV No.	101286	Ref. No. —
	olive ID ø 6mm Qty 1 pcs		
	GEV No.	110080	Ref. No. —
	knob ø 70mm shaft ø 10x8mm shaft flat universal		
	GEV No.	112206	Ref. No. —
	knob dial plate silver gas tap PEL21/22/23 t.max.°C ED ø 63mm ID ø 45.5mm		

23S/O series



















GEV No.	101091	Ref. No.	054811
description	gas tap PEL type 23S/O gas inlet M28x1.5 (tube ø 20mm) bypass nozzle ø 0.35mm gas outlet M24x1.5 (tube ø 16mm) thermocouple connection M9x1 pilot connection M10x1 shaft ø 10x8mm shaft L 35/19mm shaft flat upper		
spare parts for	101091		
	GEV No.	100455	Ref. No. —
	bypass nozzle type PEL23/24 bore ø 0.35mm thread M8x0.5		
	GEV No.	101045	Ref. No. —
	magnet unit T1: M9x1 T2: M22x1 L 46mm ø 18mm suitable for PEL23S M9x1		
	GEV No.	101244	Ref. No. —
	gas connection thread M24x1.5 tube ø 12/16mm horizontal for PEL gas taps		
	GEV No.	101336	Ref. No. —
	gas tap front part shaft ø 10x8mm shaft L 35/17mm shaft flat upper/lower suitable for PEL23S		
	GEV No.	101463	Ref. No. —
	screw suitable for PEL23S Qty 4 pcs		
	GEV No.	528455	Ref. No. —
	O-ring Viton thickness 2.62mm ID ø 18.72mm Qty 1 pcs		
accessories for	101091		
	GEV No.	100908	Ref. No. 052125
	union screw thread M10x1 for pipe ø 4mm Qty 1 pcs		
	GEV No.	100909	Ref. No. —
	union screw thread M10x1 for pipe ø 6mm Qty 1 pcs		
	GEV No.	101246	Ref. No. —
	olive for pipe ø 4mm Qty 1 pcs		
	GEV No.	101252	Ref. No. —
	union nut thread M24x1.5 for pipe ø 12mm		
	GEV No.	101253	Ref. No. —
	union nut thread M24x1.5 PEL for pipe ø 16mm		

Table continues overleaf



accessories for		101091		
	GEV No.	101254	Ref. No.	—
union nut thread M28x1.5 tube ø 20mm				
	GEV No.	101255	Ref. No.	—
olive for pipe ø 12mm Qty 1 pcs				
	GEV No.	101256	Ref. No.	—
olive for pipe ø 16mm Qty 1 pcs				
	GEV No.	101257	Ref. No.	—
olive for pipe ø 20mm Qty 1 pcs				
	GEV No.	101286	Ref. No.	—
olive ID ø 6mm Qty 1 pcs				
	GEV No.	110080	Ref. No.	—
knob ø 70mm shaft ø 10x8mm shaft flat universal				
	GEV No.	112206	Ref. No.	—
knob dial plate silver gas tap PEL21/22/23 t.max.°C ED ø 63mm ID ø 45.5mm				

accessories for		101630		
	GEV No.	101246	Ref. No.	—
olive for pipe ø 4mm Qty 1 pcs				
	GEV No.	101286	Ref. No.	—
olive ID ø 6mm Qty 1 pcs				
	GEV No.	110064	Ref. No.	—
knob				
	GEV No.	110066	Ref. No.	—
knob screw				
	GEV No.	550396	Ref. No.	—
shaft extension L 25mm JUNKERS				







alternatives to EGA

GPEL20 series

with pipe outlet



1

GEV No.	101608	Ref. No.	0H6700	
description	gas tap alternatives to EGA type GPEL20R with pipe outlet without ignition flame connection gas inlet M15x1 (tube ø 10mm) bypass nozzle ø 0.35mm gas outlet M17x1 (tube ø 10mm) thermocouple connection M8x1 shaft ø 8x7mm shaft L 34/15mm shaft flat lower			
spare parts for	101608			
	GEV No.	100408	Ref. No.	—
bypass nozzle type PEL20/21 bore ø 0.35mm thread M5x0.5				
	GEV No.	101060	Ref. No.	056595
magnet unit standard L 39mm D1 ø 15.4mm D2 ø 11mm suitable for PEL20-21/JUNKERS/EGA				
	GEV No.	101230	Ref. No.	—
thermocouple nut T1: M8x1 T2: M18x1 aluminium				
accessories for	101608			
	GEV No.	100926	Ref. No.	—
centring piece thread M17x1				
	GEV No.	100942	Ref. No.	—
union nut thread M15x1 for pipe ø 10mm				
	GEV No.	100943	Ref. No.	—
union nut thread M17x1 tube ø 10mm				
	GEV No.	101278	Ref. No.	060325
olive for pipe ø 10mm Qty 1 pcs				

23S/V series



1

GEV No.	101630	Ref. No.	0K9985	
description	gas tap PEL type 23S/V gas inlet 1/2" IT bypass nozzle ø 0.35mm gas outlet 1/2" MT (tube ø 14mm) thermocouple connection M10x1 pilot connection M10x1 shaft ø 10mm shaft L 25mm shaft flat			
spare parts for	101630			
	GEV No.	100455	Ref. No.	—
bypass nozzle type PEL23/24 bore ø 0.35mm thread M8x0.5				
	GEV No.	101059	Ref. No.	—
magnet unit T1: M10x1 T2: M22x1 L 46mm ø 18mm suitable for PEL23S M10x1				
	GEV No.	102767	Ref. No.	—
gas tap front part shaft ø 10mm shaft L 26.5mm shaft flat suitable for PEL23S				
accessories for	101630			
	GEV No.	100908	Ref. No.	052125
union screw thread M10x1 for pipe ø 4mm Qty 1 pcs				
	GEV No.	100909	Ref. No.	—
union screw thread M10x1 for pipe ø 6mm Qty 1 pcs				
	GEV No.	100945	Ref. No.	—
roll pin ø 3.2mm L 10mm				
	GEV No.	101218	Ref. No.	—
shaft extension JUNKERS				
	GEV No.	101219	Ref. No.	—
shaft extension L 25mm JUNKERS				

















GPEL21 series

with nozzle outlet

















1

GEV No.	101983	Ref. No.	0H6397
description	gas tap alternatives to EGA type GPEL21D with nozzle outlet (with nozzle) gas inlet M15x1 (tube ø 10mm) external nozzle ø 1.35mm internal nozzle ø 0.66mm bypass nozzle ø 0.35mm mixing pipe connection M17x1 thermocouple connection M10x1 pilot connection M10x1 shaft ø 8x7mm shaft L 34/15mm shaft flat lower		
spare parts for	101983		
	GEV No.	100300	Ref. No. 0G1792
	gas injector thread M12x1 WS 14 bore ø 1.35mm		
	GEV No.	100310	Ref. No. 0H6356
	internal nozzle bore ø 0.66mm suitable for EGA26400/26440		
	GEV No.	100408	Ref. No. —
	bypass nozzle type PEL20/21 bore ø 0.35mm thread M5x0.5		
	GEV No.	100908	Ref. No. 052125
	union screw thread M10x1 for pipe ø 4mm Qty 1 pcs		
	GEV No.	100927	Ref. No. —
	torsion spring L 2.8-8.0mm for internal nozzle ø 3mm bore ømm		
	GEV No.	101233	Ref. No. 0K2512
	union nut thread M10x1 JUNKERS		
	GEV No.	101246	Ref. No. —
	olive for pipe ø 4mm Qty 1 pcs		
	GEV No.	101526	Ref. No. —
	O-ring Viton thickness 1.78mm ID ø 4.48mm Qty 1 pcs		
	GEV No.	101593	Ref. No. —
	adjusting screw for internal nozzle thread M8x0.75		
	GEV No.	101806	Ref. No. —
	gas tap front part shaft ø 8x7mm shaft L 34/15mm shaft flat upper/lower suitable for PEL21		
accessories for	101983		
	GEV No.	100909	Ref. No. —
	union screw thread M10x1 for pipe ø 6mm Qty 1 pcs		
	GEV No.	100926	Ref. No. —
	centring piece thread M17x1		
	GEV No.	100942	Ref. No. —
	union nut thread M15x1 for pipe ø 10mm		
	GEV No.	101278	Ref. No. 060325
	olive for pipe ø 10mm Qty 1 pcs		
	GEV No.	101286	Ref. No. —
	olive ID ø 6mm Qty 1 pcs		







1

GEV No.	101668	Ref. No.	0H6399
description	gas tap alternatives to EGA type GPEL21D with nozzle outlet (with nozzle) gas inlet M15x1 (tube ø 10mm) external nozzle ø 1.35mm internal nozzle ø 1.2mm bypass nozzle ø 0.35mm mixing pipe connection M17x1 thermocouple connection M10x1 pilot connection M10x1 shaft ø 8x7mm shaft L 34/15mm shaft flat lower tube ø 10mm shaft length knob 15mm		
spare parts for	101668		
	GEV No.	100300	Ref. No. 0G1792
	gas injector thread M12x1 WS 14 bore ø 1.35mm		
	GEV No.	100313	Ref. No. 0K1252
	internal nozzle bore ø 1.20mm suitable for EGA26400/26440		
	GEV No.	100908	Ref. No. 052125
	union screw thread M10x1 for pipe ø 4mm Qty 1 pcs		
	GEV No.	100927	Ref. No. —
	torsion spring L 2.8-8.0mm for internal nozzle ø 3mm bore ømm		
	GEV No.	101060	Ref. No. 056595
	magnet unit standard L 39mm D1 ø 15.4mm D2 ø 11mm suitable for PEL20-21/JUNKERS/EGA		
	GEV No.	101233	Ref. No. 0K2512
	union nut thread M10x1 JUNKERS		
	GEV No.	101246	Ref. No. —
	olive for pipe ø 4mm Qty 1 pcs		
	GEV No.	101526	Ref. No. —
	O-ring Viton thickness 1.78mm ID ø 4.48mm Qty 1 pcs		
	GEV No.	101593	Ref. No. —
	adjusting screw for internal nozzle thread M8x0.75		
	GEV No.	101806	Ref. No. —
	gas tap front part shaft ø 8x7mm shaft L 34/15mm shaft flat upper/lower suitable for PEL21		
accessories for	101668		
	GEV No.	100909	Ref. No. —
	union screw thread M10x1 for pipe ø 6mm Qty 1 pcs		
	GEV No.	100926	Ref. No. —
	centring piece thread M17x1		
	GEV No.	100942	Ref. No. —
	union nut thread M15x1 for pipe ø 10mm		
	GEV No.	101278	Ref. No. 060325
	olive for pipe ø 10mm Qty 1 pcs		
	GEV No.	101286	Ref. No. —
	olive ID ø 6mm Qty 1 pcs		



			
GEV No.	101642	Ref. No.	0H6395
description	gas tap alternatives to EGA type GPEL21D with nozzle outlet (with nozzle) gas inlet M15x1 (tube ø 10mm) external nozzle ø 1.55mm internal nozzle ø 0.8mm bypass nozzle ø 0.45mm mixing pipe connection M17x1 thermocouple connection M10x1 pilot connection M10x1 shaft ø 8x7mm shaft L 34/15mm shaft flat lower		
spare parts for	101642		
	GEV No.	100301	Ref. No. —
	gas injector thread M12x1 WS 14 bore ø 1.55mm		
	GEV No.	100311	Ref. No. 0H6372
	internal nozzle bore ø 0.80mm suitable for EGA26400/26440		
	GEV No.	100554	Ref. No. —
	bypass nozzle type PEL20/21 bore ø 0.45mm thread M5x0.5		
	GEV No.	100908	Ref. No. 052125
	union screw thread M10x1 for pipe ø 4mm Qty 1 pcs		
	GEV No.	100927	Ref. No. —
	torsion spring L 2.8-8.0mm for internal nozzle ø 3mm bore ømm		
	GEV No.	101060	Ref. No. 056595
	magnet unit standard L 39mm D1 ø 15.4mm D2 ø 11mm suitable for PEL20-21/JUNKERS/EGA		
	GEV No.	101233	Ref. No. 0K2512
	union nut thread M10x1 JUNKERS		
	GEV No.	101246	Ref. No. —
	olive for pipe ø 4mm Qty 1 pcs		
	GEV No.	101526	Ref. No. —
	O-ring Viton thickness 1.78mm ID ø 4.48mm Qty 1 pcs		
	GEV No.	101593	Ref. No. —
	adjusting screw for internal nozzle thread M8x0.75		
	GEV No.	101806	Ref. No. —
	gas tap front part shaft ø 8x7mm shaft L 34/15mm shaft flat upper/lower suitable for PEL21		
accessories for	101642		
	GEV No.	100909	Ref. No. —
	union screw thread M10x1 for pipe ø 6mm Qty 1 pcs		
	GEV No.	100926	Ref. No. —
	centring piece thread M17x1		
	GEV No.	100942	Ref. No. —
	union nut thread M15x1 for pipe ø 10mm		
	GEV No.	101278	Ref. No. 060325
	olive for pipe ø 10mm Qty 1 pcs		
	GEV No.	101286	Ref. No. —
	olive ID ø 6mm Qty 1 pcs		

			
GEV No.	101767	Ref. No.	0H6400
description	gas tap alternatives to EGA type GPEL21D with nozzle outlet (with nozzle) gas inlet M15x1 (tube ø 10mm) external nozzle ø 1.55mm internal nozzle ø 1.4mm bypass nozzle ø 0.45mm mixing pipe connection M17x1 thermocouple connection M10x1 pilot connection M10x1 shaft ø 8x7mm shaft L 34/15mm shaft flat lower		
spare parts for	101767		
	GEV No.	100301	Ref. No. —
	gas injector thread M12x1 WS 14 bore ø 1.55mm		
	GEV No.	100322	Ref. No. 0K1254
	internal nozzle bore ø 1.40mm suitable for EGA26400/26440		
	GEV No.	100554	Ref. No. —
	bypass nozzle type PEL20/21 bore ø 0.45mm thread M5x0.5		



































			
GEV No.	101731	Ref. No.	0H6396
description	gas tap alternatives to EGA type GPEL21D with nozzle outlet (with nozzle) gas inlet M15x1 (tube ø 10mm) external nozzle ø 2.05mm internal nozzle ø 1.05mm bypass nozzle ø 0.55mm mixing pipe connection M17x1 thermocouple connection M10x1 pilot connection M10x1 shaft ø 8x7mm shaft L 34/15mm shaft flat lower		
spare parts for	101731		
	GEV No.	100303	Ref. No. 0G1794
	gas injector thread M12x1 WS 14 bore ø 2.05mm		
	GEV No.	100312	Ref. No. 0H6357
	internal nozzle bore ø 1.05mm suitable for EGA26400/26440		
	GEV No.	100550	Ref. No. —
	bypass nozzle type PEL20/21 bore ø 0.55mm thread M5x0.5		
	GEV No.	100908	Ref. No. 052125
	union screw thread M10x1 for pipe ø 4mm Qty 1 pcs		
	GEV No.	100927	Ref. No. —
	torsion spring L 2.8-8.0mm for internal nozzle ø 3mm bore ømm		
	GEV No.	101060	Ref. No. 056595
	magnet unit standard L 39mm D1 ø 15.4mm D2 ø 11mm suitable for PEL20-21/JUNKERS/EGA		
	GEV No.	101233	Ref. No. 0K2512
	union nut thread M10x1 JUNKERS		
	GEV No.	101246	Ref. No. —
	olive for pipe ø 4mm Qty 1 pcs		
	GEV No.	101526	Ref. No. —
	O-ring Viton thickness 1.78mm ID ø 4.48mm Qty 1 pcs		

Table continues overleaf



spare parts for		101731		
GEV No.		101593	Ref. No.	—
	adjusting screw for internal nozzle thread M8x0.75			
GEV No.		101806	Ref. No.	—
	gas tap front part shaft \varnothing 8x7mm shaft L 34/15mm shaft flat upper/lower suitable for PEL21			
accessories for		101731		
GEV No.		100909	Ref. No.	—
	union screw thread M10x1 for pipe \varnothing 6mm Qty 1 pcs			
GEV No.		100926	Ref. No.	—
	centring piece thread M17x1			
GEV No.		100942	Ref. No.	—
	union nut thread M15x1 for pipe \varnothing 10mm			
GEV No.		101278	Ref. No.	060325
	olive for pipe \varnothing 10mm Qty 1 pcs			
GEV No.		101286	Ref. No.	—
	olive ID \varnothing 6mm Qty 1 pcs			

				
1				
GEV No.		101641	Ref. No.	0H6401
description	gas tap alternatives to EGA type GPEL21D with nozzle outlet (with nozzle) gas inlet M15x1 (tube \varnothing 10mm) external nozzle \varnothing 2.05mm internal nozzle \varnothing 1.9mm bypass nozzle \varnothing 0.55mm mixing pipe connection M17x1 thermocouple connection M10x1 pilot connection M10x1 shaft \varnothing 7x8mm shaft L 34/15mm shaft flat lower			
spare parts for		101641		
GEV No.		100303	Ref. No.	0G1794
	gas injector thread M12x1 WS 14 bore \varnothing 2.05mm			
GEV No.		100310	Ref. No.	0H6356
	internal nozzle bore \varnothing 0.66mm suitable for EGA26400/26440			
GEV No.		100550	Ref. No.	—
	bypass nozzle type PEL20/21 bore \varnothing 0.55mm thread M5x0.5			
GEV No.		100908	Ref. No.	052125
	union screw thread M10x1 for pipe \varnothing 4mm Qty 1 pcs			
GEV No.		100927	Ref. No.	—
	torsion spring L 2.8-8.0mm for internal nozzle \varnothing 3mm bore \varnothing mm			
GEV No.		101060	Ref. No.	056595
	magnet unit standard L 39mm D1 \varnothing 15.4mm D2 \varnothing 11mm suitable for PEL20-21/JUNKERS/EGA			
GEV No.		101233	Ref. No.	0K2512
	union nut thread M10x1 JUNKERS			
GEV No.		101246	Ref. No.	—
	olive for pipe \varnothing 4mm Qty 1 pcs			

spare parts for		101641		
GEV No.		101526	Ref. No.	—
	O-ring Viton thickness 1.78mm ID \varnothing 4.48mm Qty 1 pcs			
GEV No.		101593	Ref. No.	—
	adjusting screw for internal nozzle thread M8x0.75			
GEV No.		101806	Ref. No.	—
	gas tap front part shaft \varnothing 8x7mm shaft L 34/15mm shaft flat upper/lower suitable for PEL21			
accessories for		101641		
GEV No.		100909	Ref. No.	—
	union screw thread M10x1 for pipe \varnothing 6mm Qty 1 pcs			
GEV No.		100926	Ref. No.	—
	centring piece thread M17x1			
GEV No.		100942	Ref. No.	—
	union nut thread M15x1 for pipe \varnothing 10mm			
GEV No.		101278	Ref. No.	060325
	olive for pipe \varnothing 10mm Qty 1 pcs			
GEV No.		101286	Ref. No.	—
	olive ID \varnothing 6mm Qty 1 pcs			

with pipe outlet











				
1				
GEV No.		101618	Ref. No.	0K1392
description	gas tap alternatives to EGA type GPEL21R with pipe outlet gas inlet M15x1 (tube \varnothing 10mm) bypass nozzle \varnothing 0.35mm gas outlet M17x1 (tube \varnothing 10mm) thermocouple connection M10x1 pilot connection M10x1 shaft \varnothing 8x7mm shaft L 34/15mm shaft flat lower			
spare parts for		101618		
GEV No.		100408	Ref. No.	—
	bypass nozzle type PEL20/21 bore \varnothing 0.35mm thread M5x0.5			
GEV No.		101060	Ref. No.	056595
	magnet unit standard L 39mm D1 \varnothing 15.4mm D2 \varnothing 11mm suitable for PEL20-21/JUNKERS/EGA			
GEV No.		101290	Ref. No.	—
	thermocouple nut T1: M10x1 T2: M18x1 suitable for PEL20/21			
GEV No.		101806	Ref. No.	—
	gas tap front part shaft \varnothing 8x7mm shaft L 34/15mm shaft flat upper/lower suitable for PEL21			
accessories for		101618		
GEV No.		100908	Ref. No.	052125
	union screw thread M10x1 for pipe \varnothing 4mm Qty 1 pcs			
GEV No.		100909	Ref. No.	—
	union screw thread M10x1 for pipe \varnothing 6mm Qty 1 pcs			













Table continues overleaf















accessories for		101618		
	GEV No.	100926	Ref. No.	—
centring piece thread M17x1				
	GEV No.	100942	Ref. No.	—
union nut thread M15x1 for pipe ø 10mm				
	GEV No.	100943	Ref. No.	—
union nut thread M17x1 tube ø 10mm				
	GEV No.	101246	Ref. No.	—
olive for pipe ø 4mm Qty 1 pcs				
	GEV No.	101278	Ref. No.	060325
olive for pipe ø 10mm Qty 1 pcs				
	GEV No.	101286	Ref. No.	—
olive ID ø 6mm Qty 1 pcs				
	GEV No.	110227	Ref. No.	0H6789
knob gas tap with ignition flame t.max.°C°C ø 77mm shaft ø 8x7mm shaft flat lower silver				

				
1				
GEV No.	101643	Ref. No.	0H6054	
description	gas tap alternatives to EGA type GPEL21R with pipe outlet gas inlet M15x1 (tube ø 10mm) bypass nozzle ø 0.45mm gas outlet M17x1 (tube ø 10mm) thermocouple connection M10x1 pilot connection M10x1 shaft ø 8x7mm shaft L 34/15mm shaft flat lower			
spare parts for	101643			
	GEV No.	100554	Ref. No.	—
bypass nozzle type PEL20/21 bore ø 0.45mm thread M5x0.5				
	GEV No.	100908	Ref. No.	052125
union screw thread M10x1 for pipe ø 4mm Qty 1 pcs				
	GEV No.	101060	Ref. No.	056595
magnet unit standard L 39mm D1 ø 15.4mm D2 ø 11mm suitable for PEL20-21/JUNKERS/EGA				
	GEV No.	101246	Ref. No.	—
olive for pipe ø 4mm Qty 1 pcs				
	GEV No.	101290	Ref. No.	—
thermocouple nut T1: M10x1 T2: M18x1 suitable for PEL20/21				
	GEV No.	101806	Ref. No.	—
gas tap front part shaft ø 8x7mm shaft L 34/15mm shaft flat upper/lower suitable for PEL21				
accessories for	101643			
	GEV No.	100909	Ref. No.	—
union screw thread M10x1 for pipe ø 6mm Qty 1 pcs				
	GEV No.	100926	Ref. No.	—
centring piece thread M17x1				

accessories for		101643		
	GEV No.	100942	Ref. No.	—
union nut thread M15x1 for pipe ø 10mm				
	GEV No.	101278	Ref. No.	060325
olive for pipe ø 10mm Qty 1 pcs				
	GEV No.	101286	Ref. No.	—
olive ID ø 6mm Qty 1 pcs				

				
1				
GEV No.	101664	Ref. No.	0K0215	
description	gas tap alternatives to EGA type GPEL21R with pipe outlet gas inlet M15x1 (tube ø 10mm) bypass nozzle ø 0.55mm gas outlet M17x1 (tube ø 10mm) thermocouple connection M10x1 pilot connection M10x1 shaft ø 8x7mm shaft L 34/15mm shaft flat lower			
spare parts for	101664			
	GEV No.	100550	Ref. No.	—
bypass nozzle type PEL20/21 bore ø 0.55mm thread M5x0.5				
	GEV No.	100908	Ref. No.	052125
union screw thread M10x1 for pipe ø 4mm Qty 1 pcs				
	GEV No.	101060	Ref. No.	056595
magnet unit standard L 39mm D1 ø 15.4mm D2 ø 11mm suitable for PEL20-21/JUNKERS/EGA				
	GEV No.	101246	Ref. No.	—
olive for pipe ø 4mm Qty 1 pcs				
	GEV No.	101290	Ref. No.	—
thermocouple nut T1: M10x1 T2: M18x1 suitable for PEL20/21				
	GEV No.	101806	Ref. No.	—
gas tap front part shaft ø 8x7mm shaft L 34/15mm shaft flat upper/lower suitable for PEL21				
accessories for	101664			
	GEV No.	100909	Ref. No.	—
union screw thread M10x1 for pipe ø 6mm Qty 1 pcs				
	GEV No.	100942	Ref. No.	—
union nut thread M15x1 for pipe ø 10mm				
	GEV No.	100943	Ref. No.	—
union nut thread M17x1 tube ø 10mm				
	GEV No.	101278	Ref. No.	060325
olive for pipe ø 10mm Qty 1 pcs				
	GEV No.	101286	Ref. No.	—
olive ID ø 6mm Qty 1 pcs				



			
1			
GEV No.	101644	Ref. No.	OK0214
description	gas tap alternatives to EGA type GPEL21R with pipe outlet gas inlet M15x1 (tube \varnothing 10mm) bypass nozzle \varnothing 0.65mm gas outlet M17x1 (tube \varnothing 10mm) thermocouple connection M10x1 pilot connection M10x1 shaft \varnothing 8x7mm shaft L 34/15mm shaft flat lower		
spare parts for	101644		
	GEV No.	100548	Ref. No. —
	bypass nozzle type PEL20/21 bore \varnothing 0.65mm thread M5x0.5		
	GEV No.	100908	Ref. No. 052125
	union screw thread M10x1 for pipe \varnothing 4mm Qty 1 pcs		
	GEV No.	101060	Ref. No. 056595
	magnet unit standard L 39mm D1 \varnothing 15.4mm D2 \varnothing 11mm suitable for PEL20-21/JUNKERS/EGA		
	GEV No.	101246	Ref. No. —
	olive for pipe \varnothing 4mm Qty 1 pcs		
	GEV No.	101290	Ref. No. —
	thermocouple nut T1: M10x1 T2: M18x1 suitable for PEL20/21		
	GEV No.	101806	Ref. No. —
	gas tap front part shaft \varnothing 8x7mm shaft L 34/15mm shaft flat upper/lower suitable for PEL21		
accessories for	101644		
	GEV No.	100909	Ref. No. —
	union screw thread M10x1 for pipe \varnothing 6mm Qty 1 pcs		
	GEV No.	100926	Ref. No. —
	centring piece thread M17x1		
	GEV No.	100942	Ref. No. —
	union nut thread M15x1 for pipe \varnothing 10mm		
	GEV No.	101278	Ref. No. 060325
	olive for pipe \varnothing 10mm Qty 1 pcs		
	GEV No.	101286	Ref. No. —
	olive ID \varnothing 6mm Qty 1 pcs		



GPEL22 series

with nozzle outlet

			
1			
GEV No.	101659	Ref. No.	OK1359
description	gas tap alternatives to EGA type GPEL22D with nozzle outlet (with nozzle) gas inlet M18x1.5 (tube \varnothing 12mm) external nozzle \varnothing 2.2mm internal nozzle \varnothing 1.15mm bypass nozzle \varnothing 0.35mm mixing pipe connection M22x1 thermocouple connection M8x1 pilot connection M10x1 shaft \varnothing 8x7mm shaft L 34/15mm shaft flat lower		
spare parts for	101659		
	GEV No.	100259	Ref. No. —
	bypass nozzle type PEL22 bore \varnothing 0.35mm thread M6x0.5		
	GEV No.	100330	Ref. No. —
	gas injector thread M15x1 bore \varnothing 2.20mm WS 17		
	GEV No.	100341	Ref. No. OK1274
	internal nozzle bore \varnothing 1.15mm type EGA/PEL22		
	GEV No.	100908	Ref. No. 052125
	union screw thread M10x1 for pipe \varnothing 4mm Qty 1 pcs		
	GEV No.	100927	Ref. No. —
	torsion spring L 2.8-8.0mm for internal nozzle \varnothing 3mm bore \varnothing mm		
	GEV No.	101058	Ref. No. 056594
	magnet unit L 39mm D1 \varnothing 15.4mm D2 \varnothing 13.5mm suitable for PEL22/EGA24197 standard		
	GEV No.	101230	Ref. No. —
	thermocouple nut T1: M8x1 T2: M18x1 aluminium		
	GEV No.	101246	Ref. No. —
	olive for pipe \varnothing 4mm Qty 1 pcs		
	GEV No.	101460	Ref. No. —
	O-ring \varnothing 12.37mm D1 \varnothing 2.62mm suitable for PEL22		
	GEV No.	101527	Ref. No. —
	O-ring Viton thickness 1.78mm ID \varnothing 6.75mm Qty 1 pcs		
	GEV No.	101594	Ref. No. —
	adjusting screw for internal nozzle thread M10x0.75		
	GEV No.	101820	Ref. No. —
	gas tap front part shaft \varnothing 7x8mm shaft L 34/15mm shaft flat upper/lower		
accessories for	101659		
	GEV No.	100909	Ref. No. —
	union screw thread M10x1 for pipe \varnothing 6mm Qty 1 pcs		
	GEV No.	100944	Ref. No. —
	union nut thread M18x1.5 for pipe \varnothing 12mm		





Table continues overleaf



accessories for	101659			
	GEV No.	101273	Ref. No.	—
	olive for pipe ø 12mm L 9.5mm brass Qty 1 pcs suitable for universal			
	GEV No.	101286	Ref. No.	—
	olive ID ø 6mm Qty 1 pcs			



GEV No.	101649	Ref. No.	OK1360	
description	gas tap alternatives to EGA type GPEL22D with nozzle outlet (with nozzle) gas inlet M18x1.5 (tube ø 12mm) external nozzle ø 2.6mm internal nozzle ø 1.35mm bypass nozzle ø 0.4mm mixing pipe connection M22x1 thermocouple connection M8x1 pilot connection M10x1 shaft ø 8x7mm shaft L 34/15mm shaft flat upper			
spare parts for	101649			
	GEV No.	100281	Ref. No.	—
	bypass nozzle type PEL22 bore ø 0.4mm thread M6x0.5			
	GEV No.	100457	Ref. No.	—
	gas injector thread M15x1 bore ø 2.60mm WS 17			
	GEV No.	100648	Ref. No.	—
	internal nozzle bore ø 1.35mm type EGA/PEL22			
	GEV No.	100908	Ref. No.	052125
	union screw thread M10x1 for pipe ø 4mm Qty 1 pcs			
	GEV No.	100927	Ref. No.	—
	torsion spring L 2.8-8.0mm for internal nozzle ø 3mm bore ømm			
	GEV No.	101058	Ref. No.	056594
	magnet unit L 39mm D1 ø 15.4mm D2 ø 13.5mm suitable for PEL22/ EGA24197 standard			
	GEV No.	101230	Ref. No.	—
	thermocouple nut T1: M8x1 T2: M18x1 aluminium			
	GEV No.	101246	Ref. No.	—
	olive for pipe ø 4mm Qty 1 pcs			
	GEV No.	101460	Ref. No.	—
	O-ring ø 12.37mm D1 ø 2.62mm suitable for PEL22			
	GEV No.	101527	Ref. No.	—
	O-ring Viton thickness 1.78mm ID ø 6.75mm Qty 1 pcs			
	GEV No.	101594	Ref. No.	—
	adjusting screw for internal nozzle thread M10x0.75			
	GEV No.	101820	Ref. No.	—
	gas tap front part shaft ø 7x8mm shaft L 34/15mm shaft flat upper/ lower			

accessories for	101649			
	GEV No.	100909	Ref. No.	—
	union screw thread M10x1 for pipe ø 6mm Qty 1 pcs			
	GEV No.	100944	Ref. No.	—
	union nut thread M18x1.5 for pipe ø 12mm			
	GEV No.	101273	Ref. No.	—
	olive for pipe ø 12mm L 9.5mm brass Qty 1 pcs suitable for universal			
	GEV No.	101286	Ref. No.	—
	olive ID ø 6mm Qty 1 pcs			

with pipe outlet



GEV No.	101621	Ref. No.	OK1351	
description	gas tap alternatives to EGA type GPEL22R with pipe outlet gas inlet M18x1.5 (tube ø 12mm) gas outlet M18x1.5 (tube ø 12mm) thermo-couple connection M8x1 shaft ø 8x7mm shaft L 34/15mm shaft flat lower			
spare parts for	101621			
	GEV No.	100259	Ref. No.	—
	bypass nozzle type PEL22 bore ø 0.35mm thread M6x0.5			
	GEV No.	101058	Ref. No.	056594
	magnet unit L 39mm D1 ø 15.4mm D2 ø 13.5mm suitable for PEL22/ EGA24197 standard			
	GEV No.	101290	Ref. No.	—
	thermocouple nut T1: M10x1 T2: M18x1 suitable for PEL20/21			
	GEV No.	101460	Ref. No.	—
	O-ring ø 12.37mm D1 ø 2.62mm suitable for PEL22			
	GEV No.	101820	Ref. No.	—
	gas tap front part shaft ø 7x8mm shaft L 34/15mm shaft flat upper/ lower			
accessories for	101621			
	GEV No.	100908	Ref. No.	052125
	union screw thread M10x1 for pipe ø 4mm Qty 1 pcs			
	GEV No.	100909	Ref. No.	—
	union screw thread M10x1 for pipe ø 6mm Qty 1 pcs			
	GEV No.	100944	Ref. No.	—
	union nut thread M18x1.5 for pipe ø 12mm			
	GEV No.	101246	Ref. No.	—
	olive for pipe ø 4mm Qty 1 pcs			
	GEV No.	101273	Ref. No.	—
	olive for pipe ø 12mm L 9.5mm brass Qty 1 pcs suitable for universal			

Table continues overleaf

accessories for	101621			
	GEV No.	101286	Ref. No.	—
	olive ID ø 6mm Qty 1 pcs			





alternatives to JUNKERS

1				
GEV No.	101630	Ref. No.	OK9985	
description	gas tap PEL type 235/V gas inlet 1/2" IT bypass nozzle ø 0.35mm gas outlet 1/2" MT (tube ø 14mm) thermocouple connection M10x1 pilot connection M10x1 shaft ø 10mm shaft L 25mm shaft flat			
spare parts for	101630			
	GEV No.	100455	Ref. No.	—
	bypass nozzle type PEL23/24 bore ø 0.35mm thread M8x0.5			
	GEV No.	101059	Ref. No.	—
	magnet unit T1: M10x1 T2: M22x1 L 46mm ø 18mm suitable for PEL23S M10x1			
	GEV No.	102767	Ref. No.	—
	gas tap front part shaft ø 10mm shaft L 26.5mm shaft flat suitable for PEL23S			
accessories for	101630			
	GEV No.	100908	Ref. No.	052125
	union screw thread M10x1 for pipe ø 4mm Qty 1 pcs			
	GEV No.	100909	Ref. No.	—
	union screw thread M10x1 for pipe ø 6mm Qty 1 pcs			
	GEV No.	100945	Ref. No.	—
	roll pin ø 3.2mm L 10mm			
	GEV No.	101218	Ref. No.	—
	shaft extension JUNKERS			
	GEV No.	101219	Ref. No.	—
	shaft extension L 25mm JUNKERS			
	GEV No.	101246	Ref. No.	—
	olive for pipe ø 4mm Qty 1 pcs			
	GEV No.	101286	Ref. No.	—
	olive ID ø 6mm Qty 1 pcs			
	GEV No.	110064	Ref. No.	—
	knob			
	GEV No.	110066	Ref. No.	—
	knob screw			
	GEV No.	550396	Ref. No.	—
	shaft extension L 25mm JUNKERS			

EGA

24197 series





gas taps



1				
GEV No.	101150	Ref. No.	OK0213	
description	gas tap EGA type 24197 series with pipe outlet			
spare parts for	101150			
	GEV No.	101058	Ref. No.	056594
	magnet unit L 39mm D1 ø 15.4mm D2 ø 13.5mm suitable for PEL22/EGA24197 standard			
	GEV No.	101230	Ref. No.	—
	thermocouple nut T1: M8x1 T2: M18x1 aluminium			
accessories for	101150			
	GEV No.	100944	Ref. No.	—
	union nut thread M18x1.5 for pipe ø 12mm			
	GEV No.	101273	Ref. No.	—
	olive for pipe ø 12mm L 9.5mm brass Qty 1 pcs suitable for universal			
	GEV No.	101284	Ref. No.	OK2491
	olive for pipe ø 4mm Qty 1 pcs			
	GEV No.	101285	Ref. No.	OKL220
	union screw thread M8x1 for pipe ø 4mm Qty 1 pcs JUNKERS			

1	 Image not available			
GEV No.	106251	Ref. No.	OK1389	
description	gas tap type EGA24197			
spare parts for	106251			
	GEV No.	100238	Ref. No.	—
	internal nozzle bore ø 1.35mm suitable for EGA 23268,26400,26440			
	GEV No.	100457	Ref. No.	—
	gas injector thread M15x1 bore ø 2.60mm WS 17			
	GEV No.	100927	Ref. No.	—
	torsion spring L 2.8-8.0mm for internal nozzle ø 3mm bore ømm			
	GEV No.	101058	Ref. No.	056594
	magnet unit L 39mm D1 ø 15.4mm D2 ø 13.5mm suitable for PEL22/EGA24197 standard			
	GEV No.	101230	Ref. No.	—
	thermocouple nut T1: M8x1 T2: M18x1 aluminium			

Table continues overleaf



accessories for		106251		
	GEV No.	100944	Ref. No.	—
union nut thread M18x1.5 for pipe ø 12mm				
	GEV No.	101273	Ref. No.	—
olive for pipe ø 12mm L 9.5mm brass Qty 1 pcs suitable for universal				
	GEV No.	101284	Ref. No.	0K2491
olive for pipe ø 4mm Qty 1 pcs				
	GEV No.	101285	Ref. No.	0KL220
union screw thread M8x1 for pipe ø 4mm Qty 1 pcs JUNKERS				









accessories for		101915		
	GEV No.	110357	Ref. No.	—
gas tap spindle shaft ø 8x6.5mm shaft L 36/12mm suitable for 630 Eurosit series				
	GEV No.	110358	Ref. No.	—
adapter shaft ø 10x8mm shaft L 29/18mm suitable for 630 Eurosit series				

gas thermostats





SIT

630 Eurosit series



GEV No.	101915	Ref. No.	0C6235	
description	gas thermostat type 630 Eurosit series t.max. 320°C 80-320°C gas inlet 3/8" gas outlet 3/8" thermocouple connection M9x1 pilot connection M10x1 probe ø 4mm probe L 72mm capillary pipe 1050mm SIT			
accessories for 101915				
	GEV No.	100825	Ref. No.	—
gas tap spindle shaft ø 8x6.5mm shaft L 22/14mm suitable for EUROSIT				
	GEV No.	100904	Ref. No.	0K2497
locking screw M10x1 for pipe ø 4mm Qty 1 pcs				
	GEV No.	100905	Ref. No.	—
locking screw M10x1 for pipe ø 6mm Qty 1 pcs				
	GEV No.	100949	Ref. No.	—
gasket suitable for 630 Eurosit series				
	GEV No.	101273	Ref. No.	—
olive for pipe ø 12mm L 9.5mm brass Qty 1 pcs suitable for universal				
	GEV No.	101276	Ref. No.	—
union screw thread 3/8" tube ø 12mm Qty 1 pcs				
	GEV No.	101333	Ref. No.	—
plug thread 3/8" with O-ring				
	GEV No.	101390	Ref. No.	—
gas tap spindle shaft ø 6x4.6mm shaft L 32/15mm gas tap with ignition flame suitable for ZANUSSI, MARENO for gas thermostat EUROSIT				
	GEV No.	101392	Ref. No.	—
adapter suitable for 630 Eurosit series				



GEV No.	101769	Ref. No.	0K2004	
description	gas thermostat type 630 Eurosit series t.max. 340°C 100-340°C gas inlet 3/8" gas outlet 3/8" thermocouple connection M10x1 pilot connection M10x1 probe ø 4mm probe L 72mm capillary pipe 1050mm SIT			
accessories for 101769				
	GEV No.	100904	Ref. No.	0K2497
locking screw M10x1 for pipe ø 4mm Qty 1 pcs				
	GEV No.	100905	Ref. No.	—
locking screw M10x1 for pipe ø 6mm Qty 1 pcs				
	GEV No.	101273	Ref. No.	—
olive for pipe ø 12mm L 9.5mm brass Qty 1 pcs suitable for universal				
	GEV No.	101276	Ref. No.	—
union screw thread 3/8" tube ø 12mm Qty 1 pcs				
	GEV No.	101333	Ref. No.	—
plug thread 3/8" with O-ring				

710 Minisit series

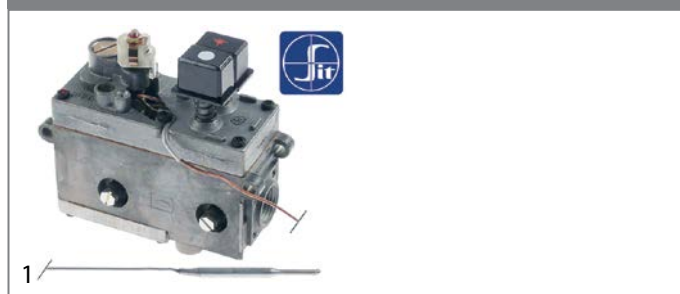

GEV No.	101132	Ref. No.	056833	
description	gas thermostat SIT type MINISIT 710 t.max. 340°C 100-340°C gas inlet 1/2" gas outlet 3/8" thermocouple connection M9x1 pilot connection M10x1 probe ø 5mm probe L 68mm capillary pipe 1050mm probe type type B1 pressure controller no pressure regulator mbar gland nut ignition gas no			
spare parts for 101132				
	GEV No.	101053	Ref. No.	—
magnet unit T1: M9x1 T2: M24x1 L 45mm ø 17mm suitable for Minisit				

Table continues overleaf

spare parts for		101132	
GEV No.	102102	Ref. No.	—
	probe 100-340°C probe ø 5mm probe L 68mm capillary pipe 1750mm t.max. 340°C oven/grill probe type type B1 suitable for MINISIT 710		
accessories for		101132	
GEV No.	100809	Ref. No.	—
	O-ring EPDM thickness 2mm ID ø 21mm Qty 1 pcs		
GEV No.	100904	Ref. No.	0K2497
	locking screw M10x1 for pipe ø 4mm Qty 1 pcs		
GEV No.	100905	Ref. No.	—
	locking screw M10x1 for pipe ø 6mm Qty 1 pcs		
GEV No.	101054	Ref. No.	0K0669
	magnet unit T1: M10x1 T2: M24x1 L 45mm ø 17mm suitable for Minisit		
GEV No.	101136	Ref. No.	054269
	piezoelectric igniter suitable for Minisit with cover cap ømm connection F6.3x0.8		
GEV No.	101137	Ref. No.	—
	cover cap without piezoelectric igniter		
GEV No.	101267	Ref. No.	—
	reducer IT 3/8" ET 1/2" L 21mm		
GEV No.	101268	Ref. No.	—
	gas connection thread 3/8" angled with O-ring MINISIT 710		
GEV No.	101269	Ref. No.	—
	gas connection thread 1/2" angled with O-ring MINISIT 710		
GEV No.	101270	Ref. No.	—
	screw connection IT 3/8" ET 3/8" L 28mm		
GEV No.	101272	Ref. No.	—
	screw connection IT 1/2" ET 3/8" L 57mm		
GEV No.	101273	Ref. No.	—
	olive for pipe ø 12mm L 9.5mm brass Qty 1 pcs suitable for universal		
GEV No.	101274	Ref. No.	—
	olive for pipe ø 16mm Qty 1 pcs		
GEV No.	101275	Ref. No.	—
	union screw thread 1/2" for pipe ø 16mm Qty 1 pcs		
GEV No.	101276	Ref. No.	—
	union screw thread 3/8" tube ø 12mm Qty 1 pcs		
GEV No.	110068	Ref. No.	054268
	knob suitable for Minisit ø 37mm		







			
1			
GEV No.	101796	Ref. No.	0H6235
description	gas thermostat SIT type MINISIT 710 t.max. 340°C 100-340°C gas inlet 1/2" gas outlet 3/8" thermocouple connection M9x1 pilot connection M10x1 probe ø 5mm probe L 68mm capillary pipe 1800mm probe type type B1 pressure controller yes pressure regulator 3-18mbar gland nut		
spare parts for		101796	
GEV No.	100026	Ref. No.	—
	ignition cable cable length 1000mm connection ø4mm / F6.3mm		
GEV No.	100809	Ref. No.	—
	O-ring EPDM thickness 2mm ID ø 21mm Qty 1 pcs		
GEV No.	101053	Ref. No.	—
	magnet unit T1: M9x1 T2: M24x1 L 45mm ø 17mm suitable for Minisit		
GEV No.	101136	Ref. No.	054269
	piezoelectric igniter suitable for Minisit with cover cap ømm connection F6.3x0.8		
GEV No.	101268	Ref. No.	—
	gas connection thread 3/8" angled with O-ring MINISIT 710		
GEV No.	102102	Ref. No.	—
	probe 100-340°C probe ø 5mm probe L 68mm capillary pipe 1750mm t.max. 340°C oven/grill probe type type B1 suitable for MINISIT 710		
GEV No.	107564	Ref. No.	—
	piezoelectric igniter body plastic blowing connection F6.3x0.8 ø 22mm		
GEV No.	110269	Ref. No.	0H6734
	knob thermostat t.max. 100°C 50-100°C ø 72mm shaft ø 6x4.6mm shaft flat lower		
accessories for		101796	
GEV No.	100904	Ref. No.	0K2497
	locking screw M10x1 for pipe ø 4mm Qty 1 pcs		
GEV No.	100905	Ref. No.	—
	locking screw M10x1 for pipe ø 6mm Qty 1 pcs		
GEV No.	101054	Ref. No.	0K0669
	magnet unit T1: M10x1 T2: M24x1 L 45mm ø 17mm suitable for Minisit		
GEV No.	101267	Ref. No.	—
	reducer IT 3/8" ET 1/2" L 21mm		
GEV No.	101270	Ref. No.	—
	screw connection IT 3/8" ET 3/8" L 28mm		
GEV No.	101272	Ref. No.	—
	screw connection IT 1/2" ET 3/8" L 57mm		

Table continues overleaf







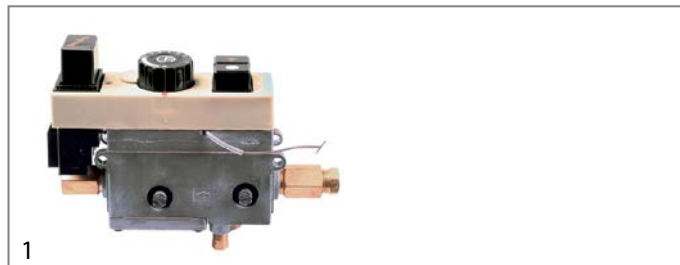

accessories for	101796		
	GEV No.	101273	Ref. No. —
	olive for pipe ø 12mm L 9.5mm brass Qty 1 pcs suitable for universal		
	GEV No.	101274	Ref. No. —
	olive for pipe ø 16mm Qty 1 pcs		
	GEV No.	101275	Ref. No. —
	union screw thread 1/2" for pipe ø 16mm Qty 1 pcs		
	GEV No.	101276	Ref. No. —
	union screw thread 3/8" tube ø 12mm Qty 1 pcs		
	GEV No.	110068	Ref. No. 054268
	knob suitable for Minisit ø 37mm		



GEV No.	102872	Ref. No.	0H6570
description	gas thermostat SIT type MINISIT 710 t.max. 340°C 120-340°C gas inlet 3/8" gas outlet 3/8" thermocouple connection M10x1 pilot connection M10x1 probe ø 5mm probe L 68mm capillary pipe 1050mm probe type type B2 pressure controller no pressure regulator gland nut		
spare parts for	102872		
	GEV No.	100068	Ref. No. —
	pilot burner 2 flames gas connection 6mm		
	GEV No.	100809	Ref. No. —
	O-ring EPDM thickness 2mm ID ø 21mm Qty 1 pcs		
	GEV No.	101054	Ref. No. 0K0669
	magnet unit T1: M10x1 T2: M24x1 L 45mm ø 17mm suitable for Minisit		
	GEV No.	101136	Ref. No. 054269
	piezoelectric igniter suitable for Minisit with cover cap ømm connection F6.3x0.8		
	GEV No.	101505	Ref. No. —
	gas connection thread 3/8" angled without O-ring MINISIT 710		
	GEV No.	101516	Ref. No. —
	flat-headed bolt thread M4 thread L 16mm SS DIN 7985/ISO 7045 Qty 1 pcs		



GEV No.	101768	Ref. No.	0H6571
description	gas thermostat SIT type MINISIT 710 t.max. 380°C 160-380°C gas inlet 3/8" gas outlet 3/8" thermocouple connection M10x1 probe ø 5mm probe L 68mm capillary pipe 1050mm probe type type B2 pressure controller no		
spare parts for	101768		
	GEV No.	101054	Ref. No. 0K0669
	magnet unit T1: M10x1 T2: M24x1 L 45mm ø 17mm suitable for Minisit		
	GEV No.	101136	Ref. No. 054269
	piezoelectric igniter suitable for Minisit with cover cap ømm connection F6.3x0.8		
	GEV No.	110068	Ref. No. 054268
	knob suitable for Minisit ø 37mm		
accessories for	101768		
	GEV No.	101273	Ref. No. —
	olive for pipe ø 12mm L 9.5mm brass Qty 1 pcs suitable for universal		
	GEV No.	101276	Ref. No. —
	union screw thread 3/8" tube ø 12mm Qty 1 pcs		
	GEV No.	101278	Ref. No. 060325
	olive for pipe ø 10mm Qty 1 pcs		
	GEV No.	101279	Ref. No. —
	union screw thread 3/8" for pipe ø 10mm Qty 1 pcs		

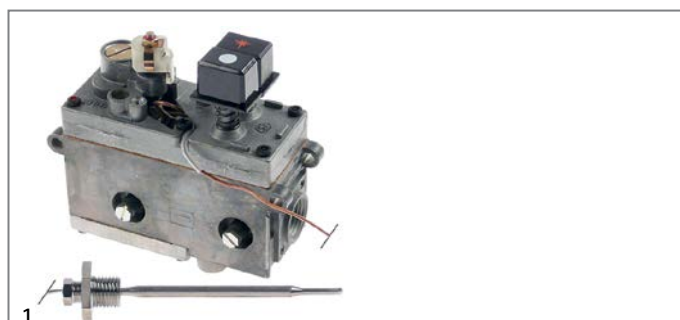













GEV No.	101133	Ref. No.	0H6231
description	gas thermostat without accessories SIT type MINISIT 710 t.max. 200°C 60-200°C gas inlet 1/2" gas outlet 3/8" thermocouple connection M10x1 pilot connection M10x1 probe ø 5mm probe L 95mm capillary pipe 1050mm probe type type D2 pressure controller no pressure regulator gland nut M14x1.5 ignition gas 4mm		
spare parts for	101133		
	GEV No.	101054	Ref. No. 0K0669
	magnet unit T1: M10x1 T2: M24x1 L 45mm ø 17mm suitable for Minisit		
	GEV No.	102844	Ref. No. —
	probe 60-200°C probe ø 5mm probe L 98mm capillary pipe 1050mm t.max. 200°C fryer probe type type D2 suitable for MINISIT 710 gland nut M14x1.5		

Table continues overleaf







accessories for		101133	
	GEV No.	100809	Ref. No. —
	O-ring EPDM thickness 2mm ID ø 21mm Qty 1 pcs		
	GEV No.	100820	Ref. No. —
	gland duct ET M14x1.5 IT M10x0.75 probe ø max. 6.5mm WS 22		
	GEV No.	100904	Ref. No. 0K2497
	locking screw M10x1 for pipe ø 4mm Qty 1 pcs		
	GEV No.	100905	Ref. No. —
	locking screw M10x1 for pipe ø 6mm Qty 1 pcs		
	GEV No.	101053	Ref. No. —
	magnet unit T1: M9x1 T2: M24x1 L 45mm ø 17mm suitable for Minisit		
	GEV No.	101136	Ref. No. 054269
	piezoelectric igniter suitable for Minisit with cover cap ømm connection F6.3x0.8		
	GEV No.	101137	Ref. No. —
	cover cap without piezoelectric igniter		
	GEV No.	101267	Ref. No. —
	reducer IT 3/8" ET 1/2" L 21mm		
	GEV No.	101268	Ref. No. —
	gas connection thread 3/8" angled with O-ring MINISIT 710		
	GEV No.	101269	Ref. No. —
	gas connection thread 1/2" angled with O-ring MINISIT 710		
	GEV No.	101270	Ref. No. —
	screw connection IT 3/8" ET 3/8" L 28mm		
	GEV No.	101272	Ref. No. —
	screw connection IT 1/2" ET 3/8" L 57mm		
	GEV No.	101273	Ref. No. —
	olive for pipe ø 12mm L 9.5mm brass Qty 1 pcs suitable for universal		
	GEV No.	101274	Ref. No. —
	olive for pipe ø 16mm Qty 1 pcs		
	GEV No.	101275	Ref. No. —
	union screw thread 1/2" for pipe ø 16mm Qty 1 pcs		
	GEV No.	101276	Ref. No. —
	union screw thread 3/8" tube ø 12mm Qty 1 pcs		
	GEV No.	110068	Ref. No. 054268
	knob suitable for Minisit ø 37mm		

gas valves and ignition boxes











gas control valves

HONEYWELL



GEV No.	106059	Ref. No.	0H6536
description	gas valve type V4600C 220/240V 50Hz gas inlet flange 45x45mm gas outlet flange 45x45mm thermocouple connection 11/32" pilot connection M1 1x1 pressure range 2.5-20mbar operator type 220/240V (V404A 1071 4) pressure controller type V5306E suitable for HONEYWELL		
accessories for	106059		
	GEV No.	101305	Ref. No. —
	gas connection straight 1/2" flange 45x45mm ELETTROSIT/V4400/4600/4605 suitable for SIT/HONEYWELL hole distance 36x36mm		
	GEV No.	101306	Ref. No. —
	gas connection angled flange 45x45mm hole distance 36x36mm 1/2" ELETTROSIT/V4400/4600/4605 screw with O-ring suitable for SIT/HONEYWELL		
	GEV No.	101307	Ref. No. —
	gas connection straight flange 45x45mm hole distance 36x36mm 3/4" ELETTROSIT/V4400/4600/4605 screw with O-ring suitable for SIT/HONEYWELL		
	GEV No.	101308	Ref. No. —
	gas connection angled flange 45x45mm hole distance 36x36mm 3/4" ELETTROSIT/V4400/4600/4605 screw with O-ring suitable for SIT/HONEYWELL		
	GEV No.	101494	Ref. No. —
	locking screw thread M11x1 for pipe ø 6mm Qty 1 pcs		



SIT				
ELETTROSIT				
				
1				
GEV No.	101993	Ref. No.	0H6072	
description	gas valve SIT type ELETTROSIT 230V gas inlet 1/2" gas outlet 1/2" thermocouple connection M9x1 pilot connection M10x1 lateral equiv. no. 0.810.126			
spare parts for	101993			
	GEV No.	101312	Ref. No.	054539
microswitch				
	GEV No.	101352	Ref. No.	—
solenoid coil 230V 50Hz suitable for ELETTROSIT				
accessories for	101993			
	GEV No.	100006	Ref. No.	—
piezoelectric igniter suitable for ELETTROSIT body plastic blowing connection ø2.4mm ø 14mm				
	GEV No.	100904	Ref. No.	0K2497
locking screw M10x1 for pipe ø 4mm Qty 1 pcs				
	GEV No.	100905	Ref. No.	—
locking screw M10x1 for pipe ø 6mm Qty 1 pcs				
	GEV No.	101301	Ref. No.	—
gas connection thread 1/2" straight ELETTROSIT screw with O-ring				
	GEV No.	101303	Ref. No.	—
gas connection straight thread 3/4" ELETTROSIT				
	GEV No.	101309	Ref. No.	—
extension				
	GEV No.	103104	Ref. No.	—
ignition switch				
	GEV No.	541504	Ref. No.	—
double nipple thread 1/2" - 1/2"				

NOVASIT				
				
1				
GEV No.	101980	Ref. No.	0K3021	
description				
spare parts for	101980			
	GEV No.	101065	Ref. No.	056589
	GEV No.	101313	Ref. No.	0K3020
accessories for	101980			
	GEV No.	100006	Ref. No.	—
	GEV No.	101305	Ref. No.	—
	GEV No.	101306	Ref. No.	—
	GEV No.	101307	Ref. No.	—
	GEV No.	101308	Ref. No.	—
	GEV No.	101312	Ref. No.	054539
	GEV No.	101314	Ref. No.	—
	GEV No.	101317	Ref. No.	0K3022
	GEV No.	101318	Ref. No.	—



TANDEM



1	
GEV No. 101189	Ref. No. 002340
description	
spare parts for 101189	
	GEV No. 101379 Ref. No. 002452
accessories for 101189	
	GEV No. 100904 Ref. No. 0K2497
	GEV No. 100905 Ref. No. —
	GEV No. 101274 Ref. No. —
	GEV No. 101275 Ref. No. —
	GEV No. 101925 Ref. No. —
	GEV No. 102845 Ref. No. —
	GEV No. 102846 Ref. No. —
	GEV No. 102847 Ref. No. —



1	
GEV No. 101984	Ref. No. 002714
description	
spare parts for 101984	
	GEV No. 101379 Ref. No. 002452

accessories for 101984			
	GEV No. 101274	Ref. No.	—
	GEV No. 101275	Ref. No.	—
	GEV No. 101925	Ref. No.	—
	GEV No. 102845	Ref. No.	—
	GEV No. 102846	Ref. No.	—
	GEV No. 102847	Ref. No.	—

ignition boxes

HONEYWELL



1			
GEV No. 101165	Ref. No. 002351		
description			
spare parts for 101165			
	GEV No. 358696	Ref. No.	—



1	
GEV No. 101166	Ref. No. 0K0326
description	



			
1			
GEV No.	102347	Ref. No.	002641
description			







gas solenoid valves





KROMSCHRÖDER			
			
1			
GEV No.	101472 ¹	Ref. No.	0H6411
description			

¹aluminium housing

ignition parts

pilot burners

SIT			
100 series			
			
1			
GEV No.	106901	Ref. No.	0H6314
description			
spare parts for	106901		
	GEV No.	100854	Ref. No. —
	GEV No.	100916	Ref. No. —
	GEV No.	100917	Ref. No. —
	GEV No.	100918	Ref. No. —
accessories for	106901		
	GEV No.	100904	Ref. No. 0K2497

accessories for	106901		
	GEV No.	100905	Ref. No. —
	GEV No.	102110	Ref. No. —
	GEV No.	102111	Ref. No. —
	GEV No.	102742	Ref. No. —



































			
1			
GEV No.	106906	Ref. No.	0H6331
description			
spare parts for	106906		
	GEV No.	100245	Ref. No. 056799
	GEV No.	100855	Ref. No. —
	GEV No.	100885	Ref. No. —
	GEV No.	100916	Ref. No. —
	GEV No.	100917	Ref. No. —
	GEV No.	100918	Ref. No. —
	GEV No.	107162	Ref. No. —
	GEV No.	107701	Ref. No. —
accessories for	106906		
	GEV No.	100245	Ref. No. 056799
	GEV No.	100246	Ref. No. 056656
	GEV No.	100904	Ref. No. 0K2497
	GEV No.	100905	Ref. No. —

Table continues overleaf



accessories for 106906				
	GEV No.	102110	Ref. No.	—
	GEV No.	102111	Ref. No.	—
	GEV No.	107171	Ref. No.	058330
	GEV No.	107700	Ref. No.	—
	GEV No.	107702	Ref. No.	—

				
1	GEV No.	106907	Ref. No.	058329
description				
spare parts for 106907				
	GEV No.	100246	Ref. No.	056656
	GEV No.	100855	Ref. No.	—
	GEV No.	100885	Ref. No.	—
	GEV No.	100916	Ref. No.	—
	GEV No.	100917	Ref. No.	—
	GEV No.	100918	Ref. No.	—
	GEV No.	107162	Ref. No.	—
	GEV No.	107702	Ref. No.	—
accessories for 106907				
	GEV No.	100245	Ref. No.	056799
	GEV No.	100904	Ref. No.	0K2497
	GEV No.	100905	Ref. No.	—

accessories for 106907				
	GEV No.	102110	Ref. No.	—
	GEV No.	102111	Ref. No.	—
	GEV No.	107171	Ref. No.	058330
	GEV No.	107700	Ref. No.	—
	GEV No.	107701	Ref. No.	—

accessories

pilot burner caps

				
1	GEV No.	100833	Ref. No.	0H6050
description				

pilot burner nozzles







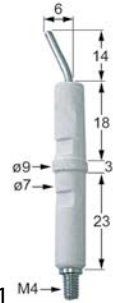









				
1	GEV No.	100245	Ref. No.	056799
description				

				
1	GEV No.	100246	Ref. No.	056656
description				

ignition electrodes

				
1	GEV No.	100706	Ref. No.	056754
description				



140 - 145 -150 series				
				
1				
GEV No.	107114 ¹	Ref. No.	059379	
description				
spare parts for	107114			
	GEV No.	100907	Ref. No.	—
accessories for	107114			
	GEV No.	100204	Ref. No.	059216
	GEV No.	100205	Ref. No.	—
	GEV No.	100206	Ref. No.	—
	GEV No.	100207	Ref. No.	059215
	GEV No.	100216	Ref. No.	—
	GEV No.	100701	Ref. No.	059380
	GEV No.	100801	Ref. No.	—
	GEV No.	100897	Ref. No.	059161
	GEV No.	100898	Ref. No.	—
	GEV No.	100906	Ref. No.	057960
	GEV No.	100908	Ref. No.	052125
	GEV No.	100909	Ref. No.	—
	GEV No.	102110	Ref. No.	—
	GEV No.	102111	Ref. No.	—

¹incl. thermocouple fitting

160 series				
				
1				
GEV No.	100105	Ref. No.	0H6336 338208	
description				
spare parts for	100105			
	GEV No.	100907	Ref. No.	—
accessories for	100105			
	GEV No.	100202	Ref. No.	—
	GEV No.	100203	Ref. No.	—
	GEV No.	100701	Ref. No.	059380
	GEV No.	100801	Ref. No.	—
	GEV No.	100869	Ref. No.	—
	GEV No.	100906	Ref. No.	057960
	GEV No.	100908	Ref. No.	052125
	GEV No.	100909	Ref. No.	—
	GEV No.	101282	Ref. No.	—
	GEV No.	101287	Ref. No.	—
	GEV No.	102110	Ref. No.	—
	GEV No.	102111	Ref. No.	—
	GEV No.	107650	Ref. No.	—





			
1			
GEV No.	100109	Ref. No.	0A2472
description			
spare parts for	100109		
	GEV No.	100907	Ref. No. —
accessories for	100109		
	GEV No.	100202	Ref. No. —
	GEV No.	100203	Ref. No. —
	GEV No.	100701	Ref. No. 059380
	GEV No.	100801	Ref. No. —
	GEV No.	100869	Ref. No. —
	GEV No.	100906	Ref. No. 057960
	GEV No.	100908	Ref. No. 052125
	GEV No.	100909	Ref. No. —
	GEV No.	101282	Ref. No. —
	GEV No.	101287	Ref. No. —
	GEV No.	102110	Ref. No. —
	GEV No.	102111	Ref. No. —
	GEV No.	107650	Ref. No. —













JUNKERS			
CB 502 series			
pilot burners			
			
1			
GEV No.	100085	Ref. No.	0K1206
description			
spare parts for	100085		
	GEV No.	100227	Ref. No. —
	GEV No.	100704	Ref. No. —
	GEV No.	100909	Ref. No. —
	GEV No.	101287	Ref. No. —
	GEV No.	101292	Ref. No. —
	GEV No.	101295	Ref. No. —
accessories for	100085		
	GEV No.	100220	Ref. No. 0K1176
	GEV No.	100221	Ref. No. —
	GEV No.	100222	Ref. No. 0K1126
	GEV No.	100223	Ref. No. —
	GEV No.	100224	Ref. No. —
	GEV No.	100225	Ref. No. —
	GEV No.	100226	Ref. No. —
	GEV No.	100228	Ref. No. —

Table continues overleaf



accessories for 100085				
	GEV No.	101281	Ref. No.	—
	GEV No.	101283	Ref. No.	—

CB 503 series
pilot burners

				
1	GEV No.	100058	Ref. No.	OK0205
description				
spare parts for 100058				
	GEV No.	100224	Ref. No.	—
	GEV No.	101281	Ref. No.	—
	GEV No.	101283	Ref. No.	—
accessories for 100058				
	GEV No.	100220	Ref. No.	OK1176
	GEV No.	100221	Ref. No.	—
	GEV No.	100222	Ref. No.	OK1126
	GEV No.	100223	Ref. No.	—
	GEV No.	100226	Ref. No.	—
	GEV No.	100227	Ref. No.	—
	GEV No.	100228	Ref. No.	—
	GEV No.	100909	Ref. No.	—
	GEV No.	101287	Ref. No.	—
	GEV No.	102110	Ref. No.	—















accessories for 100058				
	GEV No.	102111	Ref. No.	—

CB 505 series
pilot burners

				
1	GEV No.	100059	Ref. No.	OK0204
description				
spare parts for 100059				
	GEV No.	100231	Ref. No.	—
	GEV No.	100703	Ref. No.	203190
	GEV No.	100805	Ref. No.	—
	GEV No.	101282	Ref. No.	—
	GEV No.	101283	Ref. No.	—
	GEV No.	101292	Ref. No.	—
accessories for 100059				
	GEV No.	100217	Ref. No.	—
	GEV No.	100230	Ref. No.	OK1189
	GEV No.	100232	Ref. No.	—
	GEV No.	100233	Ref. No.	—
	GEV No.	100234	Ref. No.	—
	GEV No.	100907	Ref. No.	—
	GEV No.	100909	Ref. No.	—
	GEV No.	101288	Ref. No.	—

1 gas components



			
1			
GEV No.	100060	Ref. No.	0H6333
description			
spare parts for	100060		
	GEV No.	100231	Ref. No. —
	GEV No.	100703	Ref. No. 203190
	GEV No.	100805	Ref. No. —
	GEV No.	100907	Ref. No. —
	GEV No.	101282	Ref. No. —
	GEV No.	101283	Ref. No. —
	GEV No.	101292	Ref. No. —
accessories for	100060		
	GEV No.	100217	Ref. No. —
	GEV No.	100230	Ref. No. 0K1189
	GEV No.	100232	Ref. No. —
	GEV No.	100233	Ref. No. —
	GEV No.	100234	Ref. No. —
	GEV No.	100909	Ref. No. —
	GEV No.	101288	Ref. No. —















PRO-GAS			
100 series			
pilot burners			
			
1			
GEV No.	100071	Ref. No.	0H6338
description			
spare parts for	100071		
	GEV No.	100086	Ref. No. —
	GEV No.	100245	Ref. No. 056799
	GEV No.	100804	Ref. No. —
	GEV No.	100833	Ref. No. 0H6050
	GEV No.	100881	Ref. No. —
	GEV No.	100885	Ref. No. —
	GEV No.	100907	Ref. No. —
	GEV No.	100916	Ref. No. —
	GEV No.	100917	Ref. No. —
	GEV No.	100918	Ref. No. —
accessories for	100071		
	GEV No.	100246	Ref. No. 056656
	GEV No.	100904	Ref. No. 0K2497
	GEV No.	100905	Ref. No. —
	GEV No.	102110	Ref. No. —

Table continues overleaf



accessories for	100071			
	GEV No.	102111	Ref. No.	—

accessories for	100093			
	GEV No.	102110	Ref. No.	—
	GEV No.	102111	Ref. No.	—



140 - 145 -150 series

pilot burners









GEV No.	100093	Ref. No.	0H6311
description			

spare parts for 100093

	GEV No.	100216	Ref. No.	—
	GEV No.	100701	Ref. No.	059380
	GEV No.	100897	Ref. No.	059161
	GEV No.	100906	Ref. No.	057960
	GEV No.	100907	Ref. No.	—
	GEV No.	100908	Ref. No.	052125

accessories for 100093

	GEV No.	100204	Ref. No.	059216
	GEV No.	100205	Ref. No.	—
	GEV No.	100206	Ref. No.	—
	GEV No.	100207	Ref. No.	059215
	GEV No.	100803	Ref. No.	—
	GEV No.	100898	Ref. No.	—
	GEV No.	100909	Ref. No.	—





producer-specific pilot burners

JUNO



GEV No.	100856	Ref. No.	OK1210
description			

spare parts for 100856

	GEV No.	100806	Ref. No.	0H6645
	GEV No.	100847	Ref. No.	0H6343
	GEV No.	100853	Ref. No.	0H6342
	GEV No.	101598	Ref. No.	0H6316

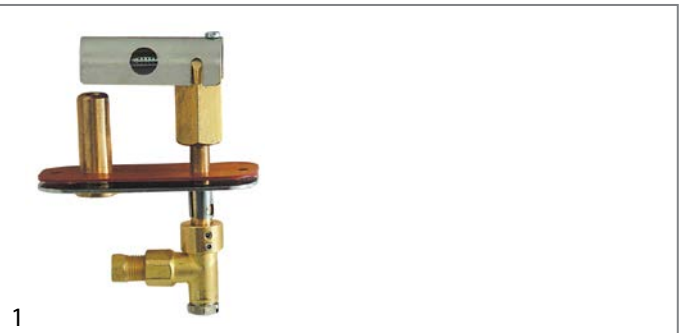

GEV No.	100857	Ref. No.	OK1211
description			

spare parts for 100857







	GEV No.	100806	Ref. No.	0H6645
	GEV No.	100847	Ref. No.	0H6343
	GEV No.	100853	Ref. No.	0H6342

Table continues overleaf

spare parts for 100857				
	GEV No.	100962	Ref. No.	—
	GEV No.	101599	Ref. No.	0G2024

electrodes



GEV No.	100701	Ref. No.	059380
description			
accessories for 100701			
	GEV No.	100906	Ref. No. 057960

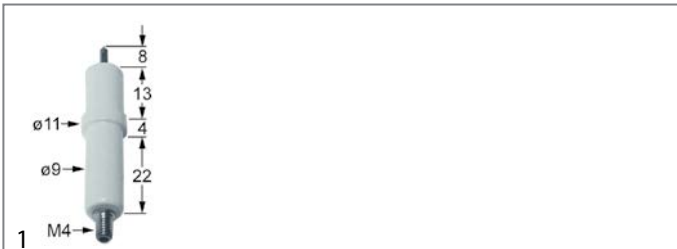

GEV No.	100703	Ref. No.	203190
description			

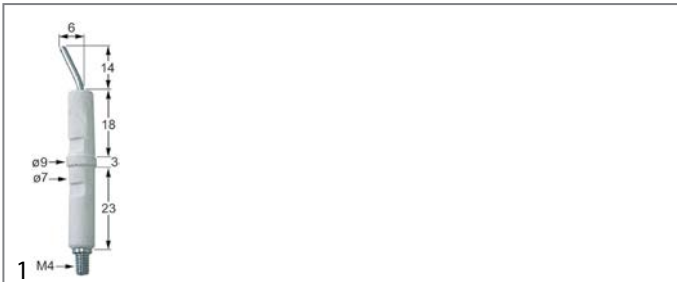

GEV No.	100706	Ref. No.	056754
description			



GEV No.	100724	Ref. No.	0H6257
description			
accessories for 100724			
	GEV No.	519546	Ref. No. —



GEV No.	100742	Ref. No.	0H6313
description			

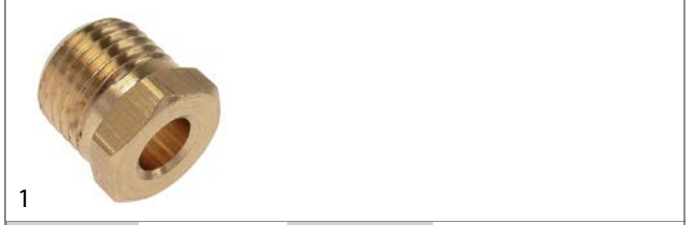

GEV No.	100906	Ref. No.	057960
description			



1

GEV No.	nla'	Ref. No.	054269
description			
spare parts for	101136		
	GEV No.	100001	Ref. No. —

'no longer available

ignition units



1

GEV No.	101016	Ref. No.	OK3019
description			



1

GEV No.	102485	Ref. No.	004240
description			



1

GEV No.	106571	Ref. No.	OK2374
description			

thermocouples

plug-in thermocouples

plug-in thermocouples standard

with barrel socket ø5mm - type Junkers with aluminised tip



GEV No.	102205	Ref. No.	058332
----------------	--------	-----------------	--------

description

accessories for 102205

	GEV No.	101260	Ref. No. —
---	---------	--------	------------

with barrel socket ø6mm

type Junkers with aluminised tip

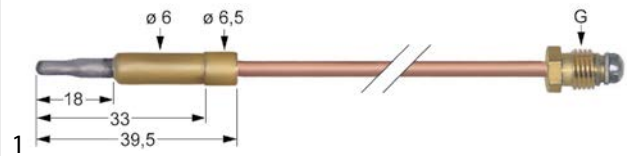

GEV No.	102218	Ref. No.	OK0682
----------------	--------	-----------------	--------

description

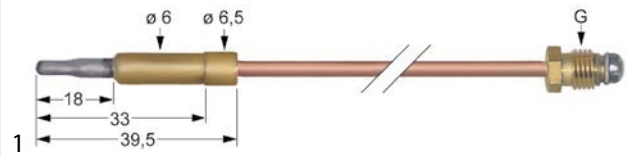

GEV No.	102221	Ref. No.	OK0686
----------------	--------	-----------------	--------

description

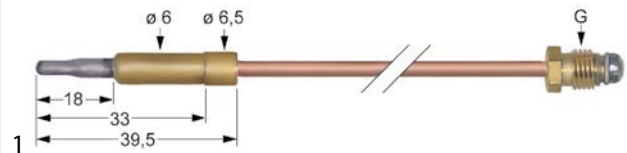

GEV No.	102223	Ref. No.	OK0654
----------------	--------	-----------------	--------

description

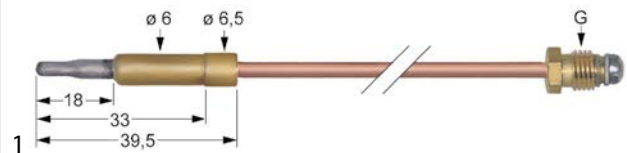

GEV No.	102228	Ref. No.	OK6175
----------------	--------	-----------------	--------

description



GEV No.	102229	Ref. No.	0H6174
description			

GEV No.	102231	Ref. No.	0K0687
description			

with barrel socket $\varnothing 6(6.5)$ mm

thermocouples SIT

GEV No.	107605	Ref. No.	051119
description			

GEV No.	107609	Ref. No.	025031
description			

GEV No.	107612	Ref. No.	0H6255
description			

GEV No.	107613	Ref. No.	0K3464
description			

GEV No.	107619	Ref. No.	0H6253
description			

GEV No.	107619	Ref. No.	0H6253
description			

GEV No.	107621	Ref. No.	0H6252
description			

GEV No.	107621	Ref. No.	0H6252
description			

plug-in thermocouples with interruption

GEV No.	107863	Ref. No.	0C3162
description			





threaded thermocouples

threaded thermocouples standard

with socket with thread M8x1

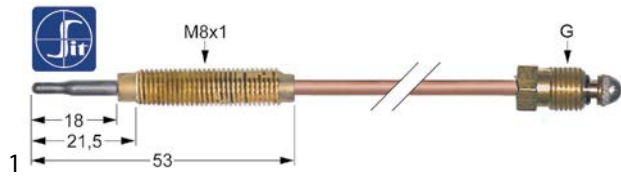
SIT



GEV No.	107631	Ref. No.	0K0652
description			
accessories for	107631		
	GEV No.	102067	Ref. No. —

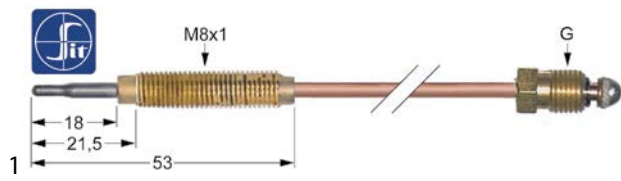

GEV No.	107643	Ref. No.	0H6256
description			
accessories for	107643		
	GEV No.	102067	Ref. No. —

extensions



GEV No.	102265	Ref. No.	055032
description			

accessories

interrupters



GEV No.	101258	Ref. No.	0H6263
description			

miscellaneous



GEV No.	102273	Ref. No.	OTR930
description			







gas burners

hob burners

producer-specific hob burners

JUNO

46, 71, 72 series

GEV No.	103001	Ref. No.	0H6325
description			
accessories for	103001		
	GEV No.	103004	Ref. No. 0H6344
	GEV No.	103007	Ref. No. 0H6863
	GEV No.	104001	Ref. No. 0H6308
	GEV No.	104057	Ref. No. 0H7089
	GEV No.	104231	Ref. No. 0H7096
	GEV No.	104233	Ref. No. —





GEV No.	103002	Ref. No.	0H6326
description			
accessories for	103002		
	GEV No.	103005	Ref. No. 0H6323
	GEV No.	103007	Ref. No. 0H6863
	GEV No.	104002	Ref. No. 0H6309

Table continues overleaf



accessories for	103002			
	GEV No.	104057	Ref. No.	0H7089





GEV No.	103003	Ref. No.	0H6327	
----------------	--------	-----------------	--------	--

description

accessories for	103003			
------------------------	--------	--	--	--

	GEV No.	103006	Ref. No.	0H6324
---	---------	--------	----------	--------

	GEV No.	103007	Ref. No.	0H6863
---	---------	--------	----------	--------

	GEV No.	104003	Ref. No.	0H6310
---	---------	--------	----------	--------

	GEV No.	104232	Ref. No.	0H7095
---	---------	--------	----------	--------

	GEV No.	104234	Ref. No.	0KC813
---	---------	--------	----------	--------



GEV No.	103004	Ref. No.	0H6344	
----------------	--------	-----------------	--------	--

description

accessories for	103004			
------------------------	--------	--	--	--

	GEV No.	103001	Ref. No.	0H6325
---	---------	--------	----------	--------

	GEV No.	103007	Ref. No.	0H6863
---	---------	--------	----------	--------

	GEV No.	104001	Ref. No.	0H6308
---	---------	--------	----------	--------

	GEV No.	104057	Ref. No.	0H7089
---	---------	--------	----------	--------

	GEV No.	104231	Ref. No.	0H7096
---	---------	--------	----------	--------

	GEV No.	104233	Ref. No.	—
---	---------	--------	----------	---





GEV No.	103005	Ref. No.	0H6323	
----------------	--------	-----------------	--------	--

description

accessories for	103005			
------------------------	--------	--	--	--

	GEV No.	103002	Ref. No.	0H6326
---	---------	--------	----------	--------

accessories for	103005			
	GEV No.	103007	Ref. No.	0H6863

	GEV No.	104002	Ref. No.	0H6309
---	---------	--------	----------	--------

	GEV No.	104057	Ref. No.	0H7089
---	---------	--------	----------	--------

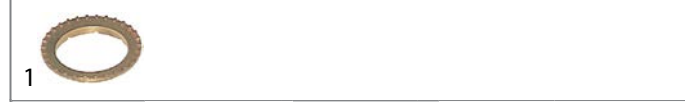

GEV No.	103006	Ref. No.	0H6324	
----------------	--------	-----------------	--------	--

description

accessories for	103006			
------------------------	--------	--	--	--

	GEV No.	103003	Ref. No.	0H6327
---	---------	--------	----------	--------

	GEV No.	103007	Ref. No.	0H6863
---	---------	--------	----------	--------

	GEV No.	104003	Ref. No.	0H6310
---	---------	--------	----------	--------

	GEV No.	104232	Ref. No.	0H7095
--	---------	--------	----------	--------

	GEV No.	104234	Ref. No.	0KC813
---	---------	--------	----------	--------



GEV No.	103007	Ref. No.	0H6863	
----------------	--------	-----------------	--------	--

description



GEV No.	104001	Ref. No.	0H6308	
----------------	--------	-----------------	--------	--

description



GEV No.	104002	Ref. No.	0H6309	
----------------	--------	-----------------	--------	--

description





GEV No.	104003	Ref. No.	0H6310	
----------------	--------	-----------------	--------	--

description



			
1			
GEV No.	104057	Ref. No.	0H7089
description			

			
1			
GEV No.	104231	Ref. No.	0H7096
description			

			
1			
GEV No.	104232	Ref. No.	0H7095
description			

			
1			
GEV No.	104234	Ref. No.	0KC813
description			

74, 75, 85, 90, 92, 95, 97 series

			
1			
GEV No.	103007	Ref. No.	0H6863
description			

			
1			
GEV No.	103086	Ref. No.	0H6319
description			

			
1			
GEV No.	103087	Ref. No.	0H6320
description			

			
1			
GEV No.	103088	Ref. No.	0H6321
description			

			
1			
GEV No.	104027	Ref. No.	0G1593
description			

			
1			
GEV No.	104028	Ref. No.	0H6340
description			

			
1			
GEV No.	104029	Ref. No.	0H6341
description			

			
1			
GEV No.	104042	Ref. No.	0H7154
description			

			
1			
GEV No.	104043	Ref. No.	0H7155
description			

1

GEV No.	104044	Ref. No.	0G1811
description			



1

GEV No.	210130	Ref. No.	0K2331
description			

pan supports



1

GEV No.	210122	Ref. No.	0KC890
description			



1

GEV No.	210131	Ref. No.	0K1983
description			



1

GEV No.	210123	Ref. No.	0KC891
description			

reducers for pan supports



1

GEV No.	210001	Ref. No.	025056
description			



1

GEV No.	210126	Ref. No.	0K2329
description			



1

GEV No.	210014	Ref. No.	0H6849
description			



1

GEV No.	210127	Ref. No.	0K2330
description			



1

GEV No.	210020	Ref. No.	0H6780
description			

accessories

reducers for pan supports



1

GEV No.	210001	Ref. No.	025056
description			

1

GEV No.	210014	Ref. No.	0H6849
description			



1

GEV No.	210127	Ref. No.	0K2330
description			



1

GEV No.	210020	Ref. No.	0H6780
description			



1

GEV No.	210130	Ref. No.	0K2331
description			

pan supports



1

GEV No.	210122	Ref. No.	0KC890
description			



1

GEV No.	210131	Ref. No.	0K1983
description			



1

GEV No.	210123	Ref. No.	0KC891
description			



1

GEV No.	210211	Ref. No.	0G2033
description			



1

GEV No.	210126	Ref. No.	0K2329
description			

air mixers



1

GEV No.	104372	Ref. No.	0G6309
description			



bar burners

bar burners



1
GEV No. 104185 **Ref. No.** OK1193

description



1
GEV No. 104186 **Ref. No.** 0H6337

description



1
GEV No. 104188 **Ref. No.** 0H6335

description



1
GEV No. 104580 **Ref. No.** 0A5124

description



1
GEV No. 105970 **Ref. No.** OKD090

description



1
GEV No. 105971 **Ref. No.** OKD091

description

ring burners



1
GEV No. 104189 **Ref. No.** 0H7082

description



1
GEV No. 104196 **Ref. No.** OKC724

description

accessories

nozzle holders



1
GEV No. 101152 **Ref. No.** 0C3158

description

air slides



1
GEV No. 104193 **Ref. No.** 0H6880

description



1
GEV No. 104194 **Ref. No.** OK2561

description



gas nozzles

main nozzles

gas nozzles M10x1



1	GEV No.	100150	Ref. No.	054630
description				



1	GEV No.	100151	Ref. No.	054127
description				



1	GEV No.	100155	Ref. No.	056470
description				



1	GEV No.	100670	Ref. No.	002265
description				



1	GEV No.	101975	Ref. No.	003722
description				



1	GEV No.	106328	Ref. No.	002393
description				



1	GEV No.	106469	Ref. No.	059382
description				



1	GEV No.	106474	Ref. No.	0A2102
description				



1	GEV No.	106475	Ref. No.	0A2083
description				



1	GEV No.	100387	Ref. No.	0A2091
description				

gas nozzles M12x1



1	GEV No.	100283	Ref. No.	0K1241
description				





1	GEV No.	100284	Ref. No.	0K1245
description				





1	GEV No.	100285	Ref. No.	0G2774
description				





			
1			
GEV No.	100286	Ref. No.	0K1246
description			

			
1			
GEV No.	100302	Ref. No.	0H6355
description			

			
1			
GEV No.	100288	Ref. No.	0K1229
description			

			
1			
GEV No.	100303	Ref. No.	0G1794
description			

			
1			
GEV No.	100289	Ref. No.	0G3001
description			

			
1			
GEV No.	100306	Ref. No.	0G2027
description			

			
1			
GEV No.	100290	Ref. No.	0K1215
description			

			
1			
GEV No.	100307	Ref. No.	0K1224
description			

			
1			
GEV No.	100291	Ref. No.	0G2914
description			

			
1			
GEV No.	100308	Ref. No.	0K1144
description			

			
1			
GEV No.	100292	Ref. No.	0G2030
description			

			
1			
GEV No.	100309	Ref. No.	0K1230
description			

			
1			
GEV No.	100300	Ref. No.	0G1792
description			

			
1			
GEV No.	100326	Ref. No.	0U4101
description			





			
1			
GEV No.	100662	Ref. No.	0K1249
description			

			
1			
GEV No.	100665	Ref. No.	0K1214
description			

gas nozzles M15x1

			
1			
GEV No.	100329	Ref. No.	230890
description			

			
1			
GEV No.	100331	Ref. No.	230887
description			

			
1			
GEV No.	100333	Ref. No.	230886
description			

			
1			
GEV No.	100334	Ref. No.	230888
description			

			
1			
GEV No.	100339	Ref. No.	230889
description			

gas nozzles (other)

			
1			
GEV No.	100561	Ref. No.	026720
description			

			
1			
GEV No.	100565	Ref. No.	050501
description			

			
1			
GEV No.	100567	Ref. No.	025983
description			

			
1			
GEV No.	100569	Ref. No.	026717
description			

			
1			
GEV No.	100571	Ref. No.	025867
description			

			
1			
GEV No.	100574	Ref. No.	026786
description			



			
1			
GEV No.	100575	Ref. No.	026213
description			

			
1			
GEV No.	100580	Ref. No.	026788
description			

			
1			
GEV No.	100581	Ref. No.	026622
description			

			
1			
GEV No.	100592	Ref. No.	051460
description			

			
1			
GEV No.	100595	Ref. No.	050750
description			

pilot burner nozzles

pilot burner nozzles JUNKERS

CB 50203_/503_ series

			
1			
GEV No.	100220	Ref. No.	0K1176
description			

			
1			
GEV No.	100222	Ref. No.	0K1126
description			

CB 5050_ series

			
1			
GEV No.	100230	Ref. No.	0K1189
description			

pilot burner nozzles SIT

100 series

			
1			
GEV No.	100245	Ref. No.	056799
description			

			
1			
GEV No.	100246	Ref. No.	056656
description			

			
1			
GEV No.	107170	Ref. No.	058525
description			

			
1			
GEV No.	107171	Ref. No.	058330
description			

140/150 series

			
1			
GEV No.	100204	Ref. No.	059216
description			

			
1			
GEV No.	100207	Ref. No.	059215
description			



160 series



1

GEV No.	107172	Ref. No.	054593
description	pilot burner nozzle SIT LPG code 25 Qty 1 pcs		



1

GEV No.	107174	Ref. No.	053670
description	pilot burner nozzle SIT natural gas code 41 Qty 1 pcs		



1

GEV No.	107175	Ref. No.	053668
description	pilot burner nozzle SIT natural gas code 51 Qty 1 pcs suitable for 160 series		

bypass nozzles

bypass nozzles EGA



1

GEV No.	106825	Ref. No.	0K1226
description	bypass nozzle EGA bore \varnothing 0.37mm		



1

GEV No.	100355	Ref. No.	0K1236
description	bypass nozzle EGA type 31248 series bore \varnothing 0.52mm		



1

GEV No.	100356	Ref. No.	0H6068
description	bypass nozzle EGA type 31248 series bore \varnothing 0.55mm total length 23mm \varnothing 5mm thread M5x0.5		



1

GEV No.	100354	Ref. No.	0H6369
description	bypass nozzle EGA type 31248 series bore \varnothing 0.5mm		



1

GEV No.	100361	Ref. No.	0H6370
description	bypass nozzle EGA type 31248 series bore \varnothing 0.65mm		



1

GEV No.	100368	Ref. No.	0H6349
description	bypass nozzle EGA type 31248 series bore \varnothing 0.6mm		



1

GEV No.	100358	Ref. No.	0H6347
description	bypass nozzle EGA type 31248 series bore \varnothing 0.75mm		



1

GEV No.	100357	Ref. No.	0H6066
description	bypass nozzle EGA type 31248 series bore \varnothing 0.7mm		



1

GEV No.	100346	Ref. No.	0K0241
description	bypass nozzle EGA type 31248 series bore \varnothing 0.85mm		



1

GEV No.	100328	Ref. No.	0K0246
description	bypass nozzle EGA type 31248 series bore \varnothing 0.8mm		



1

GEV No.	100347	Ref. No.	0K1213
description	bypass nozzle EGA type 31248 series bore \varnothing 0.9mm		



1

GEV No.	100359	Ref. No.	0K1293
description	bypass nozzle EGA type 31248 series bore \varnothing 1.2mm		



1

GEV No.	100363	Ref. No.	0K0261
description	bypass nozzle EGA type 31248 series bore \varnothing 1.5mm		

bypass nozzles PEL22



1

GEV No.	100409	Ref. No.	056743
description	bypass nozzle type PEL22 bore \varnothing 0.8mm thread M6x0.5		



internal nozzles

internal nozzles for EGA gas taps/nozzle holders

EGA 24197/24362

1			
GEV No.	100341	Ref. No.	0K1274
description	internal nozzle bore ø 1.15mm type EGA/PEL22		

1			
GEV No.	100344	Ref. No.	0K1298
description	internal nozzle bore ø 1.2mm type EGA/PEL22		

1			
GEV No.	100342	Ref. No.	230812
description	internal nozzle bore ø 1.4mm type EGA/PEL22		

1			
GEV No.	100323	Ref. No.	0K1302
description	internal nozzle bore ø 1.85mm type EGA/PEL22		

1			
GEV No.	100324	Ref. No.	230830
description	internal nozzle bore ø 2.1mm type PEL22		

1			
GEV No.	100327	Ref. No.	230904
description	internal nozzle bore ø 2.35mm type EGA/PEL22		

EGA 26400/26440/23268

1			
GEV No.	100310	Ref. No.	0H6356
description	internal nozzle bore ø 0.66mm suitable for EGA26400/26440		

1			
GEV No.	100319	Ref. No.	0K1282
description	internal nozzle bore ø 0.75mm suitable for EGA26400/26440		

1			
GEV No.	100311	Ref. No.	0H6372
description	internal nozzle bore ø 0.80mm suitable for EGA26400/26440		

1			
GEV No.	100321	Ref. No.	0K1283
description	internal nozzle bore ø 0.90mm suitable for EGA26400/26440		

1			
GEV No.	100315	Ref. No.	0G1786
description	internal nozzle bore ø 0.95mm suitable for EGA26400/26440		

1			
GEV No.	100312	Ref. No.	0H6357
description	internal nozzle bore ø 1.05mm suitable for EGA26400/26440		

1			
GEV No.	100313	Ref. No.	0K1252
description	internal nozzle bore ø 1.20mm suitable for EGA26400/26440		

1			
GEV No.	100322	Ref. No.	0K1254
description	internal nozzle bore ø 1.40mm suitable for EGA26400/26440		

1			
GEV No.	100316	Ref. No.	0K1272
description	internal nozzle bore ø 1.70mm suitable for EGA26400/26440		

1			
GEV No.	100314	Ref. No.	0G1791
description	internal nozzle bore ø 1.90mm suitable for EGA26400/26440		

1			
GEV No.	100317	Ref. No.	0K1232
description	internal nozzle bore ø 2.20mm suitable for EGA26400/26440		

auxiliary gas parts

screw connections

with rotating joint



1			
GEV No.	102758	Ref. No.	0G3754
description	rotating joint for ignition gas approval without DVGW complete		





GEV No.	102748	Ref. No.	0K2578
description	rotating joint T1: M22 T2: 3/4" L 69mm W 57mm for main gas approval without DVGW complete		

olives



GEV No.	101278	Ref. No.	060325
description	olive for pipe ø 10mm Qty 1 pcs		
accessories for	101278		
	GEV No.	100943	Ref. No. —
	union nut thread M17x1 tube ø 10mm		
	GEV No.	101300	Ref. No. —
	union nut thread M16x1.5 tube ø 10mm		
	GEV No.	101478	Ref. No. —
	union nut thread 3/8" for pipe ø 10mm		







GEV No.	101248	Ref. No.	050682
description	olive for pipe ø 12mm Qty 1 pcs suitable for PEL		
accessories for	101248		
	GEV No.	101251	Ref. No. —
	union nut thread M20x1.5 for pipe ø 12mm		



GEV No.	102517	Ref. No.	0K2859 293299
description	olive for pipe ø 15mm brass Qty 1 pcs		



GEV No.	101284	Ref. No.	0K2491
description	olive for pipe ø 4mm Qty 1 pcs		
accessories for	101284		
	GEV No.	101259	Ref. No. —
	union nut thread M8x1 for pipe ø 4mm		
	GEV No.	101285	Ref. No. 0KL220
	union screw thread M8x1 for pipe ø 4mm Qty 1 pcs JUNKERS		
	GEV No.	101294	Ref. No. —
	union nut thread M10x1 for pipe ø 4mm WS 14 L 12mm Qty 1 pcs		



GEV No.	100897	Ref. No.	059161
description	olive for pipe ø 4mm Qty 1 pcs for pilot burner		

union screws







GEV No.	100904	Ref. No.	0K2497
description	locking screw M10x1 for pipe ø 4mm Qty 1 pcs		



GEV No.	100906	Ref. No.	057960
description	screw connection thread M10x1 for ignition electrode brass Qty 1 pcs WS 10		



GEV No.	100908	Ref. No.	052125
description	union screw thread M10x1 for pipe ø 4mm Qty 1 pcs		
accessories for	100908		
	GEV No.	100897	Ref. No. 059161
	olive for pipe ø 4mm Qty 1 pcs for pilot burner		
	GEV No.	101246	Ref. No. —
	olive for pipe ø 4mm Qty 1 pcs		
	GEV No.	101280	Ref. No. —
	olive for pipe ø 4mm Qty 1 pcs		
	GEV No.	101282	Ref. No. —
	olive for pipe ø 4mm L 7.4mm Qty 1 pcs		



GEV No.	101285	Ref. No.	0KL220
description	union screw thread M8x1 for pipe ø 4mm Qty 1 pcs JUNKERS		
accessories for	101285		
	GEV No.	101284	Ref. No. 0K2491
	olive for pipe ø 4mm Qty 1 pcs		



gas hoses

miscellaneous

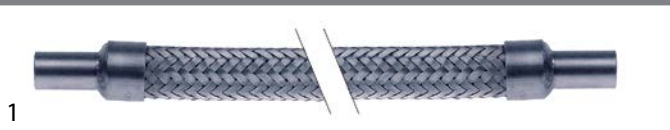

1			
GEV No.	250000	Ref. No.	0H6831 263346
description	gas hose L 790mm nominal- ϕ 12mm for tilting bratt pan SS		

pressure switches



1			
GEV No.	541182	Ref. No.	0K1397
description	pressure control		



1			
GEV No.	541073	Ref. No.	002635
description	pressure control ϕ 45mm pressure range adjustable 5-20mbar pressure connection vertical gas technology connection 1/4" pressure connection ϕ 1/4"mm		



1			
GEV No.	541446	Ref. No.	005029
description	pressure control pressure range 10-50mbar connection 1/4"		



1			
GEV No.	541075	Ref. No.	003772
description	pressure control pressure range adjustable 0.44-0.8mbar gas technology connection 6mm suitable for ZANUSSI		

equipment-specific units

for convection ovens/combi-steamers

steam generators

steam generators



1			
GEV No.	694312	Ref. No.	005234
description	steam generator L 615mm W 100mm H 425mm		

spare parts and accessories



1			
GEV No.	550917	Ref. No.	0K2769
description	flange		



1			
GEV No.	550900	Ref. No.	0KD350
description	flange L 60mm W 40mm H 1mm		



1			
GEV No.	550899	Ref. No.	0KD286
description	flange L 60mm W 40mm H 2mm		



1			
GEV No.	690878	Ref. No.	0K2793
description	taper nut		

filters



1			
GEV No.	514377	Ref. No.	0H6299
description	drain filter		

1 gas components

frame



1

GEV No.	693398	Ref. No.	057382
description	frame for level glass		

cleaning system

nozzles



1

GEV No.	510239	Ref. No.	0H6675
description	rinse jet for humidifier		

miscellaneous



1

GEV No.	693429	Ref. No.	002662
description	bush		



1

GEV No.	550697	Ref. No.	0K2358
description	bush for knob		



1

GEV No.	693432	Ref. No.	002663
description	gasket for knob		



1

GEV No.	693430	Ref. No.	051263
description	nut thread M22x1.5 H 5mm WS 26 zinc-coated steel Qty 1 pcs		



1

GEV No.	693431	Ref. No.	002727
description	plain washer		

for tilting bratt pans

miscellaneous



1

GEV No.	693243	Ref. No.	0K1817
description	roller for cable		

for boiling pans

filters



1

GEV No.	541370	Ref. No.	0G5198
description	drain filter		



1

GEV No.	514379	Ref. No.	027114
description	drain filter kettle		



gearboxes

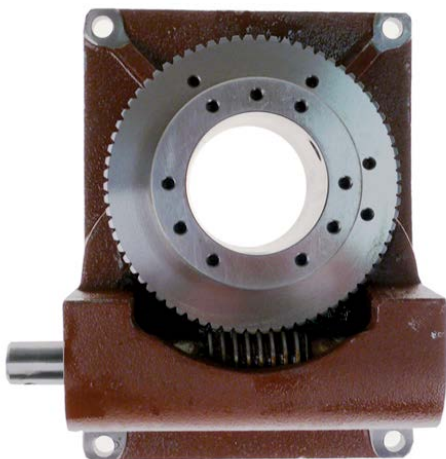

1

GEV No.	520400	Ref. No.	OG1613 280794
description	auger gear		

level glasses

complete



1

GEV No.	540200	Ref. No.	0H7003
description	level glass for kettle complete thread 1½"		

for dishwashers

hood mechanics for dishwashers

cable controls



1

GEV No.	693244	Ref. No.	0K1802
description	hauling cable		

knobs

producer-specific knobs

JUNO



1

GEV No.	112127	Ref. No.	0K2265
description	knob		



1

GEV No.	111823	Ref. No.	0H6749
description	knob energy regulator 1-3 ø 63mm shaft ø 6x4.6mm shaft flat upper silver		



1

GEV No.	111820	Ref. No.	0K2245
description	knob gas tap with ignition flame ø 63mm shaft ø 8x7mm shaft flat lower black		



1

GEV No.	111822	Ref. No.	0K2242
description	knob gas thermostat 1-8 ø 63mm shaft ø 8x6.5mm shaft flat lower		



1

GEV No.	110175	Ref. No.	0H6679
description	knob oven TH/BH/TH+BH ø 63mm shaft ø 6x4.6mm shaft flat upper silver/red		



1

GEV No.	111588	Ref. No.	OK2303
description	knob thermostat 1-10 ø 63mm shaft ø 6x4.6mm shaft flat upper		



1

GEV No.	110177	Ref. No.	0H6676
description	knob thermostat t.max. 200°C ø 63mm shaft ø 6x4.6mm shaft flat upper silver temperature range 60-200°C rotation 270°		



1

GEV No.	110180	Ref. No.	0H6746
description	knob time 60min ø 63mm shaft ø 6x4.6mm shaft flat upper silver		



1

GEV No.	110268	Ref. No.	0H6735
description	knob power ø 72mm shaft ø 6x4.6mm shaft flat horizontal		



1

GEV No.	110267	Ref. No.	0H6736
description	knob programme ø 72mm shaft ø 6x4.6mm shaft flat lower		



1

GEV No.	110273	Ref. No.	0H6726
description	knob speed ø 72mm shaft ø 6x4.6mm shaft flat horizontal		



1

GEV No.	110274	Ref. No.	0H6779
description	knob speed/power ø 72mm shaft ø 6x4.6mm shaft flat horizontal		



1

GEV No.	110270	Ref. No.	0H6733
description	knob thermostat 1-9 ø 72mm shaft ø 6x4.6mm shaft flat lower		



1

GEV No.	110269	Ref. No.	0H6734
description	knob thermostat t.max. 100°C 50-100°C ø 72mm shaft ø 6x4.6mm shaft flat lower		



1

GEV No.	110265	Ref. No.	0H6731
description	knob thermostat t.max. 250°C ø 72mm shaft ø 6x4.6mm shaft flat lower white/black temperature range 50-250°C rotation 270°		





1

GEV No.	110266	Ref. No.	0H6732
description	knob time 120min ø 72mm shaft ø 6x4.6mm shaft flat lower black		

			
1			
GEV No.	110272	Ref. No.	0H6725
description	knob time 120min ø 72mm shaft ø 6x4.6mm shaft flat lower black		

			
1			
GEV No.	110225	Ref. No.	0H6785
description	knob switch 4-position t.max.°C ø 77mm shaft ø 6x4.6mm shaft flat upper silver		

			
1			
GEV No.	111589	Ref. No.	0H6790
description	knob energy regulator 1-12 t.max.°C ø 77mm shaft ø 6x4.6mm shaft flat upper white/black		

			
1			
GEV No.	110221	Ref. No.	0H6788
description	knob switch 7-position t.max.°C ø 77mm shaft ø 6x4.6mm shaft flat upper white/black		

			
1			
GEV No.	110227	Ref. No.	0H6789
description	knob gas tap with ignition flame t.max.°C ø 77mm shaft ø 8x7mm shaft flat lower silver		

			
1			
GEV No.	110220	Ref. No.	0H6787
description	knob thermostat 1-10 t.max.°C ø 77mm shaft ø 6x4.6mm shaft flat upper		

			
1			
GEV No.	110222	Ref. No.	0K2333
description	knob oven TH/BH/TH+BH t.max.°C ø 77mm shaft ø 6x4.6mm shaft flat upper white/black		

			
1			
GEV No.	110228	Ref. No.	0K2335
description	knob thermostat t.max. 100°C ø 77mm shaft ø 6x4.6mm shaft flat lower white/black temperature range 50-100°C		

			
1			
GEV No.	110226	Ref. No.	0H6786
description	knob switch 0-1-0-1 t.max.°C ø 77mm shaft ø 6x4.6mm shaft flat upper silver		

			
1			
GEV No.	110223	Ref. No.	0H6783
description	knob thermostat t.max. 110°C ø 77mm shaft ø 6x4.6mm shaft flat upper white/black temperature range 30-110°C		



1

GEV No.	110229	Ref. No.	0H6782
description	knob thermostat t.max. 180°C ø 77mm shaft ø 6x4.6mm shaft flat upper white/black temperature range 100-180°C rotation 270°		



1

GEV No.	110224	Ref. No.	0H6784
description	knob thermostat t.max. 300°C ø 77mm shaft ø 6x4.6mm shaft flat upper silver temperature range 50-300°C rotation 270°		



1

GEV No.	112047	Ref. No.	0H6457
description	knob 1-2 ø 55mm shaft ø 6x4.6mm shaft flat lower		



1

GEV No.	110183	Ref. No.	0H6460
description	knob manual/automatic ø 55mm shaft ø 6x4.6mm shaft flat upper		



1

GEV No.	110182	Ref. No.	0H6463
description	knob steaming ø 55mm shaft ø 6x4.6mm shaft flat upper		



1

GEV No.	110185	Ref. No.	0H6461
description	knob thermostat t.max. 250°C ø 55mm shaft ø 6x4.6mm shaft flat lower black temperature range 50-250°C rotation 270°		



1

GEV No.	112046	Ref. No.	0H6751
description	knob time 120min t.max. °C ø 55mm shaft ø 6x4.6mm shaft flat lower black		



1

GEV No.	111828	Ref. No.	0H6740
description	knob time 30min ø 55mm shaft ø 6x4.6mm shaft flat lower black		



1

GEV No.	110184	Ref. No.	0H6462
description	knob time 60min ø 55mm shaft ø 6x4.6mm shaft flat lower black		





1

GEV No.	110188	Ref. No.	0H6724
description	knob time 60min ø 55mm shaft ø 6x4.6mm shaft flat lower black		

			
1			
GEV No.	110181	Ref. No.	0H6748
description	knob switch zero mark ø 45mm shaft ø 6x4.6mm shaft flat lower black		

			
1			
GEV No.	110858	Ref. No.	0H6795
description	knob switch zero mark ø 55mm shaft ø 6x4.6mm shaft flat lower black		

			
1			
GEV No.	110204	Ref. No.	0H6796
description	knob switch zero mark ø 55mm shaft ø 6x4.6mm shaft flat upper black		

			
1			
GEV No.	112045	Ref. No.	0H6721
description	knob time 90min ø 43mm shaft ø 6x4.6mm shaft flat upper black		

miscellaneous			
			
1			
GEV No.	112105	Ref. No.	0H9730
description	knob ø 21mm shaft ø 6mm		



accessories			
covers			
			
1			
GEV No.	112107	Ref. No.	0G3399
description	lid knob		

fascias			
			
1			
GEV No.	112106	Ref. No.	0K5794
description	bezel zero mark		

gaskets			
			
1			
GEV No.	693432	Ref. No.	002663
description	gasket for knob		

			
1			
GEV No.	110202	Ref. No.	0H6984
description	gasket switch shaft		

			
1			
GEV No.	110271	Ref. No.	0H6667
description	gasket switch shaft		

miscellaneous			
			
1			
GEV No.	693429	Ref. No.	002662
description	bush		
			
1			
GEV No.	550697	Ref. No.	0K2358
description	bush for knob		

			
1			
GEV No.	693430	Ref. No.	051263
description	nut thread M22x1.5 H 5mm WS 26 zinc-coated steel Qty 1 pcs		

			
1			
GEV No.	693431	Ref. No.	002727
description	plain washer		

handles and hand wheels

hand wheels

hand wheels

			
1			
GEV No.	693317	Ref. No.	0H6470
description	hand wheel ø 160mm D1 ø 40mm bore ø 20mm L1 30mm L2 50mm without handle aluminium		
accessories for	693317		
	GEV No.	514256	Ref. No. 0K2472
	cone handle ø 26mm total length 97mm thread M10 aluminium L1 82mm L2 15mm L 82mm		

			
1			
GEV No.	690085	Ref. No.	0K5532 234850
description	hand wheel ø 200mm D1 ø 48mm bore ø 20mm thread groove widthmm L1 30mm L2 60mm handle length 82mm with folding handle		
spare parts for	690085		
	GEV No.	514255	Ref. No. 0K2348
	folding handle ø 26mm total length 85mm seat ø 20mm shaft ømm thread M6 with pin L 85mm		

			
1			
GEV No.	690551	Ref. No.	0H6472
description	hand wheel ø 200mm D1 ø 48mm bore ø 20mm thread M8 groove widthmm L1 30mm L2 60mm handle length 80mm no fold-away handle		

spare parts and accessories

			
1			
GEV No.	514254	Ref. No.	0H6791 256612
description	folding handle ø 26mm total length 102mm seat ø 20mm shaft ømm thread M6 L 102mm		

			
1			
GEV No.	514255	Ref. No.	0K2348
description	folding handle ø 26mm total length 85mm seat ø 20mm shaft ømm thread M6 with pin L 85mm		

			
1			
GEV No.	514256	Ref. No.	0K2472
description	cone handle ø 26mm total length 97mm thread M10 aluminium L1 82mm L2 15mm L 82mm		

cone handles

			
1			
GEV No.	514256	Ref. No.	0K2472
description	cone handle ø 26mm total length 97mm thread M10 aluminium L1 82mm L2 15mm L 82mm		



star handles

 <p>1</p>			
GEV No.	541361	Ref. No.	0H6469
description	star handle shaft 10x10mm ø 100mm L 28mm black thermoplastic		

 <p>1</p>			
GEV No.	540365	Ref. No.	0H6468
description	star handle shaft 6x6mm ø 50mm L 18mm black thermoplastic		

 <p>1</p>			
GEV No.	540228	Ref. No.	0K1704
description	star handle shaft 8x8mm ø 80mm		

locks

handle latches

producer-specific

ELECTROLUX/JUNO

group 1

 <p>1</p>			
GEV No.	693751	Ref. No.	0H6882
description	door handle metal		

 <p>1</p>			
GEV No.	693750	Ref. No.	253497
description	snap lock		

edgemount latches

handle latches

CAFF/FERMOD

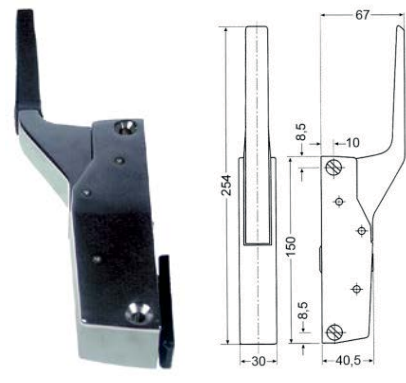
 <p>1</p>			
GEV No.	700631	Ref. No.	0K3058
description	catch complete with door catch		



producer-specific

INOXTREND

 <p>1</p>				
GEV No.	690146	Ref. No.	0K1669 234663	
description	handle latch L 172mm mounting distance 134mm non lockable heated units 6200 H 65mm type DUPLO total length 248mm			
accessories for	690146			
	GEV No.	690123	Ref. No.	—
door catch with roller				
	GEV No.	693777	Ref. No.	0K2347
gasket H 6.6mm L 105mm W 45mm L1 78mm W1 25mm for handle				
	GEV No.	693778	Ref. No.	0K1952
door catch				



MODULAR

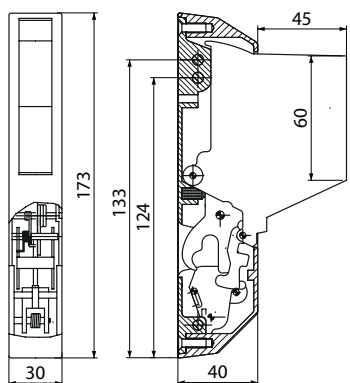

GEV No.	690146	Ref. No.	0K1669 234663
description	handle latch L 172mm mounting distance 134mm non lockable heated units 6200 H 65mm type DUPLO total length 248mm		
accessories for	690146		
	GEV No.	690123	Ref. No. —
	door catch with roller		
	GEV No.	693777	Ref. No. 0K2347
	gasket H 6.6mm L 105mm W 45mm L1 78mm W1 25mm for handle		
	GEV No.	693778	Ref. No. 0K1952
	door catch		

ZANUSSI



GEV No.	700467	Ref. No.	002647
description	catch L 173mm H 40mm mounting distance 133/124mm W 30mm non lockable 6200 total length 170mm overall height 85mm		
accessories for	700467		
	GEV No.	693937	Ref. No. 0F0029
	door handle H 44mm L 220mm W 50mm plastic black		
	GEV No.	700468	Ref. No. —
	door catch with roller		
	GEV No.	701412	Ref. No. —
	cover cap plastic round ø 11mm black for catch thickness 8mm		

door catches



GEV No.	693778	Ref. No.	0K1952
description	door catch		

snap locks

producer-specific

JUNO



GEV No.	690876	Ref. No.	0H6771
description	snap lock		



GEV No.	693750	Ref. No.	253497
description	snap lock		

espagnolette locks

universal



GEV No.	690837	Ref. No.	056551
description	bolt piece L 75mm W 29mm H 28mm cam length 17.5mm cam width 10mm mounting distance 20/40mm		





GEV No.	690041	Ref. No.	0K2246
description	cam L 148mm mounting distance 32mm		



GEV No.	693797	Ref. No.	004104 234701
description	console upper/lower for cam		





1			
GEV No.	690838	Ref. No.	056571
description	door catch with roller H 48mm L 50mm W 26mm mounting distance 28mm rollerø 10mm		

1			
GEV No.	690836	Ref. No.	056550
description	latch gear L 17mm W 26mm H 1.5mm mounting distance 42mm shaft diameter 7x7mm		

miscellaneous

1			
GEV No.	693771	Ref. No.	0K2290
description	bolt piece		

1	 Image not available		
GEV No.	700089	Ref. No.	0H6771
description	catch		

1			
GEV No.	693772	Ref. No.	0H6566
description	door catch		

1			
GEV No.	693749	Ref. No.	0K2697
description	spring for snap lock		

hinges

piano hinges

producer-specific

ELECTROLUX/JUNO

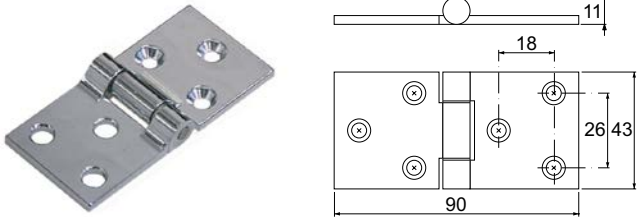
1			
GEV No.	690025	Ref. No.	0H6454
description	hinge L 90mm W 43mm H 11mm mounting distance 26mm mounting distance 1 18mm hole ø 5,5/8mm thickness 3.5mm Zamak VC		

oven hinges

1			
GEV No.	700436	Ref. No.	0KC554
description	hook for hinge		

1			
GEV No.	701561	Ref. No.	050766
description	oven hinge mounting distance 173mm mounting distance 2mm lug mounting 14mm lever length 112mm groove distance 10mm spring thickness 3mm mounting ear position left/right spring length 111mm L 205mm W 25mm with opposite support		

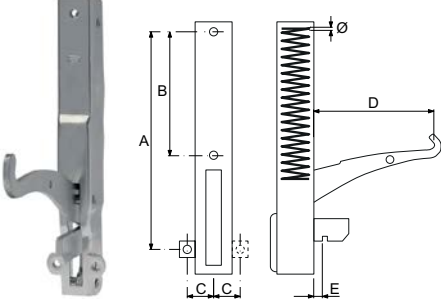
1			
GEV No.	701414	Ref. No.	0C3129
description	oven hinge mounting distance 173mm mounting distance 2mm lug mounting 14mm lever length 113mm groove distance 10mm spring thickness 4mm mounting ear position left/right spring length 111mm L 205mm W 25mm with opposite support		

door bearing



1

GEV No.	693775	Ref. No.	0H7181
description	hinge L 70mm W 45mm H 60mm mounting pos. lower		



1

GEV No.	693774	Ref. No.	0H7182
description	hinge L 70mm W 45mm H 60mm mounting pos. upper		



1

GEV No.	693776	Ref. No.	005241
description	hinge mounting pos. bottom right		



1

GEV No.	693783	Ref. No.	005112
description	hinge mounting pos. bottom right		



1

GEV No.	693756	Ref. No.	0H7063
description	hinge mounting pos. left		



1

GEV No.	693754	Ref. No.	0G5216
description	hinge mounting pos. lower		



1

GEV No.	693767	Ref. No.	005110
description	hinge mounting pos. lower		



1

GEV No.	693768	Ref. No.	0KC901
description	hinge mounting pos. lower		



1

GEV No.	693769	Ref. No.	0H7112
description	hinge mounting pos. lower		



1

GEV No.	693755	Ref. No.	0H7064
description	hinge mounting pos. right		



1

GEV No.	700029	Ref. No.	0G5222
description	hinge mounting pos. right		





1

GEV No.	693765	Ref. No.	005111
description	hinge mounting pos. upper		



			
1			
GEV No.	693766	Ref. No.	0KC899
description	hinge mounting pos. upper		

			
1			
GEV No.	693770	Ref. No.	0H7114
description	hinge mounting pos. upper		

			
1			
GEV No.	693782	Ref. No.	005242
description	hinge mounting pos. upper right		

accessories

shafts

			
1			
GEV No.	700028	Ref. No.	0K1653
description	hinge pin		

			
1			
GEV No.	693742	Ref. No.	0H6456
description	shaft for hinge mounting pos. right/left		



miscellaneous

			
1			
GEV No.	700474	Ref. No.	002653
description	disc for hinge corrugated		

			
1			
GEV No.	700478	Ref. No.	002645
description	protector for glass door for hinge		

fittings for catering equipment
 aerators and air bleeders

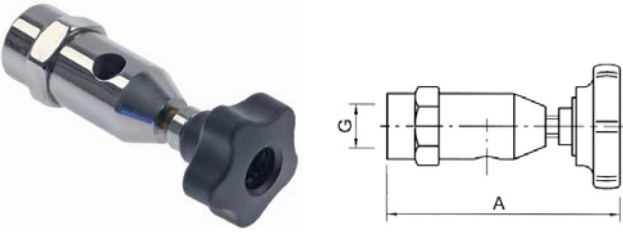

			
1			
GEV No.	540014	Ref. No.	0K5787
description	aerator and air bleeder thread 1/2" ET chrome-plated L 78mm		
spare parts for	540014		
		GEV No.	112777
		Ref. No.	—
	star handle shaft 6x6mm ø 50mm L 18mm black plastic		
		GEV No.	540365
		Ref. No.	0H6468
	star handle shaft 6x6mm ø 50mm L 18mm black thermoplastic		

			
1			
GEV No.	540016	Ref. No.	0K1865 240061
description	aerator and air bleeder thread 1/2" IT chrome-plated L 78mm		
spare parts for	540016		
		GEV No.	112777
		Ref. No.	—
	star handle shaft 6x6mm ø 50mm L 18mm black plastic		
		GEV No.	540365
		Ref. No.	0H6468
	star handle shaft 6x6mm ø 50mm L 18mm black thermoplastic		

steam valves



1

GEV No.	540013	Ref. No.	0G3246
description	aerator and air bleeder thread 3/8" ET WS 27 chrome-plated L 86mm		
spare parts for	540013		
	GEV No.	112777	Ref. No. —
	star handle shaft 6x6mm ø 50mm L 18mm black plastic		
	GEV No.	540365	Ref. No. 0H6468
	star handle shaft 6x6mm ø 50mm L 18mm black thermoplastic		

spare parts



1

GEV No.	540365	Ref. No.	0H6468
description	star handle shaft 6x6mm ø 50mm L 18mm black thermoplastic		



1

GEV No.	540949	Ref. No.	0H9729
description	aerator and air bleeder thread 1/2" ET chrome-plated with O-ring L 15mm ø 25mm		







1

GEV No.	540826	Ref. No.	0KC081
description	aerator and air bleeder thread 1/2" ET WS 24 chrome-plated brass L 30mm		



1

GEV No.	541542	Ref. No.	0KD952
description	steam valve straight connection 1" IT total length 90mm H 140mm brass		
spare parts for	541542		
	GEV No.	540229	Ref. No. —
	star handle shaft 9x9mm ø 80mm L 23mm black thermoplastic		
	GEV No.	541546	Ref. No. —
	screw chrome-plated brass thread M5 thread L 10mm		
	GEV No.	541548	Ref. No. —
	gasket PTFE ID ø 15mm H 7mm for thread 1 1/4" ED ø 35mm		
	GEV No.	541554	Ref. No. —
	gasket copper ext. ø 49 ID ø 42mm H 2mm for thread 1 1/4"		
	GEV No.	541557	Ref. No. —
	tap head chrome-plated thread 1 1/4" for steam tap 1"		

lid hinges

type ECHTERMANN

10 series

10.61

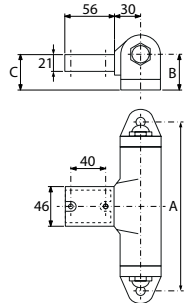
1

GEV No.	693241	Ref. No.	0K2589
description	lid hinge type 6910.61 level of centre of rotation 35mm load capacity 20-30NM opening angle 60° closing angle 10° mounting distance 198mm square pipe 50x25x2mm		
spare parts for	693241		
	GEV No.	691612	Ref. No. —
	repair kit for lid hinge load capacity 20-30NM		

1

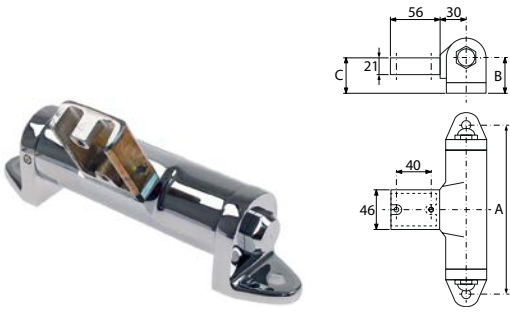
GEV No.	693242	Ref. No.	OK2590
description	lid hinge type 6910.61 level of centre of rotation 35mm load capacity 30-50NM opening angle 60° closing angle 10° mounting distance 198mm bore ø 11mm chrome-plated square pipe 50x25x2mm		
spare parts for	693242		
	GEV No.	Ref. No.	—
	691613		
	repair kit for lid hinge load capacity 30-50NM		

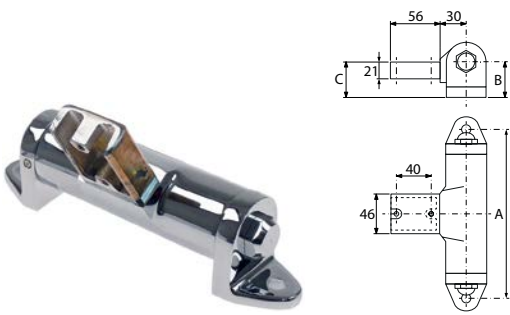

1

GEV No.	691265	Ref. No.	OK2571
description	lid hinge type 6910.61 level of centre of rotation 35mm load capacity 50-60NM opening angle 55° mounting distance 198mm chrome-plated square pipe 50x25x2mm		
spare parts for	691265		
	GEV No.	Ref. No.	—
	691614		
	repair kit for lid hinge load capacity 50-60NM		

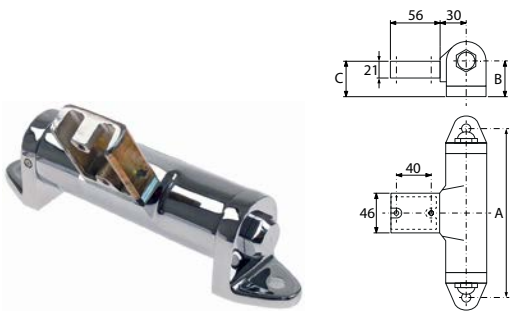

1

GEV No.	693246	Ref. No.	OK2591
description	lid hinge type 6910.61 level of centre of rotation 35mm load capacity 50-60NM opening angle 60° closing angle 10° mounting distance 198mm bore ø 11mm square pipe 50x25x2mm		
spare parts for	693246		
	GEV No.	Ref. No.	—
	691614		
	repair kit for lid hinge load capacity 50-60NM		

10.62

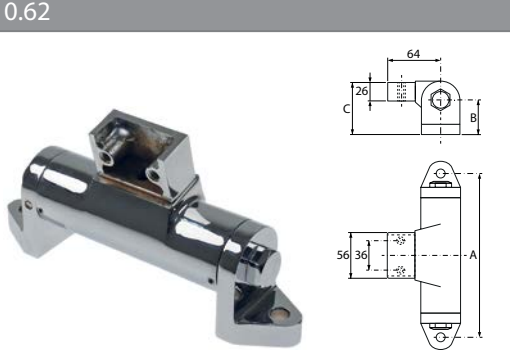

1

GEV No.	693245	Ref. No.	OK2593
description	lid hinge type 10.62 level of centre of rotation 45mm load capacity 50-60NM opening angle 75° mounting distance 198mm bore ø 11mm chrome-plated		
spare parts for	693245		
	GEV No.	Ref. No.	—
	691614		
	repair kit for lid hinge load capacity 50-60NM		

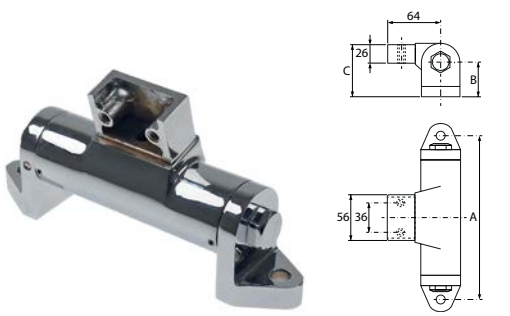

1

GEV No.	693234	Ref. No.	OK2587
description	lid hinge type 1062 level of centre of rotation 45mm load capacity 10-20NM opening angle 75° closing angle 10° mounting distance 198mm bore ø 11mm MD lid 36mm chrome-plated brass		
spare parts for	693234		
	GEV No.	Ref. No.	—
	691611		
	repair kit for lid hinge load capacity 10-20NM		

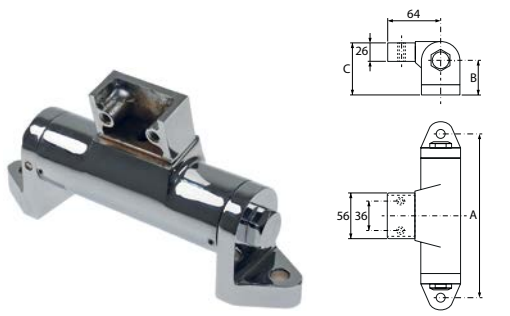

1

GEV No.	693235	Ref. No.	OH6887
description	lid hinge type 1062 level of centre of rotation 45mm load capacity 20-30NM opening angle 75° closing angle 10° mounting distance 198mm bore ø 11mm MD lid 36mm chrome-plated brass		
spare parts for	693235		
	GEV No.	Ref. No.	—
	691612		
	repair kit for lid hinge load capacity 20-30NM		

1

GEV No.	693237	Ref. No.	OK2588
description	lid hinge type 1062 level of centre of rotation 45mm load capacity 30-50NM opening angle 75° closing angle 10° mounting distance 198mm bore ø 11mm MD lid 36mm chrome-plated brass		
spare parts for	693237		
	GEV No.	691613	Ref. No. —
repair kit for lid hinge load capacity 30-50NM			

1

GEV No.	693240	Ref. No.	OK2586
description	lid hinge type 1062 level of centre of rotation 45mm load capacity up to 10NM opening angle 75° MT lid M8mm chrome-plated square pipe 60x30x2mm hole distance 198mm		
spare parts for	693240		
	GEV No.	691610	Ref. No. —
repair kit for lid hinge load capacity 10NM			

10.86

1

GEV No.	693236	Ref. No.	OK2585
description	lid hinge type 6910.86 level of centre of rotation 40mm load capacity 20-30NM opening angle 75° closing angle 10° mounting distance 198mm bore ø 11mm MD lid 100mm chrome-plated brass		
spare parts for	693236		
	GEV No.	691612	Ref. No. —
repair kit for lid hinge load capacity 20-30NM			

1

GEV No.	693238	Ref. No.	OK2594
description	lid hinge type 6910.86 level of centre of rotation 65mm load capacity 20-30NM opening angle 75° closing angle 10° mounting distance 198mm bore ø 11mm MD lid 100mm chrome-plated brass		
spare parts for	693238		
	GEV No.	691612	Ref. No. —
repair kit for lid hinge load capacity 20-30NM			

1

GEV No.	693239	Ref. No.	OK2595
description	lid hinge type 6910.86 level of centre of rotation 65mm load capacity 30-50NM opening angle 75° closing angle 10° mounting distance 198mm bore ø 11mm MD lid 100mm chrome-plated brass		
spare parts for	693239		
	GEV No.	691613	Ref. No. —
repair kit for lid hinge load capacity 30-50NM			

ELECTROLUX

spare parts

1

GEV No.	693299	Ref. No.	052894
description	torsion spring ø 28.6mm L2 103mm wire gauge ø 3.6mm L1 45mm		

drain taps

accessories

1

GEV No.	540082	Ref. No.	OK2137
description	handle for drain tap L 110mm		

1

GEV No.	540119	Ref. No.	0K3046
description	O-ring EPDM thickness 2.5mm ID ø 59mm Qty 1 pcs		



1

GEV No.	540222	Ref. No.	053809
description	O-ring EPDM thickness 2.62mm ID ø 47.3mm Qty 1 pcs		



1

GEV No.	540083	Ref. No.	0K1469
description	pressure bolt for drain tap		

steam traps

steam traps



1

GEV No.	541356	Ref. No.	0H6413
description	thermostatic steam trap thread 1/2" 60-100°C type ST 1730		

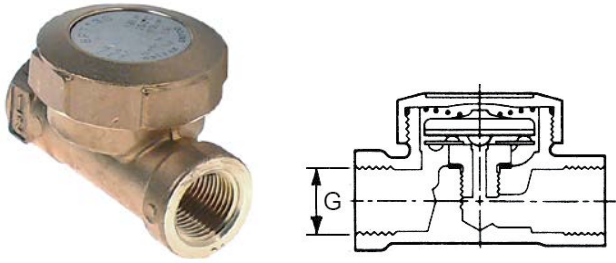

1

GEV No.	541461	Ref. No.	0K5388
description	thermostatic steam trap thread 1/2" type BPT13S brass		

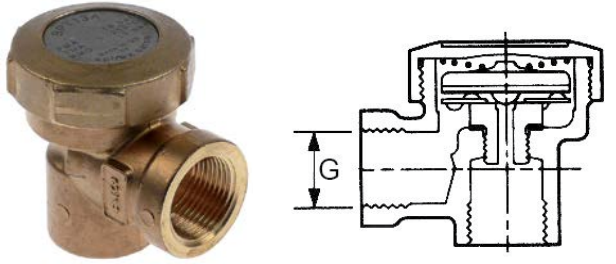

1

GEV No.	540994	Ref. No.	0H6537	
description	thermostatic steam trap thread 3/4" type BPT13A brass			
spare parts for	540994			
	GEV No.	540219	Ref. No.	—
	repair kit thread 1/2" -3/4" type BPT13			

safety valves



1

GEV No.	541357	Ref. No.	0H6302
description	safety valve		



1

GEV No.	541458	Ref. No.	0K5784
description	safety valve T1: 1/2" T2: 1/2" triggering pressure 1.3bar		

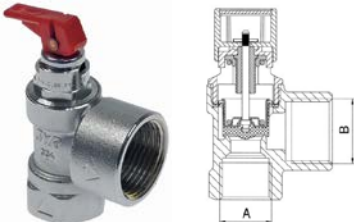

1

GEV No.	540915	Ref. No.	0H6534
description	safety valve T1: 3/4" T2: 1" triggering pressure 1.1bar 6104 R		



1

GEV No.	514376	Ref. No.	0H6434
description	safety valve triggering pressure 1bar thread 1"-3/4"		

filters

grease filters

grease filter



GEV No.	970602	Ref. No.	0H7138
description	grease filter W 520mm H 465mm thickness 20mm SS outer grids 2 inner grids 3 for range hoods		

crumb screens



GEV No.	970728	Ref. No.	241203
description	crumb screen L 338mm W 194mm H 180mm suitable for ELECTROLUX for fryer		

baskets

fryer baskets

JUNO



GEV No.	970150	Ref. No.	0H5970
description	fryer basket L1 300mm W1 180mm H1 130mm		



GEV No.	970151	Ref. No.	0H5971
description	fryer basket L1 320mm W1 180mm H1 210mm		



GEV No.	970410	Ref. No.	0G2206
description	fryer basket L1 325mm W1 225mm H1 90mm chrome-plated steel		



GEV No.	970149	Ref. No.	0K1946
description	fryer basket L1 340mm W1 310mm H1 125mm		

shelves and shelf rails

grid attachments



GEV No.	690806	Ref. No.	082317
description	rack support L 540mm H 26mm W 17.5mm plastic suitable for ELECTROLUX, ZANUSSI		

gaskets

gaskets for heated units

window seals

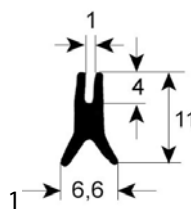

GEV No.	900752	Ref. No.	0K2281
description	window gasket profile 1550 Qty 3m		

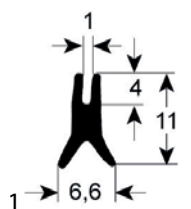

GEV No.	900591	Ref. No.	0H6761
description	window gasket profile 1550 Wmm L 3000mm		

1			
GEV No.	900144	Ref. No.	0H6828
description	window gasket profile 1790 Qty supplied by meter		

1			
GEV No.	900036	Ref. No.	0H6663
description	window gasket profile 1800 Qty supplied by meter		

1			
GEV No.	900154	Ref. No.	OK2079
description	window gasket profile 1840 perimeter 1700mm Qty 1		

1			
GEV No.	900176	Ref. No.	OK2081
description	window gasket profile 1840 perimeter 2000mm Qty 1		

1			
GEV No.	900175	Ref. No.	OK2080
description	window gasket profile 1840 perimeter 2100mm Qty 1		

1			
GEV No.	900155	Ref. No.	OK2082
description	window gasket profile 1841 perimeter 1700mm Qty 1		

1			
GEV No.	900181	Ref. No.	0H6637
description	window gasket profile 1841 perimeter 2000mm Qty 1		

1			
GEV No.	900180	Ref. No.	0H6636
description	window gasket profile 1841 perimeter 2200mm Qty 1		

1			
GEV No.	900185	Ref. No.	002837
description	window gasket profile 1875 perimeter 1500mm Qty 1		

1			
GEV No.	900186	Ref. No.	002878
description	window gasket profile 1875 perimeter 2000mm Qty 1		

door seals

1			
GEV No.	900499	Ref. No.	0H6854 268187
description	door seal		

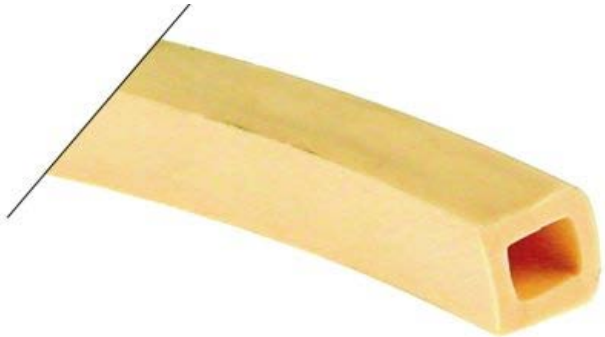

1

GEV No.	900593	Ref. No.	0H7007
description	door seal L 1000mm		



1

GEV No.	900582	Ref. No.	0H6855
description	door seal L 495mm		

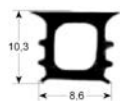

1

GEV No.	900037	Ref. No.	0H6976
description	door seal profile 2020 Qty supplied by meter		



1

GEV No.	900044	Ref. No.	0H6655
description	door seal profile 2030 W 414mm L 620mm external size Qty 1		



1

GEV No.	900042 ¹	Ref. No.	0H6653
description	door seal profile 2030 W 414mm L 620mm external size Qty 1 long side open		

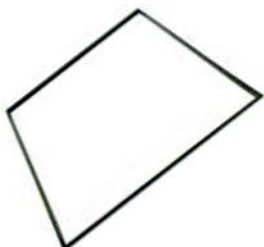

1

GEV No.	900588	Ref. No.	0H6973
description	door seal profile 2030 W 428mm L 431mm external size Qty 1		



1

GEV No.	900045	Ref. No.	0H6656
description	door seal profile 2030 W 620mm L 699mm external size Qty 1		



1

GEV No.	900041 ¹	Ref. No.	0H6654
description	door seal profile 2030 W 620mm L 699mm external size Qty 1 short side open		

¹3-sided (short side open)

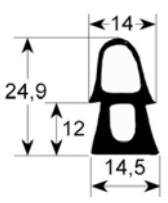

1

GEV No.	900152	Ref. No.	0K2083
description	door seal profile 2445 W 430mm L 630mm external size Qty 1		



1

GEV No.	900586 ¹	Ref. No.	0K1832
description	door seal profile 2445 W 445mm L 630mm external size Qty 1		

¹3-sided (long side open)

¹3-sided (long side open)



1			
GEV No.	900587 ¹	Ref. No.	OK1833
description	door seal profile 2445 W 620mm L 715mm external size Qty 1		

¹3-sided (short side open)

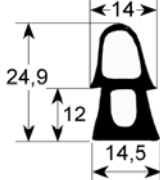

1			
GEV No.	900153	Ref. No.	OG2086
description	door seal profile 2445 W 630mm L 735mm external size Qty 1		

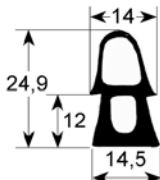

1			
GEV No.	900170	Ref. No.	0H6641
description	door seal profile 2445 W 650mm L 1350mm external size Qty 1		

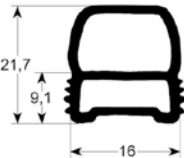

1			
GEV No.	900040	Ref. No.	0H6657
description	door seal profile 2447 W 627mm L 1321mm external size Qty 1		

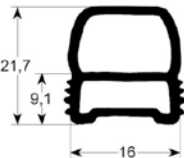

1			
GEV No.	900039	Ref. No.	0H6660
description	door seal profile 2447 W 777mm L 1321mm external size Qty 1		

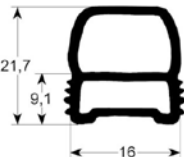

1			
GEV No.	900043	Ref. No.	0H6659
description	door seal profile 2447 W 777mm L 861mm external size Qty 1		

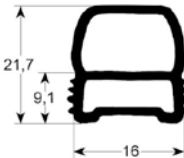

1			
GEV No.	900589	Ref. No.	0H6658
description	door seal profile 2447 W 800mm L 880mm external size Qty 1		



1			
GEV No.	900496	Ref. No.	0700268258
description	door seal profile 2447 W 810mm L 900mm		

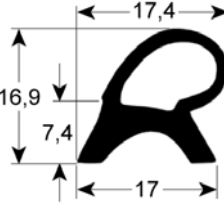

1			
GEV No.	900188	Ref. No.	055315
description	door seal profile 2450 W 640mm H 720mm external size Qty 1 suitable for ELECTROLUX 640x720		

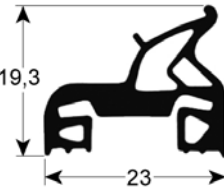

1			
GEV No.	900433	Ref. No.	005713
description	door seal profile 2520 W 430mm L 635mm external size Qty 1 suitable for ELECTROLUX, JUNO, ZANUSSI 635x430		

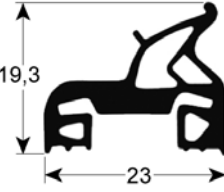

1			
GEV No.	900161	Ref. No.	005705
description	door seal profile 2520 W 640mm L 1400mm external size Qty 1 suitable for ELECTROLUX 640x1400		

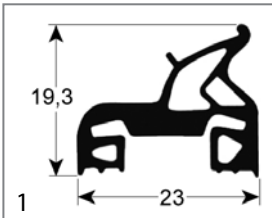

GEV No.	900590	Ref. No.	005706
description	door seal profile 2520 W 640mm L 730mm external size Qty 1 suitable for ELECTROLUX 640x730		

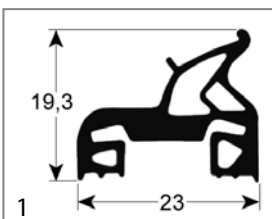

GEV No.	900160	Ref. No.	005712
description	door seal profile 2520 W 655mm L 725mm external size Qty 1 suitable for ELECTROLUX		

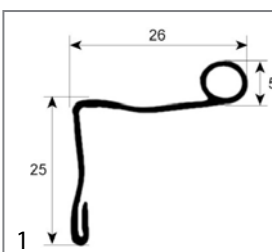

GEV No.	900047	Ref. No.	0H6768
description	door seal profile 2924 W 50mm L 570mm external size Qty 1 mounting pos. upper		

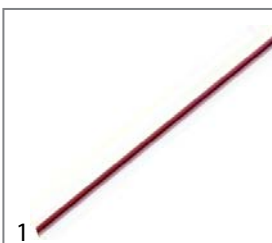

GEV No.	900516	Ref. No.	unbekannt
description	door seal profile 2940 Qty supplied by meter		

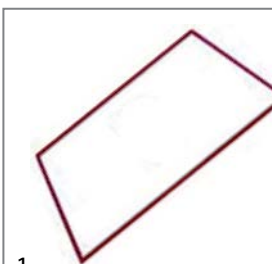

GEV No.	900148	Ref. No.	0T3708
description	door seal profile 2940 W 430mm L 600mm external size Qty 1		

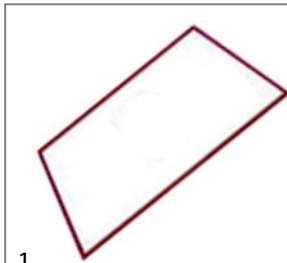

GEV No.	900145	Ref. No.	003384
description	door seal profile 2940 W 600mm L 670mm external size Qty 1		



GEV No.	900146 ¹	Ref. No.	0H6516
description	door seal profile 2940 W 600mm L 670mm external size Qty 1		

¹3-sided (long side open)

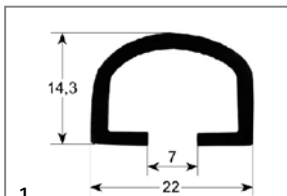

GEV No.	900038	Ref. No.	0H6986
description	door seal profile 2945 W 605mm L 1310mm external size Qty 1		

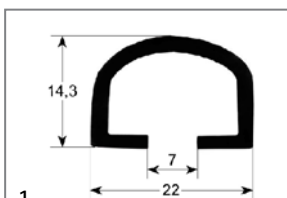

GEV No.	900149	Ref. No.	0H6865
description	door seal profile 2945 W 905mm L 1370mm external size Qty 1		



GEV No.	900147	Ref. No.	0H6760
description	door seal profile 2950 Qty supplied by meter		

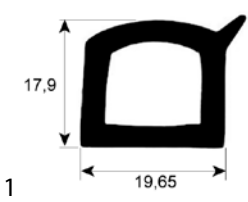

GEV No.	900051	Ref. No.	0H6767
description	door seal profile 2955 Qty supplied by meter		



GEV No.	900583	Ref. No.	0H6975
description	door seal W 435mm L 660mm		

door seals with tension springs

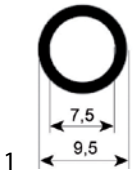

GEV No.	900046	Ref. No.	0H6762
description	oven gasket profile 2958 L 290mm Qty 1 mounting pos. lateral		



GEV No.	690003	Ref. No.	0H6606
description	spring L 310mm for gasket mounting pos. lateral		

gaskets for tray rack trolleys

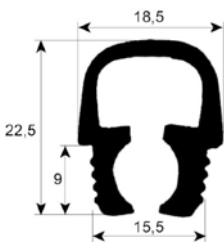

GEV No.	900150	Ref. No.	0H6661
description	tray rack trolley gasket profile 4040 L 510mm Qty 1		

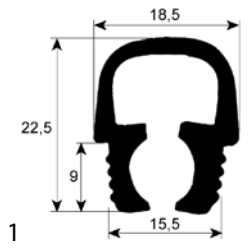

GEV No.	900592	Ref. No.	0H6662
description	tray rack trolley gasket profile 4040 L 658mm Qty 1		



GEV No.	900495	Ref. No.	0H6985
description	tray rack trolley gasket profile 4045 L 460mm Qty 1		

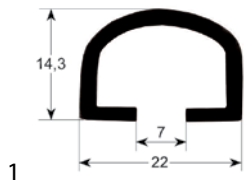

GEV No.	900584	Ref. No.	0H6866
description	tray rack trolley gasket profile 4045 L 900mm Qty 1		

boiling pan gaskets

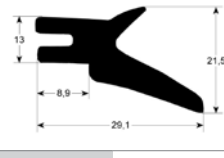

GEV No.	693249	Ref. No.	0H6980
description	boiling pan gasket profile 3030 L 770mm W 690mm suitable for JUNO		

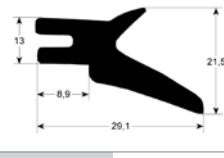

GEV No.	693248	Ref. No.	0K2806
description	boiling pan gasket profile 3030 suitable for JUNO		



GEV No.	693251	Ref. No.	0H6982
description	boiling pan gasket profile 3030 suitable for JUNO		



GEV No.	900609	Ref. No.	0K5574
description	door seal profile 3030 ø 430mm		

O-rings

EPDM

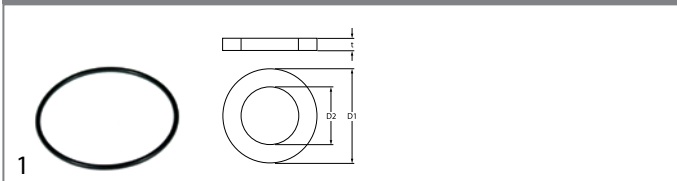

GEV No.	540119	Ref. No.	0K3046
description	O-ring EPDM thickness 2.5mm ID ø 59mm Qty 1 pcs		

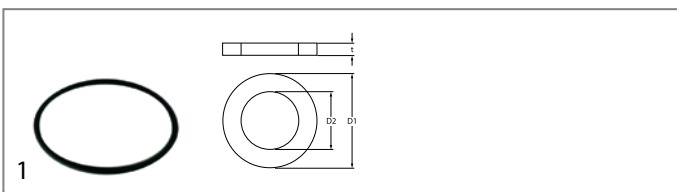

GEV No.	540222	Ref. No.	053809
description	O-ring EPDM thickness 2.62mm ID ø 47.3mm Qty 1 pcs		

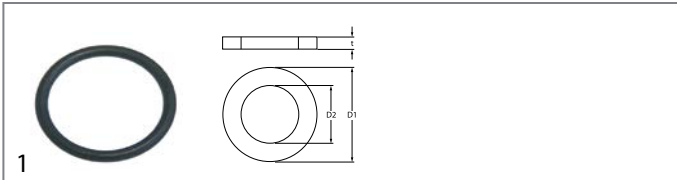

GEV No.	510408	Ref. No.	067620
description	O-ring EPDM thickness 5.34mm ID ø 47mm Qty 1 pcs		

silicone

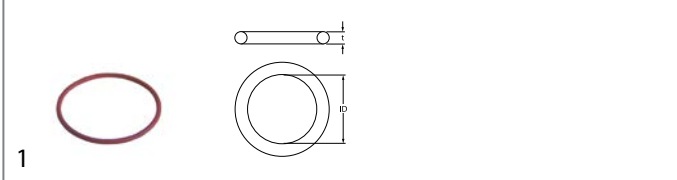

GEV No.	510561	Ref. No.	0H7021
description	O-ring silicone thickness 3mm ID ø 55mm Qty 1 pcs		

Viton

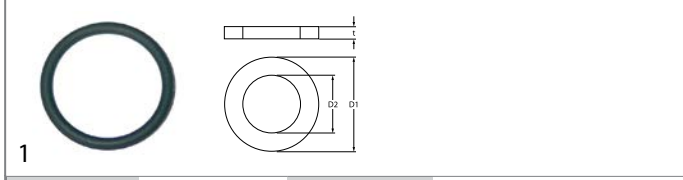

GEV No.	511300	Ref. No.	002873
description	O-ring Viton thickness 3.53mm ID ø 28.17mm for 57 series for motor shaft		

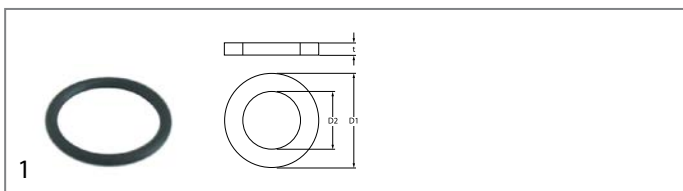

GEV No.	528412	Ref. No.	002874
description	O-ring Viton thickness 3.53mm ID ø 31.34mm Qty 1 pcs		

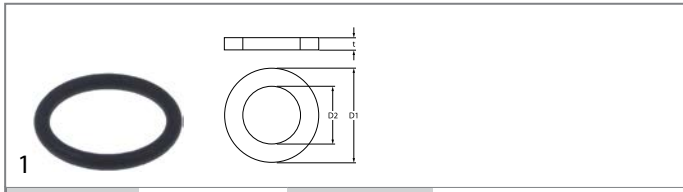

GEV No.	550530	Ref. No.	055323
description	O-ring Viton thickness 5.34mm ID ø 37.8mm Qty 1 pcs		

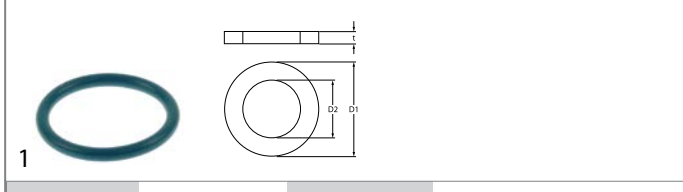

GEV No.	103007	Ref. No.	0H6863
description	O-ring Viton thickness 5mm ID ø 42.5mm Qty 1 pcs		

sealing washers

rubber gaskets

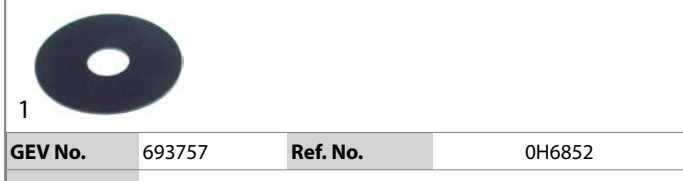

GEV No.	693757	Ref. No.	0H6852
description	flat gasket rubber ED ø 60mm ID ø 17mm thickness 1.5mm Qty 1 pcs		

PTFE gaskets



GEV No.	693745	Ref. No.	002624
description	gasket PTFE ED ø 20mm ID ø 15mm thickness 1mm Qty 1 pcs		

sealing cords

square



GEV No.	693739	Ref. No.	058404
description	sealing cord square size 12x12mm t.max. 550°C braided L 5m		

round



GEV No.	691362	Ref. No.	0K3197
description	sealing cord round ϕ 6mm t.max. 550°C braided L 5m Qty 1		

shaft gaskets

shaft gaskets



GEV No.	693747	Ref. No.	0H6857
description	shaft sealing		

miscellaneous



GEV No.	511301	Ref. No.	002699
description	shaft seal ID ϕ 16mm ED ϕ 38mm thickness 18mm		



GEV No.	511905	Ref. No.	0H6853 268134
description	shaft seal ID ϕ 23mm ED ϕ 58mm thickness 22mm		

special gaskets

miscellaneous



GEV No.	693402	Ref. No.	002706
description	boiler gasket		



GEV No.	550916	Ref. No.	0H6666
description	gasket		



GEV No.	693396	Ref. No.	057402
description	gasket level glass L 30mm W 30mm thickness 0.8mm equiv. no. 250617 suitable for JUNO		

accessories for	693396		
GEV No.	693398	Ref. No.	057382
description	frame for level glass		



GEV No.	693403	Ref. No.	003874
description	gasket suitable for ZANUSSI hot air		

miscellaneous



GEV No.	900757	Ref. No.	0K2603
description	strengthening for gasket		



GEV No.	700023	Ref. No.	0H6608
description	torsion spring \varnothing 18.2mm L2 150mm wire gauge \varnothing 3.2mm mounting pos. left L1 100mm L3 24mm		



GEV No.	700022	Ref. No.	0H6607 245663
description	torsion spring \varnothing 18.6mm L2 93mm wire gauge \varnothing 3.4mm mounting pos. right L1 133mm L3 24mm		

springs

torsion springs

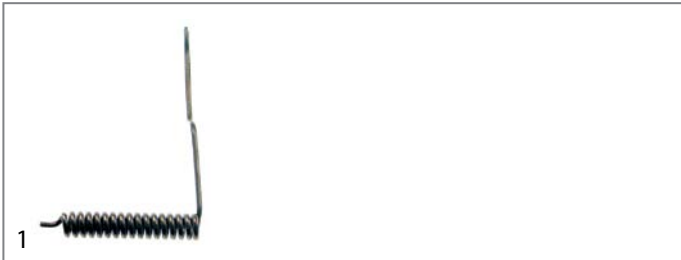

GEV No.	700426	Ref. No.	0H6915
description	torsion spring \varnothing 12.9mm L2 64mm wire gauge \varnothing 2.6mm mounting pos. right L1 100mm L3 11mm		

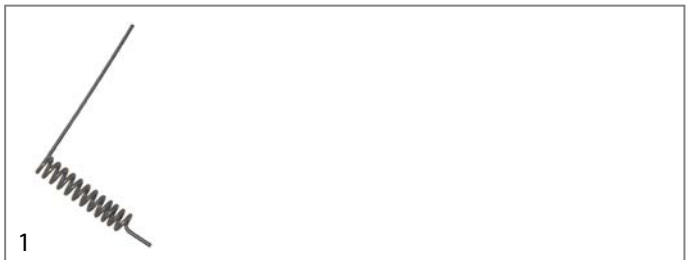

GEV No.	700027	Ref. No.	0K2680
description	torsion spring \varnothing 19.2mm L2 86mm wire gauge \varnothing 3.8mm mounting pos. left L1 131mm L3 26mm		



GEV No.	700427	Ref. No.	0H6914
description	torsion spring \varnothing 13mm L2 64mm wire gauge \varnothing 2.7mm mounting pos. left L1 101mm L3 9mm		

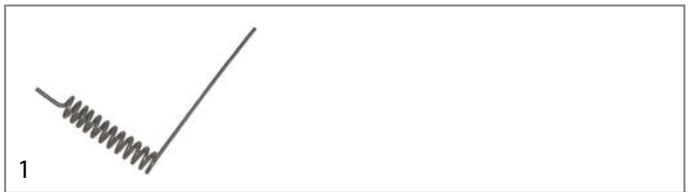

GEV No.	700026	Ref. No.	0K2679 279449
description	torsion spring \varnothing 19mm L2 88mm wire gauge \varnothing 3.4mm mounting pos. right L1 132mm L3 26mm		

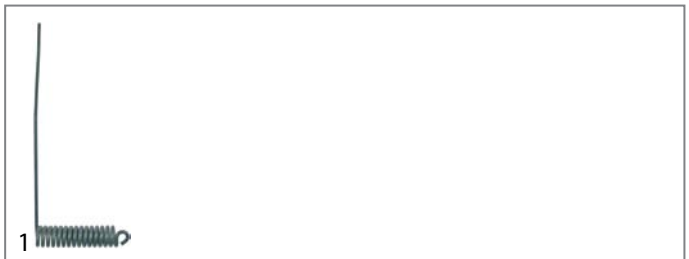

GEV No.	690880	Ref. No.	0KL682
description	torsion spring \varnothing 20.9mm L2 75mm wire gauge \varnothing 3.7mm L1 200mm L3 20mm		

 <p>1</p>			
GEV No.	693299	Ref. No.	052894
description	torsion spring ø 28.6mm L2 103mm wire gauge ø 3.6mm L1 45mm		

 <p>1</p>			
GEV No.	690879	Ref. No.	0K2675
description	torsion spring ø 43mm L2 117mm wire gauge ø 7.2mm L1 80mm L3 18mm		

miscellaneous

 <p>1</p>			
GEV No.	691220	Ref. No.	053342
description	spring clip shaft diameter 6mm ømm L 17mm W 14mm H 5mm wire gauge ø 1.5mm		

tension springs

 <p>1</p>			
GEV No.	540916	Ref. No.	0K1647
description	tension spring		

 <p>1</p>			
GEV No.	540918	Ref. No.	0K2685
description	tension spring		

 <p>1</p>			
GEV No.	540919	Ref. No.	0K2686
description	tension spring		

 <p>1</p>			
GEV No.	700418	Ref. No.	0G1777 279268
description	tension spring for double-wall lid		

 <p>1</p>			
GEV No.	700419	Ref. No.	0G1778 279258
description	tension spring for double-wall lid		

 <p>1</p>			
GEV No.	700414	Ref. No.	0K2703
description	tension spring for single-wall lid		

 <p>1</p>			
GEV No.	700415	Ref. No.	0H6903
description	tension spring for single-wall lid		

 <p>1</p>			
GEV No.	700416	Ref. No.	0G1779
description	tension spring for single-wall lid		

 <p>1</p>			
GEV No.	700417	Ref. No.	0H6918
description	tension spring for single-wall lid		

 <p>1</p>			
GEV No.	540859	Ref. No.	0K2682
description	tension spring ø 25mm total length 274mm wire gauge ø 4.1mm		

 <p>1</p>			
GEV No.	700413	Ref. No.	0K2039
description	tension spring ø 29mm total length 210mm wire gauge ø 4.1mm		

 <p>1</p>			
GEV No.	540858	Ref. No.	0K2683
description	tension spring ø 34.4mm total length 285mm wire gauge ø 5.3mm		

manometers

			
1			
GEV No.	541365	Ref. No.	0H6500
description	manometer ø 100mm pressure range 0 up to 1.6bar thread 1/2" marking 0.40 bar		

			
1			
GEV No.	541579	Ref. No.	017055
description	manometer ø 52mm pressure range 0 up to 1bar connection marking 0.5 thread 1/4"		

			
1			
GEV No.	541337	Ref. No.	0H6495
description	manometer ø 60mm pressure range -1.5 up to +1.5bar connection on the backside marking 1.1 thread 1/4"		

			
1			
GEV No.	541355	Ref. No.	0H6486
description	manometer ø 63mm pressure range 0 up to 1.6bar connection on the backside marking 1 thread 1/4"		

			
1			
GEV No.	541336	Ref. No.	0K1796 236110
description	manometer ø 63mm pressure range 0 up to 1bar thread 1/4"		

			
1			
GEV No.	541460	Ref. No.	0K5402
description	manometer pressure range 0 up to 2.5bar marking 1.3		

hose reels and spray guns



spray guns

			
1			
GEV No.	542038	Ref. No.	003175
description	spray gun for appliances 3/8" IT L 135mm		

hoses

supply hoses

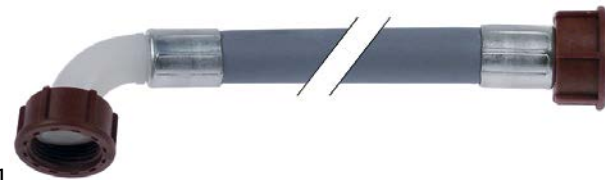
PVC supply hoses

				
1				
GEV No.	520010	Ref. No.	0C5562	
description	supply hose PVC straight-curved DN13 connections 3/4" L 1500mm operating p. 10bar burst p. 32bar t.max. 90°C blue approval VDE flat seal			
accessories for	520010			
	GEV No.	520053	Ref. No.	—
	screen connection 3/4" D1 ø 26mm D2 ø 15mm Qty 10 pcs rubber thickness 8mm			
	GEV No.	520054	Ref. No.	—
	flat gasket rubber ED ø 23.5mm ID ø 14mm thickness 2.3mm Qty 10 pcs			

industrial hoses

Niplaflex hoses

			
1			
GEV No.	530561	Ref. No.	0C4158
description	pressure hose ID ø 10mm ED ø 17mm L 5m thickness 3.5mm operating p. 10bar burst p. 30bar t.max. 110°C		



pressure hoses (other)

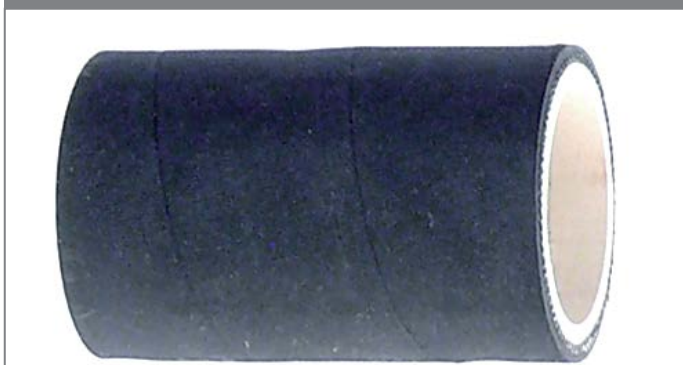

1

GEV No.	530601	Ref. No.	OK2454
description	pressure hose ID ø 40mm ED ø 52mm thickness 6mm L 80mm		

fittings, hose and pipe connectors

hose connectors

without screw connection



1

GEV No.	501210	Ref. No.	047431
description	Y-piece plastic hose ø 10-10-10mm		

valves and tank inlets

ball valves

universal

mini ball valves

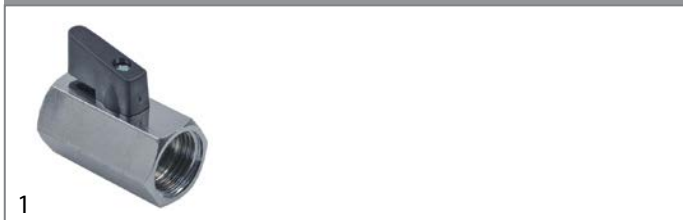

1

GEV No.	520296	Ref. No.	231201
description	ball valve connection 1/2" IT - 1/2" IT DN10 total length 47mm chrome-plated brass		
accessories for	520296		
	GEV No.	515040	Ref. No.
			—
description	drain fitting size 1/2" usable heightmm overall height 16mm ED ø 28mm chrome-plated brass		

ball valves with butterfly handle

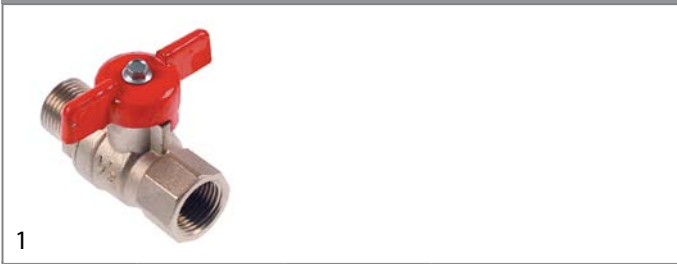

1

GEV No.	520726	Ref. No.	OK1391
description	ball valve connection 1/2" IT - 1/2" ET DN15 total length 56mm		

ball valves with lever handle



1

GEV No.	520282	Ref. No.	004729
description	ball valve connection 1" IT - 1" IT DN25 total length 67mm with lever handle		



1

GEV No.	520280	Ref. No.	0H6385 231205
description	ball valve connection 1/2" IT - 1/2" IT DN15 total length 50mm with lever handle handle length 85mm		

ball valves electric



1

GEV No.	401140	Ref. No.	005026
description	ball valve inlet 1" IT outlet 1" IT with plug 230V L 152mm 50/60Hz closed off-current mode of operation electric connection cable 200mm size DN25		



1

GEV No.	401139	Ref. No.	0C0882
description	ball valve inlet 3/4" IT outlet 3/4" IT with plug 230V L 65mm 50/60Hz closed off-current mode of operation electric connection cable 200mm		

steam valves



1

GEV No.	541542	Ref. No.	OKD952	
description	steam valve straight connection 1" IT total length 90mm H 140mm brass			
spare parts for	541542			
	GEV No.	540229	Ref. No.	—
	star handle shaft 9x9mm ø 80mm L 23mm black thermoplastic			
	GEV No.	541546	Ref. No.	—
	screw chrome-plated brass thread M5 thread L 10mm			
	GEV No.	541548	Ref. No.	—
	gasket PTFE ID ø 15mm H 7mm for thread 1 1/4" ED ø 35mm			
	GEV No.	541554	Ref. No.	—
	gasket copper ext. ø 49 ID ø 42mm H 2mm for thread 1 1/4"			
	GEV No.	541557	Ref. No.	—
	tap head chrome-plated thread 1 1/4" for steam tap 1"			

drain systems and wash basins

HT drain pipes

rubber sleeves



1

GEV No.	515085	Ref. No.	0H6650 246238
description	rubber sleeve suitable for high temperature pipe ED ø 40mm ID ø 20-32mm		

ancillary products

fitting greases



1

GEV No.	890116	Ref. No.	0G1994 400191
description	fitting grease FERMIT GLISSA tube 60g -20 up to +140°C approval complies with KTW recommendation		
description	<p>Fermit GLISSA - tube 60g</p> <p>Non-dripping lubricating grease for hot and cold water valves and fittings</p> <p>Ductile, smooth, non-dripping lubricating grease for valves and fittings, that with regard to food law is beyond reproach and is therefore also suitable for drinking water pipes. Can also be used for machines and equipment where Glissa valve and fitting grease comes into contact with food or drinking water.</p> <p>Temperature range: -20°C to +140°C</p> <p>Approved by NSF-H 1 and DIN 51502</p>		

clamps

hose clamps

DIN 3017 - W2



1

GEV No.	520112	Ref. No.	048126
description	hose clamp ø 12-20mm width 9mm Qty 10 pcs DIN 3017		



fastening material

nuts

hexagonal nuts

hexagonal nuts metric (without norm)



1

GEV No. 101345 **Ref. No.** 020997

description nut thread M15x1 H 3mm WS 19 brass Qty 1 pcs



1

GEV No. 693430 **Ref. No.** 051263

description nut thread M22x1.5 H 5mm WS 26 zinc-coated steel Qty 1 pcs

washers

washers

miscellaneous



1

GEV No. 693431 **Ref. No.** 002727

description plain washer



1

GEV No. 690844 **Ref. No.** 056416

description plain washer plastic

fasteners

clamps

hose clamps

DIN 3017 - W2



1

GEV No. 520112 **Ref. No.** 048126

description hose clamp ø 12-20mm width 9mm Qty 10 pcs DIN 3017

cable clamps



1

GEV No. 693247 **Ref. No.** 0K0194

description cable clamp wire gauge ø 5mm

retaining rings

DIN 6799



1

GEV No. 507015 **Ref. No.** 068293
0H6035
117584

description retaining ring E D1 ø 7mm D2 ø 14mm SS DIN 6799 thickness 0.9mm for shaft ø 8-11mm

roll pins



1

GEV No. 692013 **Ref. No.** 0H6043
159510

description roll pin ø 3mm L 16mm

consumables

sealants and adhesives

high temperature silicone



1

GEV No. 890059 **Ref. No.** 0G1878

description high temperature silicone FERMITOPP 300 neutral curing -40 up to +265°C black cartridge 310ml

description Fermittopp HN 300 - cartridge 310ml - black
Is used for sealing expansion joints on heating flues, ovens, reactors, chimneys, stacks, etc. The sealant is neutrally cross-linking, reacts with the moisture in the air and is characterised by extremely good hot air-resistance. The adhesive surfaces must be dry, clean and free of loose parts and in the case of porous substrates they should, if necessary, be given a first coat of primer. Post-smoothing e.g. with soap solution must take place before skinning.
Highly refractory, odourless, UV/water/colour/hot-air resistant
Temperature range -50°C to +250°C

lubricants

fitting greases



1			
GEV No.	890116	Ref. No.	OG1994 400191
description	fitting grease FERMIT GLISSA tube 60g -20 up to +140°C approval complies with KTW recommendation		
description	<p>Fermit GLISSA - tube 60g Non-dripping lubricating grease for hot and cold water valves and fittings</p> <p>Ductile, smooth, non-dripping lubricating grease for valves and fittings, that with regard to food law is beyond reproach and is therefore also suitable for drinking water pipes. Can also be used for machines and equipment where Glissa valve and fitting grease comes into contact with food or drinking water.</p> <p>Temperature range: -20°C to +140°C Approved by NSF-H 1 and DIN 51502</p>		

silicone fats



1			
GEV No.	890101	Ref. No.	0H7004
description	silicone grease FERMIT GLISSA tube 60g -40 to +200°C approval		
description	<p>Fermit GLISSA - tube 60g Non-drip lubricating grease for drinking water valves and fittings Glissa silicone grease is suitable as a lubricant and sealant for drinking water valves and fittings (e.g. cartridges of single-lever mixers, switching valves and swivel spouts). Water-repellent, physiologically safe, sealing and has a high temperature resistance up to 200°C. Complies with the guidelines of the UBA for sanitary lubricants, tested by TZW for suitability for drinking water and approved in accordance with DIN ISO 21469. Temperature range: -40°C to +200°C</p>		

fuses

fine fuses



1			
GEV No.	358610	Ref. No.	058869
description	fine fuse size ø5x20mm 10A fast-acting rated 250V Qty 10 pcs		



1			
GEV No.	358611	Ref. No.	005136
description	fine fuse size ø5x20mm 16A fast-acting rated 250V Qty 10 pcs		



1			
GEV No.	358695	Ref. No.	005032
description	fine fuse size ø5x20mm 3.15A medium lag rated 250V Qty 10 pcs		



1			
GEV No.	358594	Ref. No.	002820
description	fine fuse size ø5x20mm 0.16A slow-acting rated 250V Qty 10 pcs		



1			
GEV No.	358596	Ref. No.	002920
description	fine fuse size ø5x20mm 0.25A slow-acting rated 250V Qty 10 pcs		

fine fuse holders



1			
GEV No.	358394	Ref. No.	0H6523
description	fuse holder suitable fuse ø5x30mm mounting ø 18.3mm 6.3A rated 500V connection F2.8		



1			
GEV No.	358395	Ref. No.	0H6526
description	screw cap suitable fuse ø 14.5mm mounting ømm thread M9x1 6.3A rated 250V connection suitable for fuse holder		

A			
alarm devices	37		
axial fans	56		
B			
ball valves	131		
ball valves electric	53, 131		
bar burners	95		
boiling pan gaskets	125		
bullet connectors	63		
C			
cable clamps	133		
cables	62		
cam switches	25		
capillary tube clips	23		
clamps	132, 133		
condensators & interference suppression filters	61		
consumables	133		
contactors	38		
control equipment	29		
control thermostats	15		
copper wire	62		
cross flow fans	57		
D			
door catches	112		
door seals	121		
door seals with tension springs	125		
drain systems and wash basins	132		
E			
edgemount latches	111		
electric accessories	62		
electric timers	36		
electrodes	55		
electronic controllers	43		
energy regulators	15		
espagnolette locks	112		
F			
fans	56		
fasteners	133		
fastening material	133		
fine fuses	134		
fitting greases	132, 134		
fuses	62, 134		
G			
gas burners	90		
gas control valves	76		
gas hoses	103		
		gas nozzles	96
		gas solenoid valves	79
		gas taps	63
		gas thermostats	73
		gaskets for heated units	120
		gaskets for tray rack trolleys	125
H			
		halogen lamp	34
		handle latches	111
		heating elements	3, 7
		heating elements for bain maries	3
		heating elements for chargrills	7
		heating elements for convection	10
		heating elements for fryers	4
		heating elements for frying pans	4
		heating elements for griddles	6
		heating elements for heated trolleys	7
		heating elements for large hobs	6
		heating elements for ovens	3
		heating elements for pasta cookers	7
		heating elements for salamanders/toasters	7
		heating elements for tilting bratt pan	6
		hexagonal nuts	133
		high temperature silicone	133
		hob burners	90
		hose clamps	132, 133
		hose connectors	131
		hoses	130
		hot air fans	60
		hot air motors	57
		hot plates	13
		HT drain pipes	132
I			
		ignition boxes	78
		ignition cables	87
		ignition units	88
		immersion heating elements	8
		indicator lights	31
		indicator lights (complete)	32
		industrial hoses	130
L			
		lamp accessories	36
		lamps	31
		light bulbs	34
		lubricants	134
M			
		mechanical timers	37
		microswitches	24
		motors	61

N			
neon light bulbs	32, 33		
Niplaflex hoses	130		
nuts	133		
O			
operating capacitors	61		
O-rings	126		
oven hinges	113		
oven lamps	34		
P			
piano hinges	113		
piezoelectric igniters	87		
pilot burners	79		
pilot heating elements	7		
plug connectors	63		
position switches	25		
pressure switches	54, 103		
probe clips	22		
probes	44		
programme timers	36		
push/momentary push switches	23		
PVC supply hoses	130		
R			
radial fans	61		
radiation heaters	12		
relays	41		
retaining rings	133		
ring burners	95		
ring terminals	63		
rocker/momentary rocker switches	23		
roll pins	133		
rotary switches	29		
rubber sleeves	132		
S			
safety thermostats	19		
sealants and adhesives	133		
sealing cords	127		
sealing washers	126		
shaft gaskets	127		
shelves and shelf rails	120		
silicone	133		
silicone fats	134		
snap locks	112		
solenoid valves	50		
spray guns	130		
spring clips	22		
steam valves	132		
supply hoses	130		
		switches and momentary switches	23
		system switches (ROLD)	25
T			
		terminals and connectors	63
		thermocouples	88
		thermostats	15
		time relays	42
		timers	36
		transformers	43
V			
		valves and tank inlets	131
W			
		washers	133
		window seals	120