



GAS COMPONENTS



ELECTRIC COMPONENTS



WATER TECHNOLOGY



MECHANICAL COMPONENTS



TOOLS

Spare parts suitable for

JÜNGER

Find the complete and up-to-date range of products in our GEV Webshop



Manufacturer catalogue

The most important spare parts and accessories arranged clearly for every manufacturer

- ✓ Complete product range and all appliance data always up to date in the GEV Webshop
- ✓ Alphabetical Index at the end of the catalogue

GEV Webshop

www.gev-online.co.uk

www.gev-online.com



- 🔍 Add to Favourites
- 🔍 Sign In with email address and usual password
- 🔍 Easy-order – place several items in your basket at the same time
- 🔍 Quick Item search – no login needed



heating elements

heating elements for fryers

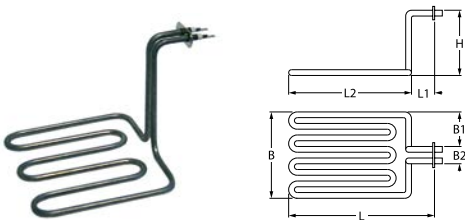

GEV No.	415342	Ref. No.	445258
description	heating element 2000W 230V heating circuits 1 L 213mm W 202mm H 155mm L1 38mm L2 175mm W1 85mm W2 26mm flange length 50mm flange width 22mm hole distance 40mm windings 3 connection male faston 6.3mm hole ø 4mm rectangular flange		
For models:	258		

heating elements for hot dog machines



GEV No.	415754	Ref. No.	420000
description	heating element 600W 230V L 138mm W 134mm H 29mm tube ø 6.5mm connection cable connection length 45mm cable length 300mm dry heating element rectangular flange heating circuits 1 hole distance 51mm flange length 60mm flange width 22mm mounting thread M4		
For models:	250, 252, 253, 254		

heating elements for chargrills



GEV No.	415343	Ref. No.	421000
description	heating element 1500W 230V L 300mm W 285mm H 30mm heating circuits 1 hole distance 305mm windings 3 mounting thread 1/8" cable length 280mm sausage roaster dry heating element lug length 26mm lug width 24mm bracket mounting connection length 42mm tube ø 6.3mm		
For models:	271, 272		

energy regulators

DIAMOND



GEV No.	380032	Ref. No.	423100
description	energy regulator 230V 13.5A turn direction right shaft ø 6x4.6mm shaft L 23mm mounting thread M4 equiv. no. 45ER104C1		
For models:	271, 272, 273, 274, 276		

accessories

knobs



GEV No.	110238	Ref. No.	423120
description	knob energy regulator 1-10 t.max. °C ø 50mm shaft ø 6x4.6mm shaft flat upper black		
For models:	271, 272, 273, 274, 276		

thermostats

control and safety thermostats

EGO

safety thermostats

55.13_ series



GEV No.	375115	Ref. No.	422000	
description	safety thermostat switch-off temp. 145°C 1-pole 1NO 16A probe ø 6mm probe L 73mm capillary pipe 830mm capillary pipe isolatedmm gland nut probe SS			
accessories for	375115			
	GEV No.	551083	Ref. No.	—
	cap for safety thermostat thread M8x1			



control thermostats with operation switch

55.10/19_ series

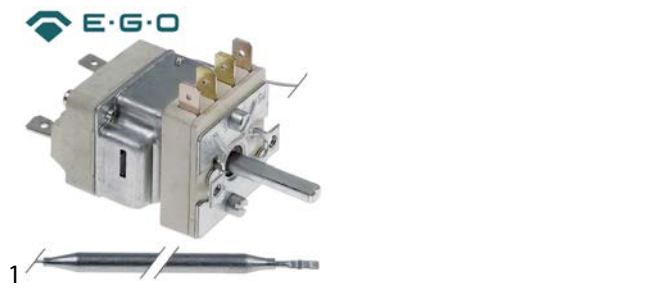

GEV No.	375473	Ref. No.	422100
description	thermostat t.max. 110°C temperature range 37-110°C 1-pole 1NO 16A probe ø 6mm probe L 129mm capillary pipe 570mm capillary pipe isolatedmm gland nut shaft ø 6x4.6mm shaft L 23mm shaft position upper rotation 270° outer switch 2NO		

RATHGEBER

control thermostats with operation switch



GEV No.	375931	Ref. No.	422100 422111
description	thermostat t.max. 110°C temperature range 30-110°C 1-pole 1NC 16A probe ø 6mm probe L 140mm capillary pipe 860mm capillary pipe isolated 65mm shaft ø 6x4.6mm shaft L 26.5mm outer switch 2-pole		
For models:	250, 252, 253, 254		

various

safety thermostats

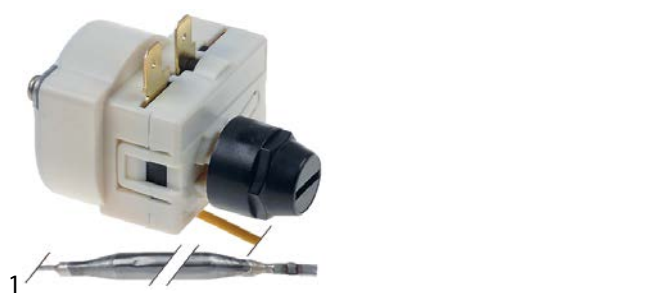

GEV No.	375932	Ref. No.	422200 422211
description	safety thermostat switch-off temp. 146°C temperature range°C 1-pole 1NCA probe ø 6mm probe L 86mm capillary pipe 850mm capillary pipe isolated 50mm gland nut shaft ømm probe SS screw connection M10x1		
For models:	250, 252, 253, 254, 258		

lamps

indicator lights

indicator lights (complete)

ø10mm

with plug-in socket



GEV No.	359140	Ref. No.	426000
description	indicator light ø 10mm yellow 230V connection male faston 6.3mm Qty 1 pcs		
For models:	271, 272, 273, 274, 276		

miscellaneous



GEV No.	359018	Ref. No.	426000
description	indicator light		

gas taps

MADEC (MP)

with nozzle outlet



GEV No.	101193	Ref. No.	431310
description	gas tap MADEC with nozzle outlet (without nozzle) gas inlet M12x1 (tube ø 8mm) external nozzle ømm internal nozzle ømm bypass nozzle ø 0.35mm mixing pipe connection M17x1 thermocouple connection M8x1 front fixing M12x1 shaft ø 8x5mm shaft L 23/13.5mm shaft flat left		
For models:	280000, 282000, 285000, 286000		

spare parts for	101193		
------------------------	--------	--	--

	GEV No.	100360	Ref. No.	—
	bypass nozzle MADEC bore ø 0.35mm thread M4.5x0.6 total length 13mm			

	GEV No.	101051	Ref. No.	431440
	magnet unit L 27mm D1 ø 12.5mm D2 ø 8.5mm suitable for JUNKERS/EGA/MADEC/SABAF standard			

	GEV No.	101234	Ref. No.	—
	union nut T1: M8x1 T2: M15			

accessories for	101193		
------------------------	--------	--	--



	GEV No.	100936	Ref. No.	—
	gas tap spindle shaft ø 5x8mm MADEC			

	GEV No.	101277	Ref. No.	—
	olive ID ø 8mm Qty 1 pcs			



	GEV No.	101296	Ref. No.	—
	union nut thread M12x1 for pipe ø 8mm			

Table continues overleaf









accessories for	101193		
	GEV No.	101299	Ref. No. —
	nut thread M12x1		
	GEV No.	101400	Ref. No. 431430
	air mixing tube thread M17x1 suitable for L350, L700		
	GEV No.	110150	Ref. No. —
	knob gas tap without ignition flame t.max.°C°C ø 50mm shaft ø 8x5.5mm shaft flat right white		



GEV No.	101073	Ref. No.	431200
description	gas tap MADEC with nozzle outlet (without nozzle) gas inlet M12x1 (tube ø 8mm) external nozzle ømm internal nozzle ømm bypass nozzle ø 0.35mm mixing pipe connection M17x1 thermocouple connection M8x1 front fixing M12x1 shaft ø 8x5mm shaft L 23/13.5mm shaft flat right gas outlet M17x1		
For models:	260, 269, 270		
spare parts for	101073		
	GEV No.	100936	Ref. No. —
	gas tap spindle shaft ø 5x8mm MADEC		
	GEV No.	101051	Ref. No. 431440
	magnet unit L 27mm D1 ø 12.5mm D2 ø 8.5mm suitable for JUNKERS/EGA/MADEC/SABAF standard		
	GEV No.	101234	Ref. No. —
	union nut T1: M8x1 T2: M15		
accessories for	101073		
	GEV No.	100927	Ref. No. —
	torsion spring L 2.8-8.0mm for internal nozzle ø 3mm bore ømm		
	GEV No.	101277	Ref. No. —
	olive ID ø 8mm Qty 1 pcs		
	GEV No.	101296	Ref. No. —
	union nut thread M12x1 for pipe ø 8mm		
	GEV No.	101299	Ref. No. —
	nut thread M12x1		
	GEV No.	101400	Ref. No. 431430
	air mixing tube thread M17x1 suitable for L350, L700		
	GEV No.	110148	Ref. No. 431220
	knob gas tap without ignition flame ø 50mm shaft ø 8x5mm shaft flat left black		
	GEV No.	110150	Ref. No. —
	knob gas tap without ignition flame t.max.°C°C ø 50mm shaft ø 8x5.5mm shaft flat right white		



GEV No.	101194	Ref. No.	431110
description	gas tap MADEC with nozzle outlet (without nozzle) gas inlet M12x1 (tube ø 8mm) external nozzle ømm internal nozzle ømm bypass nozzle ø 0.35mm mixing pipe connection M17x1 thermocouple connection M8x1 front fixing M12x1 shaft ø 8x6mm shaft L 17/9mm shaft flat upper and bottom		
For models:	251, 255, 256, 257		
spare parts for	101194		
	GEV No.	100360	Ref. No. —
	bypass nozzle MADEC bore ø 0.35mm thread M4.5x0.6 total length 13mm		
	GEV No.	101051	Ref. No. 431440
	magnet unit L 27mm D1 ø 12.5mm D2 ø 8.5mm suitable for JUNKERS/EGA/MADEC/SABAF standard		
	GEV No.	101234	Ref. No. —
	union nut T1: M8x1 T2: M15		
accessories for	101194		
	GEV No.	101277	Ref. No. —
	olive ID ø 8mm Qty 1 pcs		
	GEV No.	101296	Ref. No. —
	union nut thread M12x1 for pipe ø 8mm		
	GEV No.	101299	Ref. No. —
	nut thread M12x1		
	GEV No.	101400	Ref. No. 431430
	air mixing tube thread M17x1 suitable for L350, L700		

ignition parts

electrodes



GEV No.	100743	Ref. No.	401120
description	ignition electrode D1 ø 6mm L1 21mm BL1 18mm BL2 8mm BL3 19mm connection F 2.8x0.8mm M10x1		
For models:	260, 269, 270		
accessories for	100743		
	GEV No.	101860	Ref. No. —
	nut thread M10x1 H 4mm WS 14 chrome-plated brass Qty 1 pcs		



piezoelectric igniters

mounting diameter 22mm



GEV No.	100005	Ref. No.	401000
description	piezoelectric igniter body plastic blowing mounting ø 22mm connection ø2.4mm cable lengthmm SIT		
For models:	260, 269, 270		

thermocouples

threaded thermocouples

threaded thermocouples standard

with socket with thread M8x1

SIT

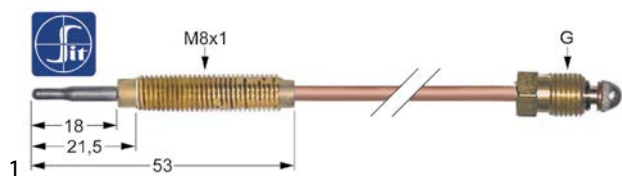

GEV No.	107628	Ref. No.	431410
description	thermocouple SIT M8x1 L 320mm M8x1		
For models:	251, 255, 256, 257, 260, 269, 270, 280000, 282000, 285000, 286000		
accessories for	107628		
	GEV No.	102067	Ref. No.
			—
	nut thread M8x1 H 3mm brass Qty 1 pcs type SEF 1		

bar burners

bar burners



GEV No.	104220	Ref. No.	433280
description	bar burner 3 row L 425mm W 110mm ø 20mm Hmm chargrill		
For models:	280000, 285000, 286000		



GEV No.	104218	Ref. No.	433282
description	bar burner 3 row L 440mm W 185mm ø 20mm Hmm chargrill		
For models:	282000		

ring burners



GEV No.	104222	Ref. No.	433270
description	ring burner L 290mm W 180mm		
For models:	269, 270		

gas burners

hob burners

accessories

air mixers



GEV No.	101400	Ref. No.	431430
description	air mixing tube thread M17x1 suitable for L350, L700		
For models:	260, 269, 270, 280000, 282000, 285000, 286000		



auxiliary gas parts

gas pressure regulators

Standard pressure according to country:

Germany 50mbar

France 37mbar

Italy 30mbar

Spain 37/50mbar

UK 20mbar



GEV No.	250005	Ref. No.	402110
description	gas pressure regulator EN61 connection small gas cylinders - 1/4" left 50mbar/1.5kg/h countries DE input pressure up to 16bar propane/ butane CE 0085		
description	low pressure gas regulator type EN61-DS - 50mbar, 1.5kg/h with excess pressure protection and hose rupture protection for external commercial installations inlet for small gas cylinders (3/8" left), outlet 1/4" conical left hand thread		
For models:	260, 269, 270, 280000, 282000		

gas hoses

DIN 4815 with DVGW approval

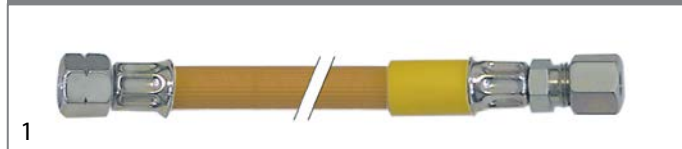

GEV No.	250004	Ref. No.	403120
description	gas hose DIN 4815 rubber with textile insertion L 400mm 1/4" left - tube ø 12mm temp.-resist. up to -30°C flexible conduit at intermediate pressure		
For models:	285000, 286000		

equipment-specific units

for hot dog machines

lids



GEV No.	697927	Ref. No.	414000
description	clamp for lid L 35mm W 20mm thickness 0.6mm		
For models:	250, 251, 252, 253, 254, 255, 256, 257, 258		

knobs

universal knobs



GEV No.	110238	Ref. No.	423120
description	knob energy regulator 1-10 t.max. °C ø 50mm shaft ø 6x4.6mm shaft flat upper black		
For models:	271, 272, 273, 274, 276		



GEV No.	110119	Ref. No.	422120
description	knob thermostat t.max. 110°C ø 50mm shaft ø 6x4.6mm shaft flat upper black temperature range 30-110°C rotation 270°		
For models:	250, 252, 253, 254		
accessories for	110119		
GEV No.	110135	Ref. No.	—
description	rosette knob up to ø 52mm		

producer-specific knobs

JÜNGER



GEV No.	110238	Ref. No.	423120
description	knob energy regulator 1-10 t.max. °C ø 50mm shaft ø 6x4.6mm shaft flat upper black		
For models:	271, 272, 273, 274, 276		

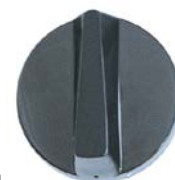

GEV No.	110148	Ref. No.	431220
description	knob gas tap without ignition flame ø 50mm shaft ø 8x5mm shaft flat left black		
For models:	260, 269, 270		



1

GEV No.	110149	Ref. No.	431320
description	knob gas tap without ignition flame t.max.°C temperature range°C ø 50mm shaft ø 6x4.6mm shaft flat right black		
For models:	280000, 282000, 285000, 286000		



1

GEV No.	110119	Ref. No.	422120
description	knob thermostat t.max. 110°C ø 50mm shaft ø 6x4.6mm shaft flat upper black temperature range 30-110°C rotation 270°		
For models:	250, 252, 253, 254		
accessories for	110119		
	GEV No.	110135	Ref. No. —
	rosette knob up to ø 52mm		

miscellaneous



1

GEV No.	111409	Ref. No.	417000
description	handle L 51mm W 89mm with mounting kit Qty 1 pcs		
For models:	250, 251, 252, 253, 254, 255, 256, 257, 258		

handles and hand wheels

mushroom cap handles



1

GEV No.	111408	Ref. No.	416000
description	lid handle with screw thread M5 handle ø 48mm L 28mm black		
For models:	250, 251, 252, 253, 254, 255, 256, 257, 258		

B

bar burners 6

E

energy regulators 3

G

gas burners 6

gas hoses 7

gas pressure regulators 7

gas taps 4

H

heating elements 3

heating elements for chargrills 3

heating elements for fryers 3

hob burners 6

I

indicator lights 4

indicator lights (complete) 4

L

lamps 4

P

piezoelectric igniters 6

R

ring burners 6

S

safety thermostats 3

T

thermocouples 6

thermostats 3