



**GAS COMPONENTS**



**ELECTRIC COMPONENTS**



**WATER TECHNOLOGY**



**MECHANICAL COMPONENTS**



**TOOLS**

Spare parts suitable for

**KASTEL**

Find the complete and up-to-date range of products in our GEV Webshop



# Manufacturer catalogue

The most important spare parts and accessories arranged clearly for every manufacturer

- ✓ Complete product range and all appliance data always up to date in the GEV Webshop
- ✓ Alphabetical Index at the end of the catalogue

## GEV Webshop

[www.gev-online.co.uk](http://www.gev-online.co.uk)

[www.gev-online.com](http://www.gev-online.com)



- 🔍 Add to Favourites
- 🔍 Sign In with email address and usual password
- 🔍 Easy-order – place several items in your basket at the same time
- 🔍 Quick Item search – no login needed



## thermostats

### bi-metal thermostats

#### safety bi-metal thermostats



**GEV No.** 390578 **Ref. No.** K00076

**description** bi-metal safety thermostat hole distance 25mm 1NC 1-pole

### refrigeration thermostats

#### RANCO

##### K22 series

RANCO



**GEV No.** 390579 **Ref. No.** K00080 (old version)

**description** thermostat RANCO type K22L1081 probe  $\varnothing$  2mm probe Lmm capillary pipe 2250mm

##### K50 series

RANCO



**GEV No.** 390286 **Ref. No.** K00079

**description** thermostat RANCO type K50L3383 probe  $\varnothing$ mm probe Lmm capillary pipe 1500mm temperature range +1 up to +3°C

### miscellaneous producers



**GEV No.** 390996 **Ref. No.** K00080

**description** thermostat probe  $\varnothing$  2mm probe Lmm capillary pipe 2250mm type K22L1081

## switches and momentary switches

### microswitches

#### lever actuated



**GEV No.** 346872 **Ref. No.** 601003

**description** microswitch with lever 250V 0.1A 1CO connection male faston 6.3mm L 50mm ambient temperature max. 85°C mounting distance 22mm type D41X actuating force: 6g lever length 36mm

### float switches



**GEV No.** 345372 **Ref. No.** 601043

**description** float switch 1CO  $\varnothing$  15mm L 104mm 250V 6A male faston 6.3mm cable lengthmm



**GEV No.** 345371 **Ref. No.** 601082

**description** float switch with plunger 250V 16A 1CO male faston 6.3mm L 60mm ambient temperature max. 125°C mounting distance 22mm type EF83161.5 actuating force: 20g blue/black

## timers

### programme timers



**GEV No.** 360368 **Ref. No.** K00257



**description** timer CDC 11904 engines 1 chambers 4 operation time 10min 230V manuf. no. 11904F1 / K00257 motor type M48R ATS

**spare parts for** 360368



**GEV No.** 360118 **Ref. No.** —  
**description** motor CDC pinion  $\varnothing$  4.9mm teeth 10 230V voltage AC 50/60Hz turn direction right motor  $\varnothing$  47mm H 19.3mm motor type M48R ATS for timer cable length 260mm 1.9/2.5W



			
1			
<b>GEV No.</b>	360367	<b>Ref. No.</b>	K00075
<b>description</b>	timer CDC 11904 engines 1 chambers 4 operation time 12min 230V shaft ømm shaft Lmm manif. no. 11904F1 / K00075 motor type M48R ATS		
<b>spare parts for</b>	360367		
	<b>GEV No.</b>	360118	<b>Ref. No.</b> —
	motor CDC pinion ø 4.9mm teeth 10 230V voltage AC 50/60Hz turn direction right motor ø 47mm H 19.3mm motor type M48R ATS for timer cable length 260mm 1.9/2.5W		

## contactors

### LOVATO

#### power contactors

			
1			
<b>GEV No.</b>	380964	<b>Ref. No.</b>	00005140
<b>description</b>	power contactor resistive load 20A 230VAC (AC3/400V) 9A/4kW main contacts 4NO auxiliary contacts connection screw connection type 11BG09T4A230		

## probes

### producer-specific probes

#### probes

			
1			
<b>GEV No.</b>	379851	<b>Ref. No.</b>	K04678
<b>description</b>	temperature probe NTC 10kOhm cable silicone probe -40 up to +110°C cable -50 up to +180°C connection plug thread probe ø6x-50mm cable length 1.5m		

			
1			
<b>GEV No.</b>	403223	<b>Ref. No.</b>	K04677
<b>description</b>	temperature probe NTC 10kOhm cable silicone probe -40 up to +110°C cable -50 up to +180°C connection plug thread probe ø6x-50mm cable length 2m		



			
1			
<b>GEV No.</b>	401892	<b>Ref. No.</b>	K01473
<b>description</b>	temperature probe NTC 10kOhm cable TPE probe -40 up to +110°C cable -40 up to +110°C connection plug thread probe ø6x14mm cable length 1.5m		

			
1			
<b>GEV No.</b>	401891	<b>Ref. No.</b>	K01472
<b>description</b>	temperature probe NTC 10kOhm cable TPE probe -40 up to +110°C cable -40 up to +110°C connection plug thread probe ø6x14mm cable length 2m		

## electronics

### PCBs

			
1			
<b>GEV No.</b>	401890	<b>Ref. No.</b>	K01471 K04601
<b>description</b>	PCB		

			
1			
<b>GEV No.</b>	403100	<b>Ref. No.</b>	K04720
<b>description</b>	PCB ice maker KP 75 L 115mm W 95mm 230V		
<b>accessories for</b>	403100		
	<b>GEV No.</b>	379851	<b>Ref. No.</b> K04678
	temperature probe NTC 10kOhm cable silicone probe -40 up to +110°C cable -50 up to +180°C connection plug thread probe ø6x-50mm cable length 1.5m		
	<b>GEV No.</b>	403223	<b>Ref. No.</b> K04677
	temperature probe NTC 10kOhm cable silicone probe -40 up to +110°C cable -50 up to +180°C connection plug thread probe ø6x-50mm cable length 2m		

## solenoid valves

### solenoid valves (water)

			
1			
<b>GEV No.</b>	370400	<b>Ref. No.</b>	K01213
<b>description</b>	solenoid valve single angled 230VAC inlet 3/4" outlet 11.5mm input/ min output 1.5l/min DN10 t.max. 90°C ELBI plastic flow regulating valve outlet white		



**TP**

**solenoid valves with reducers**

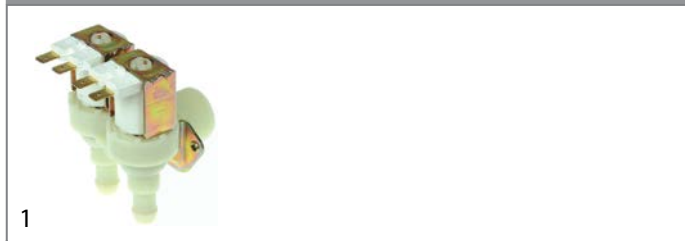

<b>GEV No.</b>	370398	<b>Ref. No.</b>	K01195
<b>description</b>	solenoid valve double angled 230VAC inlet 3/4" input 12l/min t.max. 90°C TP plastic flow regulating valve inlet blue outlet 11.5mm output A 2.5l/min output B 2.5l/min flow regulating valve outlet A yellow flow regulating valve outlet B yellow		



<b>GEV No.</b>	370395	<b>Ref. No.</b>	K01045 K01046
<b>description</b>	solenoid valve double angled 230VAC inlet 3/4" input/min output 0.8/0.8l/min DN10 t.max. 90°C TP plastic outlet 11.5mm output A 0.8l/min output B 0.8l/min flow regulating valve outlet A white flow regulating valve outlet B white		

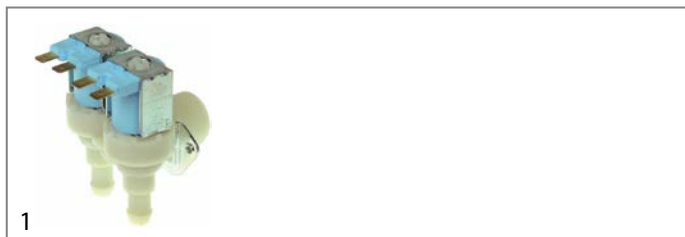

<b>GEV No.</b>	370397	<b>Ref. No.</b>	K01322
<b>description</b>	solenoid valve double angled 230VAC inlet 3/4" input/min output 1.5/2.5l/min DN10 t.max. 90°C TP plastic outlet 11.5mm flow regulating valve outlet A light brown flow regulating valve outlet B yellow		



<b>GEV No.</b>	370396	<b>Ref. No.</b>	K00204
<b>description</b>	solenoid valve double angled 230VAC inlet 3/4" t.max. 90°C TP plastic flow regulating valve inlet white outlet 11.5mm output A 1.5l/min output B 1.5l/min flow regulating valve outlet A light brown flow regulating valve outlet B light brown		

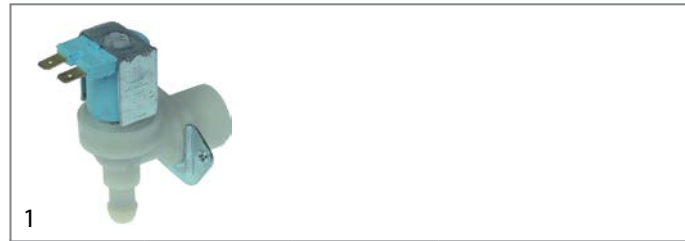

<b>GEV No.</b>	370399	<b>Ref. No.</b>	K01212
<b>description</b>	solenoid valve single angled 230VAC inlet 3/4" outlet 11.5mm input/min output 0.8l/min DN10 t.max. 90°C TP plastic		

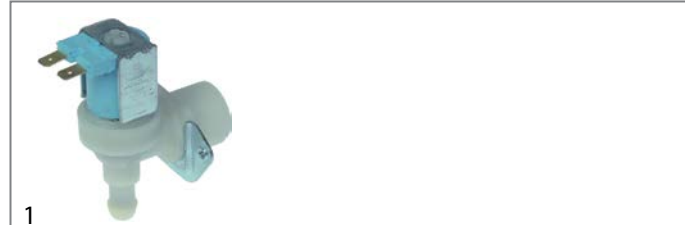

<b>GEV No.</b>	370401	<b>Ref. No.</b>	K01214
<b>description</b>	solenoid valve single angled 230VAC inlet 3/4" outlet 11.5mm output 2.5l/min t.max. 90°C TP plastic flow regulating valve outlet yellow		

**solenoid valves (refrigeration)**

**CASTEL valves**



<b>GEV No.</b>	370402	<b>Ref. No.</b>	K01531
<b>description</b>	solenoid valve CASTEL type 1028/2 230V p max 45bar 1/4" connection 1/4" -35 up to 110°C refrigeration copper/brass DN 6.35mm		

**spare parts and accessories**

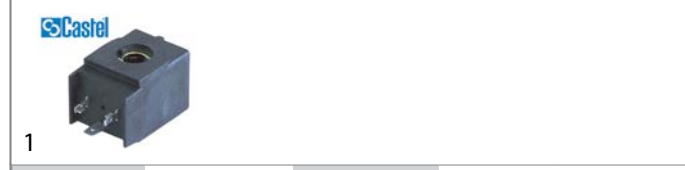

<b>GEV No.</b>	371041	<b>Ref. No.</b>	K01381
<b>description</b>	solenoid coil CASTEL 240VAC 8VA 50/60Hz seat ø 11.5mm connection DIN 43650A type HM2		

<b>accessories for</b>	371041		
------------------------	--------	--	--

	<b>GEV No.</b>	371090	<b>Ref. No.</b>	—
		power socket plug type DIN 43650A screw		

	<b>GEV No.</b>	371092	<b>Ref. No.</b>	—
		power socket plug type DIN large cable length 1000mm		





# pressure switches

## for refrigeration

### RANCO

#### DWFK series



<b>GEV No.</b>	541853	<b>Ref. No.</b>	K00077 K00077+K01106+K00489 K02908+K01106+K00489 K02908+K01106+K01078
<b>description</b>	pressure control RANCO type HR10811A4R001 switching diff.bar pressure range 17.5bar		

### SAGI NO MIYA



<b>GEV No.</b>	541120	<b>Ref. No.</b>	K00077
<b>description</b>	pressure control HD reset automatic refrigeration type HTB-X3028 connection male faston 6.3mm switch-on pressure 17bar		

# compressors

## EMBRACO / ASPERA



### R404a/R507

#### HMBP monophase

High/Medium evaporation temperature above -20/-15 °C



<b>GEV No.</b>	605132	<b>Ref. No.</b>	K00475
<b>description</b>	compressor coolant R404a/R507 type NT6222GK 200-240V 50Hz HMBP fully hermetic 17kg 1HP cylinder capacity 17.39cm <sup>3</sup> CSR H 252mmWW 810W 1032W 1040W 1174W 1307W 1583W 2247W test method ASHRAE		
<b>accessories for</b>	605132		
	<b>GEV No.</b>	365142	<b>Ref. No.</b> —
	operating capacitor capacity 15µF 450V with metal case tolerance 5% 50/60Hz ø 40mm L 110mm M8x1.25		

<b>accessories for</b>	605132		
	<b>GEV No.</b>	365153	<b>Ref. No.</b> —
	starting capacitor 52µF 330V 50/60Hz duty cycle 3s 41280A133 2252347 ø 36mm L 83mm M8 plastic connection cable 350mm		
	<b>GEV No.</b>	390981	<b>Ref. No.</b> —
	klixon suitable for NT6222GK		

## L'UNITE HERMETIQUE / TECUMSEH

### R404A

#### HMBP monophase

High/Medium evaporation temperature above -20/-15 °C



<b>GEV No.</b>	605025	<b>Ref. No.</b>	K01186
<b>description</b>	compressor coolant R404A type AE4430Z-FZ 220-240V 50Hz HMBP fully hermetic 10.2kg 1/4HP power input 427W cylinder capacity 5.7cm <sup>3</sup> CSIR H 186mmWW 258W 346W 441W 550W 682W 794W test method EN 12900 908W		
<b>spare parts for</b>	605025		
	<b>GEV No.</b>	380061	<b>Ref. No.</b> —
	start relay MTRP0027-31 120/240V voltage AC 8A 1NO		



<b>GEV No.</b>	605023	<b>Ref. No.</b>	K00085
<b>description</b>	compressor coolant R404A type AE4450Z 220-240V 50Hz HMBP fully hermetic 12.5kg 3/8HP cylinder capacity 8.85cm <sup>3</sup> CSIR H 207mmWW 434W 567W 734W 927W 1270W 1367W test method EN 12900 1729W		



1

<b>GEV No.</b>	605021	<b>Ref. No.</b>	K00200
<b>description</b>	compressor coolant R404A type AEZ4425Z 220-240V 50Hz HMBP fully hermetic 9.8kg 1/5HP cylinder capacity 4.5cm <sup>3</sup> CSIR H 186mmWW 198W 263W 341W 432W 537W 629W test method EN 12900 723W		



1

<b>GEV No.</b>	605022	<b>Ref. No.</b>	K00202
<b>description</b>	compressor coolant R404A type AEZ4440Z 230V 50Hz HMBP fully hermetic 21kg cylinder capacity 7.55cm <sup>3</sup> CSIR H 292mm 415W 517W 637W 772W 919W 1074W test method EN 12900 1234W		



1

<b>GEV No.</b>	605027	<b>Ref. No.</b>	K00476
<b>description</b>	compressor coolant R404A type CAJ4517Z 220-240V 50Hz HMBP fully hermetic 24kg 1.2HP cylinder capacity 25.95cm <sup>3</sup> CSIR H 282mmWW 1588W 1987W 2451W 2971W 3536W 4132W test method EN 12900 4742W		



1

<b>GEV No.</b>	605026	<b>Ref. No.</b>	K00206
<b>description</b>	compressor coolant R404A type CAJ9480Z 220-240V 50Hz HMBP fully hermetic 22kg 3/4HP cylinder capacity 15.2cm <sup>3</sup> CSIR H 271mm 393W 571W 774W 1009W 1284W 1607W 1989W 2334W test method EN 12900 2699W		



1

<b>GEV No.</b>	605032	<b>Ref. No.</b>	K00475 old
<b>description</b>	compressor coolant R404A type CAJ9510Z 220-240V 50Hz HMBP fully hermetic 23kg 1HP cylinder capacity 18.3cm <sup>3</sup> CSIR H 282mm 527W 732W 970W 1252W 1583W 1972W 2437W 2826W test method EN 12900 3220W		

## fans

### refrigeration fans

#### refrigeration motors universal

#### accessories

#### fan wheels

#### aluminium

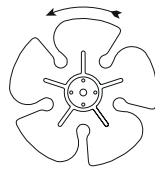
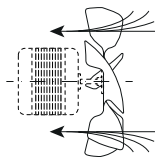
1

<b>GEV No.</b>	601566	<b>Ref. No.</b>	K01301
<b>description</b>	fan wheel sucking ø 154mm fan wheel mounting 25.4mm blade angle 28° W 34mm aluminium		

#### plastic



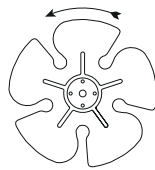
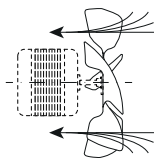

1

<b>GEV No.</b>	601395	<b>Ref. No.</b>	K01023
<b>description</b>	fan wheel sucking ø 154mm fan wheel mounting 25.4mm blade angle 28° W 32mm plastic		

cooling motors (complete)



<b>GEV No.</b>	601396	<b>Ref. No.</b>	K01380
<b>description</b>	fan 230V 10W 50/60Hz fan wheel ø 172mm shaft L 16mm feet depth 53mm L 66mm W 83mm H 83mm blade angle 32° connection cable 500mm		
<b>spare parts for</b>	601396		
	<b>GEV No.</b>	601553	<b>Ref. No.</b> —
	fan wheel sucking ø 172mm fan wheel mounting 25.4mm blade angle 28° W 35mm aluminium		



<b>GEV No.</b>	601397	<b>Ref. No.</b>	K01083
<b>description</b>	fan 230V 10W 50Hz fan wheel ø 154mm shaft L 125mm feet depth 72mm blade angle 28° connection cable 1000mm		

motors

gear motors

for ice-cube maker

for paddles



<b>GEV No.</b>	500422	<b>Ref. No.</b>	606003
<b>description</b>	gear motor ITV type MT6b-GB5FS 3.5W 230V 50Hz 30rpm shaft ø 6mm L 64mm W 51mm H 40mm for ice-cube maker		



<b>GEV No.</b>	500407	<b>Ref. No.</b>	601039
<b>description</b>	gear motor LIP type 123MR 8W 220/240V voltage AC 50/60Hz 50rpm turn direction counterclockwise shaft ø 4mm shaft intake ø 6.2mm groove width 2.3mm shaft L 8mm shaft ø 4mm W 74mm		

for sumps



<b>GEV No.</b>	500412	<b>Ref. No.</b>	601040
<b>description</b>	gear motor LIP type 021B 11W 230V 50Hz 1rpm shaft ø 7mm shaft length 20mm W 74mm D 67mm H 110mm for sump		

pumps

pumps for ice machines



<b>GEV No.</b>	501494	<b>Ref. No.</b>	K02941
<b>description</b>	pump GRE 100W 230V 50Hz inlet ø 24mm outlet ø 21mm L 227mm		





<b>GEV No.</b>	500200	<b>Ref. No.</b>	K01530
<b>description</b>	pump GRE 100W 230V 50Hz inlet ø 24mm outlet ø 23mm L 145mm rotation direction right		







1

<b>GEV No.</b>	500587	<b>Ref. No.</b>	K00553 K01206
<b>description</b>	pump OLYMPIA type L63.T19ICE 190W 230V 50Hz inlet ø 28mm outlet ø 26mm impellor ø 48mm L 200mm rotation direction right for ice-cube maker capacitor 5µF		
<b>spare parts for</b>	500587		
	<b>GEV No.</b>	601395	<b>Ref. No.</b> K01023
	fan wheel sucking ø 154mm fan wheel mounting 25.4mm blade angle 28° W 32mm plastic		



1

<b>GEV No.</b>	500963	<b>Ref. No.</b>	K01164 K01207
<b>description</b>	pump OLYMPIA type T.19 190W 230V 50Hz inlet ø 28mm outlet ø 26mm impellor ø 65mm L 200mm rotation direction right for ice-cube maker capacitor 5µF		
<b>spare parts for</b>	500963		
	<b>GEV No.</b>	601566	<b>Ref. No.</b> K01301
	fan wheel sucking ø 154mm fan wheel mounting 25.4mm blade angle 28° W 34mm aluminium		



1

<b>GEV No.</b>	500161	<b>Ref. No.</b>	600062
<b>description</b>	pump REBO type NR40 55W 230V 50Hz outlet ø 17mm L 110mm rotation direction left for ice-cube maker		
<b>spare parts for</b>	500161		
	<b>GEV No.</b>	500970	<b>Ref. No.</b> —
	pump motor 55W 230V 50Hz REBO L 205mm type outlet ømm suitable for for ice maker		

## equipment-specific units

### for ice-cube maker

#### drain systems

##### drain fittings



1

<b>GEV No.</b>	695350	<b>Ref. No.</b>	K00004
<b>description</b>	drain fitting thread M28x2 L 23mm straight for ice maker		



1

<b>GEV No.</b>	695347	<b>Ref. No.</b>	K00006
<b>description</b>	drain fitting thread M32x1.5 L 49.3mm straight connection 15mm for ice maker		

#### overflow pipes



1

<b>GEV No.</b>	695346	<b>Ref. No.</b>	K01317
<b>description</b>	overflow pipe for ice maker tube ø 2.6mm pipe length 95.5mm		

#### spray systems

##### KASTEL

##### spray arms



1

<b>GEV No.</b>	694716	<b>Ref. No.</b>	K02896
<b>description</b>	spray arm L 290mm nozzles 6 plastic for ice maker		



1

<b>GEV No.</b>	695330	<b>Ref. No.</b>	K00171 K02205
<b>description</b>	spray arm L 290mm nozzles 6 stainless steel for ice maker		



1

<b>GEV No.</b>	695329	<b>Ref. No.</b>	K00825 K02203 K02897
<b>description</b>	spray arm L 335mm nozzles 6 for ice maker		

			
1			
<b>GEV No.</b>	750391	<b>Ref. No.</b>	K04293
<b>description</b>	spray arm L 445mm nozzles 10 for ice maker		

			
1			
<b>GEV No.</b>	695331	<b>Ref. No.</b>	K00133 K02207
<b>description</b>	spray arm L 445mm nozzles 9 for ice maker		

			
1			
<b>GEV No.</b>	696627	<b>Ref. No.</b>	K02898
<b>description</b>	spray arm L 445mm nozzles 9 for ice maker		

			
1			
<b>GEV No.</b>	695332	<b>Ref. No.</b>	K00047 K02209 K02899
<b>description</b>	spray arm L 675mm nozzles 15 for ice maker		

			
1			
<b>GEV No.</b>	695333	<b>Ref. No.</b>	K00316 K02211 K02900
<b>description</b>	spray arm L 725mm nozzles 18 for ice maker		

## accessories

			
1			
<b>GEV No.</b>	695335	<b>Ref. No.</b>	K00527
<b>description</b>	end cap for ice maker		

## doors

			
1			
<b>GEV No.</b>	696662	<b>Ref. No.</b>	K03401
<b>description</b>	door for ice maker W 297mm H 197mm thickness 24mm blue		

			
1			
<b>GEV No.</b>	696663	<b>Ref. No.</b>	K04158
<b>description</b>	door for ice maker W 297mm H 197mm thickness 24mm grey		

			
1			
<b>GEV No.</b>	695307	<b>Ref. No.</b>	K00816
<b>description</b>	door for ice-cube maker W 303mm H 185mm thickness 22mm		

			
1			
<b>GEV No.</b>	695306	<b>Ref. No.</b>	K00828
<b>description</b>	door for ice-cube maker W 303mm H 185mm thickness 23mm		

			
1			
<b>GEV No.</b>	695308	<b>Ref. No.</b>	K00241
<b>description</b>	door for ice-cube maker W 337mm H 215mm thickness 23mm		

			
1			
<b>GEV No.</b>	695309	<b>Ref. No.</b>	K00245
<b>description</b>	door for ice-cube maker W 447mm H 215mm thickness 23mm		



1

<b>GEV No.</b>	695310	<b>Ref. No.</b>	K00249
<b>description</b>	door for ice-cube maker W 677mm H 315mm thickness 23mm		



1

<b>GEV No.</b>	695311	<b>Ref. No.</b>	K00456
<b>description</b>	door for ice-cube maker W 725mm H 315mm thickness 23mm		

curtains  
with holder



1

<b>GEV No.</b>	695300	<b>Ref. No.</b>	K00826
<b>description</b>	curtain for ice maker W 283mm H 160mm with holder shaft length 260mm shaft ø 7.5mm		



1

<b>GEV No.</b>	695301	<b>Ref. No.</b>	K00225
<b>description</b>	curtain for ice maker W 320mm H 160mm with holder shaft length 310mm shaft ø 7.5mm		



1

<b>GEV No.</b>	695302	<b>Ref. No.</b>	K00653
<b>description</b>	curtain for ice maker W 432mm H 160mm with holder shaft length 430mm shaft ø 7.5mm		



1

<b>GEV No.</b>	695303	<b>Ref. No.</b>	K00556
<b>description</b>	curtain for ice maker W 660mm H 160mm with holder shaft length 660mm shaft ø 7.5mm		



1

<b>GEV No.</b>	695304	<b>Ref. No.</b>	K00227
<b>description</b>	curtain for ice maker W 720mm H 202mm with holder shaft length 705mm shaft ø 7.5mm		

accessories  
lamellas



1

<b>GEV No.</b>	695305	<b>Ref. No.</b>	K00008
<b>description</b>	lamella for curtain L 70mm W 25mm ID ø 8mm		

suction system  
intake filters



1

<b>GEV No.</b>	695341	<b>Ref. No.</b>	K00012
<b>description</b>	intake filter L 60mm ø 28mm		

pipes



1

<b>GEV No.</b>	695344	<b>Ref. No.</b>	K0058
<b>description</b>	aspiration tube		

## gaskets

## miscellaneous



1

<b>GEV No.</b>	695348	<b>Ref. No.</b>	K00536
<b>description</b>	sealing ring rubber ED ø 42mm ID ø 33mm thickness 2mm Qty 1 pcs		



1

<b>GEV No.</b>	695351	<b>Ref. No.</b>	K00003
<b>description</b>	sealing ring rubber ED ø 45mm ID ø 27mm thickness 2mm Qty 1 pcs		

## hoses

## formed hoses

## straight

## miscellaneous



1

<b>GEV No.</b>	695327	<b>Ref. No.</b>	K00311
<b>description</b>	formed hose straight for ice-cube maker ID ø 17mm ED ø 25mm L 100mm		

## form L



1

<b>GEV No.</b>	695314	<b>Ref. No.</b>	K00824
<b>description</b>	formed hose L-shape for ice-cube maker ID ø 17/23mm ED ø 26/30mm L 220mm W 60mm		



1

<b>GEV No.</b>	695328	<b>Ref. No.</b>	K00048 K03462
<b>description</b>	formed hose L-shape for ice-cube maker ID ø 17mm ED ø 24mm L 90mm W 50mm		



1

<b>GEV No.</b>	695326	<b>Ref. No.</b>	K00444
<b>description</b>	formed hose L-shape for ice-cube maker ID ø 17mm ED ø 25mm L 115mm W 50mm		



1

<b>GEV No.</b>	695325	<b>Ref. No.</b>	K00445
<b>description</b>	formed hose L-shape for ice-cube maker ID ø 17mm ED ø 25mm L 195mm W 80mm		

## form S



1

<b>GEV No.</b>	695312	<b>Ref. No.</b>	K00110
<b>description</b>	formed hose S-shape for ice-cube maker ID ø 22mm ED ø 30mm L 88mm W 50mm		

## form U

## group 1



1

<b>GEV No.</b>	695318	<b>Ref. No.</b>	K00141
<b>description</b>	formed hose U-shape for ice-cube maker ID ø 17/25mm ED ø 26/32mm L 300mm W 110mm		



1

<b>GEV No.</b>	695316	<b>Ref. No.</b>	K00184
<b>description</b>	formed hose U-shape for ice-cube maker ID ø 17/26mm ED ø 26/32mm L 220mm W 100mm		



1

<b>GEV No.</b>	695320	<b>Ref. No.</b>	K00197
<b>description</b>	formed hose U-shape for ice-cube maker ID ø 17/26mm ED ø 26/32mm L 410mm W 120mm		





1

<b>GEV No.</b>	695324	<b>Ref. No.</b>	K00217
<b>description</b>	formed hose U-shape for ice-cube maker ID ø 17/26mm ED ø 26/32mm L 620mm W 130mm		



			
1			
<b>GEV No.</b>	695322	<b>Ref. No.</b>	K00109
<b>description</b>	formed hose U-shape insulated for ice-cube maker ID ø 17/25mm ED ø 26/32mm L 530mm W 130mm		

group 2			
			
1			
<b>GEV No.</b>	695313	<b>Ref. No.</b>	K00823
<b>description</b>	formed hose U-shape for ice-cube maker ID ø 17/23mm ED ø 26/32mm L 250mm W 60mm		

			
1			
<b>GEV No.</b>	695315	<b>Ref. No.</b>	K00185
<b>description</b>	formed hose U-shape for ice-cube maker ID ø 17/26mm ED ø 26/32mm L 280mm W 80mm		

			
1			
<b>GEV No.</b>	695319	<b>Ref. No.</b>	K00198
<b>description</b>	formed hose U-shape for ice-cube maker ID ø 17/26mm ED ø 26/32mm L 460mm W 100mm		

			
1			
<b>GEV No.</b>	695321	<b>Ref. No.</b>	K00072
<b>description</b>	formed hose U-shape for ice-cube maker ID ø 17/26mm ED ø 26/32mm L 550mm W 100mm		

			
1			
<b>GEV No.</b>	695323	<b>Ref. No.</b>	K00218
<b>description</b>	formed hose U-shape for ice-cube maker ID ø 17/26mm ED ø 26/32mm L 670mm W 100mm		

			
1			
<b>GEV No.</b>	695317	<b>Ref. No.</b>	K00142
<b>description</b>	formed hose U-shape for ice-cube maker ID ø 26/17mm ED ø 26/32mm L 350mm W 85mm		

hose connectors			
with thread			
			
1			
<b>GEV No.</b>	695352	<b>Ref. No.</b>	K00039
<b>description</b>	hose connector for drain assembly		

without thread			
			
1			
<b>GEV No.</b>	695336	<b>Ref. No.</b>	K00578
<b>description</b>	hose connector		

			
1			
<b>GEV No.</b>	695337	<b>Ref. No.</b>	K00001
<b>description</b>	hose connector		

			
1			
<b>GEV No.</b>	695340	<b>Ref. No.</b>	K01805
<b>description</b>	hose connector		

			
1			
<b>GEV No.</b>	695339	<b>Ref. No.</b>	K01806
<b>description</b>	hose connector for hose ID 23-10-10-23mm plastic Qty 1 pcs		



## floats

## float containers



1

<b>GEV No.</b>	695073	<b>Ref. No.</b>	601002
<b>description</b>	float container		
<b>spare parts for</b>	695073		
	<b>GEV No.</b>	346872	<b>Ref. No.</b> 601003
	microswitch with lever 250V 0.1A 1CO connection male faston 6.3mm L 50mm ambient temperature max. 85°C mounting distance 22mm type D41X actuating force: 6g lever length 36mm		



1

<b>GEV No.</b>	402163	<b>Ref. No.</b>	K03054
<b>description</b>	float container L 150mm 250V cable lengthmm ømm mounting ømm 2CO 12A male faston 6.3mm		
<b>spare parts for</b>	402163		
	<b>GEV No.</b>	348044	<b>Ref. No.</b> —
	microswitch with plunger 250V 16A 1CO connection male faston 4.8mm Lmm L1 27.8mm ambient temperature max. 125°C mounting distance 22mm with lever set type MS1-16 actuating force: 45g white		

## miscellaneous



1

<b>GEV No.</b>	695349	<b>Ref. No.</b>	K01126
<b>description</b>	nut H 7mm thread M32x1.5 plastic WS 41 Qty 1 pcs		



1

<b>GEV No.</b>	695345	<b>Ref. No.</b>	K00057
<b>description</b>	pipe for inlet		

## equipment feet and end caps

## screw-in feet



1

<b>GEV No.</b>	695353	<b>Ref. No.</b>	K01086
<b>description</b>	equipment foot thread L 17mm ø 18mm H 40mm WS 24 Qty 1 pcs		

## gaskets

## O-rings

## EPDM

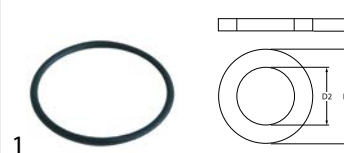

1

<b>GEV No.</b>	510447	<b>Ref. No.</b>	K03089
<b>description</b>	O-ring EPDM thickness 5.34mm ID ø 81.92mm Qty 1 pcs		

## silicone

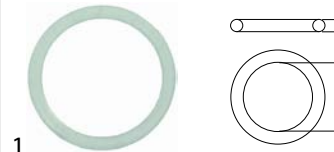

1

<b>GEV No.</b>	532517	<b>Ref. No.</b>	K01125
<b>description</b>	O-ring silicone thickness 1.78mm ID ø 17.17mm Qty 1 pcs		

## sealing washers

## rubber gaskets



1

<b>GEV No.</b>	695348	<b>Ref. No.</b>	K00536
<b>description</b>	sealing ring rubber ED ø 42mm ID ø 33mm thickness 2mm Qty 1 pcs		



1

<b>GEV No.</b>	695351	<b>Ref. No.</b>	K00003
<b>description</b>	sealing ring rubber ED ø 45mm ID ø 27mm thickness 2mm Qty 1 pcs		



## refrigeration cycle components

### cooling water regulators

#### JOHNSON CONTROLS



1

<b>GEV No.</b>	541186	<b>Ref. No.</b>	K00497
<b>description</b>	cooling water regulator 3/8" type V46SA-9951 connection 6mm soldering connection pressure range 5-23bar water pressure max. 18bar water temperature max. 90°C capillary pipe 750mm L 101mm		

### filter driers

#### CASTEL

##### STANDARD series

suitable for refrigerants R12, R22, R134a, R404A, R407C, R410A, R502, R507

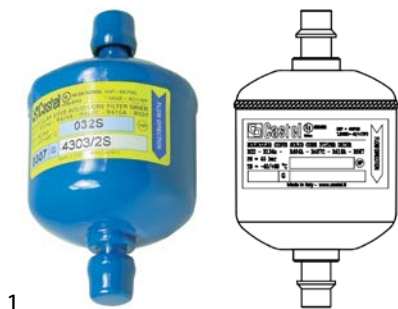

1

<b>GEV No.</b>	750038	<b>Ref. No.</b>	K00081
<b>description</b>	dryer type 4303/2S connection ODS 1/4"-ODM 3/8" 50cm <sup>3</sup> p max 45bar -40 up to +80°C		



1

<b>GEV No.</b>	750039	<b>Ref. No.</b>	K00478
<b>description</b>	dryer type 4305/2S connection ODS 1/4"-ODM 3/8" 80cm <sup>3</sup> p max 45bar -40 up to +80°C 254g		

### miscellaneous



1

<b>GEV No.</b>	750222	<b>Ref. No.</b>	K00199
<b>description</b>	dryer size 15g ø 18.9mm L 119mm connection 2,4/6,7mm		

## evaporators

### for ice-cube maker

#### for ice cube maker



1

<b>GEV No.</b>	750191	<b>Ref. No.</b>	K00332
<b>description</b>	evaporator for ice-cube maker 108 cubes L 780mm W 275mm H 42mm KP130/75-KP160/75		



1

<b>GEV No.</b>	750188	<b>Ref. No.</b>	K00145
<b>description</b>	evaporator for ice-cube maker 24 cubes L 330mm W 198mm H 40mm KP21/5-KP30/10		

1



<b>GEV No.</b>	750189	<b>Ref. No.</b>	K00139
<b>description</b>	evaporator for ice-cube maker 36 cubes L 445mm W 198mm H 42mm KP44/15-KP50/26		



<b>GEV No.</b>	750390	<b>Ref. No.</b>	K04122
<b>description</b>	evaporator for ice-cube maker 40 cubes L 445mm W 198mm H 45mm		



<b>GEV No.</b>	750190	<b>Ref. No.</b>	K00138 K04291+K04123
<b>description</b>	evaporator for ice-cube maker 60 cubes L 673mm W 198mm H 45mm KP75/40-KP100/60		

## hoses

### industrial hoses

#### PVC hoses

#### PVC braided hoses

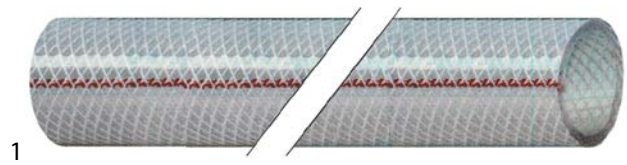

<b>GEV No.</b>	530564	<b>Ref. No.</b>	K00073
<b>description</b>	PVC braided hose ID ø 10mm ED ø 16mm L 10m thickness 3mm operating p. 10bar burst p. 30bar t.max. 60°C		

#### PVC hoses without fabric

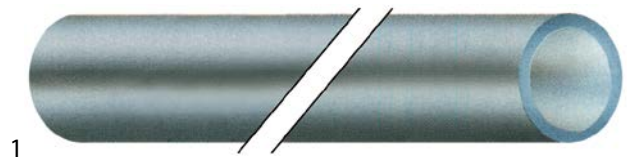

<b>GEV No.</b>	530721	<b>Ref. No.</b>	00003297 K00541 K01209
<b>description</b>	PVC hose ID ø 13mm ED ø 19mm L 5m thickness 3mm transparent		

## fittings, hose and pipe connectors

### hose connectors

#### without screw connection



<b>GEV No.</b>	517166	<b>Ref. No.</b>	K00010
<b>description</b>	Y-piece plastic hose ø 10-10-10mm 3-way		



<b>GEV No.</b>	695343	<b>Ref. No.</b>	K00230
<b>description</b>	T-piece plastic hose ø 19-19-19mm 3-way		



hose connectors

producer-specific



1

<b>GEV No.</b>	695336	<b>Ref. No.</b>	K00578
<b>description</b>	hose connector		



1

<b>GEV No.</b>	695337	<b>Ref. No.</b>	K00001
<b>description</b>	hose connector		



1

<b>GEV No.</b>	695340	<b>Ref. No.</b>	K01805
<b>description</b>	hose connector		



1

<b>GEV No.</b>	695339	<b>Ref. No.</b>	K01806
<b>description</b>	hose connector for hose ID 23-10-10-23mm plastic Qty 1 pcs		

fastening material

screws

knurled screws



1

<b>GEV No.</b>	695354	<b>Ref. No.</b>	K00013
<b>description</b>	Thumb screw thread M4 thread L 10mm ø 10mm H 6mm SS		





**B**

bi-metal thermostats 3

**C**

compressors 6  
 contactors 4  
 cooling water regulators 15

**E**

evaporators 15

**F**

fans 7  
 fastening material 17  
 filter driers 15  
 float switches 3

**H**

hose connectors 16, 17  
 hoses 16

**I**

industrial hoses 16

**K**

knurled screws 17

**M**

microswitches 3  
 motors 8

**O**

O-rings 14

**P**

pressure switches 6  
 probes 4  
 programme timers 3  
 pumps 8  
 pumps for ice machines 8  
 PVC hoses 16

**R**

refrigeration cycle components 15  
 refrigeration fans 7  
 refrigeration motors universal 7  
 refrigeration thermostats 3

**S**

safety bi-metal thermostats 3  
 screws 17  
 sealing washers 14

solenoid valves 4  
 switches and momentary switches 3

**T**

thermostats 3  
 timers 3