



**GAS COMPONENTS**



**ELECTRIC COMPONENTS**



**WATER TECHNOLOGY**



**MECHANICAL COMPONENTS**



**TOOLS**

Spare parts suitable for

**KÜPPERSBUSCH**

Find the complete and up-to-date range of products in our GEV Webshop



# Manufacturer catalogue

The most important spare parts and accessories arranged clearly for every manufacturer

- ✓ Complete product range and all appliance data always up to date in the GEV Webshop
- ✓ Alphabetical Index at the end of the catalogue

## GEV Webshop

[www.gev-online.co.uk](http://www.gev-online.co.uk)

[www.gev-online.com](http://www.gev-online.com)



- 🔍 Add to Favourites
- 🔍 Sign In with email address and usual password
- 🔍 Easy-order – place several items in your basket at the same time
- 🔍 Quick Item search – no login needed



# heating elements

## heating elements for ovens

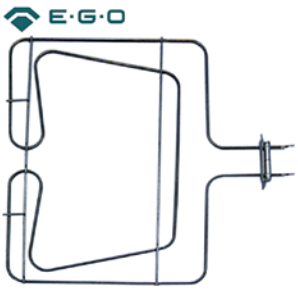

1

<b>GEV No.</b>	416915	<b>Ref. No.</b>	182323
<b>description</b>	heating element 1500W 230V heating circuits 1 L 460mm W 484mm L1 107mm W2 62mm flange length 104mm flange width 32mm tilt flange oven		
<b>For models:</b>	LEH405, LEH503, LEH505, LEH605, LEH703, LEH705, LGH405, LGH605		

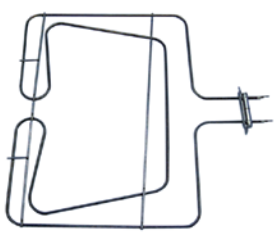

1

<b>GEV No.</b>	415995	<b>Ref. No.</b>	182322
<b>description</b>	heating element 1500W 400V heating circuits 1 L 460mm W 484mm L1 107mm L2 360mm W1 211mm W2 62mm flange length 104mm flange width 32mm hole distance 96/39mm hole ø 4mm tube ø 6.4mm connection male faston 6.3mm connection length 51mm tilt flange dry heating element		
<b>For models:</b>	EEH413, EEH503, EEH613, EEH703, EGH413, EGH613, LEH405, LEH503, LEH505, LEH605, LEH703, LEH705, LGH405, LGH605		



1

<b>GEV No.</b>	416916	<b>Ref. No.</b>	182326
<b>description</b>	heating element 2000W 230V heating circuits 1 L 490mm W 575mm L1 40mm L2 450mm W1 257mm W2 60mm flange length 105mm flange width 34mm tube ø 6.5mm tilt flange oven		
<b>For models:</b>	NEH413, NEH415, NEH505, NEH613, NEH615, NEH705, NGH403, NGH405, NGH503, NGH505, NGH603, NGH605, NGH723, NGH725		



1

<b>GEV No.</b>	415795	<b>Ref. No.</b>	182325
<b>description</b>	heating element 2000W 400V heating circuits 1 L 490mm W 575mm L1 40mm L2 450mm W1 257mm W2 60mm flange length 105mm flange width 34mm hole distance 38mm hole ø 4mm tube ø 6.5mm connection male faston 6.3mm tilt flange dry heating element oven		
<b>For models:</b>	FEH413, FEH415, FEH503, FEH505, FEH513, FEH515, FEH613, FEH615, FEH705, FEH715, FGH413, FGH415, FGH613, FGH615, NEH413, NEH415, NEH505, NEH613, NEH615, NEH705, NGH403, NGH405, NGH413, NGH415, NGH503, NGH505, NGH603, NGH605, NGH613, NGH615, NGH723, NGH725, NGH733		

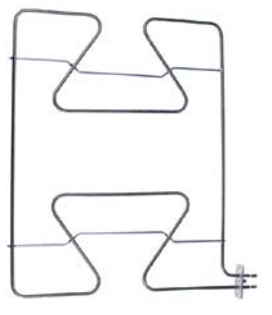

1

<b>GEV No.</b>	418223	<b>Ref. No.</b>	540471
<b>description</b>	heating element 2000W 400V L 490mm W 560mm L1 25mm L2 465mm W1 530mm W2 30mm flange length 70mm flange width 22mm hole distance 56mm hole ø M4mm tube ø 6.3mm connection length 41mm connection male faston 6.3mm heating circuits 1 rectangular flange dry heating element oven		

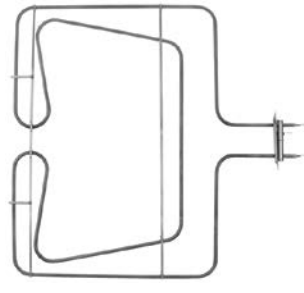

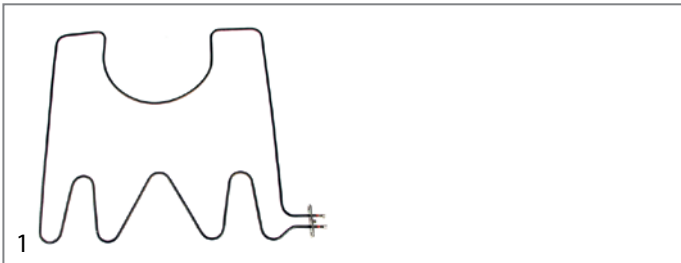

1

<b>GEV No.</b>	417605	<b>Ref. No.</b>	160631
<b>description</b>	heating element 2100W 400V L 465mm W 480mm H 10mm tube ø 6.5mm heating circuits 1 oven		

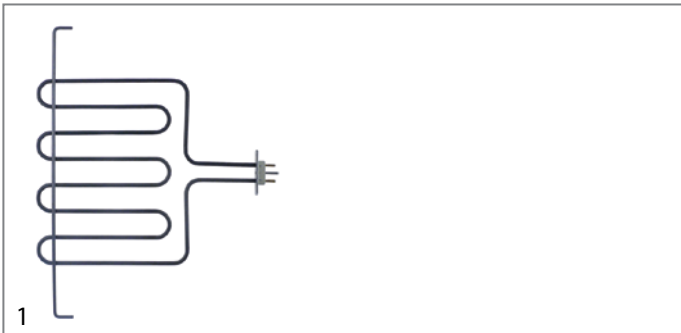

<b>GEV No.</b>	418364	<b>Ref. No.</b>	182474 182478
<b>description</b>	heating element 2250W 380V L 598mm W 553mm L1 55mm L2 543mm W1 488mm W2 30mm flange length 70mm flange width 22mm hole distance 56mm hole ø 6mm tube ø 6.5mm connection length 34mm connection male faston 6.3mm heating circuits 1 rectangular flange dry heating element		
<b>For models:</b>	EGN401, EHN401, EHN601, EHN801		



<b>GEV No.</b>	418359	<b>Ref. No.</b>	160106 181738 182665
<b>description</b>	heating element 2500W 230V L 338mm W 288mm L1 104mm L2 234mm W1 135mm W2 32mm bridge length 450mm windings 4 connection plug-in connection heating circuits 1 tube ø 6.3mm rectangular flange dry heating element hole distance 55mm flange length 72mm flange width 22mm hole ø 3mm		
<b>For models:</b>	ECL484		
<b>accessories for</b>	418359		
	<b>GEV No.</b>	550404	<b>Ref. No.</b> —
	power socket I-II phase 240V max. 16A countries I with screw connection for heating element		
	<b>GEV No.</b>	550405	<b>Ref. No.</b> 184583
	power socket male faston 6.3mm for heating element 2-pole + earthing		

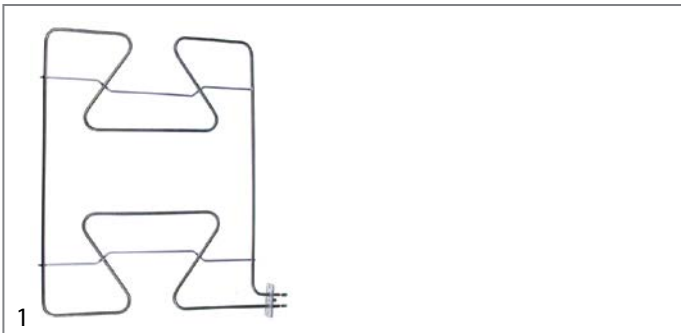





<b>GEV No.</b>	418222	<b>Ref. No.</b>	540831
<b>description</b>	heating element 2800W 400V L 500mm W 560mm L1 50mm L2 450mm W1 530mm W2 30mm flange length 70mm flange width 22mm hole distance 56mm tube ø 6.3mm dry heating element oven		



<b>GEV No.</b>	550405	<b>Ref. No.</b>	184583
<b>description</b>	power socket male faston 6.3mm for heating element 2-pole + earthing		
<b>For models:</b>	ECL484		

heating elements for bain maries





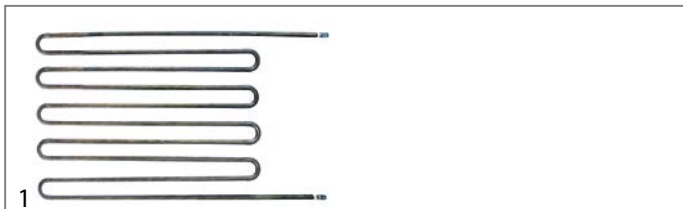



<b>GEV No.</b>	415608	<b>Ref. No.</b>	182403
<b>description</b>	heating element 2000W 230V heating circuits 1 L 430mm W 135mm connection length 20mm connection male faston 6.3mm tube ø 6.3mm 2 hole fixing thread M14x1.5 dry heating element L1 50mm L2 380mm W1 100mm W2 38mm mounting distance 32mm		
<b>For models:</b>	EWB201, EWB201-mit-Thermostat, EWN201, EWN401, EWN401-mit-beheizterm-Schrankraum, EWN402, EWP202, SEW250, SEW400, SEW450		
<b>spare parts for</b>	415608		
	<b>GEV No.</b>	510417	<b>Ref. No.</b> —
	flat gasket fibre ED ø 20mm ID ø 14mm thickness 2mm Qty 1 pcs		
<b>accessories for</b>	415608		
	<b>GEV No.</b>	520228	<b>Ref. No.</b> 40156998
	tooth lock washer ID ø 15.3mm ED ø 24mm steel Qty 1 pcs for thread M14		
	<b>GEV No.</b>	520230	<b>Ref. No.</b> 407298
	nut thread M14x1.5 H 5mm WS 19 zinc-coated steel Qty 1 pcs		
	<b>GEV No.</b>	521101	<b>Ref. No.</b> —
	nut thread M14x1.5 H 5mm WS 19 SS Qty 1 pcs		
	<b>GEV No.</b>	550262	<b>Ref. No.</b> —
	flat gasket copper ED ø 20mm ID ø 14mm thickness 2mm		







<b>GEV No.</b>	416936	<b>Ref. No.</b>	540635
<b>description</b>	heating element 2000W 230V heating circuits 1 L 470mm W 246mm connection male faston 6.3mm connection distance 240mm tube ø 6.5mm dry heating element bain marie		
<b>For models:</b>	EEW250, EEW450, EEW452		



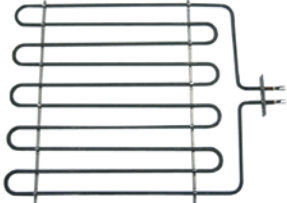

			
1			
<b>GEV No.</b>	415609	<b>Ref. No.</b>	182404
<b>description</b>	heating element 2000W 400V heating circuits 1 L 430mm W 135mm connection male faston 6.3mm tube ø 6.5mm 2 hole fixing thread M14x1.5 immersion heater L1 50mm L2 380mm W1 100mm W2 38mm mounting distance 32mm		
<b>For models:</b>	EWB201, EWB201-mit-Thermostat, EWN201, EWN401, EWN401-mit-beheizterm-Schrankraum, EWN402, SEW400, SEW450		
<b>accessories for</b>	415609		
	<b>GEV No.</b>	510417	<b>Ref. No.</b> —
flat gasket fibre ED ø 20mm ID ø 14mm thickness 2mm Qty 1 pcs			
	<b>GEV No.</b>	520228	<b>Ref. No.</b> 40156998
tooth lock washer ID ø 15.3mm ED ø 24mm steel Qty 1 pcs for thread M14			
	<b>GEV No.</b>	520230	<b>Ref. No.</b> 407298
nut thread M14x1.5 H 5mm WS 19 zinc-coated steel Qty 1 pcs			
	<b>GEV No.</b>	521101	<b>Ref. No.</b> —
nut thread M14x1.5 H 5mm WS 19 SS Qty 1 pcs			
	<b>GEV No.</b>	550262	<b>Ref. No.</b> —
flat gasket copper ED ø 20mm ID ø 14mm thickness 2mm			



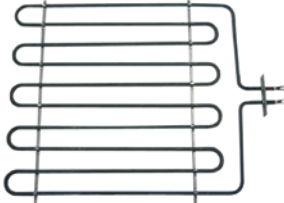

			
1			
<b>GEV No.</b>	415988	<b>Ref. No.</b>	182328
<b>description</b>	heating element 3000W 230V heating circuits 1 L 420mm W 330mm L1 36mm L2 383mm W1 147mm W2 30mm flange length 70mm flange width 23mm hole distance 56mm connection male faston 6.3mm tube ø 6.5mm rectangular flange mounting thread M3 dry heating element		
<b>For models:</b>	LEW450, LEW452, NEW180, NEW182, NEW250, NEW252, NEW450, NEW452, PEW658		
<b>accessories for</b>	415988		
	<b>GEV No.</b>	527169	<b>Ref. No.</b> —
hexagonal nut thread M3 H 2.8mm WS 5.5 brass Qty 1 pcs			
	<b>GEV No.</b>	560110	<b>Ref. No.</b> —
plain washer ID ø 3.2mm ED ø 7mm thickness 0.5mm SS Qty 20 pcs DIN 125A for thread M3			
	<b>GEV No.</b>	560130	<b>Ref. No.</b> —
hexagonal nut thread M3 H 2.4mm WS 5.5 SS DIN/ISO DIN 934 / ISO 4032/8673 Qty 20 pcs			

			
1			
<b>GEV No.</b>	415589	<b>Ref. No.</b>	182327
<b>description</b>	heating element 3000W 400V heating circuits 1 L 420mm W 330mm flange length 70mm flange width 22mm hole distance 57mm connection male faston 6.3mm tube ø 6.3mm flange 70 x 22mm dry heating element L1 41mm L2 383mm W1 149mm W2 31mm		
<b>For models:</b>	FEW250, FEW252, LEW450, LEW452, NEW250, NEW252, NEW450, NEW452, PEW458		



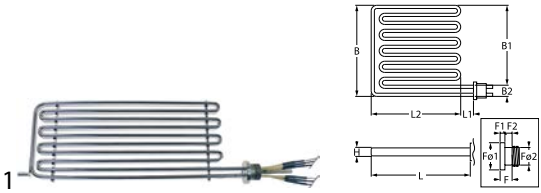

heating elements for fryers

side connection

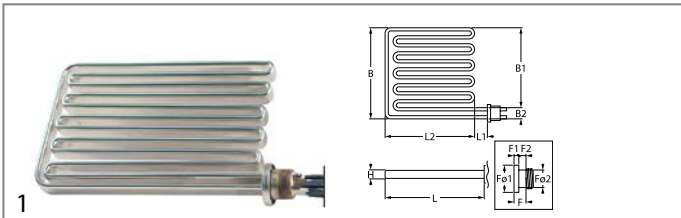
with thread

			
1			
<b>GEV No.</b>	416906	<b>Ref. No.</b>	540618
<b>description</b>	heating element 7000W 230/400V heating circuits 3 mounting pos. left L 458mm W 178mm H 22mm flange length 20mm flange length 1 9.8mm flange length 2 9.7mm flange ø1 51mm flange ø2 36mm thermostat sleeves ø 5.5mm length thermostat sleeves 180/270mm number of thermostat sleeves 2 L1 43mm L2 415mm W1 155mm W2 23mm thread M36x1.5 windings 4 cable length 650mm rotation flange immersion heater for fryer/pasta cooker connection length 75mm		
<b>For models:</b>	EEW400		
<b>accessories for</b>	416906		
	<b>GEV No.</b>	521004	<b>Ref. No.</b> 540540
hexagonal nut thread M36x1.5 WS 46 H 14mm brass			
	<b>GEV No.</b>	550673	<b>Ref. No.</b> 540538
flat gasket PTFE D1 ø 46mm D2 ø 36/38.2mm thickness 5mm Qty 1 pcs mounting pos. outer			
	<b>GEV No.</b>	550674	<b>Ref. No.</b> 540537
flat gasket PTFE ED ø 46mm ID ø 36mm thickness 4mm Qty 1 pcs mounting pos. inner			
	<b>GEV No.</b>	692060	<b>Ref. No.</b> —
retaining ring brass H 10mm ID ø 36mm ED ø 50mm			



<b>GEV No.</b>	416910	<b>Ref. No.</b>	540558
<b>description</b>	heating element 8000W 230/400V heating circuits 3 L 300mm W 185mm H 22mm flange length 20mm flange length 1 9mm flange length 2 11mm flange ø1 51mm flange ø2 36mm thermostat sleeves ø 4mm length thermostat sleeves 280/300mm number of thermostat sleeves 2 L1 15mm L2 285mm W1 162mm W2 23mm thread M36x1.5 windings 5 cable length 650mm rotation flange immersion heater pasta cooker		
<b>For models:</b>	EEF124, EEF224		
<b>accessories for</b>	416910		
	<b>GEV No.</b>	521004	<b>Ref. No.</b> 540540
	hexagonal nut thread M36x1.5 WS 46 H 14mm brass		
	<b>GEV No.</b>	550673	<b>Ref. No.</b> 540538
	flat gasket PTFE D1 ø 46mm D2 ø 36/38.2mm thickness 5mm Qty 1 pcs mounting pos. outer		
	<b>GEV No.</b>	550674	<b>Ref. No.</b> 540537
	flat gasket PTFE ED ø 46mm ID ø 36mm thickness 4mm Qty 1 pcs mounting pos. inner		
	<b>GEV No.</b>	692060	<b>Ref. No.</b> —
	retaining ring brass H 10mm ID ø 36mm ED ø 50mm		

### miscellaneous



<b>GEV No.</b>	418372	<b>Ref. No.</b>	182398
<b>description</b>	heating element 9000W 230/400V		
<b>For models:</b>	NEF144		

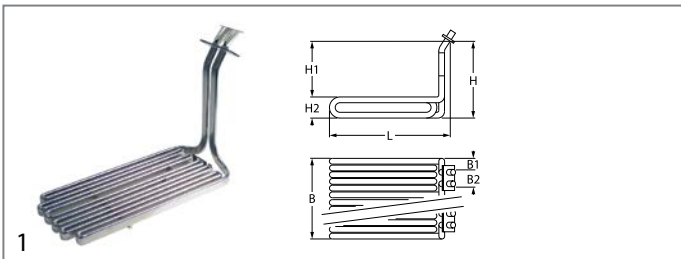

<b>GEV No.</b>	418263	<b>Ref. No.</b>	540441
<b>description</b>	heating element 7200W 230/400V heating circuits 3 L 360mm W 150mm H 220mm L1 25mm L2 335mm W1 58mm W2 42mm flange length 75mm flange width 30mm hole distance 63mm hole ø 5.5mm rectangular flange immersion heater		

### with round flange ø47.5mm

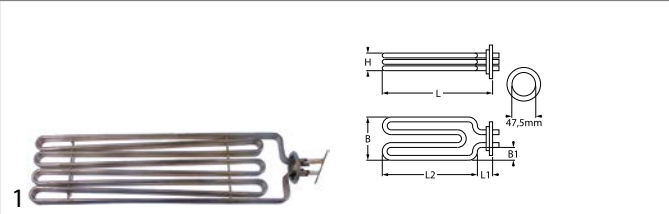

<b>GEV No.</b>	416941	<b>Ref. No.</b>	181734 182338
<b>description</b>	heating element 9900W 230/400V mounting ø 47.5mm heating circuits 3 L 510mm W 138mm H 23mm L1 21mm L2 489mm W1 51mm W2 36mm round flange connection cable cable length 160mm immersion heater tube ø 6.3mm connection length 55mm		
<b>For models:</b>	FEF170, FEF180, NEF176, PEF178, PEF188		
<b>accessories for</b>	416941		
	<b>GEV No.</b>	510408	<b>Ref. No.</b> 060842
	O-ring EPDM thickness 5.34mm ID ø 47mm Qty 1 pcs		
	<b>GEV No.</b>	510562	<b>Ref. No.</b> —
	O-ring silicone thickness 5.34mm ID ø 47mm Qty 1 pcs		
	<b>GEV No.</b>	550002	<b>Ref. No.</b> 144280
	tension strap H 10mm L 21mm W 10mm hole ø 6.5mm for heating element		
	<b>GEV No.</b>	550675	<b>Ref. No.</b> 060840
	O-ring Viton thickness 6mm ID ø 47mm Qty 1 pcs		

### 2 hole fixing

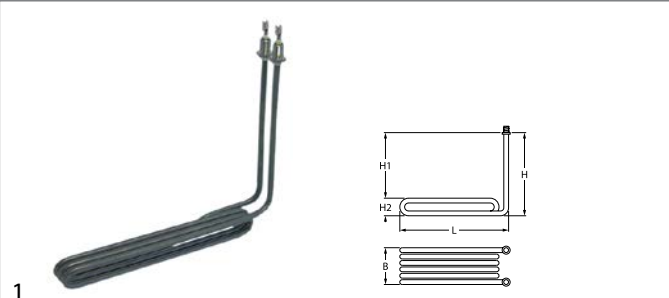

<b>GEV No.</b>	415591	<b>Ref. No.</b>	182651
<b>description</b>	heating element 2000W 230V heating circuits 1 L 285mm W 40mm H 240mm H1 200mm H2 40mm mounting pos. 20 thread M14x1.5 tube ø 8.5mm mounting distance 20mm windings 3 2 hole fixing connection male faston 6.3mm immersion heater		
<b>For models:</b>	LEF124, LEF224, NEF124, NEF224, SEF124, SEF224, TEF124, TEF224		





<b>For models:</b>	LEF124, LEF224, NEF124, NEF224, SEF124, SEF224, TEF124, TEF224		
<b>spare parts for</b>	415591		
	<b>GEV No.</b>	510417	<b>Ref. No.</b> —
	flat gasket fibre ED ø 20mm ID ø 14mm thickness 2mm Qty 1 pcs		
<b>accessories for</b>	415591		
	<b>GEV No.</b>	520228	<b>Ref. No.</b> 40156998
	tooth lock washer ID ø 15.3mm ED ø 24mm steel Qty 1 pcs for thread M14		
	<b>GEV No.</b>	520230	<b>Ref. No.</b> 407298
	nut thread M14x1.5 H 5mm WS 19 zinc-coated steel Qty 1 pcs		
	<b>GEV No.</b>	521101	<b>Ref. No.</b> —
	nut thread M14x1.5 H 5mm WS 19 SS Qty 1 pcs		

Table continues overleaf





<b>accessories for</b>	415591		
	<b>GEV No.</b>	550262	<b>Ref. No.</b> —
	flat gasket copper ED ø 20mm ID ø 14mm thickness 2mm		

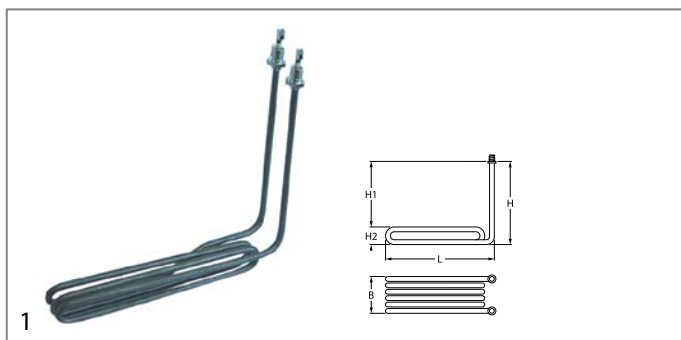

<b>GEV No.</b>	415978	<b>Ref. No.</b>	182652
<b>description</b>	heating element 3000W 230V heating circuits 1 L 288mm W 48mm H 243mm H1 205mm H2 38mm thread M14x1.5 tube ø 8.5mm windings 3 2 hole fixing connection male faston 6.3mm		
<b>For models:</b>	FEF124, FEF144, FEF144e, FEF224, FEF224e, LEF124, LEF224, NEF124, NEF144, NEF224, NEF244, PEF128, PEF148, PEF228, SEF124, SEF144, SEF224, TEF124, TEF144, TEF224		

<b>spare parts for</b>	415978		
	<b>GEV No.</b>	510417	<b>Ref. No.</b> —
	flat gasket fibre ED ø 20mm ID ø 14mm thickness 2mm Qty 1 pcs		

<b>accessories for</b>	415978		
	<b>GEV No.</b>	510417	<b>Ref. No.</b> —
	flat gasket fibre ED ø 20mm ID ø 14mm thickness 2mm Qty 1 pcs		

	<b>GEV No.</b>	520228	<b>Ref. No.</b>	40156998
	tooth lock washer ID ø 15.3mm ED ø 24mm steel Qty 1 pcs for thread M14			

	<b>GEV No.</b>	520230	<b>Ref. No.</b>	407298
	nut thread M14x1.5 H 5mm WS 19 zinc-coated steel Qty 1 pcs			

	<b>GEV No.</b>	521101	<b>Ref. No.</b>	—
	nut thread M14x1.5 H 5mm WS 19 SS Qty 1 pcs			

	<b>GEV No.</b>	550262	<b>Ref. No.</b>	—
	flat gasket copper ED ø 20mm ID ø 14mm thickness 2mm			

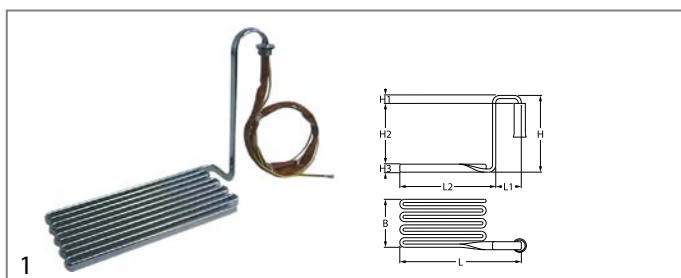

<b>GEV No.</b>	415613	<b>Ref. No.</b>	540401
<b>description</b>	heating element 8000W 380V heating circuits 3 L 423mm W 145mm H 308mm L1 65mm L2 358mm W1 65mm W2 17mm H1 33mm H2 258mm H3 17mm thread M26x1.5 cable length 1200mm immersion heater		

heating elements for griddles

	<b>GEV No.</b>	418238	<b>Ref. No.</b>	540458
<b>description</b>	heating element 2000W 400V heating circuits 1 L 494mm W 96mm H 29mm tube ø 6.3mm rectangular flange connection male faston 6.3mm hole distance 36mm flange length 45mm flange width 16mm connection length 28mm mounting thread M4 dry heating element			

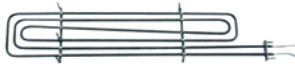
	<b>GEV No.</b>	415824	<b>Ref. No.</b>	182356
<b>description</b>	heating element 2000W 400V heating circuits 1 L 533mm W 92mm Hmm tube ø 6.3mm L1 50mm L2 483mm W1 68mm W2 24mm rectangular flange connection cable hole distance 36mm cable length 365mm flange length 45mm flange width 16mm mounting thread M4 dry heating element			

	<b>GEV No.</b>	415593	<b>Ref. No.</b>	160104 182330
<b>description</b>	heating element 2565W 230V L 554mm W 125mm H 30mm connection male faston 6.3mm dry heating element heating circuits 1 tube ø 8.5mm W1 40mm W2 45mm rectangular flange hole distance 56mm flange length 70mm flange width 22mm hole ø 5mm connection length 34mm			
<b>For models:</b>	NEB430, NEB630, NEG420, NEP600, NEP900			

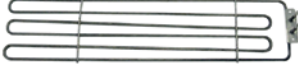
	<b>GEV No.</b>	415594	<b>Ref. No.</b>	182329
<b>description</b>	heating element 2565W 400V L 556mm W 126mm H 33mm connection male faston 6.3mm dry heating element heating circuits 1 tube ø 6.3mm W1 48mm W2 30mm rectangular flange hole distance 56mm flange length 70mm flange width 22mm mounting thread M4			
<b>For models:</b>	NEB430, NEB630, NEG420, NEP600, NEP900			

heating elements for tilting bratt pan

	<b>GEV No.</b>	415964	<b>Ref. No.</b>	181733 182344
<b>description</b>	heating element 2350W 230V L 510mm W 130mm H 30mm connection male faston dry heating element heating circuits 1 tube ø 6.3mm W1 50mm W2 30mm rectangular flange hole distance 56mm flange length 70mm flange width 22mm hole ø 5mm connection length 18mm			
<b>For models:</b>	NEP203, NEP303			

heating elements for pasta cookers



<b>GEV No.</b>	415593	<b>Ref. No.</b>	160104 182330
<b>description</b>	heating element 2565W 230V L 554mm W 125mm H 30mm connection male faston 6.3mm dry heating element heating circuits 1 tube ø 8.5mm W1 40mm W2 45mm rectangular flange hole distance 56mm flange length 70mm flange width 22mm hole ø 5mm connection length 34mm		
<b>For models:</b>	NEB430, NEB630, NEG420, NEP600, NEP900		



<b>GEV No.</b>	415594	<b>Ref. No.</b>	182329
<b>description</b>	heating element 2565W 400V L 556mm W 126mm H 33mm connection male faston 6.3mm dry heating element heating circuits 1 tube ø 6.3mm W1 48mm W2 30mm rectangular flange hole distance 56mm flange length 70mm flange width 22mm mounting thread M4		
<b>For models:</b>	NEB430, NEB630, NEG420, NEP600, NEP900		

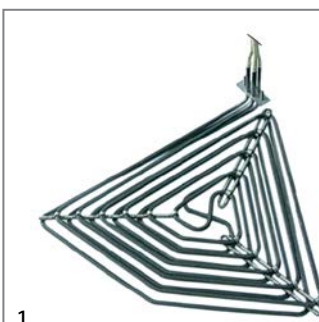

<b>GEV No.</b>	415314	<b>Ref. No.</b>	181730 182519 182730
<b>description</b>	heating element 5500W 230V L 375mm W 380mm H 35mm connection cable dry heating element heating circuits 2 tube ø 6.5mm rectangular flange hole distance 41mm flange length 60mm flange width 25mm mounting thread M5		

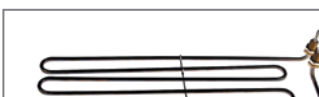





<b>GEV No.</b>	418365	<b>Ref. No.</b>	182458
<b>description</b>	heating element griddle 2000W 230V L 444mm W 127mm H 20mm connection male faston 6.3mm dry heating element tube ø 6.3mm W1 95mm W2 34mm 2 hole fixing thread M14x1.5 mounting distance 28mm		
<b>For models:</b>	EGP202		





<b>GEV No.</b>	416944	<b>Ref. No.</b>	160114 160120
<b>description</b>	heating element pressure kettle 1800W 235V L 565mm W 85mm Hmm connection male faston dry heating element heating circuits 1 tube ø 6.3mm W1 57mm W2 28mm 2 hole fixing thread 1/8" mounting distance 22mm		
<b>For models:</b>	FEP230, FEP330, FEP600, FEP610, FEP900, FEP910, PEP238, PEP338, PEP608, PEP618, PEP908, PEP918		



<b>GEV No.</b>	416906	<b>Ref. No.</b>	540618
<b>description</b>	heating element 7000W 230/400V heating circuits 3 mounting pos. left L 458mm W 178mm H 22mm flange length 20mm flange length 1 9.8mm flange length 2 9.7mm flange ø1 51mm flange ø2 36mm thermostat sleeves ø 5.5mm length thermostat sleeves 180/270mm number of thermostat sleeves 2 L1 43mm L2 415mm W1 155mm W2 23mm thread M36x1.5 windings 4 cable length 650mm rotation flange immersion heater for fryer/pasta cooker connection length 75mm		
<b>For models:</b>	EEW400		
<b>accessories for</b>	416906		
	<b>GEV No.</b>	521004	<b>Ref. No.</b> 540540
	hexagonal nut thread M36x1.5 WS 46 H 14mm brass		
	<b>GEV No.</b>	550673	<b>Ref. No.</b> 540538
	flat gasket PTFE D1 ø 46mm D2 ø 36/38.2mm thickness 5mm Qty 1 pcs mounting pos. outer		
	<b>GEV No.</b>	550674	<b>Ref. No.</b> 540537
	flat gasket PTFE ED ø 46mm ID ø 36mm thickness 4mm Qty 1 pcs mounting pos. inner		
	<b>GEV No.</b>	692060	<b>Ref. No.</b> —
	retaining ring brass H 10mm ID ø 36mm ED ø 50mm		



<b>GEV No.</b>	416910	<b>Ref. No.</b>	540558
<b>description</b>	heating element 8000W 230/400V heating circuits 3 L 300mm W 185mm H 22mm flange length 20mm flange length 1 9mm flange length 2 11mm flange ø1 51mm flange ø2 36mm thermostat sleeves ø 4mm length thermostat sleeves 280/300mm number of thermostat sleeves 2 L1 15mm L2 285mm W1 162mm W2 23mm thread M36x1.5 windings 5 cable length 650mm rotation flange immersion heater pasta cooker		
<b>For models:</b>	EEF124, EEF224		
<b>accessories for</b>	416910		
	<b>GEV No.</b>	521004	<b>Ref. No.</b> 540540
	hexagonal nut thread M36x1.5 WS 46 H 14mm brass		
	<b>GEV No.</b>	550673	<b>Ref. No.</b> 540538
	flat gasket PTFE D1 ø 46mm D2 ø 36/38.2mm thickness 5mm Qty 1 pcs mounting pos. outer		
	<b>GEV No.</b>	550674	<b>Ref. No.</b> 540537
	flat gasket PTFE ED ø 46mm ID ø 36mm thickness 4mm Qty 1 pcs mounting pos. inner		
	<b>GEV No.</b>	692060	<b>Ref. No.</b> —
	retaining ring brass H 10mm ID ø 36mm ED ø 50mm		



heating elements for chargrills

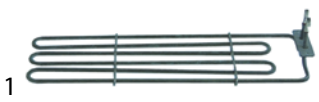

<b>GEV No.</b>	415595	<b>Ref. No.</b>	182332
<b>description</b>	heating element 1900W 400V L 410mm W 125mm H 28mm hole distance 56mm windings 3 W1 45mm W2 31mm flange length 70mm flange width 22mm connection male faston 6.3mm heating circuits 1 tube ø 6.3mm mounting thread M4 rectangular flange dry heating element		
<b>For models:</b>	LEB270, LEB430, LEG420, LEP400, NEP400, SEB230, SEB430, SEB630, SEG220, SEG420, SEG620, SES400		

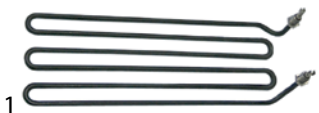

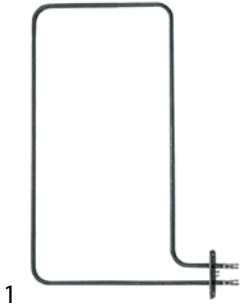

<b>GEV No.</b>	415592	<b>Ref. No.</b>	182653
<b>description</b>	heating element 2000W 230V L 400mm W 142mm H 64mm thread M14x1.5 mounting distance 94mm tube ø 8.5mm connection male faston 6.3mm windings 3 heating circuits 1 connection length 39mm 2 hole fixing dry heating element W1 21mm W2 102mm		
<b>For models:</b>	SER400, SER600		

heating elements for heated cabinets



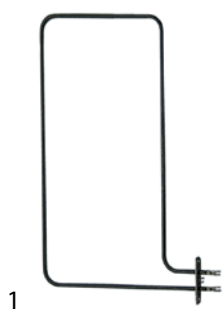



<b>GEV No.</b>	416919	<b>Ref. No.</b>	182475
<b>description</b>	heating element 500W 230V heating circuits 1 L 405mm W 260mm flange length 70mm flange width 22mm hole distance 56mm connection male faston 6.3mm tube ø 6.3mm rectangular flange hole ø 5mm dry heating element L1 375mm L2 30mm W1 53mm W2 207mm		
<b>For models:</b>	EHN601, EHP601, EWN401-mit-beheizterm-Schrankraum, LEH605, LEH703, LEH705, LGH605, LGH607, NEA182, NEH613, NEH705, NGH603, NGH723		



<b>GEV No.</b>	415970	<b>Ref. No.</b>	182476	
<b>description</b>	heating element 650W 400V heating circuits 1 L 405mm W 260mm flange length 70mm flange width 22mm hole distance 56mm connection male faston 6.3mm tube ø 6.3mm rectangular flange hole ø 5mm L1 375mm L2 30mm W1 53mm W2 207mm			
<b>For models:</b>	EHN601, EWN401-mit-beheizterm-Schrankraum, LEH605, LEH703, LEH705, LEW452, LGH605, NEH613, NEH705, NGH603, NGH613, NGH723, NGH733			
<b>accessories for</b>	415970			
	<b>GEV No.</b>	510368	<b>Ref. No.</b>	—
	gasket L 70mm W 23.5mm hole ø 5mm hole distance 56mm FIBER thickness 2mm for heating element			

bottom heaters



<b>GEV No.</b>	415760	<b>Ref. No.</b>	540463	
<b>description</b>	bottom heater 1800W 230V heating circuits 1 ø 196mm safety thermostat °C thermostat 128°C M5 mounting distance 180mm			
<b>spare parts for</b>	415760			
	<b>GEV No.</b>	375300	<b>Ref. No.</b>	—
	thermostat t.max. 128°C temperature range 35-128°C 1-pole 1NO 16A probe ø 3.1mm probe L 174mm capillary pipe 880mm capillary pipe isolated 800mm gland nut shaft L 23mm shaft position lower rotation 270°			
<b>accessories for</b>	415760			
	<b>GEV No.</b>	520323	<b>Ref. No.</b>	—
	gasket ID ø 160mm ED ø 200mm hole distance 90/180mm hole ø 7mm silicone for bottom heaters			
	<b>GEV No.</b>	520324	<b>Ref. No.</b>	—
	counterflange ID ø 160mm ED ø 200mm hole distance 90/180mm hole ø 7mm SS for bottom heaters			







heaters





			
1			
<b>GEV No.</b>	418604	<b>Ref. No.</b>	948746006
<b>description</b>	heater 5400W 230V heating circuits 3 L 650mm W 325mm H 70mm connection cable cable length 250mm		

heater battery

			
1			
<b>GEV No.</b>	415122	<b>Ref. No.</b>	402628
<b>description</b>	heater battery mounting distance 185mm W 40mm H 35mm 2000W 230V temperature restriction 105°C heating circuits 2 connection cable cable length 340mm L 197mm for cross flow fan		
<b>For models:</b>	FEH613, FEH615, FEH705, FEH715, FEW252, FGH613, FGH615, FGH617, NEA182, NEH212, NEH615, NEH705, NEW182, NEW252, NEW452, NGH202, NGH605, NGH607, NGH615, NGH617, NGH725, NGH727, NGH737		







pilot heating elements

			
1			
<b>GEV No.</b>	415607	<b>Ref. No.</b>	181729 182311
<b>description</b>	heating element 500W 230V heating circuits 1 thread 3/4" L 295mm W 20mm H 19mm length thermostat sleeves 235mm thermostat sleeves ø 6mm number of thermostat sleeves 1 thermostat sleeve clinging tube ø 6.5mm immersion heater flange with thread connection length 50mm pilot heating element		
<b>For models:</b>	CBE106-VAR091, CBE110-VAR091, CBE120-VAR091, CBE220-VAR091, CCE106, CCE110, CCE120, CCE220, CED106, CED110, CED120, CED220, CEF106, CEF110, CEF120, CEF220, CEM110, CEM120, CPE106, CPE110, CPE120, CPE220, EES060, EES080, FED080, FED150, FED250, FED300, FEK040, FEK060, FEK080, FEK100, FEK150, FER080, FER150, FER250, FER300, FER400, FES040, FES060, FES080, FES100, FES150, LES060, NED080, NED150, NED250, NED300, NEK040, NEK060...(Other models you can see in the webshop)		
<b>spare parts for</b>	415607		
	<b>GEV No.</b>	510403	<b>Ref. No.</b> —
	flat gasket fibre ED ø 36.5mm ID ø 27mm thickness 2mm Qty 1 pcs		
<b>accessories for</b>	415607		
	<b>GEV No.</b>	510421	<b>Ref. No.</b> —
	gasket copper ED ø 31.8mm ID ø 26.4mm thickness 2.2mm for thread 3/4"		
	<b>GEV No.</b>	520234	<b>Ref. No.</b> 166103
	nut thread 3/4" H 5mm brass WS 30 Qty 1 pcs		

			
1			
<b>GEV No.</b>	415653	<b>Ref. No.</b>	182415 540824
<b>description</b>	heating element 600W 230V heating circuits 1 mounting ø 47.5mm L 280mm W 36mm H 16mm round flange connection male faston 6.3mm immersion heater tube ø 6.3mm thermostat sleeves ø 7mm length thermostat sleeves 220mm number of thermostat sleeves 1 pilot heating element		
<b>spare parts for</b>	415653		
	<b>GEV No.</b>	510408	<b>Ref. No.</b> 060842
	O-ring EPDM thickness 5.34mm ID ø 47mm Qty 1 pcs		
<b>accessories for</b>	415653		
	<b>GEV No.</b>	510562	<b>Ref. No.</b> —
	O-ring silicone thickness 5.34mm ID ø 47mm Qty 1 pcs		
	<b>GEV No.</b>	550675	<b>Ref. No.</b> 060840
	O-ring Viton thickness 6mm ID ø 47mm Qty 1 pcs		

immersion heating elements



3 hole flange ø47.5mm

			
1			
<b>GEV No.</b>	415069	<b>Ref. No.</b>	182521
<b>description</b>	heating element 4500W 220V mounting ø 47.5mm heating circuits 3 L 310mm W 30.5mm H 29mm tube ø 6.3mm connection male faston 6.3mm 3 hole flange immersion heater		
<b>For models:</b>	FES040, NES040, PES048, WES0400		
<b>accessories for</b>	415069		
	<b>GEV No.</b>	510408	<b>Ref. No.</b> 060842
	O-ring EPDM thickness 5.34mm ID ø 47mm Qty 1 pcs		
	<b>GEV No.</b>	520235	<b>Ref. No.</b> 732204000 817526000
	3 hole flange hole distance 70.5mm perforation ø 6.5mm ID ø 53.5mm		
	<b>GEV No.</b>	520236	<b>Ref. No.</b> —
	flange for heating element ID ø 50mm ED ø 90mm hole ø 6.5mm 3 holes		
	<b>GEV No.</b>	521012	<b>Ref. No.</b> —
	gasket graphite ED ø 15mm ID ø 5mm thickness 1.2mm Qty 1 pcs		
	<b>GEV No.</b>	550002	<b>Ref. No.</b> 144280
	tension strap H 10mm L 21mm W 10mm hole ø 6.5mm for heating element		
	<b>GEV No.</b>	550362	<b>Ref. No.</b> —
	blind flange ø 64mm mounting ø 47.5mm		





with compression flange (miscellaneous)





<b>GEV No.</b>	415507	<b>Ref. No.</b>	409181
<b>description</b>	heating element 2000W 230V heating circuits 1 L 250mm W 35mm H 25mm connection male faston 6.3mm tube ø 8.5mm immersion heater special fixing mounting distance 21mm		
<b>For models:</b>	KGE122, KGE340, KGE360, KGE660, KGL260, KGL360, KGU113, KGU122, KGU322, KGU340		
<b>spare parts for</b>	415507		
	<b>GEV No.</b>	510364	<b>Ref. No.</b> 409186
	gasket Lmm Wmm ø 36mm for heating element thickness 3mm with 4 screw holes		
	<b>GEV No.</b>	510365	<b>Ref. No.</b> —
	counterflange ø 36mm Lmm Wmm		

with expansion flange 70 x 18mm









<b>GEV No.</b>	415465	<b>Ref. No.</b>	407264
<b>description</b>	heating element 3000W 230V heating circuits 2 flange 70x18mm L 365mm W 65mm connection male faston 6.3mm tube ø 8.5mm immersion heater expansion flange		
<b>For models:</b>	ECD106, ECD220		
<b>accessories for</b>	415465		
	<b>GEV No.</b>	379078	<b>Ref. No.</b> —
	temperature probe thermocouple K (NiCr-Ni) cable silicone probe -50 up to 1150°C cable -50 up to +180°C connection 2-wire thread probe ø1.5x100mm cable length 1.8m		









<b>GEV No.</b>	415466	<b>Ref. No.</b>	407263
<b>description</b>	heating element 6000W 230V heating circuits 2 flange 70x18mm L 365mm W 65mm connection male faston 6.3mm tube ø 8.5mm immersion heater expansion flange connection length 32mm		
<b>For models:</b>	ECD106, ECD110, ECD120, ECD220		
<b>accessories for</b>	415466		
	<b>GEV No.</b>	379078	<b>Ref. No.</b> —
	temperature probe thermocouple K (NiCr-Ni) cable silicone probe -50 up to 1150°C cable -50 up to +180°C connection 2-wire thread probe ø1.5x100mm cable length 1.8m		





with round flange ø47.5mm











<b>GEV No.</b>	415888	<b>Ref. No.</b>	181737 182674 182684
<b>description</b>	heating element 12000W 230V heating circuits 3 mounting ø 47.5mm L 510mm W 34mm H 33mm round flange connection male faston 6.3mm immersion heater tube ø 8.5mm connection length 25mm		
<b>For models:</b>	CBE120-VAR091, CBE220-VAR091, CCE120, CCE220, CED120, CED220, CEF120, CEF220, CEM120, CPE120, CPE220		
<b>accessories for</b>	415888		
	<b>GEV No.</b>	510562	<b>Ref. No.</b> —
	O-ring silicone thickness 5.34mm ID ø 47mm Qty 1 pcs		
	<b>GEV No.</b>	520235	<b>Ref. No.</b> 732204000 817526000
	3 hole flange hole distance 70.5mm perforation ø 6.5mm ID ø 53.5mm		
	<b>GEV No.</b>	520236	<b>Ref. No.</b> —
	flange for heating element ID ø 50mm ED ø 90mm hole ø 6.5mm 3 holes		
	<b>GEV No.</b>	550002	<b>Ref. No.</b> 144280
	tension strap H 10mm L 21mm W 10mm hole ø 6.5mm for heating element		
	<b>GEV No.</b>	550362	<b>Ref. No.</b> —
	blind flange ø 64mm mounting ø 47.5mm		















<b>GEV No.</b>	415604	<b>Ref. No.</b>	182520 541218
<b>description</b>	heating element 3000W 230/400V heating circuits 3 L 160mm W 36mm H 25mm connection male faston 6.3mm immersion heater round flange mounting ø 47.5mm		
<b>For models:</b>	FES080, NES080, PES088, WES0800		
<b>accessories for</b>	415604		
	<b>GEV No.</b>	510408	<b>Ref. No.</b> 060842
	O-ring EPDM thickness 5.34mm ID ø 47mm Qty 1 pcs		
	<b>GEV No.</b>	510562	<b>Ref. No.</b> —
	O-ring silicone thickness 5.34mm ID ø 47mm Qty 1 pcs		
	<b>GEV No.</b>	520235	<b>Ref. No.</b> 732204000 817526000
	3 hole flange hole distance 70.5mm perforation ø 6.5mm ID ø 53.5mm		
	<b>GEV No.</b>	520236	<b>Ref. No.</b> —
	flange for heating element ID ø 50mm ED ø 90mm hole ø 6.5mm 3 holes		
	<b>GEV No.</b>	550002	<b>Ref. No.</b> 144280
	tension strap H 10mm L 21mm W 10mm hole ø 6.5mm for heating element		
	<b>GEV No.</b>	550362	<b>Ref. No.</b> —
	blind flange ø 64mm mounting ø 47.5mm		

			
<b>GEV No.</b>	417530	<b>Ref. No.</b>	182654
<b>description</b>	heating element 3000W 230V heating circuits 3 L 255mm W 38mm H 32mm tube ø 8.5mm thermostat sleeves ø 6.3mm length thermostat sleeves 19mm number of thermostat sleeves 1 thermostat sleeve centre not clinging connection male faston 6.3mm immersion heater round flange mounting ø 47.5mm		
<b>For models:</b>	FEK080, NEK080, PEK088		
<b>accessories for</b>	417530		
	GEV No.	510408	Ref. No. 060842
	O-ring EPDM thickness 5.34mm ID ø 47mm Qty 1 pcs		
	GEV No.	510562	Ref. No. —
	O-ring silicone thickness 5.34mm ID ø 47mm Qty 1 pcs		
	GEV No.	550002	Ref. No. 144280
	tension strap H 10mm L 21mm W 10mm hole ø 6.5mm for heating element		







			
<b>GEV No.</b>	415598	<b>Ref. No.</b>	182655
<b>description</b>	heating element 4500W 230V heating circuits 3 mounting ø 47.5mm L 350mm W 28mm H 34mm round flange connection male faston 6.3mm immersion heater tube ø 6.5mm thermostat sleeves ø 6.5mm number of thermostat sleeves 1 length thermostat sleeves 305mm thermostat sleeve centre not clinging		
<b>For models:</b>	FEK040, NEK040, PEK048		
<b>spare parts for</b>	415598		
	GEV No.	510408	Ref. No. 060842
	O-ring EPDM thickness 5.34mm ID ø 47mm Qty 1 pcs		
<b>accessories for</b>	415598		
	GEV No.	510562	Ref. No. —
	O-ring silicone thickness 5.34mm ID ø 47mm Qty 1 pcs		
	GEV No.	520235	Ref. No. 732204000 817526000
	3 hole flange hole distance 70.5mm perforation ø 6.5mm ID ø 53.5mm		
	GEV No.	520236	Ref. No. —
	flange for heating element ID ø 50mm ED ø 90mm hole ø 6.5mm 3 holes		
	GEV No.	550002	Ref. No. 144280
	tension strap H 10mm L 21mm W 10mm hole ø 6.5mm for heating element		
	GEV No.	550362	Ref. No. —
	blind flange ø 64mm mounting ø 47.5mm		







			
<b>GEV No.</b>	418286	<b>Ref. No.</b>	540821
<b>description</b>	heating element 6000W 230V heating circuits 2 L 392mm W 35mm H 40mm tube ø 6.2mm connection male faston 6.3mm immersion heater round flange L1 32mm L2 360mm H1 27mm H2 13mm mounting ø 47.5mm		
<b>accessories for</b>	418286		
	GEV No.	510408	Ref. No. 060842
	O-ring EPDM thickness 5.34mm ID ø 47mm Qty 1 pcs		









<b>accessories for</b>	418286		
	GEV No.	510562	Ref. No. —
	O-ring silicone thickness 5.34mm ID ø 47mm Qty 1 pcs		
	GEV No.	520235	Ref. No. 732204000 817526000
	3 hole flange hole distance 70.5mm perforation ø 6.5mm ID ø 53.5mm		
	GEV No.	520236	Ref. No. —
	flange for heating element ID ø 50mm ED ø 90mm hole ø 6.5mm 3 holes		
	GEV No.	550002	Ref. No. 144280
	tension strap H 10mm L 21mm W 10mm hole ø 6.5mm for heating element		
	GEV No.	550362	Ref. No. —
	blind flange ø 64mm mounting ø 47.5mm		







			
<b>GEV No.</b>	415599	<b>Ref. No.</b>	182656
<b>description</b>	heating element 6000W 230V heating circuits 3 L 385mm W 31mm H 36mm tube ø 8.5mm thermostat sleeves ø 6.5mm length thermostat sleeves 180mm number of thermostat sleeves 1 thermostat sleeve centre connection male faston 6.3mm immersion heater round flange mounting ø 47.5mm		
<b>For models:</b>	FEK040, FEK060, FEK080, FEK100, NEK040, NEK060, NEK080, NEK100, NTE182, PEK048, PEK068, PEK088, PEK108		
<b>spare parts for</b>	415599		
	GEV No.	510408	Ref. No. 060842
	O-ring EPDM thickness 5.34mm ID ø 47mm Qty 1 pcs		
<b>accessories for</b>	415599		
	GEV No.	510408	Ref. No. 060842
	O-ring EPDM thickness 5.34mm ID ø 47mm Qty 1 pcs		
	GEV No.	510562	Ref. No. —
	O-ring silicone thickness 5.34mm ID ø 47mm Qty 1 pcs		
	GEV No.	520235	Ref. No. 732204000 817526000
	3 hole flange hole distance 70.5mm perforation ø 6.5mm ID ø 53.5mm		
	GEV No.	520236	Ref. No. —
	flange for heating element ID ø 50mm ED ø 90mm hole ø 6.5mm 3 holes		
	GEV No.	550002	Ref. No. 144280
	tension strap H 10mm L 21mm W 10mm hole ø 6.5mm for heating element		
	GEV No.	550362	Ref. No. —
	blind flange ø 64mm mounting ø 47.5mm		









				
<b>GEV No.</b>	415405	<b>Ref. No.</b>	182416 540841	
<b>description</b>	heating element 6000W 230V heating circuits 3 L 465mm W 38mm H 24mm tube ø 6.3mm connection male faston 6.3mm immersion heater round flange mounting ø 47.5mm			
<b>For models:</b>	EES060, FED080, FED150, FED250, FED300, FER080, FER150, FER250, FER300, FER400, FES060, FES100, LES060, NED080, NED150, NED250, NED300, NEM100, NER080, NER150, NER250, NER300, NER400, NER500, NES040, NES060, NES080, NES100, PED088, PED158, PED258, PED308, PER088, PER158, PER258, PER308, PES068, PES108			
<b>accessories for</b>	415405			
	<b>GEV No.</b>	520235	<b>Ref. No.</b>	732204000 817526000
	3 hole flange hole distance 70.5mm perforation ø 6.5mm ID ø 53.5mm			
	<b>GEV No.</b>	520236	<b>Ref. No.</b>	—
	flange for heating element ID ø 50mm ED ø 90mm hole ø 6.5mm 3 holes			
	<b>GEV No.</b>	521012	<b>Ref. No.</b>	—
	gasket graphite ED ø 15mm ID ø 5mm thickness 1.2mm Qty 1 pcs			
	<b>GEV No.</b>	550002	<b>Ref. No.</b>	144280
	tension strap H 10mm L 21mm W 10mm hole ø 6.5mm for heating element			
	<b>GEV No.</b>	550362	<b>Ref. No.</b>	—
	blind flange ø 64mm mounting ø 47.5mm			







				
<b>GEV No.</b>	418333	<b>Ref. No.</b>	160116	
<b>description</b>	heating element 7500W 230V heating circuits 3 L 455mm W 42mm H 73mm connection male faston 6.3mm immersion heater round flange L1 105mm L2 334mm H1 34mm H2 39mm mounting ø 47.5mm			
<b>For models:</b>	EES080			
<b>accessories for</b>	418333			
	<b>GEV No.</b>	510408	<b>Ref. No.</b>	060842
	O-ring EPDM thickness 5.34mm ID ø 47mm Qty 1 pcs			
	<b>GEV No.</b>	510562	<b>Ref. No.</b>	—
	O-ring silicone thickness 5.34mm ID ø 47mm Qty 1 pcs			
	<b>GEV No.</b>	520235	<b>Ref. No.</b>	732204000 817526000
	3 hole flange hole distance 70.5mm perforation ø 6.5mm ID ø 53.5mm			
	<b>GEV No.</b>	520236	<b>Ref. No.</b>	—
	flange for heating element ID ø 50mm ED ø 90mm hole ø 6.5mm 3 holes			
	<b>GEV No.</b>	550002	<b>Ref. No.</b>	144280
	tension strap H 10mm L 21mm W 10mm hole ø 6.5mm for heating element			
	<b>GEV No.</b>	550362	<b>Ref. No.</b>	—
	blind flange ø 64mm mounting ø 47.5mm			







				
<b>GEV No.</b>	416945	<b>Ref. No.</b>	782407004 782798004	
<b>description</b>	heating element 6000W 230V heating circuits 3 L 470mm W 26mm H 50mm tube ø 6.2mm connection male faston 6.3mm immersion heater round flange L1 105mm L2 365mm H1 25mm H2 25mm mounting ø 47.5mm			
<b>For models:</b>	EES060, FES040, FES060, FES080, FES100, NES040, NES060, NES080, NES100, PES048, PES068, PES088, PES108			
<b>spare parts for</b>	416945			
	<b>GEV No.</b>	510408	<b>Ref. No.</b>	060842
	O-ring EPDM thickness 5.34mm ID ø 47mm Qty 1 pcs			
<b>accessories for</b>	416945			
	<b>GEV No.</b>	510408	<b>Ref. No.</b>	060842
	O-ring EPDM thickness 5.34mm ID ø 47mm Qty 1 pcs			
	<b>GEV No.</b>	510562	<b>Ref. No.</b>	—
	O-ring silicone thickness 5.34mm ID ø 47mm Qty 1 pcs			
	<b>GEV No.</b>	520235	<b>Ref. No.</b>	732204000 817526000
	3 hole flange hole distance 70.5mm perforation ø 6.5mm ID ø 53.5mm			
	<b>GEV No.</b>	520236	<b>Ref. No.</b>	—
	flange for heating element ID ø 50mm ED ø 90mm hole ø 6.5mm 3 holes			
	<b>GEV No.</b>	550002	<b>Ref. No.</b>	144280
	tension strap H 10mm L 21mm W 10mm hole ø 6.5mm for heating element			
	<b>GEV No.</b>	550362	<b>Ref. No.</b>	—
	blind flange ø 64mm mounting ø 47.5mm			







				
<b>GEV No.</b>	415416	<b>Ref. No.</b>	182539 782799004	
<b>description</b>	heating element 7500W 230V heating circuits 3 L 460mm W 37mm H 26mm tube ø 6.3mm thermostat sleeves ø 7mm length thermostat sleeves 200mm number of thermostat sleeves 1 thermostat sleeve eccentric, non clinging connection male faston 6.3mm immersion heater round flange mounting ø 47.5mm			
<b>spare parts for</b>	415416			
	<b>GEV No.</b>	510408	<b>Ref. No.</b>	060842
	O-ring EPDM thickness 5.34mm ID ø 47mm Qty 1 pcs			
<b>accessories for</b>	415416			
	<b>GEV No.</b>	520235	<b>Ref. No.</b>	732204000 817526000
	3 hole flange hole distance 70.5mm perforation ø 6.5mm ID ø 53.5mm			
	<b>GEV No.</b>	520236	<b>Ref. No.</b>	—
	flange for heating element ID ø 50mm ED ø 90mm hole ø 6.5mm 3 holes			
	<b>GEV No.</b>	521012	<b>Ref. No.</b>	—
	gasket graphite ED ø 15mm ID ø 5mm thickness 1.2mm Qty 1 pcs			
	<b>GEV No.</b>	550002	<b>Ref. No.</b>	144280
	tension strap H 10mm L 21mm W 10mm hole ø 6.5mm for heating element			
	<b>GEV No.</b>	550362	<b>Ref. No.</b>	—
	blind flange ø 64mm mounting ø 47.5mm			



			
<b>GEV No.</b>	415600	<b>Ref. No.</b>	182657
<b>description</b>	heating element 7500W 230V heating circuits 3 L 520mm W 34mm H 32mm tube ø 9mm thermostat sleeves ø 6.3mm length thermostat sleeves 170mm number of thermostat sleeves 1 thermostat sleeve centre not clinging connection male faston 6.3mm connection length 30mm immersion heater round flange mounting ø 47.5mm		
<b>For models:</b>	FEK150, NEK150, PEK158		
<b>accessories for</b>	415600		
	<b>GEV No.</b>	510408	<b>Ref. No.</b> 060842
	O-ring EPDM thickness 5.34mm ID ø 47mm Qty 1 pcs		
	<b>GEV No.</b>	510562	<b>Ref. No.</b> —
	O-ring silicone thickness 5.34mm ID ø 47mm Qty 1 pcs		
	<b>GEV No.</b>	520235	<b>Ref. No.</b> 732204000 817526000
	3 hole flange hole distance 70.5mm perforation ø 6.5mm ID ø 53.5mm		
	<b>GEV No.</b>	520236	<b>Ref. No.</b> —
	flange for heating element ID ø 50mm ED ø 90mm hole ø 6.5mm 3 holes		
	<b>GEV No.</b>	550002	<b>Ref. No.</b> 144280
	tension strap H 10mm L 21mm W 10mm hole ø 6.5mm for heating element		
	<b>GEV No.</b>	550362	<b>Ref. No.</b> —
	blind flange ø 64mm mounting ø 47.5mm		







			
<b>GEV No.</b>	416946	<b>Ref. No.</b>	182539 782799004
<b>description</b>	heating element 7500W 230V heating circuits 3 L 645mm W 24mm H 60mm tube ø 6.2mm connection male faston 6.3mm immersion heater round flange L1 110mm L2 525mm H1 30mm H2 30mm mounting ø 47.5mm		
<b>For models:</b>	FES150, NES150, PES158, WES1500		
<b>accessories for</b>	416946		
	<b>GEV No.</b>	510408	<b>Ref. No.</b> 060842
	O-ring EPDM thickness 5.34mm ID ø 47mm Qty 1 pcs		
	<b>GEV No.</b>	510562	<b>Ref. No.</b> —
	O-ring silicone thickness 5.34mm ID ø 47mm Qty 1 pcs		
	<b>GEV No.</b>	520235	<b>Ref. No.</b> 732204000 817526000
	3 hole flange hole distance 70.5mm perforation ø 6.5mm ID ø 53.5mm		
	<b>GEV No.</b>	520236	<b>Ref. No.</b> —
	flange for heating element ID ø 50mm ED ø 90mm hole ø 6.5mm 3 holes		
	<b>GEV No.</b>	550002	<b>Ref. No.</b> 144280
	tension strap H 10mm L 21mm W 10mm hole ø 6.5mm for heating element		
	<b>GEV No.</b>	550362	<b>Ref. No.</b> —
	blind flange ø 64mm mounting ø 47.5mm		







			
<b>GEV No.</b>	418270	<b>Ref. No.</b>	540717
<b>description</b>	heating element 9000W 230V heating circuits 3 L 535mm W 36mm H 45mm tube ø 6.2mm connection male faston 6.3mm immersion heater round flange L1 35mm L2 500mm H1 35mm H2 10mm mounting ø 47.5mm		
<b>accessories for</b>	418270		
	<b>GEV No.</b>	510408	<b>Ref. No.</b> 060842
	O-ring EPDM thickness 5.34mm ID ø 47mm Qty 1 pcs		
	<b>GEV No.</b>	510562	<b>Ref. No.</b> —
	O-ring silicone thickness 5.34mm ID ø 47mm Qty 1 pcs		
	<b>GEV No.</b>	520235	<b>Ref. No.</b> 732204000 817526000
	3 hole flange hole distance 70.5mm perforation ø 6.5mm ID ø 53.5mm		
	<b>GEV No.</b>	520236	<b>Ref. No.</b> —
	flange for heating element ID ø 50mm ED ø 90mm hole ø 6.5mm 3 holes		
	<b>GEV No.</b>	550002	<b>Ref. No.</b> 144280
	tension strap H 10mm L 21mm W 10mm hole ø 6.5mm for heating element		
	<b>GEV No.</b>	550362	<b>Ref. No.</b> —
	blind flange ø 64mm mounting ø 47.5mm		

			
<b>GEV No.</b>	418287	<b>Ref. No.</b>	540842
<b>description</b>	heating element 9000W 230V heating circuits 3 L 540mm W 37mm H 28mm tube ø 6.2mm immersion heater round flange mounting ø 47.5mm		
<b>accessories for</b>	418287		
	<b>GEV No.</b>	510408	<b>Ref. No.</b> 060842
	O-ring EPDM thickness 5.34mm ID ø 47mm Qty 1 pcs		
	<b>GEV No.</b>	510562	<b>Ref. No.</b> —
	O-ring silicone thickness 5.34mm ID ø 47mm Qty 1 pcs		
	<b>GEV No.</b>	520235	<b>Ref. No.</b> 732204000 817526000
	3 hole flange hole distance 70.5mm perforation ø 6.5mm ID ø 53.5mm		
	<b>GEV No.</b>	520236	<b>Ref. No.</b> —
	flange for heating element ID ø 50mm ED ø 90mm hole ø 6.5mm 3 holes		
	<b>GEV No.</b>	550002	<b>Ref. No.</b> 144280
	tension strap H 10mm L 21mm W 10mm hole ø 6.5mm for heating element		
	<b>GEV No.</b>	550362	<b>Ref. No.</b> —
	blind flange ø 64mm mounting ø 47.5mm		







			
<b>GEV No.</b>	415875	<b>Ref. No.</b>	181736 182680
<b>description</b>	heating element 9000W 230V heating circuits 3 mounting ø 47.5mm L 518mm W 34mm H 37mm round flange connection male faston 6.3mm immersion heater tube ø 8.5mm		
<b>For models:</b>	CBE106-VAR091, CBE110-VAR091, CCE106, CCE110, CED106, CED110, CEF106, CEF110, CEM110, CPE106, CPE110		
<b>accessories for</b>	415875		
	<b>GEV No.</b>	510408	<b>Ref. No.</b> 060842
	O-ring EPDM thickness 5.34mm ID ø 47mm Qty 1 pcs		
	<b>GEV No.</b>	510562	<b>Ref. No.</b> —
	O-ring silicone thickness 5.34mm ID ø 47mm Qty 1 pcs		
	<b>GEV No.</b>	520235	<b>Ref. No.</b> 732204000 817526000
	3 hole flange hole distance 70.5mm perforation ø 6.5mm ID ø 53.5mm		
	<b>GEV No.</b>	520236	<b>Ref. No.</b> —
	flange for heating element ID ø 50mm ED ø 90mm hole ø 6.5mm 3 holes		
	<b>GEV No.</b>	550002	<b>Ref. No.</b> 144280
	tension strap H 10mm L 21mm W 10mm hole ø 6.5mm for heating element		
	<b>GEV No.</b>	550362	<b>Ref. No.</b> —
	blind flange ø 64mm mounting ø 47.5mm		

 <p>Image not available</p>			
<b>GEV No.</b>	416940	<b>Ref. No.</b>	182338
<b>description</b>	heating element 9900W 230V mounting ø 47.5mm immersion heater		
<b>accessories for</b>	416940		
	<b>GEV No.</b>	510408	<b>Ref. No.</b> 060842
	O-ring EPDM thickness 5.34mm ID ø 47mm Qty 1 pcs		
	<b>GEV No.</b>	510562	<b>Ref. No.</b> —
	O-ring silicone thickness 5.34mm ID ø 47mm Qty 1 pcs		
	<b>GEV No.</b>	520235	<b>Ref. No.</b> 732204000 817526000
	3 hole flange hole distance 70.5mm perforation ø 6.5mm ID ø 53.5mm		
	<b>GEV No.</b>	520236	<b>Ref. No.</b> —
	flange for heating element ID ø 50mm ED ø 90mm hole ø 6.5mm 3 holes		
	<b>GEV No.</b>	550002	<b>Ref. No.</b> 144280
	tension strap H 10mm L 21mm W 10mm hole ø 6.5mm for heating element		
	<b>GEV No.</b>	550362	<b>Ref. No.</b> —
	blind flange ø 64mm mounting ø 47.5mm		

heating elements for convection

			
<b>GEV No.</b>	416918	<b>Ref. No.</b>	182331
<b>description</b>	heating element 4000W 230V heating circuits 1		
<b>For models:</b>	NEH415, NEH505, NEH615, NEH705, NGH405, NGH505, NGH605, NGH725		

			
<b>GEV No.</b>	415603	<b>Ref. No.</b>	182324
<b>description</b>	heating element 4000W 400V heating circuits 1 ID ø 176mm ED ø 210mm L 240mm H 42mm L1 25mm W1 31mm H1 5mm H2 38mm flange length 70mm flange width 22mm hole distance 5.7mm connection male faston 6.3mm tube ø 6.3mm convection heating element hole ø 5mm rectangular flange		
<b>For models:</b>	FEH415, FEH615, FEH705, FEH715, FGH415, FGH615, NEH415, NEH505, NEH615, NEH705, NGH405, NGH415, NGH505, NGH605, NGH615, NGH725		
<b>accessories for</b>	415603		
	<b>GEV No.</b>	510368	<b>Ref. No.</b> —
	gasket L 70mm W 23.5mm hole ø 5mm hole distance 56mm FIBER thickness 2mm for heating element		

			
<b>GEV No.</b>	415744	<b>Ref. No.</b>	182663
<b>description</b>	heating element 4800W 230V heating circuits 2 ID ø 182mm ED ø 214mm L 266mm H 37mm L1 42mm W1 30mm H1 16mm H2 21mm flange length 70mm flange width 22mm hole distance 57mm connection male faston 6.3mm tube ø 6.3mm convection heating element mounting thread M5 rectangular flange with thread bolt		
<b>For models:</b>	ECL484		



1

<b>GEV No.</b>	415602	<b>Ref. No.</b>	182662
<b>description</b>	heating element 4800W 400V heating circuits 2 ID ø 183mm ED ø 213mm L 265mm H 33mm L1 50mm W1 31mm H1 13mm H2 20mm flange length 70mm flange width 22mm hole distance 56mm connection male faston 6.3mm connection length 28mm tube ø 6.3mm convection heating element mounting thread M5 rectangular flange with thread bolt		
<b>For models:</b>	ECL484		





1

<b>GEV No.</b>	416917	<b>Ref. No.</b>	182523
<b>description</b>	heating element 6000W 230V heating circuits 2 ID ø 180mm ED ø 215mm L 240mm H 42mm L1 20mm W1 37mm H1 5mm H2 37mm flange length 70mm flange width 22mm hole distance 56mm tube ø 6.3mm		







1

<b>GEV No.</b>	415601	<b>Ref. No.</b>	182522	
<b>description</b>	heating element 6000W 400V heating circuits 1 ID ø 175mm ED ø 210mm L 240mm H 46mm L1 65mm W1 30mm H1 43mm H2 3mm flange length 70mm flange width 22mm hole distance 55mm connection male faston 6.3mm connection length 20mm tube ø 6.5mm convection heating element hole ø 5mm rectangular flange			
<b>For models:</b>	EHP601, LEH405, LEH505, LEH605, LEH705, LGH405, LGH605			
<b>spare parts for</b>	415601			
	<b>GEV No.</b>	510368	<b>Ref. No.</b>	—
	gasket L 70mm W 23.5mm hole ø 5mm hole distance 56mm FIBER thickness 2mm for heating element			



1

<b>GEV No.</b>	415911	<b>Ref. No.</b>	407449	
<b>description</b>	heating element 9000W 230V heating circuits 4 ID ø 310mm ED ø 333mm L 410mm H 115mm L1 77mm W1 75mm H1 15mm H2 100mm thread M14x1.5 8 hole fixing connection male faston 6.3mm tube ø 8.5mm convection heating element			
<b>For models:</b>	ECD106			
<b>accessories for</b>	415911			
	<b>GEV No.</b>	510417	<b>Ref. No.</b>	—
	flat gasket fibre ED ø 20mm ID ø 14mm thickness 2mm Qty 1 pcs			
	<b>GEV No.</b>	520228	<b>Ref. No.</b>	40156998
	tooth lock washer ID ø 15.3mm ED ø 24mm steel Qty 1 pcs for thread M14			
	<b>GEV No.</b>	520230	<b>Ref. No.</b>	407298
	nut thread M14x1.5 H 5mm WS 19 zinc-coated steel Qty 1 pcs			
	<b>GEV No.</b>	521101	<b>Ref. No.</b>	—
	nut thread M14x1.5 H 5mm WS 19 SS Qty 1 pcs			
	<b>GEV No.</b>	550262	<b>Ref. No.</b>	—
	flat gasket copper ED ø 20mm ID ø 14mm thickness 2mm			



1

<b>GEV No.</b>	415469	<b>Ref. No.</b>	407299	
<b>description</b>	heating element 2000W 220V heating circuits 1 L 95mm W 520mm connection length 24mm connection male faston 6.3mm tube ø 6.3mm thread M14x1.5 2 hole fixing convection heating element mounting distance 514mm			
<b>For models:</b>	ECD110, ECD120			
<b>accessories for</b>	415469			
	<b>GEV No.</b>	510417	<b>Ref. No.</b>	—
	flat gasket fibre ED ø 20mm ID ø 14mm thickness 2mm Qty 1 pcs			
	<b>GEV No.</b>	520228	<b>Ref. No.</b>	40156998
	tooth lock washer ID ø 15.3mm ED ø 24mm steel Qty 1 pcs for thread M14			
	<b>GEV No.</b>	520230	<b>Ref. No.</b>	407298
	nut thread M14x1.5 H 5mm WS 19 zinc-coated steel Qty 1 pcs			
	<b>GEV No.</b>	521101	<b>Ref. No.</b>	—
	nut thread M14x1.5 H 5mm WS 19 SS Qty 1 pcs			
	<b>GEV No.</b>	550262	<b>Ref. No.</b>	—
	flat gasket copper ED ø 20mm ID ø 14mm thickness 2mm			





			
1			
<b>GEV No.</b>	415554	<b>Ref. No.</b>	407496
<b>description</b>	heating element 2500W 230V heating circuits 1 L 148mm W 534mm connection male faston 6.3mm tube ø 6.3mm thread M14x1.5 2 hole fixing convection heating element mounting distance 528mm		
<b>For models:</b>	ECD220		
<b>spare parts for</b>	415554		
			
<b>GEV No.</b>	510420	<b>Ref. No.</b>	407297
<b>description</b>	gasket copper ED ø 19.9mm ID ø 14.3mm thickness 2mm Qty 1 pcs		
<b>accessories for</b>	415554		
			
<b>GEV No.</b>	510417	<b>Ref. No.</b>	—
<b>description</b>	flat gasket fibre ED ø 20mm ID ø 14mm thickness 2mm Qty 1 pcs		
			
<b>GEV No.</b>	520228	<b>Ref. No.</b>	40156998
<b>description</b>	tooth lock washer ID ø 15.3mm ED ø 24mm steel Qty 1 pcs for thread M14		
			
<b>GEV No.</b>	520230	<b>Ref. No.</b>	407298
<b>description</b>	nut thread M14x1.5 H 5mm WS 19 zinc-coated steel Qty 1 pcs		
			
<b>GEV No.</b>	521101	<b>Ref. No.</b>	—
<b>description</b>	nut thread M14x1.5 H 5mm WS 19 SS Qty 1 pcs		
			
<b>GEV No.</b>	550262	<b>Ref. No.</b>	—
<b>description</b>	flat gasket copper ED ø 20mm ID ø 14mm thickness 2mm		

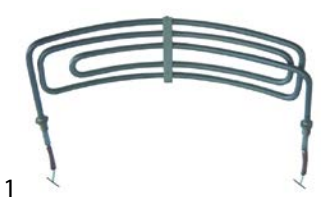

			
1			
<b>GEV No.</b>	415571	<b>Ref. No.</b>	181740 182682
<b>description</b>	heating element 3000W 230V heating circuits 1 L 360mm W 120mm tube ø 6.3mm thread M12x1 cable length 1000mm 2 hole fixing convection heating element		
<b>For models:</b>	CBE106, CBE106-VAR091, CBE110, CBE110-VAR091, CCE106, CCE110, CEC106, CEC110, CED106, CED110, CEF106, CEF110, CEM110, CPE106, CPE110		

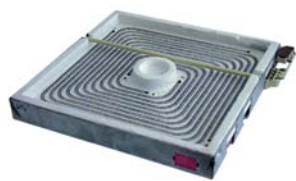

			
1			
<b>GEV No.</b>	415560	<b>Ref. No.</b>	181741 182683
<b>description</b>	heating element 4000W 230V heating circuits 1 L 353mm W 80mm tube ø 9mm thread M12x1 cable length 500mm W1 353mm 2 hole fixing convection heating element mounting distance 340mm		
<b>For models:</b>	CBE120, CBE120-VAR091, CBE220, CBE220-VAR091, CCE120, CCE220, CEC120, CEC220, CED120, CED220, CEF120, CEF220, CEM120, CPE120, CPE220		

radiation heaters

square

			
1			
<b>GEV No.</b>	490144	<b>Ref. No.</b>	160366
<b>description</b>	radiation heater L 300mm W 300mm 2500W 400V connections 3 square without pan detection EGO		
<b>For models:</b>	FEH500, FEH503, FEH505, FEH700, FEH705		
<b>spare parts for</b>	490144		
			
<b>GEV No.</b>	499157	<b>Ref. No.</b>	—
<b>description</b>	protection pipe for temperature probe ceramic L 297mm ED ø 7mm ID ø 5mm		

			
1			
<b>GEV No.</b>	490108	<b>Ref. No.</b>	160368
<b>description</b>	radiation heater L 300mm W 300mm 2500W 400V connections 3+2 connection type screw with pan detection EGO		
<b>For models:</b>	FEH510, FEH513, FEH515, FEH710, FEH715		
<b>spare parts for</b>	490108		
			
<b>GEV No.</b>	499157	<b>Ref. No.</b>	—
<b>description</b>	protection pipe for temperature probe ceramic L 297mm ED ø 7mm ID ø 5mm		

			
1			
<b>GEV No.</b>	490145	<b>Ref. No.</b>	160367 947962002
<b>description</b>	radiation heater L 300mm W 300mm 3500W 400V connections 3 square without pan detection EGO		
<b>For models:</b>	FEH500, FEH503, FEH505, FEH700, FEH705		
<b>spare parts for</b>	490145		
			
<b>GEV No.</b>	499157	<b>Ref. No.</b>	—
<b>description</b>	protection pipe for temperature probe ceramic L 297mm ED ø 7mm ID ø 5mm		



1

<b>GEV No.</b>	490143	<b>Ref. No.</b>	160369
<b>description</b>	radiation heater L 300mm W 300mm 3500W 400V connections 3+2 square with pan detection EGO		
<b>For models:</b>	FEH510, FEH513, FEH515, FEH710, FEH715		

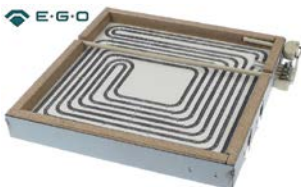

1

<b>GEV No.</b>	490195	<b>Ref. No.</b>	160398
<b>description</b>	radiation heater L 300mm W 300mm 4000W 400V heating circuits 2 H 40mm connection type screw without pan detection EGO		



1

<b>GEV No.</b>	416923	<b>Ref. No.</b>	538999 987068006 990580006
<b>description</b>	radiation heater 230V ceramic griddle		
<b>For models:</b>	LEB431, SEB431		



1

<b>GEV No.</b>	416925	<b>Ref. No.</b>	987070006 990581006
<b>description</b>	radiation heater 230V ceramic griddle		
<b>For models:</b>	LEB631, SEB631		



1

<b>GEV No.</b>	416929	<b>Ref. No.</b>	988235006 990574006
<b>description</b>	radiation heater 230V ceramic griddle		
<b>For models:</b>	NEB631		



1

<b>GEV No.</b>	416922	<b>Ref. No.</b>	540985 987067006 990582006
<b>description</b>	radiation heater 400V ceramic griddle		
<b>For models:</b>	LEB231, SEB231		



1

<b>GEV No.</b>	416924	<b>Ref. No.</b>	540993 987069006 990583006
<b>description</b>	radiation heater 400V ceramic griddle		
<b>For models:</b>	LEB431, SEB431		



1

<b>GEV No.</b>	416926	<b>Ref. No.</b>	538992 987071006 990584006
<b>description</b>	radiation heater 400V ceramic griddle		
<b>For models:</b>	LEB631, SEB631		



1

<b>GEV No.</b>	416932	<b>Ref. No.</b>	160344 988238006 990578006
<b>description</b>	radiation heater 400V ceramic griddle		
<b>For models:</b>	NEB831		



1

<b>GEV No.</b>	416933	<b>Ref. No.</b>	984748002
<b>description</b>	radiation heater ceramic griddle		
<b>For models:</b>	TEB231		





Image not available

1

<b>GEV No.</b>	416935	<b>Ref. No.</b>	986616002
<b>description</b>	radiation heater ceramic griddle		
<b>For models:</b>	TEB631		



1

<b>GEV No.</b>	416934	<b>Ref. No.</b>	409085 986615002
<b>description</b>	radiation heater rectangular 1300W 400V L 480mm W 470mm connections 3x 2 ceramic griddle		
<b>For models:</b>	TEB431		



1

<b>GEV No.</b>	416920	<b>Ref. No.</b>	996651006
<b>description</b>	radiation heater rectangular 2300W 230V L 456mm W 220mm		
<b>For models:</b>	FEB430, FEB630, PEB438, PEB638		

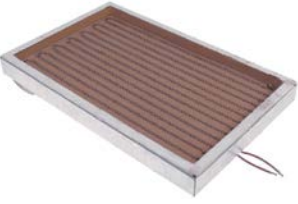

1

<b>GEV No.</b>	416921	<b>Ref. No.</b>	987066006 990049006 990579006
<b>description</b>	radiation heater rectangular 2500W 230V L 465mm W 295mm heating circuits 1 connections 2 ceramic griddle		
<b>For models:</b>	LEB231, SEB231		



1

<b>GEV No.</b>	416911	<b>Ref. No.</b>	996887006
<b>description</b>	radiation heater rectangular 3200W 400V L 420mm W 278mm		
<b>For models:</b>	EEP500		



1

<b>GEV No.</b>	416937	<b>Ref. No.</b>	540963 988312006
<b>description</b>	radiation heater rectangular 3450W 220V L 458mm W 320mm heating circuits 3 connections 3x 2 bain marie		
<b>For models:</b>	TEW250		



1

<b>GEV No.</b>	416897	<b>Ref. No.</b>	942867006 996887006
<b>description</b>	radiation heater rectangular 3500W 400V L 415mm W 275mm H 46mm heating circuits 2 connections 2x 2		
<b>For models:</b>	EEB230, EEB430		



1

<b>GEV No.</b>	419180	<b>Ref. No.</b>	160384
<b>description</b>	radiation heater rectangular 3500W 400V L 415mm W 275mm heating circuits 1 connections 2x1 connection type F6.3		



1-circuit



1			
<b>GEV No.</b>	490047	<b>Ref. No.</b>	181726 182274 182679 538695 540293
<b>description</b>	radiation heater ø 230mm 2100W 230V heating circuits 1 7-position control with temperature signalization connections 4+2 connection type male faston 6.3mm EGO		



1			
<b>GEV No.</b>	490137	<b>Ref. No.</b>	182629 182686
<b>description</b>	radiation heater ø 230mm 2300W 230V		
<b>For models:</b>	LEH500, LEH503, LEH505, LEH700, LEH703, LEH705		



1			
<b>GEV No.</b>	490136	<b>Ref. No.</b>	181721 182257 538253
<b>description</b>	radiation heater ø 230mm 2300W 230V heating circuits 1 H 32mm energy regulation with temperature signalization with ribbon heater connections 2+2 connection type male faston 6.3mm vertical EGO		
<b>For models:</b>	SEH300, TEH300		



1			
<b>GEV No.</b>	490050	<b>Ref. No.</b>	160361
<b>description</b>	radiation heater ø 250mm 2500W 230V heating circuits 1 with ribbon heater		
<b>For models:</b>	EEH210, EEH300, EEH410, EEH413, EEH500, EEH503, EEH610, EEH613, EEH700, EEH703		

2-circuit



1			
<b>GEV No.</b>	490028	<b>Ref. No.</b>	181713 182260 538254
<b>description</b>	radiation heater ø 230mm 2100W 230V heating circuits 2 energy regulation with temperature signalization partial power 650W with heating coil connections 3+2 connection type male faston 6.3mm EGO		



1			
<b>GEV No.</b>	490135	<b>Ref. No.</b>	160303 160349 181713 181718 182260 182288 502383 538254 538629 564648
<b>description</b>	radiation heater ø 230mm 2200W 230V heating circuits 2 energy regulation with temperature limiter partial power 750W with ribbon heater connections 3+2 connection type male faston 6.3mm EGO		
<b>For models:</b>	SEH300, TEH300		



1			
<b>GEV No.</b>	490146	<b>Ref. No.</b>	160362
<b>description</b>	radiation heater ø 250mm 2500W 230V heating circuits 2 energy regulation without temperature signalization partial power 1250W with heating coil connections 3 connection type male faston 6.3mm EGO		
<b>For models:</b>	EEH210, EEH410, EEH413, EEH610, EEH613		



## hot plates

### square & rectangular

#### tiltable



1			
<b>GEV No.</b>	490085	<b>Ref. No.</b>	182254 182261
<b>description</b>	hot plate dimensions 300x300mm 2500W 230V with cast edge tilt boiling plate connection 3 screw clamps H 43mm square		
<b>For models:</b>	EHN401, EHN402, EHN601, EHN602, EHN801, EHN802, NEH210, NEH212, NEH410, NEH413, NEH415, NEH610, NEH613, NEH615		

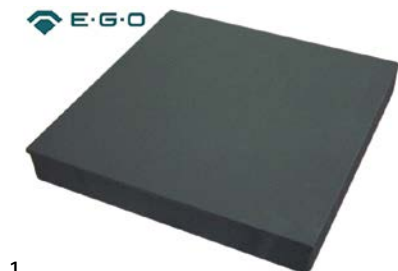

1			
<b>GEV No.</b>	490086	<b>Ref. No.</b>	181744 182250 182262
<b>description</b>	hot plate dimensions 300x300mm 2500W 400V with cast edge tilt boiling plate connection 3 screw clamps H 43mm square		
<b>For models:</b>	EHN401, EHN402, EHN601, EHN602, EHN801, EHN802, FEH210, FEH410, FEH413, FEH415, FEH610, FEH613, FEH615, NEH210, NEH212, NEH410, NEH413, NEH415, NEH610, NEH613, NEH615, PEH218, PEH418, PEH618		

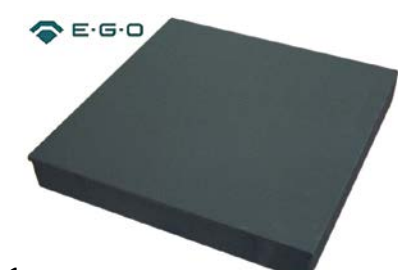

1			
<b>GEV No.</b>	490089	<b>Ref. No.</b>	182253
<b>description</b>	hot plate dimensions 300x300mm 4000W 230V with cast edge tilt boiling plate connection 4 screw clamps H 43mm square		
<b>For models:</b>	NEH410, NEH413, NEH415, NEH610, NEH613, NEH615		

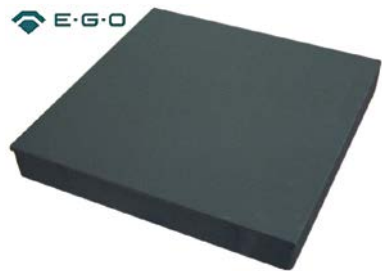

1			
<b>GEV No.</b>	490090	<b>Ref. No.</b>	181743 182033 182249
<b>description</b>	hot plate dimensions 300x300mm 4000W 400V with cast edge tilt boiling plate connection 4 screw clamps H 43mm square		
<b>For models:</b>	EHN401, EHN402, EHN601, EHN602, EHN801, EHN802, FEH210, FEH410, FEH413, FEH415, FEH610, FEH613, FEH615, NEH210, NEH212, NEH410, NEH413, NEH415, NEH610, NEH613, NEH615, PEH218, PEH418, PEH618		

### round

#### with radiused edge

#### for domestic and commercial kitchens



1			
<b>GEV No.</b>	490014	<b>Ref. No.</b>	181956 182241
<b>description</b>	hot plate ø 180mm 1500W 230V connection 4 screw clamps with 8mm spill ring		
<b>For models:</b>	EHP601, LEH405, LEH605		



1			
<b>GEV No.</b>	490015	<b>Ref. No.</b>	182245
<b>description</b>	hot plate ø 180mm 1500W 400V connection 4 screw clamps with 8mm spill ring		
<b>For models:</b>	LEH405, LEH605		



1			
<b>GEV No.</b>	490018	<b>Ref. No.</b>	181959 182248
<b>description</b>	hot plate ø 220mm 2000W 230V connection 4 screw clamps with 8mm spill ring		
<b>For models:</b>	EHP601, LEH605, SEH200		



1

<b>GEV No.</b>	490019	<b>Ref. No.</b>	182244
<b>description</b>	hot plate ø 220mm 2000W 400V connection 4 screw clamps with 8mm spill ring		
<b>For models:</b>	LEH605, SEH200		



1

<b>GEV No.</b>	490020	<b>Ref. No.</b>	182242
<b>description</b>	hot plate ø 220mm 2600W 230V connection 4 screw clamps with 8mm spill ring		
<b>For models:</b>	LEH405, LEH605		
<b>accessories for</b>	490020		
	<b>GEV No.</b>	550796	<b>Ref. No.</b>
			—
	fixing plate for hot plate ø220mm		



1

<b>GEV No.</b>	490021	<b>Ref. No.</b>	182246
<b>description</b>	hot plate ø 220mm 2600W 400V connection 4 screw clamps with 8mm spill ring		
<b>For models:</b>	LEH405, LEH605		



1

<b>GEV No.</b>	490061	<b>Ref. No.</b>	182247
<b>description</b>	hot plate ø 300mm 2500W 230V connection 4 screw clamps with 8mm spill ring		
<b>For models:</b>	LEH405, LEH605		



1

<b>GEV No.</b>	490063	<b>Ref. No.</b>	182243
<b>description</b>	hot plate ø 300mm 2500W 400V connection 4 screw clamps with 8mm spill ring		
<b>For models:</b>	LEH405, LEH605		

## energy regulators

## EGO

## 1-circuit



1

<b>GEV No.</b>	380029	<b>Ref. No.</b>	183237
<b>description</b>	energy regulator		
<b>For models:</b>	TEH300		



1



<b>GEV No.</b>	380016	<b>Ref. No.</b>	176189 183139 183160 183184
<b>description</b>	energy regulator 230V 12A dual circuit turn direction right with operation switch 1-pole		
<b>For models:</b>	LEH500, LEH503, LEH505, LEH700, LEH703, LEH705, SEH300		



1

<b>GEV No.</b>	380015	<b>Ref. No.</b>	183111 183149 183150 183236 540548
<b>description</b>	energy regulator 230V 13A single-circuit turn direction right shaft ø 6x4.6mm shaft L 23mm mounting thread M4 power release 6-100% no. 50.57021.010		
<b>For models:</b>	EEF040, EEH210, EEH300, EEH410, EEH413, EEH500, EEH503, EEH610, EEH613, EEH700, EEH703, EES060, EES080, FEF040, FEH500, FEH503, FEH505, FEH510, FEH513, FEH515, FEH700, FEH705, FEH710, FEH715, LEB231, LEB431, LEB631, LEF040, LEH500, LEH503, LEH505, LEH700, LEH703, LEH705, NEB431, NEB631, NEB831, NEF040, NEH500, NEH505, NEH700, NEH705, NEK040, NEK060, NEK080, NEK100, NEK150, NEM100, NER080, NER150...(Other models you can see in the webshop)		





			
1			
<b>GEV No.</b>	380036	<b>Ref. No.</b>	538255
<b>description</b>	energy regulator 230V 13A turn direction right shaft ø 6x4.6mm mounting thread M12x1 no. 50.57024.010		
<b>accessories for</b>	380036		
	<b>GEV No.</b>	510792	<b>Ref. No.</b> —
	hexagonal nut thread M12x1 H 4mm WS 17 stainless steel Qty 1 pcs		

2-circuit			
			
1			
<b>GEV No.</b>	380027	<b>Ref. No.</b>	161606
<b>description</b>	energy regulator EGO 230V 13A dual circuit turn direction right shaft ø 6x4.6mm shaft L 23mm mounting thread M4 power release 6-70% no. 50.55021.100		

## thermostats

### bi-metal thermostats

#### safety bi-metal thermostats

			
1			
<b>GEV No.</b>	390171	<b>Ref. No.</b>	409194
<b>description</b>	bi-metal safety thermostat hole distance 23.8mm switch-off temp. 110°C 1NC 1-pole 16A connection F6.3		
<b>For models:</b>	KGE122, KGL260, KGU113, KGU122		
<b>accessories for</b>	390171		
	<b>GEV No.</b>	510362	<b>Ref. No.</b> 409190
	gasket for thermostat ED ø 40mm ID ø 19mm suitable for COMENDA, MEIKO equiv. no. 630511/0108040		

#### bi-metal thermostats

			
1			
<b>GEV No.</b>	390609	<b>Ref. No.</b>	540276
<b>description</b>	bi-metal thermostat 1NC		

			
1			
<b>GEV No.</b>	390123	<b>Ref. No.</b>	409194
<b>description</b>	bi-metal thermostat hole distance 23.8mm switch-off temp. 50°C 1NC 1-pole 16A 250V connection F6.3 2 hole fixing		

			
1			
<b>GEV No.</b>	390523	<b>Ref. No.</b>	183240 408273
<b>description</b>	bi-metal thermostat switch-off temp. 140°C 1NC 1-pole 16A connection F6.3		
<b>For models:</b>	ECL484		

### control and safety thermostats

#### EGO

#### control thermostats

#### 51\_ series

			
1			
<b>GEV No.</b>	375593	<b>Ref. No.</b>	174637
<b>description</b>	thermostat t.max. 110°C temperature range 85-110°C 1-pole 1NO 15A probe ø 6mm probe L 265mm capillary pipe 2990mm capillary pipe isolated 1700mm gland nut shaft ø 6x4.6mm shaft L 35mm shaft position upper rotation 270° with disc disc ø 12.5mm screw connection M14x1		
<b>For models:</b>	LES060, NES040, NES060, NES080, NES100, NES150, NGR150, NGR250, NGR300, NGR400, NHR080, NHR150, NHR250, NHR300, NHR400, NHR500, NHS040, NHS060, NHS080, NHS100, NHS150, NNR080, NNR150, NNR250, NNR300, NNR400, NNR500, NNS040, NNS060, NNS080, NNS100, NNS150, WES0400, WES0600, WES0800, WES1000, WES1500		

55.10/19\_series

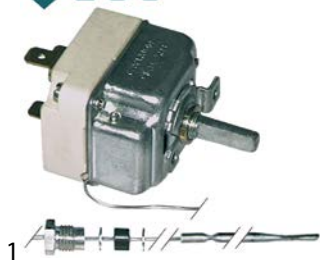

<b>GEV No.</b>	375070	<b>Ref. No.</b>	540522
<b>description</b>	thermostat t.max. 250°C temperature range 55-250°C 1-pole 1CO 16A probe ø 3.1mm probe L 226mm capillary pipe 1170mm capillary pipe isolated 1100mm gland nut M9x1 shaft L 23mm shaft position upper rotation 270°		
<b>For models:</b>	EEW250, EEW450, EEW452		

55.13\_series



<b>GEV No.</b>	375008	<b>Ref. No.</b>	174690
<b>description</b>	thermostat t.max. 110°C temperature range 30-110°C 1-pole 1CO 16A probe ø 3.1mm probe L 197mm capillary pipe 3150mm capillary pipe isolated 300mm gland nut shaft L 23mm shaft position° shaft position rotation 270°		



<b>GEV No.</b>	390133	<b>Ref. No.</b>	174690
<b>description</b>	thermostat t.max. 125°C temperature range 30-125°C 1-pole 1CO 16A probe ø 3.03mm probe L 160mm capillary pipe 2290mm capillary pipe isolated 1710mm gland nut shaft ø 6x4.6mm shaft L 23mm shaft position upper rotation 270°		
<b>For models:</b>	CEC106, CEC110, CEC120, CEC220, CED106, CED110, CED120, CED220		



<b>GEV No.</b>	375086	<b>Ref. No.</b>	407340
<b>description</b>	thermostat t.max. 180°C temperature range 60-180°C 1-pole 1CO 16A probe ø 6mm probe L 90mm capillary pipe 2400mm capillary pipe isolated 2300mm gland nut shaft ø 6x4.6mm shaft L 25mm shaft position upper rotation 270° probe material SS		
<b>For models:</b>	ECD110, ECD120, ECD220		



<b>GEV No.</b>	375010	<b>Ref. No.</b>	174664
<b>description</b>	thermostat t.max. 250°C temperature range 50-250°C 1-pole 1NO 16A probe ø 3.1mm probe L 208mm capillary pipe 1130mm capillary pipe isolatedmm gland nut shaft L 23mm shaft position upper rotation 270°		
<b>For models:</b>	EAB081, EAB101, EAB102, EAB112		



<b>GEV No.</b>	390146	<b>Ref. No.</b>	176168
<b>description</b>	thermostat t.max. 280°C temperature range 50-280°C 1-pole 1NO 16A probe ø 3.1mm probe L 160mm capillary pipe 1230mm capillary pipe isolated 800mm gland nut shaft L 23mm shaft position upper rotation 270°		
<b>For models:</b>	CEC106, CEC110, CEC120, CEC220, EAB051, ECL484, EDC106		



<b>GEV No.</b>	375087	<b>Ref. No.</b>	407276
<b>description</b>	thermostat t.max. 300°C temperature range 50-300°C 1-pole 1CO 16A probe ø 3.03mm probe L 160mm capillary pipe 1130mm capillary pipe isolated 1103mm gland nut shaft L 23mm shaft position upper rotation 270°		
<b>For models:</b>	ECD106, ECD110, ECD120, ECD220		



<b>GEV No.</b>	375612	<b>Ref. No.</b>	161614
<b>description</b>	thermostat t.max. 324°C temperature range 54-324°C 1-pole 1NO 16A probe ø 3.03mm probe L 147mm capillary pipe 1270mm capillary pipe isolated 1180mm gland nut shaft ø 6x4.6mm shaft L 23mm shaft position upper rotation 270°		
<b>For models:</b>	EEB230, EEB430, EEP500, EGP500, FEB430, FEB630, FEH415, FEH615, FEP230, FEP330, FEP600, FEP610, FEP900, FEP910, FEW250, FEW252, FGW250, NEP203, NEP303, NEP400, NEP600, NEP601, NEP900, NEP901, NGP600, NGP900, PEB438, PEB638, PEP238, PEP338, PEP608, PEP618, PEP908, PEP918, PEW458, PEW658, PGP608, PGP618, PGP908, PGP918, PGW458		



<b>GEV No.</b>	375088	<b>Ref. No.</b>	407266
<b>description</b>	thermostat t.max. 300°C temperature range 60-300°C 1-pole 1NO 16A probe ø 4mm probe L 100mm capillary pipe 830mm capillary pipe isolated 800mm gland nut shaft L 15mm shaft position upper rotation 270°		
<b>For models:</b>	ECD106, ECD110, ECD120, ECD220		



<b>GEV No.</b>	375773	<b>Ref. No.</b>	161624
<b>description</b>	thermostat t.max. 440°C temperature range fixed 440°C 1-pole 1NO 16A probe ø 3.9mm probe L 228mm capillary pipe 1130mm capillary pipe isolated 850mm gland nut shaft ømm shaft Lmm shaft position rotation°		
<b>For models:</b>	EEH210, EEH410, EEH413, EEH610, EEH613		



<b>GEV No.</b>	375505	<b>Ref. No.</b>	174681
<b>description</b>	thermostat t.max. 320°C temperature range 50-320°C 1-pole 1NO 16A probe ø 3mm probe L 160mm capillary pipe 870mm capillary pipe isolatedmm gland nut shaft ø 6x4.6mm shaft L 23mm shaft position upper rotation 270°		
<b>For models:</b>	ECL484		



<b>GEV No.</b>	375085	<b>Ref. No.</b>	407279
<b>description</b>	thermostat t.max. 90°C temperature range 0-90°C 1-pole 1CO 16A probe ø 3.1mm probe L 247mm capillary pipe 1430mm capillary pipe isolated 1400mm gland nut shaft ø 6x4.6mm shaft L 18mm shaft position upper probe material SS		
<b>For models:</b>	ECD106, ECD110, ECD120, ECD220		

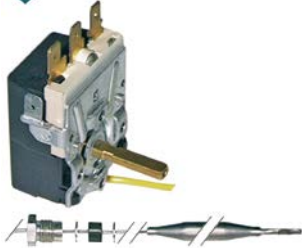

<b>GEV No.</b>	375133	<b>Ref. No.</b>	174690
<b>description</b>	thermostat t.max. 90°C temperature range 30-90°C 1-pole capillary pipe isolated gland nut		

55.34\_ series



<b>GEV No.</b>	375697	<b>Ref. No.</b>	540525
<b>description</b>	thermostat t.max. 120°C temperature range fixed 120°C 2-pole 2CO 16A probe ø 3.1mm probe L 305mm capillary pipe 720mm capillary pipe isolated 600mm gland nut shaft Lmm		
<b>For models:</b>	EEF124, EEF224		
<b>accessories for</b>	375697		
	<b>GEV No.</b>	550039	<b>Ref. No.</b> —
	probe clip for pipe ø 8.5mm for probe ø 3.1mm Qty 1 pcs		



<b>GEV No.</b>	375708	<b>Ref. No.</b>	540444
<b>description</b>	thermostat t.max. 188°C temperature range 95-188°C 3-pole 3NO 16A probe ø 6mm probe L 117mm capillary pipe 1780mm capillary pipe isolated 1400mm gland nut shaft ø 6x4.6mm shaft L 23mm shaft position upper rotation 270°		



<b>GEV No.</b>	375097	<b>Ref. No.</b>	355637
<b>description</b>	thermostat t.max. 195°C temperature range 95-195°C 3-pole 3NO 16A probe ø 6mm probe L 117mm capillary pipe 1780mm capillary pipe isolated 1400mm gland nut M9x1 shaft ø 6x4.6mm shaft L 23mm shaft position upper rotation 270°		
<b>For models:</b>	LEF124, LEF224, NEF124, NEF144, NEF176, NEF224, NEF244, SEF124, SEF144, SEF224		

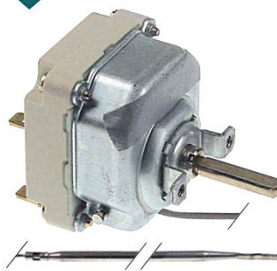

<b>GEV No.</b>	375422	<b>Ref. No.</b>	152101 152105
<b>description</b>	thermostat t.max. 210°C temperature range 95-210°C 3-pole 3NO 16A probe ø 3.1mm probe L 226mm capillary pipe 1780mm capillary pipe isolated 1600mm gland nut shaft ø 6x4.6mm shaft L 23mm shaft position upper rotation 270°		
<b>For models:</b>	TEF124, TEF144, TEF224		

55.40\_ series



<b>GEV No.</b>	375658	<b>Ref. No.</b>	540568
<b>description</b>	thermostat t.max. 300°C temperature range 60-204°C/135-300°C 4-pole 2NO/2NO 16A probe ø 4mm probe L 128mm capillary pipe 880mm capillary pipe isolated 800mm gland nut shaft ø 6x4.6mm shaft L 23mm shaft position upper rotation 310°		
<b>For models:</b>	EEW400		

safety thermostats

51.\_series



<b>GEV No.</b>	390144	<b>Ref. No.</b>	176592
<b>description</b>	safety thermostat switch-off temp. 340°C 1-pole capillary pipe isolatedmm gland nut		



<b>GEV No.</b>	375090	<b>Ref. No.</b>	407275
<b>description</b>	safety thermostat switch-off temp. 365°C 2-pole 16A probe ø 4mm probe L 120mm capillary pipe 1170mm capillary pipe isolated 1100mm gland nut probe SS		
<b>For models:</b>	ECD106, ECD110, ECD120, ECD220		

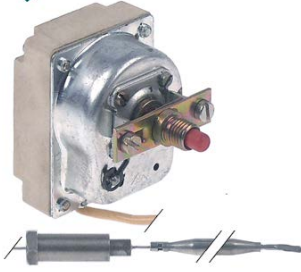

<b>GEV No.</b>	390132	<b>Ref. No.</b>	176194
<b>description</b>	thermostat capillary pipe isolatedmm gland nut		
<b>For models:</b>	NGF144, NGF224, PGF148, PGF228		

55.13\_series



<b>GEV No.</b>	375519	<b>Ref. No.</b>	540414	
<b>description</b>	safety thermostat switch-off temp. 130°C 1-pole 1NO 16A probe ø 6mm probe L 129mm capillary pipe 830mm capillary pipe isolatedmm gland nut mounting thread M8x1 probe SS			
<b>accessories for</b>	375519			
	<b>GEV No.</b>	102067	<b>Ref. No.</b>	—
	nut thread M8x1 H 3mm brass Qty 1 pcs type SEF 1			

55.31\_series



<b>GEV No.</b>	375102	<b>Ref. No.</b>	176174
<b>description</b>	safety thermostat switch-off temp. 230°C 3-pole 20A probe ø 6mm probe L 219mm capillary pipe 1730mm capillary pipe isolated 1400mm gland nut probe SS		
<b>For models:</b>	LEF124, LEF224, NEF124, NEF144, NEF176, NEF224, NEF244, SEF124, SEF144, SEF224		

55.32\_series



<b>GEV No.</b>	375707	<b>Ref. No.</b>	540443
<b>description</b>	safety thermostat switch-off temp. 230°C 3-pole 20A probe ø 6mm probe L 87mm capillary pipe 1490mm capillary pipe isolated 1100mm gland nut M9x1 probe SS		

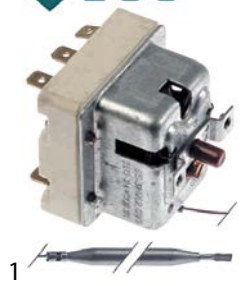

<b>GEV No.</b>	375695	<b>Ref. No.</b>	540470
<b>description</b>	safety thermostat switch-off temp. 350°C 3-pole 20A probe ø 6mm probe L 77mm capillary pipe 890mm capillary pipe isolatedmm gland nut probe SS		

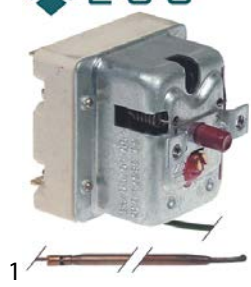

<b>GEV No.</b>	375706	<b>Ref. No.</b>	540406
<b>description</b>	safety thermostat switch-off temp. 400°C 3-pole 3NC 20A probe ø 3.9mm probe L 228mm capillary pipe 1190mm capillary pipe isolatedmm gland nut probe SS		

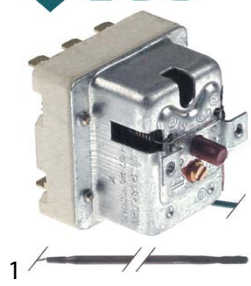

<b>GEV No.</b>	375627	<b>Ref. No.</b>	540559
<b>description</b>	safety thermostat switch-off temp. 480°C 3-pole 20A probe ø 4mm probe L 230mm capillary pipe 890mm capillary pipe isolatedmm gland nut probe probe material SS		
<b>For models:</b>	EEW400		

55.33\_ series

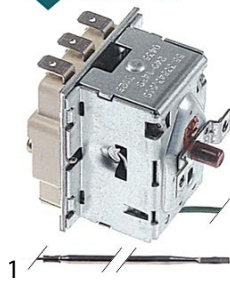

<b>GEV No.</b>	375421	<b>Ref. No.</b>	152102
<b>description</b>	safety thermostat switch-off temp. 240°C 3-pole 20A probe ø 3.1mm probe L 226mm capillary pipe 1170mm capillary pipe isolated 960mm gland nut probe SS		
<b>For models:</b>	FEF124, FEF144, FEF144e, FEF170, FEF180, FEF224, FEF224e, PEF128, PEF148, PEF178, PEF188, PEF228, TEF124, TEF144, TEF224		



<b>GEV No.</b>	375698	<b>Ref. No.</b>	540579
<b>description</b>	safety thermostat switch-off temp. 250°C 3-pole 20A probe ø 3.1mm probe L 307mm capillary pipe 710mm capillary pipe isolated 700mm gland nut probe SS		
<b>For models:</b>	EEF124, EEF224		

56.\_ series

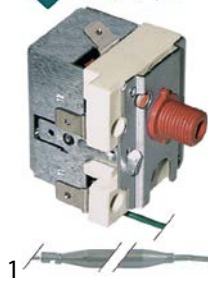

<b>GEV No.</b>	375591	<b>Ref. No.</b>	152433
<b>description</b>	safety thermostat switch-off temp. 147°C 1-pole 16A probe ø 6mm probe L 77mm capillary pipe 1860mm capillary pipe isolated 1350mm gland nut probe		
<b>For models:</b>	CBE106-VAR091, CBE110-VAR091, CBE120-VAR091, CBE220-VAR091, CCE106, CCE110, CCE120, CCE220, CPE106, CPE110, CPE120, CPE220, FES040, FES060, FES080, FES100, FES150, FGS040, FGS060, FGS080, FGS100, FGS150, PES048, PES068, PES088, PES108, PES158, PGS048, PGS068, PGS088		









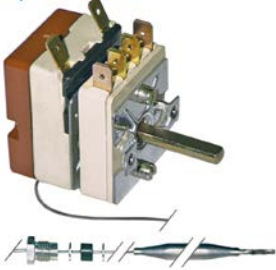

 			
<b>GEV No.</b>	375531	<b>Ref. No.</b>	152432 176592
<b>description</b>	safety thermostat switch-off temp. 340°C 1-pole 16A probe ø 4mm probe L 100mm capillary pipe 1860mm capillary pipe isolated 1710mm gland nut		
<b>For models:</b>	CBE106, CBE106-VAR091, CBE110, CBE110-VAR091, CBE120, CBE120-VAR091, CBE220, CBE220-VAR091, CBG110, CBG120, CCE106, CCE110, CCE120, CCE220, CPE106, CPE110, CPE120, CPE220		

<b>accessories for</b>	375406		
	<b>GEV No.</b>	112311	<b>Ref. No.</b> —
	knob adapter shaft ø 6x4.6mm L 0mm with spring		

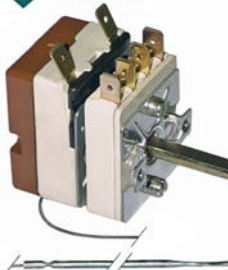
control thermostats with operation switch  
55.13\_ series

 			
<b>GEV No.</b>	375037	<b>Ref. No.</b>	355693
<b>description</b>	thermostat t.max. 110°C 1-pole capillary pipe isolatedmm gland nut		

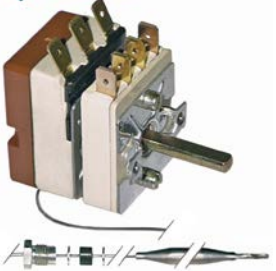
 			
<b>GEV No.</b>	375408	<b>Ref. No.</b>	174677
<b>description</b>	thermostat t.max. 320°C temperature range 50-320°C 1-pole 1NO 16A probe ø 3.03mm probe L 160mm capillary pipe 1150mm capillary pipe isolatedmm gland nut shaft ø 6x4.6mm shaft L 23mm shaft position upper rotation 270° outer switch 2NO		

 			
<b>GEV No.</b>	375406	<b>Ref. No.</b>	355693
<b>description</b>	thermostat t.max. 110°C temperature range 30-110°C 1-pole 1CO 16A probe ø 6mm probe L 113mm capillary pipe 2380mm capillary pipe isolated 1700mm gland nut M9x1 shaft ø 6x4.6mm shaft L 18mm shaft position upper rotation 270° outer switch 2NO		
<b>For models:</b>	FEH613, FEH615, FEH705, FEH715, FEW250, FEW252, FGH613, FGH615, LEH605, LEH703, LEH705, LEW450, LEW452, LGH605, LGH607, NEA182, NEH212, NEH613, NEH615, NEH705, NEW180, NEW182, NEW250, NEW252, NEW450, NEW452, NGH202, NGH603, NGH605, NGH607, NGH613, NGH615, NGH617, NGH723, NGH725, NGH727, NGH733, NGH737, PEW458, PEW658, SEW250, SEW400, SEW450, TEW250, TEW400, TEW450		
<b>accessories for</b>	375406		
	<b>GEV No.</b>	110545	<b>Ref. No.</b> 141091
	knob dial plate silver thermostat t.max. 110°C 30-110°C rotation 310° ED ø 59mm ID ø 45.5mm		
	<b>GEV No.</b>	112173	<b>Ref. No.</b> —
	knob universal ø 62mm black without adaptor/dial plate		

<b>GEV No.</b>	375613	<b>Ref. No.</b>	152107
<b>description</b>	thermostat t.max. 210°C temperature range 95-210°C 1-pole 1NO 16A probe ø 3.1mm probe L 201mm capillary pipe 1770mm capillary pipe isolated 1600mm gland nut shaft ø 6x4.6mm shaft L 23mm shaft position upper rotation 270° outer switch 2NO		
<b>For models:</b>	FEF124, FEF144, FEF224, PEF128, PEF148, PEF228		

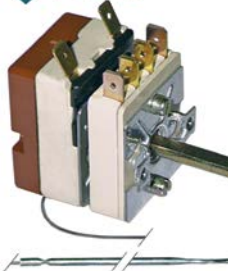
 			
<b>GEV No.</b>	375073	<b>Ref. No.</b>	174677
<b>description</b>	thermostat t.max. 320°C temperature range 50-320°C 1-pole capillary pipe isolatedmm gland nut		





55.34\_series



<b>GEV No.</b>	375592	<b>Ref. No.</b>	540592
<b>description</b>	thermostat t.max. 110°C temperature range 32-110°C 3-pole 3NO 16A probe ø 6mm probe L 138mm capillary pipe 1180mm capillary pipe isolated 1100mm gland nut shaft ø 6x4.6mm shaft L 23mm shaft position upper rotation 270° outer switch 2NO/2NO		
<b>For models:</b>	EEW250, EEW450, EEW452		



<b>GEV No.</b>	375023	<b>Ref. No.</b>	540511
<b>description</b>	thermostat t.max. 180°C temperature range 103-175/108-180°C 3-pole 2NO/2NO 16A probe ø 3.1mm probe L 305mm capillary pipe 720mm capillary pipe isolated 700mm gland nut shaft ø 6x4.6mm shaft L 23mm shaft position upper rotation 270° outer switch 2NO/2NO		
<b>For models:</b>	EEF124, EEF224		

various

safety thermostats



<b>GEV No.</b>	390510	<b>Ref. No.</b>	943228002
<b>description</b>	safety thermostat with thermocouple		
<b>For models:</b>	EGF124, EGF224		

switches and momentary switches

push/momentary push switches

2 hole fixing



<b>GEV No.</b>	345136	<b>Ref. No.</b>	407319
<b>description</b>	switch combination triple green 240V 16A connection male faston 6.3mm ambient temperature max. 125°C protection IP44		
<b>For models:</b>	ECD106, ECD110, ECD120, ECD220		

microswitches

universal



<b>GEV No.</b>	345042	<b>Ref. No.</b>	183197
<b>description</b>	microswitch with plunger 250V 16A 1CO connection male faston 6.3mm L 28mm ambient temperature max. 125°C mounting distance 22mm type EF83161.3 actuating force: 75g blue/black		
<b>For models:</b>	ECL484		
<b>accessories for</b>	345042		
	<b>GEV No.</b>	345043	<b>Ref. No.</b>
			—
	lever set 5-piece		

lever actuated



<b>GEV No.</b>	345254	<b>Ref. No.</b>	540575
<b>description</b>	microswitch with lever 250V 16A 1CO connection male faston 6.3mm ambient temperature max. 120°C mounting distance 22mm actuating force: 60g lever length 58mm		
<b>For models:</b>	EEF124, EEF224		



<b>GEV No.</b>	345255	<b>Ref. No.</b>	781660004
<b>description</b>	microswitch with lever 250V 16A 1CO connection male faston 6.3mm L 35mm L1 28mm ambient temperature max. 125°C mounting distance 22mm actuating force: 136g lever length 27mm		
<b>For models:</b>	NEK040, NEK060, NEK080, NEK100, NEK150, NNK040, NNK060, NNK080, NNK100, NNK150		



<b>GEV No.</b>	345107	<b>Ref. No.</b>	183426
<b>description</b>	microswitch with lever 250V 16A 1CO connection male faston 6.3mm L 98mm ambient temperature max. 125°C mounting distance 22mm actuating force: 30g lever length 90mm		
<b>For models:</b>	EGP500, FEK040, FEK060, FEK080, FEK100, FEK150, FNK040, FNK060, FNK080, FNK100, FNK150, NEK040, NEK060, NEK080, NEK100, NEK150, NEP060, NEP203, NEP303, NEP400, NEP600, NEP900, NGP900, NNK040, NNK060, NNK080, NNK100, NNK150, NTE182, PEK048, PEK068, PEK088, PEK108, PEK158, PNK048, PNK068, PNK088, PNK108, PNK158		





 <p>1</p>			
<b>GEV No.</b>	346375	<b>Ref. No.</b>	994902006
<b>description</b>	microswitch with lever 250V 10A connection male faston 6.3mm ambient temperature max. 85°C		
<b>For models:</b>	NEP400, NEP600, NEP601, NEP900, NEP901, NGP400, NGP600, NGP900		



roller-lever actuated  
non-standard

 <p>1</p>			
<b>GEV No.</b>	346507	<b>Ref. No.</b>	177161
<b>description</b>	microswitch with handle with a switch connection cable		
<b>For models:</b>	FEF170, FEF180, NEF176, PEF178, PEF188		



pin-plunger actuated

 <p>1</p>			
<b>GEV No.</b>	345060	<b>Ref. No.</b>	540426
<b>description</b>	microswitch with plunger 250V 16A 1NO connection male faston 6.3mm ambient temperature max. 85°C mounting distance 22mm type BS1010 actuating force: 350g red stroke 9mm		

 <p>1</p>			
<b>GEV No.</b>	345062	<b>Ref. No.</b>	177168
<b>description</b>	microswitch with plunger 250V 16A 1NO/1NC connection male faston 6.3mm ambient temperature max. 85°C mounting distance 22mm type BS1012 actuating force: 350g red stroke 8mm		
<b>For models:</b>	FEF124, FEF144, FEF144e, FEF224, FEF224e, PEF128, PEF148, PEF228, TEF124, TEF144, TEF224		

  <p>1</p>				
<b>GEV No.</b>	345042	<b>Ref. No.</b>	183197	
<b>description</b>	microswitch with plunger 250V 16A 1CO connection male faston 6.3mm L 28mm ambient temperature max. 125°C mounting distance 22mm type EF83161.3 actuating force: 75g blue/black			
<b>For models:</b>	ECL484			
<b>accessories for</b>	345042			
	<b>GEV No.</b>	345043	<b>Ref. No.</b>	—
	lever set 5-piece			

<p>M12</p>  <p>1</p>			
<b>GEV No.</b>	345138	<b>Ref. No.</b>	177160
<b>description</b>	microswitch with plunger mounting distance 25mm thread M12x1 thread L 12mm 250V 20A 1CO connection screw stroke 7mm L1 13mm ambient temperature max. 85°C type Z15G1307 actuating force: 250g		
<b>For models:</b>	CBE106, CBE106-VAR091, CBE110, CBE110-VAR091, CBE120, CBE120-VAR091, CBE220, CBE220-VAR091, CBG110, CBG120, CEC106, CEC110, CEC120, CEC220, CED106, CED110, CED120, CED220, CEF106, CEF110, CEF120, CEF220, CEM110, CEM120, CGD110, CGD120, EAB051, EDC106, FEP230, FEP330, NEP203, NEP303, PEP238, PEP338		

<p>M16</p>  <p>1</p>				
<b>GEV No.</b>	345047	<b>Ref. No.</b>	407268	
<b>description</b>	microswitch with plunger thread M16x1 thread L 27mm 250V 5A 1NO connection cable stroke 5mm ambient temperature max. 85°C with cable type 837333 actuating force: 400g			
<b>For models:</b>	ECD106, ECD110, ECD120, ECD220			
<b>accessories for</b>	345047			
	<b>GEV No.</b>	698490	<b>Ref. No.</b>	—
	cover ED ø 17mm suitable for 345047			

position switches

<p>OMRON</p>  <p>1</p>			
<b>GEV No.</b>	346299	<b>Ref. No.</b>	163611
<b>description</b>	position switch		
<b>For models:</b>	EEP500		

float switches

 <p>1</p>				
<b>GEV No.</b>	400023	<b>Ref. No.</b>	407262	
<b>description</b>	float switch thread 3/8" 1CO ø 30mm L 170mm mounting ø 3/8"mm 250V 0.5A cable cable length 2000mm			
<b>accessories for</b>	400023			
	<b>GEV No.</b>	506024	<b>Ref. No.</b>	—
	nut thread 3/8" H 6mm SS WS 22 Qty 1 pcs			



## cam switches

## on/off





1

<b>GEV No.</b>	300074	<b>Ref. No.</b>	540856
<b>description</b>	cam switch 4 operating positions 2NO sequence 0-1-0-1 16A shaft ø 6x4.6mm shaft L 23mm connection male faston 6.3mm ceramic		



1

<b>GEV No.</b>	300020	<b>Ref. No.</b>	182861
<b>description</b>	cam switch 4 operating positions 2NO sequence 0-1-0-1 16A shaft ø 6x4.6mm shaft L 23mm connection screw ceramic		
<b>For models:</b>	EGS060, EHN601, EHP601, EWB101, EWB201, EWN401-mit-beheiz-term-Schrankraum, NDD080, NDD150, NDD250, NDD300, NHD080, NHD150, NHD250, NHD300, NTE182		
<b>accessories for</b>	300020		
	<b>GEV No.</b>	110135	<b>Ref. No.</b> —
	rosette knob up to ø 52mm		
	<b>GEV No.</b>	110231	<b>Ref. No.</b> —
	knob switch 0-1-0-1 t.max.°C ø 50mm shaft ø 6x4.6mm shaft flat upper black		

## 4-position



1

<b>GEV No.</b>	300023	<b>Ref. No.</b>	183205
<b>description</b>	cam switch 4 operating positions 1NO/2CO sequence 0-1-2-3 16A shaft ø 6x4.6mm shaft L 23mm connection screw 4-position ceramic		
<b>For models:</b>	EHN401, EHN402, EHN601, EHN602, EHN801, EHN802, FEH210, FEH410, FEH413, FEH415, FEH610, FEH613, FEH615, NEH210, NEH212, NEH410, NEH413, NEH415, NEH610, NEH613, NEH615, NEP060, PEH218, PEH418, PEH618		



1

<b>GEV No.</b>	300103	<b>Ref. No.</b>	182752 183105
<b>description</b>	cam switch 4 operating positions 1NO/2CO sequence 0-1-2-3 32A shaft ø 6x4.6mm shaft L 23mm connection screw ceramic		



1

<b>GEV No.</b>	300104	<b>Ref. No.</b>	540431
<b>description</b>	cam switch 4 operating positions 3NO/1CO sequence 0-1-2-3 32A shaft ø 6x4.6mm shaft L 23mm connection screw ceramic		

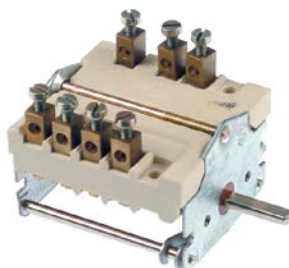

1

<b>GEV No.</b>	300190	<b>Ref. No.</b>	540431 540472
<b>description</b>	cam switch 4-position sequence 0-3-2-1 shaft ø 6x4.6mm connection screw clamp 3-pole		

## 7-position







1

<b>GEV No.</b>	300004	<b>Ref. No.</b>	182774 183206
<b>description</b>	cam switch 7 operating positions 1NO/2CO sequence 0-1-2-3-4-5-6 16A shaft ø 6x4.6mm shaft L 23mm connection male faston 6.3mm 7-position ceramic		
<b>For models:</b>	EHN401, EHN402, EHN601, EHN602, EHN801, EHN802		



**1**



<b>GEV No.</b>	300025	<b>Ref. No.</b>	182774
<b>description</b>	cam switch 7 operating positions 1NO/2CO sequence 0-1-2-3-4-5-6 16A shaft ø 6x4.6mm shaft L 23mm connection screw 7-position ceramic		
<b>For models:</b>	EHP601, FEH210, FEH410, FEH413, FEH415, FEH610, FEH613, FEH615, LEH405, LEH605, NEH210, NEH212, NEH410, NEH413, NEH415, NEH610, NEH613, NEH615, PEH218, PEH418, PEH618, SEH200		
<b>accessories for</b>	300025		
	<b>GEV No.</b>	112172	<b>Ref. No.</b> —
	knob universal ø 70mm black without adaptor/dial plate		
	<b>GEV No.</b>	112213	<b>Ref. No.</b> —
	knob dial plate silver switch 7-position t.max.°C ED ø 63mm ID ø 45.5mm		
	<b>GEV No.</b>	112311	<b>Ref. No.</b> —
	knob adapter shaft ø 6x4.6mm L 0mm with spring		

**1**



<b>GEV No.</b>	300106	<b>Ref. No.</b>	183104
<b>description</b>	cam switch 7 operating positions 1NO/2CO sequence 0-1-2-3-4-5-6 32A shaft ø 6x4.6mm shaft L 23mm connection screw 7-position shaft flat upper		
<b>For models:</b>	EHO101, EHO111		

**2 operating positions**

**1**



<b>GEV No.</b>	300112	<b>Ref. No.</b>	183232
<b>description</b>	cam switch 1NO sequence 0-1 10A shaft ø 6x4.6mm shaft L 23mm connection screw ON-OFF		
<b>For models:</b>	NED080, NED150, NED250, NED300, NEK040, NEK060, NEK080, NEK100, NEK150, NEM100, NER080, NER150, NER250, NER300, NER400, NER500, NES040, NES060, NES080, NES100, NES150, WES0400, WES0600, WES0800, WES1000, WES1500		

**4 operating positions**

**1**



<b>GEV No.</b>	300185	<b>Ref. No.</b>	182728
<b>description</b>	cam switch 4 operating positions 2NO sequence 1-2-1-2 16A shaft ø 6x4.6mm shaft L 23mm connection male faston 6.3mm ceramic		
<b>For models:</b>	EDC106, FEF124, FEF144, FEF224, NDD080, NDD150, NDD250, NDD300, NED080, NED150, NED250, NED300, NHD080, NHD150, NHD250, NHD300, PEF128, PEF148, PEF228		

**1**



<b>GEV No.</b>	300113	<b>Ref. No.</b>	183011
<b>description</b>	cam switch 4 operating positions 4NO sequence 0-1-0-2 32A shaft ø 6x4.6mm shaft L 23mm connection screw ceramic		
<b>For models:</b>	EES060, EES080, LES060, NED080, NED150, NED250, NED300, NEK040, NEK060, NEK080, NEK100, NEK150, NEM100, NER080, NER150, NER250, NER300, NER400, NER500, NES040, NES060, NES080, NES100, NES150, WES0400, WES0600, WES0800, WES1000, WES1500		

**1**



<b>GEV No.</b>	300179	<b>Ref. No.</b>	183156
<b>description</b>	cam switch 4 operating positions 4NO/1CO sequence 0-1-0-2 32A shaft ø 6x4.6mm shaft L 23mm connection screw 0-1-0-2 ceramic		
<b>For models:</b>	LEF124, LEF224, NEF124, NEF144, NEF224, NEF244, SEF124, SEF144, SEF224, TEF124, TEF144, TEF224		





			
1			
<b>GEV No.</b>	300019	<b>Ref. No.</b>	182746
<b>description</b>	cam switch 4 operating positions 4NO/1CO sequence 1-2-1-2 16A shaft ø 6x4.6mm shaft L 23mm connection male faston 6.3mm ceramic		
<b>For models:</b>	FEH415, FEH505, FEH515, FEH615, FEH705, FEH715, FGH415, FGH615, LEH405, LEH505, LEH605, LEH705, LGH405, LGH605, NEH415, NEH505, NEH615, NEH705, NGH405, NGH415, NGH505, NGH605, NGH615, NGH725		

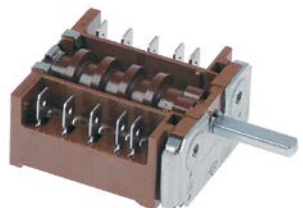

			
2			
<b>GEV No.</b>	300211	<b>Ref. No.</b>	545500
<b>description</b>	cam switch 4 operating positions 8NO sequence 0-1-0-2 16A shaft ø 6x4.6mm shaft L 18mm connection male faston 6.3mm		

			
1			
<b>GEV No.</b>	300182	<b>Ref. No.</b>	163602
<b>description</b>	cam switch 4 operating positions sequence 0-1-0-2 shaft ø 6x4.6mm connection male faston 4-pole		
<b>For models:</b>	NEP601, NEP901, NER080, NER150, NER250, NER300, NER400, NES040, NES060, NES080, NES100, NES150, NGR150, NGR250, NGR300, NGR400, NGS040, NGS060, NGS080, NGS100, NGS150, NNR080, NNR150, NNR250, NNR300, NNR400, NNS040, NNS060, NNS080, NNS100, NNS150		

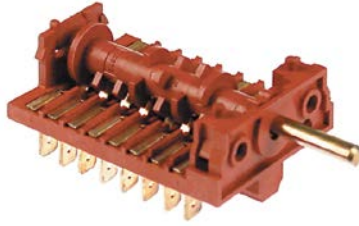
			
1			
<b>GEV No.</b>	300193	<b>Ref. No.</b>	540445
<b>description</b>	cam switch sequence 0-1-0-2		

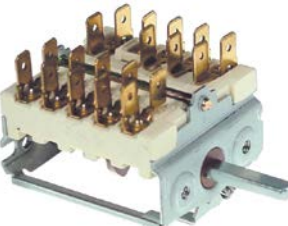
<b>5 operating positions</b>			
			
1			
<b>GEV No.</b>	300186	<b>Ref. No.</b>	540551
<b>description</b>	cam switch 16A		
<b>For models:</b>	EEW400		

<b>6 operating positions</b>			
			
1			
<b>GEV No.</b>	301235	<b>Ref. No.</b>	183155
<b>description</b>	cam switch 6 operating positions sequence 0-1-2-3-4-5 shaft ø 6x4.6mm connection male faston 4-pole		
<b>For models:</b>	ECL484		

<b>operation switches</b>			
			
1			
<b>GEV No.</b>	300080	<b>Ref. No.</b>	183110
<b>description</b>	cam switch 2 operating positions 4NO 16A sequence 0-1 shaft ø 6x4.6mm shaft L 23mm connection screw operation switch ceramic ambient temperature max. 150°C		
<b>For models:</b>	NEF144		
<b>accessories for</b>	300080		
	<b>GEV No.</b>	551456	<b>Ref. No.</b> —
gasket for switch ED ø 14mm ID ø 2.5mm thickness 3.5mm white			



1

<b>GEV No.</b>	300200	<b>Ref. No.</b>	540461
<b>description</b>	operation switch 2 operating positions 2NO 16A sequence 0-1 shaft $\varnothing$ 6x4.6mm shaft L 23mm connection male faston 6.3mm operation switch ceramic		



1

<b>GEV No.</b>	300091	<b>Ref. No.</b>	182825
<b>description</b>	operation switch EGO 2 operating positions 2NO 16A sequence 0-1 shaft $\varnothing$ 6x4.6mm shaft L 23mm connection screw ceramic		
<b>For models:</b>	EAB051, FEF040, FEW252, NEB630, NEF176, NEW182, NEW250, NEW450		

magnetic switches

miscellaneous



1

<b>GEV No.</b>	347235	<b>Ref. No.</b>	164891
<b>description</b>	magnetic switch 100V NC 5W brown mounting distance 16-18mm nominal 0.2A		



1

<b>GEV No.</b>	347812	<b>Ref. No.</b>	164891
<b>description</b>	magnetic switch 100VDC 0.1A P max. 5W cable length 2000mm 1NC connection cable L 48mm 5W L1 12mm L2 11mm white mounting distance 16-18mm nominal 0.2A		
<b>For models:</b>	CCE106, CCE110, CCE120, CCE220, CPE106, CPE110, CPE120, CPE220		

control equipment



MOELLER/EATON

switches (complete)

push/momentary push switches



1

<b>GEV No.</b>	346434	<b>Ref. No.</b>	540813	
<b>description</b>	momentary push switch mounting measurements $\varnothing$ 22mm green complete 1NC/1NO on			
<b>spare parts for</b>	346434			
	<b>GEV No.</b>	346293	<b>Ref. No.</b>	—
	contact block holder triple			
	<b>GEV No.</b>	346436	<b>Ref. No.</b>	—
	button plate green I			
	<b>GEV No.</b>	346747	<b>Ref. No.</b>	—
	push button mounting measurements $\varnothing$ 22mm silver without button lense momentary illuminable			

GENERAL ELECTRIC (AEG)

push buttons



1

<b>GEV No.</b>	345778	<b>Ref. No.</b>	163413
<b>description</b>	push button mounting measurements $\varnothing$ 22mm illuminated red		
<b>For models:</b>	EGP500, PGP608, PGP908		



1

<b>GEV No.</b>	345779	<b>Ref. No.</b>	163607
<b>description</b>	contact block GENERAL ELECTRIC P9B10VN 1NO max 400V 10A brown		
<b>For models:</b>	FEP600, FEP900, PEP608, PEP908, PGP608, PGP908		



1

<b>GEV No.</b>	346322	<b>Ref. No.</b>	163614
<b>description</b>	contact block GENERAL ELECTRIC P9B20VN 2NO max 660V 10A red		
<b>For models:</b>	EEP500, EGP500		



## lamp elements



1

<b>GEV No.</b>	346412	<b>Ref. No.</b>	163006
<b>description</b>	indicator socket GENERAL ELECTRIC 187020 max 250V 0.01A red/brown 2W socket Ba9s		
<b>For models:</b>	PGP608, PGP908		

## rotary switches



1

<b>GEV No.</b>	345781	<b>Ref. No.</b>	163608
<b>description</b>	rotary selector mounting measurements ø22mm black momentary sequence 1-0-2		
<b>For models:</b>	EEP500, EGP500, FEP600, FEP900, PEP608, PEP908, PGP608, PGP908		
<b>accessories for</b>	345781		
	<b>GEV No.</b>	345779	<b>Ref. No.</b> 163607
	contact block GENERAL ELECTRIC P9B10VN 1NO max 400V 10A brown		



1

<b>GEV No.</b>	346323	<b>Ref. No.</b>	163613
<b>description</b>	rotary selector mounting measurements ø22mm green latching sequence 1-0-2		
<b>For models:</b>	EEP500, EGP500		

## SIEMENS

## 3SB series ø22mm old

## rotary switches





1

<b>GEV No.</b>	345782	<b>Ref. No.</b>	183411
<b>description</b>	rotary selector mounting measurements ø22mm sequence 1-0-2 momentary black		
<b>For models:</b>	NEK040, NEK060, NEK080, NEK100, NEK150, NEP060, NEP203, NEP303, NEP400, NEP600, NEP601, NEP900, NEP901, NGP400, NGP600, NGP900, NNK040, NNK060, NNK080, NNK100, NNK150		

## lamps



1

<b>GEV No.</b>	359606	<b>Ref. No.</b>	183914
<b>description</b>	neon light bulb socket Ba9s 220V 2W clear ø 10mm L 28mm		
<b>For models:</b>	PGP608, PGP908		
<b>accessories for</b>	359606		
	<b>GEV No.</b>	359832	<b>Ref. No.</b> —
	lamp socket mounting measurements ø16.2mm socket Ba9s connection male faston 6.3mm		
	<b>GEV No.</b>	359853	<b>Ref. No.</b> —
	lamp socket mounting measurements ø18.2mm socket Ba9s connection male faston 6.3mm		

## encoders and potentiometers



1

<b>GEV No.</b>	300196	<b>Ref. No.</b>	407325
<b>description</b>	potentiometer 0-150		
<b>For models:</b>	ECD110, ECD120, ECD220		

## lamps

## indicator lights

## indicator lights 3-piece (housing, lens and bulb)

## lamps

## light bulbs



1

<b>GEV No.</b>	359608	<b>Ref. No.</b>	407265
<b>description</b>	light bulb socket E14 10/15W 230V ø 16mm L 51mm lens L 31mm Qty 1 pcs		
<b>For models:</b>	ECD106, ECD110, ECD120, ECD220		

## neon light bulbs



1











<b>GEV No.</b>	359606	<b>Ref. No.</b>	183914
<b>description</b>	neon light bulb socket Ba9s 220V 2W clear ø 10mm L 28mm		
<b>For models:</b>	PGP608, PGP908		
<b>accessories for</b>	359606		
	<b>GEV No.</b>	359832	<b>Ref. No.</b> —
	lamp socket mounting measurements ø16.2mm socket Ba9s connection male faston 6.3mm		

Table continues overleaf



<b>accessories for</b>	359606		
	<b>GEV No.</b>	359853	<b>Ref. No.</b> —
	lamp socket mounting measurements ø18.2mm socket Ba9s connection male faston 6.3mm		

	<b>GEV No.</b>	359600	<b>Ref. No.</b>	407269
<b>description</b>	neon light bulb socket E10 220V 0.35W clear ø 10mm L 28mm			
<b>For models:</b>	ECD106, ECD110, ECD120, ECD220			
<b>accessories for</b>	359600			
	<b>GEV No.</b>	359060	<b>Ref. No.</b>	—
	lamp socket mounting measurements ø16.2mm socket E10 connection screw			
	<b>GEV No.</b>	359063	<b>Ref. No.</b>	—
	lamp socket mounting measurements ø19.2mm socket E14 connection screw			
	<b>GEV No.</b>	359064	<b>Ref. No.</b>	—
	lamp socket mounting measurements ø22.3mm socket E14 connection screw 250/380V ambient temperature at 1W 100°C ambient temperature at 2W 85°C			
	<b>GEV No.</b>	359685	<b>Ref. No.</b>	—
	lamp socket mounting measurements ø16.2mm socket E10			
	<b>GEV No.</b>	359832	<b>Ref. No.</b>	—
	lamp socket mounting measurements ø16.2mm socket Ba9s connection male faston 6.3mm			
	<b>GEV No.</b>	359853	<b>Ref. No.</b>	—
	lamp socket mounting measurements ø18.2mm socket Ba9s connection male faston 6.3mm			
	<b>GEV No.</b>	359988	<b>Ref. No.</b>	—
	lamp socket mounting measurements ø30.5mm 250V connection F6.3 temp.-resist. 55°C E14			

indicator lights (complete)

ø10mm

with plug-in socket

	<b>GEV No.</b>	359036	<b>Ref. No.</b>	184145
<b>description</b>	indicator light ø 10mm clear 230V connection male faston 6.3mm Qty 1 pcs			
<b>For models:</b>	ECL484			

	<b>GEV No.</b>	359139	<b>Ref. No.</b>	184186
<b>description</b>	indicator light ø 10mm green 230V connection male faston 6.3mm Qty 1 pcs			
<b>For models:</b>	ECL484			



ø12mm

with screw socket

	<b>GEV No.</b>	359027	<b>Ref. No.</b>	540412
<b>description</b>	indicator light ø 12mm 250V green connection male faston 6.3mm			

ø16mm

with screw socket

	<b>GEV No.</b>	359835	<b>Ref. No.</b>	184120
<b>description</b>	indicator light ø 16mm 230V green connection male faston 6.3mm			
<b>For models:</b>	EAB051, ECL484, EDC106, EEB230, EEB430, EEF040, EEF124, EEF224, EEH210, EEH300, EEH410, EEH413, EEH500, EEH503, EEH610, EEH613, EEH700, EEH703, EEP500, EES060, EES080, EEW250, EEW400, EEW450, EEW452, EGH413, EGH613, EGP500, EGS060, EHO101, EHO111, FEB430, FEB630, FEF040, FEF124, FEF144, FEF224, FEH210, FEH410, FEH413, FEH415, FEH500, FEH503, FEH505, FEH510, FEH513, FEH515, FEH610, FEH613, FEH615...(Other models you can see in the web-shop)			
<b>accessories for</b>	359835			
	<b>GEV No.</b>	550559	<b>Ref. No.</b>	—
	nut thread M16x1 H 5.5mm WS 19			

with plug-in socket

	<b>GEV No.</b>	359166	<b>Ref. No.</b>	184118
<b>description</b>	indicator light ø 16mm 230V white			
<b>For models:</b>	EAB051, ECL484, EDC106, EEF124, EEF224, EES060, EES080, EEW250, EEW450, EEW452, EGP500, FEF040, FEF124, FEF144, FEF224, FEH613, FEH615, FEH705, FEH715, FEP600, FEP900, FGH613, FGH615, LEB231, LEB270, LEB431, LEB631, LEF040, LEF124, LEF224, LEH405, LEH503, LEH505, LEH605, LEH703, LEH705, LEP400, LES060, LEW450, LEW452, LGH405, LGH605, LGH607, NDD080, NDD150, NDD250, NDD300, NEB430, NEB431, NEB630...(Other models you can see in the web-shop)			

	<b>GEV No.</b>	359197	<b>Ref. No.</b>	184124 184265
<b>description</b>	indicator light ø 16mm 400V red			
<b>For models:</b>	EGN102, EGN401, EGN402, EGP202, EHN401, EHN601, EHN801, EPN402, EPP202, EWB101-mit-Thermostat, EWB201-mit-Thermostat, EWN101, EWN201, EWN401, EWN401-mit-beheizterm-Schrankraum, EWN402			







			
1			
<b>GEV No.</b>	359198	<b>Ref. No.</b>	184125
<b>description</b>	indicator light ø 16mm 400V white		
<b>For models:</b>	EEB230, EEB430, EEH413, EEH503, EEH613, EEH703, EEP500, EGH413, EGH613, FEB430, FEB630, FEH413, FEH415, FEH503, FEH505, FEH513, FEH515, FEH613, FEH615, FEH705, FEH715, FEW250, FEW252, FGH413, FGH415, FGH613, FGH615, LEB270, LEB430, LEG420, LEH405, LEH503, LEH505, LEH605, LEH703, LEH705, LEP400, LES060, LEW450, LEW452, LGH405, LGH605, NEA182, NEB430, NEB630, NEF144, NEG420, NEH413, NEH415, NEH505...(Other models you can see in the webshop)		







			
1			
<b>GEV No.</b>	359169	<b>Ref. No.</b>	540623
<b>description</b>	indicator light ø 16mm 400V yellow		
<b>For models:</b>	EEW400		

<b>miscellaneous</b>			
			
1			
<b>GEV No.</b>	359887	<b>Ref. No.</b>	407321
<b>description</b>	lamp socket socket E10 mounting measurements ø21mm		
<b>For models:</b>	ECD106, ECD110, ECD120, ECD220		

**screw-on/push-on fit**

<b>neon light bulbs</b>				
				
1				
<b>GEV No.</b>	359606	<b>Ref. No.</b>	183914	
<b>description</b>	neon light bulb socket Ba9s 220V 2W clear ø 10mm L 28mm			
<b>For models:</b>	PGP608, PGP908			
<b>accessories for</b>	359600			
	<b>GEV No.</b>	359832	<b>Ref. No.</b>	—
lamp socket mounting measurements ø16.2mm socket Ba9s connection male faston 6.3mm				
	<b>GEV No.</b>	359853	<b>Ref. No.</b>	—
lamp socket mounting measurements ø18.2mm socket Ba9s connection male faston 6.3mm				

				
1				
<b>GEV No.</b>	359600	<b>Ref. No.</b>	407269	
<b>description</b>	neon light bulb socket E10 220V 0.35W clear ø 10mm L 28mm			
<b>For models:</b>	ECD106, ECD110, ECD120, ECD220			
<b>accessories for</b>	359600			
	<b>GEV No.</b>	359060	<b>Ref. No.</b>	—
lamp socket mounting measurements ø16.2mm socket E10 connection screw				

<b>accessories for</b>	359600			
	<b>GEV No.</b>	359063	<b>Ref. No.</b>	—
lamp socket mounting measurements ø19.2mm socket E14 connection screw				
	<b>GEV No.</b>	359064	<b>Ref. No.</b>	—
lamp socket mounting measurements ø22.3mm socket E14 connection screw 250/380V ambient temperature at 1W 100°C ambient temperature at 2W 85°C				
	<b>GEV No.</b>	359685	<b>Ref. No.</b>	—
lamp socket mounting measurements ø16.2mm socket E10				
	<b>GEV No.</b>	359832	<b>Ref. No.</b>	—
lamp socket mounting measurements ø16.2mm socket Ba9s connection male faston 6.3mm				
	<b>GEV No.</b>	359853	<b>Ref. No.</b>	—
lamp socket mounting measurements ø18.2mm socket Ba9s connection male faston 6.3mm				
	<b>GEV No.</b>	359988	<b>Ref. No.</b>	—
lamp socket mounting measurements ø30.5mm 250V connection F6.3 temp.-resist. 55°C E14				

**light bulbs**

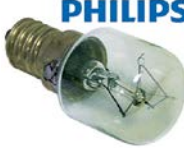
<b>for ovens</b>			
			
1			
<b>GEV No.</b>	359610	<b>Ref. No.</b>	184001 407288
<b>description</b>	light bulb t.max. 300°C socket E14 15W 230V ø 22mm L 47mm lens L 20mm for oven lamp type Philips		
<b>For models:</b>	ECD106, ECD110, ECD120, ECD220, ECL484, EHP601		

			
1			
<b>GEV No.</b>	359612	<b>Ref. No.</b>	184018
<b>description</b>	light bulb t.max. 300°C socket E14 25W 230V ø 25mm L 56mm lens L 30mm for oven lamp type Philips		
<b>For models:</b>	ECL484		

			
1			
<b>GEV No.</b>	359611	<b>Ref. No.</b>	183926
<b>description</b>	light bulb t.max. 300°C socket E14 40W 230V ø 45mm L 75mm lens L 50mm for oven lamp IMPORT		
<b>For models:</b>	CEC106, CEC110, CEC120, CEC220, CED106, CED110, CED120, CED220		



## for indicator lights



1			
<b>GEV No.</b>	359608	<b>Ref. No.</b>	407265
<b>description</b>	light bulb socket E14 10/15W 230V ø 16mm L 51mm lens L 31mm Qty 1 pcs		
<b>For models:</b>	ECD106, ECD110, ECD120, ECD220		

## halogen lamp

### for socket G4 / G6.35 / G9



1			
<b>GEV No.</b>	359599	<b>Ref. No.</b>	163000
<b>description</b>	halogen lamp socket G4 12V 20W temp.-resist. 500°C		
<b>For models:</b>	CBE106, CBE106-VAR091, CBE110, CBE110-VAR091, CBE120, CBE120-VAR091, CBE220, CBE220-VAR091, CBG110, CBG120, CCE106, CCE110, CCE120, CCE220, CEC106, CEC110, CEC120, CEC220, CED106, CED110, CED120, CED220, CEF106, CEF110, CEF120, CEF220, CEM110, CEM120, CGD110, CGD120, CPE106, CPE110, CPE120, CPE220		

## linear lamps

### infrared lamps

#### with base type R7s



1			
<b>GEV No.</b>	359628	<b>Ref. No.</b>	163018
<b>description</b>	infrared lamp socket R7s L 117.6mm 240V 300W IMPORT unjacketed		

## oven lamps

### universal oven lamps

#### mounting diameter 35.5mm



1			
<b>GEV No.</b>	359701	<b>Ref. No.</b>	407284
<b>description</b>	lamp socket socket E14 220-230V mounting ø 35.5mm connection male faston 6.3mm 15W		
<b>For models:</b>	ECD106, ECD110, ECD120, ECD220		

<b>accessories for</b>	359701			
	<b>GEV No.</b>	359705	<b>Ref. No.</b>	407390
	oven lamp glass thr.ø 33.5mm ø 52mm hard glas temp.-resist. 350°C			
	<b>GEV No.</b>	359709	<b>Ref. No.</b>	—
	oven lamp glass thr.ø 33.5mm ø 42mm hard glas temp.-resist. 350°C			
	<b>GEV No.</b>	359721	<b>Ref. No.</b>	407286
	gasket silicone ED ø 48mm ID ø 39.5mm thickness 5mm Qty 1 pcs			

<b>accessories for</b>	359701			
	<b>GEV No.</b>	359942	<b>Ref. No.</b>	—
	oven lamp glass thr.ø 33.5mm ø 41mm hard glas temp.-resist. 350°C			



1			
<b>GEV No.</b>	359705	<b>Ref. No.</b>	407390
<b>description</b>	oven lamp glass thr.ø 33.5mm ø 52mm hard glas temp.-resist. 350°C		
<b>For models:</b>	ECD106, ECD110, ECD120, ECD220		

<b>accessories for</b>	359705			
	<b>GEV No.</b>	359610	<b>Ref. No.</b>	184001 407288
	light bulb t.max. 300°C socket E14 15W 230V ø 22mm L 47mm lens L 20mm for oven lamp type Philips			
	<b>GEV No.</b>	359700	<b>Ref. No.</b>	—
	gasket for pizza oven fibre glass ID ø 32.5mm ED ø 55mm thickness 5mm			
	<b>GEV No.</b>	359721	<b>Ref. No.</b>	407286
	gasket silicone ED ø 48mm ID ø 39.5mm thickness 5mm Qty 1 pcs			
	<b>GEV No.</b>	359837	<b>Ref. No.</b>	—
	gasket ID ø 33mm ED ø 46mm thickness 1mm graphite			
	<b>GEV No.</b>	359838	<b>Ref. No.</b>	—
	gasket ID ø 33mm ED ø 45mm			

1			
<b>GEV No.</b>	359721	<b>Ref. No.</b>	407286
<b>description</b>	gasket silicone ED ø 48mm ID ø 39.5mm thickness 5mm Qty 1 pcs		
<b>For models:</b>	ECD106, ECD110, ECD120, ECD220		

#### mounting diameter 65.5mm





1				
<b>GEV No.</b>	359712	<b>Ref. No.</b>	183927	
<b>description</b>	oven lamp mounting ø 65.5mm 230V 40W socket E14 temp.-resist. 300°C connection male faston 6.3mm hard glas			
<b>For models:</b>	CEC106, CEC110, CEC120, CEC220, CED106, CED110, CED120, CED220			
<b>spare parts for</b>	359712			
	<b>GEV No.</b>	359022	<b>Ref. No.</b>	—
	lamp socket socket E14 mounting ø 65.5mm connection male faston 6.3mm			
	<b>GEV No.</b>	359611	<b>Ref. No.</b>	183926
	light bulb t.max. 300°C socket E14 40W 230V ø 45mm L 75mm lens L 50mm for oven lamp IMPORT			

Table continues overleaf







<b>spare parts for</b> 359712	
	GEV No. 359722 Ref. No. 062339 062539
gasket silicone ID ø 57.5mm ED ø 68mm thickness 2mm	
	GEV No. 359724 Ref. No. 407680
oven lamp glass thread ø 62mm H 46mm ø 74mm hard glas temp.-resist. 350°C	



<b>GEV No.</b>	359724	<b>Ref. No.</b>	407680
<b>description</b>	oven lamp glass thread ø 62mm H 46mm ø 74mm hard glas temp.-resist. 350°C		
<b>For models:</b>	CEC106, CEC110, CEC120, CEC220, CED106, CED110, CED120, CED220		

<b>55x70mm</b>			
	1		
<b>GEV No.</b>	359722	<b>Ref. No.</b>	062339 062539
<b>description</b>	gasket silicone ID ø 57.5mm ED ø 68mm thickness 2mm		
<b>For models:</b>	CEC106, CEC110, CEC120, CEC220, CED106, CED110, CED120, CED220		

<b>55x70mm</b>			
	1		
<b>GEV No.</b>	359297	<b>Ref. No.</b>	131111
<b>description</b>	frame L 95mm W 81mm mounting distance 68/83mm thickness 6mm		
<b>For models:</b>	CBE106, CBE106-VAR091, CBE110, CBE110-VAR091, CBE120, CBE120-VAR091, CBE220, CBE220-VAR091, CBG110, CBG120, CCE106, CCE110, CCE120, CCE220, CEC106, CEC110, CEC120, CEC220, CED106, CED110, CED120, CED220, CEF106, CEF110, CEF120, CEF220, CEM110, CEM120, CGD110, CGD120, CPE106, CPE110, CPE120, CPE220		
<b>accessories for</b>	359297		
	GEV No. 359299	Ref. No.	060323
gasket L 91mm W 77mm hole ø 3mm for oven lamp			

	1		
<b>GEV No.</b>	359299	<b>Ref. No.</b>	060323
<b>description</b>	gasket L 91mm W 77mm hole ø 3mm for oven lamp		
<b>For models:</b>	CBE106, CBE106-VAR091, CBE110, CBE110-VAR091, CBE120, CBE120-VAR091, CBE220, CBE220-VAR091, CBG110, CBG120, CCE106, CCE110, CCE120, CCE220, CEC106, CEC110, CEC120, CEC220, CED106, CED110, CED120, CED220, CEF106, CEF110, CEF120, CEF220, CEM110, CEM120, CGD110, CGD120, CPE106, CPE110, CPE120, CPE220		

	1		
<b>GEV No.</b>	359296	<b>Ref. No.</b>	103702
<b>description</b>	lamp glass L 74mm W 58mm thickness 3mm		
<b>For models:</b>	CBE106, CBE106-VAR091, CBE110, CBE110-VAR091, CBE120, CBE120-VAR091, CBE220, CBE220-VAR091, CBG110, CBG120, CCE106, CCE110, CCE120, CCE220, CEC106, CEC110, CEC120, CEC220, CED106, CED110, CED120, CED220, CEF106, CEF110, CEF120, CEF220, CEM110, CEM120, CGD110, CGD120, CPE106, CPE110, CPE120, CPE220		

<b>60x100mm</b>			
	1		
<b>GEV No.</b>	359767	<b>Ref. No.</b>	184016 184017
<b>description</b>	oven lamp complete L 100mm W 60mm 230V 25W socket E14 temp.-resist. 300°C connection male faston 6.3mm		
<b>For models:</b>	ECL484		

<b>lamps</b>			
<b>light bulbs</b>			
	1		
<b>GEV No.</b>	359610	<b>Ref. No.</b>	184001 407288
<b>description</b>	light bulb t.max. 300°C socket E14 15W 230V ø 22mm L 47mm lens L 20mm for oven lamp type Philips		
<b>For models:</b>	ECD106, ECD110, ECD120, ECD220, ECL484, EHP601		

	1		
<b>GEV No.</b>	359612	<b>Ref. No.</b>	184018
<b>description</b>	light bulb t.max. 300°C socket E14 25W 230V ø 25mm L 56mm lens L 30mm for oven lamp type Philips		
<b>For models:</b>	ECL484		

	1		
<b>GEV No.</b>	359611	<b>Ref. No.</b>	183926
<b>description</b>	light bulb t.max. 300°C socket E14 40W 230V ø 45mm L 75mm lens L 50mm for oven lamp IMPORT		
<b>For models:</b>	CEC106, CEC110, CEC120, CEC220, CED106, CED110, CED120, CED220		



halogen lamps

for socket G4 / G6.35 / G9



<b>GEV No.</b>	359599	<b>Ref. No.</b>	163000
<b>description</b>	halogen lamp socket G4 12V 20W temp.-resist. 500°C		
<b>For models:</b>	CBE106, CBE106-VAR091, CBE110, CBE110-VAR091, CBE120, CBE120-VAR091, CBE220, CBE220-VAR091, CBG110, CBG120, CCE106, CCE110, CCE120, CCE220, CEC106, CEC110, CEC120, CEC220, CED106, CED110, CED120, CED220, CEF106, CEF110, CEF120, CEF220, CEM110, CEM120, CGD110, CGD120, CPE106, CPE110, CPE120, CPE220		

lamp accessories

gaskets



<b>GEV No.</b>	550891	<b>Ref. No.</b>	062304
<b>description</b>	gasket for lamp L 87mm W 66mm		
<b>For models:</b>	ECL484		

timers

programme timers

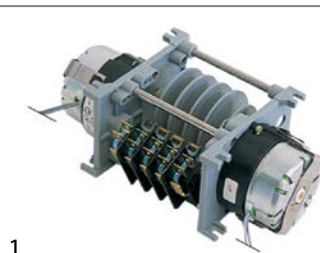

<b>GEV No.</b>	360047	<b>Ref. No.</b>	120268
<b>description</b>	timer CDC 4905DV engines 2 chambers 5 operation time 4s / 150s 230V shaft ømm shaft Lmm manuf. no. 4905DV / 360047 motor type M48L ATS		
<b>spare parts for</b>	360047		
	<b>GEV No.</b>	360083	<b>Ref. No.</b> —
	motor CDC pinion ø 4.9mm teeth 10 230V turn direction left motor ø 47mm H 19.3mm motor type M48L ATS for timer		

electric timers



<b>GEV No.</b>	350001	<b>Ref. No.</b>	174878 174946 355690 407267
<b>description</b>	timer 2CO at 250V 16A permanent position yes impulse electric shaft ø 6x4.6mm shaft L 22mm mounting distance 28mm connection rear 2-pole operation time 120min		
<b>For models:</b>	EAB051, EAB081, EAB101, EAB102, EAB112, ECD106, ECD110, ECD120, ECD220, ECL484		

with time spread



<b>GEV No.</b>	350074	<b>Ref. No.</b>	174883
<b>description</b>	timer MS65 operation time 120min time spread 30min 1CO/2NO/1NC at 250V 16A permanent position yes impulse electric shaft ø 6x4.6mm shaft L 22mm mounting distance 28mm connection lateral Invensys 4-pole shaft position lower°		
<b>For models:</b>	CEC106, CEC110, CEC120, CEC220, CED106, CED110, CED120, CED220		

alarm devices

buzzers



<b>GEV No.</b>	350050	<b>Ref. No.</b>	355612 407333
<b>description</b>	buzzer 230VAC connection male faston 6.3mm screw mounting thread M4 60dB		
<b>For models:</b>	CEC106, CEC110, CEC120, CEC220, CED106, CED110, CED120, CED220, ECL484, EDC106, NEP060, NEP203, NEP303, NTE182		



contactors

ABB

power contactors



1			
<b>GEV No.</b>	380092	<b>Ref. No.</b>	163519
<b>description</b>	power contactor resistive load 20A 230VAC (AC3/400V) 12A/5.5kW main contacts 4NO auxiliary contacts connection screw connection type B6-40-00 / B7-40-00		

GENERAL ELECTRIC (AEG)

power contactors



1			
<b>GEV No.</b>	380231	<b>Ref. No.</b>	185830 185850
<b>description</b>	power contactor resistive load 16A 230VAC (AC3/400V) 6A/3kW main contacts 3NO auxiliary contacts 1NC connection screw connection type AEG LS0701A		
<b>For models:</b>	CED106, CED110, EAB051, EDC106, NEP060, NEP600, NEP900		



1			
<b>GEV No.</b>	380239	<b>Ref. No.</b>	185830
<b>description</b>	power contactor resistive load 20A 230VAC (AC3/400V) 8.4A/4kW main contacts 3NO auxiliary contacts 1NC connection screw connection type LS05 01A type AEG LS05 01A type GE MC1A 301A		



1			
<b>GEV No.</b>	380337	<b>Ref. No.</b>	163500 185890
<b>description</b>	power contactor resistive load 20A 230VAC (AC3/400V) 8.4A/4kW main contacts 4NO auxiliary contacts connection screw connection type AEG LS05 400A type GE MC1A 400A		
<b>For models:</b>	CBE106, CBE106-VAR091, CBE110, CBE110-VAR091, CBE120, CBE120-VAR091, CCE106, CEC106, CEC110, CEC120, CEC220, CED106, CED110, CED120, CED220, CEF106, CEF110, CEF120, CEM110, CEM120, CPE106, ECL484, EES060, FEB430, FEB630, FED080, FED150, FED250, FEF124, FEF170, FEF180, FEF224, FEF224e, FEH415, FEH500, FEH503, FEH505, FEH510, FEH513, FEH515, FEH615, FEH700, FEH705, FEH710, FEH715, FEK040, FEK060, FEK080, FEK100, FEK150...(Other models you can see in the webshop)		



1			
<b>GEV No.</b>	380262	<b>Ref. No.</b>	185775 185783
<b>description</b>	power contactor resistive load 32A 230VAC (AC3/400V) 17A/7.5kW main contacts 3NO auxiliary contacts 1NC connection screw connection type AEG LS7K01A type GE CL02A 301 H 85mm		
<b>For models:</b>	CBE110, CBE110-VAR091, CCE110, CEC106, CEC110, CED106, CED110, CEF110, CEM110, CPE110, EES080, FED080, FED250, FED300, FEF144, FEF144e, FEK080, FEK100, FEK150, FEP230, FER300, FER400, FES080, FES100, FES150, NEK040, NEK060, NEK080, NEK100, NEK150, NEP203, NEP303, NEP600, NEP900, NEP901, NER080, NER150, NER250, NER300, NER400, NER500, NES040, NES060, NES080, NES100, NES150, NTE182, PED088, PED258, PED308...(Other models you can see in the webshop)		



1			
<b>GEV No.</b>	380264	<b>Ref. No.</b>	185776 185796
<b>description</b>	power contactor resistive load 45A 230VAC (AC3/400V) 25A/11kW main contacts 3NO auxiliary contacts connection screw connection type AEG LS11K 00A type GE CL25A 300		
<b>For models:</b>	CBE120, CBE120-VAR091, CBE220, CBE220-VAR091, CEC120, CEC220, CED120, CED220, CEF120, CEF220, CEM120, FED150, FEK150, FEP330, FER150, FES150, NER150, NER300, NER400, NES150, PED158, PEK158, PEP338, PER158, PES158		



1

<b>GEV No.</b>	380265	<b>Ref. No.</b>	185777 185797
<b>description</b>	power contactor resistive load 60A 230VAC (AC3/400V) 32A/16kW main contacts 3NO auxiliary contacts 1NO connection screw connection type AEG LS15K 00A type GE CL04A 310 H 98mm L 87mm W 55mm		
<b>For models:</b>	CCE120, CEC110, CED110, CPE120, FED250, FED300, FER250, NER250, PED258, PED308, PER258, PER308		



1

<b>GEV No.</b>	380266	<b>Ref. No.</b>	186174
<b>description</b>	power contactor resistive load 90A 230VAC (AC3/400V) 22kW main contacts 3NO connection screw type AEG LS22K 00A type GE CL06A 300		
<b>For models:</b>	CBE120, CBE120-VAR091, CBE220, CBE220-VAR091, CCE220, CEC120, CEC220, CED120, CED220, CEF120, CEF220, CEM120, CPE220, FEF170, FEF180, FER300, FER400, NER300, NER400, PEF178, PEF188		

auxiliary contactors



1

<b>GEV No.</b>	380277	<b>Ref. No.</b>	185778 185845
<b>description</b>	auxiliary contactor 230V		
<b>For models:</b>	CEC106, CEC110, CEC120, CEC220, CED120, CED220, EDC106, NEP060, NTE182		

motor protection circuit breakers



1

<b>GEV No.</b>	380169	<b>Ref. No.</b>	407336
<b>description</b>	motor protection circuit breaker		
<b>For models:</b>	ECD106, ECD110		



1

<b>GEV No.</b>	380170	<b>Ref. No.</b>	407332
<b>description</b>	motor protection circuit breaker		
<b>For models:</b>	ECD120, ECD220		

ISKRA (FANAL)

power contactors



1

<b>GEV No.</b>	380212	<b>Ref. No.</b>	120461
<b>description</b>	power contactor resistive load 20A 230VAC (AC3/400V) 8.5A/5.5kW main contacts 3NO auxiliary contacts 1NC connection screw connection type Fanal K07M 01 type ISKRA DSL7 01		



## MOELLER/EATON

## power contactors



1

<b>GEV No.</b>	380497	<b>Ref. No.</b>	185774 185798 185830 185844 540428
<b>description</b>	power contactor resistive load 20A 230VAC (AC3/400V) 9A/4kW main contacts 4NO auxiliary contacts connection screw connection type DILEM 4		
<b>For models:</b>	CBE106, CBE106-VAR091, CBE110, CBE110-VAR091, CBE120, CBE120-VAR091, CBE220, CBE220-VAR091, CBG110, CBG120, CEC106, CEC110, CEC120, CEC220, CED106, CED110, CED120, CED220, CEF106, CEF110, CEF120, CEF220, CEM110, CEM120, CGD110, CGD120, ECL484, FEF124, FEF144, FEF144e, FEF170, FEF180, FEF224, PEF128, PEF148, PEF178, PEF188, PEF228		



1

<b>GEV No.</b>	380166	<b>Ref. No.</b>	407409
<b>description</b>	power contactor resistive load 40A 230VAC (AC3/400V) 25A/11kW main contacts 3NO auxiliary contacts 1NC connection screw connection type DILM25 01		
<b>accessories for</b>	380166		
	<b>GEV No.</b>	<b>Ref. No.</b>	—
	auxiliary contact contacts 2NO/2NC AC15 16A for contactors DILEM connection screw type DILA-XHI22		
	<b>GEV No.</b>	<b>Ref. No.</b>	—
	auxiliary contact contacts 4NO AC15 16A for contactors DILM 7-32 connection screw type DILA-XHI40		
	<b>GEV No.</b>	<b>Ref. No.</b>	—
	auxiliary contact contacts 4NC AC15 16A for contactors DILM 7-32 connection screw type DILA-XHI04		
	<b>GEV No.</b>	<b>Ref. No.</b>	—
	auxiliary contact contacts 3NO/1NC AC15 16A for contactors DILM 7-32 connection screw type DILA-XHI31		
	<b>GEV No.</b>	<b>Ref. No.</b>	—
	auxiliary contact contacts 1NO/3NC AC15 16A for contactors DILM 7-32 connection screw type DILA-XHI13		
	<b>GEV No.</b>	<b>Ref. No.</b>	—
	auxiliary contact contacts 1NO/1NC AC15 10A for contactors DIL 17-32 connection screw type DILM 32-CHI11-S		
	<b>GEV No.</b>	<b>Ref. No.</b>	—
	RC circuit suitable for DILM 17-32 rated 110-240V		



1

<b>GEV No.</b>	380167	<b>Ref. No.</b>	407331
<b>description</b>	power contactor resistive load 66A 230VAC (AC3/400V) 50A/22kW main contacts 3NO auxiliary contacts 1NO connection screw connection type DILM 50		

## TELEMECANIQUE (Schneider Electric)

## auxiliary contactors



1

<b>GEV No.</b>	380367	<b>Ref. No.</b>	185780 185793 994853
<b>description</b>	auxiliary contactor 230VAC AC1 10A type CA2SK11P7 connection screw contacts 1NO/1NC		
<b>For models:</b>	FED080, FED150, FED250, FED300, FEH210, FEH410, FEH413, FEH415, FEH610, FEH613, FEH615, FEW250, FEW252, FGH413, FGH415, FGH613, FGH615, LEH503, LEH505, LEH703, LEH705, NEB431, NEP203, NEP303, NEP600, NEP900, NGH413, NGH415, NGH613, NGH615, NGH733, NTE182, PED088, PED158, PED258, PED308, PEH218, PEH418, PEH508, PEH518, PEH618, PEH708, PEH718, PEW458, PEW658		



1

<b>GEV No.</b>	380188	<b>Ref. No.</b>	185780 185793 994853
<b>description</b>	small relay switch main contacts 1NO auxiliary contacts 1NC supply at 50-60Hz 220-240V		





ABL SURSUM

motor protection circuit breakers



1

<b>GEV No.</b>	380300	<b>Ref. No.</b>	407528
<b>description</b>	motor protection circuit breaker type Mbs25-016 setting range 1-1.6A (AC3/400V) 0.55kW		
<b>For models:</b>	ECD106, ECD110		
<b>accessories for</b>	380300		
	<b>GEV No.</b>	380305	<b>Ref. No.</b> 407529
	auxiliary contact contacts 1NO/1NC HMS11		



1

<b>GEV No.</b>	380301	<b>Ref. No.</b>	407617
<b>description</b>	motor protection circuit breaker type Mbs25-025 setting range 1.6-2.5A (AC3/400V) 1.1kW		
<b>For models:</b>	ECD120, ECD220		

accessories



1

<b>GEV No.</b>	380305	<b>Ref. No.</b>	407529
<b>description</b>	auxiliary contact contacts 1NO/1NC HMS11		
<b>For models:</b>	ECD106, ECD110, ECD120, ECD220		

miscellaneous

power contactors



1

<b>GEV No.</b>	380165	<b>Ref. No.</b>	407330
<b>description</b>	power contactor		
<b>For models:</b>	ECD106, ECD110, ECD120, ECD220		



1

<b>GEV No.</b>	380168	<b>Ref. No.</b>	407452
<b>description</b>	power contactor		



1

<b>GEV No.</b>	380308	<b>Ref. No.</b>	407409
<b>description</b>	power contactor		
<b>For models:</b>	ECD110, ECD220		



1

<b>GEV No.</b>	380289	<b>Ref. No.</b>	407452
<b>description</b>	power contactor resistive load 20A		
<b>For models:</b>	ECD106		



## solid state relays

### CELDUC





1

<b>GEV No.</b>	401462	<b>Ref. No.</b>	164889
<b>description</b>	solid state relay CELDUC 1 phase 5A 600V 5-30VDC L 90mm W 12mm for top-hat rail screw type SKA20460		
<b>For models:</b>	CCE106, CCE110, CCE120, CCE220, CPE106, CPE110, CPE120, CPE220		



1

<b>GEV No.</b>	401459	<b>Ref. No.</b>	164888
<b>description</b>	solid state relay CELDUC 2 phase 50A 24-600V 6-16VDC L 59mm W 46mm screw type SOB965160		
<b>For models:</b>	CCE106, CCE110, CCE120, CCE220, CPE106, CPE110, CPE120, CPE220		
<b>spare parts for</b>	401459		
	<b>GEV No.</b>	401676	<b>Ref. No.</b> —
	heat-conducting foil L 57mm W 45mm		
<b>accessories for</b>	401459		
	<b>GEV No.</b>	550802	<b>Ref. No.</b> —
	PCB terminal block 4-pole raster size 5mm		

## relays

### power relays

#### with special fixing





1

<b>GEV No.</b>	380309	<b>Ref. No.</b>	407331
<b>description</b>	power relays 230VAC 16A 2-pole		
<b>For models:</b>	ECD120, ECD220		

### plug-in/print relays



1

<b>GEV No.</b>	380500	<b>Ref. No.</b>	163502 163505 540352
<b>description</b>	print relay 12VDC 2CO at 250V 8A connection pins raster size 5mm REIPOL		
<b>For models:</b>	EGP500		
<b>accessories for</b>	380500		
	<b>GEV No.</b>	380340	<b>Ref. No.</b> —
	relay socket dimensions 62x36x15mm 250V voltage AC 10A Italiana Relè manuf. no. ZMEM/5		
	<b>GEV No.</b>	380505	<b>Ref. No.</b> —
	relay socket 2CO 40.52 dimensions 81.9x15.5x75mm 250V voltage AC 10A FINDER manuf. no. 95.95.3		
	<b>GEV No.</b>	381181	<b>Ref. No.</b> —
	relay socket 2-pole 40.51/40.52/40.61 connection screw clamp dimensions 15.8x78.6mm 250V voltage AC 10A FINDER manuf. no. 95.75		

### level relays

#### miscellaneous



1

<b>GEV No.</b>	401256	<b>Ref. No.</b>	184833
<b>description</b>	level relay		
<b>For models:</b>	FED080, FED150, FED250, FED300, FGR150, FGR250, FGR300, FGR400, FGS040, FGS060, FGS080, FGS100, FGS150, NGR150, NGR250, NGR300, NGR400, PED088, PED158, PED258, PED308, PGS048, PGS068, PGS088		



1

<b>GEV No.</b>	400070	<b>Ref. No.</b>	184824
<b>description</b>	level relay 1CO 230V voltage AC		
<b>For models:</b>	CED106, CED110, CED120, CED220		



1

<b>GEV No.</b>	380345	<b>Ref. No.</b>	184824
<b>description</b>	level relay 1NC/1NO 230V voltage AC		

time relays

time relays



1

<b>GEV No.</b>	380280	<b>Ref. No.</b>	407270
<b>description</b>	time relay WIELAND NGZ11 time range 1.5-30s 24-240V AC/DC 5A connection grip connection		
<b>For models:</b>	ECD106, ECD110, ECD120, ECD220		



1

<b>GEV No.</b>	380282	<b>Ref. No.</b>	407271
<b>description</b>	time relay WIELAND NGZ310 time range 1.5-30s 24-240V AC/DC 5A connection grip connection		
<b>For models:</b>	ECD106, ECD110, ECD120, ECD220		

transformers

toroidal core transformers



1

<b>GEV No.</b>	401466	<b>Ref. No.</b>	164712
<b>description</b>	transformer primary 230V secondary 2x12V 225VA		
<b>For models:</b>	EEP500, EGP500		

encapsulated transformers

multiple connections



1

<b>GEV No.</b>	401143	<b>Ref. No.</b>	164700
<b>description</b>	transformer primary 230V secondary 9V 3.8VA		
<b>For models:</b>	FED080, FED150, FED250, FED300, FEF170, FEF180, FEK040, FEK060, FEK080, FEK100, FEK150, FEP230, FEP330, FEP610, FEP910, FER080, FER150, FER250, FER300, FER400, FES040, FES060, FES080, FES100, FES150, FGR150, FGR250, FGR300, FGR400, FGS040, FGS060, FGS080, FGS100, FGS150, FNK040, FNK060, FNK080, FNK100, FNK150, FNR080, FNR150, FNR250, FNR300, FNR400, NEP203, NEP303, NEP601, NEP901, NER080, NER150...(Other models you can see in the webshop)		

PMA



1

<b>GEV No.</b>	379054	<b>Ref. No.</b>	407157
<b>description</b>	transformer primary 230VAC secondary 12VAC 3VA secondary 0.25A H 40mm L 45mm W 50mm connection screw 50/60Hz type 153/M		
<b>For models:</b>	NEF176, NEP203, NEP303		

for lighting



1

<b>GEV No.</b>	400207	<b>Ref. No.</b>	164703
<b>description</b>	transformer L 110mm W 55mm H 33mm		
<b>For models:</b>	CBE106, CBE106-VAR091, CBE110, CBE110-VAR091, CBE120, CBE120-VAR091, CBE220, CBE220-VAR091, CBG110, CBG120, CEC106, CEC110, CEC120, CEC220, CED106, CED110, CED120, CED220, CEF106, CEF110, CEF120, CEF220, CEM110, CEM120, CGD110, CGD120		



1

<b>GEV No.</b>	401460	<b>Ref. No.</b>	164710
<b>description</b>	transformer primary 230V secondary 11.5V 20W		
<b>For models:</b>	CCE106, CCE110, CPE106, CPE110		



## miscellaneous



1

<b>GEV No.</b>	400969	<b>Ref. No.</b>	164300 164700
<b>description</b>	transformer		

## electronic controllers

## OMRON

## universal controllers

## mounting measurements 45x45mm



1

<b>GEV No.</b>	379055	<b>Ref. No.</b>	176593
<b>description</b>	electronic controller OMRON type E5C2-R40L-D mounting measurements 45x45mm 230V voltage AC TC/J 0 up to +200°C display analogue relay outputs 1 relay 3A Templn1 yes two-position controller defr. funct. no		
<b>For models:</b>	CEC106, CEC110, CEC120, CEC220, EDC106, NDD080, NDD150, NDD250, NDD300, NED080, NED150, NED250, NED300, NHD080, NHD150, NHD250, NHD300		

## SHANGFANG

## accessories



1

<b>GEV No.</b>	379054	<b>Ref. No.</b>	407157
<b>description</b>	transformer primary 230VAC secondary 12VAC 3VA secondary 0.25A H 40mm L 45mm W 50mm connection screw 50/60Hz type 153/M		
<b>For models:</b>	NEF176, NEP203, NEP303		

## STÖRK-TRONIC

## universal controllers

## built-in version



1

<b>GEV No.</b>	379304	<b>Ref. No.</b>	174403
<b>description</b>	electronic controller STÖRK-TRONIK type ST64-31.10 mounting measurements 60mm 230V voltage AC Pt100 relay outputs 1 NO-12A(6) Pt100 heated trolley front measurements 64mm built-in depth 62mm defr. funct. -80 to +400°C display 3 digits		
<b>For models:</b>	NDD080, NDD150, NDD250, NDD300, NED080, NED150, NED250, NED300, NHD080, NHD150, NHD250, NHD300		
<b>accessories for</b>	379304		
	<b>GEV No.</b>	400040	<b>Ref. No.</b> —
mounting plate SS dimensions 110x110mm cut-out ø 60mm			

## refrigeration controllers

## built-in version



1

<b>GEV No.</b>	379304	<b>Ref. No.</b>	174403
<b>description</b>	electronic controller STÖRK-TRONIK type ST64-31.10 mounting measurements 60mm 230V voltage AC Pt100 relay outputs 1 NO-12A(6) Pt100 heated trolley front measurements 64mm built-in depth 62mm defr. funct. -80 to +400°C display 3 digits		
<b>For models:</b>	NDD080, NDD150, NDD250, NDD300, NED080, NED150, NED250, NED300, NHD080, NHD150, NHD250, NHD300		
<b>accessories for</b>	379304		
	<b>GEV No.</b>	400040	<b>Ref. No.</b> —
mounting plate SS dimensions 110x110mm cut-out ø 60mm			



electronic thermometers

built-in version



<b>GEV No.</b>	379992	<b>Ref. No.</b>	176710
<b>description</b>	thermometer mounting measurements 68.5x28.5mm -99 up to +199°C 12/24V voltage AC/DC measuring input Pt100 front measurements 72x36mm STÖRK-TRONIK type ST70-01.10		
<b>For models:</b>	NEF176, NEP203, NEP303		
<b>accessories for</b>	379992		
	<b>GEV No.</b>	379054	<b>Ref. No.</b> 407157
	transformer primary 230VAC secondary 12VAC 3VA secondary 0.25A H 40mm L 45mm W 50mm connection screw 50/60Hz type 153/M		

miscellaneous

universal controllers



<b>GEV No.</b>	379020	<b>Ref. No.</b>	407338
<b>description</b>	electronic controller Pt100 steam control		
<b>For models:</b>	ECD106, ECD110, ECD120, ECD220		



<b>GEV No.</b>	400114	<b>Ref. No.</b>	161600
<b>description</b>	electronic controller type Pt100		
<b>For models:</b>	NEP203, NEP303, NEP601, NEP901, NER080, NER150, NER250, NER300, NER400, NES040, NES060, NES080, NES100, NES150, NGR150, NGR250, NGR300, NGR400, NGS040, NGS060, NGS080, NGS100, NGS150, NNR080, NNR150, NNR250, NNR300, NNR400, NNS040, NNS060, NNS080, NNS100, NNS150		
<b>accessories for</b>	400114		
	<b>GEV No.</b>	400119	<b>Ref. No.</b> 064300
	keypad foil tilting bratt pan NEP203/303/603 NER080/150/250/300		

probes

producer-specific probes

probes



<b>GEV No.</b>	378656	<b>Ref. No.</b>	161639
<b>description</b>	temperature probe 2xPt100 thread probe ø4x395mm cable length 510mm		

<b>GEV No.</b>	379911	<b>Ref. No.</b>	161615
<b>description</b>	temperature probe Pt100 cable glass fibre probe -100 up to 450°C cable -50 up to +350°C connection 2-wire thread probe ø4.6x13mm cable length 0.5m		
<b>For models:</b>	FEF170, FEF180, NEP203, NEP303, NEP601, NEP901, PEF178, PEF188		

<b>GEV No.</b>	379913	<b>Ref. No.</b>	995935002
<b>description</b>	temperature probe Pt100 cable glass fibre probe -100 up to 450°C cable -50 up to +350°C connection 2-wire thread probe ø4.6x13mm cable length 0.5m		
<b>For models:</b>	FEP230, FEP330, FEP610, FEP910, PEP238, PEP338, PEP618, PEP918		

<b>GEV No.</b>	379168	<b>Ref. No.</b>	161608
<b>description</b>	temperature probe Pt100 cable PTFE probe -100 up to 450°C cable -40 up to +250°C connection 2-wire thread M5 probe ø5x30mm cable length 2m		
<b>For models:</b>	CBE106, CBE106-VAR091, CBE110, CBE110-VAR091, CBE120, CBE120-VAR091, CBE220, CBE220-VAR091, CBG110, CBG120, CCE120, CCE220, CEC106, CEC110, CEC120, CEC220, CED106, CED110, CED120, CED220, CEF106, CEF110, CEF120, CEF220, CEM110, CEM120, CGD110, CGD120, CPE120, CPE220		

<b>GEV No.</b>	379912	<b>Ref. No.</b>	174465
<b>description</b>	temperature probe Pt100 cable PTFE probe -100 up to 450°C cable -40 up to +250°C connection 2-wire thread probe ø6x440mm cable length 1.1m		
<b>For models:</b>	FEF170, FEF180, NEF176, NEP203, NEP303, PEF178, PEF188		

<b>GEV No.</b>	379399	<b>Ref. No.</b>	161601
<b>description</b>	temperature probe Pt100 cable PVC probe -50 up to +200°C cable -10 up to 100°C connection 2-wire thread M10x1 probe ø10x10mm cable length 1.55m		
<b>For models:</b>	FED080, FED150, FED250, FED300, FEK040, FEK060, FEK080, FEK100, FEK150, FEP230, FEP330, FER080, FER150, FER250, FER300, FER400, FES040, FES060, FES080, FES100, FES150, FGR150, FGR250, FGR300, FGR400, FGS040, FGS060, FGS080, FGS100, FGS150, FNK040, FNK060, FNK080, FNK100, FNK150, FNR080, FNR150, FNR250, FNR300, FNS040, FNS060, FNS080, FNS100, FNS150, NER080, NER150, NER250, NER300, NER400, NES040...(Other models you can see in the webshop)		

<b>GEV No.</b>	379070	<b>Ref. No.</b>	407334 407339
<b>description</b>	temperature probe Pt100 cable silicone probe -50 up to +250°C cable -50 up to +180°C connection 2-wire thread probe ø4x75mm cable length 1.7m		
<b>For models:</b>	ECD106, ECD110, ECD120, ECD220		



<b>GEV No.</b>	379999	<b>Ref. No.</b>	161633
<b>description</b>	temperature probe Pt1000 cable PTFE probe -70 up to +500°C cable -40 up to +250°C connection male faston 2.8mm thread M5x1 probe ø5x30mm cable length 0.1m		
<b>For models:</b>	CCE106, CCE110, CCE120, CCE220, CPE106, CPE110, CPE120, CPE220		

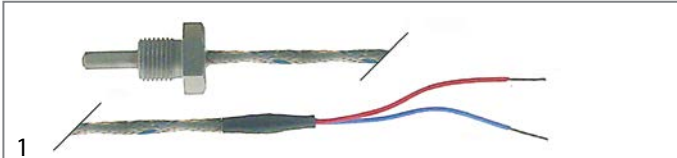

<b>GEV No.</b>	379594	<b>Ref. No.</b>	174420
<b>description</b>	temperature probe thermocouple L (Fe-CuNi) cable Vetrotex probe -200 up to +700°C cable -50 up to +350°C connection 2-wire thread M10x1 probe ø4x13mm cable length 1.9m		
<b>For models:</b>	NDD080, NDD150, NDD250, NDD300, NED080, NED150, NED250, NED300, NHD080, NHD150, NHD250, NHD300		

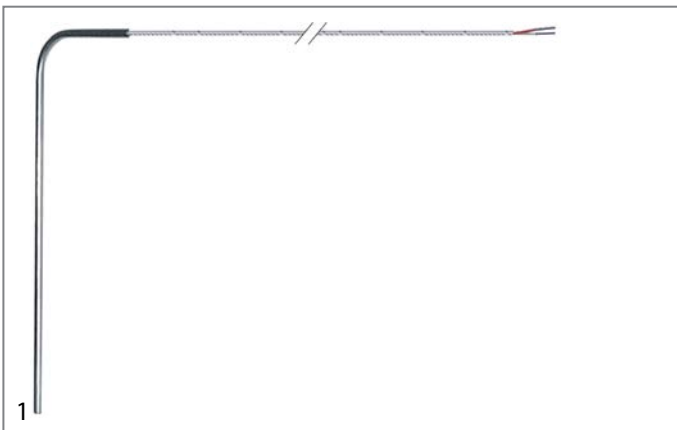

<b>GEV No.</b>	379110	<b>Ref. No.</b>	174470
<b>description</b>	temperature probe thermocouple T (Cu-CuNi) cable Vetrotex probe -50 up to +750°C cable -50 up to +350°C connection 2-wire thread probe ø4x150/50mm cable length 1.5m		
<b>For models:</b>	CEC106, CEC110		

**core probes**

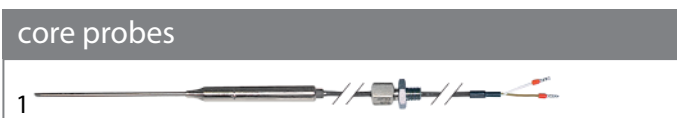

<b>GEV No.</b>	379112	<b>Ref. No.</b>	407610
<b>description</b>	core temperature probe Pt100 cable PTFE probe -40 up to +250°C cable -40 up to +250°C connection 2-wire probe ø3.2x100mm thread M12 cable length 2.8m handle ø 10mm handle length 80mm		



<b>GEV No.</b>	379898	<b>Ref. No.</b>	161628
<b>description</b>	core temperature probe Pt100 cable PTFE probe -40 up to +250°C cable -40 up to +250°C connection 2-wire probe ø4x100mm thread M9x1 cable length 2m handle ø 9mm handle length 45mm		
<b>For models:</b>	CBE106, CBE106-VAR091, CBE110, CBE110-VAR091, CBE120, CBE120-VAR091, CBE220, CBE220-VAR091, CBG110, CBG120		



<b>GEV No.</b>	379109	<b>Ref. No.</b>	174461 174464 174464+060625 781897009
<b>description</b>	core temperature probe Pt100 cable PTFE probe -40 up to +250°C cable -40 up to +250°C connection 3-wire probe ø4x100mm thread M12 cable length 2.5m handle ø 9mm handle length 60mm		
<b>For models:</b>	CEC106, CEC110, CEC120, CEC220, CED106, CED110, CED120, CED220, CEF106, CEF110, CEF120, CEF220, CEM110, CEM120, CGD110, CGD120		



<b>GEV No.</b>	379899	<b>Ref. No.</b>	161634 161642
<b>description</b>	core temperature probe Pt1000 cable thermoplastic probe -40 up to +250°C cable -40 up to +110°C connection 2-wire probe ø4x100mm thread M9x1 cable length 2m handle ø 9mm handle length 65mm		
<b>For models:</b>	CCE106, CCE110, CCE120, CCE220, CPE106, CPE110, CPE120, CPE220		

electronics

rectifiers



<b>GEV No.</b>	401465	<b>Ref. No.</b>	163503
<b>description</b>	rectifier 250V 25A		
<b>For models:</b>	EEP500, EGP500		

PCBs



<b>GEV No.</b>	401461	<b>Ref. No.</b>	161603 161630
<b>description</b>	control PCB combi-steamer CBE 106		
<b>For models:</b>	CBE106, CBE106-VAR091, CBE110, CBE110-VAR091, CBE120, CBE120-VAR091, CBE220, CBE220-VAR091, CBG110, CBG120, CEC106, CEC110, CEC120, CEC220, CED106, CED110, CED120, CED220, CGD110, CGD120		

1

<b>GEV No.</b>	401468	<b>Ref. No.</b>	164885
<b>description</b>	display PCB combi-steamer CBE 106		
<b>For models:</b>	CCE106, CCE110, CCE120, CCE220		



1

<b>GEV No.</b>	401481	<b>Ref. No.</b>	164884 165279
<b>description</b>	PCB		
<b>For models:</b>	CPE106, CPE110, CPE120, CPE220		



1

<b>GEV No.</b>	401444	<b>Ref. No.</b>	152428
<b>description</b>	keypad PCB		
<b>For models:</b>	FED080, FED150, FED250, FED300, FEP230, FEP330, PED088, PED158, PED258, PED308, PEP238, PEP338		



1

<b>GEV No.</b>	401483	<b>Ref. No.</b>	407326
<b>description</b>	PCB		
<b>For models:</b>	ECD110, ECD120, ECD220		



1

<b>GEV No.</b>	401467	<b>Ref. No.</b>	164840 164896 564626
<b>description</b>	keypad PCB		



1

<b>GEV No.</b>	401484	<b>Ref. No.</b>	176717 176719
<b>description</b>	PCB		
<b>For models:</b>	CED106, CED110, CED120, CED220		



1

<b>GEV No.</b>	400784	<b>Ref. No.</b>	164926
<b>description</b>	PCB		



1

<b>GEV No.</b>	401485	<b>Ref. No.</b>	161604
<b>description</b>	PCB		
<b>For models:</b>	CEF106, CEF110, CEF120, CEF220		





1

<b>GEV No.</b>	401486	<b>Ref. No.</b>	161605
<b>description</b>	PCB		
<b>For models:</b>	CEM110, CEM120		



1

<b>GEV No.</b>	400966	<b>Ref. No.</b>	152424 165287
<b>description</b>	PCB deep fryer/boiling pan FEF/FEK		
<b>For models:</b>	FEF144e, FEF170, FEF180, FEF224e, FEK040, FEK060, FEK080, FEK100, FEK150, FEP610, FEP910, FER080, FER150, FER250, FER300, FER400, FES040, FES060, FES080, FES100, FES150, FGR150, FGR250, FGR300, FGR400, FGS040, FGS060, FGS080, FGS100, FGS150, FNK040, FNK060, FNK080, FNK100, FNK150, FNR080, FNR150, FNR250, FNR300, FNR400, FNS040, FNS060, FNS080, FNS100, FNS150, PEF178, PEF188, PEK048, PEK068, PEK088...(Other models you can see in the webshop)		
<b>accessories for</b>	400966		
	<b>GEV No.</b>	400967	<b>Ref. No.</b> 064305
	keypad foil		



1

<b>GEV No.</b>	400411	<b>Ref. No.</b>	164883
<b>description</b>	PCB pyroceram range CH 40/45/80 230V		



1

<b>GEV No.</b>	401476	<b>Ref. No.</b>	164890
<b>description</b>	power PCB		
<b>For models:</b>	CCE106, CCE110, CCE120, CCE220, CPE106, CPE110, CPE120, CPE220		

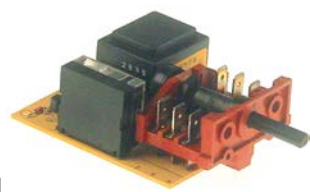

1

<b>GEV No.</b>	401133	<b>Ref. No.</b>	152405
<b>description</b>	power PCB 230V		
<b>For models:</b>	TEB231, TEB431, TEB631		



1

<b>GEV No.</b>	400968	<b>Ref. No.</b>	164851
<b>description</b>	relay PCB		
<b>For models:</b>	FEF144e, FEF224e, FEK040, FEK060, FEK080, FEK100, FEK150, FEP610, FEP910, FER080, FER150, FER250, FER300, FER400, FES040, FES060, FES080, FES100, FES150, FGS040, FGS060, FGS080, FGS100, FGS150, FNK040, FNK060, FNK080, FNK100, FNK150, FNR080, FNR150, FNR250, FNR300, FNR400, FNS040, FNS060, FNS080, FNS100, FNS150, PED088, PED158, PED258, PED308, PEK048, PEK068, PEK088, PEK108, PEK158, PEP618, PEP918...(Other models you can see in the webshop)		



1

<b>GEV No.</b>	401932	<b>Ref. No.</b>	164900
<b>description</b>	relay PCB fryer FEF__e		

central units



1

<b>GEV No.</b>	401469	<b>Ref. No.</b>	164707
<b>description</b>	control box		
<b>For models:</b>	FEK040, FEK060, FEK080, FEK100, FEK150, NEP203, NEP303, NEP400, NEP600, NEP601, NEP900, NEP901, NGP400, NGP600, NGP900, PEK048, PEK068, PEK088, PEK108, PEK158, PEP238, PEP338, PEP608, PEP618, PEP908, PEP918, PNK048, PNK068, PNK088, PNK108, PNK158		



## keypads

### front foils



1

<b>GEV No.</b>	400967	<b>Ref. No.</b>	064305
<b>description</b>	keypad foil		
<b>For models:</b>	FEF144e, FEF170, FEF180, FEF224e, FEK040, FEK060, FEK080, FEK100, FEK150, FEP610, FEP910, FNK040, FNK060, FNK080, FNK100, FNK150, PEF178, PEF188, PEK048, PEK068, PEK088, PEK108, PEK158, PEP618, PEP918, PGP618, PGP918, PNK048, PNK068, PNK088, PNK108, PNK158		

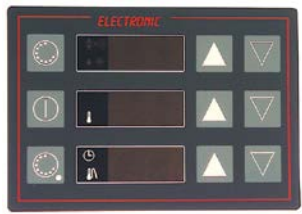

2

<b>GEV No.</b>	400971	<b>Ref. No.</b>	064304
<b>description</b>	keypad foil 9 buttons L 160mm W 110mm		
<b>For models:</b>	FED080, FED150, FED250, FED300, FEP230, FEP330, PED088, PED158, PED258, PED308, PEP238, PEP338		



1

<b>GEV No.</b>	400970	<b>Ref. No.</b>	064303
<b>description</b>	keypad foil L 160mm W 110mm		
<b>For models:</b>	FER080, FER150, FER250, FER300, FER400, FES040, FES060, FES080, FES100, FES150, FGR150, FGR250, FGR300, FGR400, FGS040, FGS060, FGS080, FGS100, FGS150, FNR080, FNR150, FNR250, FNR300, FNR400, FNS040, FNS060, FNS080, FNS100, FNS150, PER088, PER158, PER258, PER308, PES048, PES068, PES088, PES108, PES158, PGS048, PGS068, PGS088, PNR088, PNR158, PNR258, PNR308, PNS048, PNS068, PNS088, PNS108, PNS158		

### membrane keypads



1

<b>GEV No.</b>	101787	<b>Ref. No.</b>	064322
<b>description</b>	keypad foil		
<b>For models:</b>	FGH417, FGH507, FGH617, FGW250, PGB438		



1

<b>GEV No.</b>	400119	<b>Ref. No.</b>	064300
<b>description</b>	keypad foil tilting bratt pan NEP203/303/603 NER080/150/250/300		
<b>For models:</b>	NEP203, NEP303, NEP601, NEP901, NER080, NER150, NER250, NER300, NER400, NES040, NES060, NES080, NES100, NES150, NGR150, NGR250, NGR300, NGR400, NGS040, NGS060, NGS080, NGS100, NGS150, NNR080, NNR150, NNR250, NNR300, NNR400, NNS040, NNS060, NNS080, NNS100, NNS150		

## solenoid valves

### solenoid valves (water)

#### MÜLLER

medium temperature: 90°C  
duty cycle: 100%



1











<b>GEV No.</b>	370004	<b>Ref. No.</b>	173121	
<b>description</b>	solenoid valve double straight 230VAC inlet 3/4" outlet 14.5mm DN10 t.max. 90°C duty cycle 100% MÜLLER			
<b>For models:</b>	CBE120, CBE120-VAR091, CBE220, CBE220-VAR091, CBG110, CBG120, CCE120, CCE220, CEC120, CEC220, CED120, CED220, CEF120, CEF220, CEM120, CGD110, CGD120, CPE120, CPE220, NTE182			
<b>spare parts for</b>	370004			
	<b>GEV No.</b>	370129	<b>Ref. No.</b>	—
	solenoid valve body double straight inlet 3/4" outlet 14.5mm DN10 t.max. 90°C duty cycle 100% MÜLLER 230V			
	<b>GEV No.</b>	371002	<b>Ref. No.</b>	—
	solenoid valve holder MÜLLER flange support			
	<b>GEV No.</b>	371009	<b>Ref. No.</b>	—
	compression spring for solenoid coil			
	<b>GEV No.</b>	371011	<b>Ref. No.</b>	—
	spare parts kit membrane with long star star hight 8mm MÜLLER			
	<b>GEV No.</b>	371017	<b>Ref. No.</b>	—
	solenoid coil MÜLLER 230VAC connection male faston 6.3mm			
	<b>GEV No.</b>	371122	<b>Ref. No.</b>	—
	solenoid valve filter ø 19mm H 10mm suitable for MÜLLER			
	<b>GEV No.</b>	501161	<b>Ref. No.</b>	—
	tap head for solenoid valve holder for solenoid coils			
<b>accessories for</b>	370004			
	<b>GEV No.</b>	371010	<b>Ref. No.</b>	407350
	solenoid coil 230VAC connection with cable cable length 2000mm			
	<b>GEV No.</b>	371037	<b>Ref. No.</b>	—
	solenoid coil 24VAC 50/60Hz connection male faston 6.3mm			

Table continues overleaf





<b>accessories for</b> 370004			
	GEV No.	371038	Ref. No. —
solenoid coil 230VAC connection appliance plug			





<b>GEV No.</b>	370117	<b>Ref. No.</b>	407352
<b>description</b>	solenoid valve single straight 230VAC inlet 3/4" outlet 11.5mm DN10 t.max. 90°C duty cycle 100% MÜLLER		

<b>spare parts for</b>	370117		
------------------------	--------	--	--

	GEV No.	370133	Ref. No.	407597
solenoid valve body single straight inlet 3/4" outlet 11.5mm DN10 t.max. 90°C duty cycle 100% MÜLLER 230V				

	GEV No.	371002	Ref. No.	—
solenoid valve holder MÜLLER flange support				

	GEV No.	371009	Ref. No.	—
compression spring for solenoid coil				

	GEV No.	371011	Ref. No.	—
spare parts kit membrane with long star star hight 8mm MÜLLER				

	GEV No.	371017	Ref. No.	—
solenoid coil MÜLLER 230VAC connection male faston 6.3mm				

	GEV No.	371122	Ref. No.	—
solenoid valve filter ø 19mm H 10mm suitable for MÜLLER				

	GEV No.	501161	Ref. No.	—
tap head for solenoid valve holder for solenoid coils				

<b>accessories for</b> 370117			
-------------------------------	--	--	--

	GEV No.	371010	Ref. No.	407350
solenoid coil 230VAC connection with cable cable length 2000mm				

	GEV No.	371037	Ref. No.	—
solenoid coil 24VAC 50/60Hz connection male faston 6.3mm				

	GEV No.	371038	Ref. No.	—
solenoid coil 230VAC connection appliance plug				

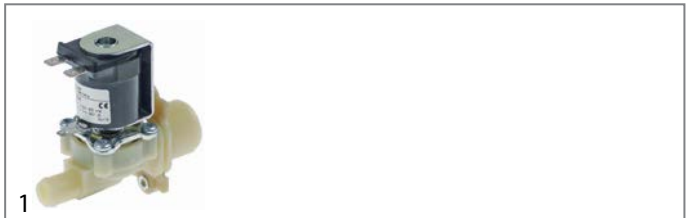



<b>GEV No.</b>	370002	<b>Ref. No.</b>	355635
----------------	--------	-----------------	--------

<b>description</b>	solenoid valve single straight 230VAC inlet 3/4" outlet 14.5mm DN10 t.max. 90°C duty cycle 100% MÜLLER		
--------------------	--	--	--

<b>For models:</b>	CBE120, CBE120-VAR091, CBE220, CBE220-VAR091, CBG120, CCE120, CCE220, CEC120, CEC220, CED120, CED220, CEF120, CEF220, CEM120, CGD120, CPE120, CPE220, EAB051, EAB081, EAB101, EAB102, EAB112, EDC106, NDD080, NDD150, NDD250, NDD300, NED080, NED150, NED250, NED300, NHD080, NHD150, NHD250, NHD300		
--------------------	--	--	--

<b>spare parts for</b>	370002		
------------------------	--------	--	--

	GEV No.	370127	Ref. No.	—
solenoid valve body single straight inlet 3/4" outlet 14.5mm DN10 t.max. 90°C duty cycle 100% MÜLLER 230V				

	GEV No.	371002	Ref. No.	—
solenoid valve holder MÜLLER flange support				

	GEV No.	371009	Ref. No.	—
compression spring for solenoid coil				

	GEV No.	371011	Ref. No.	—
spare parts kit membrane with long star star hight 8mm MÜLLER				

	GEV No.	371017	Ref. No.	—
solenoid coil MÜLLER 230VAC connection male faston 6.3mm				

	GEV No.	371122	Ref. No.	—
solenoid valve filter ø 19mm H 10mm suitable for MÜLLER				

<b>accessories for</b> 370002			
-------------------------------	--	--	--

	GEV No.	371010	Ref. No.	407350
solenoid coil 230VAC connection with cable cable length 2000mm				

	GEV No.	371037	Ref. No.	—
solenoid coil 24VAC 50/60Hz connection male faston 6.3mm				

	GEV No.	371038	Ref. No.	—
solenoid coil 230VAC connection appliance plug				

with cable connection

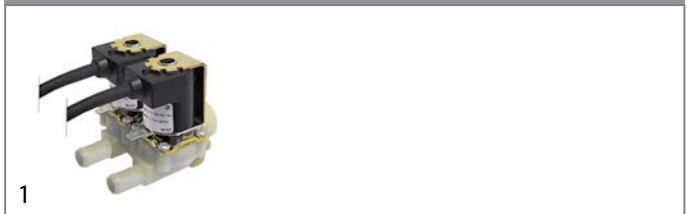

<b>GEV No.</b>	370065	<b>Ref. No.</b>	407280
----------------	--------	-----------------	--------

<b>description</b>	solenoid valve double straight 230VAC inlet 3/4" outlet 11.5mm DN10 t.max. 90°C duty cycle 100% MÜLLER cable length 2000mm		
--------------------	--	--	--

<b>spare parts for</b>	370065		
------------------------	--------	--	--

	GEV No.	370195	Ref. No.	—
solenoid valve body double straight inlet 3/4" outlet 11.5mm DN10 t.max. 90°C duty cycle 100% MÜLLER 230V				

Table continues overleaf



spare parts for		370065	
	GEV No.	371002	Ref. No. —
solenoid valve holder MÜLLER flange support			
	GEV No.	371009	Ref. No. —
compression spring for solenoid coil			
	GEV No.	371010	Ref. No. 407350
solenoid coil 230VAC connection with cable cable length 2000mm			
	GEV No.	371011	Ref. No. —
spare parts kit membrane with long star star hight 8mm MÜLLER			
	GEV No.	371122	Ref. No. —
solenoid valve filter ø 19mm H 10mm suitable for MÜLLER			
	GEV No.	501161	Ref. No. —
tap head for solenoid valve holder for solenoid coils			
accessories for		370065	
	GEV No.	371017	Ref. No. —
solenoid coil MÜLLER 230VAC connection male faston 6.3mm			
	GEV No.	371037	Ref. No. —
solenoid coil 24VAC 50/60Hz connection male faston 6.3mm			
	GEV No.	371038	Ref. No. —
solenoid coil 230VAC connection appliance plug			

1			
GEV No.	370368	Ref. No.	407352
description solenoid valve single straight 230VAC inlet 3/4" outlet 11.5mm DN10 t.max. 90°C duty cycle 100% MÜLLER cable length 2000mm			
spare parts for		370368	
	GEV No.	370133	Ref. No. 407597
solenoid valve body single straight inlet 3/4" outlet 11.5mm DN10 t.max. 90°C duty cycle 100% MÜLLER 230V			
	GEV No.	371002	Ref. No. —
solenoid valve holder MÜLLER flange support			
	GEV No.	371009	Ref. No. —
compression spring for solenoid coil			
	GEV No.	371010	Ref. No. 407350
solenoid coil 230VAC connection with cable cable length 2000mm			
	GEV No.	371011	Ref. No. —
spare parts kit membrane with long star star hight 8mm MÜLLER			
	GEV No.	371122	Ref. No. —
solenoid valve filter ø 19mm H 10mm suitable for MÜLLER			
	GEV No.	501161	Ref. No. —
tap head for solenoid valve holder for solenoid coils			
accessories for		370070	
	GEV No.	371017	Ref. No. —
solenoid coil MÜLLER 230VAC connection male faston 6.3mm			
	GEV No.	371037	Ref. No. —
solenoid coil 24VAC 50/60Hz connection male faston 6.3mm			
	GEV No.	371038	Ref. No. —
solenoid coil 230VAC connection appliance plug			

accessories for		370368	
	GEV No.	371017	Ref. No. —
solenoid coil MÜLLER 230VAC connection male faston 6.3mm			
	GEV No.	371037	Ref. No. —
solenoid coil 24VAC 50/60Hz connection male faston 6.3mm			
	GEV No.	371038	Ref. No. —
solenoid coil 230VAC connection appliance plug			

1			
GEV No.	370070	Ref. No.	173134
description solenoid valve single angled 230VAC inlet 3/4" outlet 14.5mm DN10 t.max. 90°C duty cycle 100% MÜLLER cable length 2000mm			
For models: CBE106, CBE106-VAR091, CBE110, CBE110-VAR091, CBG110, CCE106, CCE110, CEC106, CEC110, CED106, CED110, CEF106, CEF110, CEM110, CGD110, CPE106, CPE110			
spare parts for		370070	
	GEV No.	370126	Ref. No. —
solenoid valve body single angled inlet 3/4" outlet 14.5mm DN10 t.max. 90°C duty cycle 100% MÜLLER plastic			
	GEV No.	371002	Ref. No. —
solenoid valve holder MÜLLER flange support			
	GEV No.	371009	Ref. No. —
compression spring for solenoid coil			
	GEV No.	371010	Ref. No. 407350
solenoid coil 230VAC connection with cable cable length 2000mm			
	GEV No.	371011	Ref. No. —
spare parts kit membrane with long star star hight 8mm MÜLLER			
	GEV No.	371122	Ref. No. —
solenoid valve filter ø 19mm H 10mm suitable for MÜLLER			
	GEV No.	501161	Ref. No. —
tap head for solenoid valve holder for solenoid coils			
accessories for		370070	
	GEV No.	371017	Ref. No. —
solenoid coil MÜLLER 230VAC connection male faston 6.3mm			
	GEV No.	371037	Ref. No. —
solenoid coil 24VAC 50/60Hz connection male faston 6.3mm			
	GEV No.	371038	Ref. No. —
solenoid coil 230VAC connection appliance plug			



			
1			
<b>GEV No.</b>	370369	<b>Ref. No.</b>	782582004
<b>description</b>	solenoid valve single angled 230VAC inlet 3/4" outlet 14.5mm DN10 t.max. 90°C duty cycle 100% MÜLLER cable length 2000mm		
<b>spare parts for</b>	370369		
	GEV No.	370128	Ref. No. —
	solenoid valve body double angled inlet 3/4" outlet 14.5mm DN10 t.max. 90°C duty cycle 100% MÜLLER 230V double-ways		
	GEV No.	371002	Ref. No. —
	solenoid valve holder MÜLLER flange support		
	GEV No.	371009	Ref. No. —
	compression spring for solenoid coil		
	GEV No.	371010	Ref. No. 407350
	solenoid coil 230VAC connection with cable cable length 2000mm		
	GEV No.	371011	Ref. No. —
	spare parts kit membrane with long star star hight 8mm MÜLLER		
	GEV No.	371122	Ref. No. —
	solenoid valve filter ø 19mm H 10mm suitable for MÜLLER		
	GEV No.	501161	Ref. No. —
	tap head for solenoid valve holder for solenoid coils		
<b>accessories for</b>	370369		
	GEV No.	371017	Ref. No. —
	solenoid coil MÜLLER 230VAC connection male faston 6.3mm		
	GEV No.	371037	Ref. No. —
	solenoid coil 24VAC 50/60Hz connection male faston 6.3mm		
	GEV No.	371038	Ref. No. —
	solenoid coil 230VAC connection appliance plug		

spare parts and accessories

valve bodies

			
1			
<b>GEV No.</b>	370137	<b>Ref. No.</b>	407351
<b>description</b>	solenoid valve body double outlet 11.5mm		
<b>For models:</b>	ECD106, ECD110, ECD120, ECD220		

			
1			
<b>GEV No.</b>	370133	<b>Ref. No.</b>	407597
<b>description</b>	solenoid valve body single straight inlet 3/4" outlet 11.5mm DN10 t.max. 90°C duty cycle 100% MÜLLER 230V		
<b>For models:</b>	ECD106, ECD110, ECD120, ECD220		

solenoid coils

			
1			
<b>GEV No.</b>	371010	<b>Ref. No.</b>	407350
<b>description</b>	solenoid coil 230VAC connection with cable cable length 2000mm		
<b>For models:</b>	ECD106, ECD110, ECD120, ECD220		



ROBERTSHAW/INVENSYS

*medium temperature:* 90°C 90°C 60°C  
*ambient temperature:* 60°C 25°C 60°C  
*duty cycle:* 40% 100% 100%

			
1			
<b>GEV No.</b>	370371	<b>Ref. No.</b>	407280
<b>description</b>	solenoid valve double straight 230VAC inlet 3/4" outlet 11.5mm DN10 EATON (INVENSYS) cable length 2000mm		
<b>For models:</b>	ECD106, ECD110, ECD120, ECD220		

			
1			
<b>GEV No.</b>	370370	<b>Ref. No.</b>	407352
<b>description</b>	solenoid valve single straight 230VAC inlet 3/4" outlet 11.5mm DN10 EATON (INVENSYS) cable length 2000mm		
<b>For models:</b>	ECD106, ECD110, ECD120, ECD220		



metal			
LUCIFER			
2-way			
121Z series			
			
1			
<b>GEV No.</b>	370071	<b>Ref. No.</b>	173133
<b>description</b>	solenoid valve 2-ways 230VAC connection 1/8" DN 2.5mm slide-on receptacle DIN -20° up to 130°C LUCIFER-PARKER type series 121Z coil type DZ06S6 membranes FKM (water) p max 10bar		
<b>For models:</b>	CEC106, CEC110, CED106, CED110, FED080, FED150, FED250, FED300, PED088, PED158, PED258, PED308		
<b>accessories for</b>	370071		
	<b>GEV No.</b>	371090	<b>Ref. No.</b> —
	power socket plug type DIN 43650A screw		

SIRAI			
solenoid valves steam (water)			
2-way			
L153-D series			
			
1			
<b>GEV No.</b>	370079	<b>Ref. No.</b>	358119
<b>description</b>	solenoid valve 2-ways 230VAC connection 3/4" L 79mm DN 17mm slide-on receptacle DIN -10 up to 140°C SIRAI type series L153-D coil type Z134A membranes EPDM (steam/water) p max 8bar p min 0.1bar 50Hz		
<b>For models:</b>	FED080, FED150, FED250, FED300, FNR080, FNR150, FNR250, FNR300, FNR400, FNS040, FNS060, FNS080, FNS100, FNS150, NHS040, NHS060, NNR080, NNR150, NNR250, NNR300, NNR400, NNS040, NNS060, NNS080, NNS100, NNS150, NTE182, PED088, PED158, PED258, PED308, PNR088, PNR158, PNR258, PNR308, PNS048, PNS068, PNS088, PNS108, PNS158		
<b>accessories for</b>	370079		
	<b>GEV No.</b>	371077	<b>Ref. No.</b> —
	solenoid coil 230VAC 24VA SIRAI coil type Z110A/Z114A/Z134A seat ø 14mm		

solenoid valves (gas)			
DUNGS			
			
1			
<b>GEV No.</b>	106965	<b>Ref. No.</b>	173142
<b>description</b>	gas valve 230VAC DN 20mm connection 3/4" L 100mm DUNGS p max 0.36bar type MVD207/5 50/60Hz		
<b>For models:</b>	CBG110, CBG120, CGD110, CGD120, EGS060, NGS040, NGS060, NGS080, NGS100, NGS150		

ball valves electric			
			
1			
<b>GEV No.</b>	401190	<b>Ref. No.</b>	120110 151006 164011 994595006 994898006 994899006
<b>description</b>	ball valve inlet 3/4" IT outlet 3/4" IT IP42 230V L 68mm 50/60Hz closed off-current mode of operation electric connection cable 300mm 3.5W duty cycle 50%		
<b>For models:</b>	CBE106-VAR091, CBE110-VAR091, CBE120-VAR091, CBE220-VAR091, CCE106, CCE110, CCE120, CCE220, CED106, CED110, CED120, CED220, CEF106, CEF110, CEF120, CEF220, CEM110, CEM120, CPE106, CPE110, CPE120, CPE220		

			
1			
<b>GEV No.</b>	400208	<b>Ref. No.</b>	151006
<b>description</b>	ball valve mode of operation electric IT 3/4"		



## pressure switches

for steam control



1

<b>GEV No.</b>	541472	<b>Ref. No.</b>	151502
<b>description</b>	pressure control ø 45mm pressure connection vertical steam control connection male faston 6.3mm pressure connection ø 1/4"mm		



1

<b>GEV No.</b>	541408	<b>Ref. No.</b>	540416
<b>description</b>	pressure control ø 45mm pressure range 450/300mbar pressure connection vertical steam control pressure range 0.45/0.3bar connection 1/4" pressure connection 1/4"		



1

<b>GEV No.</b>	541016	<b>Ref. No.</b>	176197
<b>description</b>	pressure control ø 45mm pressure range 480/430mbar pressure connection vertical steam control pressure range 0.48/0.43bar connection 1/4" pressure connection 1/4"		
<b>For models:</b>	EES060, EES080, EGS060, FED080, FED150, FED250, FED300, FEK040, FEK060, FEK080, FEK100, FEK150, FEP230, FEP330, FER080, FER150, FER250, FER300, FER400, FES040, FES060, FES080, FES100, FES150, FGR150, FGR250, FGR300, FGR400, FGS040, FGS060, FGS080, FGS100, FGS150, NDD080, NDD150, NDD250, NDD300, NED080, NED150, NED250, NED300, NEK040, NEK060, NEK080, NEK100, NEK150, NEM100, NEP203, NEP303, NER080...(Other models you can see in the webshop)		



1

<b>GEV No.</b>	541342	<b>Ref. No.</b>	151501
<b>description</b>	pressure control ø 45mm reset pressure reclosing lockbar pressure connection vertical steam control pressure range 0.6/0.54bar connection 1/4" pressure connection 1/4"		
<b>For models:</b>	FEK040, FEK060, FEK080, FEK100, FEK150, FER080, FER150, FER250, FER300, FER400, FES040, FES060, FES080, FES100, FES150, PEK048, PEK068, PEK088, PEK108, PEK158, PER088, PER158, PER258, PER308, PES048, PES068, PES088, PES108, PES158		

## electrodes





Image not available

1

<b>GEV No.</b>	101785	<b>Ref. No.</b>	983811002
<b>description</b>	electrode		



1

<b>GEV No.</b>	400072	<b>Ref. No.</b>	146440 983811002 988107006
<b>description</b>	level electrode push-in total length 100mm probe L 90mm insulated probe length 78mm connection F6.3 ø 6mm		
<b>For models:</b>	CBE106-VAR091, CCE106, CED106, CEF106, CPE106, FED080, FED150, FED250, FED300, FGR150, FGR250, FGR300, FGR400, NGR150, NGR250, NGR300, NGR400, PED088, PED158, PED258, PED308		



1

<b>GEV No.</b>	400071	<b>Ref. No.</b>	984708002 988108006
<b>description</b>	level electrode push-in total length 170mm probe L 155mm insulated probe length 140mm connection F6.3 ø 5mm		
<b>For models:</b>	CBE110-VAR091, CBE120-VAR091, CBE220-VAR091, CCE110, CCE120, CCE220, CED110, CED120, CED220, CEF110, CEF120, CEF220, CEM110, CEM120, CPE110, CPE120, CPE220		

## fans

cross flow fans

ebm-papst



1

<b>GEV No.</b>	601146	<b>Ref. No.</b>	120111
<b>description</b>	cross flow fan QL4/0010-2112 roller ø 40mm roller length 100mm laminated core thickness 12mm motor position right 230V/50Hz 10W refrigeration bearing rubber connection male faston 6.3mm airflow 36m³/h 0 up to +60°C 230V 50Hz		
<b>For models:</b>	FGS040, FGS060, FGS080, FGS100, FGS150, NGS040, NGS060, NGS080, NGS100, NGS150, PGS048, PGS068, PGS088		



1

<b>GEV No.</b>	601297	<b>Ref. No.</b>	178415
<b>description</b>	cross flow fan QL4/2000 A6-2118L roller ø 40mm roller length 200mm laminated core thickness 18mm motor position right 230V/50Hz 17W refrigeration bearing rubber connection male faston 6.3mm airflow 80m³/h 0 up to +60°C 230V 50Hz		
<b>For models:</b>	EEH210, EEH300, EEH410, EEH413, EEH500, EEH503, EEH610, EEH613, EEH700, EEH703		

with moulded coils



1

<b>GEV No.</b>	601456	<b>Ref. No.</b>	178352 178463
<b>description</b>	cross flow fan roller ø 45mm roller length 180mm laminated core thickness 15mm motor position right 230V/50Hz 26W universal bearing silicone connection male faston 6.3mm -30 up to +100°C 230V 50/60Hz		
<b>For models:</b>	EAB051, EDC106, FEH613, FEH615, FEH705, FEH715, FEW252, FGH613, FGH615, LEH503, LEH505, LEH703, LEH705, NEA182, NEH212, NEH615, NEH705, NEW182, NEW252, NEW452, NGH202, NGH605, NGH607, NGH615, NGH617, NGH725, NGH727, NGH737, NTE182		

COPREL

with standard coil



1

<b>GEV No.</b>	601101	<b>Ref. No.</b>	174259 174262
<b>description</b>	cross flow fan COPREL TFL(FN) roller ø 60mm roller length 300mm laminated core thickness 30mm motor position left 230V/50Hz 43W refrigeration bearing rubber connection male faston 6.3mm coil type airflow 268m³/h -10 up to +60°C		
<b>For models:</b>	CBE120, CBE120-VAR091, CBE220, CBE220-VAR091, CBG110, CBG120, CCE120, CCE220, CEC120, CEC220, CED120, CED220, CEF120, CEF220, CEM120, CGD120, CPE120, CPE220		

accessories for cross flow fans

fasteners



1

<b>GEV No.</b>	359654	<b>Ref. No.</b>	733294000
<b>description</b>	bracket for cross flow fan		
<b>For models:</b>	CBE120, CBE120-VAR091, CBE220, CBE220-VAR091, CBG120, CCE120, CCE220, CEC120, CEC220, CED120, CED220, CEF120, CEF220, CEM120, CGD120, CPE120, CPE220		



1

<b>GEV No.</b>	601453	<b>Ref. No.</b>	178410 178412	
<b>description</b>	cross flow fan TFR 180 roller ø 60mm roller length 180mm laminated core thickness 16mm motor position right 230V/50-60Hz 17W universal bearing silicone connection male faston 6.3mm airflow 100m³/h -30 up to +100°C 230V 50Hz			
<b>For models:</b>	CBE106, CBE106-VAR091, CBE110, CBE110-VAR091, CBE120, CBE120-VAR091, CCE106, CCE110, CCE120, CEC106, CEC110, CEC120, CED106, CED110, CED120, CEF106, CEF110, CEF120, CEM110, CEM120, CGD110, CPE106, CPE110, CPE120, ECL484, FGR150, FGR250, FGR300, FGR400, NGR150, NGR250, NGR300, NGR400			
<b>accessories for</b>	601453			
	<b>GEV No.</b>	415114	<b>Ref. No.</b>	—
	heater battery mounting distance 185mm W 40mm H 35mm 2000W 230V temperature restriction 105°C heating circuits 2 connection cable cable length 150mm L 192mm for cross flow fan			

heater battery



1

<b>GEV No.</b>	415122	<b>Ref. No.</b>	402628
<b>description</b>	heater battery mounting distance 185mm W 40mm H 35mm 2000W 230V temperature restriction 105°C heating circuits 2 connection cable cable length 340mm L 197mm for cross flow fan		
<b>For models:</b>	FEH613, FEH615, FEH705, FEH715, FEW252, FGH613, FGH615, FGH617, NEA182, NEH212, NEH615, NEH705, NEW182, NEW252, NEW452, NGH202, NGH605, NGH607, NGH615, NGH617, NGH725, NGH727, NGH737		







hot air motors

1  Image not available

<b>GEV No.</b>	510534	<b>Ref. No.</b>	146144 754861000
<b>description</b>	clamping ring		
<b>For models:</b>	CEC106, CED106, FEH415, FEH505, FEH515, FEH615, FGH415, FGH615, NGH415, NGH615		



2 

<b>GEV No.</b>	510533	<b>Ref. No.</b>	146361 755770000
<b>description</b>	clamping ring for L9		
<b>For models:</b>	CEC110, CEC120, CEC220, CED110, CED120, CED220		

1 

<b>GEV No.</b>	693495	<b>Ref. No.</b>	146769
<b>description</b>	counterflange for fan motor ED ø 60mm int. ø 1 35mm int. ø 2 26mm thickness 7mm brass		
<b>For models:</b>	CBE110, CBE110-VAR091, CBE120, CBE120-VAR091, CBE220, CBE220-VAR091, CBG110, CBG120, CCE110, CCE120, CCE220, CEC110, CEC120, CEC220, CED110, CED120, CED220, CEF110, CEF120, CEF220, CEM110, CEM120, CGD110, CGD120, CPE110, CPE120, CPE220		

**accessories for** 693495

	<b>GEV No.</b>	510533	<b>Ref. No.</b>	146361 755770000
	<b>description</b>	clamping ring for L9		
	<b>GEV No.</b>	510540	<b>Ref. No.</b>	146360 755769000
	<b>description</b>	gasket brass for fan motor ID ø 23mm ED ø 29,6mm		
	<b>GEV No.</b>	510542	<b>Ref. No.</b>	062131
	<b>description</b>	gasket for fan motor ID ø 42mm ED ø 61mm thickness 1mm		

1 Image not available

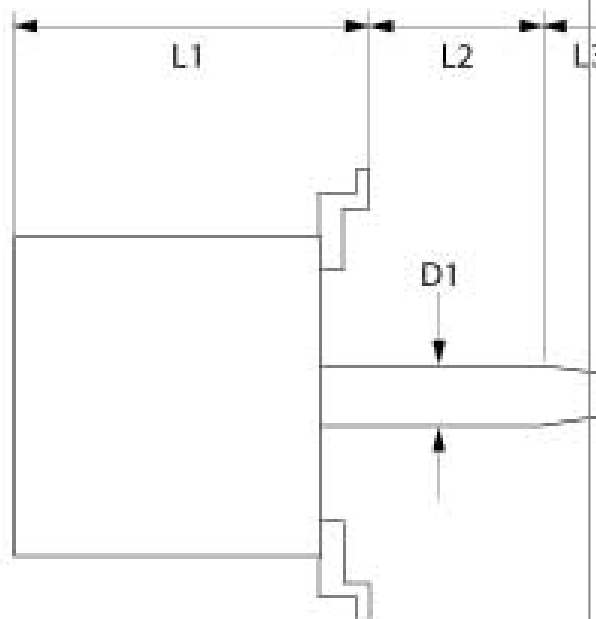

<b>GEV No.</b>	500104	<b>Ref. No.</b>	120104
<b>description</b>	fan motor		
<b>For models:</b>	CBE106-VAR091, CED106, CEF106		

1 

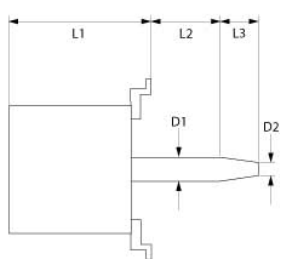

<b>GEV No.</b>	500669	<b>Ref. No.</b>	120101 120117
<b>description</b>	fan motor		
<b>For models:</b>	CBG110, CBG120, CGD110, CGD120		



1

<b>GEV No.</b>	501544	<b>Ref. No.</b>	115950
<b>description</b>	fan motor 220-240/380-415V 3 phase 50Hz 0.26/0.16kW 1440rpm L1 150mm L2 32mm L3 40mm M10R IT at 50Hz 1440rpm type L7zA-w4D-511 no. D6 D1 ø 17mm D2 ø 13mm mounting distance 180mm		
<b>For models:</b>	CBE106, CCE106, CEC106, CED106, CPE106, EAB051, ECD106, ECD110, ECD120, ECD220, EDC106		

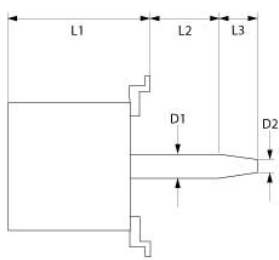
1

<b>GEV No.</b>	500109	<b>Ref. No.</b>	115980 115989 120122
<b>description</b>	fan motor 220-240/380-415V 3 phase 50Hz 0.85kW 1360rpm speeds 1 L1 220mm L2 35mm L3 29mm M14L IT 4.3/2.5A power input 1170W Cos(φ) 0.71 at 50Hz 1360rpm type L9FG4D-160 no. X1 D1 ø 23mm D2 ø 20mm		
<b>For models:</b>	CBE220, CCE220, CEC220, CED220, CPE220		

1

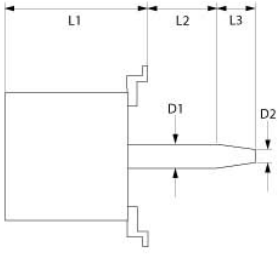
<b>GEV No.</b>	601293	<b>Ref. No.</b>	120121
<b>description</b>	fan motor 220-240/380-415V 3 phase 50Hz 0.37kW 1400rpm speeds 1 L1 177mm L2 49mm L3 30mm M14R IT 2.85/1.65A power input 580W Cos(φ) 0.55 at 50Hz 1400rpm type L9Cw4D-037 D1 ø 23mm D2 ø 20mm		
<b>For models:</b>	CCE120, CPE120		



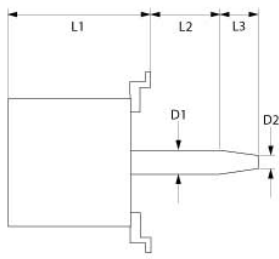

1

<b>GEV No.</b>	500905	<b>Ref. No.</b>	120105
<b>description</b>	fan motor 380-415V 3 phase 50Hz 0.12/0.4kW 700/1350rpm speeds 2 L1 180mm L2 49mm L3 30mm M14R IT 0.55/1.0A power input 40/250W at 50Hz 700/1350rpm type L9Rw84b-285 D1 ø 23mm D2 ø 20mm		
<b>For models:</b>	CBE110-VAR091, CBE120-VAR091, CED110, CED120, CEF110, CEF120, CEM110, CEM120		



1

<b>GEV No.</b>	601305	<b>Ref. No.</b>	115966
<b>description</b>	fan motor 220-240/380-415V 3 phase 50Hz 0.37kW 1410rpm speeds 1 L1 160mm L2 53mm L3 32mm D1 ø 23mm D2 ø 20mm M16R IT 1.6/0.92A Cos(φ) 0.8 at 50Hz 1410rpm		
<b>For models:</b>	CBE110, CBE120, CCE110, CCE120, CEC110, CEC120, CED110, CED120, CPE110, CPE120		
<b>accessories for</b>	601305		
	<b>GEV No.</b>	<b>Ref. No.</b>	560308
			151184
	hexagonal screw thread M16 thread L 20mm SS WS 24 Qty 1 pcs DIN 933 / ISO 4017		

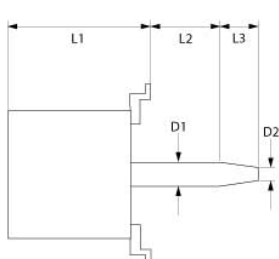
1

<b>GEV No.</b>	500906	<b>Ref. No.</b>	120103
<b>description</b>	fan motor 380-415V 3 phase 50Hz 0.12/0.9kW 700/1380rpm speeds 2 L1 217mm L2 45mm L3 30mm M14R IT 0.9/2.1A power input 240/1200W at 50Hz 700/1380rpm Y/YY type L9zw84D-286 no. V1 D1 ø 23mm D2 ø 20mm		
<b>For models:</b>	CBE220-VAR091, CED220, CEF220		



<b>GEV No.</b>	601302	<b>Ref. No.</b>	407289
<b>description</b>	fan wheel		



<b>GEV No.</b>	601298	<b>Ref. No.</b>	174256
<b>description</b>	fan wheel D1 ø 280mm H1 115mm blades 42		
<b>For models:</b>	CBE106, CBE106-VAR091, CCE106, CEC106, CED106, CEF106, CPE106		

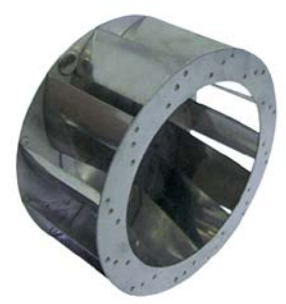

<b>GEV No.</b>	601049	<b>Ref. No.</b>	407448
<b>description</b>	fan wheel D1 ø 280mm H1 125mm blades 12 D2 ø 11mm D3 ø 16mm H2 37mm		
<b>For models:</b>	ECD106		



<b>GEV No.</b>	601311	<b>Ref. No.</b>	407289
<b>description</b>	fan wheel D1 ø 350mm H1 125mm blades 12 D2 ø 13mm D3 ø 16.5mm H2 37mm		
<b>For models:</b>	ECD110, ECD120, ECD220		



<b>GEV No.</b>	601303	<b>Ref. No.</b>	174257
<b>description</b>	fan wheel D1 ø 355mm H1 127mm blades 42 D2 ø 20mm D3 ø 22mm H2 48mm		
<b>For models:</b>	CBE110, CBE110-VAR091, CBE120, CBE120-VAR091, CBG110, CBG120, CCE110, CCE120, CEC110, CEC120, CED110, CED120, CEF110, CEF120, CEM110, CEM120, CGD110, CGD120, CPE110, CPE120		



<b>GEV No.</b>	601304	<b>Ref. No.</b>	174265
<b>description</b>	fan wheel D1 ø 400mm H1 127mm		
<b>For models:</b>	CBE220, CBE220-VAR091, CCE220, CEC220, CED220, CEF220, CPE220		



<b>GEV No.</b>	510539	<b>Ref. No.</b>	146193 754860000
<b>description</b>	flange for fan motor ED ø 60mm int. ø 1 30mm int. ø 2 20mm thickness 3mm brass		
<b>For models:</b>	CBE106, CBE106-VAR091, CCE106, CEC106, CED106, CEF106, CPE106		





<b>GEV No.</b>	693494	<b>Ref. No.</b>	146359 755768000
<b>description</b>	flange for fan motor ED ø 60mm int. ø 1 35mm int. ø 2 26mm thickness 6mm brass		
<b>For models:</b>	CEC110, CEC120, CEC220, CED110, CED120, CED220		



<b>GEV No.</b>	510541	<b>Ref. No.</b>	146195 784863000
<b>description</b>	gasket brass for fan motor ID ø 17.3mm ED ø 25mm		
<b>For models:</b>	CBE106, CBE106-VAR091, CCE106, CEC106, CED106, CEF106, CPE106		

			
1			
<b>GEV No.</b>	510537	<b>Ref. No.</b>	146194
<b>description</b>	gasket brass for fan motor ID ø 20mm ED ø 29.5mm		
<b>For models:</b>	CBE106, CBE106-VAR091, CCE106, CEC106, CED106, CEF106, CPE106		

			
1			
<b>GEV No.</b>	510540	<b>Ref. No.</b>	146360 755769000
<b>description</b>	gasket brass for fan motor ID ø 23mm ED ø 29.6mm		
<b>For models:</b>	CBE110, CBE110-VAR091, CBE120, CBE120-VAR091, CBE220, CBE220-VAR091, CBG110, CBG120, CCE110, CCE120, CCE220, CEC110, CEC120, CEC220, CED110, CED120, CED220, CEF110, CEF120, CEF220, CEM110, CEM120, CGD110, CGD120, CPE110, CPE120, CPE220		

			
1			
<b>GEV No.</b>	510542	<b>Ref. No.</b>	062131
<b>description</b>	gasket for fan motor ID ø 42mm ED ø 61mm thickness 1mm		
<b>For models:</b>	CBE106, CBE106-VAR091, CBE110, CBE110-VAR091, CBE120, CBE120-VAR091, CBE220, CBE220-VAR091, CBG110, CBG120, CCE106, CCE110, CCE120, CCE220, CEC106, CEC110, CEC120, CEC220, CED106, CED110, CED120, CED220, CEF106, CEF110, CEF120, CEF220, CEM110, CEM120, CGD110, CGD120, CPE106, CPE110, CPE120, CPE220		

hot air fans

ebm-papst

			
1			
<b>GEV No.</b>	601294	<b>Ref. No.</b>	115971 115972 178413 178414 178464
<b>description</b>	hot air fan 230V 50W D 79mm distance fan wheel - fixing 10mm mounting distance 47mm ebm-papst type EM3038LH-20		
<b>For models:</b>	ECL484		

HANNING

			
1			
<b>GEV No.</b>	601149	<b>Ref. No.</b>	174193
<b>description</b>	fan motor 230V L1 72mm L2 69mm L4 130mm HANNING type EMB-30-028		
<b>For models:</b>	FEH415, FEH505, FEH515, FEH615, FEH705, FEH715, FGH415, FGH615, NEH415, NEH505, NEH615, NEH705, NGH405, NGH415, NGH505, NGH605, NGH615, NGH725		

			
1			
<b>GEV No.</b>	601008	<b>Ref. No.</b>	174192
<b>description</b>	hot air fan 230V 45W L1 72mm L2 28mm L4 130mm HANNING type EMB-30-027 M6L		
<b>For models:</b>	GHP601, LEH405, LEH505, LEH605, LEH705, LGH405, LGH605		

accessories

fan wheels for hot air fans

			
1			
<b>GEV No.</b>	601196	<b>Ref. No.</b>	788878002
<b>description</b>	fan wheel ø 150mm W 20mm shaft intake ø 6x5mm blades 6		
<b>For models:</b>	ECL484, FEH415, FEH505, FEH515, FEH615, FEH705, FEH715, FGH415, FGH615, LEH405, LEH505, LEH605, LEH705, LGH405, LGH605, NEH415, NEH505, NEH615, NEH705, NGH405, NGH415, NGH505, NGH605, NGH615, NGH725		



			
1			
<b>GEV No.</b>	601148	<b>Ref. No.</b>	174220
<b>description</b>	fan wheel ø 152mm W 20mm shaft intake ø 6x5mm stainless steel blades 6		
<b>For models:</b>	CEC106, CEC110, CEC120, CEC220, CGD110, CGD120, EHP601, GHP601, LGH405, LGH605		

miscellaneous			
			
Image not available			
1			
<b>GEV No.</b>	500610	<b>Ref. No.</b>	120112
<b>description</b>	spindle motor		
<b>For models:</b>	NEP203, NEP303		

**motors**

gear motors

miscellaneous

			
1			
<b>GEV No.</b>	500632	<b>Ref. No.</b>	115975
<b>description</b>	gear motor type MS56A/4 90/100W 230/400V 50/60Hz 19/23rpm shaft ø 12mm L 275mm W 110mm H 160mm for kettle		
<b>For models:</b>	NEK040, NEK060, NEK080, NEK100, NEK150, NNK040, NNK060, NNK080, NNK100, NNK150		

			
1			
<b>GEV No.</b>	500611	<b>Ref. No.</b>	120116
<b>description</b>	spindle motor		
<b>For models:</b>	EEP500, EGP500		

spindle motors

MAGNETIC

			
1			
<b>GEV No.</b>	500609	<b>Ref. No.</b>	120106
<b>description</b>	spindle motor type MAX30-120-0050 24V voltage DC shaft ø 28mm for tilting bratt pan L 335mm W 115mm H 180mm MAGNETIC		
<b>For models:</b>	FEP230, FEP330, NEP400, NEP600, NEP601, NEP900, NEP901, NGP400, NGP600, NGP900, PEP238, PEP338, PEP608, PEP618, PEP908, PEP918		

**condensators & interference suppression filters**

filters

RC circuits			
			
1			
<b>GEV No.</b>	380177	<b>Ref. No.</b>	407290
<b>description</b>	RC circuit type 20002 110/220V 50/60/DChz conductor 2 connection cable 230mm L 29mm ømm H 15mm W 20mm adhesive tape plastic Qty 1 pcs		
<b>For models:</b>	ECD106, ECD110, ECD120, ECD220		

			
1			
<b>GEV No.</b>	500622	<b>Ref. No.</b>	120114
<b>description</b>	spindle motor type MAX30-120-0050 24V voltage DC shaft ø 29mm for kettle L 340mm W 120mm H 175mm MAGNETIC		
<b>For models:</b>	FEK040, FEK060, FEK080, FEK100, FEK150, FNK040, FNK060, FNK080, FNK100, FNK150, PEK048, PEK068, PEK088, PEK108, PEK158, PNK048, PNK068, PNK088, PNK108, PNK158		

**fuses**

fine fuses

			
1			
<b>GEV No.</b>	358696	<b>Ref. No.</b>	216325
<b>description</b>	fine fuse size ø5x20mm 4A medium lag rated 250V Qty 10 pcs		
<b>For models:</b>	CBE106, CBE106-VAR091, CBE110, CBE110-VAR091, CBE120, CBE120-VAR091, CBE220, CBE220-VAR091, CBG110, CBG120, CCE106, CCE110, CCE120, CCE220, CEC106, CEC110, CEC120, CEC220, CED106, CED110, CED120, CED220, CEF106, CEF110, CEF120, CEF220, CEM110, CEM120, CGD110, CGD120, CPE106, CPE110, CPE120, CPE220, EAB051, EEH410, EEH413, EEH500, EEH503, EEH610, EEH613, EEH700, EEH703, EES060, EES080, FEB430, FEB630, FED080, FED150, FED250...(Other models you can see in the webshop)		





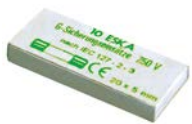

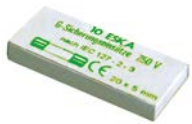
			
1			
<b>GEV No.</b>	358598	<b>Ref. No.</b>	407274
<b>description</b>	fine fuse size ø5x20mm 0.63A slow-acting rated 250V Qty 10 pcs		
<b>For models:</b>	ECD106, ECD110, ECD120, ECD220		

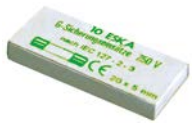
			
1			
<b>GEV No.</b>	358608	<b>Ref. No.</b>	216327
<b>description</b>	fine fuse size ø5x20mm 10A slow-acting rated 250V Qty 10 pcs		
<b>For models:</b>	CEC106, CEC110, CEC120, CEC220, CED120, CED220		

			
1			
<b>GEV No.</b>	358607	<b>Ref. No.</b>	407273
<b>description</b>	fine fuse size ø5x20mm 6.3A slow-acting rated 250V Qty 10 pcs		
<b>For models:</b>	ECD106, ECD110, ECD120, ECD220		

**fine fuse holders**

			
1			
<b>GEV No.</b>	358508	<b>Ref. No.</b>	184683
<b>description</b>	fuse holder suitable fuse ø5x25mm		

			
1			
<b>GEV No.</b>	550669	<b>Ref. No.</b>	184683
<b>description</b>	fuse holder suitable fuse ø5x25mm 10A rated 600V		
<b>For models:</b>	CBE106, CBE106-VAR091, CBE110, CBE110-VAR091, CBE120, CBE120-VAR091, CBE220, CBE220-VAR091, CBG110, CBG120, CCE106, CCE110, CCE120, CCE220, CEC106, CEC110, CEC120, CEC220, CED106, CED110, CED120, CED220, CEF106, CEF110, CEF120, CEF220, CEM110, CEM120, CGD110, CGD120, CPE106, CPE110, CPE120, CPE220, EEH410, EEH413, EEH500, EEH503, EEH610, EEH613, EEH700, EEH703, EEP500, EES060, EES080, EGP500, FEB430, FEB630, FED080, FED150...(Other models you can see in the webshop)		

			
1			
<b>GEV No.</b>	550105	<b>Ref. No.</b>	407334
<b>description</b>	rail-mounted terminal WIELAND type WK10/SIU 5X20 /V0 suitable fuse ø5x20mm 1.0-16mm <sup>2</sup> 10A rated 250V		
<b>For models:</b>	ECD106, ECD110, ECD120, ECD220		

**screw locks**

**D0-system (NEOZED)**

			
1			
<b>GEV No.</b>	358045	<b>Ref. No.</b>	407502
<b>description</b>	fuse size D02 35A rated 250/400V E18 ø 15mm L 36mm Qty 10 pcs		
<b>For models:</b>	ECD220		

			
1			
<b>GEV No.</b>	358046	<b>Ref. No.</b>	407503
<b>description</b>	fuse size D02 50A rated 250/400V E18 ø 15mm L 36mm Qty 10 pcs		
<b>For models:</b>	ECD220		

**gauge pieces (NEOZED)**

			
1			
<b>GEV No.</b>	358067	<b>Ref. No.</b>	407650
<b>description</b>	gauge piece size D02 suitable for 35A		
<b>For models:</b>	ECD220		

			
1			
<b>GEV No.</b>	358068	<b>Ref. No.</b>	407649
<b>description</b>	gauge piece size D02 suitable for 50A		
<b>For models:</b>	ECD220		

**fuse holders**

			
1			
<b>GEV No.</b>	358060	<b>Ref. No.</b>	407500
<b>description</b>	fuse holder suitable fuse D02 3-pole-pole 63A rated 400V		
<b>For models:</b>	ECD220		



			
1			
<b>GEV No.</b>	358061	<b>Ref. No.</b>	407501
<b>description</b>	fuse holder suitable fuse D02 ø 25mm mounting ø 18mm rated 400V L 30mm		
<b>For models:</b>	ECD220		

## electric accessories

### cables

### accessories

### cable glands

### threaded cable glands

### screw connections

			
1			
<b>GEV No.</b>	550319	<b>Ref. No.</b>	186249
<b>description</b>	cable gland thread PG7		
<b>For models:</b>	CED106, CED110, CED120, CED220		

### terminals and connectors

### not insulated

### female fastons with piggyback

			
1			
<b>GEV No.</b>	550055	<b>Ref. No.</b>	184721
<b>description</b>	male faston size 6.3x0.8mmmm <sup>2</sup> with piggyback CuZn gal Sn t.max. 110°C Qty 1 pcs		

### plug connectors

			
1			
<b>GEV No.</b>	550330	<b>Ref. No.</b>	185821
<b>description</b>	plug connector 12-pole		
<b>For models:</b>	CEC106, CEC110, CEC120, CEC220, CED106, CED110, CED120, CED220, TEF224		

			
1			
<b>GEV No.</b>	550333	<b>Ref. No.</b>	185817
<b>description</b>	plug connector 12-pole		
<b>For models:</b>	CEC106, CEC110, CEC120, CEC220, CED106, CED110, CED120, CED220, TEF224		

			
1			
<b>GEV No.</b>	550888	<b>Ref. No.</b>	185818
<b>description</b>	plug connector 8-pole		
<b>For models:</b>	CEC106, CEC110, CEC120, CEC220, CED106, CED110, CED120, CED220, TEB231, TEB431, TEB631, TEF124, TEF144, TEF224, TEF400, TEH300, TEW250, TEW400, TEW450		

			
1			
<b>GEV No.</b>	550889	<b>Ref. No.</b>	185822
<b>description</b>	plug connector 8-pole		
<b>For models:</b>	CEC106, CEC110, CEC120, CEC220, CED106, CED110, CED120, CED220, TEB231, TEB431, TEB631, TEF124, TEF144, TEF224, TEF400, TEH300, TEW250, TEW400, TEW450		

### terminals

### rail-mounted terminals

### WIELAND

### rail-mounted terminals type 9700A

			
1			
<b>GEV No.</b>	550374	<b>Ref. No.</b>	407450 407456
<b>description</b>	rail-mounted terminal WIELAND type 9700A/10 S35 1.5-16mm <sup>2</sup> top-hat rail 35mm blue W 10mm L 49mm		
<b>For models:</b>	ECD106, ECD110		

			
1			
<b>GEV No.</b>	550373	<b>Ref. No.</b>	407345
<b>description</b>	rail-mounted terminal WIELAND type 9700A/10 S35 1.5-16mm <sup>2</sup> top-hat rail 35mm grey W 10mm L 49mm		
<b>For models:</b>	ECD106, ECD110, ECD220		





			
1			
<b>GEV No.</b>	550375	<b>Ref. No.</b>	407346
<b>description</b>	rail-mounted terminal WIELAND type 9700A/10 SL2 S35 1.5-16mm <sup>2</sup> top-hat rail 35mm yellow/green W 10mm L 53mm		
<b>For models:</b>	ECD106, ECD110		

			
1			
<b>GEV No.</b>	550377	<b>Ref. No.</b>	407485
<b>description</b>	rail-mounted terminal WIELAND type 9700A/16 S35 2.5-35mm <sup>2</sup> top-hat rail 35mm blue W 16mm L 59mm		
<b>For models:</b>	ECD120		

			
1			
<b>GEV No.</b>	550376	<b>Ref. No.</b>	407484
<b>description</b>	rail-mounted terminal WIELAND type 9700A/16 S35 2.5-35mm <sup>2</sup> top-hat rail 35mm grey W 16mm L 59mm		
<b>For models:</b>	ECD120		

			
1			
<b>GEV No.</b>	550378	<b>Ref. No.</b>	407486
<b>description</b>	rail-mounted terminal WIELAND type 9700A/16 SL2 S35 2.5-35mm <sup>2</sup> top-hat rail 35mm yellow/green W 16mm L 53mm		
<b>For models:</b>	ECD120		

fuse terminal blocks			
			
1			
<b>GEV No.</b>	550105	<b>Ref. No.</b>	407334
<b>description</b>	rail-mounted terminal WIELAND type WK10/SIU 5X20 /V0 suitable fuse ø5x20mm 1.0-16mm <sup>2</sup> 10A rated 250V		
<b>For models:</b>	ECD106, ECD110, ECD120, ECD220		

accessories			
			
1			
<b>GEV No.</b>	550337	<b>Ref. No.</b>	407618
<b>description</b>	end barrier for fuse terminal clampsmm <sup>2</sup>		
<b>For models:</b>	ECD120, ECD220		

			
1			
<b>GEV No.</b>	550370	<b>Ref. No.</b>	407533
<b>description</b>	terminal block end bracket clampsmm <sup>2</sup>		
<b>For models:</b>	ECD106, ECD110, ECD120, ECD220		

## electronic magnets

			
1			
<b>GEV No.</b>	401463	<b>Ref. No.</b>	162200
<b>description</b>	lifting magnet		
<b>For models:</b>	CBE106, CBE106-VAR091, CBE110, CBE110-VAR091, CBE120, CBE120-VAR091, CBE220, CBE220-VAR091, CBG110, CBG120, CCE106, CCE110, CCE120, CCE220, CEC106, CEC110, CEC120, CEC220, CED106, CED110, CED120, CED220, CEF106, CEF110, CEF120, CEF220, CEM110, CEM120, CGD110, CGD120, CPE106, CPE110, CPE120, CPE220		

## gas taps

### PEL

#### 21S series



















				
1				
<b>GEV No.</b>	101671	<b>Ref. No.</b>	150127 150128 406998	
<b>description</b>	gas tap PEL type 21S gas inlet pipe flange ø21mm bypass nozzle ø 0.35mm gas outlet M17x1 (tube ø 10mm) thermocouple connection M8x1 pilot connection M10x1 shaft ø 6x4.6mm shaft L 30/23mm shaft flat upper			
<b>For models:</b>	EGH210, EGH410, EGH413, EGH417, EGH610, EGH613, EGH617			
<b>spare parts for</b>	101671			
	<b>GEV No.</b>	100408	<b>Ref. No.</b>	—
	bypass nozzle type PEL20/21 bore ø 0.35mm thread M5x0.5			
	<b>GEV No.</b>	100908	<b>Ref. No.</b>	—
	union screw thread M10x1 for pipe ø 4mm Qty 1 pcs			

Table continues overleaf

<b>spare parts for</b> 101671				
	GEV No.	101060	Ref. No.	407088
	magnet unit standard L 39mm D1 ø 15.4mm D2 ø 11mm suitable for PEL20-21/JUNKERS/EGA			
	GEV No.	101230	Ref. No.	—
	thermocouple nut T1: M8x1 T2: M18x1 aluminium			
	GEV No.	101246	Ref. No.	—
	olive for pipe ø 4mm Qty 1 pcs			
	GEV No.	101803	Ref. No.	—
	gas tap front part shaft ø 6x4.6mm shaft L 30/23mm shaft flat upper/lower suitable for PEL21			

<b>accessories for</b> 101671				
	GEV No.	100909	Ref. No.	—
	union screw thread M10x1 for pipe ø 6mm Qty 1 pcs			
	GEV No.	101278	Ref. No.	114101
	olive for pipe ø 10mm Qty 1 pcs			
	GEV No.	101286	Ref. No.	—
	olive ID ø 6mm Qty 1 pcs			
	GEV No.	101300	Ref. No.	—
	union nut thread M16x1.5 tube ø 10mm			
	GEV No.	101450	Ref. No.	—
	olive for pipe ø 8mm L 12.7mm Qty 1 pcs ED ø 10mm			
	GEV No.	101451	Ref. No.	—
	union nut thread M16x1.5 tube ø 8mm			
	GEV No.	110078	Ref. No.	—
	knob without symbol ø 70mm shaft ø 6x4.6mm shaft flat universal			
	GEV No.	112206	Ref. No.	—
	knob dial plate silver gas tap PEL21/22/23 t.max.°C ED ø 63mm ID ø 45.5mm			

				
1				
<b>GEV No.</b>	101672	<b>Ref. No.</b>	150128	
<b>description</b>	gas tap PEL type 21S gas inlet pipe flange ø21mm bypass nozzle ø 0.85mm gas outlet M17x1 (tube ø 10/8.5mm) thermocouple connection M8x1 pilot connection M10x1 shaft ø 6x4.6mm shaft L 30/23mm shaft flat upper			
<b>For models:</b>	EGH210, EGH410, EGH413, EGH417, EGH610, EGH613, EGH617			
<b>spare parts for</b> 101672				
	GEV No.	100527	Ref. No.	—
	bypass nozzle type PEL20/21 bore ø 0.85mm thread M5x0.5			
	GEV No.	100908	Ref. No.	—
	union screw thread M10x1 for pipe ø 4mm Qty 1 pcs			

<b>spare parts for</b> 101672				
	GEV No.	101060	Ref. No.	407088
	magnet unit standard L 39mm D1 ø 15.4mm D2 ø 11mm suitable for PEL20-21/JUNKERS/EGA			
	GEV No.	101230	Ref. No.	—
	thermocouple nut T1: M8x1 T2: M18x1 aluminium			
	GEV No.	101246	Ref. No.	—
	olive for pipe ø 4mm Qty 1 pcs			
<b>accessories for</b> 101672				
	GEV No.	100909	Ref. No.	—
	union screw thread M10x1 for pipe ø 6mm Qty 1 pcs			
	GEV No.	100943	Ref. No.	—
	union nut thread M17x1 tube ø 10mm			
	GEV No.	101278	Ref. No.	114101
	olive for pipe ø 10mm Qty 1 pcs			
	GEV No.	101286	Ref. No.	—
	olive ID ø 6mm Qty 1 pcs			
	GEV No.	110078	Ref. No.	—
	knob without symbol ø 70mm shaft ø 6x4.6mm shaft flat universal			
	GEV No.	112206	Ref. No.	—
	knob dial plate silver gas tap PEL21/22/23 t.max.°C ED ø 63mm ID ø 45.5mm			

23S/V series

				
1				
<b>GEV No.</b>	101630	<b>Ref. No.</b>	177208	
<b>description</b>	gas tap PEL type 23S/V gas inlet 1/2" IT bypass nozzle ø 0.35mm gas outlet 1/2" MT (tube ø 14mm) thermocouple connection M10x1 pilot connection M10x1 shaft ø 10mm shaft L 25mm shaft flat			
<b>For models:</b>	LGP400, LGS060, NGP400, NGP600, NGP900, NGS040, NGS060, NGS080, NGS100, NGS150			
<b>spare parts for</b> 101630				
	GEV No.	100455	Ref. No.	—
	bypass nozzle type PEL23/24 bore ø 0.35mm thread M8x0.5			
	GEV No.	101059	Ref. No.	—
	magnet unit T1: M10x1 T2: M22x1 L 46mm ø 18mm suitable for PEL23S M10x1			
	GEV No.	102767	Ref. No.	—
	gas tap front part shaft ø 10mm shaft L 26.5mm shaft flat suitable for PEL23S			
<b>accessories for</b> 101630				
	GEV No.	100908	Ref. No.	—
	union screw thread M10x1 for pipe ø 4mm Qty 1 pcs			

Table continues overleaf













accessories for		101630		
	GEV No.	100909	Ref. No.	—
union screw thread M10x1 for pipe ø 6mm Qty 1 pcs				
	GEV No.	100945	Ref. No.	—
roll pin ø 3.2mm L 10mm				
	GEV No.	101218	Ref. No.	—
shaft extension JUNKERS				
	GEV No.	101219	Ref. No.	752972000
shaft extension L 25mm JUNKERS				
	GEV No.	101246	Ref. No.	—
olive for pipe ø 4mm Qty 1 pcs				
	GEV No.	101286	Ref. No.	—
olive ID ø 6mm Qty 1 pcs				
	GEV No.	110064	Ref. No.	—
knob				
	GEV No.	110066	Ref. No.	133364
knob screw				
	GEV No.	550396	Ref. No.	—
shaft extension L 25mm JUNKERS				

alternatives to EGA

GPEL21 series

with nozzle outlet

				
1				
GEV No.	101734	Ref. No.	151003	
description	gas tap			

				
1				
GEV No.	101737 <sup>1</sup>	Ref. No.	151003 406928	
description	gas tap alternatives to EGA type GPEL21D gas inlet M15x1 (tube ø 10mm) external nozzle ø fixed 4.2mm internal nozzle ø 2.05mm bypass nozzle ø 0.35mm mixing pipe connection M17x1 thermocouple connection M8x1 pilot connection M10x1 shaft ø 6x4.6mm shaft L 31/23mm shaft flat left			
For models:	NGH410, NGH413, NGH415, NGH417, NGH610, NGH613, NGH615, NGH617			
spare parts for	101737			
	GEV No.	100397	Ref. No.	152636
internal nozzle bore ø 2.05mm suitable for EGA26400/26440				
	GEV No.	100408	Ref. No.	—
bypass nozzle type PEL20/21 bore ø 0.35mm thread M5x0.5				
	GEV No.	101060	Ref. No.	407088
magnet unit standard L 39mm D1 ø 15.4mm D2 ø 11mm suitable for PEL20-21/JUNKERS/EGA				
	GEV No.	101230	Ref. No.	—
thermocouple nut T1: M8x1 T2: M18x1 aluminium				
	GEV No.	101802	Ref. No.	—
gas tap front part shaft ø 6x4.6mm shaft L 30/23mm shaft flat right/left suitable for PEL21				
accessories for	101737			
	GEV No.	100942	Ref. No.	—
union nut thread M15x1 for pipe ø 10mm				
	GEV No.	100943	Ref. No.	—
union nut thread M17x1 tube ø 10mm				
	GEV No.	101278	Ref. No.	114101
olive for pipe ø 10mm Qty 1 pcs				
	GEV No.	101394	Ref. No.	—
nut thread M17x1 H 3mm WS 19 brass Qty 1 pcs				











<sup>1</sup>external nozzle cannot be replaced





			
<b>1</b>			
<b>GEV No.</b>	101653 <sup>1</sup>	<b>Ref. No.</b>	150001
<b>description</b>	gas tap alternatives to EGA type GPEL21D with nozzle outlet (with internal nozzle) gas inlet M15x1 (tube ø 10mm) external nozzle ø fixed 4.2mm internal nozzle ø 1.4mm bypass nozzle ø 0.85mm mixing pipe connection M17x1 thermocouple connection M8x1 pilot connection M10x1 shaft ø 6x4.6mm shaft L 31/23mm shaft flat left		
<b>spare parts for</b>	101653		
	<b>GEV No.</b>	100395	<b>Ref. No.</b> 152634
	internal nozzle bore ø 1.4mm suitable for EGA26400/26440		
	<b>GEV No.</b>	100527	<b>Ref. No.</b> —
	bypass nozzle type PEL20/21 bore ø 0.85mm thread M5x0.5		
	<b>GEV No.</b>	100908	<b>Ref. No.</b> —
	union screw thread M10x1 for pipe ø 4mm Qty 1 pcs		
	<b>GEV No.</b>	101060	<b>Ref. No.</b> 407088
	magnet unit standard L 39mm D1 ø 15.4mm D2 ø 11mm suitable for PEL20-21/JUNKERS/EGA		
	<b>GEV No.</b>	101230	<b>Ref. No.</b> —
	thermocouple nut T1: M8x1 T2: M18x1 aluminium		
	<b>GEV No.</b>	101246	<b>Ref. No.</b> —
	olive for pipe ø 4mm Qty 1 pcs		
	<b>GEV No.</b>	101802	<b>Ref. No.</b> —
	gas tap front part shaft ø 6x4.6mm shaft L 30/23mm shaft flat right/ left suitable for PEL21		
<b>accessories for</b>	101653		
	<b>GEV No.</b>	100909	<b>Ref. No.</b> —
	union screw thread M10x1 for pipe ø 6mm Qty 1 pcs		
	<b>GEV No.</b>	100926	<b>Ref. No.</b> —
	centring piece thread M17x1		
	<b>GEV No.</b>	100942	<b>Ref. No.</b> —
	union nut thread M15x1 for pipe ø 10mm		
	<b>GEV No.</b>	101278	<b>Ref. No.</b> 114101
	olive for pipe ø 10mm Qty 1 pcs		
	<b>GEV No.</b>	101286	<b>Ref. No.</b> —
	olive ID ø 6mm Qty 1 pcs		
	<b>GEV No.</b>	110078	<b>Ref. No.</b> —
	knob without symbol ø 70mm shaft ø 6x4.6mm shaft flat universal		
	<b>GEV No.</b>	112206	<b>Ref. No.</b> —
	knob dial plate silver gas tap PEL21/22/23 t.max.°C ED ø 63mm ID ø 45.5mm		

<sup>1</sup>external nozzle cannot be replaced

			
<b>1</b>			
<b>GEV No.</b>	101736 <sup>1</sup>	<b>Ref. No.</b>	151002 406929
<b>description</b>	gas tap alternatives to EGA type GPEL21D with nozzle outlet (with internal nozzle) gas inlet M15x1 (tube ø 10mm) external nozzle ø fixed 4.2mm internal nozzle ø 1.8mm bypass nozzle ø 0.35mm mixing pipe connection M17x1 thermocouple connection M8x1 pilot connection M10x1 shaft ø 6x4.6mm shaft L 31/23mm shaft flat left		
<b>For models:</b>	NGH210, NGH410, NGH413, NGH415, NGH417, NGH610, NGH613, NGH615, NGH617, NGH730, NGH733, NGH737		
<b>spare parts for</b>	101736		
	<b>GEV No.</b>	100396	<b>Ref. No.</b> 152635
	internal nozzle bore ø 1.8mm suitable for EGA26400/26440		
	<b>GEV No.</b>	100408	<b>Ref. No.</b> —
	bypass nozzle type PEL20/21 bore ø 0.35mm thread M5x0.5		
	<b>GEV No.</b>	101060	<b>Ref. No.</b> 407088
	magnet unit standard L 39mm D1 ø 15.4mm D2 ø 11mm suitable for PEL20-21/JUNKERS/EGA		
	<b>GEV No.</b>	101230	<b>Ref. No.</b> —
	thermocouple nut T1: M8x1 T2: M18x1 aluminium		
	<b>GEV No.</b>	101802	<b>Ref. No.</b> —
	gas tap front part shaft ø 6x4.6mm shaft L 30/23mm shaft flat right/ left suitable for PEL21		
<b>accessories for</b>	101736		
	<b>GEV No.</b>	100942	<b>Ref. No.</b> —
	union nut thread M15x1 for pipe ø 10mm		
	<b>GEV No.</b>	100943	<b>Ref. No.</b> —
	union nut thread M17x1 tube ø 10mm		
	<b>GEV No.</b>	101278	<b>Ref. No.</b> 114101
	olive for pipe ø 10mm Qty 1 pcs		
	<b>GEV No.</b>	101394	<b>Ref. No.</b> —
	nut thread M17x1 H 3mm WS 19 brass Qty 1 pcs		

<sup>1</sup>external nozzle cannot be replaced





















			
<b>GEV No.</b>	101654 <sup>1</sup>	<b>Ref. No.</b>	150002
<b>description</b>	gas tap alternatives to EGA type GPEL21D with nozzle outlet (with internal nozzle) gas inlet M15x1 (tube ø 10mm) external nozzle ø fixed 4.2mm internal nozzle ø 1.8mm bypass nozzle ø 1.1mm mixing pipe connection M17x1 thermocouple connection M8x1 pilot connection M10x1 shaft ø 6x4.6mm shaft L 31/23mm shaft flat left		
<b>spare parts for</b>	101654		
	GEV No.	100396	Ref. No. 152635
	internal nozzle bore ø 1.8mm suitable for EGA26400/26440		
	GEV No.	100530	Ref. No. —
	bypass nozzle type PEL20/21 bore ø 1.1mm thread M5x0.5		
	GEV No.	100908	Ref. No. —
	union screw thread M10x1 for pipe ø 4mm Qty 1 pcs		
	GEV No.	101060	Ref. No. 407088
	magnet unit standard L 39mm D1 ø 15.4mm D2 ø 11mm suitable for PEL20-21/JUNKERS/EGA		
	GEV No.	101230	Ref. No. —
	thermocouple nut T1: M8x1 T2: M18x1 aluminium		
	GEV No.	101246	Ref. No. —
	olive for pipe ø 4mm Qty 1 pcs		
	GEV No.	101802	Ref. No. —
	gas tap front part shaft ø 6x4.6mm shaft L 30/23mm shaft flat right/left suitable for PEL21		
<b>accessories for</b>	101654		
	GEV No.	100909	Ref. No. —
	union screw thread M10x1 for pipe ø 6mm Qty 1 pcs		
	GEV No.	100926	Ref. No. —
	centring piece thread M17x1		
	GEV No.	100942	Ref. No. —
	union nut thread M15x1 for pipe ø 10mm		
	GEV No.	101278	Ref. No. 114101
	olive for pipe ø 10mm Qty 1 pcs		
	GEV No.	101286	Ref. No. —
	olive ID ø 6mm Qty 1 pcs		
	GEV No.	110078	Ref. No. —
	knob without symbol ø 70mm shaft ø 6x4.6mm shaft flat universal		
	GEV No.	112206	Ref. No. —
	knob dial plate silver gas tap PEL21/22/23 t.max.°C ED ø 63mm ID ø 45.5mm		

<sup>1</sup>external nozzle cannot be replaced

			
<b>GEV No.</b>	101655 <sup>1</sup>	<b>Ref. No.</b>	150003
<b>description</b>	gas tap alternatives to EGA type GPEL21D with nozzle outlet (with internal nozzle) gas inlet M15x1 (tube ø 10mm) external nozzle ø fixed 4.2mm internal nozzle ø 2.05mm bypass nozzle ø 1.25mm mixing pipe connection M17x1 thermocouple connection M8x1 pilot connection M10x1 shaft ø 6x4.6mm shaft L 31/23mm shaft flat left		
<b>spare parts for</b>	101655		
	GEV No.	100394	Ref. No. —
	bypass nozzle type PEL20/21 bore ø 1.25mm thread M5x0.5		
	GEV No.	100397	Ref. No. 152636
	internal nozzle bore ø 2.05mm suitable for EGA26400/26440		
	GEV No.	100908	Ref. No. —
	union screw thread M10x1 for pipe ø 4mm Qty 1 pcs		
	GEV No.	101060	Ref. No. 407088
	magnet unit standard L 39mm D1 ø 15.4mm D2 ø 11mm suitable for PEL20-21/JUNKERS/EGA		
	GEV No.	101230	Ref. No. —
	thermocouple nut T1: M8x1 T2: M18x1 aluminium		
	GEV No.	101246	Ref. No. —
	olive for pipe ø 4mm Qty 1 pcs		
	GEV No.	101802	Ref. No. —
	gas tap front part shaft ø 6x4.6mm shaft L 30/23mm shaft flat right/left suitable for PEL21		
<b>accessories for</b>	101655		
	GEV No.	100909	Ref. No. —
	union screw thread M10x1 for pipe ø 6mm Qty 1 pcs		
	GEV No.	100926	Ref. No. —
	centring piece thread M17x1		
	GEV No.	100942	Ref. No. —
	union nut thread M15x1 for pipe ø 10mm		
	GEV No.	101278	Ref. No. 114101
	olive for pipe ø 10mm Qty 1 pcs		
	GEV No.	101286	Ref. No. —
	olive ID ø 6mm Qty 1 pcs		
	GEV No.	110078	Ref. No. —
	knob without symbol ø 70mm shaft ø 6x4.6mm shaft flat universal		
	GEV No.	112206	Ref. No. —
	knob dial plate silver gas tap PEL21/22/23 t.max.°C ED ø 63mm ID ø 45.5mm		

<sup>1</sup>external nozzle cannot be replaced

			
1			
<b>GEV No.</b>	101633	<b>Ref. No.</b>	170882 406938 406949
<b>description</b>	gas tap alternatives to EGA type GPEL21D with nozzle outlet (with nozzle) gas inlet M15x1 (tube ø 10mm) external nozzle ø 1.4mm internal nozzle ø 0.8mm bypass nozzle ø 0.35mm mixing pipe connection M17x1 thermocouple connection M8x1 pilot connection M10x1 shaft ø 6x4.6mm shaft L 31/23mm shaft flat left		
<b>For models:</b>	NGH200, NGH202, NGH400, NGH403, NGH405, NGH407, NGH600, NGH603, NGH605, NGH607		
<b>spare parts for</b>	101633		
	GEV No.	100307	Ref. No. —
	gas injector thread M12x1 WS 14 bore ø 1.40mm		
	GEV No.	100311	Ref. No. 406938
	internal nozzle bore ø 0.80mm suitable for EGA26400/26440		
	GEV No.	100408	Ref. No. —
	bypass nozzle type PEL20/21 bore ø 0.35mm thread M5x0.5		
	GEV No.	100927	Ref. No. —
	torsion spring L 2.8-8.0mm for internal nozzle ø 3mm bore ømm		
	GEV No.	101060	Ref. No. 407088
	magnet unit standard L 39mm D1 ø 15.4mm D2 ø 11mm suitable for PEL20-21/JUNKERS/EGA		
	GEV No.	101230	Ref. No. —
	thermocouple nut T1: M8x1 T2: M18x1 aluminium		
	GEV No.	101526	Ref. No. —
	O-ring Viton thickness 1.78mm ID ø 4.48mm Qty 1 pcs		
	GEV No.	101593	Ref. No. —
	adjusting screw for internal nozzle thread M8x0.75		
	GEV No.	101802	Ref. No. —
	gas tap front part shaft ø 6x4.6mm shaft L 30/23mm shaft flat right/left suitable for PEL21		
<b>accessories for</b>	101633		
	GEV No.	100908	Ref. No. —
	union screw thread M10x1 for pipe ø 4mm Qty 1 pcs		
	GEV No.	100909	Ref. No. —
	union screw thread M10x1 for pipe ø 6mm Qty 1 pcs		
	GEV No.	100926	Ref. No. —
	centring piece thread M17x1		
	GEV No.	100942	Ref. No. —
	union nut thread M15x1 for pipe ø 10mm		
	GEV No.	101246	Ref. No. —
	olive for pipe ø 4mm Qty 1 pcs		

<b>accessories for</b>	101633		
	GEV No.	101278	Ref. No. 114101
	olive for pipe ø 10mm Qty 1 pcs		
	GEV No.	101286	Ref. No. —
	olive ID ø 6mm Qty 1 pcs		
	GEV No.	110078	Ref. No. —
	knob without symbol ø 70mm shaft ø 6x4.6mm shaft flat universal		
	GEV No.	112206	Ref. No. —
	knob dial plate silver gas tap PEL21/22/23 t.max.°C ED ø 63mm ID ø 45.5mm		















			
1			
<b>GEV No.</b>	101634	<b>Ref. No.</b>	170883 406929 406948
<b>description</b>	gas tap alternatives to EGA type GPEL21D with nozzle outlet (with nozzle) gas inlet M15x1 (tube ø 10mm) external nozzle ø 1.85mm internal nozzle ø 1.05mm bypass nozzle ø 0.5mm mixing pipe connection M17x1 thermocouple connection M8x1 pilot connection M10x1 shaft ø 6x4.6mm shaft L 31/23mm shaft flat left		
<b>For models:</b>	NGH200, NGH202, NGH400, NGH403, NGH405, NGH407, NGH600, NGH603, NGH605, NGH607, NGH720, NGH723, NGH725, NGH727		
<b>spare parts for</b>	101634		
	GEV No.	100302	Ref. No. —
	gas injector thread M12x1 WS 14 bore ø 1.85mm		
	GEV No.	100312	Ref. No. —
	internal nozzle bore ø 1.05mm suitable for EGA26400/26440		
	GEV No.	100526	Ref. No. —
	bypass nozzle type PEL20/21 bore ø 0.5mm thread M5x0.5		
	GEV No.	100927	Ref. No. —
	torsion spring L 2.8-8.0mm for internal nozzle ø 3mm bore ømm		
	GEV No.	101060	Ref. No. 407088
	magnet unit standard L 39mm D1 ø 15.4mm D2 ø 11mm suitable for PEL20-21/JUNKERS/EGA		
	GEV No.	101230	Ref. No. —
	thermocouple nut T1: M8x1 T2: M18x1 aluminium		
	GEV No.	101526	Ref. No. —
	O-ring Viton thickness 1.78mm ID ø 4.48mm Qty 1 pcs		
	GEV No.	101593	Ref. No. —
	adjusting screw for internal nozzle thread M8x0.75		
	GEV No.	101802	Ref. No. —
	gas tap front part shaft ø 6x4.6mm shaft L 30/23mm shaft flat right/left suitable for PEL21		
<b>accessories for</b>	101634		
	GEV No.	100908	Ref. No. —
	union screw thread M10x1 for pipe ø 4mm Qty 1 pcs		



Table continues overleaf















accessories for		101634		
	GEV No.	100909	Ref. No.	—
union screw thread M10x1 for pipe ø 6mm Qty 1 pcs				
	GEV No.	100926	Ref. No.	—
centring piece thread M17x1				
	GEV No.	100942	Ref. No.	—
union nut thread M15x1 for pipe ø 10mm				
	GEV No.	101246	Ref. No.	—
olive for pipe ø 4mm Qty 1 pcs				
	GEV No.	101278	Ref. No.	114101
olive for pipe ø 10mm Qty 1 pcs				
	GEV No.	101286	Ref. No.	—
olive ID ø 6mm Qty 1 pcs				
	GEV No.	110078	Ref. No.	—
knob without symbol ø 70mm shaft ø 6x4.6mm shaft flat universal				
	GEV No.	112206	Ref. No.	—
knob dial plate silver gas tap PEL21/22/23 t.max.°C ED ø 63mm ID ø 45.5mm				

				
1				
GEV No.	101735 <sup>1</sup>	Ref. No.	151001 406930	
description	gas tap alternatives to EGA type GPEL21D with nozzle outlet (with nozzle) gas inlet M15x1 (tube ø 10mm) external nozzle ø fixed 4.2mm internal nozzle ø 1.4mm bypass nozzle ø 0.35mm mixing pipe connection M17x1 thermocouple connection M8x1 pilot connection M10x1 shaft ø 6x4.6mm shaft L 31/23mm shaft flat left			
spare parts for	101735			
	GEV No.	100395	Ref. No.	152634
internal nozzle bore ø 1.4mm suitable for EGA26400/26440				
	GEV No.	100408	Ref. No.	—
bypass nozzle type PEL20/21 bore ø 0.35mm thread M5x0.5				
	GEV No.	101060	Ref. No.	407088
magnet unit standard L 39mm D1 ø 15.4mm D2 ø 11mm suitable for PEL20-21/JUNKERS/EGA				
	GEV No.	101230	Ref. No.	—
thermocouple nut T1: M8x1 T2: M18x1 aluminium				
	GEV No.	101802	Ref. No.	—
gas tap front part shaft ø 6x4.6mm shaft L 30/23mm shaft flat right/left suitable for PEL21				
accessories for	101735			
	GEV No.	100942	Ref. No.	—
union nut thread M15x1 for pipe ø 10mm				



<sup>1</sup>external nozzle cannot be replaced

accessories for		101735		
	GEV No.	100943	Ref. No.	—
union nut thread M17x1 tube ø 10mm				
	GEV No.	101278	Ref. No.	114101
olive for pipe ø 10mm Qty 1 pcs				
	GEV No.	101394	Ref. No.	—
nut thread M17x1 H 3mm WS 19 brass Qty 1 pcs				

with pipe outlet				
				
1				
GEV No.	101646 <sup>1</sup>	Ref. No.	170737 406937	
description	gas tap alternatives to EGA type GPEL20RD with pipe outlet with throttle screw gas inlet M15x1 (tube ø 10mm) bypass nozzle ø 0.35mm gas outlet M17x1 (tube ø 10mm) thermocouple connection M8x1 pilot connection M10x1 shaft ø 6x4.6mm shaft L 31/23mm shaft flat upper			
spare parts for	101646			
	GEV No.	100408	Ref. No.	—
bypass nozzle type PEL20/21 bore ø 0.35mm thread M5x0.5				
	GEV No.	101060	Ref. No.	407088
magnet unit standard L 39mm D1 ø 15.4mm D2 ø 11mm suitable for PEL20-21/JUNKERS/EGA				
	GEV No.	101230	Ref. No.	—
thermocouple nut T1: M8x1 T2: M18x1 aluminium				
	GEV No.	101526	Ref. No.	—
O-ring Viton thickness 1.78mm ID ø 4.48mm Qty 1 pcs				
	GEV No.	101552	Ref. No.	—
throttle screw thread M8x0.75				
accessories for	101646			
	GEV No.	100908	Ref. No.	—
union screw thread M10x1 for pipe ø 4mm Qty 1 pcs				
	GEV No.	100909	Ref. No.	—
union screw thread M10x1 for pipe ø 6mm Qty 1 pcs				
	GEV No.	100926	Ref. No.	—
centring piece thread M17x1				
	GEV No.	100942	Ref. No.	—
union nut thread M15x1 for pipe ø 10mm				
	GEV No.	101246	Ref. No.	—
olive for pipe ø 4mm Qty 1 pcs				
	GEV No.	101278	Ref. No.	114101
olive for pipe ø 10mm Qty 1 pcs				

<sup>1</sup>with reducer for main gas line  
Table continues overleaf



<b>accessories for</b>	101646		
	GEV No.	101286	Ref. No. —
	olive ID ø 6mm Qty 1 pcs		
	GEV No.	110078	Ref. No. —
	knob without symbol ø 70mm shaft ø 6x4.6mm shaft flat universal		
	GEV No.	112206	Ref. No. —
	knob dial plate silver gas tap PEL21/22/23 t.max.°C ED ø 63mm ID ø 45.5mm		

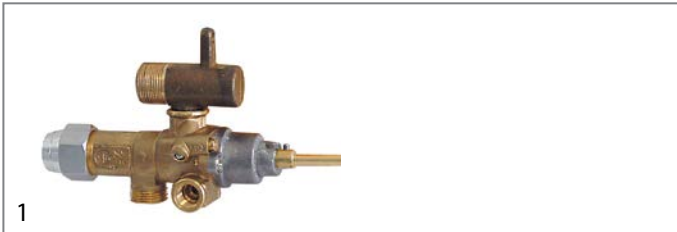

<b>GEV No.</b>	101658	<b>Ref. No.</b>	150003
<b>description</b>	gas tap alternatives to EGA type GPEL21 with pipe outlet gas inlet M15x1 (tube ø 10mm) bypass nozzle ø 0.6mm gas outlet M17x1 (tube ø 10mm) thermocouple connection M8x1 pilot connection M10x1 shaft ø 6x4.6mm shaft L 31/23mm shaft flat upper		
<b>spare parts for</b>	101658		
	GEV No.	100551	Ref. No. —
	bypass nozzle type PEL20/21 bore ø 0.6mm thread M5x0.5		
	GEV No.	100908	Ref. No. —
	union screw thread M10x1 for pipe ø 4mm Qty 1 pcs		
	GEV No.	101060	Ref. No. 407088
	magnet unit standard L 39mm D1 ø 15.4mm D2 ø 11mm suitable for PEL20-21/JUNKERS/EGA		
	GEV No.	101230	Ref. No. —
	thermocouple nut T1: M8x1 T2: M18x1 aluminium		
	GEV No.	101246	Ref. No. —
	olive for pipe ø 4mm Qty 1 pcs		
	GEV No.	101803	Ref. No. —
	gas tap front part shaft ø 6x4.6mm shaft L 30/23mm shaft flat upper/lower suitable for PEL21		
<b>accessories for</b>	101658		
	GEV No.	100909	Ref. No. —
	union screw thread M10x1 for pipe ø 6mm Qty 1 pcs		
	GEV No.	100942	Ref. No. —
	union nut thread M15x1 for pipe ø 10mm		
	GEV No.	100943	Ref. No. —
	union nut thread M17x1 tube ø 10mm		
	GEV No.	101278	Ref. No. 114101
	olive for pipe ø 10mm Qty 1 pcs		
	GEV No.	101286	Ref. No. —
	olive ID ø 6mm Qty 1 pcs		
	GEV No.	110078	Ref. No. —
	knob without symbol ø 70mm shaft ø 6x4.6mm shaft flat universal		













<b>accessories for</b>	101658		
	GEV No.	112206	Ref. No. —
	knob dial plate silver gas tap PEL21/22/23 t.max.°C ED ø 63mm ID ø 45.5mm		



<b>GEV No.</b>	101650	<b>Ref. No.</b>	150117
<b>description</b>	gas tap alternatives to EGA type GPEL21R with pipe outlet gas inlet M15x1 (tube ø 10mm) bypass nozzle ø 0.35mm gas outlet M17x1 (tube ø 10mm) thermocouple connection M8x1 pilot connection M10x1 shaft ø 6x4.6mm shaft L 31/23mm shaft flat left		
<b>For models:</b>	PGH418, PGH618		
<b>spare parts for</b>	101650		
	GEV No.	100408	Ref. No. —
	bypass nozzle type PEL20/21 bore ø 0.35mm thread M5x0.5		
	GEV No.	100908	Ref. No. —
	union screw thread M10x1 for pipe ø 4mm Qty 1 pcs		
	GEV No.	101060	Ref. No. 407088
	magnet unit standard L 39mm D1 ø 15.4mm D2 ø 11mm suitable for PEL20-21/JUNKERS/EGA		
	GEV No.	101230	Ref. No. —
	thermocouple nut T1: M8x1 T2: M18x1 aluminium		
	GEV No.	101246	Ref. No. —
	olive for pipe ø 4mm Qty 1 pcs		
	GEV No.	101802	Ref. No. —
	gas tap front part shaft ø 6x4.6mm shaft L 30/23mm shaft flat right/left suitable for PEL21		
<b>accessories for</b>	101650		
	GEV No.	100942	Ref. No. —
	union nut thread M15x1 for pipe ø 10mm		
	GEV No.	100943	Ref. No. —
	union nut thread M17x1 tube ø 10mm		
	GEV No.	101278	Ref. No. 114101
	olive for pipe ø 10mm Qty 1 pcs		
	GEV No.	101286	Ref. No. —
	olive ID ø 6mm Qty 1 pcs		
	GEV No.	110078	Ref. No. —
	knob without symbol ø 70mm shaft ø 6x4.6mm shaft flat universal		
	GEV No.	112206	Ref. No. —
	knob dial plate silver gas tap PEL21/22/23 t.max.°C ED ø 63mm ID ø 45.5mm		





			
1			
<b>GEV No.</b>	101651	<b>Ref. No.</b>	150118
<b>description</b>	gas tap alternatives to EGA type GPEL21R with pipe outlet gas inlet M15x1 (tube ø 10mm) bypass nozzle ø 1.1mm gas outlet M17x1 (tube ø 10mm) thermocouple connection M8x1 pilot connection M10x1 shaft ø 6x4.6mm shaft L 31/23mm shaft flat left		
<b>For models:</b>	PGH218, PGH418, PGH618		
<b>spare parts for</b>	101651		
	<b>GEV No.</b>	100530	<b>Ref. No.</b> —
	bypass nozzle type PEL20/21 bore ø 1.1mm thread M5x0.5		
	<b>GEV No.</b>	100908	<b>Ref. No.</b> —
	union screw thread M10x1 for pipe ø 4mm Qty 1 pcs		
	<b>GEV No.</b>	101060	<b>Ref. No.</b> 407088
	magnet unit standard L 39mm D1 ø 15.4mm D2 ø 11mm suitable for PEL20-21/JUNKERS/EGA		
	<b>GEV No.</b>	101230	<b>Ref. No.</b> —
	thermocouple nut T1: M8x1 T2: M18x1 aluminium		
	<b>GEV No.</b>	101246	<b>Ref. No.</b> —
	olive for pipe ø 4mm Qty 1 pcs		
	<b>GEV No.</b>	101802	<b>Ref. No.</b> —
	gas tap front part shaft ø 6x4.6mm shaft L 30/23mm shaft flat right/left suitable for PEL21		
<b>accessories for</b>	101651		
	<b>GEV No.</b>	100909	<b>Ref. No.</b> —
	union screw thread M10x1 for pipe ø 6mm Qty 1 pcs		
	<b>GEV No.</b>	100942	<b>Ref. No.</b> —
	union nut thread M15x1 for pipe ø 10mm		
	<b>GEV No.</b>	100943	<b>Ref. No.</b> —
	union nut thread M17x1 tube ø 10mm		
	<b>GEV No.</b>	101278	<b>Ref. No.</b> 114101
	olive for pipe ø 10mm Qty 1 pcs		
	<b>GEV No.</b>	101286	<b>Ref. No.</b> —
	olive ID ø 6mm Qty 1 pcs		
	<b>GEV No.</b>	110078	<b>Ref. No.</b> —
	knob without symbol ø 70mm shaft ø 6x4.6mm shaft flat universal		
	<b>GEV No.</b>	112206	<b>Ref. No.</b> —
	knob dial plate silver gas tap PEL21/22/23 t.max.°C ED ø 63mm ID ø 45.5mm		

			
1			
<b>GEV No.</b>	101652	<b>Ref. No.</b>	150119
<b>description</b>	gas tap alternatives to EGA type GPEL21R with pipe outlet gas inlet M15x1 (tube ø 10mm) bypass nozzle ø 1.25mm gas outlet M17x1 (tube ø 10mm) thermocouple connection M8x1 pilot connection M10x1 shaft ø 6x4.6mm shaft L 31/23mm shaft flat left		
<b>For models:</b>	PGH418, PGH618		
<b>spare parts for</b>	101652		
	<b>GEV No.</b>	100394	<b>Ref. No.</b> —
	bypass nozzle type PEL20/21 bore ø 1.25mm thread M5x0.5		
	<b>GEV No.</b>	100908	<b>Ref. No.</b> —
	union screw thread M10x1 for pipe ø 4mm Qty 1 pcs		
	<b>GEV No.</b>	101060	<b>Ref. No.</b> 407088
	magnet unit standard L 39mm D1 ø 15.4mm D2 ø 11mm suitable for PEL20-21/JUNKERS/EGA		
	<b>GEV No.</b>	101230	<b>Ref. No.</b> —
	thermocouple nut T1: M8x1 T2: M18x1 aluminium		
	<b>GEV No.</b>	101246	<b>Ref. No.</b> —
	olive for pipe ø 4mm Qty 1 pcs		
	<b>GEV No.</b>	101802	<b>Ref. No.</b> —
	gas tap front part shaft ø 6x4.6mm shaft L 30/23mm shaft flat right/left suitable for PEL21		
<b>accessories for</b>	101652		
	<b>GEV No.</b>	100909	<b>Ref. No.</b> —
	union screw thread M10x1 for pipe ø 6mm Qty 1 pcs		
	<b>GEV No.</b>	100942	<b>Ref. No.</b> —
	union nut thread M15x1 for pipe ø 10mm		
	<b>GEV No.</b>	100943	<b>Ref. No.</b> —
	union nut thread M17x1 tube ø 10mm		
	<b>GEV No.</b>	101278	<b>Ref. No.</b> 114101
	olive for pipe ø 10mm Qty 1 pcs		
	<b>GEV No.</b>	101286	<b>Ref. No.</b> —
	olive ID ø 6mm Qty 1 pcs		
	<b>GEV No.</b>	110078	<b>Ref. No.</b> —
	knob without symbol ø 70mm shaft ø 6x4.6mm shaft flat universal		
	<b>GEV No.</b>	112206	<b>Ref. No.</b> —
	knob dial plate silver gas tap PEL21/22/23 t.max.°C ED ø 63mm ID ø 45.5mm		



GPEL22 series

with nozzle outlet



<b>GEV No.</b>	101656	<b>Ref. No.</b>	170725 170726 406964
<b>description</b>	gas tap alternatives to EGA type GPEL22D with nozzle outlet (with nozzle) gas inlet M18x1.5 (tube ø 12mm) external nozzle ø 4.4mm internal nozzle ø 2.5mm bypass nozzle ø 1.65mm mixing pipe connection M22x1 thermocouple connection M8x1 pilot connection M10x1 shaft ø 6x4.6mm shaft L 35/21mm shaft flat upper		
<b>For models:</b>	GHN201, GHN202, GHN401, GHN402, GHN601, GHN602, GHN801, GHN802, GHO101		
<b>spare parts for</b>	101656		
	GEV No. 100329	Ref. No.	—
	gas injector thread M15x1 bore ø 4.40mm WS 17		
	GEV No. 100398	Ref. No.	—
	internal nozzle bore ø 2.5mm type EGA/PEL22		
	GEV No. 100413	Ref. No.	—
	bypass nozzle type PEL22 bore ø 1.65mm thread M6x0.5		
	GEV No. 100908	Ref. No.	—
	union screw thread M10x1 for pipe ø 4mm Qty 1 pcs		
	GEV No. 100927	Ref. No.	—
	torsion spring L 2.8-8.0mm for internal nozzle ø 3mm bore ømm		
	GEV No. 101058	Ref. No.	—
	magnet unit L 39mm D1 ø 15.4mm D2 ø 13.5mm suitable for PEL22/ EGA24197 standard		
	GEV No. 101230	Ref. No.	—
	thermocouple nut T1: M8x1 T2: M18x1 aluminium		
	GEV No. 101246	Ref. No.	—
	olive for pipe ø 4mm Qty 1 pcs		
	GEV No. 101460	Ref. No.	—
	O-ring ø 12.37mm D1 ø 2.62mm suitable for PEL22		
	GEV No. 101527	Ref. No.	—
	O-ring Viton thickness 1.78mm ID ø 6.75mm Qty 1 pcs		
	GEV No. 101594	Ref. No.	—
	adjusting screw for internal nozzle thread M10x0.75		
<b>accessories for</b>	101656		
	GEV No. 100909	Ref. No.	—
	union screw thread M10x1 for pipe ø 6mm Qty 1 pcs		
	GEV No. 100944	Ref. No.	—
	union nut thread M18x1.5 for pipe ø 12mm		
	GEV No. 101273	Ref. No.	—
	olive for pipe ø 12mm L 9.5mm brass Qty 1 pcs suitable for universal		

<b>accessories for</b>	101656		
	GEV No. 101286	Ref. No.	—
	olive ID ø 6mm Qty 1 pcs		
	GEV No. 110078	Ref. No.	—
	knob without symbol ø 70mm shaft ø 6x4.6mm shaft flat universal		
	GEV No. 112206	Ref. No.	—
	knob dial plate silver gas tap PEL21/22/23 t.max.°C ED ø 63mm ID ø 45.5mm		



<b>GEV No.</b>	101622	<b>Ref. No.</b>	170725 170726
<b>description</b>	gas tap alternatives to EGA type PEL22S with nozzle outlet (without nozzle) gas inlet M18x1.5 (tube ø 12mm) external nozzle ømm internal nozzle ømm bypass nozzle ø 0.35mm mixing pipe connection M22x1 thermocouple connection M8x1 pilot connection M10x1 shaft ø 6x4.6mm shaft L 35/21mm shaft flat upper		
<b>spare parts for</b>	101622		
	GEV No. 100259	Ref. No.	—
	bypass nozzle type PEL22 bore ø 0.35mm thread M6x0.5		
	GEV No. 100927	Ref. No.	—
	torsion spring L 2.8-8.0mm for internal nozzle ø 3mm bore ømm		
	GEV No. 101058	Ref. No.	—
	magnet unit L 39mm D1 ø 15.4mm D2 ø 13.5mm suitable for PEL22/ EGA24197 standard		
	GEV No. 101230	Ref. No.	—
	thermocouple nut T1: M8x1 T2: M18x1 aluminium		
	GEV No. 101460	Ref. No.	—
	O-ring ø 12.37mm D1 ø 2.62mm suitable for PEL22		
	GEV No. 101527	Ref. No.	—
	O-ring Viton thickness 1.78mm ID ø 6.75mm Qty 1 pcs		
	GEV No. 101594	Ref. No.	—
	adjusting screw for internal nozzle thread M10x0.75		
	GEV No. 101823	Ref. No.	—
	gas tap front part shaft ø 6x4.6mm shaft L 35/21mm shaft flat upper/ lower suitable for PEL22		
<b>accessories for</b>	101622		
	GEV No. 100908	Ref. No.	—
	union screw thread M10x1 for pipe ø 4mm Qty 1 pcs		
	GEV No. 100909	Ref. No.	—
	union screw thread M10x1 for pipe ø 6mm Qty 1 pcs		
	GEV No. 100944	Ref. No.	—
	union nut thread M18x1.5 for pipe ø 12mm		

Table continues overleaf



accessories for		101622		
GEV No.	Ref. No.	Ref. No.	Ref. No.	—
	101246			
olive for pipe ø 4mm Qty 1 pcs				
	101273			
olive for pipe ø 12mm L 9.5mm brass Qty 1 pcs suitable for universal				
	101286			
olive ID ø 6mm Qty 1 pcs				
	110078			
knob without symbol ø 70mm shaft ø 6x4.6mm shaft flat universal				
	112206			
knob dial plate silver gas tap PEL21/22/23 t.max.°C ED ø 63mm ID ø 45.5mm				

accessories for		101657		
GEV No.	Ref. No.	Ref. No.	Ref. No.	—
	100944			
union nut thread M18x1.5 for pipe ø 12mm				
	101246			
olive for pipe ø 4mm Qty 1 pcs				
	101273			
olive for pipe ø 12mm L 9.5mm brass Qty 1 pcs suitable for universal				
	101286			
olive ID ø 6mm Qty 1 pcs				
	110078			
knob without symbol ø 70mm shaft ø 6x4.6mm shaft flat universal				
	112206			
knob dial plate silver gas tap PEL21/22/23 t.max.°C ED ø 63mm ID ø 45.5mm				

with pipe outlet





GEV No.	Ref. No.	Ref. No.	Ref. No.	170730
<b>description</b>				
gas tap alternatives to EGA type GPEL22RD with pipe outlet with throttle screw gas inlet M18x1.5 (tube ø 12mm) bypass nozzle ø 0.5mm gas outlet M18x1.5 (tube ø 12mm) thermocouple connection M8x1 pilot connection M10x1 shaft ø 6x4.6mm shaft L 35/21mm shaft flat upper				
<b>For models:</b>				
GHN401, GHN601, GHN801, GPN402, GPP202, GWN101, GWN201, GWN202, NGH500, NGH503, NGH505, NGH720, NGH723, NGH725, NGH727, NGH730, NGH733, NGH737, PGH508				
<b>spare parts for</b>				
101657				
	100390			
bypass nozzle type PEL22 bore ø 0.5mm thread M6x0.5				
	101058			
magnet unit L 39mm D1 ø 15.4mm D2 ø 13.5mm suitable for PEL22/ EGA24197 standard				
	101230			
thermocouple nut T1: M8x1 T2: M18x1 aluminium				
	101460			
O-ring ø 12.37mm D1 ø 2.62mm suitable for PEL22				
	101527			
O-ring Viton thickness 1.78mm ID ø 6.75mm Qty 1 pcs				
	101553			
throttle screw thread M10x0.75				
<b>accessories for</b>				
101657				
	100908			
union screw thread M10x1 for pipe ø 4mm Qty 1 pcs				
	100909			
union screw thread M10x1 for pipe ø 6mm Qty 1 pcs				

JUNKERS



GEV No.	Ref. No.	Ref. No.	Ref. No.	177208
<b>description</b>				
gas tap JUNKERS type CH340 gas inlet 1/2" IT bypass nozzle ø 0.35mm gas outlet 1/2" ET thermocouple connection M10x1 pilot connection M10x1 shaft ø 10mm shaft L 20.7mm shaft flat				
<b>spare parts for</b>				
101169				
	101061			407090
magnet unit T1: M10x1 T2: M24x1 L 48mm ø 16mm suitable for JUNKERS CH330-340				
	345200			
microswitch with plunger				
<b>accessories for</b>				
101169				
	100945			
roll pin ø 3.2mm L 10mm				
	101218			
shaft extension JUNKERS				
	101219			752972000
shaft extension L 25mm JUNKERS				
	101284			114121
olive for pipe ø 4mm Qty 1 pcs				
	101285			
union screw thread M8x1 for pipe ø 4mm Qty 1 pcs JUNKERS				
	110064			
knob				

\*no longer available  
Table continues overleaf



<b>accessories for</b> 101169				
	GEV No.	110066	Ref. No.	133364
	knob screw			
	GEV No.	550396	Ref. No.	—
	shaft extension L 25mm JUNKERS			

**alternatives to JUNKERS**

				
<b>1</b>				
<b>GEV No.</b>	101630	<b>Ref. No.</b>	177208	
<b>description</b>	gas tap PEL type 23S/V gas inlet 1/2" IT bypass nozzle ø 0.35mm gas outlet 1/2" MT (tube ø 14mm) thermocouple connection M10x1 pilot connection M10x1 shaft ø 10mm shaft L 25mm shaft flat			
<b>For models:</b>	LGP400, LGS060, NGP400, NGP600, NGP900, NGS040, NGS060, NGS080, NGS100, NGS150			
<b>spare parts for</b> 101630				
	GEV No.	100455	Ref. No.	—
	bypass nozzle type PEL23/24 bore ø 0.35mm thread M8x0.5			
	GEV No.	101059	Ref. No.	—
	magnet unit T1: M10x1 T2: M22x1 L 46mm ø 18mm suitable for PEL23S M10x1			
	GEV No.	102767	Ref. No.	—
	gas tap front part shaft ø 10mm shaft L 26.5mm shaft flat suitable for PEL23S			
<b>accessories for</b> 101630				
	GEV No.	100908	Ref. No.	—
	union screw thread M10x1 for pipe ø 4mm Qty 1 pcs			
	GEV No.	100909	Ref. No.	—
	union screw thread M10x1 for pipe ø 6mm Qty 1 pcs			
	GEV No.	100945	Ref. No.	—
	roll pin ø 3.2mm L 10mm			
	GEV No.	101218	Ref. No.	—
	shaft extension JUNKERS			
	GEV No.	101219	Ref. No.	752972000
	shaft extension L 25mm JUNKERS			
	GEV No.	101246	Ref. No.	—
	olive for pipe ø 4mm Qty 1 pcs			
	GEV No.	101286	Ref. No.	—
	olive ID ø 6mm Qty 1 pcs			
	GEV No.	110064	Ref. No.	—
	knob			
	GEV No.	110066	Ref. No.	133364
	knob screw			

<b>accessories for</b> 101630				
	GEV No.	550396	Ref. No.	—
	shaft extension L 25mm JUNKERS			

**STN3R**

				
<b>1</b>				
<b>GEV No.</b>	106052	<b>Ref. No.</b>	150146	
<b>description</b>	gas tap STN3R gas inlet M20x1.5 (tube ø 12mm) bypass nozzle ø 0mm gas outlet M20x1.5 (tube ø 12mm) thermocouple connection M8x1 shaft ø 6x4.6mm shaft L 39/18mm shaft flat upper suitable for KÜPPERSBUSCH			
<b>For models:</b>	EGS060, FGH500, FGH507, PGH508			
<b>accessories for</b> 106052				
	GEV No.	101251	Ref. No.	—
	union nut thread M20x1.5 for pipe ø 12mm			
	GEV No.	101273	Ref. No.	—
	olive for pipe ø 12mm L 9.5mm brass Qty 1 pcs suitable for universal			









				
<b>1</b>				
<b>GEV No.</b>	106053	<b>Ref. No.</b>	150143	
<b>description</b>	gas tap STN3R gas inlet pipe flange ø23mm bypass nozzle ømm gas outlet M17x1 (tube ø 10mm) thermocouple connection M8x1 pilot connection M8x1 shaft ø 6x4.6mm shaft L 39/18mm shaft flat lower suitable for KÜPPERSBUSCH			
<b>For models:</b>	EGH210, EGH410, EGH413, EGH417, EGH610, EGH613, EGH617, FGH210, FGH410, FGH413, FGH415, FGH417, FGH610, FGH613, FGH615, FGH617, PGH218, PGH418, PGH618			



MADEC (MP)

with nozzle outlet



<b>GEV No.</b>	101632	<b>Ref. No.</b>	170881 406979
<b>description</b>	gas tap MADEC type 170881 with nozzle outlet (with nozzle) gas inlet M12x1 (tube ø 8mm) external nozzle ø 2.2mm internal nozzle ø 1.4mm bypass nozzle ø 0.7mm mixing pipe connection M17x1 thermocouple connection M8x1 front fixing M12x1 shaft ø 6x4.6mm shaft L 37/17mm shaft flat lower		
<b>For models:</b>	LGH405, LGH407, LGH605, LGH607		
<b>spare parts for</b>	101632		
	<b>GEV No.</b>	100293	<b>Ref. No.</b> —
	gas injector thread M12x1 WS 14 bore ø 2.20mm		
	<b>GEV No.</b>	100423	<b>Ref. No.</b> —
	internal nozzle MADEC bore ø 1.4mm		
	<b>GEV No.</b>	100427	<b>Ref. No.</b> —
	bypass nozzle MADEC bore ø 0.7mm thread M4.5x0.6		
	<b>GEV No.</b>	101051	<b>Ref. No.</b> 160860
	magnet unit L 27mm D1 ø 12.5mm D2 ø 8.5mm suitable for JUNKERS/EGA/MADEC/SABAF standard		
<b>accessories for</b>	101632		
	<b>GEV No.</b>	101277	<b>Ref. No.</b> —
	olive ID ø 8mm Qty 1 pcs		
	<b>GEV No.</b>	101296	<b>Ref. No.</b> —
	union nut thread M12x1 for pipe ø 8mm		
	<b>GEV No.</b>	101299	<b>Ref. No.</b> —
	nut thread M12x1		
	<b>GEV No.</b>	101400	<b>Ref. No.</b> —
	air mixing tube thread M17x1 suitable for L350, L700		
	<b>GEV No.</b>	110149	<b>Ref. No.</b> —
	knob gas tap without ignition flame t.max.°C temperature range°C ø 50mm shaft ø 6x4.6mm shaft flat right black		



<b>GEV No.</b>	101631	<b>Ref. No.</b>	170880 406980
<b>description</b>	gas tap MADEC with nozzle outlet (with nozzle) gas inlet M12x1 (tube ø 8mm) external nozzle ø 2.2mm internal nozzle ø 1.2mm bypass nozzle ø 0.55mm mixing pipe connection M17x1 thermocouple connection M8x1 front fixing M12x1 shaft ø 6x4.6mm shaft L 37/17mm shaft flat lower		
<b>For models:</b>	LGH405, LGH407, LGH605, LGH607		
<b>spare parts for</b>	101631		
	<b>GEV No.</b>	100293	<b>Ref. No.</b> —
	gas injector thread M12x1 WS 14 bore ø 2.20mm		
	<b>GEV No.</b>	100422	<b>Ref. No.</b> —
	internal nozzle MADEC bore ø 1.2mm		
	<b>GEV No.</b>	100426	<b>Ref. No.</b> —
	bypass nozzle MADEC bore ø 0.55mm thread M4.5x0.6		
	<b>GEV No.</b>	101051	<b>Ref. No.</b> 160860
	magnet unit L 27mm D1 ø 12.5mm D2 ø 8.5mm suitable for JUNKERS/EGA/MADEC/SABAF standard		
	<b>GEV No.</b>	101234	<b>Ref. No.</b> —
	union nut T1: M8x1 T2: M15		
<b>accessories for</b>	101631		
	<b>GEV No.</b>	100943	<b>Ref. No.</b> —
	union nut thread M17x1 tube ø 10mm		
	<b>GEV No.</b>	101277	<b>Ref. No.</b> —
	olive ID ø 8mm Qty 1 pcs		
	<b>GEV No.</b>	101296	<b>Ref. No.</b> —
	union nut thread M12x1 for pipe ø 8mm		
	<b>GEV No.</b>	101299	<b>Ref. No.</b> —
	nut thread M12x1		
	<b>GEV No.</b>	101394	<b>Ref. No.</b> —
	nut thread M17x1 H 3mm WS 19 brass Qty 1 pcs		
	<b>GEV No.</b>	101400	<b>Ref. No.</b> —
	air mixing tube thread M17x1 suitable for L350, L700		
	<b>GEV No.</b>	110149	<b>Ref. No.</b> —
	knob gas tap without ignition flame t.max.°C temperature range°C ø 50mm shaft ø 6x4.6mm shaft flat right black		

1 gas components





## EGA

### 26440 series

#### gas taps





1











<b>GEV No.</b>	101733	<b>Ref. No.</b>	151002
<b>description</b>	gas tap EGA type 26440 series		



1

<b>GEV No.</b>	101987	<b>Ref. No.</b>	170737
<b>description</b>	gas tap EGA type 26440 series		
<b>For models:</b>	LGB430, LGG420, NGB430, NGG420, NGW250, NGW450		
<b>spare parts for</b>	101987		
	<b>GEV No.</b>	101060	<b>Ref. No.</b> 407088
	magnet unit standard L 39mm D1 ø 15.4mm D2 ø 11mm suitable for PEL20-21/JUNKERS/EGA		
	<b>GEV No.</b>	101230	<b>Ref. No.</b> —
	thermocouple nut T1: M8x1 T2: M18x1 aluminium		
<b>accessories for</b>	101987		
	<b>GEV No.</b>	100926	<b>Ref. No.</b> —
	centring piece thread M17x1		
	<b>GEV No.</b>	100941	<b>Ref. No.</b> —
	union nut thread M15x1 for pipe ø 8mm		
	<b>GEV No.</b>	100942	<b>Ref. No.</b> —
	union nut thread M15x1 for pipe ø 10mm		
	<b>GEV No.</b>	100943	<b>Ref. No.</b> —
	union nut thread M17x1 tube ø 10mm		
	<b>GEV No.</b>	101277	<b>Ref. No.</b> —
	olive ID ø 8mm Qty 1 pcs		
	<b>GEV No.</b>	101278	<b>Ref. No.</b> 114101
	olive for pipe ø 10mm Qty 1 pcs		
	<b>GEV No.</b>	101284	<b>Ref. No.</b> 114121
	olive for pipe ø 4mm Qty 1 pcs		
	<b>GEV No.</b>	101285	<b>Ref. No.</b> —
	union screw thread M8x1 for pipe ø 4mm Qty 1 pcs JUNKERS		
	<b>GEV No.</b>	101383	<b>Ref. No.</b> —
	reducer ø 10/8mm		
	<b>GEV No.</b>	110078	<b>Ref. No.</b> —
	knob without symbol ø 70mm shaft ø 6x4.6mm shaft flat universal		











<b>accessories for</b>	101987		
	<b>GEV No.</b>	112206	<b>Ref. No.</b> —
	knob dial plate silver gas tap PEL21/22/23 t.max.°C ED ø 63mm ID ø 45.5mm		

	<b>GEV No.</b>	104260	<b>Ref. No.</b>	151001
<b>description</b>	gas tap EGA type 26440 series			
<b>For models:</b>	NGH410, NGH413, NGH415, NGH417, NGH610, NGH613, NGH615, NGH617			
<b>spare parts for</b>	104260			
	<b>GEV No.</b>	100346	<b>Ref. No.</b>	152681
	bypass nozzle EGA type 31248 series bore ø 0.85mm			
	<b>GEV No.</b>	100395	<b>Ref. No.</b>	152634
	internal nozzle bore ø 1.4mm suitable for EGA26400/26440			
	<b>GEV No.</b>	101060	<b>Ref. No.</b>	407088
	magnet unit standard L 39mm D1 ø 15.4mm D2 ø 11mm suitable for PEL20-21/JUNKERS/EGA			
	<b>GEV No.</b>	101230	<b>Ref. No.</b>	—
	thermocouple nut T1: M8x1 T2: M18x1 aluminium			
<b>accessories for</b>	104260			
	<b>GEV No.</b>	100942	<b>Ref. No.</b>	—
	union nut thread M15x1 for pipe ø 10mm			
	<b>GEV No.</b>	101278	<b>Ref. No.</b>	114101
	olive for pipe ø 10mm Qty 1 pcs			
	<b>GEV No.</b>	101284	<b>Ref. No.</b>	114121
	olive for pipe ø 4mm Qty 1 pcs			
	<b>GEV No.</b>	101285	<b>Ref. No.</b>	—
	union screw thread M8x1 for pipe ø 4mm Qty 1 pcs JUNKERS			
	<b>GEV No.</b>	110078	<b>Ref. No.</b>	—
	knob without symbol ø 70mm shaft ø 6x4.6mm shaft flat universal			
	<b>GEV No.</b>	112206	<b>Ref. No.</b>	—
	knob dial plate silver gas tap PEL21/22/23 t.max.°C ED ø 63mm ID ø 45.5mm			



gas thermostats

MERTIK

			
1			
<b>GEV No.</b>	101786	<b>Ref. No.</b>	152423
<b>description</b>	gas thermostat MERTIK t.max. 110°C 30-110°C gas inlet bottom 3/8" gas inlet lateral 3/8" gas outlet bottom 3/8" gas outlet lateral 3/8" thermocouple connection M10x1 capillary pipe 720mm probe ø 6mm probe L 80mm bain marie		
<b>For models:</b>	FGW250, PGW458		
<b>spare parts for</b>	101786		
	<b>GEV No.</b>	106221	<b>Ref. No.</b> —
	magnet unit L 32mm D1 ø 19mm D2 ø 14mm suitable for MERTIK		
<b>accessories for</b>	101786		
	<b>GEV No.</b>	100015	<b>Ref. No.</b> —
	ignition cable cable length 600mm connection ø2.4mm / ø2.4mm		
	<b>GEV No.</b>	100018	<b>Ref. No.</b> —
	ignition cable cable length 600mm connection ø2.4mm / ø4mm permanent temperature 200°C		
	<b>GEV No.</b>	100179	<b>Ref. No.</b> —
	ignition cable cable length 1200mm connection F2.8mm / ø2.4mm		
	<b>GEV No.</b>	100193	<b>Ref. No.</b> —
	ignition cable cable length 1200mm connection ø2.4mm / ø4mm		
	<b>GEV No.</b>	100197	<b>Ref. No.</b> —
	ignition cable cable length 600mm connection F2.8mm / ø2.4mm		
	<b>GEV No.</b>	100904	<b>Ref. No.</b> 178462
	locking screw M10x1 for pipe ø 4mm Qty 1 pcs		
	<b>GEV No.</b>	101273	<b>Ref. No.</b> —
	olive for pipe ø 12mm L 9.5mm brass Qty 1 pcs suitable for universal		
	<b>GEV No.</b>	101276	<b>Ref. No.</b> —
	union screw thread 3/8" tube ø 12mm Qty 1 pcs		
	<b>GEV No.</b>	102180	<b>Ref. No.</b> —
	ignition cable cable length 1200mm connection ø2.4mm / ø2.4mm		
	<b>GEV No.</b>	106701	<b>Ref. No.</b> —
	knob adapter thickness 14mm ED ø 26mm shaft 8x6.5mm plastic		
	<b>GEV No.</b>	106702	<b>Ref. No.</b> —
	plug thread 3/8" with O-ring L 12mm WS 8 brass suitable for MERTIK		
	<b>GEV No.</b>	106719	<b>Ref. No.</b> —
	union screw for gas thermostat MERTIK M10x1 for thermocouple ET M22x1		
	<b>GEV No.</b>	112387	<b>Ref. No.</b> —
	knob dial plate universal red		

<b>accessories for</b>	101786		
	<b>GEV No.</b>	112388	<b>Ref. No.</b> —
	knob dial plate universal silver		
	<b>GEV No.</b>	112598	<b>Ref. No.</b> —
	knob dial plate MERTIK gas regulator (piezoelectric igniter) silver		
	<b>GEV No.</b>	112599	<b>Ref. No.</b> —
	knob dial plate MERTIK gas regulator (piezoelectric igniter) red		
	<b>GEV No.</b>	112601	<b>Ref. No.</b> —
	knob dial plate silver gas thermostat MERTIK 1-8 t.max.°C ED ø 59mm ID ø 45.5mm		
	<b>GEV No.</b>	112602	<b>Ref. No.</b> —
	knob dial plate red gas thermostat MERTIK 1-8 t.max.°C ED ø 59mm ID ø 45.5mm		
	<b>GEV No.</b>	112949	<b>Ref. No.</b> —
	knob MERTIK gas regulator ø 62mm shaft flat upper black special fixing shaft 8x6.5		
	<b>GEV No.</b>	112950	<b>Ref. No.</b> —
	knob MERTIK gas regulator ø 32mm black for piezoelectric igniter		













































			
1			
<b>GEV No.</b>	101746	<b>Ref. No.</b>	152421
<b>description</b>	gas thermostat MERTIK t.max. 195°C 100-195°C gas inlet bottom 3/8" gas inlet lateral 3/8" gas outlet bottom 3/8" gas outlet lateral 3/8" capillary pipe 720mm probe ø 6mm probe L 70mm gland nut 1/4" fryer		
<b>For models:</b>	PGF148, PGF228		
<b>spare parts for</b>	101746		
	<b>GEV No.</b>	106221	<b>Ref. No.</b> —
	magnet unit L 32mm D1 ø 19mm D2 ø 14mm suitable for MERTIK		
<b>accessories for</b>	101746		
	<b>GEV No.</b>	100015	<b>Ref. No.</b> —
	ignition cable cable length 600mm connection ø2.4mm / ø2.4mm		
	<b>GEV No.</b>	100018	<b>Ref. No.</b> —
	ignition cable cable length 600mm connection ø2.4mm / ø4mm permanent temperature 200°C		
	<b>GEV No.</b>	100179	<b>Ref. No.</b> —
	ignition cable cable length 1200mm connection F2.8mm / ø2.4mm		
	<b>GEV No.</b>	100193	<b>Ref. No.</b> —
	ignition cable cable length 1200mm connection ø2.4mm / ø4mm		
	<b>GEV No.</b>	100197	<b>Ref. No.</b> —
	ignition cable cable length 600mm connection F2.8mm / ø2.4mm		
	<b>GEV No.</b>	100904	<b>Ref. No.</b> 178462
	locking screw M10x1 for pipe ø 4mm Qty 1 pcs		















Table continues overleaf







accessories for		101746		
	GEV No.	101273	Ref. No.	—
olive for pipe ø 12mm L 9.5mm brass Qty 1 pcs suitable for universal				
	GEV No.	101276	Ref. No.	—
union screw thread 3/8" tube ø 12mm Qty 1 pcs				
	GEV No.	102180	Ref. No.	—
ignition cable cable length 1200mm connection ø2.4mm / ø2.4mm				
	GEV No.	106701	Ref. No.	—
knob adapter thickness 14mm ED ø 26mm shaft 8x6.5mm plastic				
	GEV No.	106702	Ref. No.	—
plug thread 3/8" with O-ring L 12mm WS 8 brass suitable for MERTIK				
	GEV No.	106719	Ref. No.	—
union screw for gas thermostat MERTIK M10x1 for thermocouple ET M22x1				
	GEV No.	112387	Ref. No.	—
knob dial plate universal red				
	GEV No.	112388	Ref. No.	—
knob dial plate universal silver				
	GEV No.	112598	Ref. No.	—
knob dial plate MERTIK gas regulator (piezoelectric igniter) silver				
	GEV No.	112599	Ref. No.	—
knob dial plate MERTIK gas regulator (piezoelectric igniter) red				
	GEV No.	112601	Ref. No.	—
knob dial plate silver gas thermostat MERTIK 1-8 t.max.°C ED ø 59mm ID ø 45.5mm				
	GEV No.	112602	Ref. No.	—
knob dial plate red gas thermostat MERTIK 1-8 t.max.°C ED ø 59mm ID ø 45.5mm				
	GEV No.	112949	Ref. No.	—
knob MERTIK gas regulator ø 62mm shaft flat upper black special fixing shaft 8x6.5				
	GEV No.	112950	Ref. No.	—
knob MERTIK gas regulator ø 32mm black for piezoelectric igniter				

			
<b>GEV No.</b>	106222	<b>Ref. No.</b>	152429
<b>description</b>	gas thermostat MERTIK t.max. 195°C 100-195°C gas inlet bottom 3/8" gas inlet lateral 3/8" gas outlet bottom 3/8" gas outlet lateral 3/8" thermocouple connection M10x1 capillary pipe 720mm probe ø 6mm probe L 70mm gland nut 1/4"		
<b>For models:</b>	EGF124, EGF224		
<b>spare parts for</b>	106222		
	GEV No.	106221	Ref. No.
magnet unit L 32mm D1 ø 19mm D2 ø 14mm suitable for MERTIK			

accessories for		106222		
	GEV No.	100015	Ref. No.	—
ignition cable cable length 600mm connection ø2.4mm / ø2.4mm				
	GEV No.	100018	Ref. No.	—
ignition cable cable length 600mm connection ø2.4mm / ø4mm permanent temperature 200°C				
	GEV No.	100179	Ref. No.	—
ignition cable cable length 1200mm connection F2.8mm / ø2.4mm				
	GEV No.	100193	Ref. No.	—
ignition cable cable length 1200mm connection ø2.4mm / ø4mm				
	GEV No.	100197	Ref. No.	—
ignition cable cable length 600mm connection F2.8mm / ø2.4mm				
	GEV No.	100904	Ref. No.	178462
locking screw M10x1 for pipe ø 4mm Qty 1 pcs				
	GEV No.	101273	Ref. No.	—
olive for pipe ø 12mm L 9.5mm brass Qty 1 pcs suitable for universal				
	GEV No.	101276	Ref. No.	—
union screw thread 3/8" tube ø 12mm Qty 1 pcs				
	GEV No.	102180	Ref. No.	—
ignition cable cable length 1200mm connection ø2.4mm / ø2.4mm				
	GEV No.	106701	Ref. No.	—
knob adapter thickness 14mm ED ø 26mm shaft 8x6.5mm plastic				
	GEV No.	106702	Ref. No.	—
plug thread 3/8" with O-ring L 12mm WS 8 brass suitable for MERTIK				
	GEV No.	106719	Ref. No.	—
union screw for gas thermostat MERTIK M10x1 for thermocouple ET M22x1				
	GEV No.	112387	Ref. No.	—
knob dial plate universal red				
	GEV No.	112388	Ref. No.	—
knob dial plate universal silver				
	GEV No.	112598	Ref. No.	—
knob dial plate MERTIK gas regulator (piezoelectric igniter) silver				
	GEV No.	112599	Ref. No.	—
knob dial plate MERTIK gas regulator (piezoelectric igniter) red				
	GEV No.	112601	Ref. No.	—
knob dial plate silver gas thermostat MERTIK 1-8 t.max.°C ED ø 59mm ID ø 45.5mm				
	GEV No.	112602	Ref. No.	—
knob dial plate red gas thermostat MERTIK 1-8 t.max.°C ED ø 59mm ID ø 45.5mm				
	GEV No.	112949	Ref. No.	—
knob MERTIK gas regulator ø 62mm shaft flat upper black special fixing shaft 8x6.5				
	GEV No.	112950	Ref. No.	—
knob MERTIK gas regulator ø 32mm black for piezoelectric igniter				



			
<b>GEV No.</b>	101745	<b>Ref. No.</b>	152430
<b>description</b>	gas thermostat MERTIK t.max. 340°C 100-340°C gas inlet bottom 3/8" gas inlet lateral 3/8" gas outlet bottom 3/8" gas outlet lateral 3/8" thermocouple connection M10x1 capillary pipe 720mm probe Ø 4mm probe L 68mm griddle		
<b>For models:</b>	FGH417, FGH507, FGH617, PGB438		
<b>spare parts for</b>	101745		
	<b>GEV No.</b>	106221	<b>Ref. No.</b> —
	magnet unit L 32mm D1 Ø 19mm D2 Ø 14mm suitable for MERTIK		
<b>accessories for</b>	101745		
	<b>GEV No.</b>	100015	<b>Ref. No.</b> —
	ignition cable cable length 600mm connection Ø2.4mm / Ø2.4mm		
	<b>GEV No.</b>	100018	<b>Ref. No.</b> —
	ignition cable cable length 600mm connection Ø2.4mm / Ø4mm permanent temperature 200°C		
	<b>GEV No.</b>	100179	<b>Ref. No.</b> —
	ignition cable cable length 1200mm connection F2.8mm / Ø2.4mm		
	<b>GEV No.</b>	100193	<b>Ref. No.</b> —
	ignition cable cable length 1200mm connection Ø2.4mm / Ø4mm		
	<b>GEV No.</b>	100197	<b>Ref. No.</b> —
	ignition cable cable length 600mm connection F2.8mm / Ø2.4mm		
	<b>GEV No.</b>	100904	<b>Ref. No.</b> 178462
	locking screw M10x1 for pipe Ø 4mm Qty 1 pcs		
	<b>GEV No.</b>	101273	<b>Ref. No.</b> —
	olive for pipe Ø 12mm L 9.5mm brass Qty 1 pcs suitable for universal		
	<b>GEV No.</b>	101276	<b>Ref. No.</b> —
	union screw thread 3/8" tube Ø 12mm Qty 1 pcs		
	<b>GEV No.</b>	102180	<b>Ref. No.</b> —
	ignition cable cable length 1200mm connection Ø2.4mm / Ø2.4mm		
	<b>GEV No.</b>	106701	<b>Ref. No.</b> —
	knob adapter thickness 14mm ED Ø 26mm shaft 8x6.5mm plastic		
	<b>GEV No.</b>	106702	<b>Ref. No.</b> —
	plug thread 3/8" with O-ring L 12mm WS 8 brass suitable for MERTIK		
	<b>GEV No.</b>	106719	<b>Ref. No.</b> —
	union screw for gas thermostat MERTIK M10x1 for thermocouple ET M22x1		
	<b>GEV No.</b>	112387	<b>Ref. No.</b> —
	knob dial plate universal red		

<b>accessories for</b>	101745		
	<b>GEV No.</b>	112388	<b>Ref. No.</b> —
	knob dial plate universal silver		
	<b>GEV No.</b>	112598	<b>Ref. No.</b> —
	knob dial plate MERTIK gas regulator (piezoelectric igniter) silver		
	<b>GEV No.</b>	112599	<b>Ref. No.</b> —
	knob dial plate MERTIK gas regulator (piezoelectric igniter) red		
	<b>GEV No.</b>	112601	<b>Ref. No.</b> —
	knob dial plate silver gas thermostat MERTIK 1-8 t.max.°C ED Ø 59mm ID Ø 45.5mm		
	<b>GEV No.</b>	112602	<b>Ref. No.</b> —
	knob dial plate red gas thermostat MERTIK 1-8 t.max.°C ED Ø 59mm ID Ø 45.5mm		
	<b>GEV No.</b>	112949	<b>Ref. No.</b> —
	knob MERTIK gas regulator Ø 62mm shaft flat upper black special fixing shaft 8x6.5		
	<b>GEV No.</b>	112950	<b>Ref. No.</b> —
	knob MERTIK gas regulator Ø 32mm black for piezoelectric igniter		







			
<b>GEV No.</b>	101744	<b>Ref. No.</b>	152453
<b>description</b>	gas thermostat MERTIK t.max. 340°C 100-340°C gas inlet bottom 3/8" gas inlet lateral 3/8" gas outlet bottom 3/8" gas outlet lateral 3/8" thermocouple connection M10x1 pilot connection M10x1 capillary pipe 730mm probe Ø 4mm probe L 66mm cable length 1300mm with union screws and olives oven		
<b>For models:</b>	EGB230, EGB430, EGH417, EGH617, NGH417, NGH507, NGH617, NGH737, NGP600, NGP900		
<b>spare parts for</b>	101744		
	<b>GEV No.</b>	106221	<b>Ref. No.</b> —
	magnet unit L 32mm D1 Ø 19mm D2 Ø 14mm suitable for MERTIK		
<b>accessories for</b>	101744		
	<b>GEV No.</b>	100015	<b>Ref. No.</b> —
	ignition cable cable length 600mm connection Ø2.4mm / Ø2.4mm		
	<b>GEV No.</b>	100018	<b>Ref. No.</b> —
	ignition cable cable length 600mm connection Ø2.4mm / Ø4mm permanent temperature 200°C		
	<b>GEV No.</b>	100179	<b>Ref. No.</b> —
	ignition cable cable length 1200mm connection F2.8mm / Ø2.4mm		
	<b>GEV No.</b>	100193	<b>Ref. No.</b> —
	ignition cable cable length 1200mm connection Ø2.4mm / Ø4mm		
	<b>GEV No.</b>	100197	<b>Ref. No.</b> —
	ignition cable cable length 600mm connection F2.8mm / Ø2.4mm		

Table continues overleaf





accessories for		101744	
	GEV No.	100904	Ref. No. 178462
locking screw M10x1 for pipe ø 4mm Qty 1 pcs			
	GEV No.	101273	Ref. No. —
olive for pipe ø 12mm L 9.5mm brass Qty 1 pcs suitable for universal			
	GEV No.	101276	Ref. No. —
union screw thread 3/8" tube ø 12mm Qty 1 pcs			
	GEV No.	102180	Ref. No. —
ignition cable cable length 1200mm connection ø2.4mm / ø2.4mm			
	GEV No.	106701	Ref. No. —
knob adapter thickness 14mm ED ø 26mm shaft 8x6.5mm plastic			
	GEV No.	106702	Ref. No. —
plug thread 3/8" with O-ring L 12mm WS 8 brass suitable for MERTIK			
	GEV No.	106719	Ref. No. —
union screw for gas thermostat MERTIK M10x1 for thermocouple ET M22x1			
	GEV No.	112387	Ref. No. —
knob dial plate universal red			
	GEV No.	112388	Ref. No. —
knob dial plate universal silver			
	GEV No.	112598	Ref. No. —
knob dial plate MERTIK gas regulator (piezoelectric igniter) silver			
	GEV No.	112599	Ref. No. —
knob dial plate MERTIK gas regulator (piezoelectric igniter) red			
	GEV No.	112601	Ref. No. —
knob dial plate silver gas thermostat MERTIK 1-8 t.max.°C ED ø 59mm ID ø 45.5mm			
	GEV No.	112602	Ref. No. —
knob dial plate red gas thermostat MERTIK 1-8 t.max.°C ED ø 59mm ID ø 45.5mm			
	GEV No.	112949	Ref. No. —
knob MERTIK gas regulator ø 62mm shaft flat upper black special fixing shaft 8x6.5			
	GEV No.	112950	Ref. No. —
knob MERTIK gas regulator ø 32mm black for piezoelectric igniter			

**PEL**

**24STS series**





GEV No.		106027		Ref. No.		540403	
<b>description</b>							
gas thermostat PEL type 24STS 100-300°C gas inlet M20x1.5 (tube ø 12/10mm) bypass nozzle ø 0mm gas outlet M20x1.5 (tube ø 12/10mm) thermocouple connection M9x1 pilot connection M10x1 capillary pipe 1200mm probe ø 6mm probe L 100mm shaft ø 10x8mm shaft L 27/17mm shaft flat upper t.max. 300°C							
<b>spare parts for</b>							
106027							
	GEV No.	100455	Ref. No.	—			
bypass nozzle type PEL23/24 bore ø 0.35mm thread M8x0.5							
	GEV No.	101058	Ref. No.	—			
magnet unit L 39mm D1 ø 15.4mm D2 ø 13.5mm suitable for PEL22/ EGA24197 standard							
<b>accessories for</b>							
106027							
	GEV No.	101235	Ref. No.	—			
gas connection thread M20x1.5 tube ø 12/10mm for PEL gas taps horizontal							
	GEV No.	101236	Ref. No.	—			
gas connection thread M20x1.5 tube ø 12/10mm for PEL gas taps vertical							
	GEV No.	101240	Ref. No.	—			
gas connection thread M20x1.5 tube ø 12/10mm for PEL gas taps with gasket and screws horizontal							
	GEV No.	101241	Ref. No.	—			
gas connection thread M20x1.5 tube ø 12/10mm for PEL gas taps vertical							
	GEV No.	101248	Ref. No.	—			
olive for pipe ø 12mm Qty 1 pcs suitable for PEL							
	GEV No.	101249	Ref. No.	—			
olive for pipe ø 10mm Qty 1 pcs							
	GEV No.	101250	Ref. No.	—			
union nut thread M20x1.5 for pipe ø 10mm							
	GEV No.	101251	Ref. No.	—			
union nut thread M20x1.5 for pipe ø 12mm							
	GEV No.	101356	Ref. No.	—			
gas tap PEL type 21S gas inlet M16x1.5 (tube ø 10mm) bypass nozzle ø 0.35mm gas outlet M16x1.5 (tube ø 10/8mm) thermocouple connection M10x1 pilot connection M10x1 shaft ø 8x6.5mm shaft L 22/15mm shaft flat lower							
	GEV No.	101460	Ref. No.	—			
O-ring ø 12.37mm D1 ø 2.62mm suitable for PEL22							
	GEV No.	101461	Ref. No.	—			
screw kit suitable for PEL22 Qty 4 pcs							

Table continues overleaf





<b>accessories for</b>	106027			
	GEV No.	106165	Ref. No.	—
	gasket ø 27mm			
	GEV No.	110079	Ref. No.	—
	knob dial plate gas thermostat 1-8 silver			
	GEV No.	110080	Ref. No.	—
	knob ø 70mm shaft ø 10x8mm shaft flat universal			

## gas valves and ignition boxes

### gas control valves

#### HONEYWELL

	1			
<b>GEV No.</b>	102320	<b>Ref. No.</b>	151605	
<b>description</b>	gas valve type VK4105Q 220-240V 50/60Hz gas inlet flange 32x32mm gas outlet flange 32x32mm thermocouple connection pilot connection pressure range 15-60mbar max 60mbar operator type HONEYWELL coil type 220/240V (V4336A 2212 1) flange 32x32mm			
<b>For models:</b>	PGP608, PGP618, PGP908, PGP918			
<b>accessories for</b>	102320			
	GEV No.	102845	Ref. No.	—
	gas connection angled 1/2" flange 32x32mm hole distance 24x24mm Tandem			
	GEV No.	102846	Ref. No.	—
	gas connection straight 1/2" flange 32x32mm hole distance 24x24mm suitable for Tandem			

#### ROBERTSHAW

#### electric controlled valves

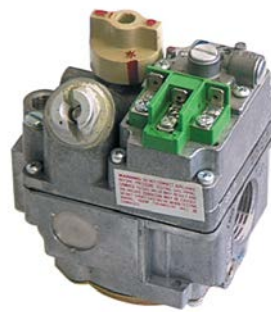

	1			
<b>GEV No.</b>	101388	<b>Ref. No.</b>	173242	
<b>description</b>	gas valve supply 220-240VAC supplyVDC 50/60Hz gas inlet 3/4" NPT gas outlet 3/4" NPT thermocouple connection 11/32" pilot connection 1/4" CCT type U7000ER-240--S7CL/s pressure controller natural gas 6.7" W.C. suitable for ROBERTSHAW			
<b>For models:</b>	NGR150, NGR250, NGR300, NGR400			
<b>spare parts for</b>	101388			
	GEV No.	101047	Ref. No.	—
	magnet unit T1: ASA 11/32 T2: M24x1 L 59mm ø 4mm suitable for ROBERTSHAW			
	GEV No.	580033	Ref. No.	—
	knob suitable for ROBERTSHAW			
<b>accessories for</b>	101388			
	GEV No.	102122	Ref. No.	—
	thermocouple ROBERTSHAW ASA 11/32 L 18" - 455mm 7/16"			
	GEV No.	102277	Ref. No.	—
	thermocouple ROBERTSHAW ASA 11/32 L 36" - 915mm 7/16"			

#### SIT

#### ELETTROSIT











	1			
<b>GEV No.</b>	101518	<b>Ref. No.</b>	173243	
<b>description</b>	gas valve SIT type ELETTROSIT 230V gas inlet 3/4" gas outlet 3/4" thermocouple connection ASA 11/32 pilot connection M10x1 lateral equiv. no. 0.810.200			
<b>For models:</b>	CBG110, CBG120, CGD110, CGD120, NGR150, NGR250, NGR300, NGR400, NGS040, NGS060, NGS080, NGS100, NGS150			
<b>spare parts for</b>	101518			
	GEV No.	100006	Ref. No.	—
	piezoelectric igniter suitable for ELETTROSIT body plastic blowing connection ø2.4mm ø 14mm			



Table continues overleaf



spare parts for		101518		
	GEV No.	101312	Ref. No.	—
	microswitch			
	GEV No.	101352	Ref. No.	—
	solenoid coil 230V 50Hz suitable for ELETTROSIT			
accessories for		101518		
	GEV No.	100905	Ref. No.	—
	locking screw M10x1 for pipe ø 6mm Qty 1 pcs			
	GEV No.	101301	Ref. No.	—
	gas connection thread 1/2" straight ELETTROSIT screw with O-ring			
	GEV No.	101303	Ref. No.	—
	gas connection straight thread 3/4" ELETTROSIT			
	GEV No.	101309	Ref. No.	—
	extension			

## TANDEM

				
1				
<b>GEV No.</b>	101985	<b>Ref. No.</b>	150126	
<b>description</b>	gas valve pilot connection M10x1 pressure range 6-50mbar power supply for modulator 230VAC rectified type 836021 series Tandem			
<b>For models:</b>	EGP500, FGR150, FGR250, FGR300, FGR400, FGS040, FGS060, FGS080, FGS100, FGS150, PGS048, PGS068, PGS088			
spare parts for		101985		
	GEV No.	101379	Ref. No.	—
	solenoid coil 230V 50Hz suitable for Tandem			
accessories for		101985		
	GEV No.	100904	Ref. No.	178462
	locking screw M10x1 for pipe ø 4mm Qty 1 pcs			
	GEV No.	100905	Ref. No.	—
	locking screw M10x1 for pipe ø 6mm Qty 1 pcs			
	GEV No.	101274	Ref. No.	—
	olive for pipe ø 16mm Qty 1 pcs			
	GEV No.	101275	Ref. No.	—
	union screw thread 1/2" for pipe ø 16mm Qty 1 pcs			
	GEV No.	101925	Ref. No.	—
	plug with O-ring thread M10x1 for pilot burner suitable for NOVASIT			
	GEV No.	102845	Ref. No.	—
	gas connection angled 1/2" flange 32x32mm hole distance 24x24mm Tandem			

accessories for		101985		
	GEV No.	102846	Ref. No.	—
	gas connection straight 1/2" flange 32x32mm hole distance 24x24mm suitable for Tandem			
	GEV No.	102847	Ref. No.	—
	O-ring			

## ignition boxes

### HONEYWELL

				
1				
<b>GEV No.</b>	101166	<b>Ref. No.</b>	540409	
<b>description</b>	ignition box HONEYWELL type S4560B 1006 electrodes 1 waiting time 0s safety time 10s 220-240V 10VA 50Hz			

				
1				
<b>GEV No.</b>	102318	<b>Ref. No.</b>	164844	
<b>description</b>	ignition box HONEYWELL type S4565AF 1007V01 electrodes 2 waiting times safety time 10s 220-240V 4VA 50/60Hz			
<b>For models:</b>	PGP608, PGP618, PGP908, PGP918			

				
1				
<b>GEV No.</b>	106639	<b>Ref. No.</b>	540353	
<b>description</b>	ignition box HONEYWELL type S4565P 2024 electrodes 2 waiting times safety time 25s 220-240V 4VA 50/60Hz			



SIT



1

<b>GEV No.</b>	101683	<b>Ref. No.</b>	164859
<b>description</b>	ignition box SIT type 503EFD electrodes 2 waiting time 1.5s safety time 10s 220/240V 7VA 50-60Hz		
<b>For models:</b>	EGP500, FGR150, FGR250, FGR300, FGR400, FGS040, FGS060, FGS080, FGS100, FGS150, PGS048, PGS068, PGS088		

gas solenoid valves

DUNGS



1

<b>GEV No.</b>	106965	<b>Ref. No.</b>	173142
<b>description</b>	gas valve 230VAC DN 20mm connection 3/4" L 100mm DUNGS p max 0.36bar type MVD207/5 50/60Hz		
<b>For models:</b>	CBG110, CBG120, CGD110, CGD120, EGS060, NGS040, NGS060, NGS080, NGS100, NGS150		

KROMSCHRÖDER



1

<b>GEV No.</b>	101986	<b>Ref. No.</b>	173142 (alt)
<b>description</b>	solenoid valve 230V		

ignition parts













pilot burners

SIT

140 - 145 -150 series



1

<b>GEV No.</b>	102831	<b>Ref. No.</b>	540450	
<b>description</b>	pilot burner SIT type 140 series 2 flames nozzle ømm gas connectionmm			
<b>spare parts for</b>	102831			
	<b>GEV No.</b>	100701	<b>Ref. No.</b>	—
	ignition electrode connection M4 Qty 1 pcs			
	<b>GEV No.</b>	100906	<b>Ref. No.</b>	—
	screw connection thread M10x1 for ignition electrode brass Qty 1 pcs WS 10			
	<b>GEV No.</b>	100907	<b>Ref. No.</b>	—
	screw connection thread M10x1 Qty 1 pcs type SEF 1 ømm for thermocouple			
<b>accessories for</b>	102831			
	<b>GEV No.</b>	100204	<b>Ref. No.</b>	—
	pilot burner nozzle SIT LPG code 14 bore ø 0.18/0.20mm Qty 1 pcs suitable for 140 series			
	<b>GEV No.</b>	100205	<b>Ref. No.</b>	—
	pilot burner nozzle SIT LPG code 19 bore ø 0.23/0.26mm Qty 1 pcs suitable for SIT 150 series			
	<b>GEV No.</b>	100206	<b>Ref. No.</b>	—
	pilot burner nozzle SIT natural gas code 36 bore ø 0.60/0.55mm Qty 1 pcs suitable for SIT 150 series			
	<b>GEV No.</b>	100207	<b>Ref. No.</b>	—
	pilot burner nozzle SIT natural gas code 27 bore ø 0.40/0.38mm suitable for SIT 140 series			
	<b>GEV No.</b>	100216	<b>Ref. No.</b>	—
	pilot burner nozzle SIT natural gas code 38 bore ø 0.45mm Qty 1 pcs suitable for SIT 150 series			
	<b>GEV No.</b>	100897	<b>Ref. No.</b>	—
	olive for pipe ø 4mm Qty 1 pcs for pilot burner			
	<b>GEV No.</b>	100898	<b>Ref. No.</b>	—
	olive for pipe ø 6mm Qty 1 pcs for pilot burner			
	<b>GEV No.</b>	100908	<b>Ref. No.</b>	—
	union screw thread M10x1 for pipe ø 4mm Qty 1 pcs			
	<b>GEV No.</b>	100909	<b>Ref. No.</b>	—
	union screw thread M10x1 for pipe ø 6mm Qty 1 pcs			

**JUNKERS**

**CB 502 series**

**pilot burners**

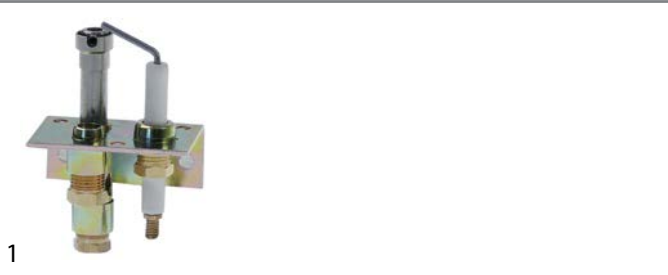



<b>GEV No.</b>	100062	<b>Ref. No.</b>	270503 356180
----------------	--------	-----------------	------------------

**description** pilot burner JUNKERS type CB502021 natural gas nozzle no.6 gas connection 6mm with primary air

**For models:** GWN101, GWN201

**spare parts for** 100062

	<b>GEV No.</b>	100227	<b>Ref. No.</b>	—
pilot burner nozzle natural gas gas pressure 25mbar code 6 Qty 1 pcs suitable for JUNKERS CB50203_				

	<b>GEV No.</b>	100719	<b>Ref. No.</b>	—
ignition electrode D1 ø 7mm D2 ø 9mm connection M4 L1 12mm L2 17mm BL1 18mm BL2 3mm BL3 23mm				

	<b>GEV No.</b>	100907	<b>Ref. No.</b>	—
screw connection thread M10x1 Qty 1 pcs type SEF 1 ømm for thermocouple				

	<b>GEV No.</b>	100909	<b>Ref. No.</b>	—
union screw thread M10x1 for pipe ø 6mm Qty 1 pcs				

	<b>GEV No.</b>	101287	<b>Ref. No.</b>	—
olive for pipe ø 6mm Qty 1 pcs				

	<b>GEV No.</b>	101291	<b>Ref. No.</b>	—
screw connection for igniter				

**accessories for** 100062

	<b>GEV No.</b>	100220	<b>Ref. No.</b>	161141
pilot burner nozzle LPG gas pressure 50mbar code 2 Qty 1 pcs suitable for JUNKERS CB503_				

	<b>GEV No.</b>	100221	<b>Ref. No.</b>	—
pilot burner nozzle LPG gas pressure 30mbar code 29 Qty 1 pcs suitable for JUNKERS CB50203_				

	<b>GEV No.</b>	100222	<b>Ref. No.</b>	161149
pilot burner nozzle LPG gas pressure 50mbar code 5 Qty 1 pcs suitable for JUNKERS CB50203_				

	<b>GEV No.</b>	100223	<b>Ref. No.</b>	161140
pilot burner nozzle natural gas gas pressure 20mbar code 3 Qty 1 pcs suitable for JUNKERS CB503_				

	<b>GEV No.</b>	100224	<b>Ref. No.</b>	—
pilot burner nozzle natural gas gas pressure 25mbar code 26 Qty 1 pcs suitable for JUNKERS CB503_				

	<b>GEV No.</b>	100225	<b>Ref. No.</b>	—
pilot burner nozzle LPG gas pressure 30mbar code 39 Qty 1 pcs suitable for JUNKERS CB503_				

	<b>GEV No.</b>	100226	<b>Ref. No.</b>	—
pilot burner nozzle LPG gas pressure 50mbar code 15 suitable for JUNKERS				

	<b>GEV No.</b>	100228	<b>Ref. No.</b>	—
pilot burner nozzle town gas gas pressure 8mbar code 4 Qty 1 pcs suitable for JUNKERS CB50203_				

**accessories for** 100062

	<b>GEV No.</b>	101281	<b>Ref. No.</b>	—
olive for pipe ø 4mm L 8.7mm Qty 1 pcs suitable for CB 502/503				

	<b>GEV No.</b>	101283	<b>Ref. No.</b>	—
union screw thread M10x1 for pipe ø 4mm Qty 1 pcs				

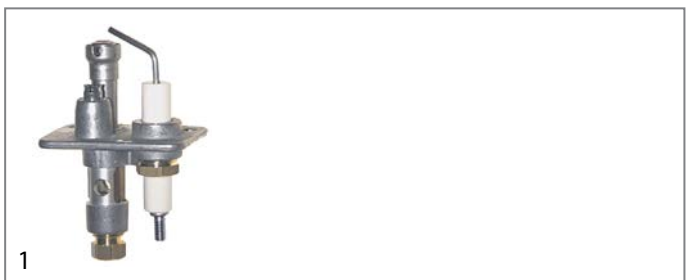



<b>GEV No.</b>	100085	<b>Ref. No.</b>	161134 161149 161234
----------------	--------	-----------------	----------------------------

**description** pilot burner JUNKERS type CB502031 natural gas nozzle no.6 gas connection 6mm with primary air

**For models:** CBG110, CBG120, CGD110, CGD120, EGB230, EGB430, EGF124, EGF224, EGS060, FGH500, FGH507, FGW250, GPN402, GPP202, GWN101, GWN201, GWN202, LGB430, LGF124, LGF224, LGG420, LGP400, LGS060, NGB430, NGF224, NGG420, NGH500, NGH503, NGH505, NGH507, NGH720, NGH723, NGH725, NGH727, NGH730, NGH733, NGH737, NGP400, NGP600, NGP900, NGS040, NGS060, NGS080, NGS100, NGS150, NGW250, NGW450, PGB438, PGF148, PGF228...(Other models you can see in the webshop)

**spare parts for** 100085

	<b>GEV No.</b>	100227	<b>Ref. No.</b>	—
pilot burner nozzle natural gas gas pressure 25mbar code 6 Qty 1 pcs suitable for JUNKERS CB50203_				

	<b>GEV No.</b>	100704	<b>Ref. No.</b>	407123
ignition electrode D1 ø 9mm connection M4 D2 ø 11mm L1 17mm L2 17mm BL1 13mm BL2 4mm BL3 22mm				

	<b>GEV No.</b>	100909	<b>Ref. No.</b>	—
union screw thread M10x1 for pipe ø 6mm Qty 1 pcs				

	<b>GEV No.</b>	101287	<b>Ref. No.</b>	—
olive for pipe ø 6mm Qty 1 pcs				

	<b>GEV No.</b>	101292	<b>Ref. No.</b>	—
union screw for igniter suitable for CB 502/505 Qty 1 pcs				

	<b>GEV No.</b>	101295	<b>Ref. No.</b>	—
clamping collet for thermocouple suitable for CB 502/505 Qty 1 pcs				

**accessories for** 100085

	<b>GEV No.</b>	100220	<b>Ref. No.</b>	161141
pilot burner nozzle LPG gas pressure 50mbar code 2 Qty 1 pcs suitable for JUNKERS CB503_				

	<b>GEV No.</b>	100221	<b>Ref. No.</b>	—
pilot burner nozzle LPG gas pressure 30mbar code 29 Qty 1 pcs suitable for JUNKERS CB50203_				

	<b>GEV No.</b>	100222	<b>Ref. No.</b>	161149
pilot burner nozzle LPG gas pressure 50mbar code 5 Qty 1 pcs suitable for JUNKERS CB50203_				



	<b>GEV No.</b>	100223	<b>Ref. No.</b>	161140
pilot burner nozzle natural gas gas pressure 20mbar code 3 Qty 1 pcs suitable for JUNKERS CB503_				

Table continues overleaf













accessories for		100085	
GEV No.		100224	Ref. No.
			—
pilot burner nozzle natural gas gas pressure 25mbar code 26 Qty 1 pcs suitable for JUNKERS CB503_			
			—
pilot burner nozzle LPG gas pressure 30mbar code 39 Qty 1 pcs suitable for JUNKERS CB503_			
			—
pilot burner nozzle LPG gas pressure 50mbar code 15 suitable for JUNKERS			
			—
pilot burner nozzle town gas gas pressure 8mbar code 4 Qty 1 pcs suitable for JUNKERS CB50203_			
			—
olive for pipe ø 4mm L 8.7mm Qty 1 pcs suitable for CB 502/503			
			—
union screw thread M10x1 for pipe ø 4mm Qty 1 pcs			



GEV No.	100061	Ref. No.	161136 784383
<b>description</b>	pilot burner JUNKERS type CB502031 natural gas nozzle no.6 gas pressure 25mbar gas connection 6mm with primary air code 6		
<b>For models:</b>	GHN201, GHN202, GHN401, GHN402, GHN601, GHN602, GHN801, GHN802, GHO101, NGH200, NGH202, NGH400, NGH403, NGH405, NGH407, NGH600, NGH603, NGH605, NGH607, NGH720, NGH723, NGH725, NGH727		

spare parts for		100061	
GEV No.		100227	Ref. No.
			—
pilot burner nozzle natural gas gas pressure 25mbar code 6 Qty 1 pcs suitable for JUNKERS CB50203_			
			—
union screw thread M10x1 for pipe ø 6mm Qty 1 pcs			
			—
olive for pipe ø 6mm Qty 1 pcs			
			—
clamping collet for thermocouple suitable for CB 502/505 Qty 1 pcs			

accessories for		100061	
GEV No.		100220	Ref. No.
			161141
pilot burner nozzle LPG gas pressure 50mbar code 2 Qty 1 pcs suitable for JUNKERS CB503_			
			—
pilot burner nozzle LPG gas pressure 30mbar code 29 Qty 1 pcs suitable for JUNKERS CB50203_			
			161149
pilot burner nozzle LPG gas pressure 50mbar code 5 Qty 1 pcs suitable for JUNKERS CB50203_			
			161140
pilot burner nozzle natural gas gas pressure 20mbar code 3 Qty 1 pcs suitable for JUNKERS CB503_			



accessories for		100061	
GEV No.		100224	Ref. No.
			—
pilot burner nozzle natural gas gas pressure 25mbar code 26 Qty 1 pcs suitable for JUNKERS CB503_			
			—
pilot burner nozzle LPG gas pressure 30mbar code 39 Qty 1 pcs suitable for JUNKERS CB503_			
			—
pilot burner nozzle LPG gas pressure 50mbar code 15 suitable for JUNKERS			
			—
pilot burner nozzle town gas gas pressure 8mbar code 4 Qty 1 pcs suitable for JUNKERS CB50203_			
			407123
ignition electrode D1 ø 9mm connection M4 D2 ø 11mm L1 17mm L2 17mm BL1 13mm BL2 4mm BL3 22mm			
			808060002
cover for pilot burner suitable for JUNKERS CB502_SS			
			—
screw connection thread M10x1 Qty 1 pcs type SEF 1 ømm for thermocouple			
			—
olive for pipe ø 4mm L 8.7mm Qty 1 pcs suitable for CB 502/503			
			—
union screw thread M10x1 for pipe ø 4mm Qty 1 pcs			
			—
union screw for igniter suitable for CB 502/505 Qty 1 pcs			

CB 503 series

pilot burners



GEV No.	100101	Ref. No.	540706
<b>description</b>	pilot burner JUNKERS type CB503003 LPG nozzle no.2 gas connection 4mm with primary air		

spare parts for		100101	
GEV No.		100224	Ref. No.
			—
pilot burner nozzle natural gas gas pressure 25mbar code 26 Qty 1 pcs suitable for JUNKERS CB503_			
			—
olive for pipe ø 4mm L 8.7mm Qty 1 pcs suitable for CB 502/503			
			—
union screw thread M10x1 for pipe ø 4mm Qty 1 pcs			















accessories for		100101	
GEV No.		100220	Ref. No.
			161141
pilot burner nozzle LPG gas pressure 50mbar code 2 Qty 1 pcs suitable for JUNKERS CB503_			









Table continues overleaf





accessories for		100101		
	GEV No.	100221	Ref. No.	—
pilot burner nozzle LPG gas pressure 30mbar code 29 Qty 1 pcs suitable for JUNKERS CB50203_				
	GEV No.	100222	Ref. No.	161149
pilot burner nozzle LPG gas pressure 50mbar code 5 Qty 1 pcs suitable for JUNKERS CB50203_				
	GEV No.	100223	Ref. No.	161140
pilot burner nozzle natural gas gas pressure 20mbar code 3 Qty 1 pcs suitable for JUNKERS CB503_				
	GEV No.	100226	Ref. No.	—
pilot burner nozzle LPG gas pressure 50mbar code 15 suitable for JUNKERS				
	GEV No.	100227	Ref. No.	—
pilot burner nozzle natural gas gas pressure 25mbar code 6 Qty 1 pcs suitable for JUNKERS CB50203_				
	GEV No.	100228	Ref. No.	—
pilot burner nozzle town gas gas pressure 8mbar code 4 Qty 1 pcs suitable for JUNKERS CB50203_				
	GEV No.	100909	Ref. No.	—
union screw thread M10x1 for pipe ø 6mm Qty 1 pcs				
	GEV No.	101287	Ref. No.	—
olive for pipe ø 6mm Qty 1 pcs				
	GEV No.	102110	Ref. No.	—
pilot tube copper pipe ø 4mm thickness 1mm L 3000mm				
	GEV No.	102111	Ref. No.	—
pilot tube copper pipe ø 6mm thickness 1mm L 3000mm				

				
1				
<b>GEV No.</b>	100058	<b>Ref. No.</b>	161139	
<b>description</b>	pilot burner JUNKERS type CB503006 natural gas nozzle no.26 gas connection 4mm			
<b>For models:</b>	EGH417, EGH617, FGH417, FGH507, FGH617, GHN201, GHN202, GHN401, GHN402, GHN601, GHN602, GHN801, GHN802, LGH407, NGH407, NGH417, NGH507, NGH607, NGH617, NGH727, NGH737			
<b>spare parts for</b>	100058			
	GEV No.	100224	Ref. No.	—
pilot burner nozzle natural gas gas pressure 25mbar code 26 Qty 1 pcs suitable for JUNKERS CB503_				
	GEV No.	101281	Ref. No.	—
olive for pipe ø 4mm L 8.7mm Qty 1 pcs suitable for CB 502/503				
	GEV No.	101283	Ref. No.	—
union screw thread M10x1 for pipe ø 4mm Qty 1 pcs				
<b>accessories for</b>	100058			
	GEV No.	100220	Ref. No.	161141
pilot burner nozzle LPG gas pressure 50mbar code 2 Qty 1 pcs suitable for JUNKERS CB503_				
	GEV No.	100221	Ref. No.	—
pilot burner nozzle LPG gas pressure 30mbar code 29 Qty 1 pcs suitable for JUNKERS CB50203_				

accessories for		100058		
	GEV No.	100222	Ref. No.	161149
pilot burner nozzle LPG gas pressure 50mbar code 5 Qty 1 pcs suitable for JUNKERS CB50203_				
	GEV No.	100223	Ref. No.	161140
pilot burner nozzle natural gas gas pressure 20mbar code 3 Qty 1 pcs suitable for JUNKERS CB503_				
	GEV No.	100226	Ref. No.	—
pilot burner nozzle LPG gas pressure 50mbar code 15 suitable for JUNKERS				
	GEV No.	100227	Ref. No.	—
pilot burner nozzle natural gas gas pressure 25mbar code 6 Qty 1 pcs suitable for JUNKERS CB50203_				
	GEV No.	100228	Ref. No.	—
pilot burner nozzle town gas gas pressure 8mbar code 4 Qty 1 pcs suitable for JUNKERS CB50203_				
	GEV No.	100909	Ref. No.	—
union screw thread M10x1 for pipe ø 6mm Qty 1 pcs				
	GEV No.	101287	Ref. No.	—
olive for pipe ø 6mm Qty 1 pcs				
	GEV No.	102110	Ref. No.	—
pilot tube copper pipe ø 4mm thickness 1mm L 3000mm				
	GEV No.	102111	Ref. No.	—
pilot tube copper pipe ø 6mm thickness 1mm L 3000mm				

CB 505 series

pilot burners













				
1				
<b>GEV No.</b>	100119	<b>Ref. No.</b>	161193	
<b>description</b>	pilot burner JUNKERS type CB505141 natural gas nozzle no.45 gas connection 4mm			
<b>For models:</b>	NGF144, NGR150, NGR250, NGR300, NGR400			
<b>spare parts for</b>	100119			
	GEV No.	100213	Ref. No.	—
pilot burner nozzle natural gas code 45 gas pressure 20mbar L 16mm Qty 1 pcs suitable for JUNKERS CB5051_				
	GEV No.	101282	Ref. No.	—
olive for pipe ø 4mm L 7.4mm Qty 1 pcs				
	GEV No.	101283	Ref. No.	—
union screw thread M10x1 for pipe ø 4mm Qty 1 pcs				
	GEV No.	101292	Ref. No.	—
union screw for igniter suitable for CB 502/505 Qty 1 pcs				
	GEV No.	101295	Ref. No.	—
clamping collet for thermocouple suitable for CB 502/505 Qty 1 pcs				
	GEV No.	102842	Ref. No.	—
gasket for pilot burner 65x18				

Table continues overleaf



accessories for		100119	
	GEV No.	100210	Ref. No. —
pilot burner nozzle LPG code 46 gas pressure 30mbar L 16mm Qty 1 pcs suitable for JUNKERS CB5051_			
	GEV No.	100211	Ref. No. —
pilot burner nozzle natural gas code 44 gas pressure 25mbar L 16mm Qty 1 pcs suitable for JUNKERS CB5051_			
	GEV No.	100212	Ref. No. —
pilot burner nozzle LPG code 42 gas pressure 50mbar L 16mm Qty 1 pcs suitable for JUNKERS CB5051_			
	GEV No.	100909	Ref. No. —
union screw thread M10x1 for pipe ø 6mm Qty 1 pcs			
	GEV No.	101288	Ref. No. —
olive for pipe ø 6mm L 6mm aluminium Qty 1 pcs ED ø 8.5mm			
	GEV No.	102842	Ref. No. —
gasket for pilot burner 65x18			

## producer-specific pilot burners

### KÜPPERSBUSCH

#### EGH\_ series (version 1)



1

<b>GEV No.</b>	102956	<b>Ref. No.</b>	-
<b>description</b>	pilot burner type C without nozzle		



1

<b>GEV No.</b>	102957	<b>Ref. No.</b>	-
<b>description</b>	pilot burner type D without nozzle		



1

<b>GEV No.</b>	102958	<b>Ref. No.</b>	-
<b>description</b>	pilot burner type E without nozzle		

#### NGH\_ series (version 2) / PGH\_ (version 1)











1

<b>GEV No.</b>	107472	<b>Ref. No.</b>	-
<b>description</b>	pilot burner complete natural/liquid gas gas line ø 4mm		
<b>accessories for</b>	107472		
	GEV No.	803031	Ref. No. —
nut spinner size 5.5mm total length 236mm blade length 125mm			

#### FGH\_ / EGH\_ (version 2) / PGH\_ series (version 2)



1

<b>GEV No.</b>	101529	<b>Ref. No.</b>	154115
<b>description</b>	pilot burner type E incl. nozzles 0.18mm / 0.20mm / 0.32mm / 0.35mm		
<b>For models:</b>	EGH210, EGH410, EGH413, EGH417, EGH610, EGH613, EGH617, FGH210, FGH410, FGH413, FGH415, FGH417, FGH610, FGH613, FGH615, FGH617, PGH218, PGH418, PGH618		
<b>spare parts for</b>	101529		
	GEV No.	100235	Ref. No. 152693
pilot burner nozzle LPG bore ø 0.2mm code 20 gas pressure 50mbar thread M5x0.8			
	GEV No.	100236	Ref. No. 152695
pilot burner nozzle natural gas bore ø 0.35mm code 35 gas pressure 20mbar thread M5x0.8 WS 5.5			
	GEV No.	100900	Ref. No. —
air mixing sleeve for pilot burner Qty 1 pcs			
	GEV No.	101583	Ref. No. 154111 154112
pilot burner head slit width 0.8mm bore ø 3mm ø 6mm M7x0.75mm total length 22mm WS 8 nickel-plated brass			
	GEV No.	101587	Ref. No. 060328
gasket for pilot burner without ignition electrode			
	GEV No.	101588	Ref. No. —
pilot burner nozzle natural gas bore ø 0.32mm code 32 gas pressure 20mbar thread M5x0.8			
	GEV No.	101589	Ref. No. —
pilot burner nozzle LPG bore ø 0.18mm code 18 gas pressure 50mbar thread M5x0.8 WS 5.5			
	GEV No.	101848	Ref. No. 135690
cover for pilot burner			

accessories universal

covers



<b>GEV No.</b>	101926	<b>Ref. No.</b>	735918000
<b>description</b>	cover for pilot burner suitable for KÜPPERSBUSCH		
<b>For models:</b>	EGS060, NGS040, NGS060, NGS080, NGS100, NGS150		

electrodes

<b>GEV No.</b>	100720	<b>Ref. No.</b>	185217
<b>description</b>	ignition electrode D1 ø 8mm BL1 42mm connection F 2.8x0.8mm with spring		
<b>For models:</b>	GHP601, LGH405, LGH407, LGH605, LGH607		

<b>GEV No.</b>	100704	<b>Ref. No.</b>	407123
<b>description</b>	ignition electrode D1 ø 9mm connection M4 D2 ø 11mm L1 17mm L2 17mm BL1 13mm BL2 4mm BL3 22mm		

<b>GEV No.</b>	101782	<b>Ref. No.</b>	162800
<b>description</b>	ignition electrode flange length 23mm flange width 16mm D1 ø 7mm L1 12mm L2 18mm BL1 15mm BL2 16mm connection M4 fixing dimensions ø4.5mm with flange		
<b>For models:</b>	EGH417, EGH617, FGH417, FGH507, FGH617, NGH417, NGH507, NGH617, NGH737		

<b>GEV No.</b>	101783	<b>Ref. No.</b>	162805
<b>description</b>	ignition electrode flange length 48mm flange width 1 29mm flange width 2 24mm D1 ø 9.5mm L1 26mm BL1 30mm BL2 35mm connection F 2.8x0.8mm fixing dimensions ø5.5x4.5mm/ø4.5mm with flange with earthing contact		
<b>For models:</b>	EGP500, FGS040, FGS060, FGS080, FGS100, FGS150, PGS048, PGS068, PGS088		

<b>GEV No.</b>	101784	<b>Ref. No.</b>	162806
<b>description</b>	ignition electrode flange length 48mm flange width 1 29mm flange width 2 24mm D1 ø 9.5mm L1 62mm BL1 20mm BL2 20mm connection F6.3x0.8mm fixing dimensions ø5.5x4.5mm/ø4.5mm with flange		
<b>For models:</b>	EGP500, FGS040, FGS060, FGS080, FGS100, FGS150, PGS048, PGS068, PGS088		

ignition cables

pre-assembled cables

<b>GEV No.</b>	102172	<b>Ref. No.</b>	784231002 807857002 808857002
<b>description</b>	ignition cable cable length 300mm connection ø4mm / F6.3mm		
<b>For models:</b>	LGB430, LGG420, NGB430, NGG420		

<b>GEV No.</b>	100025	<b>Ref. No.</b>	784231002
<b>description</b>	ignition cable cable length 600mm connection ø4mm / F6.3mm		



piezoelectric igniters

mounting diameter 18mm



1			
<b>GEV No.</b>	100004	<b>Ref. No.</b>	540955
<b>description</b>	piezoelectric igniter body plastic blowing mounting ø 18mm connection ø2.4mm		

miscellaneous



1			
<b>GEV No.</b>	nla <sup>1</sup>	<b>Ref. No.</b>	161161
<b>description</b>	piezoelectric igniter body metal connection F6.3x0.8 2 hole fixing ø 22mm		
<b>For models:</b>	EGB230, EGB430, EGF124, EGF224, EGS060, FGH500, FGH507, GPN402, GPP202, GWN101, GWN201, GWN202, LGB430, LGF124, LGF224, LGG420, LGP400, LGS060, NGB430, NGF144, NGF224, NGG420, NGH500, NGH503, NGH505, NGH507, NGH720, NGH723, NGH725, NGH727, NGH730, NGH733, NGH737, NPG400, NPG600, NPG900, NGS040, NGS060, NGS080, NGS100, NGS150, NGW250, NGW450, PGH508		

<sup>1</sup>no longer available

ignition units



1			
<b>GEV No.</b>	101016	<b>Ref. No.</b>	185310
<b>description</b>	ignition unit outputs 2 230VAC inlet F6.3x0.8 outlet F2.8x0.8 1.7VA 50Hz mounting ø 42mm		
<b>For models:</b>	CBG110, CBG120, CGD110, CGD120, NGR150, NGR250, NGR300, NGR400, NGS040, NGS060, NGS080, NGS100, NGS150		



1			
<b>GEV No.</b>	101006	<b>Ref. No.</b>	105002 105202 152002 185207 185278 185279
<b>description</b>	ignition unit outputs 6 230VAC inlet F6.3x0.8 outlet F2.8x0.8 without front fixing nut 0.6VA 50Hz mounting ømm		
<b>For models:</b>	GHP601, LGH405, LGH407, LGH605, LGH607		

thermocouples

plug-in thermocouples

plug-in thermocouples standard

with barrel socket ø5mm - type Junkers with aluminised tip



1			
<b>GEV No.</b>	102211	<b>Ref. No.</b>	174410
<b>description</b>	thermocouple M10x1 L 320mm plug connection ø5.0mm		
<b>For models:</b>	GPN402		



1			
<b>GEV No.</b>	102212	<b>Ref. No.</b>	162164
<b>description</b>	thermocouple M10x1 L 450mm plug connection ø5.0mm		



1			
<b>GEV No.</b>	102140	<b>Ref. No.</b>	162164
<b>description</b>	thermocouple M10x1 L 600mm plug connection ø5.0mm		



1			
<b>GEV No.</b>	102213	<b>Ref. No.</b>	162164
<b>description</b>	thermocouple M10x1 L 600mm plug connection ø5.0mm		
<b>For models:</b>	EGB230, EGB430, LGP400, NPG400, PGB438		



1			
<b>GEV No.</b>	102141	<b>Ref. No.</b>	162163
<b>description</b>	thermocouple M10x1 L 750mm plug connection ø5.0mm		



1			
<b>GEV No.</b>	102214	<b>Ref. No.</b>	162163
<b>description</b>	thermocouple M10x1 L 750mm plug connection ø5.0mm		
<b>For models:</b>	NGP600, NPG900		



<b>GEV No.</b>	102009	<b>Ref. No.</b>	174413
<b>description</b>	thermocouple M8x1 L 1000mm plug connection ø5.0mm		

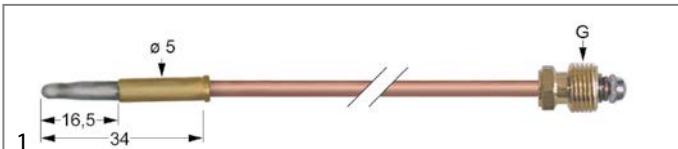

<b>GEV No.</b>	102020	<b>Ref. No.</b>	162111
<b>description</b>	thermocouple M8x1 L 320mm plug connection ø5.0mm		

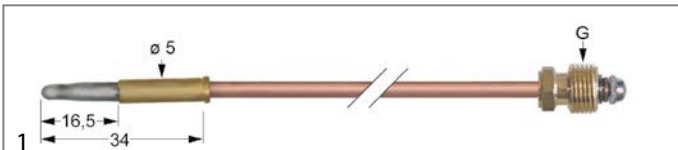

<b>GEV No.</b>	102202	<b>Ref. No.</b>	161111 162111 174409 504113 506112
<b>description</b>	thermocouple M8x1 L 320mm plug connection ø5.0mm		

**For models:** EGB230, EGB430, EGH210, EGH410, EGH413, EGH417, EGH610, EGH613, EGH617, FGH210, FGH410, FGH413, FGH415, FGH417, FGH500, FGH507, FGH610, FGH613, FGH615, FGH617, GHN201, GHN202, GHN401, GHN402, GHN601, GHN602, GHN801, GHN802, GHP601, GPP202, GWN202, LGB430, LGF124, LGF224, LGG420, LGH405, LGH407, LGH605, LGH607, NGB430, NGG420, NGH200, NGH202, NGH400, NGH403, NGH405, NGH407, NGH500, NGH503, NGH505...(Other models you can see in the webshop)

<b>accessories for</b>	102202		
	<b>GEV No.</b>	101260	<b>Ref. No.</b> —
	thermocouple fitting thread M8x1 Qty 1 pcs		

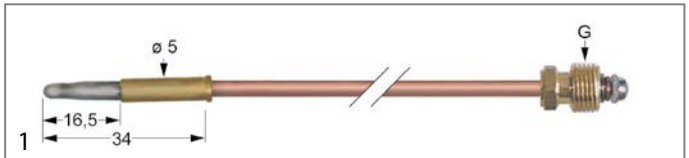

<b>GEV No.</b>	102205	<b>Ref. No.</b>	174413
<b>description</b>	thermocouple M8x1 L 750mm plug connection ø5.0mm		
<b>For models:</b>	GHN201, GHN202, GHN401, GHN402, GHN601, GHN602, GHN801, GHN802, NGH200, NGH202, NGH400, NGH403, NGH405, NGH407, NGH600, NGH603, NGH605, NGH607, NGH720, NGH723, NGH725, NGH727		

<b>accessories for</b>	102205		
	<b>GEV No.</b>	101260	<b>Ref. No.</b> —
	thermocouple fitting thread M8x1 Qty 1 pcs		

with barrel socket ø6mm

type Junkers with aluminised tip

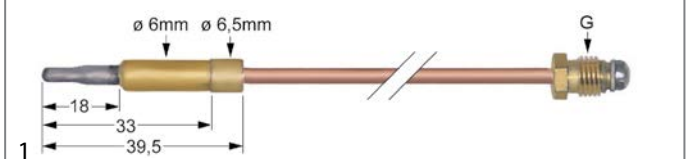

<b>GEV No.</b>	102256	<b>Ref. No.</b>	162161
<b>description</b>	thermocouple ASA 11/32 L 1000mm plug connection ø6.0mm		
<b>For models:</b>	NGR150		

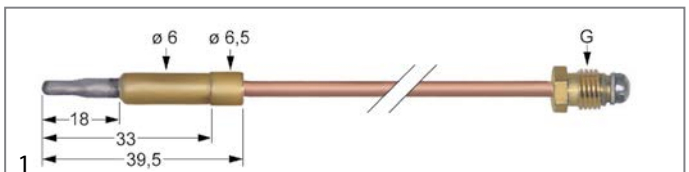

<b>GEV No.</b>	102027	<b>Ref. No.</b>	162138
<b>description</b>	thermocouple M10x1 L 1500mm plug connection ø6.0mm		

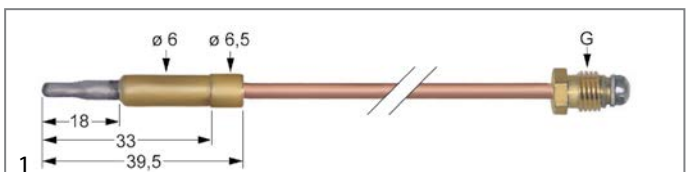

<b>GEV No.</b>	102231	<b>Ref. No.</b>	162138
<b>description</b>	thermocouple M10x1 L 1500mm plug connection ø6.0mm		

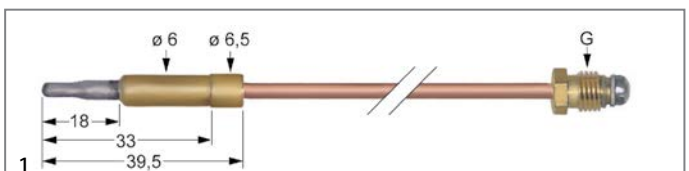

<b>GEV No.</b>	102228	<b>Ref. No.</b>	162134
<b>description</b>	thermocouple M10x1 L 750mm plug connection ø6.0mm		





<b>GEV No.</b>	102223	<b>Ref. No.</b>	162142 162143 162152 162155
<b>description</b>	thermocouple M8x1 L 1200mm plug connection ø6.0mm		
<b>For models:</b>	EGH417, EGH617, GHN401, GHN402, GHN601, GHN602, GHN801, GHN802, GHP601		

<b>GEV No.</b>	102218	<b>Ref. No.</b>	162132 162139 356251
<b>description</b>	thermocouple M8x1 L 320mm plug connection ø6.0mm		

<b>GEV No.</b>	102219	<b>Ref. No.</b>	162132 356250
<b>description</b>	thermocouple M8x1 L 450mm plug connection ø6.0mm		

<b>GEV No.</b>	102220	<b>Ref. No.</b>	162140
<b>description</b>	thermocouple M8x1 L 600mm plug connection ø6.0mm		
<b>For models:</b>	GPN402, GWN101, GWN201		

with barrel socket ø6(6.5)mm

thermocouples SIT

<b>GEV No.</b>	107621	<b>Ref. No.</b>	162138
<b>description</b>	thermocouple SIT M10x1 L 1500mm plug connection ø6.0(6.5)mm		
<b>For models:</b>	EGH417, EGH617, FGH417, FGH507, FGH617, LGH407, LGH607, NGH407, NGH417, NGH507, NGH607, NGH617, NGH727, NGH737		

threaded thermocouples (miscellaneous)

<b>GEV No.</b>	107461	<b>Ref. No.</b>	162112
<b>description</b>	thermocouple M8x1 L 600mm plug connection ø5.0mm		
<b>For models:</b>	EGH210, EGH410, EGH413, EGH417, EGH610, EGH613, EGH617, FGH210, FGH410, FGH413, FGH415, FGH417, FGH610, FGH613, FGH615, FGH617, GHP601, LGH405, LGH407, LGH605, LGH607, NGF144, NGF224, PGH218, PGH418, PGH618		

plug-in thermocouples with cable link

<b>GEV No.</b>	102814	<b>Ref. No.</b>	941066002 994544002
<b>description</b>	thermocouple L 1000mm plug connection ø5.0mm F 6.3mm M5		
<b>For models:</b>	CBG110, CBG120, CGD110, CGD120, NGS040, NGS060, NGS080, NGS100, NGS150		

<b>GEV No.</b>	102131	<b>Ref. No.</b>	162166
<b>description</b>	thermocouple with two-conductors L 1000mm plug connection ø5.0mm M8x1		
<b>For models:</b>	EGF124, EGF224, NGF144, NGF224		

<b>GEV No.</b>	102255	<b>Ref. No.</b>	996206002
<b>description</b>	thermocouple with two-conductors L 600mm plug connection ø5.0mm F 6.3mm M5		
<b>For models:</b>	FGW250, PGF148, PGF228, PGW458		

<b>GEV No.</b>	102089	<b>Ref. No.</b>	162168
<b>description</b>	thermocouple with two-conductors L 600mm plug connection ø5.0mm M8x1		

plug-in thermocouples with interruption

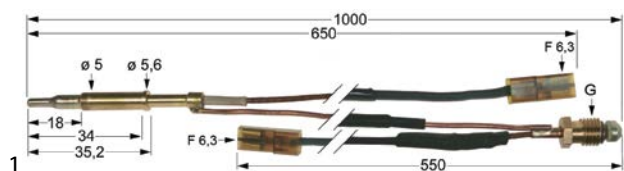

<b>GEV No.</b>	102815	<b>Ref. No.</b>	942740002
<b>description</b>	thermocouple with interrupter M8x1 L 1000mm plug connection ø5.0mm F 6.3mm		
<b>For models:</b>	EGS060		

threaded thermocouples

threaded thermocouples standard

with socket with thread M8x1

SIT

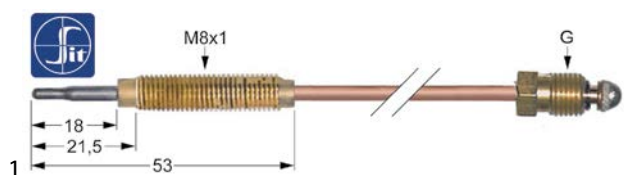

<b>GEV No.</b>	107627	<b>Ref. No.</b>	162123
<b>description</b>	thermocouple SIT M8x1 L 220mm M8x1		

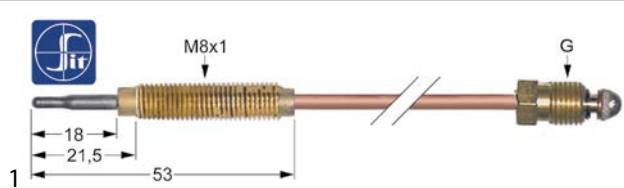

<b>GEV No.</b>	107628	<b>Ref. No.</b>	151900
<b>description</b>	thermocouple SIT M8x1 L 320mm M8x1		

<b>accessories for</b>	107628			
	<b>GEV No.</b>	102067	<b>Ref. No.</b>	—
	nut thread M8x1 H 3mm brass Qty 1 pcs type SEF 1			

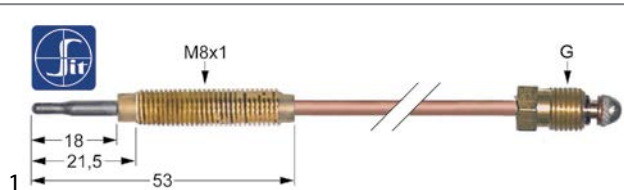

<b>GEV No.</b>	107629	<b>Ref. No.</b>	162124
<b>description</b>	thermocouple SIT M8x1 L 450mm M8x1		

type Junkers with aluminised tip

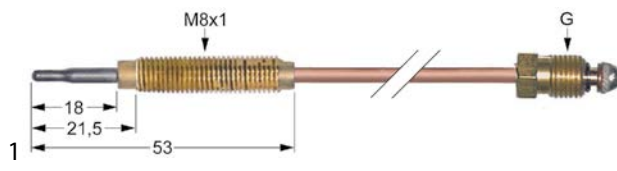

<b>GEV No.</b>	102233	<b>Ref. No.</b>	151901	
<b>description</b>	thermocouple M8x1 L 750mm M8x1			
<b>For models:</b>	NGH210, NGH410, NGH413, NGH415, NGH417, NGH610, NGH613, NGH615, NGH617, NGH730, NGH733, NGH737, PGH218, PGH418, PGH618			
<b>accessories for</b>	102233			
	<b>GEV No.</b>	102067	<b>Ref. No.</b>	—
	nut thread M8x1 H 3mm brass Qty 1 pcs type SEF 1			

accessories

display adapters



<b>GEV No.</b>	100947	<b>Ref. No.</b>	174757
<b>description</b>	display adapter thread M8x1		

interrupters



<b>GEV No.</b>	580046	<b>Ref. No.</b>	174463
<b>description</b>	extension for interruptor L 18" - 455mm		
<b>For models:</b>	NGR150, NGR250, NGR300, NGR400		



<b>GEV No.</b>	101258	<b>Ref. No.</b>	164833
<b>description</b>	interrupter thread M10x1		
<b>For models:</b>	NGP600, NGP900		



<b>GEV No.</b>	101264	<b>Ref. No.</b>	164815
<b>description</b>	interrupter thread M8x1		
<b>For models:</b>	EGB230, EGB430, EGF124, EGF224, EGH417, EGH617, FGH417, FGH507, FGH617, FGW250, PGB438, PGF148, PGF228, PGW458		



			
1			
<b>GEV No.</b>	101265	<b>Ref. No.</b>	183235
<b>description</b>	interrupter thread M9x1		
<b>For models:</b>	CBG110, CBG120, CGD110, CGD120, NGR150, NGR250, NGR300, NGR400, NGS040, NGS060, NGS080, NGS100, NGS150		

## gas burners

### hob burners

#### accessories

#### reducers for pan supports

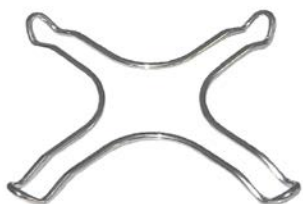
			
1			
<b>GEV No.</b>	210050	<b>Ref. No.</b>	N/A
<b>description</b>	reducer for pan support L 260mm W 260mm chrome-plated steel suitable for universal		

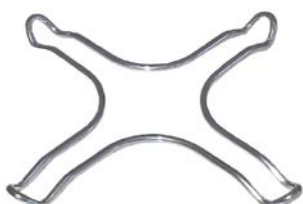
			
1			
<b>GEV No.</b>	210001	<b>Ref. No.</b>	N/A
<b>description</b>	reducer for pan support L 265mm W 265mm SS suitable for universal		

#### simmering plates

			
1			
<b>GEV No.</b>	211044	<b>Ref. No.</b>	160613
<b>description</b>	simmer plate		
<b>For models:</b>	EEH210, EEH410, EEH413, EEH610, EEH613		

### bar burners

#### bar burners

			
1			
<b>GEV No.</b>	105617	<b>Ref. No.</b>	995546511
<b>description</b>	bar burner		
<b>For models:</b>	NGP600		

			
1			
<b>GEV No.</b>	105612	<b>Ref. No.</b>	808250002
<b>description</b>	bar burner fryer		
<b>For models:</b>	NGF144		

			
1			
<b>GEV No.</b>	104166	<b>Ref. No.</b>	164401
<b>description</b>	bar burner ø 50mm Wmm Hmm L 600mm with bolt M5x12 flange width 57mm flange length 57mm kettle		
<b>For models:</b>	CBG110, CBG120, CGD110, CGD120, FGR150, FGR250, FGR300, FGR400, NGR250, NGR300, NGR400		

			
1			
<b>GEV No.</b>	105613	<b>Ref. No.</b>	995789002
<b>description</b>	bar burner ø 60mm Wmm Hmm L 240mm fryer		
<b>For models:</b>	PGF148		

			
1			
<b>GEV No.</b>	104179	<b>Ref. No.</b>	8079590002
<b>description</b>	bar burner ø 60mm Wmm Hmm L 362mm kettle		





			
1			
<b>GEV No.</b>	105619	<b>Ref. No.</b>	985811002
<b>description</b>	bar burner ø 60mm Wmm Hmm L 505mm kettle		
<b>For models:</b>	NGR150, NGR250, NGR300, NGR400		

			
1			
<b>GEV No.</b>	104177	<b>Ref. No.</b>	807528002
<b>description</b>	bar burner ømm W 30mm H 51mm L 425mm griddle		
<b>For models:</b>	NGB430, NGG420		

			
1			
<b>GEV No.</b>	104180	<b>Ref. No.</b>	807275002
<b>description</b>	bar burner ø 60mm Wmm Hmm L 585mm kettle		
<b>For models:</b>	FGS080, FGS100, NGS080, NGS100, PGS088		

			
1			
<b>GEV No.</b>	105607	<b>Ref. No.</b>	996804002
<b>description</b>	bar burner ømm W 30mm H 51mm L 585mm griddle		
<b>For models:</b>	PGB438		

			
1			
<b>GEV No.</b>	104181	<b>Ref. No.</b>	807276002
<b>description</b>	bar burner ø 60mm Wmm Hmm L 600mm kettle		
<b>For models:</b>	FGS150, NGS150		

			
1			
<b>GEV No.</b>	105614	<b>Ref. No.</b>	996072002
<b>description</b>	bar burner ømm W 40mm H 55mm L 330mm fryer		
<b>For models:</b>	PGF228		

			
1			
<b>GEV No.</b>	105905	<b>Ref. No.</b>	541545
<b>description</b>	bar burner ømm W 28mm H 42mm L 295mm flange width 35mm flange length 70mm kettle		

			
1			
<b>GEV No.</b>	104380	<b>Ref. No.</b>	807612002
<b>description</b>	bar burner ømm W 41mm H 56mm L 216mm fryer		
<b>For models:</b>	EGF124, EGF224, LGF124, LGF224, NGF224		

			
1			
<b>GEV No.</b>	105610	<b>Ref. No.</b>	807288002
<b>description</b>	bar burner ømm W 30mm H 51mm L 425mm bain marie		
<b>For models:</b>	FGW250, NGW250, PGW458		

			
1			
<b>GEV No.</b>	104176	<b>Ref. No.</b>	807286002
<b>description</b>	bar burner ømm W 41mm H 56mm L 505mm solid top		
<b>For models:</b>	FGH500, FGH507, NGH500, NGH503, NGH505, NGH507, NGH720, NGH723, NGH725, NGH727, NGH730, NGH733, NGH737, PGH508		





			
1			
<b>GEV No.</b>	104178	<b>Ref. No.</b>	807527002
<b>description</b>	bar burner solid top		
<b>For models:</b>	LGB430, LGG420		

 <p>Image not available</p>			
1			
<b>GEV No.</b>	105615	<b>Ref. No.</b>	807628511
<b>description</b>	bar burner tilting bratt pan		
<b>For models:</b>	LGP400, NGP400		

 <p>Image not available</p>			
1			
<b>GEV No.</b>	105877	<b>Ref. No.</b>	Thielmann 193635
<b>description</b>	burner griddle		

 <p>Image not available</p>			
1			
<b>GEV No.</b>	105917	<b>Ref. No.</b>	Thielmann 144615
<b>description</b>	burner ømm tilting bratt pan		

			
1			
<b>GEV No.</b>	105919	<b>Ref. No.</b>	541123 rechts Thielmann 144557
<b>description</b>	burner ømm tilting bratt pan		

 <p>Image not available</p>			
1			
<b>GEV No.</b>	105876	<b>Ref. No.</b>	Thielmann 193660
<b>description</b>	burner oven		

ring burners

 <p>Image not available</p>			
1			
<b>GEV No.</b>	105604	<b>Ref. No.</b>	807110511
<b>description</b>	ring burner		
<b>For models:</b>	LGH407, LGH607, NGH407, NGH507, NGH607, NGH727		

			
1			
<b>GEV No.</b>	104175	<b>Ref. No.</b>	161198 782413005 782413009 807110511
<b>description</b>	ring burner L 470mm W 287mm for oven		

 <p>Image not available</p>			
1			
<b>GEV No.</b>	105605	<b>Ref. No.</b>	782413005
<b>description</b>	ring burner oven		
<b>For models:</b>	FGH417, FGH507, FGH617, NGH417, NGH507, NGH617, NGH737		

accessories

nozzle holders

 <p>Image not available</p>			
1			
<b>GEV No.</b>	101548	<b>Ref. No.</b>	161675
<b>description</b>	nozzle holder external nozzle ø bore ø3.00mm internal nozzle ø bore ø1.85mm		
<b>For models:</b>	EGH417, EGH617, LGH407, LGH607		





1

<b>GEV No.</b>	101549	<b>Ref. No.</b>	161676
<b>description</b>	nozzle holder external nozzle ø bore ø3.00mm internal nozzle ø bore ø1.95mm		
<b>For models:</b>	NGH407, NGH507, NGH607, NGH727		



2

<b>GEV No.</b>	101539	<b>Ref. No.</b>	152676
<b>description</b>	nozzle holder external nozzle ø bore ø3.80mm internal nozzle ø bore ø2.05mm		
<b>For models:</b>	NGH417, NGH507, NGH617, NGH737		



1

<b>GEV No.</b>	104503	<b>Ref. No.</b>	540269
<b>description</b>	nozzle holder ID ø 8mm		

## gas nozzles

### pilot burner nozzles

#### pilot burner nozzles EGA



1

<b>GEV No.</b>	100235	<b>Ref. No.</b>	152693
<b>description</b>	pilot burner nozzle LPG bore ø 0.2mm code 20 gas pressure 50mbar thread M5x0.8		



1

<b>GEV No.</b>	100236	<b>Ref. No.</b>	152695
<b>description</b>	pilot burner nozzle natural gas bore ø 0.35mm code 35 gas pressure 20mbar thread M5x0.8 WS 5.5		
<b>For models:</b>	EGH210, EGH410, EGH413, EGH417, EGH610, EGH613, EGH617		

#### pilot burner nozzles JUNKERS

##### CB 50203\_/503\_ series



1

<b>GEV No.</b>	100220	<b>Ref. No.</b>	161141
<b>description</b>	pilot burner nozzle LPG gas pressure 50mbar code 2 Qty 1 pcs suitable for JUNKERS CB503_		
<b>For models:</b>	EGH417, EGH617, LGH407, LGH607, NGH200, NGH202, NGH407, NGH500, NGH503, NGH505, NGH507, NGH607, NGH720, NGH723, NGH725, NGH727		



1

<b>GEV No.</b>	100222	<b>Ref. No.</b>	161149
<b>description</b>	pilot burner nozzle LPG gas pressure 50mbar code 5 Qty 1 pcs suitable for JUNKERS CB50203_		
<b>For models:</b>	EGB230, EGB430, EGF124, EGF224, GHO101, LGB430, LGF124, LGF224, LGG420, LGP400, LGS060, NGB430, NGF224, NGG420, NGP400, NGW250, NGW450		



1

<b>GEV No.</b>	100223	<b>Ref. No.</b>	161140
<b>description</b>	pilot burner nozzle natural gas gas pressure 20mbar code 3 Qty 1 pcs suitable for JUNKERS CB503_		



1

<b>GEV No.</b>	102523	<b>Ref. No.</b>	161140
<b>description</b>	pilot burner nozzle natural gas gas pressure 20mbar code 3 Qty 10 pcs suitable for CB 503		
<b>For models:</b>	CEC106, EGB230, EGB430, EGF124, EGF224, EGH417, EGH617, EGS060, FGH417, FGH500, FGH507, FGH617, FGW250, GHO101, LGB430, LGF124, LGF224, LGG420, LGH407, LGP400, LGS060, NGB430, NGF144, NGF224, NGG420, NGH200, NGH202, NGH407, NGH500, NGH503, NGH505, NGH507, NGH607, NGH720, NGH723, NGH725, NGH727, NGP400, NGW250, NGW450, PGB438, PGH508		



pilot burner nozzles SIT

160 series

			
1			
<b>GEV No.</b>	107174	<b>Ref. No.</b>	540729
<b>description</b>	pilot burner nozzle SIT natural gas code 41 Qty 1 pcs		

bypass nozzles

bypass nozzles EGA

			
1			
<b>GEV No.</b>	106441	<b>Ref. No.</b>	152680
<b>description</b>	bypass nozzle EGA bore ø 1.25mm		

			
1			
<b>GEV No.</b>	100354	<b>Ref. No.</b>	163113
<b>description</b>	bypass nozzle EGA type 31248 series bore ø 0.5mm		

			
1			
<b>GEV No.</b>	100346	<b>Ref. No.</b>	152681
<b>description</b>	bypass nozzle EGA type 31248 series bore ø 0.85mm		

			
1			
<b>GEV No.</b>	100348	<b>Ref. No.</b>	150406
<b>description</b>	bypass nozzle EGA type 31248 series bore ø 1.1mm		

internal nozzles

internal nozzles for EGA gas taps/nozzle holders

EGA 26400/26440/23268

			
1			
<b>GEV No.</b>	100319	<b>Ref. No.</b>	161790
<b>description</b>	internal nozzle bore ø 0.75mm suitable for EGA26400/26440		
<b>For models:</b>	LGH405, LGH407, LGH605, LGH607		

			
1			
<b>GEV No.</b>	100311	<b>Ref. No.</b>	406938
<b>description</b>	internal nozzle bore ø 0.80mm suitable for EGA26400/26440		

			
1			
<b>GEV No.</b>	100624	<b>Ref. No.</b>	161791
<b>description</b>	internal nozzle bore ø 0.85mm suitable for EGA26400/26440		
<b>For models:</b>	LGH405, LGH407, LGH605, LGH607		

EGA 26440

			
1			
<b>GEV No.</b>	100395 <sup>1</sup>	<b>Ref. No.</b>	152634
<b>description</b>	internal nozzle bore ø 1.4mm suitable for EGA26400/26440		

<sup>1</sup>suitable for 101735 and 101653

			
1			
<b>GEV No.</b>	100396 <sup>1</sup>	<b>Ref. No.</b>	152635
<b>description</b>	internal nozzle bore ø 1.8mm suitable for EGA26400/26440		

<sup>1</sup>suitable for 101736 and 101654

			
1			
<b>GEV No.</b>	100397 <sup>1</sup>	<b>Ref. No.</b>	152636
<b>description</b>	internal nozzle bore ø 2.05mm suitable for EGA26400/26440		

<sup>1</sup>suitable for 101737 and 101655



auxiliary gas parts

screw connections

olives

			
1			
<b>GEV No.</b>	101278	<b>Ref. No.</b>	114101
<b>description</b>	olive for pipe ø 10mm Qty 1 pcs		

**For models:** EGB230, EGB430, EGF124, EGF224, EGH210, EGH410, EGH413, EGH417, EGH610, EGH613, EGH617, EGP500, FGH210, FGH410, FGH413, FGH415, FGH417, FGH610, FGH613, FGH615, FGH617, KGD131, KGE066, KGE081, KGE131, LGB430, LGF124, LGF224, LGG420, NGB430, NGF144, NGF224, NGG420, NGH200, NGH202, NGH400, NGH403, NGH405, NGH407, NGH507, NGH600, NGH603, NGH605, NGH607, NGH720, NGH723, NGH725, NGH727, NGH730, NGH733... (Other models you can see in the webshop)

<b>accessories for</b>	101278		
	<b>GEV No.</b>	100943	<b>Ref. No.</b> —
	union nut thread M17x1 tube ø 10mm		
	<b>GEV No.</b>	101300	<b>Ref. No.</b> —
	union nut thread M16x1.5 tube ø 10mm		
	<b>GEV No.</b>	101478	<b>Ref. No.</b> —
	union nut thread 3/8" for pipe ø 10mm		

			
1			
<b>GEV No.</b>	101284	<b>Ref. No.</b>	114121
<b>description</b>	olive for pipe ø 4mm Qty 1 pcs		

**For models:** EGB230, EGB430, EGF124, EGF224, EGH210, EGH410, EGH413, EGH417, EGH610, EGH613, EGH617, EGS060, FGH210, FGH410, FGH413, FGH415, FGH417, FGH507, FGH610, FGH613, FGH615, FGH617, LGB430, LGF124, LGF224, LGG420, NGF144, NGF224, NGH507, NGH727, NGW250, NGW450, PGH218, PGH418, PGH618





<b>accessories for</b>	101284		
	<b>GEV No.</b>	101259	<b>Ref. No.</b> —
	union nut thread M8x1 for pipe ø 4mm		

Table continues overleaf

<b>accessories for</b>	101284		
	<b>GEV No.</b>	101285	<b>Ref. No.</b> —
	union screw thread M8x1 for pipe ø 4mm Qty 1 pcs JUNKERS		
	<b>GEV No.</b>	101294	<b>Ref. No.</b> —
	union nut thread M10x1 for pipe ø 4mm WS 14 L 12mm Qty 1 pcs		

**union screws**

	1		
<b>GEV No.</b>	100904	<b>Ref. No.</b>	178462
<b>description</b>	locking screw M10x1 for pipe ø 4mm Qty 1 pcs		

**gas lines**

**main gas lines**

**universal**

	1		
<b>GEV No.</b>	109179	<b>Ref. No.</b>	151432
<b>description</b>	gas line connection ø4mm L 320mm ED ø 12mm SS flexible thickness 0.75mm connection length 20mm		
<b>For models:</b>	EGB230, EGB430, EGH210, EGH410, EGH413, EGH417, EGH610, EGH613, EGH617, FGH210, FGH410, FGH413, FGH415, FGH417, FGH610, FGH613, FGH615, FGH617, PGB438, PGH218, PGH418, PGH618		

	1		
<b>GEV No.</b>	109178	<b>Ref. No.</b>	151425
<b>description</b>	gas line connection ø4mm L 680mm ED ø 12mm SS flexible thickness 0.75mm connection length 30mm		
<b>For models:</b>	EGF124, EGF224, EGH210, EGH410, EGH413, EGH417, EGH610, EGH613, EGH617, FGH210, FGH410, FGH413, FGH415, FGH417, FGH610, FGH613, FGH615, FGH617, FGW250, PGH218, PGH418, PGH618		

**equipment-specific units**

**for deep fryers**

**glass panels**

	1		
<b>GEV No.</b>	691322	<b>Ref. No.</b>	148990 504872 537365
<b>description</b>	glass panel ø 40mm thickness 4mm		
<b>For models:</b>	CBG110, CBG120, CGD110, CGD120, EGB230, EGB430, EGF124, EGF224, EGP500, FGH500, FGH507, FGW250, LGB430, LGF124, LGF224, LGG420, LGP400, NGB430, NGF144, NGF224, NGG420, NGH500, NGH503, NGH505, NGH507, NGH720, NGH723, NGH725, NGH727, NGH730, NGH733, NGH737, NGP400, NGP600, NGP900, NGW250, NGW450, PGB438, PGF148, PGF228, PGH508, PGW458		

**for tilting bratt pans**

**glass panels**

	1		
<b>GEV No.</b>	691322	<b>Ref. No.</b>	148990 504872 537365
<b>description</b>	glass panel ø 40mm thickness 4mm		
<b>For models:</b>	CBG110, CBG120, CGD110, CGD120, EGB230, EGB430, EGF124, EGF224, EGP500, FGH500, FGH507, FGW250, LGB430, LGF124, LGF224, LGG420, LGP400, NGB430, NGF144, NGF224, NGG420, NGH500, NGH503, NGH505, NGH507, NGH720, NGH723, NGH725, NGH727, NGH730, NGH733, NGH737, NGP400, NGP600, NGP900, NGW250, NGW450, PGB438, PGF148, PGF228, PGH508, PGW458		

**miscellaneous**

	1		
<b>GEV No.</b>	691321	<b>Ref. No.</b>	504871 537366 706610000
<b>description</b>	frame		
<b>For models:</b>	CBG110, CBG120, CGD110, CGD120, EGB230, EGB430, EGF124, EGF224, EGP500, FGH500, FGH507, FGW250, LGB430, LGF124, LGF224, LGG420, LGP400, NGB430, NGF144, NGF224, NGG420, NGH500, NGH503, NGH505, NGH507, NGH720, NGH723, NGH725, NGH727, NGH730, NGH733, NGH737, NGP400, NGP600, NGP900, NGW250, NGW450, PGB438, PGF148, PGF228, PGH508, PGW458		

**for boiling pans**

**spare parts and accessories**

	1		
<b>GEV No.</b>	693498	<b>Ref. No.</b>	146894
<b>description</b>	bush for plunger		
<b>For models:</b>	CBG110, CBG120, CGD110, CGD120, NGR150, NGR250, NGR300, NGR400, NGS040, NGS060, NGS080, NGS100, NGS150		

	1		
<b>GEV No.</b>	693499	<b>Ref. No.</b>	146893
<b>description</b>	plunger		
<b>For models:</b>	CBG110, CBG120, CGD110, CGD120, NGR150, NGR250, NGR300, NGR400, NGS040, NGS060, NGS080, NGS100, NGS150		



filters



1

<b>GEV No.</b>	691323	<b>Ref. No.</b>	130800 852140002 942063002
<b>description</b>	drain filter kettle size 94x55mm		
<b>For models:</b>	EES060, EES080, EGS060, FEK040, FEK060, FEK080, FEK100, FEK150, FES040, FES060, FES080, FES100, FES150, FGS040, FGS060, FGS080, FGS100, FGS150, FNK040, FNK060, FNK080, FNK100, FNK150, FNS040, FNS060, FNS080, FNS100, FNS150, LES060, LGS060, NES040, NES060, NES080, NES100, NES150, NGS040, NGS060, NGS080, NGS100, NGS150, NHS040, NHS060, NHS080, NHS100, NHS150, NNS040, NNS060, NNS080, NNS100, NNS150...(Other models you can see in the webshop)		

gearboxes

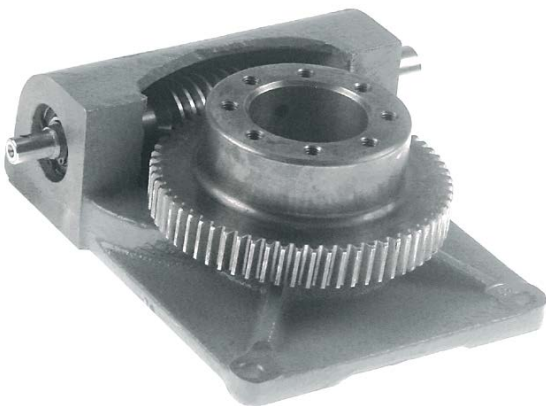

1

<b>GEV No.</b>	520402	<b>Ref. No.</b>	115914 780709004
<b>description</b>	auger gear		
<b>For models:</b>	NEK040, NEK060, NEK080, NEK100, NEK150, NNK040, NNK060, NNK080, NNK100, NNK150		

glass panels



1

<b>GEV No.</b>	691322	<b>Ref. No.</b>	148990 504872 537365
<b>description</b>	glass panel ø 40mm thickness 4mm		
<b>For models:</b>	CBG110, CBG120, CGD110, CGD120, EGB230, EGB430, EGF124, EGF224, EGP500, FGH500, FGH507, FGW250, LGB430, LGF124, LGF224, LGG420, LGP400, NGB430, NGF144, NGF224, NNG420, NGH500, NGH503, NGH505, NGH507, NGH720, NGH723, NGH725, NGH727, NGH730, NGH733, NGH737, NPG400, NPG600, NPG900, NGW250, NGW450, PGB438, PGF148, PGF228, PGH508, PGW458		

for ovens

miscellaneous



1

<b>GEV No.</b>	691321	<b>Ref. No.</b>	504871 537366 706610000
<b>description</b>	frame		
<b>For models:</b>	CBG110, CBG120, CGD110, CGD120, EGB230, EGB430, EGF124, EGF224, EGP500, FGH500, FGH507, FGW250, LGB430, LGF124, LGF224, LGG420, LGP400, NGB430, NGF144, NGF224, NNG420, NGH500, NGH503, NGH505, NGH507, NGH720, NGH723, NGH725, NGH727, NGH730, NGH733, NGH737, NPG400, NPG600, NPG900, NGW250, NGW450, PGB438, PGF148, PGF228, PGH508, PGW458		

for dishwashers

drain and intake components

miscellaneous

overflow pipes



1

<b>GEV No.</b>	691324	<b>Ref. No.</b>	061427 540244
<b>description</b>	overflow pipe L 90mm ø 40mm		
<b>For models:</b>	EEB230, EEB430, EGB230, EGB430		

washing and rinsing systems



1

<b>GEV No.</b>	510643	<b>Ref. No.</b>	408860
<b>description</b>	rinse jet		
<b>For models:</b>	KGD131, KGE052, KGE066, KGE081, KGE131		



1

<b>GEV No.</b>	521019	<b>Ref. No.</b>	408839
<b>description</b>	union nut wash jet		
<b>For models:</b>	KGD131, KGE052, KGE066, KGE081, KGE131		

knobs

producer-specific knobs

KÜPPERSBUSCH



1

<b>GEV No.</b>	110189	<b>Ref. No.</b>	189005 189009
<b>description</b>	knob without symbol ø 62mm shaft ø 6x4.6mm shaft flat upper black		
<b>For models:</b>	CBE106, CBE106-VAR091, CBE110, CBE110-VAR091, CBE120, CBE120-VAR091, CBE220, CBE220-VAR091, CBG110, CBG120, CEC106, CEC110, CEC120, CEC220, CED106, CED110, CED120, CED220, CGD110, CGD120, EAB051, ECD106, ECD110, ECD120, ECD220, ECL484, EDC106, EEB230, EEB430, EEF040, EEF124, EEF224, EEH210, EEH300, EEH410, EEH413, EEH500, EEH503, EEH610, EEH613, EEH700, EEH703, EEP500, EES060, EES080, EEW250, EEW400, EEW450, EEW452, EGB230...(Other models you can see in the webshop)		
<b>spare parts for</b>	110189		
		<b>GEV No.</b>	111776 <b>Ref. No.</b> —
	knob spring L 13.2mm W 7.4mm thickness 0.4mm Qty 10 pcs		



1

<b>GEV No.</b>	111567	<b>Ref. No.</b>	100302
<b>description</b>	knob dial plate black manual/automatic t.max.°C°C		
<b>For models:</b>	NEP601, NEP901, NER080, NER150, NER250, NER300, NER400, NES040, NES060, NES080, NES100, NES150, NGR150, NGR250, NGR300, NGR400, NGS040, NGS060, NGS080, NGS100, NGS150, NNR080, NNR150, NNR250, NNR300, NNR400, NNS040, NNS060, NNS080, NNS100, NNS150		



1

<b>GEV No.</b>	111555	<b>Ref. No.</b>	144769
<b>description</b>	knob dial plate energy regulator 1-3-2-circuit		



1

<b>GEV No.</b>	111712	<b>Ref. No.</b>	141096
<b>description</b>	knob dial plate gas tap with ignition flame		
<b>For models:</b>	EGS060, GH0101, NGH500, NGH503, NGH505, NGH507, NGH720, NGH723, NGH725, NGH727, NGH730, NGH733, NGH737, PGH508		



1

<b>GEV No.</b>	111956	<b>Ref. No.</b>	100329
<b>description</b>	knob dial plate gas tap with ignition flame		
<b>For models:</b>	EGH210, EGH410, EGH413, EGH417, EGH610, EGH613, EGH617, FGH210, FGH410, FGH413, FGH415, FGH417, FGH500, FGH507, FGH610, FGH613, FGH615, FGH617, PGH218, PGH418, PGH508, PGH618		



1

<b>GEV No.</b>	111713	<b>Ref. No.</b>	141124
<b>description</b>	knob dial plate gas thermostat 1-8 EGA		
<b>For models:</b>	NGF144		



1

<b>GEV No.</b>	110538	<b>Ref. No.</b>	141111
<b>description</b>	knob dial plate red gas tap with ignition flame EGA24197 t.max.°C°C ED ø 59mm ID ø 45.5mm		
<b>For models:</b>	LGP400, LGS060, NGP400, NGP600, NGP900, NGS040, NGS060, NGS080, NGS100, NGS150		



1

<b>GEV No.</b>	110547	<b>Ref. No.</b>	141110
<b>description</b>	knob dial plate red gas thermostat EGA 1-8 t.max.°C°C ED ø 59mm ID ø 45.5mm		
<b>For models:</b>	EGH417, EGH617, LGH407, LGH607, NGH407, NGH417, NGH507, NGH607, NGH617, NGH727, NGH737		





1

<b>GEV No.</b>	111568	<b>Ref. No.</b>	141098
<b>description</b>	knob dial plate red gas thermostat ROBERTSHAW t.max.°C°C ED ø 59mm ID ø 45.5mm		
<b>For models:</b>	NGR150, NGR250, NGR300, NGR400		





			
1			
<b>GEV No.</b>	110548	<b>Ref. No.</b>	141108
<b>description</b>	knob dial plate red switch 1-2-1-2 t.max.°C ED ø 59mm ID ø 45.5mm		
<b>For models:</b>	FEH415, FEH505, FEH515, FEH615, FEH705, FEH715, FGH415, FGH615, LEH405, LEH505, LEH605, LEH705, LGH405, LGH605, NEH415, NEH505, NEH615, NEH705, NGH405, NGH415, NGH505, NGH605, NGH615, NGH725		

			
1			
<b>GEV No.</b>	110532	<b>Ref. No.</b>	144767
<b>description</b>	knob dial plate red thermostat t.max. 300°C 0-300°C rotation 270° ED ø 59mm ID ø 45.5mm		
<b>For models:</b>	CED106, CED110, CED120, CED220		

			
1			
<b>GEV No.</b>	110533	<b>Ref. No.</b>	144766
<b>description</b>	knob dial plate red thermostat t.max. 100°C 0-100°C rotation 270° ED ø 59mm ID ø 45.5mm		
<b>For models:</b>	CED106, CED110, CED120, CED220		

			
1			
<b>GEV No.</b>	110549	<b>Ref. No.</b>	141106
<b>description</b>	knob dial plate red thermostat t.max. 300°C 50-300°C rotation 270° ED ø 59mm ID ø 45.5mm		
<b>For models:</b>	EEH413, EEH503, EEH613, EEH703, EGH413, EGH613, FEH413, FEH415, FEH503, FEH505, FEH513, FEH515, FEH613, FEH615, FEH705, FEH715, FGH413, FGH415, FGH613, FGH615, LEH405, LEH503, LEH505, LEH605, LEH703, LEH705, LGH405, LGH605, NEH413, NEH415, NEH505, NEH613, NEH615, NEH705, NGH403, NGH405, NGH413, NGH415, NGH503, NGH505, NGH603, NGH605, NGH613, NGH615, NGH723, NGH725, NGH730, NGH733		

			
1			
<b>GEV No.</b>	110546	<b>Ref. No.</b>	141109
<b>description</b>	knob dial plate red thermostat t.max. 110°C 30-110°C rotation 270° ED ø 59mm ID ø 45.5mm		
<b>For models:</b>	FEH613, FEH615, FEH705, FEH715, FEW252, FGH613, FGH615, LEH605, LEH703, LEH705, LEW452, LGH605, LGH607, NEA182, NEH212, NEH613, NEH615, NEH705, NEW182, NEW252, NEW452, NGH202, NGH603, NGH605, NGH607, NGH613, NGH615, NGH617, NGH723, NGH725, NGH727, NGH733, NGH737		

			
1			
<b>GEV No.</b>	110544	<b>Ref. No.</b>	144750
<b>description</b>	knob dial plate silver 0-FRITTIEREN-0-SCHMELZEN t.max.°C ED ø 59mm ID ø 45.5mm		
<b>For models:</b>	LEF124, LEF224, NEF124, NEF144, NEF224, NEF244, SEF124, SEF144, SEF224		

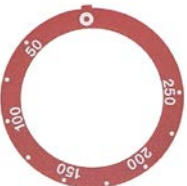
			
1			
<b>GEV No.</b>	110535	<b>Ref. No.</b>	141080
<b>description</b>	knob dial plate red thermostat t.max. 250°C 50-250°C rotation 270° ED ø 59mm ID ø 45.5mm		
<b>For models:</b>	CEC106, CEC110, CEC120, CEC220, EAB051, EDC106		

			
1			
<b>GEV No.</b>	111560	<b>Ref. No.</b>	144769
<b>description</b>	knob dial plate silver energy regulator 1-3 2-circuit t.max.°C ED ø 59mm ID ø 45.5mm		
<b>For models:</b>	LEH500, LEH503, LEH505, LEH700, LEH703, LEH705, SEH300, TEH300		

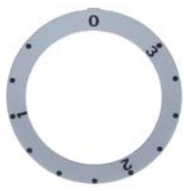

1

<b>GEV No.</b>	110551	<b>Ref. No.</b>	141078 141178
<b>description</b>	knob dial plate silver energy regulator 1-3 t.max.°C turn direction clockwise ED ø 59mm ID ø 45.5mm		
<b>For models:</b>	EEF040, EEH210, EEH300, EEH410, EEH413, EEH500, EEH503, EEH610, EEH613, EEH700, EEH703, EES060, EES080, FEF040, FEH500, FEH503, FEH505, FEH510, FEH513, FEH515, FEH700, FEH705, FEH710, FEH715, LEB231, LEB431, LEB631, LEF040, LEH500, LEH503, LEH505, LEH700, LEH703, LEH705, NEB431, NEB631, NEB831, NEF040, NEH500, NEH505, NEH700, NEH705, NEK040, NEK060, NEK080, NEK100, NEK150, NES040, NES060, NES080...(Other models you can see in the webshop)		



1

<b>GEV No.</b>	110558	<b>Ref. No.</b>	141096
<b>description</b>	knob dial plate silver gas tap PEL21/22/23 t.max.°C ED ø 59mm ID ø 45.5mm PEL		



1

<b>GEV No.</b>	110550	<b>Ref. No.</b>	141104
<b>description</b>	knob dial plate silver gas tap with ignition flame EGA26440 t.max.°C ED ø 59mm ID ø 45.5mm		
<b>For models:</b>	EGH210, EGH410, EGH413, EGH417, EGH610, EGH613, EGH617, LGB430, LGG420, NGB430, NGG420, NGH200, NGH202, NGH210, NGH400, NGH403, NGH405, NGH407, NGH410, NGH413, NGH415, NGH417, NGH600, NGH603, NGH605, NGH607, NGH610, NGH613, NGH615, NGH617, NGH720, NGH723, NGH725, NGH727, NGH737, PGH218, PGH418, PGH618		



1

<b>GEV No.</b>	110541	<b>Ref. No.</b>	141094
<b>description</b>	knob dial plate silver gas tap without ignition flame EGA26400 t.max.°C ED ø 59mm ID ø 45.5mm		
<b>For models:</b>	LGH405, LGH407, LGH605, LGH607		



1

<b>GEV No.</b>	110543	<b>Ref. No.</b>	141099
<b>description</b>	knob dial plate silver gas thermostat EGA 1-8 t.max.°C ED ø 59mm ID ø 45.5mm		
<b>For models:</b>	EGB230, EGB430, EGF124, EGF224, LGF124, LGF224, NGF224		



1

<b>GEV No.</b>	111946	<b>Ref. No.</b>	144744 144749
<b>description</b>	knob dial plate silver oven t.max.°C ED ø 59mm ID ø 45.5mm		
<b>For models:</b>	ECL484		



1

<b>GEV No.</b>	110542	<b>Ref. No.</b>	144734
<b>description</b>	knob dial plate silver switch 0-1-0-1 t.max.°C ED ø 59mm ID ø 45.5mm		



1

<b>GEV No.</b>	111569	<b>Ref. No.</b>	144734
<b>description</b>	knob dial plate silver switch 1-0-1 t.max.°C ED ø 59mm ID ø 45.5mm		
<b>For models:</b>	NDD080, NDD150, NDD250, NDD300, NED080, NED150, NED250, NED300, NEM100, NER080, NER150, NER250, NER300, NER400, NER500, NES040, NES060, NES080, NES100, NES150, NGR150, NGR250, NGR300, NGR400, NHD080, NHD150, NHD250, NHD300, NHR080, NHR150, NHR250, NHR300, NHR400, NHR500, NHS040, NHS060, NHS080, NHS100, NHS150, WES0400, WES0600, WES0800, WES1000, WES1500		



1

<b>GEV No.</b>	111711	<b>Ref. No.</b>	141079
<b>description</b>	knob dial plate silver switch 1-2-1-2 t.max.°C ED ø 59mm ID ø 45.5mm		
<b>For models:</b>	FEF124, FEF144, FEF224, PEF128, PEF148, PEF228		



1

<b>GEV No.</b>	110539	<b>Ref. No.</b>	141082
<b>description</b>	knob dial plate silver switch 2-0-1 t.max.°C 1-2°C ED ø 59mm ID ø 45.5mm		
<b>For models:</b>	EES060, EES080, LES060, NDD080, NDD150, NDD250, NDD300, NED080, NED150, NED250, NED300, NEK040, NEK060, NEK080, NEK100, NEK150, NER080, NER150, NER250, NER300, NER400, NER500, NES040, NES060, NES080, NES100, NES150, NHD080, NHD150, NHD250, NHD300, WES0400, WES0600, WES0800, WES1000, WES1500		



1

<b>GEV No.</b>	110537	<b>Ref. No.</b>	141093
<b>description</b>	knob dial plate silver switch zero mark t.max.°C ED ø 59mm ID ø 45.5mm		
<b>For models:</b>	EDC106, LES060, LGS060, NGS040, NGS060, NGS080, NGS100, NGS150, NGW250, NGW450		



1

<b>GEV No.</b>	111566	<b>Ref. No.</b>	100317
<b>description</b>	knob dial plate silver switch 2-0-1 t.max.°C ED ø 59mm ID ø 45.5mm		
<b>For models:</b>	EEW400		



1

<b>GEV No.</b>	110540	<b>Ref. No.</b>	141087
<b>description</b>	knob dial plate silver thermostat 1-10 t.max.°C 1-10°C rotation 270° ED ø 59mm ID ø 45.5mm		
<b>For models:</b>	LEB270, LES060, NEM100, NER080, NER150, NER250, NER300, NER400, NER500, NES040, NES060, NES080, NES100, NES150, NGR150, NGR250, NGR300, NGR400, NHR080, NHR150, NHR250, NHR300, NHR400, NHR500, NHS040, NHS060, NHS080, NHS100, NHS150, NNR080, NNR150, NNR250, NNR300, NNR400, NNR500, NNS040, NNS060, NNS080, NNS100, NNS150, SES400, WES0400, WES0600, WES0800, WES1000, WES1500		



1

<b>GEV No.</b>	110553	<b>Ref. No.</b>	141070
<b>description</b>	knob dial plate silver switch 4-position t.max.°C ED ø 59mm ID ø 45.5mm		
<b>For models:</b>	FEH210, FEH410, FEH413, FEH415, FEH610, FEH613, FEH615, NEH210, NEH212, NEH410, NEH413, NEH415, NEH610, NEH613, NEH615, NEP060, PEH218, PEH418, PEH618		

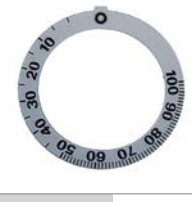

1

<b>GEV No.</b>	110556	<b>Ref. No.</b>	100305
<b>description</b>	knob dial plate silver thermostat t.max. 100°C 0-100°C rotation 270° ED ø 59mm ID ø 45.5mm		
<b>For models:</b>	CBE106, CBE106-VAR091, CBE110, CBE110-VAR091, CBE120, CBE120-VAR091, CBE220, CBE220-VAR091, CBG110, CBG120, CEC106, CEC110, CEC120, CEC220, CED106, CED110, CED120, CED220, CGD110, CGD120		



1

<b>GEV No.</b>	110552	<b>Ref. No.</b>	141061 141069
<b>description</b>	knob dial plate silver switch 7-position t.max.°C ED ø 59mm ID ø 45.5mm		
<b>For models:</b>	EHO101, EHO111, FEH210, FEH410, FEH413, FEH415, FEH610, FEH613, FEH615, LEH405, LEH605, NEH210, NEH212, NEH410, NEH413, NEH415, NEH610, NEH613, NEH615, PEH218, PEH418, PEH618, SEH200		



1

<b>GEV No.</b>	111562	<b>Ref. No.</b>	100315
<b>description</b>	knob dial plate silver thermostat t.max. 110°C 30-110°C rotation 270° ED ø 59mm ID ø 45.5mm		
<b>For models:</b>	EEW250, EEW450, EEW452		



1

<b>GEV No.</b>	110545	<b>Ref. No.</b>	141091
<b>description</b>	knob dial plate silver thermostat t.max. 110°C 30-110°C rotation 310° ED ø 59mm ID ø 45.5mm		
<b>For models:</b>	FEW250, FEW252, LEW450, LEW452, NEA182, NEW180, NEW182, NEW250, NEW252, NEW450, NEW452, PEW458, PEW658, SEW250, SEW400, SEW450, TEW250, TEW400, TEW450		

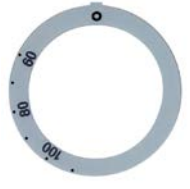

1

<b>GEV No.</b>	111565	<b>Ref. No.</b>	100320
<b>description</b>	knob dial plate silver thermostat t.max. 110°C 60-110°C rotation 180° ED ø 59mm ID ø 45.5mm		
<b>For models:</b>	EEW400		



1

<b>GEV No.</b>	111564	<b>Ref. No.</b>	100319
<b>description</b>	knob dial plate silver thermostat t.max. 185°C 100-185°C rotation 270° ED ø 59mm ID ø 45.5mm		
<b>For models:</b>	EEF124, EEF224		



1

<b>GEV No.</b>	110536	<b>Ref. No.</b>	141092
<b>description</b>	knob dial plate silver thermostat t.max. 195°C 100-195°C rotation 270° ED ø 59mm ID ø 45.5mm		
<b>For models:</b>	LEF124, LEF224, NEF124, NEF144, NEF176, NEF224, NEF244, SEF124, SEF144, SEF224, TEF124, TEF144, TEF224		



1

<b>GEV No.</b>	111563	<b>Ref. No.</b>	100312
<b>description</b>	knob dial plate silver thermostat t.max. 195°C 100-195°C rotation 270° ED ø 59mm ID ø 45.5mm		
<b>For models:</b>	FEF124, FEF144, FEF224, PEF128, PEF148, PEF228		

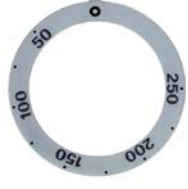

1

<b>GEV No.</b>	111947	<b>Ref. No.</b>	141088
<b>description</b>	knob dial plate silver thermostat t.max. 250°C 50-250°C rotation 270° ED ø 59mm ID ø 45.5mm		
<b>For models:</b>	ECL484		



1

<b>GEV No.</b>	110557	<b>Ref. No.</b>	100309
<b>description</b>	knob dial plate silver thermostat t.max. 270°C 0-270°C rotation 250° ED ø 59mm ID ø 45.5mm		
<b>For models:</b>	CBE106, CBE106-VAR091, CBE110, CBE110-VAR091, CBE120, CBE120-VAR091, CBE220, CBE220-VAR091, CBG110, CBG120, CEC106, CEC110, CEC120, CEC220, CGD110, CGD120		



1

<b>GEV No.</b>	110554	<b>Ref. No.</b>	100307
<b>description</b>	knob dial plate silver thermostat t.max. 300°C 0-300°C rotation 270° ED ø 59mm ID ø 45.5mm		
<b>For models:</b>	CED106, CED110, CED120, CED220		



1

<b>GEV No.</b>	110530	<b>Ref. No.</b>	141077 144707
<b>description</b>	knob dial plate silver thermostat t.max. 300°C 60-300°C rotation 270° ED ø 59mm ID ø 45.5mm		
<b>For models:</b>	ECD106, ECD110, ECD120, ECD220, EEB230, EEB430, EEP500, EGP500, FEB430, FEB630, FEP600, FEP900, LEB430, LEG420, LEP400, NEB430, NEB630, NEG420, NEP060, NEP203, NEP303, NEP400, NEP600, NEP900, PEB438, PEB638, PEP608, PEP908, PGP608, PGP908, SEB230, SEB430, SEB630, SEG220, SEG420, SEG620		



			
1			
<b>GEV No.</b>	110531	<b>Ref. No.</b>	144706
<b>description</b>	knob dial plate silver time 120min + permanent ON t.max.°C ED ø 59mm ID ø 45.5mm		
<b>For models:</b>	ECD106, ECD110, ECD120, ECD220, ECL484		

			
1			
<b>GEV No.</b>	110534	<b>Ref. No.</b>	144770
<b>description</b>	knob dial plate silver time 120min + permanent ON t.max.°C ED ø 59mm ID ø 45.5mm		
<b>For models:</b>	CEC106, CEC110, CEC120, CEC220, CED106, CED110, CED120, CED220		

			
1			
<b>GEV No.</b>	110555	<b>Ref. No.</b>	100306
<b>description</b>	knob dial plate silver time 120min + permanent ON t.max.°C ED ø 59mm ID ø 45.5mm		
<b>For models:</b>	CBE106, CBE106-VAR091, CBE110, CBE110-VAR091, CBE120, CBE120-VAR091, CBE220, CBE220-VAR091, CBG110, CBG120, CEC106, CEC110, CEC120, CEC220, CED106, CED110, CED120, CED220, CGD110, CGD120		

## accessories

### gaskets

			
1			
<b>GEV No.</b>	550886	<b>Ref. No.</b>	060306
<b>description</b>	gasket for shaft shaft ø 6x4.6mm ED ø 18mm rubber		
<b>For models:</b>	CBE106, CBE106-VAR091, CBE110, CBE110-VAR091, CBE120, CBE120-VAR091, CBE220, CBE220-VAR091, CBG110, CBG120, CEC106, CEC110, CEC120, CEC220, CED106, CED110, CED120, CED220, CGD110, CGD120, EEB230, EEB430, EEH210, EEH300, EEH410, EEH413, EEH500, EEH503, EEH610, EEH613, EEH700, EEH703, EEP500, EES060, EES080, EGH413, EGH613, EGP500, EGS060, FEB430, FEB630, FEF040, FEF124, FEF144, FEF224, FEH210, FEH410, FEH413, FEH415, FEH500...(Other models you can see in the webshop)		

### knob screws

			
1			
<b>GEV No.</b>	110066	<b>Ref. No.</b>	133364
<b>description</b>	knob screw		

## handles and hand wheels

### hand wheels

			
1			
<b>GEV No.</b>	690860	<b>Ref. No.</b>	061424 062394 062395 358534 846881004
<b>description</b>	hand wheel ø 160mm D1 ø 40mm bore ø 16mm thread M5 hole distance 8mm groove widthmm L1 22mm L2 50mm handle length 75mm with folding handle		
<b>For models:</b>	LEP400, LGP400, NEK040, NEK060, NEK080, NEK100, NEK150, NNK040, NNK060, NNK080, NNK100, NNK150		

			
1			
<b>GEV No.</b>	690800	<b>Ref. No.</b>	540479
<b>description</b>	hand wheel ø 160mm D1 ø 45mm bore ø 16mm depth of bore 32mm thread groove width 5mm L1 25mm L2 60mm handle length 82mm with folding handle		
<b>spare parts for</b>	690800		
		<b>GEV No.</b>	514428
		<b>Ref. No.</b>	—





1

<b>GEV No.</b>	690901	<b>Ref. No.</b>	540479
<b>description</b>	hand wheel $\varnothing$ 160mm D1 $\varnothing$ 45mm bore $\varnothing$ 16mm thread groove width 5mm L1 27mm L2 60mm handle length 85mm with folding handle		
<b>spare parts for</b>	690901		
	<b>GEV No.</b>	514428	<b>Ref. No.</b> —
	folding handle $\varnothing$ 25mm total length 115mm seat $\varnothing$ 26mm thread M8 with automatic return		



1

<b>GEV No.</b>	690553	<b>Ref. No.</b>	061425 062395
<b>description</b>	hand wheel $\varnothing$ 200mm D1 $\varnothing$ 50mm bore $\varnothing$ 16mm thread M6 hole distance 15mm groove widthmm L1 34mm L2 142mm handle length 85mm with folding handle		
<b>For models:</b>	NEP400, NEP600, NEP900, NGP400, NGP600, NGP900		
<b>spare parts for</b>	690553		
	<b>GEV No.</b>	514255	<b>Ref. No.</b> —
	folding handle $\varnothing$ 26mm total length 85mm seat $\varnothing$ 20mm shaft $\varnothing$ mm thread M6 with pin L 85mm		

spare parts and accessories



1

<b>GEV No.</b>	540246	<b>Ref. No.</b>	407033
<b>description</b>	cylindrical handle thread M8 $\varnothing$ 23mm L 65mm rotary		
<b>For models:</b>	NEK040, NEK060, NEK080, NEK100, NEK150, NNK040, NNK060, NNK080, NNK100, NNK150		

cylindrical handles

rotary



1

<b>GEV No.</b>	540246	<b>Ref. No.</b>	407033
<b>description</b>	cylindrical handle thread M8 $\varnothing$ 23mm L 65mm rotary		
<b>For models:</b>	NEK040, NEK060, NEK080, NEK100, NEK150, NNK040, NNK060, NNK080, NNK100, NNK150		

ball handles



1

<b>GEV No.</b>	540323	<b>Ref. No.</b>	356406
<b>description</b>	ball handle thread M10 $\varnothing$ 40mm with metal bush black		
<b>For models:</b>	EAB081, EAB101, EAB102, EAB112, EEP500, EES060, EES080, EGP500, EGS060, FED080, FED150, FED250, FED300, FEK040, FEK060, FEK080, FEK100, FEK150, FEP230, FEP330, FES040, FES060, FES080, FES100, FES150, FGS040, FGS060, FGS080, FGS100, FGS150, FNK040, FNK060, FNK080, FNK100, FNK150, FNS040, FNS060, FNS080, FNS100, FNS150, LES060, LGS060, NDD080, NDD150, NDD250, NDD300, NED080, NED150, NED250, NED300...(Other models you can see in the web-shop)		

accessories

marking caps



1

<b>GEV No.</b>	514358	<b>Ref. No.</b>	151904
<b>description</b>	marking cap blue hood handle		





1			
<b>GEV No.</b>	514359	<b>Ref. No.</b>	151903
<b>description</b>	marking cap red hood handle		



## locks

### turning lever locks

#### universal

#### RAHRBACH





1			
<b>GEV No.</b>	700098	<b>Ref. No.</b>	407376
<b>description</b>	door catch mounting pos. right off-set 38mm L 110mm H 74mm W 33mm mounting distance 68/68mm series 1750		
<b>For models:</b>	ECD120, ECD220		
<b>spare parts for</b>	700098		
	<b>GEV No.</b>	690136	<b>Ref. No.</b>
			407377 707377
	sliding plate mounting pos. right L 28mm H 3mm W 21mm H2 12.5mm		
<b>accessories for</b>	700098		
	<b>GEV No.</b>	514281	<b>Ref. No.</b>
			—
	base plate L 110mm W 35mm for door catch thickness 10mm		



1			
<b>GEV No.</b>	690136	<b>Ref. No.</b>	407377 707377
<b>description</b>	sliding plate mounting pos. right L 28mm H 3mm W 21mm H2 12.5mm		
<b>For models:</b>	ECD120, ECD220		

### STUV



1			
<b>GEV No.</b>	700098	<b>Ref. No.</b>	407376
<b>description</b>	door catch mounting pos. right off-set 38mm L 110mm H 74mm W 33mm mounting distance 68/68mm series 1750		
<b>For models:</b>	ECD120, ECD220		
<b>spare parts for</b>	700098		
	<b>GEV No.</b>	690136	<b>Ref. No.</b>
			407377 707377
	sliding plate mounting pos. right L 28mm H 3mm W 21mm H2 12.5mm		
<b>accessories for</b>	700098		
	<b>GEV No.</b>	514281	<b>Ref. No.</b>
			—
	base plate L 110mm W 35mm for door catch thickness 10mm		





## edgmount latches

### push button latches

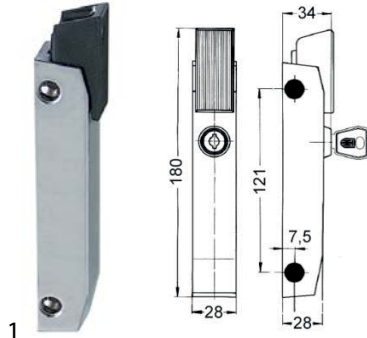
#### RAHRBACH

#### 6186 PRESTO series





1			
<b>GEV No.</b>	700045	<b>Ref. No.</b>	356468
<b>description</b>	push button latch L 180mm mounting distance 121mm non lockable refrigeration units 6186 H 34mm W 28mm type PRESTO		
<b>For models:</b>	EDC106		
<b>spare parts for</b>	700045		
	<b>GEV No.</b>	700046	<b>Ref. No.</b>
			—
	handle H 26.5mm L 55mm W 23.5mm plastic with spring spring length 14mm mounting thread M4 spring thickness 0.5mm		
<b>accessories for</b>	700045		
	<b>GEV No.</b>	690108	<b>Ref. No.</b>
			—
	base plate H 5mm L 47.5mm W 21mm for swinging strike hole distance 31mm type PRESTO no. 6186		
	<b>GEV No.</b>	690109	<b>Ref. No.</b>
			—
	base plate H 1mm L 47.5mm W 21mm plastic hole distance 31mm type PRESTO no. 6186		
	<b>GEV No.</b>	700050	<b>Ref. No.</b>
			162357
	door catch H 5mm L 47mm W 21mm hole distance 31mm with spigot refrigeration units type PRESTO no. 6186		
	<b>GEV No.</b>	700051	<b>Ref. No.</b>
			162357
	door catch H 5mm L 48mm W 21mm adjustable hole distance 31mm with spigot type PRESTO no. 6186		

handle latches

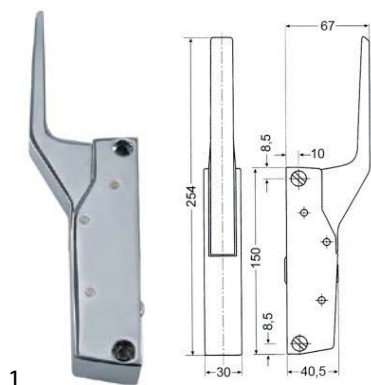
CAFF/FERMOD



<b>GEV No.</b>	700060	<b>Ref. No.</b>	133199
<b>description</b>	handle latch L 150mm mounting distance 133mm non lockable heated units G 791		
<b>For models:</b>	CBE106, CBE106-VAR091, CBE110, CBE110-VAR091, CBG110, CCE106, CCE110, CEC106, CEC110, CED106, CED110, CEF106, CEF110, CEM110, CGD110, CPE106, CPE110		
<b>accessories for</b>	700060		
	<b>GEV No.</b>	700061	<b>Ref. No.</b> 133200
	door catch L 58mm W 20mm H 35mm mounting distance 42mm chrome-plated brass for headed units		
	<b>GEV No.</b>	700062	<b>Ref. No.</b> —
	handle protection heated units		

producer-specific

KÜPPERSBUSCH



<b>GEV No.</b>	694474	<b>Ref. No.</b>	133030
<b>description</b>	catch L 174mm mounting distance 124/133mm non lockable 6200 black W 32mm total length 250mm		

STUV

3.30.016x.x series

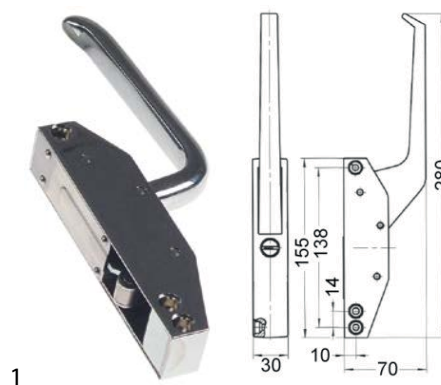

<b>GEV No.</b>	693517	<b>Ref. No.</b>	407282
<b>description</b>	catch		

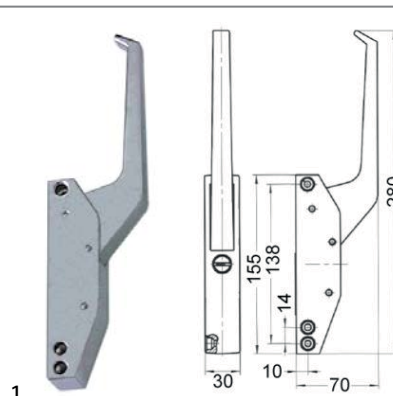





<b>GEV No.</b>	700063	<b>Ref. No.</b>	407282
<b>description</b>	handle latch L 155mm mounting distance 124/138mm non lockable refrigeration units 3.30.0164		
<b>For models:</b>	ECD106, ECD110		
<b>accessories for</b>	700063		
	<b>GEV No.</b>	700064	<b>Ref. No.</b> 407364
	door catch H 40mm L 28mm W 22mm		



door catches



<b>GEV No.</b>	700064	<b>Ref. No.</b>	407364
<b>description</b>	door catch H 40mm L 28mm W 22mm		
<b>For models:</b>	ECD106, ECD110		

			
1			
<b>GEV No.</b>	700050	<b>Ref. No.</b>	162357
<b>description</b>	door catch H 5mm L 47mm W 21mm hole distance 31mm with spigot refrigeration units type PRESTO no. 6186		
<b>accessories for</b>	700050		
			
<b>GEV No.</b>	690109	<b>Ref. No.</b>	—
<b>description</b>	base plate H 1mm L 47.5mm W 21mm plastic hole distance 31mm type PRESTO no. 6186		

			
1			
<b>GEV No.</b>	700051	<b>Ref. No.</b>	162357
<b>description</b>	door catch H 5mm L 48mm W 21mm adjustable hole distance 31mm with spigot type PRESTO no. 6186		
<b>For models:</b>	EAB051		
<b>accessories for</b>	700051		
			
<b>GEV No.</b>	690108	<b>Ref. No.</b>	—
<b>description</b>	base plate H 5mm L 47.5mm W 21mm for swinging strike hole distance 31mm type PRESTO no. 6186		

			
1			
<b>GEV No.</b>	700061	<b>Ref. No.</b>	133200
<b>description</b>	door catch L 58mm W 20mm H 35mm mounting distance 42mm chrome-plated brass for headed units		
<b>For models:</b>	CBE106, CBE106-VAR091, CBE110, CBE110-VAR091, CBG110, CCE106, CCE110, CEC106, CEC110, CED106, CED110, CEF106, CEF110, CEM110, CGD110, CPE106, CPE110		
<b>accessories for</b>	700061		
			
<b>GEV No.</b>	690414	<b>Ref. No.</b>	—
<b>description</b>	handle latch L 150mm mounting distance 133mm non lockable refrigeration units G 791		

			
1			
<b>GEV No.</b>	690123	<b>Ref. No.</b>	133032
<b>description</b>	door catch with roller		

## walk-in fridge catches

STUV

3.31.015x.x series

			
1			
<b>GEV No.</b>	700072	<b>Ref. No.</b>	407380
<b>description</b>	door catch H 17mm L 84mm W 53mm mounting distance 68mm zinc die cast with wedge heated units		
<b>For models:</b>	ECD120, ECD220		

## snap locks

producer-specific

KÜPPERSBUSCH

			
1			
<b>GEV No.</b>	700072	<b>Ref. No.</b>	407380
<b>description</b>	door catch H 17mm L 84mm W 53mm mounting distance 68mm zinc die cast with wedge heated units		
<b>For models:</b>	ECD120, ECD220		

			
1			
<b>GEV No.</b>	690101	<b>Ref. No.</b>	407379
<b>description</b>	snap lock L 85mm W 40mm mounting distance 68mm heated units H 63mm type 1750 series		
<b>For models:</b>	ECD120, ECD220		

## espagnolette locks

universal

			
1			
<b>GEV No.</b>	690041	<b>Ref. No.</b>	133195
<b>description</b>	cam L 148mm mounting distance 32mm		
<b>For models:</b>	CBE120, CBE120-VAR091, CBE220, CBE220-VAR091, CBG120, CCE120, CCE220, CEC120, CEC220, CED120, CED220, CEF120, CEF220, CEM120, CGD120, CPE120, CPE220		

			
1			
<b>GEV No.</b>	690040	<b>Ref. No.</b>	133196
<b>description</b>	door catch with roller H 42mm L 40mm W 40mm zinc die cast mounting distance 26mm type 0751 series		
<b>For models:</b>	CBE120, CBE120-VAR091, CBE220, CBE220-VAR091, CBG120, CCE120, CCE220, CEC120, CEC220, CED120, CED220, CEF120, CEF220, CEM120, CGD120, CPE120, CPE220		

producer-specific  
KÜPPERSBUSCH

			
1			
<b>GEV No.</b>	693527	<b>Ref. No.</b>	756156000
<b>description</b>	bar for door lock L 441mm ø 10mm		
<b>For models:</b>	CBE120, CBE120-VAR091, CBE220, CBE220-VAR091, CBG120, CCE120, CCE220, CEC120, CEC220, CED120, CED220, CEF120, CEF220, CEM120, CGD120, CPE120, CPE220		





			
1			
<b>GEV No.</b>	692173	<b>Ref. No.</b>	817970000
<b>description</b>	base plate H 1mm L 40mm W 40mm SS Qty 1 pcs		

			
1			
<b>GEV No.</b>	693530	<b>Ref. No.</b>	817970000
<b>description</b>	base plate L 40mm W 40mm for door catch thickness 1mm Qty 2 pcs		
<b>For models:</b>	CBE120, CBE120-VAR091, CBE220, CBE220-VAR091, CBG120, CCE120, CCE220, CEC120, CEC220, CED120, CED220, CEF120, CEF220, CEM120, CGD120, CPE120, CPE220		

			
1			
<b>GEV No.</b>	690041	<b>Ref. No.</b>	133195
<b>description</b>	cam L 148mm mounting distance 32mm		
<b>For models:</b>	CBE120, CBE120-VAR091, CBE220, CBE220-VAR091, CBG120, CCE120, CCE220, CEC120, CEC220, CED120, CED220, CEF120, CEF220, CEM120, CGD120, CPE120, CPE220		

			
1			
<b>GEV No.</b>	690040	<b>Ref. No.</b>	133196
<b>description</b>	door catch with roller H 42mm L 40mm W 40mm zinc die cast mounting distance 26mm type 0751 series		
<b>For models:</b>	CBE120, CBE120-VAR091, CBE220, CBE220-VAR091, CBG120, CCE120, CCE220, CEC120, CEC220, CED120, CED220, CEF120, CEF220, CEM120, CGD120, CPE120, CPE220		

			
1			
<b>GEV No.</b>	693516	<b>Ref. No.</b>	133193
<b>description</b>	door handle metal		
<b>For models:</b>	CBE120, CBE120-VAR091, CBE220, CBE220-VAR091, CBG120, CCE120, CCE220, CEC120, CEC220, CED120, CED220, CEF120, CEF220, CEM120, CGD120, CPE120, CPE220		

			
1			
<b>GEV No.</b>	690042	<b>Ref. No.</b>	133194
<b>description</b>	latch gear opening to the right shaft intake ø 8x8mm L 170mm W 40mm H 40mm		
<b>For models:</b>	CBE120, CBE120-VAR091, CBE220, CBE220-VAR091, CBG120, CCE120, CCE220, CEC120, CEC220, CED120, CED220, CEF120, CEF220, CEM120, CGD120, CPE120, CPE220		
<b>accessories for</b>	690042		
		<b>GEV No.</b>	690040
		<b>Ref. No.</b>	133196
	door catch with roller H 42mm L 40mm W 40mm zinc die cast mounting distance 26mm type 0751 series		
		<b>GEV No.</b>	690041
		<b>Ref. No.</b>	133195
	cam L 148mm mounting distance 32mm		
		<b>GEV No.</b>	691050
		<b>Ref. No.</b>	—
	bar ø 10mm for door latch L 113.5mm		

			
1			
<b>GEV No.</b>	692013	<b>Ref. No.</b>	156938
<b>description</b>	roll pin ø 3mm L 16mm		
<b>For models:</b>	CBE120, CBE120-VAR091, CBE220, CBE220-VAR091, CBG120, CCE120, CCE220, CEC120, CEC220, CED120, CED220, CEF120, CEF220, CEM120, CGD120, CPE120, CPE220, NGP600, NGP900		



hinges

piano hinges

producer-specific

KÜPPERSBUSCH

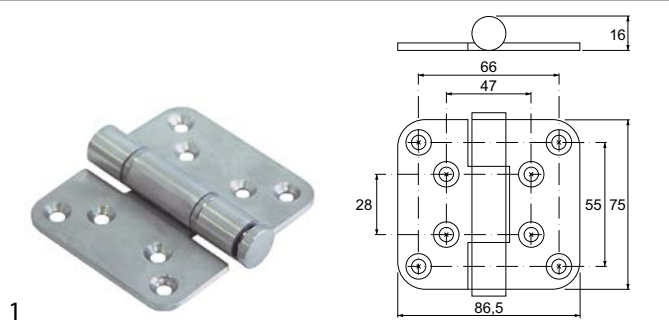

<b>GEV No.</b>	690004	<b>Ref. No.</b>	407367
<b>description</b>	hinge L 86.5mm W 75mm H 16mm mounting distance 66/55mm mounting distance 1 47/28mm hole ø 5mm thickness 3mm		
<b>For models:</b>	ECD106, ECD110		

edgmount hinges

RAHRBACH

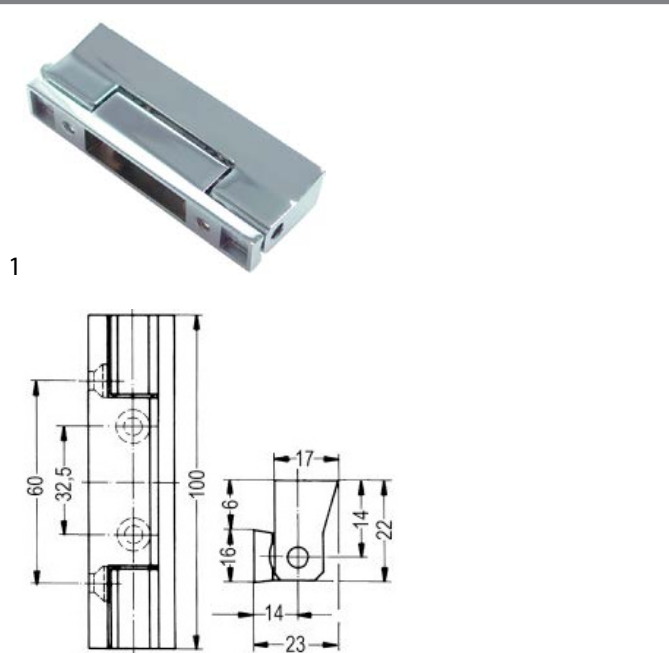

<b>GEV No.</b>	701094	<b>Ref. No.</b>	356467
<b>description</b>	edgmount hinge L 100mm W 19mm mounting distance 60/32.5mm non removable zinc die cast, chrome-plated heated units series 4484 centre of rotation 14/23mm		
<b>For models:</b>	EAB051, EAB081, EAB101, EDC106		

oven hinges

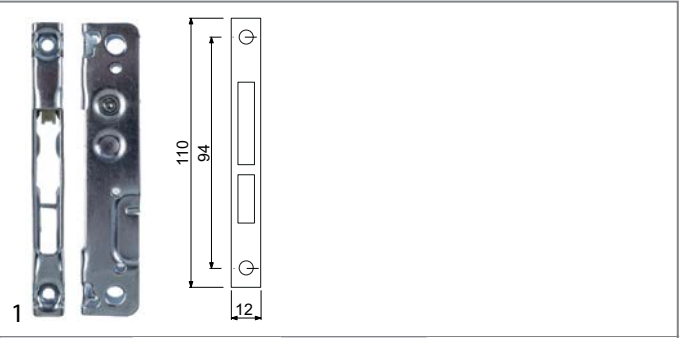

<b>GEV No.</b>	693045	<b>Ref. No.</b>	131603 131604 131618 133715 133777
<b>description</b>	opposite support L 110mm W 12mm mounting distance 94mm		
<b>For models:</b>	ECL484		

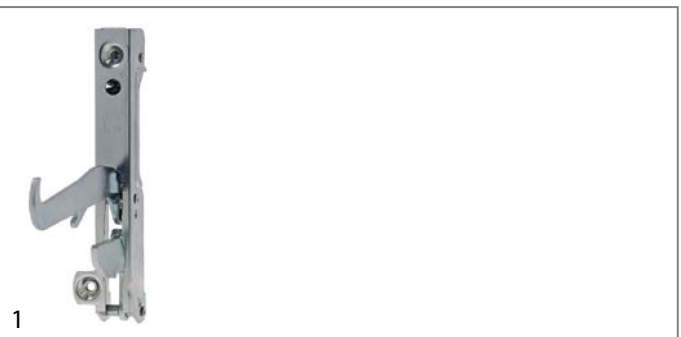

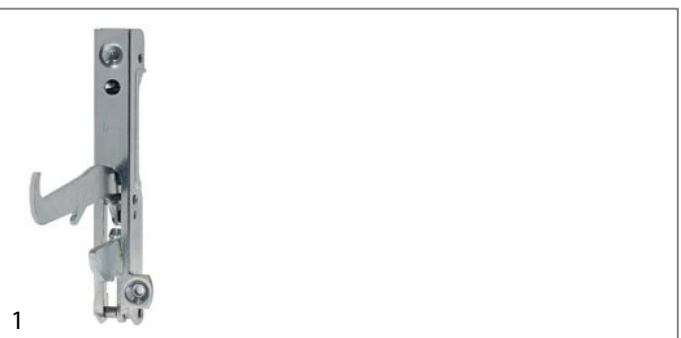

<b>GEV No.</b>	690157	<b>Ref. No.</b>	133776
<b>description</b>	oven hinge mounting distance 118mm mounting distance 2mm lug mounting 13mm lever length 114mm groove distance 6mm spring thickness 3.2mm mounting ear position left spring length 56mm L 152mm		
<b>For models:</b>	ECL484		



<b>GEV No.</b>	690156	<b>Ref. No.</b>	133775
<b>description</b>	oven hinge mounting distance 118mm mounting distance 2mm lug mounting 13mm lever length 114mm groove distance 6mm spring thickness 3.2mm mounting ear position right spring length 56mm L 152mm		
<b>For models:</b>	ECL484		

door bearing

			
1			
<b>GEV No.</b>	693535	<b>Ref. No.</b>	146725 756150000
<b>description</b>	bolt L 19mm mounting pos. upper/lower thread M6 ø 10mm		
<b>For models:</b>	CEC106, CEC110, CED106, CED110		

			
1			
<b>GEV No.</b>	693510	<b>Ref. No.</b>	146757 146795 756627000
<b>description</b>	bolt mounting pos. upper/lower for door hinge		
<b>For models:</b>	CBE106, CBE106-VAR091, CBE110, CBE110-VAR091, CBE120, CBE120-VAR091, CBE220, CBE220-VAR091, CBG110, CBG120, CCE106, CCE110, CCE120, CCE220, CEC106, CEC110, CEC120, CEC220, CED106, CED110, CED120, CED220, CEF106, CEF110, CEF120, CEF220, CEM110, CEM120, CGD110, CGD120, CPE106, CPE110, CPE120, CPE220		

			
1			
<b>GEV No.</b>	693514	<b>Ref. No.</b>	133545 133548
<b>description</b>	bush for hinge		
<b>For models:</b>	CBE106, CBE106-VAR091, CBE110, CBE110-VAR091, CBE120, CBE120-VAR091, CBE220, CBE220-VAR091, CBG110, CBG120, CCE106, CCE110, CCE120, CCE220, CEC106, CEC110, CEC120, CEC220, CED106, CED110, CED120, CED220, CEF106, CEF110, CEF120, CEF220, CEM110, CEM120, CGD110, CGD120, CPE106, CPE110, CPE120, CPE220		

			
1			
<b>GEV No.</b>	693512	<b>Ref. No.</b>	131605
<b>description</b>	hinge mounting pos. lower		
<b>For models:</b>	CBE106, CBE106-VAR091, CBE110, CBE110-VAR091, CBG110, CCE106, CCE110, CEC106, CEC110, CED106, CED110, CEF106, CEF110, CEM110, CGD110, CPE106, CPE110		

			
1			
<b>GEV No.</b>	693528	<b>Ref. No.</b>	987474002
<b>description</b>	hinge mounting pos. lower		
<b>For models:</b>	CEC120, CEC220, CED120, CED220		

			
1			
<b>GEV No.</b>	693529	<b>Ref. No.</b>	131606
<b>description</b>	hinge mounting pos. lower		
<b>For models:</b>	CBE120, CBE120-VAR091, CBE220, CBE220-VAR091, CBG120, CCE120, CCE220, CEC120, CEC220, CED120, CED220, CEF120, CEF220, CEM120, CGD120, CPE120, CPE220		

			
1			
<b>GEV No.</b>	693511	<b>Ref. No.</b>	817658000
<b>description</b>	hinge mounting pos. upper		
<b>For models:</b>	CEC106, CEC110, CED106, CED110		

			
1			
<b>GEV No.</b>	693521	<b>Ref. No.</b>	733607000 734382000
<b>description</b>	hinge mounting pos. upper		
<b>For models:</b>	CBE106, CBE106-VAR091, CBE110, CBE110-VAR091, CBE120, CBE120-VAR091, CBE220, CBE220-VAR091, CBG110, CBG120, CCE106, CCE110, CCE120, CCE220, CEC106, CEC110, CEC120, CEC220, CED106, CED110, CED120, CED220, CEF106, CEF110, CEF120, CEF220, CEM110, CEM120, CGD110, CGD120, CPE106, CPE110, CPE120, CPE220		

accessories

miscellaneous

			
1			
<b>GEV No.</b>	693513	<b>Ref. No.</b>	134382
<b>description</b>	door bumper		
<b>For models:</b>	CBE106, CBE106-VAR091, CBE110, CBE110-VAR091, CBE120, CBE120-VAR091, CBE220, CBE220-VAR091, CBG110, CBG120, CCE106, CCE110, CCE120, CCE220, CEC106, CEC110, CEC120, CEC220, CED106, CED110, CED120, CED220, CEF106, CEF110, CEF120, CEF220, CEM110, CEM120, CGD110, CGD120, CPE106, CPE110, CPE120, CPE220		

			
1			
<b>GEV No.</b>	693515	<b>Ref. No.</b>	131098
<b>description</b>	spring for hinge		
<b>For models:</b>	CEC106, CEC110, CEC120, CEC220, CED106, CED110, CED120, CED220		



**pullouts**

**rollers**

rollers

accessories



1



<b>GEV No.</b>	560133	<b>Ref. No.</b>	154896
<b>description</b>	hexagonal nut thread M6 H 5mm WS 10 SS DIN/ISO DIN 934 / ISO 4032/8673 Qty 20 pcs		
<b>For models:</b>	CEC106, CEC110, CEC120, CEC220, CGD110, CGD120, ECD106, ECD110, ECD120, ECD220, EEF040, EEF124, EEF224, EEW250, EEW400, EEW450, EEW452, FEF180, PEF188		

**fittings for catering equipment**

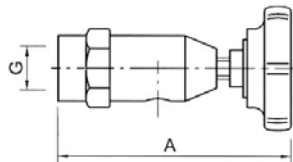
**aerators and air bleeders**



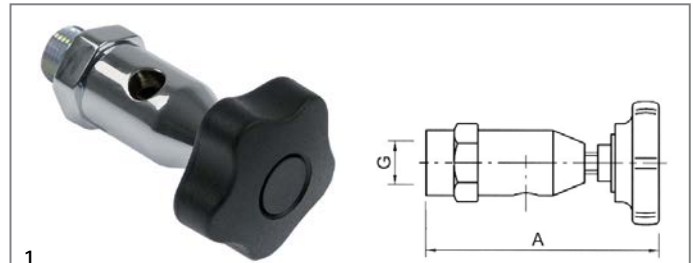

1

<b>GEV No.</b>	540016	<b>Ref. No.</b>	176017	
<b>description</b>	aerator and air bleeder thread 1/2" IT chrome-plated L 78mm			
<b>For models:</b>	NEM100, NES040, NES060, NES080, NES100, NES150, NGR150, NGR250, NGR300, NGR400, NGS040, NGS060, NGS080, NGS100, NGS150, NHS040, NHS060, NHS080, NHS100, NHS150, NNM100, NNS040, NNS060, NNS080, NNS100, NNS150			
<b>spare parts for</b>	540016			
	<b>GEV No.</b>	112777	<b>Ref. No.</b>	—
	star handle shaft 6x6mm ø 50mm L 18mm black plastic			
	<b>GEV No.</b>	540365	<b>Ref. No.</b>	—
	star handle shaft 6x6mm ø 50mm L 18mm black thermoplastic			





1

<b>GEV No.</b>	540013	<b>Ref. No.</b>	176009	
<b>description</b>	aerator and air bleeder thread 3/8" ET WS 27 chrome-plated L 86mm			
<b>For models:</b>	LES060, LGS060, NEK040, NEK060, NEK080, NEK100, NEK150, NER080, NER150, NER250, NER300, NER400, NER500, NGS040, NGS060, NGS080, NGS100, NGS150, NHR080, NHR100, NHR150, NHR250, NHR300, NHR400, NHR500, NHS040, NHS060, NHS080, NHS100, NHS150, NNK040, NNK060, NNK080, NNK100, NNK150, NNR080, NNR150, NNR250, NNR300, NNR400, NNR500, NNS040, NNS060, NNS080, NNS100, NNS150, WES0400, WES0600, WES0800, WES1000... (Other models you can see in the webshop)			
<b>spare parts for</b>	540013			
	<b>GEV No.</b>	112777	<b>Ref. No.</b>	—
	star handle shaft 6x6mm ø 50mm L 18mm black plastic			
	<b>GEV No.</b>	540365	<b>Ref. No.</b>	—
	star handle shaft 6x6mm ø 50mm L 18mm black thermoplastic			

**steam valves**



1

<b>GEV No.</b>	541543	<b>Ref. No.</b>	172655	
<b>description</b>	steam valve straight connection 1 1/4" IT total length 110mm H 148mm brass			
<b>For models:</b>	NNR080, NNR150, NNR250, NNR300, NNR400, NNR500			
<b>spare parts for</b>	541543			
	<b>GEV No.</b>	540229	<b>Ref. No.</b>	—
	star handle shaft 9x9mm ø 80mm L 23mm black thermoplastic			
	<b>GEV No.</b>	541546	<b>Ref. No.</b>	—
	screw chrome-plated brass thread M5 thread L 10mm			



1

<b>GEV No.</b>	541542	<b>Ref. No.</b>	172654
<b>description</b>	steam valve straight connection 1" IT total length 90mm H 140mm brass		
<b>For models:</b>	NNM100, NNS080, NNS100, NNS150		
<b>spare parts for</b>	541542		
	<b>GEV No.</b>	540229	<b>Ref. No.</b> —
	star handle shaft 9x9mm ø 80mm L 23mm black thermoplastic		
	<b>GEV No.</b>	541546	<b>Ref. No.</b> —
	screw chrome-plated brass thread M5 thread L 10mm		
	<b>GEV No.</b>	541548	<b>Ref. No.</b> —
	gasket PTFE ID ø 15mm H 7mm for thread 1 1/4" ED ø 35mm		
	<b>GEV No.</b>	541554	<b>Ref. No.</b> —
	gasket copper ext. ø 49 ID ø 42mm H 2mm for thread 1 1/4"		
	<b>GEV No.</b>	541557	<b>Ref. No.</b> —
	tap head chrome-plated thread 1 1/4" for steam tap 1"		



1

<b>GEV No.</b>	541541	<b>Ref. No.</b>	358137
<b>description</b>	steam valve straight connection 3/4" IT total length 75mm H 118mm brass		
<b>For models:</b>	NNA182, NNK040, NNK060, NNK080, NNK100, NNK150, NNS040, NNS060, NNW180, NNW182		
<b>spare parts for</b>	541541		
	<b>GEV No.</b>	541546	<b>Ref. No.</b> —
	screw chrome-plated brass thread M5 thread L 10mm		
	<b>GEV No.</b>	541547	<b>Ref. No.</b> —
	gasket PTFE ID ø 9.5mm H 7mm for thread 1" ED ø 27.5mm		
	<b>GEV No.</b>	541553	<b>Ref. No.</b> —
	gasket copper ext. ø 39 ID ø 33mm H 2mm for thread 1"		
	<b>GEV No.</b>	541556	<b>Ref. No.</b> —
	tap head chrome-plated thread 1" for steam tap 3/4"		
	<b>GEV No.</b>	541559	<b>Ref. No.</b> —
	star handle shaft 8x8mm ø 80mm L 23mm black thermoplastic		

lid hinges

type ECHTERMANN

10 series

10.11



1

<b>GEV No.</b>	700199	<b>Ref. No.</b>	134360
<b>description</b>	lid hinge type 6910.11 level of centre of rotation 72mm load capacity 50-60NM opening angle 80° closing angle 10° mounting distance 198mm bore ø 11mm chrome-plated		
<b>For models:</b>	NEK040, NEK060, NEK080, NEK100, NEK150, NNK040, NNK060, NNK080, NNK100, NNK150		
<b>spare parts for</b>	700199		
	<b>GEV No.</b>	691614	<b>Ref. No.</b> —
	repair kit for lid hinge load capacity 50-60NM		

10.82

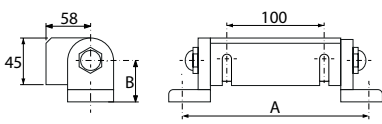
1

<b>GEV No.</b>	693214	<b>Ref. No.</b>	134357
<b>description</b>	lid hinge type 1082 level of centre of rotation 45mm load capacity 70-100NM opening angle 80° closing angle 10° mounting distance 220mm bore ø 11mm MD lid 100mm chrome-plated brass L 160mm mounting distance 1 hinge 220mm mounting distance 2 lid 100mm		
<b>For models:</b>	NEP600, NEP900		
<b>spare parts for</b>	693214		
	<b>GEV No.</b>	691615	<b>Ref. No.</b> —
	repair kit for lid hinge load capacity 70-100NM		

10.84

1

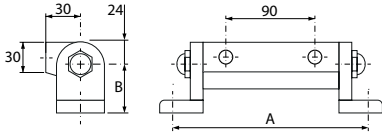
<b>GEV No.</b>	540876	<b>Ref. No.</b>	131627
<b>description</b>	lid hinge type 1084 level of centre of rotation 45mm load capacity 10-20NM opening angle 75° closing angle 10° mounting distance 198mm bore ø 11mm MD lid 90mm 53.5 MT lid M8mm chrome-plated brass		
<b>For models:</b>	EES060, EES080, EGS060, FES040, FES060, FGS040, FGS060, FNS040, FNS060, PES048, PES068, PGS048, PGS068, PNS048, PNS068		
<b>spare parts for</b>	540876		
	<b>GEV No.</b>	691611	<b>Ref. No.</b> —
	repair kit for lid hinge load capacity 10-20NM		



<b>GEV No.</b>	700196	<b>Ref. No.</b>	134372
<b>description</b>	lid hinge type 1084 level of centre of rotation 45mm load capacity 30-50NM opening angle 75° closing angle 10° mounting distance 198mm bore ø 11mm MD lid 90mm 53.5 MT lid M8mm chrome-plated brass		
<b>For models:</b>	FEK040, FEK060, FEK080, FEK100, FES080, FES100, FGS080, FGS100, FNK040, FNK060, FNK080, FNK100, FNS080, FNS100, NES040, NES060, NES080, NES100, NGS040, NGS060, NGS080, NGS100, NHS040, NHS060, NHS080, NHS100, NNS040, NNS060, NNS080, NNS100, PEK048, PEK068, PEK088, PEK108, PES088, PES108, PGS088, PNK048, PNK068, PNK088, PNK108, PNS088, PNS108		
<b>spare parts for</b>	700196		
	<b>GEV No.</b>	560576	<b>Ref. No.</b> —
	grub screw thread M8 L 30mm SS DIN 914 WS 4 Qty 10 pcs		
	<b>GEV No.</b>	691613	<b>Ref. No.</b> —
	repair kit for lid hinge load capacity 30-50NM		

<b>GEV No.</b>	700198	<b>Ref. No.</b>	134373
<b>description</b>	lid hinge type 1084 level of centre of rotation 45mm load capacity 50-60NM opening angle 75° closing angle 10° mounting distance 198mm bore ø 11mm MD lid 90mm 53.5 MT lid M8mm chrome-plated brass		
<b>For models:</b>	FES150, FGS150, FNS150, NES150, NGS150, NHS150, NNS150, PES158, PNS158		
<b>spare parts for</b>	700198		
	<b>GEV No.</b>	691614	<b>Ref. No.</b> —
	repair kit for lid hinge load capacity 50-60NM		

<b>10.88</b>			
<b>GEV No.</b>	690848	<b>Ref. No.</b>	154400
<b>description</b>	lid hinge type 1088 level of centre of rotation 45mm bore ø 11mm MD lid 220mm chrome-plated L 160mm mounting distance 1 hinge 220mm mounting distance 2 lid 90mm		
<b>For models:</b>	FEK150, FNK150, PEK158, PNK158		
<b>spare parts for</b>	690848		
	<b>GEV No.</b>	691615	<b>Ref. No.</b> —
	repair kit for lid hinge load capacity 70-100NM		

<b>10.89</b>			
<b>GEV No.</b>	693213	<b>Ref. No.</b>	131608
<b>description</b>	lid hinge type 10.89 level of centre of rotation 35mm load capacity 20-30NM opening angle 87° closing angle 10° mounting distance 214mm bore ø 8.5mm MD lid 120mm chrome-plated brass		
<b>For models:</b>	NEP400, NEP600, NEP601, NGP600		
<b>spare parts for</b>	693213		
	<b>GEV No.</b>	691612	<b>Ref. No.</b> —
	repair kit for lid hinge load capacity 20-30NM		

<b>GEV No.</b>	693215	<b>Ref. No.</b>	131609
<b>description</b>	lid hinge type 10.89 level of centre of rotation 35mm load capacity 70-100NM opening angle 87° closing angle 10° mounting distance 214mm bore ø 8.5mm MD lid 120mm chrome-plated brass		
<b>For models:</b>	NEP600, NEP601, NEP900, NEP901, NGP600, NGP900		
<b>spare parts for</b>	693215		
	<b>GEV No.</b>	691615	<b>Ref. No.</b> —
	repair kit for lid hinge load capacity 70-100NM		

<b>10.91</b>			
<b>GEV No.</b>	693212	<b>Ref. No.</b>	131624
<b>description</b>	lid hinge type 10.91 level of centre of rotation 75mm load capacity 20-30NM opening angle 87° closing angle 10° mounting distance 175mm MD lid 120mm chrome-plated brass mounting thread M8		
<b>For models:</b>	EEP500, EGP500		
<b>spare parts for</b>	693212		
	<b>GEV No.</b>	691612	<b>Ref. No.</b> —
	repair kit for lid hinge load capacity 20-30NM		



10.92

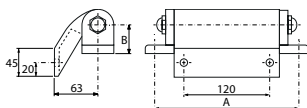

<b>GEV No.</b>	693211	<b>Ref. No.</b>	131619
<b>description</b>	lid hinge level of centre of rotation 35mm load capacity 70-100NM opening angle 87° closing angle 10° mounting distance 220mm bore ø 11mm MD lid 120mm chrome-plated brass		
<b>For models:</b>	FEP600, FEP610, FEP900, FEP910, PEP608, PEP618, PEP908, PEP918, PGP608, PGP618, PGP908, PGP918		
<b>spare parts for</b>	693211		
	<b>GEV No.</b>	691615	<b>Ref. No.</b> —
repair kit for lid hinge load capacity 70-100NM			

11 series

11.80



<b>GEV No.</b>	693216	<b>Ref. No.</b>	131930
<b>description</b>	lid hinge		
<b>For models:</b>	FEP230, PEP238		



<b>GEV No.</b>	693217	<b>Ref. No.</b>	131931
<b>description</b>	lid hinge		
<b>For models:</b>	FEP330, PEP338		

11.81



<b>GEV No.</b>	690850	<b>Ref. No.</b>	154401
<b>description</b>	lid hinge		
<b>For models:</b>	FED150, PED158		



<b>GEV No.</b>	690851	<b>Ref. No.</b>	133701 133761
<b>description</b>	lid hinge		
<b>For models:</b>	FED250, PED258		

12 series

12.84

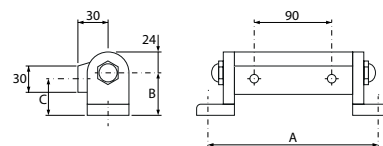

<b>GEV No.</b>	693447	<b>Ref. No.</b>	144138
<b>description</b>	lid hinge type 1284 level of centre of rotation 50mm load capacity 30-50NM opening angle 80° closing angle 10° mounting distance 198mm bore ø 11mm MD lid 90mm 26.5 MT lid M8mm chrome-plated brass		
<b>spare parts for</b>	693447		
	<b>GEV No.</b>	691613	<b>Ref. No.</b> —
repair kit for lid hinge load capacity 30-50NM			

drain taps

accessories



<b>GEV No.</b>	540878	<b>Ref. No.</b>	143733
<b>description</b>	adapter drain tap IT 2" ET 1 1/2"		
<b>For models:</b>	FED080, FED150, FED250, FED300, PED088, PED158, PED258, PED308		



## steam traps

### steam traps

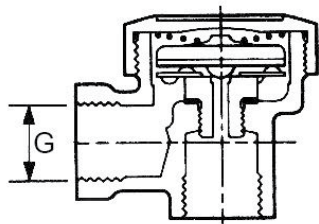

1

<b>GEV No.</b>	514272	<b>Ref. No.</b>	150901 540408
<b>description</b>	thermostatic steam trap thread 1/2" type AV13 brass		
<b>For models:</b>	EES060, EES080, EGS060, FED080, FED150, FED250, FED300, FEK040, FEK060, FEK080, FEK100, FEK150, FER080, FER150, FER250, FER300, FER400, FES040, FES060, FES080, FES100, FES150, FGR150, FGR250, FGR300, FGR400, FGS040, FGS060, FGS080, FGS100, FGS150, NER080, NER150, NER250, NER300, NER400, NES040, NES060, NES080, NES100, NES150, NGR150, NGR250, NGR300, NGR400, NGS040, NGS060, NGS080, NGS100, NGS150...(Other models you can see in the web-shop)		

## test taps

### test taps

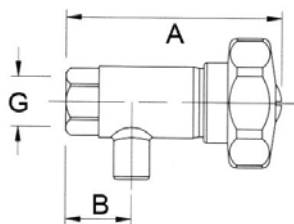

1

<b>GEV No.</b>	514277	<b>Ref. No.</b>	170403 170404
<b>description</b>	test tap thread 3/8" IT W 70mm W1 25mm		
<b>For models:</b>	LES060, LGS060, NED080, NED150, NED250, NED300, NEK040, NEK060, NEK080, NEK100, NEK150, NEM100, NER080, NER150, NER250, NER300, NER400, NER500, NES040, NES060, NES080, NES100, NES150, NGR150, NGR250, NGR300, NGR400, NGS040, NGS060, NGS080, NGS100, NGS150, NHD080, NHD150, NHD250, NHD300, NHR080, NHR100, NHR150, NHR250, NHR300, NHR400, NHR500, NHS040, NHS060, NHS080, NHS100, NHS150, WES0400, WES0600...(Other models you can see in the webshop)		

## safety fittings

### safety fittings



1

<b>GEV No.</b>	540882	<b>Ref. No.</b>	151702
<b>description</b>	safety fitting thread 1 1/2" 0.5bar chrome-plated H 185mm ø 100mm		
<b>For models:</b>	FED080, FED150, FED250, FED300, FEP230, FEP330, NEP203, NEP303, PED088, PED158, PED258, PED308, PEP238, PEP338		
<b>spare parts for</b>	540882		
	<b>GEV No.</b>	540010	<b>Ref. No.</b> —
	aerator and air bleeder thread 3/8" ET WS 22 chrome-plated metal seated L 22mm		

## safety valves



1

<b>GEV No.</b>	540883	<b>Ref. No.</b>	172758
<b>description</b>	safety valve		
<b>For models:</b>	NDD080, NDD150, NDD250, NDD300, NED080, NED150, NED250, NED300, NEP203, NEP303, NHD080, NHD150, NHD250, NHD300		



1

<b>GEV No.</b>	540880	<b>Ref. No.</b>	172766
<b>description</b>	safety valve 8511EPDMspez		
<b>For models:</b>	NEK040, NEK060, NEK080, NEK100, NEK150		

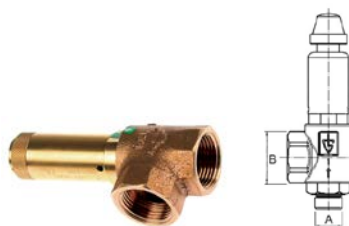

1

<b>GEV No.</b>	514354	<b>Ref. No.</b>	540407
<b>description</b>	safety valve T1: 1" T2: 1" triggering pressure 0.5bar		

			
1			
<b>GEV No.</b>	514071	<b>Ref. No.</b>	175520 358129
<b>description</b>	safety valve T1: 1" T2: 3/4"		
<b>For models:</b>	FED080, FED150, FED250, FED300, NTE182, PED088, PED158, PED258, PED308		

			
1			
<b>GEV No.</b>	514273	<b>Ref. No.</b>	151701
<b>description</b>	safety valve T1: 1/2" T2: 1/2" triggering pressure 0.65bar		
<b>For models:</b>	EES060, EES080, EGS060, FES040, FES060, FES080, FES100, FES150, FGS040, FGS060, FGS080, FGS100, FGS150, NES040, NES060, NES080, NES100, NES150, NGS040, NGS060, NGS080, NGS100, NGS150, PES048, PES068, PES088, PES108, PES158, PGS048, PGS068, PGS088		

			
1			
<b>GEV No.</b>	540881	<b>Ref. No.</b>	151704
<b>description</b>	safety valve T1: 3/4" T2: 1" triggering pressure 0.65bar		
<b>For models:</b>	FEK040, FEK060, FEK080, FEK100, FEK150, PEK048, PEK068, PEK088, PEK108, PEK158		

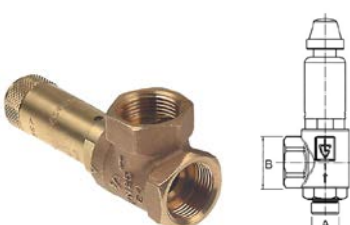
			
1			
<b>GEV No.</b>	101977	<b>Ref. No.</b>	151700
<b>description</b>	safety valve T1: 3/4" T2: 3/4" triggering pressure 0.65bar		
<b>For models:</b>	FER080, FER150, FER250, FER300, FER400, FGR150, FGR250, FGR300, FGR400, NER080, NER150, NER250, NER300, NER400, NGR150, NGR250, NGR300, NGR400, PER088, PER158, PER258, PER308		

## DERBY RUOTE

spare parts and accessories

miscellaneous

			
1			
<b>GEV No.</b>	560192	<b>Ref. No.</b>	407551
<b>description</b>	tooth lock washer ID ø 10.4mm ED ø 18mm SS DIN/ISO DIN 6798A Qty 1 pcs for thread M10		
<b>For models:</b>	ECD106, ECD110, ECD120, ECD220		

## WICKE

with bolt hole

sheet steel

			
1			
<b>GEV No.</b>	700347	<b>Ref. No.</b>	114428 144428
<b>description</b>	swivel castor with brake ø 125mm bolt hole ø10mm housing zinc-plated sheet steel		

			
1			
<b>GEV No.</b>	700346	<b>Ref. No.</b>	114429 144429
<b>description</b>	swivel castor without brake ø 125mm bolt hole ø10mm housing zinc-plated sheet steel		

## miscellaneous

with bolt hole

ø125mm

			
1			
<b>GEV No.</b>	700348	<b>Ref. No.</b>	144430
<b>description</b>	swivel castor ø 125mm bolt hole ø10mm		
<b>For models:</b>	LEH405, LEH503, LEH505, LEH605, LEH703, LEH705, NEH413, NEH415, NEH505, NEH613, NEH615, NEH705, NGH403, NGH405, NGH503, NGH505, NGH723, NGH725		



 <p>Image not available</p>			
1			
<b>GEV No.</b>	700349	<b>Ref. No.</b>	144431
<b>description</b>	swivel castor with brake ø 125mm bolt hole ø10mm		

## BLICKLE

plastic

ø125mm



<b>GEV No.</b>	700913	<b>Ref. No.</b>	114433
<b>description</b>	swivel castor with brake ø 125mm bolt hole 11mm housing plastic bearing slide bearing		



<b>GEV No.</b>	700914	<b>Ref. No.</b>	114432
<b>description</b>	swivel castor without brake ø 125mm bolt hole 11mm housing plastic bearing slide bearing		

## baskets

warewashing baskets

steel wire baskets square

glass basket



<b>GEV No.</b>	970065	<b>Ref. No.</b>	503786
<b>description</b>	glass basket L 400mm W 400mm H 170mm number of rows 4 rows spacing 90mm		

## gaskets

refrigeration gaskets

plug-in gaskets

profile 9048

We offer custom-made gaskets for this profile

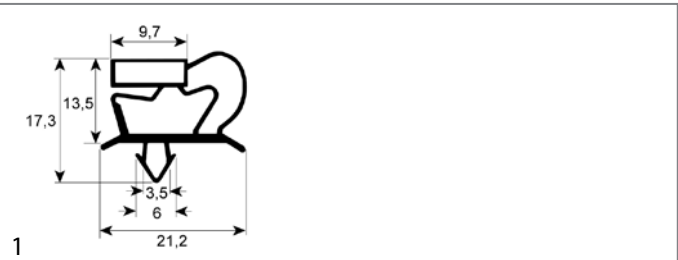

<b>GEV No.</b>	900710	<b>Ref. No.</b>	37Q5450
<b>description</b>	refrigeration gasket profile 9048 W 655mm L 1500mm plug size		

gaskets for heated units

window seals

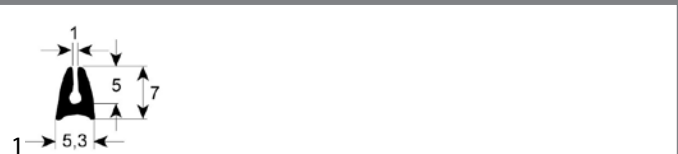

<b>GEV No.</b>	900561	<b>Ref. No.</b>	060976 062336
<b>description</b>	window gasket profile 1500 L 1430mm suitable for KÜPPERSBUSCH		
<b>For models:</b>	ECL484		

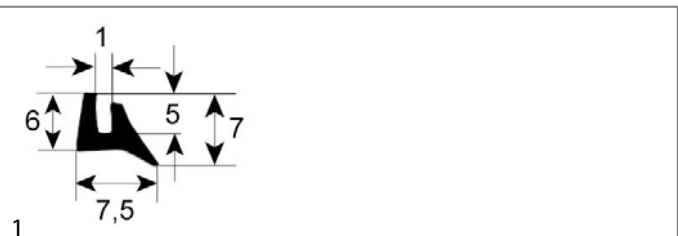

<b>GEV No.</b>	900056	<b>Ref. No.</b>	062292 407363
<b>description</b>	window gasket profile 1570 Qty supplied by meter		
<b>For models:</b>	ECD106, ECD110, ECD120, ECD220		

door seals

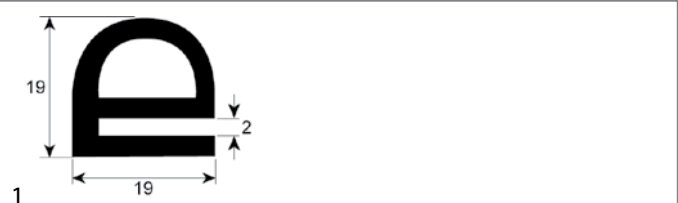

<b>GEV No.</b>	900169	<b>Ref. No.</b>	407370
<b>description</b>	door seal profile 2210 L 3800mm Qty 1		
<b>For models:</b>	ECD120		

<b>GEV No.</b>	900174	<b>Ref. No.</b>	407518
<b>description</b>	door seal profile 2210 L 4200mm Qty 1		
<b>For models:</b>	ECD220		

<b>GEV No.</b>	900054	<b>Ref. No.</b>	062329 407518
<b>description</b>	door seal profile 2210 Qty supplied by meter		
<b>For models:</b>	CBE106, CBE106-VAR091, CBE110, CBE110-VAR091, CBE120, CBE120-VAR091, CBE220, CBE220-VAR091, CBG110, CBG120, CCE106, CCE110, CCE120, CCE220, CEC106, CEC110, CEC120, CEC220, CED106, CED110, CED120, CED220, CEF106, CEF110, CEF120, CEF220, CEM110, CEM120, CGD110, CGD120, CPE106, CPE110, CPE120, CPE220		

<b>GEV No.</b>	902240	<b>Ref. No.</b>	407459
<b>description</b>	door seal profile 2230 W 470mm L 485mm external size Qty 1		
<b>For models:</b>	ECD106		

<b>GEV No.</b>	900053	<b>Ref. No.</b>	407476
<b>description</b>	door seal profile 2230 W 480mm L 725mm external size Qty 1		
<b>For models:</b>	ECD110		

<b>GEV No.</b>	900349	<b>Ref. No.</b>	060664
<b>description</b>	door seal profile 2790 W 495mm L 530mm external size Qty 1 insertion size 455x487mm		

<b>GEV No.</b>	900346	<b>Ref. No.</b>	060644 060665
<b>description</b>	door seal profile 2790 W 530mm L 730mm external size Qty 1 insertion size 505x705mm		

<b>GEV No.</b>	901594	<b>Ref. No.</b>	060667
<b>description</b>	door seal profile 2790 W 730mm L 1305mm external size suitable for KÜPPERSBUSCH insertion size 700x1280mm		

<b>GEV No.</b>	900563	<b>Ref. No.</b>	764756007 807969006
<b>description</b>	door seal profile 2935 L 543mm Qty 1 mounting pos. lower		
<b>For models:</b>	EGH417, EGH617, FEH413, FEH415, FEH503, FEH505, FEH513, FEH515, FEH613, FEH615, FEH705, FEH715, FGH413, FGH415, FGH417, FGH507, FGH613, FGH615, FGH617, LGH407, LGH607, NGH407, NGH413, NGH415, NGH417, NGH507, NGH607, NGH613, NGH615, NGH617, NGH727, NGH733, NGH737		

<b>GEV No.</b>	901432	<b>Ref. No.</b>	062122 781063
<b>description</b>	door seal profile 2946 Qty supplied by meter		
<b>For models:</b>	EAB051, EDC106		

<b>GEV No.</b>	900197	<b>Ref. No.</b>	062371
<b>description</b>	door seal profile 2968 L 345mm Qty 1 mounting pos. upper		
<b>For models:</b>	ECL484		





<b>GEV No.</b>	900196	<b>Ref. No.</b>	062372
<b>description</b>	door seal profile 2968 L 395mm Qty 1 mounting pos. right/left		
<b>For models:</b>	ECL484		

**door seals with fixing hook**

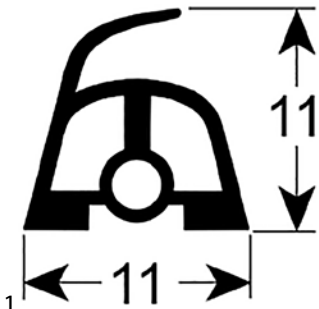

<b>GEV No.</b>	900390	<b>Ref. No.</b>	807470006
<b>description</b>	door seal L 380mm Wmm with 5 mounting clips		
<b>For models:</b>	EEH413, EEH503, EEH613, EEH703, EGH413, EGH417, EGH613, EGH617, FEH413, FEH415, FEH503, FEH505, FEH513, FEH515, FEH613, FEH615, FEH705, FEH715, FGH413, FGH415, FGH417, FGH507, FGH613, FGH615, FGH617, LEH405, LEH503, LEH505, LEH605, LEH703, LEH705, LGH405, LGH407, LGH605, LGH607, NEH413, NEH415, NEH505, NEH613, NEH615, NEH705, NGH403, NGH405, NGH413, NGH415, NGH417, NGH503, NGH505, NGH507, NGH603...(Other models you can see in the webshop)		

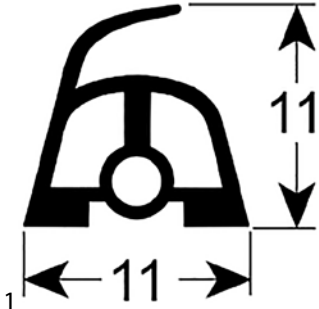

<b>GEV No.</b>	900391	<b>Ref. No.</b>	807469006
<b>description</b>	door seal L 585mm Wmm with 9 mounting clips		
<b>For models:</b>	EEH413, EEH503, EEH613, EEH703, EGH413, EGH417, EGH613, EGH617, FEH413, FEH415, FEH503, FEH505, FEH513, FEH515, FEH613, FEH615, FEH705, FEH715, FGH413, FGH415, FGH417, FGH507, FGH613, FGH615, FGH617, LEH405, LEH503, LEH505, LEH605, LEH703, LEH705, LGH405, LGH407, LGH605, LGH607, NEH413, NEH415, NEH505, NEH613, NEH615, NEH705, NGH403, NGH405, NGH413, NGH415, NGH417, NGH503, NGH505, NGH507, NGH603...(Other models you can see in the webshop)		

**gaskets for tray rack trolleys**

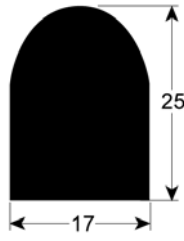

<b>GEV No.</b>	900055	<b>Ref. No.</b>	062293 062392 407392 407636
<b>description</b>	tray rack trolley gasket profile 4020 Qty supplied by meter silicone foam		
<b>For models:</b>	CBE120, CBE120-VAR091, CBE220, CBE220-VAR091, CBG120, CCE120, CCE220, CEC120, CEC220, CED120, CED220, CEF120, CEF220, CEM120, CGD120, CPE120, CPE220, ECD120, ECD220		

**O-rings**

**EPDM**



<b>GEV No.</b>	532050	<b>Ref. No.</b>	408864
<b>description</b>	O-ring EPDM thickness 2.62mm ID ø 11.91mm Qty 10 pcs		
<b>For models:</b>	KGD040, KGD131, KGE051, KGE052, KGE065, KGE066, KGE081, KGE131, KGH040		



<b>GEV No.</b>	510408	<b>Ref. No.</b>	060842
<b>description</b>	O-ring EPDM thickness 5.34mm ID ø 47mm Qty 1 pcs		
<b>For models:</b>	CBE120-VAR091, CBE220-VAR091, CCE120, CCE220, CED120, CED220, CEF120, CEF220, CEM120, CPE120, CPE220, FED080, FED150, FED250, FED300, FEK040, FEK060, FEK080, FEK100, FEK150, FER080, FER150, FER250, FER300, FER400, FES040, FES060, FES080, FES100, FES150, NER080, NER150, NER250, NER300, NER400, NES040, NES060, NES080, NES100, NES150, PEK048, PEK068, PEK088, PEK108, PEK158, PER088, PER158, PER258, PER308, PES048...(Other models you can see in the webshop)		

**silicone**



<b>GEV No.</b>	104264	<b>Ref. No.</b>	060308
<b>description</b>	O-ring silicone thickness 3.53mm ID ø 40.86mm Qty 1 pcs		
<b>For models:</b>	EGB230, EGB430, EGH210, EGH410, EGH413, EGH417, EGH610, EGH613, EGH617, EGP500, FGH210, FGH410, FGH413, FGH415, FGH417, FGH610, FGH613, FGH615, FGH617, NGH210, NGH410, NGH413, NGH415, NGH417, NGH610, NGH613, NGH615, NGH617, NGH730, NGH733, NGH737, PGH218, PGH418, PGH618		

Viton

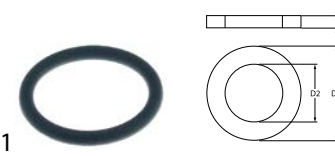

<b>GEV No.</b>	550675	<b>Ref. No.</b>	060840
<b>description</b>	O-ring Viton thickness 6mm ID ø 47mm Qty 1 pcs		
<b>For models:</b>	CBE106, CBE106-VAR091, CBE110, CBE110-VAR091, CBE120, CBE120-VAR091, CBE220, CBE220-VAR091, CBG110, CBG120, CCE106, CCE110, CCE120, CCE220, CEC106, CEC110, CEC120, CEC220, CED106, CED110, CED120, CED220, CEF106, CEF110, CEF120, CEF220, CEM110, CEM120, CGD110, CGD120, CPE106, CPE110, CPE120, CPE220, FEF170, FEF180, KGD020, KGD021, KGD030, KGD040, KGD131, KGE021, KGE051, KGE052, KGE065, KGE066, KGE080, KGE081, KGE131, KGH020...(Other models you can see in the webshop)		

sealing washers

copper gaskets

DIN-7603-C



<b>GEV No.</b>	510420	<b>Ref. No.</b>	407297
<b>description</b>	gasket copper ED ø 19.9mm ID ø 14.3mm thickness 2mm Qty 1 pcs		
<b>For models:</b>	ECD106, ECD110, ECD120, ECD220		

PTFE gaskets



<b>GEV No.</b>	550674	<b>Ref. No.</b>	540537
<b>description</b>	flat gasket PTFE ED ø 46mm ID ø 36mm thickness 4mm Qty 1 pcs mounting pos. inner		
<b>For models:</b>	EEF124, EEF224, EEW400		

silicone gaskets



<b>GEV No.</b>	103114	<b>Ref. No.</b>	060436
<b>description</b>	gasket silicone ED ø 34mm ID ø 30mm thickness 2mm Qty 1 pcs		
<b>For models:</b>	GHP601, LGH405, LGH407, LGH605, LGH607		



<b>GEV No.</b>	359721	<b>Ref. No.</b>	407286
<b>description</b>	gasket silicone ED ø 48mm ID ø 39.5mm thickness 5mm Qty 1 pcs		
<b>For models:</b>	ECD106, ECD110, ECD120, ECD220		

sealing cords

rectangular



<b>GEV No.</b>	692504	<b>Ref. No.</b>	060625
<b>description</b>	sealing cord rectangular size 3.5x4mm supplied by meter		
<b>For models:</b>	EEH210, EEH410, EEH413, EEH610, EEH613		

round



<b>GEV No.</b>	510572	<b>Ref. No.</b>	407293
<b>description</b>	sealing cord ø 10mm greased L 0.2m Qty 1		
<b>For models:</b>	ECD106, ECD110, ECD120, ECD220		

special gaskets

miscellaneous



<b>GEV No.</b>	550969	<b>Ref. No.</b>	060194 504873
<b>description</b>	gasket for glass plate for bain marie		
<b>For models:</b>	CBG110, CBG120, CGD110, CGD120, EGB230, EGB430, EGF124, EGF224, EGP500, FGH500, FGH507, FGW250, LGB430, LGF124, LGF224, LGG420, LGP400, NGB430, NGF144, NGF224, NGG420, NGH500, NGH503, NGH505, NGH507, NGH720, NGH723, NGH725, NGH727, NGH730, NGH733, NGH737, NGP400, NGP600, NGP900, NGW250, NGW450, PGB438, PGF148, PGF228, PGH508, PGW458		



<b>GEV No.</b>	550891	<b>Ref. No.</b>	062304
<b>description</b>	gasket for lamp L 87mm W 66mm		
<b>For models:</b>	ECL484		



<b>GEV No.</b>	510571	<b>Ref. No.</b>	407308
<b>description</b>	gasket suitable for KÜPPERSBUSCH equiv. no. 407308 level regulator		
<b>For models:</b>	ECD106, ECD110, ECD120, ECD220		





thermostat gaskets

			
1			
<b>GEV No.</b>	510362	<b>Ref. No.</b>	409190
<b>description</b>	gasket for thermostat ED ø 40mm ID ø 19mm suitable for COMENDA, MEIKO equiv. no. 630511/0108040		
<b>For models:</b>	BSA330, BSA360, KGD312, KGD612, KGE122, KGE340, KGE360, KGE660, KGL260, KGL360, KGU113, KGU122, KGU322, KGU340		

springs

torsion springs

 <p>Image not available</p>			
1			
<b>GEV No.</b>	700197	<b>Ref. No.</b>	131075
<b>description</b>	torsion spring		
<b>For models:</b>	NEP600, NES150, NPG600, NGS150, NHS150, NNS150, WES1500		

			
1			
<b>GEV No.</b>	700193	<b>Ref. No.</b>	131075
<b>description</b>	torsion spring ø 27.4mm wire gauge ø 5.7mm L1 20mm L2 160mm L3 16mm		

gas tension springs

gas tension springs

			
1			
<b>GEV No.</b>	700513	<b>Ref. No.</b>	540478
<b>description</b>	gas tension spring 700N		

			
1			
<b>GEV No.</b>	700515	<b>Ref. No.</b>	541124
<b>description</b>	gas tension spring 900N		

miscellaneous

			
1			
<b>GEV No.</b>	700187	<b>Ref. No.</b>	131337 814186000
<b>description</b>	spring for door		
<b>For models:</b>	EEH413, EEH503, EEH613, EEH703, EGH413, EGH417, EGH613, EGH617, FEH413, FEH415, FEH503, FEH505, FEH513, FEH515, FEH613, FEH615, FEH705, FEH715, FGH413, FGH415, FGH417, FGH507, FGH613, FGH615, FGH617, LEH405, LEH503, LEH505, LEH605, LEH703, LEH705, LGH405, LGH407, LGH605, LGH607, NEH413, NEH415, NEH505, NEH613, NEH615, NEH705, NGH403, NGH405, NGH407, NGH413, NGH415, NGH417, NGH503, NGH505, NGH507...(Other models you can see in the webshop)		

tension springs

			
1			
<b>GEV No.</b>	700191	<b>Ref. No.</b>	131072
<b>description</b>	tension spring ø 30.3mm total length 275mm wire gauge ø 4.1mm		
<b>For models:</b>	LEP400, LGP400, NEP400, NEP600, NEP900, NPG400, NPG600, NPG900		

manometers

			
1			
<b>GEV No.</b>	541345	<b>Ref. No.</b>	358107
<b>description</b>	manometer ø 60mm pressure range 0 up to 1.6bar connection on the backside marking 0.5-1 thread 1/4"		
<b>For models:</b>	LES060, LGS060, NDD080, NDD150, NDD250, NDD300, NED080, NED150, NED250, NED300, NEK040, NEK060, NEK080, NEK100, NEK150, NER080, NER150, NER250, NER300, NER400, NER500, NES040, NES060, NES080, NES100, NES150, NGR150, NGR250, NGR300, NGR400, NGS040, NGS060, NGS080, NGS100, NGS150, NHD080, NHD150, NHD250, NHD300, NHR080, NHR100, NHR150, NHR250, NHR300, NHR400, NHR500, NHS040, NHS060, NHS080, NHS100...(Other models you can see in the webshop)		







			
1			
<b>GEV No.</b>	541343	<b>Ref. No.</b>	151500 151500+060031
<b>description</b>	manometer ø 63mm pressure range 0 up to 1.6bar thread 1/4" marking 0.5-1 kettle connection on the backside		
<b>For models:</b>	EES060, EES080, EGS060, FED080, FED150, FED250, FED300, FEK040, FEK060, FEK080, FEK100, FEK150, FER080, FER150, FER250, FER300, FER400, FES040, FES060, FES080, FES100, FES150, FGR150, FGR250, FGR300, FGR400, FGS040, FGS060, FGS080, FGS100, FGS150, NER080, NER150, NER250, NER300, NER400, NES040, NES060, NES080, NES100, NES150, NGR150, NGR250, NGR300, NGR400, NGS040, NGS060, NGS080, NGS100, NGS150...(Other models you can see in the webshop)		



## hose reels and spray guns

### cleaning guns



<b>GEV No.</b>	540553 <sup>1</sup>	<b>Ref. No.</b>	172855
<b>description</b>	cleaning spray gun connection coupling DN13 brass controllable		
<b>For models:</b>	CCE106, CCE110, CCE120, CCE220, CED106, CED110, CED120, CED220, CEF106, CEF110, CEF120, CEF220, CEM110, CEM120, CGD110, CGD120, CPE106, CPE110, CPE120, CPE220		
<b>accessories for</b>	540553		
	<b>GEV No.</b>	540485	<b>Ref. No.</b> —
	coupling bush type DN13 chrome-plated brass connection 1/2" (ø13mm)		
	<b>GEV No.</b>	540516	<b>Ref. No.</b> —
	coupling bush type DN13 chrome-plated brass connection 1/2" IT		
	<b>GEV No.</b>	540640	<b>Ref. No.</b> —
	coupling bush type DN13 chrome-plated brass connection 3/4" IT		
	<b>GEV No.</b>	540641	<b>Ref. No.</b> —
	coupling bush type DN13 chrome-plated brass connection 1/2" ET		
	<b>GEV No.</b>	540642	<b>Ref. No.</b> —
	coupling bush type DN13 chrome-plated brass connection 3/4" ET		
	<b>GEV No.</b>	540643	<b>Ref. No.</b> —
	coupling bush type DN13 chrome-plated brass connection 3/4" (ø19mm)		

<sup>1</sup>controllable

## dosing pumps





### peristaltic dosing pumps

#### SEKO

#### wall-mounted version

#### with speed control



<b>GEV No.</b>	361157	<b>Ref. No.</b>	150069
<b>description</b>	dosing pump SEKO speed control 1-7l/h 230VAC detergent hose ø 4x6mm hose type K hose Santoprene suction level 1.5m type PR without accessories dimensions 103x82x92mm		
<b>spare parts for</b>	361157		
	<b>GEV No.</b>	361136	<b>Ref. No.</b> —
	roller assembly for dosing pump hole ø 4.8x4mm		
	<b>GEV No.</b>	361815	<b>Ref. No.</b> —
	pump hose detergent hose ø 6x10mm hose ø 4x6mm hose type K hose Santoprene type SEKO		
<b>accessories for</b>	361157		
	<b>GEV No.</b>	361142	<b>Ref. No.</b> —
	mounting set detergent hose type 4x6mm hose length 2m PVC 2x hose/container filter/tank intake transparent		
	<b>GEV No.</b>	520090	<b>Ref. No.</b> —
	PVC hose ID ø 4mm ED ø 6mm L 2m thickness 1mm t.max. 60°C transparent		
	<b>GEV No.</b>	520091	<b>Ref. No.</b> —
	nylon hose ID ø 4mm ED ø 6mm L 2m thickness 1mm operating p. 10bar burst p. 50bar t.max. 100°C transparent		

### membrane dosing pumps

#### self-priming

#### LANG



<b>GEV No.</b>	361032	<b>Ref. No.</b>	409298
<b>description</b>	dosing pump type N6 membrane dosing pump rinse aid pressure connection ø angled, 4x6mm suction connection ø angled, 4x6mm		
<b>For models:</b>	BSA330, KGE122, KGE340, KGE360, KGE660, KGL260, KGL360, KGU113, KGU122, KGU322, KGU340		
<b>spare parts for</b>	361032		
	<b>GEV No.</b>	361079	<b>Ref. No.</b> —
	spring for type N5/N6 for ball		

Table continues overleaf

spare parts for		361032	
	GEV No.	361080	Ref. No. —
	O-ring EPDM thickness 2mm ID ø 16mm Qty 1 pcs		
	GEV No.	361085	Ref. No. —
	O-ring EPDM thickness 2mm ID ø 8mm Qty 1 pcs		
	GEV No.	361309	Ref. No. —
	ball for type N5/N6		
	GEV No.	361310	Ref. No. —
	bracket for type N6 ball guide		
	GEV No.	361311	Ref. No. —
	O-ring EPDM thickness 2mm ID ø 6mm Qty 1 pcs for type N6		
	GEV No.	361314	Ref. No. —
	valve ring for type N6 holder for O-ring		
	GEV No.	361317	Ref. No. —
	sealing disc for type N6		
	GEV No.	361886	Ref. No. —
	non-return valve inletmm outletmm outlet ø 12.4mm L 12.7mm		

## hoses

### industrial hoses

#### rubber hoses - Goldschlange®

	1		
<b>GEV No.</b>	530540	<b>Ref. No.</b>	407411-425
<b>description</b>	pressure hose ID ø 13mm ED ø 21mm L 5m operating p. 30bar burst p. 90bar t.max. 100°C Qty 5m		

## fittings, hose and pipe connectors

### hose connectors

#### without screw connection

	1		
<b>GEV No.</b>	501341	<b>Ref. No.</b>	062214
<b>description</b>	Y-piece plastic hose ø 6-6-6mm		
<b>For models:</b>	CCE120, CCE220, CPE120, CPE220, EES060, EES080, EGS060, FED080, FED150, FED250, FED300, FEK040, FEK060, FEK080, FEK100, FEK150, FER080, FER150, FER250, FER300, FER400, FES040, FES060, FES080, FES100, FES150, FGR150, FGR250, FGR300, FGR400, FGS040, FGS060, FGS080, FGS100, FGS150, NDD080, NDD150, NDD250, NDD300, NED080, NED150, NED250, NED300, NEK040, NEK060, NEK080, NEK100, NEK150, NEM100, NEP203...(Other models you can see in the webshop)		

### fittings

#### reducers

	1		
<b>GEV No.</b>	520181	<b>Ref. No.</b>	166084
<b>description</b>	reducer thread 1/2" ET - 3/8" IT nickel-plated brass total length 15.5mm WS 24		
<b>For models:</b>	FER080, FER150, FER250, FER300, FER400, FER080, FER150, FER250, FER300, FER400, PER088, PER158, PER258, PER308		



## valves and tank inlets

### ball valves

#### ball valves electric



1

<b>GEV No.</b>	401190	<b>Ref. No.</b>	120110 151006 164011 994595006 994898006 994899006
<b>description</b>	ball valve inlet 3/4" IT outlet 3/4" IT IP42 230V L 68mm 50/60Hz closed off-current mode of operation electric connection cable 300mm 3.5W duty cycle 50%		
<b>For models:</b>	CBE106-VAR091, CBE110-VAR091, CBE120-VAR091, CBE220-VAR091, CCE106, CCE110, CCE120, CCE220, CED106, CED110, CED120, CED220, CEF106, CEF110, CEF120, CEF220, CEM110, CEM120, CPE106, CPE110, CPE120, CPE220		



2

<b>GEV No.</b>	400208	<b>Ref. No.</b>	151006
<b>description</b>	ball valve mode of operation electric IT 3/4"		

### shut-off valves

#### universal



1



<b>GEV No.</b>	540892	<b>Ref. No.</b>	170287
<b>description</b>	shut-off valve connection soldering connection 1/2" tube ø 15mm cold water total length 54mm rosette thread G2 24x24G shaft ø M4x0.7 ITmm		
<b>For models:</b>	NEM100, NER080, NER150, NER250, NER300, NER400, NER500, NES040, NES060, NES080, NES100, NES150, NEW180, NEW182, NEW250, NEW252, NEW450, NEW452, NGS040, NGS060, NGS080, NGS100, NGS150, NGW250, NGW450, NHR080, NHR100, NHR150, NHR250, NHR300, NHR400, NHR500, NHS040, NHS060, NHS080, NHS100, NHS150, NNR080, NNR150, NNR250, NNR300, NNR400, NNR500, NNS040, NNS060, NNS080, NNS100, NNS150, NNW180, NNW182...(Other models you can see in the webshop)		
<b>spare parts for</b>	540892		
	<b>GEV No.</b>	<b>Ref. No.</b>	173588
	tap head connection 1/2" tube ømm hot water total lengthmm		

<b>spare parts for</b>	540892		
	<b>GEV No.</b>	<b>Ref. No.</b>	173589
	tap head connection 1/2" tube ømm cold water total lengthmm		





1

<b>GEV No.</b>	540891	<b>Ref. No.</b>	170288
<b>description</b>	shut-off valve connection soldering connection 1/2" tube ø 15mm hot water total length 54mm rosette thread G2 24x24G shaft ø M4x0.7 ITmm		
<b>For models:</b>	LES060, LGS060, NDD080, NDD150, NDD250, NDD300, NED080, NED150, NED250, NED300, NEK040, NEK060, NEK080, NEK100, NEK150, NEM100, NER080, NER150, NER250, NER300, NER400, NER500, NES040, NES060, NES080, NES100, NES150, NGR150, NGR250, NGR300, NGR400, NGS040, NGS060, NGS080, NGS100, NGS150, NHD080, NHD150, NHD250, NHD300, NHR080, NHR100, NHR150, NHR250, NHR300, NHR400, NHR500, NHS040, NHS060, NHS080...(Other models you can see in the webshop)		

<b>spare parts for</b>	540891		
	<b>GEV No.</b>	<b>Ref. No.</b>	173588
	tap head connection 1/2" tube ømm hot water total lengthmm		
	<b>GEV No.</b>	<b>Ref. No.</b>	173589
	tap head connection 1/2" tube ømm cold water total lengthmm		



1

<b>GEV No.</b>	540893	<b>Ref. No.</b>	170285
<b>description</b>	shut-off valve connection soldering connection 3/4" tube ø 18mm cold water total length 90mm rosette thread G2 24x24G shaft ø M4x0.7 ITmm		
<b>For models:</b>	NDD080, NDD150, NDD250, NDD300, NEM100, NES040, NES060, NES080, NES100, NES150, NGR150, NGR250, NGR300, NGR400, NGS040, NGS060, NGS080, NGS100, NGS150, NHD080, NHD150, NHD250, NHD300, NHS040, NHS060, NHS080, NHS100, NHS150, NNM100, NNS040, NNS060, NNS080, NNS100, NNS150		
<b>spare parts for</b>	540893		
	<b>GEV No.</b>	<b>Ref. No.</b>	172119
	tap head connection 3/4" tube ømm cold water total lengthmm		
	<b>GEV No.</b>	<b>Ref. No.</b>	172120
	tap head connection 3/4" tube ømm hot water total lengthmm		



											
1											
<b>GEV No.</b>	540894	<b>Ref. No.</b>	170286								
<b>description</b>	shut-off valve connection soldering connection 3/4" tube ø 18mm hot water total length 90mm rosette thread G2 24x24G shaft ø M4x0.7 ITmm										
<b>For models:</b>	NDD080, NDD150, NDD250, NDD300, NEM100, NES040, NES060, NES080, NES100, NES150, NGR150, NGR250, NGR300, NGR400, NGS040, NGS060, NGS080, NGS100, NGS150, NHD080, NHD150, NHD250, NHD300, NHS040, NHS060, NHS080, NHS100, NHS150, NNM100, NNS040, NNS060, NNS080, NNS100, NNS150, WES0400, WES0600, WES0800, WES1000, WES1500										
<b>spare parts for</b>	540894										
 <table border="1"> <tr> <td><b>GEV No.</b></td> <td>540900</td> <td><b>Ref. No.</b></td> <td>172119</td> </tr> <tr> <td><b>description</b></td> <td colspan="3">tap head connection 3/4" tube ømm cold water total lengthmm</td> </tr> </table>				<b>GEV No.</b>	540900	<b>Ref. No.</b>	172119	<b>description</b>	tap head connection 3/4" tube ømm cold water total lengthmm		
<b>GEV No.</b>	540900	<b>Ref. No.</b>	172119								
<b>description</b>	tap head connection 3/4" tube ømm cold water total lengthmm										
 <table border="1"> <tr> <td><b>GEV No.</b></td> <td>540901</td> <td><b>Ref. No.</b></td> <td>172120</td> </tr> <tr> <td><b>description</b></td> <td colspan="3">tap head connection 3/4" tube ømm hot water total lengthmm</td> </tr> </table>				<b>GEV No.</b>	540901	<b>Ref. No.</b>	172120	<b>description</b>	tap head connection 3/4" tube ømm hot water total lengthmm		
<b>GEV No.</b>	540901	<b>Ref. No.</b>	172120								
<b>description</b>	tap head connection 3/4" tube ømm hot water total lengthmm										

			
1			
<b>GEV No.</b>	540900	<b>Ref. No.</b>	172119
<b>description</b>	tap head connection 3/4" tube ømm cold water total lengthmm		
<b>For models:</b>	NDD080, NDD150, NDD250, NDD300, NEM100, NES040, NES060, NES080, NES100, NES150, NGR150, NGR250, NGR300, NGR400, NGS040, NGS060, NGS080, NGS100, NGS150, NHD080, NHD150, NHD250, NHD300, NHS040, NHS060, NHS080, NHS100, NHS150, NNM100, NNS040, NNS060, NNS080, NNS100, NNS150		

			
1			
<b>GEV No.</b>	540901	<b>Ref. No.</b>	172120
<b>description</b>	tap head connection 3/4" tube ømm hot water total lengthmm		
<b>For models:</b>	NDD080, NDD150, NDD250, NDD300, NEM100, NES040, NES060, NES080, NES100, NES150, NGR150, NGR250, NGR300, NGR400, NGS040, NGS060, NGS080, NGS100, NGS150, NHD080, NHD150, NHD250, NHD300, NHS040, NHS060, NHS080, NHS100, NHS150, NNM100, NNS040, NNS060, NNS080, NNS100, NNS150		

			
1			
<b>GEV No.</b>	540899	<b>Ref. No.</b>	173589
<b>description</b>	tap head connection 1/2" tube ømm cold water total lengthmm		
<b>For models:</b>	LES060, NEM100, NER080, NER150, NER250, NER300, NER400, NER500, NES040, NES060, NES080, NES100, NES150, NEW180, NEW182, NEW250, NEW252, NEW450, NEW452, NGS040, NGS060, NGS080, NGS100, NGS150, NGW250, NGW450, NHR080, NHR100, NHR150, NHR250, NHR300, NHR400, NHR500, NHS040, NHS060, NHS080, NHS100, NHS150, NNR080, NNR150, NNR250, NNR300, NNR400, NNR500, NNS040, NNS060, NNS080, NNS100, NNS150, WES0400...(Other models you can see in the webshop)		

steam valves

											
1											
<b>GEV No.</b>	541543	<b>Ref. No.</b>	172655								
<b>description</b>	steam valve straight connection 1 1/4" IT total length 110mm H 148mm brass										
<b>For models:</b>	NNR080, NNR150, NNR250, NNR300, NNR400, NNR500										
<b>spare parts for</b>	541543										
 <table border="1"> <tr> <td><b>GEV No.</b></td> <td>540229</td> <td><b>Ref. No.</b></td> <td>—</td> </tr> <tr> <td><b>description</b></td> <td colspan="3">star handle shaft 9x9mm ø 80mm L 23mm black thermoplastic</td> </tr> </table>				<b>GEV No.</b>	540229	<b>Ref. No.</b>	—	<b>description</b>	star handle shaft 9x9mm ø 80mm L 23mm black thermoplastic		
<b>GEV No.</b>	540229	<b>Ref. No.</b>	—								
<b>description</b>	star handle shaft 9x9mm ø 80mm L 23mm black thermoplastic										
 <table border="1"> <tr> <td><b>GEV No.</b></td> <td>541546</td> <td><b>Ref. No.</b></td> <td>—</td> </tr> <tr> <td><b>description</b></td> <td colspan="3">screw chrome-plated brass thread M5 thread L 10mm</td> </tr> </table>				<b>GEV No.</b>	541546	<b>Ref. No.</b>	—	<b>description</b>	screw chrome-plated brass thread M5 thread L 10mm		
<b>GEV No.</b>	541546	<b>Ref. No.</b>	—								
<b>description</b>	screw chrome-plated brass thread M5 thread L 10mm										

			
1			
<b>GEV No.</b>	540898	<b>Ref. No.</b>	173588
<b>description</b>	tap head connection 1/2" tube ømm hot water total lengthmm		
<b>For models:</b>	NDD080, NDD150, NDD250, NDD300, NED080, NED150, NED250, NED300, NEK040, NEK060, NEK080, NEK100, NEK150, NEM100, NER080, NER150, NER250, NER300, NER400, NER500, NES040, NES060, NES080, NES100, NES150, NGR150, NGR250, NGR300, NGR400, NGS040, NGS060, NGS080, NGS100, NGS150, NHD080, NHD150, NHD250, NHD300, NHR080, NHR100, NHR150, NHR250, NHR300, NHR400, NHR500, NHS040, NHS060, NHS080, NHS100, NHS150...(Other models you can see in the webshop)		

inlet taps



1

<b>GEV No.</b>	540886	<b>Ref. No.</b>	178419
<b>description</b>	inlet spout		



1

<b>GEV No.</b>	540887	<b>Ref. No.</b>	178408 178419
<b>description</b>	inlet tap connection 3/4" ET tube ø 20mm projection 100mm overall height 110mm spout height 40mm rotation 90°		
<b>For models:</b>	EES060, EES080, EGS060, FER080, FER150, FER250, FER300, FER400, FES040, FES060, FES080, FES100, FES150, FEW250, FEW252, FGR150, FGR250, FGR300, FGR400, FGS040, FGS060, FGS080, FGS100, FGS150, FGW250, FNR080, FNR150, FNR250, FNR300, FNR400, FNS040, FNS060, FNS080, FNS100, FNS150, NDD080, NDD150, NDD250, NDD300, NEM100, NER080, NER150, NER250, NER300, NER400, NER500, NES040, NES060, NES080, NES100...(Other models you can see in the webshop)		





1

<b>GEV No.</b>	540890	<b>Ref. No.</b>	172870
<b>description</b>	inlet tap connection 3/4" ET tube ø 25mm projection 200mm overall height 245mm spout height 70mm rotation 90°		
<b>For models:</b>	FED080, FED150, FED250, FED300, PED088, PED158, PED258, PED308		





1

<b>GEV No.</b>	541542	<b>Ref. No.</b>	172654	
<b>description</b>	steam valve straight connection 1" IT total length 90mm H 140mm brass			
<b>For models:</b>	NNM100, NNS080, NNS100, NNS150			
<b>spare parts for</b>	541542			
	<b>GEV No.</b>	540229	<b>Ref. No.</b>	—
	star handle shaft 9x9mm ø 80mm L 23mm black thermoplastic			
	<b>GEV No.</b>	541546	<b>Ref. No.</b>	—
	screw chrome-plated brass thread M5 thread L 10mm			
	<b>GEV No.</b>	541548	<b>Ref. No.</b>	—
	gasket PTFE ID ø 15mm H 7mm for thread 1 1/4" ED ø 35mm			
	<b>GEV No.</b>	541554	<b>Ref. No.</b>	—
	gasket copper ext. ø 49 ID ø 42mm H 2mm for thread 1 1/4"			
	<b>GEV No.</b>	541557	<b>Ref. No.</b>	—
	tap head chrome-plated thread 1 1/4" for steam tap 1"			



1

<b>GEV No.</b>	541541	<b>Ref. No.</b>	358137	
<b>description</b>	steam valve straight connection 3/4" IT total length 75mm H 118mm brass			
<b>For models:</b>	NNA182, NNK040, NNK060, NNK080, NNK100, NNK150, NNS040, NNS060, NNW180, NNW182			
<b>spare parts for</b>	541541			
	<b>GEV No.</b>	541546	<b>Ref. No.</b>	—
	screw chrome-plated brass thread M5 thread L 10mm			
	<b>GEV No.</b>	541547	<b>Ref. No.</b>	—
	gasket PTFE ID ø 9.5mm H 7mm for thread 1" ED ø 27.5mm			
	<b>GEV No.</b>	541553	<b>Ref. No.</b>	—
	gasket copper ext. ø 39 ID ø 33mm H 2mm for thread 1"			
	<b>GEV No.</b>	541556	<b>Ref. No.</b>	—
	tap head chrome-plated thread 1" for steam tap 3/4"			
	<b>GEV No.</b>	541559	<b>Ref. No.</b>	—
	star handle shaft 8x8mm ø 80mm L 23mm black thermoplastic			



## connection fittings

### screw pipe fittings

			
1			
<b>GEV No.</b>	543275	<b>Ref. No.</b>	166558
<b>description</b>	screw-in nipple thread 3/8" tube ø 10mm chrome-plated brass		
<b>For models:</b>	CBE106-VAR091, CBE110-VAR091, CBE120-VAR091, CBE220-VAR091, CCE106, CCE110, CCE120, CCE220, CEC106, CEC110, CEC120, CEC220, CED106, CED110, CED120, CED220, CEF106, CEF110, CEF120, CEF220, CEM110, CEM120, CGD110, CGD120, CPE106, CPE110, CPE120, CPE220, FED080, FED150, FED250, FED300, FGR150, FGR250, FGR300, FGR400, NGR150, NGR250, NGR300, NGR400, PED088, PED158, PED258, PED308		

## ancillary products

### clamps

#### hose clamps

#### DIN 3017 - W2

			
1			
<b>GEV No.</b>	520112	<b>Ref. No.</b>	407427-437
<b>description</b>	hose clamp ø 12-20mm width 9mm Qty 10 pcs DIN 3017		

			
1			
<b>GEV No.</b>	520114	<b>Ref. No.</b>	407357
<b>description</b>	hose clamp ø 20-32mm width 9mm Qty 10 pcs DIN 3017		
<b>For models:</b>	ECD106, ECD110, ECD120, ECD220		

			
1			
<b>GEV No.</b>	520115	<b>Ref. No.</b>	407571
<b>description</b>	hose clamp ø 25-40mm width 9mm Qty 10 pcs DIN 3017		
<b>For models:</b>	ECD106, ECD110, ECD120, ECD220		

			
1			
<b>GEV No.</b>	520118	<b>Ref. No.</b>	260261
<b>description</b>	hose clamp ø 50-70mm width 9mm Qty 5 pcs DIN 3017		
<b>For models:</b>	CED220, KGD020, KGD021, KGD030, KGD040, KGE021, KGE051, KGE052, KGE065, KGH020, KGH030, KGH040, KGS020, KGS021, KGS030, KGU020, KGU021, KGU030		

			
1			
<b>GEV No.</b>	520117	<b>Ref. No.</b>	407307
<b>description</b>	hose clamp stainless steel ø 40-60mm width 9mm Qty 5 pcs DIN 3017		
<b>For models:</b>	ECD106, ECD110, ECD120, ECD220		

## fastening material

### screws

#### hexagonal screws

			
1			
<b>GEV No.</b>	560309	<b>Ref. No.</b>	356961
<b>description</b>	hexagonal screw thread M10 thread L 16mm SS WS 17 Qty 1 pcs DIN 933 / ISO 4017		
<b>For models:</b>	CEC106, CED106, ECD106, ECD110, ECD120, ECD220		

			
1			
<b>GEV No.</b>	560308	<b>Ref. No.</b>	151184
<b>description</b>	hexagonal screw thread M16 thread L 20mm SS WS 24 Qty 1 pcs DIN 933 / ISO 4017		
<b>For models:</b>	CBE106, CBE106-VAR091, CBE110, CBE110-VAR091, CBE120, CBE120-VAR091, CBE220, CBE220-VAR091, CBG110, CBG120, CCE106, CCE110, CCE120, CCE220, CED106, CED110, CED120, CED220, CEF106, CEF110, CEF120, CEF220, CEM110, CEM120, CPE106, CPE110, CPE120, CPE220		

			
1			
<b>GEV No.</b>	560084	<b>Ref. No.</b>	153475 153479
<b>description</b>	hexagonal screw thread M5 thread L 16mm SS WS 8 Qty 20 pcs DIN 933 / ISO 4017		
<b>For models:</b>	FEH210, FEH410, FEH413, FEH415, FEH610, FEH613, FEH615, LEP400, LES060, LGP400, LGS060, NEF176, NEH210, NEH212, NEH410, NEH413, NEH415, NEH610, NEH613, NEH615, NEP400, NEP600, NEP601, NEP900, NEP901, NGH200, NGH202, NGH400, NGH403, NGH405, NGH407, NGH600, NGH603, NGH605, NGH607, NGP400, NGP600, NGP900, SEB230, SEB430, SEB630, SEF124, SEF144, SEF224, SEF400, SEG220, SEG420, SEG620, SEH200, SER400...(Other models you can see in the webshop)		

<b>hexagonal nuts inch thread</b>			
			
1			
<b>GEV No.</b>	520234	<b>Ref. No.</b>	166103
<b>description</b>	nut thread 3/4" H 5mm brass WS 30 Qty 1 pcs		
<b>For models:</b>	CBE120, CBE120-VAR091, CBE220, CBE220-VAR091, CCE120, CCE220, CEC120, CEC220, CED120, CED220, CEF120, CEF220, CEM120, CPE120, CPE220, EES060, EES080, EGS060, FER080, FER150, FER250, FER300, FER400, FES040, FES060, FES080, FES100, FES150, FEW250, FEW252, FGR150, FGR250, FGR300, FGR400, FGS040, FGS060, FGS080, FGS100, FGS150, FGW250, FNR080, FNR150, FNR250, FNR300, FNR400, FNS040, FNS060, FNS080, FNS100, FNS150...(Other models you can see in the webshop)		

nuts

plate nuts

			
1			
<b>GEV No.</b>	101922	<b>Ref. No.</b>	155078
<b>description</b>	plate nut hole ø 2.2mm L 13mm W 11mm		
<b>For models:</b>	CAP235		

washers

washers

<b>DIN 125A</b>			
			
1			
<b>GEV No.</b>	560312	<b>Ref. No.</b>	407550
<b>description</b>	plain washer ID ø 10.5mm ED ø 20mm thickness 2mm SS Qty 1 pcs DIN 125A for thread M10		
<b>For models:</b>	ECD106, ECD110, ECD120, ECD220		

hexagonal nuts

DIN 934 / ISO 4032/8673

			
1			
<b>GEV No.</b>	560133	<b>Ref. No.</b>	154896
<b>description</b>	hexagonal nut thread M6 H 5mm WS 10 SS DIN/ISO DIN 934 / ISO 4032/8673 Qty 20 pcs		
<b>For models:</b>	CEC106, CEC110, CEC120, CEC220, CGD110, CGD120, ECD106, ECD110, ECD120, ECD220, EEF040, EEF124, EEF224, EEW250, EEW400, EEW450, EEW452, FEF180, PEF188		

DIN 9021

			
1			
<b>GEV No.</b>	560117	<b>Ref. No.</b>	407575
<b>description</b>	plain washer ID ø 6.4mm ED ø 18mm thickness 1.5mm SS Qty 20 pcs DIN 9021 for thread M6		
<b>For models:</b>	ECD106, ECD110, ECD120, ECD220		

hexagonal nuts metric (without norm)

			
1			
<b>GEV No.</b>	520230	<b>Ref. No.</b>	407298
<b>description</b>	nut thread M14x1.5 H 5mm WS 19 zinc-coated steel Qty 1 pcs		
<b>For models:</b>	ECD106, ECD110, ECD120, ECD220		

tooth lock washers

<b>DIN 6798A</b>			
			
1			
<b>GEV No.</b>	560192	<b>Ref. No.</b>	407551
<b>description</b>	tooth lock washer ID ø 10.4mm ED ø 18mm SS DIN/ISO DIN 6798A Qty 1 pcs for thread M10		
<b>For models:</b>	ECD106, ECD110, ECD120, ECD220		





			
1			
<b>GEV No.</b>	560127	<b>Ref. No.</b>	156997
<b>description</b>	tooth lock washer ID ø 6.2mm ED ø 11mm SS DIN/ISO DIN 6798A Qty 20 pcs for thread M6		
<b>For models:</b>	ECD106, ECD110, ECD120, ECD220, NGP600, NGP900, SUA401, SUA601		

miscellaneous			
			
1			
<b>GEV No.</b>	520228	<b>Ref. No.</b>	40156998
<b>description</b>	tooth lock washer ID ø 15.3mm ED ø 24mm steel Qty 1 pcs for thread M14		

## fasteners

### clamps

#### hose clamps

##### DIN 3017 - W2

			
1			
<b>GEV No.</b>	520112	<b>Ref. No.</b>	407427-437
<b>description</b>	hose clamp ø 12-20mm width 9mm Qty 10 pcs DIN 3017		

			
1			
<b>GEV No.</b>	520114	<b>Ref. No.</b>	407357
<b>description</b>	hose clamp ø 20-32mm width 9mm Qty 10 pcs DIN 3017		
<b>For models:</b>	ECD106, ECD110, ECD120, ECD220		

			
1			
<b>GEV No.</b>	520115	<b>Ref. No.</b>	407571
<b>description</b>	hose clamp ø 25-40mm width 9mm Qty 10 pcs DIN 3017		
<b>For models:</b>	ECD106, ECD110, ECD120, ECD220		

			
1			
<b>GEV No.</b>	520118	<b>Ref. No.</b>	260261
<b>description</b>	hose clamp ø 50-70mm width 9mm Qty 5 pcs DIN 3017		
<b>For models:</b>	CED220, KGD020, KGD021, KGD030, KGD040, KGE021, KGE051, KGE052, KGE065, KGH020, KGH030, KGH040, KGS020, KGS021, KGS030, KGU020, KGU021, KGU030		

			
1			
<b>GEV No.</b>	520117	<b>Ref. No.</b>	407307
<b>description</b>	hose clamp stainless steel ø 40-60mm width 9mm Qty 5 pcs DIN 3017		
<b>For models:</b>	ECD106, ECD110, ECD120, ECD220		

### retaining rings

#### DIN 471

			
1			
<b>GEV No.</b>	529702	<b>Ref. No.</b>	157024
<b>description</b>	retaining ring spindle shaft ø 16mm thickness 1mm steel DIN 471		
<b>For models:</b>	CBG110, CBG120, CGD110, CGD120, NGR150, NGR250, NGR300, NGR400, NGS040, NGS060, NGS080, NGS100, NGS150		

### roll pins

			
1			
<b>GEV No.</b>	690043	<b>Ref. No.</b>	156938
<b>description</b>	roll pin ø 3mm L 16mm		

			
1			
<b>GEV No.</b>	692013	<b>Ref. No.</b>	156938
<b>description</b>	roll pin ø 3mm L 16mm		
<b>For models:</b>	CBE120, CBE120-VAR091, CBE220, CBE220-VAR091, CBG120, CCE120, CCE220, CEC120, CEC220, CED120, CED220, CEF120, CEF220, CEM120, CGD120, CPE120, CPE220, NGP600, NGP900		

consumables

cleaning agents

detergents for coffee machines



1			
<b>GEV No.</b>	802106	<b>Ref. No.</b>	527287
<b>description</b>	detergent puly CAFF plus approval NSF 200g 10 pouch of 20g		

detergents for milk foamers



1			
<b>GEV No.</b>	802111	<b>Ref. No.</b>	527288
<b>description</b>	detergents for milk foamers bottle PULY MILK Plus approval NSF 1000ml		

descalers



1			
<b>GEV No.</b>	802117	<b>Ref. No.</b>	527287
<b>description</b>	descaler Puly Cleaner content 0.3kg for coffee and espresso machines		

various cleaners



1			
<b>GEV No.</b>	890238	<b>Ref. No.</b>	506868 507129
<b>description</b>	detergent for ceramic hobs 0.2l		

fuses

fine fuses



1			
<b>GEV No.</b>	358696	<b>Ref. No.</b>	216325
<b>description</b>	fine fuse size ø5x20mm 4A medium lag rated 250V Qty 10 pcs		
<b>For models:</b>	CBE106, CBE106-VAR091, CBE110, CBE110-VAR091, CBE120, CBE120-VAR091, CBE220, CBE220-VAR091, CBG110, CBG120, CCE106, CCE110, CCE120, CCE220, CEC106, CEC110, CEC120, CEC220, CED106, CED110, CED120, CED220, CEF106, CEF110, CEF120, CEF220, CEM110, CEM120, CGD110, CGD120, CPE106, CPE110, CPE120, CPE220, EAB051, EEH410, EEH413, EEH500, EEH503, EEH610, EEH613, EEH700, EEH703, EES060, EES080, FEB430, FEB630, FED080, FED150, FED250...(Other models you can see in the webshop)		



1			
<b>GEV No.</b>	358598	<b>Ref. No.</b>	407274
<b>description</b>	fine fuse size ø5x20mm 0.63A slow-acting rated 250V Qty 10 pcs		
<b>For models:</b>	ECD106, ECD110, ECD120, ECD220		



1			
<b>GEV No.</b>	358608	<b>Ref. No.</b>	216327
<b>description</b>	fine fuse size ø5x20mm 10A slow-acting rated 250V Qty 10 pcs		
<b>For models:</b>	CEC106, CEC110, CEC120, CEC220, CED120, CED220		



1			
<b>GEV No.</b>	358607	<b>Ref. No.</b>	407273
<b>description</b>	fine fuse size ø5x20mm 6.3A slow-acting rated 250V Qty 10 pcs		
<b>For models:</b>	ECD106, ECD110, ECD120, ECD220		

fine fuse holders





1			
<b>GEV No.</b>	358508	<b>Ref. No.</b>	184683
<b>description</b>	fuse holder suitable fuse ø5x25mm		



## screw locks

### D0-system (NEOZED)

			
1			
<b>GEV No.</b>	358045	<b>Ref. No.</b>	407502
<b>description</b>	fuse size D02 35A rated 250/400V E18 ø 15mm L 36mm Qty 10 pcs		
<b>For models:</b>	ECD220		

			
1			
<b>GEV No.</b>	358046	<b>Ref. No.</b>	407503
<b>description</b>	fuse size D02 50A rated 250/400V E18 ø 15mm L 36mm Qty 10 pcs		
<b>For models:</b>	ECD220		

## gauge pieces (NEOZED)

			
1			
<b>GEV No.</b>	358067	<b>Ref. No.</b>	407650
<b>description</b>	gauge piece size D02 suitable for 35A		
<b>For models:</b>	ECD220		

			
1			
<b>GEV No.</b>	358068	<b>Ref. No.</b>	407649
<b>description</b>	gauge piece size D02 suitable for 50A		
<b>For models:</b>	ECD220		



<b>A</b>			
alarm devices	41		
<b>B</b>			
ball valves	130		
ball valves electric	57, 130		
bar burners	97		
bi-metal thermostats	23, 23		
bottom heaters	9		
<b>C</b>			
cable glands	66		
cables	66		
cam switches	32		
castors and bumper angles	122		
clamps	133, 135		
cleaning agents	136		
cleaning guns	128, 128		
condensators & interference suppression filters	64		
connection fittings	133		
consumables	136		
contactors	42		
control equipment	35		
control thermostats	23		
cross flow fans	58		
<b>D</b>			
descalers	136		
detergents for coffee machines	136		
detergents for milk foamers	136		
door catches	112		
door seals	123		
door seals with fixing hook	125		
dosing pumps	128		
<b>E</b>			
edgemount hinges	115		
edgemount latches	111		
electric accessories	66		
electric timers	41		
electrodes	58		
electronic controllers	48		
electronic magnets	67		
energy regulators	22		
espagnolette locks	113		
<b>F</b>			
fans	58		
fasteners	135		
fastening material	133		
filters	64		
fine fuses	136		
fittings		129	
float switches		31	
fuses		64, 136	
<b>G</b>			
gas burners		97	
gas control valves		85	
gas lines		102	
gas nozzles		100	
gas solenoid valves		87	
gas taps		67	
gas thermostats		81	
gaskets for heated units		123	
gaskets for tray rack trolleys		125	
<b>H</b>			
halogen lamp		39	
handle latches		112	
heater battery		10	
heaters		10	
heating elements		3	
heating elements for bain maries		4	
heating elements for charrills		9	
heating elements for convection		15	
heating elements for fryers		5	
heating elements for griddles		7	
heating elements for heated cabinets		9	
heating elements for ovens		3	
heating elements for pasta cookers		8	
heating elements for tilting bratt pan		7	
hexagonal nuts		134	
hexagonal screws		133	
hob burners		97	
hose clamps		133, 135	
hose connectors		129	
hoses		129	
hot air fans		63	
hot air motors		60	
hot plates		21	
<b>I</b>			
ignition boxes		86	
ignition cables		92	
ignition units		93	
immersion heating elements		10	
indicator lights		36	
indicator lights (complete)		37	
industrial hoses		129	
infrared lamps		39	
inlet spouts		132	
inlet taps		132	



**L**

lamp accessories	41
lamps	36
light bulbs	38
linear lamps	39

**M**

magnetic switches	35
microswitches	30
motors	64

**N**

neon light bulbs	36, 38
nuts	134

**O**

O-rings	125
oven hinges	115
oven lamps	39

**P**

piano hinges	115
piezoelectric igniters	93
pilot burners	87
pilot heating elements	10
plate nuts	134
plug connectors	66
plug-in gaskets	123
position switches	31
pressure switches	58
probes	49
programme timers	41
push button latches	111
push/momentary push switches	30

**R**

radiation heaters	17
reducers	129
refrigeration gaskets	123
relays	46
retaining rings	135
ring burners	99
roll pins	135
rubber hoses - Goldschlange®	129

**S**

safety bi-metal thermostats	23
safety thermostats	27
screw locks	137
screw pipe fittings	133
screw-in nipple	133
screws	133

sealing cords	126
sealing washers	126
shut-off valves	130
snap locks	113
solenoid valves	53
solid state relays	46
steam valves	131
switches and momentary switches	30

**T**

terminals	66
terminals and connectors	66
thermocouples	93
thermostat gaskets	127
thermostats	23
threaded cable glands	66
time relays	47
timers	41
tooth lock washers	134
transformers	47
turning lever locks	111

**V**

valves and tank inlets	130
------------------------	-----

**W**

walk-in fridge catches	113
washers	134
window seals	123