



**GAS COMPONENTS**



**ELECTRIC COMPONENTS**



**WATER TECHNOLOGY**



**MECHANICAL COMPONENTS**



**TOOLS**

Spare parts suitable for

**LAVINOX**

Find the complete and up-to-date range of products in our GEV Webshop



# Manufacturer catalogue

The most important spare parts and accessories arranged clearly for every manufacturer

- ✓ Complete product range and all appliance data always up to date in the GEV Webshop
- ✓ Alphabetical Index at the end of the catalogue

## GEV Webshop

[www.gev-online.co.uk](http://www.gev-online.co.uk)

[www.gev-online.com](http://www.gev-online.com)



- 🔍 Add to Favourites
- 🔍 Sign In with email address and usual password
- 🔍 Easy-order – place several items in your basket at the same time
- 🔍 Quick Item search – no login needed



## heating elements

### quartz heating elements

1			
<b>GEV No.</b>	359630	<b>Ref. No.</b>	0661301000
<b>description</b>	infrared lamp 230V 500W L 490mm connection M4 ø 12mm		

### coil heating elements

1			
<b>GEV No.</b>	418593	<b>Ref. No.</b>	0617303100
<b>description</b>	heating element 1200W 230V L 305mm W 50mm H 25mm tube ø 8.5mm thread M12x1.25 connection male faston 6.3mm connection length 30mm dry heating element heating circuits 1		



### heating elements for convection

1			
<b>GEV No.</b>	418887	<b>Ref. No.</b>	0617301601
<b>description</b>	heating element 2400W 240V heating circuits 1 ID ø 180mm ED ø 192mm L 208mm H 33mm L1 10mm W1 30mm H1 5mm H2 27mm flange length 100mm flange width 22mm hole distance 86mm connection male faston 6.3mm connection length 36mm tube ø 6.3mm convection heating element mounting thread M4 rectangular flange heated cabinet		



## switches and momentary switches

### rocker/momentary rocker switches

30x22mm

1				
<b>GEV No.</b>	301003	<b>Ref. No.</b>	0641303900	
<b>description</b>	rocker switch mounting measurements 30x22mm green 2NO 250V 16A illuminated 0-I connection male faston 6.3mm ambient temperature max. 125/55°C protection IP65			
<b>accessories for</b>	301003			
	<b>GEV No.</b>	301036	<b>Ref. No.</b>	—
	protective cover internal size 30x22mm for rocker switch mounting measurementsmm			

labelled

1				
<b>GEV No.</b>	300125	<b>Ref. No.</b>	0660800901	
<b>description</b>	rocker switch mounting measurements 30x22mm green 2NO 230V 16A 0-I connection male faston 6.3mm ambient temperature max. 125/55°C protection IP65 with cover cap			
<b>accessories for</b>	300125			
	<b>GEV No.</b>	301036	<b>Ref. No.</b>	—
	protective cover internal size 30x22mm for rocker switch mounting measurementsmm			

## relays

### power relays

with bracket mounting

1			
<b>GEV No.</b>	380139	<b>Ref. No.</b>	0648301900
<b>description</b>	power relays FINDER 230VAC 16A 2CO connection F6.3 bracket mounting dimensions 68x38.2x35.8mm manuf. no. 62.82.8.230.0000		

## electronic controllers

### EVCO - EVERY CONTROL

universal controllers

built-in version





1				
<b>GEV No.</b>	378293	<b>Ref. No.</b>	0646305702	
<b>description</b>	electronic controller EVCO mounting measurements 71x29mm 230V voltage AC NTC relay outputs 1 -99 up to +150°C display 4 digits 16A default setting +50 up to +70°C type EVK401N7VHXXX01			
<b>accessories for</b>	378293			
	<b>GEV No.</b>	378261	<b>Ref. No.</b>	—
	temperature probe NTC 10kOhm cable thermoplastic probe -40 up to +110°C cable -40 up to +110°C probe ø6x35mm cable length 3m without screw connection 2-wire			
	<b>GEV No.</b>	379057	<b>Ref. No.</b>	—
	temperature probe NTC 10kOhm cable PVC probe -20 up to +80°C cable -10 up to 100°C probe ø6x25mm cable length 3m 2-wire			
	<b>GEV No.</b>	379160	<b>Ref. No.</b>	0646305800
	temperature probe NTC 10kOhm cable thermoplastic probe -40 up to +110°C cable -40 up to +110°C probe ø6x14mm cable length 1.5m without screw connection 2-wire			

Table continues overleaf



accessories for 378293			
GEV No.	379161	Ref. No.	—
	temperature probe NTC 10kOhm cable thermoplastic probe -40 up to +110°C cable -40 up to +110°C probe ø6x14mm cable length 3m without screw connection 2-wire		
GEV No.	379342	Ref. No.	—
	temperature probe NTC 10kOhm cable PVC probe -20 up to +80°C cable -10 up to 100°C probe ø6x25mm cable length 1.5m 2-wire protection IP67		
GEV No.	379343	Ref. No.	—
	temperature probe NTC 10kOhm cable silicone probe -40 up to +110°C cable -50 up to +180°C probe ø6x40mm cable length 3m 2-wire		
GEV No.	379458	Ref. No.	—
	temperature probe NTC 10kOhm cable silicone probe -40 up to +110°C cable -50 up to +180°C probe ø6x40mm cable length 1.5m without screw connection 2-wire		
GEV No.	379784	Ref. No.	—
	temperature probe NTC 2kOhm cable thermoplastic probe -40 up to +110°C cable -40 up to +110°C probe ø6x35mm cable length 2m without screw connection 2-wire resistor 2kOhm		
GEV No.	379860	Ref. No.	—
	temperature probe NTC 10kOhm cable PVC probe -20 up to +80°C cable -10 up to 100°C probe ø6x40mm cable length 1.5m without screw connection 2-wire		

## probes

### universal probes

#### temperature probes



<b>1</b>			
GEV No.	379160	Ref. No.	0646305800
description	temperature probe NTC 10kOhm cable thermoplastic probe -40 up to +110°C cable -40 up to +110°C probe ø6x14mm cable length 1.5m without screw connection 2-wire		

## fans

### cross flow fans

#### COPREL

#### with standard coil



<b>1</b>			
GEV No.	601102	Ref. No.	682301800
description	cross flow fan TFL 45 roller ø 45mm roller length 300mm motor position left 230V/50Hz 35W refrigeration bearing rubber connection male faston 6.3mm airflow 268m <sup>3</sup> /h -10 up to +60°C 230V 50Hz		

## hot air fans

### miscellaneous



1

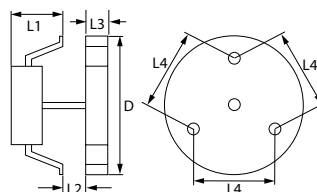

GEV No.	601011	Ref. No.	0682300800	
description	hot air fan 220-240V 40W 50/60Hz L1 65mm L2 15mm L3 25mm L4 87mm fan wheel ø 150mm FIME type C25R8023CLH			
accessories for	601011			
	GEV No.	550879	Ref. No.	—
	insulation ø 130mm thickness 3mm hole ø 20mm for hot air fan			
	GEV No.	601260	Ref. No.	—
	nut thread M6L IT for hot air fan			

## electric accessories

### terminals

#### porcelain clamps



1

GEV No.	555001	Ref. No.	0639803201
description	porcelain terminal block 2-pole 6mm <sup>2</sup> max. 30A max 450V L 26mm W 24mm H 20mm mounting distancemm Qty 1 pcs		



## equipment-specific units

### for sliding doors

#### miscellaneous



1

<b>GEV No.</b>	690570	<b>Ref. No.</b>	0140403100
<b>description</b>	rubber pad		

## hinges

### piano hinges

#### producer-specific

#### COOKMAX



1

<b>GEV No.</b>	701171	<b>Ref. No.</b>	0511304900
<b>description</b>	hinge W 31mm mounting distance 30mm thickness 1mm total length 40mm set		

#### LAVINOX



1

<b>GEV No.</b>	701171	<b>Ref. No.</b>	0511304900
<b>description</b>	hinge W 31mm mounting distance 30mm thickness 1mm total length 40mm set		

### miscellaneous



1

<b>GEV No.</b>	690000	<b>Ref. No.</b>	0511304200
<b>description</b>	hinge		

## pullouts

### drawer slides



1

<b>GEV No.</b>	696495	<b>Ref. No.</b>	0830349500
<b>description</b>	telescopic slide pair L 500mm W 13mm H 32mm		



1

<b>GEV No.</b>	696494	<b>Ref. No.</b>	0830348600
<b>description</b>	telescopic slide pair L 600mm W 13mm H 32mm		

## rollers

### roller with holder



1

<b>GEV No.</b>	690713	<b>Ref. No.</b>	0855358100
<b>description</b>	roller rollerø 22mm B1 6mm with holder SS/brass mounting pos. right door (right) bearing ball bearing Qty 1 pcs H 11mm L 64mm mounting distance 38/50mm		

**accessories for** 690713



<b>GEV No.</b>	690570	<b>Ref. No.</b>	0140403100
----------------	--------	-----------------	------------

rubber pad



1

<b>GEV No.</b>	690568	<b>Ref. No.</b>	0855320600
<b>description</b>	roller rollerø 22mm B1 6mm with holder SS/Nylon bearing ball bearing Qty 1 pcs H 12mm L 64mm mounting distance 38/50mm		

**accessories for** 690568





<b>GEV No.</b>	690570	<b>Ref. No.</b>	0140403100
----------------	--------	-----------------	------------

rubber pad

			
1			
<b>GEV No.</b>	690569	<b>Ref. No.</b>	0855309801
<b>description</b>	roller rollerø 22mm B1 6mm with holder SS/Nylon mounting pos. at the back left bearing ball bearing Qty 1 pcs L 63mm mounting distance 38/50mm		

			
1			
<b>GEV No.</b>	690567	<b>Ref. No.</b>	0855309701
<b>description</b>	roller rollerø 22mm B1 6mm with holder SS/Nylon mounting pos. left door bearing ball bearing Qty 1 pcs H 12mm L 64mm mounting distance 38/50mm		

			
1			
<b>GEV No.</b>	690711	<b>Ref. No.</b>	0855309601
<b>description</b>	roller rollerø 22mm B1 6mm with holder SS/Nylon mounting pos. right door (left) bearing ball bearing Qty 1 pcs H 11mm L 63mm mounting distance 38/50mm		

<b>accessories</b>			
			
1			
<b>GEV No.</b>	690570	<b>Ref. No.</b>	0140403100
<b>description</b>	rubber pad		

## equipment feet and end caps

### equipment feet

#### with screw mounting

			
1			
<b>GEV No.</b>	701172	<b>Ref. No.</b>	0805318400
<b>description</b>	equipment foot tube ø 52mm thread M10 thread L 18mm H 140/195mm SS size 2" Qty 1 pcs		

### bullet feet

#### plastic/SS

			
1			
<b>GEV No.</b>	700869	<b>Ref. No.</b>	0805324100
<b>description</b>	equipment foot pipe type 40x40 thickness 1-1.2mm H 23-92mm plastic/SS Qty 1 pcs		

### DERBY RUOTE

#### with fixing plate

#### chrome-plated steel

			
1			
<b>GEV No.</b>	701173	<b>Ref. No.</b>	0961300001
<b>description</b>	swivel castor ø 125mm plate fixing housing chrome-plated sheet steel plate size 95x70mm hole distance 50x70mm capacity 80kg bearing slide bearing wheel body polypropylene tread TPE tyres H 162mm wheel width 30mm Qty 1 pcs		

			
1			
<b>GEV No.</b>	701174	<b>Ref. No.</b>	0961300101
<b>description</b>	swivel castor with swivel brake ø 125mm plate fixing housing chrome-plated sheet steel plate size 95x70mm hole distance 50x70mm capacity 80kg bearing slide bearing wheel body polypropylene tread TPE tyres H 162mm wheel width 30mm Qty 1 pcs		

## shelves and shelf rails

### shelf rails and supports

#### producer-specific

			
1			
<b>GEV No.</b>	690626	<b>Ref. No.</b>	0531306100
<b>description</b>	shelf support L 32mm W 14mm H 20mm		



## drain systems and wash basins

### standpipes

producer-specific

LAVINOX



1

<b>GEV No.</b>	515133	<b>Ref. No.</b>	0830318600
<b>description</b>	drain fitting size 1½" usable heightmm overall heightmm SS		
<b>accessories for</b>	515133		
	<b>GEV No.</b>	515134	<b>Ref. No.</b> 0515373900
	standpipe size 1½" usable height 225mm overall height 250mm ED ø 40mm SS		



1

<b>GEV No.</b>	515134	<b>Ref. No.</b>	0515373900
<b>description</b>	standpipe size 1½" usable height 225mm overall height 250mm ED ø 40mm SS		
<b>accessories for</b>	515133		
	<b>GEV No.</b>	515133	<b>Ref. No.</b> 0830318600
	drain fitting size 1½" usable heightmm overall heightmm SS		





**C**

castors and bumper angles	6
coil heating elements	3
cross flow fans	4

**D**

drain systems and wash basins	7
-------------------------------	---

**E**

electric accessories	4
electronic controllers	3

**F**

fans	4
------	---

**H**

heating elements	3
heating elements for convection	3
hot air fans	4

**P**

piano hinges	5
probes	4

**Q**

quartz heating elements	3
-------------------------	---

**R**

relays	3
rocker/momentary rocker switches	3

**S**

shelves and shelf rails	6
standpipes	7
switches and momentary switches	3

**T**

temperature probes	4
terminals	4

**U**

universal probes	4
------------------	---