



GAS COMPONENTS



ELECTRIC COMPONENTS



WATER TECHNOLOGY



MECHANICAL COMPONENTS



TOOLS

Spare parts suitable for

LA MARZOCCO

Find the complete and up-to-date range of products in our GEV Webshop



Manufacturer catalogue

The most important spare parts and accessories arranged clearly for every manufacturer

- ✓ Complete product range and all appliance data always up to date in the GEV Webshop
- ✓ Alphabetical Index at the end of the catalogue

GEV Webshop

www.gev-online.co.uk

www.gev-online.com





- 🔍 Add to Favourites
- 🔍 Sign In with email address and usual password
- 🔍 Easy-order – place several items in your basket at the same time
- 🔍 Quick Item search – no login needed



heating elements



heating elements for coffee machine

			
1			
GEV No.	417397	Ref. No.	E.6.003
description	heating element 1200W 220V heating circuits 1 mounting ø 40mm hole distance 57mm L 170mm W 31mm H 30mm L1 10mm L2 75mm L3 85mm H1 9mm H2 21mm hole ø 10mm tube ø 8mm connection M3 immersion heater 3 hole flange		



			
1			
GEV No.	417126	Ref. No.	LR340220
description	heating element 1300W 230V L 215mm W 39mm H 21mm mounting distance 31mm tube ø 8.5mm thread 1/4" windings 2 connection M3 connection length 21mm 2 hole fixing immersion heater		



accessories for 417126			
	GEV No.	361182	Ref. No. —
	nut thread 1/4" H 5mm nickel-plated brass WS 17 Qty 1 pcs		
	GEV No.	510417	Ref. No. —
	flat gasket fibre ED ø 20mm ID ø 14mm thickness 2mm Qty 1 pcs		
	GEV No.	520228	Ref. No. —
	tooth lock washer ID ø 15.3mm ED ø 24mm steel Qty 1 pcs for thread M14		
	GEV No.	527169	Ref. No. —
	hexagonal nut thread M3 H 2.8mm WS 5.5 brass Qty 1 pcs		
	GEV No.	550262	Ref. No. —
	flat gasket copper ED ø 20mm ID ø 14mm thickness 2mm		
	GEV No.	560110	Ref. No. —
	plain washer ID ø 3.2mm ED ø 7mm thickness 0.5mm SS Qty 20 pcs DIN 125A for thread M3		
	GEV No.	560130	Ref. No. —
	hexagonal nut thread M3 H 2.4mm WS 5.5 SS DIN/ISO DIN 934 / ISO 4032/8673 Qty 20 pcs		

			
1			
GEV No.	417395	Ref. No.	LR36522001 LR36522003
description	heating element 1400W 220V heating circuits 1 thread 1 1/4" L 430mm W 36mm H 32mm tube ø 9.8mm connection M4 immersion heater flange with thread coffee machine WS 42		



			
1			
GEV No.	417127	Ref. No.	LR365/220
description	heating element 1400W 230V heating circuits 1 thread 1 1/4" L 395mm W 32mm tube ø 10mm connection M4 immersion heater flange with thread		
accessories for 417127			
	GEV No.	510405	Ref. No. —
	flat gasket fibre ED ø 56mm ID ø 42mm thickness 2mm for thread 1 1/4" Qty 1 pcs		

accessories for 417127			
	GEV No.	528021	Ref. No. —
	flat gasket PTFE ED ø 53mm ID ø 42.5mm thickness 3mm Qty 1 pcs equiv. no. 12001/02286 suitable for Astoria/Aurora/Brasilia/Wega		

			
1			
GEV No.	417129	Ref. No.	LR362/220
description	heating element 1600W 230V heating circuits 1 thread 1 1/4" L 660mm W 34mm tube ø 10mm connection M4 immersion heater connection length 45mm flange with thread		
accessories for 417129			
	GEV No.	510405	Ref. No. —
	flat gasket fibre ED ø 56mm ID ø 42mm thickness 2mm for thread 1 1/4" Qty 1 pcs		
	GEV No.	528021	Ref. No. —
	flat gasket PTFE ED ø 53mm ID ø 42.5mm thickness 3mm Qty 1 pcs equiv. no. 12001/02286 suitable for Astoria/Aurora/Brasilia/Wega		

			
1			
GEV No.	417045	Ref. No.	LR340/220B
description	heating element 1800W 230V heating circuits 1 thread 1 1/4" L 135mm W 36mm H 39mm tube ø 8.5mm connection male faston 6.3mm immersion heater flange with thread		
accessories for 417045			
	GEV No.	510405	Ref. No. —
	flat gasket fibre ED ø 56mm ID ø 42mm thickness 2mm for thread 1 1/4" Qty 1 pcs		
	GEV No.	528021	Ref. No. —
	flat gasket PTFE ED ø 53mm ID ø 42.5mm thickness 3mm Qty 1 pcs equiv. no. 12001/02286 suitable for Astoria/Aurora/Brasilia/Wega		

			
1			
GEV No.	417400	Ref. No.	LR366/220
description	heating element 1900W 220V heating circuits 1 thread 1 1/4" L 660mm W 35mm H 35mm tube ø 10mm connection M3 immersion heater flange with thread coffee machine WS 43		



			
1			
GEV No.	417125	Ref. No.	LR342/220B
description	heating element 2000W 220V heating circuits 1 thread 1 1/4" L 290mm W 27mm H 29mm tube ø 10mm connection M4x0.8 immersion heater connection length 42mm flange with thread coffee machine WS 42 2 groups		
accessories for 417125			
	GEV No.	510405	Ref. No. —
	flat gasket fibre ED ø 56mm ID ø 42mm thickness 2mm for thread 1 1/4" Qty 1 pcs		
	GEV No.	528021	Ref. No. —
	flat gasket PTFE ED ø 53mm ID ø 42.5mm thickness 3mm Qty 1 pcs equiv. no. 12001/02286 suitable for Astoria/Aurora/Brasilia/Wega		

electric components



			
GEV No.	417398	Ref. No.	LR357/220B
description	heating element 3000W 220V heating circuits 1 thread 1¼" L 390mm W 31mm H 31mm tube ø 10mm connection M4 immersion heater connection length 25mm flange with thread coffee machine WS 43		

			
GEV No.	417399	Ref. No.	LR345/220B
description	heating element 3000W 220V heating circuits 1 thread 1¼" L 500mm W 35mm H 35mm tube ø 10mm connection M3 immersion heater flange with thread coffee machine		

			
GEV No.	417128	Ref. No.	LR356/220B
description	heating element 4000W 220V heating circuits 1 thread 1¼" L 495mm W 35mm H 28mm tube ø 10mm connection M4 immersion heater flange with thread coffee machine 3 groups		
accessories for	417128		
	GEV No.	510405	Ref. No. —
	flat gasket fibre ED ø 56mm ID ø 42mm thickness 2mm for thread 1¼" Qty 1 pcs		
	GEV No.	528021	Ref. No. —
	flat gasket PTFE ED ø 53mm ID ø 42.5mm thickness 3mm Qty 1 pcs equiv. no. 12001/02286 suitable for Astoria/Aurora/Brasilia/Wega		

			
GEV No.	417396	Ref. No.	E.6.004 E600401 E600402
description	heating element 800W 220V heating circuits 1 mounting ø 39mm hole distance 58mm L 170mm W 31mm H 30mm L1 10mm L2 75mm L3 85mm H1 9mm H2 21mm hole ø 10mm tube ø 8mm connection M3 immersion heater 3 hole flange		

accessories

sealing washers

fibre gaskets

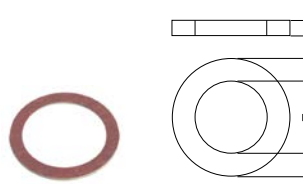
			
GEV No.	528171	Ref. No.	LR360
description	flat gasket fibre ED ø 55mm ID ø 42mm thickness 2mm Qty 1 pcs		

PTFE gaskets

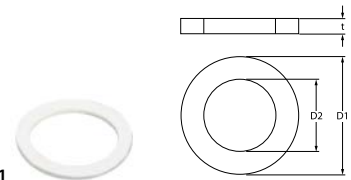
			
GEV No.	528022	Ref. No.	LR360
description	flat gasket PTFE ED ø 52mm ID ø 41mm thickness 2mm size 1¼" Qty 1 pcs suitable for CARIMALI, FAEMA, MARZOCCO, PAVONI		

O-rings

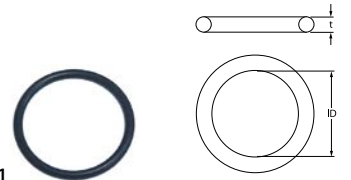
			
GEV No.	510899	Ref. No.	F.2.014
description	O-ring EPDM thickness 3.53mm ID ø 37.69mm Qty 1 pcs		

thermostats

bi-metal thermostats

safety bi-metal thermostats

			
GEV No.	390367	Ref. No.	L276B
description	bi-metal safety thermostat hole distance 39-44mm switch-off temp. 130°C 2NC 2-pole 16A connection F6.3 2 hole fixing		

switches and momentary switches

rocker/momentary rocker switches

			
GEV No.	346474	Ref. No.	L284
description	dummy element external size 30x22mm suitable for rocker switch		

			
GEV No.	347352	Ref. No.	L286/1
description	momentary rocker switch mounting measurements 30x22mm white 2NO 250V 16A steam connection male faston 6.3mm ambient temperature max. 85/125°C protection IP40		





			
1			
GEV No.	347353	Ref. No.	L286 L286LM
description	momentary rocker switch mounting measurements 30x22mm white 2NO 250V 16A water connection male faston 6.3mm ambient temperature max. 85/125°C protection IP40		

			
1			
GEV No.	346081	Ref. No.	L285/1
description	rocker switch mounting measurements 30x22mm white 2NO 250V 16A coffee connection male faston 6.3mm ambient temperature max. 100/55°C protection IP40		

			
1			
GEV No.	346082	Ref. No.	L285/2
description	rocker switch mounting measurements 30x22mm white 2NO 250V 16A steam connection male faston 6.3mm ambient temperature max. 100/55°C protection IP40		

			
1			
GEV No.	347354	Ref. No.	L285
description	rocker switch mounting measurements 30x22mm red 2NO 250V 16A illuminated heating connection male faston 6.3mm ambient temperature max. 100/55°C protection IP40		

miscellaneous			
			
1			
GEV No.	347358	Ref. No.	E.2.010
description	rocker switch mounting measurements 21x44mm black 2NO 240V 20A 0-1 connection male faston 2.8mm/6.3mm ambient temperature max. 85/125°C		

			
1			
GEV No.	347360	Ref. No.	L287
description	rocker switch mounting measurements 33x39mm white/red 2NO 250V 16A illuminated connection male faston 6.3mm ambient temperature max. 85/125°C		



push/momentary push switches

miscellaneous

			
1			
GEV No.	347357	Ref. No.	L283/C
description	push switch with frame		

toggle switches



M12x0.75

			
1			
GEV No.	346519	Ref. No.	E.2.017
description	toggle switch thread M12x0.75 2NO 250V 15A ON-OFF male faston 6.3mm		
accessories for	346519		
	GEV No.	Ref. No.	—
	346525		
	protection cap L 23.5mm W 17.3mm protection cap rubber thread M11		
	GEV No.	Ref. No.	—
	347197		
	bezel ON-OFF for toggle switch M12		

rotary switches

BREMAS

A1700 series

			
1			
GEV No.	346104	Ref. No.	E.2.002
description	rotary switch 2 0-1 sets of contacts 3 type CA0170003 400V 20A shaft ø 5x5mm shaft L 21mm shaft square connection screw		
accessories for	346104		
	GEV No.	Ref. No.	—
	111012		
	knob switch zero mark t.max.°C ø 34/60mm shaft ø 5x5mm shaft flat black H 22mm L 50mm		

			
1			
GEV No.	347364	Ref. No.	L400/17
description	rotary switch 3 0-1-2 sets of contacts 6 type CS017GZ32 400V 17A shaft ø 5x5mm shaft L 23mm shaft square connection screw		



A3200 series



1

GEV No.	347359	Ref. No.	E.2.001
description	rotary switch 2 0-1 sets of contacts 2 type CA0320002 600V 32A shaft \varnothing 5x5mm shaft L 23mm shaft square with knob connection cable 300mm		



1

GEV No.	347361 ¹	Ref. No.	L400/32
description	rotary switch 3 0-1-2 sets of contacts 2 type CS032GZ22 600V 40A shaft \varnothing 5x5mm shaft L 24mm shaft square with knob connection screw		

¹incl. knob and dial plate

1

GEV No.	346079	Ref. No.	L400/32/T
description	rotary switch 3 0-1-2 sets of contacts 4 type CS032GZ32 600V 40A shaft \varnothing 5x5mm shaft L 24mm shaft square connection screw		

accessories



1

GEV No.	111369	Ref. No.	L400/K
description	knob \varnothing 28/48mm shaft \varnothing 5x5mm black H 22mm L 40mm		

accessories

symbol labels

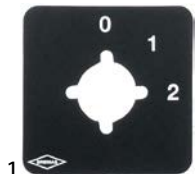

1

GEV No.	347773	Ref. No.	L400T1
description	symbol label 0-1-2 L 49mm W 49mm bore \varnothing 17mm		



1

GEV No.	347365	Ref. No.	L400/T
description	symbol label OFF-FILL-RUN L 49mm W 49mm bore \varnothing 16mm		

lamps

indicator lights

indicator lights (complete)

30x22mm



1

GEV No.	359155	Ref. No.	L288
description	indicator light mounting measurements 30x22mm 230V red connection male faston 6.3mm temp.-resist. 125°C type RL2		

contactors

TELEMECANIQUE (Schneider Electric)

power contactors



1

GEV No.	380976	Ref. No.	L500
description	power contactor resistive load 32A 230VAC (AC3/400V) 18A/7.5kW main contacts 3NO auxiliary contacts 1NO/1NC connection screw connection		



1

GEV No.	380979	Ref. No.	L510
description	power contactor resistive load 40A 230VAC (AC3/400V) 25A/11kW main contacts 3NO auxiliary contacts 1NO/1NC connection screw connection type LC1D25P7		



solid state relays

miscellaneous



1

GEV No.	402566	Ref. No.	E.4.010
description	solid state relay HFS 1 phase 25A 240V 4-32VDC L 58mm W 45mm with LED screw type D-24Z25-L		

relays

level relays

GICAR



1

GEV No.	402103	Ref. No.	LA050
description	level controller 230/240V voltage AC 50/60Hz connection F6.3 type NRL30/1E-2C/F		

probes

producer-specific probes



1

GEV No.	379499	Ref. No.	E.1.005
description	probe Pt1000 cable silicone probe -100 up to 450°C cable -50 up to +180°C connection coded plug thread 1/4" probe ø3x100mm cable length 1.5m		

electronics

PCBs



1

GEV No.	402577	Ref. No.	E.1.004
description	display L 135mm W 44mm		



1

GEV No.	402592	Ref. No.	E.1.009
description	keypad PCB L 116mm W 44mm buttons 6		



1

GEV No.	402580	Ref. No.	E.1.012
description	PCB for central unit suitable for MARZOCCO type DOS 3D5 DELUXE 2PTK BI-POWER		

central units



1

GEV No.	402583	Ref. No.	LAD3D5/3LC LAD3D5/3XLC
description	central unit 230V type 3d5 3GRCTZ voltage AC		



1

GEV No.	402582	Ref. No.	E.1.010.01
description	central unit 230V type Manuale GB5 voltage AC		



1

GEV No.	402581	Ref. No.	E.1.001
description	central unit 4-group 230V type GB5 voltage AC		



1

GEV No.	402584	Ref. No.	LAD070/3
description	central unit edition old edition		



1

GEV No.	402578	Ref. No.	LAD070/1
description	keypad unit buttons 5 type TH SMT 1GR+RL		

keypads

keypad units



1

GEV No.	402576	Ref. No.	E.1.007
description	keypad unit buttons 1		



1

GEV No.	402574	Ref. No.	E.1.002
description	keypad unit buttons 6 programmable		



1

GEV No.	402570	Ref. No.	LAD3D5/P
description	keypad unit buttons 5 suitable for MARZOCCO type 3d5 L 106mm W 44mm		



1

GEV No.	402575	Ref. No.	E.1.003
description	keypad unit buttons 6 standard		



1

GEV No.	402571	Ref. No.	LAD3D5/THE
description	keypad unit buttons 5 suitable for MARZOCCO type 3D5+TEA lighting LED with tea programm		



1

GEV No.	402573	Ref. No.	E.1.015
description	keypad unit buttons 6 with display		



1

GEV No.	402572	Ref. No.	LAD3D5/P3C
description	keypad unit buttons 5 type P3 CRONO lighting LED with timer		



1

GEV No.	400356	Ref. No.	E.1.008
description	keypad unit hot water buttons 1 L 37mm W 31mm		



1

GEV No.	400452	Ref. No.	LAD071THE
description	keypad unit type DOS MASK + TEA lighting LED		



			
1			
GEV No.	400453	Ref. No.	LAD071VT
description	keypad unit type DOS MICRO		



solenoid valves



solenoid valves (water)

metal
ASCO
spare parts and accessories
O-rings

			
1			
GEV No.	371095	Ref. No.	L165/6
description	O-ring Viton thickness 1.78mm ID ø 6.07mm Qty 1 pcs		

ODE
solenoid valves steam (water)

21A series			
			
1			
GEV No.	370590	Ref. No.	L053 L05301
description	solenoid valve 2-ways 230VAC connection 1/8" L 40mm DN 2.5mm t.max. 160°C slide-on receptacle DIN -10 up to 140°C ODE type series 21A coil type BDP membranes FKM (water/steam) p max 14bar 50/60Hz flow rate 3.2l/min duty cycle 100%		
accessories for	370590		
	GEV No.	371090	Ref. No. L205
power socket plug type DIN 43650A screw			

4767AOR series			
			
1			
GEV No.	370591	Ref. No.	B.2.004 B200401
description	solenoid valve 3-ways 230VAC L 44.5mm DN 1.5mm t.max. 160°C slide-on receptacle DIN -40 up to +180°C ODE coil type BDP membranes ruby p max 15bar 50/60Hz brass duty cycle 100%		
spare parts for	370591		
	GEV No.	371095	Ref. No. L165/6
O-ring Viton thickness 1.78mm ID ø 6.07mm Qty 1 pcs			
accessories for	370591		
	GEV No.	371090	Ref. No. L205
power socket plug type DIN 43650A screw			

solenoid valves (refrigeration)

CASTEL			
spare parts and accessories			
			
1			
GEV No.	371090	Ref. No.	L205
description	power socket plug type DIN 43650A screw		

Solenoid valve - accessories

			
1			
GEV No.	371095	Ref. No.	L165/6
description	O-ring Viton thickness 1.78mm ID ø 6.07mm Qty 1 pcs		
			
1			
GEV No.	371091	Ref. No.	615978/P-Muster bestellen
description	power socket plug type DIN 43650B cable lengthmm small		



electric components

pressure switches

for coffee machines

ø 35mm





1

GEV No.	541143	Ref. No.	L271
description	pressure control ø 35mm pressure range adjustable 0.2-6.0bar pressure connection vertical preset atbar 250V coffee machine parts connection 1/8" 1CO pressure connection 1/8"		

miscellaneous



1

GEV No.	541021	Ref. No.	L270
description	pressure control pressure range adjustable 0.5-1.4bar connection 1/4" 30A 3-pole type P302 coffee machine parts SIRAI		
accessories for	541021		
	GEV No.	550262	Ref. No. —
	flat gasket copper ED ø 20mm ID ø 14mm thickness 2mm		
	GEV No.	890100	Ref. No. —
	PTFE tape reel L 12m W 12mm -200 up to +260°C approval DIN-DVGW, KTW temperature-resistant, elastic for fine thread thickness 0.1mm		

electrodes



1

GEV No.	400214	Ref. No.	LA052
description	level electrode 1/4" total length 140mm probe L 112mm insulated probe length 26mm connection male faston 6.3mm stainless steel ø 2.5mm		

flow meters and flow sensors

flow meters

GICAR



1

GEV No.	400222	Ref. No.	LAD070
description	flow meter thread 1/4" stainless steel male faston 2.8mm approval NSF		

accessories



1

GEV No.	400088	Ref. No.	LAD070/GC
description	casing cover GICAR nickel-plated brass for flow meter		



1

GEV No.	400257	Ref. No.	LAD070/V
description	impellor GICAR H 15mm D1 ø 26.7mm D2 ø 9.8mm for flow meter		



1

GEV No.	400258	Ref. No.	LAD070/S1
description	O-ring for flow meter		



			
1			
GEV No.	400256	Ref. No.	LAD070/CGC
description	plug GICAR for flow meter		

pumps

booster pumps II

pump heads

FLUID-O-TECH

			
1			
GEV No.	499056	Ref. No.	N/A
description	pump head PA1504 FLUID-O-TECH L 82mm 150l/h connection 3/8" GAS with bypass brass clip connection for coffee machine shaft ø 10.8x4.8mm approval NSF		

			
1			
GEV No.	500454	Ref. No.	L290 L290/1
description	pump head PA1504 FLUID-O-TECH L 82mm 150l/h connection 3/8" NPT with bypass brass clip connection for coffee machine shaft ø 4.8x11mm approval NSF		

equipment-specific units

for espresso machines

filter holders

filter holder without bottom

			
1			
GEV No.	525907	Ref. No.	L111X
description	filter holder without bottom suitable for MARZOCCO complete with filter mounting ø 83 ID ø 62mm wedge height 10mm wedge position horizontal number of wedges 2 chrome-plated brass		
accessories for	525907		
	GEV No.	531286	Ref. No. —
	filter ø 70mm mounting ø 60mm H 66mm for EP capsules perforation ø 3.5mm for model universal		

filter holders standard

filter holder without spout

			
1			
GEV No.	531209	Ref. No.	L111X
description	filter holder suitable for MARZOCCO without bottom and filter mounting ø 83mm outlet ID ø 62mm wedge height 10mm wedge position horizontal number of wedges 2 lever inclined		

			
1			
GEV No.	525983	Ref. No.	L111/LM12
description	filter holder suitable for MARZOCCO without outlet mounting ø 83mm outlet 3/8" ID ø 62mm wedge height 10mm wedge position horizontal number of wedges 2 lever inclined		

			
1			
GEV No.	525982	Ref. No.	N/A
description	filter holder suitable for MARZOCCO without outlet mounting ø 83mm outlet 3/8" ID ø 62mm wedge height 9mm wedge position horizontal number of wedges 2 lever straight		

filter holders short



1

GEV No.	529205	Ref. No.	N/A
description	filter holder mounting ø 83mm outlet 3/8" ID ø 62mm handle M12x1.5 wedge high 10mm wedge position horizontal number of wedges 2 lever inclined chrome-plated brass		



1

GEV No.	529204	Ref. No.	N/A
description	filter holder mounting ø 83mm outlet 3/8" ID ø 62mm handle M12x1.75 wedge high 9mm wedge position horizontal number of wedges 2 lever straight chrome-plated brass		

filters

for 1 cup



1

GEV No.	527631	Ref. No.	N/A
description	coffee filter ø 70mm mounting ø 60.7mm H 17mm cups 1 amount of coffee 8g		



1

GEV No.	526897	Ref. No.	L115/A
description	coffee filter ø 70mm mounting ø 60mm H 27mm cups 1		

for 2 cups



1

GEV No.	526898	Ref. No.	L116/A
description	coffee filter ø 70mm mounting ø 60mm H 26.8mm cups 2 perforation ø 0.35mm		

brewing units

shower screens

with upstand and central hole



1

GEV No.	526854	Ref. No.	L107
description	shower screen ø 56.5mm H 6mm hole ø 7mm with upstand		



1

GEV No.	529092	Ref. No.	L107
description	shower screen ø 56.7mm H 6mm hole ø 7.1mm		

filter holder gaskets

with cone



1

GEV No.	528065	Ref. No.	L105/B7
description	filter holder gasket with ridge D1 ø 71.5mm D2 ø 55mm H1 7.1mm H2 6.1mm with outside notch Qty 1 pcs		

with ridge



1

GEV No.	526883	Ref. No.	H3001 L105/B8
description	filter holder gasket with ridge D1 ø 72mm D2 ø 55mm H1 8.1mm H2 6.2mm with outside notch		



			
1			
GEV No.	528066	Ref. No.	L105/B9
description	filter holder gasket with ridge D1 ø 72mm D2 ø 55mm H1 9.5mm H2 7.1mm with outside notch		

brewing units manual

components

gaskets

			
1			
GEV No.	526856	Ref. No.	H.2.001
description	gasket D1 ø 13mm ID ø 4mm thickness 4mm Viton		

components

nozzles

with thread

			
1			
GEV No.	526886	Ref. No.	L087/GI 6
description	nozzle bore ø 0.6mm thread M4 L 8.5mm		

			
1			
GEV No.	526889	Ref. No.	F.2.003
description	nozzle bore ø 0.6mm thread M5 L 20mm		

			
1			
GEV No.	526887	Ref. No.	L087/GI 7 L087GI701
description	nozzle bore ø 0.7mm thread M4 L 8.5mm		

			
1			
GEV No.	526888	Ref. No.	L087/GI
description	nozzle bore ø 0.8mm thread M4 L 8.5mm		

<p>screws</p> 			
1			
GEV No.	560417	Ref. No.	L110
description	cylinder head bolt thread M8 L 55mm thread L 29mm WS 6 SS Qty 1 pcs head ø 13mm head thickness 8mm DIN 912/ISO 4762		

<p>screw connections</p> 			
1			
GEV No.	526893	Ref. No.	L100/3
description	screw connection thread M12x1 L 22mm WS 24		

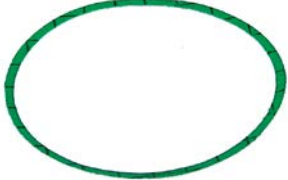
<p>gaskets</p> 			
1			
GEV No.	528961	Ref. No.	L103/B
description	flat gasket fibre ED ø 86mm ID ø 80mm thickness 0.5mm Qty 1 pcs		

water dispersions

water dispersions

2-piece

			
1			
GEV No.	526892	Ref. No.	L105
description	water distributor D1 ø 55.5mm thread M24x1.5 H 13.5mm nickel-plated brass		
accessories for	526892		
	GEV No.	526885	Ref. No.
			L106/V
			
			water distributor thread M6 H 15.6mm SS ø 10mm



1

GEV No.	526885	Ref. No.	L106/V
description	water distributor thread M6 H 15.6mm SS ø 10mm		
accessories for	526885		
	GEV No.	526892	Ref. No. L105
	water distributor D1 ø 55.5mm thread M24x1.5 H 13.5mm nickel-plated brass		

expansion valves

with bore



1

GEV No.	528791	Ref. No.	L140/C L140CLM
description	expansion valve T1: 1/4" ET L 40mm total length 56mm		

drain pans

drain pans



1

GEV No.	526866	Ref. No.	L037
description	drain pan L 100mm W 100mm H 52mm hole ø 21mm suitable for MARZOCCO		

steam/water taps

steam/water taps

steam taps

steam taps (complete)



1

GEV No.	526842	Ref. No.	B.1.001.01.R B.1.001.02.R
description	steam tap complete		



1

GEV No.	527954	Ref. No.	B.1.006
description	steam tap mounting pos. external inlet 3/8" outlet 3/8" chrome-plated brass		



1

GEV No.	526844	Ref. No.	B.1.004
description	steam tap swing lever inlet 1/4" outlet 3/4" brass		



1

GEV No.	526843	Ref. No.	L165 L165LM
description	steam tap T1: 1/4"		





bodies			
			
1			
GEV No.	526846	Ref. No.	L167 L167/LM
description	tap body T1: M16x1 T2: 1/4" L 49mm		

components			
shafts			
			
1			
GEV No.	526847	Ref. No.	L169 L169LM
description	shaft for steam tap with gasket ø 14.5mm D1 ø 10.5mm D2 ø 7.45mm D3 ø 6mm L 88.2mm brass		

bushes			
			
1			
GEV No.	526850	Ref. No.	L165/7
description	bush D1 ø 10.5mm D2 ø 9mm ID ø 6.2mm H 5.5mm brass		

gaskets			
			
1			
GEV No.	527970	Ref. No.	F.2.009
description	flat gasket PTFE ED ø 24mm ID ø 18mm thickness 2mm Qty 1 pcs		

			
1			
GEV No.	528502	Ref. No.	L165/5
description	gasket D1 ø 12mm thickness 5.7mm EPDM		

			
1			
GEV No.	526853	Ref. No.	L165/5
description	gasket D1 ø 12mm thickness 5.7mm silicone		

			
1			
GEV No.	526856	Ref. No.	H.2.001
description	gasket D1 ø 13mm ID ø 4mm thickness 4mm Viton		

gasket supports			
			
1			
GEV No.	526852	Ref. No.	B.2.010
description	piston for steam tap with gasket L 14mm brass		

expansion valves			
			
1			
GEV No.	526848	Ref. No.	L192
description	expansion valve for tap thread 1/8" hose ø 6.5mm total length 39mm		

springs			
			
1			
GEV No.	526877	Ref. No.	L165/4
description	compression spring ø 10.3mm L 34mm wire gauge ø 1.2mm		

			
1			
GEV No.	527968	Ref. No.	F.3.017
description	compression spring ø 12.5mm L 31mm wire gauge ø 1.8mm		

			
1			
GEV No.	526880	Ref. No.	F.3.005
description	compression spring ø 12mm L 29.5mm wire gauge ø 1.2mm		

			
1			
GEV No.	527969	Ref. No.	F.3.018
description	compression spring ø 8mm L 21mm wire gauge ø 0.4mm		

washers



1

GEV No.	526862	Ref. No.	I.4.001
description	plain washer ID ø 7mm ED ø 14mm thickness 0.5mm brass Qty 1 pcs		

valve bodies



1

GEV No.	526845	Ref. No.	L168 L168LM
description	front part for steam tap handle Tr18x4 thread M16x1		

steam/water pipes

steam pipes



1

GEV No.	529506	Ref. No.	L171
description	steam pipe		



1

GEV No.	526870	Ref. No.	T.1.053.SX
description	steam pipe mounting pos. left H 150mm L 170mm ø 15mm tube ø 8mm Mistral		



1

GEV No.	526869	Ref. No.	T.1.053.DX
description	steam pipe mounting pos. right H 150mm L 170mm ø 15mm tube ø 8mm Mistral		



1

GEV No.	526896	Ref. No.	T.2.101
description	steam pipe old edition H 215mm ø 14.5mm tube ø 10mm		





1

GEV No.	526868	Ref. No.	L171
description	steam pipe pivoting H 145mm ø 180mm tube ø 10mm		
accessories for	526868		
	GEV No.	526874	Ref. No.
			L165/1
	compression spring ø 25mm L 18mm wire gauge ø 1.8mm		



1

GEV No.	526871	Ref. No.	T.2.001
description	steam pipe thread 1/8" H 170mm L 195mm ø 14.5mm tube ø 10mm GB/5		
accessories for	526871		
	GEV No.	526865	Ref. No.
			H.2.003
	bush D1 ø 15mm D2 ø 11.7mm H 11.5mm PTFE steam pipe ID ø 6.6mm		
	GEV No.	528402	Ref. No.
			H.1.004 L167/2
	O-ring Viton thickness 2.62mm ID ø 10.78mm Qty 1 pcs		
	GEV No.	532567	Ref. No.
			H.1.003
	O-ring Viton thickness 2.62mm ID ø 13.1mm Qty 1 pcs		

nozzles for steam pipes



1

GEV No.	526881	Ref. No.	L173 L173LM
description	nozzle thread 1/8" ø 13mm L 19mm 4 holes bore ø 1.5mm		



1

GEV No.	526882	Ref. No.	L176
description	nozzle thread M8x0.75 ø 14mm L 34.5mm 4 holes bore ø 1.6mm		



1

GEV No.	529585	Ref. No.	L172 L172LM
description	steam nozzle thread M10x1 ø 14mm L 16mm 4 holes bore ø 2mm chrome-plated brass		



nozzles for water pipes

nozzles for water pipes

 <p>1</p>			
GEV No.	530775	Ref. No.	L160301
description	water nozzle D1 ø 23.5mm H 29.5mm thread M10x1		

water pipes

 <p>1</p>			
GEV No.	526872	Ref. No.	L160
description	water pipe thread 3/8" ø 23.5mm L 57mm WS 20		

accessories

bushes

 <p>1</p>			
GEV No.	526865	Ref. No.	H.2.003
description	bush D1 ø 15mm D2 ø 11.7mm H 11.5mm PTFE steam pipe ID ø 6.6mm		

 <p>1</p>			
GEV No.	527971	Ref. No.	F.2.010
description	bush D1 ø 7.8mm D2 ø 15mm H 21.5mm brass ID ø 6mm		

gaskets

 <p>1</p>			
GEV No.	528402	Ref. No.	H.1.004 L167/2
description	O-ring Viton thickness 2.62mm ID ø 10.78mm Qty 1 pcs		

springs

 <p>1</p>			
GEV No.	526879	Ref. No.	F.3.004
description	compression spring ø 14.5mm L 28mm wire gauge ø 2mm		

 <p>1</p>			
GEV No.	526874	Ref. No.	L165/1
description	compression spring ø 25mm L 18mm wire gauge ø 1.8mm		

tube handles

 <p>1</p>			
GEV No.	526841	Ref. No.	F.2.017
description	tube handle for pipe ø 10mm ø 15mm L 80mm rubber		

 <p>1</p>			
GEV No.	526268	Ref. No.	L171/C
description	tube handle L 35mm plastic		

 <p>1</p>			
GEV No.	528625	Ref. No.	L171/G
description	tube handle L 35mm rubber ID ø 8mm		

fuse terminal blocks

 <p>1</p>			
GEV No.	526895	Ref. No.	L171/3
description	retainer clip L 26mm wire gauge ø 2mm for steam pipe coffee machine		

union nuts

 <p>1</p>			
GEV No.	526849	Ref. No.	F.2.007
description	union nut for steam pipe thread 3/8" L 26mm hole ø 12.5mm SS		

flow controllers

 <p>1</p>			
GEV No.	520488	Ref. No.	B.2.001
description	valve inlet 1/8" outlet 1/8" L 30mm total length 49mm 2 hole fixing nickel-plated brass		

intake valves

accessories

springs



GEV No.	526876	Ref. No.	F.3.002
description	compression spring \varnothing 10.5mm L 37mm wire gauge \varnothing 1.6mm		

miscellaneous



GEV No.	528422	Ref. No.	A.5.002
description	ball \varnothing 8mm SS		

level glasses

level glasses



level glasses



GEV No.	528794	Ref. No.	L122 L122/LM
description	glass panel thickness 5mm \varnothing 65mm for water level tube		

level glasses (complete)



GEV No.	528792	Ref. No.	L120C
description	level glass complete		
spare parts for	528792		
	GEV No.	526891	Ref. No. L120/1CR
	screw connection thread M10 hole \varnothing 3.8mm H 33mm WS 12 chrome-plated		
	GEV No.	528794	Ref. No. L122 L122/LM
	glass panel thickness 5mm \varnothing 65mm for water level tube		
	GEV No.	532578	Ref. No. L122/A
	O-ring Viton thickness 3.53mm ID \varnothing 58.74mm Qty 1 pcs		

screw connections



GEV No.	526891	Ref. No.	L120/1CR
description	screw connection thread M10 hole \varnothing 3.8mm H 33mm WS 12 chrome-plated		

non-return valves

complete



GEV No.	528790	Ref. No.	L032/P
description	non-return valve T1: 3/8" T2: 3/8" L 42.5mm total length 67mm		



GEV No.	526873	Ref. No.	L032/P
description	non-return valve total length 64mm inlet 3/8" outlet 3/8" L 41mm chrome-plated brass		

knobs

steam/water taps

steam/water taps





GEV No.	111006	Ref. No.	L165/V
description	knob \varnothing 51mm thread Tr18x4 black		

spare parts for

	GEV No.	111277	Ref. No. L165/M
	nut for knob thread M24x1.5 ED \varnothing 38mm H 21mm		

accessories for

	GEV No.	111008	Ref. No. L165/MA
	knob dial plate water white		

	GEV No.	111009	Ref. No. L165/MV
	knob dial plate steam		



GEV No.	111353	Ref. No.	F.1.006
description	knob \varnothing 53mm L 52mm thread Tr18x4 black		

accessories for

	GEV No.	111354	Ref. No. F.1.007
	knob dial plate MARZOCCO \varnothing 38mm L 10mm white thread M20		



knob dial plates





1			
GEV No.	111354	Ref. No.	F.1.007
description	knob dial plate MARZOCCO ø 38mm L 10mm white thread M20		

1			
GEV No.	111009	Ref. No.	L165/MV
description	knob dial plate steam		

1			
GEV No.	111008	Ref. No.	L165/MA
description	knob dial plate water white		

accessories

1			
GEV No.	528762	Ref. No.	L165/8
description	cotter pin ø 1.8mm L 17mm		

1				
GEV No.	111006	Ref. No.	L165/V	
description	knob ø 51mm thread Tr18x4 black			
spare parts for	111006			
	GEV No.	111277	Ref. No.	L165/M
	nut for knob thread M24x1.5 ED ø 38mm H 21mm			
accessories for	111006			
	GEV No.	111008	Ref. No.	L165/MA
	knob dial plate water white			
	GEV No.	111009	Ref. No.	L165/MV
	knob dial plate steam			

1			
GEV No.	111277	Ref. No.	L165/M
description	nut for knob thread M24x1.5 ED ø 38mm H 21mm		

1			
GEV No.	347773	Ref. No.	L400T1
description	symbol label 0-1-2 L 49mm W 49mm bore ø 17mm		

1			
GEV No.	347365	Ref. No.	L400/T
description	symbol label OFF-FILL-RUN L 49mm W 49mm bore ø 16mm		

miscellaneous

1			
GEV No.	111369	Ref. No.	L400/K
description	knob ø 28/48mm shaft ø 5x5mm black H 22mm L 40mm		

accessories

miscellaneous

1			
GEV No.	111277	Ref. No.	L165/M
description	nut for knob thread M24x1.5 ED ø 38mm H 21mm		

handles and hand wheels

lever handles

1			
GEV No.	111326	Ref. No.	B.1.005
description	lever handle ø 16-19mm L 40mm thread M18x1.25 black		

gaskets

O-rings

EPDM

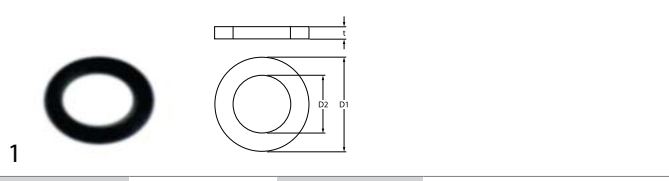

GEV No.	528485	Ref. No.	L165/6
description	O-ring EPDM thickness 1.78mm ID ø 6.07mm Qty 1 pcs		

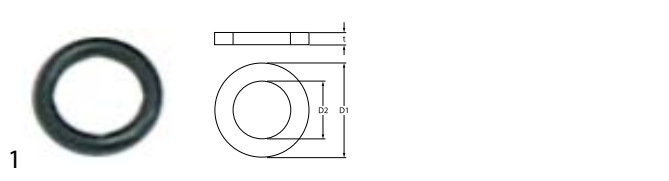

GEV No.	510303	Ref. No.	H.1.013
description	O-ring EPDM thickness 1.78mm ID ø 6.75mm Qty 1 pcs		

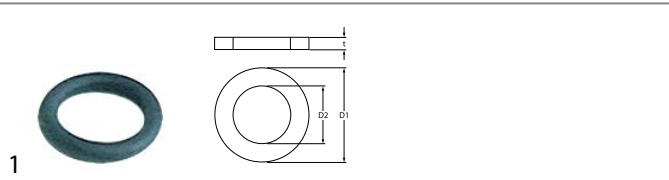

GEV No.	529412	Ref. No.	L167/2
description	O-ring EPDM thickness 2.62mm ID ø 10.78mm Qty 1 pcs		

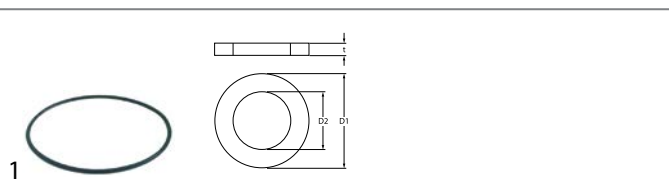

GEV No.	528800	Ref. No.	L103/A
description	O-ring EPDM thickness 2.62mm ID ø 75.87mm Qty 1 pcs		

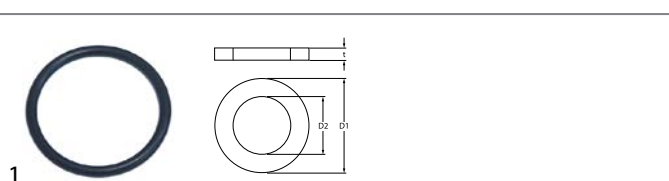

GEV No.	510899	Ref. No.	F.2.014
description	O-ring EPDM thickness 3.53mm ID ø 37.69mm Qty 1 pcs		

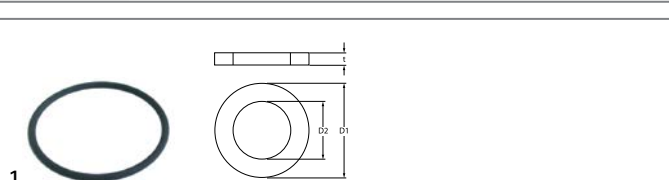

GEV No.	528793	Ref. No.	L122/A
description	O-ring EPDM thickness 3.53mm ID ø 58.74mm Qty 1 pcs		

silicone

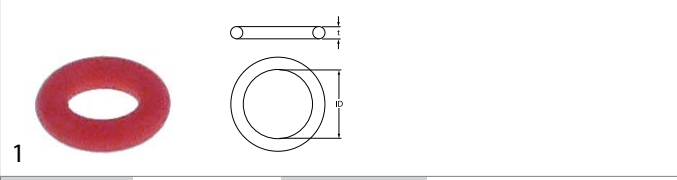

GEV No.	526403	Ref. No.	F2019
description	O-ring silicone thickness 1.78mm ID ø 3.69mm Qty 1 pcs		

Viton

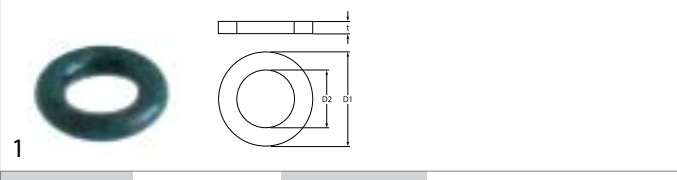

GEV No.	528687	Ref. No.	H.1.001
description	O-ring Viton thickness 1.78mm ID ø 3.69mm Qty 1 pcs		

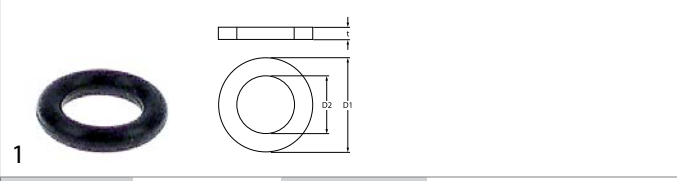

GEV No.	532497	Ref. No.	H.1.005
description	O-ring Viton thickness 1.78mm ID ø 5.28mm Qty 1 pcs		

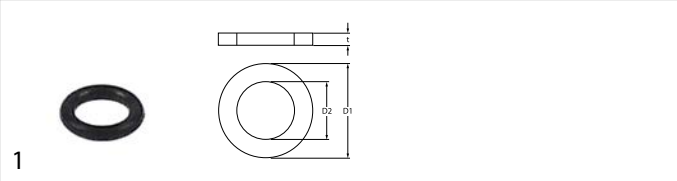

GEV No.	371095	Ref. No.	L165/6
description	O-ring Viton thickness 1.78mm ID ø 6.07mm Qty 1 pcs		

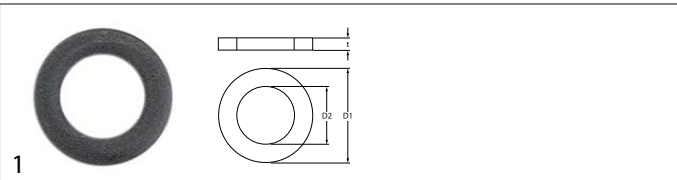

GEV No.	101527	Ref. No.	H.1.006 L171/2
description	O-ring Viton thickness 1.78mm ID ø 6.75mm Qty 1 pcs		

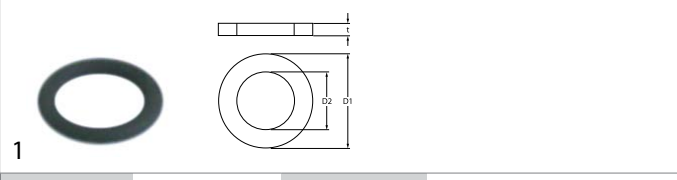

GEV No.	528402	Ref. No.	H.1.004 L167/2
description	O-ring Viton thickness 2.62mm ID ø 10.78mm Qty 1 pcs		



1

GEV No.	532567	Ref. No.	H.1.003
description	O-ring Viton thickness 2.62mm ID ø 13.1mm Qty 1 pcs		

1

GEV No.	532579	Ref. No.	H.1.002
description	O-ring Viton thickness 2.62mm ID ø 17.13mm Qty 1 pcs		

1

GEV No.	532576	Ref. No.	L103/A
description	O-ring Viton thickness 2.62mm ID ø 75.87mm Qty 1 pcs		

1

GEV No.	514222	Ref. No.	L105/A
description	O-ring Viton thickness 3.53mm ID ø 20.22mm Qty 1 pcs		

1

GEV No.	532578	Ref. No.	L122/A
description	O-ring Viton thickness 3.53mm ID ø 58.74mm Qty 1 pcs		

PTFE

1

GEV No.	528217	Ref. No.	L169/A1
description	O-ring PTFE thickness 2.62mm ID ø 9.92mm Qty 1 pcs		

sealing washers

fibre gaskets

1

GEV No.	528795	Ref. No.	L122/B
description	flat gasket FIBER ED ø 62mm ID ø 55mm thickness 0.5mm for water level tube Qty 1 pcs		

1

GEV No.	526855	Ref. No.	LR360/1
description	flat gasket fibre ED ø 53mm ID ø 40mm thickness 3mm Qty 1 pcs		

1

GEV No.	528171	Ref. No.	LR360
description	flat gasket fibre ED ø 55mm ID ø 42mm thickness 2mm Qty 1 pcs		

1

GEV No.	528961	Ref. No.	L103/B
description	flat gasket fibre ED ø 86mm ID ø 80mm thickness 0.5mm Qty 1 pcs		

rubber gaskets

1

GEV No.	526894	Ref. No.	F.2.008
description	flat gasket EPDM ED ø 15.8mm ID ø 7.8mm thickness 4mm Qty 1 pcs		

copper gaskets

DIN-7603-A

1

GEV No.	526859	Ref. No.	L100/D
description	flat gasket copper ED ø 14mm ID ø 10mm thickness 1.5mm for thread 1/8" Qty 1 pcs		

			
1			
GEV No.	526860	Ref. No.	L100/1A
description	flat gasket copper ED ø 19mm ID ø 13.5mm thickness 1.5mm for thread 1/4" Qty 1 pcs		

			
1			
GEV No.	526858	Ref. No.	L260/1A
description	flat gasket copper ED ø 27mm ID ø 21.5mm thickness 1mm Qty 1 pcs		

DIN-7603-C			
			
1			
GEV No.	528501	Ref. No.	L167/1
description	gasket copper ED ø 22mm ID ø 16mm thickness 3mm		

PTFE gaskets			
			
1			
GEV No.	527638	Ref. No.	F.4.001
description	flat gasket PTFE ED ø 12mm ID ø 10mm thickness 1mm Qty 1 pcs		

			
1			
GEV No.	527970	Ref. No.	F.2.009
description	flat gasket PTFE ED ø 24mm ID ø 18mm thickness 2mm Qty 1 pcs		

			
1			
GEV No.	526265	Ref. No.	H.2.002
description	flat gasket PTFE ED ø 24mm ID ø 19mm thickness 2mm Qty 1 pcs		

			
1			
GEV No.	528022	Ref. No.	LR360
description	flat gasket PTFE ED ø 52mm ID ø 41mm thickness 2mm size 1¼" Qty 1 pcs suitable for CARIMALI, FAEMA, MARZOCCO, PAVONI		

special gaskets

group gaskets

group 7			
			
1			
GEV No.	528803	Ref. No.	L100/A L100AG
description	group gasket L 109mm W 97mm thickness 2mm fibre suitable for MARZOCCO		

			
1			
GEV No.	526867	Ref. No.	L100AG
description	group gasket L 109mm W 97mm thickness 2mm hole distance 87.5mm Viton suitable for MARZOCCO		

springs

compression springs

			
1			
GEV No.	526877	Ref. No.	L165/4
description	compression spring ø 10.3mm L 34mm wire gauge ø 1.2mm		

			
1			
GEV No.	528503	Ref. No.	L165/7
description	compression spring ø 10.5mm L 32mm wire gauge ø 1.4mm		

			
1			
GEV No.	526876	Ref. No.	F.3.002
description	compression spring ø 10.5mm L 37mm wire gauge ø 1.6mm		

			
1			
GEV No.	526875	Ref. No.	F.3.019
description	compression spring ø 10.7mm L 29mm wire gauge ø 1.4mm		

			
1			
GEV No.	527968	Ref. No.	F.3.017
description	compression spring ø 12.5mm L 31mm wire gauge ø 1.8mm		



			
1			
GEV No.	526880	Ref. No.	F.3.005
description	compression spring ø 12mm L 29.5mm wire gauge ø 1.2mm		

			
1			
GEV No.	526879	Ref. No.	F.3.004
description	compression spring ø 14.5mm L 28mm wire gauge ø 2mm		

			
1			
GEV No.	526878	Ref. No.	F.3.012
description	compression spring ø 14.9mm L 16.7mm wire gauge ø 1.8mm		

			
1			
GEV No.	526874	Ref. No.	L165/1
description	compression spring ø 25mm L 18mm wire gauge ø 1.8mm		

			
1			
GEV No.	527969	Ref. No.	F.3.018
description	compression spring ø 8mm L 21mm wire gauge ø 0.4mm		

manometers

			
1			
GEV No.	541285	Ref. No.	L280 L280R
description	manometer double scale ø 60mm pressure range 0-3 / 0-15bar connection on the backside thread 1/8"		

			
1			
GEV No.	541759	Ref. No.	L280 L280/R
description	manometer double scale ø 60mm pressure range 0-3 / 0-18bar connection on the backside thread 1/8" suitable for MARZOCCO white/red		

			
1			
GEV No.	541202	Ref. No.	L280 L280R
description	manometer double scale ø 63mm pressure range 0-3 / 0-15bar connection on the backside thread 1/8"		

			
1			
GEV No.	541760	Ref. No.	E.3.001 E.3.001/01
description	manometer ø 41mm pressure range 0-18bar thread 1/8" marking 9, 12 water connection on the backside with capillary pipe		

			
1			
GEV No.	541761	Ref. No.	E.3.002
description	manometer ø 41mm pressure range 0-3bar thread 1/8" marking 1.5 steam connection on the backside with capillary pipe		

fastening material

screws

cylinder head bolts

DIN 912/ISO 4762

			
1			
GEV No.	560031	Ref. No.	L120/2
description	cylinder head bolt thread M6 thread L 10mm WS 5 SS Qty 20 pcs DIN 912/ISO 4762		



1

GEV No.	560417	Ref. No.	L110
description	cylinder head bolt thread M8 L 55mm thread L 29mm WS 6 SS Qty 1 pcs head ø 13mm head thickness 8mm DIN 912/ISO 4762		

nuts

hexagonal nuts

hexagonal nuts inch thread



1

GEV No.	503155	Ref. No.	L168/1
description	nut thread 1/2" H 7mm WS 25 brass Qty 1 pcs		

washers

washers

DIN 9021



1

GEV No.	528761	Ref. No.	L165/9
description	plain washer ID ø 6.5mm ED ø 18mm thickness 1.5mm SS Qty 1 pcs		

miscellaneous



1

GEV No.	526864	Ref. No.	L165/2
description	plain washer ID ø 16mm ED ø 26mm thickness 1mm brass Qty 1 pcs		



1

GEV No.	560415	Ref. No.	F.3.016 F.3.016/LM
description	plain washer ID ø 4.5mm ED ø 9mm thickness 0.7mm SS Qty 1 pcs		



1

GEV No.	526857	Ref. No.	L120/2A N/A
description	plain washer ID ø 6.4mm ED ø 12mm thickness 1mm copper Qty 1 pcs		



1

GEV No.	526863	Ref. No.	L165/9B
description	plain washer ID ø 6mm ED ø 21mm thickness 1.5mm brass Qty 1 pcs		



1

GEV No.	526862	Ref. No.	I.4.001
description	plain washer ID ø 7mm ED ø 14mm thickness 0.5mm brass Qty 1 pcs		



1

GEV No.	526861	Ref. No.	F.3.014
description	plain washer ID ø 8.4mm ED ø 15mm thickness 1mm SS Qty 1 pcs		

fasteners

retaining rings

DIN 471



1

GEV No.	529702	Ref. No.	L165/3
description	retaining ring spindle shaft ø 16mm thickness 1mm steel DIN 471		

cotter pins



1

GEV No.	528762	Ref. No.	L165/8
description	cotter pin ø 1.8mm L 17mm		

B			
bi-metal thermostats	4	solid state relays	7
booster pumps II	11	switches and momentary switches	4
C			
contactors	6	T	
cotter pins	24	thermostats	4
cylinder head bolts	23	toggle switches	5
E			
electrodes	10	W	
F			
fasteners	24	washers	24
fastening material	23		
flow meters	10		
H			
heating elements	3		
heating elements for coffee machine	3		
hexagonal nuts	24		
I			
indicator lights	6		
indicator lights (complete)	6		
L			
lamps	6		
N			
nuts	24		
O			
O-rings	20		
P			
pressure switches	10		
probes	7		
pumps	11		
push/momentary push switches	5		
R			
relays	7		
retaining rings	24		
rocker/momentary rocker switches	4		
rotary switches	5		
S			
safety bi-metal thermostats	4		
screws	23		
sealing washers	21		
solenoid valves	9		