



**GAS COMPONENTS**



**ELECTRIC COMPONENTS**



**WATER TECHNOLOGY**



**MECHANICAL COMPONENTS**



**TOOLS**

Spare parts suitable for

**LA SAN MARCO**

Find the complete and up-to-date range of products in our GEV Webshop



# Manufacturer catalogue

The most important spare parts and accessories arranged clearly for every manufacturer

- ✓ Complete product range and all appliance data always up to date in the GEV Webshop
- ✓ Alphabetical Index at the end of the catalogue

## GEV Webshop

[www.gev-online.co.uk](http://www.gev-online.co.uk)

[www.gev-online.com](http://www.gev-online.com)









- 🔍 Add to Favourites
- 🔍 Sign In with email address and usual password
- 🔍 Easy-order – place several items in your basket at the same time
- 🔍 Quick Item search – no login needed





# heating elements

## heating elements for coffee machine

 <p>1</p>			
<b>GEV No.</b>	417026	<b>Ref. No.</b>	N/A
<b>description</b>	heating element 1000W 230V heating circuits 1 L 205mm W 50mm H 18mm L1 30mm L2 35mm L3 140mm mounting distance 28mm thread M10x1 connection M3 tube ø 8.5mm 2 hole fixing immersion heater windings 2		
<b>accessories for</b>	417026		
	<b>GEV No.</b>	510416	<b>Ref. No.</b> —
	flat gasket fibre ED ø 19mm ID ø 10.5mm thickness 1.5mm for thread M10 Qty 1 pcs		
	<b>GEV No.</b>	510893	<b>Ref. No.</b> —
	O-ring EPDM thickness 2.62mm ID ø 9.92mm Qty 1 pcs		
	<b>GEV No.</b>	520231	<b>Ref. No.</b> —
	nut thread M10x1 H 6mm WS 14 zinc-coated steel Qty 1 pcs		
	<b>GEV No.</b>	521129	<b>Ref. No.</b> —
	nut thread M10 H 6mm SS WS 17 Qty 1 pcs DIN/ISO DIN 439		
	<b>GEV No.</b>	527169	<b>Ref. No.</b> —
	hexagonal nut thread M3 H 2.8mm WS 5.5 brass Qty 1 pcs		
	<b>GEV No.</b>	560110	<b>Ref. No.</b> —
	plain washer ID ø 3.2mm ED ø 7mm thickness 0.5mm SS Qty 20 pcs DIN 125A for thread M3		
	<b>GEV No.</b>	560130	<b>Ref. No.</b> —
	hexagonal nut thread M3 H 2.4mm WS 5.5 SS DIN/ISO DIN 934 / ISO 4032/8673 Qty 20 pcs		

 <p>1</p>			
<b>GEV No.</b>	417027	<b>Ref. No.</b>	N/A
<b>description</b>	heating element 1250W 220V heating circuits 1 L 370mm H 70mm L1 32mm L2 58mm L3 280mm mounting distance 25mm thread M10x1 connection M3x0.6 2 hole fixing immersion heater		

 <p>1</p>			
<b>GEV No.</b>	417023	<b>Ref. No.</b>	0794/F 108245
<b>description</b>	heating element 1750W 230V heating circuits 1 mounting ø 46mm hole distance 60mm L 123mm ø 41mm hole ø 11mm connection M3x0.6 immersion heater suitable for SAN MARCO W 41mm H 41mm		

 <p>1</p>			
<b>GEV No.</b>	417351	<b>Ref. No.</b>	108245
<b>description</b>	heating element 1750W 230V heating circuits 1 mounting ø 46mm hole distance 60mm L 135mm ø 41mm hole ø 11mm tube ø 8mm connection M3 immersion heater 3 hole flange copper W 41mm H 64mm		

 <p>1</p>			
<b>GEV No.</b>	417142	<b>Ref. No.</b>	N/A
<b>description</b>	heating element 1850W 230V heating circuits 1 L 525mm H 62mm L1 40mm L2 45mm L3 440mm mounting distance 25mm thread M10x1 connection M4 connection length 25mm tube ø 8mm 2 hole fixing immersion heater		
<b>accessories for</b>	417142		
	<b>GEV No.</b>	510416	<b>Ref. No.</b> —
	flat gasket fibre ED ø 19mm ID ø 10.5mm thickness 1.5mm for thread M10 Qty 1 pcs		
	<b>GEV No.</b>	510893	<b>Ref. No.</b> —
	O-ring EPDM thickness 2.62mm ID ø 9.92mm Qty 1 pcs		
	<b>GEV No.</b>	520231	<b>Ref. No.</b> —
	nut thread M10x1 H 6mm WS 14 zinc-coated steel Qty 1 pcs		
	<b>GEV No.</b>	521129	<b>Ref. No.</b> —
	nut thread M10 H 6mm SS WS 17 Qty 1 pcs DIN/ISO DIN 439		

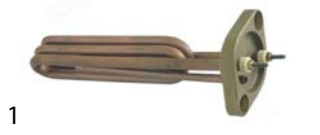
 <p>1</p>			
<b>GEV No.</b>	417185	<b>Ref. No.</b>	108414 108414B 108459
<b>description</b>	heating element 2000W 230V heating circuits 1 mounting ø 40mm L 183mm W 28mm H 38mm hole distance 58mm hole ø 9mm length thermostat sleeves 145mm thermostat sleeves ø 5mm number of thermostat sleeves 1 thermostat sleeve lateral, not adjacent windings 3 tube ø 8mm connection 1/8" immersion heater 2 hole flange suitable for SAN MARCO		









 <p>1</p>			
<b>GEV No.</b>	417024	<b>Ref. No.</b>	OMM14138
<b>description</b>	heating element 2600W 230V heating circuits 2 mounting ø 46mm hole distance 60mm L 375mm W 30mm H 56mm L1 28mm L2 62mm L3 285mm H1 25mm H2 31mm hole ø 10mm tube ø 8.5mm connection M3 immersion heater 3 hole flange suitable for SAN MARCO		
<b>accessories for</b>	417024		
	<b>GEV No.</b>	527169	<b>Ref. No.</b> —
	hexagonal nut thread M3 H 2.8mm WS 5.5 brass Qty 1 pcs		
	<b>GEV No.</b>	528010	<b>Ref. No.</b> 803F
	flat gasket PTFE ED ø 56mm ID ø 46.5mm thickness 3mm Qty 1 pcs suitable for SAN MARCO		



Table continues overleaf





<b>accessories for</b>	417024			
	GEV No.	560110	Ref. No.	—
	plain washer ID $\varnothing$ 3.2mm ED $\varnothing$ 7mm thickness 0.5mm SS Qty 20 pcs DIN 125A for thread M3			
	GEV No.	560130	Ref. No.	—
	hexagonal nut thread M3 H 2.4mm WS 5.5 SS DIN/ISO DIN 934 / ISO 4032/8673 Qty 20 pcs			

	1		
<b>GEV No.</b>	417025	<b>Ref. No.</b>	108143
<b>description</b>	heating element 2600W 230V heating circuits 3 mounting $\varnothing$ 46mm hole distance 62mm L 380mm W 35mm H 58mm L1 30mm L2 60mm L3 290mm H1 32mm H2 28mm hole $\varnothing$ 11mm tube $\varnothing$ 8.5mm thermostat sleeves $\varnothing$ 7mm length thermostat sleeves 208mm thermostat sleeve not clinging number of thermostat sleeves 1 connection M3 immersion heater 3 hole flange suitable for SAN MARCO		

<b>accessories for</b>	417025			
	GEV No.	527169	Ref. No.	—
	hexagonal nut thread M3 H 2.8mm WS 5.5 brass Qty 1 pcs			
	GEV No.	560110	Ref. No.	—
	plain washer ID $\varnothing$ 3.2mm ED $\varnothing$ 7mm thickness 0.5mm SS Qty 20 pcs DIN 125A for thread M3			
	GEV No.	560130	Ref. No.	—
	hexagonal nut thread M3 H 2.4mm WS 5.5 SS DIN/ISO DIN 934 / ISO 4032/8673 Qty 20 pcs			

	1			
<b>GEV No.</b>	417029	<b>Ref. No.</b>	108350 108350B 108460 3299	
<b>description</b>	heating element 3000W 230V heating circuits 2 mounting $\varnothing$ 40mm L 325mm W 33mm H 28mm hole distance 58mm hole $\varnothing$ 9mm length thermostat sleeves 125mm thermostat sleeves $\varnothing$ 5mm number of thermostat sleeves 1 thermostat sleeve centre not clinging windings 2 tube $\varnothing$ 8mm connection M3 immersion heater 2 hole flange suitable for SAN MARCO			
<b>accessories for</b>	417029			
	GEV No.	527169	Ref. No.	—
	hexagonal nut thread M3 H 2.8mm WS 5.5 brass Qty 1 pcs			
	GEV No.	560110	Ref. No.	—
	plain washer ID $\varnothing$ 3.2mm ED $\varnothing$ 7mm thickness 0.5mm SS Qty 20 pcs DIN 125A for thread M3			
	GEV No.	560130	Ref. No.	—
	hexagonal nut thread M3 H 2.4mm WS 5.5 SS DIN/ISO DIN 934 / ISO 4032/8673 Qty 20 pcs			

	1		
<b>GEV No.</b>	417028	<b>Ref. No.</b>	0796FS
<b>description</b>	heating element 3000W 230V heating circuits 3 mounting $\varnothing$ 46mm hole distance 62mm L 341mm W 33mm H 46mm L1 20mm L2 30mm L3 291mm H1 31mm H2 15mm hole $\varnothing$ 10mm tube $\varnothing$ 8.5mm thermostat sleeves $\varnothing$ 7mm length thermostat sleeves 186mm thermostat sleeve centre number of thermostat sleeves 1 connection M4 immersion heater 3 hole flange suitable for SAN MARCO		

	1		
<b>GEV No.</b>	417297	<b>Ref. No.</b>	108630
<b>description</b>	heating element 3500W 230V heating circuits 3 mounting $\varnothing$ 46mm hole distance 61mm L 370mm W 38mm H 62mm L1 12mm L2 78mm L3 280mm H1 35mm H2 26mm hole $\varnothing$ 11mm tube $\varnothing$ 8mm thermostat sleeves $\varnothing$ 5mm length thermostat sleeves 140mm thermostat sleeve eccentric, non clinging number of thermostat sleeves 1 connection M3 immersion heater 3 hole flange copper		

	1		
<b>GEV No.</b>	417140	<b>Ref. No.</b>	N/A
<b>description</b>	heating element 4000W 220V heating circuits 2 mounting $\varnothing$ 46mm hole distance 61mm L 555mm W 26mm H 59mm L1 25mm L2 60mm L3 470mm H1 25mm H2 34mm hole $\varnothing$ 11mm tube $\varnothing$ 8mm connection 1/8" immersion heater 3 hole flange suitable for SAN MARCO		

	1		
<b>GEV No.</b>	417337	<b>Ref. No.</b>	108351
<b>description</b>	heating element 4500W 230V heating circuits 3 mounting $\varnothing$ 40mm L 330mm W 32mm H 28mm hole distance 58mm hole $\varnothing$ 9mm length thermostat sleeves 140mm thermostat sleeves $\varnothing$ 5mm number of thermostat sleeves 1 thermostat sleeve centre not clinging tube $\varnothing$ 8mm connection M3 immersion heater copper		

	1			
<b>GEV No.</b>	417141	<b>Ref. No.</b>	108141	
<b>description</b>	heating element 4500W 230V heating circuits 3 mounting $\varnothing$ 46mm hole distance 60mm L 553mm W 34mm H 62mm L1 30mm L2 70mm L3 453mm H1 31mm H2 31mm hole $\varnothing$ 11mm tube $\varnothing$ 8mm thermostat sleeves $\varnothing$ 7mm length thermostat sleeves 200mm thermostat sleeve centre not clinging connection M3 immersion heater 3 hole flange suitable for SAN MARCO			
<b>accessories for</b>	417141			
	GEV No.	527169	Ref. No.	—
	hexagonal nut thread M3 H 2.8mm WS 5.5 brass Qty 1 pcs			
	GEV No.	560110	Ref. No.	—
	plain washer ID $\varnothing$ 3.2mm ED $\varnothing$ 7mm thickness 0.5mm SS Qty 20 pcs DIN 125A for thread M3			
	GEV No.	560130	Ref. No.	—
	hexagonal nut thread M3 H 2.4mm WS 5.5 SS DIN/ISO DIN 934 / ISO 4032/8673 Qty 20 pcs			

	1		
<b>GEV No.</b>	417296	<b>Ref. No.</b>	108632
<b>description</b>	heating element 5500W 230V heating circuits 3 mounting $\varnothing$ 46mm hole distance 60mm L 545mm W 39mm H 61mm L1 12mm L2 78mm L3 455mm H1 35mm H2 26mm hole $\varnothing$ 11mm tube $\varnothing$ 8mm thermostat sleeves $\varnothing$ 5mm length thermostat sleeves 140mm thermostat sleeve eccentric, non clinging number of thermostat sleeves 1 connection M3 immersion heater 3 hole flange copper		



accessories

sealing washers

fibre gaskets

<b>GEV No.</b>	510459	<b>Ref. No.</b>	109100
<b>description</b>	flat gasket fibre ED $\varnothing$ 50mm ID $\varnothing$ 40mm thickness 3mm Qty 1 pcs		

<b>GEV No.</b>	528304	<b>Ref. No.</b>	109081
<b>description</b>	flat gasket fibre ED $\varnothing$ 58mm ID $\varnothing$ 46mm thickness 2mm Qty 1 pcs		

PTFE gaskets

<b>GEV No.</b>	528011	<b>Ref. No.</b>	N/A
<b>description</b>	flat gasket PTFE ED $\varnothing$ 14.5mm ID $\varnothing$ 10mm thickness 2mm Qty 1 pcs suitable for SAN MARCO		

<b>GEV No.</b>	528857	<b>Ref. No.</b>	N/A
<b>description</b>	flat gasket PTFE ED $\varnothing$ 50mm ID $\varnothing$ 40mm thickness 3.2mm Qty 1 pcs suitable for SAN MARCO		

<b>GEV No.</b>	528010	<b>Ref. No.</b>	803F
<b>description</b>	flat gasket PTFE ED $\varnothing$ 56mm ID $\varnothing$ 46.5mm thickness 3mm Qty 1 pcs suitable for SAN MARCO		

thermostats

control and safety thermostats

EGO

safety thermostats

55.32\_series

<b>GEV No.</b>	390324	<b>Ref. No.</b>	108463
<b>description</b>	safety thermostat switch-off temp. 169°C 3-pole 3NC 20A probe $\varnothing$ 4mm probe L 128mm capillary pipe 890mm capillary pipe isolated 210/210mm gland nut probe SS		

switches and momentary switches

rocker/momentary rocker switches

30x22mm

<b>GEV No.</b>	301003	<b>Ref. No.</b>	108108V
<b>description</b>	rocker switch mounting measurements 30x22mm green 2NO 250V 16A illuminated 0-1 connection male faston 6.3mm ambient temperature max. 125/55°C protection IP65		
<b>accessories for</b>	301003		
	<b>GEV No.</b>	301036	<b>Ref. No.</b>
			106070 106308
	protective cover internal size 30x22mm for rocker switch mounting measurementsmm		

<b>GEV No.</b>	301062	<b>Ref. No.</b>	108602
<b>description</b>	rocker switch mounting measurements 30x22mm green 2NO 250V 16A illuminated connection male faston 6.3mm ambient temperature max. 100/55°C protection IP40		
<b>accessories for</b>	301062		
	<b>GEV No.</b>	301036	<b>Ref. No.</b>
			106070 106308
	protective cover internal size 30x22mm for rocker switch mounting measurementsmm		



			
1			
<b>GEV No.</b>	301060	<b>Ref. No.</b>	108539
<b>description</b>	rocker switch mounting measurements 30x22mm red 2NO 250V 16A illuminated connection male faston 6.3mm ambient temperature max. 125/55°C protection IP40		

			
1			
<b>GEV No.</b>	301036	<b>Ref. No.</b>	106070 106308
<b>description</b>	protective cover internal size 30x22mm for rocker switch mounting measurementsmm		

## push/momentary push switches

30x22mm

			
1			
<b>GEV No.</b>	301036	<b>Ref. No.</b>	106070 106308
<b>description</b>	protective cover internal size 30x22mm for rocker switch mounting measurementsmm		

## microswitches

lever actuated

			
1			
<b>GEV No.</b>	345103	<b>Ref. No.</b>	108034
<b>description</b>	microswitch with lever 380V 20A 1CO connection screw clamp ambient temperature max. 120°C type XO1-H2 SAIA		

roller-lever actuated

microswitches

			
1			
<b>GEV No.</b>	347272	<b>Ref. No.</b>	108231
<b>description</b>	microswitch with handle with a switch 250V 16A 1CO connection male faston ambient temperature max. 85°C mounting distance 22.2mm white lever length 20mm		

pin-plunger actuated

			
1			
<b>GEV No.</b>	347273	<b>Ref. No.</b>	108230
<b>description</b>	microswitch with plunger 250V 8A 1CO connection soldering connection ambient temperature max. 85°C mounting distance 22mm		

## rotary switches

BREMAS

A3200 series

			
1			
<b>GEV No.</b>	345114	<b>Ref. No.</b>	1008/B 108136B
<b>description</b>	rotary switch 3 1-0-2 sets of contacts 5 type CS0325832 600V 32A shaft ø 5x5mm shaft L 23mm shaft square connection screw		

accessories

knobs

			
1			
<b>GEV No.</b>	112613	<b>Ref. No.</b>	106108
<b>description</b>	knob ø 42mm H 22mm black shaft diameter 5x5mm		

## lamps

## indicator lights

indicator lights (complete)

ø 9mm

			
1			
<b>GEV No.</b>	359566	<b>Ref. No.</b>	108747ETL
<b>description</b>	indicator light ø 9mm 24V red cable length 500mm		

ø10mm

with plug-in socket



			
1			
<b>GEV No.</b>	359565	<b>Ref. No.</b>	108015
<b>description</b>	indicator light ø 10mm 250V red connection male faston 6.3mm cable length 500mm temp.-resist. 90°C		



## timers

### mechanical timers

1 

<b>GEV No.</b>	350176	<b>Ref. No.</b>	108268
<b>description</b>	timer C20 2-pole operation time 5min 2NO at 250V 16A permanent position no shaft ø 6x4.6mm shaft 6x4.6mm shaft L 20mm mounting distance 28mm		
<b>accessories for</b>	350176		
	<b>GEV No.</b>	110366	<b>Ref. No.</b> —
	knob switch zero mark t.max.°C ø 44mm shaft ø 6x4.6mm shaft flat upper black		
	<b>GEV No.</b>	112138	<b>Ref. No.</b> —
	dial plate graduation 5min permanent position no rotation 0-290° ø 60mm		

1 

<b>GEV No.</b>	350122 <sup>1</sup>	<b>Ref. No.</b>	108268
<b>description</b>	timer G 2-pole operation time 5min 2NO at 250V 16A shaft ø 3.5x3.5mm shaft L 14mm mounting distance 28mm		

<sup>1</sup>incl. knob

1 

<b>GEV No.</b>	350121	<b>Ref. No.</b>	108924
<b>description</b>	timer MI5 2-pole operation time 5min impulse mechanical 2NO at 250V 16A permanent position no shaft ø 3.5x3.5mm shaft L 17mm mounting distance 28mm mounting thread M8		
<b>spare parts for</b>	350121		
	<b>GEV No.</b>	350179	<b>Ref. No.</b> —
	timer G 2-pole operation time 5min impulse mechanical 2NO at 250V 16A permanent position no shaft ø 3.5x3.5mm shaft 3.5 x 3.5mm shaft L 17mm mounting distance 28mm connection lateral		

## relays

### level relays

#### MICRONOVA

1 

<b>GEV No.</b>	402414	<b>Ref. No.</b>	108456
<b>description</b>	level controller 220V		

1 

<b>GEV No.</b>	402416	<b>Ref. No.</b>	108055 108455
<b>description</b>	level controller 220V connection male faston 6.3mm type C020		

## probes

### sensors

1 

<b>GEV No.</b>	526941	<b>Ref. No.</b>	108270
<b>description</b>	temperature probe probe L 64mm probe ø 3mm cable length 400mm		

1 

<b>GEV No.</b>	379475	<b>Ref. No.</b>	108774
<b>description</b>	temperature probe Pt1000 coffee machine parts probe L 102mm probe ø 3mm 2-pole cable length 1000mm cable material silicone		

## electronics

### PCBs

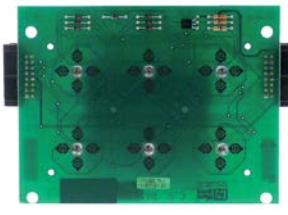
1 

<b>GEV No.</b>	402419	<b>Ref. No.</b>	108762
<b>description</b>	control PCB L 117mm W 90mm buttons 6		

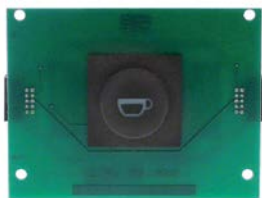

1	<b>GEV No.</b>	402423	<b>Ref. No.</b>	108793
	<b>description</b>	control PCB L 117mm W 90mm with button buttons 1		



1	<b>GEV No.</b>	402421	<b>Ref. No.</b>	108792
	<b>description</b>	control PCB L 117mm W 90mm with keys buttons 6		



1	<b>GEV No.</b>	402426	<b>Ref. No.</b>	108760
	<b>description</b>	control PCB L 360mm W 90mm buttons 15		



1	<b>GEV No.</b>	402425	<b>Ref. No.</b>	108761 108791 108812
	<b>description</b>	control PCB L 360mm W 90mm with display buttons 15		



1	<b>GEV No.</b>	402424	<b>Ref. No.</b>	108790
	<b>description</b>	control PCB L 360mm W 90mm with keys buttons 15		

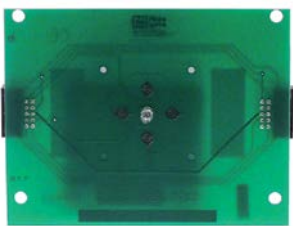

1	<b>GEV No.</b>	402420	<b>Ref. No.</b>	108763
	<b>description</b>	control PCB L 90mm W 117mm buttons 1		



1	<b>GEV No.</b>	400494	<b>Ref. No.</b>	108406 5192
	<b>description</b>	display PCB coffee machine		



1	<b>GEV No.</b>	400491	<b>Ref. No.</b>	108286
	<b>description</b>	keypad PCB 1-group mounting pos. left		



1	<b>GEV No.</b>	400490	<b>Ref. No.</b>	108274
	<b>description</b>	keypad PCB coffee machine mounting pos. right		



1	<b>GEV No.</b>	401924	<b>Ref. No.</b>	108407
	<b>description</b>	keypad PCB tea L 47mm W 40mm buttons 4		



1	<b>GEV No.</b>	400498	<b>Ref. No.</b>	108407
	<b>description</b>	keypad PCB tea L 47mm W 40mm with display buttons 4		



1	<b>GEV No.</b>	400496	<b>Ref. No.</b>	108408
	<b>description</b>	keypad PCB water		







			
1			
<b>GEV No.</b>	401923	<b>Ref. No.</b>	108604
<b>description</b>	PCB coffee grinder L 62mm W 44mm 230V		

			
1			
<b>GEV No.</b>	401922	<b>Ref. No.</b>	108604C
<b>description</b>	PCB for coffee grinder L 84mm W 62mm 230V 400V		

central units

 <p>Image not available</p>			
1			
<b>GEV No.</b>	400757	<b>Ref. No.</b>	16499 5207
<b>description</b>	central unit		

			
1			
<b>GEV No.</b>	526951	<b>Ref. No.</b>	108756
<b>description</b>	control box 1-group for coffee machine 230V		

			
1			
<b>GEV No.</b>	402909	<b>Ref. No.</b>	108541 108541_5
<b>description</b>	control box 2-group 230V L 188mm W 110mm suitable for SAN MARCO H 72mm		

 <p>Image not available</p>			
1			
<b>GEV No.</b>	402848	<b>Ref. No.</b>	108410
<b>description</b>	control box 3-group for coffee machine 230V		

			
1			
<b>GEV No.</b>	526949	<b>Ref. No.</b>	108783
<b>description</b>	control box 4-group for coffee machine		

			
1			
<b>GEV No.</b>	526952	<b>Ref. No.</b>	108755
<b>description</b>	control box 4-group for coffee machine 230V		





			
1			
<b>GEV No.</b>	526948	<b>Ref. No.</b>	108754
<b>description</b>	control box for coffee machine		

			
1			
<b>GEV No.</b>	526950	<b>Ref. No.</b>	108285
<b>description</b>	control box for coffee machine		

			
1			
<b>GEV No.</b>	402417	<b>Ref. No.</b>	108412
<b>description</b>	control box for coffee machine 230V		



			
1			
<b>GEV No.</b>	402418	<b>Ref. No.</b>	108409 5206
<b>description</b>	control box for coffee machine 230V		
<b>For models:</b>	SAN MARCO 95		

<b>accessories for</b>	400489		
	<b>GEV No.</b>	400490	<b>Ref. No.</b> 108274
	keypad PCB coffee machine mounting pos. right		
	<b>GEV No.</b>	401438	<b>Ref. No.</b> —
	keypad housing		
	<b>GEV No.</b>	401439	<b>Ref. No.</b> —
	bezel for keypad		
	<b>GEV No.</b>	550695	<b>Ref. No.</b> —
	gasket for keypad housing		

## keypads

### membrane keypads

			
1			
<b>GEV No.</b>	400343	<b>Ref. No.</b>	108296
<b>description</b>	keypad foil espresso machine Serie 85		



### control panel

			
1			
<b>GEV No.</b>	526933	<b>Ref. No.</b>	106128
<b>description</b>	control panel coffee machine		

### keypad units

			
1			
<b>GEV No.</b>	400488	<b>Ref. No.</b>	608066
<b>description</b>	keypad unit espresso machine Serie 85 edition 1-group		
<b>accessories for</b>	400488		
	<b>GEV No.</b>	400343	<b>Ref. No.</b> 108296
	keypad foil espresso machine Serie 85		
	<b>GEV No.</b>	400491	<b>Ref. No.</b> 108286
	keypad PCB 1-group mounting pos. left		
	<b>GEV No.</b>	401438	<b>Ref. No.</b> —
	keypad housing		
	<b>GEV No.</b>	401439	<b>Ref. No.</b> —
	bezel for keypad		
	<b>GEV No.</b>	550695	<b>Ref. No.</b> —
	gasket for keypad housing		

			
1			
<b>GEV No.</b>	526936	<b>Ref. No.</b>	106119
<b>description</b>	control panel coffee machine coffee/STOP		

			
1			
<b>GEV No.</b>	400489	<b>Ref. No.</b>	608067
<b>description</b>	keypad unit espresso machine Serie 85 edition 2-4-group		
<b>accessories for</b>	400489		
	<b>GEV No.</b>	400343	<b>Ref. No.</b> 108296
	keypad foil espresso machine Serie 85		

			
1			
<b>GEV No.</b>	526937	<b>Ref. No.</b>	106117 5195
<b>description</b>	control panel coffee machine for steam/water pipes		



 <p>1</p>			
<b>GEV No.</b>	526938	<b>Ref. No.</b>	106118 5194
<b>description</b>	control panel coffee machine for steam/water pipes		

 <p>1</p>			
<b>GEV No.</b>	526934	<b>Ref. No.</b>	106129
<b>description</b>	control panel coffee machine for switch		

 <p>1</p>			
<b>GEV No.</b>	526935	<b>Ref. No.</b>	106120 5191
<b>description</b>	control panel coffee machine L 110mm H 100mm coffee buttons 7		

 <p>1</p>			
<b>GEV No.</b>	526974	<b>Ref. No.</b>	106059
<b>description</b>	control panel L 140mm W 38mm black plastic buttons 5		

accessories

 <p>1</p>			
<b>GEV No.</b>	526973	<b>Ref. No.</b>	106487
<b>description</b>	button ø 30mm L 43mm W 43mm brown coffee		

 <p>1</p>			
<b>GEV No.</b>	526972	<b>Ref. No.</b>	106486
<b>description</b>	buttons strip L 97mm W 31mm brown buttons 3 hot water		

 <p>1</p>			
<b>GEV No.</b>	526970	<b>Ref. No.</b>	106485
<b>description</b>	keyset L 97mm W 66mm brown buttons 6		

 <p>1</p>			
<b>GEV No.</b>	526971	<b>Ref. No.</b>	106491
<b>description</b>	keyset L 97mm W 66mm brown buttons 6 cappuccino		

 <p>1</p>			
<b>GEV No.</b>	400497	<b>Ref. No.</b>	106130 5185
<b>description</b>	push button set 4-piece water		

 <p>1</p>			
<b>GEV No.</b>	400495	<b>Ref. No.</b>	106133 5190
<b>description</b>	push button set 7-piece coffee		

solenoid valves

solenoid valves (water)





















<p>TP</p>  <p>1</p>				
<b>GEV No.</b>	370021	<b>Ref. No.</b>	D15098 P125	
<b>description</b>	solenoid valve double straight 230VAC inlet 3/4" outlet 11.5mm DN10 TP flow regulating valve inlet white			
<b>spare parts for</b>	370021			
	<b>GEV No.</b>	371013	<b>Ref. No.</b>	—
	solenoid coil TP 230VAC 50/60Hz			
<b>accessories for</b>	370021			
	<b>GEV No.</b>	371220	<b>Ref. No.</b>	—
	reducer TP flow rate 3l/min red tolerance ±15%			

Table continues overleaf

accessories for		370021	
GEV No.	371221	Ref. No.	—
	reducer TP flow rate 5.5l/min yellow tolerance ±15%		
	reducer TP flow rate 6l/min grey tolerance ±15%		
	reducer TP flow rate 10l/min white tolerance ±15%		
	reducer TP flow rate 12l/min bronze tolerance ±15%		
	reducer TP flow rate 16l/min light brown tolerance ±15%		
	reducer TP flow rate 20l/min red tolerance ±15%		
	reducer TP flow rate 0.25l/min red tolerance ±25%		
	reducer TP flow rate 0.35l/min violet tolerance ±25%		
	reducer TP flow rate 0.5l/min orange tolerance ±25%		
	reducer TP flow rate 0.8l/min white tolerance ±25%		
	reducer TP flow rate 1l/min light blue tolerance ±25%		
	reducer TP flow rate 1.2l/min brown tolerance ±25%		
	reducer TP flow rate 1.5l/min light brown tolerance ±25%		
	reducer TP flow rate 2.5l/min yellow tolerance ±25%		
	reducer TP flow rate 3.4l/min dark green tolerance ±25%		
	reducer TP flow rate 5l/min black tolerance ±25%		
	reducer TP flow rate 8l/min blue tolerance ±20%		

metal			
ASCO			
spare parts and accessories			
O-rings			
 1			
<b>GEV No.</b>	371095	<b>Ref. No.</b>	1025
<b>description</b>	O-ring Viton thickness 1.78mm ID ø 6.07mm Qty 1 pcs		

PARKER				
2-way				
E-146 series				
 1				
<b>GEV No.</b>	370206	<b>Ref. No.</b>	1096	
<b>description</b>	solenoid valve 2-ways 230VAC connection 1/8" L 40mm DN 2.5mm slide-on receptacle DIN -20° up to 130°C PARKER type series VE-146 coil type ZB09 membranes FKM (water) p max 15bar p min 0bar			
<b>spare parts for</b>	370206			
	<b>GEV No.</b>	371029	<b>Ref. No.</b>	—
	solenoid coil PARKER 230VAC 9VA coil type ZB09 seat ø 14mm H 33mm W 34mm D 43mm			
<b>accessories for</b>	370206			
	<b>GEV No.</b>	371090	<b>Ref. No.</b>	—
	power socket plug type DIN 43650A screw			







3-way				
VE-128 series				
 1				
<b>GEV No.</b>	370057	<b>Ref. No.</b>	1027 108063	
<b>description</b>	solenoid valve 3-ways 230VAC body outer cone DN 1.2mm slide-on receptacle DIN -20° up to 140°C PARKER type series VE-128 coil type ZB09 membranes ruby p max 10bar brass flange 32x32mm			
<b>spare parts for</b>	370057			
	<b>GEV No.</b>	370062	<b>Ref. No.</b>	—
	solenoid valve body PARKER 3-ways outer cone			
	<b>GEV No.</b>	371029	<b>Ref. No.</b>	—
	solenoid coil PARKER 230VAC 9VA coil type ZB09 seat ø 14mm H 33mm W 34mm D 43mm			

Table continues overleaf



<b>accessories for</b>	370057		
	<b>GEV No.</b>	371090	<b>Ref. No.</b> —
	power socket plug type DIN 43650A screw		
	<b>GEV No.</b>	371095	<b>Ref. No.</b> 1025
	O-ring Viton thickness 1.78mm ID ø 6.07mm Qty 1 pcs		
	<b>GEV No.</b>	371100	<b>Ref. No.</b> —
	O-ring silicone thickness 1.78mm ID ø 6.07mm Qty 1 pcs		

**SIRAI**  
solenoid valves steam (water)

2-way  
L121 series



<b>GEV No.</b>	370084	<b>Ref. No.</b>	108035
<b>description</b>	solenoid valve 2-ways 230VAC connection 1/4" L 42mm DN 3.2mm slide-on receptacle DIN -10 up to 140°C SIRAI type series L121 coil type ZA34A membranes EPDM p max 8bar p min 0.1bar		
<b>spare parts for</b>	370084		
	<b>GEV No.</b>	371176	<b>Ref. No.</b> —
	solenoid coil 230VAC 14VA SIRAI coil type ZA34A seat ø 14mm		

Solenoid valve - accessories

	<b>GEV No.</b>	371095	<b>Ref. No.</b> 1025
	O-ring Viton thickness 1.78mm ID ø 6.07mm Qty 1 pcs		

electrodes

	<b>GEV No.</b>	401925	<b>Ref. No.</b> 202237
	level electrode thread 1/4"		

flow meters and flow sensors

flow meters

GICAR



<b>GEV No.</b>	400004	<b>Ref. No.</b>	2209.006
<b>description</b>	flow meter thread 1/4" stainless steel with LED plug connection approval NSF		
<b>accessories for</b>	400004		
	<b>GEV No.</b>	400256	<b>Ref. No.</b> —
	plug GICAR for flow meter		

pumps

booster pumps II

pump heads

FLUID-O-TECH



<b>GEV No.</b>	504364	<b>Ref. No.</b>	202001
<b>description</b>	pump head PA1504Z FLUID-O-TECH L 82mm 150l/h connection 3/8" NPT with bypass brass clip connection for coffee machine shaft ø 4.8x11mm		



<b>GEV No.</b>	500064	<b>Ref. No.</b>	0805 N/A
<b>description</b>	pump head PO204 FLUID-O-TECH L 82mm 200l/h connection 3/8" GAS with bypass brass clip connection for coffee machine shaft ø 4.8x11mm		
<b>accessories for</b>	500064		
	<b>GEV No.</b>	520126	<b>Ref. No.</b> —
	clamp for pump/motor		



## fuses

### fine fuses



1			
<b>GEV No.</b>	358687	<b>Ref. No.</b>	1248
<b>description</b>	fine fuse size ø5x20mm 0.5A medium lag rated 250V Qty 10 pcs		

## equipment-specific units

### for display coolers

#### housing and bezels



1			
<b>GEV No.</b>	526939	<b>Ref. No.</b>	106116
<b>description</b>	cover cap for keypad L 50mm W 42mm		



1			
<b>GEV No.</b>	526940	<b>Ref. No.</b>	106109
<b>description</b>	cover cap for keypad L 85mm W 66mm		



1			
<b>GEV No.</b>	526942	<b>Ref. No.</b>	106127 5196
<b>description</b>	front panel for switching unit		



1			
<b>GEV No.</b>	526943	<b>Ref. No.</b>	106111
<b>description</b>	switch panel for gas appliance		

### for espresso machines

#### filter holders

##### filter holders standard

##### filter holder without spout



1			
<b>GEV No.</b>	525993	<b>Ref. No.</b>	N/A
<b>description</b>	filter holder suitable for SAN MARCO without outlet mounting ø 82mm outlet 3/8" ID ø 57.8mm wedge height 13.2mm number of wedges 3 lever straight chrome-plated brass		

##### filter holders short



1			
<b>GEV No.</b>	529057	<b>Ref. No.</b>	1664 502034 502750
<b>description</b>	filter holder mounting ø 82mm outlet 3/8" ID ø 57.8mm handle M10x1.5 wedge height 13.2mm number of wedges 3 lever straight chrome-plated brass		

#### handles

##### with external thread



1			
<b>GEV No.</b>	529053	<b>Ref. No.</b>	1665
<b>description</b>	handle ø 35mm thread M10x1.5 thread L 15mm L 125mm black		



spouts			
with thread 3/8"			
			
1			
<b>GEV No.</b>	529004	<b>Ref. No.</b>	205494
<b>description</b>	filter holder spout thread 3/8" 1-way curved/long outlet distancemm		

			
1			
<b>GEV No.</b>	529007	<b>Ref. No.</b>	205495
<b>description</b>	filter holder spout thread 3/8" 2-way curved/short outlet distance 45mm		

filters			
for 1 cup			
			
1			
<b>GEV No.</b>	525952	<b>Ref. No.</b>	202108
<b>description</b>	coffee filter ø 66mm mounting ø 57mm H 22mm cups 1 amount of coffee 6g stainless steel		

			
1			
<b>GEV No.</b>	525958	<b>Ref. No.</b>	202116
<b>description</b>	coffee filter ø 66mm mounting ø 57mm H 22mm cups 1 amount of coffee 7g SS		

			
1			
<b>GEV No.</b>	525950	<b>Ref. No.</b>	202110
<b>description</b>	coffee filter ø 66mm mounting ø 57mm H 22mm cups 1 amount of coffee 8g stainless steel		

			
1			
<b>GEV No.</b>	529026	<b>Ref. No.</b>	0238 202116 202119
<b>description</b>	coffee filter ø 66mm mounting ø 57mm H 25mm cups 1 amount of coffee 9g		

			
1			
<b>GEV No.</b>	529098	<b>Ref. No.</b>	N/A
<b>description</b>	coffee filter ø 70mm mounting ø 60.3mm H 22mm cups 1 amount of coffee 7g		

for 2 cups			
			
1			
<b>GEV No.</b>	525953	<b>Ref. No.</b>	202112
<b>description</b>	coffee filter ø 66mm mounting ø 57mm H 24mm cups 2 amount of coffee 12g		

			
1			
<b>GEV No.</b>	525957	<b>Ref. No.</b>	202117
<b>description</b>	coffee filter ø 66mm mounting ø 57mm H 25mm cups 2 amount of coffee 14g		

			
1			
<b>GEV No.</b>	529027	<b>Ref. No.</b>	0237 202121
<b>description</b>	coffee filter ø 66mm mounting ø 57mm H 26.4mm cups 2 amount of coffee 18g		

			
1			
<b>GEV No.</b>	525951	<b>Ref. No.</b>	202114
<b>description</b>	coffee filter ø 66mm mounting ø 57mm H 26mm cups 2 amount of coffee 16g		

blind filters



1			
<b>GEV No.</b>	529028	<b>Ref. No.</b>	1159 202115
<b>description</b>	blind filter ø 65.5mm mounting ø 56mm H 21.5mm		

filter holder springs



1			
<b>GEV No.</b>	525956	<b>Ref. No.</b>	200056
<b>description</b>	filter holder spring L 70mm W 60mm wire gauge ø 1.2mm for espresso filter holder		



1			
<b>GEV No.</b>	529079	<b>Ref. No.</b>	1830 200056
<b>description</b>	filter holder spring L 70mm W 60mm wire gauge ø 1.3mm for espresso filter holder		



1			
<b>GEV No.</b>	531243	<b>Ref. No.</b>	N/A
<b>description</b>	filter holder spring L 70mm W 60mm wire gauge ø 1.3mm for espresso filter holder Qty 20 pcs		

brewing units

shower screens

flat



1			
<b>GEV No.</b>	529088	<b>Ref. No.</b>	202011
<b>description</b>	shower screen ø 48mm hole ø 5.5mm flat		

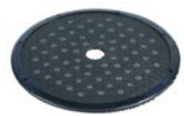

1			
<b>GEV No.</b>	525954	<b>Ref. No.</b>	202271
<b>description</b>	shower screen ø 48mm hole ø 5mm flat		

filter holder gaskets

flat

standard



1			
<b>GEV No.</b>	528038	<b>Ref. No.</b>	1019 109011
<b>description</b>	filter holder gasket D1 ø 64mm D2 ø 52.5mm H 5.5mm Qty 1 pcs		



1			
<b>GEV No.</b>	528081	<b>Ref. No.</b>	N/A
<b>description</b>	filter holder gasket D1 ø 64mm D2 ø 52.5mm H 6.5mm Qty 1 pcs		

brewing units with solenoid valve

components



1			
<b>GEV No.</b>	526947	<b>Ref. No.</b>	206272
<b>description</b>	infusor 1/4" L 50mm ø 39mm SS		

components

nozzles

with thread



1			
<b>GEV No.</b>	525943	<b>Ref. No.</b>	205408
<b>description</b>	nozzle bore ø 0.55mm thread M6 L 23mm for brewing unit		





1			
<b>GEV No.</b>	525942	<b>Ref. No.</b>	205037
<b>description</b>	nozzle bore ø 1mm thread M5 L 15mm for brewing unit		







injector tubes

 <p>1</p>			
<b>GEV No.</b>	526998	<b>Ref. No.</b>	1016/E 205308
<b>description</b>	injector pipe for brewing unit copper ø 6mm M6 L 80mm		

 <p>1</p>			
<b>GEV No.</b>	526996	<b>Ref. No.</b>	602000
<b>description</b>	injector pipe for brewing unit L 90mm ø 6mm		

 <p>1</p>			
<b>GEV No.</b>	526999	<b>Ref. No.</b>	205331
<b>description</b>	injector pipe for brewing unit ø 6mm L 57mm copper thread M5		

 <p>1</p>			
<b>GEV No.</b>	526997	<b>Ref. No.</b>	206199
<b>description</b>	injector pipe ø 6mm L 86mm PTFE		

screws

 <p>1</p>			
<b>GEV No.</b>	560373	<b>Ref. No.</b>	204074
<b>description</b>	cylinder head bolt thread M4 thread L 12mm WS 3 SS Qty 1 pcs intake internal hexagon DIN 912/ISO 4762		

miscellaneous

 <p>1</p>			
<b>GEV No.</b>	526994	<b>Ref. No.</b>	109117
<b>description</b>	bush PTFE ø 12mm H 10mm		

water dispersions

<p>water dispersions</p> <p>group 3</p>  <p>1</p>			
<b>GEV No.</b>	525955	<b>Ref. No.</b>	206823
<b>description</b>	water distributor ø 54mm H 12mm 4 holes hole ø 2.5mm mounting ø 5mm brass		

safety valves

<p>safety valves</p> <p>metric thread</p>  <p>1</p>			
<b>GEV No.</b>	529309	<b>Ref. No.</b>	N/A
<b>description</b>	safety valve connection M18x1.5 triggering pressure 1.8bar		

gaskets

 <p>1</p>			
<b>GEV No.</b>	526991	<b>Ref. No.</b>	109096
<b>description</b>	flat gasket copper ED ø 23mm ID ø 17mm thickness 1.5mm		

expansion valves

<p>gaskets</p>  <p>1</p>			
<b>GEV No.</b>	525969	<b>Ref. No.</b>	109069
<b>description</b>	sealing disc ED ø 13mm H 3.4mm without hole		

compression springs

 <p>1</p>			
<b>GEV No.</b>	525968	<b>Ref. No.</b>	200049
<b>description</b>	compression spring ø 10.3mm L 28mm wire gauge ø 1.5mm for expansion valve		

with non-return valve



1

<b>GEV No.</b>	529554	<b>Ref. No.</b>	400029 400029A
<b>description</b>	expansion valve with non-return valve 3/8"-1/4" nominal-ø 6mm		



1

<b>GEV No.</b>	525961	<b>Ref. No.</b>	400029A
<b>description</b>	expansion valve with non-return valve 3/8"-1/8" nominal-ø 5mm		

drain pans

drain pans



1

<b>GEV No.</b>	526975	<b>Ref. No.</b>	106490
<b>description</b>	drain pan L 75mm W 85mm H 56mm hose ø 15mm		



1

<b>GEV No.</b>	529751	<b>Ref. No.</b>	106056
<b>description</b>	drain pan L 80mm W 70mm H 55mm hose ø 14mm		

aerators and air bleeders



1

<b>GEV No.</b>	529303	<b>Ref. No.</b>	3041	
<b>description</b>	aerator and air bleeder connection 1/4" only steam			
<b>spare parts for</b>	529303			
	<b>GEV No.</b>	528687	<b>Ref. No.</b>	—
	O-ring Viton thickness 1.78mm ID ø 3.69mm Qty 1 pcs			

boilers

gaskets

unperforated



1

<b>GEV No.</b>	528133	<b>Ref. No.</b>	109073
<b>description</b>	boiler gasket D1 ø 165mm D2 ø 150mm thickness 3mm PTFE suitable for SAN MARCO		



1

<b>GEV No.</b>	525963	<b>Ref. No.</b>	109099
<b>description</b>	gasket fibre ED ø 132mm ID ø 123mm thickness 3mm Qty 1 pcs		



1

<b>GEV No.</b>	525962	<b>Ref. No.</b>	109073
<b>description</b>	gasket fibre ED ø 163mm ID ø 150mm thickness 3mm Qty 1 pcs		

heat exchangers

injector tubes



1

<b>GEV No.</b>	527456	<b>Ref. No.</b>	3312 400071 400071B
<b>description</b>	injector pipe ø 6mm L 175mm thread 1/4"		

			
1			
<b>GEV No.</b>	526962	<b>Ref. No.</b>	400070 400070B
<b>description</b>	injector pipe T-piece tube ø 6mm pipe length 175mm T1: 1/4" T2: 1/4" brass		

			
1			
<b>GEV No.</b>	526961	<b>Ref. No.</b>	400071A
<b>description</b>	injector pipe tube ø 6mm pipe length 175mm T1: 1/8" T2: 1/8"		

			
1			
<b>GEV No.</b>	526960	<b>Ref. No.</b>	400115A
<b>description</b>	injector pipe tube ø 6mm pipe length 86mm T1: 1/4" T2: 1/4"		

steam/water taps

steam/water taps

steam taps

steam taps (complete)

			
1			
<b>GEV No.</b>	526944	<b>Ref. No.</b>	400150
<b>description</b>	steam tap complete		

			
1			
<b>GEV No.</b>	526953	<b>Ref. No.</b>	400300
<b>description</b>	steam tap complete beige		

			
1			
<b>GEV No.</b>	526955	<b>Ref. No.</b>	400086
<b>description</b>	steam tap mounting pos. left/right complete		

components

shafts

			
1			
<b>GEV No.</b>	526979	<b>Ref. No.</b>	205094
<b>description</b>	shaft for steam-/water-tap ø 7mm L 70mm stainless steel		

bushes

			
1			
<b>GEV No.</b>	526984	<b>Ref. No.</b>	205009
<b>description</b>	bush D1 ø 17mm D2 ø 7mm H 8mm brass		

			
1			
<b>GEV No.</b>	528867	<b>Ref. No.</b>	109049
<b>description</b>	bush PTFE		

gaskets

			
1			
<b>GEV No.</b>	528303	<b>Ref. No.</b>	109049
<b>description</b>	gasket D1 ø 12.5mm D2 ø 7mm thickness 5.5mm PTFE steam/water tap conical		

			
1			
<b>GEV No.</b>	528302	<b>Ref. No.</b>	109024
<b>description</b>	gasket D1 ø 15mm D2 ø 5.3mm thickness 4.3mm rubber for steam-/water-tap		

			
1			
<b>GEV No.</b>	525971	<b>Ref. No.</b>	109024
<b>description</b>	gasket D1 ø 15mm D2 ø 5.4mm thickness 4.2mm for steam-/water-tap		

			
1			
<b>GEV No.</b>	526986	<b>Ref. No.</b>	109023
<b>description</b>	gasket D1 ø 17mm D2 ø 6mm thickness 4mm rubber		

			
1			
<b>GEV No.</b>	525970	<b>Ref. No.</b>	109079
<b>description</b>	gasket D1 ø 23mm D2 ø 18.5mm thickness 1mm fibre		

**gasket supports**

			
1			
<b>GEV No.</b>	526981	<b>Ref. No.</b>	205003
<b>description</b>	piston for steam-/water-tap ø 19mm brass		

**springs**

			
1			
<b>GEV No.</b>	525965	<b>Ref. No.</b>	200033
<b>description</b>	compression spring ø 16mm L 20mm wire gauge ø 1.7mm for steam-/water-tap		

			
1			
<b>GEV No.</b>	525964	<b>Ref. No.</b>	200026
<b>description</b>	compression spring ø 16mm L 20mm wire gauge ø 1.8mm for steam-/water-tap		

**tap bodies**

			
1			
<b>GEV No.</b>	526967	<b>Ref. No.</b>	502050
<b>description</b>	tap body L 94mm		

**levers**

			
1			
<b>GEV No.</b>	526965	<b>Ref. No.</b>	502004
<b>description</b>	lever L 68mm		

**nuts**

			
1			
<b>GEV No.</b>	526982	<b>Ref. No.</b>	205123
<b>description</b>	hexagonal nut thread M18x1.5 H 6mm WS 26 Qty 1 pcs		

			
1			
<b>GEV No.</b>	526983	<b>Ref. No.</b>	205007
<b>description</b>	hexagonal nut thread M25 H 6mm WS 27 brass Qty 1 pcs		

**union nuts**

			
1			
<b>GEV No.</b>	526966	<b>Ref. No.</b>	0.526966 205008
<b>description</b>	union nut ID ø 15mm L 22mm WS 27		



screw connections



1			
<b>GEV No.</b>	526980	<b>Ref. No.</b>	205310
<b>description</b>	screw connection for steam-/water-tap WS 27 brass		

miscellaneous



1			
<b>GEV No.</b>	525948	<b>Ref. No.</b>	202235
<b>description</b>	ball for steam-/water-tap stainless steel $\varnothing$ 6.3mm		



1			
<b>GEV No.</b>	526987	<b>Ref. No.</b>	205585
<b>description</b>	cap for steam-/water-tap $\varnothing$ 18mm H 6mm		



1			
<b>GEV No.</b>	525949	<b>Ref. No.</b>	206949
<b>description</b>	pin for steam-/water-tap stainless steel $\varnothing$ 3mm L 52mm		



1			
<b>GEV No.</b>	526985	<b>Ref. No.</b>	205534
<b>description</b>	reducing washer for water tap brass $\varnothing$ 14.3mm ID $\varnothing$ 2mm thickness 2mm		



1			
<b>GEV No.</b>	526988	<b>Ref. No.</b>	205583
<b>description</b>	rosette for water tap stainless steel $\varnothing$ 23mm ID $\varnothing$ 15mm H 2mm		

water taps

water taps



1			
<b>GEV No.</b>	526945	<b>Ref. No.</b>	400087
<b>description</b>	water tap complete		



1			
<b>GEV No.</b>	526954	<b>Ref. No.</b>	400301
<b>description</b>	water tap complete beige		

steam/water pipes

steam pipes



1			
<b>GEV No.</b>	529299	<b>Ref. No.</b>	507131
<b>description</b>	steam pipe L 170mm tube $\varnothing$ 8mm chrome-plated Serie 85 M10x0.75		



1			
<b>GEV No.</b>	526946	<b>Ref. No.</b>	206224
<b>description</b>	steam pipe L 190mm		

			
<b>GEV No.</b>	526957	<b>Ref. No.</b>	206903
<b>description</b>	steam pipe L 190mm tube ø 10mm		

			
<b>GEV No.</b>	529836	<b>Ref. No.</b>	507131
<b>description</b>	steam pipe ø 10mm SS		

			
<b>GEV No.</b>	526964	<b>Ref. No.</b>	206903C
<b>description</b>	steam pipe short L 180mm tube ø 10mm stainless steel		

water pipes

			
<b>GEV No.</b>	529555	<b>Ref. No.</b>	507132
<b>description</b>	water pipe ø 10mm L 127mm suitable for Serie 85 bore ø 5mm WS 22		

			
<b>GEV No.</b>	525959	<b>Ref. No.</b>	507132
<b>description</b>	water pipe thread 3/8" L 85mm tube ø 11mm WS 22 nozzle ø 16mm		

accessories

bushes

			
<b>GEV No.</b>	528208	<b>Ref. No.</b>	109091
<b>description</b>	gasket D1 ø 14.5mm D2 ø 10.5mm H 4.5mm PTFE for steam/water pipes		

springs

			
<b>GEV No.</b>	525966	<b>Ref. No.</b>	200051 200150
<b>description</b>	compression spring ø 11.8mm L 15mm wire gauge ø 2.2mm		

miscellaneous

			
<b>GEV No.</b>	528306	<b>Ref. No.</b>	205525
<b>description</b>	disc for steam/water pipes brass D1 ø 14.3mm D2 ø 7.5mm thickness 2mm		

gaskets

flat gaskets

PTFE gaskets

			
<b>GEV No.</b>	526993	<b>Ref. No.</b>	109078
<b>description</b>	flat gasket PTFE ED ø 34mm ID ø 26.5mm thickness 2mm Qty 1 pcs for thread 3/4"		

intake valves

accessories

springs

			
<b>GEV No.</b>	525967	<b>Ref. No.</b>	200150
<b>description</b>	compression spring ø 14.5mm L 20mm wire gauge ø 1.8mm for filling valve		

			
<b>GEV No.</b>	528866	<b>Ref. No.</b>	200034
<b>description</b>	compression spring ø 15mm L 20mm wire gauge ø 2.2mm for filling valve		

levers

			
<b>GEV No.</b>	528864	<b>Ref. No.</b>	502067
<b>description</b>	lever for filling valve		



level glasses

level glasses

gaskets

1			
<b>GEV No.</b>	525944	<b>Ref. No.</b>	109150
<b>description</b>	gasket D1 ø 20mm D2 ø 14mm H 10mm for water level tube		

1			
<b>GEV No.</b>	529392	<b>Ref. No.</b>	0701
<b>description</b>	gasket D1 ø 6.8mm D2 ø 17mm thickness 1mm water level glass suitable for SAN MARCO		

balls

1			
<b>GEV No.</b>	525945	<b>Ref. No.</b>	106480
<b>description</b>	ball ø 10mm plastic for water level tube red		

level glass pipes

1			
<b>GEV No.</b>	526978	<b>Ref. No.</b>	206910
<b>description</b>	water level tube ø 15mm H 115mm		

1			
<b>GEV No.</b>	529390	<b>Ref. No.</b>	104002
<b>description</b>	water level tube ø 30mm H 110mm		

pipes

pipes

1			
<b>GEV No.</b>	527457	<b>Ref. No.</b>	205290 3363
<b>description</b>	connecting fitting ø 26mm L 39mm T1: 1/4" T2: 3/4"		

accessories

1			
<b>GEV No.</b>	526969	<b>Ref. No.</b>	106151
<b>description</b>	gasket ø 10mm L 6mm PTFE hole ø 4mm		

non-return valves

complete

1			
<b>GEV No.</b>	525960	<b>Ref. No.</b>	202201
<b>description</b>	non-return valve inlet 3/8" outlet 3/8" L 62mm		

1			
<b>GEV No.</b>	528790	<b>Ref. No.</b>	202201
<b>description</b>	non-return valve T1: 3/8" T2: 3/8" L 42.5mm total length 67mm		

miscellaneous

1			
<b>GEV No.</b>	526958	<b>Ref. No.</b>	400166
<b>description</b>	heat exchanger T1: 1/2" T2: 1/2" ø 60mm L 198mm copper		

			
1			
<b>GEV No.</b>	526959	<b>Ref. No.</b>	1034/A 507320
<b>description</b>	heat exchanger T1: 3/4" T2: 3/4" ø 50mm L 195mm for nickel-plated copper		

			
1			
<b>GEV No.</b>	526956	<b>Ref. No.</b>	507430
<b>description</b>	heat exchanger thread 1/2" IT		

			
1			
<b>GEV No.</b>	525947	<b>Ref. No.</b>	205175
<b>description</b>	roller ø 15mm W 10mm brass hole ø 7mm		

			
1			
<b>GEV No.</b>	526968	<b>Ref. No.</b>	0700 400062
<b>description</b>	tie bar for level glass T3: M6 L 167mm WS 16		

screw connections

double nipples

			
1			
<b>GEV No.</b>	526989	<b>Ref. No.</b>	206213
<b>description</b>	screw connection T1: 1/2" T2: 3/8" int. ø 11mm int. ø 210mm L 37mm brass Qty 1 pcs for flow heaters		

			
1			
<b>GEV No.</b>	526990	<b>Ref. No.</b>	206214
<b>description</b>	screw connection T1: 3/4" T2: 1/2" int. ø 119.5mm int. ø 211.5mm L 32mm brass Qty 1 pcs for flow heaters		

for coffee grinders

grinding burrs

grinding burrs straight

standard

			
1			
<b>GEV No.</b>	526931	<b>Ref. No.</b>	202174
<b>description</b>	grinding burrs pair turn direction right D1 ø 64mm ID ø 37mm H 8.5mm tooth spacing 4mm hole ø 6.3mm bore ø 8.5mm mounting ø 49		

			
1			
<b>GEV No.</b>	527246	<b>Ref. No.</b>	N/A
<b>description</b>	grinding burrs pair turn direction right D1 ø 64mm ID ø 38mm H 8.6mm tooth spacing 3mm hole ø 6mm bore ø 8.5mm mounting ø 48 straight suitable for SAN MARCO		

			
1			
<b>GEV No.</b>	527247	<b>Ref. No.</b>	202213 202254
<b>description</b>	grinding burrs pair turn direction right D1 ø 83.5mm ID ø 45mm H 9mm tooth spacing 4mm hole ø 6mm bore ø 10mm mounting ø 66 straight suitable for GAGGIA, ARISTARCO, SAN MARCO mounting distance 56mm		

grinding burrs conical

			
1			
<b>GEV No.</b>	526932	<b>Ref. No.</b>	202251
<b>description</b>	grinding burrs pair turn direction right D1 ø 68mm D2 ø 49mm H 25mm shaft ø 13mm with flute suitable for SAN MARCO		





grinding burrs straight/conical

1			
<b>GEV No.</b>	526930	<b>Ref. No.</b>	202250
<b>description</b>	grinding burr set turn direction right D1 ø 84mm D2 ø 45mm shaft ø 13mm H 9mm 3-piece suitable for SAN MARCO		

screws

1			
<b>GEV No.</b>	526921	<b>Ref. No.</b>	204116
<b>description</b>	cylinder head bolt thread M4 thread L 10mm head ø 7mm zinc-coated steel Qty 1 pcs intake slotted head thickness 2.5mm		

1			
<b>GEV No.</b>	526922	<b>Ref. No.</b>	204061
<b>description</b>	flat-headed bolt thread M5 thread L 10mm steel Qty 1 pcs intake slotted head ø 8mm head thickness 3mm		

spillage trays

1			
<b>GEV No.</b>	526917	<b>Ref. No.</b>	106554
<b>description</b>	drain tray L 133mm W 166mm black		

1			
<b>GEV No.</b>	526918	<b>Ref. No.</b>	106258
<b>description</b>	drain tray L 220mm W 110mm		

miscellaneous

1			
<b>GEV No.</b>	530534	<b>Ref. No.</b>	106054+106145
<b>description</b>	equipment foot rectangular L 30mm plastic for coffee grinder		

dosing containers

dosing container lids

1			
<b>GEV No.</b>	526908	<b>Ref. No.</b>	106044
<b>description</b>	lid for dosing container ø 120mm		

1			
<b>GEV No.</b>	526910	<b>Ref. No.</b>	106551
<b>description</b>	lid for dosing container ø 120mm		

1			
<b>GEV No.</b>	526909	<b>Ref. No.</b>	106260
<b>description</b>	lid for dosing container ø 120mm grey		

springs

group 1

1			
<b>GEV No.</b>	526923	<b>Ref. No.</b>	300284
<b>description</b>	compression spring ø 4.6mm L 33mm wire gauge ø 0.4mm for ratchet		

1			
<b>GEV No.</b>	526925	<b>Ref. No.</b>	300281SX
<b>description</b>	torsion spring ø 26.5mm wire gauge ø 2mm L1 23mm L2 29mm left		

1			
<b>GEV No.</b>	526926	<b>Ref. No.</b>	300306
<b>description</b>	torsion spring ø 26.5mm wire gauge ø 2mm L1 27mm L2 27mm right		

glass cylinders



1	<b>GEV No.</b>	526907	<b>Ref. No.</b>	106036
<b>description</b> cylinder for dosing container ø 123mm H 100mm				

levers

levers



1	<b>GEV No.</b>	531099	<b>Ref. No.</b>	300355X
<b>description</b> lever left hole ø 16mm L 140mm grey				



1	<b>GEV No.</b>	526915	<b>Ref. No.</b>	300355
<b>description</b> lever right hole ø 16mm L 140mm grey				



1	<b>GEV No.</b>	526916	<b>Ref. No.</b>	300285
<b>description</b> lever right hole ø 16mm L 140mm plastic black				

coffee presses

components

pressers



1	<b>GEV No.</b>	526912	<b>Ref. No.</b>	106084
<b>description</b> coffee press ø 53.7mm H 26mm thread M8 black				



1	<b>GEV No.</b>	526911	<b>Ref. No.</b>	106263
<b>description</b> coffee press ø 53.7mm thread M8 grey				



1	<b>GEV No.</b>	526914	<b>Ref. No.</b>	106264
<b>description</b> coffee press ø 56.5mm H 25mm thread M8 grey				



1	<b>GEV No.</b>	526913	<b>Ref. No.</b>	106085
<b>description</b> coffee press ø 56.5mm H 27mm thread M8 black				

ratches

springs



1	<b>GEV No.</b>	526928	<b>Ref. No.</b>	300265
<b>description</b> compression spring ø 3.5mm L 20mm wire gauge ø 0.4mm for ratchet				



1	<b>GEV No.</b>	526923	<b>Ref. No.</b>	300284
<b>description</b> compression spring ø 4.6mm L 33mm wire gauge ø 0.4mm for ratchet				

pins



1	<b>GEV No.</b>	526929	<b>Ref. No.</b>	300277
<b>description</b> pressure pin ø 4mm L 15.5mm				



1	<b>GEV No.</b>	526924	<b>Ref. No.</b>	300282
<b>description</b> pressure pin ø 5mm L 16mm				

adjustment mechanism

lockable adjustment



1	<b>GEV No.</b>	526920	<b>Ref. No.</b>	106171
<b>description</b> push button for coffee grinder shaft ø 6mm shaft length 36mm black				



<b>GEV No.</b>	526919	<b>Ref. No.</b>	106262
<b>description</b>	push button for coffee grinder shaft ø 6mm shaft length 36mm grey		

springs



<b>GEV No.</b>	526927	<b>Ref. No.</b>	200061
<b>description</b>	compression spring ø 5.5mm L 3.2mm wire gauge ø 0.5mm		

coffee beans containers

container lids



<b>GEV No.</b>	526906	<b>Ref. No.</b>	106550
<b>description</b>	lid for coffee beans container ø 170mm		



<b>GEV No.</b>	526901	<b>Ref. No.</b>	106051
<b>description</b>	lid for coffee beans container ø 175mm		



<b>GEV No.</b>	527327	<b>Ref. No.</b>	N/A
<b>description</b>	lid for coffee beans container ø 210mm		



<b>GEV No.</b>	526904	<b>Ref. No.</b>	106250
<b>description</b>	lid for coffee beans container ø 220mm grey		

coffee beans containers



<b>GEV No.</b>	526900	<b>Ref. No.</b>	106166
<b>description</b>	coffee beans container ø 175mm H 220mm seat ø 68mm		



<b>GEV No.</b>	526903	<b>Ref. No.</b>	106202
<b>description</b>	coffee beans container ø 221mm H 231mm seat ø 68mm		



1

<b>GEV No.</b>	531179	<b>Ref. No.</b>	N/A
<b>description</b>	coffee beans container without lid ø 207mm H 245mm universal		
<b>accessories for</b>	531179		
	<b>GEV No.</b>	527327	<b>Ref. No.</b> N/A
lid for coffee beans container ø 210mm			

## supports



1

<b>GEV No.</b>	531171	<b>Ref. No.</b>	N/A
<b>description</b>	support for coffee beans container intake conical seat ø 67-66mm suitable for SAN MARCO		

## locks

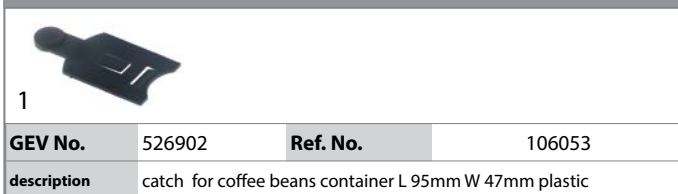

1

<b>GEV No.</b>	526902	<b>Ref. No.</b>	106053
<b>description</b>	catch for coffee beans container L 95mm W 47mm plastic		

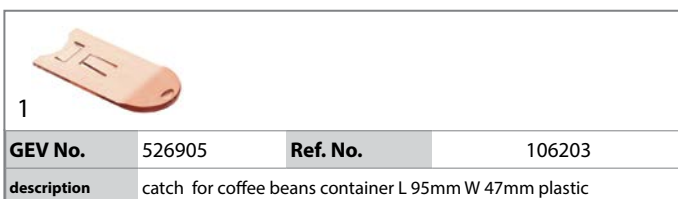

1

<b>GEV No.</b>	526905	<b>Ref. No.</b>	106203
<b>description</b>	catch for coffee beans container L 95mm W 47mm plastic		

## knobs

## steam/water taps

## steam/water taps



1

<b>GEV No.</b>	526976	<b>Ref. No.</b>	106414
<b>description</b>	knob ø 61mm shaft ø 7x7mm beige steam/water		



1

<b>GEV No.</b>	526977	<b>Ref. No.</b>	106413
<b>description</b>	turning handle 2-0-1 ø 51mm shaft ø 5x5mm beige		

## handles and hand wheels

## cylindrical handles

## fixed



1

<b>GEV No.</b>	111037	<b>Ref. No.</b>	106026
<b>description</b>	cylindrical handle thread M10 bore ø 13.6mm ø 24mm L 80mm plastic		

## cone handles



1

<b>GEV No.</b>	112614	<b>Ref. No.</b>	106020
<b>description</b>	cone handle thread M10 ø 20mm L 40mm plastic black		

## lever handles



1

<b>GEV No.</b>	111010	<b>Ref. No.</b>	106107 5102
<b>description</b>	lever handle plastic black L 95mm W 60mm		



miscellaneous

 <p>1</p>			
<b>GEV No.</b>	111051	<b>Ref. No.</b>	106072
<b>description</b>	handle L 45mm W 46mm ø 26mm for filling valve plastic black		

gaskets

O-rings

EPDM

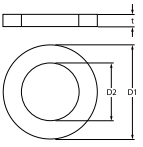
  <p>1</p>			
<b>GEV No.</b>	510177	<b>Ref. No.</b>	109017
<b>description</b>	O-ring EPDM thickness 1.78mm ID ø 7.66mm Qty 1 pcs		

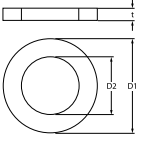
  <p>1</p>			
<b>GEV No.</b>	529251	<b>Ref. No.</b>	109046
<b>description</b>	O-ring EPDM thickness 2.62mm ID ø 15.08mm Qty 1 pcs		

silicone

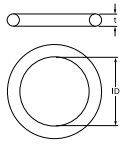
  <p>1</p>			
<b>GEV No.</b>	532520	<b>Ref. No.</b>	109046
<b>description</b>	O-ring silicone thickness 2.62mm ID ø 15.08mm Qty 1 pcs		

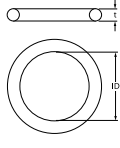
  <p>1</p>			
<b>GEV No.</b>	532568	<b>Ref. No.</b>	109113
<b>description</b>	O-ring silicone thickness 2.62mm ID ø 21.89mm Qty 1 pcs		

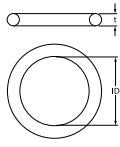
  <p>1</p>			
<b>GEV No.</b>	532569	<b>Ref. No.</b>	109045
<b>description</b>	O-ring silicone thickness 5.34mm ID ø 75.57mm Qty 1 pcs		

Viton

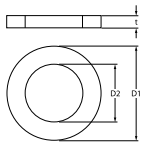
  <p>1</p>			
<b>GEV No.</b>	371095	<b>Ref. No.</b>	1025
<b>description</b>	O-ring Viton thickness 1.78mm ID ø 6.07mm Qty 1 pcs		

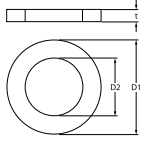
  <p>1</p>			
<b>GEV No.</b>	528282	<b>Ref. No.</b>	109017
<b>description</b>	O-ring Viton thickness 1.78mm ID ø 7.66mm Qty 1 pcs		

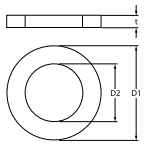
  <p>1</p>			
<b>GEV No.</b>	532567	<b>Ref. No.</b>	109114
<b>description</b>	O-ring Viton thickness 2.62mm ID ø 13.1mm Qty 1 pcs		

sealing washers

fibre gaskets

 <p>1</p>			
<b>GEV No.</b>	526995	<b>Ref. No.</b>	109061
<b>description</b>	flat gasket FIBER ED ø 28mm ID ø 22mm thickness 1mm Qty 1 pcs		

 <p>1</p>			
<b>GEV No.</b>	528134	<b>Ref. No.</b>	3362
<b>description</b>	flat gasket fibre ED ø 34mm ID ø 27mm thickness 2mm for thread 3/4" Qty 1 pcs		

 <p>1</p>			
<b>GEV No.</b>	510459	<b>Ref. No.</b>	109100
<b>description</b>	flat gasket fibre ED ø 50mm ID ø 40mm thickness 3mm Qty 1 pcs		

			
1			
<b>GEV No.</b>	528304	<b>Ref. No.</b>	109081
<b>description</b>	flat gasket fibre ED ø 58mm ID ø 46mm thickness 2mm Qty 1 pcs		

			
1			
<b>GEV No.</b>	525963	<b>Ref. No.</b>	109099
<b>description</b>	gasket fibre ED ø 132mm ID ø 123mm thickness 3mm Qty 1 pcs		

			
1			
<b>GEV No.</b>	525962	<b>Ref. No.</b>	109073
<b>description</b>	gasket fibre ED ø 163mm ID ø 150mm thickness 3mm Qty 1 pcs		

rubber gaskets

			
1			
<b>GEV No.</b>	528859	<b>Ref. No.</b>	109051 109069
<b>description</b>	flat gasket rubber ED ø 14mm ID ø 4mm thickness 4mm Qty 1 pcs		

copper gaskets

DIN-7603-A

			
1			
<b>GEV No.</b>	526991	<b>Ref. No.</b>	109096
<b>description</b>	flat gasket copper ED ø 23mm ID ø 17mm thickness 1.5mm		

PTFE gaskets

			
1			
<b>GEV No.</b>	528858	<b>Ref. No.</b>	109099
<b>description</b>	flat gasket PTFE ED ø 132mm ID ø 123mm thickness 3.2mm Qty 1 pcs suitable for SAN MARCO		

			
1			
<b>GEV No.</b>	528011	<b>Ref. No.</b>	N/A
<b>description</b>	flat gasket PTFE ED ø 14.5mm ID ø 10mm thickness 2mm Qty 1 pcs suitable for SAN MARCO		

			
1			
<b>GEV No.</b>	528865	<b>Ref. No.</b>	109079
<b>description</b>	flat gasket PTFE ED ø 22mm ID ø 19.5mm thickness 1mm Qty 1 pcs suitable for SAN MARCO		

			
1			
<b>GEV No.</b>	526992	<b>Ref. No.</b>	109106
<b>description</b>	flat gasket PTFE ED ø 27mm ID ø 21mm thickness 2mm Qty 1 pcs		

			
1			
<b>GEV No.</b>	526993	<b>Ref. No.</b>	109078
<b>description</b>	flat gasket PTFE ED ø 34mm ID ø 26.5mm thickness 2mm Qty 1 pcs for thread 3/4"		

			
1			
<b>GEV No.</b>	528418 <sup>1</sup>	<b>Ref. No.</b>	1033
<b>description</b>	flat gasket PTFE ED ø 34mm ID ø 27mm thickness 2mm Qty 2 pcs		

<sup>1</sup>Qty 2 pieces

			
1			
<b>GEV No.</b>	528857	<b>Ref. No.</b>	N/A
<b>description</b>	flat gasket PTFE ED ø 50mm ID ø 40mm thickness 3.2mm Qty 1 pcs suitable for SAN MARCO		

			
1			
<b>GEV No.</b>	528010	<b>Ref. No.</b>	803F
<b>description</b>	flat gasket PTFE ED ø 56mm ID ø 46.5mm thickness 3mm Qty 1 pcs suitable for SAN MARCO		

silicone gaskets

			
1			
<b>GEV No.</b>	529391	<b>Ref. No.</b>	0705 109015
<b>description</b>	flat gasket silicone ED ø 31mm ID ø 19mm thickness 3mm Qty 1 pcs		



special gaskets

group gaskets



1			
<b>GEV No.</b>	528877	<b>Ref. No.</b>	109070
<b>description</b>	gasket L 94mm W 45mm thickness 2.2mm hole distance 74mm suitable for SAN MARCO		



Image not available

1			
<b>GEV No.</b>	528135	<b>Ref. No.</b>	N/A
<b>description</b>	group gasket L 95mm W 45mm		

springs

torsion springs



1			
<b>GEV No.</b>	525946	<b>Ref. No.</b>	200003
<b>description</b>	torsion spring $\phi$ 14.3mm L2 13mm wire gauge $\phi$ 1.3mm L1 8mm L3 6.5mm Qty 1 pcs		

compression springs



1			
<b>GEV No.</b>	525966	<b>Ref. No.</b>	200051 200150
<b>description</b>	compression spring $\phi$ 11.8mm L 15mm wire gauge $\phi$ 2.2mm		



1			
<b>GEV No.</b>	528307	<b>Ref. No.</b>	200051 200150
<b>description</b>	compression spring $\phi$ 11.8mm L 17mm wire gauge $\phi$ 2.2mm		



1			
<b>GEV No.</b>	528866	<b>Ref. No.</b>	200034
<b>description</b>	compression spring $\phi$ 15mm L 20mm wire gauge $\phi$ 2.2mm for filling valve		



1			
<b>GEV No.</b>	528869	<b>Ref. No.</b>	200026
<b>description</b>	compression spring $\phi$ 16.4mm L 21mm wire gauge $\phi$ 2mm		



1			
<b>GEV No.</b>	528868	<b>Ref. No.</b>	200033
<b>description</b>	compression spring $\phi$ 16.6mm L 20mm wire gauge $\phi$ 2.1mm		



1			
<b>GEV No.</b>	525965	<b>Ref. No.</b>	200033
<b>description</b>	compression spring $\phi$ 16mm L 20mm wire gauge $\phi$ 1.7mm for steam-/water-tap		





1			
<b>GEV No.</b>	525964	<b>Ref. No.</b>	200026
<b>description</b>	compression spring $\phi$ 16mm L 20mm wire gauge $\phi$ 1.8mm for steam-/water-tap		



1			
<b>GEV No.</b>	526928	<b>Ref. No.</b>	300265
<b>description</b>	compression spring $\phi$ 3.5mm L 20mm wire gauge $\phi$ 0.4mm for ratchet		

1 			
<b>GEV No.</b>	526923	<b>Ref. No.</b>	300284
<b>description</b>	compression spring ø 4.6mm L 33mm wire gauge ø 0.4mm for ratchet		

1 			
<b>GEV No.</b>	526927	<b>Ref. No.</b>	200061
<b>description</b>	compression spring ø 5.5mm L 3.2mm wire gauge ø 0.5mm		

1 			
<b>GEV No.</b>	528860	<b>Ref. No.</b>	200049
<b>description</b>	compression spring ø 9.8mm L 27mm wire gauge ø 1.7mm		

## manometers

1 			
<b>GEV No.</b>	541220	<b>Ref. No.</b>	1174 202102
<b>description</b>	manometer double scale ø 63mm pressure range 0-3 / 0-15bar connection on the backside thread 1/8"		

1 			
<b>GEV No.</b>	541720	<b>Ref. No.</b>	202270
<b>description</b>	manometer double scale ø 63mm pressure range 0-3 / 0-15bar connection on the backside thread 1/8"		

1 			
<b>GEV No.</b>	541221	<b>Ref. No.</b>	14-065
<b>description</b>	manometer ø 50mm pressure range 0 up to 3bar thread 1/4" marking 1-1.25 connection on the backside		

## hoses

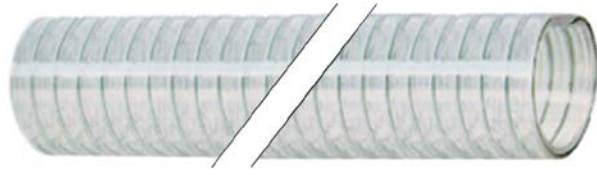

### industrial hoses

#### hoses wire reinforced

1 			
<b>GEV No.</b>	520035	<b>Ref. No.</b>	1676
<b>description</b>	drain hose ID ø 14mm ED ø 20mm L 30m wire reinforced		

## water softeners

### manual softener

1 				
<b>GEV No.</b>	520130	<b>Ref. No.</b>	800015	
<b>description</b>	lid type DVA BP complete for softener			
<b>spare parts for</b>	520130			
	<b>GEV No.</b>	520131	<b>Ref. No.</b>	—
	O-ring ID ø 77mm thickness 6.5mm suitable for type LT/BP			
	<b>GEV No.</b>	530803	<b>Ref. No.</b>	—
	lid handle			

## fastening material

### screws

#### flat-headed bolts

1 			
<b>GEV No.</b>	526922	<b>Ref. No.</b>	204061
<b>description</b>	flat-headed bolt thread M5 thread L 10mm steel Qty 1 pcs intake slotted head ø 8mm head thickness 3mm		

#### hexagonal screws

1 			
<b>GEV No.</b>	560408	<b>Ref. No.</b>	204083
<b>description</b>	hexagonal screw thread M5 thread L 22mm SS WS 8 Qty 1 pcs head thickness 3.5mm DIN 933 / ISO 4017		







cylinder head bolts			
DIN 912/ISO 4762			
			
1			
<b>GEV No.</b>	560373	<b>Ref. No.</b>	204074
<b>description</b>	cylinder head bolt thread M4 thread L 12mm WS 3 SS Qty 1 pcs intake internal hexagon DIN 912/ISO 4762		

			
1			
<b>GEV No.</b>	560026	<b>Ref. No.</b>	23560
<b>description</b>	cylinder head bolt thread M4 thread L 16mm WS 3 SS Qty 20 pcs DIN 912/ISO 4762		

			
1			
<b>GEV No.</b>	560315	<b>Ref. No.</b>	204056
<b>description</b>	cylinder head bolt thread M5 thread L 12mm WS 4 SS Qty 20 pcs DIN 912/ISO 4762		

miscellaneous			
			
1			
<b>GEV No.</b>	526921	<b>Ref. No.</b>	204116
<b>description</b>	cylinder head bolt thread M4 thread L 10mm head ø 7mm zinc-coated steel Qty 1 pcs intake slotted head thickness 2.5mm		

grub screws			
DIN 913/ISO 4026			
			
1			
<b>GEV No.</b>	560407	<b>Ref. No.</b>	204315
<b>description</b>	grub screw thread M4 L 10mm stainless steel DIN 913 WS 2 Qty 1 pcs		

nuts			
hexagonal nuts			
hexagonal nuts metric (without norm)			
			
1			
<b>GEV No.</b>	526982	<b>Ref. No.</b>	205123
<b>description</b>	hexagonal nut thread M18x1.5 H 6mm WS 26 Qty 1 pcs		

			
1			
<b>GEV No.</b>	526983	<b>Ref. No.</b>	205007
<b>description</b>	hexagonal nut thread M25 H 6mm WS 27 brass Qty 1 pcs		

washers			
tooth lock washers			
DIN 6798A			
			
1			
<b>GEV No.</b>	560126	<b>Ref. No.</b>	204032
<b>description</b>	tooth lock washer ID ø 5.2mm ED ø 10mm SS DIN/ISO DIN 6798A Qty 20 pcs for thread M5		

fasteners			
retaining rings			
DIN 6799			
			
1			
<b>GEV No.</b>	529724	<b>Ref. No.</b>	204320
<b>description</b>	retaining ring E D1 ø 4mm D2 ø 9mm SS DIN 6799 thickness 0.7mm for shaft ø 4-5mm		

			
1			
<b>GEV No.</b>	528709	<b>Ref. No.</b>	204017
<b>description</b>	retaining ring E D1 ø 4mm D2 ø 9mm steel DIN 6799 thickness 0.7mm for shaft ø 5-7mm		

			
1			
<b>GEV No.</b>	691470	<b>Ref. No.</b>	204316
<b>description</b>	retaining ring E D1 ø 8mm D2 ø 16mm SS DIN 6799 thickness 1mm for shaft ø 9-12mm		



## consumables

### fuses

#### fine fuses



1

<b>GEV No.</b>	358687	<b>Ref. No.</b>	1248
<b>description</b>	fine fuse size ø5x20mm 0.5A medium lag rated 250V Qty 10 pcs		

<b>B</b>			
booster pumps II	13		
<b>C</b>			
consumables	34		
cylinder head bolts	33		
<b>E</b>			
electrodes	13		
<b>F</b>			
fasteners	33		
fastening material	32		
fine fuses	34		
flat-headed bolts	32		
flow meters	13		
fuses	14, 34		
<b>G</b>			
grub screws	33		
<b>H</b>			
heating elements	3		
heating elements for coffee machine	3		
hexagonal nuts	33		
hexagonal screws	32		
hoses	32		
hoses wire reinforced	32		
<b>I</b>			
indicator lights	6		
indicator lights (complete)	6		
industrial hoses	32		
<b>L</b>			
lamps	6		
<b>M</b>			
manual softener	32		
mechanical timers	7		
microswitches	6		
<b>N</b>			
nuts	33		
<b>O</b>			
O-rings	29		
<b>P</b>			
probes	7		
pumps	13		
push/momentary push switches	6		
<b>R</b>			
relays	7		
retaining rings	33		
rocker/momentary rocker switches	5		
rotary switches	6		
<b>S</b>			
safety thermostats	5		
screws	32		
sealing washers	29		
solenoid valves	11		
switches and momentary switches	5		
<b>T</b>			
thermostats	5		
timers	7		
tooth lock washers	33		
<b>W</b>			
water softeners	32		