



GAS COMPONENTS



ELECTRIC COMPONENTS



WATER TECHNOLOGY



MECHANICAL COMPONENTS



TOOLS

Spare parts suitable for

LAMBER

Find the complete and up-to-date range of products in our GEV Webshop



Manufacturer catalogue

The most important spare parts and accessories arranged clearly for every manufacturer

- ✓ Complete product range and all appliance data always up to date in the GEV Webshop
- ✓ Alphabetical Index at the end of the catalogue

GEV Webshop

www.gev-online.co.uk

www.gev-online.com



- 🔍 Add to Favourites
- 🔍 Sign In with email address and usual password
- 🔍 Easy-order – place several items in your basket at the same time
- 🔍 Quick Item search – no login needed



heating elements



coil heating elements



| | | | |
|---|---|-----------------|---------|
|  | | | |
| GEV No. | 418823 | Ref. No. | 0303100 |
| description | heating element 1000W 230V L 405mm W 50mm H 25mm tube ø 8.5mm thread M14x1.5 connection M5 heating circuits 1 | | |

immersion heating elements



3 hole flange ø57.5mm



| | | | |
|---|---|-----------------|---------|
|  | | | |
| GEV No. | 416229 | Ref. No. | 0303001 |
| description | heating element 2400W 230V mounting ø 57.5mm heating circuits 2 L 235mm W 37mm H 35mm number of thermostat sleeves 1 thermostat sleeves ø 7mm length thermostat sleeves 225mm thermostat sleeve not clinging tube ø 8mm hole distance 75mm hole ø 7.8mm connection length 29mm connection M5 3 hole flange immersion heater | | |
| For models: | DSP1, DSP2, S200, S280, S280Dep, Super-QS, Super-QS-Dep | | |

| | | | |
|---|---|-----------------|---------|
|  | | | |
| GEV No. | 416230 | Ref. No. | 0300011 |
| description | heating element 3000W 230V mounting ø 57.5mm heating circuits 3 L 235mm W 34mm H 48mm number of thermostat sleeves 1 thermostat sleeves ø 7mm length thermostat sleeves 215mm thermostat sleeve upper tube ø 8.5mm hole distance 72mm hole ø 10mm connection length 20mm connection M5 3 hole flange immersion heater | | |
| For models: | 015-24L, 050F, 050F-Dep, DSP5, MATIC20, P550 | | |
| spare parts for | 416230 | | |
| | GEV No. | Ref. No. | 0200041 |
| |  O-ring EPDM thickness 5.34mm ID ø 56.52mm Qty 1 pcs | | |

| | | | |
|---|--|-----------------|---------|
|  | | | |
| GEV No. | 416231 | Ref. No. | 0300002 |
| description | heating element 4500W 230V mounting ø 57.5mm heating circuits 3 L 307mm W 45mm H 36mm number of thermostat sleeves 1 thermostat sleeves ø 7mm length thermostat sleeves 210mm thermostat sleeve eccentric, non clinging tube ø 8.5mm hole distance 74mm hole ø 8/10mm connection M5 3 hole flange immersion heater | | |
| For models: | DSP4, DSP5, F85, F85-Dep, MATIC20 | | |
| spare parts for | 416231 | | |
| | GEV No. | Ref. No. | 0200041 |
| |  O-ring EPDM thickness 5.34mm ID ø 56.52mm Qty 1 pcs | | |

| | | | |
|---|----------------|--------|-----------------|
| accessories for | 416231 | | |
|  | GEV No. | 520258 | Ref. No. |
| | | | 0301112 |
| | protection cap | | |

| | | | |
|--|--|-----------------|---------|
|  | | | |
| GEV No. | 416232 | Ref. No. | 0300012 |
| description | heating element 6000W 230V mounting ø 57.5mm heating circuits 3 L 293mm W 40mm H 36mm number of thermostat sleeves 1 thermostat sleeves ø 7mm length thermostat sleeves 280mm thermostat sleeve eccentric, non clinging tube ø 8.5mm hole distance 74mm hole ø 8x10mm connection M5 3 hole flange immersion heater | | |
| For models: | 015-24L, F85, F85-Dep, L20, L21, LP31L, LP6L, M115, M150, MATIC20, P550 | | |
| spare parts for | 416232 | | |
| | GEV No. | Ref. No. | 0200041 |
| |  O-ring EPDM thickness 5.34mm ID ø 56.52mm Qty 1 pcs | | |

| | | | |
|---|--|-----------------|-----------------|
|  | | | |
| GEV No. | 416233 | Ref. No. | 0300299 |
| description | heating element 9000W 230V mounting ø 57.5mm heating circuits 3 L 440mm W 42mm H 38mm number of thermostat sleeves 1 thermostat sleeves ø 7.5mm length thermostat sleeves 290mm thermostat sleeve eccentric, non clinging tube ø 8.5mm hole distance 73mm hole ø 8/10mm connection M5 3 hole flange immersion heater | | |
| For models: | 015-24L, LP31L, LP6, LP6L, M115, M150, MATIC20 | | |
| accessories for | 416233 | | |
|  | GEV No. | 520258 | Ref. No. |
| | | | 0301112 |
| | protection cap | | |





| | | | |
|--|--|-----------------|---------|
|  | | | |
| GEV No. | 416225 | Ref. No. | 0303042 |
| description | heating element 2400W 230V heating circuits 3 thread 1 1/4" L 275mm W 90mm H 40mm L1 25mm L2 50mm L3 200mm W1 31mm W2 28mm H1 20mm H2 20mm connection M4 immersion heater tube ø 6.3mm flange with thread connection length 40mm WS 32 | | |
| For models: | DSP5 | | |
| spare parts for | 416225 | | |
| | GEV No. | Ref. No. | — |
| |  O-ring EPDM thickness 3.53mm ID ø 41.28mm Qty 1 pcs | | |
| accessories for | 416225 | | |
| | GEV No. | Ref. No. | — |
| |  flat gasket fibre ED ø 56mm ID ø 42mm thickness 2mm for thread 1 1/4" Qty 1 pcs | | |

Table continues overleaf



1 electric components



| | | | | |
|---|---------|--------|----------|---|
| accessories for 416225 | | | | |
|  | GEV No. | 520232 | Ref. No. | — |
| nut thread 1/4" H 5mm nickel-plated brass WS 47 Qty 1 pcs | | | | |
|  | GEV No. | 528021 | Ref. No. | — |
| flat gasket PTFE ED ø 53mm ID ø 42.5mm thickness 3mm Qty 1 pcs equiv. no. 12001/02286 suitable for Astoria/Aurora/Brasilia/Wega | | | | |



| | | | | |
|--------------------|--|-----------------|---------|--|
| GEV No. | 416226 | Ref. No. | 0300022 | |
| description | heating element 4500W 230V heating circuits 3 thread 1/4" L 260mm W 90mm H 35mm L1 60mm L2 50mm L3 150mm W1 31mm W2 28mm H1 15mm H2 20mm connection M4 immersion heater tube ø 6.3mm flange with thread connection length 42mm | | | |

| | | | | |
|---|---------|--------|----------|---|
| accessories for 416226 | | | | |
|  | GEV No. | 510405 | Ref. No. | — |
| flat gasket fibre ED ø 56mm ID ø 42mm thickness 2mm for thread 1/4" Qty 1 pcs | | | | |
|  | GEV No. | 520232 | Ref. No. | — |
| nut thread 1/4" H 5mm nickel-plated brass WS 47 Qty 1 pcs | | | | |
|  | GEV No. | 528021 | Ref. No. | — |
| flat gasket PTFE ED ø 53mm ID ø 42.5mm thickness 3mm Qty 1 pcs equiv. no. 12001/02286 suitable for Astoria/Aurora/Brasilia/Wega | | | | |







| | | | | |
|--------------------|---|-----------------|---------|--|
| GEV No. | 420358 | Ref. No. | 0303045 | |
| description | heating element 1000W 230V heating circuits 1 L 125mm W 40mm H 35mm thread 1/4" mounting distance 32mm tube ø 8mm connection male faston 6.3mm immersion heater 2 hole fixing | | | |

| | | | | |
|---|---------|--------|----------|---|
| accessories for 420358 | | | | |
|  | GEV No. | 501362 | Ref. No. | — |
| flat gasket fibre ED ø 22mm ID ø 13.5mm thickness 2mm Qty 1 pcs | | | | |







| | | | | |
|--------------------|--|-----------------|---------|--|
| GEV No. | 416227 | Ref. No. | 0303044 | |
| description | heating element 1000W 230V heating circuits 1 L 195mm W 40mm thread 1/4" mounting distance 32mm tube ø 8mm 2 hole fixing immersion heater connection male faston 6.3mm | | | |
| For models: | S200 | | | |

| | | | | |
|---|---------|--------|----------|---|
| accessories for 416227 | | | | |
|  | GEV No. | 361182 | Ref. No. | — |
| nut thread 1/4" H 5mm nickel-plated brass WS 17 Qty 1 pcs | | | | |
|  | GEV No. | 510417 | Ref. No. | — |
| flat gasket fibre ED ø 20mm ID ø 14mm thickness 2mm Qty 1 pcs | | | | |
|  | GEV No. | 520228 | Ref. No. | — |
| tooth lock washer ID ø 15.3mm ED ø 24mm steel Qty 1 pcs for thread M14 | | | | |

| | | | | |
|---|---------|--------|----------|---|
| accessories for 416227 | | | | |
|  | GEV No. | 550262 | Ref. No. | — |
| flat gasket copper ED ø 20mm ID ø 14mm thickness 2mm | | | | |



| | | | | |
|--------------------|---|-----------------|---------|--|
| GEV No. | 416228 | Ref. No. | 0300067 | |
| description | heating element 2000W 230V heating circuits 1 L 197mm W 46mm H 33mm thread 1/4" mounting distance 38mm tube ø 8.5mm connection male faston 6.3mm immersion heater 2 hole fixing | | | |
| For models: | 050F, 050F-Dep, DSP1, DSP2, DSP4, F85, F85-Dep, L20, L21, S280, S280Dep, Super-QS, Super-QS-Dep | | | |

| | | | | |
|---|---------|--------|----------|---|
| accessories for 416228 | | | | |
|  | GEV No. | 361182 | Ref. No. | — |
| nut thread 1/4" H 5mm nickel-plated brass WS 17 Qty 1 pcs | | | | |
|  | GEV No. | 510417 | Ref. No. | — |
| flat gasket fibre ED ø 20mm ID ø 14mm thickness 2mm Qty 1 pcs | | | | |
|  | GEV No. | 520228 | Ref. No. | — |
| tooth lock washer ID ø 15.3mm ED ø 24mm steel Qty 1 pcs for thread M14 | | | | |
|  | GEV No. | 550262 | Ref. No. | — |
| flat gasket copper ED ø 20mm ID ø 14mm thickness 2mm | | | | |



| | | | | |
|--------------------|---|-----------------|---------|--|
| GEV No. | 420220 | Ref. No. | 0303050 | |
| description | heating element 3000W 230V heating circuits 1 L 270mm W 39mm H 18mm thread 1/4" mounting distance 31mm tube ø 8mm connection screw 2 hole fixing immersion heater | | | |

thermostats

bi-metal thermostats

safety bi-metal thermostats



| | | | | |
|--------------------|---|-----------------|---------|--|
| GEV No. | 375913 | Ref. No. | 0300302 | |
| description | bi-metal safety thermostat hole distance 23.8mm switch-off temp. 105°C 1NC 1-pole 16A connection F6.3 2 hole fixing mounting ø 18mm | | | |
| For models: | 015-24L, DSP4, DSP5, F85-Dep, L20, L21 | | | |



| | | | |
|---|--|-----------------|---------|
|  | | | |
| 1 | | | |
| GEV No. | 390681 | Ref. No. | 0300301 |
| description | bi-metal safety thermostat hole distance 40mm switch-off temp. 105°C 2NC 2-pole 16A 250V connection F6.3 | | |
| For models: | 050F, 050F-Dep, DSP1, DSP2 | | |

bi-metal thermostats

| | | | |
|---|---|-----------------|---------|
|  | | | |
| 1 | | | |
| GEV No. | 390680 | Ref. No. | 0300303 |
| description | bi-metal thermostat hole distance 23.8mm switch-off temp. 65°C 1NC 1-pole 16A connection F6.3 2 hole fixing | | |
| For models: | DSP1, DSP2, DSP4, DSP5 | | |

control and safety thermostats

IMIT / TEMPOMATIC / ARTHERMO

control thermostats

| | | | |
|--|--|-----------------|---------|
|  | | | |
| 1 | | | |
| GEV No. | 390460 | Ref. No. | 0300005 |
| description | thermostat t.max. 90°C temperature range 30-90°C 1-pole 1CO 16A probe ø 6.5mm probe L 95mm capillary pipe 2000mm capillary pipe isolated 1950mm gland nut shaft ømm shaft Lmm shaft position rotation 270° probe material copper | | |
| For models: | 015-24L, 050F, 050F-Dep, DSP1, DSP2, DSP4, DSP5, F85, F85-Dep, L20, L21, LP31L, LP6, LP6L, P550, S200, S280, S280Dep, Super-QS, Super-QS-Dep | | |

safety thermostats

| | | | |
|---|--|-----------------|---------|
|  | | | |
| 1 | | | |
| GEV No. | 390751 | Ref. No. | 0300305 |
| description | safety thermostat switch-off temp. 80°C 1-pole 1CO probe ø 5mm probe L 131mm capillary pipe 1000mm capillary pipe isolated 930mm gland nut probe | | |
| For models: | M115, M150, MATIC20 | | |

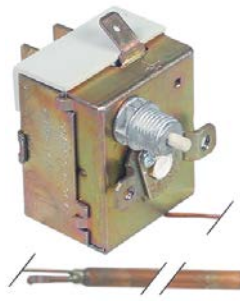
| | | | |
|--|--|-----------------|--------------------|
|  | | | |
| 1 | | | |
| GEV No. | 390458 | Ref. No. | 0300004 0300196 |
| description | safety thermostat switch-off temp. 90-110°C 1-pole 16A probe ø 6.5mm probe L 90mm capillary pipe 2000mm capillary pipe isolated 1950mm gland nut probe | | |
| For models: | F85, LP31L, LP6, LP6L, P550, S200, S280, S280Dep, Super-QS, Super-QS-Dep | | |

PRODIGY / FIRT

control thermostats

| | | | |
|---|--|-----------------|---------|
|  | | | |
| 1 | | | |
| GEV No. | 390733 | Ref. No. | 0300270 |
| description | thermostat t.max. 90°C temperature range 30-90°C 1-pole 16A probe ø 6.5mm probe L 85mm capillary pipe 1350mm capillary pipe isolated 1325mm shaft ø 6x4.6mm shaft L 5mm rotation 270° 230V with knob | | |
| For models: | M115, M150, MATIC20 | | |

accessories

plunger sockets

| | | | |
|---|---|-----------------|---------|
|  | | | |
| 1 | | | |
| GEV No. | 506059 | Ref. No. | 0200270 |
| description | thermowell double | | |
| For models: | 015-24L, F85, LP31L, LP6, LP6L, M115, M150, MATIC20, P550 | | |





| | | | |
|---|--|-----------------|---------|
|  | | | |
| 1 | | | |
| GEV No. | 506130 | Ref. No. | 0300006 |
| description | thermowell thread 1/2" L 107mm SS single ø 6.5mm | | |
| For models: | 015-24L, 050F, 050F-Dep, F85, F85-Dep, L20, L21, S200, S280, S280Dep, Super-QS, Super-QS-Dep | | |

| | | | |
|---|--|-----------------|---------|
|  | | | |
| 1 | | | |
| GEV No. | 345565 | Ref. No. | 0301000 |
| description | push switch mounting measurements 28.5x28.5mm green 2NO 250V 16A connection male faston 6.3mm ambient temperature max. 150°C protection IP40 | | |
| For models: | 015-24L, 050F, 050F-Dep, DSP5, F85, L20, LP31L, LP6, LP6L, P550, S200, S280, S280Dep, Super-QS, Super-QS-Dep | | |

switches and momentary switches

push/momentary push switches

| | | | |
|---|--|-----------------|--------------------|
| 19x13mm | | | |
|  | | | |
| 1 | | | |
| GEV No. | 347167 | Ref. No. | 0301009 0301018 |
| description | momentary push switch mounting measurements 19x13mm black 1NO 250V 16A non-illuminated connection male faston 4.8mm 1-pole | | |
| For models: | DSP1, DSP2, DSP4 | | |

| | | | |
|---|---|-----------------|---------|
|  | | | |
| 1 | | | |
| GEV No. | 345499 | Ref. No. | 0301004 |
| description | push switch mounting measurements 28.5x28.5mm grey 1CO/1NO 250V 16A connection male faston 6.3mm ambient temperature max. 150°C protection IP40 | | |
| For models: | 050F, 050F-Dep, F85, S280Dep, Super-QS-Dep | | |

| | | | |
|--|--|-----------------|---------|
|  | | | |
| 1 | | | |
| GEV No. | 359446 ¹ | Ref. No. | 0301003 |
| description | push switch mounting measurements 19x13mm yellow 2NO 250V 16A illuminated connection male faston 6.3mm ambient temperature max. 125°C protection IP65 with cover cap | | |
| For models: | DSP1, DSP2, DSP4 | | |

| | | | |
|--|--|-----------------|---------|
| microswitches | | | |
| lever actuated | | | |
|  | | | |
| 1 | | | |
| GEV No. | 346969 | Ref. No. | 0300141 |
| description | microswitch with lever 250V 16A 1NO connection male faston 6.3mm L 59mm L1 29mm ambient temperature max. 120°C mounting distance 22mm actuating force: 50g lever length 50mm | | |

¹illuminated

| | | | |
|---|--|-----------------|---------|
| 28.5x28.5mm | | | |
|  | | | |
| 1 | | | |
| GEV No. | 345498 | Ref. No. | 0301101 |
| description | momentary push switch mounting measurements 28.5x28.5mm green 2NO 250V 16A connection male faston 6.3mm ambient temperature max. 150°C protection IP40 | | |
| For models: | S200 | | |

| | | | |
|---|--|-----------------|---------|
| position switches | | | |
| SIEMENS | | | |
| 3SE0 series | | | |
| switches (complete) | | | |
|  | | | |
| 1 | | | |
| GEV No. | 347236 | Ref. No. | 0300232 |
| description | position switch with handle with a switch 1NO/1NC 230V | | |

| | | | |
|---|--|-----------------|---------|
|  | | | |
| 1 | | | |
| GEV No. | 345497 | Ref. No. | 0301005 |
| description | push switch mounting measurements 28.5x28.5mm green 2CO 250V 16A connection male faston 6.3mm ambient temperature max. 150°C protection IP40 | | |
| For models: | 015-24L, 050F, 050F-Dep, F85, L20, L21, S200, S280, S280Dep, Super-QS, Super-QS-Dep | | |

| | | | |
|---|---|-----------------|---------|
| system switches (ROLD) | | | |
|  | | | |
| 1 | | | |
| GEV No. | 345537 | Ref. No. | 0301051 |
| description | element holder mounting measurements 20.6x16.4mm grey arched for push buttons 13x17mm | | |
| For models: | 015-24L, 050F, 050F-Dep, DSP5, F85-Dep, L20, L21 | | |



| | | | |
|---|--|-----------------|---------|
|  | | | |
| 1 | | | |
| GEV No. | 346810 | Ref. No. | 0301068 |
| description | push button size 17x13mm blue | | |
| For models: | 015-24L, 050F, 050F-Dep, DSP5, F85-Dep, L20, L21 | | |

| | | | |
|---|------------------------------------|-----------------|---------|
|  | | | |
| 1 | | | |
| GEV No. | 346809 | Ref. No. | 0301066 |
| description | push button size 17x13mm green | | |
| For models: | 015-24L, 050F, 050F-Dep, DSP5, L20 | | |

| | | | |
|---|-------------------------------|-----------------|---------|
|  | | | |
| 1 | | | |
| GEV No. | 345539 | Ref. No. | 0301069 |
| description | push button size 17x13mm grey | | |
| For models: | 050F, 050F-Dep, DSP5, F85-Dep | | |



| | | | |
|--|---------------------------------|-----------------|---------|
|  | | | |
| 1 | | | |
| GEV No. | 346572 | Ref. No. | 0301067 |
| description | push button size 17x13mm yellow | | |
| For models: | F85-Dep | | |

rotary switches



LOVATO

| | | | |
|---|---|-----------------|---------|
|  | | | |
| 1 | | | |
| GEV No. | 347976 ¹ | Ref. No. | 0301020 |
| description | rotary switch 2 0-1 sets of contacts 2 type GN209775U20 690V 20A shaft \varnothing 6x6mm shaft L 15mm shaft square connection screw | | |

¹incl. knob and dial plate

| | | | |
|---|---|-----------------|-----------------|
|  | | | |
| 1 | | | |
| GEV No. | 347429 ¹ | Ref. No. | 0301022 |
| description | rotary switch 3 0-1-2 sets of contacts 3 type GN209773U20 690V 20A shaft \varnothing 6x6mm shaft L 15mm shaft square connection screw | | |
| For models: | M150, MATIC20 | | |
| spare parts for | 347429 | | |
|  | GEV No. | 112633 | Ref. No. |
| | | | 0300352 |
| | knob \varnothing 33mm shaft \varnothing 6x6mm grey | | |

¹incl. knob

| | | | |
|--|---|-----------------|-------------------------------|
|  | | | |
| 1 | | | |
| GEV No. | 345799 | Ref. No. | 0300206 0301019 0301025 |
| description | rotary switch 4 1-2-3-4 sets of contacts 7 type GN20 9779 U20 690V 20A shaft \varnothing 6x6mm shaft L 13.5mm shaft square connection screw | | |
| For models: | 015-24L, F85-Dep, L21, LP31L, LP6, LP6L, P550 | | |
| accessories for | 345799 | | |
|  | GEV No. | 112633 | Ref. No. |
| | | | 0300352 |
| | knob \varnothing 33mm shaft \varnothing 6x6mm grey | | |



accessories

levers

| | | | |
|--|--|-----------------|---------|
|  | | | |
| 1 | | | |
| GEV No. | 347168 | Ref. No. | 0301084 |
| description | lever 0-1 lever length 118mm L 90mm W 90mm shaft 8x8mm mounting distance 68x68mm | | |
| For models: | M150, MATIC20 | | |

magnetic switches

40x13mm

| | | | |
|--|--|-----------------|--------------------|
|  | | | |
| 1 | | | |
| GEV No. | 345504 | Ref. No. | 0300138 0300183 |
| description | magnetic switch L 40mm W 13mm 1NO 250V 0.04A P max. 10W connection cable cable length 1000mm | | |
| For models: | 015-24L, 050F, 050F-Dep, DSP1, DSP2, DSP4, DSP5, F85, F85-Dep, L20, L21, P550, S200, S280, S280Dep, Super-QS, Super-QS-Dep | | |
| accessories for | 345504 | | |
|  | GEV No. | 345399 | Ref. No. |
| | | | 0800141 0800142 |
| | magnet \varnothing 3.3mm L 40mm H 8mm W 13mm hole distance 30mm M3 | | |



65x20mm

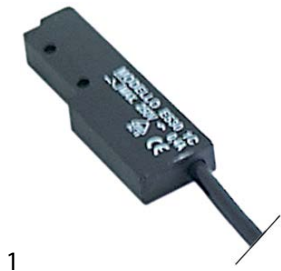

1

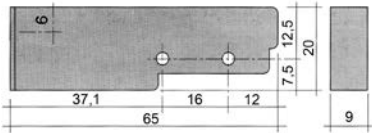

| | | | |
|---|--|-----------------|------------------------------------|
| GEV No. | 345116 | Ref. No. | 0300082 |
| description | magnetic switch L 65mm W 20mm 1NO 250V 0.4A P max. 100W connection cable cable length 3000mm | | |
| For models: | LP31L, LP6, LP6L, M115, M150, MATIC20 | | |
| accessories for | 345116 | | |
|  | GEV No. | 345399 | Ref. No. 0800141 0800142 |
| | magnet \varnothing 3.3mm L 40mm H 8mm W 13mm hole distance 30mm M3 | | |

accessories

magnets



1

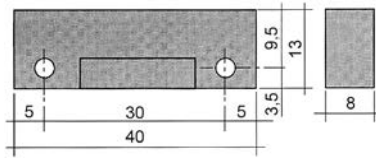

| | | | |
|--------------------|--|-----------------|--------------------|
| GEV No. | 345399 | Ref. No. | 0800141 0800142 |
| description | magnet \varnothing 3.3mm L 40mm H 8mm W 13mm hole distance 30mm M3 | | |
| For models: | 015-24L, DSP5 | | |



1

| | | | |
|--------------------|---------------------------------|-----------------|---------|
| GEV No. | 347653 | Ref. No. | 0800139 |
| description | magnet \varnothing 8mm L 40mm | | |
| For models: | M115, M150, MATIC20 | | |

magnetic holders



1

| | | | |
|--------------------|--|-----------------|---------|
| GEV No. | 347943 | Ref. No. | 0200623 |
| description | magnet holder H 75mm thread M10x1.5 \varnothing 17mm | | |
| For models: | M115, M150, MATIC20 | | |

miscellaneous



1

| | | | |
|--------------------|---|-----------------|---------|
| GEV No. | 347938 | Ref. No. | 0406141 |
| description | bracket L 86mm W 10mm H 12mm for magnetic switch SS | | |
| For models: | 015-24L, L20, L21 | | |

control equipment

SIEMENS

3SB series \varnothing 22mm new

switches (complete)





1

| | | | |
|---|---|-----------------|-------------------|
| GEV No. | 347942 | Ref. No. | 0301010 |
| description | momentary push switch mounting measurements \varnothing 22mm blue 1NO non-illuminated | | |
| For models: | LP31L, LP6, LP6L, M115, M150, MATIC20, P550 | | |
| spare parts for | 347942 | | |
|  | GEV No. | 346630 | Ref. No. — |
| | contact block SIEMENS 3SB3400-0B 1NO max 400V 10A black | | |



1

| | | | |
|---|--|-----------------|-------------------|
| GEV No. | 347944 | Ref. No. | 0301011 |
| description | momentary push switch mounting measurements \varnothing 22mm red 1NC/1NO OFF | | |
| For models: | M115, M150, MATIC20 | | |
| spare parts for | 347944 | | |
|  | GEV No. | 346630 | Ref. No. — |
| | contact block SIEMENS 3SB3400-0B 1NO max 400V 10A black | | |
|  | GEV No. | 346631 | Ref. No. — |
| | contact block SIEMENS 3SB3400-0C 1NC max 400V 10A black | | |



miscellaneous



1

| | | | |
|---|---|-----------------|-----------------|
| GEV No. | 347939 | Ref. No. | 0300397 |
| description | contact block red L 74mm 1NC 1-pole ø 22mm type ECX1030 | | |
| For models: | M150, MATIC20 | | |
| accessories for | 347939 | | |
|  | GEV No. | 347940 | Ref. No. |
| | | | 0301015 |
| | emergency stop switch mounting measurements ø22mm red | | |



1

| | | | |
|--|---|-----------------|-----------------|
| GEV No. | 347940 | Ref. No. | 0301015 |
| description | emergency stop switch mounting measurements ø22mm red | | |
| For models: | M115, M150, MATIC20 | | |
| accessories for | 347940 | | |
|  | GEV No. | 347939 | Ref. No. |
| | | | 0300397 |
| | contact block red L 74mm 1NC 1-pole ø 22mm type ECX1030 | | |

lamps



1

| | | | |
|--------------------|---|-----------------|---------|
| GEV No. | 359807 | Ref. No. | 0300387 |
| description | light bulb socket Ba9s 24V 2W ø 10mm L 28mm clear | | |
| For models: | M150, MATIC20 | | |

lamps

indicator lights

indicator lights 3-piece (housing, lens and bulb)

lamps

light bulbs



1

| | | | |
|--------------------|---|-----------------|---------|
| GEV No. | 359807 | Ref. No. | 0300387 |
| description | light bulb socket Ba9s 24V 2W ø 10mm L 28mm clear | | |
| For models: | M150, MATIC20 | | |

indicator lights (complete)

ø 6mm



1

| | | | |
|--------------------|---|-----------------|---------|
| GEV No. | 359434 | Ref. No. | 0300284 |
| description | indicator light ø 6mm 230V green | | |
| For models: | 015-24L, 050F, 050F-Dep, DSP5, F85, L20, L21, P550, S200, S280, S280Dep, Super-QS, Super-QS-Dep | | |

ø10mm

with screw socket



1

| | | | |
|--------------------|---|-----------------|---------|
| GEV No. | 357023 | Ref. No. | 0301901 |
| description | indicator light ø 10mm 24V green cable length 200mm | | |
| For models: | LP31L, LP6, M115 | | |



1

| | | | |
|--------------------|--|-----------------|---------|
| GEV No. | 360578 | Ref. No. | 0301907 |
| description | indicator light ø 10mm white 24V connection cable cable length 200mm | | |
| For models: | LP31L, LP6 | | |



1

| | | | |
|--------------------|---|-----------------|---------|
| GEV No. | 360579 | Ref. No. | 0301902 |
| description | indicator light ø 10mm yellow 24V connection cable cable length 200mm | | |
| For models: | LP31L, LP6, M115 | | |

screw-on/push-on fit

light bulbs

for indicator lights



1

| | | | |
|--------------------|---|-----------------|---------|
| GEV No. | 359807 | Ref. No. | 0300387 |
| description | light bulb socket Ba9s 24V 2W ø 10mm L 28mm clear | | |
| For models: | M150, MATIC20 | | |



timers

programme timers





1

| | | | |
|--------------------|--|-----------------|--------------------|
| GEV No. | 402949 | Ref. No. | 0300829 0301821 |
| description | electronic timer 9.2.21.16G engines chambers operation time 230V shaft ømm shaft Lmm voltage 50/60 | | |
| For models: | DSP5 | | |



1

| | | | |
|---|--|-----------------|-------------------------|
| GEV No. | 360403 | Ref. No. | 0300818 |
| description | timer CDC 11803 engines 1 chambers 3 operation time 120s 230V shaft ømm shaft Lmm manif. no. 11803F1 / 0300818 motor type M48R ATS | | |
| spare parts for | 360403 | | |
|  | GEV No. | 360118 | Ref. No. 0300850 |
| | motor CDC pinion ø 4.9mm teeth 10 230V voltage AC 50/60Hz turn direction right motor ø 47mm H 19.3mm motor type M48R ATS for timer cable length 260mm 1.9/2.5W | | |





1

| | | | |
|---|--|-----------------|-------------------------|
| GEV No. | 360411 | Ref. No. | 0300818 |
| description | timer CDC 11803 engines 1 chambers 3 operation time 120s 230V shaft ømm shaft Lmm motor type M48R ATS | | |
| spare parts for | 360411 | | |
|  | GEV No. | 360118 | Ref. No. 0300850 |
| | motor CDC pinion ø 4.9mm teeth 10 230V voltage AC 50/60Hz turn direction right motor ø 47mm H 19.3mm motor type M48R ATS for timer cable length 260mm 1.9/2.5W | | |





1

| | | | |
|---|--|-----------------|-------------------|
| GEV No. | 360257 | Ref. No. | 0300117 |
| description | timer CDC 4904F engines 1 chambers 4 operation time 6min 230V shaft ømm shaft Lmm manif. no. 4904F3 / 360257 motor type M48L ATS | | |
| For models: | 015-24L | | |
| spare parts for | 360257 | | |
|  | GEV No. | 360083 | Ref. No. — |
| | motor CDC pinion ø 4.9mm teeth 10 230V turn direction left motor ø 47mm H 19.3mm motor type M48L ATS for timer | | |





1

| | | | |
|---|--|-----------------|-------------------------|
| GEV No. | 360393 | Ref. No. | 0300803 |
| description | timer CDC 4905 engines 1 chambers 5 operation time 12min 230V shaft ømm shaft Lmm | | |
| For models: | L21, LP6L, P550 | | |
| spare parts for | 360393 | | |
|  | GEV No. | 360118 | Ref. No. 0300850 |
| | motor CDC pinion ø 4.9mm teeth 10 230V voltage AC 50/60Hz turn direction right motor ø 47mm H 19.3mm motor type M48R ATS for timer cable length 260mm 1.9/2.5W | | |





1

| | | | |
|---|--|-----------------|-------------------|
| GEV No. | 360457 | Ref. No. | 0300822 |
| description | timer CDC 4907DV engines 2 chambers 7 operation time 6s / 8min 24V | | |
| For models: | LP31L, LP6 | | |
| spare parts for | 360457 | | |
|  | GEV No. | 360323 | Ref. No. — |
| | motor CDC pinion ø 4.9mm teeth 10 24V voltage AC turn direction left motor ø 47mm H 19.3mm motor type M48L ATS for timer | | |

1

| | | | |
|---|--|-----------------|--|
| GEV No. | 360255 | Ref. No. | 0300101 0300806 0300807 0300812 |
| description | timer CDC 7003F engines 1 chambers 3 operation time 6min 230V shaft ø 6x4.6mm shaft L 20mm manuf. no. 7003F3 / 360255 motor type M37LN | | |
| For models: | F85, L20 | | |
| spare parts for | 360255 | | |
|  | GEV No. | 360131 | Ref. No. — |
| | motor CDC pinion ø 5.4mm teeth 12 230V turn direction left motor ø 37mm motor type M37LN for timer | | |
| accessories for | 360255 | | |
|  | GEV No. | 110905 | Ref. No. 0300049 |
| | knob switch zero mark ø 42mm shaft ø 6x4.6mm shaft flat right black | | |



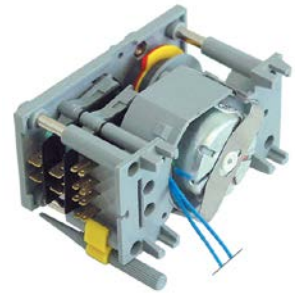

1

| | | | |
|--------------------|---|-----------------|---------|
| GEV No. | 360582 | Ref. No. | 0300804 |
| description | timer CDC 7802 engines 1 chambers 2 operation time 60s 208V 60Hz shaft ømm shaft Lmm manuf. no. 7802M1 / 0300804 motor type M37RS warewashing | | |





1

| | | | |
|---|--|-----------------|-------------------|
| GEV No. | 360254 | Ref. No. | 0300085 |
| description | timer CDC 7802 engines 1 chambers 2 operation time 60s 230V manuf. no. 7802M1 / 0300085 motor type M37RN | | |
| For models: | 015-24L, 050F, 050F-Dep, F85, L20, L21, S200, S280, S280Dep, Super-QS, Super-QS-Dep | | |
| spare parts for | 360254 | | |
|  | GEV No. | 360119 | Ref. No. — |
| | motor CDC pinion ø 5.4mm teeth 12 230V turn direction right motor ø 37mm motor type M37RN for timer | | |





1

| | | | |
|---|---|-----------------|-------------------|
| GEV No. | 360256 | Ref. No. | 0300143 |
| description | timer CDC 7804F engines 1 chambers 4 operation time 120s 230V shaft ømm shaft Lmm manuf. no. 7804F1 / 360256 motor type M37RN | | |
| For models: | 050F, 050F-Dep, S200, S280, S280Dep, Super-QS, Super-QS-Dep | | |
| spare parts for | 360256 | | |
|  | GEV No. | 360119 | Ref. No. — |
| | motor CDC pinion ø 5.4mm teeth 12 230V turn direction right motor ø 37mm motor type M37RN for timer | | |



1

| | | | |
|---|---|-----------------|-------------------|
| GEV No. | 360253 | Ref. No. | 0300297 |
| description | timer CDC 7804F engines 1 chambers 4 operation time 20min 230V manuf. no. 7804F1 / 0300297 motor type M37RN | | |
| For models: | 050F, 050F-Dep, F85, S280Dep, Super-QS-Dep | | |
| spare parts for | 360253 | | |
|  | GEV No. | 360119 | Ref. No. — |
| | motor CDC pinion ø 5.4mm teeth 12 230V turn direction right motor ø 37mm motor type M37RN for timer | | |



1

| | | | |
|--------------------|---|-----------------|---------|
| GEV No. | 360580 | Ref. No. | 0300821 |
| description | timer CDC 7805F engines 1 chambers 5 operation time 120s 230V shaft ømm shaft Lmm manuf. no. 7805F1 motor type M37RN voltage AC | | |
| For models: | 050F, 050F-Dep | | |



1

| | | | |
|--------------------|---|-----------------|---------|
| GEV No. | 360581 | Ref. No. | 0300805 |
| description | timer CDC 7805F engines 1 chambers 5 operation time 150s 208V shaft ømm shaft Lmm manuf. no. 7805F1 motor type M37RS voltage AC | | |
| For models: | S200, S280, S280Dep, Super-QS, Super-QS-Dep | | |





1

| | | | |
|--------------------|--|-----------------|---------|
| GEV No. | 360500 | Ref. No. | 0300801 |
| description | timer CDC 7806M engines 1 chambers 6 operation time 150s 230V manuf. no. 7806M1 motor type M37RN 5 chambers adjustable, 1 chamber fixed voltage AC | | |



1

| | | | |
|---|--|-----------------|-------------------------|
| GEV No. | 360402 | Ref. No. | 0300100 |
| description | timer CDC 9003F engines 1 chambers 3 operation time 6min 230V shaft ø 6x4.6mm shaft L 22mm manuf. no. 9003F3 / 0300100 motor type M48R ATS | | |
| spare parts for | 360402 | | |
|  | GEV No. | 360118 | Ref. No. 0300850 |
| | motor CDC pinion ø 4.9mm teeth 10 230V voltage AC 50/60Hz turn direction right motor ø 47mm H 19.3mm motor type M48R ATS for timer cable length 260mm 1.9/2.5W | | |
| accessories for | 360402 | | |
|  | GEV No. | 110197 | Ref. No. — |
| | knob switch zero mark ø 42mm shaft ø 6x4.6mm shaft flat adjustable black | | |

digital timers



1

| | | | |
|--------------------|------------------|-----------------|---------|
| GEV No. | 400946 | Ref. No. | 0300810 |
| description | timer electronic | | |

spare parts and accessories

motors

CDC



1

| | | | |
|--------------------|--|-----------------|---------|
| GEV No. | 360118 | Ref. No. | 0300850 |
| description | motor CDC pinion ø 4.9mm teeth 10 230V voltage AC 50/60Hz turn direction right motor ø 47mm H 19.3mm motor type M48R ATS for timer cable length 260mm 1.9/2.5W | | |

contactors

GENERAL ELECTRIC (AEG)

power contactors



1



| | | | |
|--------------------|--|-----------------|---------|
| GEV No. | 380237 | Ref. No. | 0300392 |
| description | power contactor resistive load 16A 230VAC (AC3/400V) 6A/3kW main contacts 3NO auxiliary contacts 1NC connection male faston 6.3mm type AEG LS0701F | | |
| For models: | 015-24L, L21, LP6L, P550 | | |





1

| | | | |
|--------------------|--|-----------------|---------|
| GEV No. | 380236 | Ref. No. | 0300059 |
| description | power contactor resistive load 16A 230VAC (AC3/400V) 6A/3kW main contacts 3NO auxiliary contacts 1NO connection male faston 6.3mm type AEG LS0710F | | |
| For models: | DSP4, DSP5 | | |



| | | | |
|---|--|-----------------|---------|
|   | | | |
| 1 | | | |
| GEV No. | 380238 | Ref. No. | 0300058 |
| description | power contactor resistive load 20A 230VAC (AC3/400V) 8.4A/4kW main contacts 3NO auxiliary contacts 1NO connection screw connection type LS0510A type AEG LS0510A type GE MC1A 310A | | |

| | | | |
|---|--|-----------------|---------|
|   | | | |
| 1 | | | |
| GEV No. | 380244 | Ref. No. | 0300390 |
| description | power contactor resistive load 25A 230VAC (AC3/400V) 9A/4kW main contacts 3NO auxiliary contacts 1NO connection screw connection type AEG LS4K 10A type GE CL00A 310 | | |
| For models: | P550 | | |

TELEMECANIQUE (Schneider Electric)

power contactors

| | | | |
|---|--|-----------------|---------|
|  | | | |
| 1 | | | |
| GEV No. | 380479 | Ref. No. | 0300050 |
| description | power contactor resistive load 25A 230VAC (AC3/400V) 9A/4kW main contacts 3NO auxiliary contacts 1NO/1NC connection screw connection type LC1D09P7 | | |
| For models: | 015-24L, LP6L, P550 | | |

relays



power relays

with flange mounting

| | | | |
|--|--|-----------------|--------------------|
|  | | | |
| 1 | | | |
| GEV No. | 380310 | Ref. No. | 0300063 0301745 |
| description | power relays FINDER 230VAC 16A 2CO connection male faston 6.3mm screw mounting at 250VA manuf. no. 62.82.8.230.0000+062.10 | | |
| For models: | F85-Dep | | |

with bracket mounting

| | | | |
|---|---|-----------------|---------|
|  | | | |
| 1 | | | |
| GEV No. | 380815 | Ref. No. | 0301794 |
| description | power relays 230VAC 16A 2NO connection male faston 6.3mm flange dimensions 36x38x68mm | | |

| | | | |
|---|---|-----------------|---------|
|   | | | |
| 1 | | | |
| GEV No. | 380139 | Ref. No. | 0301747 |
| description | power relays FINDER 230VAC 16A 2CO connection F6.3 bracket mounting dimensions 68x38.2x35.8mm manuf. no. 62.82.8.230.0000 | | |

| | | | |
|--|--|-----------------|---------|
|  | | | |
| 1 | | | |
| GEV No. | 380808 | Ref. No. | 0301746 |
| description | power relays FINDER 230VAC 16A 3CO connection male faston 6.3mm bracket mounting manuf. no. 62.83.8.230.0000 | | |
| For models: | 050F, 050F-Dep, F85, F85-Dep, S280Dep, Super-QS-Dep | | |



1

| | | | |
|--------------------|---|-----------------|---------|
| GEV No. | 380702 | Ref. No. | 0301795 |
| description | power relays FINDER 230VAC 16A 3NO connection male faston 6.3mm flange dimensions 36x38x68mm manif. no. 62.83.8.230.0300 230V | | |

relay sockets



1

| | | | |
|--------------------|--|-----------------|---------|
| GEV No. | 380885 | Ref. No. | 0300121 |
| description | relay socket 11-pole dimensions 47x47x20mm | | |

time relays

time relays



1

| | | | |
|------------------------|---|-----------------|---------|
| GEV No. | 401894 | Ref. No. | 0300823 |
| description | time relay 9.2.21.04G 230V 11-pole model NDWT 30/11 | | |
| accessories for | 401894 | | |



| | | | |
|--------------------|--|-----------------|---------|
| GEV No. | 380885 | Ref. No. | 0300121 |
| description | relay socket 11-pole dimensions 47x47x20mm | | |

electronic controllers

EVCO - EVERY CONTROL

electronic thermometers

built-in version



1

| | | | |
|--------------------|---|-----------------|---------|
| GEV No. | 378346 | Ref. No. | 0500400 |
| description | thermometer EVCO type EVK100P3 mounting measurements 71x29mm 12/24V voltage AC/DC -50 up to +150°C measuring input PTC display 3½ digits front measurements 75x33mm protection IP64 accuracy 1% | | |

probes

accessories

probe extension cables



1

| | | | |
|--------------------|----------------|-----------------|---------|
| GEV No. | 378309 | Ref. No. | 0305101 |
| description | probe L 2500mm | | |

electronics

PCBs



1

| | | | |
|--------------------|-------------|-----------------|---------|
| GEV No. | 402338 | Ref. No. | 0306011 |
| description | display PCB | | |



1

| | | | |
|--------------------|--|-----------------|---------|
| GEV No. | 403266 | Ref. No. | 0500406 |
| description | thermometer dishwasher Linear 30/40/60 LS 350/500 L 10mm W 9mm temperature 24V | | |



keypads

front foils

| | | | |
|---|------------|-----------------|---------|
|  | | | |
| 1 | | | |
| GEV No. | 506441 | Ref. No. | 0400041 |
| description | front foil | | |

| | | | |
|---|---------------------------------|-----------------|---------|
|  | | | |
| 1 | | | |
| GEV No. | 506152 | Ref. No. | 0500230 |
| description | keypad foil dishwasher S200/240 | | |
| For models: | S200 | | |

membrane keypads





| | | | |
|---|---|-----------------|--------------------|
|  | | | |
| 1 | | | |
| GEV No. | 403279 | Ref. No. | 0502003 0502008 |
| description | membrane keypad warewashing 045F buttons 3 Qty 1 pcs L 317mm W 40mm | | |















control panel

| | | | |
|--|---------------|-----------------|---------|
|  | | | |
| 1 | | | |
| GEV No. | 506440 | Ref. No. | 0400192 |
| description | control panel | | |

solenoïd valves















solenoïd valves (water)





| | | | |
|---|--|-----------------|-----------------|
| TP | | | |
|  | | | |
| 1 | | | |
| GEV No. | 370021 | Ref. No. | 0300056 |
| description | solenoid valve double straight 230VAC inlet 3/4" outlet 11.5mm DN10 TP flow regulating valve inlet white | | |
| spare parts for | 370021 | | |
|  | GEV No. | 371013 | Ref. No. |
| | | | — |
| | solenoid coil TP 230VAC 50/60Hz | | |
| accessories for | 370021 | | |
|  | GEV No. | 371220 | Ref. No. |
| | | | — |
| | reducer TP flow rate 3l/min red tolerance ±15% | | |
|  | GEV No. | 371221 | Ref. No. |
| | | | — |
| | reducer TP flow rate 5.5l/min yellow tolerance ±15% | | |
|  | GEV No. | 371222 | Ref. No. |
| | | | — |
| | reducer TP flow rate 6l/min grey tolerance ±15% | | |

| | | | |
|---|--|--------|-----------------|
| accessories for | 370021 | | |
|  | GEV No. | 371223 | Ref. No. |
| | | | — |
| | reducer TP flow rate 10l/min white tolerance ±15% | | |
|  | GEV No. | 371224 | Ref. No. |
| | | | — |
| | reducer TP flow rate 12l/min bronze tolerance ±15% | | |
|  | GEV No. | 371225 | Ref. No. |
| | | | — |
| | reducer TP flow rate 16l/min light brown tolerance ±15% | | |
|  | GEV No. | 371226 | Ref. No. |
| | | | — |
| | reducer TP flow rate 20l/min red tolerance ±15% | | |
|  | GEV No. | 371230 | Ref. No. |
| | | | — |
| | reducer TP flow rate 0.25l/min red tolerance ±25% | | |
|  | GEV No. | 371231 | Ref. No. |
| | | | — |
| | reducer TP flow rate 0.35l/min violet tolerance ±25% | | |
|  | GEV No. | 371232 | Ref. No. |
| | | | — |
| | reducer TP flow rate 0.5l/min orange tolerance ±25% | | |
|  | GEV No. | 371233 | Ref. No. |
| | | | — |
| | reducer TP flow rate 0.8l/min white tolerance ±25% | | |
|  | GEV No. | 371234 | Ref. No. |
| | | | — |
| | reducer TP flow rate 1l/min light blue tolerance ±25% | | |
|  | GEV No. | 371235 | Ref. No. |
| | | | — |
| | reducer TP flow rate 1.2l/min brown tolerance ±25% | | |
|  | GEV No. | 371236 | Ref. No. |
| | | | — |
| | reducer TP flow rate 1.5l/min light brown tolerance ±25% | | |
|  | GEV No. | 371237 | Ref. No. |
| | | | — |
| | reducer TP flow rate 2.5l/min yellow tolerance ±25% | | |
|  | GEV No. | 371238 | Ref. No. |
| | | | — |
| | reducer TP flow rate 3.4l/min dark green tolerance ±25% | | |
|  | GEV No. | 371239 | Ref. No. |
| | | | — |
| | reducer TP flow rate 5l/min black tolerance ±25% | | |
|  | GEV No. | 371240 | Ref. No. |
| | | | — |
| | reducer TP flow rate 8l/min blue tolerance ±20% | | |

1 electric components



| | | | |
|---|--|-----------------|-------------------|
| GEV No. | 370017 | Ref. No. | 0300025 |
| description | solenoid valve single straight 230VAC inlet 3/4" outlet 11.5mm DN10 TP p max 10bar | | |
| For models: | 015-24L, 050F, 050F-Dep, DSP1, DSP2, DSP4, DSP5, F85, F85-Dep, L20, L21, LP6L, P550, S200, S280, S280Dep, Super-QS, Super-QS-Dep | | |
| spare parts for | 370017 | | |
|  | GEV No. | 371013 | Ref. No. — |
| | solenoid coil TP 230VAC 50/60Hz | | |
| accessories for | 370017 | | |
|  | GEV No. | 371220 | Ref. No. — |
| | reducer TP flow rate 3l/min red tolerance ±15% | | |
|  | GEV No. | 371221 | Ref. No. — |
| | reducer TP flow rate 5.5l/min yellow tolerance ±15% | | |
|  | GEV No. | 371222 | Ref. No. — |
| | reducer TP flow rate 6l/min grey tolerance ±15% | | |
|  | GEV No. | 371223 | Ref. No. — |
| | reducer TP flow rate 10l/min white tolerance ±15% | | |
|  | GEV No. | 371224 | Ref. No. — |
| | reducer TP flow rate 12l/min bronze tolerance ±15% | | |
|  | GEV No. | 371225 | Ref. No. — |
| | reducer TP flow rate 16l/min light brown tolerance ±15% | | |
|  | GEV No. | 371226 | Ref. No. — |
| | reducer TP flow rate 20l/min red tolerance ±15% | | |
|  | GEV No. | 371230 | Ref. No. — |
| | reducer TP flow rate 0.25l/min red tolerance ±25% | | |
|  | GEV No. | 371231 | Ref. No. — |
| | reducer TP flow rate 0.35l/min violet tolerance ±25% | | |
|  | GEV No. | 371232 | Ref. No. — |
| | reducer TP flow rate 0.5l/min orange tolerance ±25% | | |
|  | GEV No. | 371233 | Ref. No. — |
| | reducer TP flow rate 0.8l/min white tolerance ±25% | | |
|  | GEV No. | 371234 | Ref. No. — |
| | reducer TP flow rate 1l/min light blue tolerance ±25% | | |
|  | GEV No. | 371235 | Ref. No. — |
| | reducer TP flow rate 1.2l/min brown tolerance ±25% | | |
|  | GEV No. | 371236 | Ref. No. — |
| | reducer TP flow rate 1.5l/min light brown tolerance ±25% | | |

| | | | |
|---|---|--------|-------------------|
| accessories for | 370017 | | |
|  | GEV No. | 371237 | Ref. No. — |
| | reducer TP flow rate 2.5l/min yellow tolerance ±25% | | |
|  | GEV No. | 371238 | Ref. No. — |
| | reducer TP flow rate 3.4l/min dark green tolerance ±25% | | |
|  | GEV No. | 371239 | Ref. No. — |
| | reducer TP flow rate 5l/min black tolerance ±25% | | |
|  | GEV No. | 371240 | Ref. No. — |
| | reducer TP flow rate 8l/min blue tolerance ±20% | | |

solenoid valves with reducers



| | | | |
|--------------------|--|-----------------|---------|
| GEV No. | 370242 | Ref. No. | 0300096 |
| description | solenoid valve triple straight 230VAC inlet 3/4" outlet 11.5mm plastic | | |

various



| | | | |
|--------------------|---|-----------------|---------|
| GEV No. | 370241 | Ref. No. | 0301149 |
| description | solenoid valve 2-fold, with reducer straight 230VAC suitable for Lamber | | |
| For models: | 050F, 050F-Dep, F85, F85-Dep, S280, S280Dep, Super-QS, Super-QS-Dep | | |



| | | | |
|---|---|-----------------|-------------------|
| GEV No. | 370636 | Ref. No. | 0301161 |
| description | solenoid valve single CO 230VAC outlet 10.5mm MILANO 00168401 plastic 3-ways inlet 10.5mm 50/60Hz male faston 6.3mm | | |
| accessories for | 370636 | | |
|  | GEV No. | 371142 | Ref. No. — |
| | reducer for solenoid valve ø 8.2mm | | |



metal

BÜRKERT

solenoid valves (various)



| | | | |
|--------------------|---|-----------------|---------|
| 1 | | | |
| GEV No. | 370741 | Ref. No. | 0301159 |
| description | solenoid valve 2-ways 230VAC inlet 1/2" IT outlet 1/2" IT L 135mm BÜRKERT membranes EPDM p max 16bar p min 0.2bar 50/60Hz brass | | |



| | | | |
|--------------------|---|-----------------|---------|
| 1 | | | |
| GEV No. | 370544 | Ref. No. | 0300173 |
| description | solenoid valve 2-ways 24VAC inlet 1/2" outlet 1/2" L 65mm DN 13mm BÜRKERT membranes NBR 24V brass | | |
| For models: | M115, M150, MATIC20 | | |

SIRAI

2-way

L180-B series

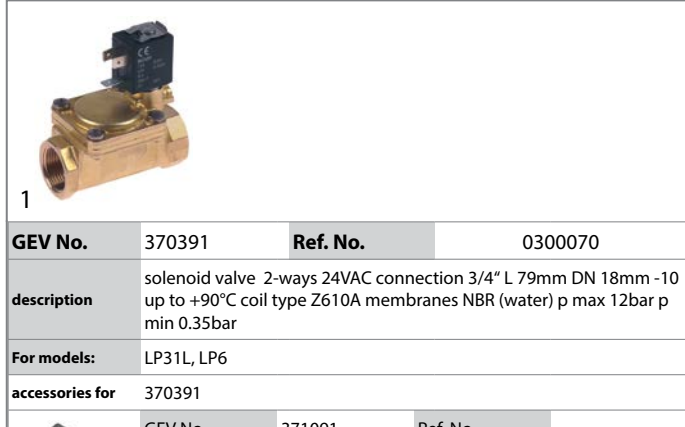

| | | | |
|------------------------|--|-----------------|---------|
| 1 | | | |
| GEV No. | 370391 | Ref. No. | 0300070 |
| description | solenoid valve 2-ways 24VAC connection 3/4" L 79mm DN 18mm -10 up to +90°C coil type Z610A membranes NBR (water) p max 12bar p min 0.35bar | | |
| For models: | LP31L, LP6 | | |
| accessories for | 370391 | | |



| | | | |
|--|--------|-----------------|---|
| GEV No. | 371091 | Ref. No. | — |
| power socket plug type DIN 43650B cable lengthmm small | | | |

drain valves



| | | | |
|--------------------|---|-----------------|---------|
| 1 | | | |
| GEV No. | 370543 | Ref. No. | 0300066 |
| description | drain solenoid valve angled 230V single inlet 46mm outlet 1 1/2" duty cycle 60% SIRAI Z923G plastic | | |



| | | | |
|--------------------|--|-----------------|---------|
| 1 | | | |
| GEV No. | 371109 | Ref. No. | 0301157 |
| description | drain valve 230V 50/60Hz single inlet 50mm outlet 50mm | | |

pressure switches

for warewashing

ø 58mm with male faston 6.3mm

with connection horizontal



| | | | |
|--------------------|---|-----------------|---------|
| 1 | | | |
| GEV No. | 541842 | Ref. No. | 0301503 |
| description | pressure control pressure range 100/40mbar connection 6mm ø 58mm pressure connection horizontal warewashing pressure connection ø 5.5mm | | |
| For models: | L20, L21 | | |

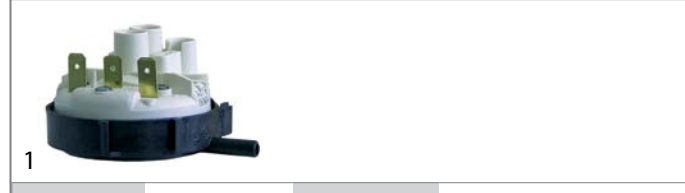

| | | | |
|--------------------|---|-----------------|---------|
| 1 | | | |
| GEV No. | 541011 | Ref. No. | 0301501 |
| description | pressure control pressure range 110/70mbar connection 6mm ø 58mm pressure connection horizontal warewashing | | |
| For models: | 015-24L, LP31L, LP6, LP6L, M115, M150, MATIC20, P550 | | |



1

| | | | |
|--------------------|---|-----------------|--------------------|
| GEV No. | 541165 | Ref. No. | 0300026 0301502 |
| description | pressure control pressure range 60/30mbar connection 6mm ø 58mm pressure connection horizontal warewashing pressure connection ø 6mm | | |
| For models: | 015-24L, 050F, 050F-Dep, DSP1, DSP2, DSP4, DSP5, F85, F85-Dep, LP31L, LP6, LP6L, M115, M150, MATIC20, P550, S200, S280, S280Dep, Super-QS, Super-QS-Dep | | |

EBARA

pumps



1

| | | | |
|--------------------|---|-----------------|--------------------|
| GEV No. | 499007 | Ref. No. | 0301249 0301254 |
| description | pump inlet ø 63mm outlet ø 63mm type DWO150 230/400V 50Hz 3 phase 1.1kW 1.5HP L 360mm EBARA | | |
| For models: | M115, M150 | | |

pumps

wash and rinse pumps

ALBA (C&A)

pumps



1

| | | | |
|---|--|-----------------|---|
| GEV No. | 500417 | Ref. No. | 0300252 |
| description | pump inlet ø 28mm outlet ø 28mm type C904 230V 50Hz 1 phase 0.15kW 0.2HP L 200mm rotation direction right capacitor 6.3µF ALBA PUMPS (C&A) | | |
| For models: | DSP1, DSP2, S200, S280, S280Dep, Super-QS, Super-QS-Dep | | |
| spare parts for | 500417 | | |
|  | GEV No. | 365012 | Ref. No. 0300110 |
| | operating capacitor capacity 6.3µF 450V tolerance 5% 50Hz ambient temperature max. -25 to +85°C ø 30mm L 61mm M8 plastic connection male faston 6.3mm protection | | |
|  | GEV No. | 510693 | Ref. No. 0200242 0200340 0209707 |
| | mechanical shaft seal for shaft ø 12mm slide ring ext. ø 24mm slide ring H 15.5mm slide ring int. ø 11mm counter ring mounting ø 24mm height counter ring 8mm counter ring int. ø 13.5mm | | |
|  | GEV No. | 532490 | Ref. No. — |
| | O-ring EPDM thickness 2.62mm ID ø 72.69mm Qty 1 pcs | | |



1





| | | | |
|---|--|-----------------|-------------------------|
| GEV No. | 500357 | Ref. No. | 0301254 |
| description | pump inlet ø 63mm outlet ø 63mm type DWO150 230/400V 50Hz 3 phase 1.1kW 1.5HP L 360mm rotation direction left EBARA inlet ø 63mm outlet ø 63mm | | |
| For models: | 015-24L, P550 | | |
| spare parts for | 500357 | | |
|  | GEV No. | 503147 | Ref. No. 0209906 |
| | pump cover gasket thickness 3.53mm ID ø 148.8mm Qty 1 pcs | | |
|  | GEV No. | 503148 | Ref. No. 0209709 |
| | mechanical shaft seal for shaft ø 18mm height counter ring 12.5mm ID ø 18.5mm ED ø 32mm H 31mm mounting ø 33mm int. ø 19mm | | |
|  | GEV No. | 521270 | Ref. No. 0209820 |
| | impellor ø 88mm H 24mm with flute shaft intake ø 13mm rotation direction left blades 6 stainless steel | | |

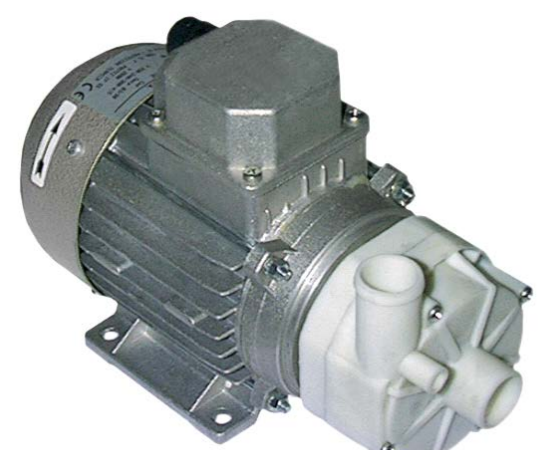

FIR
pumps



1

| | | | |
|---|--|-----------------|-------------------|
| GEV No. | 500030 | Ref. No. | 0300205 |
| description | pump inlet ø 28mm outlet ø 26mm type 4226.2540 230/400V 50Hz 3 phase 0.35kW 0.5HP L 260mm rotation direction right FIR | | |
| spare parts for | 500030 | | |
|  | GEV No. | 510510 | Ref. No. — |
| | pump cover pump type 2212/2228/2229/2211 | | |
|  | GEV No. | 510690 | Ref. No. — |
| | mechanical shaft seal for shaft ø 8mm ED ø 24mm mounting ø 24/26mm | | |
|  | GEV No. | 521202 | Ref. No. — |
| | impellor ø 72mm H 17mm thread M5L | | |
|  | GEV No. | 521703 | Ref. No. — |
| | pump cover gasket EPDM thickness 2.5mm ID ø 75mm Qty 1 pcs | | |



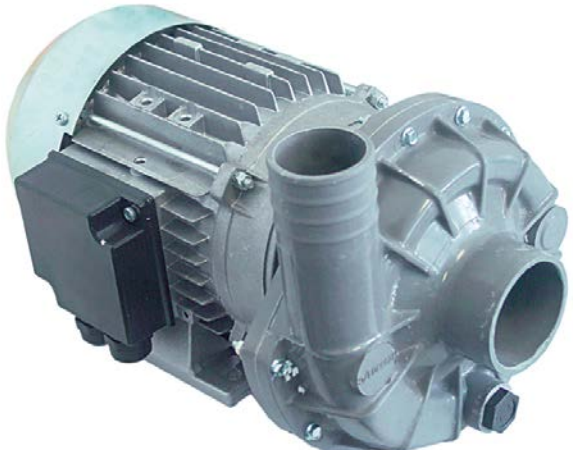

1

| | | | |
|--------------------|---|-----------------|---------|
| GEV No. | 500375 | Ref. No. | 0300245 |
| description | pump inlet ø 45mm outlet ø 40mm type 3983.1411 230V 50Hz 1 phase 0.37kW 0.5HP L 200mm rotation direction right capacitor 12.5µF FIR | | |



1

| | | | |
|---|--|-----------------|-------------------------------|
| GEV No. | 500323 | Ref. No. | 0300310 |
| description | pump inlet ø 63mm outlet ø 47mm type 1227.2721 230/400V 50Hz 3 phase 2kW 2.7HP L 335mm rotation direction right FIR | | |
| spare parts for | 500323 | | |
|  | GEV No. | 510599 | Ref. No. — |
| | impellor ø 123mm H 34mm M8L | | |
|  | GEV No. | 510693 | Ref. No. |
| | | | 0200242 0200340 0209707 |
| | mechanical shaft seal for shaft ø 12mm slide ring ext. ø 24mm slide ring H 15.5mm slide ring int. ø 11mm counter ring mounting ø 24mm height counter ring 8mm counter ring int. ø 13.5mm | | |
|  | GEV No. | 521513 | Ref. No. — |
| | pump cover FIR inlet ø 63mm outlet ø 47mm turn direction right ID ø 150mm inner high 32mm | | |
|  | GEV No. | 524416 | Ref. No. |
| | | | 0200290 |
| | pump cover gasket thickness 4x4mm Qty 1 pcs | | |

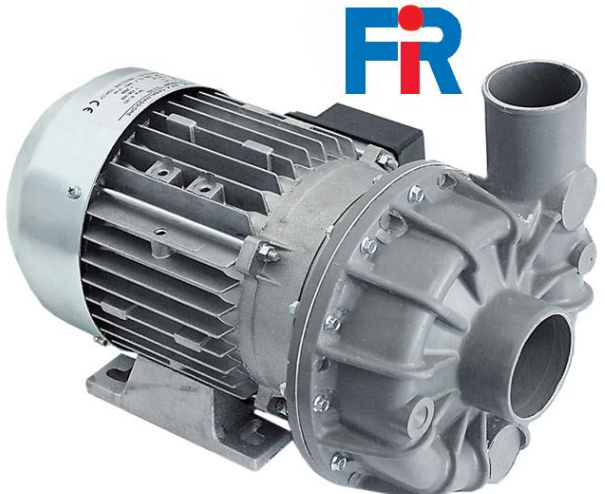

1





| | | | |
|---|---|-----------------|-----------------|
| GEV No. | 500111 | Ref. No. | 0300021 |
| description | pump inlet ø 63mm outlet ø 53mm type 1241.2500 230/400V 50Hz 3 phase 1.1kW 1.5HP L 330mm rotation direction left FIR | | |
| spare parts for | 500111 | | |
|  | GEV No. | 510531 | Ref. No. |
| | | | 0200593 |
| | pump cover FIR inlet ø 63mm outlet ø 53mm auxiliary pressure connection M16x1.5mm supporting pressure open turn direction left ø 185mm ID ø 150mm inner high 37mm | | |

Table continues overleaf

| | | | | |
|--|---------|--------|----------|-------------------------------|
| spare parts for 500111 | | | | |
|  | GEV No. | 510612 | Ref. No. | — |
| impellor ø 110mm H 34mm M8R | | | | |
|  | GEV No. | 510693 | Ref. No. | 0200242 0200340 0209707 |
| mechanical shaft seal for shaft ø 12mm slide ring ext. ø 24mm slide ring H 15.5mm slide ring int. ø 11mm counter ring mounting ø 24mm height counter ring 8mm counter ring int. ø 13.5mm | | | | |
|  | GEV No. | 524416 | Ref. No. | 0200290 |
| pump cover gasket thickness 4x4mm Qty 1 pcs | | | | |





1



| | | | |
|--------------------|---|-----------------|---------|
| GEV No. | 499293 | Ref. No. | 0301243 |
| description | pump inlet ø 63mm outlet ø 53mm type 2241.2703 230/400V 50Hz 3 phase 0.89kW 1.2HP L 300mm rotation direction left FIR | | |

LGB



1

| | | | |
|--|--|-----------------|------------------|
| GEV No. | 500353 | Ref. No. | 0300372 |
| description | pump inlet ø 28mm outlet ø 26mm type ZF115SX 230V 50Hz 1 phase 0.2kW 0.27HP L 190mm rotation direction right capacitor 5µF LGB | | |
| spare parts for 500353 | | | |
|  | GEV No. | 365017 | Ref. No. 0300105 |
| operating capacitor capacity 5µF 450V tolerance 5% 50/60Hz ambient temperature max. -25 to +85°C ø 28mm L 54mm M8 plastic connection male faston 6.3mm 16.10.08 protection | | | |
|  | GEV No. | 510122 | Ref. No. 0200595 |
| pump cover LGB inlet ø 28mm outlet ø 26mm auxiliary pressure connection 13mm supporting pressure open ø 98mm ID ø 77mm inner height 31mm | | | |
|  | GEV No. | 510703 | Ref. No. 0200397 |
| mechanical shaft seal for shaft ø 13mm slide ring H 13mm height counter ring 5.5mm ED ø 26mm | | | |

| | | | | |
|---|---------|--------|----------|---------|
| spare parts for 500353 | | | | |
|  | GEV No. | 521223 | Ref. No. | 0209804 |
| impellor ø 61mm H 17mm thread M7L shaft ø 13mm shaft length 12mm | | | | |
|  | GEV No. | 528800 | Ref. No. | 0209905 |
| O-ring EPDM thickness 2.62mm ID ø 75.87mm Qty 1 pcs | | | | |



1

| | | | |
|--|--|-----------------|------------------|
| GEV No. | 500352 | Ref. No. | 0300373 |
| description | pump inlet ø 28mm outlet ø 26mm type ZF130SX 230V 50Hz 1 phase 0.2kW 0.27HP L 195mm rotation direction right capacitor 6.3µF LGB | | |
| spare parts for 500352 | | | |
|  | GEV No. | 365012 | Ref. No. 0300110 |
| operating capacitor capacity 6.3µF 450V tolerance 5% 50Hz ambient temperature max. -25 to +85°C ø 30mm L 61mm M8 plastic connection male faston 6.3mm protection | | | |
|  | GEV No. | 510122 | Ref. No. 0200595 |
| pump cover LGB inlet ø 28mm outlet ø 26mm auxiliary pressure connection 13mm supporting pressure open ø 98mm ID ø 77mm inner height 31mm | | | |
|  | GEV No. | 510703 | Ref. No. 0200397 |
| mechanical shaft seal for shaft ø 13mm slide ring H 13mm height counter ring 5.5mm ED ø 26mm | | | |
|  | GEV No. | 521085 | Ref. No. — |
| impellor ø 72mm H 17mm thread M7L shaft ø 13mm shaft length 12mm blades 3 | | | |
|  | GEV No. | 528800 | Ref. No. 0209905 |
| O-ring EPDM thickness 2.62mm ID ø 75.87mm Qty 1 pcs | | | |



1

| | | | |
|---|--|-----------------|-------------------------|
| GEV No. | 500355 | Ref. No. | 0301203 0301204 |
| description | pump inlet ø 45mm outlet ø 40mm type ZF320SX 230V 50Hz 1 phase 0.7kW 0.95HP L 200mm rotation direction right capacitor 12.5µF LGB | | |
| For models: | 050F, 050F-Dep, DSP4, DSP5, F85, F85-Dep, L20, L21 | | |
| spare parts for | 500355 | | |
|  | GEV No. | 365014 | Ref. No. 0300081 |
| | operating capacitor capacity 12.5µF 450V tolerance 5%Hz ambient temperature max. -25 to +85°C ø 35mm L 70mm M8 plastic connection male faston 6.3mm 45S.C3DS.12.5 protection | | |
|  | GEV No. | 510702 | Ref. No. — |
| | mechanical shaft seal height counter ring 5.5mm ID ø 12mm | | |
|  | GEV No. | 512404 | Ref. No. — |
| | bracket mounting distance 130mm | | |
|  | GEV No. | 521246 | Ref. No. — |
| | impellor ø 103mm H 26mm thread M8L shaft ø 20mm shaft length 7mm seat ø 8.2mm blades 6 | | |
|  | GEV No. | 521542 | Ref. No. — |
| | pump cover LGB inlet ø 45mm outlet ø 40mm auxiliary pressure connection 13mm supporting pressure open ø 150mm ID ø 120mm inner height 25mm | | |
|  | GEV No. | 521714 | Ref. No. — |
| | pump cover gasket thickness 4x4mm Qty 1 pcs | | |

booster pumps I



1

| | | | |
|---|--|-----------------|-------------------------|
| GEV No. | 500060 | Ref. No. | 0300361 |
| description | pump inlet ø 1" outlet ø 1" type PQM60 230V 50Hz 1 phase 0.37kW PEDRELLO | | |
| For models: | 015-24L, L20, L21, LP6L, P550 | | |
| accessories for | 500060 | | |
|  | GEV No. | 365015 | Ref. No. 0300106 |
| | operating capacitor capacity 10µF 400V tolerance 5%Hz ambient temperature max. -25 to +85°C ø 35.5mm L 59mm M8 plastic connection male faston 6.3mm protection | | |



1



| | | | |
|--------------------|--|-----------------|---------|
| GEV No. | 499292 | Ref. No. | 0100631 |
| description | pump inlet ø 1¼" IT outlet ø 1" IT type CDX/A 120/07 230-240V 50Hz 3 phase 0.55kW 0.75HP L 320mm rotation direction left EBARA | | |
| For models: | LP6 | | |

drain pumps

PLASET



1

| | | | |
|---|--|-----------------|-------------------------|
| GEV No. | 500354 | Ref. No. | 0300068 |
| description | drain pump inlet ø 30mm outlet ø 22mm 230V 30W 50Hz PLASET type 64079 | | |
| For models: | 015-24L, 050F, 050F-Dep, DSP5, F85, F85-Dep, L20, L21, S200, S280, S280Dep, Super-QS, Super-QS-Dep | | |
| accessories for | 500354 | | |
|  | GEV No. | 506074 | Ref. No. 0200521 |
| | drain hose ID ø 32mm ED ø 41mm L 1m wire reinforced | | |
|  | GEV No. | 506207 | Ref. No. 0900006 |
| | drain hose DN19 L 1500mm straight ø inside 19mm straight ext. ø 24mm elbow ø inside 21mm elbow ext. ø 27mm outer hose ø 25mm | | |

booster pumps II

accessories



1

| | | | |
|--------------------|--|-----------------|---------|
| GEV No. | 365015 | Ref. No. | 0300106 |
| description | operating capacitor capacity 10µF 400V tolerance 5%Hz ambient temperature max. -25 to +85°C ø 35.5mm L 59mm M8 plastic connection male faston 6.3mm protection | | |
| For models: | F85 | | |



1

| | | | |
|--------------------|--|-----------------|---------|
| GEV No. | 365017 | Ref. No. | 0300105 |
| description | operating capacitor capacity 5µF 450V tolerance 5% 50/60Hz ambient temperature max. -25 to +85°C ø 28mm L 54mm M8 plastic connection male faston 6.3mm 16.10.08 protection | | |
| For models: | S200, S280, S280Dep, Super-QS, Super-QS-Dep | | |



1

| | | | |
|--------------------|--|-----------------|---------|
| GEV No. | 365012 | Ref. No. | 0300110 |
| description | operating capacitor capacity 6.3µF 450V tolerance 5% 50Hz ambient temperature max. -25 to +85°C ø 30mm L 61mm M8 plastic connection male faston 6.3mm protection | | |



1

| | | | |
|--------------------|--|-----------------|---------|
| GEV No. | 365017 | Ref. No. | 0300105 |
| description | operating capacitor capacity 5µF 450V tolerance 5% 50/60Hz ambient temperature max. -25 to +85°C ø 28mm L 54mm M8 plastic connection male faston 6.3mm 16.10.08 protection | | |
| For models: | S200, S280, S280Dep, Super-QS, Super-QS-Dep | | |



1

| | | | |
|--------------------|--|-----------------|---------|
| GEV No. | 365012 | Ref. No. | 0300110 |
| description | operating capacitor capacity 6.3µF 450V tolerance 5% 50Hz ambient temperature max. -25 to +85°C ø 30mm L 61mm M8 plastic connection male faston 6.3mm protection | | |

condensators & interference suppression filters

operating capacitors

plastic



1

| | | | |
|--------------------|--|-----------------|---------|
| GEV No. | 365015 | Ref. No. | 0300106 |
| description | operating capacitor capacity 10µF 400V tolerance 5%Hz ambient temperature max. -25 to +85°C ø 35.5mm L 59mm M8 plastic connection male faston 6.3mm protection | | |
| For models: | F85 | | |



1

| | | | |
|--------------------|--|-----------------|---------|
| GEV No. | 365014 | Ref. No. | 0300081 |
| description | operating capacitor capacity 12.5µF 450V tolerance 5%Hz ambient temperature max. -25 to +85°C ø 35mm L 70mm M8 plastic connection male faston 6.3mm 45S.C3DS.12.5 protection | | |
| For models: | 050F, 050F-Dep, DSP4, DSP5, F85, F85-Dep, L20, L21 | | |

filters

interference suppression filters



1

| | | | |
|--------------------|--|-----------------|---------|
| GEV No. | 365046 | Ref. No. | 0300900 |
| description | interference suppression filter type 10S7E-G1474253105-Q 115/250V 50/60Hz conductor 2 with E connection male faston 6.3mm L 40mm ø 40mm Hmm Wmm M8 plastic Qty 1 pcs | | |
| For models: | 015-24L, 050F, 050F-Dep, DSP1, DSP2, DSP4, DSP5, F85, F85-Dep, L20, L21, LP31L, LP6, LP6L, M115, M150, MATIC20, P550, S200, S280, S280Dep, Super-QS, Super-QS-Dep | | |

fuses

line circuit breakers

miscellaneous

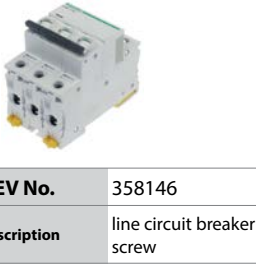

1

| | | | |
|--------------------|---|-----------------|---------|
| GEV No. | 358146 | Ref. No. | 0301723 |
| description | line circuit breaker 3-pole 16A tripping type C rated 400V connection screw | | |
| For models: | M150, MATIC20 | | |



| | | | |
|---|---|-----------------|---------|
|  | | | |
| 1 | | | |
| GEV No. | 358145 | Ref. No. | 0301729 |
| description | line circuit breaker 3-pole 32A tripping type C rated 400V connection screw | | |
| For models: | M115 | | |

| | | | |
|---|--------------------------------------|-----------------|---------|
|  | | | |
| 1 | | | |
| GEV No. | 358144 | Ref. No. | 0301730 |
| description | shunt release rated 12-24V Qty 1 pcs | | |
| For models: | M115, M150, MATIC20 | | |

electric accessories

terminals

connection boxes

| | | | |
|--|---|-----------------|---------|
|  | | | |
| 1 | | | |
| GEV No. | 550670 | Ref. No. | 0300750 |
| description | power terminal block 3-pole contacts P+N+E | | |
| For models: | DSP1, DSP2, S200, S280, S280Dep, Super-QS, Super-QS-Dep | | |

| | | | |
|---|--|-----------------|---------|
|  | | | |
| 1 | | | |
| GEV No. | 550671 | Ref. No. | 0300751 |
| description | power terminal block 6-pole contacts 3P+N+E | | |
| For models: | 050F, 050F-Dep, DSP4, DSP5, F85, F85-Dep, L20, L21 | | |

rail-mounted terminals

SIEMENS



feed-through terminals

| | | | |
|---|--|-----------------|---------|
|  | | | |
| 1 | | | |
| GEV No. | 551238 | Ref. No. | 0300405 |
| description | rail-mounted terminal 16mm ² beige 1-pole | | |
| For models: | LP31L, LP6, M115 | | |

auxiliary gas parts

screw connections

olives

| | | | | |
|---|--|-----------------|-----------------|---|
|  | | | | |
| 1 | | | | |
| GEV No. | 101273 | Ref. No. | 0200182 | |
| description | olive for pipe ø 12mm L 9.5mm brass Qty 1 pcs suitable for universal | | | |
| For models: | 015-24L, DSP1, DSP2, DSP4, DSP5, L20, L21, LP31L, LP6, LP6L, S200, S280, S280Dep, Super-QS, Super-QS-Dep | | | |
| accessories for | 101273 | | | |
|  | GEV No. | 100944 | Ref. No. | — |
| | union nut thread M18x1.5 for pipe ø 12mm | | | |
|  | GEV No. | 101276 | Ref. No. | — |
| | union screw thread 3/8" tube ø 12mm Qty 1 pcs | | | |

equipment-specific units

for dough mixers

chains

connectors

| | | | |
|---|---|-----------------|---------|
|  | | | |
| 1 | | | |
| GEV No. | 693276 | Ref. No. | 0813444 |
| description | connector single DIN/ISO 08 B-1 splitting 1/2" links 1 L 23mm internal width 11.8mm rollerø 4.3mm metal | | |
| For models: | M115, M150, MATIC20 | | |

for espresso machines

brewing units

filter holder gaskets

O-rings



1

| | | | |
|--------------------|---|-----------------|---------|
| GEV No. | 510409 | Ref. No. | 0200041 |
| description | O-ring EPDM thickness 5.34mm ID ø 56.52mm Qty 1 pcs | | |
| For models: | 015-24L, 050F, 050F-Dep, DSP1, DSP2, DSP4, DSP5, F85, F85-Dep, L20, L21, LP31L, LP6, LP6L, M115, M150, MATIC20, P550, S200, S280, S280Dep, Super-QS, Super-QS-Dep | | |

steam/water taps

steam/water pipes

accessories

gaskets



1

| | | | |
|--------------------|--|-----------------|---------|
| GEV No. | 510893 | Ref. No. | 0203012 |
| description | O-ring EPDM thickness 2.62mm ID ø 9.92mm Qty 1 pcs | | |

for dishwashers

drain and intake components

LAMBER

drain /intake bodies



1

| | | | |
|--------------------|---|-----------------|---------|
| GEV No. | 517685 | Ref. No. | 0221333 |
| description | drain connection ø 40mm L 62mm thread 1½" | | |



1

| | | | |
|--------------------|---|-----------------|---------|
| GEV No. | 506035 | Ref. No. | 0200128 |
| description | drain fitting thread 1¼" ID ø 27mm | | |
| For models: | DSP1, DSP2, S200, S280, S280Dep, Super-QS, Super-QS-Dep | | |



1

| | | | |
|------------------------|---|-----------------|---------|
| GEV No. | 506026 | Ref. No. | 0200113 |
| description | drain fitting thread 2"/1¼" ID ø 42mm | | |
| For models: | 015-24L, 050F, 050F-Dep, DSP4, DSP5, F85, F85-Dep, L20, L21, P550 | | |
| accessories for | 506026 | | |
| | GEV No. | Ref. No. | 0200173 |
| | | | |
| | flat gasket rubber ED ø 75mm ID ø 58.5mm thickness 2mm Qty 1 pcs | | |



1

| | | | |
|--------------------|--|-----------------|---------|
| GEV No. | 506017 | Ref. No. | 0200078 |
| description | drain fitting with gasket thread 1¼" ID ø 24mm hose ø 32mm | | |
| For models: | 015-24L, 050F, 050F-Dep, F85, F85-Dep, L20, L21, P550, S200, S280, S280Dep, Super-QS, Super-QS-Dep | | |

| | | | |
|------------------------|--|-----------------|---|
| spare parts for | 506017 | | |
| | GEV No. | Ref. No. | — |
| | | | |
| | flat gasket rubber ED ø 31mm ID ø 22mm thickness 2mm Qty 1 pcs | | |



1

| | | | |
|--------------------|-------------------|-----------------|---------|
| GEV No. | 506028 | Ref. No. | 0200115 |
| description | flange ED ø 140mm | | |



1

| | | | |
|--------------------|--|-----------------|---------|
| GEV No. | 506072 | Ref. No. | 0200403 |
| description | flat gasket fibre ED ø 38mm ID ø 27mm thickness 2mm outflow for thread 1¼" Qty 1 pcs | | |
| For models: | 015-24L, 050F, 050F-Dep, DSP5, F85, F85-Dep, L20, L21, P550, S200, S280, S280Dep, Super-QS, Super-QS-Dep | | |



1

| | | | |
|--------------------|---|-----------------|--------------------|
| GEV No. | 506121 | Ref. No. | 0201524 0208153 |
| description | flat gasket rubber ED ø 68mm ID ø 41mm thickness 2mm Qty 1 pcs | | |
| For models: | DSP1, DSP2, L20, L21, S200, S280, S280Dep, Super-QS, Super-QS-Dep | | |



1

| | | | |
|--------------------|---|-----------------|---------|
| GEV No. | 506043 | Ref. No. | 0200173 |
| description | flat gasket rubber ED ø 75mm ID ø 58.5mm thickness 2mm Qty 1 pcs | | |
| For models: | 015-24L, 050F, 050F-Dep, DSP4, DSP5, F85, F85-Dep, L20, L21, P550 | | |





1



| | | | |
|--------------------|--|-----------------|---------|
| GEV No. | 504442 | Ref. No. | 0201532 |
| description | gasket for intake filter ED ø 140mm ID ø 84mm thickness 2mm hole distance 78mm | | |







| | | | |
|---|--|-----------------|---------|
|  | | | |
| 1 | | | |
| GEV No. | 506022 | Ref. No. | 0200098 |
| description | gasket with 4 screw holes ED ø 134mm ID ø 65mm thickness 2.5mm | | |
| For models: | DSP4, DSP5 | | |

| | | | |
|---|---|-----------------|-------------|
|  | | | |
| 1 | | | |
| GEV No. | 506106 | Ref. No. | 0208153 old |
| description | gasket with 4 screw holes ED ø 68mm ID ø 41mm | | |

| | | | |
|---|----------------|-----------------|---------|
|  | | | |
| 1 | | | |
| GEV No. | 506123 | Ref. No. | 0221305 |
| description | hose connector | | |



| | | | |
|---|--|-----------------|-------------------------|
|  | | | |
| 1 | | | |
| GEV No. | 506122 | Ref. No. | 0221302 |
| description | hose connector plastic straight thread 1¼" hose ø 31mm Qty 1 pcs | | |
| For models: | 015-24L, DSP5, L20, L21, P550 | | |
| accessories for | 506122 | | |
|  | GEV No. | 506072 | Ref. No. 0200403 |
| | flat gasket fibre ED ø 38mm ID ø 27mm thickness 2mm outflow for thread 1¼" Qty 1 pcs | | |
|  | GEV No. | 506074 | Ref. No. 0200521 |
| | drain hose ID ø 32mm ED ø 41mm L 1m wire reinforced | | |

| | | | |
|---|---|-----------------|-------------------------|
|  | | | |
| 1 | | | |
| GEV No. | 506129 | Ref. No. | 0221331 |
| description | hose connector thread 1½" hose ø 40mm | | |
| For models: | 050F, 050F-Dep, F85, F85-Dep | | |
| accessories for | 506129 | | |
|  | GEV No. | 506015 | Ref. No. 0200056 |
| | O-ring EPDM thickness 3.53mm ID ø 39.69mm Qty 1 pcs | | |
|  | GEV No. | 506016 | Ref. No. 0200058 |
| | quick-fit retaining nut thread 1½" | | |

| | | | |
|---|-------------|-----------------|---------|
|  | | | |
| 1 | | | |
| GEV No. | 506096 | Ref. No. | 0201470 |
| description | intake body | | |

| | | | |
|--|-----------------------------------|-----------------|---------|
|  | | | |
| 1 | | | |
| GEV No. | 506030 | Ref. No. | 0200118 |
| description | intake body ED ø 110mm thread 1¼" | | |
| For models: | DSP5, M115, M150, MATIC20 | | |

| | | | |
|--|------------------------|-----------------|---------|
|  | | | |
| 1 | | | |
| GEV No. | 506029 | Ref. No. | 0200116 |
| description | intake body ED ø 140mm | | |
| For models: | DSP4, DSP5 | | |

| | | | |
|---|---|-----------------|------------------------------------|
|  | | | |
| 1 | | | |
| GEV No. | 506034 | Ref. No. | 0200127 |
| description | intake body thread 1¼" ID ø 25mm | | |
| For models: | DSP1, DSP2, L20, L21, S200, S280, S280Dep, Super-QS, Super-QS-Dep | | |
| accessories for | 506034 | | |
|  | GEV No. | 506018 | Ref. No. 0200080 |
| | nut thread 1¼" | | |
|  | GEV No. | 506121 | Ref. No. 0201524 0208153 |
| | flat gasket rubber ED ø 68mm ID ø 41mm thickness 2mm Qty 1 pcs | | |

| | | | |
|---|--|-----------------|---------|
|  | | | |
| 1 | | | |
| GEV No. | 506018 | Ref. No. | 0200080 |
| description | nut thread 1¼" | | |
| For models: | 015-24L, 050F, 050F-Dep, DSP1, DSP2, DSP4, DSP5, F85, F85-Dep, L20, L21, P550, S200, S280, S280Dep, Super-QS, Super-QS-Dep | | |

| | | | |
|---|---|-----------------|---------|
|  | | | |
| 1 | | | |
| GEV No. | 506027 | Ref. No. | 0200114 |
| description | nut thread 2" for intake body | | |
| For models: | 015-24L, 050F, 050F-Dep, DSP4, DSP5, F85, F85-Dep, L20, L21, P550 | | |



1

| | | | |
|--------------------|---|-----------------|---------|
| GEV No. | 506015 | Ref. No. | 0200056 |
| description | O-ring EPDM thickness 3.53mm ID ø 39.69mm Qty 1 pcs | | |
| For models: | 015-24L, 050F, 050F-Dep, DSP1, DSP2, DSP4, DSP5, F85, L20, L21, P550, S200, S280, S280Dep, Super-QS, Super-QS-Dep | | |



1

| | | | |
|--------------------|---|-----------------|---------|
| GEV No. | 532547 | Ref. No. | 0203009 |
| description | O-ring EPDM thickness 3.53mm ID ø 44.45mm Qty 1 pcs | | |
| For models: | 050F, 050F-Dep, F85, F85-Dep | | |



1

| | | | |
|--------------------|---|-----------------|---------|
| GEV No. | 528315 | Ref. No. | 0800074 |
| description | O-ring EPDM thickness 3.53mm ID ø 47.63mm Qty 1 pcs | | |



1

| | | | |
|--------------------|---|-----------------|---------|
| GEV No. | 506016 | Ref. No. | 0200058 |
| description | quick-fit retaining nut thread 1½" | | |
| For models: | 050F, 050F-Dep, F85, F85-Dep, LP31L, LP6, LP6L, M115, M150, MATIC20 | | |

filters



1

| | | | |
|--------------------|--|-----------------|---------|
| GEV No. | 517675 | Ref. No. | 0202015 |
| description | filter for dishwasher L 122mm W 122mm H 100mm SS | | |



1

| | | | |
|--------------------|--|-----------------|---------|
| GEV No. | 517676 | Ref. No. | 0202000 |
| description | filter for dishwasher L 200mm W 155mm H 120mm SS | | |



1

| | | | |
|--------------------|---|-----------------|---------|
| GEV No. | 517674 | Ref. No. | 0202008 |
| description | filter for dishwasher L 248mm W 248mm H 41mm SS | | |
| For models: | M115, M150 | | |



1

| | | | |
|--------------------|---|-----------------|---------|
| GEV No. | 517673 | Ref. No. | 0202034 |
| description | filter for dishwasher L 365mm W 292mm H 17mm SS | | |

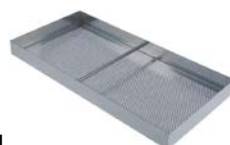

1

| | | | |
|--------------------|---|-----------------|---------|
| GEV No. | 517672 | Ref. No. | 0202063 |
| description | filter for dishwasher L 415mm W 203mm H 37mm SS | | |



1

| | | | |
|--------------------|---|-----------------|---------|
| GEV No. | 517681 | Ref. No. | 0202014 |
| description | filter for dishwasher L 608mm W 180mm H 30mm SS | | |



1

| | | | |
|--------------------|---|-----------------|---------|
| GEV No. | 517680 | Ref. No. | 0202013 |
| description | filter for dishwasher L 660mm W 200mm H 62mm SS | | |
| For models: | M150 | | |



1

| | | | |
|--------------------|---------------------------------|-----------------|---------|
| GEV No. | 517684 | Ref. No. | 0200310 |
| description | filter ø 22mm H 93mm SS | | |
| For models: | LP31L, LP6, M115, M150, MATIC20 | | |





| | | | |
|---|-------------|-----------------|---------|
|  | | | |
| 1 | | | |
| GEV No. | 506115 | Ref. No. | 0202006 |
| description | flat filter | | |

| | | | |
|---|------------------------------|-----------------|---------|
|  | | | |
| 1 | | | |
| GEV No. | 506133 | Ref. No. | 0400151 |
| description | flat filter | | |
| For models: | 050F, 050F-Dep, F85, F85-Dep | | |

| | | | |
|---|-----------------------------|-----------------|---------|
|  | | | |
| 1 | | | |
| GEV No. | 506410 | Ref. No. | 0202005 |
| description | flat filter L 270mm W 165mm | | |

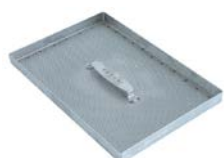
| | | | |
|--|-----------------------------|-----------------|---------|
|  | | | |
| 1 | | | |
| GEV No. | 506134 | Ref. No. | 0400152 |
| description | flat filter L 320mm W 235mm | | |
| For models: | 015-24L, DSP5, L21, P550 | | |

| | | | |
|---|-----------------------------|-----------------|---------|
|  | | | |
| 1 | | | |
| GEV No. | 506135 | Ref. No. | 0400153 |
| description | flat filter L 322mm W 216mm | | |

| | | | |
|--|----------------------------------|-----------------|---------|
|  Image not available | | | |
| 1 | | | |
| GEV No. | 506143 | Ref. No. | 0400395 |
| description | flat filter mounting pos. centre | | |
| For models: | 050F, 050F-Dep, F85, F85-Dep | | |

| | | | |
|---|----------------------------------|-----------------|---------|
|  Image not available | | | |
| 1 | | | |
| GEV No. | 506144 | Ref. No. | 0400396 |
| description | flat filter mounting pos. centre | | |

| | | | |
|--|--|-----------------|---------|
|  | | | |
| 1 | | | |
| GEV No. | 517683 | Ref. No. | 0202055 |
| description | rectangular filter L 140mm W 60mm H 86mm plastic | | |

| | | | |
|--|---|-----------------|---------|
|  | | | |
| 1 | | | |
| GEV No. | 506056 | Ref. No. | 0200247 |
| description | round filters ø 100mm | | |
| For models: | DSP1, DSP2, S200, S280, S280Dep, Super-QS, Super-QS-Dep | | |

| | | | |
|--|---|-----------------|---------|
|  | | | |
| 1 | | | |
| GEV No. | 506422 | Ref. No. | 0202003 |
| description | round filters ø 101mm connection ø48x55mm for pump suitable for L25/S | | |

| | | | |
|--|--|-----------------|---------|
|  | | | |
| 1 | | | |
| GEV No. | 517677 | Ref. No. | 0202065 |
| description | round filters ø 145mm H 90mm overall height 130mm SS | | |



1

| | | | |
|--------------------|------------------------------|-----------------|---------|
| GEV No. | 506009 | Ref. No. | 0200024 |
| description | round filters ø 165mm H 50mm | | |
| For models: | L20, L21 | | |



1

| | | | |
|--------------------|------------------------------------|-----------------|---------|
| GEV No. | 506119 | Ref. No. | 0202209 |
| description | round filters ø 185mm H 80mm | | |
| For models: | 015-24L, M115, M150, MATIC20, P550 | | |



1

| | | | |
|--------------------|--|-----------------|---------|
| GEV No. | 506010 | Ref. No. | 0200025 |
| description | round filters ø 215mm | | |
| For models: | 050F, 050F-Dep, DSP4, DSP5, F85, F85-Dep | | |

overflow pipes



1

| | | | |
|--------------------|---|-----------------|---------|
| GEV No. | 517662 | Ref. No. | 0800903 |
| description | cover ø 80mm ID ø 55mm H 25mm for overflow pipe | | |
| For models: | LP31L, LP6, LP6L, M115, M150, MATIC20 | | |



1

| | | | |
|--------------------|--|-----------------|---------|
| GEV No. | 517663 | Ref. No. | 0500801 |
| description | knob ø 35.5mm thread M8 H 23.5mm for overflow pipe | | |
| For models: | LP31L, LP6, LP6L, M115, M150, MATIC20 | | |



1

| | | | |
|--------------------|---|-----------------|---------|
| GEV No. | 506007 | Ref. No. | 0200020 |
| description | overflow pipe L 125mm ø 28mm | | |
| For models: | DSP1, DSP2, S200, S280, S280Dep, Super-QS, Super-QS-Dep | | |



1

| | | | |
|--------------------|--|-----------------|---------|
| GEV No. | 506047 | Ref. No. | 0200180 |
| description | overflow pipe L 140mm ø 45mm | | |
| For models: | 050F, 050F-Dep, DSP4, DSP5, F85, F85-Dep | | |



1

| | | | |
|--------------------|------------------------------|-----------------|---------|
| GEV No. | 524259 | Ref. No. | 0204007 |
| description | overflow pipe L 180mm ø 28mm | | |



1

| | | | |
|--------------------|------------------------------|-----------------|---------|
| GEV No. | 517668 | Ref. No. | 0200021 |
| description | overflow pipe L 200mm ø 45mm | | |



1

| | | | |
|--------------------|------------------------------|-----------------|---------|
| GEV No. | 506008 | Ref. No. | 0200022 |
| description | overflow pipe L 226mm ø 45mm | | |
| For models: | L20, L21 | | |



1

| | | | |
|--------------------|------------------------------|-----------------|---------|
| GEV No. | 506416 | Ref. No. | 0200023 |
| description | overflow pipe L 320mm ø 45mm | | |



| | | | |
|---|--|-----------------|---------|
|  | | | |
| 1 | | | |
| GEV No. | 506120 | Ref. No. | 0204003 |
| description | overflow pipe L 366mm ø 45mm usable height 340mm | | |
| For models: | 015-24L, P550 | | |

| | | | |
|---|--|-----------------|---------|
|  | | | |
| 1 | | | |
| GEV No. | 524784 | Ref. No. | 0204006 |
| description | overflow pipe L 405mm ø 45mm plastic ID ø 38mm | | |

| | | | |
|---|------------------------------|-----------------|---------|
|  | | | |
| 1 | | | |
| GEV No. | 517664 | Ref. No. | 0204004 |
| description | overflow pipe L 430mm ø 45mm | | |

| | | | |
|---|------------------------------|-----------------|------------------------------------|
|  | | | |
| 1 | | | |
| GEV No. | 517661 | Ref. No. | 0204001 0204001+0200304+0500801 |
| description | overflow pipe L 530mm ø 45mm | | |
| For models: | M115, M150, MATIC20 | | |
| accessories for | 517661 | | |
|  | GEV No. | 516255 | Ref. No. 0200304 |
| gasket silicone ED ø 45mm ID ø 35mm thickness 6mm Qty 1 pcs | | | |
|  | GEV No. | 517662 | Ref. No. 0800903 |
| cover ø 80mm ID ø 55mm H 25mm for overflow pipe | | | |
|  | GEV No. | 517663 | Ref. No. 0500801 |
| knob ø 35.5mm thread M8 H 23.5mm for overflow pipe | | | |

| | | | |
|---|---|-----------------|---------|
|  | | | |
| 1 | | | |
| GEV No. | 517665 | Ref. No. | 0204002 |
| description | overflow pipe L 575mm ø 45mm SS ID ø 33mm | | |
| For models: | LP6, LP6L | | |

containers

dosing containers

| | | | |
|--|---------------------------|-----------------|---------|
|  | | | |
| 1 | | | |
| GEV No. | 506432 | Ref. No. | 0520003 |
| description | rinse aid container 0.25l | | |

salt tanks

| | | | |
|---|--|-----------------|-------------------------|
|  | | | |
| 1 | | | |
| GEV No. | 510929 | Ref. No. | 0200149 |
| description | salt tank ø 120mm H 117mm hose ø 10mm mounting ø 70mm overall height 157mm | | |
| For models: | 050F, 050F-Dep, F85, F85-Dep, S280, S280Dep, Super-QS, Super-QS-Dep | | |
| spare parts for | 510929 | | |
|  | GEV No. | 506015 | Ref. No. 0200056 |
| O-ring EPDM thickness 3.53mm ID ø 39.69mm Qty 1 pcs | | | |
|  | GEV No. | 510018 | Ref. No. — |
| nut ø 92mm H 10.5mm for salt tank ID ø 64mm | | | |
|  | GEV No. | 524177 | Ref. No. — |
| lid ø 69mm H 20mm for salt tank ID ø 50mm | | | |
| accessories for | 510929 | | |
|  | GEV No. | 510071 | Ref. No. — |
| flat gasket rubber ED ø 81mm ID ø 68mm thickness 3mm for salt tank Qty 1 pcs | | | |
|  | GEV No. | 510654 | Ref. No. — |
| gasket H 6mm D1 ø 82mm D2 ø 68mm | | | |
|  | GEV No. | 510883 | Ref. No. — |
| gasket rubber ED ø 86mm ID ø 66mm thickness 2mm for salt tank Qty 1 pcs | | | |

boilers

boilers for dishwashers



1

| | | | |
|--------------------|---|-----------------|---------|
| GEV No. | 506142 | Ref. No. | 0400268 |
| description | boiler | | |
| For models: | S200, S280, S280Dep, Super-QS, Super-QS-Dep | | |



1

| | | | |
|--------------------|---------|-----------------|---------|
| GEV No. | 506145 | Ref. No. | 0403051 |
| description | boiler | | |
| For models: | 015-24L | | |



1

| | | | |
|--------------------|--------------------|-----------------|----------------------------|
| GEV No. | 506136 | Ref. No. | 0400259 siehe Bemerkung |
| description | boiler capacity 3l | | |



1

| | | | |
|--------------------|----------------------|-----------------|---------|
| GEV No. | 506141 | Ref. No. | 0400264 |
| description | boiler capacity 4.5l | | |



1

| | | | |
|--------------------|--------------------|-----------------|----------------------------|
| GEV No. | 506137 | Ref. No. | 0400260 siehe Bemerkung |
| description | boiler capacity 4l | | |



1

| | | | |
|--------------------|------------------------------|-----------------|---------|
| GEV No. | 506139 | Ref. No. | 0400262 |
| description | boiler capacity 5l | | |
| For models: | 050F, 050F-Dep, F85, F85-Dep | | |



1

| | | | |
|--------------------|--------------------|-----------------|-------------|
| GEV No. | 506138 | Ref. No. | 0400261 old |
| description | boiler capacity 8l | | |



1

| | | | |
|--------------------|--------------------|-----------------|---------|
| GEV No. | 506140 | Ref. No. | 0400263 |
| description | boiler capacity 8l | | |



1

| | | | |
|--------------------|------------------------------------|-----------------|---------|
| GEV No. | 506262 | Ref. No. | 0400261 |
| description | boiler capacity 8l | | |
| For models: | 015-24L, L20, L21, LP6, LP6L, P550 | | |



1

| | | | |
|--------------------|--|-----------------|---|
| GEV No. | 517679 | Ref. No. | 400266 400266+1x200324+6x300079+1x403012 |
| description | boiler with insulation ø 220mm L 540mm | | |



rotation plates

rotation plates



1

GEV No. 506442 **Ref. No.** 0800027

description rotation plate for model A81

softener cartridges

softening columns



1

GEV No. 530000 **Ref. No.** 0200011

description softener 4-fold L 380mm W 180mm

For models: 050F, 050F-Dep, F85, F85-Dep, S280, S280Dep, Super-QS, Super-QS-Dep



1

GEV No. 530001 **Ref. No.** 200011

description softener 4-fold L 380mm W 180mm

housing and bezels

fastening angles



1

GEV No. 504437 **Ref. No.** 0406127

description fastening angle for valve SS L 85mm W 65mm thickness 1mm H 20mm

fascias



1

GEV No. 506440 **Ref. No.** 0400192

description control panel

hood mechanics for dishwashers

bolts



1

GEV No. 506171 **Ref. No.** 0800117

description screw bolt for grab handle hood mechanics

For models: 015-24L, DSP5, L21



1

GEV No. 506206 **Ref. No.** 0899999

description screw bolt for grab handle hood mechanics

For models: 015-24L

bushes





1

GEV No. 506190 **Ref. No.** 0800497

description bush for grab handle hood mechanics

For models: 015-24L, DSP5, L21

| | | | |
|---|--------------------------------|-----------------|---------|
|  | | | |
| 1 | | | |
| GEV No. | 506188 | Ref. No. | 0800418 |
| description | bush for roller hood mechanics | | |
| For models: | 015-24L, DSP5, L21 | | |

| | | | |
|---|-------------------------|-----------------|---------|
|  | | | |
| 1 | | | |
| GEV No. | 506211 | Ref. No. | 0800108 |
| description | bush hood mechanics | | |
| For models: | 015-24L, DSP5, L20, L21 | | |

| | | | |
|---|----------------------------|-----------------|---------|
|  | | | |
| 1 | | | |
| GEV No. | 506212 | Ref. No. | 0800109 |
| description | spacer bush hood mechanics | | |
| For models: | 015-24L, DSP5, L20, L21 | | |



| | | | |
|---|----------------------------|-----------------|---------|
|  | | | |
| 1 | | | |
| GEV No. | 506213 | Ref. No. | 0800110 |
| description | spacer bush hood mechanics | | |
| For models: | 015-24L, DSP5, L20, L21 | | |

guide bars

| | | | |
|---|-----------------------------|-----------------|---------|
|  | | | |
| 1 | | | |
| GEV No. | 506436 | Ref. No. | 0800116 |
| description | guide bar L 1115mm ø 31.5mm | | |
| For models: | DSP5, L20, L21 | | |

linkage

| | | | |
|---|---|-----------------|---------|
|  | | | |
| 1 | | | |
| GEV No. | 506426 | Ref. No. | 0800701 |
| description | linkage L 602mm hood mechanics for dishwasher | | |
| For models: | DSP5 | | |

| | | | |
|---|---|-----------------|-----------------|
|  | | | |
| 1 | | | |
| GEV No. | 506228 | Ref. No. | 0800702 |
| description | linkage L 635mm hood mechanics for dishwasher | | |
| For models: | 015-24L | | |
| accessories for | 506228 | | |
|  | GEV No. | 560475 | Ref. No. |
| | | | 0800144 |
| | hexagonal nut thread M10 H 11.5mm zinc-coated steel WS 17 Qty 1 pcs DIN/ISO DIN 982 | | |

hood handles

| | | | |
|--|----------------|-----------------|---------|
|  | | | |
| 1 | | | |
| GEV No. | 506176 | Ref. No. | 0800241 |
| description | hood handle | | |
| For models: | DSP5, L20, L21 | | |

| | | | |
|--|-------------|-----------------|---------|
|  | | | |
| Image not available | | | |
| 1 | | | |
| GEV No. | 506201 | Ref. No. | 0800750 |
| description | hood handle | | |
| For models: | 015-24L | | |

| | | | |
|--|-------------|-----------------|---------|
|  | | | |
| Image not available | | | |
| 1 | | | |
| GEV No. | 506202 | Ref. No. | 0800751 |
| description | hood handle | | |
| For models: | 015-24L | | |

rollers

| | | | |
|---|--|-----------------|---------|
|  | | | |
| 1 | | | |
| GEV No. | 506163 | Ref. No. | 0800048 |
| description | roller hood mechanics dimensions 23/9.4/8mm | | |
| For models: | 015-24L, DSP5, L20, L21, M115, M150, MATIC20 | | |

| | | | |
|--|--|-----------------|---------|
|  | | | |
| 1 | | | |
| GEV No. | 506178 | Ref. No. | 0800244 |
| description | roller hood mechanics dimensions 35x12mm PVC | | |
| For models: | 015-24L, DSP5, L21 | | |

miscellaneous



1

| | | | |
|--------------------|--|-----------------|---------|
| GEV No. | 506023 | Ref. No. | 0200099 |
| description | gasket hood mechanics thread M8 | | |
| For models: | 015-24L, 050F, 050F-Dep, DSP4, DSP5, F85, F85-Dep, L20, L21, LP31L, LP6, LP6L, M115, M150, MATIC20, P550 | | |



1

| | | | |
|--------------------|---------------------------|-----------------|---------|
| GEV No. | 506170 | Ref. No. | 0800115 |
| description | hinge pine hood mechanics | | |
| For models: | 015-24L, DSP5, L20, L21 | | |



1

| | | | |
|--------------------|--|-----------------|---------|
| GEV No. | 524791 | Ref. No. | 0200650 |
| description | plate for hood mechanics L 39mm thread M10 zinc-coated steel H 10mm W 21mm | | |
| For models: | 015-24L, DSP5, L20, L21 | | |



1

| | | | |
|--------------------|---------------------------------------|-----------------|---------------------------------|
| GEV No. | 506159 | Ref. No. | 0150007 0800020 GA0150007 |
| description | rod guide hood mechanics with rollers | | |
| For models: | 015-24L, DSP5, L20, L21 | | |



1

| | | | |
|--------------------|-----------------------------|-----------------|---------|
| GEV No. | 506177 | Ref. No. | 0800242 |
| description | spacer piece hood mechanics | | |
| For models: | 015-24L | | |



1

| | | | |
|--------------------|---|-----------------|---------|
| GEV No. | 506189 | Ref. No. | 0800420 |
| description | spacer piece hood mechanics L 18mm thread M16 | | |
| For models: | 015-24L, DSP5, L21 | | |

basket guides

guide bars



1

| | | | |
|--------------------|---|-----------------|---------|
| GEV No. | 506439 | Ref. No. | 0400156 |
| description | guide bar for warewashing basket mounting pos. left | | |
| For models: | 050F, 050F-Dep, F85, F85-Dep | | |



1

| | | | |
|--------------------|--|-----------------|---------|
| GEV No. | 506438 | Ref. No. | 0400157 |
| description | guide bar for warewashing basket mounting pos. right | | |
| For models: | 050F, 050F-Dep, F85, F85-Dep | | |

basket holders



| | | | |
|--|--|-----------------|--|
| GEV No. | 971148 | Ref. No. | 0400360 siehe Bemerkung |
| description | basket support for dishwasher L 580mm W 510mm H 75mm | | |
| For models: | 015-24L | | |
| accessories for | 971148 | | |
|  | GEV No. | 971151 | Ref. No. 0400370 0400370 (KIT) |
| mixer coupling L 450mm H 75mm | | | |

miscellaneous



| | | | |
|--------------------|---|-----------------|---------|
| GEV No. | 512078 | Ref. No. | 0800094 |
| description | guide for dishwasher L 99mm W 45mm H 31.5mm | | |
| For models: | M115, M150, MATIC20 | | |







| | | | |
|--------------------|-------------------------------|-----------------|--------------------------|
| GEV No. | 971151 | Ref. No. | 0400370 0400370 (KIT) |
| description | mixer coupling L 450mm H 75mm | | |
| For models: | 015-24L, DSP5, L20, L21 | | |

air traps

air traps



| | | | |
|--|---|-----------------|------------------------------------|
| GEV No. | 506221 | Ref. No. | 0201455 0201455+0200196+0800652 |
| description | air trap L 40mm W 40mm H 85mm thread M12x1.75 ABS plastic | | |
| For models: | 015-24L, 050F, 050F-Dep, DSP1, DSP5, F85, F85-Dep, L20, L21, LP31L, LP6, LP6L, M115, M150, MATIC20, P550, S200, S280, S280Dep, Super-QS, Super-QS-Dep | | |
| accessories for | 506221 | | |
|  | GEV No. | 506063 | Ref. No. 0200295 |
| gasket suitable for Lamber equiv. no. 0200295 air trap ED ø 15.5mm ID ø 11.5mm Nyltite | | | |

| | | | |
|---|----------------|--------|-------------------------|
| accessories for | 506221 | | |
|  | GEV No. | 506076 | Ref. No. 0200638 |
| hose connector thread M12x1.75 hose ø 6mm | | | |
|  | GEV No. | 506220 | Ref. No. 0200196 |
| gasket ø 4mm H 2.5mm nylon | | | |
|  | GEV No. | 560227 | Ref. No. 0800652 |
| hexagonal nut thread M3 H 4mm SS WS 5.5 Qty 1 pcs self-locking | | | |



| | | | |
|--------------------|---|-----------------|---------|
| GEV No. | 506414 | Ref. No. | 0200019 |
| description | air trap ø 40mm H 100mm hose ø 10mm plastic | | |
| For models: | DSP2, DSP4 | | |

air trap accessories



| | | | |
|--------------------|---------------------|-----------------|---------|
| GEV No. | 506429 | Ref. No. | 0200289 |
| description | gasket for air trap | | |
| For models: | DSP2, DSP4 | | |



| | | | |
|--------------------|--|-----------------|---------|
| GEV No. | 506220 | Ref. No. | 0200196 |
| description | gasket ø 4mm H 2.5mm nylon | | |
| For models: | 015-24L, 050F, 050F-Dep, DSP1, DSP5, F85, F85-Dep, L20, L21, LP31L, LP6, LP6L, S200, S280, S280Dep, Super-QS, Super-QS-Dep | | |





| | | | |
|--------------------|--|-----------------|---------|
| GEV No. | 506431 | Ref. No. | 0200200 |
| description | hose ED ø 10/15mm ID ø 4/10mm L 2200mm temp.-resist. 70°C for air trap | | |
| For models: | 015-24L, DSP2, DSP4, L20, L21, LP31L, LP6, LP6L | | |



| | | | |
|--------------------|---|-----------------|---------|
| GEV No. | 506040 | Ref. No. | 0200147 |
| description | hose connector ø 4mm thread M12 | | |
| For models: | 050F, 050F-Dep, DSP1, DSP5, F85, F85-Dep, S200, S280, S280Dep, Super-QS, Super-QS-Dep | | |





| | | | |
|---|---|-----------------|---------|
|  | | | |
| 1 | | | |
| GEV No. | 506076 | Ref. No. | 0200638 |
| description | hose connector thread M12x1.75 hose ø 6mm | | |
| For models: | M115, M150, MATIC20, P550 | | |

| | | | |
|--|---|-----------------|---------|
|  | | | |
| 1 | | | |
| GEV No. | 694970 | Ref. No. | 0802707 |
| description | gear wheel H 28mm ID ø 64mm ED ø 85mm hole ø 20mm | | |
| For models: | M115, M150 | | |

mechanics for flight type dishwashers

| | | | |
|---|--|-----------------|---------|
|  | | | |
| 1 | | | |
| GEV No. | 524826 | Ref. No. | 0802051 |
| description | bush for ratchet L 21mm ID ø 8mm ED ø 10mm suitable for Lamber | | |
| For models: | M115, M150, MATIC20 | | |

| | | | |
|---|--|-----------------|---------|
|  | | | |
| 1 | | | |
| GEV No. | 524787 | Ref. No. | 0802046 |
| description | thread bolt for drive shaft L 62mm ø 12mm suitable for Lamber thread M8x1.25 | | |
| For models: | M115, M150, MATIC20 | | |

| | | | |
|---|---------------------------------|-----------------|---------|
|  | | | |
| 1 | | | |
| GEV No. | 524789 | Ref. No. | 0800492 |
| description | cable clamp wire gauge ø 5mm SS | | |
| For models: | M115, M150, MATIC20 | | |

backflow preventers

backflow preventers

| | | | |
|--|-------------------------------|-----------------|---------|
|  | | | |
| 1 | | | |
| GEV No. | 506210 | Ref. No. | 0500602 |
| description | backflow preventer dishwasher | | |

| | | | |
|--|---|-----------------|---------|
|  | | | |
| 1 | | | |
| GEV No. | 504436 | Ref. No. | 0800407 |
| description | coupling for transport system L 55mm ø 70mm ID ø 19mm suitable for Lamber | | |
| For models: | M115, M150, MATIC20 | | |

| | | | |
|--|--|-----------------|---------|
|  | | | |
| 1 | | | |
| GEV No. | 516101 | Ref. No. | 0500605 |
| description | backflow preventer dishwasher hose ø 12mm | | |
| For models: | 015-24L, 050F, 050F-Dep, DSP5, F85, F85-Dep, L20, L21, LP31L, LP6, LP6L, M115, M150, P550, S200, S280, S280Dep, Super-QS, Super-QS-Dep | | |

| | | | |
|---|---|-----------------|---------|
|  | | | |
| 1 | | | |
| GEV No. | 524790 | Ref. No. | 0802048 |
| description | distance washers for drive shaft H 10mm ID ø 12.4mm ED ø 22mm | | |
| For models: | M115, M150, MATIC20 | | |

| | | | |
|---|----------------|--------|-------------------|
| spare parts for 516101 | | | |
|  | GEV No. | 506367 | Ref. No. — |
| flat gasket rubber ED ø 40mm ID ø 28mm thickness 1.8mm Qty 1 pcs | | | |

| | | | |
|---|----------------------------------|-----------------|-------------------------|
|  | | | |
| 1 | | | |
| GEV No. | 529272 | Ref. No. | 0800123 0800150 |
| description | drive shaft for transport system | | |
| For models: | M115, M150, MATIC20 | | |
| accessories for 529272 | | | |
|  | GEV No. | 532144 | Ref. No. — |
| O-ring EPDM thickness 3.53mm ID ø 98.02mm Qty 10 pcs | | | |
|  | GEV No. | 694970 | Ref. No. 0802707 |
| gear wheel H 28mm ID ø 64mm ED ø 85mm hole ø 20mm | | | |

non-return valves

| | | | |
|--|---|-----------------|---------|
|  | | | |
| 1 | | | |
| GEV No. | 506073 | Ref. No. | 0200426 |
| description | non-return valve plastic total length 26mm hose ø 11mm | | |
| For models: | 050F, 050F-Dep, F85, F85-Dep, S280, S280Dep, Super-QS, Super-QS-Dep | | |

miscellaneous



1

| | | | |
|--------------------|--|-----------------|---------|
| GEV No. | 506160 | Ref. No. | 0800028 |
| description | plain washer ID ø 8.6mm ED ø 16mm thickness 1.5mm SS Qty 1 pcs | | |
| For models: | 015-24L, DSP5, L20, L21, LP31L, LP6, LP6L, M115, M150, MATIC20 | | |

door mechanics

springs

tension springs



1

| | | | |
|--------------------|---|-----------------|---------|
| GEV No. | 519494 | Ref. No. | 0800714 |
| description | tension spring ø 9mm wire gauge ø 1.5mm total length 168mm for door | | |
| For models: | 050F, 050F-Dep, F85, F85-Dep | | |

linkage



1

| | | | |
|--------------------|---|-----------------|---------|
| GEV No. | 506186 | Ref. No. | 0800408 |
| description | door pin L 180mm door pin ø 5mm | | |
| For models: | DSP1, DSP2, S200, S280, S280Dep, Super-QS, Super-QS-Dep | | |



1

| | | | |
|--------------------|---|-----------------|---------|
| GEV No. | 506179 | Ref. No. | 0800400 |
| description | door pin L 305mm door pin ø 5mm | | |
| For models: | 050F, 050F-Dep, DSP2, DSP4, DSP5, F85, F85-Dep, LP31L, LP6, LP6L, M115, M150, P550, S280, S280Dep, Super-QS, Super-QS-Dep | | |

threaded shafts



1

| | | | |
|--------------------|---|-----------------|---------|
| GEV No. | 506180 | Ref. No. | 0800401 |
| description | threaded part spigot | | |
| For models: | 050F, 050F-Dep, DSP1, DSP2, DSP4, F85, F85-Dep, S200, S280, S280Dep, Super-QS, Super-QS-Dep | | |

sliding plates



1

| | | | |
|--------------------|---|-----------------|------------------------------|
| GEV No. | 506182 | Ref. No. | 0800403 0800403+2x0800187 |
| description | sliding plate plate | | |
| For models: | 050F, 050F-Dep, DSP1, DSP2, DSP4, F85, F85-Dep, S200, S280, S280Dep, Super-QS, Super-QS-Dep | | |

hinges



1

| | | | |
|--------------------|------------------------|-----------------|---------|
| GEV No. | 506167 | Ref. No. | 0800098 |
| description | door bolt door bearing | | |



1

| | | | |
|--------------------|------------------------|-----------------|---------|
| GEV No. | 506168 | Ref. No. | 0800099 |
| description | door bolt door bearing | | |
| For models: | DSP1, DSP2, DSP4 | | |



1

| | | | |
|--------------------|--|-----------------|---------|
| GEV No. | 692467 | Ref. No. | 0800174 |
| description | hinge L 52mm W 57mm H 18mm mounting distance 34mm hole ø 5mm plastic | | |

rod support



1

| | | | |
|--------------------|-----------------|-----------------|---------|
| GEV No. | 506434 | Ref. No. | 0400190 |
| description | support bracket | | |

door bumpers



1

| | | | |
|--------------------|---|-----------------|------------------------------------|
| GEV No. | 506181 | Ref. No. | 0800402 0800402+0800256+0800653 |
| description | door bumper hinge camp | | |
| For models: | 050F, 050F-Dep, DSP1, DSP2, DSP4, DSP5, F85, F85-Dep, P550, S200, S280, S280Dep, Super-QS, Super-QS-Dep | | |





1

| | | | |
|--------------------|------------------------------|-----------------|---------|
| GEV No. | 506185 | Ref. No. | 0800406 |
| description | door bumper hinge camp brass | | |
| For models: | LP31L, LP6, LP6L, M115, M150 | | |



locks

| | | | |
|--|---|-----------------|---------|
|  <p>1</p> | | | |
| GEV No. | 506157 | Ref. No. | 0800006 |
| description | door catch catch | | |
| For models: | 050F, 050F-Dep, DSP1, DSP2, DSP4, F85, F85-Dep, S200, S280, S280Dep, Super-QS, Super-QS-Dep | | |

| | | | |
|--|---|-----------------|------------------------------------|
|  <p>1</p> | | | |
| GEV No. | 506183 | Ref. No. | 0800404 0800404+0800652+0800665 |
| description | door catch counterpart | | |
| For models: | 050F, 050F-Dep, DSP1, DSP2, DSP4, F85, F85-Dep, S200, S280, S280Dep, Super-QS, Super-QS-Dep | | |

| | | | |
|---|--------------------------|-----------------|---------|
|  <p>1</p> | | | |
| GEV No. | 506184 | Ref. No. | 0800405 |
| description | door catch SS door catch | | |

miscellaneous

| | | | |
|--|--------------------|-----------------|---------|
|  <p>1</p> | | | |
| GEV No. | 506173 | Ref. No. | 0800169 |
| description | bush for door bolt | | |
| For models: | DSP1, DSP2, DSP4 | | |

| | | | |
|--|--------------------|-----------------|---------|
|  <p>1</p> | | | |
| GEV No. | 506187 | Ref. No. | 0800409 |
| description | bush for door bolt | | |

| | | | |
|--|---------------------------------------|-----------------|---------|
|  <p>1</p> | | | |
| GEV No. | 524254 | Ref. No. | 0800480 |
| description | hauling cable for door ø 3mm L 1800mm | | |
| For models: | M115, M150, MATIC20 | | |

screw connections

| | | | |
|--|--|-----------------|---------|
|  <p>1</p> | | | |
| GEV No. | 506196 | Ref. No. | 0800673 |
| description | nut brass | | |
| For models: | 015-24L, 050F, 050F-Dep, DSP5, F85, F85-Dep, L20, L21, LP31L, LP6, LP6L, P550, S200, S280, S280Dep, Super-QS, Super-QS-Dep | | |

| | | | |
|---|---|-----------------|---------|
|  <p>1</p> | | | |
| GEV No. | 506027 | Ref. No. | 0200114 |
| description | nut thread 2" for intake body | | |
| For models: | 015-24L, 050F, 050F-Dep, DSP4, DSP5, F85, F85-Dep, L20, L21, P550 | | |

| | | | |
|---|---|-----------------|---------|
|  <p>1</p> | | | |
| GEV No. | 506132 | Ref. No. | 0300047 |
| description | nut thread 3/8" | | |
| For models: | 050F, 050F-Dep, F85, F85-Dep, S200, S280, S280Dep, Super-QS, Super-QS-Dep | | |

washing and rinsing systems

| | | | |
|--|--|-----------------|---------|
|  <p>1</p> | | | |
| GEV No. | 506012 | Ref. No. | 0200038 |
| description | bearing rinse arm SS | | |
| For models: | 015-24L, 050F, 050F-Dep, DSP1, DSP2, DSP4, DSP5, F85, F85-Dep, L20, L21, P550, S200, S280, S280Dep, Super-QS, Super-QS-Dep | | |

| | | | |
|---|--|-----------------|---------|
|  <p>1</p> | | | |
| GEV No. | 506174 | Ref. No. | 0800175 |
| description | bush for rinse arm mounting pos. lower | | |
| For models: | LP31L, LP6, LP6L | | |



1

| | | | |
|--------------------|--|-----------------|---------|
| GEV No. | 506193 | Ref. No. | 0800500 |
| description | bush for rinse arm mounting pos. lower | | |
| For models: | LP31L, LP6, LP6L | | |



1

| | | | |
|--------------------|--|-----------------|---------|
| GEV No. | 506192 | Ref. No. | 0800499 |
| description | bush for rinse arm ø 13.3mm | | |
| For models: | 015-24L, 050F, 050F-Dep, F85, F85-Dep, L20, L21, P550, S200, S280, S280Dep, Super-QS, Super-QS-Dep | | |



1

| | | | |
|--------------------|--|-----------------|---------|
| GEV No. | 506191 | Ref. No. | 0800498 |
| description | bush for rinse arm ø 16.2mm | | |
| For models: | 015-24L, 050F, 050F-Dep, F85, F85-Dep, L20, L21, P550, S200, S280, S280Dep, Super-QS, Super-QS-Dep | | |



1

| | | | |
|--------------------|---|-----------------|---------|
| GEV No. | 517682 | Ref. No. | 0200121 |
| description | bush for wash arm mounting pos. upper H 52mm thread 1¼" D1 ø 54mm D2 ø 41mm Qty 1 pcs | | |



1

| | | | |
|--------------------|---|-----------------|---------|
| GEV No. | 506197 | Ref. No. | 0800685 |
| description | disc for wash arm ID ø 18mm ED ø 50mm thickness 2mm nylon | | |



1

| | | | |
|--------------------|---|-----------------|---------|
| GEV No. | 506198 | Ref. No. | 0800686 |
| description | disc for wash arm ID ø 50mm ED ø 22mm thickness 2mm nylon | | |
| For models: | 015-24L, 050F, 050F-Dep, F85, F85-Dep, L20, L21, P550 | | |



1

| | | | |
|--------------------|--|-----------------|---------|
| GEV No. | 524264 | Ref. No. | 0800053 |
| description | disc for wash arm support mounting pos. upper ø 50mm H 2mm | | |
| For models: | DSP4, DSP5 | | |



1

| | | | |
|--------------------|--|-----------------|---------|
| GEV No. | 506161 | Ref. No. | 0800030 |
| description | disc SS for wash arm ID ø 18.2mm ED ø 50mm | | |



1

| | | | |
|--------------------|---|-----------------|---------|
| GEV No. | 506094 | Ref. No. | 0201458 |
| description | flange thread 1¼" ø 110mm | | |
| For models: | 015-24L, 050F, 050F-Dep, F85, F85-Dep, L20, L21, P550 | | |



1

| | | | |
|--------------------|--|-----------------|---------|
| GEV No. | 524792 | Ref. No. | 0200259 |
| description | gasket for rinse arm mounting pos. upper/lower ø 22.5mm ID ø 13mm thickness 10mm | | |
| For models: | M115, M150, MATIC20 | | |



1

| | | | |
|--------------------|--|-----------------|---------|
| GEV No. | 524786 | Ref. No. | 0200400 |
| description | gasket for wash arm mounting pos. upper/lower ø 46mm ID ø 36mm | | |
| For models: | M115, M150, MATIC20 | | |



1

| | | | |
|--------------------|--|-----------------|---------|
| GEV No. | 524258 | Ref. No. | 0201504 |
| description | gasket suitable for Lamber for wash arm support L 100mm W 100mm Qty 1m ID ø 61mm | | |
| For models: | LP31L, LP6, LP6L | | |



| | | | |
|--------------------|--|-----------------|---------|
| | | | |
| 1 | | | |
| GEV No. | 504440 | Ref. No. | 0201505 |
| description | gasket suitable for Lamber L 100mm W 100mm ID ø 43mm thickness 3mm | | |
| For models: | M115, M150, MATIC20 | | |

| | | | |
|--------------------|---|-----------------|---------|
| | | | |
| 1 | | | |
| GEV No. | 504441 | Ref. No. | 0201503 |
| description | gasket suitable for Lamber L 100mm W 100mm Qty 1m ID ø 40mm thickness 3mm | | |
| For models: | M115, M150, MATIC20 | | |

| | | | |
|--------------------|-------------------------------|-----------------|---------|
| | | | |
| 1 | | | |
| GEV No. | 506128 | Ref. No. | 0221315 |
| description | hose connector curved plastic | | |

| | | | |
|--------------------|---|-----------------|---------|
| | | | |
| 1 | | | |
| GEV No. | 506127 | Ref. No. | 0221314 |
| description | hose connector thread 1¼" for hose ID 30mm curved plastic | | |
| For models: | DSP4, MATIC20 | | |

| | | | |
|--------------------|---------------------------------------|-----------------|---------|
| | | | |
| 1 | | | |
| GEV No. | 506101 | Ref. No. | 0201820 |
| description | rinse arm support mounting pos. lower | | |
| For models: | 050F, 050F-Dep, F85, F85-Dep | | |

| | | | |
|--------------------|---------------------------------------|-----------------|---------|
| | | | |
| 1 | | | |
| GEV No. | 506103 | Ref. No. | 0201830 |
| description | rinse arm support mounting pos. lower | | |

| | | | |
|--------------------|---|-----------------|---------|
| | | | |
| 1 | | | |
| GEV No. | 506020 | Ref. No. | 0200096 |
| description | rinse pipe | | |
| For models: | DSP1, DSP2, DSP4, DSP5, S200, S280, S280Dep, Super-QS, Super-QS-Dep | | |

| | | | |
|--------------------|------------|-----------------|---------|
| | | | |
| 1 | | | |
| GEV No. | 506091 | Ref. No. | 0201344 |
| description | rinse pipe | | |

| | | | |
|--------------------|-------------------|-----------------|---------|
| | | | |
| 1 | | | |
| GEV No. | 506104 | Ref. No. | 0201836 |
| description | rinse pipe | | |
| For models: | 015-24L, L20, L21 | | |

| | | | |
|--------------------|------------|-----------------|---------|
| | | | |
| 1 | | | |
| GEV No. | 506437 | Ref. No. | 0201335 |
| description | rinse pipe | | |

| | | | |
|--------------------|--|-----------------|---------|
| | | | |
| 1 | | | |
| GEV No. | 506200 | Ref. No. | 0800712 |
| description | spring SS for rinse pipe | | |
| For models: | 015-24L, 050F, 050F-Dep, F85, F85-Dep, L20, L21, P550, S200, S280, S280Dep, Super-QS, Super-QS-Dep | | |

| | | | |
|--------------------|--|-----------------|---------|
| | | | |
| 1 | | | |
| GEV No. | 506172 | Ref. No. | 0800130 |
| description | Thumb screw thread M6 thread L 9mm ø 22mm H 6mm SS | | |
| For models: | 015-24L, 050F, 050F-Dep, F85, F85-Dep, L20, L21, LP31L, LP6, LP6L, P550, S200, S280, S280Dep, Super-QS, Super-QS-Dep | | |



1

| | | | |
|--------------------|---|-----------------|---------|
| GEV No. | 510338 | Ref. No. | 0200219 |
| description | union nut dosing pump thread 1/2" ø 32mm H 15mm for dosing pump | | |



1

| | | | |
|--------------------|--------------------------------------|-----------------|---------|
| GEV No. | 506102 | Ref. No. | 0201822 |
| description | wash arm support mounting pos. lower | | |



1

| | | | |
|--------------------|-----------|-----------------|---------|
| GEV No. | 506100 | Ref. No. | 0201811 |
| description | wash pipe | | |



1

| | | | |
|--------------------|--|-----------------|---------|
| GEV No. | 506421 | Ref. No. | 0800043 |
| description | wash pipe L 200mm nylon size inch 1 1/4" | | |
| For models: | M150 | | |



1

| | | | |
|--------------------|-------------------------------|-----------------|---------|
| GEV No. | 506105 | Ref. No. | 0201841 |
| description | wash pipe mounting pos. lower | | |

washing and rinsing systems (sorted by producer)

LAMBER



1

| | | | |
|--------------------|---|-----------------|---------|
| GEV No. | 506267 | Ref. No. | 0200861 |
| description | rinse arm L 372mm mounting pos. upper nozzles 4 mounting ø 16mm | | |



1

| | | | |
|--------------------|--|-----------------|---------|
| GEV No. | 506064 | Ref. No. | 0200296 |
| description | rinse arm L 375mm mounting pos. lower nozzles 4 mounting ø 17mm complete | | |
| For models: | S280, S280Dep, Super-QS, Super-QS-Dep | | |



1

| | | | |
|--------------------|---|-----------------|--------------------|
| GEV No. | 506265 | Ref. No. | 0200808 0200855 |
| description | rinse arm L 376mm mounting pos. lower nozzles 4 | | |
| For models: | DSP2 | | |



1

| | | | |
|--------------------|--|-----------------|-------------------------------|
| GEV No. | 506261 | Ref. No. | 0200804 0200807 0200852 |
| description | rinse arm L 420mm mounting pos. upper nozzles 4 thread M18x1 | | |
| For models: | 015-24L, 050F, 050F-Dep, F85, F85-Dep, L20, L21, P550 | | |

1

| | | | |
|--------------------|---|-----------------|---------|
| GEV No. | 517830 | Ref. No. | 0200850 |
| description | rinse arm L 480mm mounting pos. lower nozzles 6 | | |



1

| | | | |
|--------------------|--|-----------------|---------|
| GEV No. | 506276 | Ref. No. | 0200859 |
| description | rinse arm L 620mm nozzles 6 mounting ø uppermm | | |



1

| | | | |
|--------------------|--|-----------------|---------|
| GEV No. | 517667 | Ref. No. | 0500515 |
| description | wash arm L 380mm mounting pos. upper/lower nozzles 6 | | |
| For models: | M115, M150, MATIC20 | | |



1

| | | | |
|--------------------|---|-----------------|--------------------|
| GEV No. | 506155 | Ref. No. | 0500502 0500505 |
| description | wash arm L 383mm mounting pos. upper nozzles 6 mounting ø 43.5mm | | |
| For models: | 050F, 050F-Dep, DSP1, DSP2, DSP4, DSP5, F85, F85-Dep, L20, L21, S200, S280, S280Dep, Super-QS, Super-QS-Dep | | |



1

| | | | |
|--------------------|--|-----------------|---------|
| GEV No. | 506153 | Ref. No. | 0500500 |
| description | wash arm L 545mm mounting pos. lower nozzles 6 mounting ø 43mm | | |
| For models: | 050F, 050F-Dep, DSP4, DSP5, F85, F85-Dep, L20, L21, P550 | | |



1

| | | | |
|--------------------|---|-----------------|---------|
| GEV No. | 524783 | Ref. No. | 0500510 |
| description | wash arm L 550/600mm mounting pos. upper/lower nozzles 8 complete | | |
| For models: | LP31L, LP6, LP6L | | |



1

| | | | |
|--------------------|---|-----------------|---------|
| GEV No. | 524782 | Ref. No. | 0500516 |
| description | wash arm L 550mm mounting pos. upper/lower nozzles 6 complete | | |





1

| | | | |
|--------------------|--|-----------------|--------------------|
| GEV No. | 506154 | Ref. No. | 0200094 0500501 |
| description | wash arm L 550mm mounting pos. upper/lower nozzles 8 mounting ø 43mm | | |
| For models: | 015-24L | | |



1

| | | | | |
|---|--|-----------------|--------------------|---------|
| GEV No. | 506061 | Ref. No. | 0200286 0200287 | |
| description | rinse arm L 470mm nozzles 6 mounting ø 17mm mounting pos. lower complete | | | |
| For models: | 015-24L, 050F, 050F-Dep, F85, F85-Dep, L20, L21, P550 | | | |
| accessories for | 506061 | | | |
|  | GEV No. | 506012 | Ref. No. | 0200038 |
| | bearing rinse arm SS | | | |







1

| | | | |
|--------------------|---|-----------------|---------|
| GEV No. | 505045 | Ref. No. | 0200303 |
| description | O-ring EPDM thickness 1.78mm ID ø 5.28mm Qty 1 pcs | | |
| For models: | 015-24L, 050F, 050F-Dep, F85, F85-Dep, L20, L21, LP31L, LP6, LP6L, M115, M150, MATIC20, P550, S200, S280, S280Dep, Super-QS, Super-QS-Dep | | |

| | | | |
|---|--|-----------------|---------|
|  | | | |
| 1 | | | |
| GEV No. | 506001 | Ref. No. | 0200012 |
| description | rinse arm L 235mm nozzles 3 thread M12x1 mounting pos. lower | | |
| For models: | 015-24L, 050F, 050F-Dep, F85, F85-Dep, L20, L21, P550 | | |

| | | | |
|---|--|-----------------|---------|
|  | | | |
| 1 | | | |
| GEV No. | 506002 | Ref. No. | 0200013 |
| description | rinse arm L 235mm nozzles 3 thread M12x1 mounting pos. lower | | |
| For models: | 015-24L, 050F, 050F-Dep, F85, F85-Dep, L20, L21, P550 | | |

| | | | |
|---|--|-----------------|---------|
|  | | | |
| 1 | | | |
| GEV No. | 506019 | Ref. No. | 0200086 |
| description | rinse arm boss | | |
| For models: | 015-24L, 050F, 050F-Dep, DSP1, DSP2, DSP4, DSP5, F85, F85-Dep, L20, L21, P550, S200, S280, S280Dep, Super-QS, Super-QS-Dep | | |

| | | | |
|---|--|-----------------|-------------------------|
|  | | | |
| 1 | | | |
| GEV No. | 506089 | Ref. No. | 0201164 |
| description | rinse jet | | |
| For models: | 015-24L, 050F, 050F-Dep, F85, F85-Dep, L20, L21, P550, S200, S280, S280Dep, Super-QS, Super-QS-Dep | | |
| accessories for | 506089 | | |
|  | GEV No. | 505045 | Ref. No. 0200303 |
| | O-ring EPDM thickness 1.78mm ID ø 5.28mm Qty 1 pcs | | |
|  | GEV No. | 524788 | Ref. No. 0200625 |
| | union nut for rinse jet mounting pos. upper/lower thread M12x1 H 10mm WS 14 | | |

| | | | |
|---|--|-----------------|---------|
|  | | | |
| 1 | | | |
| GEV No. | 506090 | Ref. No. | 0201165 |
| description | rinse jet ø 1.5mm approval NSF | | |
| For models: | 015-24L, 050F, 050F-Dep, F85, F85-Dep, L20, L21, P550, S200, S280, S280Dep, Super-QS, Super-QS-Dep | | |

| | | | |
|---|--|-----------------|---------|
|  | | | |
| 1 | | | |
| GEV No. | 506075 | Ref. No. | 0200608 |
| description | union nut rinse jet | | |
| For models: | 015-24L, 050F, 050F-Dep, F85, F85-Dep, L20, L21, P550, S200, S280, S280Dep, Super-QS, Super-QS-Dep | | |

| | | | |
|--|--|-----------------|---------|
|  | | | |
| 1 | | | |
| GEV No. | 506079 | Ref. No. | 0200804 |
| description | rinse arm L 420mm nozzles 4 mounting ø 16mm mounting pos. upper complete | | |

| | | | |
|--|--|-----------------|---------|
|  | | | |
| 1 | | | |
| GEV No. | 506062 | Ref. No. | 0200288 |
| description | rinse arm L 422mm nozzles 4 mounting ø 17mm mounting pos. lower complete | | |

| | | | |
|---|---|-----------------|---------|
|  | | | |
| 1 | | | |
| GEV No. | 505045 | Ref. No. | 0200303 |
| description | O-ring EPDM thickness 1.78mm ID ø 5.28mm Qty 1 pcs | | |
| For models: | 015-24L, 050F, 050F-Dep, F85, F85-Dep, L20, L21, LP31L, LP6, LP6L, M115, M150, MATIC20, P550, S200, S280, S280Dep, Super-QS, Super-QS-Dep | | |



| | | | |
|---|--|-----------------|---------|
|  | | | |
| 1 | | | |
| GEV No. | 506067 | Ref. No. | 0200370 |
| description | rinse arm L 200mm nozzles 2 thread M12x1 mounting pos. upper | | |
| For models: | 015-24L, 050F, 050F-Dep, F85, F85-Dep, L20, L21, P550 | | |

| | | | |
|---|--|-----------------|---------|
|  | | | |
| 1 | | | |
| GEV No. | 506068 | Ref. No. | 0200371 |
| description | rinse arm L 200mm nozzles 2 thread M12x1 mounting pos. upper | | |
| For models: | 015-24L, 050F, 050F-Dep, F85, F85-Dep, L20, L21, P550 | | |

| | | | |
|---|--|-----------------|---------|
|  | | | |
| 1 | | | |
| GEV No. | 506019 | Ref. No. | 0200086 |
| description | rinse arm boss | | |
| For models: | 015-24L, 050F, 050F-Dep, DSP1, DSP2, DSP4, DSP5, F85, F85-Dep, L20, L21, P550, S200, S280, S280Dep, Super-QS, Super-QS-Dep | | |



| | | | |
|--|--|-----------------|---------|
|  <p>1</p> | | | |
| GEV No. | 506088 | Ref. No. | 0201151 |
| description | rinse arm boss | | |
| For models: | 015-24L, 050F, 050F-Dep, F85, F85-Dep, L20, L21, P550, S200, S280, S280Dep, Super-QS, Super-QS-Dep | | |

| | | | |
|--|--|-----------------|----------------|
|  <p>1</p> | | | |
| GEV No. | 506089 | Ref. No. | 0201164 |
| description | rinse jet | | |
| For models: | 015-24L, 050F, 050F-Dep, F85, F85-Dep, L20, L21, P550, S200, S280, S280Dep, Super-QS, Super-QS-Dep | | |
| accessories for | 506089 | | |
| | GEV No. | Ref. No. | 0200303 |
| |  <p>O-ring EPDM thickness 1.78mm ID ø 5.28mm Qty 1 pcs</p> | | |
| | GEV No. | Ref. No. | 0200625 |
| |  <p>union nut for rinse jet mounting pos. upper/lower thread M12x1 H 10mm WS 14</p> | | |

| | | | |
|---|--|-----------------|---------|
|  <p>1</p> | | | |
| GEV No. | 506090 | Ref. No. | 0201165 |
| description | rinse jet ø 1.5mm approval NSF | | |
| For models: | 015-24L, 050F, 050F-Dep, F85, F85-Dep, L20, L21, P550, S200, S280, S280Dep, Super-QS, Super-QS-Dep | | |

| | | | |
|--|--|-----------------|---------|
|  <p>1</p> | | | |
| GEV No. | 506075 | Ref. No. | 0200608 |
| description | union nut rinse jet | | |
| For models: | 015-24L, 050F, 050F-Dep, F85, F85-Dep, L20, L21, P550, S200, S280, S280Dep, Super-QS, Super-QS-Dep | | |

| | | | |
|--|---|-----------------|---------|
|  <p>1</p> | | | |
| GEV No. | 506215 | Ref. No. | 0200806 |
| description | rinse arm L 322mm nozzles 4 mounting ø 16mm mounting pos. upper | | |
| For models: | S200, S280, S280Dep, Super-QS, Super-QS-Dep | | |

| | | | |
|---|---|-----------------|---------|
|  <p>1</p> | | | |
| GEV No. | 506077 | Ref. No. | 0200801 |
| description | rinse arm L 325mm nozzles 4 mounting ø 17mm mounting pos. lower | | |
| For models: | S200 | | |



| | | | |
|--|---|-----------------|---------|
|  <p>1</p> | | | |
| GEV No. | 505045 | Ref. No. | 0200303 |
| description | O-ring EPDM thickness 1.78mm ID ø 5.28mm Qty 1 pcs | | |
| For models: | 015-24L, 050F, 050F-Dep, F85, F85-Dep, L20, L21, LP31L, LP6, LP6L, M115, M150, MATIC20, P550, S200, S280, S280Dep, Super-QS, Super-QS-Dep | | |

| | | | |
|--|--|-----------------|---------|
|  <p>1</p> | | | |
| GEV No. | 506003 | Ref. No. | 0200016 |
| description | rinse arm L 150mm nozzles 2 thread M12x1 mounting pos. upper/lower | | |
| For models: | S200, S280, S280Dep, Super-QS, Super-QS-Dep | | |

| | | | |
|--|--|-----------------|---------|
|  <p>1</p> | | | |
| GEV No. | 506004 | Ref. No. | 0200017 |
| description | rinse arm L 150mm nozzles 2 thread M12x1 mounting pos. upper/lower | | |
| For models: | S200, S280, S280Dep, Super-QS, Super-QS-Dep | | |

| | | | |
|--|--|-----------------|---------|
|  <p>1</p> | | | |
| GEV No. | 506019 | Ref. No. | 0200086 |
| description | rinse arm boss | | |
| For models: | 015-24L, 050F, 050F-Dep, DSP1, DSP2, DSP4, DSP5, F85, F85-Dep, L20, L21, P550, S200, S280, S280Dep, Super-QS, Super-QS-Dep | | |

| | | | |
|---|--|-----------------|---------|
|  | | | |
| 1 | | | |
| GEV No. | 506088 | Ref. No. | 0201151 |
| description | rinse arm boss | | |
| For models: | 015-24L, 050F, 050F-Dep, F85, F85-Dep, L20, L21, P550, S200, S280, S280Dep, Super-QS, Super-QS-Dep | | |

| | | | |
|---|--|-----------------|-----------------|
|  | | | |
| 1 | | | |
| GEV No. | 506089 | Ref. No. | 0201164 |
| description | rinse jet | | |
| For models: | 015-24L, 050F, 050F-Dep, F85, F85-Dep, L20, L21, P550, S200, S280, S280Dep, Super-QS, Super-QS-Dep | | |
| accessories for | 506089 | | |
|  | GEV No. | 505045 | Ref. No. |
| | | | 0200303 |
| | O-ring EPDM thickness 1.78mm ID ø 5.28mm Qty 1 pcs | | |
|  | GEV No. | 524788 | Ref. No. |
| | | | 0200625 |
| | union nut for rinse jet mounting pos. upper/lower thread M12x1 H 10mm WS 14 | | |

| | | | |
|--|--|-----------------|---------|
|  | | | |
| 1 | | | |
| GEV No. | 506090 | Ref. No. | 0201165 |
| description | rinse jet ø 1.5mm approval NSF | | |
| For models: | 015-24L, 050F, 050F-Dep, F85, F85-Dep, L20, L21, P550, S200, S280, S280Dep, Super-QS, Super-QS-Dep | | |

| | | | |
|---|--|-----------------|---------|
|  | | | |
| 1 | | | |
| GEV No. | 506075 | Ref. No. | 0200608 |
| description | union nut rinse jet | | |
| For models: | 015-24L, 050F, 050F-Dep, F85, F85-Dep, L20, L21, P550, S200, S280, S280Dep, Super-QS, Super-QS-Dep | | |

| | | | |
|---|--|-----------------|---------|
|  | | | |
| 1 | | | |
| GEV No. | 506078 | Ref. No. | 0200802 |
| description | rinse arm L 620mm nozzles 6 mounting ø 16mm mounting pos. lower complete | | |

| | | | |
|---|---|-----------------|---------|
|  | | | |
| 1 | | | |
| GEV No. | 505045 | Ref. No. | 0200303 |
| description | O-ring EPDM thickness 1.78mm ID ø 5.28mm Qty 1 pcs | | |
| For models: | 015-24L, 050F, 050F-Dep, F85, F85-Dep, L20, L21, LP31L, LP6, LP6L, M115, M150, MATIC20, P550, S200, S280, S280Dep, Super-QS, Super-QS-Dep | | |

| | | | |
|---|--|-----------------|---------|
|  | | | |
| 1 | | | |
| GEV No. | 506069 | Ref. No. | 0200372 |
| description | rinse arm L 295mm nozzles 3 thread M12x1 mounting pos. upper/lower | | |
| For models: | LP31L, LP6, LP6L | | |

| | | | |
|---|--|-----------------|---------|
|  | | | |
| 1 | | | |
| GEV No. | 506070 | Ref. No. | 0200373 |
| description | rinse arm L 295mm nozzles 3 thread M12x1 mounting pos. upper/lower | | |
| For models: | LP31L, LP6, LP6L | | |

| | | | |
|--|------------------|-----------------|---------|
|  | | | |
| 1 | | | |
| GEV No. | 506087 | Ref. No. | 0201150 |
| description | rinse arm boss | | |
| For models: | LP31L, LP6, LP6L | | |

| | | | |
|---|---|-----------------|---------|
|  | | | |
| 1 | | | |
| GEV No. | 517658 | Ref. No. | 0201172 |
| description | rinse jet mounting pos. upper/lower ø 1.2mm H 19mm SS | | |
| For models: | LP31L, LP6, LP6L, M115, M150, MATIC20 | | |

| | | | |
|---|---|-----------------|---------|
|  | | | |
| 1 | | | |
| GEV No. | 524788 | Ref. No. | 0200625 |
| description | union nut for rinse jet mounting pos. upper/lower thread M12x1 H 10mm WS 14 | | |
| For models: | 015-24L, 050F, 050F-Dep, F85, F85-Dep, L20, L21, LP31L, LP6, LP6L, M115, M150, MATIC20, S200, S280, S280Dep, Super-QS, Super-QS-Dep | | |





| | | | |
|---|--|-----------------|---------|
|  | | | |
| 1 | | | |
| GEV No. | 506080 | Ref. No. | 0200805 |
| description | rinse arm L 472mm nozzles 6 mounting ø 16mm mounting pos. upper complete | | |

| | | | |
|---|---|-----------------|---------|
|  | | | |
| 1 | | | |
| GEV No. | 505045 | Ref. No. | 0200303 |
| description | O-ring EPDM thickness 1.78mm ID ø 5.28mm Qty 1 pcs | | |
| For models: | 015-24L, 050F, 050F-Dep, F85, F85-Dep, L20, L21, LP31L, LP6, LP6L, M115, M150, MATIC20, P550, S200, S280, S280Dep, Super-QS, Super-QS-Dep | | |

| | | | |
|---|--|-----------------|---------|
|  | | | |
| 1 | | | |
| GEV No. | 506001 | Ref. No. | 0200012 |
| description | rinse arm L 235mm nozzles 3 thread M12x1 mounting pos. lower | | |
| For models: | 015-24L, 050F, 050F-Dep, F85, F85-Dep, L20, L21, P550 | | |

| | | | |
|---|--|-----------------|---------|
|  | | | |
| 1 | | | |
| GEV No. | 506002 | Ref. No. | 0200013 |
| description | rinse arm L 235mm nozzles 3 thread M12x1 mounting pos. lower | | |
| For models: | 015-24L, 050F, 050F-Dep, F85, F85-Dep, L20, L21, P550 | | |

| | | | |
|---|--|-----------------|---------|
|  | | | |
| 1 | | | |
| GEV No. | 506088 | Ref. No. | 0201151 |
| description | rinse arm boss | | |
| For models: | 015-24L, 050F, 050F-Dep, F85, F85-Dep, L20, L21, P550, S200, S280, S280Dep, Super-QS, Super-QS-Dep | | |

| | | | |
|---|---|-----------------|---------|
|  | | | |
| 1 | | | |
| GEV No. | 517658 | Ref. No. | 0201172 |
| description | rinse jet mounting pos. upper/lower ø 1.2mm H 19mm SS | | |
| For models: | LP31L, LP6, LP6L, M115, M150, MATIC20 | | |

| | | | |
|---|---|-----------------|---------|
|  | | | |
| 1 | | | |
| GEV No. | 524788 | Ref. No. | 0200625 |
| description | union nut for rinse jet mounting pos. upper/lower thread M12x1 H 10mm WS 14 | | |
| For models: | 015-24L, 050F, 050F-Dep, F85, F85-Dep, L20, L21, LP31L, LP6, LP6L, M115, M150, MATIC20, S200, S280, S280Dep, Super-QS, Super-QS-Dep | | |

| | | | |
|--|---|-----------------|---------|
|  | | | |
| 1 | | | |
| GEV No. | 517656 | Ref. No. | 0201844 |
| description | rinse arm mounting pos. upper/lower L 500mm nozzles 4 stationary thread M12x1 | | |
| For models: | M115, M150 | | |

| | | | |
|---|---|-----------------|---------|
|  | | | |
| 1 | | | |
| GEV No. | 524781 | Ref. No. | 0200376 |
| description | rinse arm mounting pos. upper/lower L 590mm nozzles 5 stationary thread M12x1 | | |

| | | | |
|---|---|-----------------|---------|
|  | | | |
| 1 | | | |
| GEV No. | 505045 | Ref. No. | 0200303 |
| description | O-ring EPDM thickness 1.78mm ID ø 5.28mm Qty 1 pcs | | |
| For models: | 015-24L, 050F, 050F-Dep, F85, F85-Dep, L20, L21, LP31L, LP6, LP6L, M115, M150, MATIC20, P550, S200, S280, S280Dep, Super-QS, Super-QS-Dep | | |

| | | | |
|---|---|-----------------|---------|
|  | | | |
| 1 | | | |
| GEV No. | 517658 | Ref. No. | 0201172 |
| description | rinse jet mounting pos. upper/lower ø 1.2mm H 19mm SS | | |
| For models: | LP31L, LP6, LP6L, M115, M150, MATIC20 | | |

| | | | |
|---|---|-----------------|---------|
|  | | | |
| 1 | | | |
| GEV No. | 506233 | Ref. No. | 0201171 |
| description | rinse jet mounting pos. upper/lower ø 1.5mm H 20mm SS | | |
| For models: | 015-24L, 050F, 050F-Dep, F85, F85-Dep, L20, L21, MATIC20, S200, S280, S280Dep, Super-QS, Super-QS-Dep | | |

| | | | |
|---|---|-----------------|---------|
|  | | | |
| 1 | | | |
| GEV No. | 506234 | Ref. No. | 0201170 |
| description | rinse jet mounting pos. upper/lower ø 1.8mm H 20mm SS | | |

| | | | |
|---|---|-----------------|---------|
|  | | | |
| 1 | | | |
| GEV No. | 524788 | Ref. No. | 0200625 |
| description | union nut for rinse jet mounting pos. upper/lower thread M12x1 H 10mm WS 14 | | |
| For models: | 015-24L, 050F, 050F-Dep, F85, F85-Dep, L20, L21, LP31L, LP6, LP6L, M115, M150, MATIC20, S200, S280, S280Dep, Super-QS, Super-QS-Dep | | |



| | | | |
|---|---|-----------------|---------|
|  | | | |
| 1 | | | |
| GEV No. | 506216 | Ref. No. | 0200803 |
| description | rinse arm L 372mm nozzles 4 mounting ø 16mm mounting pos. upper | | |

| | | | |
|---|---|-----------------|---------|
|  | | | |
| 1 | | | |
| GEV No. | 505045 | Ref. No. | 0200303 |
| description | O-ring EPDM thickness 1.78mm ID ø 5.28mm Qty 1 pcs | | |
| For models: | 015-24L, 050F, 050F-Dep, F85, F85-Dep, L20, L21, LP31L, LP6, LP6L, M115, M150, MATIC20, P550, S200, S280, S280Dep, Super-QS, Super-QS-Dep | | |

| | | | |
|---|--|-----------------|---------|
|  | | | |
| 1 | | | |
| GEV No. | 506005 | Ref. No. | 0200014 |
| description | rinse arm L 175mm nozzles 2 thread M12x1 mounting pos. upper/lower | | |
| For models: | S280, S280Dep, Super-QS, Super-QS-Dep | | |

| | | | |
|---|--|-----------------|---------|
|  | | | |
| 1 | | | |
| GEV No. | 506006 | Ref. No. | 0200015 |
| description | rinse arm L 175mm nozzles 2 thread M12x1 mounting pos. upper/lower | | |
| For models: | S280, S280Dep, Super-QS, Super-QS-Dep | | |

| | | | |
|---|--|-----------------|---------|
|  | | | |
| 1 | | | |
| GEV No. | 506088 | Ref. No. | 0201151 |
| description | rinse arm boss | | |
| For models: | 015-24L, 050F, 050F-Dep, F85, F85-Dep, L20, L21, P550, S200, S280, S280Dep, Super-QS, Super-QS-Dep | | |

| | | | |
|---|--|-----------------|-----------------|
|  | | | |
| 1 | | | |
| GEV No. | 506089 | Ref. No. | 0201164 |
| description | rinse jet | | |
| For models: | 015-24L, 050F, 050F-Dep, F85, F85-Dep, L20, L21, P550, S200, S280, S280Dep, Super-QS, Super-QS-Dep | | |
| accessories for | 506089 | | |
|  | GEV No. | 505045 | Ref. No. |
| | | | 0200303 |
| | O-ring EPDM thickness 1.78mm ID ø 5.28mm Qty 1 pcs | | |
|  | GEV No. | 524788 | Ref. No. |
| | | | 0200625 |
| | union nut for rinse jet mounting pos. upper/lower thread M12x1 H 10mm WS 14 | | |

| | | | |
|--|--|-----------------|---------|
|  | | | |
| 1 | | | |
| GEV No. | 506090 | Ref. No. | 0201165 |
| description | rinse jet ø 1.5mm approval NSF | | |
| For models: | 015-24L, 050F, 050F-Dep, F85, F85-Dep, L20, L21, P550, S200, S280, S280Dep, Super-QS, Super-QS-Dep | | |

| | | | |
|---|--|-----------------|---------|
|  | | | |
| 1 | | | |
| GEV No. | 506075 | Ref. No. | 0200608 |
| description | union nut rinse jet | | |
| For models: | 015-24L, 050F, 050F-Dep, F85, F85-Dep, L20, L21, P550, S200, S280, S280Dep, Super-QS, Super-QS-Dep | | |

| | | | |
|--|---|-----------------|---------|
|  | | | |
| 1 | | | |
| GEV No. | 517659 | Ref. No. | 0200814 |
| description | rinse arm mounting pos. lower L 480mm nozzles 6 mounting ø 20mm | | |





| | | | |
|---|---|-----------------|---------|
|  | | | |
| 1 | | | |
| GEV No. | 517660 | Ref. No. | 0200815 |
| description | rinse arm mounting pos. lower nozzles 5 | | |
| For models: | DSP4 | | |

| | | | |
|---|--|-----------------|---------|
|  | | | |
| 1 | | | |
| GEV No. | 506019 | Ref. No. | 0200086 |
| description | rinse arm boss | | |
| For models: | 015-24L, 050F, 050F-Dep, DSP1, DSP2, DSP4, DSP5, F85, F85-Dep, L20, L21, P550, S200, S280, S280Dep, Super-QS, Super-QS-Dep | | |





| | | | |
|---|------------------------------------|-----------------|---------|
|  | | | |
| 1 | | | |
| GEV No. | 506049 | Ref. No. | 0200186 |
| description | rinse jet thread 1/8" hole ø 0.9mm | | |
| For models: | DSP1, DSP2, DSP4, DSP5 | | |

| | | | |
|---|------------------------------------|-----------------|---------|
|  | | | |
| 1 | | | |
| GEV No. | 506050 | Ref. No. | 0200187 |
| description | rinse jet thread 1/8" hole ø 1.8mm | | |
| For models: | DSP1, DSP2, DSP4, DSP5 | | |

| | | | |
|---|--|-----------------|---------|
|  | | | |
| 1 | | | |
| GEV No. | 506048 | Ref. No. | 0200181 |
| description | union nut thread 3/8" SS cone-shaped | | |
| For models: | 015-24L, DSP1, DSP2, DSP4, DSP5, L20, L21, P550, S200, S280, S280Dep, Super-QS, Super-QS-Dep | | |

| | | | |
|---|--|-----------------|---------|
|  | | | |
| 1 | | | |
| GEV No. | 517670 | Ref. No. | 0201174 |
| description | wash jet for pre-rinsing mounting pos. upper/lower H 23mm ø 12mm | | |

| | | | |
|--|---|-----------------|---------|
|  | | | |
| 1 | | | |
| GEV No. | 506268 | Ref. No. | 0200853 |
| description | rinse arm L 425mm nozzles 5 mounting ø 18mm | | |

| miscellaneous | | | |
|---|--------------------------------|-----------------|-----------------|
|  | | | |
| 1 | | | |
| GEV No. | 506066 | Ref. No. | 0200315 |
| description | opposite support rinse jet | | |
| For models: | DSP1, DSP2, DSP4, DSP5 | | |
| accessories for | 506066 | | |
|  | GEV No. | 506417 | Ref. No. |
| | | | 0200089 |
| description | swirl H 14mm ø 10mm 2mm H1 5mm | | |
|  | GEV No. | 506418 | Ref. No. |
| | | | 0200088 |
| description | rinse jet | | |
|  | GEV No. | 506430 | Ref. No. |
| | | | 0200249 |
| description | rinse jet holder | | |

| | | | |
|---|------------------------|-----------------|---------|
|  | | | |
| 1 | | | |
| GEV No. | 506418 | Ref. No. | 0200088 |
| description | rinse jet | | |
| For models: | DSP1, DSP2, DSP4, DSP5 | | |

| | | | |
|---|-----------------------------|-----------------|---------|
|  | | | |
| 1 | | | |
| GEV No. | 506037 | Ref. No. | 0200132 |
| description | rinse jet thread 1/8" brass | | |

| | | | |
|---|------------------|-----------------|---------|
|  | | | |
| 1 | | | |
| GEV No. | 506057 | Ref. No. | 0200250 |
| description | rinse jet holder | | |









| | | | |
|---|--|-----------------|-----------------|
|  | | | |
| 1 | | | |
| GEV No. | 506430 | Ref. No. | 0200249 |
| description | rinse jet holder | | |
| For models: | DSP1, DSP2, DSP4, DSP5 | | |
| spare parts for | 506430 | | |
|  | GEV No. | 510177 | Ref. No. |
| | | | 0200239 |
| description | O-ring EPDM thickness 1.78mm ID ø 7.66mm Qty 1 pcs | | |

Table continues overleaf

| | | | |
|---|--------------------------------|--------|-------------------------|
| accessories for | 506430 | | |
|  | GEV No. | 506066 | Ref. No. 0200315 |
| | opposite support rinse jet | | |
|  | GEV No. | 506417 | Ref. No. 0200089 |
| | swirl H 14mm ø 10mm 2mm H1 5mm | | |
|  | GEV No. | 506418 | Ref. No. 0200088 |
| | rinse jet | | |

| | | | |
|---|--------------------------------|--------|-------------------------|
|  | GEV No. | 506417 | Ref. No. 0200089 |
| description | swirl H 14mm ø 10mm 2mm H1 5mm | | |
| For models: | DSP1, DSP2, DSP4, DSP5 | | |

| | | | |
|---|--------------------------------------|--------|-------------------------|
|  | GEV No. | 506099 | Ref. No. 0201809 |
| description | opposite support mounting pos. lower | | |

| | | | |
|---|--------------------------------------|--------|-------------------------|
|  | GEV No. | 506033 | Ref. No. 0200126 |
| description | wash arm support mounting pos. lower | | |
| For models: | 050F, 050F-Dep, F85, F85-Dep | | |

| | | | |
|---|--------------------------------------|--------|-------------------------|
|  | GEV No. | 506427 | Ref. No. 0201801 |
| description | wash arm support mounting pos. lower | | |

| | | | |
|---|---|--------|-------------------------|
|  | GEV No. | 524785 | Ref. No. 0201452 |
| description | wash arm support mounting pos. lower thread 1/4" D1 ø 59mm D2 ø 43mm D3 ø 37mm H 65mm ID ø 31.5mm | | |

| | | | |
|---|---|--------|-------------------------|
|  | GEV No. | 506092 | Ref. No. 0201451 |
| description | wash arm support mounting pos. lower thread 1/4" ø 15.5mm nylon | | |
| For models: | DSP1, DSP2, DSP4, S200, S280, S280Dep, Super-QS, Super-QS-Dep | | |

| | | | |
|---|---|--------|-------------------------|
|  | GEV No. | 506219 | Ref. No. 0200032 |
| description | wash arm bearing 14 holes ø 54mm D2 ø 41mm H 52mm thread 1/4" | | |

| | | | |
|---|---|--------|-------------------------|
|  | GEV No. | 506116 | Ref. No. 0202101 |
| description | wash arm bearing mounting pos. lower 2 holes hole ø 16mm seat ø 18mm ø 35.5mm D2 ø 41mm D3 ø 53.5mm H 51.5mm double thread 1/4" | | |
| For models: | 015-24L, 050F, 050F-Dep, DSP5, F85, F85-Dep, L20, L21 | | |

| | | | |
|---|---|--------|-------------------------|
|  | GEV No. | 506117 | Ref. No. 0202103 |
| description | wash arm bearing mounting pos. lower 4 holes hole ø 16mm seat ø 18mm ø 35mm D2 ø 41mm D3 ø 54mm H 52mm 4-fold thread 1/4" | | |
| For models: | 015-24L, DSP1, DSP2, DSP4, P550, S200, S280, S280Dep, Super-QS, Super-QS-Dep | | |

| | | | |
|---|--|--------|-------------------------|
|  | GEV No. | 506118 | Ref. No. 0202120 |
| description | wash arm bearing mounting pos. upper 4 holes hole ø 16mm seat ø 22mm ø 35.5mm D2 ø 41mm D3 ø 54mm H 52mm thread 1/4" | | |
| For models: | 015-24L, 050F, 050F-Dep, F85, F85-Dep, L20, L21, P550 | | |

| | | | |
|---|---|--------|-------------------------|
|  | GEV No. | 506227 | Ref. No. 0202113 |
| description | wash arm bearing mounting pos. upper ø 54mm D2 ø 41mm D3 ø 35.5mm H 51.5mm 4-fold thread M8 | | |
| For models: | DSP4, DSP5 | | |



rinse arm shafts

| | | | |
|---|-----------------|-----------------|---------|
|  | | | |
| 1 | | | |
| GEV No. | 506084 | Ref. No. | 0201001 |
| description | rinse arm shaft | | |

| | | | |
|---|--|-----------------|---------|
|  | | | |
| 1 | | | |
| GEV No. | 506086 | Ref. No. | 0201003 |
| description | rinse arm shaft | | |
| For models: | 015-24L, 050F, 050F-Dep, F85, F85-Dep, L20, L21, P550, S200, S280, S280Dep, Super-QS, Super-QS-Dep | | |

| | | | |
|--|---|-----------------|---------|
|  Image not available | | | |
| 1 | | | |
| GEV No. | 506085 | Ref. No. | 0201002 |
| description | rinse arm shaft for rinse arm mounting pos. upper | | |

gear wheels

| | | | |
|---|--|-----------------|---------|
|  | | | |
| 1 | | | |
| GEV No. | 698414 | Ref. No. | 0802722 |
| description | gear wheel splitting 1/2" teeth 22 shaft intake ø 45mm H 7mm | | |
| For models: | M115, M150 | | |

knobs

producer-specific knobs

LAMBER

| | | | |
|---|--------------------------------|-----------------|---------|
|  | | | |
| 1 | | | |
| GEV No. | 112633 | Ref. No. | 0300352 |
| description | knob ø 33mm shaft ø 6x6mm grey | | |
| For models: | F85-Dep | | |

| | | | |
|--|---|-----------------|---------|
|  | | | |
| 1 | | | |
| GEV No. | 110905 | Ref. No. | 0300049 |
| description | knob switch zero mark ø 42mm shaft ø 6x4.6mm shaft flat right black | | |
| For models: | F85, L20 | | |

handles and hand wheels

handle rails

LAMBER

| | | | |
|--|--|-----------------|---------|
|  | | | |
| 1 | | | |
| GEV No. | 508399 | Ref. No. | 0500017 |
| description | handle rail L 310mm W 25mm H 30mm grey hole distance 180mm Qty 1 pcs | | |
| For models: | DSP1, DSP2, DSP4 | | |

handle rails

| | | | |
|--|--|-----------------|---------|
|  | | | |
| 1 | | | |
| GEV No. | 508399 | Ref. No. | 0500017 |
| description | handle rail L 310mm W 25mm H 30mm grey hole distance 180mm Qty 1 pcs | | |
| For models: | DSP1, DSP2, DSP4 | | |

bracket handles

| | | | |
|--|------------------------|-----------------|--------------------|
|  | | | |
| 1 | | | |
| GEV No. | 506147 | Ref. No. | 0500045 0500049 |
| description | pull handle | | |
| For models: | DSP5, LP31L, LP6, LP6L | | |

hinges

piano hinges

producer-specific

LAMBER

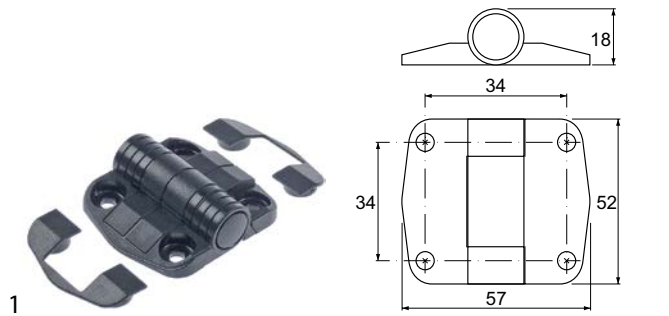

| | | | |
|--------------------|--|-----------------|---------|
| GEV No. | 692467 | Ref. No. | 0800174 |
| description | hinge L 52mm W 57mm H 18mm mounting distance 34mm hole ø 5mm plastic | | |

pullouts

rollers

rollers

accessories



| | | | |
|--------------------|---|-----------------|--------------------|
| GEV No. | 560133 | Ref. No. | 0800063 0800656 |
| description | hexagonal nut thread M6 H 5mm WS 10 SS DIN/ISO DIN 934 / ISO 4032/8673 Qty 20 pcs | | |
| For models: | 015-24L, 050F, 050F-Dep, F85, F85-Dep, L20, L21, LP31L, LP6, LP6L, M115, M150, MATIC20, P550, S200, S280, S280Dep, Super-QS, Super-QS-Dep | | |

gaskets

O-rings

EPDM

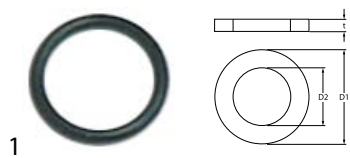

| | | | |
|--------------------|---|-----------------|---------|
| GEV No. | 510302 | Ref. No. | 0200103 |
| description | O-ring EPDM ID ø 12.42mm thickness 1.78mm Qty 1 pcs | | |
| For models: | 050F, 050F-Dep, F85, F85-Dep, S200, S280, S280Dep, Super-QS, Super-QS-Dep | | |

| | | | |
|--------------------|---|-----------------|---------|
| GEV No. | 505045 | Ref. No. | 0200303 |
| description | O-ring EPDM thickness 1.78mm ID ø 5.28mm Qty 1 pcs | | |
| For models: | 015-24L, 050F, 050F-Dep, F85, F85-Dep, L20, L21, LP31L, LP6, LP6L, M115, M150, MATIC20, P550, S200, S280, S280Dep, Super-QS, Super-QS-Dep | | |

| | | | |
|--------------------|--|-----------------|---------|
| GEV No. | 510177 | Ref. No. | 0200239 |
| description | O-ring EPDM thickness 1.78mm ID ø 7.66mm Qty 1 pcs | | |
| For models: | DSP1, DSP2, DSP4, DSP5 | | |

| | | | |
|--------------------|---|-----------------|---------|
| GEV No. | 532047 | Ref. No. | 0200211 |
| description | O-ring EPDM thickness 2.62mm ID ø 7.59mm Qty 10 pcs | | |
| For models: | 015-24L, F85-Dep, L20, L21 | | |

| | | | |
|--------------------|---|-----------------|---------|
| GEV No. | 528800 | Ref. No. | 0209905 |
| description | O-ring EPDM thickness 2.62mm ID ø 75.87mm Qty 1 pcs | | |

| | | | |
|--------------------|--|-----------------|---------|
| GEV No. | 510893 | Ref. No. | 0203012 |
| description | O-ring EPDM thickness 2.62mm ID ø 9.92mm Qty 1 pcs | | |

| | | | |
|--------------------|---|-----------------|---------|
| GEV No. | 506015 | Ref. No. | 0200056 |
| description | O-ring EPDM thickness 3.53mm ID ø 39.69mm Qty 1 pcs | | |
| For models: | 015-24L, 050F, 050F-Dep, DSP1, DSP2, DSP4, DSP5, F85, L20, L21, P550, S200, S280, S280Dep, Super-QS, Super-QS-Dep | | |

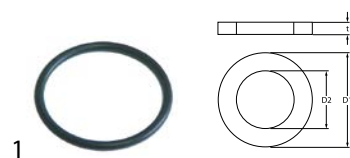
1

| | | | |
|--------------------|---|-----------------|---------|
| GEV No. | 532547 | Ref. No. | 0203009 |
| description | O-ring EPDM thickness 3.53mm ID ø 44.45mm Qty 1 pcs | | |
| For models: | 050F, 050F-Dep, F85, F85-Dep | | |



1

| | | | |
|--------------------|---|-----------------|---------|
| GEV No. | 510409 | Ref. No. | 0200041 |
| description | O-ring EPDM thickness 5.34mm ID ø 56.52mm Qty 1 pcs | | |
| For models: | 015-24L, 050F, 050F-Dep, DSP1, DSP2, DSP4, DSP5, F85, F85-Dep, L20, L21, LP31L, LP6, LP6L, M115, M150, MATIC20, P550, S200, S280, S280Dep, Super-QS, Super-QS-Dep | | |

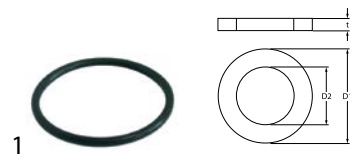

1

| | | | |
|--------------------|---|-----------------|---------|
| GEV No. | 528315 | Ref. No. | 0800074 |
| description | O-ring EPDM thickness 3.53mm ID ø 47.63mm Qty 1 pcs | | |

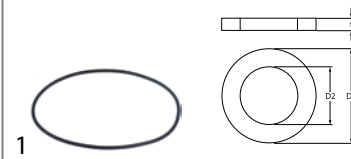

1

| | | | |
|--------------------|---|-----------------|---------|
| GEV No. | 503147 | Ref. No. | 0209906 |
| description | pump cover gasket thickness 3.53mm ID ø 148.8mm Qty 1 pcs | | |

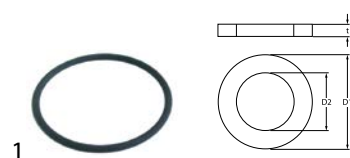

1

| | | | |
|--------------------|---|-----------------|---------|
| GEV No. | 528793 | Ref. No. | 0203003 |
| description | O-ring EPDM thickness 3.53mm ID ø 58.74mm Qty 1 pcs | | |

sealing washers

fibre gaskets

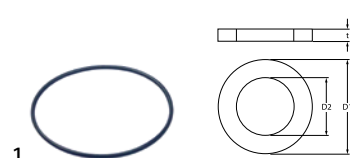

1

| | | | |
|--------------------|---|-----------------|---------|
| GEV No. | 890224 | Ref. No. | 0203004 |
| description | O-ring EPDM thickness 3.53mm ID ø 98.02mm Qty 1 pcs | | |
| For models: | M115, M150, MATIC20 | | |



1

| | | | |
|--------------------|--|-----------------|---------|
| GEV No. | 506046 | Ref. No. | 0200178 |
| description | flat gasket FIBER ED ø 19.5mm ID ø 13mm thickness 2mm Qty 1 pcs | | |
| For models: | 015-24L, 050F, 050F-Dep, DSP5, F85, F85-Dep, L20, L21, S200, S280, S280Dep, Super-QS, Super-QS-Dep | | |

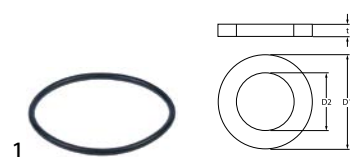

1

| | | | |
|--------------------|---|-----------------|---------|
| GEV No. | 510811 | Ref. No. | 0200224 |
| description | O-ring EPDM thickness 3mm ID ø 59.2mm Qty 1 pcs | | |



1

| | | | |
|--------------------|---|-----------------|---------|
| GEV No. | 506071 | Ref. No. | 0200402 |
| description | flat gasket FIBER ED ø 25mm ID ø 18mm thickness 2mm Qty 1 pcs | | |
| For models: | S200, S280, S280Dep, Super-QS, Super-QS-Dep | | |

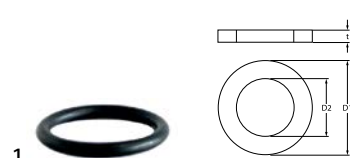

1

| | | | |
|--------------------|---|-----------------|---------|
| GEV No. | 532577 | Ref. No. | 0203011 |
| description | O-ring EPDM thickness 5.34mm ID ø 40.65mm Qty 1 pcs | | |
| For models: | F85-Dep | | |



1

| | | | |
|--------------------|--|-----------------|---------|
| GEV No. | 506042 | Ref. No. | 0200171 |
| description | flat gasket FIBER ED ø 27mm ID ø 17mm thickness 2mm Qty 1 pcs | | |
| For models: | 015-24L, DSP1, DSP2, DSP4, L20, L21, S200, S280, S280Dep, Super-QS, Super-QS-Dep | | |



1

| | | | |
|--------------------|---|-----------------|---------|
| GEV No. | 506025 | Ref. No. | 0200110 |
| description | flat gasket FIBER ED ø 31mm ID ø 21mm thickness 2mm Qty 1 pcs | | |
| For models: | 015-24L, 050F, 050F-Dep, F85, F85-Dep, L20, L21, LP31L, LP6, LP6L, M115, M150, MATIC20, P550, S200, S280, S280Dep, Super-QS, Super-QS-Dep | | |



2

| | | | |
|--------------------|--|-----------------|---------|
| GEV No. | 506072 | Ref. No. | 0200403 |
| description | flat gasket fibre ED ø 38mm ID ø 27mm thickness 2mm outflow for thread 1¼" Qty 1 pcs | | |
| For models: | 015-24L, 050F, 050F-Dep, DSP5, F85, F85-Dep, L20, L21, P550, S200, S280, S280Dep, Super-QS, Super-QS-Dep | | |

rubber gaskets



1

| | | | |
|--------------------|---|-----------------|---------|
| GEV No. | 506051 | Ref. No. | 0200188 |
| description | flat gasket rubber ED ø 25mm ID ø 16mm thickness 2mm Qty 1 pcs | | |
| For models: | 015-24L, 050F, 050F-Dep, DSP1, DSP2, DSP4, DSP5, F85, F85-Dep, L20, L21, LP6, LP6L, P550, S200, S280, S280Dep, Super-QS, Super-QS-Dep | | |



1

| | | | |
|--------------------|--|-----------------|---------|
| GEV No. | 516254 | Ref. No. | 0201500 |
| description | flat gasket rubber ED ø 66mm ID ø 46mm thickness 2.1mm Qty 1 pcs | | |
| For models: | LP31L, LP6, LP6L, M115, M150, MATIC20 | | |



1

| | | | |
|--------------------|---|-----------------|--------------------|
| GEV No. | 506121 | Ref. No. | 0201524 0208153 |
| description | flat gasket rubber ED ø 68mm ID ø 41mm thickness 2mm Qty 1 pcs | | |
| For models: | DSP1, DSP2, L20, L21, S200, S280, S280Dep, Super-QS, Super-QS-Dep | | |



1

| | | | |
|--------------------|---|-----------------|---------|
| GEV No. | 506043 | Ref. No. | 0200173 |
| description | flat gasket rubber ED ø 75mm ID ø 58.5mm thickness 2mm Qty 1 pcs | | |
| For models: | 015-24L, 050F, 050F-Dep, DSP4, DSP5, F85, F85-Dep, L20, L21, P550 | | |

PTFE gaskets



1

| | | | |
|--------------------|--|-----------------|--------------------|
| GEV No. | 506164 | Ref. No. | 0200222 0800052 |
| description | flat gasket PTFE ED ø 57mm ID ø 41mm thickness 2mm Qty 1 pcs | | |
| For models: | 015-24L, 050F, 050F-Dep, DSP1, DSP2, DSP4, DSP5, F85, F85-Dep, L20, L21, P550, S200, S280, S280Dep, Super-QS, Super-QS-Dep | | |



1

| | | | |
|--------------------|--|-----------------|---------|
| GEV No. | 506058 | Ref. No. | 0200268 |
| description | gasket PTFE ED ø 15mm ID ø 12.2mm thickness 9mm beveled size 3/8" Qty 1 pcs | | |
| For models: | 015-24L, 050F, 050F-Dep, DSP1, DSP2, DSP4, DSP5, F85, F85-Dep, L20, L21, LP31L, LP6, LP6L, P550, S200, S280, S280Dep, Super-QS, Super-QS-Dep | | |

silicone gaskets



1

| | | | |
|--------------------|---|-----------------|---------|
| GEV No. | 516255 | Ref. No. | 0200304 |
| description | gasket silicone ED ø 45mm ID ø 35mm thickness 6mm Qty 1 pcs | | |
| For models: | LP31L, LP6, LP6L, M115, M150, MATIC20 | | |

shaft gaskets

shaft gaskets



1

| | | | |
|--------------------|--|-----------------|---------|
| GEV No. | 697121 | Ref. No. | 0800080 |
| description | shaft seal ID ø 17mm ED ø 40mm thickness 7mm | | |
| For models: | M115, M150, MATIC20 | | |



1

| | | | |
|--------------------|--|-----------------|---------|
| GEV No. | 698001 | Ref. No. | 0800078 |
| description | shaft seal ID ø 20mm ED ø 35mm thickness 7mm | | |
| For models: | M115, M150, MATIC20 | | |

| | | | |
|---|---|-----------------|---------|
|  | | | |
| 1 | | | |
| GEV No. | 698413 | Ref. No. | 0209780 |
| description | shaft sealing ID \varnothing 18mm ED \varnothing 40mm thickness 7mm | | |

special gaskets

miscellaneous

| | | | |
|---|------------------|-----------------|---------|
|  | | | |
| 1 | | | |
| GEV No. | 506044 | Ref. No. | 0200175 |
| description | gasket | | |
| For models: | DSP1, DSP2, DSP4 | | |

| | | | |
|---|--|-----------------|---------|
|  | | | |
| 1 | | | |
| GEV No. | 506039 | Ref. No. | 0200145 |
| description | gasket ED \varnothing 7mm ID \varnothing 5mm thickness 3mm | | |
| For models: | DSP1, DSP2, DSP4 | | |

| | | | |
|--|---------------------|-----------------|---------|
|  | | | |
| 1 | | | |
| GEV No. | 506429 | Ref. No. | 0200289 |
| description | gasket for air trap | | |
| For models: | DSP2, DSP4 | | |

| | | | |
|---|--|-----------------|---------|
|  | | | |
| 1 | | | |
| GEV No. | 504442 | Ref. No. | 0201532 |
| description | gasket for intake filter ED \varnothing 140mm ID \varnothing 84mm thickness 2mm hole distance 78mm | | |

| | | | |
|---|--|-----------------|---------|
|  | | | |
| 1 | | | |
| GEV No. | 524792 | Ref. No. | 0200259 |
| description | gasket for rinse arm mounting pos. upper/lower \varnothing 22.5mm ID \varnothing 13mm thickness 10mm | | |
| For models: | M115, M150, MATIC20 | | |

| | | | |
|--|--|-----------------|---------|
|  | | | |
| 1 | | | |
| GEV No. | 524786 | Ref. No. | 0200400 |
| description | gasket for wash arm mounting pos. upper/lower \varnothing 46mm ID \varnothing 36mm | | |
| For models: | M115, M150, MATIC20 | | |

| | | | |
|--|---|-----------------|---------|
|  | | | |
| 1 | | | |
| GEV No. | 506063 | Ref. No. | 0200295 |
| description | gasket suitable for Lamber equiv. no. 0200295 air trap ED \varnothing 15.5mm ID \varnothing 11.5mm Nyltite | | |
| For models: | 015-24L, 050F, 050F-Dep, DSP1, DSP5, F85, F85-Dep, L20, L21, LP31L, LP6, LP6L, M115, M150, MATIC20, P550, S200, S280, S280Dep, Super-QS, Super-QS-Dep | | |

| | | | |
|---|---|-----------------|--------------------|
|  | | | |
| 1 | | | |
| GEV No. | 506097 | Ref. No. | 0201506 0203506 |
| description | gasket suitable for Lamber equiv. no. 0201506 L 100mm W 100mm thickness 3mm | | |
| For models: | 015-24L, LP31L, LP6, LP6L, M115, M150, MATIC20, P550 | | |

| | | | |
|--|--|-----------------|---------|
|  | | | |
| 1 | | | |
| GEV No. | 524258 | Ref. No. | 0201504 |
| description | gasket suitable for Lamber for wash arm support L 100mm W 100mm Qty 1m ID \varnothing 61mm | | |
| For models: | LP31L, LP6, LP6L | | |

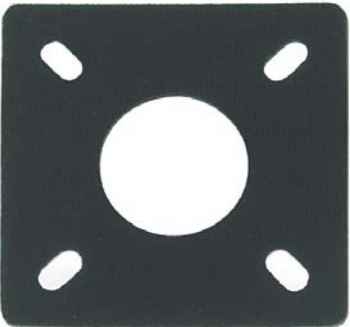

1

| | | | |
|--------------------|--|-----------------|---------|
| GEV No. | 504440 | Ref. No. | 0201505 |
| description | gasket suitable for Lamber L 100mm W 100mm ID ø 43mm thickness 3mm | | |
| For models: | M115, M150, MATIC20 | | |

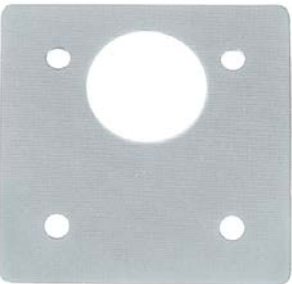

1

| | | | |
|--------------------|---|-----------------|---------|
| GEV No. | 504441 | Ref. No. | 0201503 |
| description | gasket suitable for Lamber L 100mm W 100mm Qty 1m ID ø 40mm thickness 3mm | | |
| For models: | M115, M150, MATIC20 | | |

gaskets for wash arm support



1

| | | | |
|--------------------|---|-----------------|---------|
| GEV No. | 506021 | Ref. No. | 0200097 |
| description | gasket D1 ø 45mm D2 ø 105mm thickness 3.4mm rubber with 4 screw holes wash arm support equiv. no. 0200097 suitable for Lamber | | |
| For models: | 015-24L, 050F, 050F-Dep, DSP5, F85, F85-Dep, L20, L21, M115, M150, MATIC20, P550 | | |

transmission technology and ball bearings

chains

roller chains 08B-1 single

1 

| | | | |
|------------------------|--|-----------------|---------|
| GEV No. | 697854 | Ref. No. | 0800081 |
| description | roller chain DIN/ISO 08 B-1 splitting 1/2" / 12.7mm links 90 L 226mm internal width 7.75mm rollerø 8.51mm single | | |
| For models: | MATIC20 | | |
| accessories for | 697854 | | |

| | | | | |
|---|--------------------|---|-----------------|---------|
|  | GEV No. | 693276 | Ref. No. | 0813444 |
| | description | connector single DIN/ISO 08 B-1 splitting 1/2" links 1 L 23mm internal width 11.8mm rollerø 4.3mm metal | | |

connectors

1 

| | | | |
|--------------------|---|-----------------|---------|
| GEV No. | 693276 | Ref. No. | 0813444 |
| description | connector single DIN/ISO 08 B-1 splitting 1/2" links 1 L 23mm internal width 11.8mm rollerø 4.3mm metal | | |
| For models: | M115, M150, MATIC20 | | |

half links

1 

| | | | |
|--------------------|--|-----------------|---------|
| GEV No. | 697841 | Ref. No. | 0813534 |
| description | half link single DIN/ISO 08 B-1 splitting 1/2" | | |
| For models: | M115, M150, MATIC20 | | |

springs

spring compressors

1 

| | | | |
|--------------------|------------------------------|-----------------|---------|
| GEV No. | 517160 | Ref. No. | 0800210 |
| description | spring compressor thread M10 | | |
| For models: | 015-24L, L20, L21 | | |



tension springs

| | | | |
|---|----------------|-----------------|---------|
|  | | | |
| 1 | | | |
| GEV No. | 506424 | Ref. No. | 0800033 |
| description | tension spring | | |

| | | | |
|---|---|-----------------|---------|
|  | | | |
| 1 | | | |
| GEV No. | 700730 | Ref. No. | 0800161 |
| description | tension spring ø 12mm total length 100mm wire gauge ø 1mm | | |
| For models: | LP31L, LP6, LP6L | | |

| | | | |
|---|---|-----------------|---------|
|  | | | |
| 1 | | | |
| GEV No. | 506199 | Ref. No. | 0800711 |
| description | tension spring ø 40.5mm total length 355mm wire gauge ø 5mm L1 220mm D1 ø 40.5mm for hood H1 30mm L 355mm windings 42 | | |
| For models: | 015-24L, DSP5, L20, L21 | | |

manometers

| | | | |
|--|---|-----------------|---------|
|  | | | |
| 1 | | | |
| GEV No. | 541865 | Ref. No. | 0301152 |
| description | manometer ø 51mm pressure range 0 up to 4bar thread 1/4" marking 3 connection on the backside | | |
| For models: | M115, M150, MATIC20 | | |

dosing pumps

peristaltic dosing pumps

various

built-in version

| | | | |
|---|--------------------------|-----------------|---------|
|  | | | |
| 1 | | | |
| GEV No. | 361299 | Ref. No. | 0500058 |
| description | dosing pump hose ø 5x7mm | | |

piston pumps

spare parts

| | | | |
|---|--|-----------------|---------|
|  | | | |
| 1 | | | |
| GEV No. | 510298 | Ref. No. | 0200425 |
| description | lip valve dosing pump suitable for DB2/DS5 | | |
| For models: | 015-24L, 050F, 050F-Dep, F85, F85-Dep, L20, L21, S200, S280, S280Dep, Super-QS, Super-QS-Dep | | |

membrane dosing pumps

self-priming

LANG



| | | | |
|--|---|--|---------|
|  | | | |
| 1 | | | |
| GEV No. | 361221 | Ref. No. | 0500057 |
| description | dosing pump type N6 rinse aid pressure connection ø 4x6mm suction connection ø 6x8mm LANG | | |
| For models: | DSP1, DSP2, DSP4, DSP5 | | |
| spare parts for | 361221 | | |
| |  | GEV No. | 361079 |
| | | Ref. No. | — |
| | | spring for type N5/N6 for ball | |
| |  | GEV No. | 361080 |
| | | Ref. No. | — |
| | | O-ring EPDM thickness 2mm ID ø 16mm Qty 1 pcs | |
| |  | GEV No. | 361085 |
| | | Ref. No. | — |
| | | O-ring EPDM thickness 2mm ID ø 8mm Qty 1 pcs | |
| |  | GEV No. | 361309 |
| | | Ref. No. | — |
| | | ball for type N5/N6 | |
| |  | GEV No. | 361310 |
| | | Ref. No. | — |
| | | bracket for type N6 ball guide | |
| |  | GEV No. | 361311 |
| | | Ref. No. | — |
| | | O-ring EPDM thickness 2mm ID ø 6mm Qty 1 pcs for type N6 | |
| |  | GEV No. | 361314 |
| | | Ref. No. | — |
| | | valve ring for type N6 holder for O-ring | |
| |  | GEV No. | 361317 |
| | | Ref. No. | — |
| | | sealing disc for type N6 | |
| |  | GEV No. | 361886 |
| | | Ref. No. | — |
| | | non-return valve inletmm outletmm outlet ø 12.4mm L 12.7mm | |
| |  | GEV No. | 505228 |
| | | Ref. No. | — |
| | | spacer bush ID ø 4.5mm ED ø 10mm L 16mm for dosing pump | |

various



| | | | |
|--------------------|--|-----------------|---------|
| GEV No. | 361015 | Ref. No. | 0599999 |
| description | dosing pump membrane dosing pump rinse aid inlet 6x8mm outlet 4x6mm pressure connection ø 4x6mm suction connection ø 6x8mm | | |
| For models: | 015-24L, 050F, 050F-Dep, F85, F85-Dep, L20, L21, P550, S200, S280, S280Dep, Super-QS, Super-QS-Dep | | |

spare parts for 361015

| | | | | |
|---|--------------------|--|-----------------|---------|
|  | GEV No. | 361132 | Ref. No. | 0200428 |
| | description | membrane dosing pump | | |
|  | GEV No. | 510298 | Ref. No. | 0200425 |
| | description | lip valve dosing pump suitable for DB2/DS5 | | |

spare parts



| | | | |
|--------------------|--|-----------------|---------|
| GEV No. | 510298 | Ref. No. | 0200425 |
| description | lip valve dosing pump suitable for DB2/DS5 | | |
| For models: | 015-24L, 050F, 050F-Dep, F85, F85-Dep, L20, L21, S200, S280, S280Dep, Super-QS, Super-QS-Dep | | |



| | | | |
|--------------------|--|-----------------|---------|
| GEV No. | 361132 | Ref. No. | 0200428 |
| description | membrane dosing pump | | |
| For models: | 015-24L, 050F, 050F-Dep, F85, F85-Dep, L20, L21, S200, S280, S280Dep, Super-QS, Super-QS-Dep | | |



| | | | |
|--------------------|---|-----------------|---------|
| GEV No. | 510338 | Ref. No. | 0200219 |
| description | union nut dosing pump thread 1/2" ø 32mm H 15mm for dosing pump | | |

self-priming with supporting pressure

ELETTROBAR



| | | | |
|--------------------|--|-----------------|---------|
| GEV No. | 510298 | Ref. No. | 0200425 |
| description | lip valve dosing pump suitable for DB2/DS5 | | |
| For models: | 015-24L, 050F, 050F-Dep, F85, F85-Dep, L20, L21, S200, S280, S280Dep, Super-QS, Super-QS-Dep | | |

GERMAC

spare parts



| | | | |
|--------------------|--|-----------------|---------|
| GEV No. | 510298 | Ref. No. | 0200425 |
| description | lip valve dosing pump suitable for DB2/DS5 | | |
| For models: | 015-24L, 050F, 050F-Dep, F85, F85-Dep, L20, L21, S200, S280, S280Dep, Super-QS, Super-QS-Dep | | |

accessories

container filters



| | | | |
|--------------------|--|-----------------|---------|
| GEV No. | 361062 | Ref. No. | 0200443 |
| description | container filter hose ø 4mm | | |
| For models: | 015-24L, 050F, 050F-Dep, DSP1, DSP2, DSP4, DSP5, F85, F85-Dep, L20, L21, P550, S200, S280, S280Dep, Super-QS, Super-QS-Dep | | |



| | | | |
|--------------------|--|-----------------|---------|
| GEV No. | 506095 | Ref. No. | 0201460 |
| description | filter SS for rinse aid container | | |
| For models: | 015-24L, 050F, 050F-Dep, DSP5, F85, F85-Dep, L20, L21, S200, S280, S280Dep, Super-QS, Super-QS-Dep | | |











hoses

dosing hoses

| | | | |
|---|---|-----------------|---------|
|  | | | |
| 1 | | | |
| GEV No. | 512477 | Ref. No. | 0200511 |
| description | hose ED ø 6mm ID ø 4mm PVC | | |
| For models: | 050F, 050F-Dep, DSP5, F85, F85-Dep, S200, S280, S280Dep, Super-QS, Super-QS-Dep | | |

PVC hoses

| | | | |
|---|--|-----------------|-------------------|
|  | | | |
| 1 | | | |
| GEV No. | 520090 | Ref. No. | 0200091 |
| description | PVC hose ID ø 4mm ED ø 6mm L 2m thickness 1mm t.max. 60°C transparent | | |
| For models: | 015-24L, 050F, 050F-Dep, DSP1, DSP2, DSP4, DSP5, F85, F85-Dep, L20, L21, P550, S200, S280, S280Dep, Super-QS, Super-QS-Dep | | |
| accessories for | 520090 | | |
|  | GEV No. | 361058 | Ref. No. — |
| | container filter with non-return valve SS hose ø 4x6mm ø 20mm L 56mm | | |
|  | GEV No. | 361066 | Ref. No. — |
| | container filter straight SS hose ø 4x6mm L 37mm non return valve ball valve | | |
|  | GEV No. | 361106 | Ref. No. — |
| | container filter with weight and non-return valve SS hose ø 4x6mm ø 21mm L 51mm non return valve lip valve | | |
|  | GEV No. | 361141 | Ref. No. — |
| | container filter with weight ceramic hose ø 4mm | | |
|  | GEV No. | 361230 | Ref. No. — |
| | container filter with weight stainless steel hose ø 4x6mm | | |
|  | GEV No. | 361462 | Ref. No. — |
| | container filter with weight SS hose ø 4x6mm | | |
|  | GEV No. | 361728 | Ref. No. — |
| | container filter with 4m 4x6 hose SS hose ø 4x6mm hose length 4000mm | | |

tank inlets

| | | | |
|---|--|-----------------|---------|
|  | | | |
| 1 | | | |
| GEV No. | 506150 | Ref. No. | 0500090 |
| description | tank inlet | | |
| For models: | 015-24L, 050F, 050F-Dep, F85, F85-Dep, L20, L21, S200, S280, S280Dep, Super-QS, Super-QS-Dep | | |

hoses

drain hoses

| | | | |
|--|---|-----------------|---------|
|  | | | |
| 1 | | | |
| GEV No. | 506214 | Ref. No. | 0200112 |
| description | drain hose | | |
| For models: | 015-24L, 050F, 050F-Dep, DSP5, F85, F85-Dep, L20, L21, P550 | | |

| | | | |
|--|------------------|-----------------|-------------------------------|
|  | | | |
| 1 | | | |
| GEV No. | 506060 | Ref. No. | 0200274 0200293 0200529 |
| description | drain hose | | |
| For models: | DSP1, DSP2, DSP4 | | |

| | | | |
|---|--|-----------------|---------|
|  | | | |
| 1 | | | |
| GEV No. | 506207 | Ref. No. | 0900006 |
| description | drain hose DN19 L 1500mm straight ø inside 19mm straight ext. ø 24mm elbow ø inside 21mm elbow ext. ø 27mm outer hose ø 25mm | | |
| For models: | 015-24L, 050F, 050F-Dep, DSP5, F85, F85-Dep, L20, L21, S200, S280, S280Dep, Super-QS, Super-QS-Dep | | |

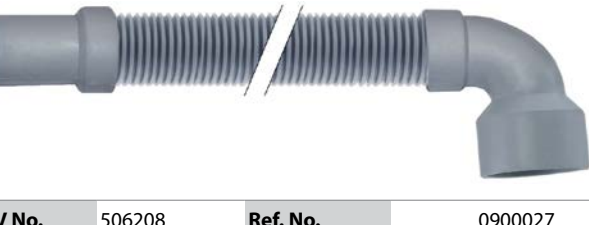
| | | | |
|--|--|-----------------|---------|
|  | | | |
| 1 | | | |
| GEV No. | 506208 | Ref. No. | 0900027 |
| description | drain hose DN25 L 1500mm straight ø inside 25mm straight ext. ø 30mm elbow ø inside 40mm elbow ext. ø 46mm outer hose ø 32mm | | |
| For models: | DSP1, DSP2, DSP4, S200, S280, S280Dep, Super-QS, Super-QS-Dep | | |

industrial hoses

pressure control hoses



| | | | |
|--------------------|--|-----------------|---------|
| GEV No. | 530068 | Ref. No. | 0200515 |
| description | pressure hose ID ø 4mm ED ø 8.5mm L 1m operating p. 30bar burst p. 90bar temp.-resist. 60°C L 1000mm Qty 1m | | |
| For models: | 050F, 050F-Dep, DSP1, DSP5, F85, F85-Dep, LP31L, LP6, LP6L, M115, M150, MATIC20, P550, S200, S280, S280Dep, Super-QS, Super-QS-Dep | | |

PVC hoses

PVC hoses without fabric



| | | | |
|--------------------|--|-----------------|---------|
| GEV No. | 520090 | Ref. No. | 0200091 |
| description | PVC hose ID ø 4mm ED ø 6mm L 2m thickness 1mm t.max. 60°C transparent | | |
| For models: | 015-24L, 050F, 050F-Dep, DSP1, DSP2, DSP4, DSP5, F85, F85-Dep, L20, L21, P550, S200, S280, S280Dep, Super-QS, Super-QS-Dep | | |

accessories for 520090

| | | | | |
|--|--|--------|-----------------|---|
| | GEV No. | 361058 | Ref. No. | — |
| | container filter with non-return valve SS hose ø 4x6mm ø 20mm L 56mm | | | |
| | GEV No. | 361066 | Ref. No. | — |
| | container filter straight SS hose ø 4x6mm L 37mm non return valve ball valve | | | |
| | GEV No. | 361106 | Ref. No. | — |
| | container filter with weight and non-return valve SS hose ø 4x6mm ø 21mm L 51mm non return valve lip valve | | | |
| | GEV No. | 361141 | Ref. No. | — |
| | container filter with weight ceramic hose ø 4mm | | | |
| | GEV No. | 361230 | Ref. No. | — |
| | container filter with weight stainless steel hose ø 4x6mm | | | |
| | GEV No. | 361462 | Ref. No. | — |
| | container filter with weight SS hose ø 4x6mm | | | |
| | GEV No. | 361728 | Ref. No. | — |
| | container filter with 4m 4x6 hose SS hose ø 4x6mm hose length 4000mm | | | |

hoses wire reinforced

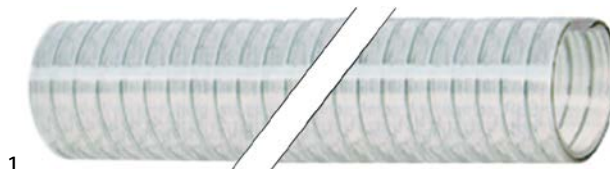

| | | | |
|--------------------|---|-----------------|---------|
| GEV No. | 506074 | Ref. No. | 0200521 |
| description | drain hose ID ø 32mm ED ø 41mm L 1m wire reinforced | | |
| For models: | 015-24L | | |

formed hoses

straight



| | | | |
|--------------------|------------------------------|-----------------|---------|
| GEV No. | 506218 | Ref. No. | 0201923 |
| description | extraction hose | | |
| For models: | 050F, 050F-Dep, F85, F85-Dep | | |



| | | | |
|--------------------|---------------------------------|-----------------|---------|
| GEV No. | 506011 | Ref. No. | 0200031 |
| description | formed hose dishwasher straight | | |



| | | | |
|--------------------|---------------------------------|-----------------|---------|
| GEV No. | 506112 | Ref. No. | 0201914 |
| description | formed hose dishwasher straight | | |
| For models: | 015-24L, P550 | | |

1

| | | | |
|--------------------|--|-----------------|---------|
| GEV No. | 504160 | Ref. No. | 0201900 |
| description | formed hose L 100mm dishwasher straight hose ext. ø 60mm equiv. no. 4085, 3927 | | |
| For models: | M115, M150, MATIC20 | | |



1

| | | | |
|--------------------|---|-----------------|---------|
| GEV No. | 506036 | Ref. No. | 0200131 |
| description | formed hose L 100mm dishwasher straight ø 30mm | | |
| For models: | 015-24L, 050F, 050F-Dep, F85, F85-Dep, L20, L21, P550 | | |



1

| | | | |
|--------------------|--|-----------------|---------|
| GEV No. | 506032 | Ref. No. | 0200122 |
| description | formed hose L 130mm dishwasher straight hose ext. ø 50mm | | |



1

| | | | |
|--------------------|--|-----------------|---------|
| GEV No. | 506113 | Ref. No. | 0201919 |
| description | formed hose L 150mm dishwasher straight enlarged mounting pos. lower nominal-ø 60/43mm | | |
| For models: | 015-24L, DSP5, P550 | | |



1

| | | | |
|--------------------|--|-----------------|---------|
| GEV No. | 506423 | Ref. No. | 0201924 |
| description | formed hose L 230mm dishwasher straight ø 40mm | | |
| For models: | L20, L21 | | |



1

| | | | |
|--------------------|---|-----------------|---------|
| GEV No. | 506031 | Ref. No. | 0200119 |
| description | formed hose L 50mm dishwasher straight hose ext. ø 35mm | | |



1

| | | | |
|--------------------|---|-----------------|---------|
| GEV No. | 506038 | Ref. No. | 0200133 |
| description | formed hose L 60mm dishwasher straight mounting pos. lower ø 40mm | | |

form L



1

| | | | |
|--------------------|---|-----------------|---------|
| GEV No. | 506107 | Ref. No. | 0201904 |
| description | formed hose end piece A ext. ø 37mm AD2 ø 28mm warewashing L-shape equiv. no. 0201904 | | |
| For models: | DSP1, DSP2 | | |



1

| | | | |
|--------------------|---|-----------------|---------|
| GEV No. | 506108 | Ref. No. | 0201905 |
| description | formed hose end piece A ext. ø 38mm AD2 ø 29mm warewashing L-shape equiv. no. 0201905 | | |
| For models: | DSP1, DSP2, S200, S280, S280Dep, Super-QS, Super-QS-Dep | | |



1

| | | | |
|--------------------|--|-----------------|---------|
| GEV No. | 506055 | Ref. No. | 0200244 |
| description | formed hose L 133mm warewashing L-shape equiv. no. 0200244 ID ø 37mm | | |

1

| | | | |
|--------------------|---------------------------------|-----------------|---------|
| GEV No. | 506435 | Ref. No. | 0200124 |
| description | formed hose warewashing L-shape | | |
| For models: | DSP4 | | |



1

| | | | |
|--------------------|---|-----------------|---------|
| GEV No. | 506110 | Ref. No. | 0201907 |
| description | formed hose warewashing L-shape equiv. no. 02001907 | | |



1

| | | | |
|--------------------|--|-----------------|---------|
| GEV No. | 506109 | Ref. No. | 0201906 |
| description | formed hose warewashing L-shape equiv. no. 0201906 | | |

form S



1

| | | | |
|--------------------|------------------------------|-----------------|---------|
| GEV No. | 506217 | Ref. No. | 0201922 |
| description | formed hose | | |
| For models: | 050F, 050F-Dep, F85, F85-Dep | | |



1

| | | | |
|--------------------|--|-----------------|---------|
| GEV No. | 506209 | Ref. No. | 0200213 |
| description | formed hose S-shape warewashing equiv. no. 0200213 | | |



1

| | | | |
|--------------------|--|-----------------|--------------------|
| GEV No. | 506053 | Ref. No. | 0200093 0200232 |
| description | formed hose S-shape warewashing equiv. no. 0200232 | | |
| For models: | DSP5 | | |

for dishwashers

ventilation hoses



1

| | | | |
|--------------------|------------------------------------|-----------------|---------|
| GEV No. | 506156 | Ref. No. | 0500600 |
| description | ventilation hose warewashing | | |
| For models: | 050F, 050F-Dep, DSP4, F85, F85-Dep | | |

miscellaneous



1

| | | | |
|--------------------|---|-----------------|---------|
| GEV No. | 511642 | Ref. No. | 0200931 |
| description | flex hose ET 1/2" IT 3/4" L 23mm SS ext. ø 18 | | |
| For models: | LP6 | | |



1

| | | | |
|--------------------|--|-----------------|---------|
| GEV No. | 506431 | Ref. No. | 0200200 |
| description | hose ED ø 10/15mm ID ø 4/10mm L 2200mm temp.-resist. 70°C for air trap | | |
| For models: | 015-24L, DSP2, DSP4, L20, L21, LP31L, LP6, LP6L | | |



fittings, hose and pipe connectors

fittings

double nipples



1

| | | | |
|--------------------|--|-----------------|---------|
| GEV No. | 520164 | Ref. No. | 0200698 |
| description | double nipple nickel-plated brass thread 1/4" - 3/8" Qty 1 pcs | | |



1

| | | | |
|--------------------|--|-----------------|---------|
| GEV No. | 506013 | Ref. No. | 0200040 |
| description | double nipple SS thread 1/4" - 3/8" Qty 1 pcs | | |
| For models: | 015-24L, DSP1, DSP2, DSP4, DSP5, L20, L21, S200, S280, S280Dep, Super-QS, Super-QS-Dep | | |

reducers



1

| | | | |
|--------------------|--|-----------------|---------|
| GEV No. | 520880 | Ref. No. | 0200909 |
| description | reducer thread 1 1/4" ET - 1" IT brass total length 26mm WS 42 Qty 1 pcs | | |



1

| | | | |
|--------------------|--|-----------------|---------|
| GEV No. | 520879 | Ref. No. | 0200920 |
| description | reducer thread 3/4" ET - 1/2" IT brass total length 17mm WS 26 Qty 1 pcs | | |
| For models: | LP31L, LP6, M115, M150 | | |



1

| | | | |
|--------------------|--|-----------------|---------|
| GEV No. | 506083 | Ref. No. | 0200932 |
| description | reducer thread 1" ET - 1/2" IT brass total length 22mm WS 34 | | |
| For models: | 015-24L, L20, L21, LP31L, LP6L, P550 | | |

angle pieces



1

| | | | |
|--------------------|--|-----------------|---------|
| GEV No. | 541675 | Ref. No. | 0200905 |
| description | angle piece thread 1/2" ET - 1/2" IT brass | | |
| For models: | LP6, M115, M150, MATIC20 | | |



1

| | | | |
|--------------------|--|-----------------|---------|
| GEV No. | 540020 | Ref. No. | 0200910 |
| description | angle piece thread 1/2" IT - 1/2" IT chrome-plated brass | | |
| For models: | LP31L, LP6, M115, M150, MATIC20 | | |





1

| | | | |
|--------------------|---------------------------------------|-----------------|---------|
| GEV No. | 506041 | Ref. No. | 0200162 |
| description | angle piece thread 3/8" polypropylene | | |
| For models: | 015-24L, L20, L21 | | |



hose connectors

plastic



| | | | | |
|---|------------------------|---|-----------------|---------|
| 1 | GEV No. | 506122 | Ref. No. | 0221302 |
| | description | hose connector plastic straight thread 1/4" hose ø 31mm Qty 1 pcs | | |
| | For models: | 015-24L, DSP5, L20, L21, P550 | | |
| | accessories for | 506122 | | |
|  | GEV No. | 506072 | Ref. No. | 0200403 |
| | | flat gasket fibre ED ø 38mm ID ø 27mm thickness 2mm outflow for thread 1/4" Qty 1 pcs | | |
|  | GEV No. | 506074 | Ref. No. | 0200521 |
| | | drain hose ID ø 32mm ED ø 41mm L 1m wire reinforced | | |



| | | | | |
|---|------------------------|--|-----------------|---------|
| 1 | GEV No. | 506125 | Ref. No. | 0221310 |
| | description | hose connector plastic angled thread 3/8" hose ø 12mm Qty 1 pcs | | |
| | For models: | 015-24L, 050F, 050F-Dep, F85, F85-Dep, L20, L21, S200, S280, S280Dep, Super-QS, Super-QS-Dep | | |
| | accessories for | 506125 | | |
|  | GEV No. | 506042 | Ref. No. | 0200171 |
| | | flat gasket FIBER ED ø 27mm ID ø 17mm thickness 2mm Qty 1 pcs | | |
|  | GEV No. | 506132 | Ref. No. | 0300047 |
| | | nut thread 3/8" | | |

producer-specific



| | | | | |
|---|--------------------|--|-----------------|---------|
| 1 | GEV No. | 506082 | Ref. No. | 0200906 |
| | description | hose connector angled brass ø 1/2"mm | | |
| | For models: | 015-24L, L20, L21, LP31L, LP6, LP6L, M115, M150, MATIC20, P550 | | |



| | | | | |
|---|--------------------|--|-----------------|---------|
| 1 | GEV No. | 506052 | Ref. No. | 0200231 |
| | description | hose connector connection 3/4" hose ø 12mm | | |
| | For models: | LP31L | | |



| | | | | |
|---|--------------------|--|-----------------|---------|
| 1 | GEV No. | 506126 | Ref. No. | 0221313 |
| | description | hose connector curved plastic ø 3/4"mm | | |
| | For models: | LP31L, M115, M150 | | |



| | | | | |
|---|--------------------|--|-----------------|---------|
| 1 | GEV No. | 506081 | Ref. No. | 0200903 |
| | description | hose connector straight ø 1/2"mm | | |
| | For models: | 015-24L, L20, L21, LP31L, LP6, LP6L, M115, M150, MATIC20, P550 | | |



| | | | | |
|---|--------------------|----------------------------------|-----------------|---------|
| 1 | GEV No. | 506014 | Ref. No. | 0200049 |
| | description | hose connector straight ø 3/4"mm | | |





| | | | | |
|---|--------------------|---|-----------------|---------|
| 1 | GEV No. | 506415 | Ref. No. | 0221304 |
| | description | hose connector thread 2" for hose ø60mm | | |
| | For models: | LP31L, LP6L | | |



| | | | | |
|---|--------------------|--|-----------------|---------|
| 1 | GEV No. | 505256 | Ref. No. | 0200646 |
| | description | hose connector thread M12 ø 13mm 1/2" ET | | |
| | For models: | M115, M150, MATIC20 | | |



| | | | |
|---|--------------------------|-----------------|---------|
|  | | | |
| 1 | | | |
| GEV No. | 506124 | Ref. No. | 0221307 |
| description | reducer straight plastic | | |

| | | | |
|---|---------------|-----------------|---------|
|  | | | |
| 1 | | | |
| GEV No. | 506098 | Ref. No. | 0201804 |
| description | T-piece | | |
| For models: | 015-24L, P550 | | |

water cycle components

pressure reduction valves

pressure reduction valves

universal

| | | | |
|--|--|-----------------|---------|
|  | | | |
| 1 | | | |
| GEV No. | 520881 | Ref. No. | 0301151 |
| description | pressure reduction valve DESBORDES series DN15 connection 1/2" default setting 3bar setting range 1-5.5bar EN1567 p max 25bar t.max. 80°C brass WRAS/ACS | | |
| For models: | M115, M150, MATIC20 | | |

ancillary products

clamps

hose clamps

DIN 3017 - W2

| | | | |
|---|--|-----------------|---------|
|  | | | |
| 1 | | | |
| GEV No. | 520115 | Ref. No. | 0200298 |
| description | hose clamp ø 25-40mm width 9mm Qty 10 pcs DIN 3017 | | |
| For models: | 015-24L, 050F, 050F-Dep, DSP1, DSP2, DSP4, DSP5, F85, F85-Dep, L20, L21, P550, S200, S280, S280Dep, Super-QS, Super-QS-Dep | | |

| | | | |
|--|---|-----------------|--------------------|
|  | | | |
| 1 | | | |
| GEV No. | 520119 | Ref. No. | 0200248 0200713 |
| description | hose clamp ø 60-80mm width 9mm Qty 5 pcs DIN 3017 | | |
| For models: | L20, L21, M115, M150, MATIC20, P550 | | |

| | | | |
|--|---|-----------------|---------|
|  | | | |
| 1 | | | |
| GEV No. | 520117 | Ref. No. | 0200069 |
| description | hose clamp stainless steel ø 40-60mm width 9mm Qty 5 pcs DIN 3017 | | |
| For models: | 050F, 050F-Dep, DSP4, DSP5, F85, F85-Dep, L20, L21, P550 | | |

DIN 3017 - W4

| | | | |
|---|--|-----------------|--------------------|
|  | | | |
| 1 | | | |
| GEV No. | 520120 | Ref. No. | 0200190 0200300 |
| description | hose clamp SS W4 ø 12-20mm width 9mm Qty 1 pcs DIN 3017 | | |
| For models: | 015-24L, 050F, 050F-Dep, DSP1, DSP2, DSP4, DSP5, F85, F85-Dep, L20, L21, LP31L, LP6, LP6L, P550, S200, S280, S280Dep, Super-QS, Super-QS-Dep | | |

tools

hand tools

wrenches

miscellaneous

| | | | |
|--|--------------------------------------|-----------------|---------|
|  | | | |
| 1 | | | |
| GEV No. | 801662 | Ref. No. | 0802792 |
| description | adjusting spanner for clutch L 270mm | | |
| For models: | M115, M150, MATIC20 | | |

measuring equipment

thermometers

built-in thermometers



1

| | | | |
|--------------------|---|-----------------|---------|
| GEV No. | 541086 | Ref. No. | 0500005 |
| description | thermometer mounting measurements 58x25.5mm 0 up to +120°C capillary pipe 2000mm probe ø 6mm probe L 23mm | | |
| For models: | M115, M150 | | |



1

| | | | |
|--------------------|---|-----------------|---------|
| GEV No. | 541305 | Ref. No. | 0500008 |
| description | thermometer mounting measurements 62x11mm +20 up to +120°C capillary pipe 1500mm probe ø 6.5mm probe L 16mm | | |

ø52mm



1

| | | | |
|--------------------|--|-----------------|---------|
| GEV No. | 541065 | Ref. No. | 0500009 |
| description | thermometer mounting ø 52mm t.max. 120°C 0 up to +120°C probe ø 6.5mm probe L 28mm capillary pipe 1500mm | | |
| For models: | F85, LP31L, LP6, LP6L, MATIC20, P550, S280, S280Dep, Super-QS, Super-QS-Dep | | |

fastening material

screws

sheet metal screws



1

| | | | |
|--------------------|--|-----------------|---------|
| GEV No. | 560240 | Ref. No. | 0800001 |
| description | sheet metal screws ø 3.9mm L 16mm SS Qty 20 pcs DIN 7982/ISO 7050 head ø 7.5mm sunk head | | |
| For models: | DSP1, DSP2, DSP4, DSP5 | | |

hexagonal screws



1

| | | | |
|--------------------|--|-----------------|---------|
| GEV No. | 506445 | Ref. No. | 0800228 |
| description | hexagonal screw thread M10 thread L 35mm SS WS 17 Qty 1 pcs DIN 933 / ISO 4017 | | |
| For models: | 015-24L, DSP5, L20, L21 | | |



1

| | | | |
|--------------------|--|-----------------|---------|
| GEV No. | 560476 | Ref. No. | 0800661 |
| description | hexagonal screw thread M10 thread L 40mm zinc-coated steel WS 17 Qty 1 pcs head thickness 6.4mm DIN 933 / ISO 4017 | | |
| For models: | 015-24L, DSP5, L20, L21 | | |



1

| | | | |
|--------------------|---|-----------------|---------|
| GEV No. | 560539 | Ref. No. | 0800667 |
| description | hexagonal screw thread M10 thread L 42mm SS WS 17 Qty 1 pcs head thickness 6.5mm DIN 933 / ISO 4017 | | |
| For models: | M115, M150, MATIC20 | | |



1

| | | | |
|--------------------|---|-----------------|---------|
| GEV No. | 560085 | Ref. No. | 0800648 |
| description | hexagonal screw thread M5 thread L 20mm SS WS 8 Qty 20 pcs DIN 933 / ISO 4017 | | |
| For models: | DSP1, DSP2, DSP4 | | |



1

| | | | |
|--------------------|--|-----------------|---------|
| GEV No. | 560088 | Ref. No. | 0800062 |
| description | hexagonal screw thread M6 thread L 20mm SS WS 10 Qty 20 pcs DIN 933 / ISO 4017 | | |
| For models: | LP31L, LP6, LP6L, P550 | | |





1

| | | | |
|--------------------|---|-----------------|---------|
| GEV No. | 506447 | Ref. No. | 0800009 |
| description | hexagonal screw thread M8 thread L 16mm SS WS 13 Qty 1 pcs DIN 933 / ISO 4017 | | |
| For models: | DSP4, DSP5, LP31L, LP6, LP6L | | |





| | | | |
|---|---|-----------------|---------|
|  | | | |
| 1 | | | |
| GEV No. | 506446 | Ref. No. | 0800016 |
| description | hexagonal screw thread M8 thread L 40mm SS WS 13 Qty 1 pcs DIN 933 / ISO 4017 | | |
| For models: | 015-24L, 050F, 050F-Dep, F85, F85-Dep, P550 | | |

| | | | |
|---|---|-----------------|---------|
|  | | | |
| 1 | | | |
| GEV No. | 560129 | Ref. No. | 0800257 |
| description | hexagonal nut thread M5 H 4mm WS 8 SS DIN/ISO DIN 934 / ISO 4032/8673 Qty 1 pcs | | |
| For models: | DSP1, DSP2, DSP4 | | |

| | | | |
|---|---|-----------------|---------|
| grub screws | | | |
| DIN 914/ISO 4027 | | | |
|  | | | |
| 1 | | | |
| GEV No. | 560175 | Ref. No. | 0800682 |
| description | grub screw thread M8 L 16mm DIN 914/ISO 4027 intake internal hexagon WS 4 Qty 1 pcs | | |
| For models: | LP6L, M115, M150, MATIC20 | | |

| | | | |
|---|---|-----------------|--------------------|
|  | | | |
| 1 | | | |
| GEV No. | 560133 | Ref. No. | 0800063 0800656 |
| description | hexagonal nut thread M6 H 5mm WS 10 SS DIN/ISO DIN 934 / ISO 4032/8673 Qty 20 pcs | | |
| For models: | 015-24L, 050F, 050F-Dep, F85, F85-Dep, L20, L21, LP31L, LP6, LP6L, M115, M150, MATIC20, P550, S200, S280, S280Dep, Super-QS, Super-QS-Dep | | |

| | | | |
|---|--|-----------------|---------|
| knurled screws | | | |
|  | | | |
| 1 | | | |
| GEV No. | 506172 | Ref. No. | 0800130 |
| description | Thumb screw thread M6 thread L 9mm ø 22mm H 6mm SS | | |
| For models: | 015-24L, 050F, 050F-Dep, F85, F85-Dep, L20, L21, LP31L, LP6, LP6L, P550, S200, S280, S280Dep, Super-QS, Super-QS-Dep | | |

| | | | |
|---|---|-----------------|---------|
|  | | | |
| 1 | | | |
| GEV No. | 560197 | Ref. No. | 0800106 |
| description | nut thread M10 H 8mm WS 17 SS DIN/ISO DIN 934 / ISO 4032/8673 Qty 1 pcs | | |
| For models: | 015-24L, DSP5, L20, L21 | | |

| | | | |
|---|-----------------------|-----------------|---------|
| nuts | | | |
| knurled nuts | | | |
|  | | | |
| 1 | | | |
| GEV No. | 506146 | Ref. No. | 0500011 |
| description | knurled nut thread M6 | | |

| | | | |
|---|--|-----------------|---------|
|  | | | |
| 1 | | | |
| GEV No. | 506166 | Ref. No. | 0800091 |
| description | nut thread M12 H 10mm WS 19 SS DIN/ISO DIN 934 / ISO 4032/8673 Qty 1 pcs | | |
| For models: | 015-24L, 050F, 050F-Dep, DSP5, F85, F85-Dep, L20, L21, S200, S280, S280Dep, Super-QS, Super-QS-Dep | | |

| | | | |
|---|--|-----------------|---------|
| hexagonal nuts | | | |
| DIN 934 / ISO 4032/8673 | | | |
|  | | | |
| 1 | | | |
| GEV No. | 560199 | Ref. No. | 0800082 |
| description | hexagonal nut thread M10 H 8mm WS 17 SS DIN/ISO DIN 934 / ISO 4032/8673 Qty 10 pcs | | |
| For models: | M115, M150, MATIC20 | | |

| | | | |
|---|---|-----------------|---------|
| DIN 985 | | | |
|  | | | |
| 1 | | | |
| GEV No. | 560227 | Ref. No. | 0800652 |
| description | hexagonal nut thread M3 H 4mm SS WS 5.5 Qty 1 pcs self-locking | | |
| For models: | 050F, 050F-Dep, DSP1, DSP2, DSP4, DSP5, F85, F85-Dep, S200, S280, S280Dep, Super-QS, Super-QS-Dep | | |

| | | | |
|---|--|-----------------|---------|
|  | | | |
| 1 | | | |
| GEV No. | 560142 | Ref. No. | 0800669 |
| description | hexagonal nut thread M6 H 6mm SS WS 10 Qty 20 pcs DIN/ISO DIN 985 self-locking | | |
| For models: | LP31L, LP6, LP6L, M115, M150 | | |

| | | | |
|---|---|-----------------|---------|
|  | | | |
| 1 | | | |
| GEV No. | 521101 | Ref. No. | 0800664 |
| description | nut thread M14x1.5 H 5mm WS 19 SS Qty 1 pcs | | |

hexagonal nuts inch thread

| | | | |
|---|--|-----------------|---------|
|  | | | |
| 1 | | | |
| GEV No. | 506194 | Ref. No. | 0800655 |
| description | nut thread 1/2" H 3mm nickel-plated brass WS 24 Qty 1 pcs | | |
| For models: | 050F, 050F-Dep, F85, F85-Dep, M115, M150, MATIC20, S200, S280, S280Dep, Super-QS, Super-QS-Dep | | |

DIN 982 (self-locking, tall version)

| | | | |
|---|---|-----------------|---------|
|  | | | |
| 1 | | | |
| GEV No. | 560475 | Ref. No. | 0800144 |
| description | hexagonal nut thread M10 H 11.5mm zinc-coated steel WS 17 Qty 1 pcs DIN/ISO DIN 982 | | |
| For models: | 015-24L, DSP5, L20, L21 | | |

| | | | |
|---|--|-----------------|---------|
|  | | | |
| 1 | | | |
| GEV No. | 506024 | Ref. No. | 0200101 |
| description | nut thread 3/8" H 6mm SS WS 22 Qty 1 pcs | | |
| For models: | 015-24L, L20, L21, S200, S280, S280Dep, Super-QS, Super-QS-Dep | | |

union nuts

| | | | |
|---|--|-----------------|---------|
|  | | | |
| 1 | | | |
| GEV No. | 506196 | Ref. No. | 0800673 |
| description | nut brass | | |
| For models: | 015-24L, 050F, 050F-Dep, DSP5, F85, F85-Dep, L20, L21, LP31L, LP6, LP6L, P550, S200, S280, S280Dep, Super-QS, Super-QS-Dep | | |

hexagonal nuts metric (without norm)

| | | | |
|---|--|-----------------|---------|
|  | | | |
| Image not available | | | |
| 1 | | | |
| GEV No. | 506162 | Ref. No. | 0800045 |
| description | nut | | |
| For models: | 015-24L, L20, L21, LP31L, LP6, LP6L, M115, M150, MATIC20, P550 | | |

washers

spring rings

| | | | |
|---|---|-----------------|---------|
|  | | | |
| 1 | | | |
| GEV No. | 560123 | Ref. No. | 0800066 |
| description | lock washer ID ø 6.3mm ED ø 11mm SS DIN127 Qty 20 pcs for thread M6 | | |
| For models: | 015-24L, 050F, 050F-Dep, DSP5, F85, F85-Dep, L20, L21, LP31L, LP6, LP6L, M115, M150, MATIC20, P550, S200, S280, S280Dep, Super-QS, Super-QS-Dep | | |

| | | | |
|---|--|-----------------|---------|
|  | | | |
| 1 | | | |
| GEV No. | 521131 | Ref. No. | 0800205 |
| description | nut thread M12x1 H 3.5mm WS 17 SS Qty 1 pcs | | |
| For models: | 015-24L, 050F, 050F-Dep, DSP1, DSP2, DSP4, DSP5, F85, F85-Dep, L20, L21, LP31L, LP6, LP6L, P550, S200, S280, S280Dep, Super-QS, Super-QS-Dep | | |





| washers | | | |
|---|---|-----------------|---------|
| DIN 125A | | | |
|  | | | |
| 1 | | | |
| GEV No. | 560112 | Ref. No. | 0800256 |
| description | plain washer ID ø 5.3mm ED ø 10mm thickness 1mm SS Qty 20 pcs DIN 125A for thread M5 | | |
| For models: | 050F, 050F-Dep, DSP1, DSP2, DSP4, F85, F85-Dep, S200, S280, S280Dep, Super-QS, Super-QS-Dep | | |

| | | | |
|---|--|-----------------|---------|
|  | | | |
| 1 | | | |
| GEV No. | 560113 | Ref. No. | 0800004 |
| description | plain washer ID ø 6.4mm ED ø 12mm thickness 1.6mm SS Qty 20 pcs DIN 125A for thread M6 | | |
| For models: | LP31L, LP6, LP6L | | |

| DIN 9021 | | | |
|--|--|-----------------|---------|
|  | | | |
| 1 | | | |
| GEV No. | 528761 | Ref. No. | 0800064 |
| description | plain washer ID ø 6.5mm ED ø 18mm thickness 1.5mm SS Qty 1 pcs | | |
| For models: | 050F, 050F-Dep, F85, F85-Dep, LP31L, LP6, LP6L, M115, M150, MATIC20, P550, S200, S280, S280Dep, Super-QS, Super-QS-Dep | | |

| miscellaneous | | | |
|---|---------|-----------------|---------|
|  | | | |
| 1 | | | |
| GEV No. | 506205 | Ref. No. | 0800906 |
| description | disc SS | | |

| | | | |
|---|--|-----------------|---------|
|  | | | |
| 1 | | | |
| GEV No. | 506160 | Ref. No. | 0800028 |
| description | plain washer ID ø 8.6mm ED ø 16mm thickness 1.5mm SS Qty 1 pcs | | |
| For models: | 015-24L, DSP5, L20, L21, LP31L, LP6, LP6L, M115, M150, MATIC20 | | |

| tooth lock washers | | | |
|---|---|-----------------|---------|
| DIN 6798A | | | |
|  | | | |
| 1 | | | |
| GEV No. | 560125 | Ref. No. | 0800101 |
| description | tooth lock washer ID ø 4.2mm ED ø 8mm SS DIN/ISO DIN 6798A Qty 20 pcs for thread M4 | | |
| For models: | 050F, 050F-Dep, F85, F85-Dep, LP31L, LP6, LP6L, S200, S280, S280Dep, Super-QS, Super-QS-Dep | | |

fasteners

clamps

| hose clamps | | | |
|--|--|-----------------|---------|
| DIN 3017 - W2 | | | |
|  | | | |
| 1 | | | |
| GEV No. | 520115 | Ref. No. | 0200298 |
| description | hose clamp ø 25-40mm width 9mm Qty 10 pcs DIN 3017 | | |
| For models: | 015-24L, 050F, 050F-Dep, DSP1, DSP2, DSP4, DSP5, F85, F85-Dep, L20, L21, P550, S200, S280, S280Dep, Super-QS, Super-QS-Dep | | |

| | | | |
|--|---|-----------------|--------------------|
|  | | | |
| 1 | | | |
| GEV No. | 520119 | Ref. No. | 0200248 0200713 |
| description | hose clamp ø 60-80mm width 9mm Qty 5 pcs DIN 3017 | | |
| For models: | L20, L21, M115, M150, MATIC20, P550 | | |

| | | | |
|--|---|-----------------|---------|
|  | | | |
| 1 | | | |
| GEV No. | 520117 | Ref. No. | 0200069 |
| description | hose clamp stainless steel ø 40-60mm width 9mm Qty 5 pcs DIN 3017 | | |
| For models: | 050F, 050F-Dep, DSP4, DSP5, F85, F85-Dep, L20, L21, P550 | | |

DIN 3017 - W4



1

| | | | |
|--------------------|--|-----------------|--------------------|
| GEV No. | 520120 | Ref. No. | 0200190 0200300 |
| description | hose clamp SS W4 ø 12-20mm width 9mm Qty 1 pcs DIN 3017 | | |
| For models: | 015-24L, 050F, 050F-Dep, DSP1, DSP2, DSP4, DSP5, F85, F85-Dep, L20, L21, LP31L, LP6, LP6L, P550, S200, S280, S280Dep, Super-QS, Super-QS-Dep | | |

cable clamps



1

| | | | |
|--------------------|---------------------------------|-----------------|---------|
| GEV No. | 524789 | Ref. No. | 0800492 |
| description | cable clamp wire gauge ø 5mm SS | | |
| For models: | M115, M150, MATIC20 | | |

retaining rings

DIN 471



1

| | | | |
|--------------------|---|-----------------|---------|
| GEV No. | 514030 | Ref. No. | 0800133 |
| description | retaining ring shaft ø 20mm thickness 1.3mm steel DIN 471 | | |

screw caps



1

| | | | |
|--------------------|--|-----------------|------------------------------|
| GEV No. | 505257 | Ref. No. | 0800166 + 0200295 0802080 |
| description | screw thread 1/8" with gasket thread L 15mm V2A WS 13 head thickness 4mm | | |
| For models: | LP31L, LP6, M115, M150, MATIC20 | | |

| | | | |
|---|--------|---------------------------------|--------|
| B | | | |
| bi-metal thermostats | 4, 5 | indicator lights (complete) | 9 |
| booster pumps I | 21 | industrial hoses | 58 |
| booster pumps II | 21 | K | |
| C | | knurled nuts | 65 |
| cable clamps | 68 | knurled screws | 65 |
| clamps | 63, 67 | L | |
| coil heating elements | 3 | lamps | 9 |
| condensators & interference suppression filters | 22 | light bulbs | 9 |
| contactors | 12 | M | |
| container filters | 56 | magnetic switches | 7 |
| control equipment | 8 | measuring equipment | 64 |
| control thermostats | 5 | microswitches | 6 |
| D | | N | |
| digital timers | 12 | nuts | 65 |
| dosing hoses | 57 | O | |
| dosing pumps | 55 | operating capacitors | 22 |
| double nipples | 61 | O-rings | 50 |
| drain hoses | 57 | P | |
| drain pumps | 21 | piano hinges | 50 |
| E | | plunger sockets | 5 |
| electric accessories | 23 | position switches | 6 |
| electronic controllers | 14 | pressure control hoses | 58 |
| F | | pressure reduction valves | 63, 63 |
| fasteners | 67 | pressure switches | 17 |
| fastening material | 64 | probes | 14 |
| filters | 22 | programme timers | 10 |
| fittings | 61 | pumps | 18 |
| formed hoses | 58 | push/momentary push switches | 6 |
| fuses | 22 | PVC hoses | 58 |
| G | | R | |
| gaskets for wash arm support | 54 | reducers | 61 |
| grub screws | 65 | relays | 13 |
| H | | retaining rings | 68 |
| hand tools | 63 | rotary switches | 7 |
| heating elements | 3 | S | |
| hexagonal nuts | 65 | safety bi-metal thermostats | 4 |
| hexagonal screws | 64 | safety thermostats | 5 |
| hose clamps | 63, 67 | screw caps | 68 |
| hose connectors | 62 | screws | 64 |
| hoses | 57 | sealing washers | 51 |
| hoses wire reinforced | 58 | shaft gaskets | 52 |
| I | | sheet metal screws | 64 |
| immersion heating elements | 3 | solenoid valves | 15 |
| indicator lights | 9 | spring rings | 66 |
| | | switches and momentary switches | 6 |

system switches (ROLD) 6

T

tank inlets 57

terminals 23

thermostats 4

time relays 14

timers 10

tools 63

tooth lock washers 67

U

union nuts 66

V

ventilation hoses 60

W

wash and rinse pumps 18

washers 67

water cycle components 63

wrenches 63