



GAS COMPONENTS



ELECTRIC COMPONENTS



WATER TECHNOLOGY



MECHANICAL COMPONENTS



TOOLS

Spare parts suitable for

LASA

Find the complete and up-to-date range of products in our GEV Webshop



Manufacturer catalogue

The most important spare parts and accessories arranged clearly for every manufacturer

- ✓ Complete product range and all appliance data always up to date in the GEV Webshop
- ✓ Alphabetical Index at the end of the catalogue

GEV Webshop

www.gev-online.co.uk

www.gev-online.com



- 🔍 Add to Favourites
- 🔍 Sign In with email address and usual password
- 🔍 Easy-order – place several items in your basket at the same time
- 🔍 Quick Item search – no login needed







heating elements

heating elements for pasta cookers



| | | | |
|--------------------------------------------------------------------------------------------|--------------------------------------------------------------------------------------------------------------------------------------------------------------------------------------------------------------------------------------------------------------------------------------------------------------------------------------------------------------------------------------|-----------------|-----------------|
|  <p>1</p> | | | |
| GEV No. | 415020 | Ref. No. | 3205500+2188400 |
| description | heating element 4500W 230V mounting \varnothing 57.5mm heating circuits 3 L 355mm W 35mm H 47mm number of thermostat sleeves 1 thermostat sleeves \varnothing 7mm length thermostat sleeves 295mm thermostat sleeve upper tube \varnothing 8.5mm hole distance 70mm hole \varnothing 10mm connection length 25mm connection male faston 6.3mm 3 hole flange immersion heater | | |

heating elements for salamanders/toast-

| | | | |
|--------------------------------------------------------------------------------------------|----------------------------------------------------------------------------------------------------------------------------------------------------------------------------------------|-----------------|-------------------|
|  <p>1</p> | | | |
| GEV No. | 415938 | Ref. No. | 320803 3208030 |
| description | heating element 1800W 230V heating circuits 1 L 330mm W 82mm H 25mm thread M10x1 mounting distance 72mm tube \varnothing 6.3mm 2 hole fixing connection length 20mm immersion heater | | |
| accessories for | 415938 | | |
|  | GEV No. | 510416 | Ref. No. — |
| | flat gasket fibre ED \varnothing 19mm ID \varnothing 10.5mm thickness 1.5mm for thread M10 Qty 1 pcs | | |
|  | GEV No. | 510893 | Ref. No. — |
| | O-ring EPDM thickness 2.62mm ID \varnothing 9.92mm Qty 1 pcs | | |
|  | GEV No. | 520231 | Ref. No. — |
| | nut thread M10x1 H 6mm WS 14 zinc-coated steel Qty 1 pcs | | |
|  | GEV No. | 521129 | Ref. No. — |
| | nut thread M10 H 6mm SS WS 17 Qty 1 pcs DIN/ISO DIN 439 | | |

immersion heating elements

3 hole flange \varnothing 47.5mm

| | | | |
|----------------------------------------------------------------------------------------------|----------------------------------------------------------------------------------------------------------------------------------------------------------------------------------------------------------------------------------------------------------------------------|-----------------|-----------------|
|  <p>1</p> | | | |
| GEV No. | 416205 | Ref. No. | 3202500 4194 |
| description | heating element 3000W 230V heating circuits 1 L 260mm W 29mm H 35mm number of thermostat sleeves 1 thermostat sleeves \varnothing 10mm length thermostat sleeves 214mm tube \varnothing 6.2mm hole distance 65mm hole \varnothing 8mm connection M4 immersion heater | | |
| spare parts for | 416205 | | |
|  | GEV No. | 510408 | Ref. No. |
| | O-ring EPDM thickness 5.34mm ID \varnothing 47mm Qty 1 pcs | | |

| | | | |
|-----------------------------------------------------------------------------------|------------------------------------------------------------------|--------|-------------------|
| accessories for | 416205 | | |
|  | GEV No. | 510562 | Ref. No. — |
| | O-ring silicone thickness 5.34mm ID \varnothing 47mm Qty 1 pcs | | |

| | | | |
|---------------------------------------------------------------------------------------------|-----------------------------------------------------------------------------------------------------------------------------------------------------------------------------------------------------------------------------------------------------------------------------------------------------------------------------------------------------------------------------|-----------------|--------------------------------|
|  <p>1</p> | | | |
| GEV No. | 415935 | Ref. No. | 103705400 320801 3208010 |
| description | heating element 4500W 230V mounting \varnothing 47.5mm heating circuits 3 L 320mm W 34mm H 30mm number of thermostat sleeves 1 thermostat sleeves \varnothing 7mm length thermostat sleeves 300mm thermostat sleeve eccentric, clinging tube \varnothing 6.3mm hole distance 63mm hole \varnothing 10mm connection male faston 6.3mm 3 hole flange immersion heater | | |

| | | | |
|-----------------------------------------------------------------------------------|--------------------------------------------------------------|--------|-----------------|
| spare parts for | 415935 | | |
|  | GEV No. | 510408 | Ref. No. |
| | O-ring EPDM thickness 5.34mm ID \varnothing 47mm Qty 1 pcs | | |



| | | | |
|------------------------------------------------------------------------------------|------------------------------------------------------------------|--------|-------------------|
| accessories for | 415935 | | |
|  | GEV No. | 510562 | Ref. No. — |
| | O-ring silicone thickness 5.34mm ID \varnothing 47mm Qty 1 pcs | | |

| | | | |
|-----------------------------------------------------------------------------------------------|------------------------------------------------------------------------------------------------------------------------------------------------------------------------------------------------------------------------------------------------------------------------------------------------------------------------------------------------------------------------|-----------------|-------------------------------------------------|
|  <p>1</p> | | | |
| GEV No. | 418686 | Ref. No. | 3201500 3206000 320808 3208080 4306 |
| description | heating element 6000W 230V mounting \varnothing 47.5mm heating circuits 3 L 350mm W 35mm H 40mm number of thermostat sleeves 1 thermostat sleeves \varnothing 7mm length thermostat sleeves 220mm thermostat sleeve clinging tube \varnothing 6.3mm hole distance 63mm hole \varnothing 8mm connection length 7mm connection M4 3 hole flange immersion heater | | |



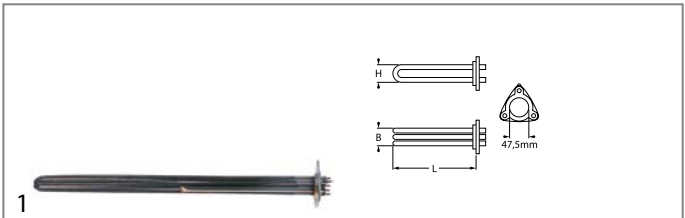

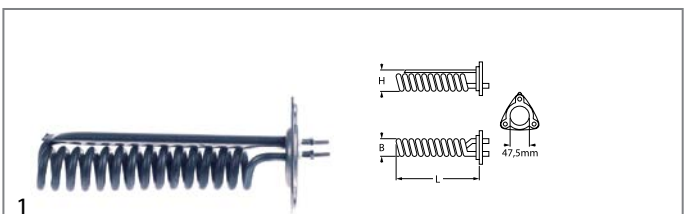

| | | | |
|-------------------------------------------------------------------------------------|--------------------------------------------------------------|--------|-----------------|
| accessories for | 418686 | | |
|  | GEV No. | 510408 | Ref. No. |
| | O-ring EPDM thickness 5.34mm ID \varnothing 47mm Qty 1 pcs | | |

| | | | |
|-------------------------------------------------------------------------------------|------------------------------------------------------------------|--------|-------------------|
|  | GEV No. | 510562 | Ref. No. — |
| | O-ring silicone thickness 5.34mm ID \varnothing 47mm Qty 1 pcs | | |





| | | | |
|-----------------------------------------------------------------------------------|------------------------------------------------------------------------------------------------------------------------------------------------------------------------------------------------------------------------------------------------------------------------------------------------------------------------------------------------------------------------|-----------------|--------------------------------------------------------|
| GEV No. | 418687 | Ref. No. | 320816 3208160 |
| description | heating element 8800W 230V mounting \varnothing 47.5mm heating circuits 3 L 550mm W 35mm H 40mm number of thermostat sleeves 1 thermostat sleeves \varnothing 7mm length thermostat sleeves 235mm thermostat sleeve clinging tube \varnothing 6.3mm hole distance 63mm hole \varnothing 8mm connection length 7mm connection M4 3 hole flange immersion heater | | |
| accessories for | 418687 | | |
|  | GEV No. | 510408 | Ref. No. 218800 2188000 218840 2188400 |
| | O-ring EPDM thickness 5.34mm ID \varnothing 47mm Qty 1 pcs | | |
|  | GEV No. | 510562 | Ref. No. — |
| | O-ring silicone thickness 5.34mm ID \varnothing 47mm Qty 1 pcs | | |



| | | | |
|-------------------------------------------------------------------------------------|------------------------------------------------------------------------------------------------------------------------------------------------------------------------------------------------------------------------------------------------------------------------------------------------------------------------------------------|-----------------|--------------------------------------------------------|
| GEV No. | 417165 | Ref. No. | 320700 3207000 |
| description | heating element 2470/2940W 220/240V mounting \varnothing 47.5mm heating circuits 1 L 196mm W 35mm H 45mm number of thermostat sleeves 1 thermostat sleeves \varnothing 9mm length thermostat sleeves 170mm thermostat sleeve upper tube \varnothing 6.4mm hole distance 63mm connection length 23mm connection M4 immersion heater | | |
| accessories for | 417165 | | |
|  | GEV No. | 510408 | Ref. No. 218800 2188000 218840 2188400 |
| | O-ring EPDM thickness 5.34mm ID \varnothing 47mm Qty 1 pcs | | |
|  | GEV No. | 510562 | Ref. No. — |
| | O-ring silicone thickness 5.34mm ID \varnothing 47mm Qty 1 pcs | | |
|  | GEV No. | 521103 | Ref. No. — |
| | nut thread M4 H 3mm WS 7 brass Qty 20 pcs | | |
|  | GEV No. | 521104 | Ref. No. — |
| | washer ID \varnothing 4.3mm ED \varnothing 8mm thickness 0.5mm brass Qty 20 pcs for thread M4 | | |
|  | GEV No. | 560111 | Ref. No. — |
| | plain washer ID \varnothing 4.3mm ED \varnothing 9mm thickness 0.8mm SS Qty 20 pcs DIN 125A for thread M4 | | |
|  | GEV No. | 560131 | Ref. No. — |
| | hexagonal nut thread M4 H 3.2mm WS 7 SS DIN/ISO DIN 934 / ISO 4032/8673 Qty 20 pcs | | |

group 8



| | | | |
|-----------------------------------------------------------------------------------|----------------------------------------------------------------------------------------------------------------------------------------------------------------------------------------------------------------------|-----------------|--------------------------------------------------------|
| GEV No. | 418636 | Ref. No. | 320809 3208090 |
| description | heating element 4500W 230V mounting \varnothing 47.5mm heating circuits 3 L 290mm W 28mm H 45mm H1 25mm H2 20mm tube \varnothing 6mm hole distance 62mm hole \varnothing 8x10mm 3 hole flange immersion heater | | |
| spare parts for | 418636 | | |
|  | GEV No. | 510408 | Ref. No. 218800 2188000 218840 2188400 |
| | O-ring EPDM thickness 5.34mm ID \varnothing 47mm Qty 1 pcs | | |
|  | GEV No. | 521030 | Ref. No. — |
| | O-ring Viton thickness 5.34mm ID \varnothing 47mm Qty 1 pcs | | |

3 hole flange \varnothing 57.5mm

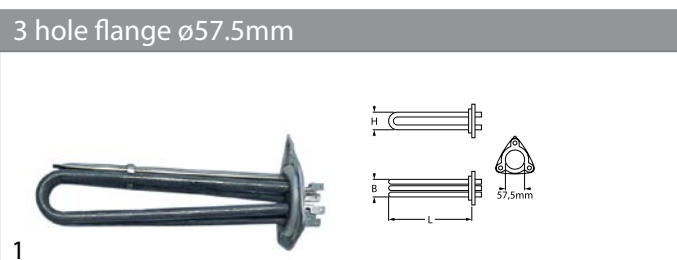

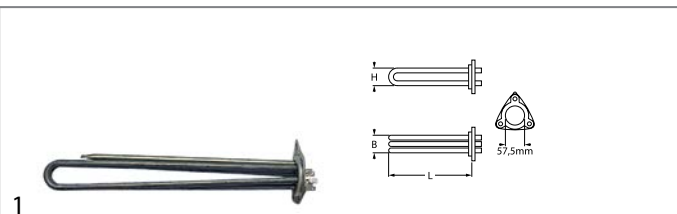

| | | | |
|--------------------|------------------------------------------------------------------------------------------------------------------------------------------------------------------------------------------------------------------------------------------------------------------------------------------------------------------------------------------------------------------------------|-----------------|-------------------|
| GEV No. | 415934 | Ref. No. | 320804 3208040 |
| description | heating element 3500W 230V mounting \varnothing 57.5mm heating circuits 3 L 192mm W 38mm H 50mm number of thermostat sleeves 1 thermostat sleeves \varnothing 7.5mm length thermostat sleeves 180mm thermostat sleeve eccentric, clinging tube \varnothing 8.5mm hole distance 72mm hole \varnothing 8mm connection male faston 6.3mm 3 hole flange immersion heater | | |

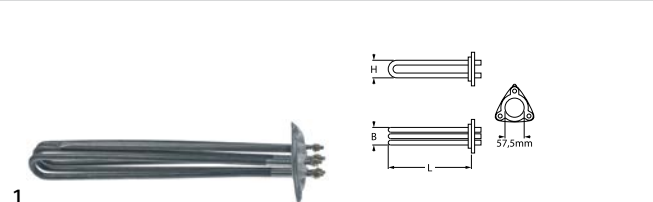

| | | | |
|--------------------|--------------------------------------------------------------------------------------------------------------------------------------------------------------------------------------------------------------------------------------------------------------------------------------------------------------------------------------------------------------------------------------|-----------------|-----------------|
| GEV No. | 415020 | Ref. No. | 3205500+2188400 |
| description | heating element 4500W 230V mounting \varnothing 57.5mm heating circuits 3 L 355mm W 35mm H 47mm number of thermostat sleeves 1 thermostat sleeves \varnothing 7mm length thermostat sleeves 295mm thermostat sleeve upper tube \varnothing 8.5mm hole distance 70mm hole \varnothing 10mm connection length 25mm connection male faston 6.3mm 3 hole flange immersion heater | | |



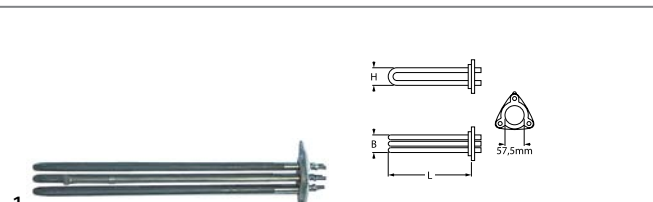

1

| | | | |
|-----------------------------------------------------------------------------------|---------------------------------------------------------------------------------------------------------------------------------------------------------------------------------------------------------------------------------------------------------------------------------------------------------|-----------------|-----------------------------------|
| GEV No. | 415021 | Ref. No. | 320802 3208020 |
| description | heating element 6000W 230V mounting ϕ 57.5mm heating circuits 3 L 343mm W 37mm H 50mm number of thermostat sleeves 1 thermostat sleeves ϕ 7mm length thermostat sleeves 294mm thermostat sleeve not clinging tube ϕ 8.5mm hole distance 72mm hole ϕ 8mm connection M5 3 hole flange | | |
| spare parts for | 415021 | | |
|  | GEV No. | 510409 | Ref. No. 218845 2188450 |
| accessories for | 415021 | | |
|  | GEV No. | 550002 | Ref. No. — |
| description | tension strap H 10mm L 21mm W 10mm hole ϕ 6.5mm for heating element | | |



1

| | | | |
|-------------------------------------------------------------------------------------|----------------------------------------------------------------------------------------------------------------------------------------------------------------------------------------------------------------------------------------------------------------------------------------------------------------------|-----------------|-----------------------------------|
| GEV No. | 415937 | Ref. No. | 320805 3208050 |
| description | heating element 9000W 230V mounting ϕ 57.5mm heating circuits 3 L 340mm W 37mm H 52mm number of thermostat sleeves 1 thermostat sleeves ϕ 7mm length thermostat sleeves 300mm thermostat sleeve clinging tube ϕ 8.5mm hole distance 72mm hole ϕ 8mm connection M5 3 hole flange immersion heater | | |
| spare parts for | 415937 | | |
|  | GEV No. | 510409 | Ref. No. 218845 2188450 |
| description | O-ring EPDM thickness 5.34mm ID ϕ 56.52mm Qty 1 pcs | | |

with compression flange 62 x 26mm

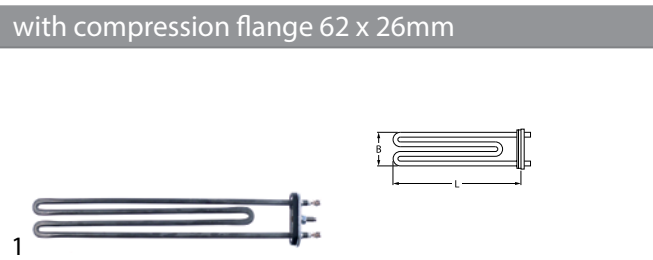

1

| | | | |
|--------------------|--------------------------------------------------------------------------------------------------------------------------------------------------------------------|-----------------|-------|
| GEV No. | 415266 | Ref. No. | 10714 |
| description | heating element 2000W 230V heating circuits 1 compression flange flange 62x26mm L 300mm W 41mm Hmm connection male faston 6.3mm tube ϕ 6.3mm immersion heater | | |

accessories

sealing washers

O-rings

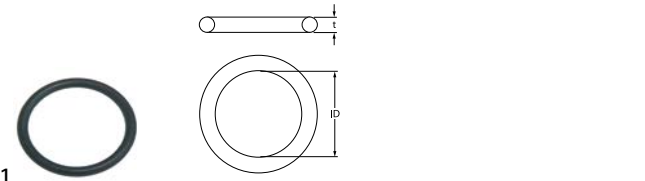

1

| | | | |
|--------------------|-------------------------------------------------------|-----------------|----------------------------------------|
| GEV No. | 510408 | Ref. No. | 218800 2188000 218840 2188400 |
| description | O-ring EPDM thickness 5.34mm ID ϕ 47mm Qty 1 pcs | | |

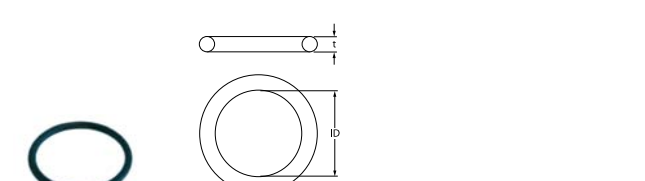

1

| | | | |
|--------------------|----------------------------------------------------------|-----------------|-------------------|
| GEV No. | 510409 | Ref. No. | 218845 2188450 |
| description | O-ring EPDM thickness 5.34mm ID ϕ 56.52mm Qty 1 pcs | | |

thermostats

bi-metal thermostats

bi-metal thermostats



1

| | | | |
|--------------------|--------------------------------------------------|-----------------|-------------------|
| GEV No. | 390232 | Ref. No. | 326722 3267220 |
| description | bi-metal thermostat switch-off temp. 55°C 1-pole | | |



control and safety thermostats

EGO

control thermostats

55.10/19_series

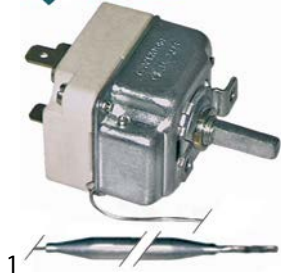

| | | | |
|----------------|--------|-----------------|-------------------|
| GEV No. | 375211 | Ref. No. | 326732 3267320 |
|----------------|--------|-----------------|-------------------|

description thermostat t.max. 85°C temperature range 30-85°C 1-pole 1CO 16A probe ø 6mm probe L 130mm capillary pipe 900mm capillary pipe isolated 900mm gland nut shaft L 23mm shaft position upper rotation 270° probe material SS

55.34_series



| | | | |
|----------------|--------|-----------------|-------------------|
| GEV No. | 375210 | Ref. No. | 326724 3267240 |
|----------------|--------|-----------------|-------------------|

description thermostat t.max. 90°C temperature range 38-90°C 3-pole 3CO 16A probe ø 6mm probe L 215mm capillary pipe 900mm capillary pipe isolated 900mm gland nut shaft Lmm rotation 270°

safety thermostats

55.32_series

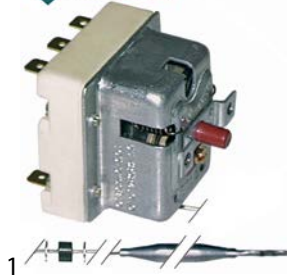

| | | | |
|----------------|--------|-----------------|-------------------|
| GEV No. | 375209 | Ref. No. | 326726 3267260 |
|----------------|--------|-----------------|-------------------|

description safety thermostat switch-off temp. 140°C 3-pole 20A probe ø 6mm probe L 89mm capillary pipe 900mm capillary pipe isolated 900mm gland nut probe SS

IMIT / TEMPOMATIC / ARATHERMO

control thermostats

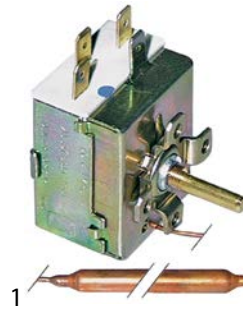

| | | | |
|----------------|--------|-----------------|-------------------|
| GEV No. | 390006 | Ref. No. | 326400 3264000 |
|----------------|--------|-----------------|-------------------|

description thermostat t.max. 86°C temperature range 0-86°C 1-pole 1CO 16A probe ø 6.5mm probe L 95mm capillary pipe 1500mm capillary pipe isolated gland nut shaft ø 6x4.6mm shaft L 19mm rotation 270°

accessories for 390006

| | | | |
|----------------|--------|-----------------|---|
| GEV No. | 110100 | Ref. No. | — |
|----------------|--------|-----------------|---|

knob thermostat t.max. 90°C 0-90°C ø 42mm shaft ø 6x4.6mm shaft flat -135° black



| | | | |
|----------------|--------|-----------------|---|
| GEV No. | 110105 | Ref. No. | — |
|----------------|--------|-----------------|---|

rosette knob ø 42mm ø 6mm zero mark

safety thermostats



| | | | |
|----------------|--------|-----------------|-------------------|
| GEV No. | 390601 | Ref. No. | 326710 3267100 |
|----------------|--------|-----------------|-------------------|

description safety thermostat switch-off temp. 120°C 1-pole 16A probe ø 6.5mm probe L 93mm capillary pipe 1500mm capillary pipe isolated 1440mm gland nut probe

accessories

gland nut accessories

locking screws





| | | | |
|----------------|--------|-----------------|-------------------|
| GEV No. | 550913 | Ref. No. | 241729 2417290 |
|----------------|--------|-----------------|-------------------|

description union screw thread M12x1 probe ø max. 6mm WS 12 brass



plunger sockets



| | | | |
|-----------------------------------------------------------------------------------------------------------------------------------------------------------------------|-------------------------------------------------------------|-----------------|-------------------|
|  <p>1</p> | | | |
| GEV No. | 541519 | Ref. No. | 241738 2417380 |
| description | thermowell IT M10x1 ET M14x1.5 L 33mm brass single ø 10.5mm | | |
| accessories for | 541519 | | |
|  <p>GEV No. 521101 Ref. No. —</p> <p>nut thread M14x1.5 H 5mm WS 19 SS Qty 1 pcs</p> | | | |

switches and momentary switches

rocker/momentary rocker switches

30x22mm

| | | | |
|--------------------------------------------------------------------------------------------|-------------------------------------------------------------------------------------------------------------------------------------------------------------------|-----------------|-------------------|
|  <p>1</p> | | | |
| GEV No. | 347704 | Ref. No. | 316720 3167200 |
| description | momentary rocker switch mounting measurements 30x22mm red 2CO 250V 16A illuminated connection male faston 6.3mm ambient temperature max. 100/55°C protection IP40 | | |

| | | | |
|--------------------------------------------------------------------------------------------------------------------------------------------------------------------------------------------------------------|---------------------------------------------------------------------------------------------------------------------------------------------------------|-----------------|-------------------|
|  <p>1</p> | | | |
| GEV No. | 346978 | Ref. No. | 316560 3165600 |
| description | momentary rocker switch mounting measurements 30x22mm black 2CO 250V 16A connection male faston 6.3mm ambient temperature max. 125/55°C protection IP40 | | |
| accessories for | 346978 | | |
|  <p>GEV No. 301036 Ref. No. —</p> <p>protective cover internal size 30x22mm for rocker switch mounting measurementsmm</p> | | | |

push/momentary push switches

ø25mm

| | | | |
|----------------------------------------------------------------------------------------------|-----------------------------------------------------------------------------------------------------------------------------------------------------|-----------------|-------------------|
|  <p>1</p> | | | |
| GEV No. | 346936 | Ref. No. | 316824 3168240 |
| description | momentary push switch mounting ø 25mm green 1NO/indicator light 250V 16A connection male faston 6.3mm ambient temperature max. 85°C protection IP40 | | |

microswitches

lever actuated



| | | | |
|--------------------------------------------------------------------------------------------|---------------------------------------------------------------------------------------------------------------------------------------------------------------|-----------------|-------------------|
|  <p>1</p> | | | |
| GEV No. | 345254 | Ref. No. | 312103 3121030 |
| description | microswitch with lever 250V 16A 1CO connection male faston 6.3mm ambient temperature max. 120°C mounting distance 22mm actuating force: 60g lever length 58mm | | |

pin-plunger actuated

M10

| | | | |
|--------------------------------------------------------------------------------------------|---------------------------------------------------------------------------------------------------------------------------------------------------------------------------------------------------------|-----------------|-----------------|
|  <p>1</p> | | | |
| GEV No. | 345032 | Ref. No. | 3121000 3276 |
| description | microswitch with plunger thread M10x1 thread L 12mm 250V 16A 1CO connection male faston 6.3mm stroke 7mm mounting distance 22mm L 28mm ambient temperature max. 125°C type SP9603 actuating force: 180g | | |

M12

| | | | |
|---------------------------------------------------------------------------------------------------------------------------------------------------------------------------------------------|-------------------------------------------------------------------------------------------------------------------------------------------------------------------------------------------------------|-----------------|---------|
|  <p>1</p> | | | |
| GEV No. | 345350 | Ref. No. | 3121010 |
| description | microswitch with plunger mounting distance 22mm thread M12x0.75 thread L 16mm 250V 16A 1CO connection male faston 6.3mm stroke 4mm ambient temperature max. 125°C type EF83161.3 actuating force: 66g | | |
| accessories for | 345350 | | |
|  <p>GEV No. 345351 Ref. No. —</p> <p>nut thread M12x0.75 H 1.6mm WS 14 chrome-plated brass Qty 1 pcs</p> | | | |

position switches

SIEMENS

3SE2 series

position switches (complete)

| | | | |
|----------------------------------------------------------------------------------------------|---------------------|-----------------|-------------------|
|  <p>1</p> | | | |
| GEV No. | 346935 | Ref. No. | 316820 3168200 |
| description | microswitch 1NO/1NC | | |



cam switches

3 operating positions



1

| | | | |
|--------------------|----------------------------------------------------------------------------------------------------------------------|-----------------|-------------------|
| GEV No. | 300086 | Ref. No. | 316812 3168120 |
| description | cam switch 3 operating positions programme sequence 1-0-2 shaft \varnothing 6x4.6mm connection male faston 10-pole | | |

rotary switches

TECNOMATIC



1

| | | | |
|--------------------|-----------------------------------------------------------------------------------------------------------------------------------------------------|-----------------|-------------------|
| GEV No. | 346034 | Ref. No. | 316810 3168100 |
| description | rotary switch 2 0-1 sets of contacts 4 type HD12X275R000 600V 12A shaft \varnothing 6x4.6mm shaft L 40mm shaft round connection male faston 6.3mm | | |



1

| | | | |
|--------------------|-------------------------------------------------------------------------------------------------------------------------------------------------------|-----------------|-------------------|
| GEV No. | 300366 | Ref. No. | 316818 3168180 |
| description | rotary switch 3 0-1-2 sets of contacts 3 type HD12X312AR000 600V 12A shaft \varnothing 5x5mm shaft L 23mm shaft square connection male faston 6.3mm | | |



1

| | | | |
|--------------------|--------------------------------------------------------------------------------------------------------------------------------------------------------|-----------------|-------------------|
| GEV No. | 300365 | Ref. No. | 316819 3168190 |
| description | rotary switch 4 0-1-2-3 sets of contacts 4 type HD12X274R000 600V 12A shaft \varnothing 5x5mm shaft L 22mm shaft square connection male faston 6.3mm | | |

magnetic switches

36x13mm

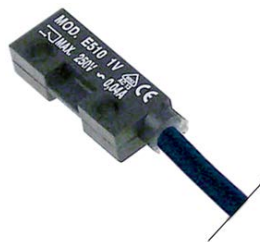

1

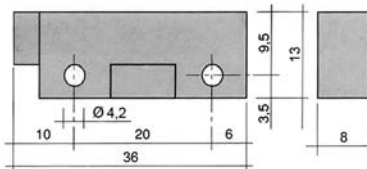

| | | | |
|--------------------|---------------------------------------------------------------------------------------------------------------------|-----------------|----------------------------------------|
| GEV No. | 345792 ¹ | Ref. No. | 312104 3121040 312106 3121060 |
| description | magnetic switch L 36mm W 13mm 1NO 250V 0.04A P max. 10W connection cable cable length 2500mm mounting distance 20mm | | |

¹with coded connector

accessories

magnets



1

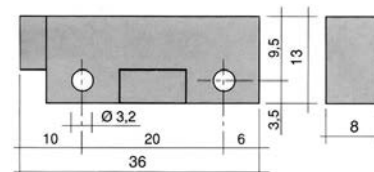

| | | | |
|--------------------|------------------------------------------------------------------------------------------|-----------------|-------------------|
| GEV No. | 345398 | Ref. No. | 312105 3121050 |
| description | magnet \varnothing mm L 36mm H 8mm W 13mm hole distance 20mm M3 hole \varnothing 3mm | | |

lamps

indicator lights

indicator lights 2-piece (lens and indicator lamp)

indicator light lenses

 \varnothing 12mm (type SDY-3)

1

| | | | |
|--------------------|-----------------------------------------------------------------------------------------|-----------------|-------------------|
| GEV No. | 359262 | Ref. No. | 310906 3109060 |
| description | indicator light housings mounting measurements \varnothing 12mm green round Qty 1 pcs | | |





| | | | |
|--------------------------------------------------------------------------------------------|------------------------------------------------------------------------------------------------------|-----------------|------------------------------|
| indicator lamps for socket type SRZ / SDK / SDY / SFK | | | |
|  <p>1</p> | | | |
| GEV No. | 359132 | Ref. No. | 3109030 310905 3109050 |
| description | indicator lamp green 250V connection male faston 6.3mm protection IP54 ambient temperature max. 85°C | | |

timers

programme timers

| | | | |
|--------------------------------------------------------------------------------------------|------------------------------------------------------------------------------------------------------------------------|-----------------|---------------------------------|
|  <p>1</p> | | | |
| GEV No. | 360397 | Ref. No. | 340609 3406090 (old version) |
| description | timer BIGATTI engines 2 chambers 5 operation time 60s up to 3min 230V manif. no. LA007 / 3406090 motor type UDS40NE1RK | | |

| | | | |
|---------------------------------------------------------------------------------------------|--------------------------------------------------------------------------|-----------------|---------|
|  <p>1</p> | | | |
| GEV No. | 360687 | Ref. No. | 3406090 |
| description | timer CDC 4905DV engines 2 chambers 5 operation time 60s up to 3min 230V | | |

| | | | |
|----------------------------------------------------------------------------------------------------------------------------------------------------------------|-------------------------------------------------------------------------------------------------------------------------------------------|-----------------|-----------------------------------|
|  <p>1</p> | | | |
| GEV No. | 360040 | Ref. No. | 3324 340200 3402000 4188 |
| description | timer CDC 9003F engines 1 chambers 3 operation time 6min 230V shaft ø 6x4.6mm shaft L 21mm manif. no. 9003F3 / PRCIH5 motor type M48R ATS | | |
| For models: | LB925H, LS3-A | | |
| spare parts for | 360040 | | |
|  | GEV No. | 360118 | Ref. No. — |
| motor CDC pinion ø 4.9mm teeth 10 230V voltage AC 50/60Hz turn direction right motor ø 47mm H 19.3mm motor type M48R ATS for timer cable length 260mm 1.9/2.5W | | | |

| | | | |
|-----------------------------------------------------------------------------------|----------------|--------|-------------------|
| accessories for | 360040 | | |
|  | GEV No. | 110197 | Ref. No. — |
| knob switch zero mark ø 42mm shaft ø 6x4.6mm shaft flat adjustable black | | | |

| | | | |
|---------------------------------------------------------------------------------------------|--------------------------------------------------------------------------------------------------------------------------------------------------------------------------------------------------------------------------|-----------------|---------|
|  <p>1</p> | | | |
| GEV No. | 360395 | Ref. No. | 3406031 |
| description | timer FIBER P25 engines 1 chambers 4 operation time 180s 230V shaft ø 6x4.6mm shaft L 40mm manif. no. P255J04H5J6 motor type M51BJ0R6400 for devices with mechanical dosing pump edition since year of construction 2000 | | |



| | | | |
|---------------------------------------------------------------------------------------------|------------------------------------------------------------------------------------------------------------------------------------------------------------------------------------------------------------------------|-----------------|---------|
|  <p>1</p> | | | |
| GEV No. | 360120 | Ref. No. | 3406030 |
| description | timer FIBER P25 engines 1 chambers 5 operation time 180s 230V shaft ø 6x4.6mm shaft L 40mm manif. no. P255J05H542 motor type M51BJ0R6400 for devices with electric dosing pump edition until year of construction 2000 | | |

| | | | |
|--------------------------------------------------------------------------------------------------------------------------------------------------------------------|----------------|--------|-------------------|
| spare parts for | 360120 | | |
|  | GEV No. | 360673 | Ref. No. — |
| motor kit pinion ø 6.8mm teeth 15 230V voltage AC 50/60Hz turn direction clockwise motor ø 48mm H 18.5mm motor type UDS-40NE1RNZ165 cable length 150mm with holder | | | |

| | | | |
|-----------------------------------------------------------------------------------------------|-----------------------------------------------------------------------------------------------------------------------------------------------------|-----------------|---------|
|  <p>1</p> | | | |
| GEV No. | 360398 | Ref. No. | 3406051 |
| description | timer FIBER P25 engines 2 chambers 7 operation time 12s / 2min 230V shaft ømm shaft Lmm manif. no. P255J07JGJ7 motor type M51BJ0R6400 / M51BJ0L6400 | | |





1

| | | | |
|-----------------------------------------------------------------------------------|--------------------------------------------------------------------------------------------------------------------------------------------------------------------------|-----------------|-------------------|
| GEV No. | 360122 | Ref. No. | 340605 3406050 |
| description | timer FIBER P25 engines 2 chambers 8 operation time 12s / 2min 230V shaft ømm shaft Lmm manif. no. P255J08JG75 motor type M51BJ0R6400 / M51BJ0L6400 | | |
| spare parts for | 360122 | | |
|  | GEV No. | 360673 | Ref. No. — |
| | motor kit pinion ø 6.8mm teeth 15 230V voltage AC 50/60Hz turn direction clockwise motor ø 48mm H 18.5mm motor type UDS-40NE1RNZ165 cable length 150mm with holder | | |
|  | GEV No. | 360674 | Ref. No. — |
| | motor kit pinion ø 6.8mm teeth 15 230V voltage AC 50/60Hz turn direction counterclockwise motor ø 48mm H 18.5mm motor type UDS40NE1RNZ165 cable length 150mm with holder | | |



1

| | | | |
|-------------------------------------------------------------------------------------|--------------------------------------------------------------------------------------------------------------------------------------------------------------------------|-----------------|-------------------|
| GEV No. | 360121 | Ref. No. | 340604 3406040 |
| description | timer FIBER P25 engines 2 chambers 8 operation time 40s / 120s 230V shaft ømm shaft Lmm manif. no. P255J08JH76 motor type M51BJ0R6400 / M51BJ0L6400 | | |
| spare parts for | 360121 | | |
|  | GEV No. | 360673 | Ref. No. — |
| | motor kit pinion ø 6.8mm teeth 15 230V voltage AC 50/60Hz turn direction clockwise motor ø 48mm H 18.5mm motor type UDS-40NE1RNZ165 cable length 150mm with holder | | |
|  | GEV No. | 360674 | Ref. No. — |
| | motor kit pinion ø 6.8mm teeth 15 230V voltage AC 50/60Hz turn direction counterclockwise motor ø 48mm H 18.5mm motor type UDS40NE1RNZ165 cable length 150mm with holder | | |



1

| | | | |
|--------------------|----------------------------------------------------------------------------------------------------------------------------------|-----------------|-------------------|
| GEV No. | 360406 | Ref. No. | 340400 3404000 |
| description | timer FIBER P26 engines 1 chambers 4 operation time 18min 230V shaft ømm shaft Lmm manif. no. P265J04J907 motor type M61B40R6400 | | |



1

| | | | |
|--------------------|-----------------------------------------------------------------------------------------------------------------------------------|-----------------|-------------------|
| GEV No. | 360396 | Ref. No. | 340607 3406070 |
| description | timer FIBER P26 engines 1 chambers 5 operation time 18min 230V shaft ømm shaft Lmm manif. no. P265J05J9017 motor type M61B40L6400 | | |



1

| | | | |
|--------------------|------------------------------------------------------------------------------------------------------------------------------------------|-----------------|-----------|
| GEV No. | 360076 | Ref. No. | 512069300 |
| description | timer FIBER P37 engines 1 chambers 3 operation time 180s 230V shaft ø 6x4.6mm shaft L 18mm manif. no. P375J03H524 motor type M51BJ0R6400 | | |

contactors

SIEMENS

power contactors



1

| | | | |
|-------------------------------------------------------------------------------------|------------------------------------------------------------------------------------------------------------------------------|-----------------|-----------------------------------|
| GEV No. | 380848 | Ref. No. | 342623 3426230 |
| description | power contactor resistive load 20A 230VAC (AC3/400V) 8.4A/4kW main contacts 3NO connection screw connection type 3TF30000-0A | | |
| accessories for | 380848 | | |
|  | GEV No. | 380849 | Ref. No. 342624 3426240 |
| | contact block contacts 1NO/1NC | | |



auxiliary contacts



| | | | |
|--------------------|--------------------------------|-----------------|-------------------|
| 1 | | | |
| GEV No. | 380849 | Ref. No. | 342624 3426240 |
| description | contact block contacts 1NO/1NC | | |

overload switches



| | | | |
|--------------------|-------------------------------------------------------|-----------------|-------------------|
| 1 | | | |
| GEV No. | 380850 | Ref. No. | 342625 3426250 |
| description | overload switch setting range 3.2-5A type 3UA50 00-1F | | |

relays

power relays

with DIN rail mounting

upper



| | | | |
|-------------------------------------------------------------------------------------|------------------------------------------------------------------------------------------------------|-----------------|-------------------|
| 1 | | | |
| GEV No. | 380183 | Ref. No. | 342626 3426260 |
| description | power relays FINDER 230VAC 12A 2CO connection male faston 4.8mm DIN rail manuf. no. 56.32.8.230.0007 | | |
| accessories for | 380183 | | |
|  | GEV No. | 380476 | Ref. No. — |
| | relay socket dimensions 78x27x33.5mm 250V voltage AC 10A FINDER manuf. no. 96.72 | | |



solenoïd valves

solenoïd valves (water)

ELBI

straight



| | | | |
|-----------------------------------------------------------------------------------|-----------------------------------------------------------------------------------------------------------|-----------------|-------------------|
| 1 | | | |
| GEV No. | 373021 | Ref. No. | 330050 3300500 |
| description | solenoïd valve double straight 230VAC inlet 3/4" outlet 11.5mm output 1x 4.7l/min DN10 ELBI | | |
| spare parts for | 373021 | | |
|  | GEV No. | 370467 | Ref. No. — |
| | solenoïd valve filter suitable for ELBI | | |
|  | GEV No. | 371263 | Ref. No. — |
| | reducer ELBI type EATON (INVENSYS) flow rate 4.7l/min pressure range 0 up to 10bar tolerance ±15/25% grey | | |



| | | | |
|-------------------------------------------------------------------------------------|--------------------------------------------------------------------------|-----------------|---------------------------|
| 1 | | | |
| GEV No. | 373025 | Ref. No. | 330500 3305000 4165 |
| description | solenoïd valve triple straight 230VAC inlet 3/4" outlet 11.5mm DN10 ELBI | | |
| spare parts for | 373025 | | |
|  | GEV No. | 370467 | Ref. No. — |
| | solenoïd valve filter suitable for ELBI | | |

spare parts and accessories

















reducers



outlet side





| | | | |
|--------------------|-----------------------------------------------------------------------------------------|-----------------|-------------------|
| 1 | | | |
| GEV No. | 371260 | Ref. No. | 330650 3306500 |
| description | reducer type ELBI flow rate 0.5l/min pressure range 0 up to 10bar tolerance ±15/25% red | | |



| TP | | | |
|-------------------------------------------------------------------------------------|----------------------------------------------------------------------|-----------------|----------------------------------------|
|  | | | |
| 1 | | | |
| GEV No. | 370015 | Ref. No. | 330100 3301000 330651 3306510 |
| description | solenoid valve single angled 230VAC inlet 3/4" outlet 11.5mm DN10 TP | | |
| accessories for | 370015 | | |
|  | GEV No. | 371220 | Ref. No. — |
| reducer TP flow rate 3l/min red tolerance ±15% | | | |
|  | GEV No. | 371221 | Ref. No. — |
| reducer TP flow rate 5.5l/min yellow tolerance ±15% | | | |
|  | GEV No. | 371222 | Ref. No. — |
| reducer TP flow rate 6l/min grey tolerance ±15% | | | |
|  | GEV No. | 371223 | Ref. No. — |
| reducer TP flow rate 10l/min white tolerance ±15% | | | |
|  | GEV No. | 371224 | Ref. No. — |
| reducer TP flow rate 12l/min bronze tolerance ±15% | | | |
|  | GEV No. | 371225 | Ref. No. — |
| reducer TP flow rate 16l/min light brown tolerance ±15% | | | |
|  | GEV No. | 371226 | Ref. No. — |
| reducer TP flow rate 20l/min red tolerance ±15% | | | |
|  | GEV No. | 371230 | Ref. No. — |
| reducer TP flow rate 0.25l/min red tolerance ±25% | | | |
|  | GEV No. | 371231 | Ref. No. — |
| reducer TP flow rate 0.35l/min violet tolerance ±25% | | | |
|  | GEV No. | 371232 | Ref. No. — |
| reducer TP flow rate 0.5l/min orange tolerance ±25% | | | |
|  | GEV No. | 371233 | Ref. No. — |
| reducer TP flow rate 0.8l/min white tolerance ±25% | | | |
|  | GEV No. | 371234 | Ref. No. — |
| reducer TP flow rate 1l/min light blue tolerance ±25% | | | |
|  | GEV No. | 371235 | Ref. No. — |
| reducer TP flow rate 1.2l/min brown tolerance ±25% | | | |
|  | GEV No. | 371236 | Ref. No. — |
| reducer TP flow rate 1.5l/min light brown tolerance ±25% | | | |
|  | GEV No. | 371237 | Ref. No. — |
| reducer TP flow rate 2.5l/min yellow tolerance ±25% | | | |

| accessories for 370015 | | | |
|-----------------------------------------------------------------------------------|---------|--------|------------|
|  | GEV No. | 371238 | Ref. No. — |
| reducer TP flow rate 3.4l/min dark green tolerance ±25% | | | |
|  | GEV No. | 371239 | Ref. No. — |
| reducer TP flow rate 5l/min black tolerance ±25% | | | |
|  | GEV No. | 371240 | Ref. No. — |
| reducer TP flow rate 8l/min blue tolerance ±20% | | | |

| metal | | | |
|-----------------------------------------------------------------------------------|---------|--------|------------------|
| ASCO | | | |
| spare parts and accessories | | | |
| O-rings | | | |
| 1 | | | |
|  | GEV No. | 371095 | Ref. No. 2182100 |
| description O-ring Viton thickness 1.78mm ID ø 6.07mm Qty 1 pcs | | | |

| Solenoid valve - accessories | | | |
|------------------------------------------------------------------------------------|---------|--------|------------------|
| 1 | | | |
|  | GEV No. | 371095 | Ref. No. 2182100 |
| description O-ring Viton thickness 1.78mm ID ø 6.07mm Qty 1 pcs | | | |

| pressure switches | | | |
|---------------------------------------------------------------------------------------------------------------------------------|---------|--------|----------------------------|
| for warewashing | | | |
| ø 58mm with male faston 6.3mm | | | |
| with connection horizontal | | | |
| 1 | | | |
|  | GEV No. | 541047 | Ref. No. 328303 3283030 |
| description pressure control pressure range 340/200mbar connection 6mm ø 58mm pressure connection horizontal warewashing | | | |



| | | | |
|-----------------------------------------------------------------------------------|------------------------------------------------------------------------------------------------------------|-----------------|-------------------|
|  | | | |
| 1 | | | |
| GEV No. | 541046 | Ref. No. | 328301 3283010 |
| description | pressure control pressure range 45/20mbar connection 6mm ø 58mm pressure connection horizontal warewashing | | |

| | | | |
|-----------------------------------------------------------------------------------|------------------------------------------------------------------------------------------------------------|-----------------|---------------------|
|  | | | |
| 1 | | | |
| GEV No. | 541140 | Ref. No. | 3281100 37610054 |
| description | pressure control pressure range 55/30mbar connection 6mm ø 58mm pressure connection horizontal warewashing | | |

| | | | |
|------------------------------------------------------------------------------------|--------------------------------------------------------------------------------------------------------------------------------------------------|-----------------|---------------------------|
| with connection vertical | | | |
|  | | | |
| 1 | | | |
| GEV No. | 541520 | Ref. No. | 328100 3281000 3609 |
| description | pressure control pressure range 55/30mbar connection male faston 6.3mm ø 55mm pressure connection vertical warewashing pressure connection ø 6mm | | |

| | | | |
|-------------------------------------------------------------------------------------|-------------------------|-----------------|-------------------|
| miscellaneous | | | |
|  | | | |
| 1 | | | |
| GEV No. | 541038 | Ref. No. | 328302 3283020 |
| description | pressure control double | | |

| | | | |
|------------------------------------------------------------------------------------|----------------------------------------------------|-----------------|-------------------|
| accessories | | | |
|  | | | |
| 1 | | | |
| GEV No. | 541109 | Ref. No. | 260032 2600320 |
| description | Y-piece plastic hose ø 8-6-8mm for pressure switch | | |

pumps

wash and rinse pumps

| | | | |
|-------------------------------------------------------------------------------------|----------------------------------------------------------------------------------------------------------------------------------------------------------------------------|-----------------|--------------------------------------|
| FIR | | | |
| pumps | | | |
|  | | | |
| 1 | | | |
| GEV No. | 500465 | Ref. No. | 351890 3518900 |
| description | pump inlet ø 28mm outlet ø 26mm type 2213.1601 230V 50Hz 1 phase 0.11kW 0.15HP L 195mm rotation direction left capacitor 5µF FIR | | |
| spare parts for | 500465 | | |
|  | GEV No. | 365017 | Ref. No. 334600 3346000 |
| | operating capacitor capacity 5µF 450V tolerance 5% 50/60Hz ambient temperature max. -25 to +85°C ø 28mm L 54mm M8 plastic connection male faston 6.3mm 16.10.08 protection | | |
|  | GEV No. | 510384 | Ref. No. — |
| | pump cover inlet ø 28mm outlet ø 26mm ø 100mm ID ø 76mm | | |
|  | GEV No. | 510695 | Ref. No. — |
| | mechanical shaft seal height counter ring 5.5mm ID ø 11mm | | |
|  | GEV No. | 511711 | Ref. No. — |
| | O-ring EPDM thickness 3.53mm ID ø 78.97mm Qty 1 pcs | | |
|  | GEV No. | 521266 | Ref. No. — |
| | impellor ø 67mm H 18mm thread M7 shaft ø 11mm shaft length 32mm blades 3 | | |







1

| | | | |
|-------------------------------------------------------------------------------------|------------------------------------------------------------------------------------------------------------------------------------------------------------------------------------|-----------------|-------------------------------------------|
| GEV No. | 500028 | Ref. No. | 351890 old version 3518900 old version |
| description | pump inlet \varnothing 28mm outlet \varnothing 26mm type 2213.1912 230V 50Hz 1 phase 0.11kW 0.15HP L 195mm rotation direction left capacitor 6.3 μ F FIR | | |
| spare parts for | 500028 | | |
|  | GEV No. | 365012 | Ref. No. — |
| | operating capacitor capacity 6.3 μ F 450V tolerance 5% 50Hz ambient temperature max. -25 to +85°C \varnothing 30mm L 61mm M8 plastic connection male faston 6.3mm protection | | |
|  | GEV No. | 510384 | Ref. No. — |
| | pump cover inlet \varnothing 28mm outlet \varnothing 26mm \varnothing 100mm ID \varnothing 76mm | | |
|  | GEV No. | 510532 | Ref. No. — |
| | impellor \varnothing 72mm H 22mm shaft \varnothing 11mm shaft length 32mm blades 3 | | |
|  | GEV No. | 510695 | Ref. No. — |
| | mechanical shaft seal height counter ring 5.5mm ID \varnothing 11mm | | |
|  | GEV No. | 521703 | Ref. No. — |
| | pump cover gasket EPDM thickness 2.5mm ID \varnothing 75mm Qty 1 pcs | | |





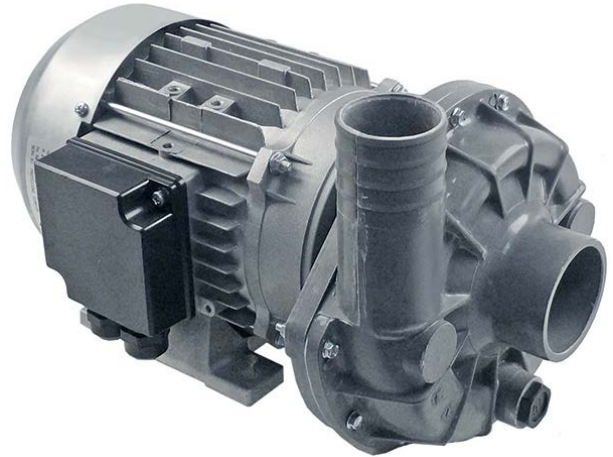

1

| | | | |
|-------------------------------------------------------------------------------------|----------------------------------------------------------------------------------------------------------------------------------------------------------------------------------|-----------------|-------------------|
| GEV No. | 500479 | Ref. No. | 351934 3519340 |
| description | pump inlet \varnothing 45mm outlet \varnothing 40mm type 3911.1423 230V 50Hz 1 phase 0.56kW 0.75HP L 204mm rotation direction right capacitor 10 μ F FIR | | |
| spare parts for | 500479 | | |
|  | GEV No. | 365015 | Ref. No. — |
| | operating capacitor capacity 10 μ F 400V tolerance 5%Hz ambient temperature max. -25 to +85°C \varnothing 35.5mm L 59mm M8 plastic connection male faston 6.3mm protection | | |

| | | | |
|-----------------------------------------------------------------------------------|---------------------------------------------------------------------------------------------------------------------------------------------------------------------------------------------------------------|--------|-------------------|
| spare parts for | 500479 | | |
|  | GEV No. | 510508 | Ref. No. — |
| | pump cover FIR inlet \varnothing 45mm outlet \varnothing 40mm pump type PU 0.5/3911 turn direction right \varnothing 160mm ID \varnothing 125mm inner height 25mm | | |
|  | GEV No. | 510610 | Ref. No. — |
| | impellor \varnothing 95.5mm H 23mm shaft intake \varnothing 9/8mm rotation direction right seat \varnothing 16mm blades 6 | | |
|  | GEV No. | 510692 | Ref. No. — |
| | mechanical shaft seal for shaft \varnothing 11mm slide ring ext. \varnothing 24mm slide ring H 13mm counter ring mounting \varnothing 26mm height counter ring 8mm counter ring int. \varnothing 14mm | | |
|  | GEV No. | 521702 | Ref. No. — |
| | pump cover gasket thickness 3.5x4.5mm Qty 1 pcs | | |



1

| | | | |
|-------------------------------------------------------------------------------------|------------------------------------------------------------------------------------------------------------------------------------------------------------------------------------------------------------------------------------------------------|-----------------|-------------------|
| GEV No. | 500023 | Ref. No. | 351936 3519360 |
| description | pump inlet \varnothing 63mm outlet \varnothing 47mm type 1225.2725 230/400V 50Hz 3 phase 1.1kW 1.5HP L 335mm rotation direction right FIR | | |
| spare parts for | 500023 | | |
|  | GEV No. | 510602 | Ref. No. — |
| | impellor \varnothing 110mm H 34mm rotation direction right thread M8L shaft \varnothing 28mm seat \varnothing 12.2mm blades 6 | | |
|  | GEV No. | 510693 | Ref. No. — |
| | mechanical shaft seal for shaft \varnothing 12mm slide ring ext. \varnothing 24mm slide ring H 15.5mm slide ring int. \varnothing 11mm counter ring mounting \varnothing 24mm height counter ring 8mm counter ring int. \varnothing 13.5mm | | |
|  | GEV No. | 521513 | Ref. No. — |
| | pump cover FIR inlet \varnothing 63mm outlet \varnothing 47mm turn direction right ID \varnothing 150mm inner height 32mm | | |
|  | GEV No. | 524416 | Ref. No. — |
| | pump cover gasket thickness 4x4mm Qty 1 pcs | | |



booster pumps I



1

| | | | |
|-----------------------------------------------------------------------------------|----------------------------------------------------------------------------------------------------------------------------------------------------------------|-----------------|-------------------|
| GEV No. | 500060 | Ref. No. | 351930 3519300 |
| description | pump inlet ø 1" outlet ø 1" type PQM60 230V 50Hz 1 phase 0.37kW PEDRELLO | | |
| accessories for | 500060 | | |
| | GEV No. | 365015 | Ref. No. |
|  | | | — |
| description | operating capacitor capacity 10µF 400V tolerance 5%Hz ambient temperature max. -25 to +85°C ø 35.5mm L 59mm M8 plastic connection male faston 6.3mm protection | | |



1

| | | | |
|--------------------|----------------------------------------------------------------------------------------------|-----------------|----------------------------------------|
| GEV No. | 500478 | Ref. No. | 351942 3519420 351948 3519480 |
| description | pump inlet ø 13mm outlet ø 13mm type C.4035 230V 0.28kW ALBA PUMPS (C&A) turn direction left | | |

drain pumps

ASKOLL



1

| | | | |
|--------------------|---------------------|-----------------|-------------------|
| GEV No. | 500210 | Ref. No. | 351935 3519350 |
| description | drain pump 230V 40W | | |

booster pumps II

accessories



1

| | | | |
|--------------------|----------------------------------------------------------------------------------------------------------------------------------------------------------------------------|-----------------|-------------------|
| GEV No. | 365017 | Ref. No. | 334600 3346000 |
| description | operating capacitor capacity 5µF 450V tolerance 5% 50/60Hz ambient temperature max. -25 to +85°C ø 28mm L 54mm M8 plastic connection male faston 6.3mm 16.10.08 protection | | |

condensators & interference suppression filters

operating capacitors

plastic



1

| | | | |
|--------------------|----------------------------------------------------------------------------------------------------------------------------------------------------------------------------|-----------------|-------------------|
| GEV No. | 365017 | Ref. No. | 334600 3346000 |
| description | operating capacitor capacity 5µF 450V tolerance 5% 50/60Hz ambient temperature max. -25 to +85°C ø 28mm L 54mm M8 plastic connection male faston 6.3mm 16.10.08 protection | | |

filters

interference suppression filters



1

| | | | |
|--------------------|----------------------------------------------------------------------------------------------------------------------------------------------|-----------------|-------------------|
| GEV No. | 365044 | Ref. No. | 334606 3346060 |
| description | interference suppression filter type FC701Y2F 250V 50-60Hz conductor 2 with E connection cable 200mm L 42mm ø 23mm Hmm Wmm plastic Qty 1 pcs | | |



fuses

screw locks

D0-system (NEOZED)



1

| | | | |
|--------------------|--------------------------------------------------------------|-----------------|-------------------|
| GEV No. | 358072 | Ref. No. | 316823 3168230 |
| description | fuse size D01 6A rated 250/400V E14 ø 11mm L 36mm Qty 10 pcs | | |

fuse holders



1

| | | | |
|--------------------|-------------------------------------------------------------------------------------|-----------------|----------------------------------------|
| GEV No. | 358000 | Ref. No. | 342628 3426280 342629 3426290 |
| description | fuse holder suitable fuse D01 16A rated 400V for DIN rail mounting suitable for D01 | | |

electric accessories

terminals

connection terminals with screw/faston connections



1

| | | | |
|--------------------|--------------------------------------------------------------------------------------------------------------------------------------|-----------------|-------------------|
| GEV No. | 550278 | Ref. No. | 308200 3082000 |
| description | power terminal block 3-pole max. 40A max 400V connection ø6mm ² / F6.3 temp.-resist. 150°C cross section 6mm ² | | |



1

| | | | |
|--------------------|--------------------------------------------------------------------------------------------------------------------------------------|-----------------|-------------------|
| GEV No. | 550411 | Ref. No. | 308300 3083000 |
| description | power terminal block 6-pole max. 40A max 450V connection ø6mm ² / F6.3 temp.-resist. 150°C cross section 6mm ² | | |

connection terminals with faston connections



1

| | | | |
|--------------------|----------------------------------------------|-----------------|-------------------|
| GEV No. | 550754 | Ref. No. | 308610 3086100 |
| description | connection terminal 6-pole max. 16A max 380V | | |

terminal boards



1

| | | | |
|--------------------|-----------------------------------------------|-----------------|-------------------|
| GEV No. | 550413 | Ref. No. | 308611 3086110 |
| description | terminal board 3-pole thread M5 L 55mm W 36mm | | |

equipment-specific units

for espresso machines

brewing units

filter holder gaskets

O-rings



1

| | | | |
|--------------------|-----------------------------------------------------|-----------------|-------------------|
| GEV No. | 510409 | Ref. No. | 218845 2188450 |
| description | O-ring EPDM thickness 5.34mm ID ø 56.52mm Qty 1 pcs | | |

for dishwashers

drain and intake components

LASA

drain /intake bodies



1

| | | | |
|--------------------|--------------------------------------------------------------------|-----------------|--------------------|
| GEV No. | 501356 | Ref. No. | 2440050 2440051 |
| description | drain fitting thread 1 1/2" ID ø 35mm L 40mm end piece ext. ø 57mm | | |

accessories for



| | | | |
|----------------|--------|-----------------|---|
| GEV No. | 505180 | Ref. No. | — |
|----------------|--------|-----------------|---|

O-ring EPDM thickness 3.53mm ID ø 47.22mm Qty 1 pcs

Table continues overleaf



| | | | |
|-----------------------------------------------------------------------------------|---------|--------|----------------------------------------|
| accessories for | | 501356 | |
|  | GEV No. | 506224 | Ref. No. |
| | | | 244004 2440040 267160 2671600 |
| nut thread 1½" plastic | | | |



| | | | |
|--------------------------------------|--------|----------|-----------------------------------------|
| GEV No. | 507374 | Ref. No. | 267340 2673400 (old version) 3589 |
| description drain fitting thread 1¼" | | | |

spare parts for 507374

| | | | |
|-----------------------------------------------------------------------------------|---------|--------|---------------------------|
|  | GEV No. | 507058 | Ref. No. |
| | | | 267120 2671200 3591 |
| screw connection thread 1¼" H 14mm WS 55 | | | |

| | | | |
|-----------------------------------------------------------------------------------|---------|--------|---------------------------|
|  | GEV No. | 507373 | Ref. No. |
| | | | 241430 2414300 3588 |
| threaded rod L 42mm | | | |

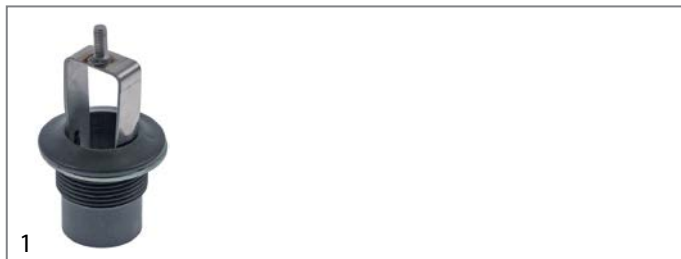

| | | | |
|---------------------------------------------|--------|----------|---------|
| GEV No. | 507577 | Ref. No. | 2673400 |
| description drain fitting thread 1¼" H 87mm | | | |



| | | | |
|-------------------------------------------------------------------|--------|----------|---------|
| GEV No. | 501374 | Ref. No. | 6490890 |
| description drain fitting thread 1½" ID ø 39mm L 40mm hose ø 41mm | | | |



| | | | |
|-------------------------|--------|----------|-------------------|
| GEV No. | 511916 | Ref. No. | 260970 2609700 |
| description intake body | | | |

spare parts for 511916

| | | | |
|-------------------------------------------------------------------------------------|---------|--------|-------------------|
|  | GEV No. | 511917 | Ref. No. |
| | | | 260969 2609690 |
| intake filter | | | |

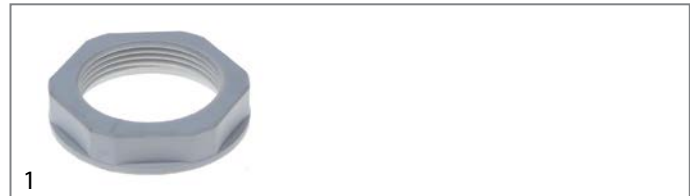

| | | | |
|------------------------------------|--------|----------|----------------------------------------|
| GEV No. | 506224 | Ref. No. | 244004 2440040 267160 2671600 |
| description nut thread 1½" plastic | | | |



| | | | |
|-----------------------------------------------------------------|--------|----------|---------|
| GEV No. | 532537 | Ref. No. | 2188600 |
| description O-ring EPDM thickness 3.53mm ID ø 113.9mm Qty 1 pcs | | | |



| | | | |
|------------------------------------------------------|--------|----------|---------------------------|
| GEV No. | 507058 | Ref. No. | 267120 2671200 3591 |
| description screw connection thread 1¼" H 14mm WS 55 | | | |



filters



| | | | |
|------------------------------------------------------------------------------------------------|--------|----------|--------|
| GEV No. | 524928 | Ref. No. | 743176 |
| description flat filter L 560mm W 270mm H 20mm with hole mounting pos. right for dishwasher SS | | | |





| | | | |
|--------------------------------------------------------------------------------------------------|--------|----------|--------|
| GEV No. | 524929 | Ref. No. | 743177 |
| description flat filter L 560mm W 270mm H 20mm without hole mounting pos. left for dishwasher SS | | | |

| | | | |
|-----------------------------------------------------------------------------------|----------------|-----------------|-----------------------------------|
|  | | | |
| 1 | | | |
| GEV No. | 511917 | Ref. No. | 260969 2609690 |
| description | intake filter | | |
| spare parts for | 511917 | | |
|  | GEV No. | 511916 | Ref. No. 260970 2609700 |
| | intake body | | |

| | | | |
|-----------------------------------------------------------------------------------|---------------------|-----------------|---------------------------|
|  | | | |
| 1 | | | |
| GEV No. | 507373 | Ref. No. | 241430 2414300 3588 |
| description | threaded rod L 42mm | | |

overflow pipes

| | | | |
|------------------------------------------------------------------------------------|----------------------------------------------------------------------------------------------------|-----------------|---------|
|  | | | |
| 1 | | | |
| GEV No. | 519454 | Ref. No. | 2609710 |
| description | overflow pipe \varnothing 31mm L 238mm ID \varnothing 27mm ED \varnothing 31mm thickness 3mm | | |



| | | | |
|-------------------------------------------------------------------------------------|----------------------------------------------------------|-----------------|--------------------|
|  | | | |
| 1 | | | |
| GEV No. | 501357 | Ref. No. | 7451360 7451780 |
| description | overflow pipe \varnothing 40mm L 460mm stainless steel | | |

softener cartridges

softening columns

| | | | |
|-------------------------------------------------------------------------------------|---------------------------------|-----------------|----------------------------------------|
|  | | | |
| 1 | | | |
| GEV No. | 530000 | Ref. No. | 346100 3461000 346200 3462000 |
| description | softener 4-fold L 380mm W 180mm | | |

complete

| | | | |
|------------------------------------------------------------------------------------|----------------|-----------------|-------------------|
|  | | | |
| 1 | | | |
| GEV No. | 516086 | Ref. No. | 3464020 |
| description | softener | | |
| spare parts for | 516086 | | |
|  | GEV No. | 516087 | Ref. No. — |
| | container lid | | |

hood mechanics for dishwashers

springs

| | | | |
|------------------------------------------------------------------------------------|-------------------------------------------------------------------------------------|-----------------|-------------------|
|  | | | |
| 1 | | | |
| GEV No. | 511968 | Ref. No. | 238517 2385170 |
| description | spring for hood mechanics L 383mm wire gauge \varnothing 5.5mm \varnothing 43mm | | |

air traps

air traps

| | | | |
|--------------------------------------------------------------------------------------|---------------------------------------------|-----------------|-------------------|
|  | | | |
| 1 | | | |
| GEV No. | 510343 | Ref. No. | 277561 2775610 |
| description | air trap L 140mm \varnothing 33mm plastic | | |



| | | | |
|-------------------------------------------------------------------------------------|------------------------|-----------------|-----------------------------------------------------------------------------------------|
|  | | | |
| 1 | | | |
| GEV No. | 511454 | Ref. No. | 260968 2609680 2609680+2185600+2023250+2035650 2609680+2187700+2023250+2035650 |
| description | air trap W 45mm H 95mm | | |



door mechanics

locks

| | | | |
|-----------------------------------------------------------------------------------|-----------------------------------|-----------------|---------|
|  | | | |
| 1 | | | |
| GEV No. | 510628 | Ref. No. | 2609880 |
| description | catch hook plastic for door latch | | |

| | | | |
|-----------------------------------------------------------------------------------|-----------------------------------|-----------------|-------------------------|
|  | | | |
| 1 | | | |
| GEV No. | 510627 | Ref. No. | 2609870 |
| description | housing plastic for door latch | | |
| accessories for | 510627 | | |
|  | GEV No. | 510628 | Ref. No. 2609880 |
| | catch hook plastic for door latch | | |
|  | GEV No. | 510629 | Ref. No. 2385150 |
| | spring for door latch | | |

| | | | |
|-------------------------------------------------------------------------------------|-----------------------|-----------------|---------|
|  | | | |
| 1 | | | |
| GEV No. | 510629 | Ref. No. | 2385150 |
| description | spring for door latch | | |

screw connections

| | | | |
|-------------------------------------------------------------------------------------|------------------------------------------|-----------------|---------------------------|
|  | | | |
| 1 | | | |
| GEV No. | 507058 | Ref. No. | 267120 2671200 3591 |
| description | screw connection thread 1¼" H 14mm WS 55 | | |

washing and rinsing systems

| | | | |
|-------------------------------------------------------------------------------------|-----------------------------------------------------------|-----------------|--------|
|  | | | |
| 1 | | | |
| GEV No. | 524932 | Ref. No. | 266002 |
| description | extension for wash arm support ø 68/62mm ID ø 53mm H 60mm | | |

| | | | |
|------------------------------------------------------------------------------------|-------------------------------------------------------------|-----------------|-------------------|
|  | | | |
| 1 | | | |
| GEV No. | 524933 | Ref. No. | 270302 2703020 |
| description | gasket for wash arm support ø 100mm ID ø 68mm thickness 7mm | | |

| | | | |
|------------------------------------------------------------------------------------|----------------------------------------------|-----------------|-------------------|
|  | | | |
| 1 | | | |
| GEV No. | 510238 | Ref. No. | 230598 2305980 |
| description | knurled nut ø 27mm H 13.4mm wash arm support | | |

| | | | |
|------------------------------------------------------------------------------------|-----------------------------------------------------------|-----------------|-------------------|
|  | | | |
| 1 | | | |
| GEV No. | 519469 | Ref. No. | 260974 2609740 |
| description | screw connection for wash arm support mounting pos. lower | | |

washing and rinsing systems (sorted by producer)



LASA

| | | | |
|--------------------------------------------------------------------------------------|-----------------------------------------------------------------------|-----------------|-------------------|
|  | | | |
| 1 | | | |
| GEV No. | 518084 | Ref. No. | 260983 2609830 |
| description | rinse arm L 215mm nozzles 4 mounting ø 18mm mounting pos. upper/lower | | |

| | | | |
|--------------------------------------------------------------------------------------|-------------------------------------------------------------------------------|-----------------|---------|
|  | | | |
| 1 | | | |
| GEV No. | 518083 | Ref. No. | 2610010 |
| description | wash arm L 190mm nozzles 4 mounting ø 31.7mm mounting pos. upper/lower ø 32mm | | |

| | | | |
|-----------------------------------------------------------------------------------|------------------|-----------------|---------|
|  | | | |
| 1 | | | |
| GEV No. | 510237 | Ref. No. | 2600130 |
| description | rinse jet H 18mm | | |

| | | | |
|-----------------------------------------------------------------------------------|--------------------------------------------------------------------------------|-----------------|-------------------|
|  | | | |
| 1 | | | |
| GEV No. | 524931 | Ref. No. | 261003 2610030 |
| description | wash arm boss mounting pos. upper/lower ø 71mm ID ø 59mm L 135mm W 88mm H 62mm | | |

| | | | |
|------------------------------------------------------------------------------------|-----------------------------------------------------------|-----------------|----------------------------------------|
|  | | | |
| 1 | | | |
| GEV No. | 519453 | Ref. No. | 260973 2609730 644657 6446570 |
| description | wash arm support mounting pos. lower | | |
| accessories for | 519453 | | |
|  | GEV No. | 519469 | Ref. No. 260974 2609740 |
| | screw connection for wash arm support mounting pos. lower | | |

| | | | |
|-------------------------------------------------------------------------------------|----------------------------------------------------|-----------------|-------------------|
|  | | | |
| 1 | | | |
| GEV No. | 519452 | Ref. No. | 260976 2609760 |
| description | wash arm support mounting pos. upper ø 41mm H 64mm | | |

knobs

producer-specific knobs

LASA

| | | | |
|-------------------------------------------------------------------------------------|------------------------------------------------------|-----------------|-------------------|
|  | | | |
| 1 | | | |
| GEV No. | 111816 | Ref. No. | 263500 2635000 |
| description | knob ø 20mm shaft ø 6x4.6mm shaft flat universal red | | |

| | | | |
|------------------------------------------------------------------------------------|---------------------------------------------------------------|-----------------|-----------------------------------------------------------|
|  | | | |
| 1 | | | |
| GEV No. | 111815 | Ref. No. | 260016 2600160 644660 6446600 6446600+2004400 |
| description | knob switch zero mark ø 45mm shaft ø 6x4.6mm shaft flat right | | |

| | | | |
|------------------------------------------------------------------------------------|---------------------------------------------------------------------|-----------------|----------------------------------------|
|  | | | |
| 1 | | | |
| GEV No. | 112550 | Ref. No. | 260007 2600070 644656 6446560 |
| description | knob switch zero mark ø 45mm shaft ø 6x4.6mm shaft flat right black | | |

accessories

gaskets

| | | | |
|-------------------------------------------------------------------------------------|-------------------------------------|-----------------|--------|
|  | | | |
| 1 | | | |
| GEV No. | 112563 | Ref. No. | 270310 |
| description | gasket for shaft D1 ø 16mm D2 ø 6mm | | |

rosettes

| | | | |
|-------------------------------------------------------------------------------------|-------------------------------|-----------------|-------------------|
|  | | | |
| 1 | | | |
| GEV No. | 112551 | Ref. No. | 260010 2600100 |
| description | rosette for knob up to ø 45mm | | |

| | | | |
|-------------------------------------------------------------------------------------|-------------------------------|-----------------|-------------------|
|  | | | |
| 1 | | | |
| GEV No. | 112552 | Ref. No. | 260009 2600090 |
| description | rosette for knob up to ø 45mm | | |



gaskets

O-rings

EPDM



1

| | | | |
|--------------------|----------------------------------------------------------|-----------------|-------------------|
| GEV No. | 510302 | Ref. No. | 218852 2188520 |
| description | O-ring EPDM ID ϕ 12.42mm thickness 1.78mm Qty 1 pcs | | |



1

| | | | |
|--------------------|-------------------------------------------------------|-----------------|---------|
| GEV No. | 504512 | Ref. No. | 2182550 |
| description | O-ring EPDM thickness 1.78mm ID ϕ 14mm Qty 1 pcs | | |



1

| | | | |
|--------------------|---------------------------------------------------------|-----------------|-------------------|
| GEV No. | 510303 | Ref. No. | 218030 2180300 |
| description | O-ring EPDM thickness 1.78mm ID ϕ 6.75mm Qty 1 pcs | | |



1

| | | | |
|--------------------|-----------------------------------------------------------|-----------------|---------|
| GEV No. | 532062 | Ref. No. | 2185700 |
| description | O-ring EPDM thickness 2.62mm ID ϕ 29.82mm Qty 10 pcs | | |



1

| | | | |
|--------------------|----------------------------------------------------------|-----------------|---------|
| GEV No. | 532537 | Ref. No. | 2188600 |
| description | O-ring EPDM thickness 3.53mm ID ϕ 113.9mm Qty 1 pcs | | |



1

| | | | |
|--------------------|-------------------------------------------------------|-----------------|----------------------------------------|
| GEV No. | 510408 | Ref. No. | 218800 2188000 218840 2188400 |
| description | O-ring EPDM thickness 5.34mm ID ϕ 47mm Qty 1 pcs | | |



1

| | | | |
|--------------------|----------------------------------------------------------|-----------------|-------------------|
| GEV No. | 510409 | Ref. No. | 218845 2188450 |
| description | O-ring EPDM thickness 5.34mm ID ϕ 56.52mm Qty 1 pcs | | |

silicone

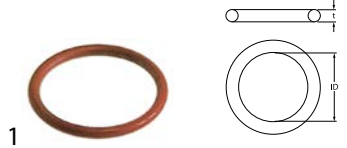

1

| | | | |
|--------------------|--------------------------------------------------------------|-----------------|----------------------------------------|
| GEV No. | 532650 | Ref. No. | 218560 2185600 218770 2187700 |
| description | O-ring silicone thickness 3.53mm ID ϕ 15.47mm Qty 1 pcs | | |

Viton

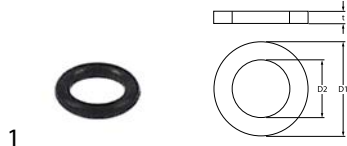

1

| | | | |
|--------------------|----------------------------------------------------------|-----------------|---------|
| GEV No. | 371095 | Ref. No. | 2182100 |
| description | O-ring Viton thickness 1.78mm ID ϕ 6.07mm Qty 1 pcs | | |

NBR

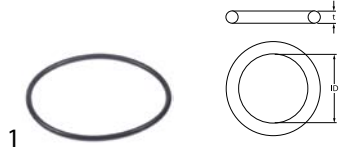

1

| | | | |
|--------------------|---------------------------------------------------------|-----------------|--------|
| GEV No. | 532651 | Ref. No. | 218130 |
| description | O-ring NBR thickness 3.53mm ID ϕ 71.44mm Qty 1 pcs | | |

springs

miscellaneous



1

| | | | |
|--------------------|----------------------------------------------------------------------------------------|-----------------|--------|
| GEV No. | 511969 | Ref. No. | 238512 |
| description | protection spring shaft diametermm ϕ 11mm L 112mm Wmm Hmm wire gauge ϕ 0.6mm | | |



manometers

| | | | |
|--------------------------------------------------------------------------------------------|-------------------------------------------------------------------------------------|-----------------|-------------------|
|  <p>1</p> | | | |
| GEV No. | 541272 | Ref. No. | 326728 3267280 |
| description | manometer ø 40mm pressure range 0 up tp 4bar thread 1/8" connection on the backside | | |

dosing pumps



membrane dosing pumps

self-priming

various





| | | | |
|---------------------------------------------------------------------------------------------|----------------------------------------------------------------------------------------------------------------------------|-----------------|------------|
|  <p>1</p> | | | |
| GEV No. | 361015 | Ref. No. | 3489010 |
| description | dosing pump membrane dosing pump rinse aid inlet 6x8mm outlet 4x6mm pressure connection ø 4x6mm suction connection ø 6x8mm | | |
| spare parts for | 361015 | | |
| | GEV No. | 361132 | Ref. No. — |
|  | membrane dosing pump | | |
| | GEV No. | 510298 | Ref. No. — |
|  | lip valve dosing pump suitable for DB2/DS5 | | |

| | | | |
|-------------------------------------------------------------------------------------------------|--------------------------------------------------------------------------------------------------------------------|-----------------|------------|
|  <p>1 2x</p> | | | |
| GEV No. | 361741 | Ref. No. | 3489030 |
| description | dosing pump type model 2 rinse aid inlet 4x6mm outlet 4x6mm pressure connection ø 4x6mm suction connection ø 4x6mm | | |
| spare parts for | 361741 | | |
| | GEV No. | 361307 | Ref. No. — |
|  | membrane dosing pump ø 68mm hole ø 6mm for type DIB3P/DIB5P | | |
| | GEV No. | 361459 | Ref. No. — |
|  | hose connector ø 6mm for dosing pump | | |
| | GEV No. | 361462 | Ref. No. — |
|  | container filter with weight SS hose ø 4x6mm | | |

| | | | |
|-----------------------------------------------------------------------------------|-----------------------------------------------------------------------|--------|------------|
| spare parts for | 361741 | | |
| | GEV No. | 508116 | Ref. No. — |
|  | union nut thread M10x1 H 16mm WS 16 plastic Qty 1 pcs | | |
| | GEV No. | 508123 | Ref. No. — |
|  | T-piece 3-way hose ø 13-5-13mm plastic | | |
| | GEV No. | 520090 | Ref. No. — |
|  | PVC hose ID ø 4mm ED ø 6mm L 2m thickness 1mm t.max. 60°C transparent | | |

self-priming with supporting pressure

OMNIWASH

| | | | |
|---------------------------------------------------------------------------------------------|-------------------------------------------------------------------------------------------------------------|-----------------|--------------|
|  <p>1</p> | | | |
| GEV No. | 361054 | Ref. No. | 3229 3929 |
| description | dosing pump rinse aid pressure connection ø 6mm suction connection ø 6mm auxiliary pressure connection 10mm | | |
| spare parts for | 361054 | | |
| | GEV No. | 361308 | Ref. No. — |
|  | membrane rinse aid pressure connection ømm suction connection ømm auxiliary pressure connectionmm | | |
| | GEV No. | 361348 | Ref. No. — |
|  | lip valve rinse aid pressure connection ømm suction connection ømm auxiliary pressure connectionmm | | |
| accessories for | 361054 | | |
| | GEV No. | 520252 | Ref. No. — |
|  | nylon hose ID ø 6mm ED ø 8mm L 5m thickness 1mm operating p. 10bar burst p. 50bar t.max. 100°C white | | |
| | GEV No. | 520278 | Ref. No. — |
|  | PVC hose ID ø 6mm ED ø 8mm L 2m thickness 1mm t.max. 60°C transparent | | |

hoses

formed hoses

straight

| | | | |
|-----------------------------------------------------------------------------------------------|-----------------------------------------------------------|-----------------|----------------------------------------|
|  <p>1</p> | | | |
| GEV No. | 504273 | Ref. No. | 193318 1933180 271245 2712450 |
| description | extraction hose hose ext. ø 68mm hose int. ø 60mm L 150mm | | |

1

| | | | |
|--------------------|-----------------------------------------------------------------------------------|-----------------|-------------------|
| GEV No. | 519455 | Ref. No. | 270317 2703170 |
| description | formed hose hose ext. ø 50/60mm hose int. ø 38/48mm L 69mm dishwasher black Qty 1 | | |

with branch



1

| | | | |
|--------------------|------------------------------------------------------------------------|-----------------|-------------------|
| GEV No. | 524930 | Ref. No. | 270313 2703130 |
| description | formed hose ext. ø 62/55 D1 ø 43mm D2 ø 49mm L 170mm warewashing black | | |

for dishwashers

miscellaneous



1

| | | | |
|--------------------|---------------------------------------------------------|-----------------|---------|
| GEV No. | 510806 | Ref. No. | 6422180 |
| description | extraction hose ED ø 8mm ID ø 5mm Qty supplied by meter | | |

fittings, hose and pipe connectors

hose connectors

without screw connection



1

| | | | |
|--------------------|----------------------------------------------------|-----------------|-------------------|
| GEV No. | 541109 | Ref. No. | 260032 2600320 |
| description | Y-piece plastic hose ø 8-6-8mm for pressure switch | | |

ancillary products

clamps

hose clamps

DIN 3017 - W2



1

| | | | |
|--------------------|----------------------------------------------------|-----------------|---------|
| GEV No. | 520111 | Ref. No. | 2140960 |
| description | hose clamp ø 10-16mm width 9mm Qty 10 pcs DIN 3017 | | |

fastening material

nuts

hexagonal nuts

DIN 934 / ISO 4032/8673



1

| | | | |
|--------------------|-----------------------------------------------------------------------------------|-----------------|--------------|
| GEV No. | 560340 | Ref. No. | 3231 3676 |
| description | hexagonal nut thread M4 H 3.2mm WS 7 SS DIN/ISO DIN 934 / ISO 4032/8673 Qty 1 pcs | | |

fasteners

clamps

hose clamps

DIN 3017 - W2



1

| | | | |
|--------------------|----------------------------------------------------|-----------------|---------|
| GEV No. | 520111 | Ref. No. | 2140960 |
| description | hose clamp ø 10-16mm width 9mm Qty 10 pcs DIN 3017 | | |

consumables

fuses

screw locks

D0-system (NEOZED)



1

| | | | |
|--------------------|--------------------------------------------------------------|-----------------|-------------------|
| GEV No. | 358072 | Ref. No. | 316823 3168230 |
| description | fuse size D01 6A rated 250/400V E14 ø 11mm L 36mm Qty 10 pcs | | |

| | | |
|-------------------------------------------------|--------|------|
| B | | |
| bi-metal thermostats | 5, 5 | |
| booster pumps I | 15 | |
| booster pumps II | 15 | |
| C | | |
| cam switches | 8 | |
| clamps | 23, 23 | |
| condensators & interference suppression filters | 15 | |
| consumables | 24 | |
| contactors | 10 | |
| control thermostats | 6, 6 | |
| D | | |
| dosing pumps | 22 | |
| drain pumps | 15 | |
| E | | |
| electric accessories | 16 | |
| F | | |
| fasteners | 23 | |
| fastening material | 23 | |
| filters | 15 | |
| formed hoses | 22 | |
| fuses | 16, 24 | |
| H | | |
| heating elements | 3 | |
| heating elements for pasta cookers | 3 | |
| heating elements for salamanders/toasters | 3 | |
| hexagonal nuts | 23 | |
| hose clamps | 23, 23 | |
| hose connectors | 23 | |
| hoses | 22 | |
| I | | |
| immersion heating elements | 3 | |
| indicator lights | 8 | |
| L | | |
| lamps | 8 | |
| M | | |
| magnetic switches | 8 | |
| microswitches | 7 | |
| N | | |
| nuts | 23 | |
| O | | |
| operating capacitors | 15 | |
| O-rings | | 21 |
| P | | |
| plunger sockets | | 7 |
| position switches | | 7 |
| pressure switches | | 12 |
| programme timers | | 9 |
| pumps | | 13 |
| push/momentary push switches | | 7 |
| R | | |
| relays | | 11 |
| rocker/momentary rocker switches | | 7 |
| rotary switches | | 8 |
| S | | |
| safety thermostats | | 6, 6 |
| screw locks | | 24 |
| solenoid valves | | 11 |
| switches and momentary switches | | 7 |
| T | | |
| terminals | | 16 |
| thermostats | | 5 |
| timers | | 9 |
| W | | |
| wash and rinse pumps | | 13 |