



GAS COMPONENTS



ELECTRIC COMPONENTS



WATER TECHNOLOGY



MECHANICAL COMPONENTS



TOOLS

Spare parts suitable for

LIEBHERR

Find the complete and up-to-date range of products in our GEV Webshop



Manufacturer catalogue

The most important spare parts and accessories arranged clearly for every manufacturer

- ✓ Complete product range and all appliance data always up to date in the GEV Webshop
- ✓ Alphabetical Index at the end of the catalogue

GEV Webshop

www.gev-online.co.uk

www.gev-online.com



- 🔍 Add to Favourites
- 🔍 Sign In with email address and usual password
- 🔍 Easy-order – place several items in your basket at the same time
- 🔍 Quick Item search – no login needed



thermostats

refrigeration thermostats

RANCO

K50 series

RANCO



GEV No. 390619 **Ref. No.** 6151995

description thermostat RANCO type K50P6073/001 probe ømm probe Lmm capillary pipe 2000mm

For models: FKS 5000-20E

accessories for 390619



GEV No. 112945 **Ref. No.** 7422505

knob ø 22mm shaft ø 6x4.6mm shaft flat vertical white

K57 series

RANCO



GEV No. 390618 **Ref. No.** 6151761

description thermostat RANCO type K57L2865 capillary pipe 1950mm temperature range -40 up to +40°C probe ø9.5x107mm

accessories for 390618



GEV No. 112945 **Ref. No.** 7422505

knob ø 22mm shaft ø 6x4.6mm shaft flat vertical white

RANCO



GEV No. 390617 **Ref. No.** 6151753

description thermostat RANCO type K57-L2866 probe ø 2mm probe Lmm capillary pipe 2000mm temperature range -40 up to +40°C

switches and momentary switches

microswitches

with push button

switches with snap-fit



1

GEV No. 347018 **Ref. No.** 6060995

description microswitch with push button 250V 1A 1CO connection male faston 2.8mm L 28x12mm ambient temperature max. 85°C actuating force: 60g

magnetic switches

accessories

magnets



1

GEV No. 691490 **Ref. No.** 7424266

description magnet ømm L 29.5mm H 7mm W 28.5mm hole distance 13mm

probes

producer-specific probes

probes



1

GEV No. 379753 **Ref. No.** 6942216
6942236
9590088
9590142-00

description probe NTC cable PVC probe -40 up to +110°C cable -10 up to 100°C connection 2-wire thread M15x1.75 probe ø8x29mm cable length 3.1m



1

GEV No. 381418 **Ref. No.** 9590 206-00

description probe repair set NTC cable PVC probe -40 up to +110°C cable -10 up to 100°C connection 2-wire thread M15x1.75 probe ø8x29mm cable length 3.1m



electronics

PCBs

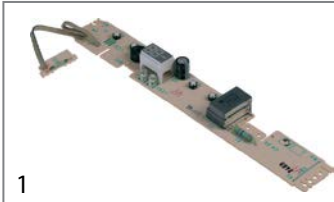

1			
GEV No.	402069	Ref. No.	6113321 6114289-00 6114431-00 6114489-00 6114667-00
description	keypad PCB refrigerator GKV5710		

compressors

EMBRACO / ASPERA

R600A

LBP monophase

Lower evaporation temperature below -20°C



1			
GEV No.	605085	Ref. No.	6119659
description	compressor coolant R600a type EMT45CDP 220-240V 50Hz HBP fully hermetic 7.7kg 1/8HP power input 152W cylinder capacity 6.78cm ³ RSIRWW 164W 209W 262W 322W 392W 477W test method ASHRAE		
For models:	FKS 5000-20E		
spare parts for	605085		
	GEV No.	381088	Ref. No. 6940650
	start relay		
	GEV No.	390620	Ref. No. 6940609
	overload protector for engine protective curcuit breaker T0357/07 t.max. 150°C reset automatic		

HBP monophase

High evaporation temperature above -15°C



1			
GEV No.	605083	Ref. No.	6119717
description	compressor coolant R600a type EMT30CDP 220-240V 50Hz HBP fully hermetic 7.2kg 1/8HP cylinder capacity 4.5cm ³ RSIR H 158mmWW 112W 142W 180W 222W 268W 320W test method ASHRAE		
spare parts for	605083		
	GEV No.	381088	Ref. No. 6940650
	start relay		
	GEV No.	390621	Ref. No. 6941014
	overload protector for engine protective curcuit breaker T0224/07 t.max. 150°C reset automatic		

accessories

starting relays

miscellaneous



1			
GEV No.	381087	Ref. No.	6940863
description	start relay		



1			
GEV No.	381088	Ref. No.	6940650
description	start relay		
For models:	FKS 5000-20E		



overload protector (klixon)



1

GEV No.	390621	Ref. No.	6941014
description	overload protector for engine protective curcuit breaker T0224/07 t.max. 150°C reset automatic		



1

GEV No.	390620	Ref. No.	6940609
description	overload protector for engine protective curcuit breaker T0357/07 t.max. 150°C reset automatic		
For models:	FKS 5000-20E		

fans

refrigeration fans

cold air circulating fans

cold air circulating fans



1

GEV No.	601477	Ref. No.	6118671 6118791	
description	fan motor 230V 50-60Hz shaft L 22mm shaft ø 3mm type F61-10			
accessories for	601477			
	GEV No.	601480	Ref. No.	6299905
	fan wheel blowing ø 164mm W 27mm shaft intake ø 3mm plastic blades 3			



1

GEV No.	601479	Ref. No.	6108993 6118787 6118795	
description	fan motor 230V 50-60Hz shaft L 22mm shaft ø 3mm type F61-10G			
accessories for	601479			
	GEV No.	601480	Ref. No.	6299905
	fan wheel blowing ø 164mm W 27mm shaft intake ø 3mm plastic blades 3			



1

GEV No.	601478	Ref. No.	6118751	
description	fan motor 230V 50-60Hz shaft L 22mm shaft ø 3mm type F61-10G with plug			
accessories for	601478			
	GEV No.	601480	Ref. No.	6299905
	fan wheel blowing ø 164mm W 27mm shaft intake ø 3mm plastic blades 3			

accessories

fan wheels for cold air circulating fans



1

GEV No.	601480	Ref. No.	6299905
description	fan wheel blowing ø 164mm W 27mm shaft intake ø 3mm plastic blades 3		

brackets for cold air circulating fans



1

GEV No.	691504	Ref. No.	7427581
description	bracket		



1

GEV No.	691478	Ref. No.	7422558
description	bracket for fan		



1

GEV No.	691479	Ref. No.	7427579 7430145 7430145-00
description	bracket for fan		

equipment-specific units

for fridges

housing and bezels

holders



1

GEV No.	691491	Ref. No.	7424773
----------------	--------	-----------------	---------

description	bracket
--------------------	---------

knobs

producer-specific knobs

LIEBHERR



1

GEV No.	112945	Ref. No.	7422505
----------------	--------	-----------------	---------

description	knob ø 22mm shaft ø 6x4.6mm shaft flat vertical white
--------------------	---

For models:	FKS 5000-20E
--------------------	--------------

handles and hand wheels

miscellaneous



1

GEV No.	691492	Ref. No.	7042411 7042411-01
----------------	--------	-----------------	-----------------------

description	door handle L 190mm W 83mm hole distance 155mm refrigerator white H 25mm
--------------------	--

For models:	FKS 5000-20E
--------------------	--------------

locks

locking devices

producer-specific

LIEBHERR



1

GEV No.	691481	Ref. No.	7043513
----------------	--------	-----------------	---------

description	key cylinder
--------------------	--------------

accessories for	691481
------------------------	--------



GEV No.	691482	Ref. No.	7042814
----------------	--------	-----------------	---------

spare keys for key cylinder 691481	
------------------------------------	--



1

GEV No.	691483	Ref. No.	7041775 7041789
----------------	--------	-----------------	--------------------

description	key cylinder
--------------------	--------------

accessories for	691483
------------------------	--------



GEV No.	691484	Ref. No.	7042837
----------------	--------	-----------------	---------

spare keys for key cylinder 691483	
------------------------------------	--



1

GEV No.	691489	Ref. No.	7043075-00 7043075-00 + 9190305-00 /020 7043075-00 9190305-00 /020 7043195-00 7043343 9190345-00
----------------	--------	-----------------	---



description	key cylinder
--------------------	--------------

accessories for	691489
------------------------	--------





GEV No.	691486	Ref. No.	7042196 7043341
----------------	--------	-----------------	--------------------

spare keys for key cylinder 691485, 691489	
--	--

			
1			
GEV No.	691485	Ref. No.	7042356 7042846 7042846-00
description	key cylinder closer		
For models:	FKS 5000-20E		
accessories for	691485		
			
GEV No.	691486	Ref. No.	7042196 7043341
description	spare keys for key cylinder 691485, 691489		

			
1			
GEV No.	691482	Ref. No.	7042814
description	spare keys for key cylinder 691481		

			
1			
GEV No.	691484	Ref. No.	7042837
description	spare keys for key cylinder 691483		

			
1			
GEV No.	691486	Ref. No.	7042196 7043341
description	spare keys for key cylinder 691485, 691489		
For models:	FKS 5000-20E		

hinges

door bearing

			
1			
GEV No.	700758	Ref. No.	7043459 9450457-00 /018 9450469-00 9450649-00
description	bearing block L 42mm W 38mm H 48mm mounting distance 28mm bolt 51mm bolt ø 8mm		

			
1			
GEV No.	700756	Ref. No.	7113077
description	bolt L 21mm thread M6 ø 6mm for hinge		
For models:	FKS 5000-20E		

			
1			
GEV No.	700750	Ref. No.	7113761
description	bolt L 48mm thread M6 ø 8mm for hinge		

			
1			
GEV No.	700755	Ref. No.	7043029 7043461
description	bolt L 50mm ø 8mm		

			
1			
GEV No.	700754	Ref. No.	7422079
description	bush L 30mm ø 9mm white for hinge		
For models:	FKS 5000-20E		

			
1			
GEV No.	700752	Ref. No.	7429351
description	bush L 46mm mounting pos. left ø 14mm white for hinge		

			
1			
GEV No.	700753	Ref. No.	7429349
description	bush L 46mm mounting pos. right ø 14mm white for hinge		



1

GEV No.	700751	Ref. No.	7429517
description	bush L 49mm ø 11mm white for hinge		



1

GEV No.	700757	Ref. No.	9450057
description	hinge refrigerator		
For models:	FKS 5000-20E		
spare parts for	700757		
	GEV No.	700756	Ref. No. 7113077
	bolt L 21mm thread M6 ø 6mm for hinge		

filters

device filters



1

GEV No.	694678	Ref. No.	7429177
description	air filter L 315mm W 265mm ømm H 120mm LKPV/LGPV 1420,652 suitable for LIEBHERR		

equipment feet and end caps

equipment feet

with screw mounting



1

GEV No.	701205	Ref. No.	7043485
description	equipment foot tube ø 67mm thread M10 thread L 15mm H 150-210mm SS size 2 1/2" Qty 1 pcs		

screw-in feet



1

GEV No.	701207	Ref. No.	7042301
description	equipment foot thread M10 WS 22 L 20mm		
For models:	FKS 5000-20E		

equipment feet with stem



1

GEV No.	701206	Ref. No.	7402121
description	equipment foot ø 32mm H 14mm mounting ø 10mm overall height 25.5mm plastic Qty 1 pcs		
For models:	FKS 5000-20E		

gaskets

refrigeration gaskets

miscellaneous



1

GEV No.	901339	Ref. No.	7108528-00 7108528-00+7108528-00 7111062-00 7111062-00+9096042-00
description	refrigeration gasket conversion kit W 580mm L 675mm external size		



1

GEV No.	901338	Ref. No.	7108136 7111004-00 7111004-00+9096042-00
description	refrigeration gasket conversion kit W 585mm L 765mm external size		



1

GEV No.	901337	Ref. No.	7108154+9086532+7081554 7108154-00
description	refrigeration gasket conversion kit W 747mm L 1400mm external size FKS 5000/5010, UKS 5000		



plug-in gaskets

profile 9952

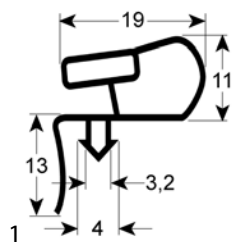

GEV No.	901275	Ref. No.	7108383
description	refrigeration gasket profile 9952 W 572mm L 733mm plug size		

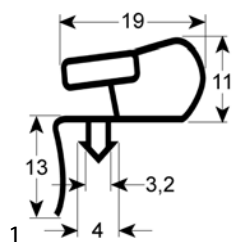

GEV No.	900801	Ref. No.	7108357
description	refrigeration gasket profile 9952 W 580mm L 1650mm plug size		

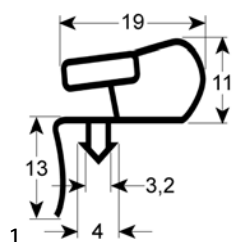

GEV No.	900798	Ref. No.	7108393
description	refrigeration gasket profile 9952 W 580mm L 760mm plug size		

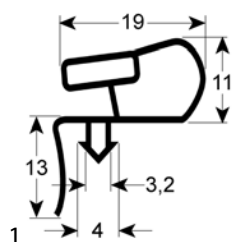

GEV No.	901340	Ref. No.	7109677-00 7109677-00+7080419-00
description	refrigeration gasket profile 9952 W 585mm L 1665mm plug size service kit		

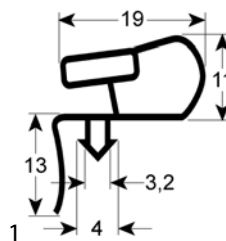

GEV No.	900800	Ref. No.	7109407
description	refrigeration gasket profile 9952 W 710mm L 1565mm plug size		

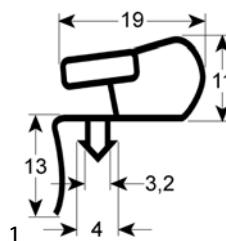

GEV No.	900799	Ref. No.	7108401
description	refrigeration gasket profile 9952 W 730mm L 1380mm plug size		
For models:	FKS 5000-20E		

profile 9505

We offer custom-made gaskets for this profile

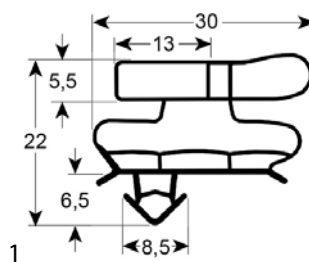

GEV No.	902039	Ref. No.	N/A
description	refrigeration gasket profile 9505 Wmm L 2500mm		

screw-in gaskets

profile 9515

We offer custom-made gaskets for this profile

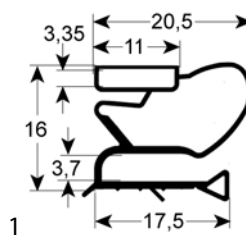

GEV No.	902287	Ref. No.	N/A
description	refrigeration gasket profile 9515 Wmm L 2500mm		

refrigeration cycle components

filter driers

miscellaneous



1

GEV No.	750165	Ref. No.	5942032 5942034 5942036
description	dryer size 10g ø 16mm L 125mm connection 2,1/4,9mm		
For models:	FKS 5000-20E		

evaporators

for fridges

producer-specific



1

GEV No.	750147	Ref. No.	5940997
description	evaporator for fridge FKS 5000 L 850mm W 575mm type FKS5000/02 LIEBHERR		
For models:	FKS 5000-20E		



1

GEV No.	750146	Ref. No.	5940757
description	evaporator for fridge FKV 4310 L 1000mm W 460mm type FKDV 3712-20 A LIEBHERR		



1

GEV No.	750148	Ref. No.	5940995
description	evaporator for fridge UKS 1800 L 430mm W 460mm LIEBHERR		

measuring equipment

thermometers

built-in thermometers



1

GEV No.	541929	Ref. No.	6111959
description	thermometer mounting measurements 58x25.5mm -40 up to +40°C capillary pipe 700mm probe ø 6mm probe L 85mm		

battery powered



1

GEV No.	379752	Ref. No.	6111963 6111997
description	thermometer mounting measurements 58x25.5mm front measurements 29x62mm battery comp. front up to +100°C cable length 2200mm		

C

cold air circulating fans	5
compressors	4

E

evaporators	10
-------------	----

F

fans	5
filter driers	10

M

magnetic switches	3
measuring equipment	10
microswitches	3

P

plug-in gaskets	9
probes	3

R

refrigeration cycle components	10
refrigeration fans	5
refrigeration gaskets	8
refrigeration thermostats	3

S

screw-in gaskets	9
switches and momentary switches	3

T

thermostats	3
-------------	---