



GAS COMPONENTS



ELECTRIC COMPONENTS



WATER TECHNOLOGY



MECHANICAL COMPONENTS



TOOLS

Spare parts suitable for

LINCAR

Find the complete and up-to-date range of products in our GEV Webshop



Manufacturer catalogue

The most important spare parts and accessories arranged clearly for every manufacturer

- ✓ Complete product range and all appliance data always up to date in the GEV Webshop
- ✓ Alphabetical Index at the end of the catalogue

GEV Webshop

www.gev-online.co.uk

www.gev-online.com



- 🔍 Add to Favourites
- 🔍 Sign In with email address and usual password
- 🔍 Easy-order – place several items in your basket at the same time
- 🔍 Quick Item search – no login needed



heating elements

heating elements for ovens

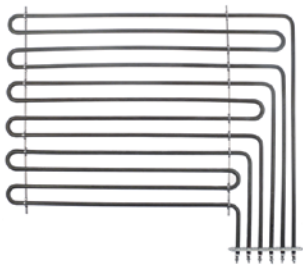

1

GEV No.	420483	Ref. No.	38000205
description	heating element 2700W 230V L 496mm W 615mm L1 90mm L2 405mm W1 480mm W2 125mm flange length 158mm flange width 22mm hole distance 145mm hole ø 4mm tube ø 8.5mm connection screw heating circuits 3 mounting thread M4 oven		
For models:	G0009, G0010, G0104, G0107, G0114, G0117, G0122, G0704, G0705, G0776, G0777		

accessories for 416824

GEV No.	550447	Ref. No.	—
----------------	--------	-----------------	---



ring nut thread M54x1.5

heating elements for griddles



1

GEV No.	420478	Ref. No.	38000211
description	heating element 1800W 230V heating circuits 1 L 425mm W 84mm H 76mm tube ø 8.5mm		
For models:	G1025, G1026, G1029, G1030, G1035, G1036, G1039, G1040, G1043, G1044		

heating elements for fryers

off-center connection

with thread

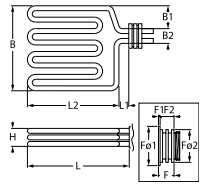
1

GEV No.	420482	Ref. No.	38000230
description	heating element 12000W 230V heating circuits 3 L 315mm W 175mm H 32mm flange length 26mm flange ø1 62mm sensor screw connection M10x1 number of thermostat sleeves 2 thermostat sleeve upper/lower L1 15mm L2 300mm W1 30mm W2 33mm for o-ring ø 51/56mm tube ø 8.5mm cable length 515mm connection cable		
For models:	G1110, G1112		

heating elements for tilting bratt pan



1

GEV No.	415250	Ref. No.	38000218
description	heating element gril 1650W 230V L 490mm W 42mm H 45mm connection M4 dry heating element heating circuits 1 tube ø 8.5mm 2 hole fixing thread 1/4" mounting distance 37mm		





1

GEV No.	416692	Ref. No.	38000248
description	heating element tilting bratt pan 2900W 230V L 312mm W 200mm H 82mm connection M5 dry heating element heating circuits 1 tube ø 8.5mm W1 66mm W2 68mm connection distance 61mm		
For models:	G1701, G1705		

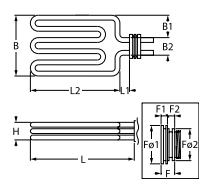
center connection

1

GEV No.	416824	Ref. No.	38000229
description	heating element 7000W 230/400V heating circuits 3 L 325mm W 110mm H 33mm flange length 19.5mm flange length 1 9.5mm flange length 2 9.8mm flange ø1 62mm flange ø2 57mm thermostat sleeves ø 8mm sensor screw connection 2x M10x1 thermostat sleeve upper/lower L1 18mm L2 307mm W1 40mm W2 35mm thread M54x1.5 tube ø 8.5mm cable length 520mm rotation flange immersion heater fryer connection length 50mm 2		
spare parts for	416824		
GEV No.	510243	Ref. No.	—
	O-ring Viton thickness 3.53mm ID ø 55.56mm Qty 1 pcs		
GEV No.	550496	Ref. No.	—
	O-ring Viton thickness 3.53mm ID ø 50.39mm Qty 1 pcs		

heating elements for pasta cookers



1

GEV No.	419214	Ref. No.	38000207
description	heating element 1840W 230V heating circuits 1 L 277mm W 60mm connection M4 thread M12x1 tube ø 8.5mm		
For models:	G1210, G1211		



1





GEV No.	418032	Ref. No.	38000234
description	heating element 2000W 240V heating circuits 1 L 280mm W 75mm H 2 hole fixing connection M4 thread 1/4" tube ø 8.5mm mounting distance 67mm pasta cooker		
accessories for	418032		
GEV No.	361182	Ref. No.	—
	nut thread 1/4" H 5mm nickel-plated brass WS 17 Qty 1 pcs		
GEV No.	510417	Ref. No.	—
	flat gasket fibre ED ø 20mm ID ø 14mm thickness 2mm Qty 1 pcs		

Table continues overleaf

accessories for 418032			
	GEV No.	520228	Ref. No. —
tooth lock washer ID ø 15.3mm ED ø 24mm steel Qty 1 pcs for thread M14			
	GEV No.	550262	Ref. No. —
flat gasket copper ED ø 20mm ID ø 14mm thickness 2mm			

			
GEV No.	416077	Ref. No.	38000235
description	heating element 2520/3000W 220/240V heating circuits 1 L 445mm W 66mm Hmm 2 hole fixing connection M4 thread 1/4" tube ø 8.5mm mounting distance 58mm connection length 34mm pasta cooker immersion heater		

accessories for 416077			
	GEV No.	361182	Ref. No. —
nut thread 1/4" H 5mm nickel-plated brass WS 17 Qty 1 pcs			
	GEV No.	510417	Ref. No. —
flat gasket fibre ED ø 20mm ID ø 14mm thickness 2mm Qty 1 pcs			
	GEV No.	520228	Ref. No. —
tooth lock washer ID ø 15.3mm ED ø 24mm steel Qty 1 pcs for thread M14			
	GEV No.	521103	Ref. No. —
nut thread M4 H 3mm WS 7 brass Qty 20 pcs			
	GEV No.	521104	Ref. No. —
washer ID ø 4.3mm ED ø 8mm thickness 0.5mm brass Qty 20 pcs for thread M4			
	GEV No.	550262	Ref. No. —
flat gasket copper ED ø 20mm ID ø 14mm thickness 2mm			
	GEV No.	560111	Ref. No. —
plain washer ID ø 4.3mm ED ø 9mm thickness 0.8mm SS Qty 20 pcs DIN 125A for thread M4			
	GEV No.	560131	Ref. No. —
hexagonal nut thread M4 H 3.2mm WS 7 SS DIN/ISO DIN 934 / ISO 4032/8673 Qty 20 pcs			

heating elements for chargrills

			
GEV No.	415250	Ref. No.	38000218
description	heating element grill 1650W 230V L 490mm W 42mm H 45mm connection M4 dry heating element heating circuits 1 tube ø 8.5mm 2 hole fixing thread 1/4" mounting distance 37mm		

immersion heating elements

3 hole flange ø47.5mm

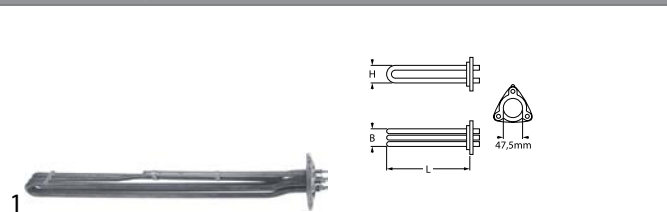

GEV No.	419113	Ref. No.	38000267
description	heating element 9000W 230V mounting ø 47.5mm heating circuits 3 L 550mm W 38mm H 45mm number of thermostat sleeves 1 thermostat sleeves ø 7.3mm length thermostat sleeves 260mm tube ø 8.5mm connection M4 3 hole flange immersion heater L1 55mm H1 33mm H2 34mm		
accessories for 419113			
	GEV No.	510408	Ref. No. —
O-ring EPDM thickness 5.34mm ID ø 47mm Qty 1 pcs			

heating elements for convection



GEV No.	418087	Ref. No.	38000227
description	heating element 15000W 230/400V heating circuits 3 ID ø 398mm ED ø 415mm L 452mm H 121mm L1 32mm W1 105mm H1 80mm H2 25mm flange length 142mm flange width 25mm hole distance 126mm connection M4 tube ø 8.5mm convection heating element hole ø 6mm rectangular flange		
accessories for 418087			
	GEV No.	550548	Ref. No. —
gasket L 144mm W 25.5mm thickness 2.2mm for heating element suitable for GIORIK equiv. no. 2005173			

hot plates

square & rectangular

with radiused edge

			
GEV No.	490068 ¹	Ref. No.	40000010
description	hot plate dimensions 220x220mm 2600W 400V with spill ring connection 4 screw clamps protector yes square		
For models:	G0110, G0112, G0114, G0115, G0117		

¹incl. protector



			
1			
GEV No.	490176 ¹	Ref. No.	40000021
description	hot plate dimensions 220x220mm 2600W 440V with spill ring connection 4 screw clamps protector yes		

¹incl. protector

 			
1			
GEV No.	490057 ¹	Ref. No.	40000002 40000022
description	hot plate dimensions 300x300mm 3000W 400V with spill ring connection 4 screw clamps protector yes square		

¹incl. protector

round

with radiused edge

for domestic and commercial kitchens

			
1			
GEV No.	490021	Ref. No.	40000015
description	hot plate ø 220mm 2600W 400V connection 4 screw clamps with 8mm spill ring		
For models:	G0100, G0102, G0104, G0105, G0107, G0700, G0702, G0703, G0704, G0705		

			
1			
GEV No.	490175	Ref. No.	40000020
description	hot plate ø 220mm 2600W 440V connection 4 screw clamps with 8mm spill ring		

replace set

			
1			
GEV No.	417661	Ref. No.	40000025
description	hot plate ø 90mm 2000W 230V connection 3 screw clamps with 8mm spill ring M6 equiv. no. 12.184.74.040 1 pair		

thermostats

control and safety thermostats

EGO

control thermostats

55.10/19_ series



 			
1			
GEV No.	375363	Ref. No.	40010010
description	thermostat t.max. 161°C temperature range 73-161°C 1-pole 1NO 16A probe ø 3mm probe L 144mm capillary pipe 1600mm capillary pipe isolated 1600mm gland nut shaft ø 6x4.6mm shaft L 23mm shaft position upper rotation 270°		
For models:	G1700, G1702, G1704, G1706		

 			
1			
GEV No.	375270	Ref. No.	40000906
description	thermostat t.max. 295°C temperature range 45-295°C 1-pole 1NO 16A probe ø 4mm probe L 100mm capillary pipe 900mm capillary pipe isolated 350mm gland nut shaft L 23mm shaft position upper rotation 270°		
For models:	G1701, G1705		



55.13_series



GEV No.	375007	Ref. No.	40000901
description	thermostat t.max. 110°C temperature range 30-110°C 1-pole 1NO 16A probe ø 6mm probe L 113mm capillary pipe 870mm capillary pipe isolatedmm gland nut M9x1 shaft L 25mm shaft position upper rotation 270°		
accessories for	375007		
	GEV No.	110119	Ref. No. —
	knob thermostat t.max. 110°C ø 50mm shaft ø 6x4.6mm shaft flat upper black temperature range 30-110°C rotation 270°		
	GEV No.	110241	Ref. No. —
	knob thermostat t.max. 110°C ø 50mm shaft ø 6x4.6mm shaft flat upper black temperature range 30-110°C		



GEV No.	375492	Ref. No.	40000907 40000955 40001027
description	thermostat t.max. 190°C temperature range 94-190°C 1-pole 1NO 16A probe ø 6mm probe L 94mm capillary pipe 1090mm capillary pipe isolated 960mm gland nut M10x1 shaft ø 6x4.6mm shaft L 23mm shaft position upper rotation 310° probe material SS		
For models:	G1100, G1101, G1102, G1103, G1110, G1112, G1113		

55.34_series



GEV No.	375602	Ref. No.	40000908
description	thermostat t.max. 120°C temperature range 45-120°C 3-pole 3CO 16A probe ø 6mm probe L 140mm capillary pipe 900mm capillary pipe isolated 870mm gland nut shaft ø 6x4.6mm shaft L 23mm shaft position upper rotation 270°		
For models:	G1210, G1211		

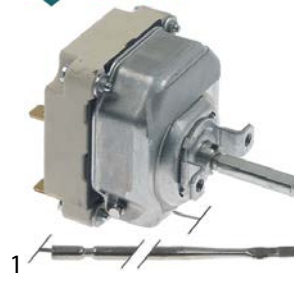

GEV No.	375192	Ref. No.	40000905
description	thermostat t.max. 300°C temperature range 50-300°C 3-pole 3NO 16A probe ø 3mm probe L 219mm capillary pipe 900mm capillary pipe isolatedmm gland nut shaft ø 6x4.6mm shaft L 23mm shaft position upper rotation 270°		
For models:	G0009, G0010, G0104, G0107, G0114, G0117, G0122, G0704, G0705, G0776, G0777, G1025, G1026, G1029, G1030, G1035, G1036, G1039, G1040, G1043, G1044		

safety thermostats

55.10/19_series

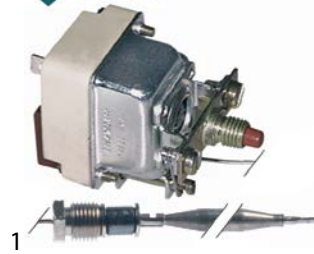

GEV No.	375651	Ref. No.	40000917
description	safety thermostat capillary pipe 670mm probe ø 6mm 1-pole probe L 77mm 16A capillary pipe isolated 650mm gland nut M10x1 switch-off temp. 350°C probe		



GEV No.	375391	Ref. No.	40000924
description	safety thermostat switch-off temp. 224°C 1-pole 0.5A probe ø 6mm probe L 133mm capillary pipe 870mm capillary pipe isolatedmm gland nut M10x1 probe		
For models:	G1100, G1101, G1102, G1103		



E-G-O

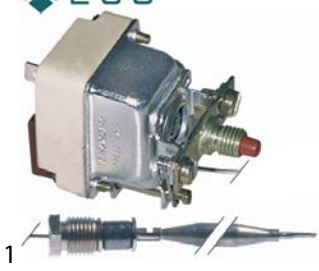

GEV No.	375968	Ref. No.	40000914
description	safety thermostat switch-off temp. 360°C 1-pole 1NC 16A probe ø 6mm probe L 77mm capillary pipe 870mm capillary pipe isolated 660mm gland nut M10x1 probe probe material SS M8x1		

E-G-O



GEV No.	375375	Ref. No.	40000919
description	safety thermostat switch-off temp. 230°C 3-pole 20A probe ø 6mm probe L 94mm capillary pipe 900mm capillary pipe isolated 670mm gland nut M10x1 probe SS		
For models:	G1111		

55.32_series

E-G-O



GEV No.	375364	Ref. No.	40000926
description	safety thermostat switch-off temp. 190°C 3-pole 20A probe ø 4mm probe L 120mm capillary pipe 3000mm capillary pipe isolated 3000mm gland nut probe		

E-G-O



GEV No.	375228	Ref. No.	40000920
description	safety thermostat switch-off temp. 350°C 3-pole 20A probe ø 3mm probe L 188mm capillary pipe 900mm capillary pipe isolated 900mm gland nut probe SS		
For models:	G1025, G1026, G1029, G1030, G1035, G1036, G1039, G1040, G1043, G1044		

E-G-O



GEV No.	375984	Ref. No.	40000922
description	safety thermostat switch-off temp. 225°C 3-pole 3NC 20A probe ø 6mm probe L 94mm capillary pipe 900mm capillary pipe isolated 670mm gland nut M10x1 probe SS		
For models:	G1110, G1112, G1113		

E-G-O





GEV No.	375628	Ref. No.	40000923
description	safety thermostat switch-off temp. 350°C 3-pole 20A probe ø 4mm probe L 120mm capillary pipe 900mm capillary pipe isolated 670mm gland nut M10x1 probe SS		



			
			
1			
GEV No.	375350	Ref. No.	4000921
description	safety thermostat switch-off temp. 360°C 3-pole 20A probe ø 4mm probe L 120mm capillary pipe 1800mm capillary pipe isolated 1800mm gland nut probe SS		
For models:	G1701, G1705		

56._ series

			
			
1			
GEV No.	375783	Ref. No.	4000902
description	safety thermostat switch-off temp. 240°C 1-pole 0.5A probe ø 6mm probe L 77mm capillary pipe 860mm capillary pipe isolated 750mm gland nut M10x1 probe SS		

accessories



connecting bows

			
1			
GEV No.	550059	Ref. No.	40003020
description	connecting bow short for switch Qty 1 pcs		
For models:	G1210, G1211		

switches and momentary switches

rocker/momentary rocker switches

30x22mm

			
1			
GEV No.	301004	Ref. No.	40001032
description	rocker switch mounting measurements 30x22mm black 2CO 250V 16A connection male faston 6.3mm ambient temperature max. 125/55°C protection IP40		
accessories for	301004		
	GEV No.	301036	Ref. No.
			—
	protective cover internal size 30x22mm for rocker switch mounting measurementsmm		



push/momentary push switches



ø16mm

			
1			
GEV No.	346346	Ref. No.	4000803
description	momentary push switch mounting ø 16mm red 1NO/indicator light 250V 3A connection male faston 2.8mm ambient temperature max. 125/55°C protection IP40		

accessories

protective covers

			
1			
GEV No.	346343	Ref. No.	4000801
description	protective cover		
accessories for	346343		
	GEV No.	346344	Ref. No.
			4000802
	ring for protecting cover		

			
1			
GEV No.	346344	Ref. No.	4000802
description	ring for protecting cover		
accessories for	346344		
	GEV No.	346343	Ref. No.
			4000801
	protective cover		

microswitches

pin-plunger actuated

M10

			
1			
GEV No.	346347	Ref. No.	40001610
description	microswitch with plunger thread M10x0.75 thread L 14mm 250V 6A 2NO connection male faston 6.3mm stroke 4mm mounting distance 22mm ambient temperature max. 85°C actuating force: 100g		



cam switches

on/off



1

GEV No.	300129	Ref. No.	40001025
description	cam switch 2 operating positions 2NO sequence 0-1 16A shaft \varnothing 6x4.6mm shaft L 23mm connection male faston 6.3mm ceramic		
For models:	G1300, G1301		

7-position



1

GEV No.	300106	Ref. No.	40001005
description	cam switch 7 operating positions 1NO/2CO sequence 0-1-2-3-4-5-6 32A shaft \varnothing 6x4.6mm shaft L 23mm connection screw 7-position shaft flat upper		
For models:	G0100, G0102, G0104, G0105, G0107, G0110, G0112, G0114, G0115, G0117, G0700, G0702, G0703, G0704, G0705		

3 operating positions



1

GEV No.	300167	Ref. No.	40001026
description	cam switch 3 operating positions 2NO/1CO sequence 0-1-2 16A shaft \varnothing 6x4.6mm shaft L 23mm connection screw		

with potentiometer

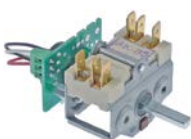

1

GEV No.	300249	Ref. No.	40001045 40001701
description	cam switch 2 operating positions 2NO sequence 0-1 16A shaft \varnothing 6x4.6mm shaft L 23mm connection screw 10K/J cable lengthmm 10kOhm ceramic		
For models:	G0120, G0121, G0122, G0125, G0126, G0127		

operation switches



1

GEV No.	300002	Ref. No.	40001010
description	cam switch 2 operating positions 4NO 16A sequence 0-1 shaft \varnothing 6x4.6mm shaft L 23mm connection male faston 6.3mm ceramic		
For models:	G0009, G0010, G0104, G0107, G0114, G0117, G0122, G0704, G0705, G0776, G0777, G1025, G1026, G1029, G1030, G1035, G1036, G1039, G1040, G1043, G1044		



1

GEV No.	300166	Ref. No.	40001024
description	cam switch 2 operating positions 4NO 16A sequence 0-1 shaft \varnothing 6x4.6mm shaft L 23mm connection male faston 6.3mm ceramic 4-pole ambient temperature max. 318°C		
For models:	G1111, G1210, G1211		



1

GEV No.	300080	Ref. No.	40001018
description	cam switch 2 operating positions 4NO 16A sequence 0-1 shaft \varnothing 6x4.6mm shaft L 23mm connection screw operation switch ceramic ambient temperature max. 150°C		
accessories for	300080		
	GEV No.	551456	Ref. No. —
	gasket for switch ED \varnothing 14mm ID \varnothing 2.5mm thickness 3.5mm white		



rotary switches

BREMAS

A3200 series



1			
GEV No.	345817	Ref. No.	40001021
description	rotary switch 2 0-1 sets of contacts 4 type CS0327690 600V 32A shaft ø 5x5mm shaft L 26mm shaft square connection screw		
For models:	G1110, G1112, G1113		

accessories for	357227		
	GEV No.	359833	Ref. No. —
	indicator light lens red Qty 1 pcs ø 8mm		
	GEV No.	359948	Ref. No. 40001510
	indicator light lens clear Qty 1 pcs ø 8mm		

1			
GEV No.	357228	Ref. No.	40001506 40001515
description	indicator light 230V green connection cable 250mm		
For models:	G0009, G0010, G0104, G0107, G0114, G0117, G0122, G0704, G0705, G0776, G0777, G1025, G1026, G1029, G1030, G1035, G1036, G1039, G1040, G1043, G1044, G1100, G1101, G1102, G1103, G1104, G1110, G1111, G1112, G1113, G1210, G1211, G1300, G1301		

accessories for	357228		
	GEV No.	359819	Ref. No. —
	indicator light lens green Qty 1 pcs ø 8mm		

indicator lights (complete)
ø12mm
with screw socket

1			
GEV No.	359291	Ref. No.	40001521 40001527
description	indicator light ø 12mm 400V green connection male faston 6.3mm		
For models:	G1701, G1705		

1			
GEV No.	359290	Ref. No.	40001520
description	indicator light ø 12mm 400V yellow connection male faston 6.3mm		
For models:	G1701, G1705		

with plug-in socket			
1			
GEV No.	357240	Ref. No.	40001519
description	indicator light ø 12mm red 400V connection F6.3 temp.-resist. 120°C Qty 1 pcs		

encoders and potentiometers

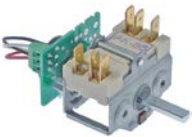

1			
GEV No.	300249	Ref. No.	40001045 40001701
description	cam switch 2 operating positions 2NO sequence 0-1 16A shaft ø 6x4.6mm shaft L 23mm connection screw 10K/J cable lengthmm 10kOhm ceramic		
For models:	G0120, G0121, G0122, G0125, G0126, G0127		

lamps

indicator lights

indicator lights 2-piece (lens and indicator lamp)

indicator light lenses

ø 8mm (type RL-2)



1			
GEV No.	359948	Ref. No.	40001510
description	indicator light lens clear Qty 1 pcs ø 8mm		
For models:	G0122, G0700, G0702, G0703, G0704, G0705, G1110, G1111, G1112, G1113, G1210, G1211, G1300, G1301		

indicator lamps for socket type RL



1			
GEV No.	357227	Ref. No.	40001505 40001514
description	indicator light 230V clear connection cable 250mm		
For models:	G0009, G0010, G0100, G0102, G0104, G0105, G0107, G0110, G0112, G0114, G0115, G0117, G0122, G0700, G0702, G0703, G0704, G0705, G0776, G0777, G1025, G1026, G1029, G1030, G1035, G1036, G1039, G1040, G1043, G1044, G1100, G1101, G1102, G1103, G1104, G1110, G1111, G1112, G1113, G1210, G1211, G1300, G1301		
accessories for	357227		
	GEV No.	359820	Ref. No. —
	indicator light lens yellow Qty 1 pcs ø 8mm		



screw-on/push-on fit

halogen lamp

for socket G4 / G6.35 / G9

1			
	500°C		
GEV No.	359599	Ref. No.	40002000
description	halogen lamp socket G4 12V 20W temp.-resist. 500°C		

oven lamps

lamps

halogen lamps

for socket G4 / G6.35 / G9

1			
	500°C		
GEV No.	359599	Ref. No.	40002000
description	halogen lamp socket G4 12V 20W temp.-resist. 500°C		

relays

level relays

GICAR

1			
	500°C		
GEV No.	401173	Ref. No.	40004000
description	level relay 230V connection F6.3 type RL30/3ES/F		

electronic controllers

DIXELL

universal controllers

1			
	71 x 29mm		
GEV No.	378220	Ref. No.	40000933
description	electronic controller DIXELL type XT110C-5C0TU mounting measurements 71x29mm 230V voltage AC NTC/PTC/Pt100/TC(J,K) relay outputs 1 CO-8A(3) NTC/PTC/Pt100/TC(J,K) DI defr. funct. no depend on probe°C display 3½ digits		
accessories for	378220		
	GEV No.	378074	Ref. No. —
	temperature probe thermocouple J (Fe-CuNi) cable Vetrotex probe -50 up to +750°C cable -50 up to +350°C probe ø3x100mm cable length 3m without screw connection 2-wire		
	GEV No.	378075	Ref. No. —
	temperature probe thermocouple K (NiCr-Ni) cable Vetrotex probe -50 up to 1150°C cable -50 up to +350°C probe ø4.5x150mm cable length 3m without screw connection 2-wire		
	GEV No.	379062	Ref. No. —
	temperature probe thermocouple J (Fe-CuNi) cable Vetrotex probe -50 up to +750°C cable -50 up to +350°C probe ø6x50mm cable length 3m without screw connection 2-wire		
	GEV No.	379130	Ref. No. —
	temperature probe Pt100 cable Vetrotex probe -200 up to +600°C cable -50 up to +350°C probe ø6x100mm cable length 1.4m without screw connection 3-wire resistance at 0°C 100Ohm		
	GEV No.	379131	Ref. No. —
	temperature probe Pt100 cable Vetrotex probe -200 up to +600°C cable -50 up to +350°C probe ø6x85mm cable length 3m without screw connection 3-wire resistance at 0°C 100Ohm		
	GEV No.	379693	Ref. No. —
	temperature probe thermocouple J (Fe-CuNi) cable Vetrotex probe 0 up to +350°C cable°C probe ø6x100mm cable length 1.35m without screw connection cable colours red/blue 2-wire		
	GEV No.	379751	Ref. No. —
	temperature probe thermocouple K (NiCr-Ni) cable silicone probe -50 up to 1150°C cable -50 up to +180°C connection 2-wire thread probe ø1.5x35mm cable length 2.8m		

fuses

fine fuses

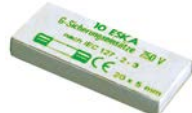
1			
	10 ESCA		
GEV No.	358605	Ref. No.	40000500 40000503
description	fine fuse size ø5x20mm 3.15A slow-acting rated 250V Qty 10 pcs		
For models:	G1701, G1702, G1705, G1706		



electric accessories

terminals

connection terminals with screw connection



1			
GEV No.	550355	Ref. No.	205,007
description	power terminal block 6-pole max. 40A max 400V connection M6/M6 temp.-resist. 150°C cross section 6mm ² hole distance 122mm		
For models:	G0009, G0010, G0100, G0102, G0104, G0105, G0107, G0110, G0112, G0114, G0115, G0117, G0120, G0121, G0122, G0125, G0126, G0127, G0700, G0702, G0703, G0704, G0705, G0776, G0777, G1025, G1026, G1029, G1030, G1035, G1036, G1039, G1040, G1043, G1044, G1210, G1211		

gas taps

PEL

21S series



1			
GEV No.	107682	Ref. No.	40020032
description	gas tap PEL type 21S gas inlet M16x1.5 (tube ø 10mm) bypass nozzle ø 0.4mm gas outlet M16x1.5 (tube ø 10/8mm) thermocouple connection M9x1 pilot connection M10x1 shaft ø 8x6.5mm shaft L 22/15mm shaft flat upper		
For models:	G0000, G0002, G0004, G0005, G0007, G0008, G0009, G0010, G0030, G0031, G0032, G0033, G0034, G0035, G0664, G0665, G0666, G0667, G0669, G0776, G0777		



1			
GEV No.	107681	Ref. No.	40020031
description	gas tap PEL type 21S gas inlet M16x1.5 (tube ø 10mm) bypass nozzle ø 0.6mm gas outlet M16x1.5 (tube ø 10/8mm) thermocouple connection M9x1 pilot connection M10x1 shaft ø 8x6.5mm shaft L 22/15mm shaft flat upper		
For models:	G0002, G0004, G0005, G0007, G0008, G0009, G0010, G0016, G0017, G0030, G0031, G0034, G0035, G0665, G0666, G0667, G0669, G0776, G0777, G1000, G1001, G1010, G1011, G1018		



1			
GEV No.	107680	Ref. No.	40020030
description	gas tap PEL type 21S gas inlet M16x1.5 (tube ø 10mm) bypass nozzle ø 0.75mm gas outlet M16x1.5 (tube ø 10/8mm) thermocouple connection M9x1 pilot connection M10x1 shaft ø 8x6.5mm shaft L 22/15mm shaft flat upper		
For models:	G0000, G0002, G0004, G0005, G0007, G0008, G0009, G0010, G0030, G0031, G0032, G0033, G0034, G0035, G0664, G0665, G0666, G0667, G0669, G0776, G0777		



1			
GEV No.	107592	Ref. No.	40020029
description	gas tap PEL type 21S gas inlet M16x1.5 (tube ø 10mm) bypass nozzle ø 1mm gas outlet M16x1.5 (tube ø 10/8mm) thermocouple connection M9x1 pilot connection M10x1 shaft ø 8x6.5mm shaft L 22/15mm shaft flat upper		
For models:	G1200, G1201		
spare parts for	107592		
	GEV No.	Ref. No.	—
	100529		
	bypass nozzle type PEL20/21 bore ø 1mm thread M5x0.5		
	GEV No.	Ref. No.	—
	101231		
	thermocouple nut T1: M9x1 T2: M18x1		
accessories for	107592		
	GEV No.	Ref. No.	—
	101277		
	olive ID ø 8mm Qty 1 pcs		
	GEV No.	Ref. No.	—
	101278		
	olive for pipe ø 10mm Qty 1 pcs		
	GEV No.	Ref. No.	—
	101300		
	union nut thread M16x1.5 tube ø 10mm		
	GEV No.	Ref. No.	—
	101451		
	union nut thread M16x1.5 tube ø 8mm		



22S/O series			
			
1			
GEV No.	103269	Ref. No.	40020003
description	gas tap PEL type 22S/O gas inlet M20x1.5 (tube ø 12mm) bypass nozzle ø 1mm gas outlet M20x1.5 (tube ø 12/10mm) thermocouple connection M9x1 pilot connection M10x1 shaft ø 10x8mm shaft L 25/17mm shaft flat lower		
For models:	G1500, G1501		







23S/O series			
			
1			
GEV No.	101893	Ref. No.	40020006
description	gas tap PEL type 23S/O gas inlet M28x1.5 (tube ø 20mm) bypass nozzle ø 0.35mm gas outlet M24x1.5 (tube ø 16mm) thermocouple connection M9x1 pilot connection M10x1 shaft ø 10x8mm shaft L 25/17mm shaft flat lower		
spare parts for	101893		
	GEV No.	101045	Ref. No. —
	magnet unit T1: M9x1 T2: M22x1 L 46mm ø 18mm suitable for PEL23S M9x1		
	GEV No.	101204	Ref. No. —
	gas tap front part shaft ø 10x8mm shaft L 25/17mm shaft flat upper/lower suitable for PEL23S		
	GEV No.	101244	Ref. No. —
	gas connection thread M24x1.5 tube ø 12/16mm horizontal for PEL gas taps		
	GEV No.	101463	Ref. No. —
	screw suitable for PEL23S Qty 4 pcs		
	GEV No.	528455	Ref. No. —
	O-ring Viton thickness 2.62mm ID ø 18.72mm Qty 1 pcs		
accessories for	101893		
	GEV No.	100908	Ref. No. 105076
	union screw thread M10x1 for pipe ø 4mm Qty 1 pcs		
	GEV No.	100909	Ref. No. 40021603
	union screw thread M10x1 for pipe ø 6mm Qty 1 pcs		
	GEV No.	101246	Ref. No. —
	olive for pipe ø 4mm Qty 1 pcs		
	GEV No.	101252	Ref. No. —
	union nut thread M24x1.5 for pipe ø 12mm		
	GEV No.	101253	Ref. No. —
	union nut thread M24x1.5 PEL for pipe ø 16mm		

accessories for 101893			
	GEV No.	101254	Ref. No. —
	union nut thread M28x1.5 tube ø 20mm		
	GEV No.	101255	Ref. No. —
	olive for pipe ø 12mm Qty 1 pcs		
	GEV No.	101256	Ref. No. —
	olive for pipe ø 16mm Qty 1 pcs		
	GEV No.	101257	Ref. No. —
	olive for pipe ø 20mm Qty 1 pcs		
	GEV No.	101286	Ref. No. —
	olive ID ø 6mm Qty 1 pcs		
	GEV No.	110080	Ref. No. —
	knob ø 70mm shaft ø 10x8mm shaft flat universal		
	GEV No.	112206	Ref. No. —
	knob dial plate silver gas tap PEL21/22/23 t.max. °C ED ø 63mm ID ø 45.5mm		



gas thermostats



SIT











630 Eurosit series

			
1			
GEV No.	101992	Ref. No.	40020133
description	gas thermostat type 630 Eurosit series t.max. 190°C 110-190°C gas inlet 3/8" gas outlet 3/8" thermocouple connection M9x1 pilot connection M10x1 probe ø 4mm probe L 202mm capillary pipe 1050mm SIT		
accessories for	101992		
	GEV No.	100904	Ref. No. —
	locking screw M10x1 for pipe ø 4mm Qty 1 pcs		
	GEV No.	100905	Ref. No. —
	locking screw M10x1 for pipe ø 6mm Qty 1 pcs		
	GEV No.	101273	Ref. No. —
	olive for pipe ø 12mm L 9.5mm brass Qty 1 pcs suitable for universal		
	GEV No.	101276	Ref. No. —
	union screw thread 3/8" tube ø 12mm Qty 1 pcs		
	GEV No.	101333	Ref. No. —
	plug thread 3/8" with O-ring		
	GEV No.	510655	Ref. No. —
	gasket silicone ø 7.8mm L 5mm blue Shore 55° Qty 10 pcs		



			
1 			
GEV No.	107221	Ref. No.	40020113
description	gas thermostat type 630 Eurosit series t.max. 250°C 40-250°C gas inlet 3/8" gas outlet 3/8" thermocouple connection M9x1 pilot connection M10x1 probe ø 4mm probe L 72mm capillary pipe 1050mm SIT		

			
1 			
GEV No.	101125	Ref. No.	40020105 40020110
description	gas thermostat type 630 Eurosit series t.max. 340°C 100-340°C gas inlet 3/8" gas outlet 3/8" thermocouple connection M9x1 pilot connection M10x1 probe ø 4mm probe L 72mm capillary pipe 1050mm SIT		
For models:	G0008, G0031, G0033, G0035, G1700, G1702, G1704, G1706		

accessories for	101125			
	GEV No.	100825	Ref. No.	—
gas tap spindle shaft ø 8x6.5mm shaft L 22/14mm suitable for EUROSIT				
	GEV No.	100904	Ref. No.	—
locking screw M10x1 for pipe ø 4mm Qty 1 pcs				
	GEV No.	100905	Ref. No.	—
locking screw M10x1 for pipe ø 6mm Qty 1 pcs				
	GEV No.	100949	Ref. No.	—
gasket suitable for 630 Eurosit series				
	GEV No.	101273	Ref. No.	—
olive for pipe ø 12mm L 9.5mm brass Qty 1 pcs suitable for universal				
	GEV No.	101276	Ref. No.	—
union screw thread 3/8" tube ø 12mm Qty 1 pcs				
	GEV No.	101333	Ref. No.	—
plug thread 3/8" with O-ring				
	GEV No.	101390	Ref. No.	—
gas tap spindle shaft ø 6x4.6mm shaft L 32/15mm gas tap with ignition flame suitable for ZANUSSI, MARENO for gas thermostat EUROSIT				
	GEV No.	101392	Ref. No.	—
adapter suitable for 630 Eurosit series				
	GEV No.	110357	Ref. No.	—
gas tap spindle shaft ø 8x6.5mm shaft L 36/12mm suitable for 630 Eurosit series				

accessories for	101125			
	GEV No.	110358	Ref. No.	—
adapter shaft ø 10x8mm shaft L 29/18mm suitable for 630 Eurosit series				

PEL

25ST series

			
1 			
GEV No.	107593	Ref. No.	40020010
description	gas thermostat PEL type 25ST 100-300°C gas inlet M16x1.5 (tube ø 10mm) bypass nozzle ø 0.9mm gas outlet M16x1.5 (tube ø 10mm) thermocouple connection M9x1 pilot connection M10x1 capillary pipe 1200mm probe ø 6mm probe L 100mm shaft ø 8x6.5mm shaft L 21/15mm shaft flat upper ignition gas M10x1		
For models:	G0004, G0007, G0017, G0666, G0667, G1004, G1005, G1014, G1015, G1019		

GEV No.	101125	Ref. No.	40020105 40020110
description	gas thermostat type 630 Eurosit series t.max. 340°C 100-340°C gas inlet 3/8" gas outlet 3/8" thermocouple connection M9x1 pilot connection M10x1 probe ø 4mm probe L 72mm capillary pipe 1050mm SIT		
For models:	G0008, G0031, G0033, G0035, G1700, G1702, G1704, G1706		

gas valves and ignition boxes



gas control valves

SIT

NOVASIT

			
1 			
GEV No.	101162	Ref. No.	40020115
description	gas valve SIT series Novasit 820 230V 50Hz gas inlet 1/2" gas outlet 1/2" thermocouple connection M9x1 pilot connection M10x1 ignition pressure 3-5mbar pressure range 3-30mbar pressure regulator connection blind equiv. no. 0.820.010		
For models:	G1100, G1101, G1102, G1103, G1104		

GEV No.	101162	Ref. No.	40020115
description	gas valve SIT series Novasit 820 230V 50Hz gas inlet 1/2" gas outlet 1/2" thermocouple connection M9x1 pilot connection M10x1 ignition pressure 3-5mbar pressure range 3-30mbar pressure regulator connection blind equiv. no. 0.820.010		
For models:	G1100, G1101, G1102, G1103, G1104		

accessories for	101162			
	GEV No.	101065	Ref. No.	—
magnet unit with cable L 44mm D1 ø 30mm D2 ø 20mm suitable for NOVASIT				
	GEV No.	101313	Ref. No.	—
solenoid coil 230V 50Hz				



accessories for	101162			
	GEV No.	100006	Ref. No.	—
piezoelectric igniter suitable for ELETTROSIT body plastic blowing connection ø2.4mm ø 14mm				
	GEV No.	101305	Ref. No.	—
gas connection straight 1/2" flange 45x45mm ELETTROSIT/V4400/4600/4605 suitable for SIT/HONEYWELL hole distance 36x36mm				

Table continues overleaf



accessories for		101162	
	GEV No.	101306	Ref. No. —
gas connection angled flange 45x45mm hole distance 36x36mm 1/2" ELETROSIT/V4400/4600/4605 screw with O-ring suitable for SIT/HONEYWELL			
	GEV No.	101307	Ref. No. —
gas connection straight flange 45x45mm hole distance 36x36mm 3/4" ELETROSIT/V4400/4600/4605 screw with O-ring suitable for SIT/HONEYWELL			
	GEV No.	101308	Ref. No. —
gas connection angled flange 45x45mm hole distance 36x36mm 3/4" ELETROSIT/V4400/4600/4605 screw with O-ring suitable for SIT/HONEYWELL			
	GEV No.	101312	Ref. No. —
microswitch			
	GEV No.	101314	Ref. No. —
solenoid coil 24V 50Hz			
	GEV No.	101317	Ref. No. —
plug with cable L 1000mm suitable for NOVASIT			
	GEV No.	101318	Ref. No. —
cover cap for solenoid coil suitable for NOVASIT			

accessories			
	1		
GEV No.	100110	Ref. No.	40021132
description	pilot burner SIT type 190 series 3 flames nozzle 6mm gas connectionmm		
accessories for	100110		
	GEV No.	100202	Ref. No. —
pilot burner nozzle natural gas code 41 Qty 1 pcs nozzle ø 0.41mm			
	GEV No.	100203	Ref. No. —
pilot burner nozzle LPG code 25 Qty 1 pcs nozzle ø 0.25mm			
	GEV No.	100701	Ref. No. 40020907
ignition electrode connection M4 Qty 1 pcs			
	GEV No.	100906	Ref. No. —
screw connection thread M10x1 for ignition electrode brass Qty 1 pcs WS 10			
	GEV No.	100907	Ref. No. —
screw connection thread M10x1 Qty 1 pcs type SEF 1 ømm for thermocouple			
	GEV No.	100908	Ref. No. 105076
union screw thread M10x1 for pipe ø 4mm Qty 1 pcs			
	GEV No.	100909	Ref. No. 40021603
union screw thread M10x1 for pipe ø 6mm Qty 1 pcs			
	GEV No.	101282	Ref. No. —
olive for pipe ø 4mm L 7.4mm Qty 1 pcs			
	GEV No.	101287	Ref. No. —
olive for pipe ø 6mm Qty 1 pcs			

accessories for		100110	
	GEV No.	102110	Ref. No. —
pilot tube copper pipe ø 4mm thickness 1mm L 3000mm			
	GEV No.	102111	Ref. No. —
pilot tube copper pipe ø 6mm thickness 1mm L 3000mm			
	GEV No.	107650	Ref. No. 38023085
pilot burner nozzle SIT LPG code 30 Qty 1 pcs			

ignition parts

pilot burners









SIT

100 series



GEV No.	106906	Ref. No.	309,004 40022510
description	pilot burner SIT type 100 series 3 flames nozzle ø 0.2mm gas connection 6mm		
For models:	G0004, G0007, G0008, G0016, G0017, G0030, G0031, G0033, G0035, G0666, G0667, G1000, G1001, G1004, G1005, G1010, G1011, G1014, G1015, G1018, G1019, G1100, G1101, G1102, G1103, G1104, G1700, G1702, G1704, G1706		
spare parts for	106906		
	GEV No.	100245	Ref. No. 38023032
pilot burner nozzle LPG code 20 bore ø 0.2mm Qty 1 pcs thread M8x0.75			
	GEV No.	100855	Ref. No. —
pilot burner bracket triple			
	GEV No.	100885	Ref. No. —
air mixing sleeve for pilot burner Qty 1 pcs			
	GEV No.	100916	Ref. No. —
compression spring for pilot burner Qty 1 pcs			
	GEV No.	100917	Ref. No. —
gasket for pilot burner Qty 1 pcs aluminium			
	GEV No.	100918	Ref. No. —
screw for pilot burner			
	GEV No.	107162	Ref. No. —
pilot burner cap SIT 3 flames Hmm Lmm Qty 1 pcs			
	GEV No.	107701	Ref. No. —
pilot burner bottom part SIT 100 series nozzle ø 0.2mm			
accessories for	106906		
	GEV No.	100245	Ref. No. 38023032
pilot burner nozzle LPG code 20 bore ø 0.2mm Qty 1 pcs thread M8x0.75			

Table continues overleaf

accessories for		106906	
	GEV No.	100246	Ref. No. —
pilot burner nozzle natural gas bore ø 0.35mm Qty 1 pcs thread M8x0.75			
	GEV No.	100904	Ref. No. —
locking screw M10x1 for pipe ø 4mm Qty 1 pcs			
	GEV No.	100905	Ref. No. —
locking screw M10x1 for pipe ø 6mm Qty 1 pcs			
	GEV No.	102110	Ref. No. —
pilot tube copper pipe ø 4mm thickness 1mm L 3000mm			
	GEV No.	102111	Ref. No. —
pilot tube copper pipe ø 6mm thickness 1mm L 3000mm			
	GEV No.	107171	Ref. No. —
pilot burner nozzle SIT natural/liquid gas bore ø 0.25mm Qty 1 pcs			
	GEV No.	107700	Ref. No. —
pilot burner bottom part SIT 100 series nozzle ø 0.25mm			
	GEV No.	107702	Ref. No. —
pilot burner bottom part SIT 100 series nozzle ø 0.35mm			

accessories

pilot burner caps

	1		
GEV No.	107166	Ref. No.	40021120
description pilot burner head SIT 1 flame Hmm Lmm Qty 1 pcs			
For models: G0000, G0002, G0004, G0005, G0007, G0008, G0009, G0010, G0030, G0031, G0032, G0033, G0034, G0035, G0664, G0665, G0666, G0667, G0669, G0776, G0777			

pilot burner nozzles

	1		
GEV No.	100245	Ref. No.	38023032
description pilot burner nozzle LPG code 20 bore ø 0.2mm Qty 1 pcs thread M8x0.75			
For models: G0004, G0005, G0007, G0008, G0009, G0010, G0035			

	1		
GEV No.	102972	Ref. No.	38023040 38023082
description pilot burner nozzle natural gas code 40 bore ø 0.4mm Qty 1 pcs			
For models: G0004, G0005, G0007, G0008, G0009, G0010, G0035			

ignition electrodes

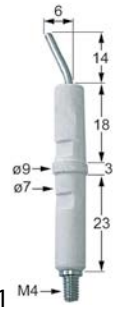
	1		
GEV No.	100706	Ref. No.	40020902
description ignition electrode connection M4 Qty 1 pcs			

	1		
GEV No.	100707	Ref. No.	009,008
description ignition electrode D1 ø 7mm D2 ø 9mm connection ø2.4mm L1 14mm L2 6mm BL1 18mm BL2 3mm BL3 23mm to clip Qty 1 pcs			

140 - 145 -150 series

	1		
GEV No.	107114 ¹	Ref. No.	40021131
description pilot burner SIT type 140 series 2 flames nozzle ømm gas connectionmm			
For models: G1500, G1501			
spare parts for 107114			
	GEV No.	100907	Ref. No. —
screw connection thread M10x1 Qty 1 pcs type SEF 1 ømm for thermocouple			
accessories for 107114			
	GEV No.	100204	Ref. No. —
pilot burner nozzle SIT LPG code 14 bore ø 0.18/0.20mm Qty 1 pcs suitable for 140 series			
	GEV No.	100205	Ref. No. —
pilot burner nozzle SIT LPG code 19 bore ø 0.23/0.26mm Qty 1 pcs suitable for SIT 150 series			
	GEV No.	100206	Ref. No. —
pilot burner nozzle SIT natural gas code 36 bore ø 0.60/0.55mm Qty 1 pcs suitable for SIT 150 series			
	GEV No.	100207	Ref. No. —
pilot burner nozzle SIT natural gas code 27 bore ø 0.40/0.38mm suitable for SIT 140 series			
	GEV No.	100216	Ref. No. —
pilot burner nozzle SIT natural gas code 38 bore ø 0.45mm Qty 1 pcs suitable for SIT 150 series			





¹incl. thermocouple fitting
Table continues overleaf







accessories for		107114		
	GEV No.	100701	Ref. No.	40020907
	ignition electrode connection M4 Qty 1 pcs			
	GEV No.	100801	Ref. No.	—
	gasket for pilot burner Qty 1 pcs			
	GEV No.	100897	Ref. No.	—
	olive for pipe ø 4mm Qty 1 pcs for pilot burner			
	GEV No.	100898	Ref. No.	—
	olive for pipe ø 6mm Qty 1 pcs for pilot burner			
	GEV No.	100906	Ref. No.	—
	screw connection thread M10x1 for ignition electrode brass Qty 1 pcs WS 10			
	GEV No.	100908	Ref. No.	105076
	union screw thread M10x1 for pipe ø 4mm Qty 1 pcs			
	GEV No.	100909	Ref. No.	40021603
	union screw thread M10x1 for pipe ø 6mm Qty 1 pcs			
	GEV No.	102110	Ref. No.	—
	pilot tube copper pipe ø 4mm thickness 1mm L 3000mm			
	GEV No.	102111	Ref. No.	—
	pilot tube copper pipe ø 6mm thickness 1mm L 3000mm			

accessories for		100110		
	GEV No.	100906	Ref. No.	—
	screw connection thread M10x1 for ignition electrode brass Qty 1 pcs WS 10			
	GEV No.	100907	Ref. No.	—
	screw connection thread M10x1 Qty 1 pcs type SEF 1 ømm for thermocouple			
	GEV No.	100908	Ref. No.	105076
	union screw thread M10x1 for pipe ø 4mm Qty 1 pcs			
	GEV No.	100909	Ref. No.	40021603
	union screw thread M10x1 for pipe ø 6mm Qty 1 pcs			
	GEV No.	101282	Ref. No.	—
	olive for pipe ø 4mm L 7.4mm Qty 1 pcs			
	GEV No.	101287	Ref. No.	—
	olive for pipe ø 6mm Qty 1 pcs			
	GEV No.	102110	Ref. No.	—
	pilot tube copper pipe ø 4mm thickness 1mm L 3000mm			
	GEV No.	102111	Ref. No.	—
	pilot tube copper pipe ø 6mm thickness 1mm L 3000mm			
	GEV No.	107650	Ref. No.	38023085
	pilot burner nozzle SIT LPG code 30 Qty 1 pcs			

160 series				
				
1				
GEV No.	106243	Ref. No.	40021140	
description	pilot burner SIT type 160 series 2 flames nozzle ø 0.41mm gas connection 6mm nozzle no.41			

190 series				
				
1				
GEV No.	100110	Ref. No.	40021132	
description	pilot burner SIT type 190 series 3 flames nozzle ømm gas connectionmm			
accessories for		100110		
	GEV No.	100202	Ref. No.	—
	pilot burner nozzle natural gas code 41 Qty 1 pcs nozzle ø 0.41mm			
	GEV No.	100203	Ref. No.	—
	pilot burner nozzle LPG code 25 Qty 1 pcs nozzle ø 0.25mm			
	GEV No.	100701	Ref. No.	40020907
	ignition electrode connection M4 Qty 1 pcs			

POLIDORO				
pilot burners				
				
1				
GEV No.	103264	Ref. No.	40021130	
description	pilot burner POLIDORO 3 flames natural/liquid gas code 22/27-2 gas connection 6mm			
For models:	G0032, G0033, G0034, G0035, G1200, G1201			
spare parts for		103264		
	GEV No.	100000	Ref. No.	—
	pilot burner nozzle POLIDORO LPG code 22 bore ø 0.22mm Qty 1 pcs			
	GEV No.	106703	Ref. No.	—
	pilot burner nozzle POLIDORO natural gas code 27.2 bore ø 2x0.27mm Qty 1 pcs			
accessories for		103264		
	GEV No.	100701	Ref. No.	40020907
	ignition electrode connection M4 Qty 1 pcs			

electrodes

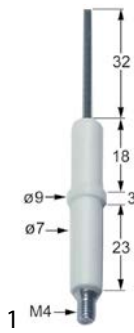

GEV No.	100701	Ref. No.	40020907
description	ignition electrode connection M4 Qty 1 pcs		
For models:	G1500, G1501		
accessories for	100701		
	GEV No.	100906	Ref. No. —
	screw connection thread M10x1 for ignition electrode brass Qty 1 pcs WS 10		



GEV No.	100706	Ref. No.	40020902
description	ignition electrode connection M4 Qty 1 pcs		

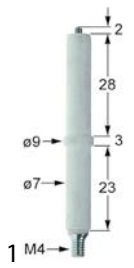

GEV No.	102314	Ref. No.	40020906
description	ignition electrode D1 ø 7mm D2 ø 9mm connection M4 L1 2mm BL1 28mm BL2 3mm BL3 23mm		
For models:	G0032, G0033, G0034, G0035, G1200, G1201		

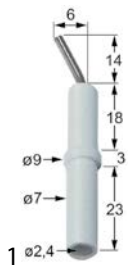

GEV No.	100707	Ref. No.	009,008
description	ignition electrode D1 ø 7mm D2 ø 9mm connection ø2.4mm L1 14mm L2 6mm BL1 18mm BL2 3mm BL3 23mm to clip Qty 1 pcs		

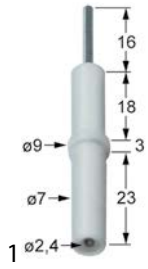

GEV No.	102330	Ref. No.	40020900
description	ignition electrode D1 ø 7mm D2 ø 9mm L1 16mm BL1 18mm BL2 3mm BL3 23mm to clip connection ø 2.4mm		
For models:	G1700, G1702, G1704, G1706		

piezoelectric igniters

mounting diameter 22mm



GEV No.	100013	Ref. No.	40010011
description	piezoelectric igniter body plastic blowing mounting ø 22mm connection ø2.4mm cable lengthmm		
accessories for	100013		
	GEV No.	100023	Ref. No. —
	female bullet size 2.3mm 0.5-1.5mm ² CuZn t.max. 125°C Qty 20 pcs		



GEV No.	100005	Ref. No.	40010000
description	piezoelectric igniter body plastic blowing mounting ø 22mm connection ø2.4mm cable lengthmm SIT		
For models:	G0004, G0007, G0008, G0016, G0017, G0030, G0031, G0032, G0033, G0034, G0035, G0666, G0667, G1000, G1001, G1004, G1005, G1010, G1011, G1014, G1015, G1018, G1019		

ignition units



GEV No.	101002	Ref. No.	40002100
description	ignition unit outputs 2 230VAC dimensions 88x23x34mm mounting distance 73mm inlet F6.3x0.8 outlet F2.8x0.8 0.6VA 50/60Hz		
For models:	G1100, G1101, G1102, G1103, G1104		



ignition switches

			
GEV No.	107783	Ref. No.	40002105
description	ignition switch for battery type AA 1.5V mounting \varnothing 22mm built-in depth 68mm connection F 2.8 mounting distance mm dimensions 98x58x35mm outputs 1		
For models:	G1014, G1015, G1019, G1200, G1201, G1500		

thermocouples

plug-in thermocouples

plug-in thermocouples standard

with barrel socket \varnothing 6(6.5)mm

thermocouples SIT

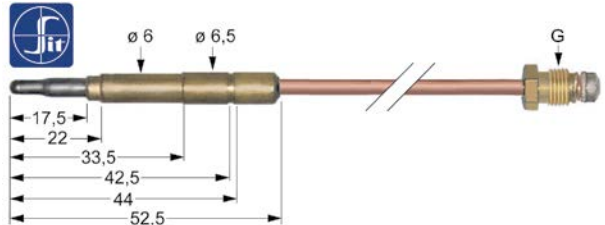
			
GEV No.	107613	Ref. No.	40021010
description	thermocouple SIT M9x1 L 1200mm plug connection \varnothing 6.0(6.5)mm		
For models:	G0004, G0007, G0008, G0017, G0031, G0033, G0035, G0666, G0667		

GEV No.	107611	Ref. No.	40021008 40021012
description	thermocouple SIT M9x1 L 850mm plug connection \varnothing 6.0(6.5)mm		
For models:	G0007, G0010, G0030, G0031, G0034, G0035, G1700, G1702, G1704, G1706		

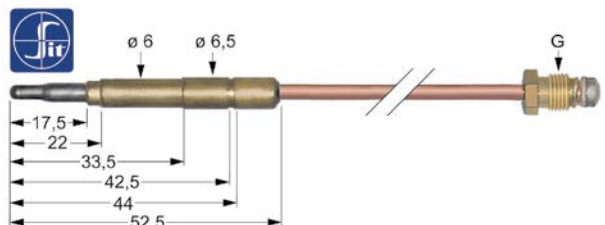
			
GEV No.	107607	Ref. No.	40021005
description	thermocouple SIT M9x1 L 400mm plug connection \varnothing 6.0(6.5)mm		
For models:	G0000, G0002, G0004, G0005, G0007, G0008, G0009, G0010, G0030, G0031, G0032, G0033, G0034, G0035, G0664, G0665, G0666, G0667, G0669, G0776, G0777, G1000, G1001, G1004, G1005, G1010, G1011, G1014, G1015, G1018, G1019		

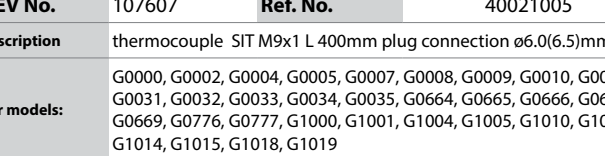
			
GEV No.	107609	Ref. No.	40021032
description	thermocouple SIT M9x1 L 600mm plug connection \varnothing 6.0(6.5)mm		
For models:	G1500, G1501		

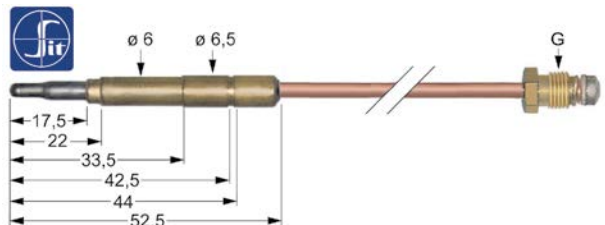
			
GEV No.	107164	Ref. No.	40021042
description	thermocouple SIT with interrupter M9x1 L 1000mm plug connection \varnothing 6.0(6.5)mm soldering connection		

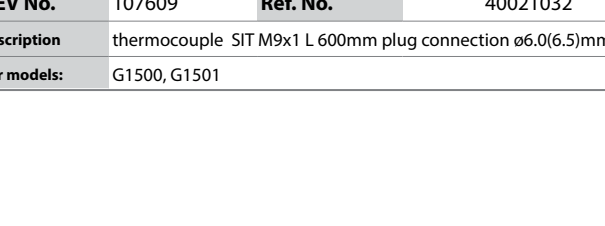
			
GEV No.	107177	Ref. No.	40021028
description	thermocouple SIT with interrupter M9x1 L 600mm plug connection \varnothing 6.0mm F 6.3mm		
For models:	G1100, G1101, G1102, G1103, G1104		

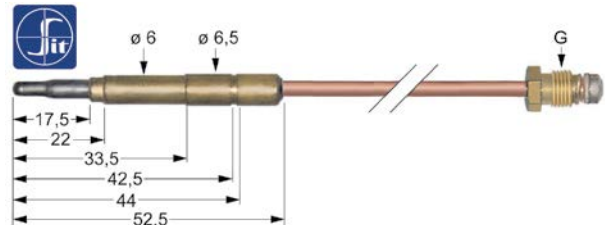
			
GEV No.	107610	Ref. No.	40021007
description	thermocouple SIT M9x1 L 750mm plug connection \varnothing 6.0(6.5)mm		
For models:	G0000, G0002, G0004, G0005, G0008, G0009, G0016, G0017, G0030, G0031, G0032, G0033, G0034, G0035, G0664, G0665, G0666, G0667, G0669, G0776, G0777		

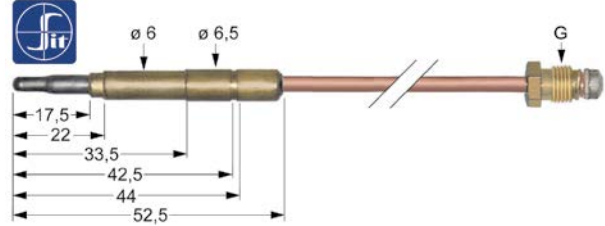
			
GEV No.	107611	Ref. No.	40021008 40021012
description	thermocouple SIT M9x1 L 850mm plug connection \varnothing 6.0(6.5)mm		
For models:	G0007, G0010, G0030, G0031, G0034, G0035, G1700, G1702, G1704, G1706		

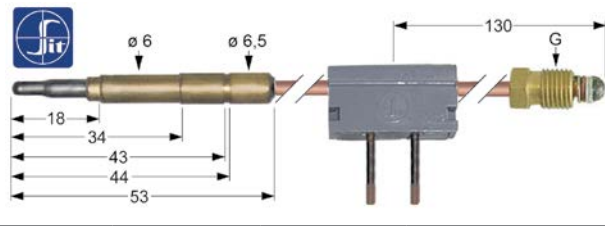
			
GEV No.	107164	Ref. No.	40021042
description	thermocouple SIT with interrupter M9x1 L 1000mm plug connection \varnothing 6.0(6.5)mm soldering connection		

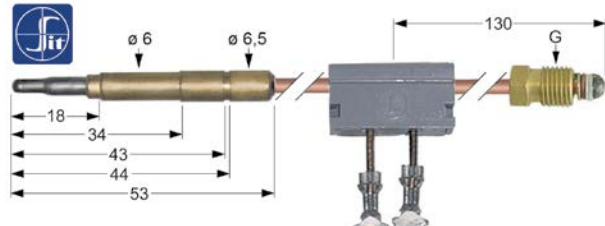
			
GEV No.	107177	Ref. No.	40021028
description	thermocouple SIT with interrupter M9x1 L 600mm plug connection \varnothing 6.0mm F 6.3mm		
For models:	G1100, G1101, G1102, G1103, G1104		

plug-in thermocouples with interruption

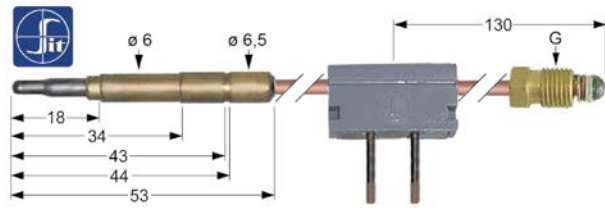
			
GEV No.	107164	Ref. No.	40021042
description	thermocouple SIT with interrupter M9x1 L 1000mm plug connection \varnothing 6.0(6.5)mm soldering connection		

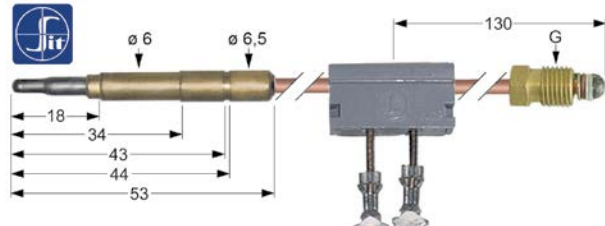
			
GEV No.	107177	Ref. No.	40021028
description	thermocouple SIT with interrupter M9x1 L 600mm plug connection \varnothing 6.0mm F 6.3mm		
For models:	G1100, G1101, G1102, G1103, G1104		

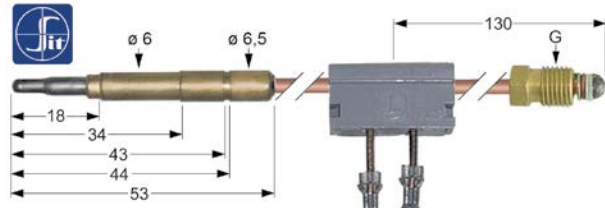
			
GEV No.	107177	Ref. No.	40021028
description	thermocouple SIT with interrupter M9x1 L 600mm plug connection \varnothing 6.0mm F 6.3mm		
For models:	G1100, G1101, G1102, G1103, G1104		

			
GEV No.	107177	Ref. No.	40021028
description	thermocouple SIT with interrupter M9x1 L 600mm plug connection \varnothing 6.0mm F 6.3mm		
For models:	G1100, G1101, G1102, G1103, G1104		



accessories

screws



1			
GEV No.	102464	Ref. No.	38024012
description	thermocouple fitting thread M10x1 brass Qty 1 pcs		
For models:	G0032, G0033, G0034, G0035, G1200, G1201		



1			
GEV No.	103216	Ref. No.	38020211
description	burner head 4.5kW for burner cap ø 104mm ED ø 136mm seat ø 98mm enamelled		
For models:	G0002, G0004, G0005, G0007, G0008, G0009, G0010, G0034, G0035, G0665, G0666, G0667, G0669, G0776, G0777		

accessories for	103216		
	GEV No.	103215	Ref. No.
			38020221



burner cap 4.5kW ED ø 104mm seat ø 98mm enamelled

gas burners

hob burners

universal hob burners

ARC

65 series



1			
GEV No.	103213	Ref. No.	38020220
description	burner cap 3kW ED ø 73mm seat ø 67mm enamelled		
For models:	G0000, G0002, G0004, G0005, G0007, G0008, G0009, G0010, G0030, G0031, G0032, G0033, G0034, G0035, G0664, G0665, G0666, G0667, G0669, G0776, G0777		



1			
GEV No.	103218	Ref. No.	38020212
description	burner head 7.5kW for burner cap ø 128mm ED ø 151mm seat ø 120mm enamelled		
For models:	G0000, G0002, G0004, G0005, G0007, G0008, G0009, G0010, G0030, G0031, G0032, G0033, G0034, G0035, G0664, G0665, G0666, G0667, G0669, G0776, G0777		

accessories for	103218		
	GEV No.	103217	Ref. No.
			38020222



burner cap 7.5kW ED ø 128mm ID ø 70mm seat ø 119.6mm enamelled



1			
GEV No.	103215	Ref. No.	38020221
description	burner cap 4.5kW ED ø 104mm seat ø 98mm enamelled		
For models:	G0002, G0004, G0005, G0007, G0008, G0009, G0010, G0034, G0035, G0665, G0666, G0667, G0669, G0776, G0777		

bar burners

bar burners



1			
GEV No.	105475	Ref. No.	38020140
description	bar burner 2 row L 575mm W 225mm ømm H 45mm 11kW chargrill		



1			
GEV No.	103217	Ref. No.	38020222
description	burner cap 7.5kW ED ø 128mm ID ø 70mm seat ø 119.6mm enamelled		
For models:	G0000, G0002, G0004, G0005, G0007, G0008, G0009, G0010, G0030, G0031, G0032, G0033, G0034, G0035, G0664, G0665, G0666, G0667, G0669, G0776, G0777		



1			
GEV No.	107789	Ref. No.	38020111
description	bar burner L 475mm W 155mm ø 25mm H 50mm flange width 65mm flange length 50mm 5.5kW griddle		
For models:	G1000, G1001, G1004, G1005, G1010, G1011, G1014, G1015, G1018, G1019		



1			
GEV No.	103214	Ref. No.	38020210
description	burner head 3kW for burner cap ø 73mm seat ø 67mm enamelled		
For models:	G0000, G0002, G0004, G0005, G0007, G0008, G0009, G0010, G0030, G0031, G0032, G0033, G0034, G0035, G0664, G0665, G0666, G0667, G0669, G0776, G0777		

accessories for 103214

	GEV No.	103213	Ref. No.	38020220
--	----------------	--------	-----------------	----------



burner cap 3kW ED ø 73mm seat ø 67mm enamelled



			
1			
GEV No.	105481	Ref. No.	38020123
description	bar burner ø 40mm Wmm Hmm L 325mm flange ø 61mm tilting bratt pan		
For models:	G1700, G1702, G1704, G1706		

			
1			
GEV No.	105482	Ref. No.	38020124
description	bar burner ø 40mm Wmm Hmm L 396mm flange ø 61mm tilting bratt pan		

			
1			
GEV No.	105690	Ref. No.	20121700
description	bar burner ø 60mm Wmm Hmm L 258mm flange width 67mm flange length 67mm pasta cooker		
For models:	G1200, G1201		
accessories for	105690		
	GEV No.	100508	Ref. No. —
	gas injector thread M9x1 WS 10 bore ø 1.45mm		
	GEV No.	100513	Ref. No. —
	gas injector thread M9x1 WS 10 bore ø 2.15mm		

tube burners

			
1			
GEV No.	105532	Ref. No.	38020129
description	tubular burner L 295mm W 55mm H 70mm mounting pos. centre for fryer oval		
For models:	G1101, G1104		

			
1			
GEV No.	105530	Ref. No.	38020128
description	tubular burner L 295mm W 55mm H 70mm mounting pos. left for fryer oval		
For models:	G1100, G1101, G1103, G1104		

			
1			
GEV No.	105531	Ref. No.	38020130
description	tubular burner L 295mm W 55mm H 70mm mounting pos. right for fryer oval		
For models:	G1100, G1101, G1103, G1104		

gas nozzles

main nozzles

gas nozzles M9x1

			
1			
GEV No.	100505	Ref. No.	40021420
description	gas injector thread M9x1 WS 10 bore ø 1.2mm		
For models:	G1100, G1101, G1102, G1103, G1104		

			
1			
GEV No.	107596	Ref. No.	40021423
description	gas injector thread M9x1 WS 10 bore ø 1.45mm		

			
1			
GEV No.	107595	Ref. No.	40021430
description	gas injector thread M9x1 WS 10 bore ø 1.5mm		

			
1			
GEV No.	107597	Ref. No.	38023052
description	gas injector thread M9x1 WS 10 bore ø 1.6mm		

gas nozzles M10x1

			
1			
GEV No.	100466	Ref. No.	38023000
description	gas injector thread M10x1 WS 12 bore ø 0.95mm		
For models:	G0000, G0002, G0004, G0005, G0007, G0008, G0009, G0010, G0016, G0017, G0030, G0031, G0032, G0033, G0034, G0035, G0664, G0665, G0666, G0667, G0669, G0776, G0777, G1014, G1015, G1019		

			
1			
GEV No.	100469	Ref. No.	38023006
description	gas injector thread M10x1 WS 12 bore ø 1.15mm		
For models:	G0000, G0002, G0004, G0005, G0007, G0008, G0010, G0016, G0017, G0030, G0031, G0032, G0033, G0034, G0035, G0664, G0665, G0666, G0667, G0669, G0776, G0777, G1014, G1015, G1019		

			
1			
GEV No.	103211	Ref. No.	38023001
description	gas injector thread M10x1 WS 12 bore ø 1.25mm		

			
1			
GEV No.	103212	Ref. No.	38023007
description	gas injector thread M10x1 WS 12 bore ø 1.32mm		
For models:	G0000, G0002, G0004, G0005, G0007, G0008, G0009, G0010, G0016, G0017, G0030, G0031, G0032, G0033, G0034, G0035, G0664, G0665, G0666, G0667, G0669, G0776, G0777, G1014, G1015, G1019		

			
1			
GEV No.	100446	Ref. No.	38023010
description	gas injector thread M10x1 WS 12 bore ø 1.3mm		

			
1			
GEV No.	100473	Ref. No.	38023003
description	gas injector thread M10x1 WS 12 bore ø 1.45mm		
For models:	G0000, G0002, G0004, G0005, G0007, G0008, G0010, G0016, G0017, G0030, G0031, G0032, G0033, G0034, G0035, G0664, G0665, G0666, G0667, G0669, G0776, G0777, G1014, G1015, G1019		

			
1			
GEV No.	100472	Ref. No.	38023002
description	gas injector thread M10x1 WS 12 bore ø 1.4mm		
For models:	G0008		

			
1			
GEV No.	100478	Ref. No.	38023008
description	gas injector thread M10x1 WS 12 bore ø 1.75mm		
For models:	G0000, G0002, G0004, G0005, G0007, G0008, G0010, G0016, G0017, G0030, G0031, G0032, G0033, G0034, G0035, G0664, G0665, G0666, G0667, G0669, G0776, G0777, G1014, G1015, G1019		

			
1			
GEV No.	100480	Ref. No.	38023012
description	gas injector thread M10x1 WS 12 bore ø 1.85mm		

			
1			
GEV No.	100479	Ref. No.	38023004
description	gas injector thread M10x1 WS 12 bore ø 1.8mm		

			
1			
GEV No.	100482	Ref. No.	38023011
description	gas injector thread M10x1 WS 12 bore ø 1.95mm		





			
1			
GEV No.	100485	Ref. No.	38023005
description	gas injector thread M10x1 WS 12 bore ø 2.2mm		
For models:	G0008		

			
1			
GEV No.	107650	Ref. No.	38023085
description	pilot burner nozzle SIT LPG code 30 Qty 1 pcs		

			
1			
GEV No.	100483	Ref. No.	38023009
description	gas injector thread M10x1 WS 12 bore ø 2mm		
For models:	G0000, G0002, G0004, G0005, G0007, G0008, G0009, G0010, G0016, G0017, G0030, G0031, G0032, G0033, G0034, G0035, G0664, G0665, G0666, G0667, G0669, G0776, G0777, G1014, G1015, G1019		

			
1			
GEV No.	107173	Ref. No.	38023031
description	pilot burner nozzle SIT natural gas code 35 Qty 1 pcs suitable for 160 series nozzle ø 0.35mm		
For models:	G0000, G0002, G0004, G0005, G0007, G0008, G0009, G0010, G0030, G0031, G0032, G0033, G0034, G0035, G0664, G0665, G0666, G0667, G0669, G0776, G0777		

			
1			
GEV No.	100491	Ref. No.	38023013
description	gas injector thread M10x1 WS 12 bore ø 3mm		

			
1			
GEV No.	107174	Ref. No.	38023104
description	pilot burner nozzle SIT natural gas code 41 Qty 1 pcs		

pilot burner nozzles

pilot burner nozzles SIT

100 series

			
1			
GEV No.	100245	Ref. No.	38023032
description	pilot burner nozzle LPG code 20 bore ø 0.2mm Qty 1 pcs thread M8x0.75		
For models:	G0004, G0005, G0007, G0008, G0009, G0010, G0035		

			
1			
GEV No.	102972	Ref. No.	38023040 38023082
description	pilot burner nozzle natural gas code 40 bore ø 0.4mm Qty 1 pcs		
For models:	G0004, G0005, G0007, G0008, G0009, G0010, G0035		

160 series

			
1			
GEV No.	107649	Ref. No.	38023030
description	pilot burner nozzle SIT LPG code 20 Qty 1 pcs		
For models:	G0000, G0002, G0004, G0005, G0007, G0008, G0009, G0010, G0030, G0031, G0032, G0033, G0034, G0035, G0664, G0665, G0666, G0667, G0669, G0776, G0777		

bypass nozzles

bypass nozzles PEL20/21

			
1			
GEV No.	100527	Ref. No.	40020202
description	bypass nozzle type PEL20/21 bore ø 0.85mm thread M5x0.5		

			
1			
GEV No.	100557	Ref. No.	40020200
description	bypass nozzle type PEL20/21 bore ø 1.05mm thread M5x0.5		

			
1			
GEV No.	100530	Ref. No.	40020203
description	bypass nozzle type PEL20/21 bore ø 1.1mm thread M5x0.5		

bypass nozzles PEL22

			
1			
GEV No.	100391	Ref. No.	40020210
description	bypass nozzle type PEL22 bore ø 0.55mm thread M6x0.5		
For models:	G0004, G0005, G0007, G0009, G0010		



auxiliary gas parts

screw connections

olives

			
1			
GEV No.	101857	Ref. No.	40021125
description	olive for pipe ø 6mm Qty 1 pcs suitable for 160 series for pilot burner		
For models:	G0000, G0002, G0004, G0005, G0007, G0008, G0009, G0010, G0030, G0031, G0032, G0033, G0034, G0035, G0664, G0665, G0666, G0667, G0669, G0776, G0777		

union screws

			
1			
GEV No.	100908	Ref. No.	105076
description	union screw thread M10x1 for pipe ø 4mm Qty 1 pcs		
For models:	G1500, G1501		
accessories for	100908		
	GEV No.	100897	Ref. No. —
	olive for pipe ø 4mm Qty 1 pcs for pilot burner		
	GEV No.	101246	Ref. No. —
	olive for pipe ø 4mm Qty 1 pcs		
	GEV No.	101280	Ref. No. —
	olive for pipe ø 4mm Qty 1 pcs		
	GEV No.	101282	Ref. No. —
	olive for pipe ø 4mm L 7.4mm Qty 1 pcs		

			
1			
GEV No.	100909	Ref. No.	40021603
description	union screw thread M10x1 for pipe ø 6mm Qty 1 pcs		
For models:	G1500, G1501		
accessories for	100909		
	GEV No.	100898	Ref. No. —
	olive for pipe ø 6mm Qty 1 pcs for pilot burner		
	GEV No.	101286	Ref. No. —
	olive ID ø 6mm Qty 1 pcs		
	GEV No.	101287	Ref. No. —
	olive for pipe ø 6mm Qty 1 pcs		
	GEV No.	101288	Ref. No. —
	olive for pipe ø 6mm L 6mm aluminium Qty 1 pcs ED ø 8.5mm		

			
1			
GEV No.	100428	Ref. No.	40020216
description	bypass nozzle type PEL22 bore ø 0.65mm thread M6x0.5		

			
1			
GEV No.	100392	Ref. No.	40020215
description	bypass nozzle type PEL22 bore ø 0.6mm thread M6x0.5		

			
1			
GEV No.	100432	Ref. No.	40020218
description	bypass nozzle type PEL22 bore ø 0.75mm thread M6x0.5		

			
1			
GEV No.	100429	Ref. No.	40020217
description	bypass nozzle type PEL22 bore ø 0.7mm thread M6x0.5		

			
1			
GEV No.	100410	Ref. No.	40020211
description	bypass nozzle type PEL22 bore ø 0.85mm thread M6x0.5		
For models:	G0004, G0005, G0007, G0009, G0010		

			
1			
GEV No.	100409	Ref. No.	40020219
description	bypass nozzle type PEL22 bore ø 0.8mm thread M6x0.5		

			
1			
GEV No.	100435	Ref. No.	40020212
description	bypass nozzle type PEL22 bore ø 1.05mm thread M6x0.5		

			
1			
GEV No.	100436	Ref. No.	40020214
description	bypass nozzle type PEL22 bore ø 1.1mm thread M6x0.5		



equipment-specific units

for tilting bratt pans

miscellaneous



GEV No.	693111	Ref. No.	38040401
description	spindle		
For models:	G1700, G1701, G1704, G1705		

for pasta cookers



GEV No.	698999	Ref. No.	40041002
description	lever with bezel		
For models:	G1200, G1201, G1210, G1211, G1300, G1301		

handles and hand wheels

hand wheels

hand wheels



GEV No.	692443	Ref. No.	40040220
description	hand wheel \varnothing 150mm D1 \varnothing 38mm bore \varnothing 14mm thread groove width 6mm groove depth 13mm mounting distance 18mm L1 40mm L2 43mm handle length 65mm with folding handle		
For models:	G1700, G1701, G1704, G1705		



GEV No.	692430	Ref. No.	40040221
description	hand wheel \varnothing 200mm D1 \varnothing 50mm bore \varnothing 20mm thread groove width 6mm groove depth 13mm mounting distance 30mm L1 47mm L2 50mm handle length 90mm with folding handle		

ball handles





GEV No.	540323	Ref. No.	40041009
description	ball handle thread M10 \varnothing 40mm with metal bush black		

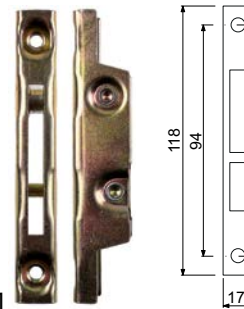

hinges

oven hinges

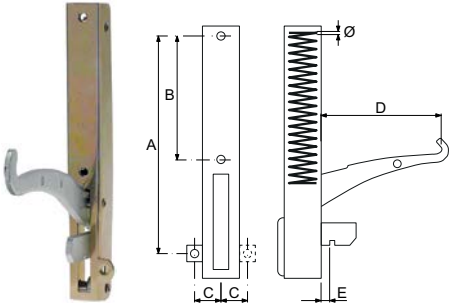

GEV No.	700001	Ref. No.	40040210
description	opposite support L 118mm W 17mm mounting distance 94mm		
For models:	G0004, G0007, G0008, G0009, G0010, G0017, G0031, G0033, G0035, G0104, G0107, G0114, G0117, G0122, G0666, G0667, G0704, G0705, G0776, G0777		

			
GEV No.	700006	Ref. No.	40040201
description	oven hinge mounting distance 173mm mounting distance 2 105mm lug mounting 14mm lever length 120mm groove distance 11mm spring thickness 3.5mm mounting ear position left spring length 112mm W 25mm		
For models:	G0004, G0007, G0008, G0009, G0010, G0017, G0031, G0033, G0035, G0104, G0107, G0114, G0117, G0122, G0666, G0667, G0704, G0705, G0776, G0777		
accessories for	700006		
	GEV No.	700001	Ref. No. 40040210
	opposite support L 118mm W 17mm mounting distance 94mm		
	GEV No.	700007	Ref. No. 40040200
	oven hinge mounting distance 173mm mounting distance 2 105mm lug mounting 14mm lever length 120mm groove distance 11mm spring thickness 3.5mm mounting ear position right spring length 112mm W 25mm		

			
GEV No.	700007	Ref. No.	40040200
description	oven hinge mounting distance 173mm mounting distance 2 105mm lug mounting 14mm lever length 120mm groove distance 11mm spring thickness 3.5mm mounting ear position right spring length 112mm W 25mm		
For models:	G0004, G0007, G0008, G0009, G0010, G0017, G0031, G0033, G0035, G0104, G0107, G0114, G0117, G0122, G0666, G0667, G0704, G0705, G0776, G0777		
accessories for	700007		
	GEV No.	700001	Ref. No. 40040210
	opposite support L 118mm W 17mm mounting distance 94mm		

fittings for catering equipment

lid hinges

FIREX

lid hinges

			
GEV No.	514412	Ref. No.	40040224
description	lid hinge L 230mm mounting distance 1 150mm flange radius 320mm spring thickness 4mm for circular lids		
spare parts for	514412		
	GEV No.	540846	Ref. No. —
	torsion spring ϕ 42.5mm wire gauge ϕ 4.1mm L1 93mm L2 26mm L3 26mm mounting pos. left		
	GEV No.	540847	Ref. No. —
	torsion spring ϕ 42.5mm wire gauge ϕ 4.1mm L1 93mm L2 26mm L3 26mm mounting pos. right		

drain taps

brass

drain taps

			
GEV No.	540275	Ref. No.	40050025
description	drain tap 2" IT with union nut A 90mm B 151mm B1 80mm chrome-plated brass		
spare parts for	540275		
	GEV No.	540214	Ref. No. —
	handle ID ϕ 6mm L 145mm		
accessories for	540275		
	GEV No.	529484	Ref. No. —
	flat gasket fibre ED ϕ 58mm ID ϕ 50mm thickness 2mm Qty 1 pcs		
	GEV No.	542448	Ref. No. —
	gasket silicone 60x49x2 for drain tap 2"		



accessories



1			
GEV No.	540958	Ref. No.	40050026
description	rosette for drain tap hose ext. ø 120mm ID ø 60mm H 13mm		

gaskets

gaskets for heated units

door seals with fixing hook

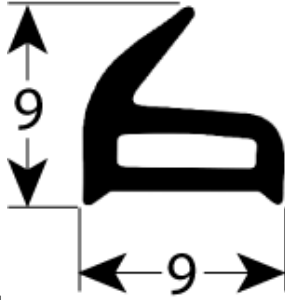

1			
GEV No.	901947	Ref. No.	38040300
description	door seal L 720mm with 5 mounting clips		
For models:	G0004, G0007, G0008, G0009, G0010, G0017, G0031, G0033, G0035, G0104, G0107, G0114, G0117, G0122, G0666, G0667, G0704, G0705, G0776, G0777		



1			
GEV No.	902142	Ref. No.	38040301
description	gasket L 315mm 3 Qty 1 pcs		
For models:	G0004, G0007, G0008, G0009, G0010, G0017, G0031, G0033, G0035, G0104, G0107, G0114, G0117, G0122, G0666, G0667, G0704, G0705, G0776, G0777		

valves and tank inlets

shut-off valves

universal



1			
GEV No.	693107	Ref. No.	40050000
description	shut-off valve connection 1/2" 1/2" cold total length 54mm L1 27mm L2 30mm marking blue rosette thread G2 26x19G connection ø M4x0.7 ITmm		
For models:	G1700, G1701, G1702, G1704, G1705, G1706		
spare parts for	693107		
	GEV No.	514085	Ref. No. —
	rosette connection 26x19G chrome-plated total lengthmm mounting pos.		
	GEV No.	514086	Ref. No. —
	hexagonal nut connection 26x19G brass total lengthmm mounting pos. H 6mm WS 34 Qty 1 pcs		
	GEV No.	540672	Ref. No. —
	gasket suitable for tap head		
	GEV No.	547711	Ref. No. —
	hood handle shaft intake ø 8mm marking blue metal H2 21mm D1 ø 33mm type D suitable for MONOLITH shaft length H1 8mm		
	GEV No.	548168	Ref. No. —
	star handle connection hot total lengthmm mounting pos. ø 57mm marking red		
	GEV No.	548169	Ref. No. —
	star handle connection cold total lengthmm mounting pos. chrome-plated ø 57mm		
accessories for	693107		
	GEV No.	514086	Ref. No. —
	hexagonal nut connection 26x19G brass total lengthmm mounting pos. H 6mm WS 34 Qty 1 pcs		

consumables

fuses

fine fuses



1			
GEV No.	358605	Ref. No.	40000500 40000503
description	fine fuse size ø5x20mm 3.15A slow-acting rated 250V Qty 10 pcs		
For models:	G1701, G1702, G1705, G1706		

B			
bar burners	20		
C			
cam switches	9		
consumables	27		
control thermostats	5		
D			
door seals with fixing hook	27		
E			
electric accessories	12		
electronic controllers	11		
F			
fine fuses	27		
fuses	11, 27		
G			
gas burners	20		
gas control valves	14		
gas nozzles	21		
gas taps	12		
gas thermostats	13		
gaskets for heated units	27		
H			
halogen lamp	11		
heating elements	3		
heating elements for charrills	4		
heating elements for convection	4		
heating elements for fryers	3		
heating elements for griddles	3		
heating elements for ovens	3		
heating elements for pasta cookers	3		
heating elements for tilting bratt pan	3		
hob burners	20		
hot plates	4		
I			
ignition switches	19		
ignition units	18		
immersion heating elements	4		
indicator lights	10		
indicator lights (complete)	10		
L			
lamps	10		
M			
microswitches	8		
O			
oven hinges	25		
oven lamps	11		
P			
piezoelectric igniters	18		
pilot burners	15		
push/momentary push switches	8		
R			
relays	11		
rocker/momentary rocker switches	8		
rotary switches	10		
S			
safety thermostats	6		
shut-off valves	27		
switches and momentary switches	8		
T			
terminals	12		
thermocouples	19		
thermostats	5		
tube burners	21		
V			
valves and tank inlets	27		