



GAS COMPONENTS



ELECTRIC COMPONENTS



WATER TECHNOLOGY



MECHANICAL COMPONENTS



TOOLS

Spare parts suitable for

LOHBERGER

Find the complete and up-to-date range of products in our GEV Webshop



Manufacturer catalogue

The most important spare parts and accessories arranged clearly for every manufacturer

- ✓ Complete product range and all appliance data always up to date in the GEV Webshop
- ✓ Alphabetical Index at the end of the catalogue

GEV Webshop

www.gev-online.co.uk

www.gev-online.com



- 🔍 Add to Favourites
- 🔍 Sign In with email address and usual password
- 🔍 Easy-order – place several items in your basket at the same time
- 🔍 Quick Item search – no login needed



heating elements

heating elements for ovens

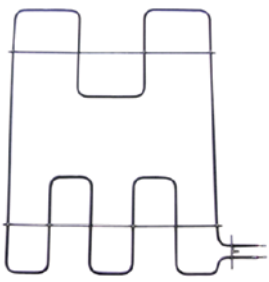

1

GEV No.	415223	Ref. No.	51440360
description	heating element 2500W 400V L 450mm W 570mm L1 20mm L2 430mm W1 500mm W2 30mm flange length 70mm flange width 18mm hole distance 56mm hole ø 3mm tube ø 6.5mm connection length 23mm connection male faston 6.3mm heating circuits 1 rectangular flange dry heating element		
accessories for	415223		
	GEV No.	510368	Ref. No. —
	gasket L 70mm W 23.5mm hole ø 5mm hole distance 56mm FIBER thickness 2mm for heating element		

heating elements for bain maries



1

GEV No.	415224	Ref. No.	51440350
description	heating element 1200W 400V heating circuits 1 L 280mm W 96mm flange length 45mm flange width 17mm hole distance 35mm tube ø 6.3mm cable length 250mm rectangular flange hole ø 5mm dry heating element L1 15mm L2 265mm W1 71mm W2 25mm		

heating elements for fryers



1

GEV No.	417621	Ref. No.	FF211060
description	heating element 7500W 230V heating circuits 3 L 345mm W 126mm H 320mm rectangular flange fryer cable lengthmm tube ø 8.5mm		

heating elements for large hobs

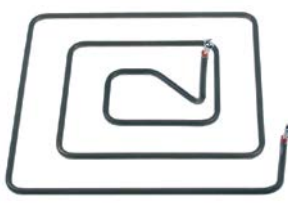

1

GEV No.	418704	Ref. No.	N/A
description	heating element 1160W 400V L 255mm W 240mm H 75mm tube ø 6.5mm mounting pos. inner connection screw INCOLOY		

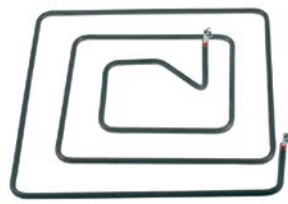

1

GEV No.	418705	Ref. No.	N/A
description	heating element 1335W 400V L 270mm W 270mm H 75mm tube ø 6.5mm mounting pos. centre connection screw INCOLOY		

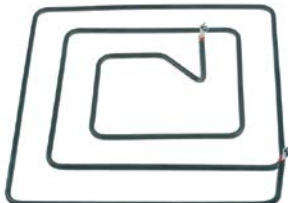

1

GEV No.	418706	Ref. No.	—
description	heating element 1505W 400V L 300mm W 300mm H 75mm tube ø 6.5mm mounting pos. outer connection screw INCOLOY		



1

GEV No.	418703	Ref. No.	51440405
description	heating element 4000W 400V L 300mm W 300mm H 75mm heating circuits 3 tube ø 6.5mm connection screw		

heating elements for refrigeration

heating elements for defrosting



1

GEV No.	419208	Ref. No.	1666250 PO1666250
description	heating element 250W 230V L 420mm W 50mm Hmm cable length 360mm tube ø 6mm refrigerator connection F6.3		

→ electric components



immersion heating elements

with expansion flange 70 x 18mm



GEV No.	415465	Ref. No.	F7U47139
description	heating element 3000W 230V heating circuits 2 flange 70x18mm L 365mm W 65mm connection male faston 6.3mm tube ø 8.5mm immersion heater expansion flange		
accessories for	415465		
	GEV No.	379078	Ref. No.
			—
description	temperature probe thermocouple K (NiCr-Ni) cable silicone probe -50 up to 1150°C cable -50 up to +180°C connection 2-wire thread probe ø1.5x100mm cable length 1.8m		

miscellaneous



GEV No.	415794	Ref. No.	F7U47101
description	heating element 6000W 230V heating circuits 3 L 360mm W 35mm H 43mm tube ø 8.5mm connection M4 immersion heater rectangular flange hole distance 44mm flange length 74mm flange width 63mm hole ø 6mm		
accessories for	415794		
	GEV No.	510745	Ref. No.
			F7I07004
description	gasket silicone L 73mm W 62mm thickness 3mm hole ø 4mm hole distance 62/55mm for heating element		

accessories

sealing washers

O-rings

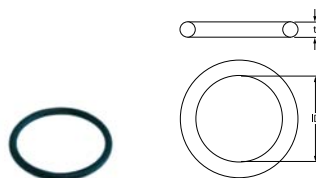

GEV No.	510409	Ref. No.	H67500-118
description	O-ring EPDM thickness 5,34mm ID ø 56,52mm Qty 1 pcs		

flange gaskets

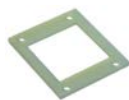

GEV No.	510745	Ref. No.	F7I07004
description	gasket silicone L 73mm W 62mm thickness 3mm hole ø 4mm hole distance 62/55mm for heating element		

GEV No.	416376	Ref. No.	1666320 PO1666320
description	heating element 300W 230V L 430mm W 85mm connection male faston 6.3mm cable length 400mm tube ø 6.3mm defrosting H 70mm		

GEV No.	419207	Ref. No.	1666352 PO1666352
description	heating element 350W 230V L 510mm W 340mm connection F 2.8 cable length 1000mm tube ø 8.5mm refrigerator		

heating elements for condensate evaporation

GEV No.	420095	Ref. No.	1666095 PO1666095
description	heating element 95W 230V L 445mm W 60mm H 25mm cable length 4000mm tube ø 6.2mm		

heating elements for tilting bratt pan

GEV No.	415208	Ref. No.	F2001128
description	heating element tilting bratt pan 2000W 230V L 641mm W 87mm H 43mm dry heating element heating circuits 1 tube ø 6.3mm L1 10mm cable length 235mm		

heating cartridges

GEV No.	417227	Ref. No.	1666090 PO1666090
description	heating cartridge 90W 230V ø 12mm L 124mm thread 3/8" cable length 4000mm Hmm Wmm condensate evaporation		

pilot heating elements

GEV No.	415793	Ref. No.	F7U47107
description	heating element 450W 230V heating circuits 1 L 194mm W 42mm rectangular flange hole distance 62mm hole ø 6.5mm connection M4 tube ø 6.5mm flange length 74mm flange width 63mm immersion heater		
accessories for	415793		
	GEV No.	510745	Ref. No.
			F7I07004
description	gasket silicone L 73mm W 62mm thickness 3mm hole ø 4mm hole distance 62/55mm for heating element		



energy regulators

EGO

1-circuit



GEV No.	380015	Ref. No.	51440126
description	energy regulator 230V 13A single-circuit turn direction right shaft ø 6x4.6mm shaft L 23mm mounting thread M4 power release 6-100% no. 50.57021.010		

thermostats

bi-metal thermostats

safety bi-metal thermostats



GEV No.	390954	Ref. No.	51440146
description	bi-metal safety thermostat hole distance 23.5mm switch-off temp. 120°C 1NC 1-pole 10A 250V connection F6.3 threaded mounting ø 15mm with reset function		

control and safety thermostats

EGO

control thermostats

55.13_series



GEV No.	375925	Ref. No.	F2072039
description	thermostat t.max. 190°C 1-pole 1NO probe ø 6mm probe L 79mm capillary pipe 1830mm shaft ø 6x4.6mm shaft L 28mm		

safety thermostats

55.32_series



GEV No.	375418	Ref. No.	51440160
description	safety thermostat switch-off temp. 340°C 3-pole 20A probe ø 4mm probe L 128mm capillary pipe 1190mm capillary pipe isolatedmm gland nut probe SS		

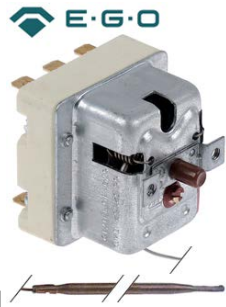

GEV No.	375878	Ref. No.	51440167
description	safety thermostat switch-off temp. 570°C 3-pole probe ø 3.9mm probe L 228mm capillary pipe 890mm capillary pipe isolatedmm gland nut starting temperature 530°C		

55.33_series



GEV No.	375516	Ref. No.	F2072038
description	safety thermostat switch-off temp. 250°C 3-pole 20A probe ø 6mm probe L 107mm capillary pipe 1470mm capillary pipe isolated 1100mm gland nut M9x1 probe SS		



control thermostats with operation switch

55.13_ series

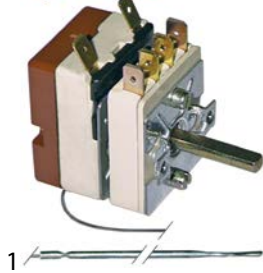

1

GEV No.	375073	Ref. No.	51440140
description	thermostat t.max. 320°C temperature range 50-320°C 1-pole capillary pipe isolated gland nut		

55.34_ series

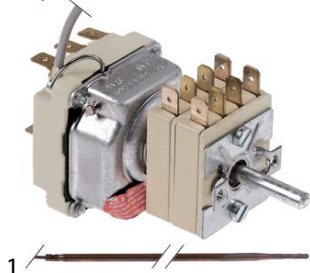

1

GEV No.	375879	Ref. No.	51440191
description	thermostat t.max. 440°C temperature range 100-440°C 3-pole 3NO probe ø 3.9mm probe L 228mm capillary pipe 1110mm capillary pipe isolated 600mm gland nut rotation 270° outer switch 2NO/2NO		

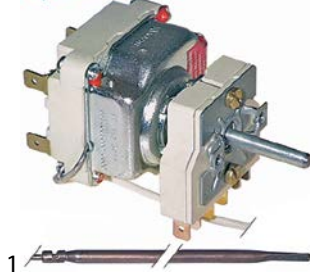

1

GEV No.	375246	Ref. No.	51440169
description	thermostat t.max. 645°C temperature range 100-615/645°C 2-pole 2NO 16A probe ø 4mm probe L 230mm capillary pipe 1100mm capillary pipe isolated 600mm gland nut shaft ø 6x4.6mm shaft L 25mm shaft position lower rotation 270° outer switch 2NO probe material copper		

switches and momentary switches

rocker/momentary rocker switches

27.8x25mm



1

GEV No.	348221	Ref. No.	1635110 PO1635110
description	rocker switch mounting measurements 27.8x25mm black/green 1NO/indicator light 250V 16A ON-OFF connection F6.3x0.8 ambient temperature max. 100/55°C protection IP40		

30x22mm



1

GEV No.	301314	Ref. No.	1635103 PO1635103
description	rocker switch mounting measurements 30x22mm white 2NO 250V 16A ON-OFF connection male faston 6.3mm ambient temperature max. 100/55°C protection IP40		

cam switches

on/off

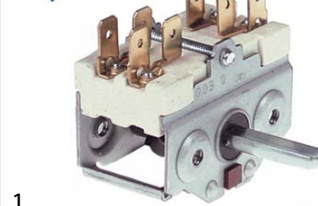

1

GEV No.	300074	Ref. No.	51450150
description	cam switch 4 operating positions 2NO sequence 0-1-0-1 16A shaft ø 6x4.6mm shaft L 23mm connection male faston 6.3mm ceramic		





magnetic switches

65x20mm

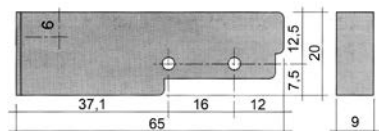

1



GEV No.	345116	Ref. No.	161801 PO161801
description	magnetic switch L 65mm W 20mm 1NO 250V 0.4A P max. 100W connection cable cable length 3000mm		
accessories for	345116		
	GEV No.	345399	Ref. No. —
	magnet ø 3.3mm L 40mm H 8mm W 13mm hole distance 30mm M3		

lamps

LED

indicator lamps

mounting diameter 24mm



1

GEV No.	360603	Ref. No.	51460224
description	indicator light LED mounting ø 24mm 230VAC green connection male faston 2.8mm 0.4W mounting thread M24 L 59mm		



1

GEV No.	360602	Ref. No.	51460223
description	indicator light LED mounting ø 24mm 230VAC yellow connection male faston 2.8mm 0.4W mounting thread M24 L 59mm		

relays

power relays

with DIN rail mounting

lateral



1

GEV No.	380313	Ref. No.	166550972 PO166550972
description	power relays FINDER 230VAC 16A 3CO connection male faston DIN rail manuf. no. 62.83.8.230.0008		

electronic controllers





ELIWELL

refrigeration controllers

built-in version



1

GEV No.	379570	Ref. No.	16811201 PO16811201
description	electronic controller ELIWELL type ID961 mounting measurements 71x29mm 12V voltage AC/DC NTC/PTC relay outputs 1 relay -50 up to +150°C display 3½ digits RoomTempIN yes compressor relay 8A		
accessories for	379570		
	GEV No.	379053	Ref. No. —
	temperature probe PTC 1kOhm cable PVC probe -50 up to +150°C cable -10 up to 100°C probe ø6x30mm cable length 3m without screw connection 2-wire		
	GEV No.	379064	Ref. No. —
	temperature probe PTC 1kOhm cable silicone probe -50 up to +150°C cable -50 up to +180°C probe ø6x40mm cable length 3m without screw connection 2-wire		
	GEV No.	379161	Ref. No. —
	temperature probe NTC 10kOhm cable thermoplastic probe -40 up to +110°C cable -40 up to +110°C probe ø6x14mm cable length 3m without screw connection 2-wire		
	GEV No.	379782	Ref. No. —
	temperature probe PTC 1kOhm cable thermoplastic probe -50 up to +150°C cable -40 up to +110°C probe ø6x14mm cable length 3m 2-wire resistor 1kOhm		



1

GEV No.	379577	Ref. No.	1681108 PO1681108
description	electronic controller ELIWELL type ID974 mounting measurements 71x29mm 230V voltage AC NTC/PTC relay outputs 3 relays -50 up to +150°C display 3½ digits RoomTempN yes DEF Probe yes DEF Relay 8A fan relay 5A compressor relay 8A		
accessories for	379577		
	GEV No.	Ref. No.	—
	379053		temperature probe PTC 1kOhm cable PVC probe -50 up to +150°C cable -10 up to 100°C probe ø6x30mm cable length 3m without screw connection 2-wire
	GEV No.	Ref. No.	—
	379064		temperature probe PTC 1kOhm cable silicone probe -50 up to +150°C cable -50 up to +180°C probe ø6x40mm cable length 3m without screw connection 2-wire
	GEV No.	Ref. No.	—
	379161		temperature probe NTC 10kOhm cable thermoplastic probe -40 up to +110°C cable -40 up to +110°C probe ø6x14mm cable length 3m without screw connection 2-wire
	GEV No.	Ref. No.	—
	379782		temperature probe PTC 1kOhm cable thermoplastic probe -50 up to +150°C cable -40 up to +110°C probe ø6x14mm cable length 3m 2-wire resistor 1kOhm

EVCO - EVERY CONTROL

refrigeration controllers

built-in version



1

GEV No.	378506	Ref. No.	32140974 PO32140974
description	electronic controller EVCO type EVKB23N7PXXSX01 mounting measurements 71x29mm 230V PTC/NTC -40 up to +105°C preprogrammed		

probes

universal probes

temperature probes



GEV No.	379160	Ref. No.	167212 PO167212
description	temperature probe NTC 10kOhm cable thermoplastic probe -40 up to +110°C cable -40 up to +110°C probe ø6x14mm cable length 1.5m without screw connection 2-wire		



GEV No.	379052	Ref. No.	167201 PO167201
description	temperature probe PTC 1kOhm cable silicone probe -50 up to +150°C cable -50 up to +180°C probe ø6x40mm cable length 1.5m without screw connection 2-wire		

producer-specific probes

core probes



1

GEV No.	401756	Ref. No.	167230 PO167230
description	core temperature probe PTC 1kOhm cable silicone probe -40 up to +120°C cable -50 up to +180°C connection 2-wire probe ø4.5x100mm thread cable length 4.5m handle ø 10mm handle length 120mm L1 150mm L2 50mm		

keypads

front foils



1

GEV No.	401772	Ref. No.	14261050 PO14261050
description	keypad foil blast chiller L 212mm W 102mm buttons 9 POLARIS		



compressors

ACC/ZEL

R134A

HMBP monophase

High/Medium evaporation temperature above -20/-15 °C



GEV No.	605008	Ref. No.	141565100030 PO141565100030
description	compressor coolant R134a type GL80TB 220-240V 50Hz HMBP fully hermetic 9.5kg 1/5HP power input 554W cylinder capacity 7.6cm ³ CSIR H 175.5mm 165W 215W 290W 390W 500W 615W 727W 840W test method ASHRAE ambient temperature max. 43°C		

L'UNITE HERMETIQUE / TECUMSEH

R404A

HMBP monophase

High/Medium evaporation temperature above -20/-15 °C



GEV No.	605023	Ref. No.	141565100040 PO141565100040
description	compressor coolant R404A type AE4450Z 220-240V 50Hz HMBP fully hermetic 12.5kg 3/8HP cylinder capacity 8.85cm ³ CSIR H 207mmWW 434W 567W 734W 927W 1270W 1367W test method EN 12900 1729W		

SECOP DANFOSS

R134A

HMBP monophase

High/Medium evaporation temperature above -20/-15 °C



GEV No.	605089	Ref. No.	141514208850 PO141514208850
description	compressor coolant R134a type NL8.4MF 220-240V 50Hz HMBP fully hermetic 10.5kg 1/4HP cylinder capacity 8.35cm ³ RSIR/CSIR H 197mmW 235W 305W 390W 491W 610W 749W 912W test method ASHRAE		
spare parts for	605089		
	GEV No.	381528	Ref. No. —
	start relay DANFOSS 117U6016 HST		

evaporation and condensing trays

condensing trays heated

universal

heating cartridges



GEV No.	417227	Ref. No.	1666090 PO1666090
description	heating cartridge 90W 230V ø 12mm L 124mm thread 3/8" cable length 4000mm Hmm Wmm condensate evaporation		



fans

axial fans

import



GEV No.	601080 ¹	Ref. No.	1648110155 PO1648110155
description	axial fan L 119mm W 119mm H 38mm 230VAC 50/60Hz 23/20W bearing ball bearing connection male faston 2.8mm metal ADDA fan wheel ø 110mm temp.-resist. 70°C		
accessories for	601080		
	GEV No.	550898	Ref. No. —
	connecting cable cable length 2000mm connection F 2.8 connection distance 7.9mm for axial flow fan		
	GEV No.	692519	Ref. No. —
	guard L 120mm W 120mm plastic		

¹with ball bearings



GEV No.	601055 ¹	Ref. No.	1648110150 PO1648110150
description	axial fan L 92mm W 92mm H 25mm 230VAC 50/60Hz 14.5/14W bearing ball bearing connection male faston 2.8mm metal ADDA fan wheel ø 85mm temp.-resist. 70°C		
accessories for	601055		
	GEV No.	550898	Ref. No. —
	connecting cable cable length 2000mm connection F 2.8 connection distance 7.9mm for axial flow fan		
	GEV No.	691103	Ref. No. —
	guard ø 90mm mounting distance 83mm for axial fan 92mm		

¹with ball bearings

refrigeration fans

refrigeration motors universal

IMPORT

multi fit fan motors



GEV No.	601022	Ref. No.	1648001015 PO1648001015
description	fan motor 10W 230V 50-60Hz L1 44mm L2 54mm L3 85mm W 84mm cable length 500mm 1300rpm YZF10-20-18/26 5 mounting options bearing slide bearing		

cross flow fans

ebm-papst



GEV No.	601000	Ref. No.	1648106045 PO1648106045
description	cross flow fan ebm-papst QLK45/0006-2513 roller ø 45mm roller length 60mm laminated core thickness 13mm motor position left 230V/50Hz 15W refrigeration bearing rubber connection male faston 6.3mm airflow 36m ³ /h 0 up to +60°C		











GEV No.	601505	Ref. No.	51470402
description	cross flow fan QLN65/2400A17-3030L roller ø 65mm roller length 240mm laminated core thickness 29mm motor position right 230V/50Hz 22W refrigeration bearing silicone connection F 6.3 0 up to +60°C 230V throughput 200m ³ /h 50Hz		









EMMEVI - FERGAS			
with moulded coils			
			
1			
GEV No.	601110	Ref. No.	1648106018 PO1648106018
description	cross flow fan TGO 60/1-180/20 roller ø 60mm roller length 180mm laminated core thickness 20mm motor position left 230V/50Hz 28W refrigeration bearing rubber connection male faston 6.3mm -30 up to +100°C 230V cable length 1800mm		

gas taps

alternatives to EGA

GPEL21 series				
with nozzle outlet				
				
1				
GEV No.	101615	Ref. No.	52110220	
description	gas tap alternatives to EGA type GPEL21D with nozzle outlet (without nozzle) gas inlet M15x1 (tube ø 10mm) external nozzle ømm internal nozzle ømm bypass nozzle ø 0.35mm mixing pipe connection M17x1 thermocouple connection M8x1 pilot connection M10x1 shaft ø 8x6.5mm shaft L 31/15mm shaft flat upper and bottom			
spare parts for	101615			
	GEV No.	100408	Ref. No.	—
bypass nozzle type PEL20/21 bore ø 0.35mm thread M5x0.5				
	GEV No.	101060	Ref. No.	—
magnet unit standard L 39mm D1 ø 15.4mm D2 ø 11mm suitable for PEL20-21/JUNKERS/EGA				
	GEV No.	101230	Ref. No.	—
thermocouple nut T1: M8x1 T2: M18x1 aluminium				
	GEV No.	101808	Ref. No.	—
gas tap front part shaft ø 8x6.5mm shaft L 31/15mm shaft flat upper and bottom suitable for PEL21				
accessories for	101615			
	GEV No.	100908	Ref. No.	—
union screw thread M10x1 for pipe ø 4mm Qty 1 pcs				
	GEV No.	100909	Ref. No.	—
union screw thread M10x1 for pipe ø 6mm Qty 1 pcs				
	GEV No.	100926	Ref. No.	—
centring piece thread M17x1				
	GEV No.	100927	Ref. No.	—
torsion spring L 2.8-8.0mm for internal nozzle ø 3mm bore ømm				

accessories for	101615			
	GEV No.	100942	Ref. No.	—
union nut thread M15x1 for pipe ø 10mm				
	GEV No.	100943	Ref. No.	52150025
union nut thread M17x1 tube ø 10mm				
	GEV No.	101246	Ref. No.	—
olive for pipe ø 4mm Qty 1 pcs				
	GEV No.	101278	Ref. No.	52150320
olive for pipe ø 10mm Qty 1 pcs				
	GEV No.	101286	Ref. No.	—
olive ID ø 6mm Qty 1 pcs				
	GEV No.	110217	Ref. No.	—
knob gas tap with ignition flame ø 64mm shaft ø 9x7mm shaft flat horizontal black				

STN3R

			
1			
GEV No.	107335	Ref. No.	52113010 52113035
description	gas tap STN3R gas inlet pipe flange ø21mm gas outlet M17x1 (tube ø 10mm) thermocouple connection M8x1 shaft ø 6x4.6mm shaft L 25/15mm shaft flat lower with pipe outlet suitable for LOHBERGER		

ignition parts

pilot burners







JUNKERS				
CB 503 series				
pilot burners				
				
1				
GEV No.	100058	Ref. No.	F2119021	
description	pilot burner JUNKERS type CB503006 natural gas nozzle no.26 gas connection 4mm			
spare parts for	100058			
	GEV No.	100224	Ref. No.	—
pilot burner nozzle natural gas gas pressure 25mbar code 26 Qty 1 pcs suitable for JUNKERS CB503_				
	GEV No.	101281	Ref. No.	—
olive for pipe ø 4mm L 8.7mm Qty 1 pcs suitable for CB 502/503				

Table continues overleaf

spare parts for 100058	
	GEV No. 101283 Ref. No. — union screw thread M10x1 for pipe ø 4mm Qty 1 pcs
accessories for 100058	
	GEV No. 100220 Ref. No. — pilot burner nozzle LPG gas pressure 50mbar code 2 Qty 1 pcs suitable for JUNKERS CB503_
	GEV No. 100221 Ref. No. — pilot burner nozzle LPG gas pressure 30mbar code 29 Qty 1 pcs suitable for JUNKERS CB50203_
	GEV No. 100222 Ref. No. — pilot burner nozzle LPG gas pressure 50mbar code 5 Qty 1 pcs suitable for JUNKERS CB50203_
	GEV No. 100223 Ref. No. — pilot burner nozzle natural gas gas pressure 20mbar code 3 Qty 1 pcs suitable for JUNKERS CB503_
	GEV No. 100226 Ref. No. — pilot burner nozzle LPG gas pressure 50mbar code 15 suitable for JUNKERS
	GEV No. 100227 Ref. No. — pilot burner nozzle natural gas gas pressure 25mbar code 6 Qty 1 pcs suitable for JUNKERS CB50203_
	GEV No. 100228 Ref. No. — pilot burner nozzle town gas gas pressure 8mbar code 4 Qty 1 pcs suitable for JUNKERS CB50203_
	GEV No. 100909 Ref. No. — union screw thread M10x1 for pipe ø 6mm Qty 1 pcs
	GEV No. 101287 Ref. No. — olive for pipe ø 6mm Qty 1 pcs
	GEV No. 102110 Ref. No. — pilot tube copper pipe ø 4mm thickness 1mm L 3000mm
	GEV No. 102111 Ref. No. — pilot tube copper pipe ø 6mm thickness 1mm L 3000mm

producer-specific pilot burners	
LOHBERGER	
old version	
	1
GEV No. 102956	Ref. No. -
description	pilot burner type C without nozzle

	1
GEV No. 102957	Ref. No. -
description	pilot burner type D without nozzle

	1
GEV No. 102958	Ref. No. -
description	pilot burner type E without nozzle

electrodes

	1
GEV No. 102965	Ref. No. 52165040
description	ignition electrode connection F 2.8x0.8mm

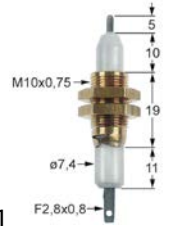
	1
GEV No. 103247	Ref. No. 52152050
description	ignition electrode D1 ø 7.4mm L1 5mm BL1 10mm BL2 19mm BL3 11mm connection F 2.8x0.8mm M10x0.75

piezoelectric igniters

mounting diameter 22mm	
	1
GEV No. 100008	Ref. No. F2119024
description	piezoelectric igniter body plastic blowing mounting ø 22mm connection ø2mm cable lengthmm



thermocouples

threaded thermocouples

threaded thermocouples standard

with socket with thread M8x1

SIT

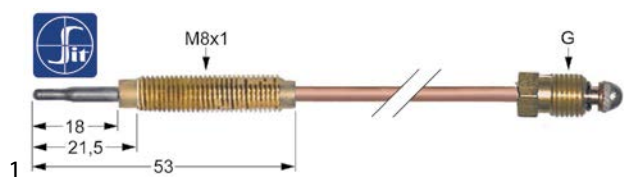

GEV No. 107632 **Ref. No.** 52120050

description thermocouple SIT M8x1 L 1000mm M8x1

accessories for 107632

GEV No. 102067 **Ref. No.** 52150110

description nut thread M8x1 H 3mm brass Qty 1 pcs type SEF 1

accessories

nuts



GEV No. 102067 **Ref. No.** 52150110

description nut thread M8x1 H 3mm brass Qty 1 pcs type SEF 1

gas burners

accessories

nozzle holders



GEV No. 104522 **Ref. No.** 52165016

description nozzle holder ID ø 10mm ET M17x1

gas nozzles

pilot burner nozzles

pilot burner nozzles EGA



GEV No. 100214 **Ref. No.** 52140300

description pilot burner nozzle LPG bore ø 0.16mm Qty 1 pcs

auxiliary gas parts

screw connections

olives



GEV No. 101278 **Ref. No.** 52150320

description olive for pipe ø 10mm Qty 1 pcs

accessories for 101278

GEV No. 100943 **Ref. No.** 52150025

description union nut thread M17x1 tube ø 10mm

GEV No. 101300 **Ref. No.** —

description union nut thread M16x1.5 tube ø 10mm

GEV No. 101478 **Ref. No.** —

description union nut thread 3/8" for pipe ø 10mm



GEV No. 101284 **Ref. No.** 52150310

description olive for pipe ø 4mm Qty 1 pcs

accessories for 101284

GEV No. 101259 **Ref. No.** —

description union nut thread M8x1 for pipe ø 4mm

GEV No. 101285 **Ref. No.** 52150210

description union screw thread M8x1 for pipe ø 4mm Qty 1 pcs JUNKERS

GEV No. 101294 **Ref. No.** —

description union nut thread M10x1 for pipe ø 4mm WS 14 L 12mm Qty 1 pcs

union nuts



GEV No. 100943 **Ref. No.** 52150025

description union nut thread M17x1 tube ø 10mm

accessories for 100943

GEV No. 101278 **Ref. No.** 52150320

description olive for pipe ø 10mm Qty 1 pcs

union screws



1

GEV No.	101285	Ref. No.	52150210
description	union screw thread M8x1 for pipe ø 4mm Qty 1 pcs JUNKERS		
accessories for	101285		
	GEV No.	101284	Ref. No. 52150310
	olive for pipe ø 4mm Qty 1 pcs		

equipment-specific units

for espresso machines

brewing units

filter holder gaskets

O-rings



1

GEV No.	510409	Ref. No.	H67500-118
description	O-ring EPDM thickness 5.34mm ID ø 56.52mm Qty 1 pcs		

locks

locking devices

producer-specific

LOHBERGER



1

GEV No.	690462	Ref. No.	1483001 1483003 PO1483001 PO1483003
description	key cylinder ø 23mm thread M19x1 mounting measurements 16.5x19mm hub 38-45mm shaft ø 11mm thread L 12mm		
spare parts for	690462		
	GEV No.	691589	Ref. No. —
	spare keys for key cylinder 690462 key number 9233		



1

GEV No.	690637	Ref. No.	14830061 PO14830061
description	key cylinder with slide latch ø 23mm thread M19x1 mounting measurements 16.5x19mm hub 38-45mm shaft ø 11mm thread L 24mm		

hinges

spring assisted hinges

universal

CAFF/FERMOD

group 2



1

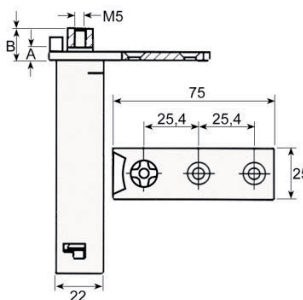

GEV No.	690494	Ref. No.	1412001 PO1412001
description	spring assisted hinge series 175 mounting pos. left/right torx L 75mm W 25.6mm H 100mm A 4mm B 11mm mounting measurements 22x22mm intake torx refrigeration units mounting distance 25mm		



INTERKLIMAT

hinges



1

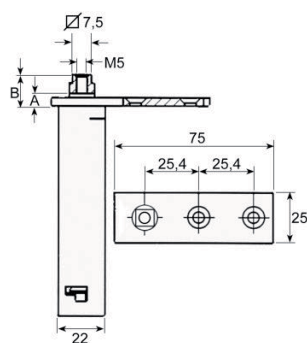

GEV No.	690622	Ref. No.	1412050 PO1412050
description	spring assisted hinge series 28L mounting pos. left/right L 75mm W 25mm H 103mm A 13mm B 18mm mounting measurements 22x22mm intake 7.5x7.5 refrigeration units		

shelves and shelf rails

grates

universal

with upstand



1

GEV No.	970807	Ref. No.	1440050530 PO1440050530
description	grate W 530mm D 500mm H 40mm plastic-coated steel wire gauge frame 8.8mm lengthwise wires gauge 4.8mm crossing wires 1 grey		

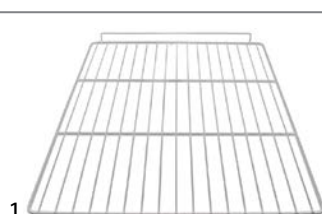

1

GEV No.	970556	Ref. No.	1440065530 PO1440065530	
description	grate W 530mm D 650mm GN 2/1 plastic-coated steel with hinge camp wire gauge frame 9mm lengthwise wires gauge 5mm crossing wires 2 white suitable for refrigerator			
accessories for	970556			
	GEV No.	690330	Ref. No.	—
	rack L 1000mm W 22mm H 4mm aperture 3x8mm hole distance 12.5mm stainless steel			

accessories for	970556			
	GEV No.	690332	Ref. No.	—
	shelf support L 31/28mm W 22mm H 17mm SS with hook Qty 1 pcs			
	GEV No.	694700	Ref. No.	—
	shelf support L 31/28mm W 22mm H 18mm SS Qty 12 pcs			
	GEV No.	694701	Ref. No.	—
	shelf support L 31/28mm W 22mm H 17mm SS with hook Qty 12 pcs			

producer-specific



1

GEV No.	970662	Ref. No.	1440055535 PO1440055535
description	grate W 530mm D 550mm with layer RILSAN		

grid attachments



1

GEV No.	970661	Ref. No.	33510070 PO33510070
description	bearing rail L 600mm H 34.2mm W 17mm		

shelf rails and supports

producer-specific



1

GEV No.	700846	Ref. No.	3351300030 PO3351300030
description	pair of setting bar U-shape L 540mm W 30mm		



1

GEV No.	690566	Ref. No.	33510071 PO33510071
description	pair of setting bar U-shape L 615mm W 26mm inner high 18mm mounting pos. left/right		

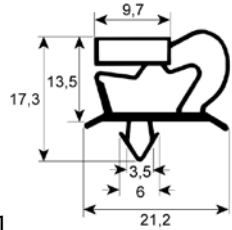

1

GEV No.	900548	Ref. No.	14414300290 PO14414300290
description	refrigeration gasket profile 9048 W 267mm L 394mm plug size		

gaskets

refrigeration gaskets

plug-in gaskets

profile 9048

We offer custom-made gaskets for this profile

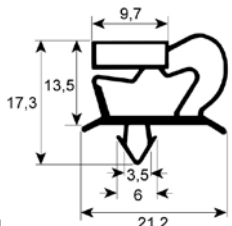

1

GEV No.	901021	Ref. No.	14414300150 PO14414300150
description	refrigeration gasket profile 9048 W 142mm L 396mm plug size		

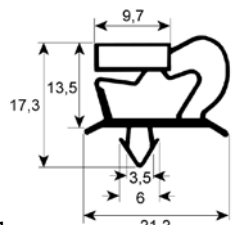

1

GEV No.	900849	Ref. No.	14415396291 PO14415396291
description	refrigeration gasket profile 9048 W 278mm L 396mm plug size drawer		

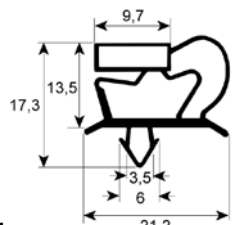

1

GEV No.	900836	Ref. No.	14413090501 PO14413090501
description	refrigeration gasket profile 9048 W 295mm L 485mm plug size		

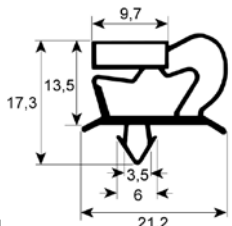

1

GEV No.	900347	Ref. No.	14414300200 PO14414300200
description	refrigeration gasket profile 9048 W 178mm L 396mm plug size		

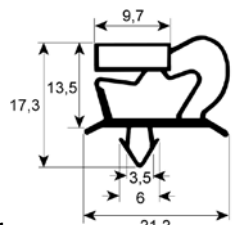

1

GEV No.	900359	Ref. No.	14413090418 PO14413090418
description	refrigeration gasket profile 9048 W 296mm L 405mm plug size drawer size 1/2		

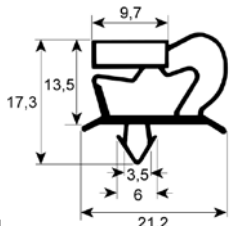

1

GEV No.	900360	Ref. No.	14411990418 PO14411990418
description	refrigeration gasket profile 9048 W 186mm L 405mm plug size size 1/3		



GEV No.	901778	Ref. No.	14412950408 PO14412950408
description	refrigeration gasket profile 9048 W 300mm L 410mm plug size		

GEV No.	901020	Ref. No.	14414020516 PO14414020516
description	refrigeration gasket profile 9048 W 402mm L 516mm plug size		

GEV No.	900831	Ref. No.	14414300390 PO14414300390
description	refrigeration gasket profile 9048 W 354mm L 396mm plug size drawer size 2/3		

GEV No.	900358	Ref. No.	14414180418 PO14414180418
description	refrigeration gasket profile 9048 W 405mm L 405mm plug size drawer size 2/3		

GEV No.	901234	Ref. No.	14416600390 PO14416600390
description	refrigeration gasket profile 9048 W 390mm L 660mm plug size for blast chiller		

GEV No.	900830	Ref. No.	14414080540 PO14414080540
description	refrigeration gasket profile 9048 W 405mm L 535mm plug size door		

GEV No.	900731	Ref. No.	14414300620 PO14414300620
description	refrigeration gasket profile 9048 W 396mm L 566mm plug size		

GEV No.	900357	Ref. No.	14414180640 PO14414180640
description	refrigeration gasket profile 9048 W 405mm L 627mm plug size door for refrigerated counter size 1/1		

GEV No.	901015	Ref. No.	14415601460 PO14415601460
description	refrigeration gasket profile 9048 W 560mm L 1460mm plug size		

GEV No.	900355	Ref. No.	14416760784 PO14416760784
description	refrigeration gasket profile 9048 W 663mm L 767mm plug size		

GEV No.	900838	Ref. No.	14416451606 PO14416451606
description	refrigeration gasket profile 9048 W 606mm L 1566mm plug size		

GEV No.	900732	Ref. No.	14416801580 PO14416801580
description	refrigeration gasket profile 9048 W 684mm L 1584mm plug size		

GEV No.	900839	Ref. No.	14415990738 PO14415990738
description	refrigeration gasket profile 9048 W 606mm L 744mm plug size door		

GEV No.	900733	Ref. No.	14416800759 PO14416800759
description	refrigeration gasket profile 9048 W 684mm L 762mm plug size		

GEV No.	900795	Ref. No.	14416451605 PO14416451605
description	refrigeration gasket profile 9048 W 645mm L 1605mm plug size door		

GEV No.	900841	Ref. No.	14417000780 PO14417000780
description	refrigeration gasket profile 9048 W 700mm L 780mm plug size		

GEV No.	900356	Ref. No.	14416761594 PO14416761594
description	refrigeration gasket profile 9048 W 660mm L 1580mm plug size		

GEV No.	900837	Ref. No.	14417321850 PO14417321850
description	refrigeration gasket profile 9048 W 732mm L 1848mm plug size		



profile 9703

We offer custom-made gaskets for this profile

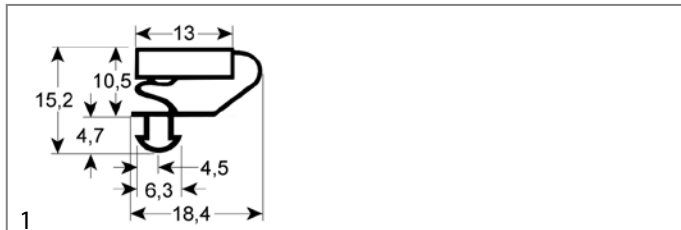

GEV No.	900843	Ref. No.	14426761595 PO14426761595
description	refrigeration gasket profile 9703 W 712mm L 1610mm plug size door		

profile 9794

We offer custom-made gaskets for this profile

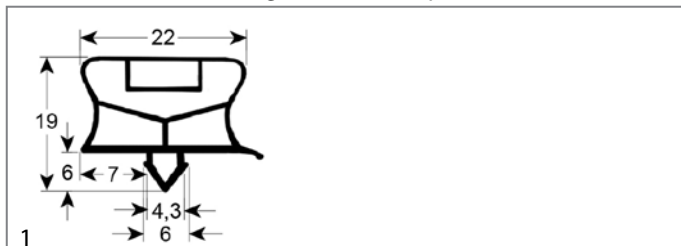

GEV No.	901413	Ref. No.	14415010640 PO14415010640
description	refrigeration gasket profile 9794 W 480mm L 625mm plug size		

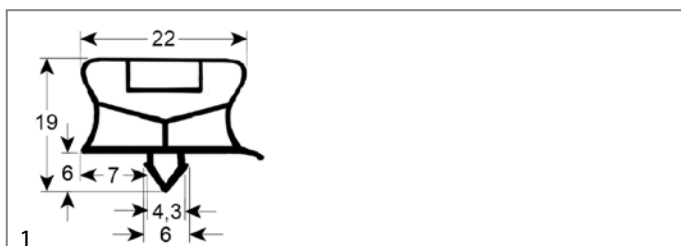

GEV No.	900344	Ref. No.	14415991559 PO14415991559
description	refrigeration gasket profile 9794 W 595mm L 1565mm plug size		

gaskets for heated units

door seals

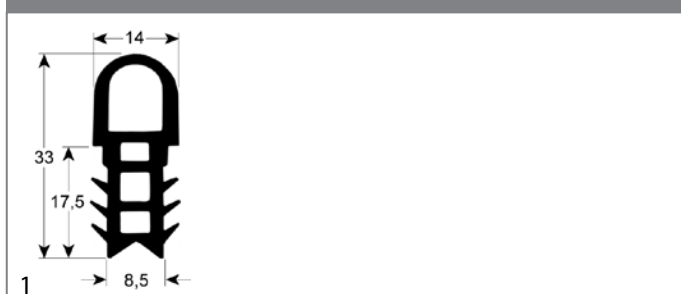

GEV No.	900064	Ref. No.	F5070120
description	door seal profile 2060 W 705mm L 1080mm outer plug size Qty 1 suitable for CONVOTHERM short side open		

O-rings

EPDM

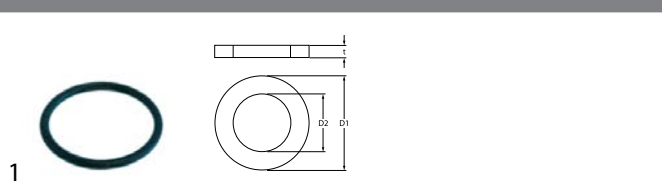

GEV No.	510409	Ref. No.	H67500-118
description	O-ring EPDM thickness 5.34mm ID ø 56.52mm Qty 1 pcs		

evaporators

for fridges

producer-specific

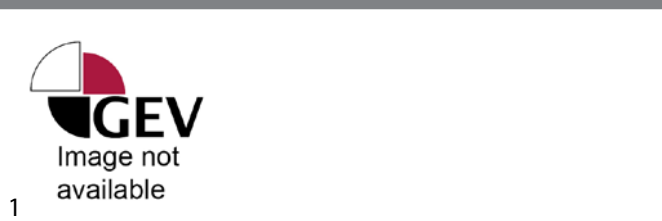

GEV No.	750267	Ref. No.	14330309240 PO14330309240
description	evaporator		

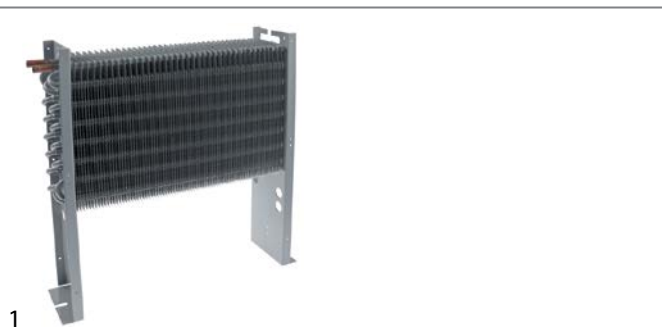

GEV No.	750386	Ref. No.	14330210187 PO14330210187
description	evaporator L 350mm W 90mm H 375mm Dmm overall width 395mm connection 3/8"mm mounting distance 1 350mm		



GEV No.	750269	Ref. No.	14330210186 PO14330210186
description	evaporator L 350mm W 90mm H 375mm overall width 400mm connection 3/8"mm mounting distance 1 350mm with boiler		



mechanical components, equipment accessories



1

GEV No.	750306	Ref. No.	14330210175 PO14330210175
description	evaporator L 380mm W 75mm H 270mm		



1

GEV No.	750292	Ref. No.	14330210167 14330210168 PO14330210167 PO14330210168
description	evaporator L 400mm W 70mm H 390mm		



1

GEV No.	750362	Ref. No.	1433110401 PO1433110401
description	evaporator L 435mm W 405mm H 120mm complete with fan		







1

GEV No.	750268	Ref. No.	14330312410 PO14330312410
description	evaporator L 500mm W 70mm H 160mm		

hose reels and spray guns

spray guns



GEV No.	540302	Ref. No.	20601006 VO-2060.1006	
description	spray gun for appliances 1/2" ET L 135mm type RATIONAL			
spare parts for	540302			
	GEV No.	517056	Ref. No.	—
	O-ring EPDM thickness 2mm ID ø 6.5mm Qty 1 pcs			
	GEV No.	532535	Ref. No.	—
	O-ring EPDM thickness 5mm ID ø 10mm Qty 1 pcs			
	GEV No.	548016	Ref. No.	—
	compression spring ø 10mm L 17mm wire gauge ø 0.9mm for hand spray			
	GEV No.	548017	Ref. No.	—
	pressure bolt for hand spray			

valves and tank inlets

tank inlets

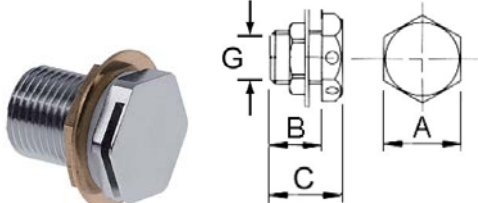

1

GEV No.	691605	Ref. No.	519.10300
description	tank inlet connection 1/2" WS 27 L1 26mm L2 32mm with non-return valve		

fastening material

screws

hexagonal screws



GEV No.	560084	Ref. No.	51272162
description	hexagonal screw thread M5 thread L 16mm SS WS 8 Qty 20 pcs DIN 933 / ISO 4017		



nuts

hexagonal nuts

hexagonal nuts metric (without norm)



GEV No.	102067	Ref. No.	52150110
description	nut thread M8x1 H 3mm brass Qty 1 pcs type SEF 1		

fasteners

slot nuts



GEV No.	697784	Ref. No.	52423002
description	slot nut W 8mm H 7mm L 20mm		

GEV No.	560288	Ref. No.	52423004
description	slot nut W 8mm H 7mm L 25mm		

A			
axial fans	10		
B			
bi-metal thermostats	5		
C			
cam switches	6		
compressors	9		
condensing trays heated	9		
control thermostats	5		
cross flow fans	10		
D			
door seals	19		
E			
electronic controllers	7		
energy regulators	5		
evaporators	19		
F			
fans	10		
fasteners	21		
fastening material	20		
G			
gas burners	13		
gas nozzles	13		
gas taps	11		
gaskets for heated units	19		
grates	15		
H			
heating cartridges	4		
heating elements	3		
heating elements for bain maries	3		
heating elements for condensate evaporation	4		
heating elements for defrosting	3		
heating elements for fryers	3		
heating elements for large hobs	3		
heating elements for ovens	3		
heating elements for refrigeration	3		
heating elements for tilting bratt pan	4		
hexagonal nuts	21		
hexagonal screws	20		
I			
immersion heating elements	4		
L			
lamps	7		
		LED	7
M			
		magnetic switches	7
N			
		nuts	21
O			
		O-rings	19
P			
		piezoelectric igniters	12
		pilot burners	11
		pilot heating elements	4
		plug-in gaskets	16
		probes	8
R			
		refrigeration fans	10
		refrigeration gaskets	16
		refrigeration motors universal	10
		relays	7
		rocker/momentary rocker switches	6
S			
		safety bi-metal thermostats	5
		safety thermostats	5
		screws	20
		shelves and shelf rails	15
		slot nuts	21
		spray guns	20
		spray guns with external thread	20
		spring assisted hinges	14
		switches and momentary switches	6
T			
		tank inlets	20
		temperature probes	8
		thermocouples	13
		thermostats	5
U			
		universal probes	8
V			
		valves and tank inlets	20