



GAS COMPONENTS



ELECTRIC COMPONENTS



WATER TECHNOLOGY



MECHANICAL COMPONENTS



TOOLS

Spare parts suitable for

LOTUS

Find the complete and up-to-date range of products in our GEV Webshop



Manufacturer catalogue

The most important spare parts and accessories arranged clearly for every manufacturer

- ✓ Complete product range and all appliance data always up to date in the GEV Webshop
- ✓ Alphabetical Index at the end of the catalogue

GEV Webshop

www.gev-online.co.uk

www.gev-online.com







- 🔍 Add to Favourites
- 🔍 Sign In with email address and usual password
- 🔍 Easy-order – place several items in your basket at the same time
- 🔍 Quick Item search – no login needed



heating elements

heating elements for ovens



GEV No.	416516	Ref. No.	537020901
description	heating element 1200W 230V heating circuits 1 L 505mm W 123mm thread M12x1 mounting distance 115mm tube ø 8.5mm connection male faston 6.3mm mounting pos. lower 2 hole fixing dry heating element		
For models:	CF4-78ET, CF4-78ETX, CF4-78GE, CF4-78GPE, CF6-712ET, CF6-712ETV, CF6-712ETVX, CF6-712ETX, CF6-712GEV, CF6-712GPE, CF6-712GPEV, CF-712GE, CF-712GPE, CFC4-78ET, CFC4-78ETX, CFQ4-78ET, CFQ4-78ETX, CFQ6-712ET, CFQ6-712ETV, CFQ6-712ETVX, CFQ6-712ETX, MF-710ET, TPF2-712GP, TPF2-712GPE, TPF2-712GPEV, TPF2-78GP, TPF2-78GPE, TPF4-712GPE, TPF4-712GPEV, TPF-78ET, TPF-78GE		
accessories for	416516		
	GEV No.	361182	Ref. No. —
	nut thread 1/4" H 5mm nickel-plated brass WS 17 Qty 1 pcs		
	GEV No.	510417	Ref. No. —
	flat gasket fibre ED ø 20mm ID ø 14mm thickness 2mm Qty 1 pcs		
	GEV No.	520228	Ref. No. —
	tooth lock washer ID ø 15.3mm ED ø 24mm steel Qty 1 pcs for thread M14		
	GEV No.	550262	Ref. No. —
	flat gasket copper ED ø 20mm ID ø 14mm thickness 2mm		

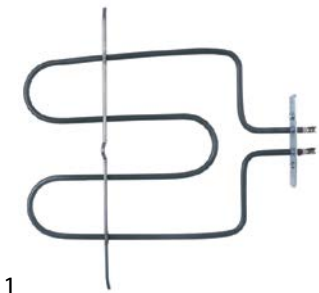





GEV No.	415776	Ref. No.	537006400
description	heating element 1500W 220V heating circuits 1 L 285mm W 205mm L1 52mm L2 233mm W2 32mm flange length 100mm flange width 22mm hole distance 86/43mm bridge length 305mm hole ø 3mm tube ø 6.5mm connection male faston 6.3mm connection length 23mm rectangular flange grill setting oven		
For models:	CF-62EM, CF-62EM-A, CF-62ET, CF-62ET-A, CF-62GEM, CF-62GEM-A, CFC-62EM, CFC-62ET		



GEV No.	419250	Ref. No.	537028102
description	heating element 1700W 230V heating circuits 1 L 670mm W 120mm thread M12x1 mounting distance 117mm tube ø 8.5mm connection male faston 6.3mm mounting pos. lower M12x1 dry heating element		



GEV No.	418068	Ref. No.	537028100
description	heating element 1700W 230V heating circuits 1 L 685mm W 125mm thread M12x1 mounting distance 117mm tube ø 8.5mm connection male faston 6.3mm mounting pos. lower M12x1 dry heating element		
For models:	CF4-98ET, CF4-98ETX, CF4-98GE, CF6-912ET, CF6-912ETV, CF6-912ETVX, CF6-912GE, CF6-912GEV, CF8-916ET, CF8-916ETV, CF8-916GE, CF8-916GEV, CFC4-98ET, CFQ4-98ET, CFQ4-98ETX, CFQ6-912ET, CFQ6-912ETV, CFQ6-912ETVX, CFQ8-916ET, CFQ8-916ETV, CFQ9-916ET, CFV6-912ET, CFV6-912GEV, CFV4-98ET, CFVQ6-912ET, TPF2-912GEV, TPF2-98GE, TPF4-912GE, TPF4-912GEV, TPF-98ET, TPF-98GE		
accessories for	418068		
	GEV No.	520229	Ref. No. —
	nut thread M12x1 H 4mm WS 16 zinc-coated steel Qty 1 pcs		
	GEV No.	521110	Ref. No. —
	flat gasket fibre ED ø 20mm ID ø 13mm thickness 2mm Qty 1 pcs		
	GEV No.	521131	Ref. No. —
	nut thread M12x1 H 3.5mm WS 17 SS Qty 1 pcs		
	GEV No.	528110	Ref. No. —
	O-ring EPDM thickness 2.62mm ID ø 12.37mm Qty 1 pcs		

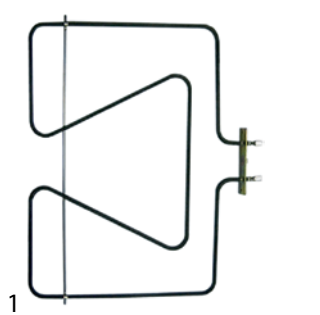



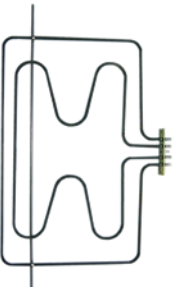

GEV No.	415775	Ref. No.	537006300
description	heating element 1750W 230V heating circuits 1 L 326mm W 405mm L1 34mm L2 292mm W1 170mm W2 60mm flange length 100mm flange width 22mm hole distance 86mm tube ø 6.3mm connection male faston 6.3mm mounting pos. lower rectangular flange dry heating element oven mounting thread M4		
For models:	CF-10EM, CF-10EM-6, CF-10EM-A, CF-10ET, CF-10ET-6, CF-10ET-A, CF-10GEM, CF-10GEM-6, CF-10GEM6-A, CF-10GEM-A, CF4-68ET, CF4-68ETX, CF4-68GEM, CF4-8ET, CF4-8ETS, CF4-8GEM, CF4-GEMS, CF6-610ET, CF6-610ETX, CF6-610GEM, CF-8EM, CF-8EM-A, CF-8ET, CF-8ET-A, CF-8GEM, CF-8GEM-A, CFC4-8ET, CFM-10EM, CFM-10EM-6, CFM-10EM-A, CFM-10ET, CFM-10ET-6, CFM-10ET-A, CFM-10GEM, CFM-10GEM-6, CFM-10GEM6-A, CFM-10GEM-A, CFM2-68GEM, CFM3-612GEMV, CFM4-68ET, CFM4-68GEM, CFM6-610ET, CFM6-610GEM, CFM-8EM, CFM-8EM-A, CFM-8ET, CFM-8ET-A, CFM-8GEM, CFM-8GEM-A, MFM-610EM...(Other models you can see in the webshop)		

electric components







GEV No.	415774	Ref. No.	537006200
description	heating element 3050W 230V heating circuits 2 L 325mm W 474mm L1 40mm L2 285mm W1 237mm W2 60mm flange length 100mm flange width 22mm hole distance 85mm bridge length 620mm hole ø M4mm tube ø 6.3mm connection male faston 6.3mm mounting pos. upper rectangular flange dry heating element oven		
For models:	CF-10EM, CF-10EM-6, CF-10EM-A, CF-10ET, CF-10ET-6, CF-10ET-A, CF-10GEM, CF-10GEM-6, CF-10GEM6-A, CF-10GEM-A, CF4-68ET, CF4-68ETX, CF4-68GEM, CF4-8ET, CF4-8ETS, CF4-8GEM, CF4-GEMS, CF6-610ET, CF6-610ETX, CF6-610GEM, CF-8EM, CF-8EM-A, CF-8ET, CF-8ET-A, CF-8GEM, CF-8GEM-A, CFC4-8ET, CFM-10EM, CFM-10EM-6, CFM-10EM-A, CFM-10ET, CFM-10ET-6, CFM-10ET-A, CFM-10GEM, CFM-10GEM-6, CFM-10GEM6-A, CFM-10GEM-A, CFM2-68GEM, CFM3-612GEMV, CFM4-68ET, CFM4-68GEM, CFM6-610ET, CFM6-610GEM, CFM-8EM, CFM-8EM-A, CFM-8ET, CFM-8ET-A, CFM-8GEM, CFM-8GEM-A, MFM-610EM...(Other models you can see in the webshop)		



GEV No.	416661	Ref. No.	537025400
description	heating element 700W 230V L 500mm W 123mm thread M12x1 mounting distance 115mm tube ø 8.5mm connection male faston 6.3mm mounting pos. upper 2 hole fixing dry heating element		
For models:	CF4-78ET, CF4-78ETX, CF4-78GE, CF4-78GPE, CF6-712ET, CF6-712ETV, CF6-712ETVX, CF6-712ETX, CF6-712GEV, CF6-712GPE, CF6-712GPEV, CF-712GE, CF-712GPE, CFC4-78ET, CFC4-78ETX, CFQ4-78ET, CFQ4-78ETX, CFQ6-712ET, CFQ6-712ETV, CFQ6-712ETVX, CFQ6-712ETX, MF-710ET, TPF2-712GP, TPF2-712GPE, TPF2-712GPEV, TPF2-78GP, TPF2-78GPE, TPF4-712GPE, TPF4-712GPEV, TPF-78ET, TPF-78GE		
spare parts for	416661		
		GEV No. 521110	Ref. No. —
	flat gasket fibre ED ø 20mm ID ø 13mm thickness 2mm Qty 1 pcs		
accessories for	416661		
		GEV No. 520229	Ref. No. —
	nut thread M12x1 H 4mm WS 16 zinc-coated steel Qty 1 pcs		
		GEV No. 521131	Ref. No. —
	nut thread M12x1 H 3.5mm WS 17 SS Qty 1 pcs		
		GEV No. 528110	Ref. No. —
	O-ring EPDM thickness 2.62mm ID ø 12.37mm Qty 1 pcs		



GEV No.	418067	Ref. No.	537027800 537027801
description	heating element 800W 230V heating circuits 1 L 685mm W 125mm thread M12x1 mounting distance 117mm tube ø 8.5mm connection male faston 6.3mm mounting pos. upper M12x1 dry heating element		
For models:	CF4-98ET, CF4-98ETX, CF4-98GE, CF6-912ET, CF6-912ETV, CF6-912ETVX, CF6-912GE, CF6-912GEV, CF8-916ET, CF8-916ETV, CF8-916GE, CF8-916GEV, CFC4-98ET, CFQ4-98ET, CFQ4-98ETX, CFQ6-912ET, CFQ6-912ETV, CFQ6-912ETVX, CFQ8-916ET, CFQ8-916ETV, CFQ9-916ET, CFV6-912ET, CFV6-912GEV, CFVC4-98ET, CFVQ6-912ET, TPF2-912GEV, TPF2-98GE, TPF4-912GE, TPF4-912GEV, TPF-98ET, TPF-98GE		
accessories for	418067		
		GEV No. 520229	Ref. No. —
	nut thread M12x1 H 4mm WS 16 zinc-coated steel Qty 1 pcs		
		GEV No. 521110	Ref. No. —
	flat gasket fibre ED ø 20mm ID ø 13mm thickness 2mm Qty 1 pcs		
		GEV No. 521131	Ref. No. —
	nut thread M12x1 H 3.5mm WS 17 SS Qty 1 pcs		
		GEV No. 528110	Ref. No. —
	O-ring EPDM thickness 2.62mm ID ø 12.37mm Qty 1 pcs		

heating elements for bain maries



GEV No.	416194	Ref. No.	537004800
description	heating element 1189W 230V heating circuits 1 L 278mm W 150mm connection male faston 6.3mm tube ø 6.3mm 2 hole fixing thread 1/8" immersion heater/dry heating element L1 135mm L2 143mm H 22mm mounting distance 144mm		
For models:	BM-61EM, MP-62, MP-62EM, SV-23		







GEV No.	415700	Ref. No.	N/A
description	heating element 1300W 230V heating circuits 1 L 280mm W 110mm connection male faston 6.3mm tube ø 6.3mm 2 hole fixing thread M10x1 immersion heater/dry heating element bain marie/pasta cooker L1 135mm L2 145mm H 20mm mounting distance 104mm		
accessories for	415700		
		GEV No. 510416	Ref. No. —
	flat gasket fibre ED ø 19mm ID ø 10.5mm thickness 1.5mm for thread M10 Qty 1 pcs		
		GEV No. 510893	Ref. No. —
	O-ring EPDM thickness 2.62mm ID ø 9.92mm Qty 1 pcs		
		GEV No. 520231	Ref. No. —
	nut thread M10x1 H 6mm WS 14 zinc-coated steel Qty 1 pcs		

Table continues overleaf









accessories for	415700		
	GEV No.	521129	Ref. No. —
	nut thread M10 H 6mm SS WS 17 Qty 1 pcs DIN/ISO DIN 439		

	1		
GEV No.	415772	Ref. No.	537004200
description	heating element 823W 230V L 276mm W 108mm H 20mm 2 hole fixing connection male faston 6.3mm thread M10x1 tube ø 6.3mm connection length 22mm dry heating element		
For models:	BM-61EM, BM-62EM, BM-62ET, BS-4EM, BS-4EMX, BS-61EM, BS-62EM, BS-74EM, BS-94EM, BSD-64EM, BST-64EM, BST-74EM, BST-94EM, CP-61EM, CP-62ET, SV-11, SV-113, SV-12, SV-123, SV-13		

heating elements for frying pans

	1		
GEV No.	418072	Ref. No.	537029500
description	heating element 2000W 230V heating circuits 1 L 498mm W 92mm connection 6.3 tube ø 8.5mm 2 hole fixing thread M12x1 dry heating element multi purpose roasting pan mounting distance 84mm		
For models:	BRF-74ET, BRF-78ET, BRFD-64ET		



	1		
GEV No.	415771	Ref. No.	537015100
description	heating element 2000W 230V L 280mm W 170mm connection length 23mm connection male faston 6.3mm tube ø 8.5mm 2 hole fixing thread M12x1 immersion heater/dry heating element for frying pan/boiling kettle L1 135mm L2 145mm H 23mm mounting distance 154mm		
For models:	BR-62ET, BR-6ET, BRT-66ET, BRT-66ETX		
accessories for	415771		
	GEV No.	520229	Ref. No. —
	nut thread M12x1 H 4mm WS 16 zinc-coated steel Qty 1 pcs		
	GEV No.	521110	Ref. No. —
	flat gasket fibre ED ø 20mm ID ø 13mm thickness 2mm Qty 1 pcs		
	GEV No.	521131	Ref. No. —
	nut thread M12x1 H 3.5mm WS 17 SS Qty 1 pcs		
	GEV No.	528110	Ref. No. —
	O-ring EPDM thickness 2.62mm ID ø 12.37mm Qty 1 pcs		

	1		
GEV No.	418071	Ref. No.	537030300
description	heating element 2600W 230V heating circuits 1 L 665mm W 95mm connection male faston 6.3mm tube ø 8.5mm 2 hole fixing thread M12x1 dry heating element multi purpose roasting pan mounting distance 88mm		
For models:	BRF-94ET, BRF-98ET		
accessories for	418071		
	GEV No.	520229	Ref. No. —
	nut thread M12x1 H 4mm WS 16 zinc-coated steel Qty 1 pcs		
	GEV No.	521110	Ref. No. —
	flat gasket fibre ED ø 20mm ID ø 13mm thickness 2mm Qty 1 pcs		
	GEV No.	521131	Ref. No. —
	nut thread M12x1 H 3.5mm WS 17 SS Qty 1 pcs		
	GEV No.	528110	Ref. No. —
	O-ring EPDM thickness 2.62mm ID ø 12.37mm Qty 1 pcs		

heating elements for fryers

side connection

miscellaneous



	1		
GEV No.	418077	Ref. No.	537026800
description	heating element 19500W 230/400V heating circuits 3 mounting pos. right L 458mm W 190mm H 35mm flange length 36.5mm flange length 1 3mm flange length 2 33.5mm flange ø1 65mm flange ø2 60mm thermostat sleeves ø 6mm length thermostat sleeves 180mm number of thermostat sleeves 2 thermostat sleeve eccentric, clinging/not clinging L1 18mm L2 440mm W1 38mm W2 152mm tube ø 8.5mm cable length 500mm rotation flange fryer heaters connection length 30mm		
For models:	F18-94ET, F18-94ETX, F2-18-98ET, F2-18-98ETX, F2-25-98ET, F2-25-98ETX, F25-94ET, F25-94ETX		
accessories for	418077		
	GEV No.	550494	Ref. No. 536009800
	O-ring Viton thickness 3.53mm ID ø 47.22mm Qty 1 pcs		





off-center connection

miscellaneous



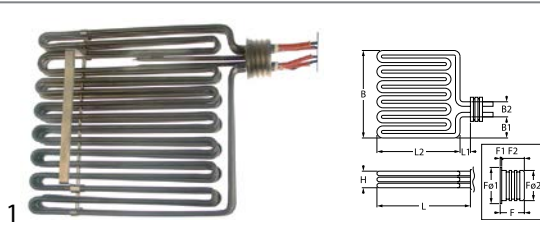

GEV No.	416527	Ref. No.	537026700
description	heating element 13500W 230/400V heating circuits 3 mounting pos. left L 340mm W 215mm H 35mm flange length 36.5mm flange length 1 3mm flange length 2 33.5mm flange ø1 65mm flange ø2 60mm thermostat sleeves ø 6.5mm length thermostat sleeves 210mm number of thermostat sleeves 2 windings 8 L1 25mm L2 315mm W1 35mm W2 37mm tube ø 8.5mm cable length 280mm rotation flange fryer heaters fryer connection length 35mm		
For models:	F18-74ET, F18-74ETX, F18-94ET, F18-94ETX, F18D-64ET, F2-18-74ET, F2-18-74ETX, F2-18-78ET, F2-18-78ETX, F2-18-98ET, F2-18-98ETX, F2-25-98ET, F2-25-98ETX, F25-94ET, F25-94ETX		
accessories for	416527		
	GEV No.	345032	Ref. No. 537011500
	microswitch with plunger thread M10x1 thread L 12mm 250V 16A 1CO connection male faston 6.3mm stroke 7mm mounting distance 22mm L 28mm ambient temperature max. 125°C type SP9603 actuating force: 180g		
	GEV No.	550494	Ref. No. 536009800
	O-ring Viton thickness 3.53mm ID ø 47.22mm Qty 1 pcs		



GEV No.	416526	Ref. No.	537021400 537021401
description	heating element 13500W 230/400V heating circuits 3 mounting pos. left L 340mm W 300mm H 35mm flange length 36.5mm flange length 2 33.5mm flange ø1 65mm flange ø2 60mm thermostat sleeves ø 6.5mm length thermostat sleeves 210mm number of thermostat sleeves 2 windings 8 L1 25mm L2 315mm W1 36mm W2 37mm tube ø 8.5mm cable length 300mm rotation flange immersion heater connection length 42mm		
For models:	F18-74ET, F2-18-78ET		
accessories for	416526		
	GEV No.	345032	Ref. No. 537011500
	microswitch with plunger thread M10x1 thread L 12mm 250V 16A 1CO connection male faston 6.3mm stroke 7mm mounting distance 22mm L 28mm ambient temperature max. 125°C type SP9603 actuating force: 180g		
	GEV No.	550494	Ref. No. 536009800
	O-ring Viton thickness 3.53mm ID ø 47.22mm Qty 1 pcs		



GEV No.	416525	Ref. No.	537021301
description	heating element 9750W 230/400V heating circuits 3 mounting pos. left L 305mm W 220mm H 35mm flange length 36.5mm flange length 1 3mm flange length 2 33.5mm flange ø1 65mm flange ø2 60mm thermostat sleeves ø 6.5mm length thermostat sleeves 220mm number of thermostat sleeves 2 thermostat sleeve eccentric, clinging/not clinging windings 6 L1 23mm L2 282mm W1 34mm W2 37mm tube ø 8mm cable length 280mm rotation flange immersion heater fryer connection length 25mm		
For models:	F13-74ET, F2-13-78ET		
accessories for	416525		
	GEV No.	345032	Ref. No. 537011500
	microswitch with plunger thread M10x1 thread L 12mm 250V 16A 1CO connection male faston 6.3mm stroke 7mm mounting distance 22mm L 28mm ambient temperature max. 125°C type SP9603 actuating force: 180g		
	GEV No.	550494	Ref. No. 536009800
	O-ring Viton thickness 3.53mm ID ø 47.22mm Qty 1 pcs		

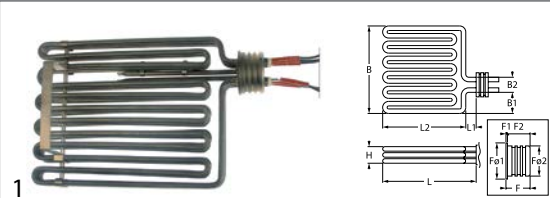

GEV No.	416524	Ref. No.	537021300
description	heating element 9750W 230V L1 20mm L2 285mm W1 34mm W2 37mm rotation flange tube ø 8.5mm heating circuits 3 cable length 280mm H 35mm L 305mm W 220mm windings 6 thermostat sleeves ø 6.5mm number of thermostat sleeves 2 length thermostat sleeves 210mm connection length 45mm flange length 1 3mm flange length 2 33.6mm flange length 36.6mm flange ø1 65mm flange ø2 60mm mounting pos. left fryer thermostat sleeve eccentric, clinging/not clinging immersion heater		
For models:	F13-74ET, F2-13-78ET		

2 hole fixing

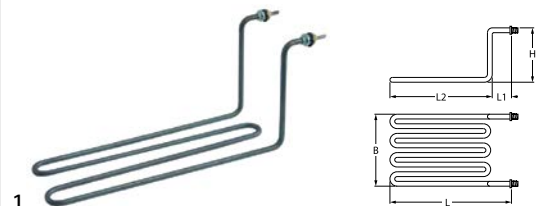









GEV No.	416651	Ref. No.	537010800
description	heating element 1800W 230V heating circuits 1 L 388mm W 127mm H 172mm L1 30mm L2 358mm thread M12x1 tube ø 8.5mm windings 2 2 hole fixing connection male faston 6.3mm fryer		
For models:	FMPE-20, FMPE-25, FMPE-30, FPE-20		
accessories for	416651		
	GEV No.	520229	Ref. No. —
	nut thread M12x1 H 4mm WS 16 zinc-coated steel Qty 1 pcs		
	GEV No.	521110	Ref. No. —
	flat gasket fibre ED ø 20mm ID ø 13mm thickness 2mm Qty 1 pcs		

Table continues overleaf



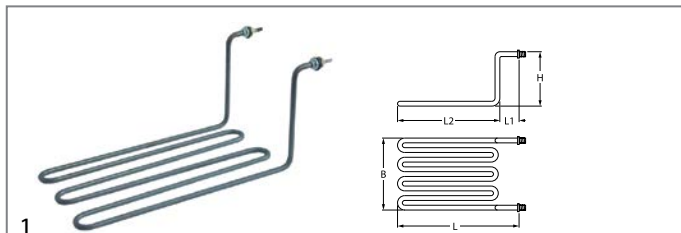



accessories for	416651			
	GEV No.	521131	Ref. No.	—
	nut thread M12x1 H 3.5mm WS 17 SS Qty 1 pcs			
	GEV No.	528110	Ref. No.	—
	O-ring EPDM thickness 2.62mm ID ø 12.37mm Qty 1 pcs			

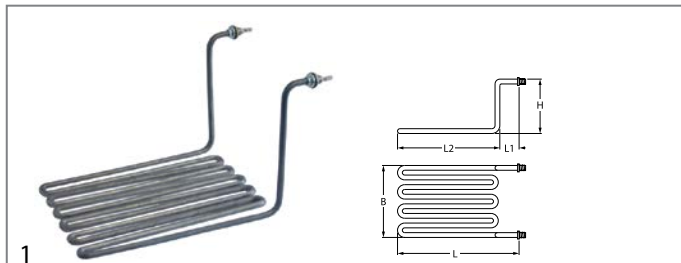





GEV No.	416652	Ref. No.	537010900	
description	heating element 2500W 230V heating circuits 1 L 390mm W 192mm H 170mm L1 29mm L2 361mm thread M12x1 tube ø 9mm windings 3 2 hole fixing connection male faston 6.3mm fryer			
For models:	FMPE-25, FPE-25			
accessories for	416652			
	GEV No.	520229	Ref. No.	—
	nut thread M12x1 H 4mm WS 16 zinc-coated steel Qty 1 pcs			
	GEV No.	521110	Ref. No.	—
	flat gasket fibre ED ø 20mm ID ø 13mm thickness 2mm Qty 1 pcs			
	GEV No.	521131	Ref. No.	—
	nut thread M12x1 H 3.5mm WS 17 SS Qty 1 pcs			
	GEV No.	528110	Ref. No.	—
	O-ring EPDM thickness 2.62mm ID ø 12.37mm Qty 1 pcs			

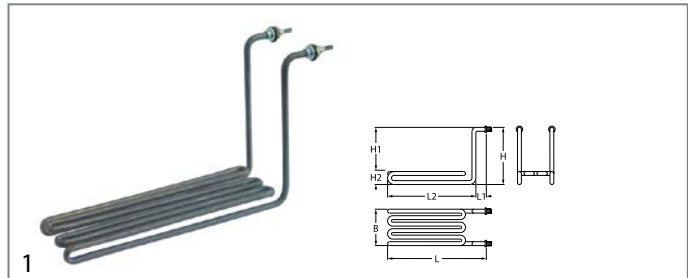

GEV No.	416648	Ref. No.	537003300	
description	heating element 3000W 230V heating circuits 1 L 315mm W 185mm H 180mm L1 28mm L2 277mm thread 1/4" mounting distance 174mm tube ø 8.5mm windings 6 2 hole fixing connection male faston 6.3mm fryer heaters			
For models:	FEM-2-6, FEM-6, FQ-4EM, FQ-61EM, FQ-61ET, FQ-62EM, FQ-62ET, FQ-6EM			
accessories for	416648			
	GEV No.	361182	Ref. No.	—
	nut thread 1/4" H 5mm nickel-plated brass WS 17 Qty 1 pcs			
	GEV No.	510417	Ref. No.	—
	flat gasket fibre ED ø 20mm ID ø 14mm thickness 2mm Qty 1 pcs			
	GEV No.	520228	Ref. No.	—
	tooth lock washer ID ø 15.3mm ED ø 24mm steel Qty 1 pcs for thread M14			
	GEV No.	550262	Ref. No.	—
	flat gasket copper ED ø 20mm ID ø 14mm thickness 2mm			



GEV No.	416649	Ref. No.	537003700	
description	heating element 2000W 230V heating circuits 1 L 328mm W 110mm H 196mm L1 30mm L2 298mm H1 170mm H2 26mm thread M12x1 tube ø 8.5mm 2 hole fixing connection male faston 6.3mm fryer windings 4			
For models:	FE-10, FE2-10, FME-10, FME-2-10			
spare parts for	416649			
	GEV No.	521110	Ref. No.	—
	flat gasket fibre ED ø 20mm ID ø 13mm thickness 2mm Qty 1 pcs			
accessories for	416649			
	GEV No.	520229	Ref. No.	—
	nut thread M12x1 H 4mm WS 16 zinc-coated steel Qty 1 pcs			
	GEV No.	521131	Ref. No.	—
	nut thread M12x1 H 3.5mm WS 17 SS Qty 1 pcs			
	GEV No.	528110	Ref. No.	—
	O-ring EPDM thickness 2.62mm ID ø 12.37mm Qty 1 pcs			

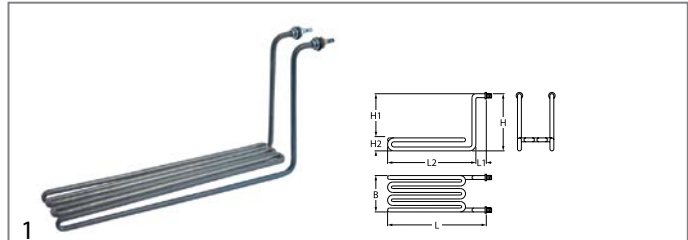

GEV No.	416650	Ref. No.	537004300	
description	heating element 3000W 230V heating circuits 1 L 405mm W 89mm H 198mm L1 29mm L2 376mm H1 169mm H2 29mm thread M12x1 tube ø 8.5mm 2 hole fixing connection male faston 6.3mm fryer windings 4			
For models:	FME-15, FME-2-15			
accessories for	416650			
	GEV No.	520229	Ref. No.	—
	nut thread M12x1 H 4mm WS 16 zinc-coated steel Qty 1 pcs			
	GEV No.	521110	Ref. No.	—
	flat gasket fibre ED ø 20mm ID ø 13mm thickness 2mm Qty 1 pcs			
	GEV No.	521131	Ref. No.	—
	nut thread M12x1 H 3.5mm WS 17 SS Qty 1 pcs			
	GEV No.	528110	Ref. No.	—
	O-ring EPDM thickness 2.62mm ID ø 12.37mm Qty 1 pcs			



1			
GEV No.	415704	Ref. No.	537003500
description	heating element 1800W 230V heating circuits 1 L 310mm W 60mm H 200mm L1 30mm L2 280mm H1 160mm H2 40mm thread M12x1 mounting distance 50mm tube \varnothing 8.5mm 2 hole fixing connection male faston 6.3mm fryer windings 4		
For models:	FE-2-8, FE-8, FP-62ET, FP-6ET, FQ-4ET, FQ-61EM, FQ-61ET, FQ-62EM, FQ-62ET, FQ-6ET		
spare parts for	415704		
	GEV No.	521110	Ref. No. —
	flat gasket fibre ED \varnothing 20mm ID \varnothing 13mm thickness 2mm Qty 1 pcs		
accessories for	415704		
	GEV No.	520229	Ref. No. —
	nut thread M12x1 H 4mm WS 16 zinc-coated steel Qty 1 pcs		
	GEV No.	521131	Ref. No. —
	nut thread M12x1 H 3.5mm WS 17 SS Qty 1 pcs		
	GEV No.	528110	Ref. No. —
	O-ring EPDM thickness 2.62mm ID \varnothing 12.37mm Qty 1 pcs		

1			
GEV No.	415705	Ref. No.	537003100
description	heating element 2500W 230V heating circuits 1 L 285mm W 104mm H 205mm L1 20mm L2 265mm H1 169mm H2 36mm thread 1/4" mounting distance 28mm tube \varnothing 8.5mm 2 hole fixing connection male faston 6.3mm immersion heater W1 34mm W2 36mm windings 4		
For models:	FEC-4		
spare parts for	415705		
	GEV No.	510417	Ref. No. —
	flat gasket fibre ED \varnothing 20mm ID \varnothing 14mm thickness 2mm Qty 1 pcs		
accessories for	415705		
	GEV No.	361182	Ref. No. —
	nut thread 1/4" H 5mm nickel-plated brass WS 17 Qty 1 pcs		
	GEV No.	520228	Ref. No. —
	tooth lock washer ID \varnothing 15.3mm ED \varnothing 24mm steel Qty 1 pcs for thread M14		
	GEV No.	550262	Ref. No. —
	flat gasket copper ED \varnothing 20mm ID \varnothing 14mm thickness 2mm		

heating elements for griddles

1			
GEV No.	415703	Ref. No.	537005100
description	heating element 1000W 230V heating circuits 1 L 333mm W 80mm H 64mm tube \varnothing 6.3mm W1 20mm W2 51mm connection male faston 6.3mm connection length 19mm dry heating element		
For models:	FTL-61EM, FTL-61EMS, FTL-61ET, FTL-61ETS, FTL-62EM, FTL-62EMS, FTL-62ET, FTL-62ETS, FTL-63ET, FTL-63ETS, FTL-64ET, FTL-64ETS, FTLR-62EM, FTLR-62EMS, FTLR-62ET, FTLR-62ETS, FTLR-63ET, FTLR-63ETS, FTLR-64ET, FTLR-64ETS, FTR-61EM, FTR-61EMS, FTR-61ET, FTR-61ETS, FTR-62EM, FTR-62EMS, FTR-62ET, FTR-62ETS		

1			
GEV No.	415367	Ref. No.	537005200
description	heating element 1500W 230V heating circuits 1 L 425mm W 90mm H 70mm tube \varnothing 6.3mm W2 60mm connection male faston 6.3mm griddle connection distance 52mm dry heating element		
For models:	FTL-4EM, FTL-4EMS, FTL-4ET, FTL-4ETS, FTL-6EM, FTL-6EMS, FTL-6ET, FTL-6ETS, FTL-8EM, FTL-8EMS, FTL-8ET, FTL-8ETS, FTLD-64ET, FTLD-66ET, FTLD-68ET, FTLR-6EM, FTLR-6EMS, FTLR-6ET, FTLR-6ETS, FTLR-8EM, FTLR-8EMS, FTLR-8ET, FTLR-8ETS, FTLRD-66ET, FTLRD-68ET, FTR-4EM, FTR-4EMS, FTR-4ET, FTR-4ETS, FTR-6EM, FTR-6EMS, FTR-6ET, FTR-6ETS, FTRD-64ET, FTRD-66ET, FTRD-68ET		

1			
GEV No.	416518	Ref. No.	537021000
description	heating element 1500W 230V heating circuits 1 L 498mm W 158mm H 59mm tube \varnothing 6.3mm W2 67mm connection male faston 6.3mm griddle connection distance 126mm dry heating element		
For models:	FTL-712ET, FTL-712ETS, FTL-712ETX, FTL-74ET, FTL-74ETS, FTL-74ETX, FTL-76ET, FTL-76ETS, FTL-78ET, FTL-78ETS, FTL-78ETX, FTLR-712ET, FTLR-712ETS, FTLR-712ETX, FTLR-76ET, FTLR-76ETS, FTLR-78ET, FTLR-78ETS, FTLR-78ETX, FTR-712ET, FTR-712ETS, FTR-712ETX, FTR-74ET, FTR-74ETS, FTR-74ETX, FTR-76ET, FTR-76ETS, FTR-78ET, FTR-78ETS, FTR-78ETX, FTTL-712ET, FTTL-74ET, FTTL-74ETS, FTTL-76ET, FTTL-76ETS, FTTL-78ET, FTTL-78ETS, FTTLR-712ET, FTTLR-76ET, FTTLR-76ETS, FTTLR-78ET, FTTLR-78ETS		

1			
GEV No.	416519	Ref. No.	537014700
description	heating element 1900W 230V heating circuits 3 tube \varnothing 11mm L 397mm W 220mm H 20mm connection male faston 6.3mm dry heating element griddle		
For models:	FTC-61EM, FTC-61ET, FTC-62EM, FTC-62ET		



1

GEV No.	418069	Ref. No.	537025200
description	heating element 2000W 230V heating circuits 1 L 660mm W 85mm H 60mm tube ø 6.3mm W2 75mm connection male faston 6.3mm griddle connection distance 45mm dry heating element		
For models:	FTL-94ET, FTL-94ETS, FTL-94ETX, FTL-98ET, FTL-98ETS, FTL-98ETX, FTLR94ET, FTLR94ETS, FTLR-98ET, FTLR-98ETS, FTLR-98ETX, FTR-94ET, FTR-94ETX, FTR-98ET, FTR-98ETS, FTR-98ETX, FTTL-94ET, FTTL-94ETS, FTTL-98ET, FTTL-98ETS, FTTLR-98ET, FTTLR-98ETS, FTTR-94ET, FTTR-94ETS, FTTR-98ET, FTTR-98ETS		



2

GEV No.	415702	Ref. No.	537004100
description	heating element 2400W 230V heating circuits 1 L 342mm W 227mm H 53mm tube ø 6.3mm W1 30mm W2 165mm connection male faston 6.3mm griddle connection distance 158mm dry heating element		

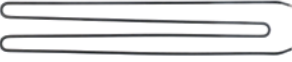

1

GEV No.	419225	Ref. No.	537025201
description	heating element 2500W 230V heating circuits 1 L 600mm W 85mm H 60mm tube ø 6mm		
For models:	FTL-94ET, FTL-94ETX, FTL-98ET, FTL-98ETX, FTLR-98ET, FTLR-98ETX, FTR-94ET, FTR-94ETX, FTR-98ET, FTR-98ETX, FTTL-94ET, FTTL-98ET, FTTLR-98ET, FTTR-94ET, FTTR-98ET		



1

GEV No.	416645	Ref. No.	537004100
description	heating element 2653W 230V heating circuits 1 warming plate		
For models:	FTL-61EM, FTL-61EMS, FTL-61ET, FTL-61ETS, FTL-62EM, FTL-62EMS, FTL-62ET, FTL-62ETS, FTL-63EM, FTL-63EMS, FTL-64EM, FTL-64EMS, FTLR-62EM, FTLR-62EMS, FTLR-62ET, FTLR-62ETS, FTLR-63EM, FTLR-63EMS, FTLR-64EM, FTLR-64EMS, FTR-61EM, FTR-61EMS, FTR-61ET, FTR-61ETS, FTR-62EM, FTR-62EMS, FTR-62ET, FTR-62ETS, WP		



1

GEV No.	415373	Ref. No.	537013100
description	heating element 3240W 230V heating circuits 3 tube ø 11mm L 390mm W 265mm H 30mm connection male faston 6.3mm dry heating element		
For models:	FTC-4EM, FTC-4EMX, FTC-4ET, FTC-8EMX, FTC-8ET		

heating elements for tilting bratt pan







1

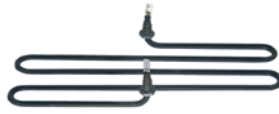

GEV No.	416692	Ref. No.	40400082
description	heating element tilting bratt pan 2900W 230V L 312mm W 200mm H 82mm connection M5 dry heating element heating circuits 1 tube ø 8.5mm W1 66mm W2 68mm connection distance 61mm		



heating elements for pasta cookers









1

GEV No.	415700	Ref. No.	N/A	
description	heating element 1300W 230V heating circuits 1 L 280mm W 110mm connection male faston 6.3mm tube ø 6.3mm 2 hole fixing thread M10x1 immersion heater/dry heating element bain marie/pasta cooker L1 135mm L2 145mm H 20mm mounting distance 104mm			
accessories for	415700			
	GEV No.	510416	Ref. No.	—
	flat gasket fibre ED ø 19mm ID ø 10.5mm thickness 1.5mm for thread M10 Qty 1 pcs			
	GEV No.	510893	Ref. No.	—
	O-ring EPDM thickness 2.62mm ID ø 9.92mm Qty 1 pcs			
	GEV No.	520231	Ref. No.	—
	nut thread M10x1 H 6mm WS 14 zinc-coated steel Qty 1 pcs			
	GEV No.	521129	Ref. No.	—
	nut thread M10 H 6mm SS WS 17 Qty 1 pcs DIN/ISO DIN 439			

			
GEV No.	416521	Ref. No.	537021100
description	heating element 2000W 230V heating circuits 1 L 300mm ϕ 30mm thread 1" flange ϕ 55mm cable length 180mm connection cable immersion heater pasta cooker flange width 48mm		
For models:	CP-74ET, CP-74ETX, CP-78ET, CP-78ETX, CPD-64ET		
accessories for	416521		
	GEV No.	520233	Ref. No. —
	nut thread 1" H 6mm brass WS 47 Qty 1 pcs		
	GEV No.	532484	Ref. No. 536009700
	O-ring silicone thickness 2.62mm ID ϕ 37.77mm Qty 1 pcs		

			
GEV No.	416522	Ref. No.	537021200
description	heating element 2000W 230V heating circuits 1 L 300mm W 55mm connection cable thread 1" ϕ 30mm flange ϕ 55mm flange width 48mm thermostat sleeves ϕ 6mm length thermostat sleeves 196mm cable length 210mm number of thermostat sleeves 1 pasta cooker thermostat sleeve not clinging immersion heater		
For models:	CP-74ET, CP-74ETX, CP-78ET, CP-78ETX, CPD-64ET		
spare parts for	416522		
	GEV No.	532484	Ref. No. 536009700
	O-ring silicone thickness 2.62mm ID ϕ 37.77mm Qty 1 pcs		
accessories for	416522		
	GEV No.	520233	Ref. No. —
	nut thread 1" H 6mm brass WS 47 Qty 1 pcs		

			
GEV No.	415701	Ref. No.	537004900
description	heating element 2000W 230V L 276mm W 140mm H 20mm 2 hole fixing connection male faston 6.3mm thread M10x1 tube ϕ 6.5mm W1 140mm mounting distance 133mm immersion heater		
For models:	CP-4ET, CP-61EM, CP-62ET, CP-6ET		
accessories for	415701		
	GEV No.	510416	Ref. No. —
	flat gasket fibre ED ϕ 19mm ID ϕ 10.5mm thickness 1.5mm for thread M10 Qty 1 pcs		
	GEV No.	510893	Ref. No. —
	O-ring EPDM thickness 2.62mm ID ϕ 9.92mm Qty 1 pcs		
	GEV No.	520231	Ref. No. —
	nut thread M10x1 H 6mm WS 14 zinc-coated steel Qty 1 pcs		
	GEV No.	521129	Ref. No. —
	nut thread M10 H 6mm SS WS 17 Qty 1 pcs DIN/ISO DIN 439		

			
GEV No.	418073	Ref. No.	537024200
description	heating element 3500W 230V heating circuits 1 L 475mm flange with thread thread 1" ϕ 30mm flange ϕ 55mm flange width 48mm cable length 300mm immersion heater		
For models:	CP-94ET, CP-94ETX, CP-98ET, CP-98ETX, CPB-98ET		
accessories for	418073		
	GEV No.	510404	Ref. No. —
	flat gasket fibre ED ϕ 44mm ID ϕ 34mm thickness 2mm Qty 1 pcs		
	GEV No.	528018	Ref. No. —
	flat gasket PTFE ED ϕ 41mm ID ϕ 33mm thickness 3mm size 1" Qty 1 pcs		

			
GEV No.	418074	Ref. No.	537024300
description	heating element 3500W 230V heating circuits 1 L 475mm screw mounting connection cable thread 1" ϕ 30mm flange ϕ 55mm flange width 48mm thermostat sleeves ϕ 6.5mm length thermostat sleeves 215mm cable length 300mm number of thermostat sleeves 1 thermostat sleeve eccentric, non clinging immersion heater		
For models:	CP-94ET, CP-94ETX, CP-98ET, CP-98ETX, CPB-98ET		

			
GEV No.	415772	Ref. No.	537004200
description	heating element 823W 230V L 276mm W 108mm H 20mm 2 hole fixing connection male faston 6.3mm thread M10x1 tube ϕ 6.3mm connection length 22mm dry heating element		
For models:	BM-61EM, BM-62EM, BM-62ET, BS-4EM, BS-4EMX, BS-61EM, BS-62EM, BS-74EM, BS-94EM, BSD-64EM, BST-64EM, BST-74EM, BST-94EM, CP-61EM, CP-62ET, SV-11, SV-113, SV-12, SV-123, SV-13		

heating elements for pizza ovens





			
GEV No.	416644	Ref. No.	537003200
description	heating element 750W 230V L 373mm W 327mm L1 25mm L2 35mm L3 310mm W1 25mm W2 282mm thread M12x1 mounting distance 275mm connection length 30mm connection male faston 6.3mm tube ϕ 6.3mm heating circuits 1 dry heating element 2 hole fixing		
For models:	RV, RV-IPERLOTUS, TS-1		



heating elements for rechauds







1

GEV No.	415708	Ref. No.	537004700
description	heating element 1400W 230V heating circuits 1 L 338mm W 215mm H 85mm L2 338mm mounting distance 209mm thread 1/4" tube ø 6.3mm connection male faston 6.3mm 2 hole fixing dry heating element connection length 34mm		
accessories for	415708		
	GEV No.	361182	Ref. No. —
	nut thread 1/4" H 5mm nickel-plated brass WS 17 Qty 1 pcs		
	GEV No.	510417	Ref. No. —
	flat gasket fibre ED ø 20mm ID ø 14mm thickness 2mm Qty 1 pcs		
	GEV No.	520228	Ref. No. —
	tooth lock washer ID ø 15.3mm ED ø 24mm steel Qty 1 pcs for thread M14		
	GEV No.	550262	Ref. No. —
	flat gasket copper ED ø 20mm ID ø 14mm thickness 2mm		





1

GEV No.	415707	Ref. No.	537004600
description	heating element 700W 230V L 135mm W 208mm H 88mm L1 5mm L2 140mm mounting distance 205mm thread M12x1 tube ø 6.3mm connection male faston 6.3mm 2 hole fixing dry heating element		
accessories for	415707		
	GEV No.	520229	Ref. No. —
	nut thread M12x1 H 4mm WS 16 zinc-coated steel Qty 1 pcs		
	GEV No.	521110	Ref. No. —
	flat gasket fibre ED ø 20mm ID ø 13mm thickness 2mm Qty 1 pcs		
	GEV No.	521131	Ref. No. —
	nut thread M12x1 H 3.5mm WS 17 SS Qty 1 pcs		
	GEV No.	528110	Ref. No. —
	O-ring EPDM thickness 2.62mm ID ø 12.37mm Qty 1 pcs		

heating elements for chargrills



1

GEV No.	415770	Ref. No.	537010700
description	heating element 2000W 230V L 420mm W 90mm H 8.5mm 2 hole fixing thread M12x1 mounting distance 71mm connection male faston 6.3mm dry heating element tube ø 8.5mm heating circuits 1		
For models:	CW-4ET, CW-61ET, CW-62ET, CW-6ET		
spare parts for	415770		
	GEV No.	520229	Ref. No. —
	nut thread M12x1 H 4mm WS 16 zinc-coated steel Qty 1 pcs		
	GEV No.	521110	Ref. No. —
	flat gasket fibre ED ø 20mm ID ø 13mm thickness 2mm Qty 1 pcs		
	GEV No.	521131	Ref. No. —
	nut thread M12x1 H 3.5mm WS 17 SS Qty 1 pcs		







1

GEV No.	416520	Ref. No.	537022000
description	heating element 2000W 230V L 450mm W 95mm H 8.5mm thread M12x1 mounting distance 86.5mm connection male faston 6.3mm dry heating element tube ø 8.5mm heating circuits 1 connection length 24mm connection distance 97mm		
For models:	CW-74ET, CW-74ETX, CW-78ET, CW-78ETX, CWT-74ET, CWT-74ETX, CWT-78ET, CWT-78ETX		



1

GEV No.	418070	Ref. No.	537029801
description	heating element 2600W 230V L 615mm W 85mm chargrill 2 hole fixing thread M12x1 mounting distance 80mm connection male faston 6.3mm dry heating element tube ø 8.5mm heating circuits 1		
For models:	CW-94ET, CW-98ET, CWT-94ET, CWT-98ET		
accessories for	418070		
	GEV No.	520229	Ref. No. —
	nut thread M12x1 H 4mm WS 16 zinc-coated steel Qty 1 pcs		
	GEV No.	521110	Ref. No. —
	flat gasket fibre ED ø 20mm ID ø 13mm thickness 2mm Qty 1 pcs		
	GEV No.	521131	Ref. No. —
	nut thread M12x1 H 3.5mm WS 17 SS Qty 1 pcs		
	GEV No.	528110	Ref. No. —
	O-ring EPDM thickness 2.62mm ID ø 12.37mm Qty 1 pcs		

heating elements for salamanders/toast-



GEV No.	416647	Ref. No.	537020500
----------------	--------	-----------------	-----------

description heating element 2000W 230V L 225mm W 208mm 2 hole fixing thread 1/4" mounting distance 198mm connection M4 dry heating element tube ø 8.5mm heating circuits 1 H 8.5mm

For models: SL-600, SL-600EM, SL-600EMX, SL-600ET, SL-600ETX, SL-600X

spare parts for 416647

	GEV No.	510417	Ref. No.	—
flat gasket fibre ED ø 20mm ID ø 14mm thickness 2mm Qty 1 pcs				

accessories for 416647

	GEV No.	361182	Ref. No.	—
nut thread 1/4" H 5mm nickel-plated brass WS 17 Qty 1 pcs				

	GEV No.	520228	Ref. No.	—
tooth lock washer ID ø 15.3mm ED ø 24mm steel Qty 1 pcs for thread M14				

	GEV No.	550262	Ref. No.	—
flat gasket copper ED ø 20mm ID ø 14mm thickness 2mm				

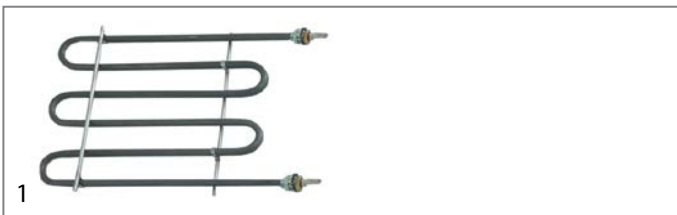

GEV No.	416646	Ref. No.	537020600
----------------	--------	-----------------	-----------

description heating element 2000W 230V L 290mm W 216mm 2 hole fixing thread M12x1 mounting distance 195mm connection male faston 6.3mm dry heating element tube ø 8.5mm heating circuits 1 connection length 35mm H 8.5mm

For models: SA-400EM, SA-400EMX, SA-600EM, SA-600EMX, SA-600ET, SA-600ETX



GEV No.	416643	Ref. No.	537004500
----------------	--------	-----------------	-----------

description heating element 850W 230V L 310mm W 90mm thread 1/4" mounting distance 84mm connection male faston 6.3mm tube ø 6.3mm heating circuits 1 dry heating element 2 hole fixing

For models: TS-3, TS-6

accessories for 416643

	GEV No.	361182	Ref. No.	—
nut thread 1/4" H 5mm nickel-plated brass WS 17 Qty 1 pcs				

	GEV No.	510417	Ref. No.	—
flat gasket fibre ED ø 20mm ID ø 14mm thickness 2mm Qty 1 pcs				

	GEV No.	520228	Ref. No.	—
tooth lock washer ID ø 15.3mm ED ø 24mm steel Qty 1 pcs for thread M14				

accessories for	416643			
	GEV No.	550262	Ref. No.	—
flat gasket copper ED ø 20mm ID ø 14mm thickness 2mm				

heating elements for heating bridges



GEV No.	416523	Ref. No.	537004400
----------------	--------	-----------------	-----------

description heating element 320W 230V L 316mm W 96mm connection male faston 6.3mm tube ø 6.3mm 2 hole fixing thread M12x1.5 dry heating element heated bridge mounting distance 90mm chip scuttle

For models: RI-4EM, RI-4EMX, RI-62EM

heating cartridges





GEV No.	416521	Ref. No.	537021100
----------------	--------	-----------------	-----------

description heating element 2000W 230V heating circuits 1 L 300mm ø 30mm thread 1" flange ø 55mm cable length 180mm connection cable immersion heater pasta cooker flange width 48mm

For models: CP-74ET, CP-74ETX, CP-78ET, CP-78ETX, CPD-64ET

accessories for 416521

	GEV No.	520233	Ref. No.	—
nut thread 1" H 6mm brass WS 47 Qty 1 pcs				

	GEV No.	532484	Ref. No.	536009700
O-ring silicone thickness 2.62mm ID ø 37.77mm Qty 1 pcs				



GEV No.	416522	Ref. No.	537021200
----------------	--------	-----------------	-----------

description heating element 2000W 230V heating circuits 1 L 300mm W 55mm connection cable thread 1" ø 30mm flange ø 55mm flange width 48mm thermostat sleeves ø 6mm length thermostat sleeves 196mm cable length 210mm number of thermostat sleeves 1 pasta cooker thermostat sleeve not clinging immersion heater

For models: CP-74ET, CP-74ETX, CP-78ET, CP-78ETX, CPD-64ET



spare parts for 416522

	GEV No.	532484	Ref. No.	536009700
O-ring silicone thickness 2.62mm ID ø 37.77mm Qty 1 pcs				

accessories for 416522

	GEV No.	520233	Ref. No.	—
nut thread 1" H 6mm brass WS 47 Qty 1 pcs				





			
1			
GEV No.	418073	Ref. No.	537024200
description	heating element 3500W 230V heating circuits 1 L 475mm flange with thread 1" ø 30mm flange ø 55mm flange width 48mm cable length 300mm immersion heater		
For models:	CP-94ET, CP-94ETX, CP-98ET, CP-98ETX, CPB-98ET		
accessories for	418073		
	GEV No.	510404	Ref. No. —
	flat gasket fibre ED ø 44mm ID ø 34mm thickness 2mm Qty 1 pcs		
	GEV No.	528018	Ref. No. —
	flat gasket PTFE ED ø 41mm ID ø 33mm thickness 3mm size 1" Qty 1 pcs		

			
1			
GEV No.	418074	Ref. No.	537024300
description	heating element 3500W 230V heating circuits 1 L 475mm screw mounting connection cable thread 1" ø 30mm flange ø 55mm flange width 48mm thermostat sleeves ø 6.5mm length thermostat sleeves 215mm cable length 300mm number of thermostat sleeves 1 thermostat sleeve eccentric, non clinging immersion heater		
For models:	CP-94ET, CP-94ETX, CP-98ET, CP-98ETX, CPB-98ET		



ceramic heaters



245x60mm

			
1			
GEV No.	415103	Ref. No.	537015200
description	ceramic emitter 650W 230V cable beaded cord L 245mm W 60mm H 35mm		
For models:	BS-74EM, BS-94EM, BSD-64EM, BST-64EM, BST-74EM, BST-94EM		
spare parts for	415103		
	GEV No.	415109	Ref. No. —
	spring clip		
accessories for	415103		
	GEV No.	415110	Ref. No. —
	reflector L 245mm W 95mm H 31mm thickness 0.75mm hole ø 15x40mm		



immersion heating elements

with round flange ø57.5mm

			
1			
GEV No.	418040	Ref. No.	10062
description	heating element 6000W 230V heating circuits 3 L 385mm W 32mm H 42mm tube ø 6.3mm thermostat sleeves ø 7mm length thermostat sleeves 275mm number of thermostat sleeves 1 thermostat sleeve clinging connection male faston 6.3mm connection length 27mm immersion heater round flange mounting ø 57.5mm		
accessories for	418040		
	GEV No.	550002	Ref. No. —
	tension strap H 10mm L 21mm W 10mm hole ø 6.5mm for heating element		

			
1			
GEV No.	418041	Ref. No.	16600
description	heating element 8000W 230V heating circuits 3 L 470mm W 42mm H 31mm tube ø 6.4mm thermostat sleeves ø 7mm length thermostat sleeves 278mm number of thermostat sleeves 1 thermostat sleeve clinging connection male faston 6.3mm connection length 27mm immersion heater round flange mounting ø 57.5mm		
spare parts for	418041		
	GEV No.	510409	Ref. No. —
	O-ring EPDM thickness 5.34mm ID ø 56.52mm Qty 1 pcs		
accessories for	418041		
	GEV No.	550002	Ref. No. —
	tension strap H 10mm L 21mm W 10mm hole ø 6.5mm for heating element		

heating elements for convection

			
1			
GEV No.	415777	Ref. No.	537006500
description	heating element 2000W 230V heating circuits 1 ID ø 178mm ED ø 190mm L 245mm H 32mm L1 50mm W1 31mm H1 3mm H2 25mm flange length 70mm flange width 22mm hole distance 56mm connection male faston 6.3mm connection length 39mm tube ø 6.3mm convection heating element hole ø 5mm rectangular flange		
For models:	CF-62EM, CF-62EM-A, CF-62ET, CF-62ET-A, CF-62GEM, CF-62GEM-A, CFC-62EM, CFC-62ET		
spare parts for	415777		
	GEV No.	510368	Ref. No. —
	gasket L 70mm W 23.5mm hole ø 5mm hole distance 56mm FIBER thickness 2mm for heating element		

			
1			
GEV No.	420532	Ref. No.	040001201 537019000
description	heating element 3000W 230V heating circuits 1 ID ø 186mm ED ø 199mm L 250mm H 45mm L1 42mm W1 30mm H1 10mm H2 30mm flange length 70mm flange width 22mm hole distance 56mm connection 6.3x0.8 connection length 22mm tube ø 6.5mm convection heating element hole ø 5mm rectangular flange		
For models:	CF4-8ET, CF4-8GEM, CF-62EM, CF-62EM-A, CF-62ET, CF-62ET-A, CF-62GEM, CF-62GEM-A, CFC4-8ET, CFC-62EM, CFC-62ET, CFM-10EM, CFM-10EM-6, CFM-10EM-A, CFM-10ET, CFM-10ET-6, CFM-10ET-A, CFM-10GEM, CFM-10GEM-6, CFM-10GEM6-A, CFM-10GEM-A, CFM2-68GEM, CFM3-612GEMV, CFM4-66ET, CFM4-66GEM, CFM4-68ET, CFM4-68GEM, CFM6-610ET, CFM6-610GEM, CFM-8EM, CFM-8EM-A, CFM-8ET, CFM-8ET-A, CFM-8GEM, CFM-8GEM-A, CFMC4-66ET, MFM-610EM, MFM-68EM, TPFM4-610GEM		

			
1			
GEV No.	418019	Ref. No.	C3616-00
description	heating element 3900W 230V heating circuits 3 ID ø 206mm ED ø 218mm L 275mm H 40mm L1 48mm W1 104mm H1 10mm H2 24mm flange length 142mm flange width 25mm hole distance 62.5mm connection M4 connection length 62mm tube ø 6mm convection heating element hole ø 6.5mm rectangular flange		

			
1			
GEV No.	418020	Ref. No.	RRC3090-00
description	heating element 7800W 230V heating circuits 3 ID ø 264mm ED ø 277mm L 315mm H 100mm L1 35mm W1 101mm H1 29mm H2 67mm flange length 142mm flange width 23mm hole distance 63mm connection M4 connection length 75mm tube ø 6.3mm convection heating element mounting thread M4 rectangular flange		

radiation heaters

			
1			
GEV No.	490153	Ref. No.	537026400
description	radiation heater octagonal 3400W 230V L 300mm W 300mm heating circuits 2 H 30mm with heating coil energy regulation with temperature signalization connections 4+2 connection type cable cable length 900mm AD		
For models:	CFC4-98ET, PCC-94ET, PCC-98ET		

1-circuit			
			
1			
GEV No.	490024	Ref. No.	537014500
description	radiation heater ø 165mm 1200W 230V heating circuits 1 energy regulation with temperature signalization with heating coil connections 2+2 connection type male faston 6.3mm EGO		
For models:	CFC-62EM, CFC-62ET, PCC-61EM, PCC-62EM, PCC-62ET		

			
1			
GEV No.	490116	Ref. No.	537014501
description	radiation heater ø 165mm 1200W 230V heating circuits 1 H 33mm 7-position control with temperature signalization with ribbon heater connections 2+2 connection type male faston 6.3mm CERAMASPEED		
For models:	CFC-62EM, CFC-62ET, CFMC4-66ET, PCC-61EM, PCC-62EM, PCC-62ET, PCCT-63ET, PCCT-63ETX, PCCT-66ET, PCCT-66ETX		

			
1			
GEV No.	490042	Ref. No.	537012900
description	radiation heater ø 200mm 1800W 230V heating circuits 1 energy regulation with temperature signalization with ribbon heater connections 2+2 connection type male faston 6.3mm EGO		
For models:	CFC4-8ET, PCC-4EM, PCC-4EMX, PCC-4ET, PCC-6EM, PCC-6EMX, PCC-6ET, PCC-8EMX, PCC-8ET		

2-circuit			
			
1			
GEV No.	490119	Ref. No.	537013000 537014600
description	radiation heater ø 200mm 1700W 230V heating circuits 2 energy regulation with temperature signalization partial power 600W with ribbon heater connections 3+2 connection type male faston 6.3mm EGO		
For models:	CFC-62EM, CFC-62ET, PCC-4EM, PCC-4EMX, PCC-4ET, PCC-61EM, PCC-62EM, PCC-62ET, PCC-6EM, PCC-6EMX, PCC-6ET		



			
1			
GEV No.	490114	Ref. No.	537015301
description	radiation heater ø 230mm 2200W 230V heating circuits 2 energy regulation with temperature signalization partial power 750W with ribbon heater connections 2+2 connection type male faston 6.3mm CERAMASPEED		
For models:	CFC-62EM, CFC-62ET, PCC-4EM, PCC-4EMX, PCC-4ET, PCC-61EM, PCC-62EM, PCC-62ET, PCC-6EM, PCC-6EMX, PCC-6ET		

			
1			
GEV No.	490044	Ref. No.	537015300
description	radiation heater ø 230mm 2200W 230V heating circuits 2 energy regulation with temperature signalization partial power 750W with ribbon heater connections 3+2 connection type male faston 6.3mm EGO		
For models:	CFC4-8ET, PCC-8EMX, PCC-8ET		

			
1			
GEV No.	490118	Ref. No.	537019400
description	radiation heater ø 250mm 2500W heating circuits 2 partial power 1000W		
For models:	CFC4-78ET, CFC4-78ETX, CFC4-8ET, CFVC4-78ET, PCC-74ET, PCC-78ET, PCC-8EMX, PCC-8ET, PCDD-64ET, PCDD-68ET, PCCT-74ET, PCCT-78ET		

			
1			
GEV No.	415981	Ref. No.	537012000
description	foil heating element L 460mm W 375mm 1100W 230V t.max. 175°C silicone cable length 500mm thickness 1mm heating circuits 1		
For models:	BM-6EM, BM-6EMX		

			
1			
GEV No.	418075	Ref. No.	537026000
description	foil heating element L 570mm W 230mm 1500W 230V probe ø 6mm without temperature limiter silicone cable length 600mm thickness 1mm		
For models:	BM-94EM, BM-98EM, BMD-84EM, BMT-94EM, BMT-98EM		

hot plates

square & rectangular

with radiused edge

			
1			
GEV No.	490066 ¹	Ref. No.	537017000 537017700
description	hot plate dimensions 220x220mm 2600W 230V with spill ring connection 4 screw clamps protector yes square		
For models:	BR-6ET, BR-6ETX, CF4-68ET, CF4-68ETX, CF4-78ET, CF4-78ETX, CF6-610ET, CF6-610ETX, CF6-712ET, CF6-712ETV, CF6-712ETVX, CF6-712ETX, CFM4-66ET, CFM4-68ET, CFM6-610ET, CFQ4-78ET, CFQ4-78ETX, CFQ6-712ET, CFQ6-712ETV, CFQ6-712ETVX, CFQ6-712ETX, CFV4-78ET, CFV6-712ETV, CFVQ4-78ET, CFVQ6-712ETV, CP-4ETX, CP-6ETX, CW-4ETX, CW-6ETX, FQ-4ETX, FQ-6ETX, FTL-4ETX, FTL-6ETX, FTL-8ETX, FTLR-6ETX, FTLR-8ETX, FTR-4ETX, FTR-6ETX, PC-10ETX, PC-4ETX, PC-6ETX, PC-712ET, PC-712ETX, PC-74ET, PC-74ETX, PC-78ET, PC-78ETX, PC-8ETX, PCD-64ET, PCD-68ET...(Other models you can see in the webshop)		

¹incl. protector

foil heating elements

			
1			
GEV No.	415980	Ref. No.	537011900
description	foil heating element L 375mm W 275mm 650W 230V t.max. 175°C without temperature limiter silicone cable length 250mm thickness 1mm		
For models:	BM-10EM, BM-10EMX, BM-4EM, BM-4EMX, BM-74EM, BM-74ET, BM-78EM, BM-78ET, BM-8EM, BM-8EMX, BMD-64EM, BMT-74EM, BMT-78EM, BS-4EM, BS-4EMX		

 			
1			
GEV No.	490068 ¹	Ref. No.	537022700
description	hot plate dimensions 220x220mm 2600W 400V with spill ring connection 4 screw clamps protector yes square		
For models:	CF4-68ET, CF4-68ETX, CF4-78ET, CF4-78ETX, CF6-610ET, CF6-610ETX, CF6-712ET, CF6-712ETV, CF6-712ETVX, CF6-712ETX, CFM4-66ET, CFM4-68ET, CFM6-610ET, CFQ4-78ET, CFQ4-78ETX, CFQ6-712ET, CFQ6-712ETV, CFQ6-712ETVX, CFQ6-712ETX, CFV4-78ET, CFV6-712ETV, CFVQ4-78ET, CFVQ6-712ETV, PC-712ET, PC-712ETX, PC-74ET, PC-74ETX, PC-78ET, PC-78ETX, PCQ-712ET, PCQ-712ETX, PCQ-74ET, PCQ-74ETX, PCQ-78ET, PCQ-78ETX, PCQT-712ET, PCQT-712ETX, PCQT-74ET, PCQT-78ET, PCT-63ET, PCT-66ET, PCT-712ET, PCT-712ETX, PCT-74ET, PCT-74ETX, PCT-78ET, PCT-78ETX		



¹incl. protector



 			
1			
GEV No.	490071 ¹	Ref. No.	537017100
description	hot plate dimensions 300x300mm 4000W 230V with spill ring connection 4 screw clamps protector yes square		
For models:	CF4-98ET, CF4-98ETX, CF6-912ET, CF6-912ETV, CF6-912ETVX, CF8-916ET, CF8-916ETV, CFQ4-98ET, CFQ4-98ETX, CFQ6-912ET, CFQ6-912ETV, CFQ6-912ETVX, CFQ8-916ET, CFQ8-916ETV, CFQ9-916ET, CFV4-98ET, CFV6-912ET, CFV6-912ETV, CFVQ4-98ET, CFVQ6-912ET, CFVQ6-912ETV, PC-912ET, PC-912ETX, PC-916ET, PC-916ETX, PC-94ET, PC-94ETX, PC-98ET, PC-98ETX, PCQ-912ET, PCQ-916ET, PCQ-94ET, PCQ-98ET, PCQD-84ET, PCQD-88ET, PCQT-912ET, PCQT-916ET, PCQT-94ET, PCQT-94ETX, PCQT-98ET, PCQT-98ETX, PCT-912ET, PCT-912ETX, PCT-916ET, PCT-916ETX, PCT-94ET, PCT-94ETX, PCT-98ET, PCT-98ETX		



¹incl. protector

round
with radiused edge
for domestic and commercial kitchens

 			
1			
GEV No.	490010	Ref. No.	537002100
description	hot plate ø 145mm 1000W 230V connection 4 screw clamps with 8mm spill ring		
For models:	CF-10EM, CF-10EM-6, CF-10EM-A, CF-10ET, CF-10ET-6, CF-10ET-A, CF4-68ET, CF-62EM, CF-62EM-A, CF-62ET, CF-62ET-A, CF6-610ET, CF-8EM, CF-8EM-A, CF-8ET, CF-8ET-A, CFM-10EM, CFM-10EM-6, CFM-10EM-A, CFM-10ET, CFM-10ET-6, CFM-10ET-A, CFM4-66ET, CFM4-68ET, CFM6-610ET, CFM-8EM, CFM-8EM-A, CFM-8ET, CFM-8ET-A, PC-61EM, PC-62EM, PC-62ET, PCT-63ET, PCT-66ET		

 			
1			
GEV No.	490014	Ref. No.	537002200
description	hot plate ø 180mm 1500W 230V connection 4 screw clamps with 8mm spill ring		
For models:	CF-10EM, CF-10EM-6, CF-10EM-A, CF-10ET, CF-10ET-6, CF-10ET-A, CF-62EM, CF-62EM-A, CF-62ET, CF-62ET-A, CF-8EM, CF-8EM-A, CF-8ET, CF-8ET-A, CFM-10EM, CFM-10EM-6, CFM-10EM-A, CFM-10ET, CFM-10ET-6, CFM-10ET-A, CFM-8EM, CFM-8EM-A, CFM-8ET, CFM-8ET-A, PC-10ET, PC-61EM, PC-62EM, PC-62ET, PC-6EM, PC-6ET		

 			
1			
GEV No.	490016	Ref. No.	537019800
description	hot plate ø 180mm 2000W 230V connection 4 screw clamps with 8mm spill ring		
For models:	CF4-68ET, CF4-68ETX, CF6-610ET, CF6-610ETX, CFM4-66ET, CFM4-68ET, CFM6-610ET, PCT-63ET, PCT-66ET		

 			
1			
GEV No.	490018	Ref. No.	537002300
description	hot plate ø 220mm 2000W 230V connection 4 screw clamps with 8mm spill ring		
For models:	CF-10EM, CF-10EM-A, CF-10ET, CF-10ET-A, CF4-8ET, CF4-8ETS, CF-8EM, CF-8EM-A, CF-8ET, CF-8ET-A, CFM-10EM, CFM-10EM-A, CFM-10ET, CFM-10ET-A, CFM-8EM, CFM-8EM-A, CFM-8ET, CFM-8ET-A, CFPB6-79G, PC-10ET, PC-4EM, PC-4ET, PC-6EM, PC-6ET, PC-8ET		

 			
1			
GEV No.	490020	Ref. No.	537019900
description	hot plate ø 220mm 2600W 230V connection 4 screw clamps with 8mm spill ring		
For models:	CF4-68ET, CF4-68ETX, CF4-78ET, CF4-78ETX, CF6-610ET, CF6-610ETX, CF6-712ET, CF6-712ETV, CF6-712ETVX, CF6-712ETX, CFM4-66ET, CFM4-68ET, CFM6-610ET, CFQ4-78ET, CFQ4-78ETX, CFQ6-712ET, CFQ6-712ETV, CFQ6-712ETVX, CFQ6-712ETX, CFV4-78ET, CFV6-712ETV, CFVQ4-78ET, CFVQ6-712ETV, PC-712ET, PC-712ETX, PC-74ET, PC-74ETX, PC-78ET, PC-78ETX, PCD-64ET, PCD-68ET, PCQ-712ET, PCQ-712ETX, PCQ-74ET, PCQ-74ETX, PCQ-78ET, PCQ-78ETX, PCQD-64ET, PCQD-68ET, PCQT-712ET, PCQT-712ETX, PCQT-74ET, PCQT-78ET, PCT-63ET, PCT-66ET, PCT-712ET, PCT-712ETX, PCT-74ET, PCT-74ETX, PCT-78ET... (Other models you can see in the webshop)		
accessories for	490020		
		GEV No.	550796
		Ref. No.	—
	fixing plate for hot plate ø220mm		





			
GEV No.	490062	Ref. No.	537017400
description	hot plate ø 300mm 3500W 220V connection 4 screw clamps with 8mm spill ring		
For models:	CF4-98ET, CF4-98ETX, CF6-912ET, CF6-912ETV, CF6-912ETVX, CF8-916ET, CF8-916ETV, CFQ4-98ET, CFQ4-98ETX, CFQ6-912ET, CFQ6-912ETV, CFQ6-912ETVX, CFQ8-916ET, CFQ8-916ETV, CFQ9-916ET, CFV4-98ET, CFV6-912ET, CFV6-912ETV, CFVQ4-98ET, CFVQ6-912ET, CFVQ6-912ETV, PC-912ET, PC-912ETX, PC-916ET, PC-916ETX, PC-94ET, PC-94ETX, PC-98ET, PC-98ETX, PCQ-912ET, PCQ-916ET, PCQ-94ET, PCQ-98ET, PCQT-912ET, PCQT-916ET, PCQT-94ET, PCQT-94ETX, PCQT-98ET, PCQT-98ETX, PCT-912ET, PCT-912ETX, PCT-916ET, PCT-916ETX, PCT-94ET, PCT-94ETX, PCT-98ET, PCT-98ETX		

<p>2-circuit</p> 			
GEV No.	380027	Ref. No.	537021500
description	energy regulator EGO 230V 13A dual circuit turn direction right shaft ø 6x4.6mm shaft L 23mm mounting thread M4 power release 6-70% no. 50.55021.100		
For models:	CFC4-78ET, CFC4-78ETX, CFC4-8ET, CFC4-98ET, CFC-62EM, CFC-62ET, CFMC4-66ET, CFVC4-78ET, CFVC4-98ET, PCC-4EM, PCC-4EMX, PCC-4ET, PCC-61EM, PCC-62EM, PCC-62ET, PCC-6EM, PCC-6EMX, PCC-6ET, PCC-74ET, PCC-78ET, PCC-8EMX, PCC-8ET, PCC-94ET, PCC-98ET, PC-CD-64ET, PCDD-68ET, PCCT-63ET, PCCT-66ET, PCCT-74ET, PCCT-78ET, PCCT-94ET, PCCT-98ET		

energy regulators

EGO

<p>1-circuit</p> 			
GEV No.	380016	Ref. No.	537013400
description	energy regulator 230V 12A dual circuit turn direction right with operation switch 1-pole		
For models:	CFC4-8ET, PCC-4EM, PCC-4EMX, PCC-4ET, PCC-6EM, PCC-6EMX, PCC-6ET, PCC-8EMX, PCC-8ET		

			
GEV No.	380015	Ref. No.	07931 537013300 537020100
description	energy regulator 230V 13A single-circuit turn direction right shaft ø 6x4.6mm shaft L 23mm mounting thread M4 power release 6-100% no. 50.57021.010		
For models:	CFC4-8ET, CFC-62EM, CFC-62ET, CFMC4-66ET, CWK-74ET, CWK-78ET, CWK-94ET, CWK-98ET, CWKT-64ET, CWKT-68ET, CWKT-74ET, CWKT-78ET, CWKT-94ET, CWKT-98ET, FTC-4EM, FTC-4EMX, FTC-61EM, FTC-61ET, FTC-62EM, FTC-62ET, FTC-6EM, FTC-6EMX, FTC-6ET, FTC-74ET, FTC-78ET, FTC-8EMX, FTC-8ET, FTC-94ET, FTC-98ET, FTCD-64EM, FTCD-66ET, FTCT-64ET, FTCT-66ET, FTCT-74ET, FTCT-78ET, FTCT-94ET, FTCT-98ET, PCC-4EM, PCC-4EMX, PCC-4ET, PCC-61EM, PCC-62EM, PCC-62ET, PCC-6EM, PCC-6EMX, PCC-6ET, PCC-8EMX, PCC-8ET, PC-CT-63ET, SA-400EM...(Other models you can see in the webshop)		

thermostats

bi-metal thermostats

safety bi-metal thermostats

			
GEV No.	390235	Ref. No.	537012100
description	bi-metal safety thermostat hole distance 23.8mm switch-off temp. 165°C 1NC 1-pole 16A connection F6.3 2 hole fixing		
For models:	BM-10EM, BM-10EMX, BM-4EM, BM-4EMX, BM-6EM, BM-6EMX, BM-74EM, BM-74ET, BM-78EM, BM-78ET, BM-8EM, BM-8EMX, BM-94EM, BM-98EM, BMD-64EM, BMD-84EM, BMT-63EM, BMT-64EM, BMT-66EM, BMT-74EM, BMT-78EM, BMT-94EM, BMT-98EM, BS-4EM, BS-4EMX, CF4-68ET, CF4-68ETX, CF6-610ET, CF6-610ETX		

control and safety thermostats

EGO

control thermostats

55.10/19_ series

			
GEV No.	375001	Ref. No.	537012200
description	thermostat t.max. 112°C temperature range 30-110°C 1-pole 1NO 16A probe ø 6mm probe L 130mm capillary pipe 900mm capillary pipe isolated gland nut M9x1 shaft L 23mm shaft position upper rotation 270°		
For models:	BM-10EM, BM-4EM, BM-6EM, BM-74EM, BM-78EM, BM-8EM, BM-94EM, BM-98EM, BMD-64EM, BMD-84EM, BMT-63EM, BMT-64EM, BMT-66EM, BMT-74EM, BMT-78EM, BMT-94EM, BMT-98EM, BS-74EM, BS-94EM, BSD-64EM, BST-64EM, BST-74EM, BST-94EM, CP-61EM, CP-94ET, CP-94ETX, CP-98ET, CP-98ETX, CPB-98ET, FTL-94G, FTL-98G, FTLR-98G, FTR-94G, FTR-98G		



GEV No.	375198	Ref. No.	537037700
description	thermostat t.max. 190°C temperature range 100-190°C 1-pole 1NO 16A probe ø 6mm probe L 130mm capillary pipe 3000mm capillary pipe isolated 2650mm gland nut M9x1 shaft L 23mm shaft position upper rotation 270° probe material SS		
For models:	F18-94G, F2-18-98G, F2-25-98G, F25-94G, F45-78G, F45-78G-AUS, FMPE-20, FMPE-25, FMPE-30, FPE-20, FPE-25		



GEV No.	375314	Ref. No.	537019100
description	thermostat t.max. 320°C temperature range 50-320°C 1-pole 1NO 16A probe ø 3mm probe L 120mm capillary pipe 1200mm capillary pipe isolatedmm gland nut shaft ø 6x4.6mm shaft L 23mm shaft position upper rotation 270° with 2 probes		
For models:	CF4-8ET, CF4-8GEM, CFC4-8ET, CFM-10EM, CFM-10EM-6, CFM-10EM-A, CFM-10ET, CFM-10ET-6, CFM-10ET-A, CFM-10GEM, CFM-10GEM-6, CFM-10GEM6-A, CFM-10GEM-A, CFM-8EM, CFM-8EM-A, CFM-8ET, CFM-8ET-A, CFM-8GEM, CFM-8GEM-A		



GEV No.	390046	Ref. No.	537000600 537014300
description	thermostat t.max. 190°C temperature range 104-190°C 1-pole 1NO 16A probe ø 6mm probe L 133mm capillary pipe 870mm capillary pipe isolatedmm gland nut M9x1 shaft ø 6x4.6mm shaft L 23mm shaft position lower rotation 270° probe material SS		
For models:	F10D-64ET, F10D-64ETX, F10T-63EM, F10T-63ET, F10T-63ETX, F13-64EM, F13-64ET, F13-74ET, F13-74ETX, F13T-74E, F13T-74ET, F13T-74ETX, F18-74ET, F18-74ETX, F18-94ET, F18-94ETX, F18-94G, F18D-64ET, F2-10D-66ET, F2-10D-66ETX, F2-10T-66EM, F2-10T-66ET, F2-10T-66ETX, F2-13-78ET, F2-13-78ETX, F2-13-98ET, F2-13T-78E, F2-13T-78ET, F2-18-74ET, F2-18-74ETX, F2-18-78ET, F2-18-78ETX, F2-18-98ET, F2-18-98ETX, F2-18-98G, F2-25-98ET, F2-25-98ETX, F2-25-98G, F25-94ET, F25-94ETX, F25-94G, F2-8-74ET, F2-8-94ET, F2-8D-64ET, F2-8T-74ET, F2-8T-74ETX, F2-8T-94ET, F45-78ET, FE-10...(Other models you can see in the webshop)		



GEV No.	375232	Ref. No.	537001600
description	thermostat t.max. 320°C temperature range 55-320°C 1-pole capillary pipe isolatedmm gland nut		
For models:	BRF-64ET, BRF-74ET, BRF-78ET, BRF-94ET, BRF-98ET, BRFD-64ET, BRT-66ET, BRT-66ETX, CF-10EM, CF-10EM-6, CF-10EM-A, CF-10ET, CF-10ET-6, CF-10ET-A, CF-10GEM, CF-10GEM-6, CF-10GEM6-A, CF-10GEM-A, CF2-58GE, CF2-68GEM, CF3-512GEV, CF3-612GEMV, CF4-8ETS, CF4-GEMS, CF-8EM, CF-8EM-A, CF-8ET, CF-8ET-A, CF-8GEM, CF-8GEM-A, CFPB6-79GEM, CW-74ET, CW-74ETX, CW-78ET, CW-78ETX, CW-94ET, CW-98ET, CWT-64ET, CWT-64ETX, CWT-66ET, CWT-66ETX, CWT-68ET, CWT-68ETX, CWT-74ET, CWT-74ETX, CWT-78ET, CWT-78ETX, CWT-94ET, CWT-98ET, FTL-4EM...(Other models you can see in the webshop)		



GEV No.	375270	Ref. No.	40100042
description	thermostat t.max. 295°C temperature range 45-295°C 1-pole 1NO 16A probe ø 4mm probe L 100mm capillary pipe 900mm capillary pipe isolated 350mm gland nut shaft L 23mm shaft position upper rotation 270°		



GEV No.	375231	Ref. No.	537001500
description	thermostat t.max. 90°C temperature range 30-90°C 1-pole 1NO 16A probe ø 6mm probe L 130mm capillary pipe 900mm capillary pipe isolated 600mm gland nut M9x1 shaft L 18mm shaft position upper rotation 270°		
For models:	BM-10EM, BM-4EM, BM-61EM, BM-62EM, BM-62ET, BM-6EM, BM-74EM, BM-74ET, BM-78EM, BM-78ET, BM-8EM, BM-94EM, BM-98EM, BMD-64EM, BMD-84EM, BMT-63EM, BMT-64EM, BMT-66EM, BMT-74EM, BMT-78EM, BMT-94EM, BMT-98EM, BS-4EM, BS-4EMX, BS-61EM, BS-62EM, BS-74EM, BS-94EM, BSD-64EM, BST-64EM, BST-74EM, BST-94EM, CP-61EM, CP-62ET, MP-62, MP-62EM, SV-11, SV-113, SV-12, SV-123, SV-13, SV-23		



55.13_series



GEV No.	375954	Ref. No.	RRC2218-00
description	thermostat t.max. 109°C 1-pole 1CO 16A probe ø 3.03mm probe L 198mm capillary pipe 900mm capillary pipe isolated 610mm gland nut M9x1 shaft ømm shaft Lmm shaft position° shaft position rotation°		
For models:	RDA-5E, RDA-5EM		



GEV No.	375412	Ref. No.	537013500
description	thermostat t.max. 320°C temperature range 50-320°C 3-pole 3NO 16A probe ø 3.1mm probe L 226mm capillary pipe 1480mm capillary pipe isolated 1400mm gland nut shaft ø 6x4.6mm shaft L 23mm shaft position upper rotation 318°		
For models:	FTC-4EM, FTC-4EMX, FTC-4ET, FTC-61EM, FTC-61ET, FTC-62EM, FTC-62ET, FTC-6EM, FTC-6EMX, FTC-6ET, FTC-8EMX, FTC-8ET		



GEV No.	375505	Ref. No.	537006100
description	thermostat t.max. 320°C temperature range 50-320°C 1-pole 1NO 16A probe ø 3mm probe L 160mm capillary pipe 870mm capillary pipe isolatedmm gland nut shaft ø 6x4.6mm shaft L 23mm shaft position upper rotation 270°		
For models:	CF-10EM, CF-10EM-6, CF-10EM-A, CF-10ET, CF-10ET-6, CF-10ET-A, CF-10GEM, CF-10GEM-6, CF-10GEM-A, CF-10GEM-6, CF-10GEM-A, CF-4-8ETS, CF-4-GEMS, CF-62EM, CF-62EM-A, CF-62ET, CF-62ET-A, CF-62GEM, CF-62GEM-A, CF-8EM, CF-8EM-A, CF-8ET, CF-8ET-A, CF-8GEM, CF-8GEM-A, CFC-62EM, CFC-62ET		



GEV No.	375621	Ref. No.	537000900
description	thermostat t.max. 320°C temperature range 50-320°C 3-pole 3NO 16A probe ø 3mm probe L 219mm capillary pipe 1200mm capillary pipe isolated 1200mm gland nut shaft ø 6x4.6mm shaft L 23mm shaft position upper rotation 318°		
For models:	BR-62ET, BR-6ET, BR-6ETX, BR-64ET, BR-64ETX, BR-74ET, BR-74ETX, BR-78ET, BR-78ETX, BR-94ET, BR-94ETX, BRFD-64ET, BRT-66ET, BRT-66ETX, CF4-78ET, CF4-78ETX, CF4-78GE, CF4-78GPE, CF4-98ET, CF4-98ETX, CF4-98GE, CF6-712ET, CF6-712ETV, CF6-712ETVX, CF6-712ETX, CF6-712GEV, CF6-712GPE, CF6-712GPEV, CF6-912ET, CF6-912ETV, CF6-912ETVX, CF6-912GE, CF6-912GEV, CF-712GE, CF-712GPE, CF8-916ET, CF8-916ETV, CF8-916GE, CF8-916GEV, CFC4-78ET, CFC4-78ETX, CFC4-98ET, CFC4-98ETX, CFQ4-78ETX, CFQ4-98ET, CFQ4-98ETX, CFQ6-712ET, CFQ6-712ETV, CFQ6-712ETVX, CFQ6-712ETX, CFQ6-912ET, CFQ6-912ETV, CFQ6-912ETVX...(Other models you can see in the webshop)		

55.34_series

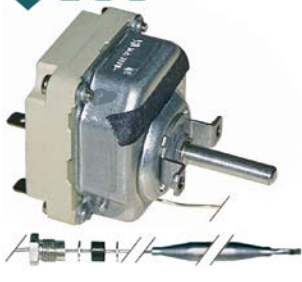

GEV No.	375143	Ref. No.	537012300
description	thermostat t.max. 110°C temperature range 32-110°C 3-pole 3NO 16A probe ø 6mm probe L 138mm capillary pipe 1480mm capillary pipe isolated 1100mm gland nut M9x1 shaft ø 6x4.6mm shaft L 23mm shaft position upper rotation 270°		
For models:	BM-10EMX, BM-4EMX, BM-6EMX, BM-8EMX, CP-4ET, CP-4ETX, CP-62ET, CP-6ET, CP-6ETX, CP-74ET, CP-74ETX, CP-78ET, CP-78ETX, CP-94ET, CP-94ETX, CP-98ET, CP-98ETX, CPD-64ET		





GEV No.	375411	Ref. No.	537000800
description	thermostat t.max. 93°C temperature range 30-93°C 3-pole 3NO 16A probe ø 6mm probe L 129mm capillary pipe 1480mm capillary pipe isolated 1100mm gland nut M10x1 shaft ø 6x4.6mm shaft L 23mm shaft position upper rotation 270°		
For models:	BM-10EMX, BM-4EMX, BM-61EM, BM-62EM, BM-62ET, BM-6EMX, BM-8EMX, BS-4EMX, CP-61EM, CP-62ET		

safety thermostats

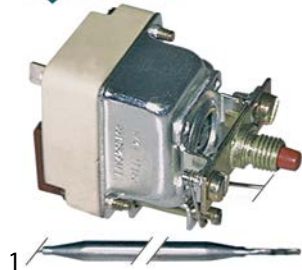
55.10/19_ series



GEV No.	375233	Ref. No.	537001300
description	safety thermostat switch-off temp. 235°C 1-pole 16A probe ø 6mm probe L 133mm capillary pipe 870mm capillary pipe isolated 830mm gland nut probe SS		
For models:	F10T-63EM, F10T-63ET, F10T-63ETX, F13-64EM, F13-64ET, F13-74ET, F13-74ETX, F13T-74E, F13T-74ET, F13T-74ETX, F18-74ET, F18-74ETX, F18-94ET, F18-94ETX, F2-10T-66EM, F2-10T-66ET, F2-10T-66ETX, F2-13-78ET, F2-13-78ETX, F2-13T-78E, F2-13T-78ET, F2-18-74ET, F2-18-74ETX, F2-18-78ET, F2-18-78ETX, F2-18-98ET, F2-18-98ETX, F2-25-98ET, F2-25-98ETX, F25-94ET, F25-94ETX, FEM-2-6, FEM-6, FMPE-25, FMPE-30, FPE-25, FQ-4EM, FQ-61EM, FQ-61ET, FQ-62EM, FQ-62ET, FQ-6EM		

accessories for	375233		
	GEV No.	102067	Ref. No. 533009800
	nut thread M8x1 H 3mm brass Qty 1 pcs type SEF 1		
	GEV No.	551083	Ref. No. —
	cap for safety thermostat thread M8x1		



GEV No.	375352	Ref. No.	537010000
description	safety thermostat switch-off temp. 245°C 1-pole 1NC 16A probe ø 6mm probe L 130mm capillary pipe 1200mm capillary pipe isolated 1200mm gland nut probe		

55.32_ series



GEV No.	375622	Ref. No.	10064
description	safety thermostat switch-off temp. 147°C 1-pole 20A probe ø 6mm probe L 89mm capillary pipe 900mm capillary pipe isolated 800mm gland nut probe		



GEV No.	375393	Ref. No.	537001400
description	safety thermostat switch-off temp. 235°C 3-pole 1CO/2NC 20A probe ø 6mm probe L 87mm capillary pipe 1790mm capillary pipe isolated 1710mm gland nut M9x1 probe SS		
For models:	F10D-64ET, F10D-64ETX, F10T-63EM, F10T-63ET, F10T-63ETX, F13-64EM, F13-64ET, F13-74ET, F13-74ETX, F13T-74E, F13T-74ET, F13T-74ETX, F18-74ET, F18-74ETX, F18-94ET, F18-94ETX, F18D-64ET, F2-10D-66ET, F2-10D-66ETX, F2-10T-66EM, F2-10T-66ET, F2-10T-66ETX, F2-13-78ET, F2-13-78ETX, F2-13-98ET, F2-13T-78E, F2-13T-78ET, F2-18-74ET, F2-18-74ETX, F2-18-78ET, F2-18-78ETX, F2-18-98ET, F2-18-98ETX, F2-25-98ET, F2-25-98ETX, F25-94ET, F25-94ETX, F2-8-74ET, F2-8-94ET, F2-8D-64ET, F2-8T-74ET, F2-8T-74ETX, F2-8T-94ET, FE-10, FE2-10, FE-2-8, FE-8, FME-10, FME-15...(Other models you can see in the webshop)		

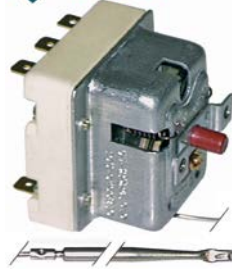

GEV No.	375350	Ref. No.	40100062
description	safety thermostat switch-off temp. 360°C 3-pole 20A probe ø 4mm probe L 120mm capillary pipe 1800mm capillary pipe isolated 1800mm gland nut probe SS		



GEV No.	390227	Ref. No.	40100062
description	safety thermostat switch-off temp. 360°C 3-pole 20A probe ø 4mm probe L 120mm capillary pipe 1800mm capillary pipe isolated 1800mm gland nut probe SS		



GEV No.	390181	Ref. No.	537012700 537012800
description	safety thermostat switch-off temp. 420°C 3-pole 20A probe ø 3.9mm probe L 306mm capillary pipe 870mm capillary pipe isolated 850mm gland nut probe SS		
For models:	BR-62ET, BR-6ET, BR-6ETX, BRF-64ET, BRF-74ET, BRF-78ET, BRF-94ET, BRF-98ET, BRFD-64ET, BRT-66ET, BRT-66ETX, CF4-78ET, CF4-78ETX, CF4-78GE, CF4-78GPE, CF4-98ET, CF4-98ETX, CF4-98GE, CF6-712ET, CF6-712ETV, CF6-712ETVX, CF6-712ETX, CF6-712GEV, CF6-712GPE, CF6-712GPEV, CF6-912ET, CF6-912ETV, CF6-912ETVX, CF6-912GE, CF6-912GEV, CF-712GE, CF-712GPE, CF8-916ET, CF8-916ETV, CF8-916GE, CF8-916GEV, CFC4-78ET, CFC4-78ETX, CFC4-98ET, CFQ4-78ET, CFQ4-78ETX, CFQ4-98ET, CFQ4-98ETX, CFQ6-712ET, CFQ6-712ETV, CFQ6-712ETVX, CFQ6-712ETX, CFQ6-912ET, CFQ6-912ETV, CFQ6-912ETVX...(Other models you can see in the webshop)		

various

safety thermostats



GEV No.	390184	Ref. No.	537012700
description	safety thermostat switch-off temp. 420°C 1-pole		
For models:	FTL-4EM, FTL-4EMS, FTL-61EM, FTL-61EMS, FTL-6EM, FTL-6EMS, FTL-8EM, FTL-8EMS, FTLR-6EM, FTLR-6EMS, FTLR-8EM, FTLR-8EMS, FTR-4EM, FTR-4EMS, FTR-61EM, FTR-61EMS, FTR-6EM, FTR-6EMS		

accessories

gland nut accessories

ducts



GEV No.	550336	Ref. No.	533008500+533010900
description	gland duct ET M14x1 IT M10x1 with gasket and nut		
spare parts for	550336		
GEV No.	510417	Ref. No.	—
description	flat gasket fibre ED ø 20mm ID ø 14mm thickness 2mm Qty 1 pcs		



GEV No.	550335	Ref. No.	533008400
description	gland duct ET M14x1 IT M9x1 chrome-plated brass		
For models:	BM-10EM, BM-4EM, BM-61EM, BM-62EM, BM-6EM, BM-74EM, BM-74ET, BM-78EM, BM-78ET, BM-8EM, BS-4EM, BS-61EM, BS-62EM, BS-74EM, BS-94EM, BSD-64EM, BST-64EM, BST-74EM, BST-94EM, FP-62ET, FP-62ETL, FP-6ET, FQ-4EM, FQ-4ET, FQ-4ETX, FQ-61EM, FQ-61ET, FQ-62EM, FQ-62ET, FQ-6EM, FQ-6ET, FQ-6ETX, MP-62, MP-62EM, SV-11, SV-113, SV-12, SV-123, SV-13, SV-23		



GEV No.	100820	Ref. No.	533018400
description	gland duct ET M14x1.5 IT M10x0.75 probe ø max. 6.5mm WS 22		

gaskets



GEV No.	550982	Ref. No.	536005100
description	gasket graphite ø 7.5mm L 7mm Qty 1 pcs for gland nut		
For models:	BM-10EM, BM-10EMX, BM-4EM, BM-4EMX, BM-4G, BM-61EM, BM-61GF, BM-62EM, BM-62ET, BM-62GF, BM-6EM, BM-6EMX, BM-6G, BM-74EM, BM-74ET, BM-74G, BM-78EM, BM-78ET, BM-78G, BM-8EM, BM-8EMX, BM-8G, BM-94G, BM-98G, BMT-64G, BMT-66G, BMT-74G, BMT-78G, BMT-94G, BMT-98G, BS-4EM, BS-4EMX, BS-61EM, BS-62EM, BS-74EM, BSD-64EM, CP-6G, F11-54G, F13-64G, F13-74G, F13T-74G, F13T-94G, F18-74G, F18-94G, F2-13-78G, F2-13T-78G, F2-13T-98G, F2-18-78G, F2-18-98G, F2-25-98G...(Other models you can see in the webshop)		



bolts with slot



GEV No.	520243	Ref. No.	533008600
description	bolt with slot thread M9x1 Qty 10 pcs nickel-plated brass		
For models:	BM-74EM, BM-74ET, BM-78EM, BM-78ET, BS-74EM, BSD-64EM, CP-6G, F11-54G, F13-64G, F13-74G, F13T-74G, F13T-94G, F18-74G, F18-94G, F2-13-78G, F2-13T-78G, F2-13T-98G, F2-18-78G, F2-18-98G, F2-25-98G, F25-94G, F2-8-74G, F2-8-94G, F2-8T-66G, F2-8T-74G, F2-8T-94G, F45-78G, F8T-63G, FP-6G, FQ-4G, FQ-6G, FQM-4G, SV-11, SV-113, SV-12, SV-123, SV-13, SV-23		
accessories for	520243		
	GEV No.	510591	Ref. No. —
	washer with slot ED ø 8.8mm slit width 1.2mm Qty 10		
	GEV No.	510592	Ref. No. —
	gasket ø 8x8.7mm Qty 10 pcs slotted silicone		

connecting bows



GEV No.	550060	Ref. No.	537001200
description	connecting bow long for thermostat Qty 1 pcs		
For models:	BM-10EM, BM-10EMX, BM-4EM, BM-4EMX, BM-61EM, BM-62EM, BM-62ET, BM-6EM, BM-6EMX, BM-74EM, BM-74ET, BM-78EM, BM-78ET, BM-8EM, BM-8EMX, BM-94EM, BM-98EM, BMD-64EM, BMD-84EM, BMT-63EM, BMT-64EM, BMT-66EM, BMT-74EM, BMT-78EM, BMT-94EM, BMT-98EM, BR-62ET, BR-6ET, BR-6ETX, BR-64ET, BR-74ET, BR-78ET, BR-94ET, BR-98ET, BRFD-64ET, BRT-66ET, BRT-66ETX, BS-4EM, BS-4EMX, BS-61EM, BS-62EM, BS-74EM, BS-94EM, BSD-64EM, BST-64EM, BST-74EM, BST-94EM, CF4-78ET, CF4-78GE, CF4-98ET...(Other models you can see in the webshop)		

switches and momentary switches

rocker/momentary rocker switches

30x11mm



GEV No.	301014	Ref. No.	537015600
description	momentary rocker switch mounting measurements 30x11mm black 1NO 250V 16A connection male faston 6.3mm ambient temperature max. 85/125°C protection IP40 mounting ømm male faston 6.3mm		

30x22mm



GEV No.	301003	Ref. No.	537001700
description	rocker switch mounting measurements 30x22mm green 2NO 250V 16A illuminated 0-I connection male faston 6.3mm ambient temperature max. 125/55°C protection IP65		
accessories for	301003		
	GEV No.	301036	Ref. No. —
	protective cover internal size 30x22mm for rocker switch mounting measurementsmm		



GEV No.	345189	Ref. No.	537015600
description	momentary rocker switch mounting measurements 30x22mm black 2NO 250V 16A ignition connection male faston 6.3mm ambient temperature max. 125/55°C protection IP40 mounting ømm		
For models:	CF-10EM, CF-10EM-6, CF-10EM-A, CF-10ET, CF-10ET-6, CF-10ET-A, CF-10G6-A, CF-10G-6F, CF-10G-A, CF-10GEM, CF-10GEM-6, CF-10GEM6-A, CF-10GEM-A, CF-10GF, CF4-68G, CF4-68GEM, CF4-78G, CF4-78GE, CF4-8G, CF4-8GEM, CF4-GEMS, CF-62GEM, CF-62GEM-A, CF6-610G, CF6-610GEM, CF6-712G, CF6-712GEV, CF6-712GV, CF-712GE, CF-8EM, CF-8EM-A, CF-8ET, CF-8ET-A, CF-8G-A, CF-8GEM, CF-8GEM-A, CF-8GF, CFM-10GEM, CFM-10GEM-6, CFM-10GEM6-A, CFM-10GEM-A, CFM4-66GEM, CFM4-68GEM, CFM6-610GEM, CFM-8GEM, CFM-8GEM-A, F18-94G, F2-18-98G, F2-25-98G, F25-94G...(Other models you can see in the webshop)		
accessories for	345189		
	GEV No.	301036	Ref. No. —
	protective cover internal size 30x22mm for rocker switch mounting measurementsmm		





GEV No.	301098	Ref. No.	537015900
description	momentary rocker switch mounting measurements 30x22mm black 2NO 250V 16A water connection male faston 6.3mm ambient temperature max. 125/55°C protection IP40		
For models:	BM-74EM, BM-74ET, BM-74G, BM-78EM, BM-78ET, BM-78G, BS-74EM, CP-74ET, CP-74G, CP-78ET, CP-78G, FTL-94ETX, FTL-98ETX, FTLR-98ETX, FTR-94ETX, FTR-98ETX		



GEV No.	345188	Ref. No.	537015500
description	rocker switch mounting measurements 30x22mm red 2NO 250V 16A illuminated lighting connection male faston 6.3mm ambient temperature max. 150°C protection IP40		
For models:	CF-10EM, CF-10EM-6, CF-10EM-A, CF-10ET, CF-10ET-6, CF-10ET-A, CF-10G6-A, CF-10G-6F, CF-10G-A, CF-10GEM, CF-10GEM-6, CF-10GEM6-A, CF-10GEM-A, CF-10GF, CF4-8ETS, CF4-8G, CF4-8GEM, CF4-GEMS, CF-8EM, CF-8EM-A, CF-8ET, CF-8ET-A, CF-8G-A, CF-8GEM, CF-8GEM-A, CF-8GF		







blank			
			
1			
GEV No.	345982	Ref. No.	537001700
description	rocker switch mounting measurements 30x22mm green 2CO 250V 16A illuminated connection male faston 6.3mm ambient temperature max. 125/55°C protection IP65 with cover cap		
For models:	BS-74EM, BS-94EM, BSD-64EM, BST-64EM, BST-74EM, BST-94EM, CF-10G6-A, CF-10G-6F, CF-10G-A, CF-10GF, CF4-68G, CF4-8G, CF6-610G, CF-8G-A, CF-8GF, IP-EM, K-10, K-10S, K-12, K-12S, K-14, K-14S, K-15, K-15S, K-16, K-16S, K-18, K-18S, K-20, K-20S, K-22, K-22S, K-24, K-24S, K-26, K-26S, K-28, K-28S, K-30, K-30S, K-6, K-6S, K-8, K-8S, K-9, K-9S, KE-10, KE-10S, KE-12, KE-12S...(Other models you can see in the webshop)		
accessories for	345982		
	GEV No.	301036	Ref. No.
			—
	 protective cover internal size 30x22mm for rocker switch mounting measurementsmm		

pin-plunger actuated			
M10			
			
1			
GEV No.	345032	Ref. No.	537011500
description	microswitch with plunger thread M10x1 thread L 12mm 250V 16A 1CO connection male faston 6.3mm stroke 7mm mounting distance 22mm L 28mm ambient temperature max. 125°C type SP9603 actuating force: 180g		
For models:	F10D-64ET, F10D-64ETX, F10T-63EM, F10T-63ET, F10T-63ETX, F13-64EM, F13-64ET, F13-74ET, F13-74ETX, F13T-74E, F13T-74ET, F13T-74ETX, F13T-94ET, F18-74ET, F18-74ETX, F18-94ET, F18-94ETX, F18D-64ET, F2-10D-66ET, F2-10D-66ETX, F2-10T-66EM, F2-10T-66ETX, F2-10T-66ETX, F2-13-78ET, F2-13-78ETX, F2-13-98ET, F2-13T-78E, F2-13T-78ET, F2-18-74ET, F2-18-74ETX, F2-18-78ET, F2-18-78ETX, F2-18-98ET, F2-18-98ETX, F2-25-98ET, F2-25-98ETX, F25-94ET, F25-94ETX, F2-8-74ET, F2-8-94ET, F2-8D-64ET, F2-8T-74ET, F2-8T-74ETX, F2-8T-94ET, F45-78ET, FP-62ET, FP-62ETL, FP-6ET, FQ-4EM, FQ-4ET...(Other models you can see in the webshop)		

push/momentary push switches

28.5x28.5mm			
			
1			
GEV No.	345769	Ref. No.	537012500
description	momentary push switch mounting measurements 28.5x28.5mm black 1NO 250V 16A connection male faston 6.3mm ambient temperature max. 150°C protection IP40		
For models:	CP-4ET, CP-4ETX, CP-6ET, CP-6ETX		

cam switches

7-position			
			
1			
GEV No.	300025	Ref. No.	537000300
description	cam switch 7 operating positions 1NO/2CO sequence 0-1-2-3-4-5-6 16A shaft ø 6x4.6mm shaft L 23mm connection screw 7-position ceramic		
For models:	CF-10EM, CF-10EM-6, CF-10EM-A, CF-10ET, CF-10ET-6, CF-10ET-A, CF4-68ET, CF4-68ETX, CF4-78ET, CF4-78ETX, CF4-8ET, CF4-8ETS, CF-62EM, CF-62EM-A, CF-62ET, CF-62ET-A, CF6-610ET, CF6-610ETX, CF6-712ET, CF6-712ETV, CF6-712ETVX, CF6-712ETX, CF-8EM, CF-8EM-A, CF-8ET, CF-8ET-A, CFM-10EM, CFM-10EM-6, CFM-10EM-A, CFM-10ET, CFM-10ET-6, CFM-10ET-A, CFM4-66ET, CFM4-68ET, CFM6-610ET, CFM-8EM, CFM-8EM-A, CFM-8ET, CFM-8ET-A, CFQ4-78ET, CFQ4-78ETX, CFQ6-712ET, CFQ6-712ETV, CFQ6-712ETVX, CFQ6-712ETX, CFV4-78ET, CFV6-712ETV, CFVQ4-78ET, CFVQ6-712ETV, PC-10ET...(Other models you can see in the webshop)		
accessories for	300025		
	GEV No.	112172	Ref. No.
			—
	 knob universal ø 70mm black without adaptor/dial plate		
	GEV No.	112213	Ref. No.
			—
	 knob dial plate silver switch 7-position t.max.°C ED ø 63mm ID ø 45.5mm		
	GEV No.	112311	Ref. No.
			—
	 knob adapter shaft ø 6x4.6mm L 0mm with spring		

microswitches

lever actuated			
			
1			
GEV No.	346333	Ref. No.	537025300
description	microswitch with lever 250V 16A 1NC connection male faston 6.3mm ambient temperature max. 85°C mounting distance 22mm		
For models:	CF-10G6-A, CF-10G-6F, CF-10G-A, CF-10GF, CF-8G-A, CF-8GF		

			
1			
GEV No.	345044	Ref. No.	40100007
description	microswitch with lever 250V 16A 1CO connection male faston 6.3mm ambient temperature max. 85°C mounting distance 25mm type C99ZP3 actuating force: 25g lever length 71mm		



GEV No.	300106	Ref. No.	537027700
description	cam switch 7 operating positions 1NO/2CO sequence 0-1-2-3-4-5-6-7-8-9 16A shaft ø 6x4.6mm shaft L 23mm connection screw 7-position shaft flat upper		
For models:	CF4-98ET, CF4-98ETX, CF6-912ET, CF6-912ETV, CF6-912ETVX, CF8-916ET, CF8-916ETV, CFQ4-98ET, CFQ4-98ETX, CFQ6-912ET, CFQ6-912ETV, CFQ6-912ETVX, CFQ8-916ET, CFQ8-916ETV, CFQ9-916ET, CFV4-98ET, CFV6-912ET, CFV6-912ETV, CFVQ4-98ET, CFVQ6-912ET, CFVQ6-912ETV, PC-912ET, PC-912ETX, PC-916ET, PC-916ETX, PC-94ET, PC-94ETX, PC-98ET, PC-98ETX, PCQ-912ET, PCQ-916ET, PCQ-94ET, PCQ-98ET, PCQD-84ET, PCQD-88ET, PCQT-912ET, PCQT-916ET, PCQT-94ET, PCQT-94ETX, PCQT-98ET, PCQT-98ETX, PCT-912ET, PCT-912ETX, PCT-916ET, PCT-916ETX, PCT-94ET, PCT-94ETX, PCT-98ET, PCT-98ETX		

4 operating positions

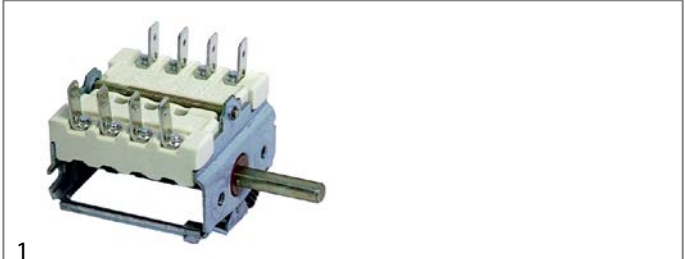

GEV No.	300184	Ref. No.	537034001
description	cam switch 4 operating positions sequence 0-3-2-1 shaft ø 6x4.6mm connection male faston 4-pole		
For models:	CF4-78ET, CF4-78ETX, CF4-78GPE, CF4-98ET, CF4-98ETX, CF4-98GE, CF6-712ET, CF6-712ETV, CF6-712ETVX, CF6-712ETX, CF6-712GPE, CF6-712GPEV, CF6-912ETV, CF6-912ETVX, CF6-912GE, CF6-912GEV, CF8-916ET, CF8-916ETV, CF8-916GE, CF8-916GEV, CFC4-78ET, CFC4-78ETX, CFC4-98ET, CFQ4-78ET, CFQ4-78ETX, CFQ4-98ET, CFQ4-98ETX, CFQ6-712ET, CFQ6-712ETV, CFQ6-712ETVX, CFQ6-712ETX, CFQ6-912ETV, CFQ6-912ETVX, CFQ8-916ET, CFQ8-916ETV, CFV6-912ET, CFV6-912GEV, CFVC4-98ET, CFVQ6-912ET, MF-710ET, TPF2-712GPE, TPF2-712GPEV, TPF2-78GPE, TPF2-912GEV, TPF2-98GE, TPF4-712GPE, TPF4-712GPEV, TPF4-912GE, TPF4-912GEV, TPF-78ET...(Other models you can see in the webshop)		

10 operating positions



GEV No.	300135	Ref. No.	537019200
description	cam switch 10 operating positions 10NO sequence 0-1-2-3-4-5-6-7-8-9 16A shaft ø 6x4.6mm shaft L 23mm connection male faston 6.3mm plastic		
For models:	CF4-8ET, CF4-8GEM, CF-62EM, CF-62EM-A, CF-62ET, CF-62ET-A, CF-62GEM, CF-62GEM-A, CFC4-8ET, CFC-62EM, CFC-62ET, CFM-10EM, CFM-10EM-6, CFM-10EM-A, CFM-10ET, CFM-10ET-6, CFM-10ET-A, CFM-10GEM, CFM-10GEM-6, CFM-10GEM-A, CFM-10GEM-6-A, CFM-8EM, CFM-8EM-A, CFM-8ET, CFM-8ET-A, CFM-8GEM, CFM-8GEM-A		



GEV No.	301205	Ref. No.	537019201
description	cam switch 10 operating positions 5NO/1CO sequence 0-1-2-3-4-5-6-7-8-9 16A shaft ø 6x4.6mm shaft L 23mm connection male faston 6.3mm ceramic		
For models:	CF4-8ET, CF4-8GEM, CF-62EM, CF-62EM-A, CF-62ET, CF-62ET-A, CF-62GEM, CF-62GEM-A, CFC4-8ET, CFC-62EM, CFC-62ET, CFM-10EM, CFM-10EM-6, CFM-10EM-A, CFM-10ET, CFM-10ET-6, CFM-10ET-A, CFM-10GEM, CFM-10GEM-6, CFM-10GEM-A, CFM-10GEM-6-A, CFM2-68GEM, CFM3-612GEMV, CFM4-66ET, CFM4-66GEM, CFM4-68ET, CFM4-68GEM, CFM6-610ET, CFM6-610GEM, CFM-8EM, CFM-8EM-A, CFM-8ET, CFM-8ET-A, CFM-8GEM, CFM-8GEM-A, CFMC4-66ET, MFM-610EM, MFM-68EM, TPFM4-610GEM		

operation switches



GEV No.	300080	Ref. No.	40100006 537000200
description	cam switch 2 operating positions 4NO 16A sequence 0-1 shaft ø 6x4.6mm shaft L 23mm connection screw operation switch ceramic ambient temperature max. 150°C		
For models:	BM-10EMX, BM-4EMX, BM-61EM, BM-62EM, BM-62ET, BM-6EMX, BM-8EMX, BR-62ET, BR-6ET, BR-6ETX, BRF-64ET, BRF-74ET, BRF-78ET, BRF-94ET, BRF-98ET, BRFD-64ET, BRT-66ET, BRT-66ETX, BS-4EMX, CF4-78ET, CF4-78GE, CF4-98ET, CF4-98GE, CF6-712ET, CF6-712ETV, CF6-712ETVX, CF6-712GEV, CF6-912ETV, CF6-912ETVX, CF6-912GEV, CF-712GE, CF8-916ET, CF8-916GE, CFC4-78ET, CFC4-98ET, CFQ4-78ET, CFQ4-98ET, CFQ6-712ET, CFQ6-712ETV, CFQ6-712ETVX, CFQ6-912ETV, CFQ6-912ETVX, CFQ8-916ET, CFV4-78ET, CFV4-78GPE, CFV4-98ET, CFV4-98GE, CFV6-712ETV, CFV6-712GPEV, CFV6-912ETV...(Other models you can see in the webshop)		
accessories for	300080		
		GEV No.	551456
		Ref. No.	—
	gasket for switch ED ø 14mm ID ø 2.5mm thickness 3.5mm white		



GEV No.	300119	Ref. No.	537005700
description	operation switch 6 operating positions 5NO 16A sequence 0-1-2-3-4-5 shaft ø 6x4.6mm shaft L 23mm connection male faston 6.3mm plastic ambient temperature max. 318°C		
For models:	CF-10EM, CF-10EM-6, CF-10EM-A, CF-10ET, CF-10ET-6, CF-10ET-A, CF-10GEM, CF-10GEM-6, CF-10GEM-A, CF-10GEM-6-A, CF2-58GE, CF2-68GEM, CF3-512GEV, CF3-612GEMV, CF4-8ETS, CF4-GEMS, CF-8EM, CF-8EM-A, CF-8ET, CF-8ET-A, CF-8GEM, CF-8GEM-A, CFPB6-79GEM		





1

GEV No.	300091	Ref. No.	537000400
description	operation switch EGO 2 operating positions 2NO 16A sequence 0-1 shaft ϕ 6x4.6mm shaft L 23mm connection screw ceramic		
For models:	BM-10EM, BM-4EM, BM-61EM, BM-62EM, BM-62ET, BM-6EM, BM-74EM, BM-74ET, BM-78EM, BM-78ET, BM-8EM, BM-94EM, BM-98EM, BMD-64EM, BMD-84EM, BMT-63EM, BMT-64EM, BMT-66EM, BMT-74EM, BMT-78EM, BMT-94EM, BMT-98EM, BRF-64ET, BRF-74ET, BRF-78ET, BRF-94ET, BRF-98ET, BRFD-64ET, BRT-66ET, BRT-66ETX, BS-4EM, BS-4EMX, BS-61EM, BS-62EM, BS-74EM, BS-94EM, BSD-64EM, BST-64EM, BST-74EM, BST-94EM, CP-61EM, CP-62ET, CP-66ET, CP-74ET, CP-74ET-USA, CP-76ET, CP-78ET, CP-78ET-USA, CP-94ET, CP-94ET-USA...(Other models you can see in the webshop)		

accessories

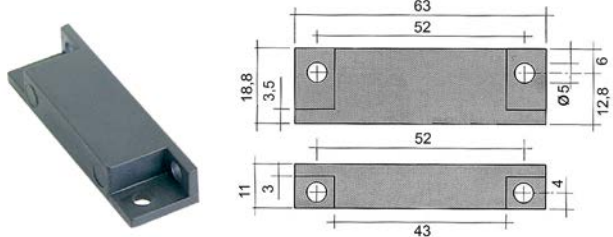
magnets



1

GEV No.	345336	Ref. No.	537015800
description	magnet ϕ 4.8mm L 63mm H 11mm W 18.8mm hole distance 51mm M4		
For models:	FE-10, FE2-10, FE-2-8, FE-8, FEM-2-6, FEM-6, FME-10, FME-15, FME-2-10, FME-2-15, FMPE-20, FMPE-25, FMPE-30, FPE-20, FPE-25		

magnetic switches

65x20mm

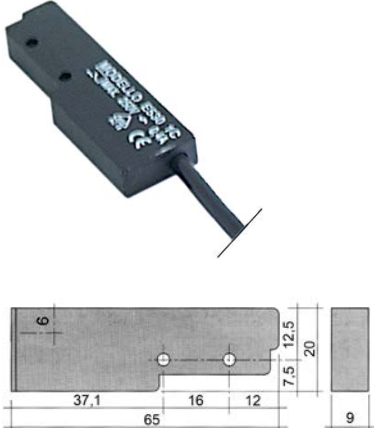

1

GEV No.	345116	Ref. No.	537015700	
description	magnetic switch L 65mm W 20mm 1NO 250V 0.4A P max. 100W connection cable cable length 3000mm			
For models:	FE-10, FE2-10, FE-2-8, FE-8, FEM-2-6, FEM-6, FME-10, FME-15, FME-2-10, FME-2-15, FMPE-20, FMPE-25, FMPE-30, FPE-20, FPE-25			
accessories for	345116			
	GEV No.	345399	Ref. No.	—
	magnet ϕ 3.3mm L 40mm H 8mm W 13mm hole distance 30mm M3			

lamps

indicator lights

indicator lights 2-piece (lens and indicator lamp)

indicator lamps for socket type SRZ / SDK / SDY / SFK



1

GEV No.	359133	Ref. No.	40200154
description	indicator lamp 400V green connection male faston 6.3mm		

indicator lights (complete)

ϕ 10mm

with screw socket



1

GEV No.	360725	Ref. No.	537031901
description	indicator light ϕ 12mm red 12V connection 2.8x0.8 cable length 150mm temp.-resist. 150°C plastic screw base		
For models:	CP-66ET, CP-66G, CP-74ET, CP-74ET-USA, CP-74G, CP-76ET, CP-76G, CP-78, CP-78ET, CP-78ET-USA, CP-94ET, CP-94ET-USA, CP-94G, CP-98ET, CP-98ET-USA, CP-98G, CPA-66ET, CPA-66G, CPA-74ET, CPA-74G, CPA-76ET, CPA-76G, CPA-78ET, CPA-78G, CPA-94ET, CPA-94G, CPA-98ET, CPA-98G, CPB-98ET, CPB-98G, CPBA-98ET, CPBA-98G, CPP-94G, CPP-94G-USA, CPT-64EM-USA, CPT-64ET, CPT-66ET, CPT-74ET, CPT-76ET, PCI-74ET, PCI-74ETD, PCI-78ET, PCI-78ETD, PCI-94ET, PCI-94ETD, PCI-98ET, PCI-98ETD, PCID-64ET, PCID-64ETD, PCID-68ET...(Other models you can see in the webshop)		



with plug-in socket



1

GEV No.	359036	Ref. No.	537014100 537017600
description	indicator light ø 10mm clear 230V connection male faston 6.3mm Qty 1 pcs		
For models:	BM-10EM, BM-10EMX, BM-4EM, BM-4EMX, BM-61EM, BM-62EM, BM-62ET, BM-6EM, BM-6EMX, BM-74EM, BM-74ET, BM-78EM, BM-78ET, BM-8EM, BM-8EMX, BM-94EM, BM-98EM, BMD-64EM, BMD-84EM, BMT-63EM, BMT-64EM, BMT-66EM, BMT-74EM, BMT-78EM, BMT-94EM, BMT-98EM, BR-62ET, BR-6ET, BR-6ETX, BRF-64ET, BRF-74ET, BRF-78ET, BRF-94ET, BRF-98ET, BRFD-64ET, BRT-66ET, BRT-66ETX, BS-4EM, BS-4EMX, BS-61EM, BS-62EM, BS-74EM, BS-94EM, BSD-64EM, BST-64EM, BST-74EM, BST-94EM, CF-10EM, CF-10EM-6, CF-10EM-A...(Other models you can see in the webshop)		



2

GEV No.	359139	Ref. No.	537014200 537017500
description	indicator light ø 10mm green 230V connection male faston 6.3mm Qty 1 pcs		
For models:	BM-10EM, BM-10EMX, BM-4EM, BM-4EMX, BM-61EM, BM-62EM, BM-62ET, BM-6EM, BM-6EMX, BM-74EM, BM-74ET, BM-78EM, BM-78ET, BM-8EM, BM-8EMX, BM-94EM, BM-98EM, BMD-64EM, BMD-84EM, BMT-63EM, BMT-64EM, BMT-66EM, BMT-74EM, BMT-78EM, BMT-94EM, BMT-98EM, BR-62ET, BR-6ET, BR-6ETX, BRF-64ET, BRF-74ET, BRF-78ET, BRF-94ET, BRF-98ET, BRFD-64ET, BRT-66ET, BRT-66ETX, BS-4EM, BS-4EMX, BS-61EM, BS-62EM, BS-74EM, BS-94EM, BSD-64EM, BST-64EM, BST-74EM, BST-94EM, CF-10EM, CF-10EM-6, CF-10EM-A...(Other models you can see in the webshop)		



1

GEV No.	359089	Ref. No.	537001800
description	indicator light ø 10mm 230V clear		
For models:	TS-1		

ø12mm

with screw socket



1

GEV No.	359291	Ref. No.	40200152
description	indicator light ø 12mm 400V green connection male faston 6.3mm		



1

GEV No.	359290	Ref. No.	40200150
description	indicator light ø 12mm 400V yellow connection male faston 6.3mm		

screw-on/push-on fit

light bulbs

for ovens



1

GEV No.	359610	Ref. No.	537005400
description	light bulb t.max. 300°C socket E14 15W 230V ø 22mm L 47mm lens L 20mm for oven lamp type Philips		
For models:	CF-10EM, CF-10EM-6, CF-10EM-A, CF-10ET, CF-10ET-6, CF-10ET-A, CF-10G6-A, CF-10G-6F, CF-10G-A, CF-10GEM, CF-10GEM-6, CF-10GEM6-A, CF-10GEM-A, CF-10GF, CF4-68ET, CF4-68G, CF4-68GEM, CF4-8ET, CF4-8ETS, CF4-8G, CF4-8GEM, CF4-GEMS, CF-62EM, CF-62EM-A, CF-62ET, CF-62ET-A, CF-62GEM, CF-62GEM-A, CF6-610ET, CF6-610G, CF6-610GEM, CF-8EM, CF-8EM-A, CF-8ET, CF-8ET-A, CF-8G-A, CF-8GEM, CF-8GEM-A, CF-8GF, CFC4-8ET, CFC-62EM, CFC-62ET, CFM-10EM, CFM-10EM-6, CFM-10EM-A, CFM-10ET, CFM-10ET-6, CFM-10ET-A, CFM-10GEM, CFM-10GEM-6...(Other models you can see in the webshop)		



1

GEV No.	359612	Ref. No.	LAMPA001
description	light bulb t.max. 300°C socket E14 25W 230V ø 25mm L 56mm lens L 30mm for oven lamp type Philips		

halogen lamp

for socket G4 / G6.35 / G9



1

GEV No.	359074	Ref. No.	C5252-00
description	halogen lamp socket G6.35 12V 35W temp.-resist. 500°C		





oven lamps

universal oven lamps

mounting diameter 35.5mm



GEV No.	359718	Ref. No.	537007900
description	oven lamp mounting ø 35.5mm 230V 15W socket E14 temp.-resist. 300°C connection male faston 6.3mm hard glas		
For models:	CF-10EM, CF-10EM-6, CF-10EM-A, CF-10ET, CF-10ET-6, CF-10ET-A, CF-10G6-A, CF-10G-6F, CF-10G-A, CF-10GEM, CF-10GEM-6, CF-10GEM6-A, CF-10GEM-A, CF-10GF, CF4-68ET, CF4-68ETX, CF4-68G, CF4-68GEM, CF4-8ET, CF4-8ETS, CF4-8G, CF4-8GEM, CF4-GEMS, CF-62EM, CF-62EM-A, CF-62ET, CF-62ET-A, CF-62GEM, CF-62GEM-A, CF6-610ET, CF6-610ETX, CF6-610G, CF6-610GEM, CF-8EM, CF-8EM-A, CF-8ET, CF-8ET-A, CF-8G-A, CF-8GEM, CF-8GEM-A, CF-8GF, CFC4-8ET, CFC-62EM, CFC-62ET, CFM-10EM, CFM-10EM-6, CFM-10EM-A, CFM-10ET, CFM-10ET-6, CFM-10ET-A...(Other models you can see in the webshop)		
spare parts for	359718		
	GEV No.	359701	Ref. No. —
	lamp socket socket E14 220-230V mounting ø 35.5mm connection male faston 6.3mm 15W		
	GEV No.	359740	Ref. No. —
	light bulb t.max. 300°C socket E14 15W 230V ø 22mm L 48mm lens L 20mm for oven lamp IMPORT		

lamps

light bulbs



GEV No.	359610	Ref. No.	537005400
description	light bulb t.max. 300°C socket E14 15W 230V ø 22mm L 47mm lens L 20mm for oven lamp type Philips		
For models:	CF-10EM, CF-10EM-6, CF-10EM-A, CF-10ET, CF-10ET-6, CF-10ET-A, CF-10G6-A, CF-10G-6F, CF-10G-A, CF-10GEM, CF-10GEM-6, CF-10GEM6-A, CF-10GEM-A, CF-10GF, CF4-68ET, CF4-68G, CF4-68GEM, CF4-8ET, CF4-8ETS, CF4-8G, CF4-8GEM, CF4-GEMS, CF-62EM, CF-62EM-A, CF-62ET, CF-62ET-A, CF-62GEM, CF-62GEM-A, CF6-610ET, CF6-610G, CF6-610GEM, CF-8EM, CF-8EM-A, CF-8ET, CF-8ET-A, CF-8G-A, CF-8GEM, CF-8GEM-A, CF-8GF, CFC4-8ET, CFC-62EM, CFC-62ET, CFM-10EM, CFM-10EM-6, CFM-10EM-A, CFM-10ET, CFM-10ET-6, CFM-10ET-A, CFM-10GEM, CFM-10GEM-6...(Other models you can see in the webshop)		



GEV No.	359612	Ref. No.	LAMPA001
description	light bulb t.max. 300°C socket E14 25W 230V ø 25mm L 56mm lens L 30mm for oven lamp type Philips		

halogen lamps

for socket G4 / G6.35 / G9

	GEV No.	359074	Ref. No.	C5252-00
description	halogen lamp socket G6.35 12V 35W temp.-resist. 500°C			

residual heat indicators

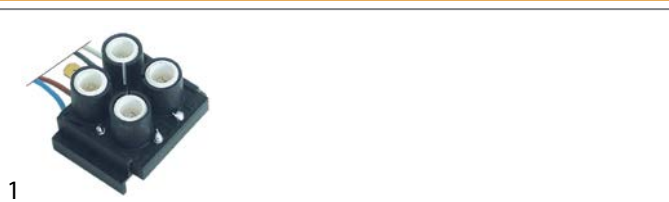

GEV No.	359269	Ref. No.	537020000
description	residual heat indicator 4-fold		
For models:	CFC4-8ET, CFC-62EM, CFC-62ET, PCC-62EM, PCC-62ET, PCC-6EM, PCC-6EMX, PCC-6ET, PCC-8EMX, PCC-8ET		

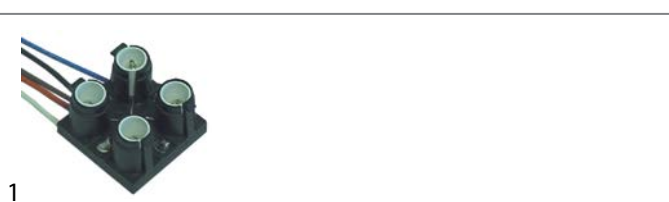

GEV No.	359326	Ref. No.	537020001
description	residual heat indicator 4-fold		
For models:	CFC4-78ET, CFC4-78ETX, CFC4-8ET, CFC4-98ET, CFC-62EM, CFC-62ET, CFMC4-66ET, CFVC4-78ET, CFVC4-98ET, PCC-62EM, PCC-62ET, PCC-6EM, PCC-6EMX, PCC-6ET, PCC-78ET, PCC-8EMX, PCC-8ET, PCC-98ET, PCCT-66ET, PCCT-66ETX, PCCT-78ET, PCCT-98ET		



GEV No.	359327	Ref. No.	537013600 537013601
description	residual heat indicator single		
For models:	PCC-4EM, PCC-4EMX, PCC-4ET, PCC-61EM, PCC-74ET, PCC-94ET, PC-CD-64ET, PC-CD-68ET, PCCT-63ET, PCCT-63ETX, PCCT-74ET, PCCT-94ET		



GEV No.	359436	Ref. No.	537013600
description	residual heat indicator single		
For models:	PCC-4EM, PCC-4EMX, PCC-4ET, PCC-61EM		



timers

electric timers



1

GEV No.	362006	Ref. No.	537019301
description	timer ITS operation time 120min 2NO at 250V 16A permanent position no shaft ø 6x4.6mm shaft L 24mm mounting distance 25mm mounting thread M4 connection 6.3x0.8 ambient temperature max. 125°C		
For models:	CF-10EM, CF-10EM-6, CF-10EM-A, CF-10ET, CF-10ET-6, CF-10ET-A, CF-10GEM, CF-10GEM-6, CF-10GEM6-A, CF-10GEM-A, CF4-68ET, CF4-68ETX, CF4-68GEM, CF4-8ET, CF4-8ETS, CF4-8GEM, CF4-GEMS, CF-62EM, CF-62EM-A, CF-62ET, CF-62ET-A, CF-62GEM, CF-62GEM-A, CF6-610ET, CF6-610ETX, CF6-610GEM, CF-8EM, CF-8EM-A, CF-8ET, CF-8ET-A, CF-8GEM, CF-8GEM-A, CFC4-8ET, CFC-62EM, CFC-62ET, CFM-10EM, CFM-10EM-6, CFM-10EM-A, CFM-10ET, CFM-10ET-6, CFM-10ET-A, CFM-10GEM, CFM-10GEM-6, CFM-10GEM6-A, CFM-10GEM-A, CFM2-68GEM, CFM3-612GEMV, CFM4-66ET, CFM4-66GEM, CFM4-68ET...(Other models you can see in the webshop)		

mechanical timers



1

GEV No.	350044	Ref. No.	537000500
description	timer C20 2-pole operation time 15min impulse mechanical 2NO at 250V 16A permanent position no shaft ø 6x4.6mm shaft 6x4.6mm shaft L 20mm mounting distance 28mm connection lateral for toaster		
For models:	TS-1		
accessories for	350044		
	GEV No.	110285	Ref. No. —



1

GEV No.	350061	Ref. No.	537019300
description	timer DTJ with bell 2-pole operation time 120min impulse mechanical 2NO at 250V 16A permanent position yes shaft ø 6x4.6mm shaft 6x4.6mm shaft L 24mm mounting distance 28mm connection lateral		
For models:	CF-10EM, CF-10EM-6, CF-10EM-A, CF-10ET, CF-10ET-6, CF-10ET-A, CF-10GEM, CF-10GEM-6, CF-10GEM6-A, CF-10GEM-A, CF4-8ET, CF4-8ETS, CF4-8GEM, CF4-GEMS, CF-62EM, CF-62EM-A, CF-62ET, CF-62ET-A, CF-62GEM, CF-62GEM-A, CF-8EM, CF-8EM-A, CF-8ET, CF-8ET-A, CF-8GEM, CF-8GEM-A, CFC4-8ET, CFC-62EM, CFC-62ET, CFM-10EM, CFM-10EM-6, CFM-10EM-A, CFM-10ET, CFM-10ET-6, CFM-10ET-A, CFM-10GEM, CFM-10GEM-6, CFM-10GEM6-A, CFM-10GEM-A, CFM-8EM, CFM-8EM-A, CFM-8ET, CFM-8ET-A, CFM-8GEM, CFM-8GEM-A		



1

GEV No.	350013	Ref. No.	537001100
description	timer G 2-pole operation time 15min impulse mechanical 2NO at 250V 16A permanent position no shaft ø 5x3.5mm shaft L 9mm mounting thread M8 connection lateral		
For models:	TS-3, TS-6		

audible timers



1

GEV No.	350075	Ref. No.	531024800
description	audible timer operation time 120min ø 58mm shaft ø 6x4.6mm shaft L 23mm mounting distance 28mm		
For models:	CF2-58G, CF2-58GE, CF2-68G, CF2-68GEM, CF3-512GEV, CF3-512GV, CF3-612GEMV, CF3-612GV, CF4-68G, CF4-78ET, CF4-78G, CF4-78GE, CF4-78GP, CF4-78GP-AUS, CF4-78GP-USA, CF4-8G, CF4-8GEM, CF4-98G, CF6-610G, CF6-712ET, CF6-712ETV, CF6-712G, CF6-712GEV, CF6-712GP, CF6-712GPV, CF6-712GPV-USA, CF6-712GV, CF6-912G, CF6-912GV, CF-712GE, CF8-916G, CF8-916GV, CFA4-78G, CFA4-98G, CFA6-712GV, CFA6-912GV, CFC4-78ET, CFPB6-79G, CFPB6-79GEM, CFQ4-78ET, CFQ6-712ET, CFQ6-712ETV, CFV4-78ET, CFV4-78GPE, CFV4-98ET, CFV4-98GE, CFV6-712ETV, CFV6-712GPEV, CFV6-912ETV, CFVC4-78ET...(Other models you can see in the webshop)		

contactors

ISKRA (FANAL)

power contactors



1

GEV No.	380213	Ref. No.	53.7.0080.00 537010100
description	power contactor resistive load 20A 230VAC (AC3/400V) 8.5A/5.5kW main contacts 3NO auxiliary contacts 1NO connection screw connection type Fanal DSL7 10 type ISKRA K07M 10		
For models:	BRF-78ET, CP-74ET, CP-74ET-USA, CP-76ET, CP-78ET, CP-78ET-USA, CPA-66ET, CPA-74ET, CPA-76ET, CPA-78ET, CPT-64EM-USA, CPT-64ET, CPT-66ET, CPT-74ET, CPT-76ET, CWK-74ET, CWK-78ET, CWK-94ET, CWK-98ET, CWKT-64ET, CWKT-68ET, CWKT-74ET, CWKT-78ET, CWKT-94ET, CWKT-98ET, F10D-64ET, F10D-64ETX, F10T-63EM, F10T-63ET, F10T-63ETX, F13-64EM, F13-64ET, F13-74ET, F13-74ETX, F13T-74E, F13T-74ET, F13T-94ET, F18-74ET, F2-10D-66ET, F2-10D-66ETX, F2-10T-66EM, F2-10T-66ET, F2-10T-66ETX, F2-13-78ET, F2-13-78ETX, F2-13-98ET, F2-13T-78E, F2-13T-78ET, F2-18-78ET, F2-8-74ET...(Other models you can see in the webshop)		



SIEMENS

power contactors



1	GEV No.	380383	Ref. No.	537009500
description	power contactor resistive load 40A 230VAC (AC3/400V) 9A/4kW main contacts 3NO auxiliary contacts connection screw connection type 3RT10-23-1AL20			
For models:	BRF-94ET, BRF-98ET, CP-94ET, CP-94ET-USA, CP-94ETX, CP-98ET, CP-98ET-USA, CP-98ETX, CPA-94ET, CPA-98ET, CPB-98ET, CPBA-98ET, F13-64EM, F13-64ET, F13-74ET, F13-74ETX, F13T-74E, F13T-74ETX, F18-74ET, F18-74ETX, F18-94ET, F18-94ETX, F18D-64ET, F2-13-78ET, F2-13-78ETX, F2-13T-78E, F2-18-74ET, F2-18-74ETX, F2-18-78ET, F2-18-78ETX, F2-18-98ET, F2-18-98ETX, F2-25-98ET, F2-25-98ETX, F25-94ET, F25-94ETX, F45-78ET, FMPE-25, FMPE-30, FP-62ETL, FPE-25, FQ-4EM, FQ-4ET, FQ-61EM, FQ-61ET, FQ-62EM, FQ-62ET, FQ-6EM, FQ-6ET			

probes

accessories

screw connections



1	GEV No.	550339	Ref. No.	533018400
description	screw connection for probe			
For models:	BM-4G, BM-61GF, BM-62GF, BM-6G, BM-74G, BM-78G, BM-8G, BM-94G, BM-98G, BMT-64G, BMT-66G, BMT-74G, BMT-78G, BMT-94G, BMT-98G			

electronics

PCBs



1	GEV No.	402297	Ref. No.	537031600 537031700
description	PCB L 70mm W 40mm			
For models:	CFC4-98ET, CFVC4-98ET, FTC-74ET, FTC-78ET, FTC-94ET, FTC-98ET, FTCT-64ET, FTCT-66ET, FTCT-74ET, FTCT-78ET, FTCT-94ET, FTCT-98ET, PCC-94ET, PCC-98ET, PCCT-94ET, PCCT-98ET			

solenoid valves

solenoid valves (water)

RPE



1	GEV No.	370123	Ref. No.	537011600
description	solenoid valve single straight 230VAC inlet 1/2" outlet 1/2" DN10			
For models:	BM-74EM, BM-74ET, BM-74G, BM-78EM, BM-78ET, BM-78G, CP-74ET, CP-74G, CP-78ET, CP-78G			

TP











1	GEV No.	370017	Ref. No.	537012600
description	solenoid valve single straight 230VAC inlet 3/4" outlet 11.5mm DN10 TP p max 10bar			
For models:	CP-4ET, CP-6ET			

spare parts for	370017
	GEV No. 371013 Ref. No. — solenoid coil TP 230VAC 50/60Hz

accessories for	370017
	GEV No. 371220 Ref. No. — reducer TP flow rate 3l/min red tolerance ±15%
	GEV No. 371221 Ref. No. — reducer TP flow rate 5.5l/min yellow tolerance ±15%
	GEV No. 371222 Ref. No. — reducer TP flow rate 6l/min grey tolerance ±15%
	GEV No. 371223 Ref. No. — reducer TP flow rate 10l/min white tolerance ±15%
	GEV No. 371224 Ref. No. — reducer TP flow rate 12l/min bronze tolerance ±15%
	GEV No. 371225 Ref. No. — reducer TP flow rate 16l/min light brown tolerance ±15%
	GEV No. 371226 Ref. No. — reducer TP flow rate 20l/min red tolerance ±15%
	GEV No. 371230 Ref. No. — reducer TP flow rate 0.25l/min red tolerance ±25%

Table continues overleaf



accessories for		370017	
	GEV No.	371231	Ref. No. —
reducer TP flow rate 0.35l/min violet tolerance $\pm 25\%$			
	GEV No.	371232	Ref. No. —
reducer TP flow rate 0.5l/min orange tolerance $\pm 25\%$			
	GEV No.	371233	Ref. No. —
reducer TP flow rate 0.8l/min white tolerance $\pm 25\%$			
	GEV No.	371234	Ref. No. —
reducer TP flow rate 1l/min light blue tolerance $\pm 25\%$			
	GEV No.	371235	Ref. No. —
reducer TP flow rate 1.2l/min brown tolerance $\pm 25\%$			
	GEV No.	371236	Ref. No. —
reducer TP flow rate 1.5l/min light brown tolerance $\pm 25\%$			
	GEV No.	371237	Ref. No. —
reducer TP flow rate 2.5l/min yellow tolerance $\pm 25\%$			
	GEV No.	371238	Ref. No. —
reducer TP flow rate 3.4l/min dark green tolerance $\pm 25\%$			
	GEV No.	371239	Ref. No. —
reducer TP flow rate 5l/min black tolerance $\pm 25\%$			
	GEV No.	371240	Ref. No. —
reducer TP flow rate 8l/min blue tolerance $\pm 20\%$			

fans

hot air motors

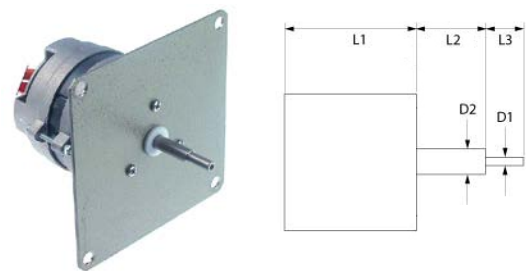

1

GEV No.	500629	Ref. No.	RRC3610-00
description	fan motor 220-240V 1 phase 50/60Hz 0.045/0.0765kW 2800/3400rpm speeds 1 L1 95mm L2 33mm L3 19mm D1 \varnothing 8mm D2 \varnothing 10mm 0.35A suitable capacitor 2.5 μ F/400V type 1048		
For models:	RDA-5E, RDA-5EM, RDE-5E, RDE-5EM, SUTA-4E, SUTA-5E		



1

GEV No.	602179	Ref. No.	C9012-00
description	fan wheel blades 55 D1 \varnothing 240mm D2 \varnothing 9mm D3 \varnothing 11mm H1 60mm H2 24mm		

pressure switches

for steam control





Image not available

1

GEV No.	541346	Ref. No.	16994
description	pressure control pressure range 0.3-0.8bar		



1

GEV No.	541350	Ref. No.	16994
description	pressure control pressure range adjustable 0.3-0.8bar connection 1/4" CO 250V 10A ambient temperature max. 60°C pressure connection 1/4"		



hot air fans

miscellaneous



1

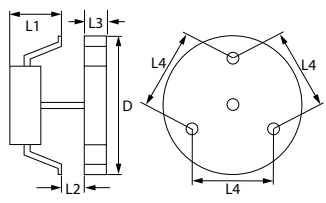

GEV No.	601184	Ref. No.	537006800 537044700+533136500+533136600
description	hot air fan 230V L1 82mm L2 15mm L3 25mm L4 87mm fan wheel ø 150mm Emmevi type 260306X		
For models:	CF4-8ET, CF4-8GEM, CF-62EM, CF-62EM-A, CF-62ET, CF-62ET-A, CF-62GEM, CF-62GEM-A, CFC4-8ET, CFC-62EM, CFC-62ET, CFM-10EM, CFM-10EM-6, CFM-10EM-A, CFM-10ET, CFM-10ET-6, CFM-10ET-A, CFM-10GEM, CFM-10GEM-6, CFM-10GEM6-A, CFM-10GEM-A, CFM2-68GEM, CFM3-612GEMV, CFM4-66ET, CFM4-66GEM, CFM4-68ET, CFM4-68GEM, CFM6-610ET, CFM6-610GEM, CFM-8EM, CFM-8EM-A, CFM-8ET, CFM-8ET-A, CFM-8GEM, CFM-8GEM-A, CFMC4-66ET		

electric accessories

terminals

connection terminals with screw/faston connections



1

GEV No.	550278	Ref. No.	537007600
description	power terminal block 3-pole max. 40A max 400V connection ø6mm ² / F6.3 temp.-resist. 150°C cross section 6mm ²		
For models:	BM-10EM, BM-10EMX, BM-4EM, BM-4EMX, BM-61EM, BM-62EM, BM-62ET, BM-6EM, BM-6EMX, BM-74EM, BM-74ET, BM-74G, BM-78EM, BM-78ET, BM-78G, BM-8EM, BM-8EMX, BM-94EM, BM-98EM, BMT-74EM, BMT-78EM, BMT-94EM, BMT-98EM, BS-4EM, BS-4EMX, BS-61EM, BS-62EM, BS-74EM, BS-94EM, BST-74EM, BST-94EM, CF-10EM, CF-10EM-6, CF-10EM-A, CF-10ET, CF-10ET-A, CF-10G6-A, CF-10G-6F, CF-10G-A, CF-10GEM, CF-10GEM-6, CF-10GEM6-A, CF-10GEM-A, CF-10GF, CF2-58GE, CF3-512GEV, CF4-78G, CF4-8G, CF4-8GEM, CF4-GEMS... (Other models you can see in the webshop)		



1

GEV No.	550411	Ref. No.	537007700 FX0144-00
description	power terminal block 6-pole max. 40A max 450V connection ø6mm ² / F6.3 temp.-resist. 150°C cross section 6mm ²		
For models:	BM-61EM, BM-62EM, BM-62ET, BR-62ET, BR-6ET, BR-6ETX, BR-74ET, BR-78ET, BR-94ET, BR-98ET, CF-10EM, CF-10EM-A, CF-10ET, CF-10ET-6, CF-10ET-A, CF4-78ET, CF4-78GE, CF4-8ET, CF4-8ETS, CF-62EM, CF-62EM-A, CF-62ET, CF-62ET-A, CF6-712ET, CF6-712ETV, CF6-712ET-VX, CF6-712GEV, CF-712GE, CF-8EM, CF-8EM-A, CF-8ET, CF-8ET-A, CFC4-78ET, CFC4-8ET, CFC-62ET, CFM-10EM, CFM-10EM-6, CFM-8ET, CFM-8ET-A, CFQ4-78ET, CFQ6-712ET, CFQ6-712ETV, CFQ6-712ETVX, CP-4ET, CP-4ETX, CP-61EM, CP-62ET, CP-6ET, CP-6ETX, CP-74ET... (Other models you can see in the webshop)		

gas taps

PEL

20S series





1

GEV No.	101094	Ref. No.	531025800 531025900
description	gas tap PEL type 20S gas inlet M16x1.5 (tube ø 10mm) bypass nozzle ø 0.35mm gas outlet M16x1.5 (tube ø 10/8mm) thermocouple connection M8x1 pilot connection shaft ø 8x6.5mm shaft L 22/15mm shaft flat lower		
spare parts for	101094		
GEV No.	100408	Ref. No.	—
description	bypass nozzle type PEL20/21 bore ø 0.35mm thread M5x0.5		
GEV No.	101060	Ref. No.	—
description	magnet unit standard L 39mm D1 ø 15.4mm D2 ø 11mm suitable for PEL20-21/JUNKERS/EGA		
GEV No.	101205	Ref. No.	—
description	gas tap front part shaft ø 8x6.5mm shaft L 22/15mm shaft flat upper/lower suitable for PEL20		
GEV No.	101230	Ref. No.	—
description	thermocouple nut T1: M8x1 T2: M18x1 aluminium		
accessories for	101094		
GEV No.	101278	Ref. No.	533039300
description	olive for pipe ø 10mm Qty 1 pcs		
GEV No.	101300	Ref. No.	533010800
description	union nut thread M16x1.5 tube ø 10mm		
GEV No.	101450	Ref. No.	—
description	olive for pipe ø 8mm L 12.7mm Qty 1 pcs ED ø 10mm		
GEV No.	101451	Ref. No.	—
description	union nut thread M16x1.5 tube ø 8mm		

Table continues overleaf



accessories for	101094		
	GEV No.	110081	Ref. No. 536017100
	knob ø 70mm shaft ø 8x6.5mm shaft flat universal		
	GEV No.	110083	Ref. No. —
	knob dial plate gas tap without ignition flame silver		





GEV No.	101491	Ref. No.	531021600
description	gas tap PEL type 20S gas inlet M16x1.5 (tube ø 10mm) bypass nozzle ø 0.35mm gas outlet M16x1.5 (tube ø 10/8mm) thermocouple connection M9x1 pilot connection shaft ø 8x6.5mm shaft L 22/15mm shaft flat lower		
For models:	F-1G, FB-1G		

spare parts for	101491		
	GEV No.	100408	Ref. No. —
	bypass nozzle type PEL20/21 bore ø 0.35mm thread M5x0.5		

	GEV No.	101060	Ref. No. —
	magnet unit standard L 39mm D1 ø 15.4mm D2 ø 11mm suitable for PEL20-21/JUNKERS/EGA		

	GEV No.	101205	Ref. No. —
	gas tap front part shaft ø 8x6.5mm shaft L 22/15mm shaft flat upper/lower suitable for PEL20		

	GEV No.	101231	Ref. No. —
	thermocouple nut T1: M9x1 T2: M18x1		

accessories for	101491		
	GEV No.	101287	Ref. No. —
	olive for pipe ø 6mm Qty 1 pcs		

	GEV No.	101300	Ref. No. 533010800
	union nut thread M16x1.5 tube ø 10mm		

	GEV No.	101450	Ref. No. —
	olive for pipe ø 8mm L 12.7mm Qty 1 pcs ED ø 10mm		

	GEV No.	101451	Ref. No. —
	union nut thread M16x1.5 tube ø 8mm		

	GEV No.	110081	Ref. No. 536017100
	knob ø 70mm shaft ø 8x6.5mm shaft flat universal		

	GEV No.	110083	Ref. No. —
	knob dial plate gas tap without ignition flame silver		

21S series





GEV No.	101095	Ref. No.	531025800 531025900
description	gas tap PEL type 21S gas inlet M16x1.5 (tube ø 10mm) bypass nozzle ø 0.35mm gas outlet M16x1.5 (tube ø 10/8mm) thermocouple connection M8x1 pilot connection M10x1 shaft ø 8x6.5mm shaft L 22/15mm shaft flat lower		

For models:	CF4-68G, CF4-68GEM, CF4-78G, CF4-78GE, CF4-8G, CF4-8GEM, CF4-GEMS, CF6-610G, CF6-610GEM, CF6-712G, CF6-712GEV, CF6-712GV, CF-712GE, CFM4-66GEM, CFM4-68GEM, CFM6-610GEM, FO-1G, FO-2G, FO-3G, FOS-1G, FOS-2G, FOS-3G, PC-12G, PC-4G, PC-712G, PC-716G, PC-74G, PC-78G, PC-8G, PCT-63G, PCT-66G, TP2-712G, TP4T-610G, TPF2-712G, TPF2-712GV, TPF4-610G, TPF4-610GEM		
--------------------	--	--	--

spare parts for	101095		
	GEV No.	100408	Ref. No. —
	bypass nozzle type PEL20/21 bore ø 0.35mm thread M5x0.5		

	GEV No.	101060	Ref. No. —
	magnet unit standard L 39mm D1 ø 15.4mm D2 ø 11mm suitable for PEL20-21/JUNKERS/EGA		

	GEV No.	101206	Ref. No. —
	gas tap front part shaft ø 8x6.5mm shaft L 22/15mm shaft flat upper/lower suitable for PEL21		

	GEV No.	101230	Ref. No. —
	thermocouple nut T1: M8x1 T2: M18x1 aluminium		

accessories for	101095		
	GEV No.	100908	Ref. No. —
	union screw thread M10x1 for pipe ø 4mm Qty 1 pcs		

	GEV No.	100909	Ref. No. 533018500
	union screw thread M10x1 for pipe ø 6mm Qty 1 pcs		

	GEV No.	101246	Ref. No. —
	olive for pipe ø 4mm Qty 1 pcs		

	GEV No.	101278	Ref. No. 533039300
	olive for pipe ø 10mm Qty 1 pcs		

	GEV No.	101286	Ref. No. —
	olive ID ø 6mm Qty 1 pcs		

	GEV No.	101300	Ref. No. 533010800
	union nut thread M16x1.5 tube ø 10mm		

	GEV No.	101450	Ref. No. —
	olive for pipe ø 8mm L 12.7mm Qty 1 pcs ED ø 10mm		

	GEV No.	101451	Ref. No. —
	union nut thread M16x1.5 tube ø 8mm		



	GEV No.	110081	Ref. No. 536017100
	knob ø 70mm shaft ø 8x6.5mm shaft flat universal		





Table continues overleaf





accessories for	101095
	GEV No. 112206 Ref. No. —
knob dial plate silver gas tap PEL21/22/23 t.max.°C ED ø 63mm ID ø 45.5mm	



GEV No.	101397	Ref. No.	531025500
description	gas tap PEL type 21S gas inlet M16x1.5 (tube ø 10mm) bypass nozzle ø 0.35mm gas outlet M16x1.5 (tube ø 10/8mm) thermocouple connection M9x1 pilot connection M10x1 shaft ø 8x6.5mm shaft L 22/15mm shaft flat lower		
For models:	CP-66G, CP-76G, CPA-66G, CPA-76G, TP2-712G, TP2-712GP, TP2-78GP, TP2-912G, TP2-98G, TP2T-712GP, TP2T-78GP, TP2T-912G, TP2T-98G, TP4-712GP, TP4-912G, TP4T-712GP, TP4T-912G, TP-74G, TP-78G, TP-94G, TP-98G, TPF2-712G, TPF2-712GP, TPF2-712GPE, TPF2-712GPEV, TPF2-712GPV, TPF2-712GV, TPF2-78GP, TPF2-78GPE, TPF2-912G, TPF2-912GE, TPF2-912GEV, TPF2-912GV, TPF2-98G, TPF2-98GE, TPF4-712GP, TPF4-712GPE, TPF4-712GPEV, TPF4-712GPV, TPF4-912G, TPF4-912GE, TPF4-912GEV, TPF4-912GV, TPF-78G, TPF-78GE, TPF-98G, TPF-98GE, TPFV2-712GPEV, TPFV2-78GPE, TPFV2-912GEV...(Other models you can see in the webshop)		





spare parts for	101397
	GEV No. 100408 Ref. No. —
bypass nozzle type PEL20/21 bore ø 0.35mm thread M5x0.5	
	GEV No. 101060 Ref. No. —
magnet unit standard L 39mm D1 ø 15.4mm D2 ø 11mm suitable for PEL20-21/JUNKERS/EGA	
	GEV No. 101206 Ref. No. —
gas tap front part shaft ø 8x6.5mm shaft L 22/15mm shaft flat upper/lower suitable for PEL21	
	GEV No. 101231 Ref. No. —
thermocouple nut T1: M9x1 T2: M18x1	

accessories for	101397
	GEV No. 100908 Ref. No. —
union screw thread M10x1 for pipe ø 4mm Qty 1 pcs	
	GEV No. 100909 Ref. No. 533018500
union screw thread M10x1 for pipe ø 6mm Qty 1 pcs	
	GEV No. 101246 Ref. No. —
olive for pipe ø 4mm Qty 1 pcs	
	GEV No. 101278 Ref. No. 533039300
olive for pipe ø 10mm Qty 1 pcs	
	GEV No. 101286 Ref. No. —
olive ID ø 6mm Qty 1 pcs	
	GEV No. 101300 Ref. No. 533010800
union nut thread M16x1.5 tube ø 10mm	
	GEV No. 101450 Ref. No. —
olive for pipe ø 8mm L 12.7mm Qty 1 pcs ED ø 10mm	
	GEV No. 101451 Ref. No. —
union nut thread M16x1.5 tube ø 8mm	

accessories for	101397
	GEV No. 110081 Ref. No. 536017100
knob ø 70mm shaft ø 8x6.5mm shaft flat universal	
	GEV No. 112206 Ref. No. —
knob dial plate silver gas tap PEL21/22/23 t.max.°C ED ø 63mm ID ø 45.5mm	









GEV No.	101918	Ref. No.	531043000
description	gas tap PEL type 21S gas inlet M16x1.5 (tube ø 10mm) bypass nozzle ø 0.65mm gas outlet M16x1.5 (tube ø 10/8mm) thermocouple connection M9x1 pilot connection M10x1 shaft ø 8x6.5mm shaft L 22/15mm shaft flat right		
For models:	CF2-58G, CF2-58GE, CF2-68G, CF2-68GEM, CF3-512GEV, CF3-512GV, CF3-612GEMV, CF3-612GV, CF4-98G, CF4-98GE, CF6-912G, CF6-912GE, CF6-912GEV, CF6-912GV, CF8-916G, CF8-916GE, CF8-916GEV, CF8-916GV, CFM2-68GEM, CFM3-612GEMV, CFV4-98GE, CFV6-912GEV, PC1T-64G, PC2T-68G, PC3-612G, PC3T-612G, PC-912G, PC-916G, PC-94G, PC-98G, PCT-912G, PCT-916G, PCT-94G, PCT-98G, TP2-912G, TP2-98G, TP2T-912G, TP2T-98G, TP4-912G, TP4T-912G, TPF2-912G, TPF2-912GE, TPF2-912GEV, TPF2-912GV, TPF2-98G, TPF2-98GE, TPF4-610G, TPF4-912G, TPF4-912GE, TPF4-912GEV...(Other models you can see in the webshop)		

spare parts for	101918
	GEV No. 100548 Ref. No. —
bypass nozzle type PEL20/21 bore ø 0.65mm thread M5x0.5	
	GEV No. 101060 Ref. No. —
magnet unit standard L 39mm D1 ø 15.4mm D2 ø 11mm suitable for PEL20-21/JUNKERS/EGA	
	GEV No. 101231 Ref. No. —
thermocouple nut T1: M9x1 T2: M18x1	
	GEV No. 101874 Ref. No. —
gas tap front part shaft ø 8x6.5mm shaft L 22/15mm shaft flat right/left type PEL21	

accessories for	101918
	GEV No. 100908 Ref. No. —
union screw thread M10x1 for pipe ø 4mm Qty 1 pcs	
	GEV No. 100909 Ref. No. 533018500
union screw thread M10x1 for pipe ø 6mm Qty 1 pcs	
	GEV No. 101246 Ref. No. —
olive for pipe ø 4mm Qty 1 pcs	
	GEV No. 101278 Ref. No. 533039300
olive for pipe ø 10mm Qty 1 pcs	
	GEV No. 101286 Ref. No. —
olive ID ø 6mm Qty 1 pcs	
	GEV No. 101300 Ref. No. 533010800
union nut thread M16x1.5 tube ø 10mm	
	GEV No. 101450 Ref. No. —
olive for pipe ø 8mm L 12.7mm Qty 1 pcs ED ø 10mm	

Table continues overleaf

accessories for 101918				
	GEV No.	101451	Ref. No.	—
union nut thread M16x1.5 tube ø 8mm				
	GEV No.	110081	Ref. No.	536017100
knob ø 70mm shaft ø 8x6.5mm shaft flat universal				
	GEV No.	112206	Ref. No.	—
knob dial plate silver gas tap PEL21/22/23 t.max.°C ED ø 63mm ID ø 45.5mm				

accessories for 101917				
	GEV No.	101451	Ref. No.	—
union nut thread M16x1.5 tube ø 8mm				
	GEV No.	110081	Ref. No.	536017100
knob ø 70mm shaft ø 8x6.5mm shaft flat universal				
	GEV No.	112206	Ref. No.	—
knob dial plate silver gas tap PEL21/22/23 t.max.°C ED ø 63mm ID ø 45.5mm				







GEV No.	101917	Ref. No.	531042900
description	gas tap PEL type 21S gas inlet M16x1.5 (tube ø 10mm) bypass nozzle ø 0.6mm gas outlet M16x1.5 (tube ø 10/8mm) thermocouple connection M9x1 pilot connection M10x1 shaft ø 8x6.5mm shaft L 22/15mm shaft flat right		
For models:	CF4-78GP, CF4-78GP-AUS, CF4-78GPE, CF4-78GP-USA, CF4-98G, CF4-98GE, CF6-712GP, CF6-712GPE, CF6-712GPEV, CF6-712GPV, CF6-712GPV-USA, CF6-912G, CF6-912GE, CF6-912GEV, CF6-912GV, CF-712GPE, CF8-916G, CF8-916GE, CF8-916GEV, CF8-916GV, CFA4-78G, CFA4-98G, CFA6-712GV, CFA6-912GV, CFV4-78GPE, CFV4-98GE, CFV6-712GPEV, CFV6-912GEV, PC-712GP, PC-712GP-USA, PC-716GP, PC-716GP-USA, PC-74GP, PC-74GP-USA, PC-78GP, PC-78GP-USA, PC-912G, PC-916G, PC-94G, PC-98G, PCA-712G, PCA-74G, PCA-78G, PCA-912G, PCA-94G, PCA-98G, PCD-64G, PCD-68G, PCT-712GP, PCT-712GP-USA...(Other models you can see in the webshop)		







GEV No.	101919	Ref. No.	531032000
description	gas tap PEL type 21S gas inlet M16x1.5 (tube ø 10mm) bypass nozzle ø 0.75mm gas outlet M16x1.5 (tube ø 10/8mm) thermocouple connection M9x1 pilot connection M10x1 shaft ø 8x6.5mm shaft L 22/15mm shaft flat right		
For models:	BR-6G, BRT-66G, CF2-58G, CF2-58GE, CF2-68G, CF2-68GEM, CF3-512GEV, CF3-512GV, CF3-612GEMV, CF3-612GV, CF4-78GP, CF4-78GP-AUS, CF4-78GPE, CF4-78GP-USA, CF4-98G, CF4-98GE, CF6-712GP, CF6-712GPE, CF6-712GPEV, CF6-712GPV, CF6-712GPV-USA, CF6-912G, CF6-912GE, CF6-912GEV, CF6-912GV, CF-712GPE, CF8-916G, CF8-916GE, CF8-916GEV, CF8-916GV, CFA4-78G, CFA4-98G, CFA6-712GV, CFA6-912GV, CFM2-68GEM, CFM3-612GEMV, CFV4-78GPE, CFV4-98GE, CFV6-712GPEV, CFV6-912GEV, CPT-64G, CPT-74G, CPT-76G, PC1T-64G, PC2T-68G, PC3-612G, PC3T-612G, PC-712GP, PC-712GP-USA, PC-716GP...(Other models you can see in the webshop)		

spare parts for 101917

	GEV No.	100551	Ref. No.	—
bypass nozzle type PEL20/21 bore ø 0.6mm thread M5x0.5				
	GEV No.	101060	Ref. No.	—
magnet unit standard L 39mm D1 ø 15.4mm D2 ø 11mm suitable for PEL20-21/JUNKERS/EGA				
	GEV No.	101231	Ref. No.	—
thermocouple nut T1: M9x1 T2: M18x1				
	GEV No.	101874	Ref. No.	—
gas tap front part shaft ø 8x6.5mm shaft L 22/15mm shaft flat right/left type PEL21				

spare parts for 101919

	GEV No.	100278	Ref. No.	—
bypass nozzle type PEL20/21 bore ø 0.75mm thread M5x0.5				
	GEV No.	101060	Ref. No.	—
magnet unit standard L 39mm D1 ø 15.4mm D2 ø 11mm suitable for PEL20-21/JUNKERS/EGA				
	GEV No.	101231	Ref. No.	—
thermocouple nut T1: M9x1 T2: M18x1				
	GEV No.	101874	Ref. No.	—
gas tap front part shaft ø 8x6.5mm shaft L 22/15mm shaft flat right/left type PEL21				

accessories for 101917

	GEV No.	100908	Ref. No.	—
union screw thread M10x1 for pipe ø 4mm Qty 1 pcs				
	GEV No.	100909	Ref. No.	533018500
union screw thread M10x1 for pipe ø 6mm Qty 1 pcs				
	GEV No.	101246	Ref. No.	—
olive for pipe ø 4mm Qty 1 pcs				
	GEV No.	101278	Ref. No.	533039300
olive for pipe ø 10mm Qty 1 pcs				
	GEV No.	101286	Ref. No.	—
olive ID ø 6mm Qty 1 pcs				
	GEV No.	101300	Ref. No.	533010800
union nut thread M16x1.5 tube ø 10mm				
	GEV No.	101450	Ref. No.	—
olive for pipe ø 8mm L 12.7mm Qty 1 pcs ED ø 10mm				

accessories for 101919











	GEV No.	100908	Ref. No.	—
union screw thread M10x1 for pipe ø 4mm Qty 1 pcs				
	GEV No.	100909	Ref. No.	533018500
union screw thread M10x1 for pipe ø 6mm Qty 1 pcs				
	GEV No.	101246	Ref. No.	—
olive for pipe ø 4mm Qty 1 pcs				
	GEV No.	101278	Ref. No.	533039300
olive for pipe ø 10mm Qty 1 pcs				
	GEV No.	101286	Ref. No.	—
olive ID ø 6mm Qty 1 pcs				
	GEV No.	101300	Ref. No.	533010800
union nut thread M16x1.5 tube ø 10mm				







Table continues overleaf



accessories for 101919				
	GEV No.	101450	Ref. No.	—
olive for pipe ø 8mm L 12.7mm Qty 1 pcs ED ø 10mm				
	GEV No.	101451	Ref. No.	—
union nut thread M16x1.5 tube ø 8mm				
	GEV No.	110081	Ref. No.	536017100
knob ø 70mm shaft ø 8x6.5mm shaft flat universal				
	GEV No.	112206	Ref. No.	—
knob dial plate silver gas tap PEL21/22/23 t.max.°C ED ø 63mm ID ø 45.5mm				

				
1				
GEV No.	107830	Ref. No.	531018900	
description	gas tap PEL type 21S gas inlet M16x1.5 (tube ø 10mm) bypass nozzle ø 0.7mm gas outlet M16x1.5 (tube ø 10/8mm) thermocouple connection M9x1 pilot connection M10x1 shaft ø 8x6.5mm shaft L 22/15mm shaft flat upper			
For models:	BR-62G, CW-61G, CW-62G			
spare parts for	107830			
	GEV No.	100552	Ref. No.	—
bypass nozzle type PEL20/21 bore ø 0.7mm thread M5x0.5				
	GEV No.	101060	Ref. No.	—
magnet unit standard L 39mm D1 ø 15.4mm D2 ø 11mm suitable for PEL20-21/JUNKERS/EGA				
	GEV No.	101230	Ref. No.	—
thermocouple nut T1: M8x1 T2: M18x1 aluminium				
	GEV No.	101877	Ref. No.	—
gas tap front part shaft ø 6x4.6mm type PEL21				
accessories for 107830				
	GEV No.	100908	Ref. No.	—
union screw thread M10x1 for pipe ø 4mm Qty 1 pcs				
	GEV No.	100909	Ref. No.	533018500
union screw thread M10x1 for pipe ø 6mm Qty 1 pcs				
	GEV No.	101246	Ref. No.	—
olive for pipe ø 4mm Qty 1 pcs				
	GEV No.	101278	Ref. No.	533039300
olive for pipe ø 10mm Qty 1 pcs				
	GEV No.	101286	Ref. No.	—
olive ID ø 6mm Qty 1 pcs				
	GEV No.	101300	Ref. No.	533010800
union nut thread M16x1.5 tube ø 10mm				
	GEV No.	101450	Ref. No.	—
olive for pipe ø 8mm L 12.7mm Qty 1 pcs ED ø 10mm				

accessories for 107830				
	GEV No.	101451	Ref. No.	—
union nut thread M16x1.5 tube ø 8mm				



				
1				
GEV No.	101220	Ref. No.	531032100	
description	gas tap PEL type 21S gas inlet M16x1.5 (tube ø 10mm) bypass nozzle ø 1mm gas outlet M16x1.5 (tube ø 10/8mm) thermocouple connection M9x1 pilot connection M10x1 shaft ø 8x6.5mm shaft L 22/15mm shaft flat right			
For models:	CP-74G, CP-74G-USA, CP-78, CP-78G, CP-78G-USA, CP-94G, CP-98G, CPA-74G, CPA-78G, CPA-94G, CPA-98G, CPM-6G, CWT-66G, TP2-712GP, TP2-78GP, TP2-912G, TP2-98G, TP2T-712GP, TP2T-78GP, TP2T-912G, TP2T-98G, TP4-712GP, TP4-912G, TP4T-610G, TP4T-712GP, TP4T-912G, TP-74G, TP-78G, TP-94G, TP-98G, TPF2-712GP, TPF2-712GPEV, TPF2-712GPV, TPF2-78GP, TPF2-78GPE, TPF2-912G, TPF2-912GE, TPF2-912GEV, TPF2-912GV, TPF2-98G, TPF2-98GE, TPF4-610G, TPF4-610GEM, TPF4-712GP, TPF4-712GPE, TPF4-712GPEV, TPF4-712GPV, TPF4-912G, TPF4-912GE, TPF4-912GEV...(Other models you can see in the webshop)			
spare parts for	101220			
	GEV No.	100529	Ref. No.	—
bypass nozzle type PEL20/21 bore ø 1mm thread M5x0.5				
	GEV No.	101231	Ref. No.	—
thermocouple nut T1: M9x1 T2: M18x1				
accessories for 101220				
	GEV No.	101277	Ref. No.	—
olive ID ø 8mm Qty 1 pcs				
	GEV No.	101278	Ref. No.	533039300
olive for pipe ø 10mm Qty 1 pcs				
	GEV No.	101300	Ref. No.	533010800
union nut thread M16x1.5 tube ø 10mm				
	GEV No.	101451	Ref. No.	—
union nut thread M16x1.5 tube ø 8mm				



23S/O series



1			
GEV No.	101091	Ref. No.	10038
description	gas tap PEL type 23S/O gas inlet M28x1.5 (tube ø 20mm) bypass nozzle ø 0.35mm gas outlet M24x1.5 (tube ø 16mm) thermocouple connection M9x1 pilot connection M10x1 shaft ø 10x8mm shaft L 35/19mm shaft flat upper		
spare parts for	101091		
	GEV No.	100455	Ref. No. —
	bypass nozzle type PEL23/24 bore ø 0.35mm thread M8x0.5		
	GEV No.	101045	Ref. No. —
	magnet unit T1: M9x1 T2: M22x1 L 46mm ø 18mm suitable for PEL23S M9x1		
	GEV No.	101244	Ref. No. —
	gas connection thread M24x1.5 tube ø 12/16mm horizontal for PEL gas taps		
	GEV No.	101336	Ref. No. —
	gas tap front part shaft ø 10x8mm shaft L 35/17mm shaft flat upper/lower suitable for PEL23S		
	GEV No.	101463	Ref. No. —
	screw suitable for PEL23S Qty 4 pcs		
	GEV No.	528455	Ref. No. —
	O-ring Viton thickness 2.62mm ID ø 18.72mm Qty 1 pcs		
accessories for	101091		
	GEV No.	100908	Ref. No. —
	union screw thread M10x1 for pipe ø 4mm Qty 1 pcs		
	GEV No.	100909	Ref. No. 533018500
	union screw thread M10x1 for pipe ø 6mm Qty 1 pcs		
	GEV No.	101246	Ref. No. —
	olive for pipe ø 4mm Qty 1 pcs		
	GEV No.	101252	Ref. No. —
	union nut thread M24x1.5 for pipe ø 12mm		
	GEV No.	101253	Ref. No. —
	union nut thread M24x1.5 PEL for pipe ø 16mm		
	GEV No.	101254	Ref. No. —
	union nut thread M28x1.5 tube ø 20mm		
	GEV No.	101255	Ref. No. —
	olive for pipe ø 12mm Qty 1 pcs		
	GEV No.	101256	Ref. No. —
	olive for pipe ø 16mm Qty 1 pcs		
	GEV No.	101257	Ref. No. —
	olive for pipe ø 20mm Qty 1 pcs		

accessories for	101091		
	GEV No.	101286	Ref. No. —
	olive ID ø 6mm Qty 1 pcs		
	GEV No.	110080	Ref. No. —
	knob ø 70mm shaft ø 10x8mm shaft flat universal		
	GEV No.	112206	Ref. No. —
	knob dial plate silver gas tap PEL21/22/23 t.max.°C ED ø 63mm ID ø 45.5mm		

SKG







1			
GEV No.	101825	Ref. No.	531034500
description	gas tap SKG gas inlet pipe flange bypass nozzle ø 0.4mm gas outlet M13x1 IT (tube ø 8mm) thermocouple connection M8x1 shaft ø 6x4.6mm shaft L 30/12mm shaft flat upper		
spare parts for	101825		
	GEV No.	101051	Ref. No. —
	magnet unit L 27mm D1 ø 12.5mm D2 ø 8.5mm suitable for JUNKERS/EGA/MADEC/SABAF standard		
accessories for	101825		
	GEV No.	101038	Ref. No. 537023600
	ignition switch 1NO mounting ømm connection F2.8x0.8		
	GEV No.	101277	Ref. No. —
	olive ID ø 8mm Qty 1 pcs		
	GEV No.	101477	Ref. No. 533016200 533026400
	union screw thread M13x1 tube ø 8mm Qty 1 pcs		
	GEV No.	101827	Ref. No. 536020100
	gasket		
	GEV No.	101828	Ref. No. 533076900
	bracket for pipe flange		



GEV No.	101829	Ref. No.	531034600
description	gas tap SKG gas inlet pipe flange ø16mm bypass nozzle ø 0.32/0.57mm gas outlet 2x M13x1 (tube ø 8mm) thermocouple connection M8x1 pilot connection shaft ø 6x4.6mm shaft L 30/13mm shaft flat upper		
For models:	CF-10G6-A, CF-10G-6F, CF-10G-A, CF-10GEM, CF-10GEM-6, CF-10GEM6-A, CF-10GEM-A, CF-10GF, CF-62GEM, CF-62GEM-A, CF-8G-A, CF-8GEM, CF-8GEM-A, CF-8GF, CFM-10GEM, CFM-10GEM-6, CFM-10GEM6-A, CFM-10GEM-A, CFM-8GEM, CFM-8GEM-A, PC-61GF, PC-62GF		
spare parts for	101829		
	GEV No.	101051	Ref. No. —
	magnet unit L 27mm D1 ø 12.5mm D2 ø 8.5mm suitable for JUNKERS/EGA/MADEC/SABAF standard		
accessories for	101829		
	GEV No.	101038	Ref. No. 537023600
	ignition switch 1NO mounting ømm connection F2.8x0.8		
	GEV No.	101277	Ref. No. —
	olive ID ø 8mm Qty 1 pcs		
	GEV No.	101477	Ref. No. 533016200 533026400
	union screw thread M13x1 tube ø 8mm Qty 1 pcs		
	GEV No.	101827	Ref. No. 536020100
	gasket		
	GEV No.	101828	Ref. No. 533076900
	bracket for pipe flange		



GEV No.	101154	Ref. No.	531002100 531002300
description	gas tap SKG without ignition flame connection		
For models:	CF-10G6-A, CF-10G-6F, CF-10G-A, CF-10GEM, CF-10GEM-6, CF-10GEM6-A, CF-10GEM-A, CF-10GF, CF-62GEM, CF-62GEM-A, CF-8G-A, CF-8GEM, CF-8GEM-A, CF-8GF, CFM-10GEM, CFM-10GEM-6, CFM-10GEM6-A, CFM-10GEM-A, CFM-8GEM, CFM-8GEM-A, PC-61GF, PC-62GF		
spare parts for	101154		
	GEV No.	101060	Ref. No. —
	magnet unit standard L 39mm D1 ø 15.4mm D2 ø 11mm suitable for PEL20-21/JUNKERS/EGA		
accessories for	101154		
	GEV No.	101060	Ref. No. —
	magnet unit standard L 39mm D1 ø 15.4mm D2 ø 11mm suitable for PEL20-21/JUNKERS/EGA		
	GEV No.	101351	Ref. No. 533018100
	mounting strap for gas tap		

accessories for	101154		
	GEV No.	101376	Ref. No. 536000801
	gasket ID ø 8mm ED ø 12mm H 3/5mm		

gas thermostats



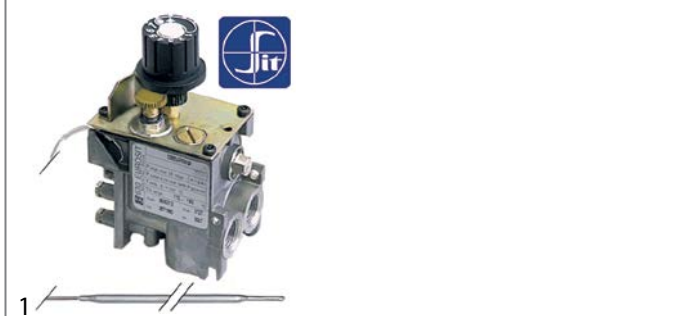

SIT

630 Eurosit series

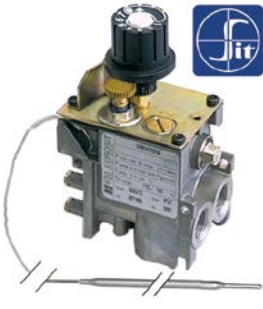

GEV No.	101413	Ref. No.	531025100 531025400
description	gas thermostat type 630 Eurosit series t.max. 100°C 30-100°C gas inlet 3/8" gas outlet 3/8" thermocouple connection M9x1 pilot connection M10x1 probe ø 5mm probe L 122mm capillary pipe 1050mm SIT		
For models:	BM-4G, BM-6G, BM-74G, BM-78G, BM-8G, BM-94G, BM-98G, BMT-64G, BMT-66G, BMT-94G, BMT-98G, CP-6G		
accessories for	101413		
	GEV No.	100904	Ref. No. —
	locking screw M10x1 for pipe ø 4mm Qty 1 pcs		
	GEV No.	100905	Ref. No. —
	locking screw M10x1 for pipe ø 6mm Qty 1 pcs		
	GEV No.	101273	Ref. No. 533017900
	olive for pipe ø 12mm L 9.5mm brass Qty 1 pcs suitable for universal		
	GEV No.	101276	Ref. No. 533018000
	union screw thread 3/8" tube ø 12mm Qty 1 pcs		
	GEV No.	101333	Ref. No. 533053600
	plug thread 3/8" with O-ring		













GEV No.	101188	Ref. No.	531025200
description	gas thermostat type 630 Eurosit series t.max. 190°C 110-190°C gas inlet 3/8" gas outlet 3/8" thermocouple connection M9x1 pilot connection M10x1 probe ø 4mm probe L 202mm capillary pipe 1050mm SIT		
For models:	F11-54G, F13-64G, F13-74G, F13T-74G, F13T-94G, F18-74G, F2-13-78G, F2-13T-78G, F2-13T-98G, F2-18-78G, F2-8-74G, F2-8-94G, F2-8T-66G, F2-8T-74G, F2-8T-94G, F8T-63G, FP-6G, FQ-4G, FQ-6G, FQM-4G		
accessories for	101188		
	GEV No.	100904	Ref. No. —
	locking screw M10x1 for pipe ø 4mm Qty 1 pcs		
	GEV No.	100905	Ref. No. —
	locking screw M10x1 for pipe ø 6mm Qty 1 pcs		
	GEV No.	101273	Ref. No. 533017900
	olive for pipe ø 12mm L 9.5mm brass Qty 1 pcs suitable for universal		
	GEV No.	101276	Ref. No. 533018000
	union screw thread 3/8" tube ø 12mm Qty 1 pcs		
	GEV No.	101333	Ref. No. 533053600
	plug thread 3/8" with O-ring		



GEV No.	107781	Ref. No.	531025201
description	gas thermostat type 630 Eurosit series t.max. 190°C 110-190°C gas inlet 3/8" gas outlet 3/8" thermocouple connection M9x1 pilot connection M10x1 probe ø 4mm probe L 208mm capillary pipe 1000mm SIT operable temperature range 110-190		
For models:	F13-64G, F13-74G, F13T-74G, F13T-94G, F18-74G, F2-13-78G, F2-13T-78G, F2-13T-98G, F2-18-78G, F2-8-74G, F2-8-94G, F2-8T-66G, F2-8T-74G, F2-8T-94G, F8T-63G, FP-6G, FQ-4G, FQ-6G, FQM-4G		



GEV No.	101125	Ref. No.	530100080 531025300
description	gas thermostat type 630 Eurosit series t.max. 340°C 100-340°C gas inlet 3/8" gas outlet 3/8" thermocouple connection M9x1 pilot connection M10x1 probe ø 4mm probe L 72mm capillary pipe 1050mm SIT		
For models:	FTL-4G, FTL-4GS, FTL-54G, FTL-56G, FTL-6G, FTL-6GS, FTL-712G, FTL-712GS, FTL-74G, FTL-74GS, FTL-76G, FTL-78G, FTL-78GS, FTL-8G, FTL-8GS, FTL-916G, FTL-94G, FTL-94GS, FTL-98G, FTL-98GS, FTLR-56G, FTLR-6G, FTLR-6GS, FTLR-712G, FTLR-712GS, FTLR-76G, FTLR-78G, FTLR-78GS, FTLR-8G, FTLR-8GS, FTLR-98G, FTLR-98GS, FTR-4G, FTR-4GS, FTR-54G, FTR-56G, FTR-6G, FTR-6GS, FTR-712G, FTR-712GS, FTR-74G, FTR-74GS, FTR-76G, FTR-78G, FTR-78GS, FTR-8G, FTR-8GS, FTR-94G, FTR-94GS, FTR-98G...(Other models you can see in the webshop)		
accessories for	101125		
	GEV No.	100825	Ref. No. —
	gas tap spindle shaft ø 8x6.5mm shaft L 22/14mm suitable for EUROSIT		
	GEV No.	100904	Ref. No. —
	locking screw M10x1 for pipe ø 4mm Qty 1 pcs		
	GEV No.	100905	Ref. No. —
	locking screw M10x1 for pipe ø 6mm Qty 1 pcs		
	GEV No.	100949	Ref. No. —
	gasket suitable for 630 Eurosit series		
	GEV No.	101273	Ref. No. 533017900
	olive for pipe ø 12mm L 9.5mm brass Qty 1 pcs suitable for universal		
	GEV No.	101276	Ref. No. 533018000
	union screw thread 3/8" tube ø 12mm Qty 1 pcs		
	GEV No.	101333	Ref. No. 533053600
	plug thread 3/8" with O-ring		
	GEV No.	101390	Ref. No. —
	gas tap spindle shaft ø 6x4.6mm shaft L 32/15mm gas tap with ignition flame suitable for ZANUSSI, MARENO for gas thermostat EUROSIT		
	GEV No.	101392	Ref. No. 536017200
	adapter suitable for 630 Eurosit series		
	GEV No.	110357	Ref. No. —
	gas tap spindle shaft ø 8x6.5mm shaft L 36/12mm suitable for 630 Eurosit series		
	GEV No.	110358	Ref. No. —
	adapter shaft ø 10x8mm shaft L 29/18mm suitable for 630 Eurosit series		



710 Minisit series

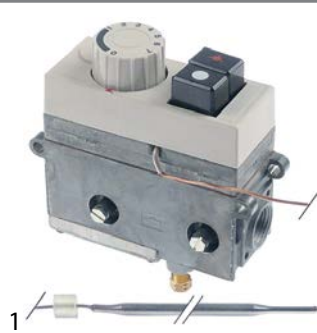

GEV No.	101689	Ref. No.	531001900
description	gas thermostat SIT type MINISIT 710 t.max. 110°C 40-110°C gas inlet 1/2" gas outlet 3/8" thermocouple connection M9x1 pilot connection M10x1 probe ø 5mm probe L 125mm capillary pipe 1050mm probe type type A1 pressure controller no pressure regulator mbar gland nut		
For models:	CP-62G		
spare parts for	101689		
	GEV No.	101053	Ref. No. 531001200
	magnet unit T1: M9x1 T2: M24x1 L 45mm ø 17mm suitable for Minisit		
	GEV No.	102100	Ref. No. 531014200
	probe 30-100°C probe ø 5mm probe L 122mm capillary pipe 1050mm t.max. 100°C bain marie probe type type A1 suitable for MINISIT 710		
accessories for	101689		
	GEV No.	100809	Ref. No. 536000500
	O-ring EPDM thickness 2mm ID ø 21mm Qty 1 pcs		
	GEV No.	100820	Ref. No. 533018400
	gland duct ET M14x1.5 IT M10x0.75 probe ø max. 6.5mm WS 22		
	GEV No.	100904	Ref. No. —
	locking screw M10x1 for pipe ø 4mm Qty 1 pcs		
	GEV No.	100905	Ref. No. —
	locking screw M10x1 for pipe ø 6mm Qty 1 pcs		
	GEV No.	101054	Ref. No. —
	magnet unit T1: M10x1 T2: M24x1 L 45mm ø 17mm suitable for Minisit		
	GEV No.	101136	Ref. No. —
	piezoelectric igniter suitable for Minisit with cover cap ømm connection F6.3x0.8		
	GEV No.	101137	Ref. No. 536000700
	cover cap without piezoelectric igniter		
	GEV No.	101267	Ref. No. —
	reducer IT 3/8" ET 1/2" L 21mm		
	GEV No.	101268	Ref. No. 533018200
	gas connection thread 3/8" angled with O-ring MINISIT 710		
	GEV No.	101269	Ref. No. —
	gas connection thread 1/2" angled with O-ring MINISIT 710		
	GEV No.	101270	Ref. No. —
	screw connection IT 3/8" ET 3/8" L 28mm		

accessories for	101689		
	GEV No.	101272	Ref. No. —
	screw connection IT 1/2" ET 3/8" L 57mm		
	GEV No.	101273	Ref. No. 533017900
	olive for pipe ø 12mm L 9.5mm brass Qty 1 pcs suitable for universal		
	GEV No.	101274	Ref. No. —
	olive for pipe ø 16mm Qty 1 pcs		
	GEV No.	101275	Ref. No. —
	union screw thread 1/2" for pipe ø 16mm Qty 1 pcs		
	GEV No.	101276	Ref. No. 533018000
	union screw thread 3/8" tube ø 12mm Qty 1 pcs		
	GEV No.	110068	Ref. No. 536000600
	knob suitable for Minisit ø 37mm		



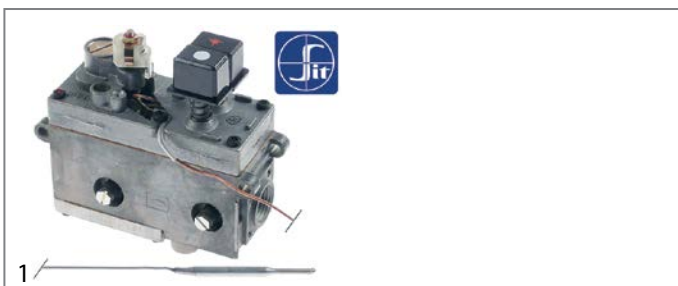

	GEV No.	101135	Ref. No.	531002700
	description	gas thermostat SIT type MINISIT 710 t.max. 190°C 110-190°C gas inlet 1/2" gas outlet 3/8" thermocouple connection M9x1 pilot connection M10x1 probe ø 6mm probe L 102mm capillary pipe 1050mm probe type type A3 pressure controller no pressure regulator mbar gland nut		
	For models:	FG-10, FG-2-10, FMG-10, FMG-15, FMG-2-10, FMG-2-15, FMFG-20, FMFG-30, FP-62G, FPG-20, FPG-30, FQ-61GF, FQ-62GF, FQM-4G		
	spare parts for	101135		
	GEV No.	101053	Ref. No.	531001200
	magnet unit T1: M9x1 T2: M24x1 L 45mm ø 17mm suitable for Minisit			
	GEV No.	102118	Ref. No.	531014100
	probe 110-190°C probe ø 6mm probe L 102mm capillary pipe 1050mm t.max. 190°C fryer probe type type A3 suitable for MINISIT 710			
accessories for	101135			
	GEV No.	100809	Ref. No.	536000500
	O-ring EPDM thickness 2mm ID ø 21mm Qty 1 pcs			
	GEV No.	100820	Ref. No.	533018400
	gland duct ET M14x1.5 IT M10x0.75 probe ø max. 6.5mm WS 22			
	GEV No.	100904	Ref. No.	—
	locking screw M10x1 for pipe ø 4mm Qty 1 pcs			
	GEV No.	100905	Ref. No.	—
	locking screw M10x1 for pipe ø 6mm Qty 1 pcs			
	GEV No.	101054	Ref. No.	—
	magnet unit T1: M10x1 T2: M24x1 L 45mm ø 17mm suitable for Minisit			

Table continues overleaf

accessories for		101135	
	GEV No.	101136	Ref. No. —
piezoelectric igniter suitable for Minisit with cover cap omm connection F6.3x0.8			
	GEV No.	101137	Ref. No. 536000700
cover cap without piezoelectric igniter			
	GEV No.	101267	Ref. No. —
reducer IT 3/8" ET 1/2" L 21mm			
	GEV No.	101268	Ref. No. 533018200
gas connection thread 3/8" angled with O-ring MINISIT 710			
	GEV No.	101269	Ref. No. —
gas connection thread 1/2" angled with O-ring MINISIT 710			
	GEV No.	101270	Ref. No. —
screw connection IT 3/8" ET 3/8" L 28mm			
	GEV No.	101272	Ref. No. —
screw connection IT 1/2" ET 3/8" L 57mm			
	GEV No.	101273	Ref. No. 533017900
olive for pipe ø 12mm L 9.5mm brass Qty 1 pcs suitable for universal			
	GEV No.	101274	Ref. No. —
olive for pipe ø 16mm Qty 1 pcs			
	GEV No.	101275	Ref. No. —
union screw thread 1/2" for pipe ø 16mm Qty 1 pcs			
	GEV No.	101276	Ref. No. 533018000
union screw thread 3/8" tube ø 12mm Qty 1 pcs			
	GEV No.	110068	Ref. No. 536000600
knob suitable for Minisit ø 37mm			



GEV No.	101132	Ref. No.	531002600
description	gas thermostat SIT type MINISIT 710 t.max. 340°C 100-340°C gas inlet 1/2" gas outlet 3/8" thermocouple connection M9x1 pilot connection M10x1 probe ø 5mm probe L 68mm capillary pipe 1050mm probe type type B1 pressure controller no pressure regulator mbar gland nut ignition gas no		
For models:	FTL-61G, FTL-61GF, FTL-61GS, FTL-61GSF, FTL-62G, FTL-62GF, FTL-62GS, FTL-62GSF, FTL-63G, FTL-63GS, FTL-64G, FTL-64GS, FTLR-62G, FTLR-62GF, FTLR-62GS, FTLR-62GSF, FTLR-63G, FTLR-63GS, FTLR-64G, FTLR-64GS, FTR-61G, FTR-61GF, FTR-61GS, FTR-61GSF, FTR-62G, FTR-62GF, FTR-62GS, FTR-62GSF		
spare parts for	101132		
	GEV No.	101053	Ref. No. 531001200
magnet unit T1: M9x1 T2: M24x1 L 45mm ø 17mm suitable for Minisit			

spare parts for		101132	
	GEV No.	102102	Ref. No. 531014000
probe 100-340°C probe ø 5mm probe L 68mm capillary pipe 1750mm t.max. 340°C oven/grill probe type type B1 suitable for MINISIT 710			
accessories for		101132	
	GEV No.	100809	Ref. No. 536000500
O-ring EPDM thickness 2mm ID ø 21mm Qty 1 pcs			
	GEV No.	100904	Ref. No. —
locking screw M10x1 for pipe ø 4mm Qty 1 pcs			
	GEV No.	100905	Ref. No. —
locking screw M10x1 for pipe ø 6mm Qty 1 pcs			
	GEV No.	101054	Ref. No. —
magnet unit T1: M10x1 T2: M24x1 L 45mm ø 17mm suitable for Minisit			
	GEV No.	101136	Ref. No. —
piezoelectric igniter suitable for Minisit with cover cap omm connection F6.3x0.8			
	GEV No.	101137	Ref. No. 536000700
cover cap without piezoelectric igniter			
	GEV No.	101267	Ref. No. —
reducer IT 3/8" ET 1/2" L 21mm			
	GEV No.	101268	Ref. No. 533018200
gas connection thread 3/8" angled with O-ring MINISIT 710			
	GEV No.	101269	Ref. No. —
gas connection thread 1/2" angled with O-ring MINISIT 710			
	GEV No.	101270	Ref. No. —
screw connection IT 3/8" ET 3/8" L 28mm			
	GEV No.	101272	Ref. No. —
screw connection IT 1/2" ET 3/8" L 57mm			
	GEV No.	101273	Ref. No. 533017900
olive for pipe ø 12mm L 9.5mm brass Qty 1 pcs suitable for universal			
	GEV No.	101274	Ref. No. —
olive for pipe ø 16mm Qty 1 pcs			
	GEV No.	101275	Ref. No. —
union screw thread 1/2" for pipe ø 16mm Qty 1 pcs			
	GEV No.	101276	Ref. No. 533018000
union screw thread 3/8" tube ø 12mm Qty 1 pcs			
	GEV No.	110068	Ref. No. 536000600
knob suitable for Minisit ø 37mm			



GEV No.	101130	Ref. No.	531001900 531002800
description	gas thermostat without cap, button and angle SIT type MINISIT 710 t.max. 100°C 30-100°C gas inlet 1/2" gas outlet 3/8" thermocouple connection M9x1 pilot connection M10x1 probe ø 5mm probe L 122mm capillary pipe 1050mm probe type type A1 pressure controller no pressure regulator mbar gland nut		
For models:	BM-61GF, BM-62GF		
spare parts for	101130		
	GEV No.	101053	Ref. No. 531001200
	magnet unit T1: M9x1 T2: M24x1 L 45mm ø 17mm suitable for Minisit		
	GEV No.	102100	Ref. No. 531014200
	probe 30-100°C probe ø 5mm probe L 122mm capillary pipe 1050mm t.max. 100°C bain marie probe type type A1 suitable for MINISIT 710		
accessories for	101130		
	GEV No.	100809	Ref. No. 536000500
	O-ring EPDM thickness 2mm ID ø 21mm Qty 1 pcs		
	GEV No.	100820	Ref. No. 533018400
	gland duct ET M14x1.5 IT M10x0.75 probe ø max. 6.5mm WS 22		
	GEV No.	100904	Ref. No. —
	locking screw M10x1 for pipe ø 4mm Qty 1 pcs		
	GEV No.	100905	Ref. No. —
	locking screw M10x1 for pipe ø 6mm Qty 1 pcs		
	GEV No.	101054	Ref. No. —
	magnet unit T1: M10x1 T2: M24x1 L 45mm ø 17mm suitable for Minisit		
	GEV No.	101136	Ref. No. —
	piezoelectric igniter suitable for Minisit with cover cap ømm connection F6.3x0.8		
	GEV No.	101137	Ref. No. 536000700
	cover cap without piezoelectric igniter		
	GEV No.	101267	Ref. No. —
	reducer IT 3/8" ET 1/2" L 21mm		
	GEV No.	101268	Ref. No. 533018200
	gas connection thread 3/8" angled with O-ring MINISIT 710		
	GEV No.	101269	Ref. No. —
	gas connection thread 1/2" angled with O-ring MINISIT 710		
	GEV No.	101270	Ref. No. —
	screw connection IT 3/8" ET 3/8" L 28mm		
	GEV No.	101272	Ref. No. —
	screw connection IT 1/2" ET 3/8" L 57mm		

accessories for	101130		
	GEV No.	101273	Ref. No. 533017900
	olive for pipe ø 12mm L 9.5mm brass Qty 1 pcs suitable for universal		
	GEV No.	101274	Ref. No. —
	olive for pipe ø 16mm Qty 1 pcs		
	GEV No.	101275	Ref. No. —
	union screw thread 1/2" for pipe ø 16mm Qty 1 pcs		
	GEV No.	101276	Ref. No. 533018000
	union screw thread 3/8" tube ø 12mm Qty 1 pcs		
	GEV No.	110068	Ref. No. 536000600
	knob suitable for Minisit ø 37mm		

GEV No.	101131	Ref. No.	531002700
description	gas thermostat without cap, button and angle SIT type MINISIT 710 t.max. 190°C 50-190°C gas inlet 1/2" gas outlet 3/8" thermocouple connection M9x1 pilot connection M10x1 probe ø 5mm probe L 98mm capillary pipe 1200mm probe type type A2 pressure controller no pressure regulator mbar gland nut		
spare parts for	101131		
	GEV No.	101053	Ref. No. 531001200
	magnet unit T1: M9x1 T2: M24x1 L 45mm ø 17mm suitable for Minisit		
	GEV No.	102103	Ref. No. 531014100
	probe 60-200°C probe ø 5mm probe L 98mm capillary pipe 1050mm t.max. 200°C fryer probe type type A2 suitable for MINISIT 710		
accessories for	101131		
	GEV No.	100809	Ref. No. 536000500
	O-ring EPDM thickness 2mm ID ø 21mm Qty 1 pcs		
	GEV No.	100820	Ref. No. 533018400
	gland duct ET M14x1.5 IT M10x0.75 probe ø max. 6.5mm WS 22		
	GEV No.	100904	Ref. No. —
	locking screw M10x1 for pipe ø 4mm Qty 1 pcs		
	GEV No.	100905	Ref. No. —
	locking screw M10x1 for pipe ø 6mm Qty 1 pcs		
	GEV No.	101054	Ref. No. —
	magnet unit T1: M10x1 T2: M24x1 L 45mm ø 17mm suitable for Minisit		
	GEV No.	101136	Ref. No. —
	piezoelectric igniter suitable for Minisit with cover cap ømm connection F6.3x0.8		
	GEV No.	101137	Ref. No. 536000700
	cover cap without piezoelectric igniter		

Table continues overleaf



accessories for		101131	
	GEV No.	101267	Ref. No. —
reducer IT 3/8" ET 1/2" L 21mm			
	GEV No.	101268	Ref. No. 533018200
gas connection thread 3/8" angled with O-ring MINISIT 710			
	GEV No.	101269	Ref. No. —
gas connection thread 1/2" angled with O-ring MINISIT 710			
	GEV No.	101270	Ref. No. —
screw connection IT 3/8" ET 3/8" L 28mm			
	GEV No.	101272	Ref. No. —
screw connection IT 1/2" ET 3/8" L 57mm			
	GEV No.	101273	Ref. No. 533017900
olive for pipe ø 12mm L 9.5mm brass Qty 1 pcs suitable for universal			
	GEV No.	101274	Ref. No. —
olive for pipe ø 16mm Qty 1 pcs			
	GEV No.	101275	Ref. No. —
union screw thread 1/2" for pipe ø 16mm Qty 1 pcs			
	GEV No.	101276	Ref. No. 533018000
union screw thread 3/8" tube ø 12mm Qty 1 pcs			
	GEV No.	110068	Ref. No. 536000600
knob suitable for Minisit ø 37mm			

accessories

probes

	1		
GEV No.	102102	Ref. No.	531014000
description probe 100-340°C probe ø 5mm probe L 68mm capillary pipe 1750mm t.max. 340°C oven/grill probe type type B1 suitable for MINISIT 710			
For models: FTL-61G, FTL-61GS, FTL-62G, FTL-62GS, FTL-63G, FTL-63GS, FTL-64G, FTL-64GS, FTLR-62G, FTLR-62GS, FTLR-63G, FTLR-63GS, FTLR-64G, FTLR-64GS, FTR-61G, FTR-61GS, FTR-62G, FTR-62GS			

	1		
GEV No.	102101	Ref. No.	531014000
description probe 100-340°C probe ø 5mm probe L 70mm capillary pipe 1000mm t.max. 340°C suitable for MINISIT 710			

	1		
GEV No.	102118	Ref. No.	531014100
description probe 110-190°C probe ø 6mm probe L 102mm capillary pipe 1050mm t.max. 190°C fryer probe type type A3 suitable for MINISIT 710			
For models: FG-10, FG-2-10, FMG-10, FMG-15, FMG-2-10, FMG-2-15, FMPG-20, FMPG-30, FP-62G, FPG-20, FPG-30, FQ-61GF, FQ-62GF, FQM-4G			
accessories for		102118	
	GEV No.	100820	Ref. No. 533018400
gland duct ET M14x1.5 IT M10x0.75 probe ø max. 6.5mm WS 22			

	1		
GEV No.	102100	Ref. No.	531014200
description probe 30-100°C probe ø 5mm probe L 122mm capillary pipe 1050mm t.max. 100°C bain marie probe type type A1 suitable for MINISIT 710			
For models: BM-61GF, BM-62GF, CP-62G, F18-94G			

	1		
GEV No.	102103	Ref. No.	531014100
description probe 60-200°C probe ø 5mm probe L 98mm capillary pipe 1050mm t.max. 200°C fryer probe type type A2 suitable for MINISIT 710			

PEL

24ST series







	1		
GEV No.	101759	Ref. No.	531045700 531045800
description gas thermostat PEL type 24ST 100-300°C gas inlet M20x1.5 (tube ø 12mm) bypass nozzle ø 1.5mm gas outlet M20x1.5 (tube ø 12/10mm) thermocouple connection M9x1 pilot connection M10x1 capillary pipe 1200mm probe ø 6mm probe L 100mm shaft ø 10x8mm shaft L 27/17mm shaft flat upper			
For models: BRF-94G, BRF-98G			
spare parts for		101759	
	GEV No.	100679	Ref. No. —
bypass nozzle type PEL23/24 bore ø 1.5mm thread M8x0.5			
	GEV No.	101058	Ref. No. —
magnet unit L 39mm D1 ø 15.4mm D2 ø 13.5mm suitable for PEL22/EGA24197 standard			
	GEV No.	106200	Ref. No. —
nut thread M9x1 suitable for PEL 24/25S			

Table continues overleaf



accessories for		101759		
	GEV No.	100908	Ref. No.	—
union screw thread M10x1 for pipe ø 4mm Qty 1 pcs				
	GEV No.	100909	Ref. No.	533018500
union screw thread M10x1 for pipe ø 6mm Qty 1 pcs				
	GEV No.	101246	Ref. No.	—
olive for pipe ø 4mm Qty 1 pcs				
	GEV No.	101248	Ref. No.	—
olive for pipe ø 12mm Qty 1 pcs suitable for PEL				
	GEV No.	101249	Ref. No.	—
olive for pipe ø 10mm Qty 1 pcs				
	GEV No.	101250	Ref. No.	—
union nut thread M20x1.5 for pipe ø 10mm				
	GEV No.	101251	Ref. No.	—
union nut thread M20x1.5 for pipe ø 12mm				
	GEV No.	101286	Ref. No.	—
olive ID ø 6mm Qty 1 pcs				
	GEV No.	110079	Ref. No.	—
knob dial plate gas thermostat 1-8 silver				
	GEV No.	110080	Ref. No.	—
knob ø 70mm shaft ø 10x8mm shaft flat universal				

accessories for		101172		
	GEV No.	100908	Ref. No.	—
union screw thread M10x1 for pipe ø 4mm Qty 1 pcs				
	GEV No.	100909	Ref. No.	533018500
union screw thread M10x1 for pipe ø 6mm Qty 1 pcs				
	GEV No.	101246	Ref. No.	—
olive for pipe ø 4mm Qty 1 pcs				
	GEV No.	101278	Ref. No.	533039300
olive for pipe ø 10mm Qty 1 pcs				
	GEV No.	101286	Ref. No.	—
olive ID ø 6mm Qty 1 pcs				
	GEV No.	101300	Ref. No.	533010800
union nut thread M16x1.5 tube ø 10mm				
	GEV No.	101450	Ref. No.	—
olive for pipe ø 8mm L 12.7mm Qty 1 pcs ED ø 10mm				
	GEV No.	101451	Ref. No.	—
union nut thread M16x1.5 tube ø 8mm				
	GEV No.	110079	Ref. No.	—
knob dial plate gas thermostat 1-8 silver				
	GEV No.	110081	Ref. No.	536017100
knob ø 70mm shaft ø 8x6.5mm shaft flat universal				

25ST series				
				
1				
GEV No.	101172	Ref. No.	531031600 531033800 531033900 531034000 531044300 531044400	
description	gas thermostat PEL type 25ST 100-300°C gas inlet M16x1.5 (tube ø 10mm) bypass nozzle ø 0.35mm gas outlet M16x1.5 (tube ø 10/8mm) thermocouple connection M9x1 pilot connection M10x1 capillary pipe 1200mm probe ø 6mm probe L 100mm shaft ø 8x6.5mm shaft L 21/15mm shaft flat upper			
For models:	BRF-64G, BRF-74G, BRF-78G, BRF-94G, BRF-98G, CF4-78G, CF4-78GP, CF4-78GP-AUS, CF4-78GP-USA, CF4-98G, CF6-712G, CF6-712GP, CF6-712GPV, CF6-712GPV-USA, CF6-712GV, CF6-912G, CF6-912GV, CF8-916G, CF8-916GV, CFA4-78G, CFA4-98G, CFA6-712GV, CFA6-912GV, CFPB6-79G, PAF-78G, PAF-98G, TPF2-712G, TPF2-712GPV, TPF2-712GV, TPF2-78GP, TPF2-912G, TPF2-912GE, TPF2-912GV, TPF2-98G, TPF4-712GP, TPF4-712GPV, TPF4-912G, TPF4-912GV, TPF-78G, TPF-98G			
spare parts for	101172			
	GEV No.	100259	Ref. No.	—
bypass nozzle type PEL22 bore ø 0.35mm thread M6x0.5				
	GEV No.	101060	Ref. No.	—
magnet unit standard L 39mm D1 ø 15.4mm D2 ø 11mm suitable for PEL20-21/JUNKERS/EGA				
	GEV No.	106200	Ref. No.	—
nut thread M9x1 suitable for PEL 24/25S				







SABAF				
				
1				
GEV No.	101679	Ref. No.	531031800	
description	gas thermostat SABAF t.max. 300°C gas inlet pipe flange bypass nozzle ø 0.35mm gas outlet 3/8" ET (tube ø 10mm) gas outlet 2 M13x1 IT (tube ø 8mm) thermocouple connection M8x1 (2x) capillary pipe 850mm probe ø 4mm probe L 150mm shaft ø 8x6.5mm shaft flat left L1 34mm L2 14mm			
For models:	CF4-8G, CF4-8GEM			
accessories for	101679			
	GEV No.	101277	Ref. No.	—
olive ID ø 8mm Qty 1 pcs				
	GEV No.	101278	Ref. No.	533039300
olive for pipe ø 10mm Qty 1 pcs				
	GEV No.	101351	Ref. No.	533018100
mounting strap for gas tap				
	GEV No.	101376	Ref. No.	536000801
gasket ID ø 8mm ED ø 12mm H 3/5mm				
	GEV No.	101477	Ref. No.	533016200 533026400
union screw thread M13x1 tube ø 8mm Qty 1 pcs				

Table continues overleaf

accessories for 101679				
	GEV No.	101478	Ref. No.	—
union nut thread 3/8" for pipe ø 10mm				



GEV No.	101175	Ref. No.	531008301 531031700
----------------	--------	-----------------	------------------------

description gas thermostat SABAF t.max. 300°C gas inlet pipe flange bypass nozzle ø 0.35mm gas outlet 3/8" ET (tube ø 10mm) gas outlet 2 M13x1 IT (tube ø 8mm) thermocouple connection M8x1 (2x) capillary pipe 850mm probe ø 4mm probe L 150mm shaft ø 8x6.5mm shaft L 27/13mm shaft flat upper

For models: CF-10G6-A, CF-10G-6F, CF-10G-A, CF-10GF, CF4-8G, CF4-8GEM, CF-8G-A, CF-8GF

spare parts for 101175

	GEV No.	101060	Ref. No.	—
magnet unit standard L 39mm D1 ø 15.4mm D2 ø 11mm suitable for PEL20-21/JUNKERS/EGA				

accessories for 101175

	GEV No.	101277	Ref. No.	—
olive ID ø 8mm Qty 1 pcs				

	GEV No.	101278	Ref. No.	533039300
olive for pipe ø 10mm Qty 1 pcs				

	GEV No.	101375	Ref. No.	533016701
flange for gas tap				

	GEV No.	101376	Ref. No.	536000801
gasket ID ø 8mm ED ø 12mm H 3/5mm				

	GEV No.	101477	Ref. No.	533016200 533026400
union screw thread M13x1 tube ø 8mm Qty 1 pcs				

	GEV No.	101478	Ref. No.	—
union nut thread 3/8" for pipe ø 10mm				

	GEV No.	110328	Ref. No.	536003100
knob gas thermostat 1-10 ø 44mm shaft ø 8x6.5mm shaft flat lower silver				

	GEV No.	693074	Ref. No.	533016800
pipe				

	GEV No.	346333	Ref. No.	537025300
microswitch with lever 250V 16A 1NC connection male faston 6.3mm ambient temperature max. 85°C mounting distance 22mm				

accessories for 101836

	GEV No.	101277	Ref. No.	—
olive ID ø 8mm Qty 1 pcs				

	GEV No.	101278	Ref. No.	533039300
olive for pipe ø 10mm Qty 1 pcs				

	GEV No.	101351	Ref. No.	533018100
mounting strap for gas tap				

	GEV No.	101376	Ref. No.	536000801
gasket ID ø 8mm ED ø 12mm H 3/5mm				

	GEV No.	101477	Ref. No.	533016200 533026400
union screw thread M13x1 tube ø 8mm Qty 1 pcs				

	GEV No.	101478	Ref. No.	—
union nut thread 3/8" for pipe ø 10mm				

	GEV No.	101277	Ref. No.	—
olive ID ø 8mm Qty 1 pcs				

	GEV No.	101837	Ref. No.	531031801
---	----------------	--------	-----------------	-----------

description gas thermostat SABAF t.max. 300°C gas inlet pipe flange bypass nozzle ø 0.45mm gas outlet 3/8" ET (tube ø 10mm) gas outlet 2 M13x1 IT (tube ø 8mm) thermocouple connection M8x1 (2x) capillary pipe 850mm probe ø 4mm probe L 140mm shaft ø 8x6.5mm shaft L 34/14mm shaft flat left

For models: CF4-8G

accessories for 101837

	GEV No.	101277	Ref. No.	—
olive ID ø 8mm Qty 1 pcs				

accessories for 101837				
	GEV No.	101278	Ref. No.	533039300
olive for pipe ø 10mm Qty 1 pcs				

	GEV No.	101351	Ref. No.	533018100
mounting strap for gas tap				

	GEV No.	101376	Ref. No.	536000801
gasket ID ø 8mm ED ø 12mm H 3/5mm				

	GEV No.	101477	Ref. No.	533016200 533026400
union screw thread M13x1 tube ø 8mm Qty 1 pcs				

	GEV No.	101478	Ref. No.	—
union nut thread 3/8" for pipe ø 10mm				

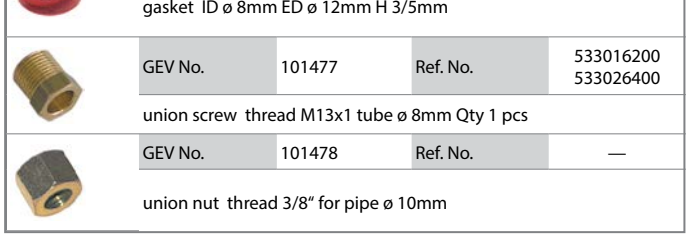

GEV No.	101836	Ref. No.	531031702
----------------	--------	-----------------	-----------

description gas thermostat t.max. 300°C gas inlet pipe flange ø21mm bypass nozzle ø 0.45mm gas outlet 3/8" ET (tube ø 10mm) gas outlet 2 M13x1 IT (tube ø 8mm) thermocouple connection 2x M8x1 capillary pipe 850mm probe ø 4mm probe L 140mm shaft ø 8x6.5mm shaft L 35/14mm shaft flat left with microswitch

For models: CF-10G6-A, CF-10G-6F, CF-10G-A, CF-10GF, CF-8G-A, CF-8GF

spare parts for 101836

	GEV No.	101277	Ref. No.	—
olive ID ø 8mm Qty 1 pcs				

	GEV No.	101278	Ref. No.	533039300
olive for pipe ø 10mm Qty 1 pcs				

	GEV No.	101351	Ref. No.	533018100
mounting strap for gas tap				

	GEV No.	101376	Ref. No.	536000801
gasket ID ø 8mm ED ø 12mm H 3/5mm				

	GEV No.	101477	Ref. No.	533016200 533026400
union screw thread M13x1 tube ø 8mm Qty 1 pcs				

	GEV No.	101478	Ref. No.	—
union nut thread 3/8" for pipe ø 10mm				

	GEV No.	101277	Ref. No.	—
olive ID ø 8mm Qty 1 pcs				

	GEV No.	101278	Ref. No.	—
olive ID ø 8mm Qty 1 pcs				

	GEV No.	101351	Ref. No.	—
mounting strap for gas tap				

	GEV No.	101376	Ref. No.	—
gasket ID ø 8mm ED ø 12mm H 3/5mm				

	GEV No.	101477	Ref. No.	—
union screw thread M13x1 tube ø 8mm Qty 1 pcs				

	GEV No.	101478	Ref. No.	—
union nut thread 3/8" for pipe ø 10mm				

	GEV No.	101277	Ref. No.	—
olive ID ø 8mm Qty 1 pcs				

	GEV No.	101278	Ref. No.	—
olive ID ø 8mm Qty 1 pcs				

	GEV No.	101351	Ref. No.	—
mounting strap for gas tap				

	GEV No.	101376	Ref. No.	—
gasket ID ø 8mm ED ø 12mm H 3/5mm				

	GEV No.	101477	Ref. No.	—
union screw thread M13x1 tube ø 8mm Qty 1 pcs				

	GEV No.	101478	Ref. No.	—
union nut thread 3/8" for pipe ø 10mm				

	GEV No.	101277	Ref. No.	—
olive ID ø 8mm Qty 1 pcs				

	GEV No.	101278	Ref. No.	—
olive ID ø 8mm Qty 1 pcs				

	GEV No.	101351	Ref. No.	—
mounting strap for gas tap				

	GEV No.	101376	Ref. No.	—
gasket ID ø 8mm ED ø 12mm H 3/5mm				

	GEV No.	101477	Ref. No.	—
union screw thread M13x1 tube ø 8mm Qty 1 pcs				

	GEV No.	101478	Ref. No.	—
union nut thread 3/8" for pipe ø 10mm				

	GEV No.	101277	Ref. No.	—
olive ID ø 8mm Qty 1 pcs				

	GEV No.	101278	Ref. No.	—
olive ID ø 8mm Qty 1 pcs				

	GEV No.	101351	Ref. No.	—
mounting strap for gas tap				

	GEV No.	101376	Ref. No.	—
gasket ID ø 8mm ED ø 12mm H 3/5mm				

	GEV No.	101477	Ref. No.	—
union screw thread M13x1 tube ø 8mm Qty 1 pcs				

	GEV No.	101478	Ref. No.	—
union nut thread 3/8" for pipe ø 10mm				

GEV No.	107150 ¹	Ref. No.	531008303
description	gas thermostat t.max. 300°C gas inlet pipe flange ø21mm bypass nozzle ø 0.5mm gas outlet 3/8" ET (tube ø 10mm)mm gas outlet 2 M13x1 IT (tube ø 8mm) thermocouple connection 2x M8x1 capillary pipe 850mm probe ø 4mm probe L 140mm shaft ø 8x6.5mm shaft L 35/14mm shaft flat left with microswitch		
For models:	CF-10G6-A, CF-10G-6F, CF-10G-A, CF-10GF, CF-8G-A, CF-8GF		

¹with microswitch and additional gas outlet M13x1 IT (tube ø 8mm)







gas valves and ignition boxes

gas control valves

SIT

MINISIT



GEV No.	101106	Ref. No.	531011000 531032200
description	gas valve gas inlet 3/8" gas outlet 3/8" operable temperature range manual thermocouple connection M9x1 pilot connection M10x1 Minisit SIT		
For models:	CPM-62G		
spare parts for	101106		
	GEV No.	100809	Ref. No. 536000500
	O-ring EPDM thickness 2mm ID ø 21mm Qty 1 pcs		
	GEV No.	101053	Ref. No. 531001200
	magnet unit T1: M9x1 T2: M24x1 L 45mm ø 17mm suitable for Minisit		
	GEV No.	101054	Ref. No. —
	magnet unit T1: M10x1 T2: M24x1 L 45mm ø 17mm suitable for Minisit		
	GEV No.	101136	Ref. No. —
	piezoelectric igniter suitable for Minisit with cover cap ømm connection F6.3x0.8		
	GEV No.	101137	Ref. No. 536000700
	cover cap without piezoelectric igniter		
	GEV No.	110068	Ref. No. 536000600
	knob suitable for Minisit ø 37mm		

accessories for	101106		
	GEV No.	100904	Ref. No. —
	locking screw M10x1 for pipe ø 4mm Qty 1 pcs		
	GEV No.	100905	Ref. No. —
	locking screw M10x1 for pipe ø 6mm Qty 1 pcs		
	GEV No.	101267	Ref. No. —
	reducer IT 3/8" ET 1/2" L 21mm		
	GEV No.	101268	Ref. No. 533018200
	gas connection thread 3/8" angled with O-ring MINISIT 710		
	GEV No.	101269	Ref. No. —
	gas connection thread 1/2" angled with O-ring MINISIT 710		
	GEV No.	101270	Ref. No. —
	screw connection IT 3/8" ET 3/8" L 28mm		
	GEV No.	101272	Ref. No. —
	screw connection IT 1/2" ET 3/8" L 57mm		
	GEV No.	101273	Ref. No. 533017900
	olive for pipe ø 12mm L 9.5mm brass Qty 1 pcs suitable for universal		
	GEV No.	101274	Ref. No. —
	olive for pipe ø 16mm Qty 1 pcs		
	GEV No.	101275	Ref. No. —
	union screw thread 1/2" for pipe ø 16mm Qty 1 pcs		
	GEV No.	101276	Ref. No. 533018000
	union screw thread 3/8" tube ø 12mm Qty 1 pcs		

NOVASIT

















GEV No.	101187	Ref. No.	531042100
description	gas valve SIT series Novasit 820 0.17VHz gas inlet 1/2" gas outlet 1/2" thermocouple connection M9x1 pilot connection M10x1 ignition pressurebar pressure range 5-50mbar pressure regulator connection blind equiv. no. 0.820.301 supply Operator millivolt		
spare parts for	101187		
	GEV No.	101065	Ref. No. —
	magnet unit with cable L 44mm D1 ø 30mm D2 ø 20mm suitable for NOVASIT		
accessories for	101187		
	GEV No.	100110	Ref. No. —
	pilot burner SIT type 190 series 3 flames nozzle ømm gas connectionmm		

Table continues overleaf

accessories for		101187	
GEV No.	101305	Ref. No.	—
	gas connection straight 1/2" flange 45x45mm ELETTROSIT/V4400/4600/4605 suitable for SIT/HONEYWELL hole distance 36x36mm		
	gas connection angled flange 45x45mm hole distance 36x36mm 1/2" ELETTROSIT/V4400/4600/4605 screw with O-ring suitable for SIT/HONEYWELL		
	gas connection straight flange 45x45mm hole distance 36x36mm 3/4" ELETTROSIT/V4400/4600/4605 screw with O-ring suitable for SIT/HONEYWELL		531043300
	gas connection angled flange 45x45mm hole distance 36x36mm 3/4" ELETTROSIT/V4400/4600/4605 screw with O-ring suitable for SIT/HONEYWELL		
	thermopile ROBERTSHAW L 900mm probe ø 9mm probe L 57mm 250-750mV screw connection 7/16"		537033000



accessories for		101956	
GEV No.	101305	Ref. No.	—
	gas connection straight 1/2" flange 45x45mm ELETTROSIT/V4400/4600/4605 suitable for SIT/HONEYWELL hole distance 36x36mm		
	gas connection angled flange 45x45mm hole distance 36x36mm 1/2" ELETTROSIT/V4400/4600/4605 screw with O-ring suitable for SIT/HONEYWELL		
	gas connection straight flange 45x45mm hole distance 36x36mm 3/4" ELETTROSIT/V4400/4600/4605 screw with O-ring suitable for SIT/HONEYWELL		531043300
	gas connection angled flange 45x45mm hole distance 36x36mm 3/4" ELETTROSIT/V4400/4600/4605 screw with O-ring suitable for SIT/HONEYWELL		

accessories for		101956	
GEV No.	101312	Ref. No.	—
	microswitch		
	solenoid coil 24V 50Hz		
	plug with cable L 1000mm suitable for NOVASIT		
	cover cap for solenoid coil suitable for NOVASIT		536022600

ignition parts

pilot burners





























SIT			
100 series			
	1		
GEV No.	106901	Ref. No.	533091400 533091500
description	pilot burner SIT type 100 series 1 flame nozzle ø 0.2mm gas connection 6mm		
For models:	CF2-58G, CF2-58GE, CF2-68G, CF2-68GEM, CF3-512GEV, CF3-512GV, CF3-612GEMV, CF3-612GV, CF4-78GP, CF4-78GP-AUS, CF4-78GPE, CF4-78GP-USA, CF4-98G, CF4-98GE, CF6-712GP, CF6-712GPE, CF6-712GPEV, CF6-712GPV, CF6-712GPV-USA, CF6-912G, CF6-912GE, CF6-912GEV, CF6-912GV, CF-712GPE, CF8-916G, CF8-916GE, CF8-916GEV, CF8-916GV, CFM2-68GEM, CFM3-612GEMV, CFV4-78GPE, CFV4-98GE, CFV6-712GPEV, CFV6-912GEV, PC1T-64G, PC2T-68G, PC3-612G, PC3T-612G, PC-712GP, PC-712GP-USA, PC-716GP, PC-716GP-USA, PC-74GP, PC-74GP-USA, PC-78GP, PC-78GP-USA, PC-912G, PC-916G, PC-94G, PC-98G...(Other models you can see in the webshop)		
spare parts for	106901		
	GEV No.	100854	Ref. No. —
	pilot burner bracket double		
	GEV No.	100916	Ref. No. —
	compression spring for pilot burner Qty 1 pcs		
	GEV No.	100917	Ref. No. —
	gasket for pilot burner Qty 1 pcs aluminium		
	GEV No.	100918	Ref. No. —
	screw for pilot burner		
accessories for	106901		
	GEV No.	100904	Ref. No. —
	locking screw M10x1 for pipe ø 4mm Qty 1 pcs		
	GEV No.	100905	Ref. No. —
	locking screw M10x1 for pipe ø 6mm Qty 1 pcs		

Table continues overleaf



accessories for 106901				
	GEV No.	102110	Ref. No.	—
	pilot tube copper pipe ø 4mm thickness 1mm L 3000mm			
	GEV No.	102111	Ref. No.	—
	pilot tube copper pipe ø 6mm thickness 1mm L 3000mm			
	GEV No.	102742	Ref. No.	—
	pilot burner nozzle LPG code 25 bore ø 0.25mm Qty 1 pcs			

 <p>1</p>				
GEV No.	106906	Ref. No.	30100005 530100005	
description	pilot burner SIT type 100 series 3 flames nozzle ø 0.2mm gas connection 6mm			
spare parts for	106906			
	GEV No.	100245	Ref. No.	533091000
	pilot burner nozzle LPG code 20 bore ø 0.2mm Qty 1 pcs thread M8x0.75			
	GEV No.	100855	Ref. No.	—
	pilot burner bracket triple			
	GEV No.	100885	Ref. No.	—
	air mixing sleeve for pilot burner Qty 1 pcs			
	GEV No.	100916	Ref. No.	—
	compression spring for pilot burner Qty 1 pcs			
	GEV No.	100917	Ref. No.	—
	gasket for pilot burner Qty 1 pcs aluminium			
	GEV No.	100918	Ref. No.	—
	screw for pilot burner			
	GEV No.	107162	Ref. No.	—
	pilot burner cap SIT 3 flames Hmm Lmm Qty 1 pcs			
	GEV No.	107701	Ref. No.	—
	pilot burner bottom part SIT 100 series nozzle ø 0.2mm			
accessories for 106906				
	GEV No.	100245	Ref. No.	533091000
	pilot burner nozzle LPG code 20 bore ø 0.2mm Qty 1 pcs thread M8x0.75			
	GEV No.	100246	Ref. No.	533091200
	pilot burner nozzle natural gas bore ø 0.35mm Qty 1 pcs thread M8x0.75			
	GEV No.	100904	Ref. No.	—
	locking screw M10x1 for pipe ø 4mm Qty 1 pcs			
	GEV No.	100905	Ref. No.	—
	locking screw M10x1 for pipe ø 6mm Qty 1 pcs			
	GEV No.	102110	Ref. No.	—
	pilot tube copper pipe ø 4mm thickness 1mm L 3000mm			

accessories for 106906				
	GEV No.	102111	Ref. No.	—
	pilot tube copper pipe ø 6mm thickness 1mm L 3000mm			
	GEV No.	107171	Ref. No.	—
	pilot burner nozzle SIT natural/liquid gas bore ø 0.25mm Qty 1 pcs			
	GEV No.	107700	Ref. No.	—
	pilot burner bottom part SIT 100 series nozzle ø 0.25mm			
	GEV No.	107702	Ref. No.	—
	pilot burner bottom part SIT 100 series nozzle ø 0.35mm			

accessories				
pilot burner nozzles				
 <p>1</p>				
GEV No.	100245	Ref. No.	533091000	
description	pilot burner nozzle LPG code 20 bore ø 0.2mm Qty 1 pcs thread M8x0.75			
For models:	CF2-58G, CF2-58GE, CF2-68G, CF2-68GEM, CF3-512GEV, CF3-512GV, CF3-612GEMV, CF3-612GV, CF4-78GP, CF4-78GP-AUS, CF4-78GPE, CF4-78GP-USA, CF4-98G, CF4-98GE, CF6-712GP, CF6-712GPE, CF6-712GPEV, CF6-712GPV, CF6-712GPV-USA, CF6-912G, CF6-912GE, CF6-912GEV, CF6-912GV, CF-712GPE, CF8-916G, CF8-916GE, CF8-916GEV, CF8-916GV, CFA4-78G, CFA4-98G, CFA6-712GV, CFA6-912GV, CFM2-68GEM, CFM3-612GEMV, CFV4-78GPE, CFV4-98GE, CFV6-712GPEV, CFV6-912GEV, PA-78G, PA-98G, PAF-78G, PAF-98G, PAT-78G, PAT-98G, PC1T-64G, PC2T-68G, PC3-612G, PC3T-612G, PC-712GP, PC-712GP-USA...(Other models you can see in the webshop)			

 <p>1</p>				
GEV No.	100246	Ref. No.	533091200	
description	pilot burner nozzle natural gas bore ø 0.35mm Qty 1 pcs thread M8x0.75			
For models:	CF2-58G, CF2-58GE, CF2-68G, CF2-68GEM, CF3-512GEV, CF3-512GV, CF3-612GEMV, CF3-612GV, CF4-78GP, CF4-78GP-AUS, CF4-78GPE, CF4-78GP-USA, CF4-98G, CF4-98GE, CF6-712GP, CF6-712GPE, CF6-712GPEV, CF6-712GPV, CF6-712GPV-USA, CF6-912G, CF6-912GE, CF6-912GEV, CF6-912GV, CF-712GPE, CF8-916G, CF8-916GE, CF8-916GEV, CF8-916GV, CFA4-78G, CFA4-98G, CFA6-712GV, CFA6-912GV, CFM2-68GEM, CFM3-612GEMV, CFV4-78GPE, CFV4-98GE, CFV6-712GPEV, CFV6-912GEV, PA-78G, PA-98G, PAF-78G, PAF-98G, PAT-78G, PAT-98G, PC1T-64G, PC2T-68G, PC3-612G, PC3T-612G, PC-712GP, PC-712GP-USA...(Other models you can see in the webshop)			

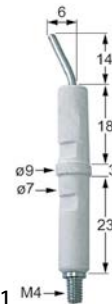
ignition electrodes				
 <p>1</p>				
GEV No.	100706	Ref. No.	30100054	
description	ignition electrode connection M4 Qty 1 pcs			

140 - 145 -150 series



GEV No.	107133	Ref. No.	533023200
description	pilot burner SIT type 140 series 1 flame nozzle ømm gas connecti-onmm		
For models:	CF4-78G, CF4-78GP, CF4-78GP-AUS, CF4-78GP-USA, CF4-98G, CF6-712G, CF6-712GP, CF6-712GPV, CF6-712GPV-USA, CF6-712GV, CF6-912G, CF6-912GP, CF8-916G, CF8-916GV, CFA4-78G, CFA4-98G, CFA6-712GV, CFA6-912GV, CFPB6-79G, PAF-78G, PAF-98G, TP2-712G, TP2-712GP, TP2-78GP, TP2-912G, TP2-98G, TP2T-712GP, TP2T-78GP, TP2T-912G, TP2T-98G, TP4-712GP, TP4-912G, TP4T-610G, TP4T-712GP, TP4T-912G, TP-74G, TP-78G, TP-94G, TP-98G, TPF2-712G, TPF2-712GP, TPF2-712GPE, TPF2-712GPEV, TPF2-712GPV, TPF2-712GV, TPF2-78GP, TPF2-78GPE, TPF2-912G, TPF2-912GE, TPF2-912GEV...(Other models you can see in the webshop)		
accessories for	107133		
	GEV No.	100204	Ref. No. —
	description	pilot burner nozzle SIT LPG code 14 bore ø 0.18/0.20mm Qty 1 pcs suitable for 140 series	
	GEV No.	100205	Ref. No. 533020500
	description	pilot burner nozzle SIT LPG code 19 bore ø 0.23/0.26mm Qty 1 pcs suitable for SIT 150 series	
	GEV No.	100206	Ref. No. —
	description	pilot burner nozzle SIT natural gas code 36 bore ø 0.60/0.55mm Qty 1 pcs suitable for SIT 150 series	
	GEV No.	100207	Ref. No. 533020600
	description	pilot burner nozzle SIT natural gas code 27 bore ø 0.40/0.38mm suitable for SIT 140 series	
	GEV No.	100216	Ref. No. —
	description	pilot burner nozzle SIT natural gas code 38 bore ø 0.45mm Qty 1 pcs suitable for SIT 150 series	
	GEV No.	100701	Ref. No. 537003000
	description	ignition electrode connection M4 Qty 1 pcs	
	GEV No.	100897	Ref. No. —
	description	olive for pipe ø 4mm Qty 1 pcs for pilot burner	
	GEV No.	100898	Ref. No. 533023300
	description	olive for pipe ø 6mm Qty 1 pcs for pilot burner	
	GEV No.	100906	Ref. No. 533018600
	description	screw connection thread M10x1 for ignition electrode brass Qty 1 pcs WS 10	
	GEV No.	100907	Ref. No. —
	description	screw connection thread M10x1 Qty 1 pcs type SEF 1 ømm for thermocouple	
	GEV No.	100908	Ref. No. —
	description	union screw thread M10x1 for pipe ø 4mm Qty 1 pcs	
	GEV No.	100909	Ref. No. 533018500
	description	union screw thread M10x1 for pipe ø 6mm Qty 1 pcs	
	GEV No.	102110	Ref. No. —
	description	pilot tube copper pipe ø 4mm thickness 1mm L 3000mm	
	GEV No.	102111	Ref. No. —
	description	pilot tube copper pipe ø 6mm thickness 1mm L 3000mm	











GEV No.	107114 ¹	Ref. No.	533023400
description	pilot burner SIT type 140 series 2 flames nozzle ømm gas connecti-onmm		
For models:	BRT-66G, CPT-64G, CPT-66G, CPT-74G, CPT-76G, FTL-54G, FTL-56G, FTL-712G, FTL-712GS, FTL-712G-USA, FTL-74G, FTL-74GS, FTL-74G-USA, FTL-76G, FTL-76GS, FTL-76G-USA, FTL-78G, FTL-78G-AUS, FTL-78GS, FTL-78G-USA, FTL-916G, FTL-94G, FTL-94GS, FTL-98G, FTL-98GS, FTLR-56G, FTLR-712G, FTLR-712GS, FTLR-712G-USA, FTLR-76G, FTLR-76GS, FTLR-76G-USA, FTLR-78G, FTLR-78G-AUS, FTLR-78GS, FTLR-78G-USA, FTLR-98G, FTLR-98GS, FTR-54G, FTR-56G, FTR-712G, FTR-712GS, FTR-712G-USA, FTR-74G, FTR-74GS, FTR-74G-USA, FTR-76G, FTR-76GS, FTR-76G-USA, FTR-78G...(Other models you can see in the webshop)		
spare parts for	107114		
	GEV No.	100907	Ref. No. —
	description	screw connection thread M10x1 Qty 1 pcs type SEF 1 ømm for thermocouple	
accessories for	107114		
	GEV No.	100204	Ref. No. —
	description	pilot burner nozzle SIT LPG code 14 bore ø 0.18/0.20mm Qty 1 pcs suitable for 140 series	
	GEV No.	100205	Ref. No. 533020500
	description	pilot burner nozzle SIT LPG code 19 bore ø 0.23/0.26mm Qty 1 pcs suitable for SIT 150 series	
	GEV No.	100206	Ref. No. —
	description	pilot burner nozzle SIT natural gas code 36 bore ø 0.60/0.55mm Qty 1 pcs suitable for SIT 150 series	
	GEV No.	100207	Ref. No. 533020600
	description	pilot burner nozzle SIT natural gas code 27 bore ø 0.40/0.38mm suitable for SIT 140 series	
	GEV No.	100216	Ref. No. —
	description	pilot burner nozzle SIT natural gas code 38 bore ø 0.45mm Qty 1 pcs suitable for SIT 150 series	
	GEV No.	100701	Ref. No. 537003000
	description	ignition electrode connection M4 Qty 1 pcs	
	GEV No.	100801	Ref. No. —
	description	gasket for pilot burner Qty 1 pcs	
	GEV No.	100897	Ref. No. —
	description	olive for pipe ø 4mm Qty 1 pcs for pilot burner	
	GEV No.	100898	Ref. No. 533023300
	description	olive for pipe ø 6mm Qty 1 pcs for pilot burner	
	GEV No.	100906	Ref. No. 533018600
	description	screw connection thread M10x1 for ignition electrode brass Qty 1 pcs WS 10	
	GEV No.	100908	Ref. No. —
	description	union screw thread M10x1 for pipe ø 4mm Qty 1 pcs	
	GEV No.	100909	Ref. No. 533018500
	description	union screw thread M10x1 for pipe ø 6mm Qty 1 pcs	
	GEV No.	102110	Ref. No. —
	description	pilot tube copper pipe ø 4mm thickness 1mm L 3000mm	











¹incl. thermocouple fitting
Table continues overleaf

















accessories for	107114		
GEV No.	102111	Ref. No.	—
	pilot tube copper pipe ø 6mm thickness 1mm L 3000mm		

















GEV No.	107132	Ref. No.	533023200
description	pilot burner SIT type 140 series 2 flames nozzle ømm gas connectionmm		
accessories for	107132		
	GEV No.	100204	Ref. No. —
	pilot burner nozzle SIT LPG code 14 bore ø 0.18/0.20mm Qty 1 pcs suitable for 140 series		
	GEV No.	100205	Ref. No. 533020500
	pilot burner nozzle SIT LPG code 19 bore ø 0.23/0.26mm Qty 1 pcs suitable for SIT 150 series		
	GEV No.	100206	Ref. No. —
	pilot burner nozzle SIT natural gas code 36 bore ø 0.60/0.55mm Qty 1 pcs suitable for SIT 150 series		
	GEV No.	100207	Ref. No. 533020600
	pilot burner nozzle SIT natural gas code 27 bore ø 0.40/0.38mm suitable for SIT 140 series		
	GEV No.	100216	Ref. No. —
	pilot burner nozzle SIT natural gas code 38 bore ø 0.45mm Qty 1 pcs suitable for SIT 150 series		
	GEV No.	100701	Ref. No. 537003000
	ignition electrode connection M4 Qty 1 pcs		
	GEV No.	100897	Ref. No. —
	olive for pipe ø 4mm Qty 1 pcs for pilot burner		
	GEV No.	100898	Ref. No. 533023300
	olive for pipe ø 6mm Qty 1 pcs for pilot burner		
	GEV No.	100906	Ref. No. 533018600
	screw connection thread M10x1 for ignition electrode brass Qty 1 pcs WS 10		
	GEV No.	100907	Ref. No. —
	screw connection thread M10x1 Qty 1 pcs type SEF 1 ømm for thermocouple		
	GEV No.	100908	Ref. No. —
	union screw thread M10x1 for pipe ø 4mm Qty 1 pcs		
	GEV No.	100909	Ref. No. 533018500
	union screw thread M10x1 for pipe ø 6mm Qty 1 pcs		
	GEV No.	102110	Ref. No. —
	pilot tube copper pipe ø 4mm thickness 1mm L 3000mm		
	GEV No.	102111	Ref. No. —
	pilot tube copper pipe ø 6mm thickness 1mm L 3000mm		











160 series			
	1		
GEV No.	100053	Ref. No.	533011500
description	pilot burner SIT type 160 series 2 flames nozzle ømm gas connectionmm		
spare parts for	100053		
	GEV No.	100907	Ref. No. —
	screw connection thread M10x1 Qty 1 pcs type SEF 1 ømm for thermocouple		
accessories for	100053		
	GEV No.	100202	Ref. No. —
	pilot burner nozzle natural gas code 41 Qty 1 pcs nozzle ø 0.41mm		
	GEV No.	100203	Ref. No. —
	pilot burner nozzle LPG code 25 Qty 1 pcs nozzle ø 0.25mm		
	GEV No.	100701	Ref. No. 537003000
	ignition electrode connection M4 Qty 1 pcs		
	GEV No.	100801	Ref. No. —
	gasket for pilot burner Qty 1 pcs		
	GEV No.	100869	Ref. No. —
	pilot burner nozzle natural gas code 51 Qty 1 pcs suitable for 160 series nozzle ø 0.51mm		
	GEV No.	100906	Ref. No. 533018600
	screw connection thread M10x1 for ignition electrode brass Qty 1 pcs WS 10		
	GEV No.	100908	Ref. No. —
	union screw thread M10x1 for pipe ø 4mm Qty 1 pcs		
	GEV No.	100909	Ref. No. 533018500
	union screw thread M10x1 for pipe ø 6mm Qty 1 pcs		
	GEV No.	101282	Ref. No. —
	olive for pipe ø 4mm L 7.4mm Qty 1 pcs		
	GEV No.	101287	Ref. No. —
	olive for pipe ø 6mm Qty 1 pcs		
	GEV No.	102110	Ref. No. —
	pilot tube copper pipe ø 4mm thickness 1mm L 3000mm		
	GEV No.	102111	Ref. No. —
	pilot tube copper pipe ø 6mm thickness 1mm L 3000mm		
	GEV No.	107650	Ref. No. 533020200
	pilot burner nozzle SIT LPG code 30 Qty 1 pcs		















			
GEV No.	100054	Ref. No.	533011500
description	pilot burner SIT type 160 series 2 flames nozzle ømm gas connecti-onmm		
For models:	BM-74G, BM-78G, BM-94G, BM-98G, BMT-64G, BMT-66G, BMT-74G, BMT-78G, BMT-94G, BMT-98G, BRF-64G, BRF-74G, BRF-78G, BRF-94G, BRF-98G, CP-66G, CP-74G, CP-74G-USA, CP-76G, CP-78, CP-78G, CP-78G-USA, CP-94G, CP-94G-USA, CP-98G, CP-98G-USA, CPA-66G, CPA-74G, CPA-76G, CPA-78G, CPA-94G, CPA-98G, CPB-98G, CPBA-98G, CPM-62G, CPM-6G, CPP-94G, CPP-94G-USA, CPT-64G, CPT-66G, CW-4G, CW-61G, CW-62G, CW-6G, FTL-61G, FTL-61GF, FTL-61GS, FTL-61GSF, FTL-62G, FTL-62GF...(Other models you can see in the webshop)		
spare parts for	100054		
	GEV No.	100907	Ref. No. —
	screw connection thread M10x1 Qty 1 pcs type SEF 1 ømm for thermocouple		
accessories for	100054		
	GEV No.	100202	Ref. No. —
	pilot burner nozzle natural gas code 41 Qty 1 pcs nozzle ø 0.41mm		
	GEV No.	100203	Ref. No. —
	pilot burner nozzle LPG code 25 Qty 1 pcs nozzle ø 0.25mm		
	GEV No.	100701	Ref. No. 537003000
	ignition electrode connection M4 Qty 1 pcs		
	GEV No.	100801	Ref. No. —
	gasket for pilot burner Qty 1 pcs		
	GEV No.	100869	Ref. No. —
	pilot burner nozzle natural gas code 51 Qty 1 pcs suitable for 160 series nozzle ø 0.51mm		
	GEV No.	100906	Ref. No. 533018600
	screw connection thread M10x1 for ignition electrode brass Qty 1 pcs WS 10		
	GEV No.	100908	Ref. No. —
	union screw thread M10x1 for pipe ø 4mm Qty 1 pcs		
	GEV No.	100909	Ref. No. 533018500
	union screw thread M10x1 for pipe ø 6mm Qty 1 pcs		
	GEV No.	101282	Ref. No. —
	olive for pipe ø 4mm L 7.4mm Qty 1 pcs		
	GEV No.	101287	Ref. No. —
	olive for pipe ø 6mm Qty 1 pcs		
	GEV No.	102110	Ref. No. —
	pilot tube copper pipe ø 4mm thickness 1mm L 3000mm		
	GEV No.	102111	Ref. No. —
	pilot tube copper pipe ø 6mm thickness 1mm L 3000mm		
	GEV No.	107650	Ref. No. 533020200
	pilot burner nozzle SIT LPG code 30 Qty 1 pcs		



			
GEV No.	100056	Ref. No.	533011000
description	pilot burner SIT type 160 series 3 flames nozzle ømm gas connecti-onmm		
For models:	BM-4G, BM-61GF, BM-62GF, BM-6G, BM-8G, BR-62G, BR-6G, CP-62G, CP-6G, CP-74G, CP-74G-USA, CP-78G, CP-78G-USA, CP-94G, CP-94G-USA, CP-98G, CP-98G-USA, CPA-94G, CW-74G, CW-74G-USA, CW-78G, CW-78G-USA, CW-94G, CW-98G, CWT-64G, CWT-66G, CWT-68G, CWT-74G, CWT-74G-USA, CWT-78G, CWT-78G-USA, CWT-94G, CWT-98G, F11-54G, F13-64G, F13-74G, F13T-74G, F13T-94G, F18-74G, F2-13-78G, F2-13T-78G, F2-13T-98G, F2-18-78G, F2-8-74G, F2-8-94G, F2-8T-66G, F2-8T-74G, F2-8T-94G, F45-78G, F8T-63G...(Other models you can see in the webshop)		
spare parts for	100056		
	GEV No.	100907	Ref. No. —
	screw connection thread M10x1 Qty 1 pcs type SEF 1 ømm for thermocouple		
accessories for	100056		
	GEV No.	100202	Ref. No. —
	pilot burner nozzle natural gas code 41 Qty 1 pcs nozzle ø 0.41mm		
	GEV No.	100203	Ref. No. —
	pilot burner nozzle LPG code 25 Qty 1 pcs nozzle ø 0.25mm		
	GEV No.	100701	Ref. No. 537003000
	ignition electrode connection M4 Qty 1 pcs		
	GEV No.	100801	Ref. No. —
	gasket for pilot burner Qty 1 pcs		
	GEV No.	100869	Ref. No. —
	pilot burner nozzle natural gas code 51 Qty 1 pcs suitable for 160 series nozzle ø 0.51mm		
	GEV No.	100870	Ref. No. —
	olive for pipe ø 4mm Qty 1 pcs suitable for 160 series for pilot burner		
	GEV No.	100906	Ref. No. 533018600
	screw connection thread M10x1 for ignition electrode brass Qty 1 pcs WS 10		
	GEV No.	100908	Ref. No. —
	union screw thread M10x1 for pipe ø 4mm Qty 1 pcs		
	GEV No.	100909	Ref. No. 533018500
	union screw thread M10x1 for pipe ø 6mm Qty 1 pcs		
	GEV No.	101287	Ref. No. —
	olive for pipe ø 6mm Qty 1 pcs		
	GEV No.	102110	Ref. No. —
	pilot tube copper pipe ø 4mm thickness 1mm L 3000mm		
	GEV No.	102111	Ref. No. —
	pilot tube copper pipe ø 6mm thickness 1mm L 3000mm		
	GEV No.	107650	Ref. No. 533020200
	pilot burner nozzle SIT LPG code 30 Qty 1 pcs		



POLIDORO			
pilot burners			
			
GEV No.	102800	Ref. No.	08122
description	pilot burner POLIDORO 3 flames code gas connection 6mm		
spare parts for	102800		
	GEV No.	100906	Ref. No. 533018600
screw connection thread M10x1 for ignition electrode brass Qty 1 pcs WS 10			
	GEV No.	100907	Ref. No. —
screw connection thread M10x1 Qty 1 pcs type SEF 1 0mm for thermocouple			
	GEV No.	100909	Ref. No. 533018500
union screw thread M10x1 for pipe 06mm Qty 1 pcs			
	GEV No.	101287	Ref. No. —
olive for pipe 06mm Qty 1 pcs			
accessories for	102800		
	GEV No.	100208	Ref. No. —
pilot burner nozzle POLIDORO LPG code 20 bore 0.2mm Qty 1 pcs			
	GEV No.	100209	Ref. No. —
pilot burner nozzle POLIDORO natural gas code 40 bore 0.4mm Qty 1 pcs			
	GEV No.	100701	Ref. No. 537003000
ignition electrode connection M4 Qty 1 pcs			
	GEV No.	100908	Ref. No. —
union screw thread M10x1 for pipe 04mm Qty 1 pcs			
	GEV No.	101280	Ref. No. —
olive for pipe 04mm Qty 1 pcs			

producer-specific pilot burners			
LOTUS			
			
GEV No.	102805	Ref. No.	533091900
description	pilot burner SIT type 160 series 3 flames nozzle 06mm gas connectionmm		
For models:	F18-94G, F2-18-98G, F2-25-98G, F25-94G		
spare parts for	102805		
	GEV No.	100907	Ref. No. —
screw connection thread M10x1 Qty 1 pcs type SEF 1 0mm for thermocouple			

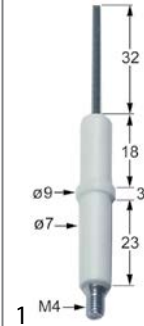
accessories for	102805		
	GEV No.	100202	Ref. No. —
pilot burner nozzle natural gas code 41 Qty 1 pcs nozzle 0.41mm			
	GEV No.	100203	Ref. No. —
pilot burner nozzle LPG code 25 Qty 1 pcs nozzle 0.25mm			
	GEV No.	100701	Ref. No. 537003000
ignition electrode connection M4 Qty 1 pcs			
	GEV No.	100801	Ref. No. —
gasket for pilot burner Qty 1 pcs			
	GEV No.	100869	Ref. No. —
pilot burner nozzle natural gas code 51 Qty 1 pcs suitable for 160 series nozzle 0.51mm			
	GEV No.	100906	Ref. No. 533018600
screw connection thread M10x1 for ignition electrode brass Qty 1 pcs WS 10			
	GEV No.	100908	Ref. No. —
union screw thread M10x1 for pipe 04mm Qty 1 pcs			
	GEV No.	100909	Ref. No. 533018500
union screw thread M10x1 for pipe 06mm Qty 1 pcs			
	GEV No.	101282	Ref. No. —
olive for pipe 04mm L 7.4mm Qty 1 pcs			
	GEV No.	101287	Ref. No. —
olive for pipe 06mm Qty 1 pcs			
	GEV No.	107650	Ref. No. 533020200
pilot burner nozzle SIT LPG code 30 Qty 1 pcs			

electrodes			
			
GEV No.	100701	Ref. No.	537003000
description	ignition electrode connection M4 Qty 1 pcs		
accessories for	100701		
	GEV No.	100906	Ref. No. 533018600
screw connection thread M10x1 for ignition electrode brass Qty 1 pcs WS 10			

GEV No.	100706	Ref. No.	30100054
description	ignition electrode connection M4 Qty 1 pcs		

GEV No.	100728	Ref. No.	837002000+537011700 837002000+547010500
description	ignition electrode D1 ø 10mm cable length 1420mm to clip		

GEV No.	100799	Ref. No.	537002000
description	ignition electrode D1 ø 10mm D2 ø 7mm connection F 2.8x0.8mm L1 21mm BL1 12mm BL2 18mm to clip		
For models:	CF-10G6-A, CF-10G-6F, CF-10G-A, CF-10GF, CF4-8G, CF4-8GEM, CF-8G-A, CF-8GF		

GEV No.	102328	Ref. No.	537024400
description	ignition electrode D1 ø 6mm cable length 1380mm connection F 2.8x0.8mm D2 ø 10mm L1 17mm BL1 20mm BL2 23mm to clip		
For models:	CF-10G6-A, CF-10G-6F, CF-10G-A, CF-10GF, CF2-58G, CF2-58GE, CF2-68G, CF3-512GEV, CF3-512GV, CF3-612GV, CF4-68G, CF4-8G, CF6-610G, CF-8G-A, CF-8GF, TPF4-610G		

GEV No.	102329	Ref. No.	537024500
description	ignition electrode D1 ø 6mm cable length 700mm connection F 2.8x0.8mm D2 ø 10mm L1 23mm BL1 20mm BL2 23mm to clip		
For models:	CF-10G6-A, CF-10G-6F, CF-10G-A, CF-10GF, CF2-58G, CF2-58GE, CF2-68G, CF3-512GEV, CF3-512GV, CF3-612GV, CF4-68G, CF4-8G, CF6-610G, CF-8G-A, CF-8GF, TPF4-610G		

GEV No.	100871	Ref. No.	537003000
description	ignition electrode D1 ø 7mm connection M4 to clip		
For models:	BM-4G, BM-61GF, BM-62GF, BM-6G, BM-74G, BM-78G, BM-8G, BR-62G, BR-6G, CP-62G, CP-6G, CP-74G, CP-78G, CPM-62G, CPM-6G, CW-4G, CW-61G, CW-62G, CW-6G, CW-74G, CW-78G, F13-74G, F18-74G, F2-13-78G, F2-18-78G, FG-10, FG-2-10, FMG-10, FMG-15, FMG-2-10, FMG-2-15, FMPG-20, FMPG-30, FP-62G, FP-6G, FPG-20, FPG-30, FQ-4G, FQ-61GF, FQ-62GF, FQ-6G, FQM-4G, FTL-4G, FTL-4GS, FTL-61G, FTL-61GF, FTL-61GS, FTL-61GSF, FTL-62G, FTL-62GF...(Other models you can see in the webshop)		

GEV No.	102330	Ref. No.	30100052 537008300
description	ignition electrode D1 ø 7mm D2 ø 9mm L1 16mm BL1 18mm BL2 3mm BL3 23mm to clip connection ø 2.4mm		
For models:	BM-74G, BM-78G, BM-94G, BM-98G, BMT-64G, BMT-66G, BMT-74G, BMT-78G, BMT-94G, BMT-98G, BRF-64G, BRF-74G, BRF-78G, BRF-94G, BRF-98G, CF4-78G, CF4-78GP, CF4-78GP-AUS, CF4-78GP-USA, CF4-98G, CF6-712G, CF6-712GP, CF6-712GPV, CF6-712GPV-USA, CF6-712GV, CF6-912G, CF6-912GV, CF8-916G, CF8-916GV, CFA4-78G, CFA4-98G, CFA6-712GV, CFA6-912GV, CFPB6-79G, CP-62G, CP-66G, CP-74G, CP-74G-USA, CP-76G, CP-78, CP-78G, CP-78G-USA, CP-94G, CP-94G-USA, CP-98G, CP-98G-USA, CPA-66G, CPA-74G, CPA-76G, CPA-78G...(Other models you can see in the webshop)		



GEV No.	106619	Ref. No.	537010200
description	ignition electrode D1 ø 7mm D2 ø 9mm L1 17mm BL1 18mm BL2 3mm BL3 23mm to clip connection ø 2.4mm		
For models:	BRT-66G, CP-74G, CP-74G-USA, CP-78G, CP-78G-USA, CP-94G-USA, CP-98G-USA, CPP-94G-USA, CPT-64G, CPT-66G, CPT-74G, CPT-76G, CW-74G, CW-74G-USA, CW-78G, CW-78G-USA, CWT-74G-USA, CWT-78G-USA, FTL-54G, FTL-56G, FTL-712G, FTL-712GS, FTL-712G-USA, FTL-74G, FTL-74GS, FTL-74G-USA, FTL-76G, FTL-76GS, FTL-76G-USA, FTL-78G, FTL-78G-AUS, FTL-78GS, FTL-78G-USA, FTL-916G, FTL-94G, FTL-94GS, FTL-98G, FTL-98GS, FTLR-56G, FTLR-712G, FTLR-712GS, FTLR-712G-USA, FTLR-76G, FTLR-76GS, FTLR-76G-USA, FTLR-78G, FTLR-78G-AUS, FTLR-78GS, FTLR-78G-USA, FTLR-98G...(Other models you can see in the webshop)		

GEV No.	102327	Ref. No.	537021800
description	ignition electrode flange length 19mm flange width 12mm D1 ø 8mm L1 1mm BL1 21mm BL2 15mm connection F 4.8x0.8mm fixing dimensions ø4x3.5mm with flange		
For models:	CF-10G6-A, CF-10G-6F, CF-10G-A, CF-10GEM, CF-10GEM-6, CF-10GEM6-A, CF-10GEM-A, CF-10GF, CF-62GEM, CF-62GEM-A, CF-8G-A, CF-8GEM, CF-8GEM-A, CF-8GF, CFM-10GEM, CFM-10GEM-6, CFM-10GEM6-A, CFM-10GEM-A, CFM-8GEM, CFM-8GEM-A, PC-61GF, PC-62GF		

GEV No.	100800	Ref. No.	537010300
description	ignition electrode D1 ø 8mm BL1 56mm connection F 2.8x0.8mm to clip with spring		
For models:	CF4-68G, CF4-68GEM, CF4-78G, CF4-78GE, CF4-8G, CF4-8GEM, CF4-GEMS, CF6-610G, CF6-610GEM, CF6-712G, CF6-712GEV, CF6-712GV, CF-712GE, CFM4-66GEM, CFM4-68GEM, CFM6-610GEM, FO-1G, FO-2G, FO-3G, PC-12G, PC-4G, PC-712G, PC-716G, PC-74G, PC-78G, PC-8G, PCT-63G, PCT-66G, TP2-712G, TP4T-610G, TPF2-712G, TPF2-712GV, TPF4-610G, TPF4-610GEM		
spare parts for	100800		
	GEV No.	Ref. No.	—
	516198		
	retaining ring E D1 ø 6mm D2 ø 12mm SS DIN 6799 thickness 0.7mm for shaft ø 7-9mm		
	GEV No.	Ref. No.	—
	526087		
	compression spring ø 10.7mm L 14.5mm wire gauge ø 0.7mm		

GEV No.	100729	Ref. No.	537002700
description	ignition electrode L1 5mm D1 ø 8mm D2 ø 10mm BL1 41mm BL2 14mm connection F 2.8x0.8mm to clip with spring		
For models:	CF-10G6-A, CF-10G-6F, CF-10G-A, CF-10GEM, CF-10GEM-6, CF-10GEM6-A, CF-10GEM-A, CF-10GF, CF-62GEM, CF-62GEM-A, CF-8G-A, CF-8GEM, CF-8GEM-A, CF-8GF, CFM-10GEM, CFM-10GEM-6, CFM-10GEM6-A, CFM-10GEM-A, CFM-8GEM, CFM-8GEM-A, PC-61GF, PC-62GF		

GEV No.	100906	Ref. No.	533018600
description	screw connection thread M10x1 for ignition electrode brass Qty 1 pcs WS 10		
For models:	BM-4G, BM-61GF, BM-62GF, BM-6G, BM-74G, BM-78G, BM-8G, BM-94G, BM-98G, BMT-64G, BMT-66G, BMT-74G, BMT-78G, BMT-94G, BMT-98G, BR-62G, BR-6G, BR-6G, BR-64G, BR-74G, BR-78G, BR-94G, BR-98G, BRT-66G, CF4-78G, CF4-78GP, CF4-78GP-AUS, CF4-78GP-USA, CF4-98G, CF6-712G, CF6-712GP, CF6-712GPV, CF6-712GPV-USA, CF6-712GV, CF6-912G, CF6-912GV, CF8-916G, CF8-916GV, CFA4-78G, CFA4-98G, CFA6-712GV, CFA6-912GV, CFPB6-79G, CP-62G, CP-66G, CP-6G, CP-74G, CP-74G-USA, CP-76G, CP-78, CP-78G...(Other models you can see in the webshop)		

GEV No.	102326	Ref. No.	537021700
description	ignition electrode flange length 17mm flange width 10mm D1 ø 5.5mm L1 1mm BL1 12mm BL2 16mm connection F2.8x0.8 fixing dimensions ø4x3.5mm with flange		
For models:	CF-10G6-A, CF-10G-6F, CF-10G-A, CF-10GEM, CF-10GEM-6, CF-10GEM6-A, CF-10GEM-A, CF-10GF, CF-62GEM, CF-62GEM-A, CF-8G-A, CF-8GEM, CF-8GEM-A, CF-8GF, CFM-10GEM, CFM-10GEM-6, CFM-10GEM6-A, CFM-10GEM-A, CFM-8GEM, CFM-8GEM-A, PC-61GF, PC-62GF		

GEV No.	102264	Ref. No.	533084100
description	spring clip for igniter/thermocouple		
For models:	CF-10G6-A, CF-10G-6F, CF-10G-A, CF-10GF, CF2-58G, CF2-58GE, CF2-68G, CF3-512GEV, CF3-512GV, CF3-612GV, CF4-68G, CF4-8G, CF6-610G, CF-8G-A, CF-8GF, TPF4-610G		

ignition cables

pre-assembled cables



GEV No. 100190 Ref. No. 547010500
description ignition cable cable length 1200mm connection F2.8mm / F2.8mm
For models: CF-10G6-A, CF-10G-6F, CF-10G-A, CF-10GF, CF4-8G, CF4-8GEM, CF-8G-A, CF-8GF



GEV No. 100191 Ref. No. 547002300
description ignition cable cable length 2000mm connection F2.8mm / ø2.4mm
For models: CF4-78G, CF4-78GP, CF4-78GP-AUS, CF4-78GP-USA, CF6-712G, CF6-712GP, CF6-712GPV, CF6-712GPV-USA, CF6-712GV, CFA4-78G, CFA6-712GV, PAF-78G, TP2-712G, TPF2-712G, TPF2-712GPV, TPF2-712GV, TPF2-78GP, TPF4-712GP, TPF4-712GPV, TPF-78G



GEV No. 100036 Ref. No. 537002500
description ignition cable cable length 500mm connection F2.8mm / F2.8mm
For models: CF-10EM, CF-10EM-A, CF-10ET, CF-10ET-A, CF-62EM, CF-62EM-A, CF-62ET, CF-62ET-A, CF-8EM, CF-8EM-A, CF-8ET, CF-8ET-A, PC-61EM, PC-62EM, PC-62ET



GEV No. 100166 Ref. No. 547002700
description ignition cable cable length 500mm connection ø2.4mm / lug M4
For models: BM-4G, BM-61GF, BM-62GF, BM-6G, BM-74G, BM-78G, BM-8G, BR-62G, BR-6G, CP-62G, CP-6G, CP-74G, CP-78G, CW-4G, CW-61G, CW-62G, CW-6G, CW-74G, CW-78G, F13-74G, F18-74G, F2-13-78G, F2-18-78G, FG-10, FG-2-10, FMG-10, FMG-15, FMG-2-10, FMG-2-15, FMGP-20, FMGP-30, FP-62G, FP-6G, FPG-20, FPG-30, FQ-4G, FQ-61GF, FQ-62GF, FQ-6G, FQM-4G, FTL-4G, FTL-4GS, FTL-61G, FTL-61GF, FTL-61GS, FTL-61GSF, FTL-62G, FTL-62GF, FTL-62GS, FTL-62GSF...(Other models you can see in the webshop)

GEV No. 100197 Ref. No. 547002600
description ignition cable cable length 600mm connection F2.8mm / ø2.4mm
For models: CF-10G6-A, CF-10G-6F, CF-10G-A, CF-10GEM, CF-10GEM-6, CF-10GEM6-A, CF-10GEM-A, CF-10GF, CF-62GEM, CF-62GEM-A, CF-8G-A, CF-8GEM, CF-8GEM-A, CF-8GF, CFM-10GEM, CFM-10GEM-6, CFM-10GEM6-A, CFM-10GEM-A, CFM-8GEM, CFM-8GEM-A, CP-66G, CP-74G, CP-76G, CP-78, CP-94G, CP-98G, CPA-66G, CPA-74G, CPA-76G, CPA-78G, CPA-94G, CPA-98G, CPB-98G, CPBA-98G, F2-18-98G, F25-94G, FO-1G, FO-2G, FO-3G, PC-4G, PC-61GF, PC-62GF, PC-8G

GEV No. 100015 Ref. No. 547003200
description ignition cable cable length 600mm connection ø2.4mm / ø2.4mm
For models: BM-74G, BM-78G, BM-94G, BM-98G, BMT-64G, BMT-66G, BMT-74G, BMT-78G, BMT-94G, BMT-98G, BRF-64G, BRF-74G, BRF-78G, BRF-94G, BRF-98G, BRT-66G, CP-62G, CP-66G, CP-74G, CP-74G-USA, CP-76G, CP-78G, CP-78G-USA, CP-94G, CP-94G-USA, CP-98G, CP-98G-USA, CPA-94G, CPP-94G, CPP-94G-USA, CPT-64G, CPT-66G, CW-74G, CW-74G-USA, CW-78G, CW-78G-USA, CW-94G, CW-98G, CWT-64G, CWT-66G, CWT-68G, CWT-74G, CWT-74G-USA, CWT-78G, CWT-78G-USA, CWT-94G, CWT-98G, F11-54G, F13-64G, F13-74G...(Other models you can see in the webshop)

GEV No. 100018 Ref. No. 547013900
description ignition cable cable length 600mm connection ø2.4mm / ø4mm permanent temperature 200°C
For models: CF4-98G, CF6-912G, CF6-912GV, CF8-916G, CF8-916GV, CFA4-98G, CFA6-912GV, CPB-98G, F45-78G, PAF-98G, TP-78G, TPF2-912G, TPF2-912GE, TPF2-912GV, TPF2-98G, TPF4-912G, TPF4-912GV, TPF-78G, TPF-78GE, TPF-98G

GEV No. 100178 Ref. No. 547014600
description ignition cable cable length 900mm connection F2.8mm / ø2.4mm
For models: CF4-8G, CF4-8GEM, CF4-GEMS, PC-12G, PC-4G, PC-8G

GEV No. 100146 Ref. No. 547006800
description ignition cable cable length 900mm connection ø2.4mm / lug M4
For models: CPM-62G, CPM-6G, FTL-61G, FTL-61GS, FTL-62G, FTL-62GS, FTL-63G, FTL-63GS, FTL-64G, FTL-64GS, FTLR-62G, FTLR-62GS, FTLR-63G, FTLR-63GS, FTLR-64G, FTLR-64GS, FTR-61G, FTR-61GS, FTR-62G, FTR-62GS

piezoelectric igniters

mounting diameter 18mm

GEV No. 100009 Ref. No. 537002800
description piezoelectric igniter body plastic blowing mounting ø 18mm connection ø2.4mm front measurements 26mm M18x1.5
For models: BM-4G, BM-61GF, BM-62GF, BM-6G, BM-74G, BM-78G, BM-8G, BM-94G, BM-98G, BMT-64G, BMT-66G, BMT-74G, BMT-78G, BMT-94G, BMT-98G, BR-62G, BR-6G, BRF-64G, BRF-74G, BRF-78G, BRF-94G, BRF-98G, BRT-66G, CF-10G6-A, CF-10G-6F, CF-10G-A, CF-10GF, CF2-58G, CF2-58GE, CF2-68G, CF3-512GEV, CF3-512GV, CF3-612GV, CF4-78GP, CF4-78GP-AUS, CF4-78GP-USA, CF4-98G, CF-62GEM, CF-62GEM-A, CF6-712GP, CF6-712GPV, CF6-712GPV-USA, CF6-912G, CF6-912GV, CF8-916G, CF8-916GV, CF-8G-A, CF-8GF, CFA4-78G, CFA4-98G...(Other models you can see in the webshop)
accessories for 100009
 GEV No. 101339 Ref. No. — cover cap for piezoelectric igniter
 GEV No. 106869 Ref. No. — cover cap for piezoelectric igniter ID ø 22mm ED ø 35mm H 25mm
 GEV No. 107931 Ref. No. — cover cap for piezoelectric igniter ID ø 21mm ED ø 36mm



mounting diameter 22mm



GEV No.	100013	Ref. No.	537008500
description	piezoelectric igniter body plastic blowing mounting ø 22mm connection ø2.4mm cable lengthmm		
For models:	CW-4G, CW-61G, CW-62G, CW-6G		
accessories for	100013		
	GEV No.	100023	Ref. No. —
	female bullet size 2.3mm 0.5-1.5mm ² CuZn t.max. 125°C Qty 20 pcs		

ignition units



GEV No.	101002	Ref. No.	537060300
description	ignition unit outputs 2 230VAC dimensions 88x23x34mm mounting distance 73mm inlet F6.3x0.8 outlet F2.8x0.8 0.6VA 50/60Hz		
For models:	CP-66G, CP-74G, CP-76G, CP-78, CP-94G, CP-98G, CPA-66G, CPA-74G, CPA-76G, CPA-78G, CPA-94G, CPA-98G, CPB-98G, CPBA-98G, CPP-94G, CPP-94G-USA, F18-94G, F2-18-98G, F2-25-98G, F25-94G		



GEV No.	107226	Ref. No.	2 x 537006601+547002400
description	ignition unit outputs 2x4 220VAC with cable harness conversion kit for LOTUS		



GEV No.	101003	Ref. No.	537006600 547006600
description	ignition unit outputs 4 230VAC 50Hz		
For models:	CF4-68GEM, CF4-78GE, CF4-8GEM, CF4-GEMS, CF-62GEM, CF-62GEM-A, CF-8GEM, CF-8GEM-A, CFM4-66GEM, CFM4-68GEM, CFM-8GEM, CFM-8GEM-A, PC-61GF, PC-62GF, PC-74G, PC-78G, TP2-712G, TPF2-712G, TPF2-712GV		



GEV No.	102388	Ref. No.	537006601
description	ignition unit outputs 4 230VAC dimensions 111x23x34mm mounting distance 100mm inlet F6.3x0.8 outlet F2.8x0.8 type WAC-T4 0.6VA 50/60Hz		
For models:	CF4-68GEM, CF4-8GEM, CF4-GEMS, CF6-610G, CFM4-66GEM, CFM4-68GEM, TPF4-610G		



GEV No.	101004	Ref. No.	537005600
description	ignition unit outputs 6 230VAC inlet F6.3x0.8 outlet F2.8x0.8 50Hz mounting ø 88mm		
For models:	CF-10G-A, CF-10GEM, CF-10GEM-6, CF-10GEM6-A, CF-10GEM-A, CF-10GF, CF4-68G, CF4-78G, CF4-8G, CF4-8GEM, CF-62GEM, CF-62GEM-A, CF6-610GEM, CF6-712GEV, CF-712GE, CF-8G-A, CF-8GEM, CF-8GEM-A, CF-8GF, CFM-10GEM, CFM-10GEM-6, CFM-10GEM6-A, CFM-10GEM-A, CFM6-610GEM, CFM-8GEM, CFM-8GEM-A, PC-712G		



GEV No.	101008	Ref. No.	537008400
description	ignition unit outputs 8 230VAC inlet F6.3x0.8 outlet F2.8x0.8 50Hz mounting ø 103mm		
For models:	CF-10G6-A, CF-10G-6F, CF-10G-A, CF-10GEM, CF-10GEM-6, CF-10GEM-A, CF-10GF, CF6-610G, CF6-712G, CF6-712GV, CFM-10GEM, CFM-10GEM-6, CFM-10GEM-A, PC-716G, TPF4-610G		

ignition switches



GEV No.	101038	Ref. No.	537023600
description	ignition switch 1NO mounting ømm connection F2.8x0.8		
For models:	CF-10G6-A, CF-10G-6F, CF-10G-A, CF-10GEM, CF-10GEM-6, CF-10GEM6-A, CF-10GEM-A, CF-10GF, CF-62GEM, CF-62GEM-A, CF-8G-A, CF-8GEM, CF-8GEM-A, CF-8GF, CFM-10GEM, CFM-10GEM-6, CFM-10GEM6-A, CFM-10GEM-A, CFM-8GEM, CFM-8GEM-A, PC-61GF, PC-62GF		



gas components



GEV No.	301014	Ref. No.	537015600
description	momentary rocker switch mounting measurements 30x11mm black 1NO 250V 16A connection male faston 6.3mm ambient temperature max. 85/125°C protection IP40 mounting ømm male faston 6.3mm		



GEV No.	345189	Ref. No.	537015600
description	momentary rocker switch mounting measurements 30x22mm black 2NO 250V 16A ignition connection male faston 6.3mm ambient temperature max. 125/55°C protection IP40 mounting ømm		
For models:	CF-10EM, CF-10EM-6, CF-10EM-A, CF-10ET, CF-10ET-6, CF-10ET-A, CF-10G6-A, CF-10G6-F, CF-10G-A, CF-10GEM, CF-10GEM-6, CF-10GEM6-A, CF-10GEM-A, CF-10GF, CF4-68G, CF4-68GEM, CF4-78G, CF4-78GE, CF4-8G, CF4-8GEM, CF4-GEMS, CF-62GEM, CF-62GEM-A, CF6-610G, CF6-610GEM, CF6-712G, CF6-712GEV, CF6-712GV, CF-712GE, CF-8EM, CF-8EM-A, CF-8ET, CF-8ET-A, CF-8G-A, CF-8GEM, CF-8GEM-A, CF-8GF, CFM-10GEM, CFM-10GEM-6, CFM-10GEM6-A, CFM-10GEM-A, CFM4-66GEM, CFM4-68GEM, CFM6-610GEM, CFM-8GEM, CFM-8GEM-A, F18-94G, F2-18-98G, F2-25-98G, F25-94G...(Other models you can see in the webshop)		
accessories for	345189		
	GEV No.	301036	Ref. No. —
	protective cover internal size 30x22mm for rocker switch mounting measurementsmm		

thermocouples

plug-in thermocouples

plug-in thermocouples standard

with barrel socket ø6(6.5)mm

thermocouples SIT

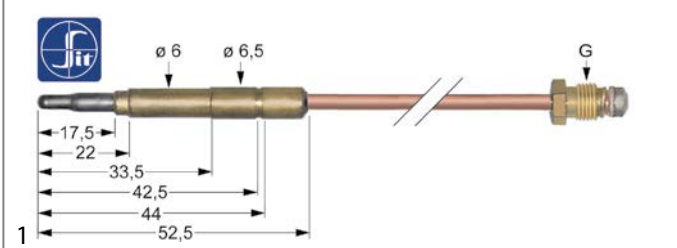

GEV No.	107621	Ref. No.	10070
description	thermocouple SIT M10x1 L 1500mm plug connection ø6.0(6.5)mm		

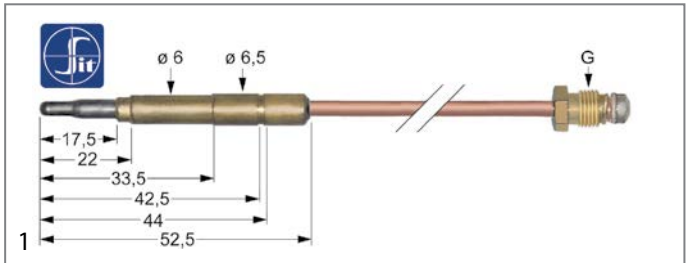

GEV No.	107614	Ref. No.	533041800
description	thermocouple SIT M9x1 L 1500mm plug connection ø6.0(6.5)mm		
For models:	CF4-78G, CF4-78GP, CF4-78GP-AUS, CF4-78GP-USA, CF4-98G, CF6-712G, CF6-712GP, CF6-712GPV, CF6-712GPV-USA, CF6-712GV, CF6-912G, CF6-912GV, CF8-916G, CF8-916GV, CFA4-78G, CFA4-98G, CFA6-712GV, CFA6-912GV, CFPB6-79G, PAF-78G, PAF-98G, TPF2-712G, TPF2-712GPV, TPF2-712GV, TPF2-78GP, TPF2-912G, TPF2-912GE, TPF2-912GV, TPF2-98G, TPF4-712GP, TPF4-712GPV, TPF4-912G, TPF4-912GV, TPF-78G, TPF-98G		

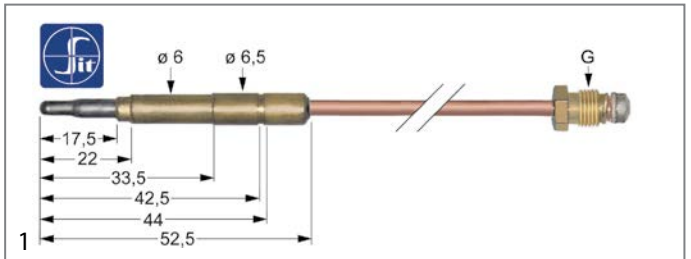

GEV No.	107608	Ref. No.	533045700 533053200
description	thermocouple SIT M9x1 L 500mm plug connection ø6.0(6.5)mm		
For models:	BM-4G, BM-61GF, BM-62GF, BM-6G, BM-74G, BM-78G, BM-8G, BM-94G, BM-98G, BMT-64G, BMT-66G, BMT-74G, BMT-78G, BMT-94G, BMT-98G, BR-62G, BR-6G, BRF-64G, BRF-74G, BRF-78G, BRF-94G, BRF-98G, BRT-66G, CF4-78GP, CF4-78GP-AUS, CF4-78GPE, CF4-78GP-USA, CF4-98G, CF4-98GE, CF6-712GP, CF6-712GPE, CF6-712GPV, CF6-712GPV-USA, CF6-912G, CF6-912GE, CF6-912GEV, CF6-912GV, CF-712GPE, CF8-916G, CF8-916GE, CF8-916GEV, CF8-916GV, CFV4-78GPE, CFV4-98GE, CFV6-712GPEV, CFV6-912GEV, CP-62G, CP-6G, CP-74G...(Other models you can see in the webshop)		

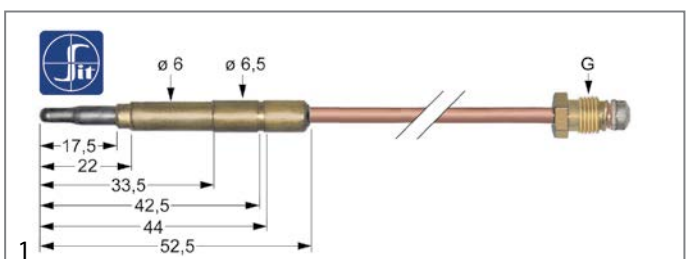

GEV No.	107611	Ref. No.	533039400
description	thermocouple SIT M9x1 L 850mm plug connection ø6.0(6.5)mm		
For models:	CF2-58G, CF2-58GE, CF2-68G, CF2-68GEM, CF3-512GEV, CF3-512GV, CF3-612GEMV, CF3-612GV, CF4-78GP, CF4-78GP-AUS, CF4-78GPE, CF4-78GP-USA, CF4-98G, CF4-98GE, CF6-712GP, CF6-712GPE, CF6-712GPV, CF6-712GPV-USA, CF6-912G, CF6-912GE, CF6-912GEV, CF6-912GV, CF8-916G, CF8-916GE, CF8-916GEV, CF8-916GV, CFM2-68GEM, CFM3-612GEMV, CFV4-78GPE, CFV4-98GE, CFV6-712GPEV, CFV6-912GEV, CP-66G, CP-76G, CPA-66G, CPA-76G, CPB-98G, CPBA-98G, CPM-62G, CPM-6G, PC1T-64G, PC2T-68G, PC3-612G, PC3T-612G, PC-712GP, PC-712GP-USA, PC-716GP, PC-716GP-USA, PC-74GP...(Other models you can see in the webshop)		



threaded thermocouples (miscellaneous)

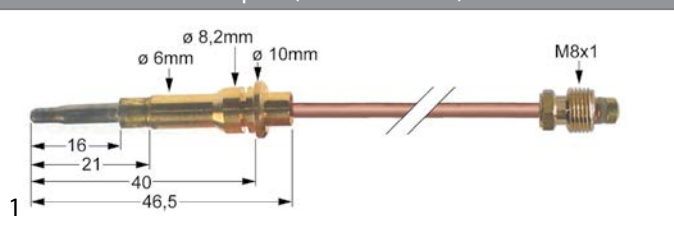

GEV No.	102262	Ref. No.	533083900
description	thermocouple M8x1 L 1200mm plug connection ø6.0mm		
For models:	CF-10G6-A, CF-10G-6F, CF-10G-A, CF-10GF, CF2-58G, CF2-58GE, CF2-68G, CF3-512GEV, CF3-512GV, CF3-612GV, CF4-68G, CF4-8G, CF6-610G, CF-8G-A, CF-8GF, TPF4-610G		

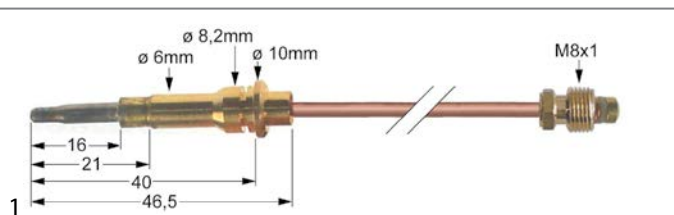

GEV No.	102263	Ref. No.	533083800
description	thermocouple M8x1 L 1400mm plug connection ø6.0mm		
For models:	CF-10G6-A, CF-10G-6F, CF-10G-A, CF-10GF, CF2-58G, CF2-58GE, CF2-68G, CF3-512GEV, CF3-512GV, CF3-612GV, CF4-68G, CF4-8G, CF6-610G, CF-8G-A, CF-8GF, TPF4-610G		

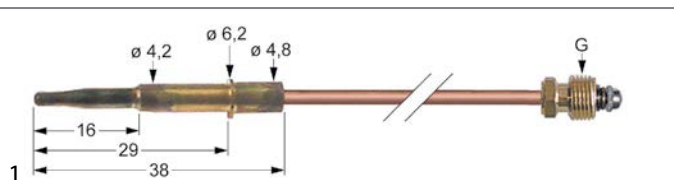

GEV No.	102261	Ref. No.	533077200
description	thermocouple M8x1 L 600mm plug connection ø6.0mm		
For models:	CF-10G6-A, CF-10G-6F, CF-10G-A, CF-10GEM, CF-10GEM-6, CF-10GEM6-A, CF-10GEM-A, CF-10GF, CF-62GEM, CF-62GEM-A, CF-8G-A, CF-8GEM, CF-8GEM-A, CF-8GF, CFM-10GEM, CFM-10GEM-6, CFM-10GEM6-A, CFM-10GEM-A, CFM-8GEM, CFM-8GEM-A, PC-61GF, PC-62GF		

plug-in thermocouples with cable link

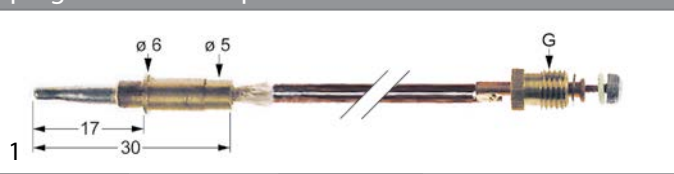

GEV No.	102260	Ref. No.	533077100
description	thermocouple with two-conductors L 600mm plug connection ø6.0mm M8x1		
For models:	CF-10G6-A, CF-10G-6F, CF-10G-A, CF-10GEM, CF-10GEM-6, CF-10GEM6-A, CF-10GEM-A, CF-10GF, CF-62GEM, CF-62GEM-A, CF-8G-A, CF-8GEM, CF-8GEM-A, CF-8GF, CFM-10GEM, CFM-10GEM-6, CFM-10GEM6-A, CFM-10GEM-A, CFM-8GEM, CFM-8GEM-A, PC-61GF, PC-62GF		

plug-in thermocouples with interruption

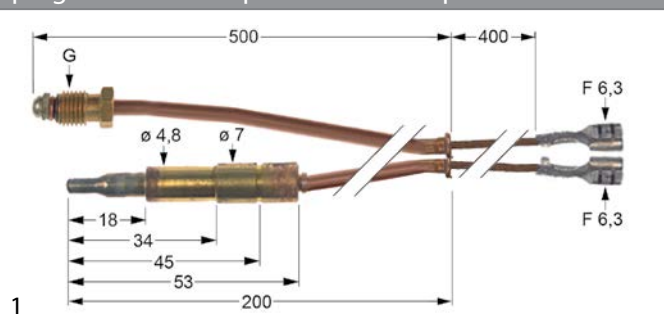

GEV No.	102115	Ref. No.	533067200
description	thermocouple with interrupter M9x1 L 500mm plug connection ø4.8mm F 6.3mm		
For models:	CPT-74G, CPT-76G, F11-54G, F13-64G, F13-74G, F13T-74G, F13T-94G, F18-74G, F18-94G, F2-13-78G, F2-13T-78G, F2-13T-98G, F2-18-78G, F2-18-98G, F2-25-98G, F25-94G, F2-8-74G, F2-8-94G, F2-8T-66G, F2-8T-74G, F2-8T-94G, F45-78G, F8T-63G, FG-10, FG-2-10, FMG-10, FMG-15, FMG-2-10, FMG-2-15, FMPG-20, FMPG-30, FP-62G, FP-6G, FPG-20, FPG-30, FQ-4G, FQ-61GF, FQ-62GF, FQ-6G, FQM-4G		

threaded thermocouples

threaded thermocouples standard

with socket with thread M8x1

SIT

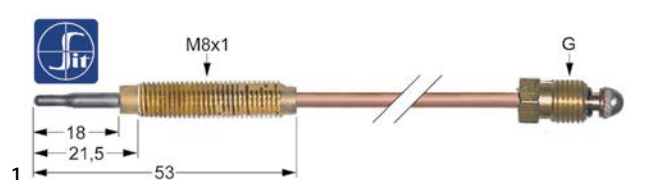

GEV No.	107633	Ref. No.	533011800
description	thermocouple SIT M8x1 L 1200mm M8x1		
For models:	CF-10G6-A, CF-10G-6F, CF-10G-A, CF-10GF, CF4-8G, CF4-8GEM, CF-8G-A, CF-8GF		

accessories for	107633		
	GEV No.	102067	Ref. No. 533009800
			nut thread M8x1 H 3mm brass Qty 1 pcs type SEF 1

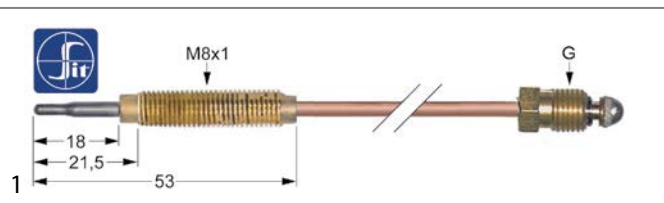

GEV No.	107634	Ref. No.	533053700
description	thermocouple SIT M8x1 L 1500mm M8x1		
For models:	CF4-8G, CF4-8GEM		

accessories for	107634		
	GEV No.	102067	Ref. No. 533009800
			nut thread M8x1 H 3mm brass Qty 1 pcs type SEF 1

GEV No.	107630	Ref. No.	53301100
description	thermocouple SIT M8x1 L 600mm M8x1		
accessories for	107630		
	GEV No.	102067	Ref. No. 533009800
nut thread M8x1 H 3mm brass Qty 1 pcs type SEF 1			

thermopiles

GEV No.	102116	Ref. No.	537033000
description	thermopile ROBERTSHAW L 900mm probe ø 9mm probe L 57mm 250-750mV screw connection 7/16"		

extensions

GEV No.	102013	Ref. No.	533053300
description	thermocouple extension thread M9x1 L 500mm		
For models:	BM-4G, BM-6G, BM-74G, BM-78G, BM-8G, BM-94G, BM-98G, BMT-64G, BMT-66G, BMT-74G, BMT-78G, BMT-94G, BMT-98G, CP-62G, CP-6G, F13T-74G, F-1G, F2-13T-78G, F2-8T-66G, F45-78G, F8T-63G, FP-62G, FP-6G, FQ-4G, FQ-61GF, FQ-62GF, FQ-6G, FQM-4G, FTL-54G, FTL-56G, FTL-712G, FTL-712GS, FTL-712G-USA, FTL-74G, FTL-74GS, FTL-74G-USA, FTL-76G, FTL-76G-USA, FTL-78G, FTL-78G-AUS, FTL-78GS, FTL-78G-USA, FTL-916G, FTL-94G, FTL-94GS, FTL-98G, FTL-98GS, FTLR-56G, FTLR-712G, FTLR-712GS...(Other models you can see in the webshop)		
accessories for	102013		
	GEV No.	101261	Ref. No. —
thermocouple fitting thread M9x1 Qty 1 pcs			

accessories

nuts

GEV No.	102067	Ref. No.	533009800
description	nut thread M8x1 H 3mm brass Qty 1 pcs type SEF 1		
For models:	CF-10G6-A, CF-10G-6F, CF-10G-A, CF-10GEM, CF-10GEM-6, CF-10GEM6-A, CF-10GEM-A, CF-10GF, CF4-78G, CF4-78GE, CF4-8G, CF4-8GEM, CF4-GEMS, CF-62GEM, CF-62GEM-A, CF6-712G, CF6-712GEV, CF6-712GV, CF-712GE, CF-8G-A, CF-8GEM, CF-8GEM-A, CF-8GF, CFM-10GEM, CFM-10GEM-6, CFM-10GEM6-A, CFM-10GEM-A, CFM-8GEM, CFM-8GEM-A, F-1G, FB-1G, FO-1G, FO-2G, FO-3G, FOS-1G, FOS-2G, FOS-3G, PC-12G, PC-4G, PC-61GF, PC-62GF, PC-712G, PC-716G, PC-74G, PC-78G, PC-8G, TP2-712G, TPF2-712G, TPF2-712GV		

interrupters

GEV No.	101265	Ref. No.	533011600
description	interrupter thread M9x1		
For models:	FG-10, FG-2-10, FMG-10, FMG-15, FMG-2-10, FMG-2-15, FMPG-20, FMPG-30, FP-62G, FP-6G, FPG-20, FPG-30, FQ-4G, FQ-61GF, FQ-62GF, FQ-6G, FQM-4G		

gas burners

hob burners

universal hob burners

GEV



GEV No.	106379	Ref. No.	N/A
description	air mixing tube for burner cap ø 80mm L 23mm D1 ø 20mm D2 ø 15.6mm D3 ø 14mm		

GEV No.	103068	Ref. No.	532001200
description	burner cap ø 100mm		
For models:	CF-10G6-A, CF-10G-6F, CF-10G-A, CF-10GEM, CF-10GEM-6, CF-10GEM6-A, CF-10GEM-A, CF-10GF, CF-62GEM, CF-62GEM-A, CF-8G-A, CF-8GEM, CF-8GEM-A, CF-8GF, CFM-10GEM, CFM-10GEM-6, CFM-10GEM6-A, CFM-10GEM-A, CFM-8GEM, CFM-8GEM-A, PC-61GF, PC-62GF		
accessories for	103068		
	GEV No.	103067	Ref. No. 532000900
burner ring for burner cap ø 100mm			
	GEV No.	104102	Ref. No. 532000600
burner head for burner cap ø 100mm ext. ø 130			
	GEV No.	104103	Ref. No. 532000300
burner holder suitable for burner ø100mm with nozzle holder			

GEV No.	103066	Ref. No.	532001100
description	burner cap ø 80mm		
For models:	CF-10G6-A, CF-10G-6F, CF-10G-A, CF-10GEM, CF-10GEM-6, CF-10GEM6-A, CF-10GEM-A, CF-10GF, CF-62GEM, CF-62GEM-A, CF-8G-A, CF-8GEM, CF-8GEM-A, CF-8GF, CFM-10GEM, CFM-10GEM-6, CFM-10GEM6-A, CFM-10GEM-A, CFM-8GEM, CFM-8GEM-A, PC-61GF, PC-62GF		
accessories for	103066		
	GEV No.	103065	Ref. No. 532000800
burner ring for burner cap ø 80mm			

Table continues overleaf



accessories for	103066		
	GEV No.	104100	Ref. No. 532000500
	burner head for burner cap ø 80mm		
	GEV No.	104101	Ref. No. 532000200
	burner holder for burner cap ø 80mm with nozzle holder with mixing sleeve		

	1		
GEV No.	104102	Ref. No.	532000600
description	burner head for burner cap ø 100mm ext. ø 130		
For models:	CF-10G6-A, CF-10G-6F, CF-10G-A, CF-10GEM, CF-10GEM-6, CF-10GEM6-A, CF-10GEM-A, CF-10GF, CF-62GEM, CF-62GEM-A, CF-8G-A, CF-8GEM, CF-8GEM-A, CF-8GF, CFM-10GEM, CFM-10GEM-6, CFM-10GEM6-A, CFM-10GEM-A, CFM-8GEM, CFM-8GEM-A, PC-61GF, PC-62GF		

	1		
GEV No.	104100	Ref. No.	532000500
description	burner head for burner cap ø 80mm		
For models:	CF-10G6-A, CF-10G-6F, CF-10G-A, CF-10GEM, CF-10GEM-6, CF-10GEM6-A, CF-10GEM-A, CF-10GF, CF-62GEM, CF-62GEM-A, CF-8G-A, CF-8GEM, CF-8GEM-A, CF-8GF, CFM-10GEM, CFM-10GEM-6, CFM-10GEM6-A, CFM-10GEM-A, CFM-8GEM, CFM-8GEM-A, PC-61GF, PC-62GF		
accessories for	104100		
	GEV No.	103065	Ref. No. 532000800
	burner ring for burner cap ø 80mm		
	GEV No.	103066	Ref. No. 532001100
	burner cap ø 80mm		
	GEV No.	104103	Ref. No. 532000300
	burner holder suitable for burner ø100mm with nozzle holder		

	1		
GEV No.	104101	Ref. No.	532000200
description	burner holder for burner cap ø 80mm with nozzle holder with mixing sleeve		
For models:	CF-10G6-A, CF-10G-6F, CF-10G-A, CF-10GEM, CF-10GEM-6, CF-10GEM6-A, CF-10GEM-A, CF-10GF, CF-62GEM, CF-62GEM-A, CF-8G-A, CF-8GEM, CF-8GEM-A, CF-8GF, CFM-10GEM, CFM-10GEM-6, CFM-10GEM6-A, CFM-10GEM-A, CFM-8GEM, CFM-8GEM-A, PC-61GF, PC-62GF		
accessories for	104101		
	GEV No.	103065	Ref. No. 532000800
	burner ring for burner cap ø 80mm		
	GEV No.	103066	Ref. No. 532001100
	burner cap ø 80mm		
	GEV No.	104100	Ref. No. 532000500
	burner head for burner cap ø 80mm		

	1		
GEV No.	104103	Ref. No.	532000300
description	burner holder suitable for burner ø100mm with nozzle holder		
For models:	CF-10G6-A, CF-10G-6F, CF-10G-A, CF-10GEM, CF-10GEM-6, CF-10GEM6-A, CF-10GEM-A, CF-10GF, CF-62GEM, CF-62GEM-A, CF-8G-A, CF-8GEM, CF-8GEM-A, CF-8GF, CFM-10GEM, CFM-10GEM-6, CFM-10GEM6-A, CFM-10GEM-A, CFM-8GEM, CFM-8GEM-A, PC-61GF, PC-62GF		
accessories for	104103		
	GEV No.	103067	Ref. No. 532000900
	burner ring for burner cap ø 100mm		
	GEV No.	103068	Ref. No. 532001200
	burner cap ø 100mm		
	GEV No.	104102	Ref. No. 532000600
	burner head for burner cap ø 100mm ext. ø 130		

	1		
GEV No.	103067	Ref. No.	532000900
description	burner ring for burner cap ø 100mm		
For models:	CF-10G6-A, CF-10G-6F, CF-10G-A, CF-10GEM, CF-10GEM-6, CF-10GEM6-A, CF-10GEM-A, CF-10GF, CF-62GEM, CF-62GEM-A, CF-8G-A, CF-8GEM, CF-8GEM-A, CF-8GF, CFM-10GEM, CFM-10GEM-6, CFM-10GEM6-A, CFM-10GEM-A, CFM-8GEM, CFM-8GEM-A, PC-61GF, PC-62GF		
accessories for	103067		
	GEV No.	103068	Ref. No. 532001200
	burner cap ø 100mm		
	GEV No.	104102	Ref. No. 532000600
	burner head for burner cap ø 100mm ext. ø 130		
	GEV No.	104103	Ref. No. 532000300
	burner holder suitable for burner ø100mm with nozzle holder		

	1		
GEV No.	103065	Ref. No.	532000800
description	burner ring for burner cap ø 80mm		
For models:	CF-10G6-A, CF-10G-6F, CF-10G-A, CF-10GEM, CF-10GEM-6, CF-10GEM6-A, CF-10GEM-A, CF-10GF, CF-62GEM, CF-62GEM-A, CF-8G-A, CF-8GEM, CF-8GEM-A, CF-8GF, CFM-10GEM, CFM-10GEM-6, CFM-10GEM6-A, CFM-10GEM-A, CFM-8GEM, CFM-8GEM-A, PC-61GF, PC-62GF		
accessories for	103065		
	GEV No.	103066	Ref. No. 532001100
	burner cap ø 80mm		
	GEV No.	104100	Ref. No. 532000500
	burner head for burner cap ø 80mm		
	GEV No.	104101	Ref. No. 532000200
	burner holder for burner cap ø 80mm with nozzle holder with mixing sleeve		

ARC

65 series



GEV No.	104332	Ref. No.	532004800
description	angle piece horizontal 3kW for Venturi		
For models:	CF4-78GP, CF4-78GP-AUS, CF4-78GPE, CF4-78GP-USA, CF6-712GP, CF6-712GPE, CF6-712GPEV, CF6-712GPV, CF6-712GPV-USA, CF-712GPE, CFV4-78GPE, CFV6-712GPEV, PC-712GP, PC-712GP-USA, PC-716GP, PC-716GP-USA, PC-74GP, PC-74GP-USA, PC-78GP, PC-78GP-USA, PCD-64G, PCD-68G, PCT-712GP, PCT-712GP-USA, PCT-716GP, PCT-716GP-USA, PCT-74GP, PCT-78GP, PCT-78GP-USA, TP4-712GP, TP4T-712GP, TPF4-712GP, TPF4-712GPE, TPF4-712GPEV, TPF4-712GPV, TPFV4-712GPEV		



GEV No.	104334	Ref. No.	532005000
description	angle piece horizontal 7.5kW for Venturi		
For models:	CF4-78GP, CF4-78GP-AUS, CF4-78GPE, CF4-78GP-USA, CF6-712GP, CF6-712GPE, CF6-712GPEV, CF6-712GPV, CF6-712GPV-USA, CF-712GPE, CFV4-78GPE, CFV6-712GPEV, PC-712GP, PC-712GP-USA, PC-716GP, PC-716GP-USA, PC-74GP, PC-74GP-USA, PC-78GP, PC-78GP-USA, PCD-64G, PCD-68G, PCT-712GP, PCT-712GP-USA, PCT-716GP, PCT-74GP, PCT-78GP, PCT-78GP-USA, TP2-712GP, TP2-78GP, TP2T-712GP, TP2T-78GP, TP4-712GP, TP4T-712GP, TPF2-712GP, TPF2-712GPE, TPF2-712GPEV, TPF2-712GPV, TPF2-78GP, TPF2-78GPE, TPF4-712GP, TPF4-712GPE, TPF4-712GPEV, TPF4-712GPV, TPFV2-712GPEV, TPFV2-78GPE, TPFV4-712GPEV		



GEV No.	104310	Ref. No.	532007400
description	burner cap 3kW ED ø 73mm seat ø 67mm chrome-plated		
For models:	CF4-78GP, CF4-78GP-AUS, CF4-78GPE, CF4-78GP-USA, CF6-712GP, CF6-712GPE, CF6-712GPEV, CF6-712GPV, CF6-712GPV-USA, CF-712GPE, CFV4-78GPE, CFV6-712GPEV, PC-712GP, PC-712GP-USA, PC-716GP, PC-716GP-USA, PC-74GP, PC-74GP-USA, PC-78GP, PC-78GP-USA, PCD-64G, PCD-68G, PCT-712GP, PCT-712GP-USA, PCT-716GP, PCT-716GP-USA, PCT-74GP, PCT-78GP, PCT-78GP-USA, TP4-712GP, TP4T-712GP, TPF4-712GP, TPF4-712GPE, TPF4-712GPEV, TPF4-712GPV, TPFV4-712GPEV		



GEV No.	104320	Ref. No.	532004700
description	burner cap 7.5kW ED ø 128mm ID ø 70mm seat ø 119.6mm chrome-plated		
For models:	CF4-78GP, CF4-78GP-AUS, CF4-78GPE, CF4-78GP-USA, CF6-712GP, CF6-712GPE, CF6-712GPEV, CF6-712GPV, CF6-712GPV-USA, CF-712GPE, CFA4-78G, CFA4-98G, CFA6-712GV, CFA6-912GV, CFV4-78GPE, CFV6-712GPEV, PC-712GP, PC-712GP-USA, PC-716GP, PC-716GP-USA, PC-74GP, PC-74GP-USA, PC-78GP, PC-78GP-USA, PCA-712G, PCA-74G, PCA-78G, PCA-912G, PCA-94G, PCA-98G, PCD-64G, PCD-68G, PCT-712GP, PCT-712GP-USA, PCT-716GP, PCT-74GP, PCT-78GP, PCT-78GP-USA, TP2-712GP, TP2-78GP, TP2T-712GP, TP2T-78GP, TP4-712GP, TP4T-712GP, TPF2-712GP, TPF2-712GPE, TPF2-712GPEV, TPF2-712GPV, TPF2-78GP, TPF2-78GPE... (Other models you can see in the webshop)		



GEV No.	104311	Ref. No.	532004200
description	burner head 3kW for burner cap ø 73mm seat ø 67mm chrome-plated		
For models:	CF4-78GP, CF4-78GP-AUS, CF4-78GPE, CF4-78GP-USA, CF6-712GP, CF6-712GPE, CF6-712GPEV, CF6-712GPV, CF6-712GPV-USA, CF-712GPE, CFV4-78GPE, CFV6-712GPEV, PC-712GP, PC-712GP-USA, PC-716GP, PC-716GP-USA, PC-74GP, PC-74GP-USA, PC-78GP, PC-78GP-USA, PCD-64G, PCD-68G, PCT-712GP, PCT-712GP-USA, PCT-716GP, PCT-716GP-USA, PCT-74GP, PCT-78GP, PCT-78GP-USA, TP4-712GP, TP4T-712GP, TPF4-712GP, TPF4-712GPE, TPF4-712GPEV, TPF4-712GPV, TPFV4-712GPEV		

accessories for	104311	GEV No.	104310	Ref. No.	532007400
					burner cap 3kW ED ø 73mm seat ø 67mm chrome-plated



GEV No.	104321	Ref. No.	532004400
description	burner head 7.5kW for burner cap ø 128mm ED ø 151mm seat ø 120mm chrome-plated		
For models:	CF4-78GP, CF4-78GP-AUS, CF4-78GPE, CF4-78GP-USA, CF6-712GP, CF6-712GPE, CF6-712GPEV, CF6-712GPV, CF6-712GPV-USA, CF-712GPE, CFA4-78G, CFA4-98G, CFA6-712GV, CFA6-912GV, CFV4-78GPE, CFV6-712GPEV, PC-712GP, PC-712GP-USA, PC-716GP, PC-716GP-USA, PC-74GP, PC-74GP-USA, PC-78GP, PC-78GP-USA, PCA-712G, PCA-74G, PCA-78G, PCA-912G, PCA-94G, PCA-98G, PCD-64G, PCD-68G, PCT-712GP, PCT-712GP-USA, PCT-716GP, PCT-74GP, PCT-78GP, PCT-78GP-USA, TP2-712GP, TP2-78GP, TP2T-712GP, TP2T-78GP, TP4-712GP, TP4T-712GP, TPF2-712GP, TPF2-712GPE, TPF2-712GPEV, TPF2-712GPV, TPF2-78GP, TPF2-78GPE... (Other models you can see in the webshop)		



GEV No.	104327	Ref. No.	533101000
description	burner pipe 3kW L 93mm total length 108mm air mixer ø 14mm ED ø 26.6mm ID ø 20.7mm		
For models:	CF4-78GP, CF4-78GP-AUS, CF4-78GPE, CF4-78GP-USA, CF6-712GP, CF6-712GPE, CF6-712GPEV, CF6-712GPV, CF6-712GPV-USA, CF-712GPE, CFV4-78GPE, CFV6-712GPEV, PC-712GP, PC-712GP-USA, PC-716GP, PC-716GP-USA, PC-74GP, PC-74GP-USA, PC-78GP, PC-78GP-USA, PCD-64G, PCD-68G, PCT-712GP, PCT-712GP-USA, PCT-716GP, PCT-716GP-USA, PCT-74GP, PCT-78GP, PCT-78GP-USA, TP4-712GP, TP4T-712GP, TPF4-712GP, TPF4-712GPE, TPF4-712GPEV, TPF4-712GPV, TPFV4-712GPEV		



GEV No.	104329	Ref. No.	533101200
description	burner pipe 7.5kW L 93mm total length 108mm air mixer ø 29.7mm ED ø 33.8mm ID ø 27.6mm		
For models:	CF4-78GP, CF4-78GP-AUS, CF4-78GPE, CF4-78GP-USA, CF6-712GP, CF6-712GPE, CF6-712GPEV, CF6-712GPV, CF6-712GPV-USA, CF-712GPE, CFV4-78GPE, CFV6-712GPEV, PC-712GP, PC-712GP-USA, PC-716GP, PC-716GP-USA, PC-74GP, PC-74GP-USA, PC-78GP, PC-78GP-USA, PCD-64G, PCD-68G, PCT-712GP, PCT-712GP-USA, PCT-716GP, PCT-74GP, PCT-78GP, PCT-78GP-USA, TP2-712GP, TP2-78GP, TP2T-712GP, TP2T-78GP, TP4-712GP, TP4T-712GP, TPF2-712GP, TPF2-712GPE, TPF2-712GPEV, TPF2-712GPV, TPF2-78GP, TPF2-78GPE, TPF4-712GP, TPF4-712GPE, TPF4-712GPEV, TPF4-712GPV, TPFV2-712GPEV, TPFV2-78GPE, TPFV4-712GPEV		



SABAF			
DUAL tripple ring burner series - flat skirt version			
			
1			
GEV No.	105742	Ref. No.	532003600
description	burner cap 4.5kW ø 128mm mounting pos. outer bright finish		
For models:	CF-10G6-A, CF-10G-6F, CF-10G-A, CF-10GEM, CF-10GEM-6, CF-10GEM6-A, CF-10GEM-A, CF-10GF, CF-62GEM, CF-62GEM-A, CF-8G-A, CF-8GEM, CF-8GEM-A, CF-8GF, CFM-10GEM, CFM-10GEM-6, CFM-10GEM6-A, CFM-10GEM-A, CFM-8GEM, CFM-8GEM-A, PC-61GF, PC-62GF		
accessories for	105742		
	GEV No.	Ref. No.	
	105740	532003500	burner cap 4.5kW ø 48mm mounting pos. inner bright finish
	105741	532003200	burner head 4.5kW mounting pos. inner for burner cap ø 55mm
	105743	532003300	burner head 4.5kW mounting pos. outer for burner cap ø 128mm
	105745	532003000	burner lower part 4.5kW

			
1			
GEV No.	105740	Ref. No.	532003500
description	burner cap 4.5kW ø 48mm mounting pos. inner bright finish		
For models:	CF-10G6-A, CF-10G-6F, CF-10G-A, CF-10GEM, CF-10GEM-6, CF-10GEM6-A, CF-10GEM-A, CF-10GF, CF-62GEM, CF-62GEM-A, CF-8G-A, CF-8GEM, CF-8GEM-A, CF-8GF, CFM-10GEM, CFM-10GEM-6, CFM-10GEM6-A, CFM-10GEM-A, CFM-8GEM, CFM-8GEM-A, PC-61GF, PC-62GF		
accessories for	105740		
	GEV No.	Ref. No.	
	105741	532003200	burner head 4.5kW mounting pos. inner for burner cap ø 55mm
	105742	532003600	burner cap 4.5kW ø 128mm mounting pos. outer bright finish
	105743	532003300	burner head 4.5kW mounting pos. outer for burner cap ø 128mm
	105745	532003000	burner lower part 4.5kW

			
1			
GEV No.	105741	Ref. No.	532003200
description	burner head 4.5kW mounting pos. inner for burner cap ø 55mm		
For models:	CF-10G6-A, CF-10G-6F, CF-10G-A, CF-10GEM, CF-10GEM-6, CF-10GEM6-A, CF-10GEM-A, CF-10GF, CF-62GEM, CF-62GEM-A, CF-8G-A, CF-8GEM, CF-8GEM-A, CF-8GF, CFM-10GEM, CFM-10GEM-6, CFM-10GEM6-A, CFM-10GEM-A, CFM-8GEM, CFM-8GEM-A, PC-61GF, PC-62GF		
accessories for	105741		
	GEV No.	Ref. No.	
	105740	532003500	burner cap 4.5kW ø 48mm mounting pos. inner bright finish
	105742	532003600	burner cap 4.5kW ø 128mm mounting pos. outer bright finish
	105743	532003300	burner head 4.5kW mounting pos. outer for burner cap ø 128mm
	105745	532003000	burner lower part 4.5kW





			
1			
GEV No.	105743	Ref. No.	532003300
description	burner head 4.5kW mounting pos. outer for burner cap ø 128mm		
For models:	CF-10G6-A, CF-10G-6F, CF-10G-A, CF-10GEM, CF-10GEM-6, CF-10GEM6-A, CF-10GEM-A, CF-10GF, CF-62GEM, CF-62GEM-A, CF-8G-A, CF-8GEM, CF-8GEM-A, CF-8GF, CFM-10GEM, CFM-10GEM-6, CFM-10GEM6-A, CFM-10GEM-A, CFM-8GEM, CFM-8GEM-A, PC-61GF, PC-62GF		
accessories for	105743		
	GEV No.	Ref. No.	
	105740	532003500	burner cap 4.5kW ø 48mm mounting pos. inner bright finish
	105741	532003200	burner head 4.5kW mounting pos. inner for burner cap ø 55mm
	105742	532003600	burner cap 4.5kW ø 128mm mounting pos. outer bright finish
	105745	532003000	burner lower part 4.5kW

			
1			
GEV No.	105745	Ref. No.	532003000
description	burner lower part 4.5kW		
For models:	CF-10G6-A, CF-10G-6F, CF-10G-A, CF-10GEM, CF-10GEM-6, CF-10GEM6-A, CF-10GEM-A, CF-10GF, CF-62GEM, CF-62GEM-A, CF-8G-A, CF-8GEM, CF-8GEM-A, CF-8GF, CFM-10GEM, CFM-10GEM-6, CFM-10GEM6-A, CFM-10GEM-A, CFM-8GEM, CFM-8GEM-A, PC-61GF, PC-62GF		
accessories for	105745		
	GEV No.	105740	Ref. No. 532003500
	burner cap 4.5kW ø 48mm mounting pos. inner bright finish		
	GEV No.	105741	Ref. No. 532003200
	burner head 4.5kW mounting pos. inner for burner cap ø 55mm		
	GEV No.	105742	Ref. No. 532003600
	burner cap 4.5kW ø 128mm mounting pos. outer bright finish		
	GEV No.	105743	Ref. No. 532003300
	burner head 4.5kW mounting pos. outer for burner cap ø 128mm		

FLAM GAS





SF series





			
1			
GEV No.	105749	Ref. No.	544424100
description	air mixer		
For models:	CF2-58G, CF2-58GE, CF2-68G, CF2-68GEM, CF3-512GEV, CF3-512GV, CF3-612GEMV, CF3-612GV, CF4-98G, CF4-98GE, CF6-912G, CF6-912GE, CF6-912GEV, CF6-912GV, CF8-916G, CF8-916GE, CF8-916GEV, CF8-916GV, CFM2-68GEM, CFM3-612GEMV, CFV4-98GE, CFV6-912GEV, PC1T-64G, PC2T-68G, PC3-612G, PC3T-612G, PC-912G, PC-916G, PC-94G, PC-98G, PCD-44G, PCT-912G, PCT-916G, PCT-94G, PCT-98G, TP2-912G, TP2-98G, TP2T-912G, TP2T-98G, TP4-912G, TP4T-912G, TPF2-912G, TPF2-912GE, TPF2-912GEV, TPF2-912GV, TPF2-98G, TPF2-98GE, TPF4-610G, TPF4-912G, TPF4-912GE...(Other models you can see in the webshop)		
accessories for	105749		
	GEV No.	105748	Ref. No. 531034900
	burner lower part for burner cap ø 60mm 4kW		
	GEV No.	105752	Ref. No. 531035000
	burner lower part for burner cap ø 80mm 7kW		
	GEV No.	105755	Ref. No. 531035100
	burner lower part for burner cap ø 110mm 10kW		

			
1			
GEV No.	105753	Ref. No.	532003900
description	burner cap ø 100mm 10kW		
For models:	CF2-58G, CF2-58GE, CF2-68G, CF2-68GEM, CF3-512GEV, CF3-512GV, CF3-612GEMV, CF3-612GV, CF4-98G, CF4-98GE, CF6-912G, CF6-912GE, CF6-912GEV, CF6-912GV, CF8-916G, CF8-916GE, CF8-916GEV, CF8-916GV, CFM2-68GEM, CFM3-612GEMV, CFV4-98GE, CFV6-912GEV, PC1T-64G, PC2T-68G, PC3-612G, PC3T-612G, PC-912G, PC-916G, PC-94G, PC-98G, PCD-44G, PCT-912G, PCT-916G, PCT-94G, PCT-98G, TP2-912G, TP2-98G, TP2T-912G, TP2T-98G, TP4-912G, TP4T-912G, TPF2-912G, TPF2-912GE, TPF2-912GEV, TPF2-912GV, TPF2-98G, TPF2-98GE, TPF4-912G, TPF4-912GE, TPF4-912GEV...(Other models you can see in the webshop)		
accessories for	105753		
	GEV No.	105749	Ref. No. 544424100
	air mixer		
	GEV No.	105754	Ref. No. 531035400
	burner head for burner cap ø 110mm 10kW		
	GEV No.	105755	Ref. No. 531035100
	burner lower part for burner cap ø 110mm 10kW		

			
1			
GEV No.	105746	Ref. No.	532003700
description	burner cap ø 60mm 4kW		
For models:	CF4-98G, CF4-98GE, CF6-912G, CF6-912GE, CF6-912GEV, CF6-912GV, CF8-916G, CF8-916GE, CF8-916GEV, CF8-916GV, CFV4-98GE, CFV6-912GEV, PC-912G, PC-916G, PC-94G, PC-98G, PCT-912G, PCT-916G, PCT-94G, PCT-98G, TP4-912G, TP4T-912G, TPF2-912GE, TPF4-912G, TPF4-912GE, TPF4-912GEV, TPF4-912GV, TPFV4-912GEV		
accessories for	105746		
	GEV No.	105747	Ref. No. 531035200
	burner head for burner cap ø 60mm 4kW		
	GEV No.	105748	Ref. No. 531034900
	burner lower part for burner cap ø 60mm 4kW		
	GEV No.	105749	Ref. No. 544424100
	air mixer		





			
1			
GEV No.	105750	Ref. No.	532003800
description	burner cap ø 80mm 7kW		
For models:	CF2-58G, CF2-58GE, CF2-68G, CF2-68GEM, CF3-512GEV, CF3-512GV, CF3-612GEMV, CF3-612GV, CF4-98G, CF4-98GE, CF6-912G, CF6-912GE, CF6-912GEV, CF6-912GV, CF8-916G, CF8-916GE, CF8-916GEV, CF8-916GV, CFM2-68GEM, CFM3-612GEMV, CFV4-98GE, CFV6-912GEV, PC1T-64G, PC2T-68G, PC3-612G, PC3T-612G, PC-912G, PC-916G, PC-94G, PC-98G, PCT-912G, PCT-916G, PCT-94G, PCT-98G, TP2-912G, TP2-98G, TP2T-912G, TP2T-98G, TP4-912G, TP4T-912G, TPF2-912G, TPF2-912GE, TPF2-912GEV, TPF2-912GV, TPF2-98G, TPF2-98GE, TPF4-610G, TPF4-912G, TPF4-912GE, TPF4-912GEV...(Other models you can see in the webshop)		
accessories for	105750		
	GEV No.	105749	Ref. No. 544424100
air mixer			
	GEV No.	105751	Ref. No. 531035300
burner head for burner cap ø 80mm 7kW			
	GEV No.	105752	Ref. No. 531035000
burner lower part for burner cap ø 80mm 7kW			

			
1			
GEV No.	105747	Ref. No.	531035200
description	burner head for burner cap ø 60mm 4kW		
For models:	CF4-98G, CF4-98GE, CF6-912G, CF6-912GE, CF6-912GEV, CF6-912GV, CF8-916G, CF8-916GE, CF8-916GEV, CF8-916GV, CFV4-98GE, CFV6-912GEV, PC-912G, PC-916G, PC-94G, PC-98G, PCT-912G, PCT-916G, PCT-94G, PCT-98G, TP4-912G, TP4T-912G, TPF2-912GE, TPF4-912G, TPF4-912GE, TPF4-912GEV, TPF4-912GV, TPFV4-912GEV		
accessories for	105747		
	GEV No.	105746	Ref. No. 532003700
burner cap ø 60mm 4kW			
	GEV No.	105748	Ref. No. 531034900
burner lower part for burner cap ø 60mm 4kW			
	GEV No.	105749	Ref. No. 544424100
air mixer			





			
1			
GEV No.	105754	Ref. No.	531035400
description	burner head for burner cap ø 110mm 10kW		
For models:	CF2-58G, CF2-58GE, CF2-68G, CF2-68GEM, CF3-512GEV, CF3-512GV, CF3-612GEMV, CF3-612GV, CF4-98G, CF4-98GE, CF6-912G, CF6-912GE, CF6-912GEV, CF6-912GV, CF8-916G, CF8-916GE, CF8-916GEV, CF8-916GV, CFM2-68GEM, CFM3-612GEMV, CFV4-98GE, CFV6-912GEV, PC1T-64G, PC2T-68G, PC3-612G, PC3T-612G, PC-912G, PC-916G, PC-94G, PC-98G, PCD-44G, PCT-912G, PCT-916G, PCT-94G, PCT-98G, PCW-74G, PCWT-74G, TP2-912G, TP2-98G, TP2T-912G, TP2T-98G, TP4-912G, TP4T-912G, TPF2-912G, TPF2-912GE, TPF2-912GEV, TPF2-912GV, TPF2-98G, TPF2-98GE, TPF4-912G...(Other models you can see in the webshop)		
accessories for	105754		
	GEV No.	105749	Ref. No. 544424100
air mixer			
	GEV No.	105753	Ref. No. 532003900
burner cap ø 100mm 10kW			
	GEV No.	105755	Ref. No. 531035100
burner lower part for burner cap ø 110mm 10kW			

			
1			
GEV No.	105751	Ref. No.	531035300
description	burner head for burner cap ø 80mm 7kW		
For models:	CF2-58G, CF2-58GE, CF2-68G, CF2-68GEM, CF3-512GEV, CF3-512GV, CF3-612GEMV, CF3-612GV, CF4-98G, CF4-98GE, CF6-912G, CF6-912GE, CF6-912GEV, CF6-912GV, CF8-916G, CF8-916GE, CF8-916GEV, CF8-916GV, CFM2-68GEM, CFM3-612GEMV, CFV4-98GE, CFV6-912GEV, PC1T-64G, PC2T-68G, PC3-612G, PC3T-612G, PC-912G, PC-916G, PC-94G, PC-98G, PCT-912G, PCT-916G, PCT-94G, PCT-98G, TP2-912G, TP2-98G, TP2T-912G, TP2T-98G, TP4-912G, TP4T-912G, TPF2-912G, TPF2-912GE, TPF2-912GEV, TPF2-912GV, TPF2-98G, TPF2-98GE, TPF4-610G, TPF4-912G, TPF4-912GE, TPF4-912GEV...(Other models you can see in the webshop)		
accessories for	105751		
	GEV No.	105749	Ref. No. 544424100
air mixer			
	GEV No.	105750	Ref. No. 532003800
burner cap ø 80mm 7kW			
	GEV No.	105752	Ref. No. 531035000
burner lower part for burner cap ø 80mm 7kW			

			
GEV No.	105755	Ref. No.	531035100
description	burner lower part for burner cap ø 110mm 10kW		
For models:	CF2-58G, CF2-58GE, CF2-68G, CF2-68GEM, CF3-512GEV, CF3-512GV, CF3-612GEMV, CF3-612GV, CF4-98G, CF4-98GE, CF6-912G, CF6-912GE, CF6-912GEV, CF6-912GV, CF8-916G, CF8-916GE, CF8-916GEV, CF8-916GV, CFM2-68GEM, CFM3-612GEMV, CFV4-98GE, CFV6-912GEV, PC1T-64G, PC2T-68G, PC3-612G, PC3T-612G, PC-912G, PC-916G, PC-94G, PC-98G, PCD-44G, PCT-912G, PCT-916G, PCT-94G, PCT-98G, PCW-74G, PCWT-74G, TP2-912G, TP2-98G, TP2T-912G, TP2T-98G, TP4-912G, TP4T-912G, TPF2-912G, TPF2-912GE, TPF2-912GEV, TPF2-912GV, TPF2-98G, TPF2-98GE, TPF4-912G...(Other models you can see in the webshop)		
accessories for	105755		
	GEV No.	105749	Ref. No. 544424100
	air mixer		
	GEV No.	105753	Ref. No. 532003900
	burner cap ø 100mm 10kW		
	GEV No.	105754	Ref. No. 531035400
	burner head for burner cap ø 110mm 10kW		





			
GEV No.	105752	Ref. No.	531035000
description	burner lower part for burner cap ø 80mm 7kW		
For models:	CF2-58G, CF2-58GE, CF2-68G, CF2-68GEM, CF3-512GEV, CF3-512GV, CF3-612GEMV, CF3-612GV, CF4-98G, CF4-98GE, CF6-912G, CF6-912GE, CF6-912GEV, CF6-912GV, CF8-916G, CF8-916GE, CF8-916GEV, CF8-916GV, CFM2-68GEM, CFM3-612GEMV, CFV4-98GE, CFV6-912GEV, PC1T-64G, PC2T-68G, PC3-612G, PC3T-612G, PC-912G, PC-916G, PC-94G, PC-98G, PCT-912G, PCT-916G, PCT-94G, PCT-98G, TP2-912G, TP2-98G, TP2T-912G, TP2T-98G, TP4-912G, TP4T-912G, TPF2-912G, TPF2-912GE, TPF2-912GEV, TPF2-912GV, TPF2-98G, TPF2-98GE, TPF4-610G, TPF4-912G, TPF4-912GE, TPF4-912GEV...(Other models you can see in the webshop)		
accessories for	105752		
	GEV No.	105749	Ref. No. 544424100
	air mixer		
	GEV No.	105750	Ref. No. 532003800
	burner cap ø 80mm 7kW		
	GEV No.	105751	Ref. No. 531035300
	burner head for burner cap ø 80mm 7kW		



			
GEV No.	105748	Ref. No.	531034900
description	burner lower part for burner cap ø 60mm 4kW		
For models:	CF4-98G, CF4-98GE, CF6-912G, CF6-912GE, CF6-912GEV, CF6-912GV, CF8-916G, CF8-916GE, CF8-916GEV, CF8-916GV, CFV4-98GE, CFV6-912GEV, PC-912G, PC-916G, PC-94G, PC-98G, PCT-912G, PCT-916G, PCT-94G, PCT-98G, TP4-912G, TP4T-912G, TPF2-912GE, TPF4-912G, TPF4-912GE, TPF4-912GEV, TPF4-912GV, TPFV4-912GEV		
accessories for	105748		
	GEV No.	105746	Ref. No. 532003700
	burner cap ø 60mm 4kW		
	GEV No.	105747	Ref. No. 531035200
	burner head for burner cap ø 60mm 4kW		
	GEV No.	105749	Ref. No. 544424100
	air mixer		

producer-specific hob burners			
LOTUS			
55, 90 series			
			
GEV No.	105749	Ref. No.	544424100
description	air mixer		
For models:	CF2-58G, CF2-58GE, CF2-68G, CF2-68GEM, CF3-512GEV, CF3-512GV, CF3-612GEMV, CF3-612GV, CF4-98G, CF4-98GE, CF6-912G, CF6-912GE, CF6-912GEV, CF6-912GV, CF8-916G, CF8-916GE, CF8-916GEV, CF8-916GV, CFM2-68GEM, CFM3-612GEMV, CFV4-98GE, CFV6-912GEV, PC1T-64G, PC2T-68G, PC3-612G, PC3T-612G, PC-912G, PC-916G, PC-94G, PC-98G, PCD-44G, PCT-912G, PCT-916G, PCT-94G, PCT-98G, TP2-912G, TP2-98G, TP2T-912G, TP2T-98G, TP4-912G, TP4T-912G, TPF2-912G, TPF2-912GE, TPF2-912GEV, TPF2-912GV, TPF2-98G, TPF2-98GE, TPF4-610G, TPF4-912G, TPF4-912GE...(Other models you can see in the webshop)		
accessories for	105749		
	GEV No.	105748	Ref. No. 531034900
	burner lower part for burner cap ø 60mm 4kW		
	GEV No.	105752	Ref. No. 531035000
	burner lower part for burner cap ø 80mm 7kW		
	GEV No.	105755	Ref. No. 531035100
	burner lower part for burner cap ø 110mm 10kW		



			
GEV No.	105753	Ref. No.	532003900
description	burner cap ø 100mm 10kW		
For models:	CF2-58G, CF2-58GE, CF2-68G, CF2-68GEM, CF3-512GEV, CF3-512GV, CF3-612GEMV, CF3-612GV, CF4-98G, CF4-98GE, CF6-912G, CF6-912GE, CF6-912GEV, CF6-912GV, CF8-916G, CF8-916GE, CF8-916GEV, CF8-916GV, CFM2-68GEM, CFM3-612GEMV, CFV4-98GE, CFV6-912GEV, PC1T-64G, PC2T-68G, PC3-612G, PC3T-612G, PC-912G, PC-916G, PC-94G, PC-98G, PCD-44G, PCT-912G, PCT-916G, PCT-94G, PCT-98G, TP2-912G, TP2-98G, TP2T-912G, TP2T-98G, TP4-912G, TP4T-912G, TPF2-912G, TPF2-912GE, TPF2-912GEV, TPF2-912GV, TPF2-98G, TPF2-98GE, TPF4-912G, TPF4-912GE, TPF4-912GEV...(Other models you can see in the webshop)		
accessories for	105753		
	GEV No.	105749	Ref. No. 544424100
	air mixer		
	GEV No.	105754	Ref. No. 531035400
	burner head for burner cap ø 110mm 10kW		
	GEV No.	105755	Ref. No. 531035100
	burner lower part for burner cap ø 110mm 10kW		



			
GEV No.	105750	Ref. No.	532003800
description	burner cap ø 80mm 7kW		
For models:	CF2-58G, CF2-58GE, CF2-68G, CF2-68GEM, CF3-512GEV, CF3-512GV, CF3-612GEMV, CF3-612GV, CF4-98G, CF4-98GE, CF6-912G, CF6-912GE, CF6-912GEV, CF6-912GV, CF8-916G, CF8-916GE, CF8-916GEV, CF8-916GV, CFM2-68GEM, CFM3-612GEMV, CFV4-98GE, CFV6-912GEV, PC1T-64G, PC2T-68G, PC3-612G, PC3T-612G, PC-912G, PC-916G, PC-94G, PC-98G, PCT-912G, PCT-916G, PCT-94G, PCT-98G, TP2-912G, TP2-98G, TP2T-912G, TP2T-98G, TP4-912G, TP4T-912G, TPF2-912G, TPF2-912GE, TPF2-912GEV, TPF2-912GV, TPF2-98G, TPF2-98GE, TPF4-610G, TPF4-912G, TPF4-912GE, TPF4-912GEV...(Other models you can see in the webshop)		
accessories for	105750		
	GEV No.	105749	Ref. No. 544424100
	air mixer		
	GEV No.	105751	Ref. No. 531035300
	burner head for burner cap ø 80mm 7kW		
	GEV No.	105752	Ref. No. 531035000
	burner lower part for burner cap ø 80mm 7kW		

			
GEV No.	105746	Ref. No.	532003700
description	burner cap ø 60mm 4kW		
For models:	CF4-98G, CF4-98GE, CF6-912G, CF6-912GE, CF6-912GEV, CF6-912GV, CF8-916G, CF8-916GE, CF8-916GEV, CF8-916GV, CFV4-98GE, CFV6-912GEV, PC-912G, PC-916G, PC-94G, PC-98G, PCT-912G, PCT-916G, PCT-94G, PCT-98G, TP4-912G, TP4T-912G, TPF2-912GE, TPF4-912G, TPF4-912GE, TPF4-912GEV, TPF4-912GV, TPFV4-912GEV		
accessories for	105746		
	GEV No.	105747	Ref. No. 531035200
	burner head for burner cap ø 60mm 4kW		
	GEV No.	105748	Ref. No. 531034900
	burner lower part for burner cap ø 60mm 4kW		
	GEV No.	105749	Ref. No. 544424100
	air mixer		

			
GEV No.	105754	Ref. No.	531035400
description	burner head for burner cap ø 110mm 10kW		
For models:	CF2-58G, CF2-58GE, CF2-68G, CF2-68GEM, CF3-512GEV, CF3-512GV, CF3-612GEMV, CF3-612GV, CF4-98G, CF4-98GE, CF6-912G, CF6-912GE, CF6-912GEV, CF6-912GV, CF8-916G, CF8-916GE, CF8-916GEV, CF8-916GV, CFM2-68GEM, CFM3-612GEMV, CFV4-98GE, CFV6-912GEV, PC1T-64G, PC2T-68G, PC3-612G, PC3T-612G, PC-912G, PC-916G, PC-94G, PC-98G, PCD-44G, PCT-912G, PCT-916G, PCT-94G, PCT-98G, PCW-74G, PCWT-74G, TP2-912G, TP2-98G, TP2T-912G, TP2T-98G, TP4-912G, TP4T-912G, TPF2-912G, TPF2-912GE, TPF2-912GEV, TPF2-912GV, TPF2-98G, TPF2-98GE, TPF4-912G...(Other models you can see in the webshop)		
accessories for	105754		
	GEV No.	105749	Ref. No. 544424100
	air mixer		
	GEV No.	105753	Ref. No. 532003900
	burner cap ø 100mm 10kW		
	GEV No.	105755	Ref. No. 531035100
	burner lower part for burner cap ø 110mm 10kW		



1

GEV No.	105747	Ref. No.	531035200
description	burner head for burner cap ø 60mm 4kW		
For models:	CF4-98G, CF4-98GE, CF6-912G, CF6-912GE, CF6-912GEV, CF6-912GV, CF8-916G, CF8-916GE, CF8-916GEV, CF8-916GV, CFV4-98GE, CFV6-912GEV, PC-912G, PC-916G, PC-94G, PC-98G, PCT-912G, PCT-916G, PCT-94G, PCT-98G, TP4-912G, TP4T-912G, TPF2-912GE, TPF4-912G, TPF4-912GE, TPF4-912GEV, TPF4-912GV, TPFV4-912GEV		
accessories for	105747		
	GEV No.	105746	Ref. No. 532003700
	burner cap ø 60mm 4kW		
	GEV No.	105748	Ref. No. 531034900
	burner lower part for burner cap ø 60mm 4kW		
	GEV No.	105749	Ref. No. 544424100
	air mixer		



1

GEV No.	105751	Ref. No.	531035300
description	burner head for burner cap ø 80mm 7kW		
For models:	CF2-58G, CF2-58GE, CF2-68G, CF2-68GEM, CF3-512GEV, CF3-512GV, CF3-612GEMV, CF3-612GV, CF4-98G, CF4-98GE, CF6-912G, CF6-912GE, CF6-912GEV, CF6-912GV, CF8-916G, CF8-916GE, CF8-916GEV, CF8-916GV, CFM2-68GEM, CFM3-612GEMV, CFV4-98GE, CFV6-912GEV, PC1T-64G, PC2T-68G, PC3-612G, PC3T-612G, PC-912G, PC-916G, PC-94G, PC-98G, PCT-912G, PCT-916G, PCT-94G, PCT-98G, TP2-912G, TP2-98G, TP2T-912G, TP2T-98G, TP4-912G, TP4T-912G, TPF2-912G, TPF2-912GE, TPF2-912GEV, TPF2-912GV, TPF2-98G, TPF2-98GE, TPF4-610G, TPF4-912G, TPF4-912GE, TPF4-912GEV...(Other models you can see in the webshop)		
accessories for	105751		
	GEV No.	105749	Ref. No. 544424100
	air mixer		
	GEV No.	105750	Ref. No. 532003800
	burner cap ø 80mm 7kW		
	GEV No.	105752	Ref. No. 531035000
	burner lower part for burner cap ø 80mm 7kW		



1

GEV No.	105755	Ref. No.	531035100
description	burner lower part for burner cap ø 110mm 10kW		
For models:	CF2-58G, CF2-58GE, CF2-68G, CF2-68GEM, CF3-512GEV, CF3-512GV, CF3-612GEMV, CF3-612GV, CF4-98G, CF4-98GE, CF6-912G, CF6-912GE, CF6-912GEV, CF6-912GV, CF8-916G, CF8-916GE, CF8-916GEV, CF8-916GV, CFM2-68GEM, CFM3-612GEMV, CFV4-98GE, CFV6-912GEV, PC1T-64G, PC2T-68G, PC3-612G, PC3T-612G, PC-912G, PC-916G, PC-94G, PC-98G, PCD-44G, PCT-912G, PCT-916G, PCT-94G, PCT-98G, PCW-74G, PCWT-74G, TP2-912G, TP2-98G, TP2T-912G, TP2T-98G, TP4-912G, TP4T-912G, TPF2-912G, TPF2-912GE, TPF2-912GEV, TPF2-912GV, TPF2-98G, TPF2-98GE, TPF4-912G...(Other models you can see in the webshop)		
accessories for	105755		
	GEV No.	105749	Ref. No. 544424100
	air mixer		
	GEV No.	105753	Ref. No. 532003900
	burner cap ø 100mm 10kW		
	GEV No.	105754	Ref. No. 531035400
	burner head for burner cap ø 110mm 10kW		



1

GEV No.	105748	Ref. No.	531034900
description	burner lower part for burner cap ø 60mm 4kW		
For models:	CF4-98G, CF4-98GE, CF6-912G, CF6-912GE, CF6-912GEV, CF6-912GV, CF8-916G, CF8-916GE, CF8-916GEV, CF8-916GV, CFV4-98GE, CFV6-912GEV, PC-912G, PC-916G, PC-94G, PC-98G, PCT-912G, PCT-916G, PCT-94G, PCT-98G, TP4-912G, TP4T-912G, TPF2-912GE, TPF4-912G, TPF4-912GE, TPF4-912GEV, TPF4-912GV, TPFV4-912GEV		
accessories for	105748		
	GEV No.	105746	Ref. No. 532003700
	burner cap ø 60mm 4kW		
	GEV No.	105747	Ref. No. 531035200
	burner head for burner cap ø 60mm 4kW		
	GEV No.	105749	Ref. No. 544424100
	air mixer		



 <p>1</p>			
GEV No.	105752	Ref. No.	531035000
description	burner lower part for burner cap ø 80mm 7kW		
For models:	CF2-58G, CF2-58GE, CF2-68G, CF2-68GEM, CF3-512GEV, CF3-512GV, CF3-612GEMV, CF3-612GV, CF4-98G, CF4-98GE, CF6-912G, CF6-912GE, CF6-912GEV, CF6-912GV, CF8-916G, CF8-916GE, CF8-916GEMV, CF8-916GV, CFM2-68GEM, CFM3-612GEMV, CFV4-98GE, CFV6-912GEV, PC1T-64G, PC2T-68G, PC3-612G, PC3T-612G, PC-912G, PC-916G, PC-94G, PC-98G, PCT-912G, PCT-916G, PCT-94G, PCT-98G, TP2-912G, TP2-98G, TP2T-912G, TP2T-98G, TP4-912G, TP4T-912G, TPF2-912G, TPF2-912GE, TPF2-912GEV, TPF2-912GV, TPF2-98G, TPF2-98GE, TPF4-610G, TPF4-912G, TPF4-912GE, TPF4-912GEV...(Other models you can see in the webshop)		
accessories for	105752		
	GEV No.	105749	Ref. No. 544424100
	air mixer		
	GEV No.	105750	Ref. No. 532003800
	burner cap ø 80mm 7kW		
	GEV No.	105751	Ref. No. 531035300
	burner head for burner cap ø 80mm 7kW		

60 (1) series

 <p>1</p>			
GEV No.	106379	Ref. No.	N/A
description	air mixing tube for burner cap ø 80mm L 23mm D1 ø 20mm D2 ø 15.6mm D3 ø 14mm		

 <p>1</p>			
GEV No.	103068	Ref. No.	532001200
description	burner cap ø 100mm		
For models:	CF-10G6-A, CF-10G-6F, CF-10G-A, CF-10GEM, CF-10GEM-6, CF-10GEM6-A, CF-10GEM-A, CF-10GF, CF-62GEM, CF-62GEM-A, CF-8G-A, CF-8GEM, CF-8GEM-A, CF-8GF, CFM-10GEM, CFM-10GEM-6, CFM-10GEM6-A, CFM-10GEM-A, CFM-8GEM, CFM-8GEM-A, PC-61GF, PC-62GF		
accessories for	103068		
	GEV No.	103067	Ref. No. 532000900
	burner ring for burner cap ø 100mm		
	GEV No.	104102	Ref. No. 532000600
	burner head for burner cap ø 100mm ext. ø 130		
	GEV No.	104103	Ref. No. 532000300
	burner holder suitable for burner ø100mm with nozzle holder		



 <p>1</p>			
GEV No.	103066	Ref. No.	532001100
description	burner cap ø 80mm		
For models:	CF-10G6-A, CF-10G-6F, CF-10G-A, CF-10GEM, CF-10GEM-6, CF-10GEM6-A, CF-10GEM-A, CF-10GF, CF-62GEM, CF-62GEM-A, CF-8G-A, CF-8GEM, CF-8GEM-A, CF-8GF, CFM-10GEM, CFM-10GEM-6, CFM-10GEM6-A, CFM-10GEM-A, CFM-8GEM, CFM-8GEM-A, PC-61GF, PC-62GF		
accessories for	103066		
	GEV No.	103065	Ref. No. 532000800
	burner ring for burner cap ø 80mm		
	GEV No.	104100	Ref. No. 532000500
	burner head for burner cap ø 80mm		
	GEV No.	104101	Ref. No. 532000200
	burner holder for burner cap ø 80mm with nozzle holder with mixing sleeve		

 <p>1</p>			
GEV No.	104102	Ref. No.	532000600
description	burner head for burner cap ø 100mm ext. ø 130		
For models:	CF-10G6-A, CF-10G-6F, CF-10G-A, CF-10GEM, CF-10GEM-6, CF-10GEM6-A, CF-10GEM-A, CF-10GF, CF-62GEM, CF-62GEM-A, CF-8G-A, CF-8GEM, CF-8GEM-A, CF-8GF, CFM-10GEM, CFM-10GEM-6, CFM-10GEM6-A, CFM-10GEM-A, CFM-8GEM, CFM-8GEM-A, PC-61GF, PC-62GF		



 <p>1</p>			
GEV No.	104100	Ref. No.	532000500
description	burner head for burner cap ø 80mm		
For models:	CF-10G6-A, CF-10G-6F, CF-10G-A, CF-10GEM, CF-10GEM-6, CF-10GEM6-A, CF-10GEM-A, CF-10GF, CF-62GEM, CF-62GEM-A, CF-8G-A, CF-8GEM, CF-8GEM-A, CF-8GF, CFM-10GEM, CFM-10GEM-6, CFM-10GEM6-A, CFM-10GEM-A, CFM-8GEM, CFM-8GEM-A, PC-61GF, PC-62GF		
accessories for	104100		
	GEV No.	103065	Ref. No. 532000800
	burner ring for burner cap ø 80mm		
	GEV No.	103066	Ref. No. 532001100
	burner cap ø 80mm		
	GEV No.	104103	Ref. No. 532000300
	burner holder suitable for burner ø100mm with nozzle holder		

			
1			
GEV No.	104101	Ref. No.	532000200
description	burner holder for burner cap ø 80mm with nozzle holder with mixing sleeve		
For models:	CF-10G6-A, CF-10G-6F, CF-10G-A, CF-10GEM, CF-10GEM-6, CF-10GEM6-A, CF-10GEM-A, CF-10GF, CF-62GEM, CF-62GEM-A, CF-8G-A, CF-8GEM, CF-8GEM-A, CF-8GF, CFM-10GEM, CFM-10GEM-6, CFM-10GEM6-A, CFM-10GEM-A, CFM-8GEM, CFM-8GEM-A, PC-61GF, PC-62GF		
accessories for	104101		
	GEV No.	103065	Ref. No. 532000800
	burner ring for burner cap ø 80mm		
	GEV No.	103066	Ref. No. 532001100
	burner cap ø 80mm		
	GEV No.	104100	Ref. No. 532000500
	burner head for burner cap ø 80mm		





			
1			
GEV No.	104103	Ref. No.	532000300
description	burner holder suitable for burner ø100mm with nozzle holder		
For models:	CF-10G6-A, CF-10G-6F, CF-10G-A, CF-10GEM, CF-10GEM-6, CF-10GEM6-A, CF-10GEM-A, CF-10GF, CF-62GEM, CF-62GEM-A, CF-8G-A, CF-8GEM, CF-8GEM-A, CF-8GF, CFM-10GEM, CFM-10GEM-6, CFM-10GEM6-A, CFM-10GEM-A, CFM-8GEM, CFM-8GEM-A, PC-61GF, PC-62GF		
accessories for	104103		
	GEV No.	103067	Ref. No. 532000900
	burner ring for burner cap ø 100mm		
	GEV No.	103068	Ref. No. 532001200
	burner cap ø 100mm		
	GEV No.	104102	Ref. No. 532000600
	burner head for burner cap ø 100mm ext. ø 130		

			
1			
GEV No.	103067	Ref. No.	532000900
description	burner ring for burner cap ø 100mm		
For models:	CF-10G6-A, CF-10G-6F, CF-10G-A, CF-10GEM, CF-10GEM-6, CF-10GEM6-A, CF-10GEM-A, CF-10GF, CF-62GEM, CF-62GEM-A, CF-8G-A, CF-8GEM, CF-8GEM-A, CF-8GF, CFM-10GEM, CFM-10GEM-6, CFM-10GEM6-A, CFM-10GEM-A, CFM-8GEM, CFM-8GEM-A, PC-61GF, PC-62GF		
accessories for	103067		
	GEV No.	103068	Ref. No. 532001200
	burner cap ø 100mm		
	GEV No.	104102	Ref. No. 532000600
	burner head for burner cap ø 100mm ext. ø 130		

accessories for	103067		
	GEV No.	104103	Ref. No. 532000300
	burner holder suitable for burner ø100mm with nozzle holder		



			
1			
GEV No.	103065	Ref. No.	532000800
description	burner ring for burner cap ø 80mm		
For models:	CF-10G6-A, CF-10G-6F, CF-10G-A, CF-10GEM, CF-10GEM-6, CF-10GEM6-A, CF-10GEM-A, CF-10GF, CF-62GEM, CF-62GEM-A, CF-8G-A, CF-8GEM, CF-8GEM-A, CF-8GF, CFM-10GEM, CFM-10GEM-6, CFM-10GEM6-A, CFM-10GEM-A, CFM-8GEM, CFM-8GEM-A, PC-61GF, PC-62GF		
accessories for	103065		
	GEV No.	103066	Ref. No. 532001100
	burner cap ø 80mm		
	GEV No.	104100	Ref. No. 532000500
	burner head for burner cap ø 80mm		
	GEV No.	104101	Ref. No. 532000200
	burner holder for burner cap ø 80mm with nozzle holder with mixing sleeve		



60 (2) series

			
1			
GEV No.	105742	Ref. No.	532003600
description	burner cap 4.5kW ø 128mm mounting pos. outer bright finish		
For models:	CF-10G6-A, CF-10G-6F, CF-10G-A, CF-10GEM, CF-10GEM-6, CF-10GEM6-A, CF-10GEM-A, CF-10GF, CF-62GEM, CF-62GEM-A, CF-8G-A, CF-8GEM, CF-8GEM-A, CF-8GF, CFM-10GEM, CFM-10GEM-6, CFM-10GEM6-A, CFM-10GEM-A, CFM-8GEM, CFM-8GEM-A, PC-61GF, PC-62GF		
accessories for	105742		
	GEV No.	105740	Ref. No. 532003500
	burner cap 4.5kW ø 48mm mounting pos. inner bright finish		
	GEV No.	105741	Ref. No. 532003200
	burner head 4.5kW mounting pos. inner for burner cap ø 55mm		
	GEV No.	105743	Ref. No. 532003300
	burner head 4.5kW mounting pos. outer for burner cap ø 128mm		
	GEV No.	105745	Ref. No. 532003000
	burner lower part 4.5kW		



			
GEV No.	105740	Ref. No.	532003500
description	burner cap 4.5kW ø 48mm mounting pos. inner bright finish		
For models:	CF-10G6-A, CF-10G-6F, CF-10G-A, CF-10GEM, CF-10GEM-6, CF-10GEM6-A, CF-10GEM-A, CF-10GF, CF-62GEM, CF-62GEM-A, CF-8G-A, CF-8GEM, CF-8GEM-A, CF-8GF, CFM-10GEM, CFM-10GEM-6, CFM-10GEM6-A, CFM-10GEM-A, CFM-8GEM, CFM-8GEM-A, PC-61GF, PC-62GF		
accessories for	105740		
	GEV No.	105741	Ref. No. 532003200
	burner head 4.5kW mounting pos. inner for burner cap ø 55mm		
	GEV No.	105742	Ref. No. 532003600
	burner cap 4.5kW ø 128mm mounting pos. outer bright finish		
	GEV No.	105743	Ref. No. 532003300
	burner head 4.5kW mounting pos. outer for burner cap ø 128mm		
	GEV No.	105745	Ref. No. 532003000
	burner lower part 4.5kW		

			
GEV No.	105738	Ref. No.	532003400
description	burner cap ø 100mm		
For models:	CF-10G6-A, CF-10G-6F, CF-10G-A, CF-10GEM, CF-10GEM-6, CF-10GEM6-A, CF-10GEM-A, CF-10GF, CF-62GEM, CF-62GEM-A, CF-8G-A, CF-8GEM, CF-8GEM-A, CF-8GF, CFM-10GEM, CFM-10GEM-6, CFM-10GEM6-A, CFM-10GEM-A, CFM-8GEM, CFM-8GEM-A, PC-61GF, PC-62GF		
accessories for	105738		
	GEV No.	105739	Ref. No. 532003100
	burner head ø 110mm seat ø 90mm		
	GEV No.	105744	Ref. No. 532002900 532002901
	burner lower part for burner cap ø 100mm		



			
GEV No.	105741	Ref. No.	532003200
description	burner head 4.5kW mounting pos. inner for burner cap ø 55mm		
For models:	CF-10G6-A, CF-10G-6F, CF-10G-A, CF-10GEM, CF-10GEM-6, CF-10GEM6-A, CF-10GEM-A, CF-10GF, CF-62GEM, CF-62GEM-A, CF-8G-A, CF-8GEM, CF-8GEM-A, CF-8GF, CFM-10GEM, CFM-10GEM-6, CFM-10GEM6-A, CFM-10GEM-A, CFM-8GEM, CFM-8GEM-A, PC-61GF, PC-62GF		
accessories for	105741		
	GEV No.	105740	Ref. No. 532003500
	burner cap 4.5kW ø 48mm mounting pos. inner bright finish		
	GEV No.	105742	Ref. No. 532003600
	burner cap 4.5kW ø 128mm mounting pos. outer bright finish		
	GEV No.	105743	Ref. No. 532003300
	burner head 4.5kW mounting pos. outer for burner cap ø 128mm		



accessories for	105741		
	GEV No.	105745	Ref. No. 532003000
	burner lower part 4.5kW		



			
GEV No.	105743	Ref. No.	532003300
description	burner head 4.5kW mounting pos. outer for burner cap ø 128mm		
For models:	CF-10G6-A, CF-10G-6F, CF-10G-A, CF-10GEM, CF-10GEM-6, CF-10GEM6-A, CF-10GEM-A, CF-10GF, CF-62GEM, CF-62GEM-A, CF-8G-A, CF-8GEM, CF-8GEM-A, CF-8GF, CFM-10GEM, CFM-10GEM-6, CFM-10GEM6-A, CFM-10GEM-A, CFM-8GEM, CFM-8GEM-A, PC-61GF, PC-62GF		
accessories for	105743		
	GEV No.	105740	Ref. No. 532003500
	burner cap 4.5kW ø 48mm mounting pos. inner bright finish		
	GEV No.	105741	Ref. No. 532003200
	burner head 4.5kW mounting pos. inner for burner cap ø 55mm		
	GEV No.	105742	Ref. No. 532003600
	burner cap 4.5kW ø 128mm mounting pos. outer bright finish		
	GEV No.	105745	Ref. No. 532003000
	burner lower part 4.5kW		





			
GEV No.	105739	Ref. No.	532003100
description	burner head ø 110mm seat ø 90mm		
For models:	CF-10G6-A, CF-10G-6F, CF-10G-A, CF-10GEM, CF-10GEM-6, CF-10GEM6-A, CF-10GEM-A, CF-10GF, CF-62GEM, CF-62GEM-A, CF-8G-A, CF-8GEM, CF-8GEM-A, CF-8GF, CFM-10GEM, CFM-10GEM-6, CFM-10GEM6-A, CFM-10GEM-A, CFM-8GEM, CFM-8GEM-A, PC-61GF, PC-62GF		
accessories for	105739		
	GEV No.	105738	Ref. No. 532003400
	burner cap ø 100mm		
	GEV No.	105744	Ref. No. 532002900 532002901
	burner lower part for burner cap ø 100mm		

			
GEV No.	105745	Ref. No.	532003000
description	burner lower part 4.5kW		
For models:	CF-10G6-A, CF-10G-6F, CF-10G-A, CF-10GEM, CF-10GEM-6, CF-10GEM6-A, CF-10GEM-A, CF-10GF, CF-62GEM, CF-62GEM-A, CF-8G-A, CF-8GEM, CF-8GEM-A, CF-8GF, CFM-10GEM, CFM-10GEM-6, CFM-10GEM6-A, CFM-10GEM-A, CFM-8GEM, CFM-8GEM-A, PC-61GF, PC-62GF		
accessories for	105745		
	GEV No.	105740	Ref. No. 532003500
	burner cap 4.5kW ø 48mm mounting pos. inner bright finish		
	GEV No.	105741	Ref. No. 532003200
	burner head 4.5kW mounting pos. inner for burner cap ø 55mm		
	GEV No.	105742	Ref. No. 532003600
	burner cap 4.5kW ø 128mm mounting pos. outer bright finish		
	GEV No.	105743	Ref. No. 532003300
	burner head 4.5kW mounting pos. outer for burner cap ø 128mm		

			
GEV No.	105744	Ref. No.	532002900 532002901
description	burner lower part for burner cap ø 100mm		
For models:	CF-10G6-A, CF-10G-6F, CF-10G-A, CF-10GEM, CF-10GEM-6, CF-10GEM6-A, CF-10GEM-A, CF-10GF, CF-62GEM, CF-62GEM-A, CF-8G-A, CF-8GEM, CF-8GEM-A, CF-8GF, CFM-10GEM, CFM-10GEM-6, CFM-10GEM6-A, CFM-10GEM-A, CFM-8GEM, CFM-8GEM-A, PC-61GF, PC-62GF		
accessories for	105744		
	GEV No.	105738	Ref. No. 532003400
	burner cap ø 100mm		
	GEV No.	105739	Ref. No. 532003100
	burner head ø 110mm seat ø 90mm		

65, 70 series			
			
GEV No.	105043	Ref. No.	533053000
description	air mixing tube ø 18mm L 38mm		
For models:	BRF-64G, BRF-74G, BRF-94G, CF4-68G, CF4-68GEM, CF4-78G, CF4-78GE, CF4-78GP, CF4-78GP-AUS, CF4-78GP-USA, CF4-8G, CF4-8GEM, CF4-98G, CF4-GEMS, CF6-610G, CF6-610GEM, CF6-712G, CF6-712GEV, CF6-712GPV, CF6-712GPV-USA, CF6-712GV, CF6-912GV, CF-712GE, CF8-916G, CFA4-78G, CFA4-98G, CFA6-712GV, CFA6-912GV, CFM4-66GEM, CFM4-68GEM, CFM6-610GEM, CFPB6-79G, FO-1G, FO-2G, FO-3G, FOS-1G, FOS-2G, FOS-3G, PAF-78G, PAF-98G, PC-12G, PC-4G, PC-712G, PC-716G, PC-74G, PC-78G, PC-8G, PCT-63G, PCT-66G, TP2-712G...(Other models you can see in the webshop)		
accessories for	105043		
	GEV No.	105415	Ref. No. 532001300
	venturi for burner cap ø 82mm 3.5kW		

			
GEV No.	105044	Ref. No.	533053100
description	air mixing tube ø 20mm L 38mm		
For models:	BRF-78G, CF4-68G, CF4-68GEM, CF4-78G, CF4-78GE, CF4-8G, CF4-8GEM, CF4-GEMS, CF6-610G, CF6-610GEM, CF6-712G, CF6-712GEV, CF6-712GP, CF6-712GV, CF-712GE, CFM4-66GEM, CFM4-68GEM, CFM6-610GEM, F18-94G, F2-18-98G, F2-25-98G, F25-94G, F45-78G, FO-1G, FO-2G, FO-3G, FOS-1G, FOS-2G, FOS-3G, PC-12G, PC-4G, PC-712G, PC-716G, PC-74G, PC-78G, PC-8G, PCT-63G, PCT-66G, TP2-712G, TP4T-610G, TPF2-712G, TPF2-712GV, TPF4-610G, TPF4-610GEM, TPF4-712GP		
accessories for	105044		
	GEV No.	105418	Ref. No. 532001400
	venturi for burner cap ø 102mm 5.5kW		

			
GEV No.	105413	Ref. No.	532001700
description	burner cap 3.5kW ø 82mm		
accessories for	105413		
	GEV No.	105043	Ref. No. 533053000
	air mixing tube ø 18mm L 38mm		
	GEV No.	105414	Ref. No. 532001500
	burner head for burner cap ø 82mm 3.5kW without pin		
	GEV No.	105415	Ref. No. 532001300
	venturi for burner cap ø 82mm 3.5kW		

			
GEV No.	106977	Ref. No.	532006400
description	burner cap 3.5kW ø 82mm with notch		
For models:	CF4-68G, CF4-68GEM, CF4-8G, CF4-8GEM, CF4-GEMS, CF6-610G, CF6-610GEM, CFM4-66GEM, CFM4-68GEM, CFM6-610GEM, FO-1G, FO-2G, FO-3G, FOS-1G, FOS-2G, FOS-3G, PC-12G, PC-4G, PC-8G, PCT-63G, PCT-66G, TP4T-610G, TPF4-610G, TPF4-610GEM		









			
GEV No.	105416	Ref. No.	532001800
description	burner cap 5.5kW ø 102mm with central hole		
For models:	CF4-78G, CF4-78GE, CF4-8G, CF4-8GEM, CF4-GEMS, CF6-712G, CF6-712GEV, CF6-712GV, CF-712GE, FO-1G, FO-2G, FO-3G, FOS-1G, FOS-2G, FOS-3G, PC-12G, PC-4G, PC-712G, PC-716G, PC-74G, PC-78G, PC-8G, TP2-712G, TPF2-712G, TPF2-712GV		
accessories for	105416		
	GEV No.	105044	Ref. No. 533053100
	air mixing tube ø 20mm L 38mm		
	GEV No.	105417	Ref. No. 532001600
	burner head for burner cap ø 102mm 5.5kW without pin		

Table continues overleaf



accessories for	105416		
	GEV No.	105418	Ref. No. 532001400
	venturi for burner cap ø 102mm 5.5kW		

1			
GEV No.	106752	Ref. No.	532006500
description	burner cap 5.5kW ø 102mm with notch		
For models:	CF4-68G, CF4-68GEM, CF4-8G, CF4-8GEM, CF4-GEMS, CF6-610G, CF6-610GEM, CFM4-66GEM, CFM4-68GEM, CFM6-610GEM, FO-1G, FO-2G, FO-3G, FOS-1G, FOS-2G, FOS-3G, PC-12G, PC-4G, PC-8G, PCT-63G, PCT-66G, TP4T-610G, TPF4-610G, TPF4-610GEM		
accessories for	106752		
	GEV No.	106753	Ref. No. 532006700
	burner head for burner cap ø 102mm 5.5kW with roll pin		

1			
GEV No.	106753	Ref. No.	532006700
description	burner head for burner cap ø 102mm 5.5kW with roll pin		
For models:	CF4-68G, CF4-68GEM, CF4-8G, CF4-8GEM, CF4-GEMS, CF6-610G, CF6-610GEM, CFM4-66GEM, CFM4-68GEM, CFM6-610GEM, FO-1G, FO-2G, FO-3G, FOS-1G, FOS-2G, FOS-3G, PC-12G, PC-4G, PC-8G, PCT-63G, PCT-66G, TP4T-610G, TPF4-610G, TPF4-610GEM		
accessories for	106753		
	GEV No.	106752	Ref. No. 532006500
	burner cap 5.5kW ø 102mm with notch		

1			
GEV No.	105417	Ref. No.	532001600
description	burner head for burner cap ø 102mm 5.5kW without pin		
For models:	CF4-78G, CF4-78GE, CF4-8G, CF4-8GEM, CF6-712G, CF6-712GEV, CF6-712GV, CF-712GE, FO-1G, FO-2G, FO-3G, PC-4G, PC-712G, PC-716G, PC-74G, PC-78G, PC-8G, TP2-712G, TPF2-712G, TPF2-712GV		
accessories for	105417		
	GEV No.	105044	Ref. No. 533053100
	air mixing tube ø 20mm L 38mm		
	GEV No.	105416	Ref. No. 532001800
	burner cap 5.5kW ø 102mm with central hole		
	GEV No.	105418	Ref. No. 532001400
	venturi for burner cap ø 102mm 5.5kW		

1			
GEV No.	106976	Ref. No.	532006600
description	burner head for burner cap ø 82mm 3.5kW with roll pin		
For models:	CF4-68G, CF4-68GEM, CF4-8G, CF4-8GEM, CF4-GEMS, CF6-610G, CF6-610GEM, CFM4-66GEM, CFM4-68GEM, CFM6-610GEM, FO-1G, FO-2G, FO-3G, FOS-1G, FOS-2G, FOS-3G, PC-12G, PC-4G, PC-8G, PCT-63G, PCT-66G, TP4T-610G, TPF4-610G, TPF4-610GEM		

1			
GEV No.	105414	Ref. No.	532001500
description	burner head for burner cap ø 82mm 3.5kW without pin		
For models:	CF4-78G, CF4-78GE, CF4-8G, CF4-8GEM, CF6-712G, CF6-712GEV, CF6-712GV, CF-712GE, FO-1G, FO-2G, FO-3G, PC-4G, PC-712G, PC-716G, PC-74G, PC-78G, PC-8G, TP2-712G, TPF2-712G, TPF2-712GV		
accessories for	105414		
	GEV No.	105043	Ref. No. 533053000
	air mixing tube ø 18mm L 38mm		
	GEV No.	105413	Ref. No. 532001700
	burner cap 3.5kW ø 82mm		
	GEV No.	105415	Ref. No. 532001300
	venturi for burner cap ø 82mm 3.5kW		

1			
GEV No.	105418	Ref. No.	532001400
description	venturi for burner cap ø 102mm 5.5kW		
For models:	CF4-68G, CF4-68GEM, CF4-78G, CF4-78GE, CF4-8G, CF4-8GEM, CF4-GEMS, CF6-610G, CF6-610GEM, CF6-712G, CF6-712GEV, CF6-712GV, CF-712GE, CFM4-66GEM, CFM4-68GEM, CFM6-610GEM, FO-1G, FO-2G, FO-3G, FOS-1G, FOS-2G, FOS-3G, PC-12G, PC-4G, PC-712G, PC-716G, PC-74G, PC-78G, PC-8G, PCT-63G, PCT-66G, TP2-712G, TP4T-610G, TPF2-712G, TPF2-712GV, TPF4-610G, TPF4-610GEM		
accessories for	105418		
	GEV No.	105044	Ref. No. 533053100
	air mixing tube ø 20mm L 38mm		
	GEV No.	105416	Ref. No. 532001800
	burner cap 5.5kW ø 102mm with central hole		
	GEV No.	105417	Ref. No. 532001600
	burner head for burner cap ø 102mm 5.5kW without pin		



			
1			
GEV No.	105415	Ref. No.	532001300
description	venturi for burner cap ø 82mm 3.5kW		
For models:	CF4-68G, CF4-68GEM, CF4-78G, CF4-78GE, CF4-8G, CF4-8GEM, CF4-GEMS, CF6-610G, CF6-610GEM, CF6-712G, CF6-712GEV, CF6-712GV, CF-712GE, CFM4-66GEM, CFM4-68GEM, CFM6-610GEM, FO-1G, FO-2G, FO-3G, FOS-1G, FOS-2G, FOS-3G, PC-12G, PC-4G, PC-712G, PC-716G, PC-74G, PC-78G, PC-8G, PCT-63G, PCT-66G, TP2-712G, TP4T-610G, TPF2-712G, TPF2-712GV, TPF4-610G, TPF4-610GEM		
accessories for	105415		
	GEV No.	105043	Ref. No. 533053000
	air mixing tube ø 18mm L 38mm		
	GEV No.	105413	Ref. No. 532001700
	burner cap 3.5kW ø 82mm		
	GEV No.	105414	Ref. No. 532001500
	burner head for burner cap ø 82mm 3.5kW without pin		

stockpot stoves

			
1			
GEV No.	105410	Ref. No.	532002600 532002601
description	round burner ø 190mm 9.5kW		
For models:	F-1G, FB-1G		

pan supports

			
1			
GEV No.	210032	Ref. No.	532005901
description	pan support W 270mm L 340mm H 47mm		
For models:	CF4-8G, CF4-8GEM, CF4-GEMS, PC-12G, PC-4G, PC-8G		

			
1			
GEV No.	210172	Ref. No.	532002300
description	pan support W 275mm L 345mm		
For models:	CF4-78G, CF4-78GE, CF4-8G, CF4-8GEM, CF4-GEMS, CF6-712G, CF6-712GEV, CF6-712GV, CF-712GE, PC-12G, PC-4G, PC-712G, PC-716G, PC-74G, PC-78G, PC-8G, TP2-712G, TPF2-712G, TPF2-712GV		

			
1			
GEV No.	210117	Ref. No.	532002200
description	pan support W 290mm L 475mm		
For models:	CF-10G-A, CF-10GEM, CF-10GEM-A, CF-10GF, CFM-10GEM, CFM-10GEM-A		

			
1			
GEV No.	210216	Ref. No.	532002101
description	pan support W 290mm L 505mm		
For models:	CF-10G6-A, CF-10G-6F, CF-10G-A, CF-10GEM, CF-10GEM-6, CF-10GEM6-A, CF-10GEM-A, CF-10GF, CF-62GEM, CF-62GEM-A, CF-8G-A, CF-8GEM, CF-8GEM-A, CF-8GF, CFM-10GEM, CFM-10GEM-6, CFM-10GEM6-A, CFM-10GEM-A, CFM-8GEM, CFM-8GEM-A, PC-61GF, PC-62GF		

			
1			
GEV No.	210217	Ref. No.	532002201
description	pan support W 290mm L 505mm		
For models:	CF-10G-A, CF-10GEM, CF-10GEM-A, CF-10GF, CFM-10GEM, CFM-10GEM-A		





			
1			
GEV No.	210167	Ref. No.	532002400
description	pan support W 346mm L 372mm		
For models:	FO-1G, FO-2G, FO-3G, FOS-1G, FOS-2G, FOS-3G		

			
1			
GEV No.	210218	Ref. No.	532004000
description	pan support W 365mm L 395mm		
For models:	CF2-58G, CF2-58GE, CF2-68G, CF2-68GEM, CF3-512GEV, CF3-512GV, CF3-612GEMV, CF3-612GV, CF4-98G, CF4-98GE, CF6-912G, CF6-912GE, CF6-912GEV, CF6-912GV, CF8-916G, CF8-916GE, CF8-916GEV, CF8-916GV, CFM2-68GEM, CFM3-612GEMV, CFV4-98GE, CFV6-912GEV, PC1T-64G, PC2T-68G, PC3-612G, PC3T-612G, PC-912G, PC-916G, PC-94G, PC-98G, PCD-44G, PCT-912G, PCT-916G, PCT-94G, PCT-98G, PCW-74G, PCWT-74G, TP2-912G, TP2-98G, TP2T-912G, TP2T-98G, TP4-912G, TP4T-912G, TPF2-912G, TPF2-912GE, TPF2-912GEV, TPF2-912GV, TPF2-98G, TPF2-98GE, TPF4-610G...(Other models you can see in the webshop)		

reducers for pan supports

			
1			
GEV No.	210050	Ref. No.	533009200
description	reducer for pan support L 260mm W 260mm chrome-plated steel suitable for universal		
For models:	CF2-58G, CF2-58GE, CF2-68G, CF2-68GEM, CF3-512GEV, CF3-512GV, CF3-612GEMV, CF3-612GV, CF4-78G, CF4-78GE, CF4-8G, CF4-8GEM, CF4-98G, CF4-98GE, CF4-GEMS, CF6-712G, CF6-712GEV, CF6-712GV, CF6-912G, CF6-912GE, CF6-912GEV, CF6-912GV, CF-712GE, CF8-916G, CF8-916GE, CF8-916GEV, CF8-916GV, CFM2-68GEM, CFM3-612GEMV, CFV4-98GE, CFV6-912GEV, FO-1G, FO-2G, FO-3G, FOS-1G, FOS-2G, FOS-3G, PC-12G, PC1T-64G, PC2T-68G, PC3-612G, PC3T-612G, PC-4G, PC-712G, PC-716G, PC-74G, PC-78G, PC-8G, PC-912G, PC-916G... (Other models you can see in the webshop)		

			
1			
GEV No.	210001	Ref. No.	533009200
description	reducer for pan support L 265mm W 265mm SS suitable for universal		

			
1			
GEV No.	210018	Ref. No.	533009100
description	reducer for pan support ø 160mm		
For models:	CF-10G6-A, CF-10G-6F, CF-10G-A, CF-10GEM, CF-10GEM-6, CF-10GEM6-A, CF-10GEM-A, CF-10GF, CF-62GEM, CF-62GEM-A, CF-8G-A, CF-8GEM, CF-8GEM-A, CF-8GF, CFM-10GEM, CFM-10GEM-6, CFM-10GEM6-A, CFM-10GEM-A, CFM-8GEM, CFM-8GEM-A		

spillage trays

			
1			
GEV No.	693076	Ref. No.	544301100
description	drain tray L 325mm W 257mm		
For models:	CF4-78G, CF4-78GE, CF6-712G, CF6-712GEV, CF6-712GV, CF-712GE, PC-712G, PC-716G, PC-74G, PC-78G, TP2-712G, TPF2-712G, TPF2-712GV		

			
1			
GEV No.	210168	Ref. No.	544330300 544330301
description	drain tray L 355mm W 326mm		
For models:	FO-1G, FO-2G, FO-3G, FOS-1G, FOS-2G, FOS-3G		

			
1			
GEV No.	693075	Ref. No.	544300800 544498800
description	drain tray L 530mm W 326mm		
For models:	CF4-8G, CF4-8GEM, CF4-GEMS, PC-12G, PC-4G, PC-8G		



accessories

reducers for pan supports



GEV No.	210050	Ref. No.	533009200
description	reducer for pan support L 260mm W 260mm chrome-plated steel suitable for universal		
For models:	CF2-58G, CF2-58GE, CF2-68G, CF2-68GEM, CF3-512GEV, CF3-512GV, CF3-612GEMV, CF3-612GV, CF4-78G, CF4-78GE, CF4-8G, CF4-8GEM, CF4-98G, CF4-98GE, CF4-GEMS, CF6-712G, CF6-712GEV, CF6-912G, CF6-912GE, CF6-912GEV, CF6-912GV, CF-712GE, CF8-916G, CF8-916GE, CF8-916GEV, CF8-916GV, CFM2-68GEM, CFM3-612GEMV, CFV4-98GE, CFV6-912GEV, FO-1G, FO-2G, FO-3G, FOS-1G, FOS-2G, FOS-3G, PC-12G, PC1T-64G, PC2T-68G, PC3-612G, PC3T-612G, PC-4G, PC-712G, PC-716G, PC-74G, PC-78G, PC-8G, PC-912G, PC-916G... (Other models you can see in the webshop)		



GEV No.	210001	Ref. No.	533009200
description	reducer for pan support L 265mm W 265mm SS suitable for universal		



GEV No.	210018	Ref. No.	533009100
description	reducer for pan support ø 160mm		
For models:	CF-10G6-A, CF-10G-6F, CF-10G-A, CF-10GEM, CF-10GEM-6, CF-10GEM6-A, CF-10GEM-A, CF-10GF, CF-62GEM, CF-62GEM-A, CF-8G-A, CF-8GEM, CF-8GEM-A, CF-8GF, CFM-10GEM, CFM-10GEM-6, CFM-10GEM6-A, CFM-10GEM-A, CFM-8GEM, CFM-8GEM-A		

pan supports



GEV No.	210032	Ref. No.	532005901
description	pan support W 270mm L 340mm H 47mm		
For models:	CF4-8G, CF4-8GEM, CF4-GEMS, PC-12G, PC-4G, PC-8G		



GEV No.	210172	Ref. No.	532002300
description	pan support W 275mm L 345mm		
For models:	CF4-78G, CF4-78GE, CF4-8G, CF4-8GEM, CF4-GEMS, CF6-712G, CF6-712GEV, CF6-712GV, CF-712GE, PC-12G, PC-4G, PC-712G, PC-716G, PC-74G, PC-78G, PC-8G, TP2-712G, TPF2-712G, TPF2-712GV		



GEV No.	210117	Ref. No.	532002200
description	pan support W 290mm L 475mm		
For models:	CF-10G-A, CF-10GEM, CF-10GEM-A, CF-10GF, CFM-10GEM, CFM-10GEM-A		



GEV No.	210216	Ref. No.	532002101
description	pan support W 290mm L 505mm		
For models:	CF-10G6-A, CF-10G-6F, CF-10G-A, CF-10GEM, CF-10GEM-6, CF-10GEM6-A, CF-10GEM-A, CF-10GF, CF-62GEM, CF-62GEM-A, CF-8G-A, CF-8GEM, CF-8GEM-A, CF-8GF, CFM-10GEM, CFM-10GEM-6, CFM-10GEM6-A, CFM-10GEM-A, CFM-8GEM, CFM-8GEM-A, PC-61GF, PC-62GF		



GEV No.	210217	Ref. No.	532002201
description	pan support W 290mm L 505mm		
For models:	CF-10G-A, CF-10GEM, CF-10GEM-A, CF-10GF, CFM-10GEM, CFM-10GEM-A		



			
1			
GEV No.	210167	Ref. No.	532002400
description	pan support W 346mm L 372mm		
For models:	FO-1G, FO-2G, FO-3G, FOS-1G, FOS-2G, FOS-3G		





			
1			
GEV No.	210218	Ref. No.	532004000
description	pan support W 365mm L 395mm		
For models:	CF2-58G, CF2-58GE, CF2-68G, CF2-68GEM, CF3-512GEV, CF3-512GV, CF3-612GEMV, CF3-612GV, CF4-98G, CF4-98GE, CF6-912G, CF6-912GE, CF6-912GEV, CF6-912GV, CF8-916G, CF8-916GE, CF8-916GEV, CF8-916GV, CFM2-68GEM, CFM3-612GEMV, CFV4-98GE, CFV6-912GEV, PC1T-64G, PC2T-68G, PC3-612G, PC3T-612G, PC-912G, PC-916G, PC-94G, PC-98G, PCD-44G, PCT-912G, PCT-916G, PCT-94G, PCT-98G, PCW-74G, PCWT-74G, TP2-912G, TP2-98G, TP2T-912G, TP2T-98G, TP4-912G, TP4T-912G, TPF2-912G, TPF2-912GE, TPF2-912GEV, TPF2-912GV, TPF2-98G, TPF2-98GE, TPF4-610G...(Other models you can see in the webshop)		

spillage trays



			
1			
GEV No.	210168	Ref. No.	544330300 544330301
description	drain tray L 355mm W 326mm		
For models:	FO-1G, FO-2G, FO-3G, FOS-1G, FOS-2G, FOS-3G		

air mixers



			
1			
GEV No.	105420	Ref. No.	544147400
description	air mixer		
For models:	CP-62G, CP-6G, F13-74G, F18-74G, F2-13-78G, F2-18-78G, FG-10, FG-2-10, FMG-10, FMG-15, FMG-2-10, FMG-2-15, FMPG-20, FMPG-30, FP-62G, FP-6G, FPG-20, FPG-30, FQ-4G, FQ-61GF, FQ-62GF, FQ-6G, FQM-4G		

				
1				
GEV No.	105749	Ref. No.	544424100	
description	air mixer			
For models:	CF2-58G, CF2-58GE, CF2-68G, CF2-68GEM, CF3-512GEV, CF3-512GV, CF3-612GEMV, CF3-612GV, CF4-98G, CF4-98GE, CF6-912G, CF6-912GE, CF6-912GEV, CF6-912GV, CF8-916G, CF8-916GE, CF8-916GEV, CF8-916GV, CFM2-68GEM, CFM3-612GEMV, CFV4-98GE, CFV6-912GEV, PC1T-64G, PC2T-68G, PC3-612G, PC3T-612G, PC-912G, PC-916G, PC-94G, PC-98G, PCD-44G, PCT-912G, PCT-916G, PCT-94G, PCT-98G, TP2-912G, TP2-98G, TP2T-912G, TP2T-98G, TP4-912G, TP4T-912G, TPF2-912G, TPF2-912GE, TPF2-912GEV, TPF2-912GV, TPF2-98G, TPF2-98GE, TPF4-610G, TPF4-912G, TPF4-912GE...(Other models you can see in the webshop)			
accessories for	105749			
	GEV No.	105748	Ref. No.	531034900
	burner lower part for burner cap ø 60mm 4kW			
	GEV No.	105752	Ref. No.	531035000
	burner lower part for burner cap ø 80mm 7kW			
	GEV No.	105755	Ref. No.	531035100
	burner lower part for burner cap ø 110mm 10kW			

			
1			
GEV No.	105412	Ref. No.	544012400
description	air mixing sleeve		
For models:	F-1G, FB-1G		

				
1				
GEV No.	105043	Ref. No.	533053000	
description	air mixing tube ø 18mm L 38mm			
For models:	BRF-64G, BRF-74G, BRF-94G, CF4-68G, CF4-68GEM, CF4-78G, CF4-78GE, CF4-78GP, CF4-78GP-AUS, CF4-78GP-USA, CF4-8G, CF4-8GEM, CF4-98G, CF4-GEMS, CF6-610G, CF6-610GEM, CF6-712G, CF6-712GEV, CF6-712GPV, CF6-712GPV-USA, CF6-712GV, CF6-912GV, CF-712GE, CF8-916G, CFA4-78G, CFA4-98G, CFA6-712GV, CFA6-912GV, CFM4-66GEM, CFM4-68GEM, CFM6-610GEM, CFPB6-79G, FO-1G, FO-2G, FO-3G, FOS-1G, FOS-2G, FOS-3G, PAF-78G, PAF-98G, PC-12G, PC-4G, PC-712G, PC-716G, PC-74G, PC-78G, PC-8G, PCT-63G, PCT-66G, TP2-712G...(Other models you can see in the webshop)			
accessories for	105043			
	GEV No.	105415	Ref. No.	532001300
	venturi for burner cap ø 82mm 3.5kW			





			
1			
GEV No.	105044	Ref. No.	533053100
description	air mixing tube ø 20mm L 38mm		
For models:	BRF-78G, CF4-68G, CF4-68GEM, CF4-78G, CF4-78GE, CF4-8G, CF4-8GEM, CF4-GEMS, CF6-610G, CF6-610GEM, CF6-712G, CF6-712GEV, CF6-712GP, CF6-712GV, CF-712GE, CFM4-66GEM, CFM4-68GEM, CFM6-610GEM, F18-94G, F2-18-98G, F2-25-98G, F25-94G, F45-78G, FO-1G, FO-2G, FO-3G, FOS-1G, FOS-2G, FOS-3G, PC-12G, PC-4G, PC-712G, PC-716G, PC-74G, PC-78G, PC-8G, PCT-63G, PCT-66G, TPF2-712G, TPF4-610G, TPF2-712G, TPF2-712GV, TPF4-610G, TPF4-610GEM, TPF4-712GP		
accessories for	105044		
	GEV No.	105418	Ref. No. 532001400
	venturi for burner cap ø 102mm 5.5kW		

bar burners

bar burners

			
1			
GEV No.	104143	Ref. No.	531019900
description	bar burner 2 row L 400mm W 205mm ømm H 45mm chargrill		
For models:	CW-4G, CW-61G, CW-62G, CW-6G, CW-74G, CW-78G, CWT-74G, CWT-78G		

			
1			
GEV No.	105760	Ref. No.	531036000
description	bar burner 2 row L 490mm W 200mm ømm H 40mm multi purpose roasting pan		
For models:	BRF-74G		

			
1			
GEV No.	105046	Ref. No.	531004700
description	bar burner 2 row L 490mm W 380mm ømm H 40mm oven		
For models:	CF4-78G, CF4-78GP, CF4-78GP-AUS, CF4-78GP-USA, CF4-98G, CF6-712GPV, CF6-712GPV-USA, CF6-712GV, CF6-912GV, CF8-916G, CFA4-78G, CFA4-98G, CFA6-712GV, CFA6-912GV, CFPB6-79G, PAF-78G, PAF-98G, TPF2-712GPV, TPF2-712GV, TPF2-78GP, TPF2-912GV, TPF2-98G, TPF4-712GPV, TPF4-912GV, TPF-78G, TPF-98G		

			
1			
GEV No.	105759	Ref. No.	531044500 531044501
description	bar burner 2 row L 585mm W 200mm ømm H 45mm chargrill		
For models:	CP-94G, CP-94G-USA, CP-98G, CP-98G-USA, CPA-94G, CPA-98G, CW-94G, CW-98G, CWT-94G, CWT-98G		

			
1			
GEV No.	104475	Ref. No.	531057200
description	bar burner 3 row L 365mm W 400mm ømm		
For models:	CWT-66G		

			
1			
GEV No.	105047	Ref. No.	531004800
description	bar burner 3 row L 490mm W 700mm ømm H 40mm oven		
For models:	CF6-712G, CF6-712GP, CF6-912G, CF8-916GV, TPF2-712G, TPF2-912G, TPF2-912GE, TPF4-712GP, TPF4-912G		

			
1			
GEV No.	105761	Ref. No.	531036100
description	bar burner 4 row L 490mm W 500mm ømm H 40mm multi purpose roasting pan		
For models:	BRF-78G		

			
1			
GEV No.	105756	Ref. No.	531009901
description	bar burner ø 25mm Wmm Hmm L 500mm oven		
For models:	CF-10G6-A, CF-10G-6F, CF-10G-A, CF-10GF, CF2-58G, CF2-58GE, CF2-68G, CF3-512GEV, CF3-512GV, CF3-612GV, CF4-8G, CF-8G-A, CF-8GF		





			
1			
GEV No.	104142	Ref. No.	531013800
description	bar burner ø 40mm Wmm Hmm L 260mm flange width 42mm flange length 42mm bain marie		
For models:	BM-61GF, BM-62GF, BR-62G, BR-6G, BRT-66G		

			
1			
GEV No.	104141	Ref. No.	531005100
description	bar burner ø 40mm Wmm Hmm L 260mm flange width 42mm flange length 42mm griddle		
For models:	FTL-61G, FTL-61GF, FTL-61GS, FTL-61GSF, FTL-62G, FTL-62GF, FTL-62GS, FTL-62GSF, FTL-63G, FTL-63GS, FTL-64G, FTL-64GS, FTLR-62G, FTLR-62GF, FTLR-62GS, FTLR-62GSF, FTLR-63G, FTLR-63GS, FTLR-64G, FTLR-64GS, FTR-61G, FTR-61GF, FTR-61GS, FTR-61GSF, FTR-62G, FTR-62GF, FTR-62GS, FTR-62GSF		

			
1			
GEV No.	105481	Ref. No.	30400060
description	bar burner ø 40mm Wmm Hmm L 325mm flange ø 61mm tilting bratt pan		

			
1			
GEV No.	105053	Ref. No.	531026100
description	bar burner ø 40mm Wmm Hmm L 383mm flange width 43mm flange length 43mm bain marie		
For models:	BM-6G, BM-78G, BM-8G, BM-98G, BMT-78G, BMT-98G, FTTL-66G, FTTLR-66G, FTTR-66G		

			
1			
GEV No.	105048	Ref. No.	531026000
description	bar burner ø 40mm Wmm Hmm L 385mm flange width 43mm flange length 43mm griddle		
For models:	BM-4G, BM-74G, BM-94G, BMT-74G, BMT-94G, FTL-4G, FTL-4GS, FTL-6G, FTL-6GS, FTL-712G, FTL-712GS, FTL-712G-USA, FTL-74G, FTL-74GS, FTL-74G-USA, FTL-76G, FTL-76GS, FTL-76G-USA, FTL-78G, FTL-78G-AUS, FTL-78GS, FTL-78G-USA, FTL-8G, FTL-8GS, FTLR-6G, FTLR-6GS, FTLR-712G, FTLR-712GS, FTLR-712G-USA, FTLR-76G, FTLR-76GS, FTLR-76G-USA, FTLR-78G, FTLR-78G-AUS, FTLR-78GS, FTLR-78G-USA, FTLR-8G, FTLR-8GS, FTR-4G, FTR-4GS, FTR-6G, FTR-6GS, FTR-712G, FTR-712GS, FTR-712G-USA, FTR-74G, FTR-74GS, FTR-74G-USA, FTR-76G, FTR-76GS...(Other models you can see in the webshop)		

			
1			
GEV No.	105482	Ref. No.	30400050
description	bar burner ø 40mm Wmm Hmm L 396mm flange ø 61mm tilting bratt pan		

			
1			
GEV No.	105758	Ref. No.	531039100
description	bar burner ø 40mm Wmm Hmm L 565mm with bolt M5x25 flange width 43mm flange length 43mm griddle		
For models:	FTL-916G, FTL-94G, FTL-94GS, FTL-98G, FTL-98GS, FTTLR-98G, FTTLR-98GS, FTR-94G, FTR-94GS, FTR-98G, FTR-98GS, FTTL-94G, FTTL-94GS, FTTL-98G, FTTL-98GS, FTTLR-98G, FTTLR-98GS, FTTR-94G, FTTR-94GS, FTTR-98G, FTTR-98GS		

			
1			
GEV No.	105050	Ref. No.	531028600
description	bar burner ø 50mm Wmm Hmm L 299mm 1-row flange width 57mm flange length 57mm pasta cooker		
For models:	CP-74G, CP-74G-AUS, CP-74G-USA, CP-78, CP-78G, CP-78G-AUS, CP-78G-USA, CPA-74G, CPA-78G		



1

GEV No.	104144	Ref. No.	531017800
description	bar burner ø 50mm Wmm Hmm L 390mm with bolt M5x12 flange width 57mm flange length 57mm pasta cooker		
For models:	CP-94G, CP-94G-USA, CP-98G, CP-98G-USA, CPA-94G, CPA-98G, CPM-62G, CPM-6G		



1

GEV No.	105920	Ref. No.	10053
description	bar burner ø 50mm Wmm Hmm L 450mm flange with bolt M4 flange width 65mm flange length 71mm kettle		



1

GEV No.	104146	Ref. No.	531010000
description	bar burner ømm W 125mm H 38mm L 500mm gril		
For models:	CF-10G6-A, CF-10G-6F, CF-10G-A, CF-10GF, CF4-8G, CF4-8GEM, CF-8G-A, CF-8GF		



1

GEV No.	105757	Ref. No.	531010001
description	bar burner ømm W 168mm H 45mm L 485mm gril		
For models:	CF-10G6-A, CF-10G-6F, CF-10G-A, CF-10GF, CF4-8G, CF-8G-A, CF-8GF		



1

GEV No.	105782	Ref. No.	531044600
description	burner multi purpose roasting pan		
For models:	BRF-94G		



1

GEV No.	105783	Ref. No.	531044700
description	burner multi purpose roasting pan		
For models:	BRF-98G		

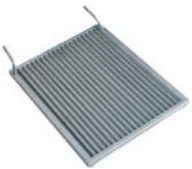

1

GEV No.	211017	Ref. No.	541065100
description	chargrill grid L 470mm W 380mm H 15mm suitable for for chargrill		
For models:	CW-4ET, CW-4ETX, CW-4G		

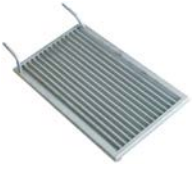

1

GEV No.	211016	Ref. No.	541057300
description	chargrill grid L 474mm W 280mm H 10mm for chargrill		
For models:	CW-61ET, CW-61G, CW-62ET, CW-62G, CW-6ET, CW-6ETX, CW-6G		



1

GEV No.	211018	Ref. No.	541108700
description	chargrill grid L 510mm W 380mm H 50mm stainless steel for chargrill		
For models:	CW-74ET, CW-74ETX, CW-74G, CW-74G-USA, CW-78ET, CW-78ETX, CW-78G, CW-78G-USA, CWT-74ET, CWT-74ETX, CWT-74G, CWT-74G-USA, CWT-78ET, CWT-78ETX, CWT-78G, CWT-78G-USA		





1

GEV No.	210118	Ref. No.	541058201
description	lava rock grid L 400mm W 225mm		
For models:	CW-61G		



			
1			
GEV No.	211014	Ref. No.	541078800
description	lava rock grid L 400mm W 325mm H 35mm		
For models:	CW-4G		

			
1			
GEV No.	211015	Ref. No.	541108800
description	lava rock grid L 440mm W 325mm H 45mm		
For models:	CW-74G, CW-74G-USA, CW-78G, CW-78G-USA, CWT-74G, CWT-74G-USA, CWT-78G, CWT-78G-USA		

			
1			
GEV No.	210119	Ref. No.	541058301
description	lava rock grid L 525mm W 400mm		
For models:	CW-62G, CW-6G		

			
1			
GEV No.	211070	Ref. No.	541132901
description	lava rock grid L 605mm W 325mm H 45mm		
For models:	CP-94G, CP-94G-USA, CP-98G, CP-98G-USA, CPA-94G, CPA-98G, CW-94G, CW-98G, CWT-94G, CWT-98G		

chargrill grids

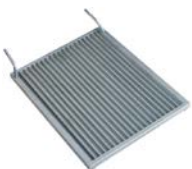
			
1			
GEV No.	211017	Ref. No.	541065100
description	chargrill grid L 470mm W 380mm H 15mm suitable for for chargrill		
For models:	CW-4ET, CW-4ETX, CW-4G		

			
1			
GEV No.	211016	Ref. No.	541057300
description	chargrill grid L 474mm W 280mm H 10mm for chargrill		
For models:	CW-61ET, CW-61G, CW-62ET, CW-62G, CW-6ET, CW-6ETX, CW-6G		

			
1			
GEV No.	211018	Ref. No.	541108700
description	chargrill grid L 510mm W 380mm H 50mm stainless steel for chargrill		
For models:	CW-74ET, CW-74ETX, CW-74G, CW-74G-USA, CW-78ET, CW-78ETX, CW-78G, CW-78G-USA, CWT-74ET, CWT-74ETX, CWT-74G, CWT-74G-USA, CWT-78ET, CWT-78ETX, CWT-78G, CWT-78G-USA		

lava rock grids

			
1			
GEV No.	210118	Ref. No.	541058201
description	lava rock grid L 400mm W 225mm		
For models:	CW-61G		

			
1			
GEV No.	211014	Ref. No.	541078800
description	lava rock grid L 400mm W 325mm H 35mm		
For models:	CW-4G		

			
1			
GEV No.	211015	Ref. No.	541108800
description	lava rock grid L 440mm W 325mm H 45mm		
For models:	CW-74G, CW-74G-USA, CW-78G, CW-78G-USA, CWT-74G, CWT-74G-USA, CWT-78G, CWT-78G-USA		

			
1			
GEV No.	210119	Ref. No.	541058301
description	lava rock grid L 525mm W 400mm		
For models:	CW-62G, CW-6G		

			
1			
GEV No.	211070	Ref. No.	541132901
description	lava rock grid L 605mm W 325mm H 45mm		
For models:	CP-94G, CP-94G-USA, CP-98G, CP-98G-USA, CPA-94G, CPA-98G, CW-94G, CW-98G, CWT-94G, CWT-98G		

tube burners

			
1			
GEV No.	105763	Ref. No.	531042300
description	tubular burner L 265mm W 52mm H 71mm for fryer oval		
For models:	F18-94G, F2-18-98G, F2-25-98G, F25-94G, F45-78G		

			
1			
GEV No.	104140	Ref. No.	531006400
description	tubular burner ø 74mm L 165mm H 60mm round for fryer/pasta cooker		
For models:	CP-62G, FMPG-20, FMPG-30, FP-62G, FPG-20, FPG-30, FQ-61GF, FQ-62GF, FQM-4G		

			
1			
GEV No.	104198	Ref. No.	531013900
description	tubular burner ø 74mm L 180mm H 60mm round for fryer		
For models:	F13-74G, F18-74G, F2-13-78G, F2-18-78G, FG-10, FG-2-10, FMG-10, FMG-15, FMG-2-10, FMG-2-15, FQ-61GF, FQ-62GF, FQM-4G		

			
1			
GEV No.	105049	Ref. No.	531030700 531030701
description	tubular burner ø 74mm L 180mm H 60mm round for fryer/pasta cooker		
For models:	CP-6G, F13-74G, F18-74G, F2-13-78G, F2-18-78G, FG-10, FG-2-10, FMG-10, FMG-15, FMG-2-10, FMG-2-15, FP-6G, FQ-4G, FQ-61GF, FQ-62GF, FQ-6G, FQM-4G		

solid top burners

			
1			
GEV No.	105045	Ref. No.	531033100
description	solid top burner ø 120mm H 102mm L 340mm		
For models:	TP2-712G, TP2-712GP, TP2-78GP, TP2-912G, TP2-98G, TP2T-712GP, TP2T-78GP, TP2T-912G, TP2T-98G, TP4-712GP, TP4-912G, TP4T-712GP, TP4T-912G, TP-74G, TP-78G, TP-94G, TP-98G, TPF2-712G, TPF2-712GP, TPF2-712GPE, TPF2-712GPEV, TPF2-712GPV, TPF2-712GV, TPF2-78GP, TPF2-78GPE, TPF2-912G, TPF2-912GE, TPF2-912GEV, TPF2-912GV, TPF2-98G, TPF2-98GE, TPF4-712GP, TPF4-712GPE, TPF4-712GPEV, TPF4-712GPV, TPF4-912G, TPF4-912GE, TPF4-912GEV, TPF4-912GV, TPF-78G, TPF-78GE, TPF-98G, TPF-98GE, TPFV2-712GPEV, TPFV2-78GPE, TPFV2-912GEV, TPFV2-98GE, TPFV4-712GPEV, TPFV4-912GEV, TPFV-78GE...(Other models you can see in the webshop)		

accessories

nozzle holders

			
1			
GEV No.	105411	Ref. No.	533052300 533052301
description	nozzle holder		
For models:	BM-74G, BM-78G, BM-94G, BM-98G, BMT-64G, BMT-66G, BMT-74G, BMT-78G, BMT-94G, BMT-98G, CF2-58G, CF2-58GE, CF2-68G, CF2-68GEM, CF3-512GEV, CF3-512GV, CF3-612GEMV, CF3-612GV, CF4-68G, CF4-68GEM, CF4-78G, CF4-78GE, CF4-78GP, CF4-78GP-AUS, CF4-78GPE, CF4-78GP-USA, CF4-8G, CF4-8GEM, CF4-98G, CF4-98GE, CF4-GEMS, CF6-610G, CF6-610GEM, CF6-712G, CF6-712GEV, CF6-712GP, CF6-712GPE, CF6-712GPEV, CF6-712GPV, CF6-712GPV-USA, CF6-712GV, CF6-912G, CF6-912GE, CF6-912GEV, CF6-912GV, CF-712GE, CF-712GPE, CF8-916G, CF8-916GE, CF8-916GEV...(Other models you can see in the webshop)		



			
1			
GEV No.	105419	Ref. No.	531025600
description	nozzle holder		
For models:	BM-4G, BM-61GF, BM-62GF, BM-6G, BM-74G, BM-78G, BM-8G, BR-62G, BR-6G, BRF-64G, BRF-74G, BRF-78G, BRF-94G, CF2-58G, CF2-58GE, CF2-68G, CF3-512GEV, CF3-512GV, CF3-612GV, CF4-68G, CF4-78G, CF4-78GP, CF4-78GP-AUS, CF4-78GP-USA, CF4-98G, CF6-610G, CF6-712G, CF6-712GP, CF6-712GPV, CF6-712GPV-USA, CF6-712GV, CF6-912G, CF6-912GP, CF8-916G, CF8-916GV, CFA4-78G, CFA4-98G, CFA6-712GV, CFA6-912GV, CFPB6-79G, CP-62G, CP-74G, CP-74G-USA, CP-78G, CP-78G-USA, CP-94G, CP-94G-USA, CP-98G, CP-98G-USA, CPA-94G...(Other models you can see in the webshop)		

			
1			
GEV No.	101360	Ref. No.	531025600
description	nozzle holder angled 90°		

miscellaneous			
			
1			
GEV No.	101363	Ref. No.	544254900
description	bracket for nozzle holder		
For models:	CW-61G, CW-62G		

			
1			
GEV No.	101361	Ref. No.	541058700
description	connection socket burner		
For models:	CP-94G, CP-94G-USA, CP-98G, CP-98G-USA, CPA-94G, CPA-98G, CW-61G, CW-62G, CW-94G, CW-98G, CWT-74G, CWT-74G-USA, CWT-78G, CWT-78G-USA, CWT-94G, CWT-98G		

gas nozzles

main nozzles

gas nozzles M6x0.75			
			
1			
GEV No.	104765	Ref. No.	533081100
description	gas injector thread M6x0.75 WS 7 bore ø 0.8mm		
For models:	CF-10G6-A, CF-10G-6F, CF-10G-A, CF-10GEM, CF-10GEM-6, CF-10GEM6-A, CF-10GEM-A, CF-10GF, CF-62GEM, CF-62GEM-A, CF-8G-A, CF-8GEM, CF-8GEM-A, CF-8GF, CFM-10GEM, CFM-10GEM-6, CFM-10GEM6-A, CFM-10GEM-A, CFM-8GEM, CFM-8GEM-A, PC-61GF, PC-62GF		

			
1			
GEV No.	103321	Ref. No.	533080700
description	gas injector thread M6x0.75 WS 7 bore ø 1.34mm		
For models:	CF-10G6-A, CF-10G-6F, CF-10G-A, CF-10GEM, CF-10GEM-6, CF-10GEM6-A, CF-10GEM-A, CF-10GF, CF-62GEM, CF-62GEM-A, CF-8G-A, CF-8GEM, CF-8GEM-A, CF-8GF, CFM-10GEM, CFM-10GEM-6, CFM-10GEM6-A, CFM-10GEM-A, CFM-8GEM, CFM-8GEM-A, PC-61GF, PC-62GF		

			
1			
GEV No.	103324	Ref. No.	533081200
description	gas injector thread M6x0.75 WS 7 bore ø 1.3mm		
For models:	CF-10G6-A, CF-10G-6F, CF-10G-A, CF-10GEM, CF-10GEM-6, CF-10GEM6-A, CF-10GEM-A, CF-10GF, CF-62GEM, CF-62GEM-A, CF-8G-A, CF-8GEM, CF-8GEM-A, CF-8GF, CFM-10GEM, CFM-10GEM-6, CFM-10GEM6-A, CFM-10GEM-A, CFM-8GEM, CFM-8GEM-A, PC-61GF, PC-62GF		

gas nozzles M7x1

			
1			
GEV No.	102549	Ref. No.	533049000
description	gas injector thread M7x1 WS 10 bore ø 0.72mm		
For models:	CF-10G6-A, CF-10G-6F, CF-10G-A, CF-10GEM, CF-10GEM-6, CF-10GEM6-A, CF-10GEM-A, CF-10GF, CF-62GEM, CF-62GEM-A, CF-8G-A, CF-8GEM, CF-8GEM-A, CF-8GF, CFM-10GEM, CFM-10GEM-6, CFM-10GEM6-A, CFM-10GEM-A, CFM-8GEM, CFM-8GEM-A, PC-61GF, PC-62GF		

			
1			
GEV No.	102554	Ref. No.	533032100
description	gas injector thread M7x1 WS 10 bore ø 0.82mm		
For models:	CF-10G6-A, CF-10G-6F, CF-10G-A, CF-10GEM, CF-10GEM-6, CF-10GEM6-A, CF-10GEM-A, CF-10GF, CF-62GEM, CF-62GEM-A, CF-8G-A, CF-8GEM, CF-8GEM-A, CF-8GF, CFM-10GEM, CFM-10GEM-6, CFM-10GEM6-A, CFM-10GEM-A, CFM-8GEM, CFM-8GEM-A, PC-61GF, PC-62GF		

			
1			
GEV No.	100520	Ref. No.	533049100
description	gas injector thread M7x1 WS 10 bore ø 1.2mm		
For models:	CF-10G6-A, CF-10G-6F, CF-10G-A, CF-10GEM, CF-10GEM-6, CF-10GEM6-A, CF-10GEM-A, CF-10GF, CF-62GEM, CF-62GEM-A, CF-8G-A, CF-8GEM, CF-8GEM-A, CF-8GF, CFM-10GEM, CFM-10GEM-6, CFM-10GEM6-A, CFM-10GEM-A, CFM-8GEM, CFM-8GEM-A, PC-61GF, PC-62GF		



1

GEV No.	100522	Ref. No.	533032400
description	gas injector thread M7x1 WS 10 bore ø 1.35mm		
For models:	CF-10G6-A, CF-10G-6F, CF-10G-A, CF-10GEM, CF-10GEM-6, CF-10GEM6-A, CF-10GEM-A, CF-10GF, CF-62GEM, CF-62GEM-A, CF-8G-A, CF-8GEM, CF-8GEM-A, CF-8GF, CFM-10GEM, CFM-10GEM-6, CFM-10GEM6-A, CFM-10GEM-A, CFM-8GEM, CFM-8GEM-A, PC-61GF, PC-62GF		



1

GEV No.	103322	Ref. No.	533032300
description	gas injector thread M7x1 WS 10 bore ø 1.42mm		
For models:	CF-10G6-A, CF-10G-6F, CF-10G-A, CF-10GEM, CF-10GEM-6, CF-10GEM6-A, CF-10GEM-A, CF-10GF, CF-62GEM, CF-62GEM-A, CF-8G-A, CF-8GEM, CF-8GEM-A, CF-8GF, CFM-10GEM, CFM-10GEM-6, CFM-10GEM6-A, CFM-10GEM-A, CFM-8GEM, CFM-8GEM-A, PC-61GF, PC-62GF		



1

GEV No.	100525	Ref. No.	533012500
description	gas injector thread M7x1 WS 10 bore ø 1.6mm		
For models:	CF-10G6-A, CF-10G-6F, CF-10G-A, CF-10GEM, CF-10GEM-6, CF-10GEM6-A, CF-10GEM-A, CF-10GF, CF-62GEM, CF-62GEM-A, CF-8G-A, CF-8GEM, CF-8GEM-A, CF-8GF, CFM-10GEM, CFM-10GEM-6, CFM-10GEM6-A, CFM-10GEM-A, CFM-8GEM, CFM-8GEM-A, PC-61GF, PC-62GF		

gas nozzles M10x1



1

GEV No.	103323	Ref. No.	533031100
description	gas injector thread M10x1 WS 11 bore ø 0.6mm inner peaked		
For models:	BM-61GF		



1

GEV No.	100640	Ref. No.	533031901
description	gas injector thread M10x1 WS 11 bore ø 1.3mm inner peaked		
For models:	BM-74G, BMT-74G, FTL-63G, FTL-63GS, FTL-64G, FTL-64GS, FTLR-62G, FTLR-63G, FTLR-63GS, FTLR-64G, FTLR-64GS, FTR-62G, FTTL-610G, FTTL-610GS, FTTL-64G, FTTL-64GS, FTTL-66G, FTTL-66GS, FTTL-68G, FTTL-68GS, FTTLR-610G, FTTLR-610GS, FTTLR-66G, FTTLR-66GS, FTTLR-68G, FTTLR-68GS, FTTR-610G, FTTR-610GS, FTTR-64G, FTTR-64GS, FTTR-66G, FTTR-66GS, FTTR-68G, FTTR-68GS		



1

GEV No.	100653	Ref. No.	533057000
description	gas injector thread M10x1 WS 11 bore ø 1.5mm inner flat		
For models:	FTL-4G, FTL-4GS, FTL-6G, FTL-6GS, FTL-712G, FTL-712GS, FTL-712G-USA, FTL-74G, FTL-74GS, FTL-74G-USA, FTL-76G, FTL-76GS, FTL-76G-USA, FTL-78G, FTL-78G-AUS, FTL-78GS, FTL-78G-USA, FTL-8G, FTL-8GS, FTLR-6G, FTLR-6GS, FTLR-712G, FTLR-712GS, FTLR-712G-USA, FTLR-76G, FTLR-76GS, FTLR-76G-USA, FTLR-78G, FTLR-78G-AUS, FTLR-78GS, FTLR-78G-USA, FTLR-8G, FTLR-8GS, FTR-4G, FTR-4GS, FTR-6G, FTR-6GS, FTR-712G, FTR-712GS, FTR-712G-USA, FTR-74G, FTR-74GS, FTR-74G-USA, FTR-76G, FTR-76GS, FTR-76G-USA, FTR-78G, FTR-78G-AUS, FTR-78GS, FTR-78G-USA...(Other models you can see in the webshop)		



1

GEV No.	100444	Ref. No.	533015100
description	gas injector thread M10x1 WS 12 bore ø 0.8mm		
For models:	BM-94G, BMT-94G, CF4-78GP, CF4-78GP-AUS, CF4-78GPE, CF4-78GP-USA, CF6-712GP, CF6-712GPE, CF6-712GPEV, CF6-712GPV, CF6-712GPV-USA, CF-712GPE, CFV4-78GPE, CFV6-712GPEV, CP-62G, CP-6G, F11-54G, F2-8T-66G, F8T-63G, FP-62G, FQ-61GF, FQ-62GF, FQM-4G, PC-712GP, PC-712GP-USA, PC-716GP, PC-716GP-USA, PC-74GP, PC-74GP-USA, PC-78GP, PC-78GP-USA, PCD-64G, PCD-68G, PCT-712GP, PCT-712GP-USA, PCT-716GP, PCT-716GP-USA, PCT-74GP, PCT-78GP, PCT-78GP-USA, TP4-712GP, TP4T-712GP, TPF4-712GP, TPF4-712GPE, TPF4-712GPEV, TPF4-712GPV, TPFV4-712GPEV		



1

GEV No.	100466	Ref. No.	533030100
description	gas injector thread M10x1 WS 12 bore ø 0.95mm		
For models:	CF4-98G, CF4-98GE, CF6-912G, CF6-912GE, CF6-912GEV, CF6-912GV, CF8-916G, CF8-916GE, CF8-916GEV, CF8-916GV, CFV4-98GE, CFV6-912GEV, CP-62G, CW-61G, CW-62G, CW-6G, F13-74G, F18-74G, F2-13-78G, F2-18-78G, FMG-10, FMG-15, FMG-2-10, FMG-2-15, FMPG-30, FP-62G, FPG-30, FQM-4G, PC-912G, PC-916G, PC-94G, PC-98G, PCT-912G, PCT-916G, PCT-94G, PCT-98G, TP4-912G, TP4T-912G, TPF2-912GE, TPF4-912G, TPF4-912GE, TPF4-912GEV, TPF4-912GV, TPFV4-912GEV		





1

GEV No.	100469	Ref. No.	533043900
description	gas injector thread M10x1 WS 12 bore ø 1.15mm		



			
1			
GEV No.	100468	Ref. No.	533043200
description	gas injector thread M10x1 WS 12 bore ø 1.1mm		
For models:	CF4-78GP, CF4-78GP-AUS, CF4-78GPE, CF4-78GP-USA, CF6-712GP, CF6-712GPE, CF6-712GPEV, CF6-712GPV, CF6-712GPV-USA, CFV4-78GPE, CFV6-712GPEV, CPT-64G, CPT-74G, CPT-76G, CW-61G, CW-62G, CW-6G, CWT-64G, CWT-68G, F13-74G, F18-74G, F2-13-78G, F2-18-78G, F2-8-74G, F2-8-94G, FMG-10, FMG-15, FMG-2-10, FMG-2-15, FQM-4G, PC-712GP, PC-712GP-USA, PC-716GP, PC-716GP-USA, PC-74GP, PC-74GP-USA, PC-78GP, PC-78GP-USA, PCD-64G, PCD-68G, PCT-712GP, PCT-712GP-USA, PCT-716GP, PCT-716GP-USA, PCT-74GP, PCT-78GP, PCT-78GP-USA, TP2-712GP, TP2-78GP, TP2T-712GP...(Other models you can see in the webshop)		

			
1			
GEV No.	100479	Ref. No.	533019400
description	gas injector thread M10x1 WS 12 bore ø 1.8mm		
For models:	CF2-58G, CF2-58GE, CF2-68G, CF3-512GEV, CF3-512GV, CF3-612GV, CF4-68G, CF4-68GEM, CF4-78G, CF4-78GE, CF4-78GP, CF4-78GP-AUS, CF4-78GPE, CF4-78GP-USA, CF4-8G, CF4-8GEM, CF4-GEMS, CF6-610G, CF6-610GEM, CF6-712G, CF6-712GEV, CF6-712GP, CF6-712GPE, CF6-712GPEV, CF6-712GPV, CF6-712GPV-USA, CF6-712GV, CF6-912G, CF-712GE, CF-712GPE, CF8-916GV, CFA4-78G, CFA4-98G, CFA6-712GV, CFA6-912GV, CFM4-66GEM, CFM4-68GEM, CFM6-610GEM, CFV4-78GPE, CFV6-712GPEV, CP-6G, CWT-64G, CWT-68G, F13-74G, F13T-74G, F13T-94G, F18-74G, F18-94G, F2-13-78G, F2-13T-78G...(Other models you can see in the webshop)		

			
2			
GEV No.	100471	Ref. No.	533014800
description	gas injector thread M10x1 WS 12 bore ø 1.35mm		
For models:	CF2-58G, CF2-58GE, CF2-68G, CF2-68GEM, CF3-512GEV, CF3-512GV, CF3-612GEMV, CF3-612GV, CF4-78GP, CF4-78GP-AUS, CF4-78GPE, CF4-78GP-USA, CF4-98G, CF4-98GE, CF6-712GP, CF6-712GPE, CF6-712GPEV, CF6-712GPV, CF6-712GPV-USA, CF6-912G, CF6-912GE, CF6-912GEV, CF6-912GV, CF-712GPE, CF8-916G, CF8-916GE, CF8-916GEM, CF8-916GEV, CF8-916GV, CFM2-68GEM, CFM3-612GEMV, CFV4-78GPE, CFV4-98GE, CFV6-712GPEV, CFV6-912GEV, CP-62G, CP-74G, CP-74G-USA, CP-78, CP-78G, CP-78G-USA, CPA-74G, CPA-78G, CW-74G, CW-74G-USA, CW-78G, CW-78G-USA, CW-94G, CW-98G, CWT-74G, CWT-78G...(Other models you can see in the webshop)		

			
1			
GEV No.	102550	Ref. No.	533031401
description	gas injector thread M10x1 WS 12 bore ø 1.55mm		
For models:	BM-4G, BM-62GF, BM-6G, BM-8G, BMT-66G, FTL-61G, FTL-61GF, FTL-61GS, FTL-61GSF, FTL-62G, FTL-62GF, FTL-62GS, FTL-62GSF, FTL-63G, FTL-64G, FTL-916G, FTL-94G, FTL-94GS, FTL-98G, FTL-98GS, FTLR-62G, FTLR-62GF, FTLR-62GS, FTLR-62GSF, FTLR-63G, FTLR-64G, FTLR-98G, FTLR-98GS, FTR-61G, FTR-61GF, FTR-61GS, FTR-61GSF, FTR-62G, FTR-62GF, FTR-62GS, FTR-62GSF, FTR-94G, FTR-94GS, FTR-98G, FTR-98GS, FTTL-610G, FTTL-64G, FTTL-66G, FTTL-68G, FTTL-94G, FTTL-94GS, FTTL-98G, FTTL-98GS, FTTLR-610G, FTTLR-66G...(Other models you can see in the webshop)		

pilot burner nozzles

pilot burner nozzles SIT

100 series

			
1			
GEV No.	100473	Ref. No.	533015200
description	gas injector thread M10x1 WS 12 bore ø 1.45mm		
For models:	CF4-68G, CF4-68GEM, CF4-78G, CF4-78GE, CF4-78GP, CF4-78GP-AUS, CF4-78GPE, CF4-78GP-USA, CF4-8G, CF4-8GEM, CF4-98G, CF4-98GE, CF4-GEMS, CF6-610G, CF6-610GEM, CF6-712G, CF6-712GEV, CF6-712GP, CF6-712GPE, CF6-712GPEV, CF6-712GPV, CF6-712GPV-USA, CF6-912G, CF6-912GE, CF6-912GEV, CF6-912GV, CF-712GE, CF-712GPE, CF8-916G, CF8-916GE, CF8-916GEM, CF8-916GEV, CFA4-78G, CFA4-98G, CFA6-712GV, CFA6-912GV, CFM4-66GEM, CFM4-68GEM, CFM6-610GEM, CFPB6-79G, CFV4-78GPE, CFV4-98GE, CFV6-712GPEV, CFV6-912GEV, CP-62G, CPB-98G, CPBA-98G, CW-74G, CW-74G-USA...(Other models you can see in the webshop)		

			
1			
GEV No.	100245	Ref. No.	533091000
description	pilot burner nozzle LPG code 20 bore ø 0.2mm Qty 1 pcs thread M8x0.75		
For models:	CF2-58G, CF2-58GE, CF2-68G, CF2-68GEM, CF3-512GEV, CF3-512GV, CF3-612GEMV, CF3-612GV, CF4-78GP, CF4-78GP-AUS, CF4-78GPE, CF4-78GP-USA, CF4-98G, CF4-98GE, CF6-712GP, CF6-712GPE, CF6-712GPEV, CF6-712GPV, CF6-712GPV-USA, CF6-912G, CF6-912GE, CF6-912GEV, CF6-912GV, CF-712GPE, CF8-916G, CF8-916GE, CF8-916GEM, CF8-916GEV, CF8-916GV, CFA4-78G, CFA4-98G, CFA6-712GV, CFA6-912GV, CFM2-68GEM, CFM3-612GEMV, CFV4-78GPE, CFV4-98GE, CFV6-712GPEV, CFV6-912GEV, PA-78G, PA-98G, PAF-78G, PAF-98G, PAT-78G, PAT-98G, PC1T-64G, PC2T-68G, PC3-612G, PC3T-612G, PC-712GP, PC-712GP-USA...(Other models you can see in the webshop)		

			
1			
GEV No.	100474	Ref. No.	533014900
description	gas injector thread M10x1 WS 12 bore ø 1.5mm		

			
1			
GEV No.	100246	Ref. No.	533091200
description	pilot burner nozzle natural gas bore ø 0.35mm Qty 1 pcs thread M8x0.75		
For models:	CF2-58G, CF2-58GE, CF2-68G, CF2-68GEM, CF3-512GEV, CF3-512GV, CF3-612GEMV, CF3-612GV, CF4-78GP, CF4-78GP-AUS, CF4-78GPE, CF4-78GP-USA, CF4-98G, CF4-98GE, CF6-712GP, CF6-712GPE, CF6-712GPEV, CF6-712GPV, CF6-712GPV-USA, CF6-912G, CF6-912GE, CF6-912GEV, CF6-912GV, CF-712GPE, CF8-916G, CF8-916GE, CF8-916GEM, CF8-916GEV, CF8-916GV, CFA4-78G, CFA4-98G, CFA6-712GV, CFA6-912GV, CFM2-68GEM, CFM3-612GEMV, CFV4-78GPE, CFV4-98GE, CFV6-712GPEV, CFV6-912GEV, PA-78G, PA-98G, PAF-78G, PAF-98G, PAT-78G, PAT-98G, PC1T-64G, PC2T-68G, PC3-612G, PC3T-612G, PC-712GP, PC-712GP-USA...(Other models you can see in the webshop)		

140/150 series



GEV No.	100205	Ref. No.	533020500
description	pilot burner nozzle SIT LPG code 19 bore ø 0.23/0.26mm Qty 1 pcs suitable for SIT 150 series		
For models:	BRT-66G, CF4-78G, CF4-78GP, CF4-78GP-AUS, CF4-78GP-USA, CF4-98G, CF6-712G, CF6-712GP, CF6-712GPV, CF6-712GPV-USA, CF6-712GV, CF6-912G, CF6-912GV, CF8-916G, CF8-916GV, CFA4-78G, CFA4-98G, CFA6-712GV, CFA6-912GV, CFPB6-79G, FTL-54G, FTL-56G, FTL-712G, FTL-712GS, FTL-712G-USA, FTL-74G, FTL-74GS, FTL-74G-USA, FTL-76G, FTL-76GS, FTL-76G-USA, FTL-78G, FTL-78G-AUS, FTL-78GS, FTL-78G-USA, FTL-916G, FTL-94G, FTL-94GS, FTL-98G, FTL-98GS, FTLR-56G, FTLR-712G, FTLR-712GS, FTLR-712G-USA, FTLR-76G, FTLR-76GS, FTLR-76G-USA, FTLR-78G, FTLR-78G-AUS, FTLR-78GS... (Other models you can see in the webshop)		



GEV No.	100207	Ref. No.	533020600
description	pilot burner nozzle SIT natural gas code 27 bore ø 0.40/0.38mm suitable for SIT 140 series		
For models:	BRT-66G, CF4-78G, CF4-78GP, CF4-78GP-AUS, CF4-78GP-USA, CF4-98G, CF6-712G, CF6-712GP, CF6-712GPV, CF6-712GPV-USA, CF6-712GV, CF6-912G, CF6-912GV, CF8-916G, CF8-916GV, CFA4-78G, CFA4-98G, CFA6-712GV, CFA6-912GV, CFPB6-79G, CPT-64G, CPT-66G, CPT-74G, CPT-76G, FTL-54G, FTL-56G, FTL-712G, FTL-712GS, FTL-712G-USA, FTL-74G, FTL-74GS, FTL-74G-USA, FTL-76G, FTL-76GS, FTL-76G-USA, FTL-78G, FTL-78G-AUS, FTL-78GS, FTL-78G-USA, FTL-916G, FTL-94G, FTL-94GS, FTL-98G, FTL-98GS, FTLR-56G, FTLR-712G, FTLR-712GS, FTLR-712G-USA, FTLR-76G, FTLR-76GS... (Other models you can see in the webshop)		

160 series



GEV No.	107172	Ref. No.	533020800
description	pilot burner nozzle SIT LPG code 25 Qty 1 pcs		
For models:	BM-74G, BM-78G, BM-94G, BM-98G, BMT-64G, BMT-66G, BMT-74G, BMT-78G, BMT-94G, BMT-98G, BR-74G, BR-78G, BR-94G, BR-98G, CP-66G, CP-74G, CP-74G-USA, CP-76G, CP-78, CP-78G, CP-78G-USA, CPA-66G, CPA-74G, CPA-76G, CPA-78G, CPP-94G, CPP-94G-USA, CPT-64G, CPT-66G		



GEV No.	107650	Ref. No.	533020200
description	pilot burner nozzle SIT LPG code 30 Qty 1 pcs		
For models:	BM-4G, BM-61GF, BM-62GF, BM-6G, BM-74G, BM-78G, BM-8G, BR-62G, BR-6G, BR-64G, BR-74G, BR-78G, CP-62G, CP-6G, CP-74G, CP-74G-USA, CP-78G, CP-78G-USA, CP-94G, CP-94G-USA, CP-98G, CP-98G-USA, CPA-94G, CPA-98G, CPB-98G, CPBA-98G, CPM-62G, CPM-6G, CW-4G, CW-61G, CW-62G, CW-6G, CW-74G, CW-74G-USA, CW-78G, CW-78G-USA, CW-94G, CW-98G, CWT-64G, CWT-66G, CWT-68G, CWT-74G, CWT-78G, CWT-94G, CWT-98G, F11-54G, F13-64G, F13-74G, F13T-74G, F13T-94G... (Other models you can see in the webshop)		



GEV No.	107174	Ref. No.	533020300
description	pilot burner nozzle SIT natural gas code 41 Qty 1 pcs		
For models:	BM-74G, BM-78G, BM-94G, BM-98G, BMT-64G, BMT-66G, BMT-74G, BMT-78G, BMT-94G, BMT-98G, BR-74G, BR-78G, BR-94G, BR-98G, CP-66G, CP-74G, CP-74G-USA, CP-76G, CP-78, CP-78G, CP-78G-USA, CPA-66G, CPA-74G, CPA-76G, CPA-78G, CPB-98G, CPBA-98G, CPP-94G, CPP-94G-USA, CPT-64G, CPT-66G		



GEV No.	107175	Ref. No.	533020400
description	pilot burner nozzle SIT natural gas code 51 Qty 1 pcs suitable for 160 series		
For models:	BM-4G, BM-61GF, BM-62GF, BM-6G, BM-74G, BM-78G, BM-8G, BR-62G, BR-6G, BR-64G, BR-74G, BR-78G, CP-62G, CP-6G, CP-74G, CP-74G-USA, CP-78G, CP-78G-USA, CP-94G, CP-94G-USA, CP-98G, CP-98G-USA, CPA-94G, CPA-98G, CPM-62G, CPM-6G, CW-4G, CW-61G, CW-62G, CW-6G, CW-74G, CW-74G-USA, CW-78G, CW-78G-USA, CW-94G, CW-98G, CWT-64G, CWT-66G, CWT-68G, CWT-74G, CWT-78G, CWT-94G, CWT-98G, F11-54G, F13-64G, F13-74G, F13T-74G, F13T-94G, F18-74G, F18-94G... (Other models you can see in the webshop)		

bypass nozzles

bypass nozzles PEL22



GEV No.	100432	Ref. No.	533069700
description	bypass nozzle type PEL22 bore ø 0.75mm thread M6x0.5		
For models:	BRF-64G, BRF-74G, CF4-78G, CF4-78GP, CF4-78GP-AUS, CF4-78GP-USA, CF4-98G, CF6-712GPV, CF6-712GPV-USA, CF6-712GV, CF6-912GV, CF8-916G, CFA4-78G, CFA4-98G, CFA6-712GV, CFA6-912GV, CFPB6-79G, PAF-78G, PAF-98G, TPF2-712GPV, TPF2-712GV, TPF2-78G, TPF2-912GV, TPF2-98G, TPF4-712GPV, TPF4-912GV, TPF-78G, TPF-98G		

bypass nozzles SABAF



GEV No.	107151	Ref. No.	533045901
description	bypass nozzle bore ø 0.45mm thread M4x0.5 SABAF		
For models:	CF-10G6-A, CF-10G6-F, CF-10G-A, CF-10GF, CF2-58G, CF2-58GE, CF2-68G, CF3-512GEV, CF3-512GV, CF3-612GV, CF4-68G, CF4-8G, CF6-610G, CF-8G-A, CF-8GF, TPF4-610G		



auxiliary gas parts

screw connections

olives

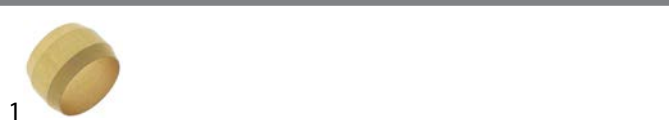

GEV No.	101278	Ref. No.	533039300
description	olive for pipe ø 10mm Qty 1 pcs		
For models:	BM-4G, BM-61GF, BM-62GF, BM-6G, BM-74EM, BM-74G, BM-78EM, BM-78G, BM-8G, BM-94EM, BM-94G, BM-98EM, BM-98G, BMD-64EM, BMD-84EM, BMT-64G, BMT-66G, BMT-74G, BMT-78G, BMT-94G, BMT-98G, BR-62G, BR-6G, BR-64G, BR-74G, BR-78G, BR-94G, BRT-66G, CF2-58G, CF2-58GE, CF2-68G, CF2-68GEM, CF3-512GEV, CF3-512GV, CF3-612GEMV, CF3-612GV, CF4-68G, CF4-68GEM, CF4-78ET, CF4-78ETX, CF4-78G, CF4-78GE, CF4-78GP, CF4-78GP-AUS, CF4-78GPE, CF4-78GP-USA, CF4-8G, CF4-8GEM, CF4-98ET, CF4-98ETX...(Other models you can see in the webshop)		

accessories for	101278			
	GEV No.	100943	Ref. No.	—
description	union nut thread M17x1 tube ø 10mm			
	GEV No.	101300	Ref. No.	533010800
description	union nut thread M16x1.5 tube ø 10mm			
	GEV No.	101478	Ref. No.	—
description	union nut thread 3/8" for pipe ø 10mm			



GEV No.	101273	Ref. No.	533017900
description	olive for pipe ø 12mm L 9.5mm brass Qty 1 pcs suitable for universal		
For models:	BM-61GF, BM-62GF, BM-74G, BM-78G, BM-94G, BM-98G, BMT-64G, BMT-66G, BMT-74G, BMT-78G, BMT-94G, BMT-98G, BR-64G, BR-74G, BR-78G, BR-94G, BR-98G, CP-62G, CP-6G, CPM-62G, F11-54G, F13-64G, F13-74G, F13T-74G, F13T-94G, F18-74G, F2-13-78G, F2-13T-78G, F2-13T-98G, F2-18-78G, F2-8-74G, F2-8-94G, F2-8T-66G, F2-8T-74G, F2-8T-94G, F8T-63G, FG-10, FG-2-10, FMG-10, FMG-15, FMG-2-10, FMG-2-15, FMGP-20, FMGP-30, FP-62G, FP-6G, FPG-20, FPG-30, FQ-4G, FQ-61GF...(Other models you can see in the webshop)		

accessories for	101273			
	GEV No.	100944	Ref. No.	—
description	union nut thread M18x1.5 for pipe ø 12mm			
	GEV No.	101276	Ref. No.	533018000
description	union screw thread 3/8" tube ø 12mm Qty 1 pcs			



GEV No.	106598	Ref. No.	533010200
description	olive for pipe ø 18mm Qty 1 pcs ED ø 21mm		
For models:	BM-10EM, BM-10EMX, BM-4EM, BM-4EMX, BM-4G, BM-61EM, BM-61GF, BM-62EM, BM-62ET, BM-62GF, BM-6EM, BM-6EMX, BM-6G, BM-8EM, BM-8EMX, BM-8G, BMT-63EM, BMT-64EM, BMT-64G, BMT-66EM, BMT-66G, BMT-74EM, BMT-74G, BMT-78EM, BMT-78G, BMT-94EM, BMT-94G, BMT-98EM, BMT-98G, BS-4EM, BS-4EMX, CP-61EM, CP-62ET, CP-62G, CP-6G, CPT-64EM-USA, CPT-64ET, CPT-64G, CPT-66ET, CPT-66G, CPT-74ET, CPT-74G, CPT-76ET, CPT-76G, CWK-74ET, CWK-78ET, CWK-94ET, CWK-98ET, CWKT-64ET, CWKT-68ET...(Other models you can see in the webshop)		



GEV No.	100898	Ref. No.	533023300
description	olive for pipe ø 6mm Qty 1 pcs for pilot burner		
For models:	BRT-66G, CF4-78G, CF4-78GP, CF4-78GP-AUS, CF4-78GP-USA, CF4-98G, CF6-712G, CF6-712GP, CF6-712GPV, CF6-712GPV-USA, CF6-712GV, CF6-912G, CF6-912GV, CF8-916G, CF8-916GV, CFA4-78G, CFA4-98G, CFA6-712GV, CFA6-912GV, CFPB6-79G, CPT-64G, CPT-66G, CPT-74G, CPT-76G, FTL-54G, FTL-56G, FTL-712G, FTL-712GS, FTL-712G-USA, FTL-74G, FTL-74GS, FTL-74G-USA, FTL-76G, FTL-76GS, FTL-76G-USA, FTL-78G, FTL-78G-AUS, FTL-78GS, FTL-78G-USA, FTL-916G, FTL-94G, FTL-94GS, FTL-98G, FTL-98GS, FTLR-56G, FTLR-712G, FTLR-712GS, FTLR-712G-USA, FTLR-76G, FTLR-76GS...(Other models you can see in the webshop)		

accessories for	100898			
	GEV No.	100909	Ref. No.	533018500
description	union screw thread M10x1 for pipe ø 6mm Qty 1 pcs			



GEV No.	101857	Ref. No.	533010400
description	olive for pipe ø 6mm Qty 1 pcs suitable for 160 series for pilot burner		
For models:	BM-4G, BM-61GF, BM-62GF, BM-6G, BM-74G, BM-78G, BM-8G, BM-94G, BM-98G, BMT-64G, BMT-66G, BMT-74G, BMT-78G, BMT-94G, BMT-98G, BR-62G, BR-6G, BR-64G, BR-74G, BR-78G, BR-94G, BR-98G, CP-62G, CP-66G, CP-6G, CP-74G, CP-74G-USA, CP-76G, CP-78G, CP-78G-USA, CP-94G, CP-94G-USA, CP-98G, CP-98G-USA, CPA-66G, CPA-74G, CPA-76G, CPA-78G, CPA-94G, CPA-98G, CPB-98G, CPBA-98G, CPM-62G, CPM-6G, CPP-94G, CPP-94G-USA, CPT-64G, CPT-66G, CW-4G...(Other models you can see in the webshop)		

union nuts



GEV No.	101300	Ref. No.	533010800
description	union nut thread M16x1.5 tube ø 10mm		
For models:	BM-4G, BM-61GF, BM-62GF, BM-6G, BM-74EM, BM-74G, BM-78EM, BM-78G, BM-8G, BM-94EM, BM-94G, BM-98EM, BM-98G, BMD-64EM, BMD-84EM, BMT-64G, BMT-66G, BMT-74G, BMT-78G, BMT-94G, BMT-98G, BR-62G, BR-6G, BR-64G, BR-74G, BR-78G, BR-94G, BRT-66G, CF2-58G, CF2-58GE, CF2-68G, CF2-68GEM, CF3-512GEV, CF3-512GV, CF3-612GEMV, CF3-612GV, CF4-68G, CF4-68GEM, CF4-78ET, CF4-78ETX, CF4-78G, CF4-78GE, CF4-78GP, CF4-78GP-AUS, CF4-78GPE, CF4-78GP-USA, CF4-8G, CF4-8GEM, CF4-98ET, CF4-98ETX...(Other models you can see in the webshop)		

accessories for	101300			
	GEV No.	101278	Ref. No.	533039300
description	olive for pipe ø 10mm Qty 1 pcs			



union screws



GEV No.	100906	Ref. No.	533018600
description	screw connection thread M10x1 for ignition electrode brass Qty 1 pcs WS 10		
For models:	BM-4G, BM-61GF, BM-62GF, BM-6G, BM-74G, BM-78G, BM-8G, BM-94G, BM-98G, BMT-64G, BMT-66G, BMT-74G, BMT-78G, BMT-94G, BMT-98G, BR-62G, BR-6G, BRF-64G, BRF-74G, BRF-78G, BRF-94G, BRF-98G, BRT-66G, CF4-78G, CF4-78GP, CF4-78GP-AUS, CF4-78GP-USA, CF4-98G, CF6-712G, CF6-712GP, CF6-712GPV, CF6-712GPV-USA, CF6-712GV, CF6-912G, CF6-912GV, CF8-916G, CF8-916GV, CFA4-78G, CFA4-98G, CFA6-712GV, CFA6-912GV, CFPB6-79G, CP-62G, CP-66G, CP-6G, CP-74G, CP-74G-USA, CP-76G, CP-78, CP-78G...(Other models you can see in the webshop)		



GEV No.	106597	Ref. No.	533010100
description	union screw thread 3/4" for pipe ø 18mm L 20mm Qty 1 pcs WS 27		
For models:	BM-10EM, BM-10EMX, BM-4EM, BM-4EMX, BM-4G, BM-61EM, BM-61GF, BM-62EM, BM-62ET, BM-62GF, BM-6EM, BM-6EMX, BM-6G, BM-8EM, BM-8EMX, BM-8G, BMT-63EM, BMT-64EM, BMT-64G, BMT-66EM, BMT-66G, BMT-74EM, BMT-74G, BMT-78EM, BMT-78G, BMT-94EM, BMT-94G, BMT-98EM, BMT-98G, BS-4EM, BS-4EMX, CP-61EM, CP-62ET, CP-62G, CP-6G, CPT-64EM-USA, CPT-64ET, CPT-64G, CPT-66ET, CPT-66G, CPT-74ET, CPT-74G, CPT-76ET, CPT-76G, CWK-74ET, CWK-78ET, CWK-94ET, CWK-98ET, CWKT-64ET, CWKT-68ET...(Other models you can see in the webshop)		



GEV No.	100909	Ref. No.	533018500
description	union screw thread M10x1 for pipe ø 6mm Qty 1 pcs		
accessories for	100909		
	GEV No.	Ref. No.	533023300
	olive for pipe ø 6mm Qty 1 pcs for pilot burner		
	GEV No.	Ref. No.	—
	olive ID ø 6mm Qty 1 pcs		
	GEV No.	Ref. No.	—
	olive for pipe ø 6mm Qty 1 pcs		
	GEV No.	Ref. No.	—
	olive for pipe ø 6mm L 6mm aluminium Qty 1 pcs ED ø 8.5mm		



GEV No.	101475	Ref. No.	533016900 533026400
description	union screw thread M13x1 for pipe ø 8mm Qty 1 pcs		
For models:	CF-10G6-A, CF-10G-6F, CF-10G-A, CF-10GF, CF4-8G, CF4-8GEM, CF-8G-A, CF-8GF		



GEV No.	101477	Ref. No.	533016200 533026400
description	union screw thread M13x1 tube ø 8mm Qty 1 pcs		
For models:	CF-10G6-A, CF-10G-6F, CF-10G-A, CF-10GEM, CF-10GEM-6, CF-10GEM6-A, CF-10GEM-A, CF-10GF, CF2-58G, CF2-58GE, CF2-68G, CF3-512GEV, CF3-512GV, CF3-612GV, CF4-68G, CF4-8G, CF4-8GEM, CF-62GEM, CF-62GEM-A, CF6-610G, CF-8G-A, CF-8GEM, CF-8GEM-A, CF-8GF, CFM-10GEM, CFM-10GEM-6, CFM-10GEM6-A, CFM-10GEM-A, CFM-8GEM, CFM-8GEM-A, PC-61GF, PC-62GF, TPF4-610G		

equipment-specific units

for dough mixers

flange bearings



GEV No.	693112	Ref. No.	20400012
description	flange bearing type UCF204 shaft ø 20mm 4 hole flange hole distance 64mm H 33mm flange length 86mm flange width 86mm hole ø 12mm flange F204 ball bearing UC204G2 FH 25.5mm		

for convection ovens/combi-steamers

spare parts and accessories



GEV No.	551458	Ref. No.	C8136-00
description	connecting piece L 45mm W 15mm H 38mm		

door mechanics

accessories



1

GEV No.	696845	Ref. No.	C2094-00
description	base plate W 38mm hole ø 7mm stainless steel L 192mm		

for tilting bratt pans

spindles



1

GEV No.	693110	Ref. No.	SMB012800
description	threaded rod L 363mm ø 20mm		

miscellaneous



1

GEV No.	693111	Ref. No.	SMB013000
description	spindle		



1

GEV No.	693114	Ref. No.	SMB063000
description	spindle		



1

GEV No.	693109	Ref. No.	SC02200
description	threaded bush for tilting bratt pan brass thread TR20x4		

for rechauds

warming plates

components



1

GEV No.	691100	Ref. No.	541013200
description	support for warming plate		



1

GEV No.	691101	Ref. No.	544138400
description	warming plate aluminium		

for toasters

pliers



1

GEV No.	690010	Ref. No.	531004500
description	plier for toaster H 180mm total length 100mm		
For models:	TS-3, TS-6		

knobs

universal knobs



1

GEV No.	110242	Ref. No.	531000300
description	knob thermostat t.max. 180°C ø 50mm shaft ø 6x4.6mm shaft flat upper black temperature range 100-180°C		
For models:	FEC-4		

producer-specific knobs

LOTUS



1

GEV No.	110582	Ref. No.	536013900
description	knob energy regulator 0-6 1-circuit t.max.°C ø 40mm shaft ø 6x4.6mm shaft flat left black		
For models:	CFC-62EM, CFC-62ET, PCC-61EM, PCC-62EM, PCC-62ET		



1

GEV No.	110583	Ref. No.	536013500
description	knob energy regulator 0-6 2-circuit t.max.°C ø 40mm shaft ø 6x4.6mm shaft flat left black		
For models:	CFC-62EM, CFC-62ET, PCC-61EM, PCC-62EM, PCC-62ET		



1

GEV No.	110329	Ref. No.	536013600
description	knob gas tap PEL21/22/23 ø 40mm shaft ø 6x4.6mm shaft flat left black		
For models:	BR-62G, CW-61G, CW-62G		



1

GEV No.	111819	Ref. No.	536020200
description	knob gas tap with ignition flame SKG 2-circuit ø 40mm shaft ø 6x4.6mm shaft flat upper black		
For models:	CF-10G6-A, CF-10G-6F, CF-10G-A, CF-10GEM, CF-10GEM-6, CF-10GEM6-A, CF-10GEM-A, CF-10GF, CF-62GEM, CF-62GEM-A, CF-8G-A, CF-8GEM, CF-8GEM-A, CF-8GF, CFM-10GEM, CFM-10GEM-6, CFM-10GEM6-A, CFM-10GEM-A, CFM-8GEM, CFM-8GEM-A, PC-61GF, PC-62GF		



1

GEV No.	111724	Ref. No.	536002501
description	knob gas tap with ignition flame SKG ø 40mm shaft ø 6x4.6mm shaft flat upper black		
For models:	CF-10G6-A, CF-10G-6F, CF-10G-A, CF-10GEM, CF-10GEM-6, CF-10GEM6-A, CF-10GEM-A, CF-10GF, CF-62GEM, CF-62GEM-A, CF-8G-A, CF-8GEM, CF-8GEM-A, CF-8GF, CFM-10GEM, CFM-10GEM-6, CFM-10GEM6-A, CFM-10GEM-A, CFM-8GEM, CFM-8GEM-A, PC-61GF, PC-62GF		



1

GEV No.	110320	Ref. No.	536002100
description	knob switch 7-position t.max.°C ø 40mm shaft ø 6x4.6mm shaft flat left black		
For models:	CF-10EM, CF-10EM-6, CF-10EM-A, CF-10ET, CF-10ET-6, CF-10ET-A, CF-62EM, CF-62EM-A, CF-62ET, CF-62ET-A, CF-8EM, CF-8EM-A, CF-8ET, CF-8ET-A, CFM-10EM, CFM-10EM-6, CFM-10EM-A, CFM-10ET, CFM-10ET-6, CFM-10ET-A, CFM-8EM, CFM-8EM-A, CFM-8ET, CFM-8ET-A, PC-61EM, PC-62EM, PC-62ET		



1

GEV No.	110877	Ref. No.	536011500
description	knob switch zero mark t.max.°C ø 40mm shaft ø 6x4.6mm shaft flat left black		
For models:	WP		



1

GEV No.	110322	Ref. No.	536002400
description	knob thermostat t.max. 180°C ø 40mm shaft ø 6x4.6mm shaft flat left rotation 270° black temperature range 100-180°C		
For models:	FP-62ET, FP-62ETL, FQ-61EM, FQ-61ET, FQ-62EM, FQ-62ET		





1

GEV No.	110667	Ref. No.	536002300
description	knob thermostat t.max. 300°C ø 40mm shaft ø 6x4.6mm shaft flat left rotation 210° black temperature range 50-300°C		
For models:	BR-62ET, CW-61ET, CW-62ET, FTL-61ET, FTL-61ETS, FTL-62ET, FTL-62ETS, FTL-63ET, FTL-63ETS, FTL-64ET, FTL-64ETS, FTLR-62ET, FTLR-62ETS, FTLR-63ET, FTLR-63ETS, FTLR-64ET, FTLR-64ETS, FTR-61ET, FTR-61ETS, FTR-62ET, FTR-62ETS		





			
1			
GEV No.	110324	Ref. No.	536002600
description	knob thermostat t.max. 300°C ø 40mm shaft ø 6x4.6mm shaft flat left rotation 310° black temperature range 50-300°C		
For models:	FTC-61EM, FTC-61ET, FTC-62EM, FTC-62ET, FTL-61EM, FTL-61EMS, FTL-62EM, FTL-62EMS, FTL-63EM, FTL-63EMS, FTL-64EM, FTL-64EMS, FTLR-62EM, FTLR-62EMS, FTLR-63EM, FTLR-63EMS, FTLR-64EM, FTLR-64EMS, FTR-61EM, FTR-61EMS, FTR-62EM, FTR-62EMS		

			
1			
GEV No.	110321	Ref. No.	536002200
description	knob thermostat t.max. 90°C 30-90°C ø 40mm shaft ø 6x4.6mm shaft flat left rotation 270° black		
For models:	BM-61EM, BM-62EM, BM-62ET, BS-61EM, BS-62EM, CP-61EM, CP-62ET, MP-62, MP-62EM, SV-11, SV-113, SV-12, SV-123, SV-13, SV-23		

			
1			
GEV No.	110328	Ref. No.	536003100
description	knob gas thermostat 1-10 ø 44mm shaft ø 8x6.5mm shaft flat lower silver		
For models:	CF-10G6-A, CF-10G-6F, CF-10G-A, CF-10GF, CF4-8G, CF4-8GEM, CF-8G-A, CF-8GF		

			
1			
GEV No.	110338	Ref. No.	536002800
description	knob oven ø 62mm shaft ø 6x4.6mm shaft flat left black		
For models:	CF-10EM, CF-10EM-6, CF-10EM-A, CF-10ET, CF-10ET-6, CF-10ET-A, CF-10GEM, CF-10GEM-6, CF-10GEM6-A, CF-10GEM-A, CF4-8ETS, CF4-GEMS, CF-8EM, CF-8EM-A, CF-8ET, CF-8ET-A, CF-8GEM, CF-8GEM-A		

			
1			
GEV No.	110327	Ref. No.	536002900
description	knob switch zero mark ø 45mm shaft ø 6x4.6mm shaft flat upper black		

			
1			
GEV No.	110090	Ref. No.	536003000
description	knob switch zero mark t.max. °C ø 38mm shaft ø 6x4.6mm shaft flat upper white		
For models:	TS-1		

			
1			
GEV No.	110242	Ref. No.	531000300
description	knob thermostat t.max. 180°C ø 50mm shaft ø 6x4.6mm shaft flat upper black temperature range 100-180°C		
For models:	FEC-4		

			
1			
GEV No.	110743	Ref. No.	536002000
description	knob time 15min ø 44mm shaft ø 5x3.5mm shaft flat on both sides black		
For models:	TS-3, TS-6		



			
1			
GEV No.	111730	Ref. No.	536019900
description	knob without symbol ø 70mm LOTUS shaft ø 10x8mm		
For models:	BRF-98G, CPB-98G		
accessories for	111730		
		GEV No.	110565
		Ref. No.	539018500
	knob dial plate switch 7-position t.max. °C red		

Table continues overleaf

accessories for		111730	
	GEV No.	110566	Ref. No. 539018600
	knob dial plate thermostat t.max. 110°C 30-110°C rotation 270° red		
	GEV No.	110579	Ref. No. 539022600
	knob dial plate gas tap with ignition flame t.max.°C°C red		
	GEV No.	110584	Ref. No. 539018500
	knob dial plate energy regulator 1-6 t.max.°C°C turn direction clockwise ED ø 63mm ID ø 45.5mm red		
	GEV No.	110585	Ref. No. 539016400
	knob dial plate thermostat t.max. 180°C 100-180°C rotation 270° ED ø 63mm ID ø 45.5mm red		
	GEV No.	110586	Ref. No. 539018200
	knob dial plate thermostat t.max. 90°C 30-90°C rotation 270° ED ø 63mm ID ø 45.5mm red		
	GEV No.	110587	Ref. No. 539018300
	knob dial plate thermostat t.max. 300°C 50-300°C rotation 270° ED ø 64mm ID ø 45.5mm red		
	GEV No.	110588	Ref. No. 539018400
	knob dial plate thermostat t.max. 300°C 50-300°C rotation 310° ED ø 63mm ID ø 45.5mm red		
	GEV No.	110589	Ref. No. 539018000
	knob dial plate energy regulator 0-6 2-circuit t.max.°C°C ED ø 63mm ID ø 45.5mm red		
	GEV No.	110600	Ref. No. 539008100
	knob dial plate gas thermostat t.max. 300°C 150-300°C ED ø 63mm ID ø 45.5mm silver		
	GEV No.	110646	Ref. No. 539023400
	knob dial plate time 120min t.max.°C°C ED ø 63mm ID ø 45.5mm silver		
	GEV No.	110647	Ref. No. 539017900
	knob dial plate silver thermostat t.max. 300°C 50-300°C rotation 310° ED ø 63mm ID ø 45.5mm		
	GEV No.	110648	Ref. No. 539022900
	knob dial plate gas thermostat t.max. 300°C 60-300°C ED ø 63mm ID ø 45.5mm red		
	GEV No.	110649	Ref. No. 539023200
	knob dial plate gas thermostat t.max. 250°C ED ø 63mm ID ø 45.5mm silver		
	GEV No.	110668	Ref. No. 539023000
	knob dial plate gas thermostat tail t.max.°C°C ED ø 63mm ID ø 45.5mm red		
	GEV No.	110669	Ref. No. 539022800
	knob dial plate gas thermostat t.max. 90°C ED ø 63mm ID ø 45.5mm red		
	GEV No.	110670	Ref. No. 539022700
	knob dial plate gas thermostat t.max. 190°C ED ø 63mm ID ø 45.5mm red		
	GEV No.	110876	Ref. No. 539022500
	knob dial plate gas tap without ignition flame t.max.°C°C red		
	GEV No.	111727	Ref. No. 539023201
	knob dial plate gas thermostat t.max. 275°C silver		
	GEV No.	111728	Ref. No. 539023600
	knob dial plate time 120min t.max.°C°C silver		
	GEV No.	111729	Ref. No. 539008200
	knob dial plate gas thermostat t.max. 300°C 150-300°C ED ø 63mm ID ø 45.5mm red		















accessories for		111726	
	GEV No.	111726	Ref. No. 536019700
	description knob without symbol ø 70mm LOTUS shaft ø 6x4.6mm		
	For models: BM-74EM, BM-78EM, BM-94EM, BM-98EM, BMT-63EM, BMT-64EM, BMT-66EM, BMT-74EM, BMT-78EM, BMT-94EM, BMT-98EM, BRF-64ET, BRF-74ET, BRF-78ET, BRF-94ET, BRF-98ET, BRT-66ET, BS-74EM, BS-94EM, BST-64EM, BST-74EM, BST-94EM, CF2-58G, CF2-58GE, CF2-68G, CF2-68GEM, CF3-512GEV, CF3-512GV, CF3-612GEMV, CF3-612GV, CF4-68ET, CF4-68G, CF4-68GEM, CF4-78ET, CF4-78G, CF4-78GE, CF4-78GP, CF4-78GPE, CF4-98ET, CF4-98G, CF4-98GE, CF6-610ET, CF6-610G, CF6-610GEM, CF6-712ET, CF6-712ETV, CF6-712ETVX, CF6-712G, CF6-712GEV, CF6-712GP..(Other models you can see in the webshop)		
accessories for		111726	
	GEV No.	110565	Ref. No. 539018500
	knob dial plate switch 7-position t.max.°C°C red		
	GEV No.	110566	Ref. No. 539018600
	knob dial plate thermostat t.max. 110°C 30-110°C rotation 270° red		
	GEV No.	110579	Ref. No. 539022600
	knob dial plate gas tap with ignition flame t.max.°C°C red		
	GEV No.	110584	Ref. No. 539018500
	knob dial plate energy regulator 1-6 t.max.°C°C turn direction clockwise ED ø 63mm ID ø 45.5mm red		
	GEV No.	110585	Ref. No. 539016400
	knob dial plate thermostat t.max. 180°C 100-180°C rotation 270° ED ø 63mm ID ø 45.5mm red		
	GEV No.	110586	Ref. No. 539018200
	knob dial plate thermostat t.max. 90°C 30-90°C rotation 270° ED ø 63mm ID ø 45.5mm red		
	GEV No.	110587	Ref. No. 539018300
	knob dial plate thermostat t.max. 300°C 50-300°C rotation 270° ED ø 64mm ID ø 45.5mm red		
	GEV No.	110588	Ref. No. 539018400
	knob dial plate thermostat t.max. 300°C 50-300°C rotation 310° ED ø 63mm ID ø 45.5mm red		
	GEV No.	110589	Ref. No. 539018000
	knob dial plate energy regulator 0-6 2-circuit t.max.°C°C ED ø 63mm ID ø 45.5mm red		
	GEV No.	110600	Ref. No. 539008100
	knob dial plate gas thermostat t.max. 300°C 150-300°C ED ø 63mm ID ø 45.5mm silver		
	GEV No.	110644	Ref. No. 539023500
	knob dial plate thermostat t.max. 250°C 50-250°C ED ø 63mm ID ø 45.5mm silver		
	GEV No.	110645	Ref. No. 539023300
	knob dial plate program switch t.max.°C°C ED ø 63mm ID ø 45.5mm silver		
	GEV No.	110646	Ref. No. 539023400
	knob dial plate time 120min t.max.°C°C ED ø 63mm ID ø 45.5mm silver		
	GEV No.	110647	Ref. No. 539017900
	knob dial plate silver thermostat t.max. 300°C 50-300°C rotation 310° ED ø 63mm ID ø 45.5mm		

Table continues overleaf

accessories for		111726		
	GEV No.	110648	Ref. No.	539022900
	knob dial plate gas thermostat t.max. 300°C 60-300°C ED ø 63mm ID ø 45.5mm red			
	GEV No.	110649	Ref. No.	539023200
	knob dial plate gas thermostat t.max. 250°C ED ø 63mm ID ø 45.5mm silver			
	GEV No.	110668	Ref. No.	539023000
	knob dial plate gas thermostat tail t.max.°C ED ø 63mm ID ø 45.5mm red			
	GEV No.	110669	Ref. No.	539022800
	knob dial plate gas thermostat t.max. 90°C ED ø 63mm ID ø 45.5mm red			
	GEV No.	110670	Ref. No.	539022700
	knob dial plate gas thermostat t.max. 190°C ED ø 63mm ID ø 45.5mm red			
	GEV No.	110876	Ref. No.	539022500
	knob dial plate gas tap without ignition flame t.max.°C°C red			
	GEV No.	111727	Ref. No.	539023201
	knob dial plate gas thermostat t.max. 275°C silver			
	GEV No.	111728	Ref. No.	539023600
	knob dial plate time 120min t.max.°C°C silver			
	GEV No.	111729	Ref. No.	539008200
	knob dial plate gas thermostat t.max. 300°C 150-300°C ED ø 63mm ID ø 45.5mm red			



GEV No.	111725	Ref. No.	536019800	
description	knob without symbol ø 70mm LOTUS shaft ø 8x6.5mm			
For models:	BM-74G, BM-78G, BM-94G, BM-98G, BMT-94G, BMT-98G, BRF-64G, BRF-74G, BRF-78G, BRF-94G, BRT-66G, CF2-58G, CF2-58GE, CF2-68G, CF2-68GEM, CF3-512GEV, CF3-512GV, CF3-612GEMV, CF3-612GV, CF4-68G, CF4-68GEM, CF4-78G, CF4-78GE, CF4-78GP, CF4-78GPE, CF4-98G, CF4-98GE, CF6-610G, CF6-610GEM, CF6-712G, CF6-712GEV, CF6-712GPV, CF6-712GPEV, CF6-712GPE, CF6-912GE, CF6-912GEV, CF6-912GV, CF-712GE, CF-712GPE, CF8-916G, CF8-916GE, CF8-916GEV, CF8-916GV, CFM2-68GEM, CFM3-612GEMV, CFM4-66GEM, CFM4-68GEM, CFM6-610GEM...(Other models you can see in the webshop)			
accessories for		111725		
	GEV No.	110565	Ref. No.	539018500
	knob dial plate switch 7-position t.max.°C°C red			
	GEV No.	110566	Ref. No.	539018600
	knob dial plate thermostat t.max. 110°C 30-110°C rotation 270° red			
	GEV No.	110579	Ref. No.	539022600
	knob dial plate gas tap with ignition flame t.max.°C°C red			
	GEV No.	110584	Ref. No.	539018500
	knob dial plate energy regulator 1-6 t.max.°C°C turn direction clockwise ED ø 63mm ID ø 45.5mm red			
	GEV No.	110585	Ref. No.	539016400
	knob dial plate thermostat t.max. 180°C 100-180°C rotation 270° ED ø 63mm ID ø 45.5mm red			

accessories for		111725		
	GEV No.	110586	Ref. No.	539018200
	knob dial plate thermostat t.max. 90°C 30-90°C rotation 270° ED ø 63mm ID ø 45.5mm red			
	GEV No.	110587	Ref. No.	539018300
	knob dial plate thermostat t.max. 300°C 50-300°C rotation 270° ED ø 64mm ID ø 45.5mm red			
	GEV No.	110588	Ref. No.	539018400
	knob dial plate thermostat t.max. 300°C 50-300°C rotation 310° ED ø 63mm ID ø 45.5mm red			
	GEV No.	110589	Ref. No.	539018000
	knob dial plate energy regulator 0-6 2-circuit t.max.°C°C ED ø 63mm ID ø 45.5mm red			
	GEV No.	110600	Ref. No.	539008100
	knob dial plate gas thermostat t.max. 300°C 150-300°C ED ø 63mm ID ø 45.5mm silver			
	GEV No.	110644	Ref. No.	539023500
	knob dial plate thermostat t.max. 250°C 50-250°C ED ø 63mm ID ø 45.5mm silver			
	GEV No.	110645	Ref. No.	539023300
	knob dial plate program switch t.max.°C°C ED ø 63mm ID ø 45.5mm silver			
	GEV No.	110646	Ref. No.	539023400
	knob dial plate time 120min t.max.°C°C ED ø 63mm ID ø 45.5mm silver			
	GEV No.	110647	Ref. No.	539017900
	knob dial plate silver thermostat t.max. 300°C 50-300°C rotation 310° ED ø 63mm ID ø 45.5mm			
	GEV No.	110648	Ref. No.	539022900
	knob dial plate gas thermostat t.max. 300°C 60-300°C ED ø 63mm ID ø 45.5mm red			
	GEV No.	110649	Ref. No.	539023200
	knob dial plate gas thermostat t.max. 250°C ED ø 63mm ID ø 45.5mm silver			
	GEV No.	110668	Ref. No.	539023000
	knob dial plate gas thermostat tail t.max.°C°C ED ø 63mm ID ø 45.5mm red			
	GEV No.	110669	Ref. No.	539022800
	knob dial plate gas thermostat t.max. 90°C ED ø 63mm ID ø 45.5mm red			
	GEV No.	110670	Ref. No.	539022700
	knob dial plate gas thermostat t.max. 190°C ED ø 63mm ID ø 45.5mm red			
	GEV No.	110876	Ref. No.	539022500
	knob dial plate gas tap without ignition flame t.max.°C°C red			
	GEV No.	111727	Ref. No.	539023201
	knob dial plate gas thermostat t.max. 275°C silver			
	GEV No.	111728	Ref. No.	539023600
	knob dial plate time 120min t.max.°C°C silver			
	GEV No.	111729	Ref. No.	539008200
	knob dial plate gas thermostat t.max. 300°C 150-300°C ED ø 63mm ID ø 45.5mm red			



GEV No.	110589	Ref. No.	539018000
description	knob dial plate energy regulator 0-6 2-circuit t.max.°C ED ø 63mm ID ø 45.5mm red		
For models:	CFC4-78ET, CFC4-8ET, CFC4-98ET, CFMC4-66ET, PCC-4EM, PCC-4EMX, PCC-4ET, PCC-6EM, PCC-6EMX, PCC-6ET, PCC-74ET, PCC-78ET, PCC-8EMX, PCC-8ET, PCC-94ET, PCC-98ET, PCCT-63ET, PCCT-66ET, PCCT-74ET, PCCT-78ET, PCCT-94ET, PCCT-98ET		



GEV No.	110584	Ref. No.	539018500
description	knob dial plate energy regulator 1-6 t.max.°C turn direction clockwise ED ø 63mm ID ø 45.5mm red		
For models:	CFC4-78ET, CFC4-8ET, FTC-74ET, FTC-78ET, FTC-94ET, FTC-98ET, FTCT-64ET, FTCT-66ET, FTCT-74ET, FTCT-78ET, FTCT-94ET, FTCT-98ET, PCC-4EM, PCC-4EMX, PCC-4ET, PCC-6EM, PCC-6EMX, PCC-6ET, PCC-74ET, PCC-78ET, PCC-8EMX, PCC-8ET, PCI-74ET, PCI-78ET, PCI-94ET, PCI-98ET, PCIT-64ET, PCIT-74ET, PCIT-78ET, PCIT-94ET, PCIT-98ET, PCIW-4ET, PCIW-74ET, PCIW-94ET, PCIWT-64ET, PCIWT-74ET, PCIWT-94ET, SA-400EM, SA-400EMX, SA-600EM, SA-600EMX, SA-600ET, SA-600ETX, SL-600, SL-600EM, SL-600EMX, SL-600ET, SL-600ETX, SL-600X, SLC-600EM...(Other models you can see in the webshop)		



GEV No.	110579	Ref. No.	539022600
description	knob dial plate gas tap with ignition flame t.max.°C red		
For models:	BR-6G, BRT-66G, CF2-58G, CF2-58GE, CF2-68G, CF2-68GEM, CF3-512GEV, CF3-512GV, CF3-612GEMV, CF3-612GV, CF4-78GP, CF4-78GPE, CF4-98G, CF4-98GE, CF6-712GP, CF6-712GPEV, CF6-712GPV, CF6-912G, CF6-912GE, CF6-912GEV, CF6-912GV, CF-712GPE, CF8-916G, CF8-916GE, CF8-916GEV, CF8-916GV, CFM2-68GEM, CFM3-612GEMV, CP-66G, CP-74G, CP-76G, CP-78G, CP-94G, CP-98G, CPB-98G, CPM-6G, CPT-64G, CPT-66G, CW-4G, CW-6G, CW-74G, CW-78G, CW-94G, CW-98G, CWT-64G, CWT-66G, CWT-68G, CWT-94G, CWT-98G, PC1T-64G...(Other models you can see in the webshop)		



GEV No.	110876	Ref. No.	539022500
description	knob dial plate gas tap without ignition flame t.max.°C red		
For models:	CF4-68G, CF4-68GEM, CF4-78ET, CF4-78G, CF4-78GE, CF4-8G, CF4-8GEM, CF4-GEMS, CF6-610G, CF6-610GEM, CF6-712ET, CF6-712ETV, CF6-712G, CF6-712GEV, CF6-712GV, CF-712GE, CFM4-66GEM, CFM4-68GEM, CFM6-610GEM, CFQ4-78ET, CFQ6-712ET, CFQ6-712ETV, F-1G, FB-1G, FO-1G, FO-2G, FO-3G, FOS-1G, FOS-2G, FOS-3G, PC-12G, PC-4G, PC-712ET, PC-712G, PC-716G, PC-74ET, PC-74G, PC-78ET, PC-78G, PC-8G, PCQ-712ET, PCQ-74ET, PCQ-78ET, PCT-63G, PCT-66G, TP2-712G, TPF2-712G, TPF2-712GV, TPF4-610G		



GEV No.	110670	Ref. No.	539022700
description	knob dial plate gas thermostat t.max. 190°C ED ø 63mm ID ø 45.5mm red		
For models:	F11-54G, F13-64G, F13-74G, F13T-74G, F13T-94G, F18-74G, F2-13-78G, F2-13T-78G, F2-13T-98G, F2-18-78G, F2-8-74G, F2-8-94G, F2-8T-66G, F2-8T-94G, F8T-63G, FP-6G, FQ-4G, FQ-6G, FQM-4G, FTL-712G, FTL-712GS, FTL-74G, FTL-74GS, FTL-76G, FTL-76GS, FTL-78G, FTL-78GS, FTLR-712G, FTLR-712GS, FTLR-76G, FTLR-76GS, FTLR-78G, FTLR-78GS, FTR-712G, FTR-712GS, FTR-74G, FTR-74GS, FTR-76G, FTR-76GS, FTR-78G, FTR-78GS		



GEV No.	110649	Ref. No.	539023200
description	knob dial plate gas thermostat t.max. 250°C ED ø 63mm ID ø 45.5mm silver		
For models:	CF4-8G, CF4-8GEM		



GEV No.	111727	Ref. No.	539023201
description	knob dial plate gas thermostat t.max. 275°C silver		
For models:	CF-10G6-A, CF-10G-6F, CF-10G-A, CF-10GF, CF2-58G, CF2-68G, CF3-512GV, CF3-612GV, CF4-68G, CF4-8G, CF6-610G, CF-8G-A, CF-8GF, TPF4-610G		

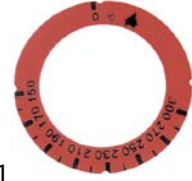

GEV No.	111729	Ref. No.	539008200
description	knob dial plate gas thermostat t.max. 300°C 150-300°C ED ø 63mm ID ø 45.5mm red		
For models:	BRF-64G, BRF-74G, BRF-78G, BRF-94G, BRF-98G		

1

GEV No.	110600	Ref. No.	539008100
description	knob dial plate gas thermostat t.max. 300°C ED ø 63mm ID ø 45.5mm silver		
For models:	CF4-78G, CF4-78GP, CF4-98G, CF6-712G, CF6-712GP, CF6-712GPV, CF6-712GV, CF6-912G, CF6-912GV, CF8-916G, CF8-916GV, TPF2-712G, TPF2-712GPV, TPF2-712GV, TPF2-912G, TPF2-912GE, TPF2-912GV, TPF2-98G, TPF4-712GP, TPF4-712GPV, TPF4-912G, TPF4-912GV, TPF-78G, TPF-98G		



1

GEV No.	110645	Ref. No.	539023300
description	knob dial plate program switch t.max. °C ED ø 63mm ID ø 45.5mm silver		
For models:	CF4-8ET, CF4-8GEM, CF-62EM, CF-62EM-A, CF-62ET, CF-62ET-A, CF-62GEM, CF-62GEM-A, CFC4-8ET, CFC-62EM, CFC-62ET, CFM-10EM, CFM-10EM-6, CFM-10EM-A, CFM-10ET, CFM-10ET-6, CFM-10ET-A, CFM-10GEM, CFM-10GEM-6, CFM-10GEM6-A, CFM-10GEM-A, CFM-8EM, CFM-8EM-A, CFM-8ET, CFM-8ET-A, CFM-8GEM, CFM-8GEM-A		



1

GEV No.	110648	Ref. No.	539022900
description	knob dial plate gas thermostat t.max. 300°C ED ø 63mm ID ø 45.5mm red		
For models:	FTL-4G, FTL-4GS, FTL-6G, FTL-6GS, FTL-712G, FTL-712GS, FTL-74G, FTL-74GS, FTL-78G, FTL-78GS, FTL-8G, FTL-8GS, FTL-94G, FTL-94GS, FTL-98G, FTL-98GS, FTLR-6G, FTLR-6GS, FTLR-712G, FTLR-712GS, FTLR-78G, FTLR-78GS, FTLR-8G, FTLR-8GS, FTLR-98G, FTLR-98GS, FTR-4G, FTR-4GS, FTR-54G, FTR-6G, FTR-6GS, FTR-712G, FTR-712GS, FTR-74G, FTR-74GS, FTR-78G, FTR-78GS, FTR-8G, FTR-8GS, FTR-94G, FTR-94GS, FTR-98G, FTR-98GS, FTTL-610G, FTTL-610GS, FTTL-64G, FTTL-64GS, FTTL-66G, FTTL-66GS, FTTL-68G...(Other models you can see in the webshop)		



1

GEV No.	110647	Ref. No.	539017900
description	knob dial plate silver thermostat t.max. 300°C ED ø 63mm ID ø 45.5mm		
For models:	CF4-78ET, CF4-78GE, CF4-78GPE, CF4-98ET, CF4-98GE, CF6-712ET, CF6-712ETV, CF6-712ETVX, CF6-712GEV, CF6-712GPEV, CF6-912ET, CF6-912ETV, CF6-912ETVX, CF6-912GE, CF6-912GEV, CF-712GE, CF-712GPE, CF8-916ET, CF8-916ETV, CF8-916GE, CF8-916GEV, CFC4-78ET, CFC4-98ET, CFQ4-78ET, CFQ4-98ET, CFQ6-712ET, CFQ6-712ETV, CFQ6-712ETVX, CFQ6-912ET, CFQ6-912ETV, CFQ6-912ETVX, CFQ8-916ETV, CFQ9-916ET, TPF2-712GP, TPF2-712GPE, TPF2-712GPEV, TPF2-78GP, TPF2-78GPE, TPF2-912GEV, TPF2-98GE, TPF4-712GPE, TPF4-712GPEV, TPF4-912GE, TPF4-912GEV, TPF-78ET, TPF-78GE, TPF-98ET, TPF-98GE		



1

GEV No.	110669	Ref. No.	539022800
description	knob dial plate gas thermostat t.max. 90°C ED ø 63mm ID ø 45.5mm red		
For models:	BM-4G, BM-6G, BM-74G, BM-78G, BM-8G, BM-94G, BM-98G, BMT-64G, BMT-66G, BMT-94G, BMT-98G		



1

GEV No.	110561	Ref. No.	539018100
description	knob dial plate switch 7-position t.max. °C ED ø 63mm ID ø 45.5mm red		
For models:	CF4-68ET, CF4-78ET, CF4-8ET, CF4-8ETS, CF4-98ET, CF6-610ET, CF6-712ET, CF6-712ETV, CF6-712ETVX, CF6-912ET, CF6-912ETV, CF6-912ETVX, CF8-916ET, CF8-916ETV, CFM4-66ET, CFM4-68ET, CFM6-610ET, CFQ4-78ET, CFQ4-98ET, CFQ6-712ET, CFQ6-712ETV, CFQ6-712ETVX, CFQ6-912ET, CFQ6-912ETV, CFQ6-912ETVX, CFQ8-916ETV, CFQ9-916ET, PC-10ET, PC-10ETX, PC-4EM, PC-4ET, PC-4ETX, PC-6EM, PC-6ET, PC-6ETX, PC-712ET, PC-74ET, PC-78ET, PC-8ET, PC-8ETX, PC-912ET, PC-916ET, PC-94ET, PC-98ET, PCQ-712ET, PCQ-74ET, PCQ-78ET, PCQ-912ET, PCQ-916ET, PCQ-94ET...(Other models you can see in the webshop)		



1

GEV No.	110668	Ref. No.	539023000
description	knob dial plate gas thermostat tail t.max. °C ED ø 63mm ID ø 45.5mm red		
For models:	CP-6G		



1

GEV No.	110565	Ref. No.	539018500
description	knob dial plate switch 7-position t.max. °C ED ø 63mm ID ø 45.5mm red		



1

GEV No.	110566	Ref. No.	539018600
description	knob dial plate thermostat t.max. 110°C 30-110°C rotation 270° red		
For models:	CP-4ET, CP-4ETX, CP-6ET, CP-6ETX, CP-74ET, CP-78ET, CP-94ET, CP-98ET		



1

GEV No.	110585	Ref. No.	539016400
description	knob dial plate thermostat t.max. 180°C 100-180°C rotation 270° ED ø 63mm ID ø 45.5mm red		
For models:	F10T-63EM, F10T-63ET, F13-64ET, F13-74ET, F13T-74E, F13T-94ET, F18-74ET, F18-94ET, F18-94ETX, F18-94G, F2-10T-66EM, F2-10T-66ET, F2-13-78ET, F2-13-98ET, F2-13T-78E, F2-18-78ET, F2-18-98ET, F2-18-98ETX, F2-18-98G, F2-25-98ET, F2-25-98ETX, F2-25-98G, F25-94ET, F25-94ETX, F25-94G, F2-8-74ET, F2-8-94ET, F2-8T-74ET, F2-8T-94ET, F45-78ET, F45-78G, FE-10, FE2-10, FE-2-8, FE-8, FEM-2-6, FEM-6, FME-10, FME-15, FME-2-10, FME-2-15, FMPE-20, FMPE-25, FMPE-30, FP-6ET, FPE-20, FPE-25, FQ-4EM, FQ-4ET, FQ-4ETX...(Other models you can see in the webshop)		



1

GEV No.	110644	Ref. No.	539023500
description	knob dial plate thermostat t.max. 250°C 50-250°C ED ø 63mm ID ø 45.5mm silver		
For models:	CF4-8ET, CF4-8GEM, CF-62EM, CF-62EM-A, CF-62ET, CF-62ET-A, CF-62GEM, CF-62GEM-A, CFC4-8ET, CFC-62EM, CFC-62ET, CFM-10EM, CFM-10EM-6, CFM-10EM-A, CFM-10ET, CFM-10ET-6, CFM-10ET-A, CFM-10GEM, CFM-10GEM-6, CFM-10GEM6-A, CFM-10GEM-A, CFM-8EM, CFM-8EM-A, CFM-8ET, CFM-8ET-A, CFM-8GEM, CFM-8GEM-A		



1

GEV No.	110587	Ref. No.	539018300
description	knob dial plate thermostat t.max. 300°C 50-300°C rotation 270° ED ø 64mm ID ø 45.5mm red		
For models:	BRF-78ET, BRF-98ET, FTC-4EM, FTC-4EMX, FTC-4ET, FTC-6EM, FTC-6EMX, FTC-6ET, FTC-8EMX, FTC-8ET, FTL-4EM, FTL-4EMS, FTL-6EM, FTL-6EMS, FTL-8EM, FTL-8EMS, FTLR-6EM, FTLR-6EMS, FTLR-8EM, FTLR-8EMS, FTR-4EM, FTR-4EMS, FTR-6EM, FTR-6EMS		



1

GEV No.	110588	Ref. No.	539018400
description	knob dial plate thermostat t.max. 300°C 50-300°C rotation 310° ED ø 63mm ID ø 45.5mm red		
For models:	BR-6ET, BR-6ETX, BRF-64ET, BRF-74ET, BRF-94ET, BRT-66ET, CW-4ET, CW-4ETX, CW-6ET, CW-6ETX, CW-74ET, CW-78ET, CW-94ET, CW-98ET, CWT-64ET, CWT-66ET, CWT-68ET, CWT-74ET, CWT-78ET, CWT-94ET, CWT-98ET, FTL-4ET, FTL-4ETS, FTL-4ETX, FTL-6ET, FTL-6ETS, FTL-6ETX, FTL-712ET, FTL-712ETS, FTL-74ET, FTL-74ETS, FTL-76ET, FTL-76ETS, FTL-78ET, FTL-78ETS, FTL-8ET, FTL-8ETS, FTL-8ETX, FTL-94ET, FTL-94ETS, FTL-94ETX, FTL-98ET, FTL-98ETS, FTL-98ETX, FTLR-6ET, FTLR-6ETS, FTLR-6ETX, FTLR-712ET, FTLR-712ETS, FTLR-76ET...(Other models you can see in the webshop)		



1

GEV No.	110586	Ref. No.	539018200
description	knob dial plate thermostat t.max. 90°C 30-90°C rotation 270° ED ø 63mm ID ø 45.5mm red		
For models:	BM-10EM, BM-10EMX, BM-4EM, BM-4EMX, BM-6EM, BM-6EMX, BM-74EM, BM-74ET, BM-78EM, BM-78ET, BM-8EM, BM-8EMX, BM-94EM, BM-98EM, BMT-63EM, BMT-64EM, BMT-66EM, BMT-74EM, BMT-78EM, BMT-94EM, BMT-98EM, BS-4EM, BS-4EMX, BS-74EM, BS-94EM, BST-64EM, BST-74EM, BST-94EM		



1

GEV No.	110646	Ref. No.	539023400
description	knob dial plate time 120min t.max.°C ED ø 63mm ID ø 45.5mm silver		
For models:	CF-10EM, CF-10EM-6, CF-10EM-A, CF-10ET, CF-10ET-6, CF-10ET-A, CF-10GEM, CF-10GEM-6, CF-10GEM6-A, CF-10GEM-A, CF4-68ET, CF4-68GEM, CF4-8ET, CF4-8ETS, CF4-8GEM, CF4-GEMS, CF-62EM, CF-62EM-A, CF-62ET, CF-62ET-A, CF-62GEM, CF-62GEM-A, CF6-610ET, CF6-610GEM, CF-8EM, CF-8EM-A, CF-8ET, CF-8ET-A, CF-8GEM, CF-8GEM-A, CFC4-8ET, CFC-62EM, CFC-62ET, CFM-10EM, CFM-10EM-6, CFM-10EM-A, CFM-10ET, CFM-10ET-6, CFM-10ET-A, CFM-10GEM, CFM-10GEM-6, CFM-10GEM6-A, CFM-10GEM-A, CFM2-68GEM, CFM3-612GEMV, CFM4-66ET, CFM4-66GEM, CFM4-68ET, CFM4-68GEM, CFM6-610ET...(Other models you can see in the webshop)		

1

GEV No.	111728	Ref. No.	539023600
description	knob dial plate time 120min t.max.°C°C silver		
For models:	CF2-58G, CF2-58GE, CF2-68G, CF2-68GEM, CF3-512GEV, CF3-512GV, CF3-612GEMV, CF3-612GV, CF4-68G, CF4-78ET, CF4-78G, CF4-78GE, CF4-78GP, CF4-8G, CF4-8GEM, CF4-98G, CF6-610G, CF6-712ET, CF6-712ETV, CF6-712ETVX, CF6-712G, CF6-712GEV, CF6-712GP, CF6-712GPV, CF6-712GV, CF6-912G, CF6-912GV, CF-712GE, CF8-916G, CF8-916GV, CFC4-78ET, CFQ4-78ET, CFQ6-712ET, CFQ6-712ETV, CFQ6-712ETVX, TPF2-712G, TPF2-712GPV, TPF2-712GV, TPF2-912G, TPF2-912GE, TPF2-912GV, TPF2-98G, TPF4-610G, TPF4-712GP, TPF4-712GPV, TPF4-912G, TPF4-912GV, TPF-78G, TPF-78GE, TPF-98G		



2

GEV No.	110072	Ref. No.	539016400
description	symbol thermostat t.max. 190°C 110-190°C LOTUS rotation 270° turn direction right ED ø 64mm ID ø 45.5mm red		

handles and hand wheels

hand wheels

hand wheels



1

GEV No.	692443	Ref. No.	SMB013600
description	hand wheel ø 150mm D1 ø 38mm bore ø 14mm thread groove width 6mm groove depth 13mm mounting distance 18mm L1 40mm L2 43mm handle length 65mm with folding handle		



1

GEV No.	692430	Ref. No.	SMB063600
description	hand wheel ø 200mm D1 ø 50mm bore ø 20mm thread groove width 6mm groove depth 13mm mounting distance 30mm L1 47mm L2 50mm handle length 90mm with folding handle		

cone handles



1

GEV No.	110704	Ref. No.	536000300
description	cone handle thread M6 ø 16mm L 25mm plastic black		

hinges

oven hinges

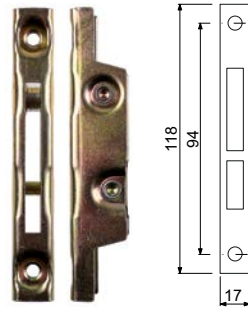

1

GEV No.	700001	Ref. No.	531022900
description	opposite support L 118mm W 17mm mounting distance 94mm		
For models:	CF2-58G, CF2-58GE, CF2-68G, CF2-68GEM, CF3-512GEV, CF3-512GV, CF3-612GEMV, CF3-612GV, CF4-78ET, CF4-78ETX, CF4-78G, CF4-78GE, CF4-78GP, CF4-78GP-AUS, CF4-78GPE, CF4-78GP-USA, CF4-98ET, CF4-98ETX, CF4-98G, CF4-98GE, CF6-712ET, CF6-712ETV, CF6-712ETVX, CF6-712ETX, CF6-712G, CF6-712GEV, CF6-712GP, CF6-712GPE, CF6-712GPEV, CF6-712GPV, CF6-712GPV-USA, CF6-712GV, CF6-912ET, CF6-912ETV, CF6-912ETVX, CF6-912G, CF6-912GE, CF6-912GEV, CF6-912GV, CF-712GE, CF-712GPE, CF8-916ET, CF8-916ETV, CF8-916G, CF8-916GE, CF8-916GEV, CF8-916GV, CFA4-78G, CFA4-98G, CFA6-712GV...(Other models you can see in the webshop)		



1

GEV No.	690031	Ref. No.	531007200
description	opposite support oven hinge		
For models:	CF-62EM, CF-62EM-A, CF-62ET, CF-62ET-A, CF-62GEM, CF-62GEM-A, CFC-62EM, CFC-62ET		



1

GEV No.	690036	Ref. No.	531008000
description	opposite support oven hinge		



1

GEV No.	701574	Ref. No.	531007301
description	oven hinge mounting distance 112mm groove distance 9mm spring thickness 3.7mm spring length 75mm L 215mm W 22mm		
For models:	CF-10EM, CF-10EM-6, CF-10EM-A, CF-10ET, CF-10ET-6, CF-10ET-A, CF-10G6-A, CF-10G-6F, CF-10G-A, CF-10GEM, CF-10GEM-6, CF-10GEM6-A, CF-10GEM-A, CF-10GF, CF4-8ET, CF4-8ETS, CF4-8G, CF4-8GEM, CF4-GEMS, CF-8EM, CF-8EM-A, CF-8ET, CF-8ET-A, CF-8G-A, CF-8GEM, CF-8GEM-A, CF-8GF, CFC4-8ET, CFM-10EM, CFM-10EM-6, CFM-10EM-A, CFM-10ET, CFM-10ET-6, CFM-10ET-A, CFM-10GEM, CFM-10GEM-6, CFM-10GEM6-A, CFM-10GEM-A, CFM-8EM, CFM-8EM-A, CFM-8ET, CFM-8ET-A, CFM-8GEM, CFM-8GEM-A		

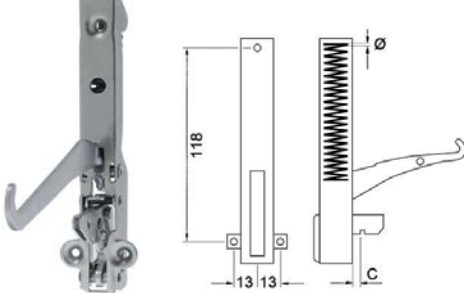

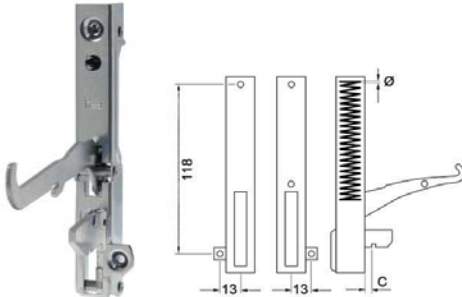

1

GEV No.	690030	Ref. No.	531007100
description	oven hinge mounting distance 118mm lug mounting 13mm lever length 117mm groove distance 10mm spring thickness 3.5mm mounting ear position left/right spring length 60mm L 155mm W 21mm		
For models:	CF-62EM, CF-62EM-A, CF-62ET, CF-62ET-A, CF-62GEM, CF-62GEM-A, CFC-62EM, CFC-62ET		
accessories for	690030		
	GEV No.	700003	Ref. No. —
	opposite support L 110mm W 12mm mounting distance 94mm		



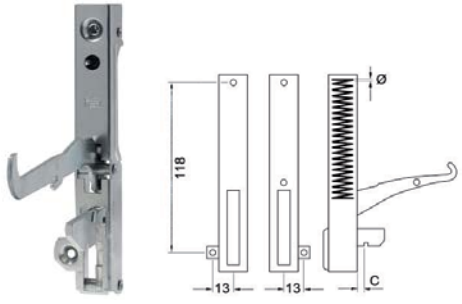

1

GEV No.	690034	Ref. No.	531007400
description	oven hinge mounting distance 120mm lever length 130mm spring thickness 3mm L 155mm		
accessories for	690034		
	GEV No.	693045	Ref. No. —
	opposite support L 110mm W 12mm mounting distance 94mm		
	GEV No.	700003	Ref. No. —
	opposite support L 110mm W 12mm mounting distance 94mm		



1

GEV No.	690035	Ref. No.	531005300
description	oven hinge mounting distance 120mm lever length 130mm spring thickness 3mm L 155mm left		
accessories for	690035		
	GEV No.	693045	Ref. No. —
	opposite support L 110mm W 12mm mounting distance 94mm		
	GEV No.	700003	Ref. No. —
	opposite support L 110mm W 12mm mounting distance 94mm		



GEV No.	690032	Ref. No.	531007300
description	oven hinge mounting distance 134mm lug mounting 12mm lever length 138mm groove distance 6mm spring thickness 3.5mm mounting ear position left/right spring length 64mm L 162mm W 20mm for glass door		
For models:	CF-10EM, CF-10EM-6, CF-10EM-A, CF-10ET, CF-10ET-6, CF-10ET-A, CF-10G6-A, CF-10G-6F, CF-10G-A, CF-10GEM, CF-10GEM-6, CF-10GEM6-A, CF-10GEM-A, CF-10GF, CF4-8ET, CF4-8ETS, CF4-8G, CF4-8GEM, CF4-GEMS, CF-8EM, CF-8EM-A, CF-8ET, CF-8ET-A, CF-8G-A, CF-8GEM, CF-8GEM-A, CF-8GF, CFC4-8ET, CFM-10EM, CFM-10EM-6, CFM-10EM-A, CFM-10ET, CFM-10ET-6, CFM-10ET-A, CFM-10GEM, CFM-10GEM-6, CFM-10GEM6-A, CFM-10GEM-A, CFM-8EM, CFM-8EM-A, CFM-8ET, CFM-8ET-A, CFM-8GEM, CFM-8GEM-A		

GEV No.	700006	Ref. No.	531022800
description	oven hinge mounting distance 173mm mounting distance 2 105mm lug mounting 14mm lever length 120mm groove distance 11mm spring thickness 3.5mm mounting ear position left spring length 112mm W 25mm		
For models:	CF2-58G, CF2-58GE, CF2-68G, CF2-68GEM, CF3-512GEV, CF3-512GV, CF3-612GEMV, CF3-612GV, CF4-78ET, CF4-78ETX, CF4-78G, CF4-78GE, CF4-78GP, CF4-78GP-AUS, CF4-78GPE, CF4-78GP-USA, CF4-98ET, CF4-98ETX, CF4-98G, CF4-98GE, CF6-712ET, CF6-712ETV, CF6-712ET-VX, CF6-712ETX, CF6-712G, CF6-712GEV, CF6-712GP, CF6-712GPE, CF6-712GPEV, CF6-712GPV, CF6-712GPV-USA, CF6-712GV, CF6-912ET, CF6-912ETV, CF6-912GV, CF6-912GE, CF6-912GEV, CF6-912GV, CF-712GE, CF-712GPE, CF8-916ET, CF8-916ETV, CF8-916G, CF8-916GE, CF8-916GEV, CF8-916GV, CFA4-78G, CFA4-98G, CFA6-712GV...(Other models you can see in the webshop)		

GEV No.	701573	Ref. No.	531059700
description	oven hinge mounting distance 142mm mounting distance 2mm lug mountingmm lever lengthmm groove distance 12mm spring thickness 3.3mm mounting ear position spring length 116mm L 170mm mounting pos. left/right W 22mm		
For models:	CF4-68ET, CF4-68ETX, CF4-68G, CF4-68GEM, CF6-610ET, CF6-610ETX, CF6-610G, CF6-610GEM, CFM2-68GEM, CFM3-612GEMV, CFM4-68ET, CFM4-68GEM, CFM6-610ET, CFM6-610GEM, MFM-610EM, TPF4-610G, TPF4-610GEM, TPFM4-610GEM		
accessories for	701573		
GEV No.	701631	Ref. No.	—
description	opposite support mounting distance 119mm L 135mm W 12mm		

accessories for	700006		
GEV No.	700001	Ref. No.	531022900
description	opposite support L 118mm W 17mm mounting distance 94mm		
GEV No.	700007	Ref. No.	531022700
description	oven hinge mounting distance 173mm mounting distance 2 105mm lug mounting 14mm lever length 120mm groove distance 11mm spring thickness 3.5mm mounting ear position right spring length 112mm W 25mm		

GEV No.	700390	Ref. No.	531007302
description	oven hinge mounting distance 142mm mounting distance 2mm lug mountingmm lever lengthmm groove distance 12mm spring thickness 3mm mounting ear position spring length 116mm L 170mm mounting pos. left/right W 22mm		

GEV No.	700007	Ref. No.	531022700
description	oven hinge mounting distance 173mm mounting distance 2 105mm lug mounting 14mm lever length 120mm groove distance 11mm spring thickness 3.5mm mounting ear position right spring length 112mm W 25mm		
For models:	CF2-58G, CF2-58GE, CF2-68G, CF2-68GEM, CF3-512GEV, CF3-512GV, CF3-612GEMV, CF3-612GV, CF4-78ET, CF4-78ETX, CF4-78G, CF4-78GE, CF4-78GP, CF4-78GP-AUS, CF4-78GPE, CF4-78GP-USA, CF4-98ET, CF4-98ETX, CF4-98G, CF4-98GE, CF6-712ET, CF6-712ETV, CF6-712ET-VX, CF6-712ETX, CF6-712G, CF6-712GEV, CF6-712GP, CF6-712GPE, CF6-712GPEV, CF6-712GPV, CF6-712GPV-USA, CF6-712GV, CF6-912ET, CF6-912ETV, CF6-912GV, CF6-912GE, CF6-912GEV, CF6-912GV, CF-712GE, CF-712GPE, CF8-916ET, CF8-916ETV, CF8-916G, CF8-916GE, CF8-916GEV, CF8-916GV, CFA4-78G, CFA4-98G, CFA6-712GV...(Other models you can see in the webshop)		
accessories for	700007		
GEV No.	700001	Ref. No.	531022900
description	opposite support L 118mm W 17mm mounting distance 94mm		

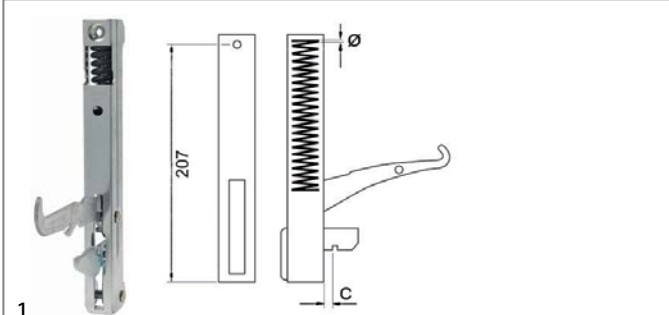

GEV No.	690037	Ref. No.	531008200
description	oven hinge mounting distance 205mm mounting distance 2mm lug mountingmm lever length 119mm groove distance 13mm spring thickness 4.3mm mounting ear position spring length 103mm L 214mm		
For models:	CF-10EM, CF-10EM-6, CF-10EM-A, CF-10ET, CF-10ET-6, CF-10ET-A, CF-10G6-A, CF-10G-6F, CF-10G-A, CF-10GEM, CF-10GEM-6, CF-10GEM6-A, CF-10GEM-A, CF-10GF, CF4-8ET, CF4-8ETS, CF4-8G, CF4-8GEM, CF4-GEMS, CF-8EM, CF-8EM-A, CF-8ET, CF-8ET-A, CF-8G-A, CF-8GEM, CF-8GEM-A, CF-8GF, CFC4-8ET, CFM-10EM, CFM-10EM-6, CFM-10EM-A, CFM-10ET, CFM-10ET-6, CFM-10ET-A, CFM-10GEM, CFM-10GEM-6, CFM-10GEM6-A, CFM-10GEM-A, CFM-8EM, CFM-8EM-A, CFM-8ET, CFM-8ET-A, CFM-8GEM, CFM-8GEM-A		

fittings for catering equipment

outlet taps

producer-specific

LOTUS



GEV No.	110704	Ref. No.	536000300
description	cone handle thread M6 ø 16mm L 25mm plastic black		



GEV No.	514006	Ref. No.	544120300
description	drain pipe L 200mm thread ø 22mm		
For models:	BM-10EM, BM-10EMX, BM-4EM, BM-4EMX, BM-4G, BM-61EM, BM-61GF, BM-62EM, BM-62ET, BM-62GF, BM-6EM, BM-6EMX, BM-6G, BM-8EM, BM-8EMX, BM-8G, BMT-63EM, BMT-64EM, BMT-64G, BMT-66EM, BMT-66G, BMT-74EM, BMT-74G, BMT-78EM, BMT-78G, BMT-94EM, BMT-94G, BMT-98EM, BMT-98G, BS-4EM, BS-4EMX, CP-61EM, CP-62ET, CP-62G, CP-6G, CPT-64EM-USA, CPT-64ET, CPT-64G, CPT-66ET, CPT-66G, CPT-74ET, CPT-74G, CPT-76ET, CPT-76G, CWK-74ET, CWK-78ET, CWK-94ET, CWK-98ET, CWKT-64ET, CWKT-68ET...(Other models you can see in the webshop)		



GEV No.	691355	Ref. No.	533009600
description	lever L 64mm for outlet tap thread M6 ET - M6 ET		
For models:	BM-61EM, BM-61GF, BM-62EM, BM-62ET, BM-62GF, BMT-63EM, BMT-64EM, BMT-64G, BMT-66EM, BMT-66G, BMT-74EM, BMT-74G, BMT-78EM, BMT-78G, BMT-94EM, BMT-94G, BMT-98EM, BMT-98G, CFA4-78G, CFA6-712GV, CP-61EM, CP-62ET, CP-62G, CPT-64EM-USA, CPT-64ET, CPT-64G, CPT-66ET, CPT-66G, CPT-74ET, CPT-74G, CPT-76ET, CPT-76G, CWK-74ET, CWK-78ET, CWK-94ET, CWK-98ET, CWKT-64ET, CWKT-68ET, CWKT-74ET, CWKT-78ET, CWKT-94ET, CWKT-98ET, F10T-63EM, F10T-63ET, F10T-63ETX, F13T-74E, F13T-74ET, F13T-74ETX, F13T-74G, F13T-94ET...(Other models you can see in the webshop)		









GEV No.	540748	Ref. No.	533027200
description	lever L 70mm for outlet tap thread M6 ET - M6 ET thread L 28/11mm		
For models:	BM-10EM, BM-10EMX, BM-4EM, BM-4EMX, BM-4G, BM-6EM, BM-6EMX, BM-6G, BM-8EM, BM-8EMX, BM-8G, BS-4EM, BS-4EMX, CP-6G, FE-10, FE2-10, FE-2-8, FE-8, FEM-2-6, FEM-6, FG-10, FG-2-10, FP-6ET, FP-6G, FPE-20, FPE-25, FPG-20, FPG-30, FQ-4EM, FQ-4ET, FQ-4ETX, FQ-4G, FQ-6EM, FQ-6ET, FQ-6ETX, FQ-6G		
accessories for	540748		
	GEV No.	540749	Ref. No. 536000300
	cone handle plastic black for outlet tap		



GEV No.	106598	Ref. No.	533010200
description	olive for pipe ø 18mm Qty 1 pcs ED ø 21mm		
For models:	BM-10EM, BM-10EMX, BM-4EM, BM-4EMX, BM-4G, BM-61EM, BM-61GF, BM-62EM, BM-62ET, BM-62GF, BM-6EM, BM-6EMX, BM-6G, BM-8EM, BM-8EMX, BM-8G, BMT-63EM, BMT-64EM, BMT-64G, BMT-66EM, BMT-66G, BMT-74EM, BMT-74G, BMT-78EM, BMT-78G, BMT-94EM, BMT-94G, BMT-98EM, BMT-98G, BS-4EM, BS-4EMX, CP-61EM, CP-62ET, CP-62G, CP-6G, CPT-64EM-USA, CPT-64ET, CPT-64G, CPT-66ET, CPT-66G, CPT-74ET, CPT-74G, CPT-76ET, CPT-76G, CWK-74ET, CWK-78ET, CWK-94ET, CWK-98ET, CWKT-64ET, CWKT-68ET...(Other models you can see in the webshop)		



			
1			
GEV No.	540259	Ref. No.	531000100
description	outlet tap without handle thread 3/4" IT		
For models:	BM-10EM, BM-10EMX, BM-4EM, BM-4EMX, BM-4G, BM-61EM, BM-61GF, BM-62EM, BM-62ET, BM-62GF, BM-6EM, BM-6EMX, BM-6G, BM-8EM, BM-8EMX, BM-8G, BMT-63EM, BMT-64EM, BMT-64G, BMT-66EM, BMT-66G, BMT-74EM, BMT-74G, BMT-78EM, BMT-78G, BMT-94EM, BMT-94G, BMT-98EM, BMT-98G, BS-4EM, BS-4EMX, CP-61EM, CP-62ET, CP-62G, CP-6G, CPT-64EM-USA, CPT-64ET, CPT-64G, CPT-66ET, CPT-66G, CPT-74ET, CPT-74G, CPT-76ET, CPT-76G, CWK-74ET, CWK-78ET, CWK-94ET, CWK-98ET, CWKT-64ET, CWKT-68ET...(Other models you can see in the webshop)		
accessories for	540259		
		GEV No.	514006
		Ref. No.	544120300
	drain pipe L 200mm thread ø 22mm		
		GEV No.	540748
		Ref. No.	533027200
	lever L 70mm for outlet tap thread M6 ET - M6 ET thread L 28/11mm		
		GEV No.	540749
		Ref. No.	536000300
	cone handle plastic black for outlet tap		
		GEV No.	540755
		Ref. No.	—
	lever for outlet tap		
		GEV No.	691355
		Ref. No.	533009600
	lever L 64mm for outlet tap thread M6 ET - M6 ET		

			
1			
GEV No.	106597	Ref. No.	533010100
description	union screw thread 3/4" for pipe ø 18mm L 20mm Qty 1 pcs WS 27		
For models:	BM-10EM, BM-10EMX, BM-4EM, BM-4EMX, BM-4G, BM-61EM, BM-61GF, BM-62EM, BM-62ET, BM-62GF, BM-6EM, BM-6EMX, BM-6G, BM-8EM, BM-8EMX, BM-8G, BMT-63EM, BMT-64EM, BMT-64G, BMT-66EM, BMT-66G, BMT-74EM, BMT-74G, BMT-78EM, BMT-78G, BMT-94EM, BMT-94G, BMT-98EM, BMT-98G, BS-4EM, BS-4EMX, CP-61EM, CP-62ET, CP-62G, CP-6G, CPT-64EM-USA, CPT-64ET, CPT-64G, CPT-66ET, CPT-66G, CPT-74ET, CPT-74G, CPT-76ET, CPT-76G, CWK-74ET, CWK-78ET, CWK-94ET, CWK-98ET, CWKT-64ET, CWKT-68ET...(Other models you can see in the webshop)		

aerators and air bleeders

			
1			
GEV No.	540825	Ref. No.	14945
description	aerator and air bleeder thread 3/8" ET WS 24 chrome-plated L 37mm		

inlet taps

			
1			
GEV No.	514048	Ref. No.	531018500
description	ball valve connection 1/2" complete total length 55mm mounting pos. any brass H 30mm L 55mm rosette ø 70mm rosette thread G2 M22x1		
For models:	CP-6G, CPM-62G, CPM-6G		
spare parts for	514048		
		GEV No.	540871
		Ref. No.	—
	lever handle cold water suitable for intake tap		

			
1			
GEV No.	514049	Ref. No.	531020800
description	ball valve connection 3/4" complete total length 66mm mounting pos. brass equiv. no. 531020800		
For models:	CP-4ET, CP-4ETX, CP-6ET, CP-6ETX		





drain taps

brass

drain taps



1

GEV No.	540275	Ref. No.	10027
description	drain tap 2" IT with union nut A 90mm B 151mm B1 80mm chrome-plated brass		
spare parts for	540275		
	GEV No.	540214	Ref. No. —
	handle ID ø 6mm L 145mm		
accessories for	540275		
	GEV No.	529484	Ref. No. —
	flat gasket fibre ED ø 58mm ID ø 50mm thickness 2mm Qty 1 pcs		
	GEV No.	542448	Ref. No. —
	gasket silicone 60x49x2 for drain tap 2"		

test taps

test taps

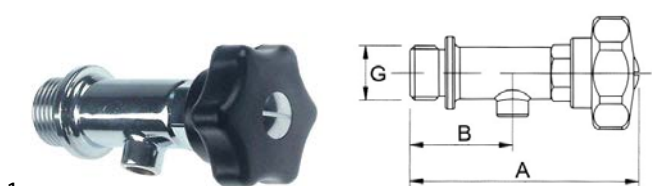

1

GEV No.	540818	Ref. No.	10044
description	test tap thread 1/2" ET W 88mm W1 38mm		

safety fittings

safety fittings



1

GEV No.	514276	Ref. No.	11032
description	safety fitting thread 3/4" 0.45bar H 165mm ø 65mm		
spare parts for	514276		
	GEV No.	514094	Ref. No. —
	angle piece thread 3/8"		
	GEV No.	514276	Ref. No. 11032
	safety fitting thread 3/4" 0.45bar H 165mm ø 65mm		
	GEV No.	540825	Ref. No. 14945
	aerator and air bleeder thread 3/8" ET WS 24 chrome-plated L 37mm		
	GEV No.	540828	Ref. No. 10023
	manometer siphon thread 3/8"		
	GEV No.	541579	Ref. No. 10022
	manometer ø 52mm pressure range 0 up to 1bar connection marking 0.5 thread 1/4"		



1









GEV No.	514275	Ref. No.	17054
description	safety fitting thread 3/4" 0.45bar with manometer and aerator/air bleeder 3.3kg H 200mm W 150mm		
spare parts for	514275		
	GEV No.	514094	Ref. No. —
	angle piece thread 3/8"		
	GEV No.	514276	Ref. No. 11032
	safety fitting thread 3/4" 0.45bar H 165mm ø 65mm		
	GEV No.	540825	Ref. No. 14945
	aerator and air bleeder thread 3/8" ET WS 24 chrome-plated L 37mm		
	GEV No.	540828	Ref. No. 10023
	manometer siphon thread 3/8"		

Table continues overleaf



spare parts for 514275			
	GEV No. 541579	Ref. No.	10022
manometer ø 52mm pressure range 0 up to 1bar connection marking 0.5 thread 1/4"			

accessories			
	1		
GEV No. 540817	Ref. No.	10014	
description fitting support thread 1/2" ET suitable for manometer			

	1		
GEV No. 540835	Ref. No.	10013	
description screw cap thread 3/4"			
spare parts for 540835			
	GEV No. 513016	Ref. No.	—
O-ring EPDM thickness 3.53mm ID ø 26.58mm Qty 1 pcs			
accessories for 540835			
	GEV No. 513016	Ref. No.	—
O-ring EPDM thickness 3.53mm ID ø 26.58mm Qty 1 pcs			

	1		
GEV No. 540828	Ref. No.	10023	
description manometer siphon thread 3/8"			

equipment feet and end caps

equipment feet

with screw mounting

	1		
GEV No. 690038	Ref. No.	531008100	
description equipment foot tube ø 42mm thread M10 thread L 14mm H 85-140mm chrome-plated steel size 1 1/2" Qty 1 pcs			
For models: A-60, A-90, AF-1, AF-2, AF-3, BA-62, BA-80, BAL-62, BAL-80, BC1-45, BC2-45, BC-30, BC3-45, BC-45, BP-120, BP-135, BP-30DX, BP-30SX, BP-45DX, BP-45SX, BP-60, BP-90, BPL-120, BPL-135, BPL-45DX, BPL-45SX, BPL-60, BPL-90, CF-10EM, CF-10EM-6, CF-10EM-A, CF-10ET, CF-10ET-6, CF-10ET-A, CF-10G6-A, CF-10G6-6, CF-10G-A, CF-10GEM, CF-10GEM-6, CF-10GEM6-A, CF-10GEM-A, CF-10GF, CF-62EM, CF-62EM-A, CF-62ET, CF-62ET-A, CF-62GEM, CF-62GEM-A, CF-8EM, CF-8EM-A...(Other models you can see in the webshop)			

baskets

fryer baskets

LOTUS			
	1		
GEV No. 970165	Ref. No.	531000600	
description fryer basket L1 230mm W1 130mm H1 110mm			
For models: FEC-4			

	1		
GEV No. 970199	Ref. No.	531005700	
description fryer basket L1 250mm W1 200mm H1 96mm L2 350mm H2 132mm H3 195mm chrome-plated steel plastic			
For models: FQ-61GF, FQ-62GF			

	1		
GEV No. 970166	Ref. No.	531000700	
description fryer basket L1 270mm W1 200mm H1 110mm chrome-plated steel			
For models: FE-2-8, FE-8, FEM-2-6, FEM-6, FQ-61EM, FQ-61ET, FQ-62EM, FQ-62ET			

	1		
GEV No. 970327	Ref. No.	531020000	
description fryer basket L1 270mm W1 200mm H1 95mm			
For models: FQ-4EM, FQ-4ET, FQ-4ETX, FQ-6EM, FQ-6ET, FQ-6ETX			

	1		
GEV No. 970167	Ref. No.	531000800	
description fryer basket L1 270mm W1 260mm H1 110mm			
For models: FE-10, FE2-10, FME-10, FME-2-10			

	1		
GEV No. 970417	Ref. No.	531041300	
description fryer basket L1 290mm W1 280mm H1 150mm			
For models: F18-74ET, F18-74ETX, F18-94ET, F18-94ETX, F18D-64ET, F2-18-74ET, F2-18-74ETX, F2-18-78ET, F2-18-78ETX, F2-18-98ET, F2-18-98ETX, F2-25-98ET, F2-25-98ETX, F25-94ET, F25-94ETX			

pasta baskets

LOTUS

			
1			
GEV No.	970329	Ref. No.	531024100
description	fryer basket L1 300mm W1 200mm H1 100mm L2 375mm H2 162mm H3 240mm chrome-plated steel		
For models:	F10D-64ET, F10D-64ETX, F10T-63EM, F10T-63ET, F10T-63ETX, F2-10D-66ET, F2-10D-66ETX, F2-10T-66EM, F2-10T-66ET, F2-10T-66ETX, FQ-4EM, FQ-4ET, FQ-4ETX, FQ-4G, FQ-61EM, FQ-61ET, FQ-62EM, FQ-62ET, FQ-6EM, FQ-6ET, FQ-6ETX, FQ-6G		

			
1			
GEV No.	970169	Ref. No.	531013300
description	fryer basket L1 300mm W1 210mm H1 120mm		
For models:	F13-64EM, F13-64ET, F13-74ET, F13-74ETX, F13-74G, F18-74G, F2-13-78ET, F2-13-78ETX, F2-13-78G, FG-10, FG-2-10, FMG-10, FMG-2-10		

			
1			
GEV No.	970273	Ref. No.	531013400
description	fryer basket L1 330mm W1 300mm H1 120mm chrome-plated steel		
For models:	F18-74ET, F18-74G, F2-18-78ET, F2-18-78G, FME-15, FME-2-15, FMG-15, FMG-2-15, FQM-4G		

			
1			
GEV No.	970418	Ref. No.	531041700
description	fryer basket L1 450mm W1 135mm H1 150mm		
For models:	F18-94ET, F18-94ETX, F2-18-98ET, F2-18-98ETX, F2-25-98ET, F2-25-98ETX, F2-25-98G, F25-94ET, F25-94ETX, F25-94G		

			
1			
GEV No.	970630	Ref. No.	531017500
description	fryer basket L1 470mm W1 350mm H1 80mm L2 95mm H2 135mm H3 223mm		
For models:	FMPE-20, FMPG-20, FPE-20, FPG-20		

			
1			
GEV No.	971161	Ref. No.	531049300
description	fryer basket W1 197mm L1 235mm H1 90mm L2 460mm H2 115mm H3 180mm holder length 100mm		
For models:	F2-8T-66G, F8T-63G		

			
1			
GEV No.	970847	Ref. No.	531032600
description	pasta basket H1 200mm W1 100mm L1 140mm size 1/6 L2 190mm H2 220mm H3 420mm stainless steel		

			
1			
GEV No.	970259	Ref. No.	531032600 old
description	pasta basket L1 105mm W1 145mm H1 200mm H3 410mm stainless steel		

			
1			
GEV No.	970203	Ref. No.	531001600
description	pasta basket L1 140mm W1 100mm H1 140mm H3 253mm stainless steel		
For models:	CP-61EM, CP-62ET		

1

GEV No.	970907	Ref. No.	531048000
description	pasta basket L1 160mm W1 135mm H1 215mm H3 385mm stainless steel		



1

GEV No.	970789	Ref. No.	531032500
description	pasta basket L1 160mm W1 140mm H1 200mm H3 410mm stainless steel		



1

GEV No.	970209	Ref. No.	531032500
description	pasta basket L1 160mm W1 145mm H1 200mm H3 410mm stainless steel		



1

GEV No.	970585	Ref. No.	531004000
description	pasta basket L1 280mm W1 100mm H1 135mm L2 470mm H2 160mm H3 200mm stainless steel		
For models:	CP-61EM, CP-62ET		



1

GEV No.	970586	Ref. No.	531003900
description	pasta basket L1 280mm W1 200mm H1 135mm stainless steel		
For models:	CP-61EM, CP-62ET		



1

GEV No.	970258	Ref. No.	531024500
description	pasta basket L1 290mm W1 145mm H1 110mm H3 210mm stainless steel		
For models:	CP-6G		



1

GEV No.	970201	Ref. No.	531018800
description	pasta basket L1 290mm W1 150mm H1 150mm stainless steel		
For models:	CP-4ET, CP-4ETX, CP-6ET, CP-6ETX		



1

GEV No.	970200	Ref. No.	531017900
description	pasta basket L1 290mm W1 160mm H1 200mm stainless steel		
For models:	CPM-62G, CPM-6G		



1

GEV No.	970303	Ref. No.	531032400
description	pasta basket L1 320mm W1 145mm H1 200mm H3 315mm stainless steel		

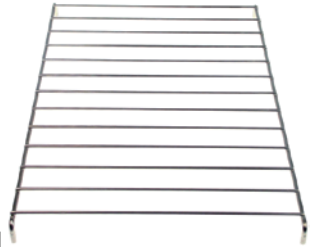

1

GEV No.	970131	Ref. No.	531004300
description	chargrill grid L 510mm W 320mm H 30mm		
For models:	CP-62ET		

crumb screens



1

GEV No.	970274	Ref. No.	531006100
description	crumb screen L 297mm W 140mm		
For models:	FE-2-8, FE-8, FEM-2-6, FEM-6, FQ-61EM, FQ-61ET, FQ-62EM, FQ-62ET		



1

GEV No.	970275	Ref. No.	531006200
description	crumb screen L 340mm W 180mm		
For models:	FE-10, FE2-10, FME-10, FME-2-10		



1

GEV No.	970276	Ref. No.	531006300
description	crumb screen L 405mm W 185mm		
For models:	FME-15, FME-2-15		

gaskets

gaskets for heated units

door seals

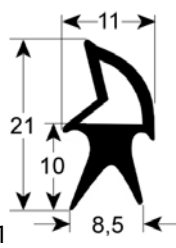

1

GEV No.	902399	Ref. No.	536011402
description	door seal L 1610mm		
For models:	CF-62EM, CF-62EM-A, CF-62ET, CF-62ET-A, CF-62GEM, CF-62GEM-A, CFC-62EM, CFC-62ET, CFM4-66ET, CFM4-66GEM, CFM4-66ET, MFM-68EM		

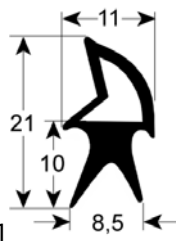

1

GEV No.	902400	Ref. No.	536011301
description	door seal L 1980mm		
For models:	CF-10EM, CF-10EM-6, CF-10EM-A, CF-10ET, CF-10ET-6, CF-10ET-A, CF-10G6-A, CF-10G-6F, CF-10G-A, CF-10GEM, CF-10GEM-6, CF-10GEM6-A, CF-10GEM-A, CF-10GF, CF4-68ET, CF4-68ETX, CF4-68G, CF4-68GEM, CF4-8ET, CF4-8ETS, CF4-8G, CF4-8GEM, CF4-GEMS, CF6-610ET, CF6-610ETX, CF6-610G, CF6-610GEM, CF-8EM, CF-8EM-A, CF-8ET, CF-8ET-A, CF-8G-A, CF-8GEM, CF-8GEM-A, CF-8GF, CFC4-8ET, CFM-10EM, CFM-10EM-6, CFM-10EM-A, CFM-10ET, CFM-10ET-6, CFM-10ET-A, CFM-10GEM, CFM-10GEM-6, CFM-10GEM6-A, CFM-10GEM-A, CFM2-68GEM, CFM3-612GEMV, CFM4-68ET, CFM4-68GEM...(Other models you can see in the webshop)		

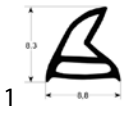

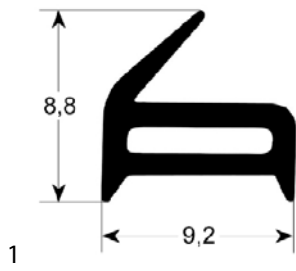

GEV No.	900066	Ref. No.	536011300
description	door seal profile 2910 W 340mm L 530mm Qty 1		
For models:	CF-10EM, CF-10EM-6, CF-10EM-A, CF-10ET, CF-10ET-6, CF-10ET-A, CF-10G6-A, CF-10G-6F, CF-10G-A, CF-10GEM, CF-10GEM-6, CF-10GEM6-A, CF-10GEM-A, CF-10GF, CF4-8ET, CF4-8ETS, CF4-8G, CF4-8GEM, CF4-GEMS, CF-8EM, CF-8EM-A, CF-8ET, CF-8ET-A, CF-8G-A, CF-8GEM, CF-8GEM-A, CF-8GF, CFC4-8ET, CFM-10EM, CFM-10EM-6, CFM-10EM-A, CFM-10ET, CFM-10ET-6, CFM-10ET-A, CFM-10GEM, CFM-10GEM-6, CFM-10GEM6-A, CFM-10GEM-A, CFM-8EM, CFM-8EM-A, CFM-8ET, CFM-8ET-A, CFM-8GEM, CFM-8GEM-A		

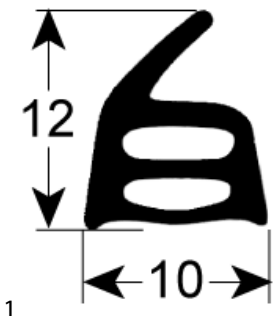

GEV No.	900245	Ref. No.	536010900 536010901
description	oven gasket profile 2915 L 1010mm W 325mm with 8 mounting clips 3-sided (long side open) Qty 1 external size		
For models:	CF6-712ET, CF6-712ETX, CF6-712G, CF6-712GP, CF6-712GPE, CF6-912ET, CF6-912G, CF6-912GE, CF-712GE, CF-712GPE, CF8-916ETV, CF8-916GEV, CF8-916GV, CFQ6-712ET, CFQ6-712ETX, CFQ6-912ET, CFQ8-916ETV, CFV6-912ET, CFVQ6-912ET, TPF2-712G, TPF2-712GP, TPF2-712GPE, TPF2-912G, TPF2-912GE, TPF4-712GP, TPF4-712GPE, TPF4-912G, TPF4-912GE		

door seals with fixing hook



GEV No.	900238	Ref. No.	536010800 536010801
description	door seal L 650mm W 340mm with 6 mounting clips 3-sided (long side open)		
For models:	CF2-58G, CF2-58GE, CF2-68G, CF2-68GEM, CF3-512GEV, CF3-512GV, CF3-612GEMV, CF3-612GV, CF4-78ET, CF4-78ETX, CF4-78G, CF4-78GE, CF4-78GP, CF4-78GP-AUS, CF4-78GPE, CF4-78GP-USA, CF4-98ET, CF4-98ETX, CF4-98G, CF4-98GE, CF6-712ETV, CF6-712ETVX, CF6-712GEV, CF6-712GPEV, CF6-712GPV, CF6-712GPV-USA, CF6-712GV, CF6-912ETV, CF6-912ETVX, CF6-912GEV, CF6-912GV, CF8-916ET, CF8-916G, CF8-916GE, CFA4-78G, CFA4-98G, CFA6-912GV, CFC4-78ET, CFC4-78ETX, CFC4-98ET, CFPB6-79G, CFPB6-79GEM, CFQ4-78ET, CFQ4-78ETX, CFQ4-98ET, CFQ4-98ETX, CFQ6-712ETV, CFQ6-712ETVX, CFQ6-912ETV, CFQ6-912ETVX...(Other models you can see in the webshop)		

O-rings

EPDM

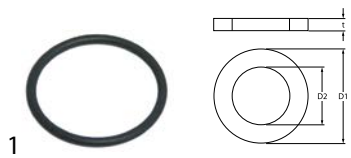

GEV No.	100809	Ref. No.	536000500
description	O-ring EPDM thickness 2mm ID ø 21mm Qty 1 pcs		
For models:	BM-61GF, BM-62GF, CP-62G, CPM-62G, FG-10, FG-2-10, FMG-10, FMG-15, FMG-2-10, FMG-2-15, FMPG-20, FMPG-30, FP-62G, FPG-20, FPG-30, FQ-61GF, FQ-62GF, FQM-4G, FTL-61G, FTL-61GS, FTL-62G, FTL-62GS, FTL-63G, FTL-63GS, FTL-64G, FTL-64GS, FTLR-62G, FTLR-62GS, FTLR-63G, FTLR-63GS, FTLR-64G, FTLR-64GS, FTR-61G, FTR-61GS, FTR-62G, FTR-62GS, K-10, K-10S, K-12, K-12S, K-14, K-14S, K-15, K-15S, K-16, K-16S, K-18, K-18S, K-20, K-20S...(Other models you can see in the webshop)		



GEV No.	902401	Ref. No.	75R0003
description	oven gasket L 470mm W 380mm 4-sided with 8 mounting clips		

silicone

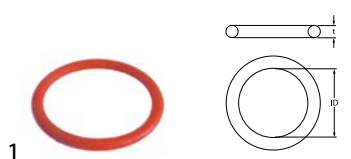

GEV No.	532484	Ref. No.	536009700
description	O-ring silicone thickness 2.62mm ID ø 37.77mm Qty 1 pcs		
For models:	CP-74ET, CP-74ETX, CP-78ET, CP-78ETX, CP-94ET, CP-94ETX, CP-98ET, CP-98ETX, CPB-98ET, CPD-64ET		



GEV No.	902402	Ref. No.	536035600
description	oven gasket L 680mm W 360mm 4-sided with 8 mounting clips		
For models:	CFQ8-916ETV, CFV4-78ET, CFV4-78GPE, CFV4-98ET, CFV4-98GE, CFV6-712ETV, CFV6-712GPEV, CFV6-912ETV, CFVC4-78ET, CFVC4-98ET, CFVPB6-79GEM, CFVQ4-78ET, CFVQ4-98ET, CFVQ6-712ETV, CFVQ6-912ETV, TPFV2-712GPEV, TPFV2-78GPE, TPFV2-912GEV, TPFV2-98GE, TPFV4-712GPEV, TPFV4-912GEV, TPFV-78ET, TPFV-78GE, TPFV-98ET, TPFV-98GE		

Viton



GEV No.	550494	Ref. No.	536009800
description	O-ring Viton thickness 3.53mm ID ø 47.22mm Qty 1 pcs		
For models:	CP-66ET, CP-74ET, CP-76ET, CP-78ET, CP-94ET, CP-98ET, CPD-64ET, F10D-64ET, F10D-64ETX, F10T-63EM, F10T-63ET, F10T-63ETX, F13-64EM, F13-64ET, F13-64ETX, F13-74ET, F13-74ETX, F13-74ETX, F13T-74E, F13T-74ET, F13T-74ETX, F13T-94ET, F13T-94ETX, F18-74ET, F18-74ETX, F18-74ETX, F18-94ET, F18-94ETX, F18D-64ET, F2-10D-66ET, F2-10D-66ETX, F2-10T-66EM, F2-10T-66ET, F2-10T-66ETX, F2-13-78ET, F2-13-78ETX, F2-13-78ETX, F2-13-98ET, F2-13T-78E, F2-13T-78ET, F2-18-74ET, F2-18-74ETX, F2-18-78ET, F2-18-78ETX, F2-18-98ET, F2-18-98ETX, F2-25-98ET, F2-25-98ETX, F25-94ET, F25-94ETX, F2-8-74ET, F2-8-94ET, F2-8D-64ET, F2-8T-74ET, F2-8T-74ETX...(Other models you can see in the webshop)		

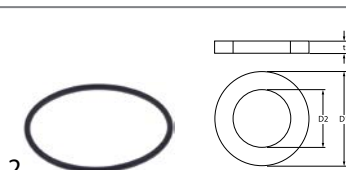

GEV No.	532725	Ref. No.	536026700
description	O-ring Viton thickness 3.53mm ID ø 74.61mm Qty 1 pcs		
For models:	CP-66ET, CP-74ET, CP-76ET, CP-78ET, CP-94ET, CP-98ET, F10D-64ET, F10D-64ETX, F10T-63EM, F10T-63ET, F10T-63ETX, F13-64EM, F13-64ET, F13-64ETX, F13-74ET, F13-74ETX, F13T-74E, F13T-74ET, F13T-74ETX, F13T-94ET, F18-74ET, F18-74ETX, F18-94ET, F18-94ETX, F18D-64ET, F2-10D-66ET, F2-10D-66ETX, F2-10T-66EM, F2-10T-66ET, F2-10T-66ETX, F2-13-78ET, F2-13-78ETX, F2-13-98ET, F2-13T-78E, F2-13T-78ET, F2-18-74ET, F2-18-74ETX, F2-18-78ET, F2-18-78ETX, F2-18-98ET, F2-18-98ETX, F2-25-98ET, F2-25-98ETX, F25-94ET, F25-94ETX, F2-8-74ET, F2-8-94ET, F2-8D-64ET, F2-8T-74ET, F2-8T-74ETX, F2-8T-94ET...(Other models you can see in the webshop)		

sealing washers

fibre gaskets



GEV No.	693077	Ref. No.	536012600
description	flat gasket FIBER ED ø 24mm ID ø 17mm thickness 1.5mm Qty 1 pcs		
For models:	BM-74EM, BM-74ET, BM-74G, BM-78EM, BM-78ET, BM-78G, BM-94EM, BM-94G, BM-98EM, BM-98G, CP-66ET, CP-66G, CP-74ET, CP-74G, CP-76ET, CP-76G, CP-78ET, CP-78G, CP-94ET, CP-94G, CP-98ET, CP-98G, CPB-98ET, CPB-98G		

manometers



GEV No.	541579	Ref. No.	10022
description	manometer ø 52mm pressure range 0 up to 1bar connection marking 0.5 thread 1/4"		

fittings, hose and pipe connectors

fittings

miscellaneous



GEV No.	693078	Ref. No.	533070700
description	connecting fitting		
For models:	BM-74EM, BM-74ET, BM-74G, BM-78EM, BM-78ET, BM-78G, BM-94EM, BM-94G, BM-98EM, BM-98G, CP-66ET, CP-66G, CP-74ET, CP-74G, CP-76ET, CP-76G, CP-78ET, CP-78G, CP-94ET, CP-94G, CP-98ET, CP-98G, CPB-98ET, CPB-98G		

valves and tank inlets

ball valves

universal

ball valves with lever handle



GEV No.	520285	Ref. No.	531018600
description	ball valve connection 1" IT - 1" ET DN25 total length 74mm with lever handle handle length 105mm		
For models:	BM-74EM, BM-74G, BM-78EM, BM-78G, BM-94EM, BM-94G, BM-98EM, BM-98G, BMD-64EM, BMD-84EM, CP-66ET, CP-66G, CP-74ET, CP-74ET-USA, CP-74ETX, CP-74G, CP-74G-AUS, CP-74G-USA, CP-76ET, CP-76G, CP-78, CP-78ET, CP-78ET-USA, CP-78ETX, CP-78G, CP-78G-AUS, CP-78G-USA, CP-94ET, CP-94ET-USA, CP-94ETX, CP-94G, CP-94G-USA, CP-98ET, CP-98ET-USA, CP-98ETX, CP-98G, CP-98G-USA, CPA-66ET, CPA-66G, CPA-74ET, CPA-74G, CPA-76ET, CPA-76G, CPA-78ET, CPA-78G, CPA-94ET, CPA-94G, CPA-98ET, CPA-98G, CPB-98ET...(Other models you can see in the webshop)		





1







GEV No.	540750	Ref. No.	531001000
description	ball valve connection 3/4" IT - hose ø22mm with lever handle handle length 95mm		
For models:	BM-74EM, BM-74ET, BM-74G, BM-78EM, BM-78ET, BM-78G, F10D-64ET, F10D-64ETX, F13-74ET, F13-74G, F18-74ET, F18-74G, F2-10D-66ET, F2-10D-66ETX, F2-13-78ET, F2-13-78G, F2-18-78ET, F2-18-78G, FME-10, FME-15, FME-2-10, FME-2-15, FMG-10, FMG-15, FMG-2-10, FMG-2-15, FMPE-20, FMPE-25, FMPE-30, FMPG-20, FMPG-30, FQM-4G		

shut-off valves

universal



1

GEV No.	693107	Ref. No.	30200008	
description	shut-off valve connection 1/2" 1/2" cold total length 54mm L1 27mm L2 30mm marking blue rosette thread G2 26x19G connection ø M4x0.7 ITmm			
spare parts for	693107			
	GEV No.	514085	Ref. No.	—
	rosette connection 26x19G chrome-plated total lengthmm mounting pos.			
	GEV No.	514086	Ref. No.	—
	hexagonal nut connection 26x19G brass total lengthmm mounting pos. H 6mm WS 34 Qty 1 pcs			
	GEV No.	540672	Ref. No.	—
	gasket suitable for tap head			
	GEV No.	547711	Ref. No.	—
	hood handle shaft intake ø 8mm marking blue metal H2 21mm D1 ø 33mm type D suitable for MONOLITH shaft length H1 8mm			
	GEV No.	548168	Ref. No.	—
	star handle connection hot total lengthmm mounting pos. ø 57mm marking red			
	GEV No.	548169	Ref. No.	—
	star handle connection cold total lengthmm mounting pos. chrome-plated ø 57mm			
accessories for	693107			
	GEV No.	514086	Ref. No.	—
	hexagonal nut connection 26x19G brass total lengthmm mounting pos. H 6mm WS 34 Qty 1 pcs			

producer-specific

LOTUS



1

GEV No.	541770	Ref. No.	531037600
description	shut-off valve connection 1/2" 1/2" cold total length 50mm mounting pos. left rosette thread G2 26x18G		
For models:	BM-74EM, BM-74G, BM-78EM, BM-78G, BM-94EM, BM-94G, BM-98EM, BM-98G, CP-66ET, CP-66G, CP-74ET, CP-74ET-USA, CP-74ETX, CP-74G, CP-74G-AUS, CP-74G-USA, CP-76ET, CP-76G, CP-78, CP-78ET, CP-78ET-USA, CP-78ETX, CP-78G, CP-78G-AUS, CP-78G-USA, CP-94ET, CP-94ET-USA, CP-94ETX, CP-94G, CP-98ET, CP-98ET-USA, CP-98ETX, CP-98G, CPA-74ET, CPA-74G, CPA-76ET, CPA-76G, CPA-78ET, CPA-78G, CPA-94ET, CPA-94G, CPA-98ET, CPA-98G, CPB-98ET, CPB-98G, CPBA-98ET, CPBA-98G, CPP-94G, CPP-94G-USA, CPT-74ET...(Other models you can see in the webshop)		

fastening material

nuts

hexagonal nuts

hexagonal nuts metric (without norm)



1

GEV No.	102067	Ref. No.	533009800
description	nut thread M8x1 H 3mm brass Qty 1 pcs type SEF 1		
For models:	CF-10G6-A, CF-10G-6F, CF-10G-A, CF-10GEM, CF-10GEM-6, CF-10GEM6-A, CF-10GEM-A, CF-10GF, CF4-78G, CF4-78GE, CF4-8G, CF4-8GEM, CF4-GEMS, CF-62GEM, CF-62GEM-A, CF6-712G, CF6-712GEV, CF6-712GV, CF-712GE, CF-8G-A, CF-8GEM, CF-8GEM-A, CF-8GF, CFM-10GEM, CFM-10GEM-6, CFM-10GEM6-A, CFM-10GEM-A, CFM-8GEM, CFM-8GEM-A, F-1G, FB-1G, FO-1G, FO-2G, FO-3G, FOS-1G, FOS-2G, FOS-3G, PC-12G, PC-4G, PC-61GF, PC-62GF, PC-712G, PC-716G, PC-74G, PC-78G, PC-8G, TP2-712G, TPF2-712G, TPF2-712GV		

A			
audible timers	28	heating elements for salamanders/toasters	12
B		heating elements for tilting bratt pan	9
ball valves	106	hexagonal nuts	107
bar burners	76	hob burners	58
bi-metal thermostats	17	hot air fans	31
C		hot air motors	30
cam switches	23	hot plates	15
ceramic heaters	13	I	
contactors	28	ignition cables	54
control thermostats	17	ignition switches	55
D		ignition units	55
door seals	104	immersion heating elements	13
door seals with fixing hook	105	indicator lights	25
E		indicator lights (complete)	25
electric accessories	31	L	
electric timers	28	lamps	25
energy regulators	17	light bulbs	26
F		M	
fans	30	magnetic switches	25
fastening material	107	mechanical timers	28
fittings	106	microswitches	23
foil heating elements	15	N	
G		nuts	107
gas burners	58	O	
gas control valves	45	O-rings	105
gas nozzles	81	oven hinges	95
gas taps	31	oven lamps	27
gas thermostats	37	P	
gaskets for heated units	104	piezoelectric igniters	54
H		pilot burners	46
halogen lamp	26	pressure switches	30
heating cartridges	12	probes	29
heating elements	3	push/momentary push switches	23
heating elements for bain maries	4	R	
heating elements for charginills	11	radiation heaters	14
heating elements for convection	13	residual heat indicators	27
heating elements for fryers	5	rocker/momentary rocker switches	22
heating elements for frying pans	5	S	
heating elements for griddles	8	safety bi-metal thermostats	17
heating elements for heating bridges	12	safety thermostats	20
heating elements for ovens	3	sealing washers	106
heating elements for pasta cookers	9	shut-off valves	107
heating elements for pizza ovens	10	solenoid valves	29
heating elements for rechauds	11	solid top burners	80
		switches and momentary switches	22

T

terminals	31
thermocouples	56
thermostats	17
timers	28
tube burners	80

V

valves and tank inlets	106
------------------------	-----