



GAS COMPONENTS



ELECTRIC COMPONENTS



WATER TECHNOLOGY



MECHANICAL COMPONENTS



TOOLS

Spare parts suitable for

MBM-ITALIEN

Find the complete and up-to-date range of products in our GEV Webshop



Manufacturer catalogue

The most important spare parts and accessories arranged clearly for every manufacturer

- ✓ Complete product range and all appliance data always up to date in the GEV Webshop
- ✓ Alphabetical Index at the end of the catalogue

GEV Webshop

www.gev-online.co.uk

www.gev-online.com

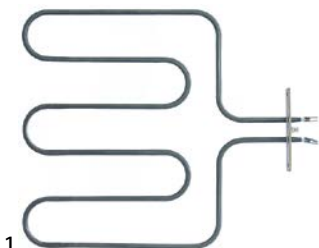


- 🔍 Add to Favourites
- 🔍 Sign In with email address and usual password
- 🔍 Easy-order – place several items in your basket at the same time
- 🔍 Quick item search – no login needed

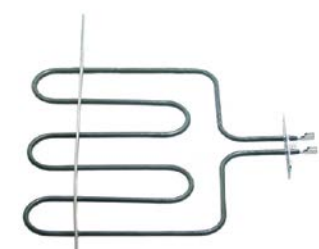


heating elements


heating elements for ovens




GEV No.	416541	Ref. No.	3997001700 RIC0002548
description	heating element 1500W 230V heating circuits 1 L 350mm W 510mm L1 40mm L2 305mm W1 233mm W2 30mm flange length 100mm flange width 22mm hole distance 86mm hole ø 5mm tube ø 6.6mm connection male faston 6.3mm windings 3 rectangular flange dry heating element oven grill settin		
For models:	E6F6, G6SF6, G6SFE6, MINIMA E6F6, MINIMA G6SF6, MINIMA G6SFE6, MINIMA G6SFEA6		



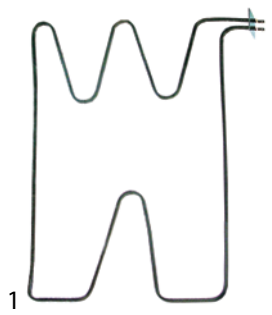
GEV No.	418495	Ref. No.	9303350400 RIC0001836
description	heating element 1800W 230V heating circuits 1 L 320mm W 287mm L1 78mm L2 242mm W1 127mm W2 30mm flange length 100mm flange width 22mm hole distance 86mm bridge length 480mm hole ø 5mm tube ø 6.3mm connection male faston 6.3mm connection length 35mm windings 3 rectangular flange dry heating element oven grill settin		
For models:	E4F6, E6FA6, G4SF6, G4SFA6, G4SFE6, G6SFA6, G6SFEA6, MINIMA E4F6, MINIMA E6FA6, MINIMA G4SF6, MINIMA G4SFE6, MINIMA G6SFA6		




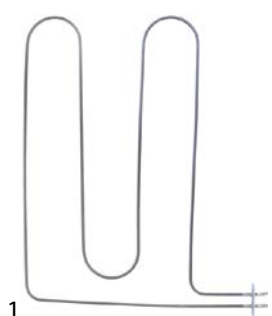
GEV No.	418492	Ref. No.	160237
description	heating element 2000W 230V L 521mm W 133mm L1 43mm L2 478mm W1 50mm W2 33mm flange length 70mm flange width 22mm hole distance 56/28mm hole ø 5mm tube ø 8.5mm connection M4 rectangular flange dry heating element		
For models:	EBM90, EBM908, EBM998T, EBM99T, EBMA998		



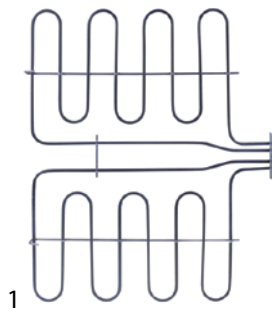
GEV No.	418493	Ref. No.	160085
description	heating element 2500W 230V heating circuits 1 L 418mm W 133mm L1 41mm L2 477mm W1 50mm W2 33mm flange length 70mm flange width 22mm hole distance 56/28mm hole ø 5mm tube ø 8.5mm connection M4 rectangular flange dry heating element		
For models:	EBM408, EBM45, EBM498T, EBM49T, EBMA498		



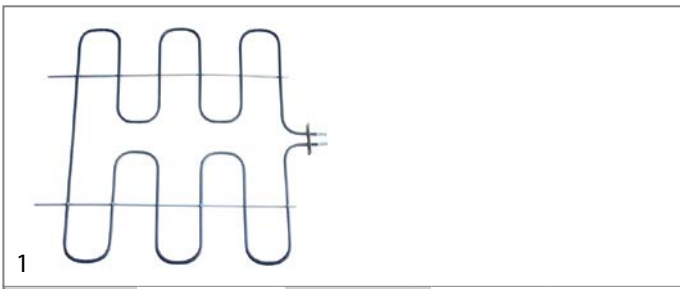
GEV No.	418148	Ref. No.	RTCU900186
description	heating element 2500W 230V L 530mm W 615mm L1 88mm L2 437mm W1 585mm W2 30mm flange length 70mm flange width 22mm hole distance 28mm hole ø M4mm tube ø 6.3mm connection M4 heating circuits 1 rectangular flange dry heating element		
For models:	E4F, E6FAR, G4SFE, G6SFEA, G8SF2, G8SF2E, GT2SDFE, GT2SFEA, GTFE		
accessories for	418148		
	GEV No.	510368	Ref. No. —
	gasket L 70mm W 23.5mm hole ø 5mm hole distance 56mm FIBER thickness 2mm for heating element		




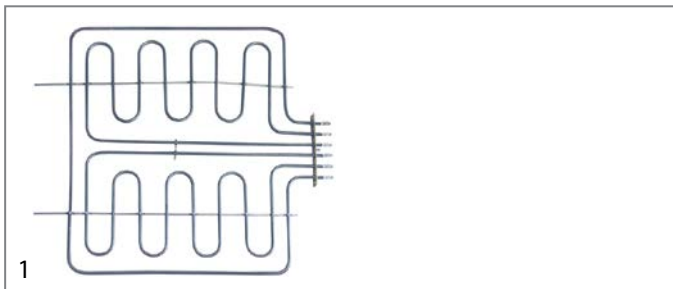
GEV No.	418632	Ref. No.	RTCU900435
description	heating element 2500W 240V L 470mm W 600mm L1 125mm W2 32mm flange length 70mm flange width 22mm hole distance 56mm hole ø 5mm dry heating element oven		
For models:	E6FM, E6FM8, G6SF98MG, G6SFMG8		



GEV No.	418490	Ref. No.	161662 182701
description	heating element 3000W 230V heating circuits 2 L 505mm W 645mm L1 82mm L2 423mm W1 293mm W2 60mm flange length 100mm flange width 22mm hole distance 86mm hole ø 5mm tube ø 6.3mm connection M4 rectangular flange oven heating element		
For models:	E4F, E4F8, E4F9, E4F98Q, E4F9Q, E4FP8, E6FA, E6FA8, E6FA9, E6FA98Q, E6FA9Q, EF09, EFB09, G4SFE8, G4SFE9, G4SFE98, G6SFEA, G6SFEA8, G6SFEA9, G6SFEA98		

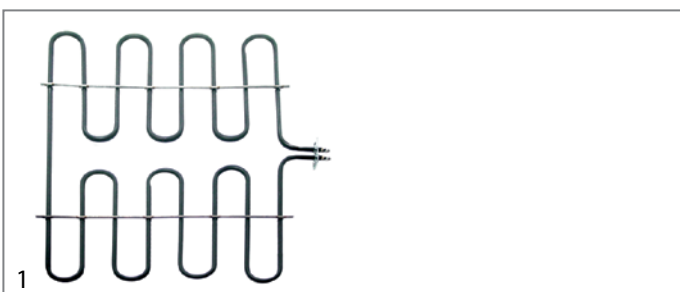



GEV No.	416543	Ref. No.	RTCU700281
description	heating element 3200W 230V heating circuits 1 L 510mm W 526mm L1 53mm L2 457mm W1 248mm W2 31mm flange length 70mm flange width 22mm bridge length 535mm hole distance 56mm hole ø 5mm tube ø 6.5mm connection M4 connection length 38mm windings 6 mounting pos. lower rectangular flange dry heating element oven		
For models:	E4F7, E4F7Q, E6FA7, E6FA7Q, EF07, EFO7, EVC4F7, G2SDMFE7, G2SMFE7, G4SFE7, G6SFEA7, GT4SF2E7, OMNIA E4F7, OMNIA E4F7Q, OMNIA E6FA7, OMNIA E6FA7Q, OMNIA EF07, OMNIA EVC4F7, OMNIA G4SFE7, OMNIA G6SFEA7		
accessories for	416543		
	GEV No.	510368	Ref. No. —
	gasket L 70mm W 23.5mm hole ø 5mm hole distance 56mm FIBER thickness 2mm for heating element		

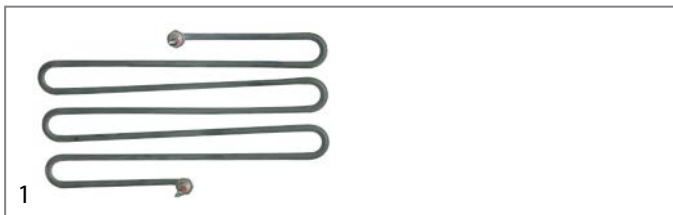


GEV No.	416542	Ref. No.	RTCU700282
description	heating element 3950W 230/400V heating circuits 3 L 510mm W 548mm L1 52mm L2 455mm W1 210mm W2 127mm flange length 160mm flange width 22mm hole distance 145mm hole ø 6mm tube ø 6.3mm connection M4 mounting pos. upper rectangular flange dry heating element oven		
For models:	E4F7, E4F7Q, E6FA7, E6FA7Q, EF07, EFO7, EVC4F7, G2SDMFE7, G2SMFE7, G4SFE7, G6SFEA7, GT4SF2E7, OMNIA E4F7, OMNIA E4F7Q, OMNIA E6FA7, OMNIA E6FA7Q, OMNIA EF07, OMNIA EVC4F7, OMNIA G4SFE7, OMNIA G6SFEA7		

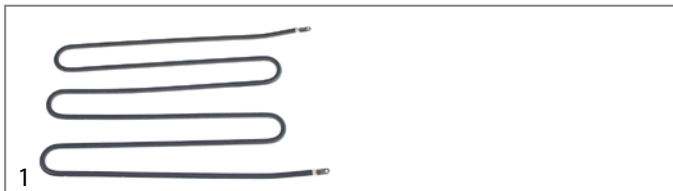
heating elements for bain maries



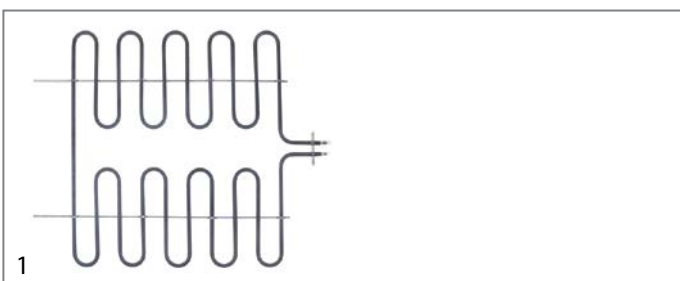
GEV No.	418491	Ref. No.	161661
description	heating element 3750W 230V heating circuits 1 L 505mm W 642mm L1 72mm L2 430mm W1 305mm W2 33mm flange length 70mm flange width 22mm bridge length 460mm hole distance 56mm hole ø 5mm tube ø 8.5mm connection M4 windings 8 rectangular flange oven heating element		
For models:	E4F, E4F8, E4F9, E4F98Q, E4F9Q, E4FP8, E6FA, E6FA8, E6FA9, E6FA98Q, E6FA9Q, EF09, EFB09, G4SFE, G4SFE8, G4SFE9, G4SFE98, G6SFEA, G6SFEA8, G6SFEA9, G6SFEA98		
accessories for	418491		
	GEV No.	510368	Ref. No. —
	gasket L 70mm W 23.5mm hole ø 5mm hole distance 56mm FIBER thickness 2mm for heating element		



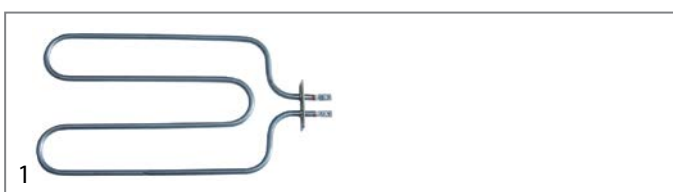
GEV No.	416194	Ref. No.	53.7.0048.00
description	heating element 1189W 230V heating circuits 1 L 278mm W 150mm connection male faston 6.3mm tube ø 6.3mm 2 hole fixing thread 1/8" immersion heater/dry heating element L1 135mm L2 143mm H 22mm mounting distance 144mm		
For models:	6BM61EM		



GEV No.	418344	Ref. No.	3710003
description	heating element 1200W 220V heating circuits 1 L 395mm W 220mm H 24mm connection M4 tube ø 8mm dry heating element L1 50mm L2 345mm connection distance 212mm		
For models:	BC2G, BC3G, BC4G, BC6G		





GEV No.	419146	Ref. No.	167379
description	heating element 3800W 240V heating circuits 1 L 510mm W 505mm L1 55mm L2 450mm W1 235mm W2 35mm flange length 70mm flange width 22mm bridge length 85mm hole distance 28mm thread M4 tube ø 8.5mm connection M4 connection length 40mm windings 5 rectangular flange dry heating element oven		
For models:	E4F77, E4F77Q, E4FP77Q, E6FA77, E6FA77Q, EF077, ETF77, EVC4F77, G4SFE77, G4SFE77P, G6SFEA77, GT4SF2E77, HE4F77, MG7E4F77, MG7E4F77Q, MG7E4FP77Q, MG7E6FA77Q, MG7ETF77, MG7EVC4F77, MG7G4SFE77, MG7G6SFEA77		





GEV No.	416554	Ref. No.	RTCU700280
description	heating element 1500W 230V heating circuits 1 L 355mm W 203mm flange length 70mm flange width 22mm hole distance 56mm connection M4 tube ø 8.5mm rectangular flange hole ø 5mm dry heating element L1 40mm L2 315mm W1 85mm W2 33mm		
For models:	EBM46, EBM47, EBM477, EBM66, EBM77, EBM777, EBMA477, EBMA777, MG7EBMA477, MG7EBMA777, MINIMA EBM 46, MINIMA EBM 66, OMNIA EBM 47, OMNIA EBM 77		

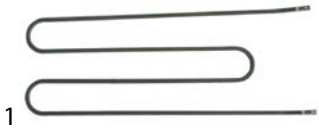


			
GEV No.	416556	Ref. No.	RTBF900068
description	heating element 1500W 230V L 570mm W 90mm connection M4 connection distance 81mm connection length 24mm tube ø 8.9mm dry heating element H 68mm		
For models:	EBM90, EFT45L, EFT45LC, EFT45R, EFT45RC, EFT90L, EFT90LC, EFT90LR, EFT90LRC, EFT90R, EFT90RC		


			
GEV No.	416555	Ref. No.	RTBE800038
description	heating element 2000W 240V heating circuits 1 L 570mm W 92mm connection M4 connection distance 77mm tube ø 8.5mm dry heating element H 65mm		
For models:	EFT99L, EFT99LC, EFT99LR, EFT99LRC, EFT99R, EFT99RC		

			
GEV No.	418471	Ref. No.	RTFOC00584
description	heating element 600W 230V heating circuits 1 L 355mm W 215mm flange length 70mm flange width 22mm hole distance 56mm connection male faston 6.3mm tube ø 8.5mm rectangular flange hole ø 5.5mm dry heating element L1 38mm L2 317mm W1 91mm W2 33mm		

			
GEV No.	415772	Ref. No.	53.7.0042.00
description	heating element 823W 230V L 276mm W 108mm H 20mm 2 hole fixing connection male faston 6.3mm thread M10x1 tube ø 6.3mm connection length 22mm dry heating element		
For models:	6BM61EM, 6BM62EM, 6BM62ET, 6BS61EM, 6BS62EM, 6CP61EM, 6CP62ET		

			
GEV No.	416032	Ref. No.	013448-00 013448-00R
description	heating element 850W 230V heating circuits 1 L 430mm L1 30mm W 145mm connection M4 connection distance 140mm tube ø 6.5mm dry heating element bain marie L2 400mm H 16mm		

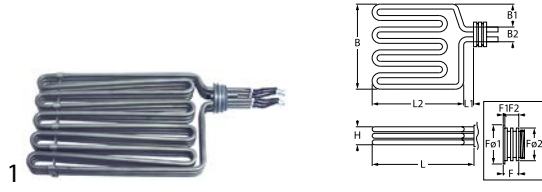




heating elements for frying pans

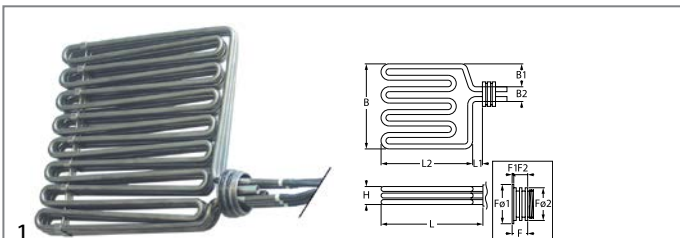
			
GEV No.	416550	Ref. No.	RTCU600125
description	heating element 1500W 230V heating circuits 1 L 350mm W 155mm hole distance 141mm connection length 23mm connection M4 tube ø 8.6mm bracket mounting hole ø M5mm dry heating element L1 148mm L2 158mm H 30mm lug length 40mm lug width 18mm		
For models:	EBR6, MINIMA EBR 6		



heating elements for fryers

off-center connection

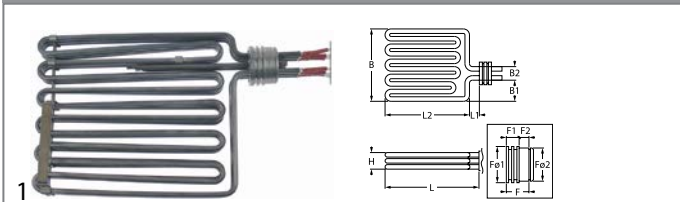
with thread




			
GEV No.	416070	Ref. No.	RTBF700101
description	heating element 10200W 230/400V heating circuits 3 L 300mm W 180mm H 33mm flange length 19.5mm flange length 1 9.5mm flange length 2 9.8mm flange ø1 62mm flange ø2 57mm thermostat sleeves ø 6.5mm sensor screw connection 2x M10x1 thermostat sleeve upper/lower L1 18mm L2 282mm W1 30mm W2 35mm thread M54x1.5 windings 5 tube ø 8.5mm cable length 450mm rotation flange immersion heater fryer connection length 130mm 2		
For models:	FE 15		
spare parts for	416070		
	GEV No.	510243	Ref. No. RTBF800321 RTCU700565
	GEV No.	550496	Ref. No. —
accessories for	416070		
	GEV No.	510243	Ref. No. RTBF800321 RTCU700565
	GEV No.	550662	Ref. No. —
			ring nut thread M54x1.5 H 7mm

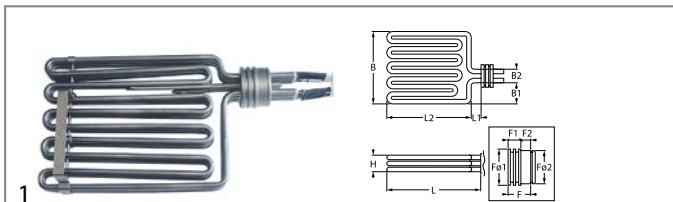





GEV No.	416560	Ref. No.	RTBF800318
description	heating element 15000W 230/400V heating circuits 3 mounting pos. left L 300mm W 290mm H 34mm flange length 19.5mm flange length 1 9.5mm flange length 2 10mm flange ø1 62mm flange ø2 57mm thermostat sleeves ø 6.5mm sensor screw connection 2x M10x1 thermostat sleeve upper/lower L1 15mm L2 285mm W1 38mm W2 35mm thread M54x1.5 windings 8 tube ø 8.5mm cable length 450mm rotation flange immersion heater fryer connection length 90mm 2		
For models:	EF45, EF90		
accessories for	416560		
	GEV No.	510243	Ref. No. RTBF800321 RTCU700565
	O-ring Viton thickness 3.53mm ID ø 55.56mm Qty 1 pcs		
	GEV No.	550662	Ref. No. —
	ring nut thread M54x1.5 H 7mm		

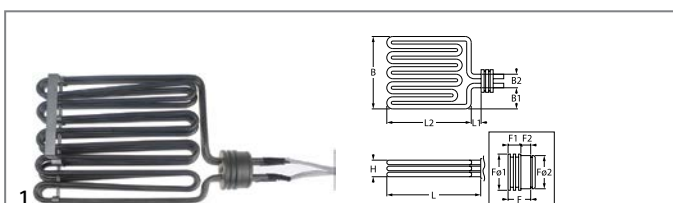
with retaining rings






GEV No.	418494	Ref. No.	160035 166412 180953 RIC0003816
description	heating element 16000W 230/400V heating circuits 3 mounting pos. left L 336mm W 252mm H 31mm flange length 1 23.5mm flange length 2 13.2mm flange ø1 61.8mm flange ø2 57.9mm thermostat sleeves ø 9mm thermostat sleeve upper/lower windings 6 L1 15mm L2 321mm W1 34mm W2 62mm tube ø 8.5mm cable length 465mm rotation flange immersion heater with accessories fryer connection length 65mm 2 sensor screw connection 2x M10x1		
For models:	EF408, EF45, EF49, EF498, EF498T, EF49T, EF90, EF908, EF99, EF998, EF998T, EF99T		
accessories for	418494		
	GEV No.	510243	Ref. No. RTBF800321 RTCU700565
	O-ring Viton thickness 3.53mm ID ø 55.56mm Qty 1 pcs		
	GEV No.	510244	Ref. No. RTMIN00283
	retaining ring shaft ø 60mm thickness 2mm steel DIN 471		
	GEV No.	551117	Ref. No. PACU701198
	plug conical ø 6.2/8mm L 37.5mm for probe rubber		



GEV No.	418544	Ref. No.	180950 RIC0003795 RTCU700570
description	heating element 9000W 230/400V heating circuits 3 mounting pos. left L 285mm W 205mm H 35mm flange length 1 23.5mm flange length 2 12.5mm flange ø1 61.8mm flange ø2 57.9mm thermostat sleeves ø 9mm thermostat sleeve upper/lower windings 5 L1 265mm L2 20mm W1 169mm W2 36mm tube ø 8.5mm cable length 350mm rotation flange immersion heater fryer connection length 60mm 2 sensor screw connection 2x M10x1		
For models:	EF47, EF477, EF477T, EF47T, EF77, EF777, EF777T, EF77T, MG7EF477, MG7EF477T, MG7EF777, MG7EF777T, OMNIA EF 47, OMNIA EF 47T, OMNIA EF 77, OMNIA EF 77T		
accessories for	418544		
	GEV No.	510243	Ref. No. RTBF800321 RTCU700565
	O-ring Viton thickness 3.53mm ID ø 55.56mm Qty 1 pcs		
	GEV No.	510244	Ref. No. RTMIN00283
	retaining ring shaft ø 60mm thickness 2mm steel DIN 471		
	GEV No.	551117	Ref. No. PACU701198
	plug conical ø 6.2/8mm L 37.5mm for probe rubber		



GEV No.	418628	Ref. No.	RIC0003794
description	heating element 9000W 230/400V heating circuits 3 mounting pos. right L 285mm W 205mm H 35mm flange length 1 23.5mm flange length 2 13.2mm flange ø1 61.8mm flange ø2 57.9mm thermostat sleeves ø 9mm thermostat sleeve upper/lower windings 5 L1 20mm L2 265mm W1 37mm W2 36mm tube ø 8.5mm cable length 360mm rotation flange connection length 70mm 2 sensor screw connection 2x M10x1		
accessories for	418628		
	GEV No.	504790	Ref. No. 165587
	extension for thermowell thread M10x1 L 75mm hole ø 6.5mm brass		
	GEV No.	510243	Ref. No. RTBF800321 RTCU700565
	O-ring Viton thickness 3.53mm ID ø 55.56mm Qty 1 pcs		
	GEV No.	510244	Ref. No. RTMIN00283
	retaining ring shaft ø 60mm thickness 2mm steel DIN 471		



GEV No.	416558	Ref. No.	166410
description	heating element 9000W 230V heating circuits 3 mounting pos. left windings 5		
For models:	EF477, EF477T, EF777, EF777T		
accessories for	416558		
	GEV No.	510243	Ref. No. RTBF800321 RTCU700565
	O-ring Viton thickness 3.53mm ID ø 55.56mm Qty 1 pcs		
	GEV No.	510244	Ref. No. RTMIN00283
	retaining ring shaft ø 60mm thickness 2mm steel DIN 471		

GEV No.	416557	Ref. No.	166409 180951 RTCU600122
description	heating element 9000W 230V heating circuits 3 mounting pos. right L 290mm W 202mm H 35mm thermostat sleeves ø M10mm number of thermostat sleeves 2 windings 5 L1 18mm L2 272mm W1 32mm W2 35mm tube ø 8.5mm cable length 375mm rotation flange immersion heater connection length 65mm		
For models:	EF46, EF66, MINIMA EF 46, MINIMA EF 66		
accessories for	416557		
	GEV No.	510243	Ref. No. RTBF800321 RTCU700565
	O-ring Viton thickness 3.53mm ID ø 55.56mm Qty 1 pcs		
	GEV No.	510244	Ref. No. RTMIN00283
	retaining ring shaft ø 60mm thickness 2mm steel DIN 471		
	GEV No.	551117	Ref. No. PACU701198
	plug conical ø 6.2/8mm L 37.5mm for probe rubber		




center connection			
GEV No.	416559	Ref. No.	180952 RIC0003796 RTCU700592
description	heating element 5250W 230/400V heating circuits 3 L 285mm W 115mm H 33mm flange length 36mm flange length 1 23.2mm flange length 2 13mm flange ø1 61.8mm flange ø2 57.8mm thermostat sleeves ø 10mm sensor screw connection 2x M10x1 number of thermostat sleeves 2 thermostat sleeve upper/lower L1 15mm L2 270mm W1 40mm W2 35mm tube ø 8.5mm cable length 320mm rotation flange immersion heater fryer connection length 75mm		
For models:	EF472V, EF472VT, EF4772V, EF4772VT, EF4982V, MG7EF4772V, MG7EF4772VT, OMNIA EF472V, OMNIA EF472VT		
accessories for	416559		
	GEV No.	510243	Ref. No. RTBF800321 RTCU700565
	O-ring Viton thickness 3.53mm ID ø 55.56mm Qty 1 pcs		
	GEV No.	510244	Ref. No. RTMIN00283
	retaining ring shaft ø 60mm thickness 2mm steel DIN 471		

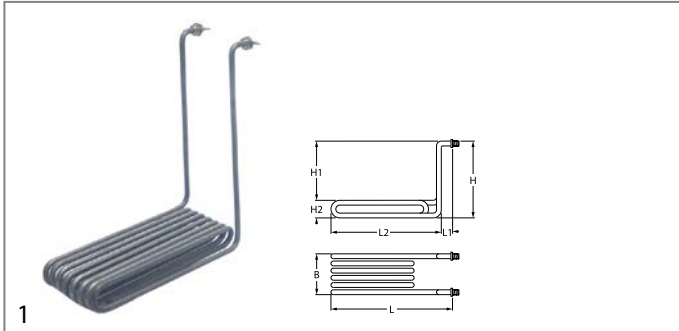
GEV No.	416506	Ref. No.	230072 RTCU600235
description	heating element 6600W 230/400V heating circuits 3 L 342mm W 127mm H 230mm rectangular flange connection M4 fryer heaters L1 15mm L2 327mm H1 25mm H2 167mm H3 38mm windings 6 hole distance 72mm hole ø 6mm flange length 160mm flange width 22mm tube ø 8.5mm		







2 hole fixing			
GEV No.	416648	Ref. No.	53.7.0033.00
description	heating element 3000W 230V heating circuits 1 L 315mm W 185mm H 180mm L1 28mm L2 277mm thread 1/4" mounting distance 174mm tube ø 8.5mm windings 6 2 hole fixing connection male faston 6.3mm fryer heaters		
For models:	6FQ61E, 6FQ62E		
accessories for	416648		
	GEV No.	361182	Ref. No. —
	nut thread 1/4" H 5mm nickel-plated brass WS 17 Qty 1 pcs		

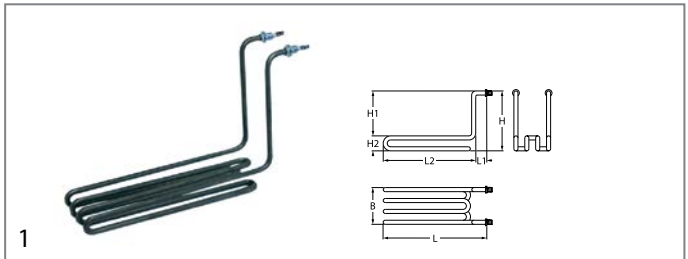
Table continues overleaf







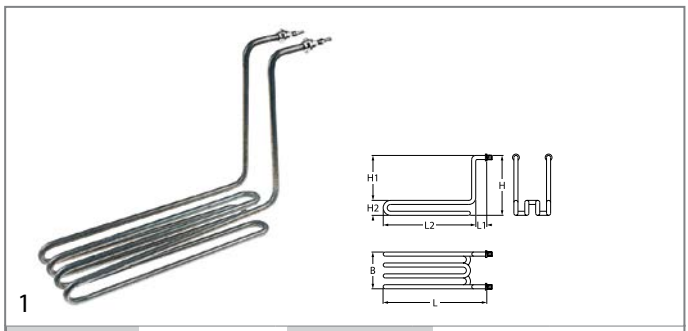
accessories for 416648			
	GEV No.	510417	Ref. No. 437002
flat gasket fibre ED \varnothing 20mm ID \varnothing 14mm thickness 2mm Qty 1 pcs			
	GEV No.	520228	Ref. No. —
tooth lock washer ID \varnothing 15.3mm ED \varnothing 24mm steel Qty 1 pcs for thread M14			
	GEV No.	550262	Ref. No. —
flat gasket copper ED \varnothing 20mm ID \varnothing 14mm thickness 2mm			








GEV No.	418497	Ref. No.	RTBF800162
description	heating element 5500W 230V heating circuits 1 L 318mm W 104mm H 315mm L1 24mm L2 294mm H1 270mm H2 45mm thread 1/4" tube \varnothing 8.5mm 2 hole fixing connection M5 windings 8 fryer		
For models:	EF45, EF90		
accessories for 418497			
	GEV No.	361182	Ref. No. —
nut thread 1/4" H 5mm nickel-plated brass WS 17 Qty 1 pcs			
	GEV No.	510417	Ref. No. 437002
flat gasket fibre ED \varnothing 20mm ID \varnothing 14mm thickness 2mm Qty 1 pcs			
	GEV No.	520228	Ref. No. —
tooth lock washer ID \varnothing 15.3mm ED \varnothing 24mm steel Qty 1 pcs for thread M14			
	GEV No.	550262	Ref. No. —
flat gasket copper ED \varnothing 20mm ID \varnothing 14mm thickness 2mm			
	GEV No.	560112	Ref. No. —
plain washer ID \varnothing 5.3mm ED \varnothing 10mm thickness 1mm SS Qty 20 pcs DIN 125A for thread M5			
	GEV No.	560132	Ref. No. —
hexagonal nut thread M5 H 4mm WS 8 SS DIN/ISO DIN 934 / ISO 4032/8673 Qty 20 pcs			



GEV No.	415704	Ref. No.	53.7.0035.00
description	heating element 1800W 230V heating circuits 1 L 310mm W 60mm H 200mm L1 30mm L2 280mm H1 160mm H2 40mm thread M12x1 mounting distance 50mm tube \varnothing 8.5mm 2 hole fixing connection male faston 6.3mm fryer windings 4		
For models:	6FQ61E, 6FQ62E		
spare parts for 415704			
	GEV No.	521110	Ref. No. —
flat gasket fibre ED \varnothing 20mm ID \varnothing 13mm thickness 2mm Qty 1 pcs			
accessories for 415704			
	GEV No.	520229	Ref. No. —
nut thread M12x1 H 4mm WS 16 zinc-coated steel Qty 1 pcs			
	GEV No.	521131	Ref. No. —
nut thread M12x1 H 3.5mm WS 17 SS Qty 1 pcs			
	GEV No.	528110	Ref. No. —
O-ring EPDM thickness 2.62mm ID \varnothing 12.37mm Qty 1 pcs			



GEV No.	416891	Ref. No.	161879 180580
description	heating element 3000W 230V heating circuits 1 L 362mm W 65mm H 240mm L1 57mm L2 305mm H1 192mm H2 48mm thread 1/4" tube \varnothing 8.5mm 2 hole fixing connection M5 fryer heaters windings 4		
For models:	EF12+12B, EF12+12S, EF12B, EF12S, EF20BP, EF60BP		
spare parts for 416891			
	GEV No.	510417	Ref. No. 437002
flat gasket fibre ED \varnothing 20mm ID \varnothing 14mm thickness 2mm Qty 1 pcs			
accessories for 416891			
	GEV No.	501318	Ref. No. —
nut thread 1/4" H 6.5mm SS WS 22 Qty 1 pcs			
	GEV No.	503045	Ref. No. —
nut thread 1/4" H 4.5mm brass WS 17 Qty 1 pcs			
	GEV No.	560112	Ref. No. —
plain washer ID \varnothing 5.3mm ED \varnothing 10mm thickness 1mm SS Qty 20 pcs DIN 125A for thread M5			
	GEV No.	560132	Ref. No. —
hexagonal nut thread M5 H 4mm WS 8 SS DIN/ISO DIN 934 / ISO 4032/8673 Qty 20 pcs			



6 hole fixing



GEV No.	418908	Ref. No.	164717
description	heating element 9000W 230V heating circuits 3 L 350mm W 228mm H 237mm L1 50mm L2 300mm H1 197mm H2 40mm thread 1/4" mounting distance 6 hole fixingmm tube ø 8.5mm connection M5 connection length 25mm immersion heater fryer		
For models:	EF12+12B, EF12+12S, EF12B, EF12S, EF25+25S		


GEV No.	416556	Ref. No.	RTBF900068
description	heating element 1500W 230V L 570mm W 90mm connection M4 connection distance 81mm connection length 24mm tube ø 8.9mm dry heating element H 68mm		
For models:	EBM90, EFT45L, EFT45LC, EFT45R, EFT45RC, EFT90L, EFT90LC, EFT90LR, EFT90LRC, EFT90R, EFT90RC		

heating elements for griddles



GEV No.	415703	Ref. No.	53.7.0051.00
description	heating element 1000W 230V heating circuits 1 L 333mm W 80mm H 64mm tube ø 6.3mm W1 20mm W2 51mm connection male faston 6.3mm connection length 19mm dry heating element		
For models:	6FT61E, 6FT62E		

GEV No.	416555	Ref. No.	RTBE800038
description	heating element 2000W 240V heating circuits 1 L 570mm W 92mm connection M4 connection distance 77mm tube ø 8.5mm dry heating element H 65mm		
For models:	EFT99L, EFT99LC, EFT99LR, EFT99LRC, EFT99R, EFT99RC		

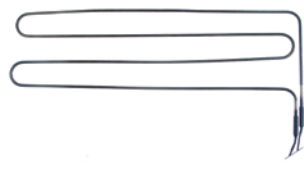
 <p>Image not available</p>			
GEV No.	416645	Ref. No.	53.7.0041.00
description	heating element 2653W 230V heating circuits 1 warming plate		
For models:	6FT61E, 6FT62E		



GEV No.	416544	Ref. No.	RTCU600183
description	heating element 1250W 240V heating circuits 1 L 416mm W 70mm H 65mm tube ø 8.5mm connection M4 connection distance 53mm dry heating element		
For models:	EFT46L, EFT46LC, EFT46R, EFT46RC, EFT66L, EFT66LC, EFT66LR, EFT66LRC, EFT66R, EFT66RC, MINIMA EFT 46L, MINIMA EFT 46LC, MINIMA EFT 46R, MINIMA EFT 46RC, MINIMA EFT 66L, MINIMA EFT 66LC, MINIMA EFT 66LR, MINIMA EFT 66LRC, MINIMA EFT 66R, MINIMA EFT 66RC, MINIMA EFT106L, MINIMA EFT106LC, MINIMA EFT106LR, MINIMA EFT106LRC		

heating elements for refrigeration

heating elements for defrosting




GEV No.	416313	Ref. No.	01152700R
description	heating element 1100W 230V L 277mm W 630mm L1 54mm L2 223mm W1 40mm W2 590mm cable length 1500mm tube ø 6.3mm dry heating element defrosting		

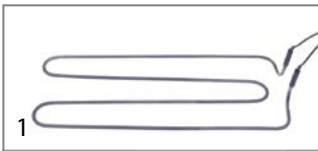


GEV No.	416547	Ref. No.	RTCU700278
description	heating element 1350W 230V heating circuits 1 L 450mm W 82mm H 64mm tube ø 8.5mm connection male faston 6.3mm connection length 19mm connection distance 80mm dry heating element		
For models:	EFT477L, EFT477LC, EFT477R, EFT477RC, EFT47L, EFT47LC, EFT47R, EFT47RC, EFT777L, EFT777LC, EFT777LR, EFT777LRC, EFT777R, EFT777RC, EFT77L, EFT77LC, EFT77LR, EFT77LRC, EFT77R, EFT77RC, EFTA477L, EFTA477LC, EFTA477R, EFTA477RC, EFTA777L, EFTA777LC, EFTA777LR, EFTA777LRC, EFTA777R, EFTA777RC, MG7EFT477L, MG7EFT477LC, MG7EFT477R, MG7EFT477RC, MG7EFT777L, MG7EFT777LC, MG7EFT777LR, MG7EFT777LRC, MG7EFT777R, MG7EFTA477L, MG7EFTA477LC, MG7EFTA477R, MG7EFTA477RC, MG7EFTA777L, MG7EFTA777LC, MG7EFTA777LR, MG7EFTA777LRC, MG7EFTA777R, OMNIA EFT 47L, OMNIA EFT 47LC, OMNIA EFT 47R, OMNIA EFT 47RC...(Other models you can see in the webshop)		

GEV No.	416312	Ref. No.	011526-00 011526-00R 011526-01 011526-01R RIC0002969
description	heating element 550W 230V L 420mm W 210mm L1 26mm L2 394mm W1 45mm W2 165mm cable length 1500mm tube ø 6.3mm immersion heater defrosting connection cable suitable for DEXION		
For models:	D70DN2, D70DNB2		




GEV No.	416418	Ref. No.	01447401R 022258-01R
description	heating element 550W 230V L 440mm W 160mm H 60mm W1 85mm W2 42mm cable length 1500mm tube ø 6.3mm connection length 40mm immersion heater defrosting		

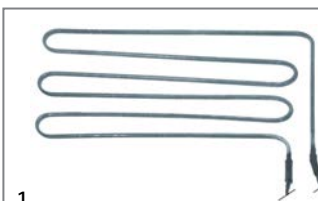


GEV No.	420338	Ref. No.	022258-02R
description	heating element 550W 230V L 440mm W 180mm H 80mm W1 60mm W2 60mm connection Faston 6.3mm cable length 1500mm tube ø 6.25mm immersion heater with thermal fuse switch-off temp. 72°C		

heating elements for condensate evaporation

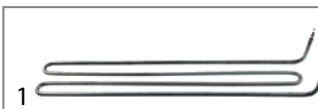


GEV No.	416374	Ref. No.	019430-02R RIC0003315
description	heating element 135W 230V L 480mm W 115mm H mm cable length 2200mm tube ø 6.25mm		



GEV No.	420393	Ref. No.	019014-00
description	heating element 750W 230V L 425mm W 350mm for blast chiller suitable for DEXION		

heating elements for tilting bratt pan






GEV No.	417335	Ref. No.	RTBF800026
description	heating element 1500W 240V L 500mm W 90mm H 70mm connection M4 dry heating element heating circuits 1 tube ø 8.5mm		
For models:	EBR, EBRA, EBRAVI, EBRVI		




GEV No.	417333	Ref. No.	RTCU700646
description	heating element 3000W 240V L 400mm W 200mm H 65mm connection M4 dry heating element heating circuits 1 tube ø 8.5mm connection distance 192mm		
For models:	EBR7, EBR77, EBRI7, EBRI77, MG7EBR77, MG7EBRI77, OMNIA EBR7, OMNIA EBRI7		
accessories for	417333		
	GEV No.	527169	Ref. No. —
	hexagonal nut thread M3 H 2.8mm WS 5.5 brass Qty 1 pcs		
	GEV No.	560110	Ref. No. —
	plain washer ID ø 3.2mm ED ø 7mm thickness 0.5mm SS Qty 20 pcs DIN 125A for thread M3		
	GEV No.	560130	Ref. No. —
	hexagonal nut thread M3 H 2.4mm WS 5.5 SS DIN/ISO DIN 934 / ISO 4032/8673 Qty 20 pcs		

heating elements for pasta cookers



GEV No.	416552	Ref. No.	RTCU700283
description	heating element 1850W 230V L 284mm W 48mm H 28mm 2 hole fixing connection M4 thread M16x1.5 tube ø 8.5mm L1 40mm L2 248mm mounting distance 40mm connection length 26mm pasta cooker immersion heater		
For models:	EC47, EC477, EC477-SC, EC77, LX7EC4, MG7EC477-SC, OMNIA EC 47		
spare parts for	416552		
	GEV No.	521137	Ref. No. —
	flat gasket fibre ED ø 20mm ID ø 18mm thickness 1.5mm for thread 3/8" Qty 1 pcs		
accessories for	416552		
	GEV No.	361183	Ref. No. —
	nut thread 3/8" H 6mm nickel-plated brass WS 20 Qty 1 pcs		










GEV No.	415701	Ref. No.	53.7.0049.00
description	heating element 2000W 230V L 276mm W 140mm H 20mm 2 hole fixing connection male faston 6.3mm thread M10x1 tube ø 6.5mm W1 140mm mounting distance 133mm immersion heater		
For models:	6CP61EM, 6CP62ET		
accessories for	415701		
	GEV No.	510416	Ref. No. —
	flat gasket fibre ED ø 19mm ID ø 10.5mm thickness 1.5mm for thread M10 Qty 1 pcs		
	GEV No.	510893	Ref. No. 456015
	O-ring EPDM thickness 2.62mm ID ø 9.92mm Qty 1 pcs		


Table continues overleaf




accessories for	415701		
	GEV No.	520231	Ref. No. —
	nut thread M10x1 H 6mm WS 14 zinc-coated steel Qty 1 pcs		
	GEV No.	521129	Ref. No. —
	nut thread M10 H 6mm SS WS 17 Qty 1 pcs DIN/ISO DIN 439		

	GEV No.	416551	Ref. No.	RTCU700284
description	heating element 3000W 230V L 264mm W 58mm H 28mm 2 hole fixing connection M4 thread M16x1.5 tube ø 8.5mm L1 38mm L2 227mm mounting distance 50mm connection length 26mm pasta cooker immersion heater			
For models:	EC47, EC66, EC77, EC777, EC777-SC, EC777T, MG7EC777-SC, MINIMA EC 66, OMNIA EC 77			


	GEV No.	416553	Ref. No.	RTCU800342
description	heating element 3000W 230V L 440mm W 50mm H 26mm 2 hole fixing connection M4 thread M16x1.5 tube ø 8.5mm L1 30mm L2 410mm mounting distance 38mm pasta cooker immersion heater			
For models:	EC408-SC, EC45, EC49, EC498-SC, EC498T-SC, EC49T, EC902V, EC9082V-SC, EC992V, EC992VT, EC9982V-SC, EC9982VT-SC			
accessories for	416553			
	GEV No.	504618	Ref. No.	3600035 RIC0004173 RTCU700623
	O-ring EPDM thickness 2.62mm ID ø 15.54mm Qty 1 pcs			

	GEV No.	415772	Ref. No.	53.7.0042.00
description	heating element 823W 230V L 276mm W 108mm H 20mm 2 hole fixing connection male faston 6.3mm thread M10x1 tube ø 6.3mm connection length 22mm dry heating element			
For models:	6BM61EM, 6BM62EM, 6BM62ET, 6BS61EM, 6BS62EM, 6CP61EM, 6CP62ET			


heating elements for chargrills

	GEV No.	416549	Ref. No.	RTCU600153
description	heating element 1500W 230V L 439mm W 79mm H 34mm 2 hole fixing mounting distance 64mm connection M4 L1 24mm L2 415mm heating circuits 1 tube ø 8.5mm dry heating element thread M12x1 chargrill			
For models:	EPL46, EPL66, MINIMA EPL 46, MINIMA EPL 66			

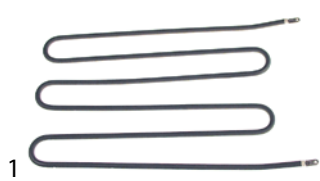
heating elements for salamanders/toast-

	GEV No.	416654	Ref. No.	RIC0002488
description	heating element 2000W 230V L 230mm W 230mm L1 22mm L2 208mm W1 83mm W2 63mm hole distance 96mm tube ø 8.5mm flange length 106mm flange width 32mm heating circuits 1 hole ø 5mm tilt flange dry heating element H 8.5mm			

heating elements for heating bridges

	GEV No.	416523	Ref. No.	53.7.0044.00
description	heating element 320W 230V L 316mm W 96mm connection male faston 6.3mm tube ø 6.3mm 2 hole fixing thread M12x1.5 dry heating element heated bridge mounting distance 90mm chip scuttle			
For models:	5RI61EM, 5RI62EM			


heating elements for heated cabinets

	GEV No.	418344	Ref. No.	3710003
description	heating element 1200W 220V heating circuits 1 L 395mm W 220mm H 24mm connection M4 tube ø 8mm dry heating element L1 50mm L2 345mm connection distance 212mm			
For models:	BC2G, BC3G, BC4G, BC6G			


heating cables


connection on both sides

with wire end ferrules

	GEV No.	416310	Ref. No.	00-556093 011524-00 011524-00R RIC0003828
description	heating cable 20W 230V L 6190mm L1 (unheated) 800mm L2 (heated) 4590mm silicone ø 3mm			
For models:	A140N2, AX140N2, B140N2, B250xxx, B400xxx, B550xxx, BX1420N2, BX250xxx, BX400xxx, BX550xxx, D140DN2, D140DNB2, D140DNP2, D140DNP3, D140N2, D140N2V, D140P2, D70N1, D70N1V, D70P1, T25TNJ, T35TNJL			




			
GEV No.	416311	Ref. No.	011525-00 011525-00R RIC0003840
description	heating cable 46W 230V 50Hz L 7560mm L1 (unheated) 800mm L2 (heated) 5960mm silicone door frame heating ø 3mm connection terminal		

with male fastons			
			
GEV No.	418755	Ref. No.	SAG000025
description	heating cable 80W 220V ø 3mm connection male faston 6.3mm cable length 5250mm		


ceramic heaters

245x60mm			
			
GEV No.	415104	Ref. No.	RTCU600117
description	ceramic emitter 1000W 230V cable beaded cord L 245mm W 60mm H 35mm		
For models:	ECC46, MINIMA ECC 46		
spare parts for	415104		
	GEV No.	415109	Ref. No. —
	spring clip		
accessories for	415104		
	GEV No.	415110	Ref. No. —
	reflector L 245mm W 95mm H 31mm thickness 0.75mm hole ø 15x40mm		



contact heaters

			
GEV No.	416237	Ref. No.	999206
description	contact heater 1400W 230V heating circuits 1 L 133mm W 120mm H 10mm dishwasher connection soldering connection connection distance 76mm connection length 37mm heat-conducting paste included hole ø 7mm dry heating element		
For models:	LF56, LF60, LFD50, LFDX50, LS520-CRP, LS521, LS521-CRP-SP		

coil heating elements

			
GEV No.	420330	Ref. No.	927132 DRE2
description	heating element 2000W 240V L 454mm W 210mm ø 27.5mm thread M14x1 connection M4 for drying warewashing heating circuits 1 2 hole fixing		
For models:	LT121, LT151, LT152, LT161, LT202, LT221, LT271, LT272, LT362, LT81, LT91, LTD101, LTD131, LTD171, LTD212, LTDX172, LTDX222, LTDX272		

immersion heating elements

3 hole flange ø38.5mm			
			
GEV No.	418642	Ref. No.	230113
description	heating element 2600W 230V mounting ø 38.5mm heating circuits 1 L 260mm W 33mm H 24mm number of thermostat sleeves 1 thermostat sleeves ø 7mm length thermostat sleeves 175mm thermostat sleeve eccentric, non clinging tube ø 6.5mm hole distance 57mm 3 hole flange connection male faston 6.3mm immersion heater		
For models:	KLB40, LB350, LB355, LB400, LB405, LB411, LB411A, LB422, LB425, LB450		
accessories for	418642		
	GEV No.	532577	Ref. No. —
	O-ring EPDM thickness 5.34mm ID ø 40.65mm Qty 1 pcs		

3 hole flange ø47.5mm









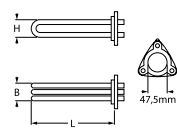



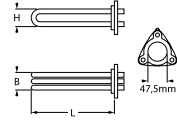


			
GEV No.	415001	Ref. No.	230081 REB230081
description	heating element 4500W 230V mounting ø 47.5mm heating circuits 3 L 316mm W 35mm H 34mm number of thermostat sleeves 1 thermostat sleeves ø 7mm length thermostat sleeves 180mm thermostat sleeve eccentric, non clinging tube ø 6.3mm hole distance 62mm hole ø 8mm connection M4 3 hole flange immersion heater		
For models:	BETA50, BETA53, LF55, LF550, LF551, LF55E, LF59, LK1000		
spare parts for	415001		
	GEV No.	510408	Ref. No. 456002 456079 REB456002
	O-ring EPDM thickness 5.34mm ID ø 47mm Qty 1 pcs		
accessories for	415001		
	GEV No.	510562	Ref. No. —
	O-ring silicone thickness 5.34mm ID ø 47mm Qty 1 pcs		


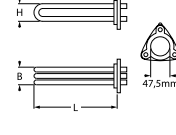

Table continues overleaf


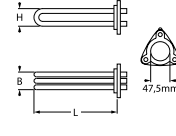






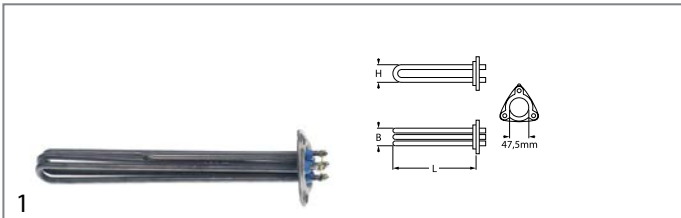
accessories for 415001				
	GEV No.	521103	Ref. No.	—
nut thread M4 H 3mm WS 7 brass Qty 20 pcs				
	GEV No.	521104	Ref. No.	—
washer ID ø 4.3mm ED ø 8mm thickness 0.5mm brass Qty 20 pcs for thread M4				
	GEV No.	560111	Ref. No.	—
plain washer ID ø 4.3mm ED ø 9mm thickness 0.8mm SS Qty 20 pcs DIN 125A for thread M4				
	GEV No.	560131	Ref. No.	—
hexagonal nut thread M4 H 3.2mm WS 7 SS DIN/ISO DIN 934 / ISO 4032/8673 Qty 20 pcs				

 				
GEV No.	417440	Ref. No.	230111	
description	heating element 4900W 230V mounting ø 47.5mm heating circuits 3 L 330mm W 32mm H 34mm number of thermostat sleeves 1 thermostat sleeves ø 7mm length thermostat sleeves 177mm thermostat sleeve not clinging tube ø 6.5mm hole distance 62mm hole ø 8mm connection M4 3 hole flange immersion heater			
For models:	LS500, LS501, LS501A, LS501G, LS501GA, LS501GPV, LS501PV, LS505, LS505T, LS511, LS511A, LS511PV, LS520-CRP, LS521, LS521-CRP-SP, LS522, LS525			
accessories for 417440				
	GEV No.	510408	Ref. No.	456002 456079 REB456002
O-ring EPDM thickness 5.34mm ID ø 47mm Qty 1 pcs				
	GEV No.	510562	Ref. No.	—
O-ring silicone thickness 5.34mm ID ø 47mm Qty 1 pcs				

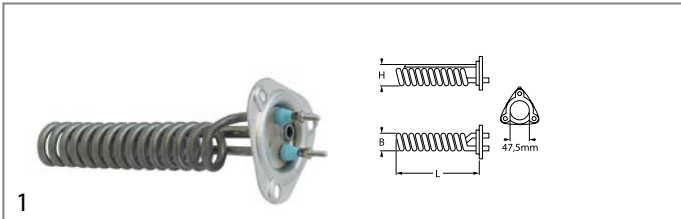
 				
GEV No.	416240	Ref. No.	230083 230083C	
description	heating element 6545W 230/400V mounting ø 48mm heating circuits 3 L 355mm W 31mm H 37mm number of thermostat sleeves 1 thermostat sleeves ø 7mm length thermostat sleeves 175mm thermostat sleeve upper centre not clinging tube ø 6.5mm hole distance 63mm hole ø 10mm connection M4 3 hole flange immersion heater			
For models:	GOLD74, LK100, LK100EM, LO155, LO65, LO80, LO80H, LO93, LOD102, LOD155, LOD202, LOD302, LOD65, LOD80, LOD80H, LOD93, LP80, LP800-00-092, LP92, LT81, LTD101, LTD209, LTD316, LTDX172, LTDX222			
accessories for 416240				
	GEV No.	510408	Ref. No.	456002 456079 REB456002
O-ring EPDM thickness 5.34mm ID ø 47mm Qty 1 pcs				
	GEV No.	510562	Ref. No.	—
O-ring silicone thickness 5.34mm ID ø 47mm Qty 1 pcs				



 				
GEV No.	419043	Ref. No.	230117	
description	heating element 7600W 400V mounting ø 47.5mm heating circuits 3 L 330mm W 40mm H 35mm number of thermostat sleeves 1 thermostat sleeves ø 7.5mm length thermostat sleeves 180mm thermostat sleeve eccentric, non clinging tube ø 8.5mm hole distance 63mm hole ø 10mm connection length 25mm connection M4 3 hole flange immersion heater			
For models:	LK600			
accessories for 419043				
	GEV No.	510408	Ref. No.	456002 456079 REB456002
O-ring EPDM thickness 5.34mm ID ø 47mm Qty 1 pcs				

 				
GEV No.	416241	Ref. No.	230020C REB230020	
description	heating element 8000W 230V mounting ø 47.5mm heating circuits 3 L 355mm W 35mm H 35mm number of thermostat sleeves 1 thermostat sleeves ø 7.5mm length thermostat sleeves 185mm thermostat sleeve not clinging tube ø 6.3mm hole distance 64mm hole ø 8mm connection M4 3 hole flange immersion heater			
For models:	L62, L64, LFD60, LK1010, LK110, LK1100, LK605, LK622, LK622I, LK625, LKDX110, LO155, LO93, LOD304, LOD402, LOD93, LP155, LP93, LT81, LTD101, LTD131, LTD171, LTD209, LTD212, LTD216, LTD220, LTD316, LTD320, LTDX172, LTDX222			
spare parts for 416241				
	GEV No.	510408	Ref. No.	456002 456079 REB456002
O-ring EPDM thickness 5.34mm ID ø 47mm Qty 1 pcs				
accessories for 416241				
	GEV No.	510093	Ref. No.	467002 69870
protection cap				
	GEV No.	510408	Ref. No.	456002 456079 REB456002
O-ring EPDM thickness 5.34mm ID ø 47mm Qty 1 pcs				
	GEV No.	510562	Ref. No.	—
O-ring silicone thickness 5.34mm ID ø 47mm Qty 1 pcs				

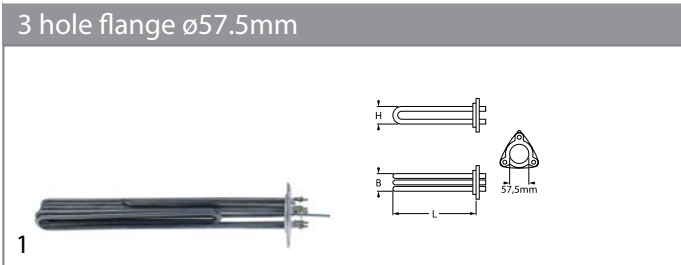



GEV No.	416242	Ref. No.	80398 80398C
description	heating element 9500W 230V mounting \varnothing 47.5mm heating circuits 3 L 330mm W 35mm H 35mm number of thermostat sleeves 1 thermostat sleeves \varnothing 7mm length thermostat sleeves 175mm thermostat sleeve eccentric, non clinging tube \varnothing 8.5mm hole distance 72mm hole \varnothing 8/10mm connection M4 3 hole flange immersion heater		
For models:	LK130, LK611, LK620, LK621, LKD130, LO155, LO65, LO93, LOD155, LOD305, LOD502, LTD209, LTD212, LTD216, LTD220, LTD326, LTDX272		

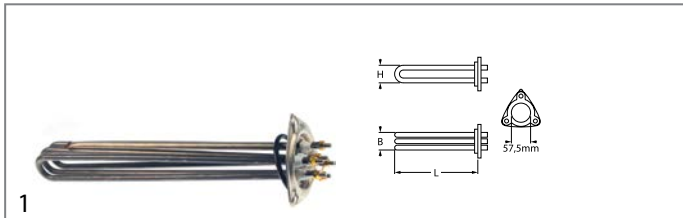


GEV No.	416280	Ref. No.	230091	
description	heating element 2700W 230V heating circuits 1 number of thermostat sleeves 1 thermostat sleeve eccentric, non clinging 3 hole flange immersion heater			
For models:	LBD40			
accessories for	416280			
	GEV No.	510408	Ref. No.	456002 456079 REB456002
	O-ring EPDM thickness 5.34mm ID \varnothing 47mm Qty 1 pcs			
	GEV No.	510562	Ref. No.	—
	O-ring silicone thickness 5.34mm ID \varnothing 47mm Qty 1 pcs			

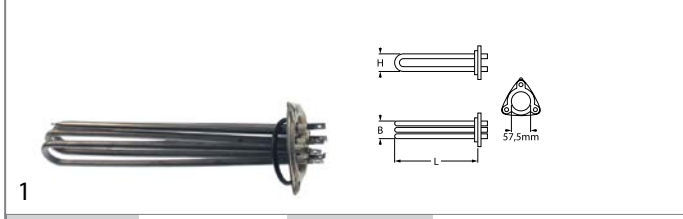
3 hole flange \varnothing 57.5mm



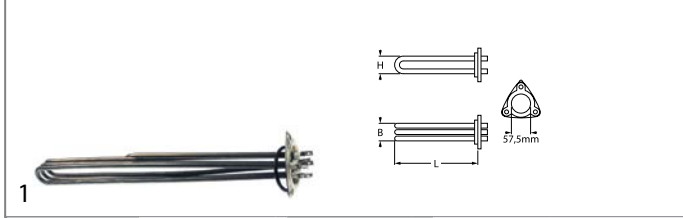
GEV No.	418871	Ref. No.	927276 DRB100	
description	heating element 10000W 230V mounting \varnothing 57.5mm heating circuits 3 L 375mm W 40mm H 33mm number of thermostat sleeves 1 thermostat sleeves \varnothing 7mm length thermostat sleeves 225mm thermostat sleeve upper centre not clinging tube \varnothing 6.3mm hole distance 73mm hole \varnothing 8mm connection length 24mm			
For models:	LT121, LT150, LT151, LT152, LT161, LT202, LT221, LT271, LT272, LT362, LT91			
accessories for	418871			
	GEV No.	510409	Ref. No.	167956 929046 CGG55
	O-ring EPDM thickness 5.34mm ID \varnothing 56.52mm Qty 1 pcs			




GEV No.	417334	Ref. No.	RTCU700619
description	heating element 4500W 230V mounting \varnothing 57.5mm heating circuits 3 L 347mm W 36mm H 50mm number of thermostat sleeves 1 thermostat sleeves \varnothing 7mm length thermostat sleeves 295mm thermostat sleeve not clinging tube \varnothing 8.5mm hole distance 72mm hole \varnothing 8mm connection M5 3 hole flange immersion heater		
For models:	E5017, E50177, MG7E50177		



GEV No.	418141	Ref. No.	RTFOC00523
description	heating element 6000W 230V mounting \varnothing 57.5mm heating circuits 3 L 297mm W 37mm H 50mm number of thermostat sleeves 1 thermostat sleeves \varnothing 7.5mm length thermostat sleeves 270mm thermostat sleeve eccentric, non clinging tube \varnothing 8.5mm hole distance 73mm hole \varnothing 8mm connection length 29mm connection M4 3 hole flange immersion heater		
For models:	FEM107, FEM107SC, FEM108, FEM108EL, FEM109, FEM110, FEM110L, FEM67, FEM67SC, FEM69, FEMD108, FEMD108EL, JOKER FEM 67 SC, JOKER FEM 69, JOKER FEM 69 AB 2002, JOKER FEM107 SC, JOKER FEM109, JOKER FEM109 AB 2002		



GEV No.	417332	Ref. No.	RTCP800008	
description	heating element 7200W 230V mounting \varnothing 57.5mm heating circuits 3 L 485mm W 34mm H 48mm number of thermostat sleeves 1 thermostat sleeves \varnothing 7mm length thermostat sleeves 265mm thermostat sleeve eccentric, non clinging tube \varnothing 8.5mm hole distance 72mm hole \varnothing 8mm connection M4 3 hole flange immersion heater			
For models:	E100I, E100I8, E100I9, E100I98, E100I9N, E100IA, E100IT9, E100IT9N, E150I, E150I8, E150I9, E150I98, E150I9N, E150IA, E150IT9, E150IT9N			
spare parts for	417332			
	GEV No.	510409	Ref. No.	167956 929046 CGG55
	O-ring EPDM thickness 5.34mm ID \varnothing 56.52mm Qty 1 pcs			



GEV No.	418140	Ref. No.	RTFOC00150
description	heating element 7500W 230V mounting \varnothing 57.5mm heating circuits 3 L 295mm W 34mm H 45mm number of thermostat sleeves 1 thermostat sleeves \varnothing 7mm length thermostat sleeves 275mm thermostat sleeve not clinging hole distance 72mm hole \varnothing 8mm connection M4 3 hole flange immersion heater		
For models:	FEM060, FEM061, FEM062, FEM100, FEM101, FEM102, FEM200, FEM201, FEM202, FEM207, FEM207SC, FEM209, FEM210, FEM210L, FEM220, FEM220L, FEM240, FEM240L, FEM610, FEM610L, FEM68, FEM68EL, FEMD68, FEMD68EL, FMM060, FMM061, FMM100, FMM101, JOKER FEM207 SC, JOKER FEM209		

GEV No.	415039	Ref. No.	927280 DRB81	
description	heating element 8000W 230V mounting \varnothing 57.5mm heating circuits 3 L 375mm W 41mm H 42mm number of thermostat sleeves 1 thermostat sleeves \varnothing 7mm length thermostat sleeves 230mm thermostat sleeve upper centre not clinging tube \varnothing 6mm hole distance 73mm hole \varnothing 10mm connection length 30mm connection M4 3 hole flange immersion heater			
For models:	LT121, LT150, LT151, LT152, LT161, LT202, LT221, LT271, LT272, LT362, LT91			
spare parts for	415039			
	GEV No.	510409	Ref. No.	167956 929046 CGG55
accessories for	415039			
	GEV No.	521103	Ref. No.	—
	nut thread M4 H 3mm WS 7 brass Qty 20 pcs			
	GEV No.	521104	Ref. No.	—
	washer ID \varnothing 4.3mm ED \varnothing 8mm thickness 0.5mm brass Qty 20 pcs for thread M4			
	GEV No.	560111	Ref. No.	—
	plain washer ID \varnothing 4.3mm ED \varnothing 9mm thickness 0.8mm SS Qty 20 pcs DIN 125A for thread M4			
	GEV No.	560131	Ref. No.	—
	hexagonal nut thread M4 H 3.2mm WS 7 SS DIN/ISO DIN 934 / ISO 4032/8673 Qty 20 pcs			

with compression flange 50 x 26mm

GEV No.	420538	Ref. No.	230102
description	heating element 1600W 230V heating circuits 1 flange 50x26mm L 305mm W 47mm H 25mm tube \varnothing 8.5mm connection F6.3		


GEV No.	420332	Ref. No.	230107	
description	heating element 600W 230V heating circuits 1 flange 50x26mm L 125mm W 48mm H 70mm tube \varnothing 8.4mm connection male faston 6.3mm immersion heater compression flange			
For models:	LB42BT-UK, LBD40, LBDX40			
spare parts for	420332			
	GEV No.	510387	Ref. No.	437086
	gasket L 46mm W 22mm \varnothing mm EPDM for heating element for flange 50x26mm			
	GEV No.	510388	Ref. No.	—
	counterflange \varnothing mm hole distancemm perforation \varnothing mm L 43mm W 21mm SS for heating element for flange 50x26mm			

GEV No.	416234	Ref. No.	230098	
description	heating element 600W 230V heating circuits 1 flange 50x26mm L 160mm W 45mm H 27mm tube \varnothing 8.8mm connection male faston 6.3mm connection length 40mm immersion heater compression flange			
For models:	KLB40, LB135, LB140, LB35, LB350, LB355, LB35C, LB40, LB400, LB405, LB40E, LB411, LB411A, LB422, LB425			
accessories for	416234			
	GEV No.	510387	Ref. No.	437086
	gasket L 46mm W 22mm \varnothing mm EPDM for heating element for flange 50x26mm			
	GEV No.	510388	Ref. No.	—
	counterflange \varnothing mm hole distancemm perforation \varnothing mm L 43mm W 21mm SS for heating element for flange 50x26mm			

GEV No.	420331	Ref. No.	230112	
description	heating element 1400W 230V compression flange flange 50x26mm L 160mm heating circuits 1 H 29mm W 190mm connection male faston 6.3mm immersion heater tube \varnothing 8.4mm			
For models:	LK600			
spare parts for	420331			
	GEV No.	510387	Ref. No.	437086
	gasket L 46mm W 22mm \varnothing mm EPDM for heating element for flange 50x26mm			


Table continues overleaf





spare parts for 420331			
	GEV No.	510388	Ref. No. —
counterflange ømm hole distancemm perforation ømm L 43mm W 21mm SS for heating element for flange 50x26mm			

with compression flange 70 x 26mm



GEV No.	415009	Ref. No.	230087
description	heating element 2500W 230V heating circuits 1 flange 70x26mm L 280mm W 51mm Hmm tube ø 6.3mm connection M4 immersion heater compression flange		
For models:	LB135, LB140, LB145		
accessories for 415009			
	GEV No.	521128	Ref. No. 437048
gasket L 66mm W 21mm ømm for heating element suitable for ELETTOBAR, WOLK			



GEV No.	415000	Ref. No.	230088
description	heating element 2900W 230V heating circuits 1 flange 70x26mm L 272mm W 51mm Hmm tube ø 6.3mm connection M4 immersion heater compression flange		
For models:	LF50, LF500		
spare parts for 415000			
	GEV No.	521128	Ref. No. 437048
gasket L 66mm W 21mm ømm for heating element suitable for ELETTOBAR, WOLK			
accessories for 415000			
	GEV No.	521128	Ref. No. 437048
gasket L 66mm W 21mm ømm for heating element suitable for ELETTOBAR, WOLK			

with expansion flange 70 x 18mm



GEV No.	416239	Ref. No.	230100
description	heating element 2600W 230V heating circuits 1 flange 70x18mm L 270mm W 65mm connection male faston 6.3mm tube ø 8.5mm immersion heater expansion flange		
For models:	LB135, LB140, LB35, LB35C, LB40, LB40E, LB45		


GEV No.	420550	Ref. No.	230109
description	heating element 4600W 230V heating circuits 3 flange 70x18mm L 360mm W 60mm L1 45mm H 55mm L2 45mm connection F 6.3mm L3 290mm immersion heater expansion flange for dishwashers tube ø 6.5mm		
For models:	LB42BT-UK, LBDX40		

GEV No.	419042	Ref. No.	230108
description	heating element 7000W 230V heating circuits 3 flange 70x18mm L 415mm W 64mm H 52mm L1 40mm L2 25mm L3 350mm tube ø 6.3mm connection male faston 6.3mm immersion heater expansion flange for dishwasher		
For models:	LFDX50		

GEV No.	416243	Ref. No.	230106
description	heating element 7600W 230V heating circuits 3 flange 70x18mm L 390mm W 60mm H 13mm connection male faston 6.3mm tube ø 6.3mm immersion heater expansion flange INCOLOY-800		
For models:	LF56, LF60, LFD50		

with round flange ø47.5mm




GEV No.	420057	Ref. No.	230116
description	heating element 3000W 230V heating circuits 1 mounting ø 47.5mm L 330mm W 33mm H 19mm tube ø 8.4mm thermostat sleeves ø 7.4mm number of thermostat sleeves 1 length thermostat sleeves 170mm		
For models:	LS500, LS500A, LS500G, LS500GA, LS500GPV, LS500PV, LS501, LS501A, LS501G, LS501GA, LS501GPV, LS501PV, LS505M, LS520		
spare parts for 420057			
	GEV No.	510408	Ref. No. 456002 456079 REB456002
O-ring EPDM thickness 5.34mm ID ø 47mm Qty 1 pcs			





miscellaneous



GEV No.	417575	Ref. No.	230118
description	heating element 2100W 230V W 165mm H 25mm L 270mm format angled		
For models:	LK605, LS505M, LS505T, LS522, LS525		


1

GEV No.	418149	Ref. No.	RTCP900050
description	heating element 1800W 230V L 255mm W 238mm H 88mm tube ø 8.5mm connection M4 dry heating element 2 hole fixing kettle W2 34mm thread 1/4" mounting distance 34mm		
For models:	E100, E100A, E150, E150A		
accessories for	418149		
	GEV No.	361182	Ref. No. —
	nut thread 1/4" H 5mm nickel-plated brass WS 17 Qty 1 pcs		
	GEV No.	510417	Ref. No. 437002
	flat gasket fibre ED ø 20mm ID ø 14mm thickness 2mm Qty 1 pcs		
	GEV No.	520228	Ref. No. —
	tooth lock washer ID ø 15.3mm ED ø 24mm steel Qty 1 pcs for thread M14		
	GEV No.	550262	Ref. No. —
	flat gasket copper ED ø 20mm ID ø 14mm thickness 2mm		













1

GEV No.	415664	Ref. No.	230085
description	heating element 2250W 230V heating circuits 1 L 300mm W 90mm H 25mm thread 1/8" mounting distance 64mm tube ø 6.3mm connection M4 immersion heater 2 hole fixing		
For models:	LB145, LB45, LB450		
accessories for	415664		
	GEV No.	510893	Ref. No. 456015
	O-ring EPDM thickness 2.62mm ID ø 9.92mm Qty 1 pcs		
	GEV No.	521103	Ref. No. —
	nut thread M4 H 3mm WS 7 brass Qty 20 pcs		
	GEV No.	521104	Ref. No. —
	washer ID ø 4.3mm ED ø 8mm thickness 0.5mm brass Qty 20 pcs for thread M4		
	GEV No.	521129	Ref. No. —
	nut thread M10 H 6mm SS WS 17 Qty 1 pcs DIN/ISO DIN 439		
	GEV No.	560111	Ref. No. —
	plain washer ID ø 4.3mm ED ø 9mm thickness 0.8mm SS Qty 20 pcs DIN 125A for thread M4		
	GEV No.	560131	Ref. No. —
	hexagonal nut thread M4 H 3.2mm WS 7 SS DIN/ISO DIN 934 / ISO 4032/8673 Qty 20 pcs		



1

GEV No.	415665	Ref. No.	230060 230086 REB230060 RIC0001697
description	heating element 2750/3250W 220/240V heating circuits 1 L 380mm W 110mm H 30mm thread M10x1 mounting distance 75mm tube ø 6.5mm connection M4 immersion heater 2 hole fixing		
For models:	L600, L61, L62, L63, L64, LF50, LF500, LF55, LF550, LF551, LF55E, LF59, LK1000, LK1010, LK1100, LK1300, LS500, LS500A, LS500G, LS500GA, LS500GPV, LS500PV, LS501, LS501A, LS501G, LS501GA, LS501GPV, LS501PV, LS505, LS505M, LS505T, LS511, LS511A, LS511PV, LS520, S58		
spare parts for	415665		
	GEV No.	510893	Ref. No. 456015
	O-ring EPDM thickness 2.62mm ID ø 9.92mm Qty 1 pcs		
accessories for	415665		
	GEV No.	510416	Ref. No. —
	flat gasket fibre ED ø 19mm ID ø 10.5mm thickness 1.5mm for thread M10 Qty 1 pcs		
	GEV No.	520231	Ref. No. —
	nut thread M10x1 H 6mm WS 14 zinc-coated steel Qty 1 pcs		
	GEV No.	520876	Ref. No. 463007
	protection cap for heating element ø 11.5mm H 32mm W 25mm plastic		
	GEV No.	521103	Ref. No. —
	nut thread M4 H 3mm WS 7 brass Qty 20 pcs		
	GEV No.	521104	Ref. No. —
	washer ID ø 4.3mm ED ø 8mm thickness 0.5mm brass Qty 20 pcs for thread M4		
	GEV No.	521129	Ref. No. —
	nut thread M10 H 6mm SS WS 17 Qty 1 pcs DIN/ISO DIN 439		
	GEV No.	560111	Ref. No. —
	plain washer ID ø 4.3mm ED ø 9mm thickness 0.8mm SS Qty 20 pcs DIN 125A for thread M4		
	GEV No.	560131	Ref. No. —
	hexagonal nut thread M4 H 3.2mm WS 7 SS DIN/ISO DIN 934 / ISO 4032/8673 Qty 20 pcs		



1









GEV No.	416235	Ref. No.	70562 80360
description	heating element 3000W 230V heating circuits 1 L 320mm W 50mm H 40mm thread M10x1 mounting distance 44mm tube ø 6.3mm connection male faston 6.3mm 2 hole fixing L1 32mm L2 288mm		
For models:	LFD60, LK100, LK100EM, LK110, LK130, LK611, LK622, LK622I, LK625, LKD130, LKDX110, LO65, LOD65, LP800-00-092, LP92		
spare parts for	416235		
	GEV No.	510893	Ref. No. 456015
	O-ring EPDM thickness 2.62mm ID ø 9.92mm Qty 1 pcs		



Table continues overleaf


accessories for	416235		
	GEV No.	510416	Ref. No. —
	flat gasket fibre ED ø 19mm ID ø 10.5mm thickness 1.5mm for thread M10 Qty 1 pcs		
	GEV No.	510893	Ref. No. 456015
	O-ring EPDM thickness 2.62mm ID ø 9.92mm Qty 1 pcs		
	GEV No.	521129	Ref. No. —
	nut thread M10 H 6mm SS WS 17 Qty 1 pcs DIN/ISO DIN 439		
	GEV No.	560192	Ref. No. —
	tooth lock washer ID ø 10.4mm ED ø 18mm SS DIN/ISO DIN 6798A Qty 1 pcs for thread M10		


	1		
GEV No.	420334	Ref. No.	41211
description	heating element 3000W 230V heating circuits 1 L 380mm W 87mm H 26mm thread M10x1 mounting distance 81mm tube ø 6.3mm connection M4 immersion heater 2 hole fixing		
For models:	LO80, LO80H, LOD80, LOD80H, LP80, LP80H		




heating elements for convection

	1		
GEV No.	418345	Ref. No.	3710004 RTBF900218
description	heating element 1600W 230V heating circuits 1 ID ø 178mm ED ø 191mm L 250mm H 40mm L1 50mm W1 32mm H1 16mm H2 24mm flange length 70mm flange width 22mm hole distance 56mm connection male faston 6.3mm tube ø 6.3mm convection heating element hole ø 5mm rectangular flange		
For models:	BC3G, BC4G, BC6G		
accessories for	418345		
	GEV No.	510368	Ref. No. —
	gasket L 70mm W 23.5mm hole ø 5mm hole distance 56mm FIBER thickness 2mm for heating element		



	1		
GEV No.	416030	Ref. No.	011482-01 011482-01R 019522-00 019522-00R
description	heating element 1900W 230V heating circuits 1 ID ø 175mm ED ø 192mm L 255mm H 42mm L1 47mm W1 30mm H1 16mm H2 26mm flange length 70mm flange width 22mm hole distance 56mm connection male faston 6.3mm tube ø 6.5mm convection heating element mounting thread M4 rectangular flange with thread bolt		
spare parts for	416030		
	GEV No.	510368	Ref. No. —
	gasket L 70mm W 23.5mm hole ø 5mm hole distance 56mm FIBER thickness 2mm for heating element		


	1		
GEV No.	418142	Ref. No.	RTFOC00307
description	heating element 21600W 230V heating circuits 3 ID ø 398mm ED ø 415mm L 465mm H 148mm L1 50mm W1 106mm H1 28mm H2 120mm flange length 142mm flange width 25mm hole distance 63mm connection M6x1 tube ø 8.5mm convection heating element hole ø 7mm rectangular flange		
For models:	FCE20, FEC200, FEM200, FEM201, FEM202, FEM207, FEM207SC, FEM209, FEM210, FEM210L, FEMD200, FEMD201, FEMD207, FEMD-207SC, FEMD209, FEP160, JOKER FEM207 SC, JOKER FEM209, JOKER FEMD207 SC, JOKER FEMD209, JOKER FEP160		

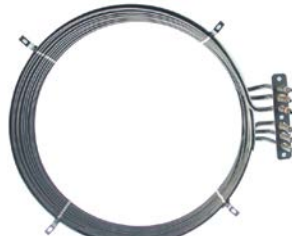
	1		
GEV No.	418146	Ref. No.	RTCU700451
description	heating element 2200W 230V heating circuits 1 ID ø 180mm ED ø 195mm L 210mm H 36mm L1 10mm W1 32mm H1 8mm H2 28mm flange length 70mm flange width 22mm hole distance 56mm tube ø 8.5mm hole ø 7mm		
For models:	EF07V, FEC023, FEMD023, PLANET FEC023, PLANET FEMD023		
accessories for	418146		
	GEV No.	510368	Ref. No. —
	gasket L 70mm W 23.5mm hole ø 5mm hole distance 56mm FIBER thickness 2mm for heating element		

	1		
GEV No.	415966	Ref. No.	RIC0001835
description	heating element 2500W 230V heating circuits 1 ID ø 176mm ED ø 188mm L 210mm H 28mm L1 22mm W1 30mm H1 3mm H2 25mm flange length 70mm flange width 22mm hole distance 56mm connection male faston 6.3mm tube ø 6.3mm convection heating element hole ø 5mm rectangular flange		
For models:	E4F6, E6F6, E6FA6, G4SFE6, G6SFE6, G6SFEA6, MINIMA E4F6, MINIMA E6F6, MINIMA E6FA6, MINIMA G4SFE6, MINIMA G6SFE6, MINIMA G6SFEA6		
spare parts for	415966		
	GEV No.	510368	Ref. No. —
	gasket L 70mm W 23.5mm hole ø 5mm hole distance 56mm FIBER thickness 2mm for heating element		
accessories for	415966		
	GEV No.	510368	Ref. No. —
	gasket L 70mm W 23.5mm hole ø 5mm hole distance 56mm FIBER thickness 2mm for heating element		




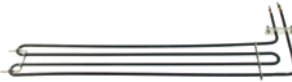
			
1			
GEV No.	416842	Ref. No.	RTCU700650
description	heating element 2600W 230V heating circuits 1 ID ø 177mm ED ø 194mm L 212mm H 28mm L1 18mm W1 33mm H1 5mm H2 23mm flange length 70mm flange width 22mm hole distance 55mm connection male faston 6.3mm tube ø 8.5mm convection heating element hole ø 7mm rectangular flange		
For models:	EF0V77, EFO7V, G4SFEV77, MG7E4FVP77Q, MG7G4SFEV77, OMNIA EF07V		
accessories for	416842		
	GEV No.	510368	Ref. No. —
	gasket L 70mm W 23.5mm hole ø 5mm hole distance 56mm FIBER thickness 2mm for heating element		

			
1			
GEV No.	419014	Ref. No.	011482-00-R
description	heating element 2700W 230V heating circuits 1 ID ø 179mm ED ø 192mm L 247mm H 34mm L1 50mm W1 30mm H1 8mm H2 25mm flange length 70mm flange width 23mm hole distance 56mm tube ø 6.3mm mounting thread M4 mounting distance 56mm		

			
1			
GEV No.	418143	Ref. No.	RTFOC00433
description	heating element 7500W 230V heating circuits 3 ID ø 250mm ED ø 265mm L 282mm H 85mm L1 17mm W1 103mm H1 17mm H2 68mm flange length 142mm flange width 25mm hole distance 64mm connection M4 connection length 75mm tube ø 6.5mm convection heating element hole ø 6mm rectangular flange		
For models:	FCE6, FCE68, FCG68, FEC065, FEMD065, FEMD066, FEMD67, FEMD-67SC, FEMD68, FEMD68EL, FEMD69, JOKER FCE 6, JOKER FCE 6 AB 2002, JOKER FEMD 67 SC, JOKER FEMD 69		


			
1			
GEV No.	420059	Ref. No.	RTFOC00013
description	heating element 9000W 230V heating circuits 3 ID ø 245mm ED ø 260mm L 290mm H 127mm L1 30mm W1 102mm H1 27mm H2 100mm flange length 25mm flange width 142mm hole distance 63mm connection M4 tube ø 6.3mm convection heating element hole ø 6mm rectangular flange		
For models:	FEC060, FEM060, FEM061, FEM062, FEMD060, FEMD061, FEP050		

			
1			
GEV No.	418144	Ref. No.	RTFOC00628
description	heating element 1500W 230V heating circuits 1 L 360mm W 110mm L1 30mm L2 330mm W2 88mm flange length 70mm flange width 22mm hole distance 56mm connection M4 tube ø 6.3mm hole ø M5mm W1 18mm rectangular flange convection heating element windings 2		
For models:	FEM610, FEM610L, FEM67, FEM67SC, FEM68, FEM68EL, FEM69, FEMD68, FEMD68EL, FEP050, FGM68, FGM68EL, FGMD68, FGMD68EL, JOKER FEM 67 SC, JOKER FEM 69, JOKER FEM 69 AB 2002, JOKER FEP050, JOKER FEP050 AB 2002		

			
1			
GEV No.	418145	Ref. No.	RTFOC00068
description	heating element 2500W 230V heating circuits 1 L 600mm W 120mm L1 30mm L2 570mm flange length 70mm flange width 22mm hole distance 56mm connection length 90mm connection screw tube ø 6.25mm thread M5 W1 35mm rectangular flange convection heating element windings 2 mounting thread M6		
For models:	FCE10, FCE108, FEC100, FEM100, FEM101, FEM102, FEM107, FEM-107SC, FEM108, FEM108EL, FEM109, FEM110, FEM110L, FEMD100, FEMD101, FEMD107, FEMD107SC, FEMD108, FEMD108EL, FEMD109, FEP080, FGM108, FGM108EL, FGM110, FGM110L, FGMD108, FGM-D108EL, JOKER FCE 10, JOKER FCE 10 AB 2002, JOKER FEM107 SC, JOKER FEM109, JOKER FEM109 AB 2002, JOKER FEMD107 SC, JOKER FEMD109, JOKER FEP080, JOKER FEP080 AB 2002		

radiation heaters


			
1			
GEV No.	416545	Ref. No.	RIC0002068
description	radiation heater rectangular 1500W 230V L 452mm W 193mm H 32mm heating circuits 1 connections 2 connection type cable AD		
For models:	ECFT66, MINIMA ECFT 66		



1

GEV No.	416546	Ref. No.	RIC0002063
description	radiation heater rectangular 2500W 230V L 452mm W 276mm heating circuits 1 connections 2 connection type cable AD ceramic griddle		
For models:	ECFT46, ECFT66, MINIMA ECFT 46, MINIMA ECFT 66		


1-circuit



1

GEV No.	490113	Ref. No.	RIC0001040 RIC0001295
description	radiation heater ø 200mm 1800W 230V heating circuits 1 energy regulation with temperature signalization with ribbon heater connections 2+2 connection type male faston 6.3mm CERAMASPEED		
For models:	EVC26, EVC27, EVC277, EVC46, EVC47, EVC477, EVC4F7, EVC4F77, MG7EVC277, MG7EVC477, MG7EVC4F77, MINIMA EVC26, MINIMA EVC46, OMNIA EVC27, OMNIA EVC47, OMNIA EVC4F7		

2-circuit



1

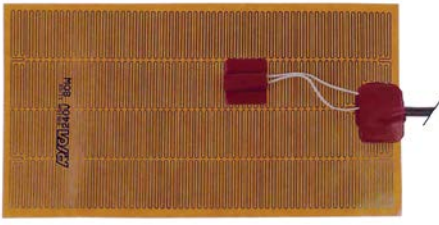
GEV No.	490139	Ref. No.	RIC0001294
description	radiation heater ø 250mm 2500W 230V heating circuits 2 energy regulation with temperature signalization partial power 1000W with ribbon heater connections 3+2 connection type male faston 6.3mm EGO		
For models:	EVC26, EVC277, EVC46, EVC477, EVC4F77, MG7EVC277, MG7EVC477, MG7EVC4F77		



1

GEV No.	490118	Ref. No.	RIC0001041
description	radiation heater ø 250mm 2500W heating circuits 2 partial power 1000W		
For models:	EVC27, EVC47, EVC4F7, MINIMA EVC26, MINIMA EVC46, OMNIA EVC27, OMNIA EVC47, OMNIA EVC4F7		

foil heating elements




1

GEV No.	416416	Ref. No.	01233602R
description	foil heating element L 240mm W 130mm 80W 230V with temperature limiter 80°C t.max.°C plastic cable length 1270mm thickness 0.5mm connection cable		



1

GEV No.	416315	Ref. No.	01233501R 0123500R
description	heater mat L 470mm W 65mm 87W 230V with temperature limiter t.max. 80°C plastic cable length 3500mm		




1

GEV No.	416314	Ref. No.	01943001R
description	heating element 110W 230V cable length 2500mm		

accessories


hexagonal nuts



1

GEV No.	510247	Ref. No.	RTBF800319
description	hexagonal nut thread M54x1.5		
For models:	EF45, EF90		

retaining rings



1

GEV No.	510244	Ref. No.	RTMIN00283
description	retaining ring shaft ø 60mm thickness 2mm steel DIN 471		
For models:	EF408, EF45, EF46, EF477, EF4772V, EF4772VT, EF477T, EF49, EF498, EF4982V, EF498L, EF498T, EF49T, EF66, EF777, EF777T, EF90, EF908, EF99, EF998, EF998L, EF998T, EF99T, MG7EF477, MG7EF4772V, MG7EF4772VT, MG7EF477T, MG7EF777, MG7EF777T, MINIMA EF 46, MINIMA EF 66		



sealing washers			
fibre gaskets			
GEV No.	510417	Ref. No.	437002
description	flat gasket fibre ED ø 20mm ID ø 14mm thickness 2mm Qty 1 pcs		
For models:	LF500, LK1000		

GEV No.	540796	Ref. No.	RTCP900025
description	gasket fibre ED ø 60mm ID ø 50mm thickness 2mm for outlet tap Qty 1 pcs		
For models:	CP100, CP100A, CP150, CP150A, CPI100, CPI100A, CPI150, CPI150A, E100, E100A, E100I, E100IA, E150, E150A, E150I, E150IA, G100, G100A, G100I, G100IA, G150, G150A, G150I, G150IA, G175, G175I		

O-rings			
GEV No.	510893	Ref. No.	456015
description	O-ring EPDM thickness 2.62mm ID ø 9.92mm Qty 1 pcs		
For models:	LB145, LB425, LB45, LB450, LF50, LF500, LF55E, LF59, LK1000, LK621, LS500, LS500A, LS500G, LS500GA, LS500GPV, LS500PV, LS501, LS501A, LS501G, LS501GA, LS501GPV, LS501PV, LS505, LS505M, LS505T, LS511, LS511A, LS511PV, LS520		

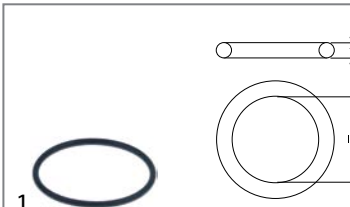
GEV No.	510072	Ref. No.	456016
description	O-ring EPDM thickness 3.53mm ID ø 32.93mm Qty 1 pcs		
For models:	GOLD74, LB140, LB35, LB40, LB40E, LB45, LF50, LF500, LF55, LF550, LF551, LF55E, LF56, LF59, LF60, LK100, LK1000, LK100EM, LK110, LK130, LK611, LKD130, LO80, LO80H, LOD202, LOD302, LOD80, LOD80H, LP80, LS505		

GEV No.	521120	Ref. No.	456075
description	O-ring EPDM thickness 5.34mm ID ø 37.47mm Qty 1 pcs		
For models:	KLB40, LB350, LB355, LB400, LB405, LB411, LB411A, LB422, LB425, LB450		

GEV No.	510408	Ref. No.	456002 456079 REB456002
description	O-ring EPDM thickness 5.34mm ID ø 47mm Qty 1 pcs		
For models:	BETA50, BETA53, GOLD74, L600, L61, L62, L63, L64, LB425, LBD40, LF55, LF550, LF551, LF55E, LF59, LFD60, LK100, LK1000, LK100EM, LK1010, LK110, LK1100, LK130, LK1300, LK600, LK605, LK611, LK620, LK621, LK622, LK622I, LK625, LKD130, LKDX110, LO155, LO65, LO80, LO80H, LO93, LOD102, LOD155, LOD202, LOD302, LOD304, LOD305, LOD402, LOD502, LOD65, LOD80, LOD80H...(Other models you can see in the webshop)		


GEV No.	510409	Ref. No.	167956 929046 CGG55
description	O-ring EPDM thickness 5.34mm ID ø 56.52mm Qty 1 pcs		
For models:	E100I9N, E100IT9N, E150I9N, E150IT9N, FEM107, FEM108, FEM108EL, FEM110, FEM110L, FEM207, FEM210, FEM210L, FEM220, FEM220L, FEM240, FEM240L, FEM610, FEM610L, FEM67, FEM68, FEM68EL, FEMD108, FEMD108EL, FEMD68, FEMD68EL, LT121, LT150, LT151, LT152, LT161, LT202, LT221, LT271, LT272, LT362, LT91		


GEV No.	510245	Ref. No.	RTBF800320
description	O-ring Viton thickness 3.53mm ID ø 50.8mm Qty 1 pcs		
For models:	EF45, EF90		




GEV No.	510243	Ref. No.	RTBF800321 RTCU700565
description	O-ring Viton thickness 3.53mm ID ø 55.56mm Qty 1 pcs		
For models:	EF408, EF45, EF46, EF47, EF472V, EF472VT, EF477, EF4772V, EF4772VT, EF477T, EF47T, EF49, EF498, EF4982V, EF498L, EF498T, EF49T, EF66, EF77, EF777, EF777T, EF77T, EF90, EF908, EF99, EF998, EF998L, EF998T, EF99T, MG7EF477, MG7EF4772V, MG7EF4772VT, MG7EF477T, MG7EF777, MG7EF777T, MINIMA EF 46, MINIMA EF 66, OMNIA EF 47, OMNIA EF 47T, OMNIA EF 77, OMNIA EF 77T, OMNIA EF472V		

flange gaskets




GEV No.	510387	Ref. No.	437086
description	gasket L 46mm W 22mm ømm EPDM for heating element for flange 50x26mm		
For models:	KLB40, LB135, LB140, LB35, LB350, LB355, LB35C, LB40, LB400, LB405, LB40E, LB411, LB411A, LB422, LB425, LB42BT-UK, LBD40, LBDX40, LK600, LK605, LS505M, LS505T, LS522, LS525		
accessories for	510387		
	GEV No.	510388	Ref. No. —
	counterflange ømm hole distancemm perforation ømm L 43mm W 21mm SS for heating element for flange 50x26mm		




GEV No.	521128	Ref. No.	437048
description	gasket L 66mm W 21mm ømm for heating element suitable for ELETTOBAR, WOLK		
For models:	LB135, LB140, LB145, LF50, LF500		

spring clips




GEV No.	550258	Ref. No.	162111
description	probe clip for pipe ø 8mm for probe ø 6mm		
For models:	FG15M, FG20M, GF15+15S, GF15S, GF25+25S, GF25S		


protection caps



GEV No.	510093	Ref. No.	467002 69870
description	protection cap		
For models:	LBD40, LF55, LF550, LF551, LF55E, LF59, LFD60, LK1000, LK600, LK605, LK620, LK621, LK625, LO155, LO65, LO80, LO80H, LO93, LOD102, LOD155, LOD202, LOD302, LOD304, LOD305, LOD402, LOD502, LOD65, LOD80, LOD93, LP80, LP800-00-092, LP92, LS500, LS500A, LS500G, LS500GA, LS500GPV, LS500PV, LS501, LS501A, LS501G, LS501GA, LS501GPV, LS501PV, LS505, LS505M, LS505T, LS511, LS511A, LS511PV...(Other models you can see in the webshop)		



GEV No.	520876	Ref. No.	463007
description	protection cap for heating element ø 11.5mm H 32mm W 25mm plastic		
For models:	LB135, LB140, LB145, LB35, LB35C, LB40, LB40E, LB45, LB450, LF50, LF500, LF55E, LF59, LK1000, LO80, LO80H, LOD80, LOD80H, LP80, LS500, LS500A, LS500G, LS500GA, LS500GPV, LS500PV, LS501, LS501A, LS501G, LS501GA, LS501GPV, LS501PV, LS505, LS505M, LS505T, LS511, LS511A, LS511PV, LS520		




GEV No.	504790	Ref. No.	165587
description	extension for thermowell thread M10x1 L 75mm hole ø 6.5mm brass		
For models:	FG15M, FG20M, GF15+15S, GF15S, GF25+25S, GF25S, GF4772VB, GF4772VS		

hot plates

square & rectangular

with radiused edge



GEV No.	490066 ¹	Ref. No.	RTCU700248
description	hot plate dimensions 220x220mm 2600W 230V with spill ring connection 4 screw clamps protector yes square		
For models:	E27, E277Q, E27Q, E2A77Q, E47, E477Q, E47Q, E4A77Q, E4F7, E4F77Q, E4F7Q, E67, E677Q, E67Q, E6A77Q, E6FA7, E6FA77Q, E6FA7Q, MG7E277Q, MG7E2A77Q, MG7E477Q, MG7E4A77Q, MG7E4F77Q, MG7E6A77Q, MG7E6FA77Q, OMNIA E27Q, OMNIA E47Q, OMNIA E4F7, OMNIA E4F7Q, OMNIA E67Q, OMNIA E6FA7, OMNIA E6FA7Q		

¹incl. protector



1			
GEV No.	490056 ¹	Ref. No.	RTCU800115
description	hot plate dimensions 300x300mm 3000W 230V with spill ring connection 4 screw clamps protector yes square		
For models:	E29, E298AQ, E298Q, E29Q, E2A, E2AR, E498AQ, E498Q, E49Q, E4A, E4A8, E4AR, E4F, E4F8, E4F98Q, E4F9Q, E698AQ, E698Q, E69Q, E6A, E6AR, E6FA, E6FA8, E6FA98Q, E6FA9Q, E6FAR, E6FM8		

¹incl. protector

1			
GEV No.	490071 ¹	Ref. No.	RTCU800116 RTCU800118
description	hot plate dimensions 300x300mm 4000W 230V with spill ring connection 4 screw clamps protector yes square		
For models:	E498AQ, E498Q, E49Q, E4A, E4A8, E4AR, E4F, E4F8, E4F98Q, E4F9Q, E698AQ, E698Q, E69Q, E6A, E6AR, E6FA, E6FA8, E6FA98Q, E6FA9Q, E6FAR, E6FM8		

¹incl. protector

round

with radiused edge

for domestic and commercial kitchens

1			
GEV No.	490010	Ref. No.	53.7.0021.00
description	hot plate ø 145mm 1000W 230V connection 4 screw clamps with 8mm spill ring		
For models:	6PC61EM, 6PC62EM, 6PC62ET		

1			
GEV No.	490012	Ref. No.	RTCU700087
description	hot plate ø 145mm 1500W 230V connection 4 screw clamps with 8mm spill ring		
For models:	C4EF70, C6EF70, E26, E27, E277, E27Q, E2A77, E46, E47, E477, E47Q, E4A77, E4F6, E4F7, E4F77, E4F7Q, E66, E67, E67Q, E6F6, E6FA6, E6FA7, E6FA77, E6FA7Q, G6SF6, G6SFA6, G6SFE6, G6SFEA6, HE4F77, MG7E2A77, MG7E477, MG7E4A77, MG7E4F77, MG7E6A77, MINIMA E26, MINIMA E46, MINIMA E4F6, MINIMA E66, MINIMA E6F6, MINIMA E6FA6, OMNIA E27, OMNIA E47, OMNIA E4F7, OMNIA E4F7Q, OMNIA E67, OMNIA E6FA7, OMNIA E6FA7Q		

1			
GEV No.	490014	Ref. No.	53.7.0022.00
description	hot plate ø 180mm 1500W 230V connection 4 screw clamps with 8mm spill ring		
For models:	6PC61EM, 6PC62EM, 6PC62ET		

1			
GEV No.	490020	Ref. No.	RTCU700086
description	hot plate ø 220mm 2600W 230V connection 4 screw clamps with 8mm spill ring		
For models:	C4EF70, C6EF70, E26, E27, E277, E27Q, E2A77, E46, E47, E477, E47Q, E4A77, E4F6, E4F7, E4F77, E4F7Q, E66, E67, E67Q, E6F6, E6FA6, E6FA7, E6FA77, E6FA7Q, G6SF6, G6SFA6, G6SFE6, G6SFEA6, HE4F77, MG7E2A77, MG7E477, MG7E4A77, MG7E4F77, MG7E6A77, MINIMA E26, MINIMA E46, MINIMA E4F6, MINIMA E66, MINIMA E6F6, MINIMA E6FA6, OMNIA E27, OMNIA E47, OMNIA E4F7, OMNIA E4F7Q, OMNIA E67, OMNIA E6FA7, OMNIA E6FA7Q		
accessories for	490020		
		GEV No.	550796
		Ref. No.	—
	fixing plate for hot plate ø220mm		

1			
GEV No.	490062	Ref. No.	160369
description	hot plate ø 300mm 3500W 220V connection 4 screw clamps with 8mm spill ring		
For models:	E29, E49, E4F9, E69, E6FA9		

accessories

miscellaneous

1			
GEV No.	490111	Ref. No.	RTCU700083
description	cover for hot plate ø 237mm		
For models:	C4EF70, C6EF70, E26, E27, E277, E27Q, E2A77, E46, E47, E477, E47Q, E4A77, E4A77Q, E4F6, E4F7, E4F77, E4F7Q, E66, E67, E67Q, E6F6, E6FA6, E6FA7, E6FA77, E6FA7Q, G6SF6, G6SFA6, G6SFE6, G6SFEA6, HE4F77, MG7E2A77, MG7E477, MG7E4A77, MG7E4F77, MG7E6A77		



energy regulators

EGO

1-circuit



GEV No.	380015	Ref. No.	RTCU800066
description	energy regulator 230V 13A single-circuit turn direction right shaft \varnothing 6x4.6mm shaft L 23mm mounting thread M4 power release 6-100% no. 50.57021.010		
For models:	ECC46, EPL46, EPL66, FCE10, FCE108, FCE20, FCE6, FCE68, FCG10, FCG108, FCG20, FCG6, FCG68, FEC060, FEC065, FEC100, FEC200, FEM060, FEM061, FEM100, FEM101, FEM200, FEM201, FEMD023, FEMD060, FEMD061, FEMD065, FEMD066, FEMD100, FEMD101, FEMD200, FEMD201, FEP050, FEP080, FEP160, FGC060, FGC065, FGC100, FGC200, FGM060, FGM061, FGM100, FGM101, FGM200, FGM201, FGMD060, FGMD061, FGMD065, FGMD066, FGMD100... (Other models you can see in the webshop)		



GEV No.	380019	Ref. No.	RIC0001299
description	energy regulator 240V 13A single-circuit turn direction right shaft \varnothing 6x4.6mm shaft L 23mm mounting thread M4 power release 6-100% no. 50.57071.010		
For models:	EVC26, EVC27, EVC46, EVC47, EVC477, MG7EVC27, MG7EVC477, MG7EVC477, MINIMA EVC26, MINIMA EVC46, OMNIA EVC27, OMNIA EVC47		

2-circuit





GEV No.	380024	Ref. No.	RIC0001010 RIC0001044 RIC0001045
description	energy regulator 240V 13A turn direction right shaft \varnothing 6x4.6mm shaft L 36mm mounting thread M4 no. 50.67079.601 with operation switch 1-pole		
For models:	EVC26, EVC27, EVC277, EVC46, EVC47, EVC477, EVC477, EVC477, MG7EVC27, MG7EVC477, MG7EVC477, MINIMA EVC26, MINIMA EVC46, OMNIA EVC27, OMNIA EVC47, OMNIA EVC47		

thermostats

bi-metal thermostats

safety bi-metal thermostats



GEV No.	390233	Ref. No.	236039 926189 DRT140
description	bi-metal safety thermostat hole distance 24mm switch-off temp. 110°C 1NC 1-pole 16A connection F6.3 2 hole fixing without holder		
For models:	GOLD74, KLB40, L600, L61, L62, L63, L64, LB135, LB140, LB145, LB35, LB350, LB355, LB35C, LB40, LB400, LB405, LB40E, LB411, LB411A, LB45, LB450, LBD40, LF50, LF500, LF55, LF55E, LF56, LF59, LF60, LFD50, LFD60, LK100, LK1000, LK100EM, LK1010, LK110, LK1100, LK130, LK1300, LK600, LK605, LK611, LK620, LK621, LK622, LK622I, LK625, LKD130, LKDX110... (Other models you can see in the webshop)		
accessories for	390233		
	GEV No.	504736	Ref. No. —
	bracket for contact thermostat		
	GEV No.	550388	Ref. No. —
	bracket for contact thermostat mounting distance 24.5mm mounting \varnothing 3.8		



GEV No.	390590	Ref. No.	C23114
description	bi-metal safety thermostat hole distance 24mm switch-off temp. °C 1NC 1-poleAV connection plug 2 hole fixing		
For models:	CB955A, CB955W, ICE45W		



GEV No.	390459	Ref. No.	236053
description	bi-metal safety thermostat hole distance mm switch-off temp. 200°C 1NC 1-pole 16A connection F6.3 M4		
For models:	LF56, LF60, LFD50, LFDX50, LS520-CRP, LS521, LS521-CRP-SP		



GEV No.	390526	Ref. No.	012728-00 01272800R
description	bi-metal safety thermostat hole distance mm switch-off temp. 25°C 1NO 1-poleAV connection F6.3		



<p>1</p>			
GEV No.	390959	Ref. No.	2LT135
description	bi-metal safety thermostat switch-off temp. 60°C 1-pole connection F6.3		
For models:	KF165W, KF185W, KL030W		

<p>1</p>			
GEV No.	390318	Ref. No.	236047
description	bi-metal safety thermostat switch-off temp. 95°C 1-pole 2 hole fixing		
For models:	KLB40, LB135, LB140, LB35, LB350, LB355, LB35C, LB40, LB400, LB405, LB40E, LB411, LB411A, LB422, LB425, LB42BT-UK, LBD40, LBDX40, LFDX50, LS500, LS500A, LS500G, LS500GA, LS500GPV, LS500PV, LS501, LS501A, LS501G, LS501GA, LS501GPV, LS501PV, LS505M, LS505T, LS511, LS511A, LS511PV, LS520, LS520-CRP, LS521, LS521-CRP-SP, LS522, LS525		

bi-metal thermostats

<p>1</p>			
GEV No.	390301	Ref. No.	236035
description	bi-metal thermostat hole distance 23.8mm switch-off temp. 60°C 1NC 1-pole 16A connection F6.3 2 hole fixing		
For models:	LB135, LB140, LB355, LB405, LK600, LK605		

<p>1</p>			
GEV No.	390319	Ref. No.	236048
description	bi-metal thermostat hole distance 23.8mm switch-off temp. 80°C 1NC 1-pole 16A connection F6.3 2 hole fixing		
For models:	LB135, LB140, LB355, LB405, LB422, LB425, LK600		

<p>1</p>			
GEV No.	390504	Ref. No.	236052
description	bi-metal thermostat hole distance 23.8mm switch-off temp. 90°C 1NO 1-pole 16A 250V connection F6.3 2 hole fixing probe ø 16mm		
For models:	LK600, LK605, LS505M, LS505T, LS522, LS525		

<p>1</p>			
GEV No.	390129	Ref. No.	236056
description	bi-metal thermostat hole distance 125mm switch-off temp. 125°C 1NC 1-pole 16A connection F6.3 M4		
For models:	LFD50, LFDX50, LS520-CRP, LS521, LS521-CRP-SP		

control and safety thermostats

EGO

control thermostats

51._ series

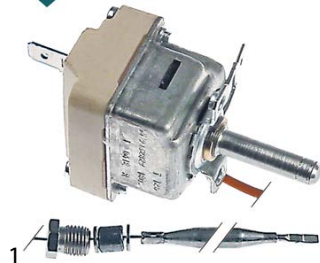
<p>1</p>			
GEV No.	375347	Ref. No.	RTCU700609
description	thermostat t.max. 175°C temperature range 95-175°C 1-pole capillary pipe isolated gland nut shaft ø 6x4.6mm		
For models:	EF45, EF46, EF47, EF472V, EF47T, EF49, EF49T, EF66, EF77, EF77T, EF90, EF99, EF99T, MINIMA EF 46, MINIMA EF 66, OMNIA EF 47T, OMNIA EF 77T		

<p>1</p>			
GEV No.	375334	Ref. No.	RTBF800152
description	thermostat t.max. 85°C temperature range 30-85°C 1-pole 1NO 16A probe ø 6mm probe L 130mm capillary pipe 900mm capillary pipe isolated 900mm gland nut shaft ø 6x4.6mm shaft L 23mm shaft position upper rotation 270°		
For models:	E2AR, E4AR, E6AR, E6FAR, EBM408, EBM45, EBM46, EBM47, EBM477, EBM498T, EBM49T, EBM77, EBM777, EBMA477, EBMA498, EBMA777, MG7EBM477, MG7EBMA477, MINIMA EBM 46, MINIMA EBM 66, OMNIA EBM 47, OMNIA EBM 77		

55.10/19_series



GEV No.	375777	Ref. No.	161791
description	thermostat t.max. 180°C temperature range 70-180°C 1-pole 1NO 16A probe ø 6mm probe L 87mm capillary pipe 600mm capillary pipe isolated 350mm gland nut shaft ø 6x4.6mm shaft L 23mm shaft position upper rotation 270°		
For models:	EF12+12B, EF12+12S, EF12B, EF12S, EF20BP, EF25+25S, EF25S, EF6+6BM, EF60BP, EF6BM, EF8+8B, EF8B, EF8BM		



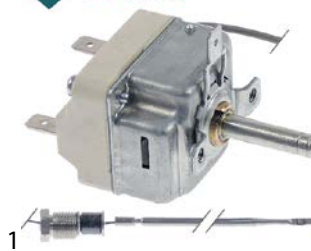
GEV No.	375765	Ref. No.	166488
description	thermostat t.max. 180°C temperature range 95-180°C 1-pole 1NO 16A probe ø 6mm probe L 130mm capillary pipe 900mm capillary pipe isolated 800mm gland nut M9x1 shaft ø 6x4.6mm shaft L 23mm shaft position upper rotation 270°		
For models:	EF12+12B, EF12+12S, EF12B, EF12S, EF20BP, EF25+25S, EF25S, EF477, EF4772V, EF4772VT, EF477T, EF60BP, EF777, EF777T, EF8+8B, EF8B, MINIMA EF 46, MINIMA EF 66, OMNIA EF 47, OMNIA EF 47T, OMNIA EF 77, OMNIA EF 77T, OMNIA EF472V		



GEV No.	375922	Ref. No.	173501
description	thermostat t.max. 185°C temperature range 101-185°C 1-pole 1NO 16A probe ø 6mm probe L 133mm capillary pipe 870mm capillary pipe isolated 520mm gland nut M10x1 shaft ø 6x4.6mm shaft L 23mm shaft position upper		
For models:	GF408N, GF908N		



GEV No.	390046	Ref. No.	53.7.0006.00
description	thermostat t.max. 190°C temperature range 104-190°C 1-pole 1NO 16A probe ø 6mm probe L 133mm capillary pipe 870mm capillary pipe isolated gland nut M9x1 shaft ø 6x4.6mm shaft L 23mm shaft position lower rotation 270° probe material SS		
For models:	6FQ61E, 6FQ62E		



GEV No.	375983	Ref. No.	RTFOC00698
description	thermostat t.max. 262°C temperature range 50-255°C 1-pole 1NO 16A probe ø 3mm probe L 230mm capillary pipe 900mm capillary pipe isolated 350mm gland nut M10x1 shaft ø 6x4.6mm shaft L 23mm shaft position upper rotation 270° probe material SS		
For models:	FCE10, FCE108, FCE20, FCE6, FCE68, FCG10, FCG108, FCG20, FCG6, FCG68, JOKER FCE 6, JOKER FCE 6 AB 2002, JOKER FCE 10, JOKER FCE 10 AB 2002, JOKER FCG 6, JOKER FCG 6 AB 2002, JOKER FCG 10, JOKER FCG 10 AB 2002		



GEV No.	375653	Ref. No.	RTFOC00646
description	thermostat t.max. 262°C temperature range 58-258°C 1-pole 1NO 16A probe ø 3mm probe L 226mm capillary pipe 870mm capillary pipe isolated 330mm gland nut shaft ø 6x4.6mm shaft L 23mm shaft position upper rotation 270°		
For models:	EMT477, EMT777, FEC023, FEMD023, G2SF6G, G3SF6G, PLANET FEC023, PLANET FEMD023		




GEV No.	375652	Ref. No.	RTFOC00698
description	thermostat t.max. 266°C temperature range 50-255°C 1-pole 1NO 16A probe ø 3mm probe L 219mm capillary pipe 900mm capillary pipe isolated 350mm gland nut M10x1 shaft ø 6x4.6mm shaft L 23mm shaft position upper rotation 270°		




GEV No.	375232	Ref. No.	53.7.0016.00 RTCU700085
description	thermostat t.max. 320°C temperature range 55-320°C 1-pole capillary pipe isolatedmm gland nut		
For models:	6FT61E, 6FT62E, C4EF70, C6EF70, E4F, E6FAR, EBR, EBR7, EBR77, EBR8, EBR9T, EBRA, EBRA9T, EBRAVI, EBRAVI9T, EBRI7, EBRI77, EBRVC98, EBRVC98T, EBRVI, EBRVI8, EBRVI98, EBRVI98T, EBRVI9T, EF0V77, EFT47L, EFT47LC, EFT47R, EFT47RC, EFT77L, EFT77LC, EFT77LR, EFT77LRC, EFT77R, EFT77RC, EFT90L, EFT90LC, EFT90LR, EFT90LRC, EFT90R, EFT90RC, G4SFE, G4SFEV77, G6SFEA, G8SF2, G8SF2E, GBR, GBR8, GBR9T, GBRA...(Other models you can see in the webshop)		




GEV No.	375354	Ref. No.	RTCU600186
description	thermostat t.max. 270°C temperature range 50-270°C 1-pole 1NO 16A probe ø 3mm probe L 219mm capillary pipe 900mm capillary pipe isolated 900mm gland nut shaft ø 6x4.6mm shaft L 23mm shaft position upper rotation 270°		
For models:	E4F6, E6F6, E6FA6, G4SFE6, G6SFE6, G6SFEA6, MINIMA E4F6, MINIMA E6F6, MINIMA E6FA6, MINIMA G4SFE6, MINIMA G6SFE6, MINIMA G6SFEA6		



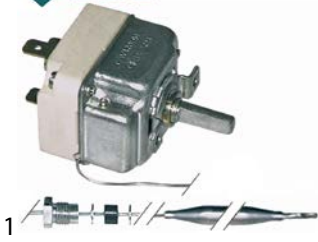
GEV No.	375332	Ref. No.	RTFOC00275
description	thermostat t.max. 55°C temperature range fixed 55°C 1-pole 1CO 16A probe ø 9/15mm probe L 22mm capillary pipe 1500mm capillary pipe isolated 800mm gland nut		
For models:	FEC060, FEC065, FEC100, FEC200, FEM060, FEM061, FEM062, FEM100, FEM101, FEM102, FEM200, FEM201, FEM202, FEMD060, FEMD061, FEMD065, FEMD066, FEMD100, FEMD101, FEMD200, FEMD201, FEP050, FEP080, FEP160, FGC060, FGC065, FGC100, FGC200, FGM060, FGM061, FGM062, FGM100, FGM101, FGM102, FGM200, FGM201, FGM202, FGMD060, FGMD061, FGMD065, FGMD066, FGMD100, FGMD101, FGMD200, FGMD201, FGP050, FGP080, FGP160, FMM060, FMM061...(Other models you can see in the webshop)		



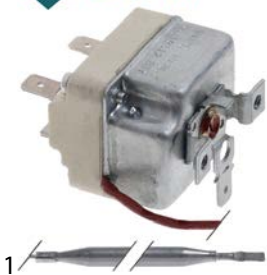
GEV No.	375002	Ref. No.	RTCU700455
description	thermostat t.max. 320°C temperature range 55-320°C 1-pole 1NO 16A probe ø 3.1mm probe L 226mm capillary pipe 870mm capillary pipe isolated 850mm gland nut shaft L 23mm shaft position upper rotation 270°		
For models:	EF07V, EFO7V, OMNIA EF07V		



GEV No.	375381	Ref. No.	3700002
description	thermostat t.max. 90°C temperature range 30-90°C 1-pole 1NO 16A probe ø 6mm probe L 130mm capillary pipe 2000mm capillary pipe isolated 2000mm gland nut shaft ø 6x4.6mm shaft L 23mm shaft position upper rotation 270°		
For models:	BC2G, BC3G, BC4G, BC6G		



GEV No.	375231	Ref. No.	53.7.0015.00
description	thermostat t.max. 90°C temperature range 30-90°C 1-pole 1NO 16A probe ø 6mm probe L 130mm capillary pipe 900mm capillary pipe isolated 600mm gland nut M9x1 shaft L 18mm shaft position upper rotation 270°		
For models:	6BM61EM, 6BM62EM, 6BM62ET, 6BS61EM, 6BS62EM, 6CP61EM, 6CP62ET		



GEV No.	375654	Ref. No.	RTFOC00670
description	thermostat t.max. 99°C temperature range fixed 99°C 1-pole 1CO 16A probe ø 6mm probe L 74mm capillary pipe 900mm capillary pipe isolated 900mm gland nut		
For models:	FEMD023, PLANET FEMD023		



55.13_ series



GEV No.	375492	Ref. No.	RTBF800163
description	thermostat t.max. 190°C temperature range 94-190°C 1-pole 1NO 16A probe ø 6mm probe L 94mm capillary pipe 1090mm capillary pipe isolated 960mm gland nut M10x1 shaft ø 6x4.6mm shaft L 23mm shaft position upper rotation 310° probe material SS		
For models:	EF45, EF90		

55.14_ series



GEV No.	390001	Ref. No.	DRT130B
description	thermostat t.max. 58°C temperature range fixed 58°C 1-pole 1NC 16A probe ø 11mm probe L 35mm capillary pipe 580mm capillary pipe isolated 580mm gland nut shaft Lmm shaft position° shaft position screw-in probe probe thread M14x1		
For models:	BETA50, BETA53		
accessories for	390001		
	GEV No.	510417	Ref. No. 437002
	flat gasket fibre ED ø 20mm ID ø 14mm thickness 2mm Qty 1 pcs		
	GEV No.	550261	Ref. No. —
	nut thread M14x1 H 4mm WS 19 SS Qty 1 pcs		

55.34_ series



GEV No.	375236	Ref. No.	RTFOC00032
description	thermostat capillary pipe isolatedmm gland nut		
For models:	FEC060, FEC100, FEM060, FEM061, FEM100, FEM101, FEMD060, FEMD061, FEMD100, FEMD101, FEP050, FEP080, FGC060, FGC100, FGM060, FGM061, FGM100, FGM101, FGMD060, FGMD061, FGMD100, FGMD101, FGP050, FGP080, FMM060, FMM061, FMM100, FMM101		



GEV No.	375385	Ref. No.	53401031820
description	thermostat t.max. 180°C temperature range 100-180°C 3-pole 3NO 16A probe ø 6mm probe L 131mm capillary pipe 2000mm capillary pipe isolated 1800mm gland nut shaft ø 6x4.6mm shaft L 23mm shaft position upper rotation 270°		



E-G-O



GEV No.	375587	Ref. No.	164332 RTBF600067
description	thermostat t.max. 285°C temperature range 100-285°C 3-pole 3NO 16A probe ø 3mm probe L 219mm capillary pipe 1150mm capillary pipe isolated 1130mm gland nut shaft ø 6x4.6mm shaft L 23mm shaft position upper rotation 270°		
For models:	E4F, E4F9, E4F9Q, E6FA, E6FA9, E6FA9Q, EF09, EFB09, G4SFE, G4SFE9, G6SFEA, G6SFEA9		

E-G-O



GEV No.	375355	Ref. No.	RTCU600067
description	thermostat t.max. 300°C temperature range 50-300°C 3-pole 3NO 16A probe ø 3mm probe L 219mm capillary pipe 900mm capillary pipe isolated 900mm gland nut shaft ø 6x4.6mm shaft L 23mm shaft position upper rotation 270°		
For models:	E4F7, E4F77, E4F77Q, E4F7Q, E4F8, E4F98Q, E4FP77Q, E4FP8, E6FA7, E6FA77, E6FA77Q, E6FA7Q, E6FA8, E6FA98Q, EBR6, EF07, EF077, EFO7, EFT106L, EFT106LC, EFT106LR, EFT106LRC, EFT408L, EFT408LC, EFT408LR, EFT45L, EFT45LC, EFT45R, EFT45RC, EFT46L, EFT46LC, EFT46R, EFT46RC, EFT477L, EFT477LC, EFT477R, EFT477RC, EFT47L, EFT47LC, EFT47R, EFT47RC, EFT498L, EFT498LC, EFT498R, EFT49L, EFT49LC, EFT49R, EFT49RC, EFT66L, EFT66LC...(Other models you can see in the webshop)		


E-G-O



GEV No.	375411	Ref. No.	160561 53.7.0008.00
description	thermostat t.max. 93°C temperature range 30-93°C 3-pole 3NO 16A probe ø 6mm probe L 129mm capillary pipe 1480mm capillary pipe isolated 1100mm gland nut M10x1 shaft ø 6x4.6mm shaft L 23mm shaft position upper rotation 270°		
For models:	6BM61EM, 6BM62EM, 6BM62ET, 6CP61EM, 6CP62ET, EBM90, EBM908, EBM998T, EBM99T, EBMA998		

55.40_series

E-G-O



GEV No.	375185	Ref. No.	RTCU900257
description	thermostat t.max. 320°C temperature range 53-320°C 4-pole 4NO 16A probe ø 3.9mm probe L 228mm capillary pipe 880mm capillary pipe isolatedmm gland nut shaft ø 6x4.6mm shaft L 23mm shaft position upper rotation 270°		
For models:	EFT45L, EFT45LC, EFT45R, EFT45RC, EFT90L, EFT90LC, EFT90LR, EFT90LRC, EFT90R, EFT90RC		

63._series

E-G-O



GEV No.	375348	Ref. No.	RTTAV00001
description	thermostat t.max. 90°C temperature range 30-90°C 3-pole capillary pipe isolatedmm gland nut		
For models:	EBM90		

safety thermostats

55.10/19_series

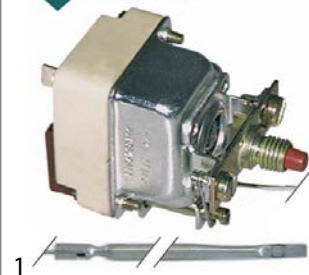
E-G-O



GEV No.	375651	Ref. No.	RTFOC00038
description	safety thermostat capillary pipe 670mm probe ø 6mm 1-pole probe L 77mm 16A capillary pipe isolated 650mm gland nut M10x1 switch-off temp. 350°C probe		
For models:	FCE6, FEC060, FEC065, FEC100, FEC200, FEM060, FEM061, FEM062, FEM100, FEM101, FEM102, FEM200, FEM201, FEMD060, FEMD061, FEMD065, FEMD066, FEMD100, FEMD101, FEMD200, FEMD201, FEP050, FEP080, FEP160, FGC060, FGC100, FGP050, FGP080, JOKER FCE 6, JOKER FCE 6 AB 2002, JOKER FCE 10, JOKER FCE 10 AB 2002, JOKER FCG 10, JOKER FCG 10 AB 2002, JOKER FEM 67 SC, JOKER FEM 69, JOKER FEM 69 AB 2002, JOKER FEM107 SC, JOKER FEM109, JOKER FEM109 AB 2002, JOKER FEM207 SC, JOKER FEM209, JOKER FEMD 67 SC, JOKER FEMD 69, JOKER FEMD107 SC, JOKER FEMD109, JOKER FEMD207 SC, JOKER FEMD209, JOKER FEP050, JOKER FEP050 AB 2002...(Other models you can see in the webshop)		



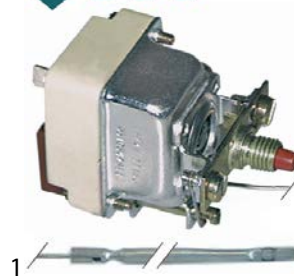
GEV No.	375676	Ref. No.	RTFOC00173
description	safety thermostat capillary pipe 870mm probe ø 3.1mm 1-pole probe L 226mm 16A capillary pipe isolated 870mm gland nut switch-off temp. 120°C probe SS		



GEV No.	375655	Ref. No.	RTFOC00231
description	safety thermostat capillary pipe 900mm probe ø 3mm 1-pole probe L 174mm 0.5A capillary pipe isolated 900mm gland nut switch-off temp. 300°C probe		
For models:	FEM107, FEM207, FGM100, FGM101, FGM102, FGM107, FGM107SC, FGM108, FGM108EL, FGM109, FGM110, FGM110L, FGM200, FGM201, FGM202, FGM207, FGM207SC, FGM209, FGM610, FGM610L, FGM67, FGM67SC, FGM68, FGM68EL, FGM69, FGMD108, FGMD108EL, FGMD68, FGMD68EL, FMM100, FMM101, JOKER FGM 67 SC, JOKER FGM 69, JOKER FGM107 SC, JOKER FGM109, JOKER FGM207 SC, JOKER FGM209		




GEV No.	375200	Ref. No.	236029 REF236029
description	safety thermostat capillary pipe 900mm probe ø 6mm 1-pole probe L 130mm 0.5A capillary pipe isolated gland nut switch-off temp. 235°C probe		

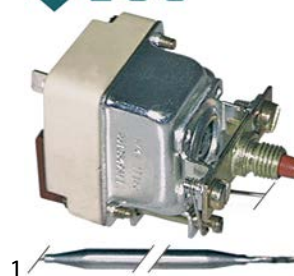


GEV No.	375886	Ref. No.	RTCP800067
description	safety thermostat switch-off temp. 140°C 1-pole 1NC 0.5A probe ø 3mm probe L 226mm capillary pipe 900mm capillary pipe isolated 840mm gland nut probe probe material SS		
For models:	G100, G100A, G100I, G100I8, G100I9, G100I98, G100I9N, G100IA, G100IT9, G100IT9N, G150, G150A, G150I, G150I8, G150I9, G150I98, G150I9N, G150IA, G150IT9, G150IT98, G150IT9N, G175I, G50I7, G50I77, OMNIA G50I7		



GEV No.	375339	Ref. No.	RTBF900094
description	safety thermostat switch-off temp. 225°C 1-pole 0.5A probe ø 6mm probe L 133mm capillary pipe 870mm capillary pipe isolated gland nut M10x1 probe		
For models:	EF6+6BM, EF6BM, EF8B, EF8BM, FG15, FG15+15, FG15M, FG20M, GF15+15S, GF15S, GF25+25S, GF25S, GF45, GF46, GF47, GF472V, GF477TS, GF49, GF49T, GF66, GF77, GF777TS, GF90, GF90-1, GF99, GF99T, MINIMA GF 46, MINIMA GF 66, OMNIA GF 47, OMNIA GF 47T, OMNIA GF 77, OMNIA GF 77T, OMNIA GF472V		

accessories for	375339		
	GEV No.	551083	Ref. No. —
cap for safety thermostat thread M8x1			



GEV No.	375233	Ref. No.	53.7.0013.00
description	safety thermostat switch-off temp. 235°C 1-pole 16A probe ø 6mm probe L 133mm capillary pipe 870mm capillary pipe isolated 830mm gland nut probe SS		
For models:	6FQ61E, 6FQ62E		






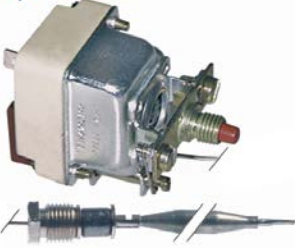
accessories for	375233		
	GEV No.	102067	Ref. No. 53.3.0098.00 9404701700
nut thread M8x1 H 3mm brass Qty 1 pcs type SEF 1			


Table continues overleaf

accessories for	375233			
	GEV No.	551083	Ref. No.	—
	cap for safety thermostat thread M8x1			

 			
GEV No.	375352	Ref. No.	53.7.0100.00
description	safety thermostat switch-off temp. 245°C 1-pole 1NC 16A probe ø 6mm probe L 130mm capillary pipe 1200mm capillary pipe isolated 1200mm gland nut probe		
For models:	6FQ61G, 6FQ62G		

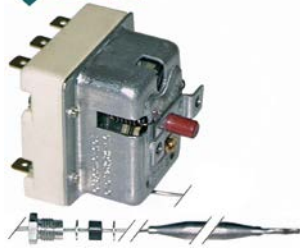
 			
GEV No.	375656	Ref. No.	RTBF800076
description	safety thermostat switch-off temp. 360°C 1-pole 0.5A probe ø 3.1mm probe L 201mm capillary pipe 900mm capillary pipe isolated 870mm gland nut probe SS		
For models:	EBR8, EBRVC98, EBRV18, EBRV198, FGM110, FGM110L, FGM207, FGM207SC, FGM210, FGM210L, FGM610, FGM610L, G2SF6G, G3SF6G, G4SF8, G4SF98, G4SF98P, G6SFA8, G6SFA98, GBR, GBR7, GBR77, GBR8, GBR9T, GBRA, GBRA9T, GBRAVI, GBRAVI9T, GBRI7, GBRI77, GBRCV98, GBRCV98T, GBRVI, GBRVI8, GBRVI98, GBRVI98T, GBRVI9T, GT2SDF8, GTF8, GTF98, MG7GBR77, MG7GBRI77, OMNIA GBR7, OMNIA GBRI7		

 			
GEV No.	375968	Ref. No.	RTFOC00483
description	safety thermostat switch-off temp. 360°C 1-pole 1NC 16A probe ø 6mm probe L 77mm capillary pipe 870mm capillary pipe isolated 660mm gland nut M10x1 probe probe material SS M8x1		
For models:	FCE10, FCE20, FCE6, FCG10, FCG20, FCG6, FEM107, FEM107SC, FEM109, FEM110, FEM110L, FEM207, FEM207SC, FEM209, FEM210, FEM210L, FEM220, FEM220L, FEM240, FEM240L, FEM610, FEM610L, FEM67, FEM67SC, FEM69, FEMD107, FEMD107SC, FEMD109, FEMD207, FEMD207SC, FEMD209, FEMD67, FEMD67SC, FEMD69, FEP050, FEP080, FEP160, FGM107, FGM107SC, FGM109, FGM110, FGM110L, FGM207, FGM207SC, FGM209, FGM210, FGM210L, FGM610, FGM610L, FGM67...(Other models you can see in the webshop)		

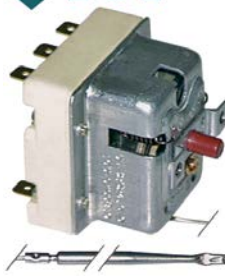
55.11_ series			
 			
GEV No.	375767	Ref. No.	3700014
description	safety thermostat switch-off temp. 170°C 1-pole 16A probe ø 3.1mm probe L 160mm capillary pipe 650mm capillary pipe isolated 600mm gland nut probe		
For models:	BC3G, BC4G, BC6G, EC11803		

55.32_ series			
 			
GEV No.	375333	Ref. No.	RTCP900074
description	safety thermostat switch-off temp. 135°C 3-pole 20A probe ø 3.1mm probe L 225mm capillary pipe 890mm capillary pipe isolated 890mm gland nut probe SS		
For models:	E100I, E100I8, E100I9, E100I98, E100I9N, E100IA, E100IT9, E100IT9N, E150I, E150I8, E150I9, E150I98, E150I9N, E150IA, E150IT9, E150IT9N, E50I7, E50I77, EC408-SC, EC45, EC477, EC477-SC, EC49, EC498-SC, EC498T-SC, EC49T, EC66, EC777, EC777-SC, EC777T, EC902V, EC9082V-SC, EC992V, EC992VT, EC9982V-SC, EC9982VT-SC, LX7EC4, MG7E50I77, MG7EC477-SC, MG7EC777-SC, MINIMA EC 66		

 			
GEV No.	375375	Ref. No.	RTBF900081
description	safety thermostat switch-off temp. 230°C 3-pole 20A probe ø 6mm probe L 94mm capillary pipe 900mm capillary pipe isolated 670mm gland nut M10x1 probe SS		



GEV No.	375258	Ref. No.	182253 RTBF800164
description	safety thermostat switch-off temp. 232°C 3-pole 20A probe ø 6mm probe L 94mm capillary pipe 900mm capillary pipe isolated 670mm gland nut M10x1 probe SS		
For models:	EF12+12B, EF12+12S, EF12B, EF12S, EF20BP, EF25+25S, EF25S, EF45, EF46, EF47, EF472V, EF472VT, EF477, EF4772V, EF4772VT, EF477T, EF47T, EF49, EF49T, EF60BP, EF66, EF77, EF777, EF777T, EF77T, EF8+8B, EF8B, EF90, EF99, EF99T, MINIMA EF 46, MINIMA EF 66, OMNIA EF 47, OMNIA EF 47T, OMNIA EF 77, OMNIA EF472V, OMNIA EF472VT		



GEV No.	390181	Ref. No.	RTBF800192
description	safety thermostat switch-off temp. 420°C 3-pole 20A probe ø 3.9mm probe L 306mm capillary pipe 870mm capillary pipe isolated 850mm gland nut probe SS		
For models:	EBR, EBR7, EBR77, EBR9T, EBRA, EBRA9T, EBRAVI, EBRAVI9T, EBRI7, EBRI77, EBRVC98T, EBRVI, EBRVI98T, EBRVI9T, MG7EBR77, MG7EBRI77, OMNIA EBR7, OMNIA EBRI7		



GEV No.	375393	Ref. No.	53.7.0014.00
description	safety thermostat switch-off temp. 235°C 3-pole 1CO/2NC 20A probe ø 6mm probe L 87mm capillary pipe 1790mm capillary pipe isolated 1710mm gland nut M9x1 probe SS		
For models:	6FQ61E, 6FQ62E		

56._ series



GEV No.	390851	Ref. No.	236015
description	safety thermostat set switch-off temp. 225°C 1-pole NC 0.5A probe ø 6mm probe L 80mm capillary pipe 900mm capillary pipe isolated 450mm gland nut M10x1		



GEV No.	375228	Ref. No.	RTCU800152
description	safety thermostat switch-off temp. 350°C 3-pole 20A probe ø 3mm probe L 188mm capillary pipe 900mm capillary pipe isolated 900mm gland nut probe SS		
For models:	E4F, E4F77, E4F77Q, E4F8, E4F9, E4F98Q, E4F9Q, E4FP77Q, E4FP8, E6FA, E6FA77, E6FA77Q, E6FA8, E6FA9, E6FA98Q, E6FA9Q, EBM66, EBM90, EBR7, EBRI7, EF077, EF09, EFB09, EFT408L, EFT408LC, EFT408LR, EFT45L, EFT45LC, EFT45R, EFT45RC, EFT498L, EFT498LC, EFT498R, EFT49L, EFT49LC, EFT49R, EFT49RC, EFT908L, EFT908LC, EFT908LR, EFT908LRC, EFT908R, EFT90L, EFT90LC, EFT90LR, EFT90LRC, EFT90R, EFT90RC, EFT998L, EFT998LC...(Other models you can see in the webshop)		


IMIT / TEMPOMATIC / AR THERMO

control thermostats






GEV No.	390008	Ref. No.	019310-00 01931000R
description	thermostat t.max. 210°C temperature range 64-210°C 1-pole 1CO 16A probe ø 5mm probe L 100mm capillary pipe 1000mm capillary pipe isolated gland nut shaft L 19mm rotation 270° probe material copper		
accessories for	390008		

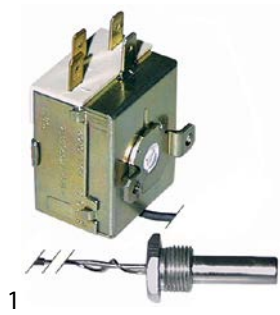
GEV No.	110102	Ref. No.	—
description	knob thermostat t.max. 210°C 40-210°C ø 42mm shaft ø 6x4.6mm shaft flat -135° black		






GEV No.	390421	Ref. No.	929107 DRT13B
description	thermostat t.max. 85°C temperature range 0-90°C 1-pole 1CO 16A probe ø 6.5mm probe L 95mm capillary pipe 1500mm capillary pipe isolated 1450mm gland nut shaft ømm shaft Lmm shaft position rotation 270° probe material copper		
For models:	BETA50, BETA53, L600, L61, L62, L63, L64, LK1000, LK100EM, LK1010, LK1100, LK1300, LP155, LP80, LP80H, LP93, LT121, LT150, LT151, LT152, LT161, LT202, LT221, LT271, LT272, LT362, LT91, LTD212, S58		





GEV No.	390005	Ref. No.	236014 926196
description	thermostat t.max. 85°C temperature range 25-85°C 1-pole 1CO 15A probe ø 11mm probe L 35mm capillary pipe 600mm capillary pipe isolated 600mm gland nut shaft ø 6x4.6mm shaft L 8mm shaft position upper° rotation 270° screw-in probe		
For models:	LK1000, LK100EM		
accessories for	390005		
	GEV No.	510417	Ref. No. 437002
	flat gasket fibre ED ø 20mm ID ø 14mm thickness 2mm Qty 1 pcs		
	GEV No.	550261	Ref. No. —
	nut thread M14x1 H 4mm WS 19 SS Qty 1 pcs		



GEV No.	390310	Ref. No.	DRT141
description	thermostat t.max. 85°C temperature range fixed 55°C 1-pole 1CO 16A probe ø 9.5mm probe L 37mm capillary pipe 600mm capillary pipe isolated 540mm gland nut shaft ømm shaft Lmm shaft position rotation° screw-in probe probe thread 3/8" probe material SS		
For models:	L600, L61, L62, L63, L64, LK1000, LK1010, LK1100, LK1300, LP80, LP80H, S58		
accessories for	390310		
	GEV No.	506024	Ref. No. —
	nut thread 3/8" H 6mm SS WS 22 Qty 1 pcs		
	GEV No.	529349	Ref. No. 437030
	flat gasket FIBER ED ø 22mm ID ø 16.5mm thickness 2mm for thread 3/8" Qty 1 pcs		



GEV No.	390006	Ref. No.	014688-00 01468800R 929044 DRT13L
description	thermostat t.max. 86°C temperature range 0-86°C 1-pole 1CO 16A probe ø 6.5mm probe L 95mm capillary pipe 1500mm capillary pipe isolatedmm gland nut shaft ø 6x4.6mm shaft L 19mm rotation 270°		
For models:	LT121, LT150, LT151, LT152, LT161, LT202, LT221, LT271, LT272, LT362, LT91		
accessories for	390006		
	GEV No.	110100	Ref. No. 929042 CWM11
	knob thermostat t.max. 90°C 0-90°C ø 42mm shaft ø 6x4.6mm shaft flat -135° black		
	GEV No.	110105	Ref. No. —
	rosette knob ø 42mm ø 56mm zero mark		



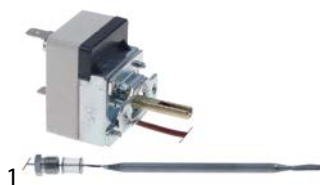
safety thermostats



GEV No.	390770	Ref. No.	927057 DRT14
description	safety thermostat switch-off temp. 90-110°C 1-pole 1CO 16/0.5A probe ø 6.5mm probe L 90mm capillary pipe 2000mm capillary pipe isolated 1950mm gland nut probe		
For models:	LT121, LT150, LT151, LT152, LT161, LT202, LT221, LT271, LT272, LT362, LT91, LTD209, LTD212, LTD216, LTD220, LTD316, LTD320, LTD326		

CAEM

control thermostats

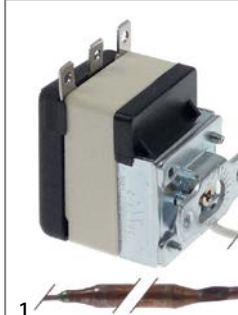


GEV No.	390777	Ref. No.	180498
description	thermostat t.max. 185°C temperature range 101-185°C 1-pole 1NC 16A probe ø 5mm probe L 107mm capillary pipe 950mm capillary pipe isolated 480mm gland nut M10x1 shaft ø 6x4.6mm shaft L 22mm rotation 270° 250V		
For models:	EF12+12B, EF12+12S, EF12B, EF12S, EF20BP, EF25+25S, EF25S, EF408, EF477, EF4772V, EF4772VT, EF477T, EF498, EF4982V, EF498L, EF498T, EF6+6BM, EF60BP, EF6BM, EF777, EF777T, EF8+8B, EF8B, EF8BM, EF908, EF998, EF998L, EF998T, MG7EF477, MG7EF4772V, MG7EF4772VT, MG7EF477T, MG7EF777, MG7EF777T		



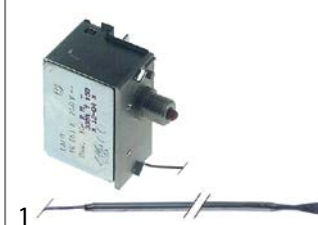
GEV No.	390672	Ref. No.	236042
description	thermostat t.max. 53°C temperature range fixed 53°C 1-pole 1CO 16A probe ø 9.5mm probe L 30mm capillary pipe 600mm capillary pipe isolated 540mm gland nut shaft Lmm screw-in probe probe thread M14x1		
For models:	KLB40, LB135, LB140, LB145, LB35, LB350, LB35C, LB40, LB400, LB45, LB450, LF50, LF500, LF59, LS500, LS500A, LS500G, LS500GA, LS500GPV, LS500PV, LS501, LS501A, LS501G, LS501GA, LS501GPV, LS501PV, LS505, LS505M, LS505T, LS520		

spare parts for	390672		
	GEV No.	Ref. No.	437002
	flat gasket fibre ED ø 20mm ID ø 14mm thickness 2mm Qty 1 pcs		
	GEV No.	Ref. No.	—
	nut thread M14x1 H 4mm WS 19 SS Qty 1 pcs		



GEV No.	390686	Ref. No.	236043
description	thermostat t.max. 83°C temperature range°C 1-pole 1CO 20A probe ø 6mm probe L 90mm capillary pipe 630mm capillary pipe isolated 550mm gland nut shaft ømm shaft Lmm shaft position rotation 270° probe material copper		
For models:	KLB40, LB135, LB140, LB145, LB35, LB350, LB35C, LB40, LB400, LB45, LB450, LF50, LF500, LF59, LK600, LK605, LS500, LS500A, LS500G, LS500GA, LS500GPV, LS500PV, LS501, LS501A, LS501G, LS501GA, LS501GPV, LS501PV, LS505, LS505M, LS505T, LS520		


safety thermostats



GEV No.	390874	Ref. No.	RTFOC00173
description	safety thermostat switch-off temp. 123°C 1-pole 16A probe ø 3mm probe L 200mm capillary pipe 920mm capillary pipe isolated 770mm gland nut probe SS		
For models:	FEM060, FEM061, FEM062, FEM100, FEM101, FEM102, FEM107, FEM107SC, FEM108, FEM108EL, FEM109, FEM110, FEM110L, FEM200, FEM201, FEM207, FEM207SC, FEM209, FEM210, FEM210L, FEM610, FEM610L, FEM67, FEM67SC, FEM68, FEM68EL, FEM69, FEMD108, FEMD108EL, FEMD68, FEMD68EL, FEP160, JOKER FEM 67 SC, JOKER FEM 69, JOKER FEM 69 AB 2002, JOKER FEM107 SC, JOKER FEM109, JOKER FEM109 AB 2002, JOKER FEM207 SC, JOKER FEM209		

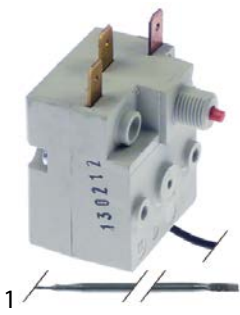


GEV No.	375996	Ref. No.	173768 180499 RIC0004363
description	safety thermostat switch-off temp. 225°C 1-pole 1NC 16A probe ø 5mm probe L 80mm capillary pipe 900mm capillary pipe isolated 410mm gland nut M10 probe SS 250V		
For models:	BGF777B, EF6+6BM, EF6BM, EF8BM, GF15+15S, GF15S, GF25+25S, GF25S, GF408, GF408N, GF477, GF4772V, GF4772VB, GF477B, GF477TS, GF498B, GF777, GF777B, GF777TS, GF908, GF908N, GF998B, MG7GF477, MG7GF4772V, MG7GF477TS, MG7GF777, MG7GF777TS		


GEV No.	390962	Ref. No.	177060
description	safety thermostat switch-off temp. 350°C 1-pole 1NC 16A probe ø 6mm probe L 78mm capillary pipe 900mm capillary pipe isolated 650mm gland nut M10x1 probe SS probe material SS 250V		
For models:	CME10-V380, CME4-V380, CME6-V380, CMFE102-V380, CMFE10-V380, CMFE6-V380, CMFG10-V380, CMFG6-V380, CYE10-V380, CYE6-V380, CYG10-V380, CYG6-V380, FCE108, FCE68, FCG108, FCG68, FEM108, FEM108EL, FEM68, FEM68EL, FEMD108, FEMD108EL, FEMD48, FEMD68, FEMD68EL, FGM108, FGM108EL, FGM68, FGM68EL, FGMD108, FGMD108EL, FGMD68, FGMD68EL		


PRODIGY / FIRT
safety thermostats




GEV No.	375478	Ref. No.	927106 DRT25
description	safety thermostat switch-off temp. 200°C temperature range°C 1-pole 1CO 20A probe ø 3.3mm probe L 190mm capillary pipe 2150mm capillary pipe isolatedmm gland nut probe SS		
For models:	LT121, LT150, LT151, LT152, LT161, LT202, LT221, LT271, LT272, LT362, LT91, LTD212		

refrigeration thermostats
universal without housing




GEV No.	390534	Ref. No.	01272700R
description	thermostat temperature range -35 up to +35°C probe ø6x110mm capillary pipe 1800mm PRODIGY		
accessories for	390534		
	GEV No.	110305	Ref. No.
			—
	knob thermostat t.max. 35°C temperature range -35 up to +35°C ø 45mm shaft ø 6x4.6mm shaft flat inclined rotation 270° white		

RANCO
K22 series




GEV No.	390524	Ref. No.	23591 R23591
description	thermostat RANCO type K22L1082 probe ømm probe Lmm capillary pipe 2000mm temperature range -22 up to -3°C		
For models:	CB955A, CB955W, ICE45A, ICE45W		




GEV No.	390207	Ref. No.	1LT020
description	thermostat RANCO type K22L2030 probe ø 2mm probe Lmm capillary pipe 2000mm temperature range -13 up to -4°C		
For models:	KF165A, KF185A, KL030A		

K50 series



GEV No.	390271	Ref. No.	013475-00 01347500R
description	thermostat RANCO type K50L3078 probe ømm probe Lmm capillary pipe 2000mm temperature range -7 up to -3°C		



GEV No.	390286	Ref. No.	23005 R23005
description	thermostat RANCO type K50L3383 probe ømm probe Lmm capillary pipe 1500mm temperature range +1 up to +3°C		
For models:	CB955A, CB955W, ICE45A, ICE45W		

RANCO



GEV No.	390272	Ref. No.	013477-00 013477-00R
description	thermostat RANCO type K50P1117 probe ømm probe Lmm capillary pipe 2000mm temperature range -32 up to -12°C		

RANCO



GEV No.	390273	Ref. No.	013471-00 01347100R
description	thermostat RANCO type K50L3194 capillary pipe 1870mm temperature range +1 up to +3°C probe ø10x40mm		

K59 series

RANCO



GEV No.	390960	Ref. No.	1LT019
description	thermostat RANCO type K59L1045 probe ø 2mm probe Lmm capillary pipe 2000mm icemaker		
For models:	KF165A, KF185A		

accessories

axis extensions



GEV No.	551063	Ref. No.	163796
description	shaft extension L1 23mm total length 45mm shaft ø 6mm Qty 1 pcs		

probe clips

spring clips

for thermostat



GEV No.	550258	Ref. No.	162111
description	probe clip for pipe ø 8mm for probe ø 6mm		
For models:	FG15M, FG20M, GF15+15S, GF15S, GF25+25S, GF25S		

gland nut accessories

ducts



GEV No.	550335	Ref. No.	53.3.0084.00
description	gland duct ET M14x1 IT M9x1 chrome-plated brass		
For models:	6BM61EM, 6BM62EM, 6FQ61E, 6FQ62E		

gaskets



GEV No.	550982	Ref. No.	RTFOC00751
description	gasket graphite ø 7.5mm L 7mm Qty 1 pcs for gland nut		
For models:	FEC023, FEMD023		

plunger sockets




GEV No.	513031	Ref. No.	929038 DZP22
description	thermowell L 125mm SS single		
For models:	LT150, LT81, LTD101, LTD131, LTD171, LTD212, LTD316, LTD320, LTD326, LTDX172, LTDX222, LTDX272		



GEV No.	550995	Ref. No.	999160
description	thermowell thread M14x1 ID ø 5mm L 40mm SS ø 9mm		
For models:	LF55E, LS511, LS511A, LS511PV		




connecting bows


			
1			
GEV No.	550060	Ref. No.	3700007 53.7.0012.00 RTBF900037 RTCU900112
description	connecting bow long for thermostat Qty 1 pcs		
For models:	?AQE477, 6BM61EM, 6BM62EM, 6BM62ET, 6BS61EM, 6BS62EM, 6CP61EM, 6CP62ET, 6FQ61E, 6FQ62E, 6FT61E, 6FT62E, AQE777, BC2G, BC3G, BC4G, BC6G, E2AR, E4AR, E4F, E4F7, E4F7Q, E4F9, E4F9Q, E6AR, E6FA, E6FA7, E6FA7Q, E6FA9, E6FA9Q, E6FAR, E6FM, E6FM8, EBM408, EBM45, EBM498T, EBM49T, EBM777, EBM90, EBM908, EBM998T, EBM99T, EBMA498, EBMA777, EBMA998, EBR6, EBR8, EBRVC98, EBRVI8, EBRVI98...(Other models you can see in the webshop)		


switches and momentary switches


rocker/momentary rocker switches


30x11mm

			
1			
GEV No.	345381	Ref. No.	017462-00 01746200R
description	rocker switch mounting measurements 30x11mm green 1NO/indicator light 24V 16A connection male faston 6.3mm		



			
1			
GEV No.	345382	Ref. No.	013473-00 01347300R
description	rocker switch mounting measurements 30x11mm green 1NO/indicator light 250V 16A 0-I connection male faston 6.3mm ambient temperature max. 85°C protection IP40		



			
1			
GEV No.	345386	Ref. No.	018153-00 01815300R
description	rocker switch mounting measurements 30x11mm yellow 1NO 250V 16A time/main switch connection male faston 6.3mm ambient temperature max. 90°C protection IP40		

			
1			
GEV No.	345384	Ref. No.	013519-00 01351900R
description	rocker switch mounting measurements 30x11mm yellow 1NO/indicator light 250V 16A 0-lighting connection male faston 6.3mm ambient temperature max. 90°C protection IP40		



			
1			
GEV No.	345383	Ref. No.	013474-00 01347400R
description	rocker switch mounting measurements 30x11mm yellow 1NO/indicator light 250V 16A fan connection male faston 6.3mm ambient temperature max. 90°C protection IP40		

30x22mm

			
1			
GEV No.	301018	Ref. No.	3700102
description	momentary rocker switch mounting measurements 30x22mm orange 2NO 250V 16A illuminated 0-I connection male faston 6.3mm ambient temperature max. 125/55°C protection IP65		
For models:	EC11803		
accessories for	301018		
			
GEV No.	301036	Ref. No.	—
description	protective cover internal size 30x22mm for rocker switch mounting measurementsmm		

			
1			
GEV No.	301003	Ref. No.	01273100R
description	rocker switch mounting measurements 30x22mm green 2NO 250V 16A illuminated 0-I connection male faston 6.3mm ambient temperature max. 125/55°C protection IP65		
For models:	M140BTAG, M140BTHG, M140BTJG, M140TNAG, M140TNHG, M140TNJG, M70BTAG, M70BTHG, M70BTJG, M70TNAG, M70TNHG, M70TNJG		
accessories for	301003		
			
GEV No.	301036	Ref. No.	—
description	protective cover internal size 30x22mm for rocker switch mounting measurementsmm		

blank


			
1			
GEV No.	345982	Ref. No.	53.7.0017.00
description	rocker switch mounting measurements 30x22mm green 2CO 250V 16A illuminated connection male faston 6.3mm ambient temperature max. 125/55°C protection IP65 with cover cap		
For models:	5RI61EM, 5RI62EM		
accessories for	345982		
			
GEV No.	301036	Ref. No.	—
description	protective cover internal size 30x22mm for rocker switch mounting measurementsmm		



labelled



1

GEV No.	300125	Ref. No.	23327 3700100
description	rocker switch mounting measurements 30x22mm green 2NO 230V 16A 0-1 connection male faston 6.3mm ambient temperature max. 125/55°C protection IP65 with cover cap		
For models:	CB955A, CB955W, EC11803, ICE45A, ICE45W		
accessories for	300125		
	GEV No.	301036	Ref. No. —
	protective cover internal size 30x22mm for rocker switch mounting measurementsmm		

push/momentary push switches

20.6x16.4mm



1

GEV No.	346595	Ref. No.	RTCU600189
description	momentary push switch mounting ø 20.6x16.4mm black 1NO 250V 16A ignition connection male faston 6.3mm ambient temperature max. 150/75°C protection IP40		
For models:	G4SF6, G4SFE6, G6SF6, G6SFA6, G6SFE6, G6SFEA6, MINIMA G4SF6, MINIMA G6SF6, MINIMA G6SFA6, MINIMA G6SFE6, MINIMA G6SFEA6		



1

GEV No.	345663	Ref. No.	RTCU600187
description	push switch mounting measurements 20.6x16.4mm black 1NO 250V 16A lamp connection male faston 6.3mm ambient temperature max. 150°C protection IP40		
For models:	G4SF6, G6SF6, G6SFA6, G6SFE6, G6SFEA6, MINIMA G4SF6, MINIMA G6SF6, MINIMA G6SFA6, MINIMA G6SFE6, MINIMA G6SFEA6		



1

GEV No.	345667	Ref. No.	RTCU600188
description	push switch mounting ø 20.6x16.4mm black 1NO 250V 16A heating connection male faston 6.3mm ambient temperature max. 150°C protection IP40		
For models:	G4SF6, G6SF6, G6SFA6, G6SFE6, G6SFEA6, MINIMA G4SF6, MINIMA G6SF6, MINIMA G6SFA6, MINIMA G6SFE6, MINIMA G6SFEA6		

28.5x28.5mm



1

GEV No.	346373	Ref. No.	RTFOC00387
description	push switch mounting measurements 28.5x28.5mm grey/red 1NO 250V 16A with indicator connection male faston 6.3mm ambient temperature max. 150°C protection IP40		
For models:	FCE10, FCE108, FCE20, FCE6, FCE68, FCG10, FCG108, FCG20, FCG6, FCG68, FEC065, FEC200, FEM200, FEM201, FEMD065, FEMD066, FEMD200, FEMD201, FEP050, FEP080, FEP160, FGC065, FGC200, FGM200, FGM201, FGMD065, FGMD066, FGMD200, FGMD201, FGP050, FGP080, FGP160, JOKER FCE 6, JOKER FCE 6 AB 2002, JOKER FCE 10, JOKER FCE 10 AB 2002, JOKER FCG 6, JOKER FCG 6 AB 2002, JOKER FCG 10, JOKER FCG 10 AB 2002, JOKER FEP050, JOKER FEP050 AB 2002, JOKER FEP080, JOKER FEP080 AB 2002, JOKER FEP160, JOKER FGP050, JOKER FGP050 AB 2002, JOKER FGP080, JOKER FGP080 AB 2002, JOKER FGP160		



1

GEV No.	301179	Ref. No.	RTFOC00362
description	push switch mounting measurements 28.5x28.5mm grey/red 2CO 250V 16A connection male faston 6.3mm ambient temperature max. 150°C protection IP40 with indicator		
For models:	FEC065, FEC200, FEM200, FEM201, FEMD065, FEMD066, FEMD200, FEMD201, FEP050, FEP080, FEP160, FGC065, FGC200, FGM200, FGM201, FGMD065, FGMD066, FGMD200, FGMD201, FGP050, FGP080, FGP160, JOKER FEP050, JOKER FEP050 AB 2002, JOKER FEP080, JOKER FEP080 AB 2002, JOKER FEP160, JOKER FGP050, JOKER FGP050 AB 2002, JOKER FGP080, JOKER FGP080 AB 2002, JOKER FGP160		

28.5x77.5mm



1

GEV No.	345625	Ref. No.	DEP61
description	switch combination latching mounting measurements 28.5x77.5mm black 2CO/2NO/2NO 250V 16A connection male faston 6.3mm ambient temperature max. 85°C protection IP40		
For models:	L61, L62, L63, L64		



1

GEV No.	345622	Ref. No.	DEP81
description	switch combination latching/latching/momentary mounting measurements 28.5x77.5mm black 2CO/2CO/2NO 250V 16A with indicator green/red connection male faston 6.3mm ambient temperature max. 150/75°C protection IP40		
For models:	S58		



accessories

push buttons



GEV No.	111758	Ref. No.	RTFOC00641 RTFOC00782
description	push button external size 23mm internal size 9mm black H 14mm		
For models:	FEC023, FEMD023, PLANET FEC023, PLANET FEMD023		

microswitches

lever actuated



GEV No.	345376	Ref. No.	01273000R
description	microswitch		



GEV No.	346182	Ref. No.	9353445500 RIC0002555
description	microswitch with lever 250V 10A 1CO connection male faston ambient temperature max. 85°C		
For models:	G4SF6, G4SFA6, G6SF6, G6SFA6, MINIMA G4SF6, MINIMA G6SF6, MINIMA G6SFA6		



GEV No.	345255	Ref. No.	161790
description	microswitch with lever 250V 16A 1CO connection male faston 6.3mm L 35mm L1 28mm ambient temperature max. 125°C mounting distance 22mm actuating force: 136g lever length 27mm		
For models:	EF12+12S, EF12S, EF20BP, EF25+25S, EF25S, EF60BP		



GEV No.	345742	Ref. No.	RTBF900277
description	microswitch with lever 250V 16A 1CO connection male faston 6.3mm L 55mm ambient temperature max. 120°C mounting distance 22mm actuating force: 75g lever length 46mm		
For models:	EF46, EF66, FEC023, FEMD023, MINIMA EF 46, MINIMA EF 66, PLANET FEC023, PLANET FEMD023		



GEV No.	345125	Ref. No.	927246 DEM11NT
description	microswitch with lever 250V 16A 1CO connection male faston 6.3mm ambient temperature max. 85°C mounting distance 25mm type C99ZP3 actuating force: 25g lever length 63.5mm		
For models:	LT121, LT150, LT151, LT152, LT161, LT202, LT221, LT271, LT272, LT362, LT81, LT91, LTD101, LTD131, LTD171, LTD209, LTD212, LTD216, LTD220, LTD316, LTD320, LTD326, LTDX172, LTDX222, LTDX272		

pin-plunger actuated



GEV No.	345105	Ref. No.	RTFOC00198
description	microswitch with plunger 250V 16A 1CO connection male faston 6.3mm L 28mm ambient temperature max. 125°C mounting distance 22mm type SM-51 actuating force: 280g black		
For models:	FEM062, FEM102, FEM109, FEM110, FEM110L, FEM200, FEM201, FEM202, FEM209, FEM210, FEM210L, FEM69, FEMD109, FEMD209, FEMD69, FGM062, FGM102, FGM109, FGM110, FGM110L, FGM200, FGM201, FGM202, FGM209, FGM210, FGM210L, FGM69, FGMD109, FGMD209, FGMD69, JOKER FEM 69, JOKER FEM 69 AB 2002, JOKER FEM109, JOKER FEM109 AB 2002, JOKER FEM209, JOKER FEMD 69, JOKER FEMD109, JOKER FEMD209, JOKER FGM 69, JOKER FGM109, JOKER FGM209, JOKER FGMD 69, JOKER FGMD109, JOKER FGMD209		


M10



GEV No.	346369	Ref. No.	173204 RTFOC00711
description	microswitch with plunger thread M10x0.75 thread L 27mm 250V 16A 1CO connection male faston 6.3mm stroke 14mm mounting distance 22mm L 43mm L1 15mm L2 42mm ambient temperature max. 125°C type VRSRE1DA1 actuating force: 150g		
For models:	FCE10, FCE6, FCG10, FCG6, FEM107, FEM107SC, FEM109, FEM110, FEM110L, FEM610, FEM610L, FEM67, FEM67SC, FEM69, FEMD107, FEMD107SC, FEMD109, FEMD67, FEMD67SC, FEMD69, FEP050, FEP080, FGM107, FGM107SC, FGM109, FGM110, FGM110L, FGM610, FGM610L, FGM67, FGM67SC, FGM69, FGMD107, FGMD107SC, FGMD109, FGMD67, FGMD67SC, FGMD69, FGP050, FGP080, JOKER FCE 6, JOKER FCE 6 AB 2002, JOKER FCE 10, JOKER FCE 10 AB 2002, JOKER FCG 6, JOKER FCG 6 AB 2002, JOKER FCG 10, JOKER FCG 10 AB 2002, JOKER FEM 67 SC, JOKER FEM 69...(Other models you can see in the webshop)		

accessories for	346369	GEV No.	100779	Ref. No.	—
					nut thread M10x0.75 H 3mm WS 14 SS Qty 2 pcs



			
1			
GEV No.	345032	Ref. No.	RTFOC00035
description	microswitch with plunger thread M10x1 thread L 12mm 250V 16A 1CO connection male faston 6.3mm stroke 7mm mounting distance 22mm L 28mm ambient temperature max. 125°C type SP9603 actuating force: 180g		
For models:	EF45, EF477, EF4772V, EF4772VT, EF477T, EF49, EF49T, EF777, EF777T, EF90, EF99, EF99T, FCE20, FCG20, FEC060, FEC065, FEC100, FEM060, FEM061, FEM062, FEM100, FEM101, FEM102, FEM110, FEM110L, FEM207, FEM207SC, FEM209, FEM210, FEM210L, FEM610, FEM610L, FEMD060, FEMD061, FEMD065, FEMD066, FEMD100, FEMD101, FEMD207, FEMD207SC, FEMD209, FEP050, FEP080, FEP160, FGC060, FGC065, FGC100, FGM060, FGM061, FGM062...(Other models you can see in the webshop)		


with push button

switches with snap-fit


			
1			
GEV No.	348008	Ref. No.	025063-00R
description	microswitch with push button 250V 2.5A 1NO/1NC connection male faston 2.8mm/6.3mm L 27mm L1 22mm ambient temperature max. 104°C actuating force: 180g		
For models:	M140BTA, M140BTAG, M140BTAH2, M140BTAP, M140BTH, M140BTHG, M140BTHH2, M140BTHP, M140BTJ, M140BTJG, M140BTJH2, M140BTJP, M140TNA, M140TNAG, M140TNAH2, M140TNAP, M140TNH, M140TNHG, M140TNHH2, M140TNHP, M140TNJ, M140TNJG, M140TNJH2, M140TNJP, M140TPJ, M140TPJH2, M70BTA, M70BTAG, M70BTAH, M70BTAP, M70BTH, M70BTHG, M70BTHH, M70BTHP, M70BTJ, M70BTJG, M70BTJH, M70BTJP, M70TNA, M70TNAG, M70TNAH, M70TNAP, M70TNH, M70TNHG, M70TNHH, M70TNHP, M70TNJ, M70TNJG, M70TNJH, M70TNJP...(Other models you can see in the webshop)		

roller actuated

roller 0°


			
1			
GEV No.	346370	Ref. No.	RTBF800113
description	microswitch with roller plunger 230V 16A 1CO connection screw L1 49mm ambient temperature max. 125°C thread L 14mm thread M10 mounting distance 25mm actuating force: 300g type MV15-2		
For models:	EBR, EBR77, EBR9T, EBRA, EBRA9T, EBRAVI, EBRAVI9T, EBRI77, EBRCV98T, EBRVI, EBRVI98T, EBRVI9T, GBR, GBR9T, GBRA, GBRA9T, GBRAVI, GBRAVI9T, GBRVC98T, GBRVI, GBRVI98T, GBRVI9T, MG7EBR77, MG7EBRI77		

accessories


			
1			
GEV No.	690799	Ref. No.	PACU700859
description	lever for microswitch		
For models:	EF45, EF477, EF4772V, EF4772VT, EF477T, EF49, EF49T, EF777, EF777T, EF90, EF99, EF99T		


position switches


HIGHLY


			
1			
GEV No.	347877	Ref. No.	927304
description	position switch 2NC 250V L 56mm W 21mm H 25mm 5A		
For models:	LTD-Rullerie-717066, LTD-Rullerie-717067, LTD-Rullerie-717086, LTD-Rullerie-717087, LT-Rullerie-717066, LT-Rullerie-717067, LT-Rullerie-717086, LT-Rullerie-717087		

system switches (ROLD)


			
1			
GEV No.	345721	Ref. No.	226102
description	blank cap holder		
For models:	LK600, LK605		


			
1			
GEV No.	345627	Ref. No.	226101
description	element holder mounting measurements 20.6x16.4mm black arched for push buttons 13x17mm		
For models:	LK100EM		


			
1			
GEV No.	345537	Ref. No.	226114
description	element holder mounting measurements 20.6x16.4mm grey arched for push buttons 13x17mm		
For models:	LB35, LB35C, LB40, LF50, LF59, LK100EM		


			
1			
GEV No.	347150	Ref. No.	226113
description	element holder mounting measurements 23.6x14.6mm grey arched for push buttons 11x21mm		
For models:	LF59		





			
1			
GEV No.	346201	Ref. No.	226080
description	element holder mounting measurements 28.5x77.5mm grey three-fold element holder		
For models:	LB45, LF50, LF59, LK100EM		


			
1			
GEV No.	345603	Ref. No.	REB226074
description	element holder triple mounting measurements 28.5x77.5mm black for push buttons 23x23mm		
For models:	BETA50, BETA53		


			
1			
GEV No.	345601	Ref. No.	299035
description	indicator lamp holder V ø 11mm		
For models:	KLB40, LB135, LB140, LB145, LB35, LB40, LB45, LF50, LF500, LF59		


			
1			
GEV No.	346241	Ref. No.	207011
description	indicator light lens ø 23.3mm yellow		
For models:	KLB40, LB135, LB140, LB145, LB35, LB40, LB45, LF50, LF500, LF59		


			
1			
GEV No.	345606	Ref. No.	226071
description	momentary switch unit 2CO 250V 16A connection male faston 6.3mm		
For models:	KLB40, LB135, LB140, LB145, LB35, LB350, LB355, LB35C, LB40, LB400, LB405, LB45, LB450, LF50, LF500, LF59, LS500, LS500A, LS500G, LS500GA, LS500GPV, LS500PV, LS501, LS501A, LS501G, LS501GA, LS501GPV, LS501PV, LS505, LS505M, LS505T, LS520		


			
1			
GEV No.	345650	Ref. No.	226095
description	momentary switch unit 2CO 250V 16A connection male faston 6.3mm		
For models:	LB140, LF500, LF59		

			
1			
GEV No.	347470	Ref. No.	227065
description	push button ø 21mm grey with lens shaft 3.5x3.5mm suitable for ROLD		

			
1			
GEV No.	347517	Ref. No.	227060
description	push button ø 21mm silver edition		
For models:	LB350, LB400, LB450, LK600, LS500, LS500A, LS500G, LS500GA, LS500GPV, LS500PV, LS501, LS501A, LS501G, LS501GA, LS501GPV, LS501PV, LS505, LS520		

			
1			
GEV No.	346211	Ref. No.	227036
description	push button ø 23mm grey with lens		
For models:	LK100EM		

			
1			
GEV No.	347152	Ref. No.	227067
description	push button size 11x21mm blue		
For models:	LF59		

			
1			
GEV No.	345621	Ref. No.	227056
description	push button size 17x13mm black		
For models:	LK100EM		



1

GEV No.	345539	Ref. No.	227068
description	push button size 17x13mm grey		
For models:	LB35, LB35C, LB40, LF50, LF59		



1

GEV No.	346035	Ref. No.	227062
description	push button size 17x13mm silver		
For models:	LK100EM		



1

GEV No.	345608	Ref. No.	409001 REB409001
description	rotary disc green/black disc \varnothing 20.6mm		
For models:	BETA50, BETA53, KLB40, LB135, LB140, LB145, LB35, LB40, LB45, LF50, LF500, LF59, LK100EM		



1

GEV No.	345605	Ref. No.	208010 REB208010
description	switch 2CO 250V 16A connection male faston 6.3mm		
For models:	BETA50, BETA53, KLB40, LB135, LB140, LB145, LB35, LB350, LB355, LB35C, LB40, LB400, LB405, LB45, LB450, LF50, LF500, LF59, LK600, LK605, LS500, LS500A, LS500G, LS500GA, LS500GPV, LS500PV, LS501, LS501A, LS501G, LS501GA, LS501GPV, LS501PV, LS505, LS505M, LS505T, LS520		



1

GEV No.	345651	Ref. No.	208011
description	switch 2CO 250V 16A connection male faston 6.3mm		
For models:	LB140, LF500, LF59		

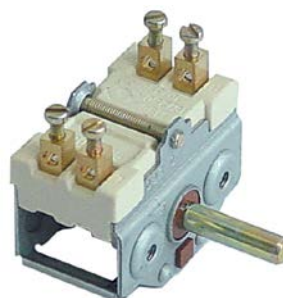


1

GEV No.	346851	Ref. No.	80804
description	switch 2CO 250V 16A connection male faston 6.3mm		
For models:	LK100EM		

cam switches

on/off



1

GEV No.	300151	Ref. No.	RTCU700212
description	cam switch 2 operating positions 2NO sequence 0-1 16A shaft \varnothing 6x4.6mm shaft L 23mm connection screw ceramic		
For models:	EBM45, EBM46, EBM47, EBM477, EBM66, EBM77, EBM90, EBMA477, EBR, EBR7, EBR77, EBR9T, EBRA, EBRA9T, EBRAVI, EBRAVI9T, EBRI7, EBRI77, EBRVC98T, EBRVI, EBRVI98T, EBRVI9T, ECC477, ECCA477, EF12+12B, EF12+12S, EF12B, EF12S, EF20BP, EF25+25S, EF25S, EF45, EF47, EF472V, EF472VT, EF477, EF477T, EF47T, EF49, EF49T, EF6+6BM, EF60BP, EF6BM, EF77, EF777, EF777T, EF8+8B, EF8B, EF8BM, EF90... (Other models you can see in the webshop)		

4-position



1

GEV No.	300104	Ref. No.	RTCP900036
description	cam switch 4 operating positions 3NO/1CO sequence 0-1-2-3 32A shaft \varnothing 6x4.6mm shaft L 23mm connection screw ceramic		
For models:	E100, E100A, E100I, E100I8, E100I9, E100I98, E100IA, E100IT9, E150, E150A, E150I, E150I8, E150I9, E150I98, E150IA, E150IT9, E50I7, E50I77, EC408-SC, EC45, EC477, EC477-SC, EC49, EC498-SC, EC498T-SC, EC49T, EC66, EC777, EC777-SC, EC777T, EC902V, EC9082V-SC, EC992V, EC992VT, EC9982V-SC, EC9982VT-SC, EFP01, LX7EC4, MG7E50177, MG7EC477-SC, MG7EC777-SC, MINIMA EC 66		



5-position



1

GEV No.	300147	Ref. No.	RTCU900068
description	cam switch 5 operating positions 1NO/2CO sequence 0-1-2-3-4 16A shaft ø 6x4.6mm shaft L 23mm connection screw 5-position		

7-position




1


GEV No.	300025	Ref. No.	53.7.0003.00 RTCU700078
----------------	--------	-----------------	----------------------------


description	cam switch 7 operating positions 1NO/2CO sequence 0-1-2-3-4-5-6 16A shaft ø 6x4.6mm shaft L 23mm connection screw 7-position ceramic		
--------------------	--	--	--

For models:	6PC61EM, 6PC62EM, 6PC62ET, C4EF70, C6EF70, E26, E27, E277, E277Q, E27Q, E29, E298AQ, E298Q, E29Q, E2A, E2A77, E2A77Q, E2AP77Q, E2AP8, E2AR, E46, E47, E477, E477Q, E47Q, E49, E498AQ, E498Q, E49Q, E4A, E4A77, E4A77Q, E4A8, E4AP77Q, E4AP8, E4AR, E4F, E4F6, E4F7, E4F77, E4F77Q, E4F7Q, E4F8, E4F9, E4F98Q, E4F9Q, E4FP77Q, E4FP8, E66, E67...(Other models you can see in the webshop)		
--------------------	---	--	--

accessories for	300025		
------------------------	--------	--	--

	GEV No.	112172	Ref. No.	—
	knob universal ø 70mm black without adaptor/dial plate			

	GEV No.	112213	Ref. No.	—
	knob dial plate silver switch 7-position t.max.°C ED ø 63mm ID ø 45.5mm			

	GEV No.	112311	Ref. No.	—
	knob adapter shaft ø 6x4.6mm L 0mm with spring			



1

GEV No.	300106	Ref. No.	RTCU800151
----------------	--------	-----------------	------------

description	cam switch 7 operating positions 1NO/2CO sequence 0-1-2-3-4-5-6 32A shaft ø 6x4.6mm shaft L 23mm connection screw 7-position shaft flat upper		
--------------------	---	--	--

For models:	E498AQ, E498Q, E49Q, E4A, E4A8, E4AR, E4F, E4F8, E4F98Q, E4F9Q, E698AQ, E698Q, E69Q, E6A, E6AR, E6FA, E6FA8, E6FA98Q, E6FA9Q, E6FAR, E6FM, E6FM8		
--------------------	--	--	--



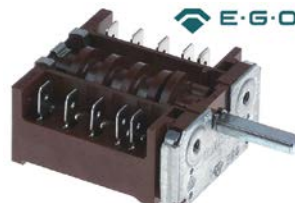
1

GEV No.	301223	Ref. No.	164122 RIC0004532
----------------	--------	-----------------	----------------------

description	cam switch 7 operating positions 3NO sequence 0-1-2-3-4-5-6 16A shaft ø 6x4.6mm shaft L 35mm connection male faston 6.3mm 7-position plastic		
--------------------	--	--	--

For models:	FEM107, FEM107SC, FEM207, FEM207SC, FEM67, FEM67SC, FEMD107, FEMD107SC, FEMD207, FEMD207SC, FGM107, FGM107SC, FGM207, FGM207SC, FGM67, FGM67SC, FGMD107, FGMD107SC, FGMD207, FGMD207SC, JOKER FEM107 SC		
--------------------	---	--	--

4 operating positions



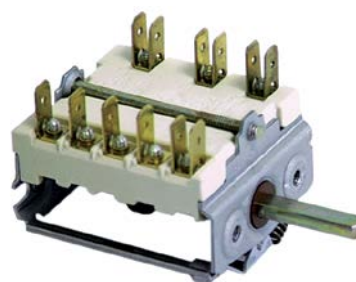
1

GEV No.	300229	Ref. No.	RTFOC00694
----------------	--------	-----------------	------------

description	cam switch 4 operating positions 4NO sequence 0-1-0-2 16A shaft ø 6x4.6mm shaft L 23mm connection male faston 6.3mm plastic		
--------------------	---	--	--

For models:	FCE10, FCE108, FCE20, FCE6, FCE68, FCG10, FCG108, FCG20, FCG6, FCG68, FEP050, FEP080, FEP160, FGP050, FGP080, FGP160, GC411-SC, GC911-SC, JOKER FCE 6, JOKER FCE 6 AB 2002, JOKER FCE 10, JOKER FCE 10 AB 2002, JOKER FCG 6, JOKER FCG 6 AB 2002, JOKER FCG 10, JOKER FCG 10 AB 2002, JOKER FEP050, JOKER FEP050 AB 2002, JOKER FEP080, JOKER FEP080 AB 2002, JOKER FEP160, JOKER FGP050, JOKER FGP050 AB 2002, JOKER FGP080, JOKER FGP080 AB 2002, JOKER FGP160		
--------------------	--	--	--

5 operating positions



1

GEV No.	301221	Ref. No.	RTFOC00143
----------------	--------	-----------------	------------

description	cam switch 5 operating positions 2NO/1CO sequence 0-4-3-2-1 16A shaft ø 6x4.6mm shaft L 23mm connection male faston 6.3mm ceramic		
--------------------	---	--	--

For models:	FEC200, FEM060, FEM061, FEM100, FEM101, FEM200, FEM201, FEMD023, FEMD060, FEMD061, FEMD065, FEMD066, FEMD100, FEMD101, FEMD200, FEMD201, FEP160, FGC200, FGM060, FGM061, FGM100, FGM101, FGM200, FGM201, FGMD060, FGMD061, FGMD065, FGMD066, FGMD100, FGMD101, FGMD200, FGMD201, FGP160, FMM060, FMM061, FMM100, FMM101, PLANET FEMD023		
--------------------	---	--	--



operation switches

E-G-O



1			
GEV No.	300166	Ref. No.	RTBF900083
description	cam switch 2 operating positions 4NO 16A sequence 0-1 shaft \varnothing 6x4.6mm shaft L 23mm connection male faston 6.3mm ceramic 4-pole ambient temperature max. 318°C		

E-G-O



1			
GEV No.	300080	Ref. No.	53.7.0002.00 RTBF900007
description	cam switch 2 operating positions 4NO 16A sequence 0-1 shaft \varnothing 6x4.6mm shaft L 23mm connection screw operation switch ceramic ambient temperature max. 150°C		
For models:	6BM61EM, 6BM62EM, 6BM62ET, 6CP61EM, 6CP62ET, 6FQ61E, 6FQ62E, EBM908, EBM998T, EBM99T, EBMA998, EBR6, EFT106L, EFT106LC, EFT106LR, EFT106LRC, EFT408L, EFT408LC, EFT408LR, EFT45L, EFT45LC, EFT45R, EFT45RC, EFT46L, EFT46LC, EFT46R, EFT46RC, EFT47L, EFT47LC, EFT47R, EFT47RC, EFT47L, EFT47LC, EFT47R, EFT47RC, EFT498L, EFT498LC, EFT498R, EFT49L, EFT49LC, EFT49R, EFT49RC, EFT66L, EFT66LC, EFT66LR, EFT66LRC, EFT66R, EFT66RC, EFT77L, EFT77LC...(Other models you can see in the webshop)		

accessories for	300080		
		GEV No.	551456
		Ref. No.	—
	gasket for switch ED \varnothing 14mm ID \varnothing 2.5mm thickness 3.5mm white		

E-G-O



1			
GEV No.	300115	Ref. No.	RTCU900258
description	cam switch 2 operating positions operation switch sequence 0-1 shaft \varnothing 6x4.6mm connection screw clamp 5-pole ambient temperature max. 318°C		
For models:	EFT45L, EFT45LC, EFT45R, EFT45RC, EFT90L, EFT90LC, EFT90LR, EFT90LRC, EFT90R, EFT90RC		

E-G-O



1			
GEV No.	300153	Ref. No.	RTCU700454
description	cam switch 3 operating positions operation switch 16A sequence 0-1-2 shaft \varnothing 6x4.6mm shaft L 23mm connection male faston 6.3mm plastic ambient temperature max. 240°C		
For models:	EF07V, EF0V77, EFO7V, G4SFEV77, MG7E4FVP77Q, MG7G4SFEV77, OMNIA EF07V		

1			
GEV No.	300191	Ref. No.	RTFOC00647
description	cam switch 3 operating positions operation switch sequence 0-1-2 shaft \varnothing 6x4.6mm connection male faston 3-pole ambient temperature max. 270°C		
For models:	FEC023, PLANET FEC023		

1			
GEV No.	300157	Ref. No.	RTCU600185
description	cam switch 4 operating positions operation switch sequence 0-1-2-3 shaft \varnothing 6x4.6mm connection male faston 3-pole ambient temperature max. 300°C		
For models:	E100I9N, E100IT9N, E150I9N, E150IT9N, E4F6, E6F6, E6FA6, G100I9N, G100IT9N, G150I9N, G150IT9N, G4SFE6, G6SFE6, G6SFEA6, MINIMA E4F6, MINIMA E6F6, MINIMA E6FA6, MINIMA G4SFE6, MINIMA G6SFE6, MINIMA G6SFEA6		


1			
GEV No.	300073	Ref. No.	RTCU700079
description	cam switch 6 operating positions 2NO/1CO 16A sequence 0-1-2-3-4-5 shaft \varnothing 6x4.6mm shaft L 23mm connection screw ceramic ambient temperature max. 150°C		
For models:	C4EF70, C6EF70, E4F7, E4F7Q, E6FA7, E6FA7Q, EF07, EFO7, EVC4F7, G2SDMFE7, G2SSMFE7, G4SFE7, G6SFEA7, GT4SF2E7, OMNIA E4F7, OMNIA E4F7Q, OMNIA E6FA7, OMNIA E6FA7Q, OMNIA EF07, OMNIA EVC4F7, OMNIA G4SFE7, OMNIA G6SFEA7		




1

GEV No.	300091	Ref. No.	3700003 53.7.0004.00 RTC900110
description	operation switch EGO 2 operating positions 2NO 16A sequence 0-1 shaft ϕ 6x4.6mm shaft L 23mm connection screw ceramic		
For models:	?AQE477, 6BM61EM, 6BM62EM, 6BM62ET, 6BS61EM, 6BS62EM, 6CP61EM, 6CP62ET, 6FQ61E, 6FQ62E, 6FT61E, 6FT62E, AQE777, BC2G, BC3G, BC4G, BC6G, E2AR, E4AR, E4F, E4F9, E4F9Q, E6AR, E6FA, E6FA9, E6FA9Q, E6FAR, E6FM8, EBM408, EBM45, EBM498T, EBM49T, EBM777, EBMA498, EBMA777, EBR8, EBRVC98, EBRV18, EBRV198, ECFT46, ECFT66, EF09, EF408, EF46, EF472VT, EF477, EF4772V, EF4772VT, EF477T, EF498...(Other models you can see in the webshop)		

miscellaneous




1

GEV No.	347628	Ref. No.	167516
description	cam switch shaft ϕ 6x4.6mm shaft L 23mm		
For models:	E4F77, E4F77Q, E4F8, E4F98Q, E4FP77Q, E4FP8, E6FA77, E6FA77Q, E6FA8, E6FA98Q, EF077, ETF77, EVC4F77, G4SFE77, G4SFE77P, G4SFE8, G4SFE98, G6SFEA77, G6SFEA8, G6SFEA98, GT45F2E77, HE4F77, MG7E4F77, MG7E4F77Q, MG7E4FP77Q, MG7E6FA77Q, MG7ETF77, MG7EVC4F77, MG7G4SFE77, MG7G6SFEA77		

rotary switches

BREMAS


A1200 series



1

GEV No.	300326	Ref. No.	927034 DEC59
description	rotary switch sets of contacts 6 0-1-2-3 type CS012015B 400V 12A shaft ϕ 5x5mm shaft L 18mm		
For models:	LT121, LT150, LT151, LT152, LT161, LT202, LT221, LT271, LT272, LT362, LT91		


A3200 series



1

GEV No.	345817	Ref. No.	RTBF800161
description	rotary switch 2 0-1 sets of contacts 4 type CS0327690 600V 32A shaft ϕ 5x5mm shaft L 26mm shaft square connection screw		
For models:	EF45, EF90		

miscellaneous




1

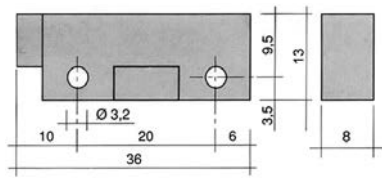
GEV No.	347689	Ref. No.	213002
description	rotary switch sets of contacts 2 2 0-1 type CS20-00063 690V 25A shaft ϕ 5x5mm shaft L 22mm shaft square connection male faston 6.3mm		
For models:	LK1000		


magnetic switches

36x13mm



1



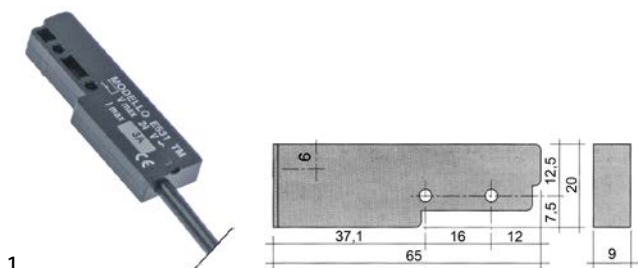
GEV No.	345118 ¹	Ref. No.	211002 211002AG 80871
description	magnetic switch L 36mm W 13mm 1NO 250V 1A P max. 50W connection cable length 980mm		
For models:	GOLD74, KLB40, LB135, LB140, LB145, LB35, LB350, LB355, LB35C, LB40, LB400, LB405, LB40E, LB411, LB411A, LB422, LB425, LB42BT-UK, LB45, LB450, LBD40, LBDX40, LF50, LF500, LF55E, LF56, LF59, LF60, LFD50, LFD60, LFDX50, LK100, LK100EM, LK110, LK130, LK600, LK605, LK611, LK620, LK621, LK622, LK622I, LK625, LKD130, LKDX110, LO65, LOD102, LOD202, LOD302, LOD304...(Other models you can see in the webshop)		
accessories for	345118		
	GEV No.	345399	Ref. No. 927088 CWM7
magnet ϕ 3.3mm L 40mm H 8mm W 13mm hole distance 30mm M3			

¹with coded connector

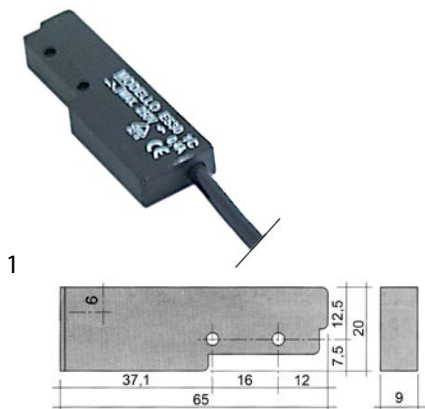


electric components


65x20mm



GEV No.	347876	Ref. No.	927056
description	magnetic switch L 65mm W 20mm 1NC 24V 4A P max. 100W connection cable length 1940mm		
For models:	LT161, LT221, LT271, LT272, LT362		



GEV No.	345116	Ref. No.	927017 DEM201
description	magnetic switch L 65mm W 20mm 1NO 250V 0.4A P max. 100W connection cable length 3000mm		
For models:	LO155, LO80, LO80H, LO93, LOD155, LOD80, LOD80H, LOD93, LP155, LP80, LP80H, LP93, LT121, LT150, LT151, LT152, LT161, LT202, LT221, LT271, LT272, LT362, LT81, LT91, LTD101, LTD131, LTD171		

accessories for	345116			
	GEV No.	345399	Ref. No.	927088 CWM7
	magnet ø 3.3mm L 40mm H 8mm W 13mm hole distance 30mm M3			


ø 6mm



GEV No.	345202	Ref. No.	DEM2038
description	magnetic switch 250V 0.04A P max. 10W probe L 29mm 1NO connection plug cable length 1400mm		
For models:	L600, L61, L62, L63, L64, LK1000, LK1010, LK1100, LK1300, S58		



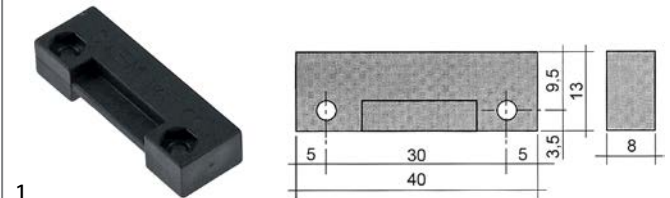
GEV No.	345630	Ref. No.	926195
description	magnetic switch 250V 0.04A P max. 10W probe L 29mm 1NO connection plug cable length 350mm		
For models:	LK1000		
accessories for	345630		

	GEV No.	345336	Ref. No.	926014 CWM8
	magnet ø 4.8mm L 63mm H 11mm W 18.8mm hole distance 51mm M4			



GEV No.	345146	Ref. No.	211001
description	magnetic switch 250V 1A P max. 50W probe L 29mm 1NO connection plug cable length 980mm		
For models:	LF56, LF60, LFD50, LFDX50		

accessories
magnets



GEV No.	345399	Ref. No.	927088 CWM7
description	magnet ø 3.3mm L 40mm H 8mm W 13mm hole distance 30mm M3		
For models:	GOLD74, LK100, LK100EM, LK110, LK130, LK600, LK605, LK611, LK622, LK622I, LKD130, LKDX110, LT121, LT150, LT151, LT152, LT161, LT202, LT221, LT271, LT272, LT362, LT81, LT91, LTD101, LTD131, LTD171, LTD209, LTD212, LTD216, LTD220, LTD316, LTD320, LTD326, LTDX172, LTDX222, LTDX272		



lamps

indicator lights

indicator lights 2-piece (lens and indicator lamp)

indicator light lenses

ø12mm (type SDY-3)



GEV No.	359262	Ref. No.	DEP142
description	indicator light housings mounting measurements ø12mm green round Qty 1 pcs		
For models:	L61, L62, L63, L64, S58		



GEV No.	359260	Ref. No.	926115 DEP140
description	indicator light housings mounting measurements ø12mm yellow round Qty 1 pcs		
For models:	L61, L62, L63, L64, LK1000, LK1010, LK1100, LK1300, LT121, LT151, LT152, LT161, LT202, LT221, LT271, LT272, LT362, LT91, S58		

indicator lamps for socket type SRZ / SDK / SDY / SFK



GEV No.	359130	Ref. No.	216006
description	indicator lamp 230V clear connection male faston 6.3mm ø 8mm		
For models:	KLB40, LB135, LB140, LB145, LB35, LB40, LB45, LF50, LF500, LF59		



GEV No.	359129	Ref. No.	927334 DEL99
description	indicator lamp 24V clear connection male faston 6.3mm		
For models:	LT121, LT151, LT152, LT161, LT202, LT221, LT271, LT272, LT362, LT91		



GEV No.	359132	Ref. No.	DEL31
description	indicator lamp green 250V connection male faston 6.3mm protection IP54 ambient temperature max. 85°C		
For models:	L61, L62, L63, L64, S58		

indicator lights (complete)

ø 6mm



GEV No.	359005	Ref. No.	216003 216025
description	indicator light ø 6mm 230V yellow cable length 400mm		
For models:	LB140, LB35, LB350, LB355, LB35C, LB40, LB400, LB405, LB450, LF50, LF500, LF59, LK600, LK605, LS500, LS500A, LS500G, LS500GA, LS500GPV, LS500PV, LS501, LS501A, LS501G, LS501GA, LS501GPV, LS501PV, LS505, LS505M, LS505T, LS520		



GEV No.	360735	Ref. No.	216032
description	indicator light ø 6mm yellow 12V cable length 280mm		
For models:	LS505M, LS505T		



GEV No.	359031	Ref. No.	DEL15
description	indicator light ø 6mm 230V green		
For models:	LK100EM		



GEV No.	359038	Ref. No.	DEL14
description	indicator light ø 6mm 230V red		
For models:	LK100EM		

ø10mm

with screw socket




GEV No.	359387	Ref. No.	3760002
description	indicator light ø 10mm 230V red cable length 250mm		
For models:	BC2G, BC3G, BC4G, BC6G		


with plug-in socket





GEV No.	359036	Ref. No.	53.7.0141.00
description	indicator light ø 10mm clear 230V connection male faston 6.3mm Qty 1 pcs		
For models:	6BM61EM, 6BM62EM, 6BM62ET, 6BS61EM, 6BS62EM, 6CP61EM, 6CP62ET, 6FQ61E, 6FQ62E, 6FT61E, 6FT62E, 6PC61EM, 6PC62EM, 6PC62ET		



			
1			
GEV No.	359230	Ref. No.	160505
description	indicator light ø 10mm green 230V connection male faston 2.8mm Qty 1 pcs		
For models:	E29, E29Q, E2A, E49, E49Q, E4A, E4F, E4F9, E4F9Q, E69, E69Q, E6FA9, E6FA9Q, EBM49T, EBM99T, EBR9T, EBRA9T, EBRAVI9T, EBRVI9T, EC45, EC49, EC49T, EC902V, EC992V, EC992VT, EF09, EF12+12B, EF12B, EF45, EF49, EF49T, EF6+6BM, EF6BM, EF8+8B, EF8B, EF8BM, EF90, EF99, EF99T, EFB09, EFT49L, EFT49LC, EFT49R, EFT49RC, EFT99L, EFT99LC, EFT99LR, EFT99LRC, EFT99R, EFT99RC...(Other models you can see in the webshop)		

			
1			
GEV No.	359139	Ref. No.	53.7.0142.00
description	indicator light ø 10mm green 230V connection male faston 6.3mm Qty 1 pcs		
For models:	6BM61EM, 6BM62EM, 6BM62ET, 6BS61EM, 6BS62EM, 6CP61EM, 6CP62ET, 6FQ61E, 6FQ62E, 6FT61E, 6FT62E		

			
1			
GEV No.	359231	Ref. No.	160506
description	indicator light ø 10mm yellow 230V connection male faston 2.8mm Qty 1 pcs		
For models:	E4F, E4F9, E4F9Q, E6FA9, E6FA9Q, EBM49T, EBM99T, EBR9T, EBRA9T, EBRAVI9T, EBRVI9T, EF09, EF12+12B, EF12B, EF45, EF49, EF49T, EF6+6BM, EF6BM, EF8+8B, EF8B, EF8BM, EF90, EF99, EF99T, EFB09, EFT49L, EFT49LC, EFT49R, EFT49RC, EFT99L, EFT99LC, EFT99LR, EFT99LRC, EFT99R, EFT99RC, G4SFE, G4SFE9, G6SFEA, G6SFEA9, GBR9T, GBRA9T, GBRAVI9T, GBRVI9T		


			
1			
GEV No.	359140	Ref. No.	216018 DEL10
description	indicator light ø 10mm yellow 230V connection male faston 6.3mm Qty 1 pcs		
For models:	L600, LK1000, LK1010, LK1100, LK1300		

ø12mm

with screw socket




			
1			
GEV No.	359291	Ref. No.	011486-00 01148600R
description	indicator light ø 12mm 400V green connection male faston 6.3mm		




with plug-in socket

			
1			
GEV No.	359042	Ref. No.	216012
description	indicator light ø 12mm yellow 230V connection male faston 6.3mm temp.-resist. 120°C Qty 1 pcs		

ø13mm

with screw socket

			
1			
GEV No.	359145	Ref. No.	166465 RTCU900489
description	indicator light ø 13mm 230V green t.max. 120°C		
For models:	?AQE477, AQE777, E100I8, E100I98, E100I9N, E100IT9N, E150I8, E150I98, E150I9N, E150IT9N, E26, E277, E277Q, E298AQ, E298Q, E2A77, E2A77Q, E2AP77Q, E2AP8, E46, E477, E477Q, E498AQ, E498Q, E4A77, E4A77Q, E4A8, E4AP77Q, E4AP8, E4F6, E4F77, E4F77Q, E4F8, E4F98Q, E4FP77Q, E4FP8, E50I77, E66, E677Q, E698AQ, E698Q, E6A77Q, E6F6, E6FA, E6FA6, E6FA77, E6FA77Q, E6FA8, E6FA98Q, E6FM8...(Other models you can see in the webshop)		
accessories for	359145		
		GEV No.	510302 Ref. No. —
		O-ring EPDM ID ø 12.42mm thickness 1.78mm Qty 1 pcs	
		GEV No.	511505 Ref. No. —
		O-ring EPDM thickness 1.78mm ID ø 12.42mm Qty 10 pcs	

			
1			
GEV No.	359146	Ref. No.	166466 DEL105A
description	indicator light ø 13mm 230V yellow		
For models:	?AQE477, AQE777, E100I9N, E100IT9N, E150I9N, E150IT9N, E4F6, E4F77, E4F77Q, E4F8, E4F98Q, E4FP77Q, E4FP8, E6F6, E6FA, E6FA6, E6FA77, E6FA77Q, E6FA8, E6FA98Q, E6FM8, EBM408, EBM45, EBM477, EBM498T, EBM66, EBM777, EBM90, EBM908, EBM998T, EBMA477, EBMA498, EBMA777, EBMA998, EBR6, EBR77, EBR8, EBRI77, EBRVC98, EBRVC98T, EBRVI8, EBRVI98, EBRVI98T, EF077, EF0V77, EF12+12B, EF12+12S, EF12B, EF12S, EF20BP...(Other models you can see in the webshop)		
accessories for	359146		
		GEV No.	510302 Ref. No. —
		O-ring EPDM ID ø 12.42mm thickness 1.78mm Qty 1 pcs	
		GEV No.	511505 Ref. No. —
		O-ring EPDM thickness 1.78mm ID ø 12.42mm Qty 10 pcs	



with plug-in socket



1

GEV No.	359142	Ref. No.	RTCU900070 RTCU900290
description	indicator light ø 13mm green 230V connection male faston 6.3mm temp.-resist. 120°C Qty 1 pcs		
For models:	E100, E100A, E100I, E100I9, E100IA, E100IT9, E150, E150A, E150I, E150I9, E150IA, E150IT9, E26, E27, E27Q, E2A, E2AR, E46, E47, E47Q, E4A, E4AR, E4F, E4F6, E4F7, E4F7Q, E50I7, E66, E67, E67Q, E6A, E6AR, E6F6, E6FA6, E6FA7, E6FA7Q, E6FAR, E6FM, EBM45, EBM46, EBM47, EBM66, EBM77, EBM90, EBR, EBR6, EBR7, EBRA, EBRAVI, EBRI7...(Other models you can see in the webshop)		



1

GEV No.	359141	Ref. No.	RTCU900071
description	indicator light ø 13mm red 230V connection male faston 6.3mm temp.-resist. 120°C Qty 1 pcs		
For models:	C4EF70, C6EF70, G6SF2, GBR, GBRA		



1

GEV No.	359143	Ref. No.	RTCU900072 RTCU900488
description	indicator light ø 13mm yellow 230V connection male faston 6.3mm temp.-resist. 120°C Qty 1 pcs		
For models:	C4EF70, C6EF70, E4F, E4F6, E4F7, E4F7Q, E6F6, E6FA6, E6FA7, E6FA7Q, E6FAR, E6FM, EBM45, EBM46, EBM47, EBM66, EBM77, EBM90, EBR, EBR6, EBR7, EBRA, EBRAVI, EBRI7, EBRVI, ECFT46, ECFT66, EF45, EF46, EF47, EF472V, EF472VT, EF47T, EF66, EF77, EF77T, EF90, EFO7V, EFT106L, EFT106LC, EFT106LR, EFT106LRC, EFT45L, EFT45LC, EFT45R, EFT45RC, EFT46L, EFT46LC, EFT46R, EFT46RC...(Other models you can see in the webshop)		

30x11mm



1

GEV No.	359058	Ref. No.	013472-00 01347200R RIC0002907
description	indicator light mounting measurements 30x11mm 230V green		

30x22mm



1

GEV No.	359157	Ref. No.	012732-00 01273200R
description	indicator light mounting measurements 30x22mm 230V green connection male faston 6.3mm temp.-resist. 125/55°C type RL2		
accessories for	359157		



GEV No.	301036	Ref. No.	—
description	protective cover internal size 30x22mm for rocker switch mounting measurementsmm		

LED

indicator lamps

mounting diameter 6mm



1

GEV No.	359404	Ref. No.	216028
description	indicator light LED mounting ø 6mm 5VDC green connection cable 200mm 2mA		
For models:	LK100EM		



1

GEV No.	358098	Ref. No.	216029
description	indicator light LED mounting ø 6mm 5VDC yellow connection cable 200mm 2mA		
For models:	LK100EM, LK600, LK605		

screw-on/push-on fit

light bulbs

for ovens



1


GEV No.	359610	Ref. No.	53.7.0054.00 9303310100 RIC0002592 RTFOC00658
description	light bulb t.max. 300°C socket E14 15W 230V ø 22mm L 47mm lens L 20mm for oven lamp type Philips		
For models:	5RI61EM, 5RI62EM, E4F6, E6F6, E6FA6, FEC023, FEMD023, FEMD48, G4SF6, G4SFA6, G4SFE6, G6SF6, G6SFA6, G6SFE6, G6SFEA6, MINIMA E4F6, MINIMA E6F6, MINIMA E6FA6, MINIMA G4SF6, MINIMA G4SFE6, MINIMA G6SF6, MINIMA G6SFA6, MINIMA G6SFE6, MINIMA G6SFEA6, PLANET FEC023, PLANET FEMD023		









1



GEV No.	359612	Ref. No.	RTFOC00037
description	light bulb t.max. 300°C socket E14 25W 230V ø 25mm L 56mm lens L 30mm for oven lamp type Philips		
For models:	FCE10, FCE20, FCE6, FCG10, FCG20, FCG6, FEC060, FEC065, FEC100, FEC200, FEM060, FEM061, FEM062, FEM100, FEM101, FEM102, FEM107SC, FEM109, FEM200, FEM201, FEM202, FEM207, FEM-207SC, FEM209, FEM67SC, FEM69, FEMD060, FEMD061, FEMD065, FEMD066, FEMD100, FEMD101, FEMD107SC, FEMD109, FEMD200, FEMD201, FEMD207, FEMD207SC, FEMD209, FEMD67SC, FEMD69, FEP050, FEP080, FEP160, FGC060, FGC065, FGC100, FGC200, FGM060, FGM061...(Other models you can see in the webshop)		






			
GEV No.	359838	Ref. No.	RTFOC00656
description	gasket ID ø 33mm ED ø 45mm		
For models:	FEC023, FEMD023, PLANET FEC023, PLANET FEMD023		

			
GEV No.	359837	Ref. No.	RTFOC00657
description	gasket ID ø 33mm ED ø 46mm thickness 1mm graphite		
For models:	FEC023, FEMD023, PLANET FEC023, PLANET FEMD023		

55x70mm			
			
GEV No.	357105	Ref. No.	177058
description	lamp socket socket G9 250V mounting measurements 55x70mm connection male faston 6.3mm H 32mm		
For models:	CME10-V380, CME4-V380, CME6-V380, CMFE102-V380, CMFE10-V380, CMFE6-V380, CMFG10-V380, CMFG6-V380, CYE10-V380, CYE6-V380, CYG10-V380, CYG6-V380, FCE108, FCE68, FCG108, FCG68, FEMD108, FEMD108EL, FEMD68, FEMD68EL, FGMD108, FGMD108EL, FGMD68, FGMD68EL		
accessories for	357105		
	GEV No.	359297	Ref. No. —
	frame L 95mm W 81mm mounting distance 68/83mm thickness 6mm		
	GEV No.	359299	Ref. No. —
	gasket L 91mm W 77mm hole ø 3mm for oven lamp		
	GEV No.	359937	Ref. No. —
	lamp glass L 80mm W 65mm mounting measurements 52x67mm		
	GEV No.	359945	Ref. No. —
	halogen lamp socket G9 230V 25W temp.-resist. 300°C		

			
GEV No.	357105	Ref. No.	177058
description	lamp socket socket G9 250V mounting measurements 55x70mm connection male faston 6.3mm H 32mm		
For models:	CME10-V380, CME4-V380, CME6-V380, CMFE102-V380, CMFE10-V380, CMFE6-V380, CMFG10-V380, CMFG6-V380, CYE10-V380, CYE6-V380, CYG10-V380, CYG6-V380, FCE108, FCE68, FCG108, FCG68, FEMD108, FEMD108EL, FEMD68, FEMD68EL, FGMD108, FGMD108EL, FGMD68, FGMD68EL		
accessories for	357105		
	GEV No.	359297	Ref. No. —
	frame L 95mm W 81mm mounting distance 68/83mm thickness 6mm		

accessories for	357105		
	GEV No.	359299	Ref. No. —
	gasket L 91mm W 77mm hole ø 3mm for oven lamp		
	GEV No.	359937	Ref. No. —
	lamp glass L 80mm W 65mm mounting measurements 52x67mm		
	GEV No.	359945	Ref. No. —
	halogen lamp socket G9 230V 25W temp.-resist. 300°C		










55x100mm			
			
GEV No.	359698	Ref. No.	RTFOC00036
description	lamp socket L 100mm W 55mm socket E14 connection male faston 6.3mm		
For models:	FCE10, FCE20, FCE6, FCG10, FCG20, FCG6, FEC060, FEC065, FEC100, FEC200, FEM060, FEM061, FEM062, FEM100, FEM101, FEM102, FEM107SC, FEM109, FEM200, FEM201, FEM202, FEM207, FEM207SC, FEM209, FEM67SC, FEM69, FEMD060, FEMD061, FEMD065, FEMD066, FEMD100, FEMD101, FEMD107SC, FEMD109, FEMD200, FEMD201, FEMD207, FEMD207SC, FEMD209, FEMD67SC, FEMD69, FEP050, FEP080, FEP160, FGC060, FGC065, FGC100, FGC200, FGM060, FGM061...(Other models you can see in the webshop)		
spare parts for	359698		
	GEV No.	358119	Ref. No. —
	frame L 118mm W 72mm mounting distance 143mm for bulb socket		
	GEV No.	358122	Ref. No. —
	gasket L 112mm W 68mm silicone thickness 3mm for bulb socket		
	GEV No.	358123	Ref. No. —
	lamp glass L 112mm W 68mm		
	GEV No.	359612	Ref. No. RTFOC00037
	light bulb t.max. 300°C socket E14 25W 230V ø 25mm L 56mm lens L 30mm for oven lamp type Philips		
	GEV No.	359714	Ref. No. 161283 RTFOC00202
	gasket for bulb socket		
	GEV No.	359715	Ref. No. RTFOC00201
	lamp glass L 110mm W 65mm thickness 5mm		
	GEV No.	359716	Ref. No. RTFOC00382
	frame for bulb socket		
accessories for	359698		
	GEV No.	359612	Ref. No. RTFOC00037
	light bulb t.max. 300°C socket E14 25W 230V ø 25mm L 56mm lens L 30mm for oven lamp type Philips		
	GEV No.	359938	Ref. No. —
	borosilicate glass L 115mm W 69mm		



			
1			
GEV No.	359716	Ref. No.	RTFOC00382
description	frame for bulb socket		
For models:	FCE10, FCE108, FCE20, FCE6, FCE68, FCG10, FCG108, FCG20, FCG6, FCG68, FEM107, FEM107SC, FEM108, FEM108EL, FEM109, FEM110, FEM110L, FEM207, FEM207SC, FEM209, FEM210, FEM210L, FEM610, FEM610L, FEM67, FEM67SC, FEM68, FEM68EL, FEM69, FEMD107, FEMD107SC, FEMD108, FEMD108EL, FEMD109, FEMD207, FEMD207SC, FEMD209, FEMD67, FEMD67SC, FEMD68, FEMD68EL, FEMD69, FEP050, FEP080, FEP160, FGM107, FGM107SC, FGM108, FGM108EL, FGM109...(Other models you can see in the webshop)		


			
1			
GEV No.	359714	Ref. No.	161283 RTFOC00202
description	gasket for bulb socket		
For models:	FCE10, FCE108, FCE20, FCE6, FCE68, FCG10, FCG108, FCG20, FCG6, FCG68, FEC060, FEC065, FEC100, FEC200, FEM060, FEM061, FEM062, FEM100, FEM101, FEM102, FEM107, FEM107SC, FEM108, FEM108EL, FEM109, FEM110, FEM110L, FEM200, FEM201, FEM202, FEM207, FEM207SC, FEM209, FEM210, FEM210L, FEM610, FEM610L, FEM67, FEM67SC, FEM68, FEM68EL, FEM69, FEMD060, FEMD061, FEMD065, FEMD066, FEMD100, FEMD101, FEMD107, FEMD107SC...(Other models you can see in the webshop)		

			
1			
GEV No.	359715	Ref. No.	RTFOC00201
description	lamp glass L 110mm W 65mm thickness 5mm		
For models:	FCE10, FCE108, FCE20, FCE6, FCE68, FCG10, FCG108, FCG20, FCG6, FCG68, FEC060, FEC065, FEC100, FEC200, FEM060, FEM061, FEM062, FEM100, FEM101, FEM102, FEM107, FEM107SC, FEM108, FEM108EL, FEM109, FEM110, FEM110L, FEM200, FEM201, FEM202, FEM207, FEM207SC, FEM209, FEM210, FEM210L, FEM610, FEM610L, FEM67, FEM67SC, FEM68, FEM68EL, FEM69, FEMD060, FEMD061, FEMD065, FEMD066, FEMD100, FEMD101, FEMD107, FEMD107SC...(Other models you can see in the webshop)		

			
1			
GEV No.	359698	Ref. No.	RTFOC00036
description	lamp socket L 100mm W 55mm socket E14 connection male faston 6.3mm		
For models:	FCE10, FCE20, FCE6, FCG10, FCG20, FCG6, FEC060, FEC065, FEC100, FEC200, FEM060, FEM061, FEM062, FEM100, FEM101, FEM102, FEM107SC, FEM109, FEM200, FEM201, FEM202, FEM207, FEM207SC, FEM209, FEM67SC, FEM69, FEMD060, FEMD061, FEMD065, FEMD066, FEMD100, FEMD101, FEMD107SC, FEMD109, FEMD200, FEMD201, FEMD207, FEMD207SC, FEMD209, FEMD67SC, FEMD69, FEP050, FEP080, FEP160, FGC060, FGC065, FGC100, FGC200, FGM060, FGM061...(Other models you can see in the webshop)		
spare parts for	359698		
	GEV No.	358119	Ref. No. —
		frame L 118mm W 72mm mounting distance 143mm for bulb socket	
	GEV No.	358122	Ref. No. —
		gasket L 112mm W 68mm silicone thickness 3mm for bulb socket	
	GEV No.	358123	Ref. No. —
		lamp glass L 112mm W 68mm	
	GEV No.	359612	Ref. No. RTFOC00037
		light bulb t.max. 300°C socket E14 25W 230V ø 25mm L 56mm lens L 30mm for oven lamp type Philips	
	GEV No.	359714	Ref. No. 161283 RTFOC00202
		gasket for bulb socket	
	GEV No.	359715	Ref. No. RTFOC00201
		lamp glass L 110mm W 65mm thickness 5mm	
accessories for	359698		
	GEV No.	359612	Ref. No. RTFOC00037
		light bulb t.max. 300°C socket E14 25W 230V ø 25mm L 56mm lens L 30mm for oven lamp type Philips	
	GEV No.	359938	Ref. No. —
		borosilicate glass L 115mm W 69mm	

lamps

light bulbs

			
1			
GEV No.	359610	Ref. No.	53.7.0054.00 9303310100 RIC0002592 RTFOC00658
description	light bulb t.max. 300°C socket E14 15W 230V ø 22mm L 47mm lens L 20mm for oven lamp type Philips		
For models:	5RI61EM, 5RI62EM, E4F6, E6F6, E6FA6, FEC023, FEMD023, FEMD48, G4SF6, G4SFA6, G4SFE6, G6SF6, G6SFA6, G6SFE6, G6SFEA6, MINIMA E4F6, MINIMA E6F6, MINIMA E6FA6, MINIMA G4SF6, MINIMA G4SFE6, MINIMA G6SF6, MINIMA G6SFA6, MINIMA G6SFE6, MINIMA G6SFEA6, PLANET FEC023, PLANET FEMD023		





1

GEV No.	360723	Ref. No.	RTFOC00030
description	timer CDC 11903F3 engines 1 chambers 3 operation time 80min 230V shaft ø 6x4.6mm shaft L 18mm manuf. no. 11903F3EVE000.0000		
For models:	FEC060, FEC100, FEC200, FEM060, FEM061, FEM100, FEM101, FEM200, FEM201, FEMD060, FEMD061, FEMD100, FEMD101, FEMD200, FEMD201, FEP050, FEP080, FEP160, FGC060, FGC100, FGC200, FGM060, FGM061, FGM100, FGM101, FGM200, FGM201, FGMD060, FGMD061, FGMD100, FGMD101, FGMD200, FGMD201, FGP050, FGP080, FGP160, FMM060, FMM061, FMM100, FMM101, JOKER FEP050, JOKER FEP050 AB 2002, JOKER FEP080, JOKER FEP080 AB 2002, JOKER FEP160, JOKER FGP050, JOKER FGP050 AB 2002, JOKER FGP080, JOKER FGP080 AB 2002, JOKER FGP160		





1

GEV No.	360566	Ref. No.	23259
description	timer CDC 11904 engines 1 chambers 4 operation time 15min 115V 60Hz shaft ømm shaft Lmm manuf. no. 11904F1BEI000.0010 motor type M48R ATS voltage AC		
For models:	CB955A, CB955W, ICE45A, ICE45W		





1

GEV No.	360525	Ref. No.	23247
description	timer CDC 11904 engines 1 chambers 4 operation time 10min 230V shaft ømm shaft Lmm manuf. no. 11904F1 / BCR000.0000 motor type M48R ATS		
For models:	CB955A, CB955W		
spare parts for	360525		
		GEV No.	360118
		Ref. No.	—
	motor CDC pinion ø 4.9mm teeth 10 230V voltage AC 50/60Hz turn direction right motor ø 47mm H 19.3mm motor type M48R ATS for timer cable length 260mm 1.9/2.5W		





1

GEV No.	360550	Ref. No.	23248
description	timer CDC 11904 engines 1 chambers 4 operation time 15min 230V 50/60Hz shaft ømm shaft Lmm manuf. no. 11904F1 / BER000.0000		
For models:	CB955A, CB955W, ICE45A, ICE45W		
spare parts for	360550		
		GEV No.	360118
		Ref. No.	—
	motor CDC pinion ø 4.9mm teeth 10 230V voltage AC 50/60Hz turn direction right motor ø 47mm H 19.3mm motor type M48R ATS for timer cable length 260mm 1.9/2.5W		



1


GEV No.	360524	Ref. No.	23222
description	timer CDC 11904 engines 1 chambers 4 operation time 12min 230V shaft ømm shaft Lmm manuf. no. 11904F1 / BDR000.0000 motor type M48R ATS		
For models:	CB955A, CB955W, ICE45A, ICE45W		
spare parts for	360524		
		GEV No.	360118
		Ref. No.	—
	motor CDC pinion ø 4.9mm teeth 10 230V voltage AC 50/60Hz turn direction right motor ø 47mm H 19.3mm motor type M48R ATS for timer cable length 260mm 1.9/2.5W		







1


GEV No.	360565	Ref. No.	23780
description	timer CDC 11904 engines 1 chambers 4 operation time 18min 230V 50/60Hz shaft ømm shaft Lmm manuf. no. 11904F1BFE000.0030 motor type M48R ATS voltage AC		
For models:	CB955A, CB955W		



1




GEV No.	360025	Ref. No.	238050AG REB238050
description	timer CDC 7003F engines 1 chambers 3 operation time 360s 230V 50Hz shaft ø 6x7mm shaft L 26mm manuf. no. 7003F3 / 360025 motor type M37LN		
For models:	L600, LK1000, LK1010, LK1100, LK1300		
spare parts for	360025		
	GEV No.	360131	Ref. No. —
	motor CDC pinion ø 5.4mm teeth 12 230V turn direction left motor ø 37mm motor type M37LN for timer		
accessories for	360025		
	GEV No.	110085	Ref. No. 226051
	push button t.max.°C°C ø 36mm shaft ømm shaft flat grey for knob		
	GEV No.	110086	Ref. No. 447089
	knob switch zero mark t.max.°C°C ø 45mm shaft ømm shaft flat special black		
	GEV No.	110087	Ref. No. 499066
	retaining ring shaft ø 8mm DIN 471		



1




GEV No.	360133	Ref. No.	238066
description	timer CDC 7804DV engines 2 chambers 4 operation time 60s / 20min 230V shaft ømm shaft Lmm manuf. no. 7804DV / 360133 motor type M37RN/M37LN		
For models:	LF50, LF500, LF55, LF550, LF551		
spare parts for	360133		
	GEV No.	360119	Ref. No. —
	motor CDC pinion ø 5.4mm teeth 12 230V turn direction right motor ø 37mm motor type M37RN for timer		
	GEV No.	360131	Ref. No. —
	motor CDC pinion ø 5.4mm teeth 12 230V turn direction left motor ø 37mm motor type M37LN for timer		


1



GEV No.	360264	Ref. No.	238073
description	timer CDC 7805DV engines 2 chambers 5 operation time 72s/20min 230V shaft ømm shaft Lmm manuf. no. 7805DV / 238073 motor type M37RN/M37LN		
For models:	LF59		
spare parts for	360264		
	GEV No.	360119	Ref. No. —
	motor CDC pinion ø 5.4mm teeth 12 230V turn direction right motor ø 37mm motor type M37RN for timer		
	GEV No.	360131	Ref. No. —
	motor CDC pinion ø 5.4mm teeth 12 230V turn direction left motor ø 37mm motor type M37LN for timer		

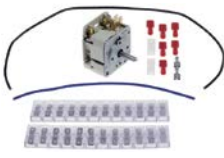
1




GEV No.	360051	Ref. No.	1LT017
description	timer FIBER P36 engines 1 chambers 2 operation time 15min 230V shaft ømm shaft Lmm manuf. no. P365JR2J717 motor type M51B-JOR6400		
For models:	KL030A, KL030W		
spare parts for	360051		
	GEV No.	360673	Ref. No. —
	motor kit pinion ø 6.8mm teeth 15 230V voltage AC 50/60Hz turn direction clockwise motor ø 48mm H 18.5mm motor type UDS-40NE1RNZ165 cable length 150mm with holder		

electric timers


1




GEV No.	350082	Ref. No.	RTFOC00699 old
description	timer 1CO/1NO at 250V 16A permanent position yes impulse electric shaft ø 6x4.6mm shaft L 23mm mounting distance 28mm connection lateral 2-pole operation time 120min		

1


GEV No.	350118	Ref. No.	RIC0004523 RTCFOC00699
description	timer MS65 operation time 120min time spreadmin 1CO/1NO permanent position no impulse electric 16(4)A shaft ø 6x4.6mm shaft 6x4.6mm shaft L 23mm 2-pole		
accessories for	350118		
	GEV No.	112070	Ref. No. 160910
	knob zero mark ø 56mm shaft ø 6x4.6mm shaft flat upper silver		





1

GEV No.	360058	Ref. No.	012720-01 01272001R
description	defrost timer type SB3.82 defrosting interval 1-12x in 24h defrosting time 2-54min fan delay 0-15min 230V defr. funct. 1-12x per 24h		

mechanical timers




1

GEV No.	350003	Ref. No.	RTFOC00568
description	timer M2 with bell 2-pole operation time 120min impulse mechanical 2NO at 250V 16A permanent position no shaft ø 6x4.6mm shaft 6x4.6mm shaft L 23mm mounting distance 28mm connection lateral		
For models:	FEC023, FEMD023, PLANET FEC023, PLANET FEMD023		
accessories for	350003		
	GEV No.	110366	Ref. No. —
	knob switch zero mark t.max.°C ø 44mm shaft ø 6x4.6mm shaft flat upper black		
	GEV No.	111199	Ref. No. —
	dial plate graduation 120min permanent position no rotation 0-330° ø 60mm timers knob ø 45mm		

alarm devices

buzzers




1

GEV No.	350084	Ref. No.	RTFOC00046
description	buzzer 230VAC buzzer		
For models:	FCE10, FCE20, FCE6, FCG10, FCG20, FCG6, FEC060, FEC065, FEC100, FEC200, FEM060, FEM061, FEM100, FEM101, FEM200, FEM201, FEMD060, FEMD061, FEMD065, FEMD066, FEMD100, FEMD101, FEMD200, FEMD201, FEP050, FEP080, FEP160, FGC060, FGC065, FGC100, FGC200, FGM060, FGM061, FGM100, FGM101, FGM200, FGM201, FGMD060, FGMD061, FGMD065, FGMD066, FGMD100, FGMD101, FGMD200, FGMD201, FGP050, FGP080, FGP160, FMM060, FMM061...(Other models you can see in the webshop)		

defrost timers

BIGATTI




1

GEV No.	360053	Ref. No.	013467-00 01346700R
description	defrost timer BIGATTI type D94.44 defrosting interval 4x per 24h defrosting time 10min fan delayin 230V defr. funct. every 12h for 20 min.		

contactors

LS Industrial Systems

power contactors



1

GEV No.	381167	Ref. No.	229042 H.775599-001
description	power contactor resistive load 20A 230VAC (AC3/400V) 9A/4kW main contacts 4NO auxiliary contacts connection screw connection type GMC-9M/4		
For models:	LF55E, LS505T, LS511, LS511A, LS511PV, LS520-CRP, LS521-CRP-SP, LS522, LS525		



GENERAL ELECTRIC (AEG)

power contactors



1

GEV No.	380231	Ref. No.	926147
description	power contactor resistive load 16A 230VAC (AC3/400V) 6A/3kW main contacts 3NO auxiliary contacts 1NC connection screw connection type AEG LS0701A		
For models:	GOLD74		



1

GEV No.	380239	Ref. No.	926040
description	power contactor resistive load 20A 230VAC (AC3/400V) 8.4A/4kW main contacts 3NO auxiliary contacts 1NC connection screw connection type LS05 01A type AEG LS05 01A type GE MC1A 301A		
For models:	LTD171, LTDX222, LTDX272		



1

GEV No.	380238	Ref. No.	229032
description	power contactor resistive load 20A 230VAC (AC3/400V) 8.4A/4kW main contacts 3NO auxiliary contacts 1NO connection screw connection type LS0510A type AEG LS0510A type GE MC1A 310A		
For models:	LF55E		



1

GEV No.	380245	Ref. No.	DTC112
description	power contactor resistive load 25A 230VAC (AC3/400V) 9A/4kW main contacts 3NO auxiliary contacts 1NC connection screw connection type AEG LS4K 01A type GE CL00A 301 H 85mm		
For models:	L61, L62, L63, L64, LK1000, LK1010, LK1100, LK1300		



1

GEV No.	381191	Ref. No.	926282 DTC112NO
description	power contactor resistive load 25A 400VAC (AC3/400V) 12A/5.5kW main contacts 3NO auxiliary contacts 1NO connection screw connection type AEG type GE CL01A310T6		
For models:	LK130, LK621, LKD130, LO155, LO80, LO80H, LO93, LOD155, LOD304, LOD402, LOD80, LOD80H, LOD93, LP80		

ISKRA (FANAL)

power contactors



1

GEV No.	380211	Ref. No.	3700037
description	power contactor 230VAC		
For models:	BC3G, BC4G		



1

GEV No.	380213	Ref. No.	019033-00 01903300R 3700080
description	power contactor resistive load 20A 230VAC (AC3/400V) 8.5A/5.5kW main contacts 3NO auxiliary contacts 1NO connection screw connection type Fanal DSL7 10 type ISKRA K07M 10		
For models:	EC11803		



LOVATO

power contactors



GEV No.	380888	Ref. No.	164608 RTCU600233 RTFOC00465
description	power contactor resistive load 20A 230VAC (AC3/400V) 12A/5.7kW main contacts 3NO auxiliary contacts 1NC connection screw connection type 11BG1201A230		
For models:	CME4-V380, CME6-V380, CMFE6-V380, CMFG6-V380, CMG6-V380, CYE6-V380, CYG6-V380, E50177, EBR77, EBRI77, EF12+12B, EF12+12S, EF12B, EF12S, EF20BP, EF25+25S, EF25S, EF46, EF477, EF4772V, EF4772VT, EF477T, EF60BP, EF66, EF777, EF777T, EF8+8B, EF8B, EFT45L, EFT45LC, EFT45R, EFT45RC, EPL46, EPL66, FCE6, FCE68, FCG10, FCG108, FCG20, FCG6, FCG68, FEM107, FEM107SC, FEM109, FEM207, FEM207SC, FEM209, FEM67, FEM67SC, FEM69...(Other models you can see in the webshop)		



GEV No.	380525	Ref. No.	RTBF800165 RTCU600371
description	power contactor resistive load 25A 230VAC (AC3/400V) 9A/4.2kW main contacts 4NO auxiliary contacts connection screw connection type BF09T4A230		
For models:	EF45, EF90, EFT47L, EFT47LC, EFT47R, EFT47RC, EFT77L, EFT77LC, EFT77LR, EFT77LRC, EFT77R, EFT77RC		

SIEMENS

power contactors



GEV No.	381391	Ref. No.	25005108
description	power contactor resistive load 16A 24VAC (AC3/400V) 4kW main contacts 3NO auxiliary contacts 1NO connection F6.3 type 3TG1010-1AC2		



GEV No.	381387	Ref. No.	73350
description	power contactor resistive load 22A 230VAC (AC3/400V) 4kW main contacts 3NO auxiliary contacts 1NO connection screw connection type 3RT2016-1AP01		
For models:	LK605, LK622, LK622I, LTD212		



GEV No.	380389	Ref. No.	229037
description	power contactor resistive load 22A 230VAC (AC3/400V) 9A/4kW main contacts 3NO auxiliary contacts 1NO connection screw connection type 3RT10-16-1AP01		
For models:	LF56, LF60, LFD50, LFD60, LFDX50, LK100, LK100EM, LK110, LK611, LKD130, LKDX110, LO155, LO65, LO80, LO80H, LO93, LOD155, LOD65, LOD80, LOD80H, LOD93, LP80, LP800-00-092, LP92, LS521, LT81		



GEV No.	380957	Ref. No.	927160
description	power contactor resistive load 22A 24VAC (AC3/400V) 12A/5.5kW main contacts 3NO auxiliary contacts 1NO connection screw connection type 3RT10-17-1AB01 50/60Hz		
For models:	LTD316, LTD320, LTD326, LTDX172, LTDX222, LTDX272		



GEV No.	380390	Ref. No.	80351
description	power contactor resistive load 40A 230VAC (AC3/400V) 12A/5.5kW main contacts 3NO auxiliary contacts connection screw connection type 3RT10-24-1AL20 50/60Hz		
For models:	LOD305, LOD502, LT81, LTD101, LTD131, LTD171, LTD209, LTD212, LTD216, LTD220		



1

GEV No.	380524	Ref. No.	RTFOC00598
description	power contactor resistive load 50A 230VAC (AC3/400V) 32A/15kW main contacts 3NO connection screw connection type 3RT10-34-1AL20		
For models:	EF45, EF49, EF49T, EF90, EF99, EF99T, FCE20, FEM107, FEM207, FEM-207SC, FEM209, FEMD207, FEMD207SC, FEMD209, FEP160, FGM207, JOKER FEM207 SC, JOKER FEM209, JOKER FEMD207 SC, JOKER FEMD209, JOKER FEP160		

auxiliary contacts



1

GEV No.	381389	Ref. No.	DEI4
description	auxiliary contact contacts 1NO/1NC AC15 6A for contactors 3RT1 connection screw AC1 10A type 3RH1921-1DA11		
For models:	LOD305, LOD502		

motor protection circuit breakers



1

GEV No.	380541	Ref. No.	927368 DEI35
description	motor protection circuit breaker type 3RV1011-0JA10 setting range 0.7-1A (AC3/400V) 0.25kW		
For models:	LT81, LTD101, LTD131, LTD171, LTD209, LTD212, LTD216, LTD220, LTD316, LTD320, LTD326, LTDX172, LTDX222, LTDX272		

ALLEN BRADLEY

power contactors



1

GEV No.	380523	Ref. No.	RTFOC00466
description	power contactor resistive load 32A 230VAC (AC3/400V) 9A/4kW main contacts 3NO auxiliary contacts 1NO connection screw connection type 100-C09KF10		
For models:	?AQE477, AQE777, E1001, E10018, E10019, E100198, E10019N, E100IT9, E100IT9N, E1501, E15018, E15019, E150198, E15019N, E150IT9, E150IT9N, EBR8, EBRVC98, EBRVC98T, EBRV18, EBRV198, EBRV198T, EF477, EF4772V, EF4772VT, EF477T, EF4982V, EF777, EF777T, EF99, EF99T, EMT477, EMT777, FCE10, FCE108, FCE6, FCE68, FCG68, FEM107, FEM-107SC, FEM109, FEM207, FEM207SC, FEM209, FEMD107, FEMD107SC, FEMD109, FEP080, JOKER FCE 6, JOKER FCE 6 AB 2002...(Other models you can see in the webshop)		

solid state relays

CELDUC



1

GEV No.	403040	Ref. No.	RIC0003591
description	solid state relay CELDUC 1 phase 25A 24-520V 4-30VDC L 58mm W 44mm screw type SC762110V 4-30VDC		
For models:	FEM108, FEM108EL, FEM110, FEM110L, FEM210, FEM210L, FEM220, FEM220L, FEM240, FEM240L, FEM610, FEM610L, FEM68, FEM68EL, FEMD108, FEMD108EL, FEMD68, FEMD68EL, FGM108, FGM108EL, FGM110, FGM110L, FGM210, FGM210L, FGM610, FGM610L, FGM68, FGM68EL, FGMD108, FGMD108EL, FGMD68, FGMD68EL		



relays

power relays

with DIN rail mounting

lateral



1

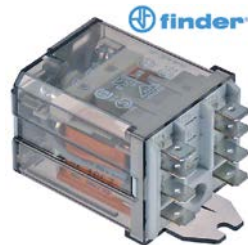
GEV No.	380313	Ref. No.	229036
description	power relays FINDER 230VAC 16A 3CO connection male faston DIN rail manuf. no. 62.83.8.230.0008		
For models:	LF55, LF55E, LF59, LK100EM, LTD131, LTD171		

with bracket mounting



1

GEV No.	380312	Ref. No.	019032-00 01903200R 229023 229024 DER100 DER11 RTFOC00144
description	power relays FINDER 230VAC 10A 3CO connection male faston 4.8mm bracket mounting dimensions 52x32.2x36.5mm manuf. no. 60.63.8.230.0000		
For models:	BETA50, BETA53, FEM060, FEM061, FEM100, FEM101, FEM107, FEM107SC, FEM109, FEM200, FEM201, FEM207, FEMD023, FEMD060, FEMD061, FEMD065, FEMD066, FEMD100, FEMD101, FEMD107, FEMD107SC, FEMD108, FEMD108EL, FEMD109, FEMD200, FEMD201, FGM060, FGM061, FGM062, FGM100, FGM101, FGM102, FGM107, FGM107SC, FGM109, FGM200, FGM201, FGM202, FGM207, FGM207SC, FGM209, FGM67, FGM67SC, FGM69, FGMD060, FGMD061, FGMD065, FGMD066, FGMD100, FGMD101...(Other models you can see in the webshop)		



1

GEV No.	380139	Ref. No.	929115 DER1108
description	power relays FINDER 230VAC 16A 2CO connection F6.3 bracket mounting dimensions 68x38.2x35.8mm manuf. no. 62.82.8.230.0000		
For models:	L600, L61, L62, L63, L64, LB40E, LB42BT-UK, LBD40, LBDX40, LF50, LFD60, LK100, LK1000, LK100EM, LK1010, LK110, LK1100, LK130, LK1300, LK611, LK620, LK621, LK622, LK622I, LK625, LKD130, LKDX110, LO155, LO65, LO80, LO80H, LO93, LOD102, LOD155, LOD202, LOD302, LOD305, LOD502, LOD65, LOD80, LOD80H, LOD93, LP155, LP80, LP800-00-092, LP80H, LP92, LP93, LTD209, LTD212...(Other models you can see in the webshop)		




1

GEV No.	380702	Ref. No.	229039 229040
description	power relays FINDER 230VAC 16A 3NO connection male faston 6.3mm flange dimensions 36x38x68mm manuf. no. 62.83.8.230.0300 230V		
For models:	LB355, LB405, LB411, LB411A, LB422, LB425, LBD40, LBDX40, LS500, LS500A, LS500G, LS500GA, LS500GPV, LS500PV, LS501, LS501A, LS501G, LS501GA, LS501GPV, LS501PV, LS505, LS505M, LS505T, LS511, LS511A, LS511PV, LS520, LS522		



1


GEV No.	380311	Ref. No.	229030
description	power relays Italiana Relè 230VAC 20A 1NC/1NO connection F6.3 bracket mounting manuf. no. A1B-230AC-FA		
For models:	LB145, LB45, LF500, LF550, LF551		





1

GEV No.	380185	Ref. No.	1LT028 229029 DER111
description	power relays Italiana Relè 230VAC 30A 1NO connection F6.3 bracket mounting dimensions 36.5x32.2x51.8mm manif. no. A10-230AC-FA		
For models:	KF165A, KF165W, KF185A, KF185W, L600, L61, L62, LB411, LB411A, LB422, LB425, LF55, LF55E, LF56, LF59, LF60, LFD50, LFD60, LFDX50, LK100, LK1000, LK100EM, LK1010, LK110, LK600, LK605, LK611, LK620, LK621, LK622, LK622I, LK625, LKDX110, LO65, LOD102, LOD65, LP800-00-092, LP92, LS505M, LS511, LS520-CRP, LS521, LS521-CRP-SP, LTD171, S58		

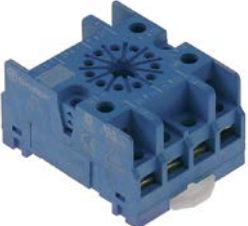
with male contacts
bullet connectors, 8 contacts




1


GEV No.	380135	Ref. No.	927044 DER163	
description	power relays FINDER 24VAC 10A 2CO connection plug-in connection round 8-pole manif. no. 60.12.8.024.0040 90.26/ZVE8 250V 8-pole			
For models:	LT121, LT150, LT151, LT152, LT161, LT202, LT221, LT271, LT272, LT362, LT91			
accessories for	380135			
	GEV No.	380137	Ref. No.	927045
	relay socket 8-pole connection plug-in connection round 8-pole dimensions 65x28x40mm 380V voltage AC 10A Italiana Relè manif. no. ZVE8			
	GEV No.	380638	Ref. No.	—
	relay socket 8-pole dimensions 51x41x23mm 250V 10A FINDER manif. no. 90.26			

relay sockets




1

GEV No.	380667	Ref. No.	022031-00	
description	relay socket 11-pole dimensions 56x43x31mm 250V voltage AC 10A FINDER manif. no. 90.27			
accessories for	380667			
	GEV No.	380805	Ref. No.	—
	support bracket			




1

GEV No.	380137	Ref. No.	927045	
description	relay socket 8-pole connection plug-in connection round 8-pole dimensions 65x28x40mm 380V voltage AC 10A Italiana Relè manif. no. ZVE8			
For models:	LT161, LT221, LT271, LT272, LT362			
accessories for	380137			
	GEV No.	380805	Ref. No.	—
	support bracket			

level relays

GICAR




1




GEV No.	400018	Ref. No.	RTFOC00146
description	level relay 230V voltage AC connection F6.3 type RL30/3ES/F/G		
For models:	FEM060, FEM061, FEM100, FEM101, FGM060, FGM061, FGM100, FGM101, FGM200, FGM201, FMM060, FMM061, FMM100, FMM101		

time relays


time relays



1

GEV No.	360172	Ref. No.	019028-00 01902800R	
description	time relay 2CO connection plug-in connection 100-240V 11-pole voltage AC 0.1s - 100h at 250V 5A			
accessories for	360172			
	GEV No.	360345	Ref. No.	—
	mounting frame for time relay for PM4H/LT4H			
	GEV No.	380136	Ref. No.	—
	relay socket 11-pole connection plug-in connection round 11-pole dimensions 65x28x40mm 250V voltage AC 10A Italiana Relè manif. no. ZVE11			
	GEV No.	380667	Ref. No.	022031-00
	relay socket 11-pole dimensions 56x43x31mm 250V voltage AC 10A FINDER manif. no. 90.27			




			
1			
GEV No.	380611	Ref. No.	929113 DET237
description	time relay FINDER 81.01.0.230 time range 0.1s-10h 12-230V AC/DC 16A mounting measurements DIN railmm 1CO connection grip connection		
For models:	L61, L62, L63, L64, LT121, LT151, LT152, LT161, LT202, LT221, LT271, LT272, LT362, LT91, S58		

transformers

open transformers


with clamp terminal

			
1			
GEV No.	401604	Ref. No.	DET313
description	transformer primary 230/400VAC secondary 12VAC 160VA		
For models:	LT150		

encapsulated transformers

with screw connection

			
1			
GEV No.	402016	Ref. No.	014687-00 01468700R
description	transformer 65VA		


			
1			
GEV No.	379054	Ref. No.	014675-00 01467500R DET64 RTFOC00039
description	transformer primary 230VAC secondary 12VAC 3VA secondary 0.25A H 40mm L 45mm W 50mm connection screw 50/60Hz type 153/M		
For models:	FEC060, FEC065, FEC100, FEC200, FEM060, FEM061, FEM100, FEM101, FEM200, FEM201, FEMD060, FEMD061, FEMD065, FEMD066, FEMD100, FEMD101, FEMD200, FEMD201, FEP050, FEP080, FEP160, FGC060, FGC065, FGC100, FGC200, FGM060, FGM061, FGM100, FGM101, FGM200, FGM201, FGMD060, FGMD061, FGMD065, FGMD066, FGMD100, FGMD101, FGMD200, FGMD201, FGP050, FGP080, FGP160, FMM060, FMM061, FMM100, FMM101, JOKER FEP050, JOKER FEP050 AB 2002, JOKER FEP080, JOKER FEP080 AB 2002...(Other models you can see in the webshop)		

electronic controllers

EKTRON

refrigeration controllers

built-in version

			
1			
GEV No.	402020	Ref. No.	014673-00 01467300R 014673-01 01467301R
description	electronic controller EKTRON type REK33-0020 mounting measurements 71x29mm 12V voltage AC/DC PTC relay outputs 3 NO-8A(4) NO-8A(4) NO-8A(4) PTC PTC built-in depth 71mm -50 up to +95°C display 3 digits		



ELIWELL

refrigeration controllers

built-in version



1			
GEV No.	402017	Ref. No.	019045-00 01904500R 019046-00 01904600R 019047-00 01904700R
description	electronic controller ELIWELL type EWPC974 mounting measurements 71x29mm		



2			
GEV No.	379645	Ref. No.	019497-00 024169-00 RIC0002683
description	electronic controller ELIWELL type ID961 mounting measurements 71x29mm 230V voltage AC NTC/PTC relay outputs 1 relay -55 up to +150°C display 3½ digits compressor relay 15A		
accessories for	379645		
	GEV No.	Ref. No.	—
	temperature probe PTC 1kOhm cable PVC probe -50 up to +150°C cable -10 up to 100°C probe ø6x30mm cable length 3m without screw connection 2-wire		
	GEV No.	Ref. No.	014674-00 01467400R 014674-01 01467401R RIC0002906
	temperature probe PTC 1kOhm cable silicone probe -50 up to +150°C cable -50 up to +180°C probe ø6x40mm cable length 3m without screw connection 2-wire		
	GEV No.	Ref. No.	—
	temperature probe NTC 10kOhm cable thermoplastic probe -40 up to +110°C cable -40 up to +110°C probe ø6x14mm cable length 3m without screw connection 2-wire		
	GEV No.	Ref. No.	—
	temperature probe PTC 1kOhm cable thermoplastic probe -50 up to +150°C cable -40 up to +110°C probe ø6x14mm cable length 3m 2-wire resistor 1kOhm		

EVCO - EVERY CONTROL

universal controllers

built-in version



1			
GEV No.	378131	Ref. No.	RTFOC00029
description	electronic controller EVERY CONTROL EVK411M mounting measurements 71x29mm 12V voltage AC/DC NTC/PTC/Pt100/Pt1000 relay outputs 1 CO-16A(8) NTC/PTC/Pt100/Pt1000/TC(J,K)/mV/mA yes protection IP65 dependend on probe°C display 3½ digits		
For models:	FEC060, FEC065, FEC100, FEC200, FEM060, FEM061, FEM100, FEM101, FEM200, FEM201, FEMD060, FEMD061, FEMD065, FEMD066, FEMD100, FEMD101, FEMD200, FEMD201, FEP050, FEP080, FEP160, FGC060, FGC065, FGC100, FGC200, FGM060, FGM061, FGM100, FGM101, FGM200, FGM201, FGMD060, FGMD061, FGMD065, FGMD066, FGMD100, FGMD101, FGMD200, FGMD201, FGP050, FGP080, FGP160, FMM060, FMM061, FMM100, FMM101, JOKER FEP050, JOKER FEP050 AB 2002, JOKER FEP080, JOKER FEP080 AB 2002...(Other models you can see in the webshop)		
accessories for	378131		
	GEV No.	Ref. No.	—
	temperature probe Pt100 cable Vetrotex probe -200 up to +600°C cable -50 up to +350°C probe ø6x100mm cable length 2.7m without screw connection 3-wire		
	GEV No.	Ref. No.	—
	temperature probe NTC 10kOhm cable thermoplastic probe -40 up to +110°C cable -40 up to +110°C probe ø6x14mm cable length 1.5m without screw connection 2-wire		
	GEV No.	Ref. No.	—
	temperature probe PTC 1kOhm cable thermoplastic probe -50 up to +150°C cable -40 up to +110°C probe ø6x14mm cable length 1.5m without screw connection 2-wire		
	GEV No.	Ref. No.	—
	temperature probe Pt1000 cable Vetrotex probe -70 up to +500°C cable -50 up to +350°C connection 2-wire thread probe ø6x180mm cable length 1.7m		



LAE

refrigeration controllers

built-in version



1

GEV No.	378300	Ref. No.	025057-00R
description	electronic controller LAE mounting measurements 71x29mm 230V voltage AC NTC/PTC relay outputs 3 -50 to +120°C display 3 digits fan relay 7A 7A compressor relay 16A		
For models:	M140BTA, M140BTAG, M140BTAH2, M140BTAP, M140BTH, M140BTHG, M140BTHH2, M140BTHP, M140BTJ, M140BTJG, M140BTJH2, M140BTJP, M140TNA, M140TNAG, M140TNAH2, M140TNAP, M140TNH, M140TNHG, M140TNHH2, M140TNHP, M140TNJ, M140TNJG, M140TNJH2, M140TNJP, M140TPJ, M140TPJH2, M62TNJ, M62TNJD2, M62TNJD2P, M62TNJD3, M62TNJD3P, M62TNJDB, M62TNJDBP, M62TNJP, M63TNJ, M63TNJD2, M63TNJD2P, M63TNJD3, M63TNJD3P, M63TNJDB, M63TNJDBP, M63TNJP, M64TNJ, M64TNJD2, M64TNJD2P, M64TNJD3, M64TNJD3P, M64TNJDB, M64TNJDBP, M64TNJP...(Other models you can see in the webshop)		



2

GEV No.	378420	Ref. No.	020518-01
description	electronic controller LAE type AT1-5AS2E-G mounting measurements 71x29mm 230V voltage AC NTC/PTC relay outputs 2 NO-16A(4) NO-7A(2) NTC/PTC front measurements 77x35mm built-in depth 70mm protection IP55 yes -50 to +120°C display 3 digits		
accessories for	378420		
	GEV No.	Ref. No.	025461-00
	temperature probe NTC 10kOhm cable TPE probe -40 up to +110°C cable -40 up to +110°C probe ø6x28mm cable length 2m cable colours grey 2-wire		



1

GEV No.	378260	Ref. No.	023382-00
description	electronic controller LAE type LD2-15B4E mounting measurements 71x29mm 230V voltage AC NTC relay outputs 3 relays yes yes -50 up to +80°C display 3 digits RoomTempIN yes DEF Relay 7A fan relay 7A compressor relay 16A		
For models:	A70N1, AX140B2, AX70B1, B250xxx, B400xxx, B550xxx, B70N1, BX140B2, BX70B1		
accessories for	378260		
	GEV No.	Ref. No.	020519-00 020519-00R RIC0003793
	temperature probe NTC 10kOhm cable thermoplastic probe -40 up to +110°C cable -40 up to +110°C probe ø6x35mm cable length 3m without screw connection 2-wire		

accessories for	378260		
	GEV No.	379784	Ref. No.
			02128300 021283-00R RIC0003862
	temperature probe NTC 2kOhm cable thermoplastic probe -40 up to +110°C cable -40 up to +110°C probe ø6x35mm cable length 2m without screw connection 2-wire resistor 2kOhm		

SHANGFANG

accessories



1

GEV No.	379054	Ref. No.	014675-00 01467500R DET64 RTFOC00039
description	transformer primary 230VAC secondary 12VAC 3VA secondary 0.25A H 40mm L 45mm W 50mm connection screw 50/60Hz type 153/M		
For models:	FEC060, FEC065, FEC100, FEC200, FEM060, FEM061, FEM100, FEM101, FEM200, FEM201, FEMD060, FEMD061, FEMD065, FEMD066, FEMD100, FEMD101, FEMD200, FEMD201, FEP050, FEP080, FEP160, FGC060, FGC065, FGC100, FGC200, FGM060, FGM061, FGM100, FGM101, FGM200, FGM201, FGMD060, FGMD061, FGMD065, FGMD066, FGMD100, FGMD101, FGMD200, FGMD201, FGP050, FGP080, FGP160, FMM060, FMM061, FMM100, FMM101, JOKER FEP050, JOKER FEP050 AB 2002, JOKER FEP080, JOKER FEP080 AB 2002...(Other models you can see in the webshop)		

miscellaneous

electronic thermometers



1


GEV No.	402047	Ref. No.	DET164
description	thermometer 14V voltage AC/DC display 2 digit PTC temperature restriction 0-60°C incl. probe		
For models:	L63, L64, LT121, LT150, LT151, LT152, LT202, LT91		



1

GEV No.	403327	Ref. No.	927333
description	thermometer ARTHERMO type ROF-DIG/12 mounting measurements 58x26mm 12V voltage AC -30 jusqu'à +110°C measuring input NTC display 3 digits front measurements 64x31mm		
For models:	LT161, LT221, LT271, LT272, LT362		





			
1			
GEV No.	379022	Ref. No.	527601R
description	thermometer mounting measurements 28.5x70.5mm -55 up to +99°C type EWTM 101		


probes


universal probes


temperature probes



			
1			
GEV No.	379784	Ref. No.	02128300 021283-00R RICO003862
description	temperature probe NTC 2kOhm cable thermoplastic probe -40 up to +110°C cable -40 up to +110°C probe ø6x35mm cable length 2m without screw connection 2-wire resistor 2kOhm		
For models:	A140N2, A70N1, AX140B2, AX140N2, AX70B1, AX70N1, B140N2, B250xxx, B400xxx, B550xxx, B70N1, BX140B2, BX1420N2, BX250xxx, BX400xxx, BX550xxx, BX70B1, BX70N1		

			
1			
GEV No.	378261	Ref. No.	020519-00 020519-00R RICO003793
description	temperature probe NTC 10kOhm cable thermoplastic probe -40 up to +110°C cable -40 up to +110°C probe ø6x35mm cable length 3m without screw connection 2-wire		
For models:	A140N2, A70N1, AX140B2, AX140N2, AX250xxx, AX400xxx, AX70B1, AX70N1, B140N2, B250xxx, B400xxx, B550xxx, B70N1, BX140B2, BX1420N2, BX250xxx, BX400xxx, BX550xxx, BX70B1, BX70N1		

			
1			
GEV No.	379805	Ref. No.	025461-00
description	temperature probe NTC 10kOhm cable TPE probe -40 up to +110°C cable -40 up to +110°C probe ø6x28mm cable length 2m cable colours grey 2-wire		

			
1			
GEV No.	379142	Ref. No.	927335 DWS96
description	temperature probe PTC 1kOhm cable PVC probe -50 up to +150°C cable -10 up to 100°C probe ø6x30mm cable length 1.5m without screw connection 2-wire		
For models:	L63, L64, LT121, LT150, LT151, LT152, LT161, LT202, LT221, LT271, LT272, LT362, LT91		


			
1			
GEV No.	379064	Ref. No.	014674-00 01467400R 014674-01 01467401R RICO002906
description	temperature probe PTC 1kOhm cable silicone probe -50 up to +150°C cable -50 up to +180°C probe ø6x40mm cable length 3m without screw connection 2-wire		


			
1			
GEV No.	379051	Ref. No.	RTFOC00034
description	temperature probe thermocouple J (Fe-CuNi) cable Vetrotex probe -50 up to +750°C cable -50 up to +350°C probe ø6x100mm cable length 3m without screw connection cable colours red/blue 2-wire		
For models:	FEC060, FEC065, FEC100, FEM060, FEM061, FEM100, FEM101, FEM107, FEM107SC, FEM109, FEM207, FEM207SC, FEM209, FEM67, FEM67SC, FEM69, FEMD060, FEMD061, FEMD100, FEMD101, FEP050, FEP080, FGC060, FGC065, FGC100, FGM060, FGM061, FGM100, FGM101, FGM107, FGM107SC, FGM109, FGM207, FGM207SC, FGM209, FGM67, FGM67SC, FGM69, FGMD060, FGMD061, FGMD100, FGMD101, FGMD67, FGMD67SC, FGMD68, FGMD68EL, FGMD69, FGP050, FGP080, FMM060..(Other models you can see in the web-shop)		
accessories for	379051		
		GEV No.	379877
		Ref. No.	—
	electronic controller HONEYWELL type DC10N-400 mounting measurements 92x92mm 24/230V voltage AC TC (J) relay outputs 1 CO-10A(6) TC (J) universal built-in depth 55mm protection IP54 accuracy 1% built-in version defr. funct. no 0 up to +400°C display 3 digits		

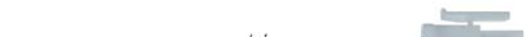
producer-specific probes


probes



			
1			
GEV No.	403942	Ref. No.	231016
description	temperature probe		
For models:	LB411, LB411A, LB422, LB425, LK605, LK620, LK621, LK622, LK622I, LK625, LOD102, LOD202, LOD302, LOD402, LOD502, LS505M, LS505T, LS511, LS511A, LS511PV, LS520-CRP, LS521-CRP-SP, LS522, LS525, LTD209, LTD212, LTD220, LTD316, LTD320, LTD326		


			
1			
GEV No.	379101	Ref. No.	DWS100
description	temperature probe NTC 10kOhm cable PVC probe -40 up to +110°C cable -10 up to 100°C connection plug thread probe ø4.5x30mm cable length 0.35m		
For models:	LK100, LK110, LK130		

			
1			
GEV No.	400910	Ref. No.	231014
description	temperature probe NTC 10kOhm cable silicone probe -40 up to +110°C cable -50 up to +180°C connection coded plug thread probe ø4.5x30mm cable length 0.35m		
For models:	GOLD74, LB40E, LB411, LB42BT-UK, LBD40, LBDX40, LF55E, LF56, LF60, LFD50, LFD60, LFDX50, LK100, LK100EM, LK110, LK130, LK611, LK621, LKD130, LKDX110, LO155, LO65, LO80, LO80H, LO93, LOD102, LOD155, LOD202, LOD302, LOD304, LOD305, LOD65, LOD80, LOD80H, LOD93, LP80, LP800-00-092, LP92, LS511, LS521, LT81, LTD101, LTD131, LTD171		


1

GEV No.	379793	Ref. No.	164729
description	temperature probe thermocouple K (NiCr-Ni) cable silicone probe -50 up to 1150°C cable -50 up to +180°C connection 2-wire thread M10x1.5 probe ø3x40mm cable length 2.5m		
For models:	CME10-V380, CME4-V380, CME6-V380, CMFE102-V380, CMFE10-V380, CMFE6-V380, CMFG10-V380, CMFG6-V380, CYE10-V380, CYE6-V380, CYG10-V380, CYG6-V380, FEM108, FEM108EL, FEM110, FEM110L, FEM210, FEM210L, FEM220, FEM220L, FEM240, FEM240L, FEM610, FEM610L, FEM68, FEM68EL, FEMD108, FEMD108EL, FEMD68, FEMD68EL, FGM108, FGM108EL, FGM110, FGM110L, FGM210, FGM210L, FGM610, FGM610L, FGM68, FGM68EL, FGMD108, FGMD108EL, FGMD68, FGMD68EL		



1


GEV No.	379794	Ref. No.	164484
description	temperature probe thermocouple K (NiCr-Ni) cable Vetrotex probe -50 up to 1150°C cable -50 up to +350°C connection 2-wire thread probe ø6x100mm cable length 1.45m		
For models:	FEM108, FEM108EL, FEM110, FEM110L, FEM210, FEM210L, FEM220, FEM220L, FEM240, FEM240L, FEM610, FEM610L, FEM68, FEM68EL, FEMD108, FEMD108EL, FEMD68, FEMD68EL, FGM108, FGM108EL, FGM110, FGM110L, FGM210, FGM210L, FGM610, FGM610L, FGM68, FGM68EL, FGMD108, FGMD108EL, FGMD68, FGMD68EL		



1


GEV No.	379950	Ref. No.	RTFOC00321
description	temperature probe thermocouple T (Cu-CuNi) cable silicone probe -150 up to +300°C cable -50 up to +180°C connection 2-wire thread M10x1 probe ø3x12/40mm cable length 2.4m		
For models:	FEC200, FEM107, FEM107SC, FEM109, FEM200, FEM201, FEM207, FEM207SC, FEM67, FEM67SC, FEM69, FEMD065, FEMD066, FEMD107, FEMD107SC, FEMD108, FEMD108EL, FEMD109, FEMD200, FEMD201, FEMD207, FEMD207SC, FEMD209, FEMD67, FEMD67SC, FEMD68, FEMD68EL, FEMD69, FEP050, FEP080, FEP160, FGC200, FGM107, FGM107SC, FGM109, FGM200, FGM201, FGM207, FGM207SC, FGM209, FGM67, FGM67SC, FGM69, FGMD065, FGMD066, FGMD107, FGMD107SC, FGMD108, FGMD108EL, FGMD109...(Other models you can see in the webshop)		

core probes



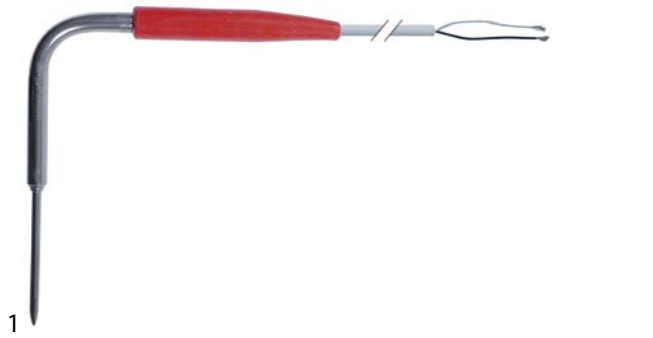
1

GEV No.	378258	Ref. No.	161390
description	core temperature probe PTC 1kOhm cable PTFE probe -40 up to +120°C cable -40 up to +250°C connection plug probe ø4x100mm thread cable length 1m handle ø 10mm handle length 80mm		
For models:	FEM107, FEM107SC, FEM109, FEM207, FEM207SC, FEM67, FEM67SC, FEM69, FEMD107SC, FEMD109, FEMD207SC, FEMD67SC, FEMD69, FGM107, FGM107SC, FGM207, FGM207SC, FGM67, FGM67SC, FGMD107SC, FGMD109, FGMD207SC, FGMD67SC, FGMD69		




1

GEV No.	378259	Ref. No.	161389
description	core temperature probe PTC 1kOhm cable PTFE probe -50 to +120°C cable -40 up to +250°C connection plug probe ø2x100mm thread cable length 1.75m handle ø 10mm handle length 80mm		
For models:	FEM107SC, FEM109, FEM207SC, FEM67SC, FEM69, FEMD107SC, FEMD109, FEMD207SC, FEMD67SC, FEMD69, FGM207SC, FGMD107SC, FGMD109, FGMD69		



1

GEV No.	379748	Ref. No.	RIC.S506/3 RIC0003230
description	core temperature probe PTC 1kOhm cable silicone probe -40 up to +120°C cable -50 up to +180°C connection 2-wire probe ø4x75mm thread cable length 5m handle ø 10mm handle length 120mm L1 150mm L2 85mm		
For models:	S10M, S14M, S20M, S5M, S7M		




1

GEV No.	379949	Ref. No.	RTFOC00464
description	core temperature probe thermocouple J (Fe-CuNi) cable SS corrugated hose probe -40 up to +250°C cable -40 up to +250°C connection 2-wire probe ø4x100mm thread cable length 1.7m handle ø 9mm handle length 80mm		
For models:	FEM107SC, FEM109, FEM207SC, FEM209, FEM67SC, FEMD107SC, FEMD109, FEMD207SC, FEMD209, FEMD67SC, FEMD69, FEP050, FEP080, FEP160, FGM107SC, FGM109, FGM207SC, FGM209, FGM67SC, FGM69, FGMD107SC, FGMD109, FGMD207SC, FGMD209, FGMD67SC, FGMD69, FGP050, FGP080, FGP160, JOKER FEM 67 SC, JOKER FEM 69, JOKER FEM107 SC, JOKER FEM109, JOKER FEM207 SC, JOKER FEM209, JOKER FEMD 67 SC, JOKER FEMD 69, JOKER FEMD107 SC, JOKER FEMD109, JOKER FEMD207 SC, JOKER FEMD209, JOKER FEP050, JOKER FEP050 AB 2002, JOKER FEP080, JOKER FEP080 AB 2002, JOKER FEP160, JOKER FGM 67 SC, JOKER FGM 69, JOKER FGM107 SC, JOKER FGM109...(Other models you can see in the webshop)		

accessories

screw connections



1

GEV No.	550339	Ref. No.	53.3.0184.00
description	screw connection for probe		
For models:	6BM61G, 6BM62G		



electronics

electronics accessories



1

GEV No.	699373	Ref. No.	419040
description	spacer piece for PCB thread M3 L 19.5mm H 10mm plastic black		
For models:	LS505M, LS505T		

EPROMS



1

GEV No.	400900	Ref. No.	225029
description	EPROM CODE 225029-3		
For models:	LB40E, LF55E, LF56, LF60		



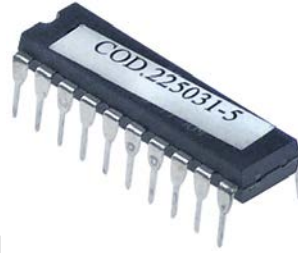
1

GEV No.	401917	Ref. No.	225034
description	EPROM CODE 225034		



1

GEV No.	401558	Ref. No.	81000 810001
description	EPROM CODE 81000-1		
For models:	GOLD74, LK100, LK110, LK130, LK611, LKD130, LO65, LTD-Rullerie-717066, LTD-Rullerie-717067, LTD-Rullerie-717086, LTD-Rullerie-717087, LT-Rullerie-717066, LT-Rullerie-717067, LT-Rullerie-717086, LT-Rullerie-717087		



1

GEV No.	403247	Ref. No.	225031
description	EPROM for dishwasher CODE 225031-5		
For models:	LB40E, LB411, LF55E, LS511		



1

GEV No.	403249	Ref. No.	225044
description	EPROM for dishwasher CODE 225044-2		
For models:	LFD50		



1

GEV No.	403244	Ref. No.	81008
description	EPROM for dishwasher CODE 81008		
For models:	LTD131, LTD171		




1


GEV No.	403241	Ref. No.	81001
description	EPROM type U61E for dishwasher CODE 81001-3		
For models:	LFD60, LO155, LO65, LO80, LO80H, LO93, LOD155, LOD65, LOD80, LOD80H, LOD93, LP80, LP800-00-092, LP92		

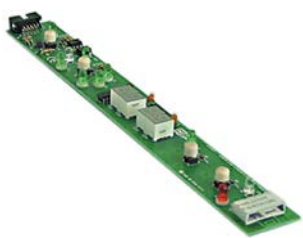


PCBs




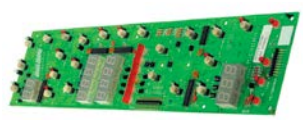
1

GEV No.	404016	Ref. No.	215032-4
description	control PCB warewashing Toptech 24-20GT 230V 50Hz		
For models:	LB425, LK625, LS525		
accessories for	404016		
	GEV No.	Ref. No.	—
	programmer KIT BOOT-LOADER suitable for EUROTEC GROUP		




1

GEV No.	400897	Ref. No.	227059 227084 DES10
description	display PCB dishwasher GS 60		
For models:	LB40E, LB411, LB411A, LB42BT-UK, LBD40, LBDX40, LF55E, LF56, LF60, LFD50, LFD60, LFDX50, LO65, LOD102, LOD65, LP800-00-092, LP92, LS511, LS511A, LS511PV, LS520-CRP, LS521, LS521-CRP-SP		
accessories for	400897		
	GEV No.	Ref. No.	80933 926272 DWS99
	ribbon cable 10-pole L 3000mm plug type coded 2 row plug: number of poles 10		




1

GEV No.	401230	Ref. No.	RTFOC00546
description	keypad PCB		
For models:	FEM109, FEM209, FEM69, FEMD109, FEMD209, FEMD69, FGM109, FGM209, FGM69, FGMD109, FGMD209, FGMD69, JOKER FEM 69, JOKER FEM 69 AB 2002, JOKER FEM109, JOKER FEM109 AB 2002, JOKER FEM209, JOKER FEMD 69, JOKER FEMD109, JOKER FEMD209, JOKER FGM 69, JOKER FGM109, JOKER FGM209, JOKER FGMD 69, JOKER FGMD109, JOKER FGMD209		




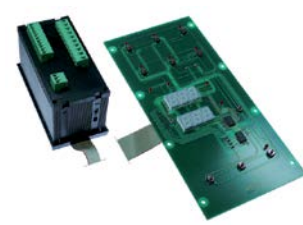
1

GEV No.	401232	Ref. No.	RTFOC00672
description	keypad PCB combi-steamer FEM 67/207		
For models:	FEM107, FEM107SC, FEM207, FEM207SC, FEM67, FEM67SC, FEMD107, FEMD107SC, FEMD108, FEMD108EL, FEMD207, FEMD207SC, FEMD67, FEMD67SC, FEMD68, FEMD68EL, FGM107, FGM107SC, FGM207, FGM207SC, FGM67, FGM67SC, FGMD107, FGMD107SC, FGMD108, FGMD108EL, FGMD207, FGMD207SC, FGMD67, FGMD67SC, FGMD68, FGMD68EL, JOKER FEM 67 SC, JOKER FEM207 SC, JOKER FEMD 67 SC, JOKER FEMD107 SC, JOKER FEMD207 SC, JOKER FGM 67 SC, JOKER FGM107 SC, JOKER FGM207 SC, JOKER FGMD 67 SC, JOKER FGMD107 SC, JOKER FGMD207 SC		




1

GEV No.	400898	Ref. No.	80889 80900
description	keypad PCB dishwasher LP10/20/30 with display		
For models:	GOLD74, LK100, LK110, LK130, LK611, LK620, LK621, LKD130, LKDX110, LO155, LO80, LO80H, LO93, LOD155, LOD202, LOD302, LOD304, LOD305, LOD402, LOD502, LOD80, LOD80H, LOD93, LP80, LT81, LTD101, LTD131, LTD171, LTD209, LTD212, LTD216, LTD220		
accessories for	400898		
	GEV No.	Ref. No.	41523
	ribbon cable 10-pole L 1200mm plug type 2 row coded Qty 1m		




1

GEV No.	401936	Ref. No.	24000001
description	keypad PCB with control		




1

GEV No.	401231	Ref. No.	RTFOC00547
description	main PCB		




1

GEV No.	401234	Ref. No.	RTFOC00671 old
description	main PCB		





1

GEV No.	401550	Ref. No.	RTFOC00547
description	main PCB		
For models:	FEM109, FEM209, FEM69, FEMD109, FEMD209, FEMD69, FGM109, FGM209, FGM69, FGMD109, FGMD209, FGMD69, JOKER FEM 69, JOKER FEM 69 AB 2002, JOKER FEM109, JOKER FEM109 AB 2002, JOKER FEM209, JOKER FEMD 69, JOKER FEMD109, JOKER FEMD209, JOKER FGM 69, JOKER FGM109, JOKER FGM209, JOKER FGMD 69, JOKER FGMD109, JOKER FGMD209		



1

GEV No.	401668	Ref. No.	RTFOC00671
description	main PCB combi-steamer FEM 67/207		
For models:	FEM107, FEM107SC, FEM207, FEM207SC, FEM67, FEM67SC, FEMD107, FEMD107SC, FEMD207, FEMD207SC, FEMD67, FEMD67SC, FGM107, FGM107SC, FGM207, FGM207SC, FGM67, FGM67SC, FGMD107, FGMD107SC, FGMD207, FGMD207SC, FGMD67, FGMD67SC, JOKER FEM 67 SC, JOKER FEM107 SC, JOKER FEM207 SC, JOKER FEMD 67 SC, JOKER FEMD107 SC, JOKER FEMD207 SC, JOKER FGM 67 SC, JOKER FGM107 SC, JOKER FGM207 SC, JOKER FGMD 67 SC, JOKER FGMD107 SC, JOKER FGMD207 SC		
accessories for	401668		
	GEV No.	550802	Ref. No. RTFOC00593
PCB terminal block 4-pole raster size 5mm			




1

GEV No.	403780	Ref. No.	215034-6
description	main PCB dishwasher ELETTRORBAR / COLGED L 136mm W 85mm		
For models:	LB355, LB405		



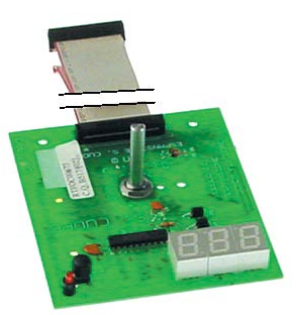
1

GEV No.	401236	Ref. No.	RTFOC00663
description	PCB		
For models:	FEC023, FEMD023, PLANET FEC023, PLANET FEMD023		



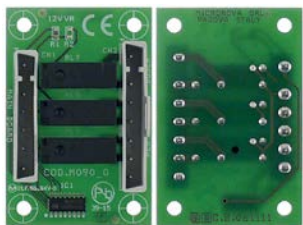
1

GEV No.	403041	Ref. No.	164493
description	PCB cable length 220mm with relay		
For models:	FEM110, FEM110L, FEM210, FEM210L, FEM220L, FEM610, FEM610L, FEM68, FEM68EL, FEMD68, FEMD68EL, FGM110, FGM110L, FGM210, FGM210L, FGM610, FGM610L, FGM68, FGM68EL, FGMD68, FGM-D68EL		



1

GEV No.	401235	Ref. No.	RTFOC00673
description	PCB determination der core temperature		
For models:	FEM107, FEM107SC, FEM207, FEM207SC, FEM67, FEM67SC, FEMD-107SC, FEMD108, FEMD108EL, FEMD207SC, FEMD67SC, FEMD68, FEMD68EL, FGM107, FGM107SC, FGM207, FGM207SC, FGM67, FGM-67SC, FGMD107SC, FGMD108, FGMD108EL, FGMD207SC, FGMD67SC, FGMD68, FGMD68EL, JOKER FEM 67 SC, JOKER FEM107 SC, JOKER FEM207 SC, JOKER FEMD 67 SC, JOKER FEMD107 SC, JOKER FEMD207 SC, JOKER FGM 67 SC, JOKER FGM107 SC, JOKER FGM207 SC, JOKER FGMD 67 SC, JOKER FGMD107 SC, JOKER FGMD207 SC		


1

GEV No.	403621	Ref. No.	215036
description	PCB dishwasher 25/26/27-05 26/27-20 L 60mm W 40mm		
For models:	LB355, LB405, LB422, LK605, LK622, LK622I, LS505M, LS505T, LS522		



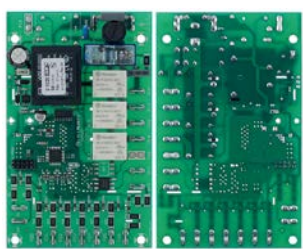
1

GEV No.	403622	Ref. No.	215039
description	PCB dishwasher 25/26/27-05 26/27-20 L 90mm W 50mm starting relay		
For models:	LS522, LS525		



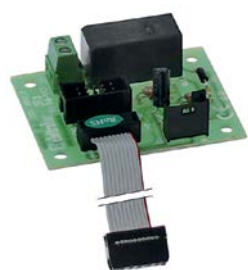
1

GEV No.	403734	Ref. No.	215034-3
description	PCB dishwasher COLGED L 135mm W 85mm		
For models:	LS505M, LS505T		




1

GEV No.	403093	Ref. No.	215038
description	PCB dishwasher L 135mm W 82mm		
For models:	LB355		




1

GEV No.	401049	Ref. No.	215022
description	PCB dishwasher LP10/20/30		
For models:	LB42BT-UK, LBDX40, LFDX50, LKDX110, LO155, LO65, LO80, LO80H, LO93, LOD155, LOD65, LOD80, LOD80H, LOD93, LP80, LP800-00-092, LP92, LT81, LTD101, LTD131, LTD171		




1

GEV No.	403572	Ref. No.	215032-1
description	PCB dishwasher Protech 1113/611 TR10 L 178mm W 125mm		
For models:	LK620, LOD402, LOD502, LS521-CRP-SP, LTD212		




1


GEV No.	403518	Ref. No.	215034-5
description	PCB dishwasher R4258E1120T7S L 136mm W 85.5mm 230V		
For models:	LK605		





1


GEV No.	401900	Ref. No.	215029
description	PCB L 120mm W 80mm		
For models:	LB350, LB400, LB405, LB450, LK600, LK605, LS500, LS500A, LS500G, LS500GA, LS500GPV, LS500PV, LS501, LS501A, LS501G, LS501GA, LS501GPV, LS501PV, LS505, LS505M, LS505T, LS520		

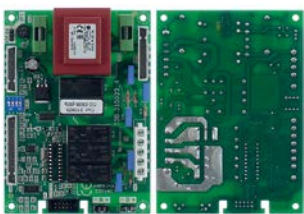





			
1			
GEV No.	361870	Ref. No.	164826
description	PCB L 130mm W 100mm		
For models:	FEM108, FEM108EL, FEM110, FEM110L, FEM210, FEM210L, FEM220, FEM220L, FEM240, FEM240L, FEM610, FEM610L, FEM68, FEM68EL, FEMD108, FEMD108EL, FEMD68, FEMD68EL, FGM108, FGM108EL, FGM110, FGM110L, FGM210, FGM210L, FGM610, FGM610L, FGM68, FGM68EL, FGMD108, FGMD108EL, FGMD68, FGMD68EL		

			
1			
GEV No.	402015	Ref. No.	016369-00R
description	PCB refrigerated counter Skin		

			
1			
GEV No.	403045	Ref. No.	215032
description	PCB suitable for ELETTRORBAR		
For models:	LK620, LK621, LOD102, LOD202, LOD302, LOD304, LOD305, LOD402, LOD502, LS520-CRP, LS521, LTD209, LTD212, LTD216, LTD220		


			
1			
GEV No.	403784	Ref. No.	215037
description	PCB warewashing ELETTRORBAR / COLGED L 60mm W 30mm		
For models:	LK605, LS505M, LS505T		

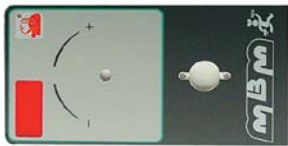
			
1			
GEV No.	403509	Ref. No.	999298
description	PCB warewashing NIAGARA/SILVER		
For models:	LB411, LB411A, LK611, LS511, LS511A, LS511PV		

			
1			
GEV No.	400899	Ref. No.	215023 DES102
description	power PCB dishwasher LP10/20/30 without EPROM		
For models:	GOLD74, LB40E, LB411, LB42BT-UK, LBD40, LBDX40, LF55E, LF56, LF60, LFD50, LFD60, LFDX50, LK100, LK100EM, LK110, LK130, LK611, LKD130, LKDX110, LO155, LO65, LO80, LO80H, LO93, LOD155, LOD65, LOD80, LOD80H, LOD93, LP80, LP800-00-092, LP92, LS511, LT81, LTD101, LTD131, LTD171		
accessories for	400899		
	GEV No.	400761	Ref. No. CN5
plug connector 5-pole			
	GEV No.	400900	Ref. No. 225029
EPROM CODE 225029-3			
	GEV No.	401558	Ref. No. 81000 810001
EPROM CODE 81000-1			
	GEV No.	403241	Ref. No. 81001
EPROM type U61E for dishwasher CODE 81001-3			
	GEV No.	550048	Ref. No. —
female bullet			


keypads


front foils


			
1			
GEV No.	401238	Ref. No.	RTFOC00505
description	front foil		
For models:	FEM107, FEM107SC, FEM207SC, FEMD107, FEMD107SC, FEMD207SC, FEP160, FGM107SC, FGM207SC, FGMD107SC, FGMD207, FGMD-207SC, JOKER FEM107 SC, JOKER FEM207 SC, JOKER FEMD107 SC, JOKER FEMD207 SC, JOKER FEP160, JOKER FGM107 SC, JOKER FGM207 SC, JOKER FGMD107 SC, JOKER FGMD207 SC		


			
1			
GEV No.	401240	Ref. No.	RTFOC00665
description	front foil		
For models:	FEM67SC, FEMD67SC, FGM67SC, FGMD67SC, JOKER FEM 67 SC, JOKER FEMD 67 SC, JOKER FGM 67 SC, JOKER FGMD 67 SC		





			
1			
GEV No.	402030	Ref. No.	01271301R
description	front foil		


			
1			
GEV No.	402031	Ref. No.	01345001R
description	front foil		

			
1			
GEV No.	402032	Ref. No.	01654900R
description	front foil		

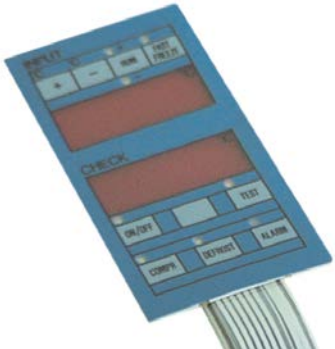
			
1			
GEV No.	401239	Ref. No.	RTFOC00506
description	keypad foil		
For models:	FEM67, FEM67SC, FEMD67, FEMD67SC, FGM67SC, FGMD67, FGMD-67SC, JOKER FEM 67 SC, JOKER FEMD 67 SC, JOKER FGM 67 SC, JOKER FGMD 67 SC		

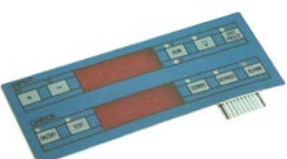
			
1			
GEV No.	401252	Ref. No.	RTFOC00548
description	keypad foil		
For models:	FEM69, FEMD69, FGM69, FGMD69, JOKER FEM 69, JOKER FEMD 69, JOKER FGM 69, JOKER FGMD 69		

			
1			
GEV No.	400896	Ref. No.	80302
description	keypad foil dishwasher Gold74		
For models:	GOLD74		

			
1			
GEV No.	505276	Ref. No.	36784
description	keypad foil dishwasher L25 L 494mm W 84mm buttons 4		

membrane keypads

			
1			
GEV No.	402023	Ref. No.	01086805R
description	membrane keypad		

			
1			
GEV No.	402024	Ref. No.	01087005R
description	membrane keypad		

solenoid valves

solenoid valves (water)

ELBI			
straight			
			
1			
GEV No.	373017	Ref. No.	240016 240021 DEV3516
description	solenoid valve single straight 230VAC inlet 3/4" outlet 11.5mm DN10 ELBI		
For models:	GOLD74, L61, L62, L63, L64, LB350, LB400, LB405, LB411, LB411A, LB422, LB425, LFD60, LK100, LK100EM, LK110, LK1100, LK130, LK1300, LK600, LK605, LK611, LK622, LK622I, LKD130, LO65, LS500, LS500A, LS500GA, LS501, LS501A, LS501GA, LS505M, LS505T, LS511A, LS520		
spare parts for	373017		
			
	GEV No.	Ref. No.	—
	solenoid valve filter suitable for ELBI		

ROBERTSHAW/INVENSYS

medium temperature: 90°C 90°C 60°C
 ambient temperature: 60°C 25°C 60°C
 duty cycle: 40% 100% 100%

spare parts and accessories

reducers

outlet side



GEV No.	374050	Ref. No.	RTFOC00120
description	reducer flow rate 0.25l/min		
For models:	FCE10, FCE6, FCG10, FCG20, FCG6, FEC060, FEC065, FEC100, FEC200, FEM060, FEM061, FEM062, FEM100, FEM101, FEM102, FEM107, FEM107SC, FEM109, FEM110, FEM110L, FEM200, FEM201, FEM202, FEM207, FEM207SC, FEM209, FEM210, FEM210L, FEM220L, FEM610, FEM610L, FEM67, FEM67SC, FEM69, FEMD060, FEMD061, FEMD065, FEMD066, FEMD100, FEMD101, FEMD107, FEMD107SC, FEMD109, FEMD200, FEMD201, FEMD207, FEMD207SC, FEMD67, FEMD67SC, FEMD69...(Other models you can see in the webshop)		



GEV No.	371250	Ref. No.	172834
description	reducer type EATON (INVENSYS) flow rate 0.25l/min pressure range 0 up to 10bar tolerance ±15/25% white		
For models:	CME10-V380, CME4-V380, CME6-V380, CMFE102-V380, CMFE10-V380, CMFE6-V380, CMFG10-V380, CMFG6-V380, CMG10-V380, CMG6-V380, CYE10-V380, CYE6-V380, CYG10-V380, CYG6-V380, FCE108, FCE68, FCG108, FCG68, FEM107, FEM108, FEM108EL, FEM207, FEM67, FEM68, FEM68EL, FEMD023, FEMD108, FEMD108EL, FEMD48, FEMD68, FEMD68EL, FGM107, FGM108, FGM108EL, FGM207, FGM67, FGM68, FGM68EL, FGMD108, FGMD108EL, FGMD68, FGMD68EL		



GEV No.	371252	Ref. No.	172833
description	reducer type EATON (INVENSYS) flow rate 1.2l/min pressure range 0 up to 10bar tolerance ±15/25% blue		
For models:	FEM107, FEM108EL, FEM207, FEM210L, FEM67, FEM68, FEM68EL, FEMD108EL, FEMD68, FEMD68EL, FGM107, FGM108EL, FGM207, FGM210L, FGM67, FGM68, FGM68EL, FGMD108EL, FGMD68, FGMD68EL		



GEV No.	374051	Ref. No.	RTFOC00145
description	reducer white		
For models:	FCE20, FEC065, FEC200, FEM060, FEM061, FEM062, FEM100, FEM101, FEM102, FEM107, FEM107SC, FEM109, FEM110, FEM110L, FEM200, FEM201, FEM202, FEM207, FEM207SC, FEM209, FEM210, FEM210L, FEM220L, FEM610, FEM610L, FEM67, FEM67SC, FEM69, FEMD065, FEMD066, FEMD200, FEMD201, FEMD207SC, FEMD209, FEP160, FGC065, FGC200, FGM060, FGM061, FGM062, FGM100, FGM101, FGM102, FGM107, FGM107SC, FGM109, FGM110, FGM110L, FGM200, FGM201...(Other models you can see in the webshop)		

GEV No.	370315	Ref. No.	929172
description	solenoid valve double straight 230VAC inlet 3/4" outlet 11.5mm input 16l/min t.max. 90°C ELBI plastic flow regulating valve inlet black		
For models:	LO155, LO93, LOD155, LOD93, LT81, LTD101, LTD131, LTD171, LTD209, LTD212, LTD216, LTD220		


GEV No.	370246	Ref. No.	240010
description	solenoid valve double straight 230VAC inlet 3/4" outlet 11.5mm t.max. 90°C ELBI plastic output B 0.5l/min flow regulating valve outlet B red		
For models:	KLB40, LB135, LB140, LB145, LB35, LB35C, LB40, LB40E, LB411, LB45, LBD40, LF50, LF500, LF55, LF550, LF551, LF55E, LF56, LF59, LF60, LFD50, LSS11		


GEV No.	370247	Ref. No.	240002
description	solenoid valve triple straight 230VAC inlet 3/4" outlet 11.5mm t.max. 90°C ELBI plastic flow regulating valve inlet orange output B 0.5l/min flow regulating valve outlet B red		
For models:	LB140, LF500		


ELTEK


GEV No.	370779	Ref. No.	2DR025
description	solenoid valve single straight 230VAC inlet 3/4 outlet 11.5mm input 7l/min output 1.2l/min DN10 ELTEK		
For models:	KF165W, KF185W, KL030A		




RPE			
			
1			
GEV No.	374021	Ref. No.	RTFOC00203
description	solenoid valve double straight 230VAC inlet 3/4" outlet 10mm DN10 RPE		
For models:	CME10-V380, CME6-V380, FEC060, FEC065, FEC200, FEM060, FEM061, FEM062, FEM100, FEM101, FEM102, FEM107, FEM108, FEM108EL, FEM200, FEM201, FEM202, FEM207, FEM207SC, FEM209, FEM210, FEM210L, FEM220, FEM220L, FEM240, FEM240L, FEM67, FEM68, FEM68EL, FEMD060, FEMD061, FEMD065, FEMD066, FEMD107, FEMD107SC, FEMD108, FEMD108EL, FEMD109, FEMD200, FEMD201, FEMD67, FEMD67SC, FEMD68, FEMD68EL, FEMD69, FEP050, FEP160, FGC065, FGC100, FGC200...(Other models you can see in the web-shop)		

			
1			
GEV No.	374017	Ref. No.	3740017 RTFOC00022
description	solenoid valve single straight 230VAC inlet 3/4" outlet 10mm input 6l/min DN10 RPE polyamide flow regulating valve inlet white membranes NBR pressure range 0.2-10bar		
For models:	CYE10-V380, CYE6-V380, CYG10-V380, CYG6-V380, EC11803, FCE10, FCE108, FCE20, FCE6, FCE68, FCG10, FCG108, FCG20, FCG6, FCG68, FEC023, FEC060, FEC100, FEM060, FEM061, FEM062, FEM100, FEM101, FEM102, FEM110L, FEM200, FEM201, FEM202, FEM207, FEM207SC, FEM209, FEM210, FEM210L, FEM610L, FEMD023, FEMD100, FEMD101, FEMD207, FEMD207SC, FEMD209, FEMD48, FEP050, FEP080, FEP160, FGC060, FGC100, FGM060, FGM061, FGM062, FGM100...(Other models you can see in the webshop)		

			
1			
GEV No.	374025	Ref. No.	RTFOC00520
description	solenoid valve triple straight 230VAC inlet 3/4" outlet 10mm DN10 RPE		
For models:	CME10-V380, CME4-V380, CME6-V380, CMFE102-V380, CMFE10-V380, CMFE6-V380, CMFG10-V380, CMFG6-V380, CMG10-V380, CMG6-V380, FEM107, FEM107SC, FEM108EL, FEM109, FEM110, FEM110L, FEM210, FEM210L, FEM220, FEM220L, FEM240, FEM240L, FEM610, FEM610L, FEM67, FEM67SC, FEM68EL, FEM69, FEMD108EL, FEMD68EL, FGM107, FGM107SC, FGM108EL, FGM109, FGM110, FGM110L, FGM210, FGM210L, FGM610, FGM610L, FGM67, FGM67SC, FGM68EL, FGM69, FGMD108EL, FGMD68EL, JOKER FEM 67 SC, JOKER FEM 69, JOKER FEM 69 AB 2002, JOKER FEM107 SC...(Other models you can see in the webshop)		

solenoid valves with reducers			
2-fold			
			
1			
GEV No.	370835	Ref. No.	2DR026
description	solenoid valve double straight 230VAC inlet 3/4 outlet 10.5mm input 7l/min output 2x1.2l/min DN10 t.max. 90°C RPE		
For models:	KLO30W		

			
1			
GEV No.	374004	Ref. No.	178257
description	solenoid valve double straight 230VAC outlet JG 8 input 10-12l/min t.max. 60°C RPE plastic flow regulating valve inlet white		
For models:	FEM110L, FEM210, FEM210L, FEM610L, FGM110L, FGM210, FGM210L, FGM610L		

TP			
			
1			
GEV No.	370021	Ref. No.	240003
description	solenoid valve double straight 230VAC inlet 3/4" outlet 11.5mm DN10 TP flow regulating valve inlet white		
For models:	LB135, LB140, LB145, LB35, LB40, LB40E, LB45, LF500, LF56, LF60		




















spare parts for	370021			
	GEV No.	371013	Ref. No.	—
	solenoid coil TP 230VAC 50/60Hz			
accessories for	370021			
	GEV No.	371220	Ref. No.	—
	reducer TP flow rate 3l/min red tolerance ±15%			
	GEV No.	371221	Ref. No.	—
	reducer TP flow rate 5.5l/min yellow tolerance ±15%			
	GEV No.	371222	Ref. No.	—
	reducer TP flow rate 6l/min grey tolerance ±15%			
	GEV No.	371223	Ref. No.	—
	reducer TP flow rate 10l/min white tolerance ±15%			
	GEV No.	371224	Ref. No.	—
	reducer TP flow rate 12l/min bronze tolerance ±15%			
	GEV No.	371225	Ref. No.	—
	reducer TP flow rate 16l/min light brown tolerance ±15%			

Table continues overleaf
























accessories for		370021		
GEV No.	Ref. No.	Ref. No.	Ref. No.	Ref. No.
	371226	—	—	—
reducer TP flow rate 20l/min red tolerance ±15%				
	371230	—	—	—
reducer TP flow rate 0.25l/min red tolerance ±25%				
	371231	—	—	—
reducer TP flow rate 0.35l/min violet tolerance ±25%				
	371232	—	—	—
reducer TP flow rate 0.5l/min orange tolerance ±25%				
	371233	—	—	—
reducer TP flow rate 0.8l/min white tolerance ±25%				
	371234	—	—	—
reducer TP flow rate 1l/min light blue tolerance ±25%				
	371235	—	—	—
reducer TP flow rate 1.2l/min brown tolerance ±25%				
	371236	—	—	—
reducer TP flow rate 1.5l/min light brown tolerance ±25%				
	371237	—	—	—
reducer TP flow rate 2.5l/min yellow tolerance ±25%				
	371238	—	—	—
reducer TP flow rate 3.4l/min dark green tolerance ±25%				
	371239	—	—	—
reducer TP flow rate 5l/min black tolerance ±25%				
	371240	—	—	—
reducer TP flow rate 8l/min blue tolerance ±20%				

				
1				
GEV No.	370111	Ref. No.	927001 DEV32416	
description	solenoid valve double straight 24VAC inlet 3/4" outlet 11.5mm DN10 TP			
For models:	LT121, LT150, LT151, LT152, LT161, LT202, LT221, LT271, LT272, LT362, LT91			
spare parts for	370111			
	GEV No.	371035	Ref. No.	—
solenoid coil 24VAC				
accessories for	370111			
	GEV No.	371220	Ref. No.	—
reducer TP flow rate 3l/min red tolerance ±15%				
	GEV No.	371221	Ref. No.	—
reducer TP flow rate 5.5l/min yellow tolerance ±15%				

accessories for		370111		
GEV No.	Ref. No.	Ref. No.	Ref. No.	Ref. No.
	371222	—	—	—
reducer TP flow rate 6l/min grey tolerance ±15%				
	371223	—	—	—
reducer TP flow rate 10l/min white tolerance ±15%				
	371224	—	—	—
reducer TP flow rate 12l/min bronze tolerance ±15%				
	371225	—	—	—
reducer TP flow rate 16l/min light brown tolerance ±15%				
	371226	—	—	—
reducer TP flow rate 20l/min red tolerance ±15%				
	371230	—	—	—
reducer TP flow rate 0.25l/min red tolerance ±25%				
	371231	—	—	—
reducer TP flow rate 0.35l/min violet tolerance ±25%				
	371232	—	—	—
reducer TP flow rate 0.5l/min orange tolerance ±25%				
	371233	—	—	—
reducer TP flow rate 0.8l/min white tolerance ±25%				
	371234	—	—	—
reducer TP flow rate 1l/min light blue tolerance ±25%				
	371235	—	—	—
reducer TP flow rate 1.2l/min brown tolerance ±25%				
	371236	—	—	—
reducer TP flow rate 1.5l/min light brown tolerance ±25%				
	371237	—	—	—
reducer TP flow rate 2.5l/min yellow tolerance ±25%				
	371238	—	—	—
reducer TP flow rate 3.4l/min dark green tolerance ±25%				
	371239	—	—	—
reducer TP flow rate 5l/min black tolerance ±25%				
	371240	—	—	—
reducer TP flow rate 8l/min blue tolerance ±20%				



			
			
1			
GEV No.	370017	Ref. No.	240011 240018
description	solenoid valve single straight 230VAC inlet 3/4" outlet 11.5mm DN10 TP p max 10bar		
For models:	KLB40, LB135, LB140, LB145, LB35, LB350, LB355, LB35C, LB40, LB400, LB405, LB40E, LB411, LB411A, LB422, LB42BT-UK, LB45, LB450, LBD40, LBDX40, LF50, LF500, LF55, LF550, LF551, LF55E, LF56, LF59, LF60, LFD50, LFDX50, LK1000, LK620, LK621, LK625, LKDX110, LO65, LOD102, LOD202, LOD302, LOD304, LOD305, LOD402, LOD502, LOD65, LP800-00-092, LP92, LS500, LS500A, LS500G...(Other models you can see in the webshop)		
spare parts for	370017		
		GEV No.	371013 Ref. No. —
	solenoid coil TP 230VAC 50/60Hz		
accessories for	370017		
		GEV No.	371220 Ref. No. —
	reducer TP flow rate 3l/min red tolerance ±15%		
		GEV No.	371221 Ref. No. —
	reducer TP flow rate 5.5l/min yellow tolerance ±15%		
		GEV No.	371222 Ref. No. —
	reducer TP flow rate 6l/min grey tolerance ±15%		
		GEV No.	371223 Ref. No. —
	reducer TP flow rate 10l/min white tolerance ±15%		
		GEV No.	371224 Ref. No. —
	reducer TP flow rate 12l/min bronze tolerance ±15%		
		GEV No.	371225 Ref. No. —
	reducer TP flow rate 16l/min light brown tolerance ±15%		
		GEV No.	371226 Ref. No. —
	reducer TP flow rate 20l/min red tolerance ±15%		
		GEV No.	371230 Ref. No. —
	reducer TP flow rate 0.25l/min red tolerance ±25%		
		GEV No.	371231 Ref. No. —
	reducer TP flow rate 0.35l/min violet tolerance ±25%		
		GEV No.	371232 Ref. No. —
	reducer TP flow rate 0.5l/min orange tolerance ±25%		
		GEV No.	371233 Ref. No. —
	reducer TP flow rate 0.8l/min white tolerance ±25%		
		GEV No.	371234 Ref. No. —
	reducer TP flow rate 1l/min light blue tolerance ±25%		
		GEV No.	371235 Ref. No. —
	reducer TP flow rate 1.2l/min brown tolerance ±25%		

accessories for	370017		
		GEV No.	371236 Ref. No. —
	reducer TP flow rate 1.5l/min light brown tolerance ±25%		
		GEV No.	371237 Ref. No. —
	reducer TP flow rate 2.5l/min yellow tolerance ±25%		
		GEV No.	371238 Ref. No. —
	reducer TP flow rate 3.4l/min dark green tolerance ±25%		
		GEV No.	371239 Ref. No. —
	reducer TP flow rate 5l/min black tolerance ±25%		
		GEV No.	371240 Ref. No. —
	reducer TP flow rate 8l/min blue tolerance ±20%		













			
			
1			
GEV No.	370015	Ref. No.	015552-00 01555200R
description	solenoid valve single angled 230VAC inlet 3/4" outlet 11.5mm DN10 TP		
accessories for	370015		
		GEV No.	371220 Ref. No. —
	reducer TP flow rate 3l/min red tolerance ±15%		
		GEV No.	371221 Ref. No. —
	reducer TP flow rate 5.5l/min yellow tolerance ±15%		
		GEV No.	371222 Ref. No. —
	reducer TP flow rate 6l/min grey tolerance ±15%		
		GEV No.	371223 Ref. No. —
	reducer TP flow rate 10l/min white tolerance ±15%		
		GEV No.	371224 Ref. No. —
	reducer TP flow rate 12l/min bronze tolerance ±15%		
		GEV No.	371225 Ref. No. —
	reducer TP flow rate 16l/min light brown tolerance ±15%		
		GEV No.	371226 Ref. No. —
	reducer TP flow rate 20l/min red tolerance ±15%		
		GEV No.	371230 Ref. No. —
	reducer TP flow rate 0.25l/min red tolerance ±25%		
		GEV No.	371231 Ref. No. —
	reducer TP flow rate 0.35l/min violet tolerance ±25%		
		GEV No.	371232 Ref. No. —
	reducer TP flow rate 0.5l/min orange tolerance ±25%		


Table continues overleaf





accessories for		370015		
	GEV No.	371233	Ref. No.	—
	reducer TP flow rate 0.8l/min white tolerance ±25%			
	GEV No.	371234	Ref. No.	—
	reducer TP flow rate 1l/min light blue tolerance ±25%			
	GEV No.	371235	Ref. No.	—
	reducer TP flow rate 1.2l/min brown tolerance ±25%			
	GEV No.	371236	Ref. No.	—
	reducer TP flow rate 1.5l/min light brown tolerance ±25%			
	GEV No.	371237	Ref. No.	—
	reducer TP flow rate 2.5l/min yellow tolerance ±25%			
	GEV No.	371238	Ref. No.	—
	reducer TP flow rate 3.4l/min dark green tolerance ±25%			
	GEV No.	371239	Ref. No.	—
	reducer TP flow rate 5l/min black tolerance ±25%			
	GEV No.	371240	Ref. No.	—
	reducer TP flow rate 8l/min blue tolerance ±20%			

solenoid valves with reducers


	1			
GEV No.	370437	Ref. No.	23010	
description	solenoid valve double angled 230VAC inlet 3/4" input 10l/min output 1.2/1.2l/min DN10 t.max. 90°C TP plastic flow regulating valve inlet white outlet 11.5mm output A 1.2l/min output B 1.2l/min flow regulating valve outlet A dark brown flow regulating valve outlet B dark brown			
For models:	CB955W, ICE45W			



	1			
GEV No.	370449	Ref. No.	23220	
description	solenoid valve single angled 230VAC inlet 3/4" outlet 11.5mm input 2.5l/min outputl/min DN10 t.max. 90°C TP plastic flow regulating valve inlet yellow			
For models:	CB955A			

	1			
GEV No.	370427	Ref. No.	23001	
description	solenoid valve single angled 230VAC inlet 3/4" outlet 11.5mm input/min output 1.2l/min DN10 t.max. 90°C TP plastic flow regulating valve outlet dark brown			
For models:	CB955A, ICE45A			


	1			
GEV No.	370245	Ref. No.	927242 DEV34S16	
description	solenoid valve single straight 24VAC inlet 3/4" outlet 11.5mm input 16l/min t.max. 90°C TP plastic flow regulating valve inlet light brown			
For models:	LT121, LT150, LT151, LT152, LT161, LT202, LT221, LT271, LT272, LT362, LT91			

various

	1			
GEV No.	370726	Ref. No.	999288	
description	solenoid valve double straight 220-240VAC inlet 11mm outlet 11mm MILANO plastic output B red			
For models:	LB405, LB411, LB411A, LB422, LB425, LS500A, LS500GA, LS501A, LS501GA, LS505M, LS505T, LS511A, LS520			

	1			
GEV No.	370636	Ref. No.	240020	
description	solenoid valve single CO 230VAC outlet 10.5mm MILANO 00168401 plastic 3-ways inlet 10.5mm 50/60Hz male faston 6.3mm			
For models:	LB350, LB400, LB425, LS500, LS500A, LS501, LS501A			
accessories for	370636			
	GEV No.	371142	Ref. No.	133009
	reducer for solenoid valve ø 8.2mm			














metal			
PARKER			
2-way			
VE-123 series			
			
1			
GEV No.	370727	Ref. No.	927142
description	solenoid valve brass 2-ways 24VAC inlet 1/2" IT outlet 1/2" IT connection 1/2" L 72mm DN 13mm t.max. 140°C -10 up to 140°C PARKER type series VE123 coil type ZB09 membranes Viton p max 5bar 50/60Hz 24V voltage AC		
For models:	LT161, LT221, LT271, LT272, LT362		




solenoid valves (refrigeration)

CASTEL
valve bodies
STANDARD series

suitable for refrigerants R22, R134a, R404A, R407C, R410A, R507

			
1			
GEV No.	370151	Ref. No.	20410
description	solenoid valve body NC type 1028/2 S p max 45bar connection 1/4" soldering connection DN 2.2mm -35 up to +105°C L 125mm refrigeration straight CASTEL		
For models:	CB955A, CB955W, ICE45A, ICE45W		
accessories for	370151		
	GEV No.	371084	Ref. No. —
	solenoid coil CASTEL 230VAC 8VA 50/60Hz connection cable 1000mm type CM2		
	GEV No.	371090	Ref. No. —
	power socket plug type DIN 43650A screw		
	GEV No.	371301	Ref. No. —
	solenoid coil CASTEL 110VAC 8VA 50/60Hz seat ø 11.5mm connection DIN 43650A type HF2		
	GEV No.	371314	Ref. No. —
	solenoid coil CASTEL 240VAC 8VA 50/60Hz seat ø 11.5mm		
	GEV No.	371321	Ref. No. —
	solenoid coil CASTEL 12/24VAC 50/60Hz seat ø 11.5mm connection DIN 43650A type HF2		

			
1			
GEV No.	370383	Ref. No.	20409
description	solenoid valve body NC type 1068/M10S p max 45bar connection 10mm soldering connection DN 7mm -35 up to +105°C L 111mm refrigeration straight CASTEL		
For models:	CB955A, CB955W		
accessories for	370383		
	GEV No.	371084	Ref. No. —
	solenoid coil CASTEL 230VAC 8VA 50/60Hz connection cable 1000mm type CM2		
	GEV No.	371090	Ref. No. —
	power socket plug type DIN 43650A screw		
	GEV No.	371301	Ref. No. —
	solenoid coil CASTEL 110VAC 8VA 50/60Hz seat ø 11.5mm connection DIN 43650A type HF2		
	GEV No.	371314	Ref. No. —
	solenoid coil CASTEL 240VAC 8VA 50/60Hz seat ø 11.5mm		
	GEV No.	371321	Ref. No. —
	solenoid coil CASTEL 12/24VAC 50/60Hz seat ø 11.5mm connection DIN 43650A type HF2		

spare parts and accessories			
			
1			
GEV No.	371041	Ref. No.	23091
description	solenoid coil CASTEL 240VAC 8VA 50/60Hz seat ø 11.5mm connection DIN 43650A type HM2		
For models:	CB955A, CB955W, ICE45A, ICE45W		
accessories for	371041		
	GEV No.	371090	Ref. No. —
	power socket plug type DIN 43650A screw		
	GEV No.	371092	Ref. No. —
	power socket plug type DIN large cable length 1000mm		



DANFOSS

valve bodies



GEV No.	370160	Ref. No.	012719-00 01271900R
description	solenoid valve body NC type EVR 3 p max 45.2bar DN 3.2mm connection 6mm soldering connection -40° up to 105°C refrigeration straight DANFOSS		
For models:	B250xxx, B400xxx, B550xxx		
accessories for	370160		
	GEV No.	371046	Ref. No. —
console for solenoid valve for EVR2,3,6,10			

PARKER

valves



GEV No.	370782	Ref. No.	1RF123
description	solenoid valve 230V connection 16mm soldering connection PARKER refrigeration straight		
For models:	KL030A, KL030W		
spare parts for	370782		
	GEV No.	371033	Ref. No. —
solenoid coil PARKER 230VAC 9VA coil type YB09 with cable seat ø 14mm			

Solenoid valve - accessories



GEV No.	371142	Ref. No.	133009
description	reducer for solenoid valve ø 8.2mm		
For models:	LB350, LB400, LS500, LS500A, LS501, LS501A		

ball valves electric



GEV No.	401386 ¹	Ref. No.	RTFOC00550
description	ball valve inlet 1/2" IT outlet 1/2" IT 230V L 60mm 50/60Hz off-current open mode of operation electric connection cable 450mm IT 1/2"		
For models:	FEM107, FEM107SC, FEM109, FEM207, FEM207SC, FEM209, FEM67, FEM67SC, FEM69, FGM107, FGM107SC, FGM109, FGM207, FGM-207SC, FGM209, FGM67, FGM67SC, FGM69, JOKER FEM 67 SC, JOKER FEM 69, JOKER FEM 69 AB 2002, JOKER FEM107 SC, JOKER FEM109, JOKER FEM109 AB 2002, JOKER FEM207 SC, JOKER FEM209, JOKER FGM 67 SC, JOKER FGM 69, JOKER FGM107 SC, JOKER FGM109, JOKER FGM207 SC, JOKER FGM209		
spare parts for	401386		
	GEV No.	401246	Ref. No. RTFOC00559
gear motor for ball valve 230V L 75mm 50/60Hz W 60mm H 72mm TCR shaft ø 31mm			

¹off-current open



GEV No.	401246	Ref. No.	RTFOC00559
description	gear motor for ball valve 230V L 75mm 50/60Hz W 60mm H 72mm TCR shaft ø 31mm		

pressure switches


for warewashing


ø 58mm with male faston 6.3mm with connection horizontal





GEV No.	541002	Ref. No.	224002
description	pressure control pressure range 110/60mbar connection 6mm ø 58mm pressure connection horizontal warewashing pressure connection ø 6mm		
For models:	GC411-SC, GC911-SC, LFD60, LK100, LK100EM, LK110, LK620, LK621, LK625, LO65, LOD102, LOD202, LOD302, LOD304, LOD305, LOD402, LOD502, LOD65, LP800-00-092, LP92		





			
1			
GEV No.	541011	Ref. No.	224010
description	pressure control pressure range 110/70mbar connection 6mm ø 58mm pressure connection horizontal warewashing		
For models:	LF50, LF55E, LK621, LS500, LS500A, LS500G, LS500GA, LS500GPV, LS500PV, LS501, LS501A, LS501G, LS501GA, LS501GPV, LS501PV, LS505M, LS505T, LS511, LS511A, LS511PV, LS520		


			
1			
GEV No.	543025	Ref. No.	224027
description	pressure control pressure range 155/130mbar connection F6.3 ø 5.5mm		
For models:	LB422, LB425		


			
1			
GEV No.	541647	Ref. No.	224011
description	pressure control pressure range 115/85mbar connection 6mm ø 58mm pressure connection ø 6mm		
For models:	LF59, LS505		


			
1			
GEV No.	541898	Ref. No.	224023
description	pressure control pressure range 165/140mbar connection 6mm ø 58mm pressure connection horizontal warewashing pressure connection ø 6mm		
For models:	LK600, LK605, LS522, LS525		


			
1			
GEV No.	543024	Ref. No.	224026
description	pressure control pressure range 120/95mbar connection F6.3 ø 5.5mm		
For models:	LB422, LB425		

			
1			
GEV No.	541105	Ref. No.	926049 DEP45
description	pressure control pressure range 180/70mbar connection 6mm ø 58mm pressure connection horizontal warewashing		
For models:	GOLD74, L63, L64, LK1100, LK130, LK1300, LKD130, LO155, LO80, LO80H, LO93, LOD155, LOD202, LOD302, LOD304, LOD305, LOD402, LOD502, LOD80, LOD80H, LOD93, LP155, LP80, LP80H, LP93, LT121, LT150, LT151, LT152, LT161, LT202, LT221, LT271, LT272, LT362, LT81, LT91, LTD101, LTD131, LTD171, LTD209, LTD212, LTD216, LTD220, LTD316, LTD320, LTD326, LTDX172, LTDX222, LTDX272		

			
1			
GEV No.	541899	Ref. No.	224022 224025
description	pressure control pressure range 125/105mbar connection 6mm ø 58mm pressure connection horizontal warewashing pressure connection ø 6mm		
For models:	LK600, LK605, LS522, LS525		


			
1			
GEV No.	541778	Ref. No.	224009
description	pressure control pressure range 208/178mbar connection 6mm ø 58mm pressure connection horizontal warewashing pressure connection ø 6mm		
For models:	LF56, LF60		

			
1			
GEV No.	541166	Ref. No.	224008
description	pressure control pressure range 140/110mbar connection 6mm ø 58mm pressure connection horizontal warewashing		
For models:	LF56, LF60		




1

GEV No.	541001	Ref. No.	224004
description	pressure control pressure range 35/17mbar connection 6mm ø 58mm pressure connection horizontal warewashing		
For models:	KLB40, LB135, LB140, LB35, LB350, LB355, LB35C, LB40, LB400, LB405, LB40E, LB411, LB411A, LB42BT-UK, LBDX40, LFD50, LFDX50, LKDX110, LO155, LO65, LO80, LO80H, LO93, LOD155, LOD65, LOD80, LOD80H, LOD93, LP80, LP800-00-092, LP92, LS505M, LS505T		




1

GEV No.	541003	Ref. No.	224003
description	pressure control pressure range 55/35mbar connection 6mm ø 58mm pressure connection horizontal warewashing pressure connection ø 6mm		
For models:	LB145, LB42BT-UK, LB45, LB450, LBD40, LBDX40, LF50, LF500, LF55E, LF59, LS500, LS500A, LS500G, LS500GA, LS500GPV, LS500PV, LS501, LS501A, LS501G, LS501GA, LS501GPV, LS501PV, LS505, LS505M, LS505T, LS511, LS511A, LS511PV, LS520		




1

GEV No.	543014	Ref. No.	224024
description	pressure control pressure range 35/22mbar connection 6mm suitable for COLGED		
For models:	LS520-CRP, LS521, LS521-CRP-SP, LS525		




1

GEV No.	541106	Ref. No.	224005
description	pressure control pressure range 90/56mbar connection 6mm ø 58mm pressure connection horizontal warewashing pressure connection ø 6mm		
For models:	LF50, LF500, LF55E		




1

GEV No.	541132	Ref. No.	224015
description	pressure control pressure range 40/18mbar connection 6mm ø 58mm pressure connection horizontal warewashing		
For models:	LFD50, LS520-CRP		



1

GEV No.	541951	Ref. No.	224029
description	pressure control pressure range 90/60mbar connection 6mm ø 58mm pressure connection horizontal warewashing pressure connection ø 6mm		
For models:	LS505M, LS505T		




1

GEV No.	541010	Ref. No.	224028
description	pressure control pressure range 50/30mbar connection 6mm ø 58mm pressure connection horizontal warewashing		
For models:	LB425		




1

GEV No.	541866	Ref. No.	224016
description	pressure control pressure range 90/75mbar connection 6mm ø 58mm pressure connection horizontal warewashing pressure connection ø 6mm		
For models:	LB42BT-UK, LBD40, LBDX40, LFD50, LS520-CRP		



1


GEV No.	541013	Ref. No.	929039 DEP4
description	pressure control pressure range 55/25mbar connection 6mm ø 58mm pressure connection horizontal warewashing		
For models:	L600, L61, L62, LK1000, LK1010, S58		

1

GEV No.	541017	Ref. No.	69850
description	pressure control with mounting strap pressure range 40/20mbar connection 6mm ø 58mm pressure connection horizontal warewashing		
For models:	LK611, LK620, LK622, LK622I, LK625, LOD102		

for steam control



1

GEV No.	541351	Ref. No.	RTCP800143
description	pressure control pressure connection vertical steam control pressure range adjustable 0.2-0.9bar connection male faston 6.3mm pressure connection ø 1/4"mm		
For models:	E100I, E100I9, E100IA, E100IT9, E150I, E150I9, E150IA, E150IT9, E50I7, E50I77		

miscellaneous



1

GEV No.	541701	Ref. No.	224999/A
description	pressure control analogue with plug		
For models:	LKDX110		


for refrigeration

SAGI NO MIYA



1


GEV No.	541479	Ref. No.	23175
description	pressure control HD reset automatic refrigeration type HTB-X114 connection 2.4mm		
For models:	CB955A, CB955W, ICE45W		



1

GEV No.	541950	Ref. No.	224018
description	pressure control kit pressure range 0-30mbar connection 6mm warewashing		
For models:	LK621, LS521, LS521-CRP-SP		


electrodes



1


GEV No.	401363	Ref. No.	PAFOC00559
description	level electrode 1/4" total length 110mm probe L 85mm insulated probe length 26mm connection male faston 6.3mm stainless steel ø 2.5mm		
For models:	FEM67, FEM67SC, FEM69, FGM67, JOKER FEM 67 SC, JOKER FEM 69, JOKER FEM 69 AB 2002		

accessories




1

GEV No.	541109	Ref. No.	035031
description	Y-piece plastic hose ø 8-6-8mm for pressure switch		
For models:	LB42BT-UK, LBD40, LBDX40, LF50, LF500, LF55E, LF56, LF59, LF60, LFD50, LS500, LS500A, LS500G, LS500GA, LS500GPV, LS500PV, LS501, LS501A, LS501G, LS501GA, LS501GPV, LS501PV, LS505, LS505M, LS505T, LS511, LS511A, LS511PV, LS520, LS520-CRP		




1

GEV No.	401241	Ref. No.	RTFOC00709
description	level electrode 1/4" total length 121mm probe L 94mm insulated probe length 26mm connection male faston 6.3mm stainless steel ø 2.5mm		
For models:	FEM107, FGM107, FGM107SC, FGM109, FGM67, FGM67SC, FGM69, JOKER FGM 67 SC, JOKER FGM 69, JOKER FGM107 SC, JOKER FGM109		




1

GEV No.	401243	Ref. No.	RTFOC00210
description	level electrode 1/4" total length 131mm probe L 105mm insulated probe length 26mm connection male faston 6.3mm stainless steel ø 2.5mm		
For models:	FEM060, FEM061, FEM062, FGM060, FGM061, FGM062, FGM100, FGM101, FGM102, FGM200, FGM201, FGM202, FGM207, FGM207SC, FGM209, FMM060, FMM061, JOKER FGM207 SC, JOKER FGM209		




2

GEV No.	400020	Ref. No.	RTFOC00148
description	level electrode 1/4" total length 150mm probe L 124mm insulated probe length 26mm connection male faston 6.3mm stainless steel ø 2.5mm		
For models:	FEM060, FEM061, FEM062, FEM100, FEM101, FMM060, FMM061, FMM100, FMM101		




1

GEV No.	401242	Ref. No.	RTFOC00207
description	level electrode 1/4" total length 155mm probe L 128mm insulated probe length 26mm connection male faston 6.3mm stainless steel ø 2.5mm		
For models:	FEM107, FEM107SC, FEM109, FGM060, FGM061, FGM062, FGM102, FGM200, FGM201, FGM202, FGM207, FGM207SC, FGM209, JOKER FEM107 SC, JOKER FEM109, JOKER FEM109 AB 2002, JOKER FGM207 SC, JOKER FGM209		




1

GEV No.	401365	Ref. No.	PAFOC00703
description	level electrode 1/4" total length 172mm probe L 145mm insulated probe length 26mm connection male faston 6.3mm stainless steel ø 2.5mm		
For models:	FEM207, FEM207SC, FEM209, JOKER FEM207 SC, JOKER FEM209		




1

GEV No.	401364	Ref. No.	PAFOC00570
description	level electrode 1/4" total length 181mm probe L 155mm insulated probe length 26mm connection male faston 6.3mm stainless steel ø 2.5mm		




1

GEV No.	401361	Ref. No.	RTFOC00255
description	level electrode 1/4" total length 190mm probe L 164mm insulated probe length 26mm connection male faston 6.3mm stainless steel ø 2.5mm		
For models:	FEM100, FEM101, FEM200, FEM201, FEM202, FEM207, FEM207SC, FMM100, FMM101, JOKER FEM207 SC, JOKER FEM209		




1

GEV No.	401161	Ref. No.	PAFOC00572
description	level electrode 1/4" total length 210mm probe L 184mm insulated probe length 26mm connection male faston 6.3mm stainless steel ø 2.5mm		
For models:	FEM107, FEM107SC, FEM109, JOKER FEM107 SC, JOKER FEM109, JOKER FEM109 AB 2002		



1

GEV No.	401362	Ref. No.	PAFOC00560
description	level electrode 1/4" total length 89mm probe L 64mm insulated probe length 27mm connection male faston 6.3mm stainless steel ø 2.5mm		
For models:	FEM67, FEM67SC, FEM69, FGM67, JOKER FEM 67 SC, JOKER FEM 69, JOKER FEM 69 AB 2002		



1

GEV No.	401244	Ref. No.	RTFOC00710
description	level electrode 1/4" total length 91mm probe L 65mm insulated probe length 26mm connection male faston 6.3mm stainless steel ø 2.5mm		
For models:	FGM107, FGM107SC, FGM109, FGM67, FGM67SC, FGM69, JOKER FGM 67 SC, JOKER FGM 69, JOKER FGM107 SC, JOKER FGM109		



flow meters and flow sensors

flow meters

miscellaneous



1

GEV No.	402680	Ref. No.	240017 240998
description	flow meter pressure range 0.2-10bar connection 10mm L 69mm		
For models:	GOLD74, LB40E, LF55E, LF56, LF60, LK130, LTDX172, LTDX222, LTDX272		

compressors

ACC/ZEL

R134A

HMBP monophase

High/Medium evaporation temperature above -20/-15 °C



1

GEV No.	605009	Ref. No.	022260-00
description	compressor coolant R134a type GL90TB 220-240V 50Hz HMBP fully hermetic 10.8kg 1/4HP power input 293W cylinder capacity 8.8cm ³ CSIR H 175.5mmW 143W 194W 259W 339W 432W 539W 661W 796W test method ASHRAE		
For models:	A70N1, AX400xxx, B400xxx, B550xxx, BX400xxx, BX550xxx, D140DN2, D140DNB2, D140DNP2, D140DNP3, D70DN2, D70DNB2, D70N1, D70N1V, D70P1		

EMBRACO / ASPERA

R404a/R507

HMBP monophase

High/Medium evaporation temperature above -20/-15 °C



1

GEV No.	605161	Ref. No.	23505
description	compressor coolant R404a/R507 type NEK6210GK 220-240V 50Hz HMBP fully hermetic 8.5kg 3/8HP cylinder capacity 8.78cm ³ CSIR H 200mmW 566W 674W 815W 988W 1195W 1435W 1707W		
For models:	ICE45A, ICE45W		

L'UNITE HERMETIQUE / TECUMSEH

R404A

HMBP monophase

High/Medium evaporation temperature above -20/-15 °C



1

GEV No.	605036	Ref. No.	23444
description	compressor coolant R404A type AEZ4425Z 220-240V 50Hz 9.8kg 1/5HP power inputW cylinder capacity 4.5cm ³ CSIR H 186mmWW 198W 263W 341W 432W		
For models:	CB955A, CB955W		



fans

axial fans

ebm-papst



GEV No.	601089 ¹	Ref. No.	01348001R
description	axial fan L 119mm W 119mm H 38mm 230VAC 50/60Hz 19W bearing slide bearing manuf. no. 4650N metal connection male faston 2.8mm ebm-papst fan wheel ø 110mm temp.-resist. 55°C		
For models:	M62TNJ, M62TNJD2, M62TNJD2P, M62TNJD3, M62TNJD3P, M62TNJDB, M62TNJDBP, M62TNJP, M63TNJ, M63TNJD2, M63TNJD2P, M63TNJD3, M63TNJD3P, M63TNJDB, M63TNJDBP, M63TNJP, M64TNJ, M64TNJD2, M64TNJD2P, M64TNJD3, M64TNJD3P, M64TNJDB, M64TNJDBP, M64TNJP, M72BTJP, M72TNJD2P, M72TNJD3P, M72TNJDBP, M72TNJP, M73BTJP, M73TNJD2P, M73TNJD3P, M73TNJDBP, M73TNJP, M74BTJP, M74TNJD2P, M74TNJD3P, M74TNJDBP, M74TNJP, M82BTJP, M82TNJP, M83BTJP, M83TNJP, MP2BTJP, MP2TNJP, MP3BTJP, MP3TNJP, MP4BTJP, MP4TNJP		
accessories for	601089		
	GEV No.	550898	Ref. No. —
	connecting cable cable length 2000mm connection F 2.8 connection distance 7.9mm for axial flow fan		
	GEV No.	691104	Ref. No. —
	guard ø 115mm mounting distance 105mm for axial fan 119mm		

¹with slide bearings



GEV No.	601030 ¹	Ref. No.	RGF00254 RTFOC000254
description	axial fan L 119mm W 119mm H 38mm 230VAC 50Hz 18W bearing ball bearing manuf. no. 4656Z metal connection male faston 2.8mm ebm-papst fan wheel ø 110mm temp.-resist. 75°C		
For models:	FCE20, FCG20, FEM207, FEM207SC, FEMD207, FEMD207SC, FEP160, FGM207, FGM207SC, FGM207, FGM207SC, FGP160		
accessories for	601030		
	GEV No.	550898	Ref. No. —
	connecting cable cable length 2000mm connection F 2.8 connection distance 7.9mm for axial flow fan		
	GEV No.	692497	Ref. No. —
	guard ø 105mm mounting distance 150mm for axial fan ebm-papst-mm		

¹with ball bearings



GEV No.	601082 ¹	Ref. No.	01468000R 01979700R
description	axial fan L 92mm W 92mm H 25mm 230VAC 50/60Hz 9/11W bearing ball bearing manuf. no. 3956 metal connection male faston 2.8mm ebm-papst fan wheel ø 85mm temp.-resist. 80°C		
accessories for	601082		
	GEV No.	691103	Ref. No. —
	guard ø 90mm mounting distance 83mm for axial fan 92mm		

¹with ball bearings



GEV No.	601074 ¹	Ref. No.	01904100R
description	axial fan L 92mm W 92mm H 25mm 24VDC 2.3W bearing ball bearing manuf. no. 3414N connection cable 300mm ebm-papst fan wheel ø 85mm temp.-resist. 70°C		
accessories for	601074		
	GEV No.	691103	Ref. No. —
	guard ø 90mm mounting distance 83mm for axial fan 92mm		

¹with ball bearings



GEV No.	601632 ¹	Ref. No.	01904100
description	axial fan L 92mm W 92mm H 25mm 24VDC 2.3W bearing slide bearing manuf. no. 3414NG connection cable 310mm ebm-papst		
accessories for	601632		
	GEV No.	691103	Ref. No. —
	guard ø 90mm mounting distance 83mm for axial fan 92mm		

¹with slide bearings



ebmpapst

1

GEV No.	601088 ¹	Ref. No.	01468500R
description	axial fan L 172mm W 150mm H 55mm 230VAC 50/60Hz 39/45W bearing ball bearing connection cable 350mm manuf. no. 7855ES metal ebm-papst fan wheel ø 140mm temp.-resist. 50°C		

¹with ball bearings

import

1

GEV No.	601080 ¹	Ref. No.	RGFOC00254 RTFOC00254
description	axial fan L 119mm W 119mm H 38mm 230VAC 50/60Hz 23/20W bearing ball bearing connection male faston 2.8mm metal ADDA fan wheel ø 110mm temp.-resist. 70°C		
For models:	CME10-V380, CME4-V380, CME6-V380, CMFE102-V380, CMFE10-V380, CMFE6-V380, CMFG10-V380, CMFG6-V380, CMG10-V380, CMG6-V380, CYE10-V380, CYE6-V380, CYG10-V380, CYG6-V380, FCE108, FCE68, FCG108, FCG20, FCG68, FEC200, FEM062, FEM102, FEM107, FEM107SC, FEM108, FEM108EL, FEM109, FEM110, FEM110L, FEM200, FEM201, FEM202, FEM207, FEM207SC, FEM209, FEM210, FEM210L, FEM220, FEM220L, FEM240, FEM240L, FEM610, FEM610L, FEM67, FEM67SC, FEM68, FEM68EL, FEM69, FEMD107, FEMD107SC...(Other models you can see in the webshop)		
accessories for	601080		
	GEV No.	550898	Ref. No. —
	connecting cable cable length 2000mm connection F 2.8 connection distance 7.9mm for axial flow fan		
	GEV No.	692519	Ref. No. —
	guard L 120mm W 120mm plastic		

¹with ball bearings

ADDA

1

GEV No.	601055 ¹	Ref. No.	01468000 RTFOC00659
description	axial fan L 92mm W 92mm H 25mm 230VAC 50/60Hz 14.5/14W bearing ball bearing connection male faston 2.8mm metal ADDA fan wheel ø 85mm temp.-resist. 70°C		
For models:	FEC023, FEMD023, PLANET FEC023, PLANET FEMD023		
accessories for	601055		
	GEV No.	550898	Ref. No. —
	connecting cable cable length 2000mm connection F 2.8 connection distance 7.9mm for axial flow fan		
	GEV No.	691103	Ref. No. —
	guard ø 90mm mounting distance 83mm for axial fan 92mm		

¹with ball bearings

refrigeration fans

refrigeration motors universal

IMPORT

multi fit fan motors

WEIGUANG
MOTORS & PUMPS

1

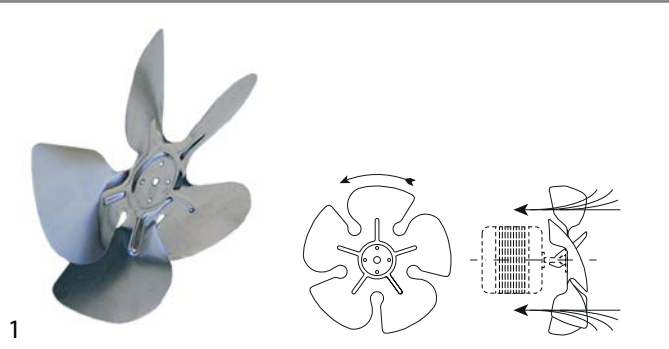
GEV No.	601022	Ref. No.	01272500R
description	fan motor 10W 230V 50-60Hz L1 44mm L2 54mm L3 85mm W 84mm cable length 500mm 1300rpm YZF10-20-18/26 5 mounting options bearing slide bearing		



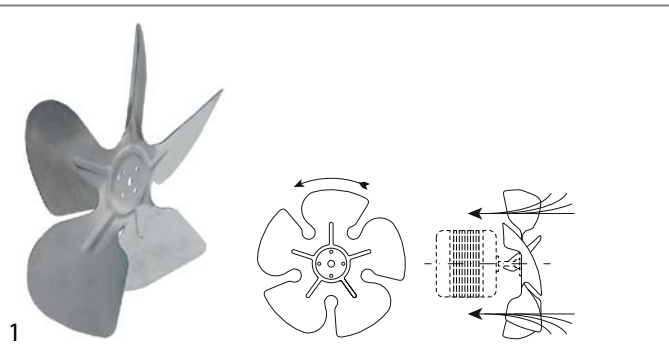
accessories

fan wheels

aluminium

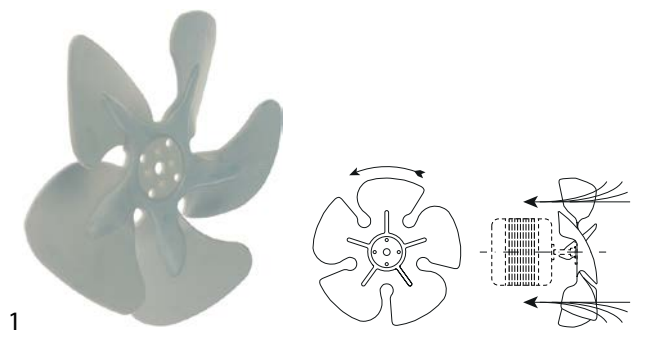


GEV No.	601071	Ref. No.	013479-00
description	fan wheel sucking \varnothing 230mm fan wheel mounting 25.4mm blade angle 25° W 37mm aluminium		
For models:	D140B2, D140DN2, D140DNB2, D140DNP2, D140DNP3, D140N2, D140N2V, D140P2, D70B1, D70DN2, D70DNB2, D70N1, D70N1V, D70P1		



GEV No.	601414	Ref. No.	20031
description	fan wheel sucking \varnothing 254mm fan wheel mounting 25.4mm blade angle 31° W 46mm aluminium		
For models:	CB955A		

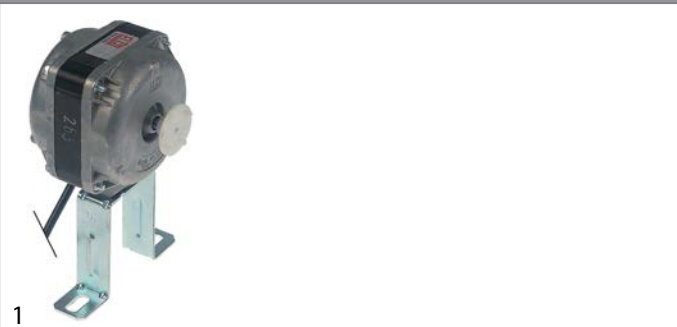
plastic



GEV No.	601412	Ref. No.	10213
description	fan wheel sucking \varnothing 154mm fan wheel mounting 25.4mm blade angle 28° W 34mm plastic		
For models:	CB955A, CB955W, ICE45A, ICE45W		

cooling motors (various)

refrigeration motors with foot



GEV No.	601418	Ref. No.	23029
description	fan motor 10W 230V 50Hz L1 48mm L2 70mm L3 85mm W 83mm feet depth 72mm cable length 500mm connection with plug		
For models:	CB955W		

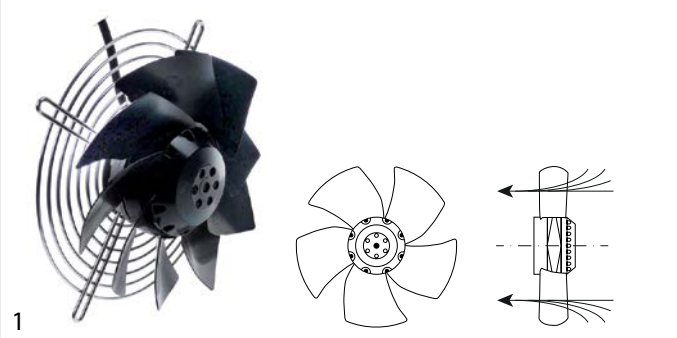


GEV No.	601419	Ref. No.	23067
description	fan motor 20W 230V 50/60Hz L1 42mm L3 91.5mm W 83mm feet depth 88mm cable length 500mm connection with plug		
For models:	CB955A		

cold air circulating fans (complete)

ebm-papst

A2E series


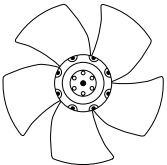
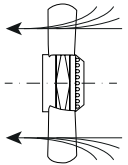


GEV No.	601663 ¹	Ref. No.	019027-00
description	fan A2E200-AI38-10 fan wheel \varnothing 200mm blades 9 230V 50/60Hz 64W 2600rpm cable length 450mm ebm-papst sucking suitable capacitor 1.5 μ F with protective grid		
spare parts for	601663		

GEV No.	365171	Ref. No.	—
	capacitor capacity 1.5 μ F 400V tolerance 5% 50/60Hz ambient temperature max. -40 up to +85°C \varnothing 25mm L 50mm M8 plastic connection cable 250mm MLR25PRL		


GEV No.	601958	Ref. No.	—
	guard \varnothing 210mm for fan hole distance 258mm		

¹incl. capacitor and guard

1

GEV No.	601964	Ref. No.	GF650/2 GF651
description	fan A2E250AM06-12 fan wheel ø 250mm blades 9 230V 50/60Hz 115/150W ø 250mm 2450rpm cable length 1400mm sucking suitable capacitor 3µF		
spare parts for	601964		
	GEV No.	365137	Ref. No.
	capacitor capacity 3µF 450V tolerance 5% 50/60Hz ambient temperature max. -25 to +85°C ø 25mm L 56mm M8 plastic connection cable 250mm 416.17.77GF protection		




1

GEV No.	601678	Ref. No.	161232
description	fan motor 220-240V 1 phase 50/60Hz 0.09/0.37kW 700/1400rpm speeds 2 L1 189mm L2 45mm L3 46mm D1 ø 24mm D2 ø 20mm 0.6/1.8A suitable capacitor 20µF Cos(φ) 0.84/0.92 type LM/FB80 no. 532259		
For models:	FCE108, FCG108, FEM107, FEM107SC, FEMD107, FEMD107SC, FEMD109, FGM107, FGM107SC, FGM207, FGM207SC, FGMD107, FGMD107SC, FGMD109, FGMD207, FGMD207SC		


cross flow fans

COPREL
with moulded coils



1


GEV No.	601456	Ref. No.	01272600R
description	cross flow fan roller ø 45mm roller length 180mm laminated core thickness 15mm motor position right 230V/50Hz 26W universal bearing silicone connection male faston 6.3mm -30 up to +100°C 230V 50/60Hz		



1


GEV No.	601230	Ref. No.	RTFOC00697
description	fan motor 220-240V 1 phase 50/60Hz 0.37kW 1400/1700rpm speeds 1 L1 188mm L2 47mm L3 47mm D1 ø 24mm D2 ø 20mm M8L IT 2.7A suitable capacitor 16 µF Cos(φ) 0.95 at 50Hz 1400rpm at 60Hz 1700rpm type LM80/4 no. 483066		
For models:	FCE10, FCE20, FCG10, FCG20, JOKER FCE 10, JOKER FCE 10 AB 2002, JOKER FCG 10, JOKER FCG 10 AB 2002		

hot air motors



1

GEV No.	601228	Ref. No.	RTFOC00011
description	fan motor		
For models:	FEC060, FEC065, FEM060, FEM061, FEM062, FEM67, FEM67SC, FEM69, FEMD060, FEMD061, FEMD065, FEMD066, FEMD67, FEMD67SC, FEMD69, FEP050, FGC060, FGC065, FGM060, FGM061, FGM062, FGM67, FGM67SC, FGM69, FGMD060, FGMD061, FGMD065, FGMD066, FGMD67, FGMD67SC, FGMD69, FGP050, FMM060, FMM061, JOKER FCG 6 AB 2002, JOKER FEM 67 SC, JOKER FEM 69, JOKER FEM 69 AB 2002, JOKER FEMD 67 SC, JOKER FEMD 69, JOKER FEP050, JOKER FEP050 AB 2002, JOKER FGM 67 SC, JOKER FGM 69, JOKER FGMD 67 SC, JOKER FGMD 69, JOKER FGP050, JOKER FGP050 AB 2002		




1

GEV No.	601379	Ref. No.	168843
description	fan motor 220-240V 1 phase 50Hz 0.074/0.37kW 1400/2800rpm speeds 2 L1 145mm L2 77mm L3 45mm D1 ø 15mm D2 ø 12mm M10L ET 2.0/0.7A suitable capacitor 20µF/450V at 50Hz 1400/2800rpm type 1075.3163		
For models:	FEM67, FGM67		


GEV No.	601229	Ref. No.	RTFOC00066
description	fan motor 220-240V 1 phase 50Hz 0.09/0.37kW 700/1400rpm speeds 2 L1 188mm L2 47mm L3 47mm D1 ø 24mm D2 ø 20mm M8L IT 0.6/1.8A suitable capacitor 20µF/450V Cos(φ) 0.84/0.92 4P/8P type LM/FB80 no. 649148		
For models:	FEC100, FEM100, FEM101, FEM102, FEM107SC, FEM109, FEM207, FEM207SC, FEM209, FEMD100, FEMD101, FEMD107SC, FEMD109, FEMD207, FEMD207SC, FEMD209, FEP080, FEP160, FGC100, FGM100, FGM101, FGM102, FGM107SC, FGM109, FGM207SC, FGM209, FGMD100, FGMD101, FGMD107SC, FGMD109, FGMD207, FGMD-207SC, FGMD209, FGP080, FGP160, FMM100, FMM101, JOKER FEM107 SC, JOKER FEM109, JOKER FEM207 SC, JOKER FEM209, JOKER FEMD107 SC, JOKER FEMD109, JOKER FEMD207 SC, JOKER FEMD209, JOKER FEP080, JOKER FEP080 AB 2002, JOKER FEP160, JOKER FGM107 SC, JOKER FGM109...(Other models you can see in the webshop)		

GEV No.	601863	Ref. No.	RIC0004598 RTFOC00322
description	fan motor 230V 1 phase 50Hz 0.05/0.4kW 700/1400rpm speeds 2 L1 190mm L2 45mm L3 48mm D1 ø 20mm D2 ø 24mm M12L IT 1/3A suitable capacitor 31.5µF 4P/8P type 1022C2353		
For models:	FEC200, FEM200, FEM201, FEM202, FEMD200, FEMD201, FEP160, FGC200, FGM200, FGM201, FGM202, FGMD200, FGMD201, FGP160		

GEV No.	601231	Ref. No.	168844 176014 RTFOC00696
description	fan motor 220-240V 1 phase 50Hz 0.37kW 2800rpm speeds 1 L1 145mm L2 77mm L3 47mm D1 ø 15mm D2 ø 12mm M10L ET 2.5A suitable capacitor 10µF/450 V Cos(φ) 0.95 at 50Hz 2800rpm type 1057A2251		
For models:	FCE6, FCE68, FCG6, FCG68, FEM610, FEM610L, FEM68, FEM68EL, FEMD68, FEMD68EL, FGM610, FGM610L, FGM68, FGM68EL, FGMD68, FGMD68EL, JOKER FCE 6, JOKER FCE 6 AB 2002, JOKER FCG 6		
accessories for	601231		
	GEV No.	365015	Ref. No. 206002 REB206002 RTFOC00701
	operating capacitor capacity 10µF 400V tolerance 5%Hz ambient temperature max. -25 to +85°C ø 35.5mm L 59mm M8 plastic connection male faston 6.3mm protection		

GEV No.	601225	Ref. No.	RTFOC00473
description	fan wheel D1 ø 220mm H1 100mm blades 12 D2 ø 11.5mm D3 ø 16mm H2 29mm		
For models:	FCE6, FCE68, FCG6, FCG68, FEM67SC, FEM69, FEMD67, FEMD67SC, FEMD69, FEP050, FGM67SC, FGM69, FGMD67, FGMD67SC, FGMD69, FGP050, JOKER FCE 6, JOKER FCE 6 AB 2002, JOKER FCG 6, JOKER FCG 6 AB 2002, JOKER FEM 67 SC, JOKER FEM 69, JOKER FEMD 67 SC, JOKER FEMD 69, JOKER FEP050, JOKER FEP050 AB 2002, JOKER FGM 67 SC, JOKER FGM 69, JOKER FGMD 67 SC, JOKER FGMD 69, JOKER FGP050, JOKER FGP050 AB 2002		

GEV No.	601685	Ref. No.	RTFOC00531
description	fan wheel D1 ø 220mm H1 100mm blades 12 D2 ø 11.5mm D3 ø 16mm H2 29mm		
For models:	FCE6, FCG6, FEM67SC, FEM69, FEMD67SC, FEMD69, FEP050, FGM67, FGM67SC, FGM69, FGMD67, FGMD67SC, FGMD69, FGP050		




1

GEV No.	601226	Ref. No.	RTFOC00517
description	fan wheel D1 ø 270mm H1 120mm blades 12 D2 ø 19.5mm D3 ø 23mm H2 46mm		
For models:	FCE10, FCE108, FCG10, FCG108, FEM107SC, FEM109, FEMD107SC, FEMD109, FEP080, FGM107SC, FGM109, FGMD107SC, FGMD109, FGP080, JOKER FCE 10, JOKER FCE 10 AB 2002, JOKER FCG 10, JOKER FCG 10 AB 2002, JOKER FEM107 SC, JOKER FEM109, JOKER FEMD107 SC, JOKER FEMD109, JOKER FEP080, JOKER FEP080 AB 2002, JOKER FGM107 SC, JOKER FGM109, JOKER FGMD107 SC, JOKER FGMD109, JOKER FGP080, JOKER FGP080 AB 2002		

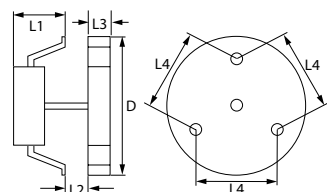




1

GEV No.	601227	Ref. No.	RTFOC00314
description	fan wheel D1 ø 350mm H1 120mm blades 12 D2 ø 19.5mm D3 ø 23mm H2 45mm		
For models:	FCE20, FCG20, FEC200, FEM200, FEM201, FEM202, FEM207, FEM207SC, FEM209, FEMD200, FEMD201, FEMD207, FEMD207SC, FEMD209, FEP160, FGC200, FGM200, FGM201, FGM202, FGM207SC, FGM209, FGMD200, FGMD201, FGMD207, FGMD207SC, FGMD209, FGP160, JOKER FEM207 SC, JOKER FEM209, JOKER FEMD207 SC, JOKER FEMD209, JOKER FEP160, JOKER FGM207 SC, JOKER FGM209, JOKER FGMD207 SC, JOKER FGMD209, JOKER FGP160		




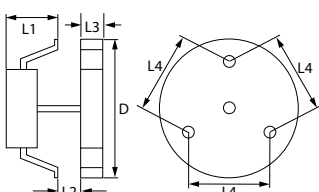
1



GEV No.	601054	Ref. No.	RTFOC00623
description	hot air fan 220-240V 32W 50/60Hz L1 60mm L2 10mm L3 25mm L4 87mm fan wheel ø 150mm FIME type C20X0E01/46		
For models:	EF0V77, EFO7V, FEC023, FEMD023, G4SFEV77, MG7E4FVP77Q, MG7G4SFEV77, OMNIA EF07V, PLANET FEC023, PLANET FEMD023		
spare parts for	601054		
	GEV No.	601441	Ref. No. —
	fan wheel ø 150mm W 25mm shaft intake ø 6x5mm stainless steel blades 7		
accessories for	601054		
	GEV No.	550879	Ref. No. —
	insulation ø 130mm thickness 3mm hole ø 20mm for hot air fan		

hot air fans

miscellaneous

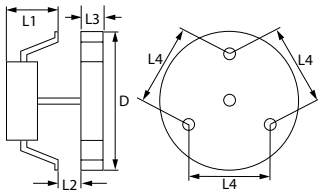



1

GEV No.	601124	Ref. No.	9343420000 RIC0002339
description	hot air fan 220-240V 30W L1 60mm L2 12mm L3 25mm L4 84mm fan wheel ø 150mm IMS type VRB150H2028		
For models:	E4F6, E6F6, E6FA6, G4SFE6, G6SFE6, G6SFEA6, MINIMA E4F6, MINIMA E6F6, MINIMA E6FA6, MINIMA G4SFE6, MINIMA G6SFE6, MINIMA G6SFEA6		



1



GEV No.	601123	Ref. No.	11950057000 RIC0004212
description	hot air fan 220-240V 47W 50/60Hz L1 80mm L2 12mm L3 20mm L4 87mm fan wheel ø 150mm FIME type C30R6086		

motors

gear motors

for ovens

for flues



1

GEV No.	361651	Ref. No.	RIC0004507 RTFOC00197
description	gear motor CROUZET type 82524421 5W 230V 50Hz 1rpm shaft ø 4mm L 66mm W 50mm H 44mm		
For models:	FEM062, FEM102, FEM109, FEM110, FEM110L, FEM200, FEM201, FEM202, FEM209, FEM210, FEM210L, FEM610, FEM610L, FEM69, FEMD109, FEMD209, FEMD69, FGM062, FGM102, FGM109, FGM110, FGM110L, FGM200, FGM201, FGM202, FGM209, FGM210, FGM210L, FGM610, FGM610L, FGM69, FGMD109, FGMD209, FGMD69, JOKER FEM 69, JOKER FEM 69 AB 2002, JOKER FEM109, JOKER FEM109 AB 2002, JOKER FEM209, JOKER FEMD 69, JOKER FEMD109, JOKER FEMD209, JOKER FGM 69, JOKER FGM109, JOKER FGM209, JOKER FGMD 69, JOKER FGMD109, JOKER FGMD209		

for dishwashers



1

GEV No.	601861	Ref. No.	927105 DPM1205
description	gear motor FIR type 71-B5 180W 400V voltage AC 50/60Hz 3 phase 900/1100rpm shaft ø 14mm L 227mm for transport system without gearbox		
For models:	LT121, LT150, LT151, LT152, LT202, LT221, LT271, LT272, LT362, LTD131, LTD171, LTD212, LTD216, LTD220, LTD316, LTD326, LTDX172, LTDX222, LTDX272		

motors

for ice-cube maker

complete



1

GEV No.	601968	Ref. No.	1LT027
description	motor 184W 220/240V 50/60Hz 1 phase shaft ø 11mm 1300rpm type 11037703 L 185mm 1.5A 0.184kW		
For models:	KF165A, KF165W, KF185A, KF185W		

for tilting bratt pans




1

GEV No.	500813	Ref. No.	RTBF900122
description	motor 120W 230V 50Hz 1 phase shaft ø 9mm shaft length 20mm 2750rpm type M TUBO 56 ø 100mm H 155mm capacitor 6.3µF AMI 0.12kW		
For models:	EBR, EBRA, EBRAVI, EBRVI, GBR, GBRA, GBRAVI, GBRVI		



accessories

fan wheels



1

GEV No.	601677	Ref. No.	927108 DWV9
description	fan wheel motor type 63B14 ø 220mm shaft intake ø 11mm H 65mm		
For models:	LT121, LT151, LT152, LT161, LT202, LT221, LT271, LT272, LT362, LT91		

pumps

wash and rinse pumps


FIR

pumps





1

GEV No.	500037	Ref. No.	929167 DPE112	
description	pump inlet ø 28mm outlet ø 26mm type 2211.1410 230V 50Hz 1 phase 0.074kW 0.1HP L 190mm rotation direction left capacitor 5µF FIR			
For models:	LKDX110, LO65, LO80, LO80H, LOD155, LOD65, LOD80, LOD80H, LP80, LP800-00-092, LP80H, LP92			
spare parts for	500037			
	GEV No.	365017	Ref. No.	206010
	operating capacitor capacity 5µF 450V tolerance 5% 50/60Hz ambient temperature max. -25 to +85°C ø 28mm L 54mm M8 plastic connection male faston 6.3mm 16.10.08 protection			
	GEV No.	510384	Ref. No.	929182
	pump cover inlet ø 28mm outlet ø 26mm ø 100mm ID ø 76mm			
	GEV No.	510695	Ref. No.	927190
	mechanical shaft seal height counter ring 5.5mm ID ø 11mm			
	GEV No.	521203	Ref. No.	929173
	impellor ø 72mm H 18mm thread M7 shaft ø 11mm shaft length 32mm blades 3			
	GEV No.	521703	Ref. No.	456038 456063
	pump cover gasket EPDM thickness 2.5mm ID ø 75mm Qty 1 pcs			



1

GEV No.	499279	Ref. No.	927137 DPE116	
description	pump inlet ø 28mm outlet ø 26mm type B246.2520 230/400V 50Hz 3 phase 0.18kW 0.25HP L 265mm rotation direction right FIR			
For models:	LT121, LT150, LT151, LT152, LT161, LT202, LT221, LT271, LT272, LT362, LT91			
spare parts for	499279			
	GEV No.	510510	Ref. No.	—
	pump cover pump type 2212/2228/2229/2211			
	GEV No.	510532	Ref. No.	80813
	impellor ø 72mm H 22mm shaft ø 11mm shaft length 32mm blades 3			
	GEV No.	510695	Ref. No.	927190
	mechanical shaft seal height counter ring 5.5mm ID ø 11mm			
	GEV No.	521703	Ref. No.	456038 456063
	pump cover gasket EPDM thickness 2.5mm ID ø 75mm Qty 1 pcs			








1

GEV No.	502287	Ref. No.	77047	
description	pump inlet ø 30mm outlet ø 26mm type 5213.4050 230/400V 50Hz 3 phase 0.11kW 0.15HP L 200mm rotation direction left			
For models:	LTD316, LTD326, LTDX172, LTDX222, LTDX272			
spare parts for	502287			
	GEV No.	699372	Ref. No.	80814
	flange for pump with cover type 5213 L 103mm W 103mm H 69mm			







1

GEV No.	500544	Ref. No.	926151 DPE210
description	pump inlet ø 60mm outlet ø 50mm type 4223.1900 230V 50Hz 1 phase 0.73kW 1HP L 225mm rotation direction right capacitor 16µF FIR		
For models:	L600, LK1000, S58		
spare parts for	500544		
	GEV No.	365021	Ref. No. 206004
	operating capacitor capacity 16µF 425V tolerance 5% 50/60Hz ambient temperature max. -25 to +85°C ø 35mm L 73mm single M8 plastic connection male faston 6.3mm 416.10.99 protection		
	GEV No.	510552	Ref. No. 437049 RAG52
	pump cover gasket pump type 1292-2/3942/3981/3911/3983		
	GEV No.	510693	Ref. No. 141002 80121 RAT72
	mechanical shaft seal for shaft ø 12mm slide ring ext. ø 24mm slide ring H 15.5mm slide ring int. ø 11mm counter ring mounting ø 24mm height counter ring 8mm counter ring int. ø 13.5mm		
	GEV No.	518067	Ref. No. 926152 RAG299
	impellor ø 103mm H 29mm M7L		
	GEV No.	521512	Ref. No. 116015 RAC441
	pump cover FIR inlet ø 60mm outlet ø 50mm		







1

GEV No.	499281	Ref. No.	80134
description	pump inlet ø 60mm outlet ø 50mm type 4298.1404 230V 50Hz 1 phase 1.1kW L 210mm rotation direction right capacitor 12.5µF FIR		
For models:	LK620, LK622, LK622I, LK625, LOD102		
spare parts for	499281		
	GEV No.	365014	Ref. No. 206012 80191 DEC212L
	operating capacitor capacity 12.5µF 450V tolerance 5%Hz ambient temperature max. -25 to +85°C ø 35mm L 70mm M8 plastic connection male faston 6.3mm 455.C3DS.12.5 protection		

spare parts for	499281		
	GEV No.	510600	Ref. No. 80197
	impellor ø 102mm H 29mm shaft intake ø 9/8mm rotation direction right blades 6		
	GEV No.	510692	Ref. No. 80193 RAT19
	mechanical shaft seal for shaft ø 11mm slide ring ext. ø 24mm slide ring H 13mm counter ring mounting ø 26mm height counter ring 8mm counter ring int. ø 14mm		
	GEV No.	521702	Ref. No. —
	pump cover gasket thickness 3.5x4.5mm Qty 1 pcs		



1

GEV No.	499336	Ref. No.	929175
description	pump inlet ø 62 outlet ø 62 type 2250.2732 230/400V 50Hz 2.95kW 4HP		
For models:	LO155, LO93, LOD155, LOD305, LOD502		
spare parts for	499336		
	GEV No.	510687	Ref. No. 929179 RAT20
	mechanical shaft seal for shaft ø 18mm height counter ring 8mm ID ø 17mm ED ø 39mm H 15mm mounting ø 42mm int. ø 21mm		
	GEV No.	521026	Ref. No. —
	pump cover gasket ID ø 182.5mm thickness 5x4.5mm		
	GEV No.	521028	Ref. No. —
	pump cover FIR inlet ø 62mm outlet ø 62mm turn direction right ø 215mm ID ø 175mm inner height 40mm		
	GEV No.	521277	Ref. No. 929181 RAG28
	impellor ø 135mm H 39mm pump type Fir 2275 - 3.6HP thread M14L		








1





GEV No.	499334	Ref. No.	929174 DPE453D
description	pump inlet ø 62mm outlet ø 62mm type 2250.2731 230/400V 50Hz 1 phase 3kW FIR		
For models:	LO155, LO93, LOD155, LOD304, LOD305, LOD402, LOD502, LOD93, LP155, LP93		
spare parts for	499334		
	GEV No.	510687	Ref. No. 929179 RAT20
	mechanical shaft seal for shaft ø 18mm height counter ring 8mm ID ø 17mm ED ø 39mm H 15mm mounting ø 42mm int. ø 1 21mm		
	GEV No.	512455	Ref. No. 929189
	fan wheel ø 155mm H 18mm shaft intake ø 18mm plastic blades 12		
	GEV No.	521026	Ref. No. —
	pump cover gasket ID ø 182.5mm thickness 5x4.5mm		
	GEV No.	521028	Ref. No. —
	pump cover FIR inlet ø 62mm outlet ø 62mm turn direction right ø 215mm ID ø 175mm inner height 40mm		
	GEV No.	521277	Ref. No. 929181 RAG28
	impellor ø 135mm H 39mm pump type Fir 2275 - 3.6HP thread M14L		







1

GEV No.	501513	Ref. No.	41990
description	pump inlet ø 63mm outlet ø 47mm type 1227.2711M10 230/400V 50Hz 3 phase 1.7kW L 340mm rotation direction right FIR		
For models:	LOD302		
spare parts for	501513		
	GEV No.	510693	Ref. No. 141002 80121 RAT72
	mechanical shaft seal for shaft ø 12mm slide ring ext. ø 24mm slide ring H 15.5mm slide ring int. ø 11mm counter ring mounting ø 24mm height counter ring 8mm counter ring int. ø 13.5mm		
	GEV No.	511667	Ref. No. —
	fan wheel ø 123mm H 17mm shaft intake ø 15mm		
	GEV No.	521513	Ref. No. 116002 80118
	pump cover FIR inlet ø 63mm outlet ø 47mm turn direction right ID ø 150mm inner height 32mm		
	GEV No.	524416	Ref. No. 80120
	pump cover gasket thickness 4x4mm Qty 1 pcs		
	GEV No.	698772	Ref. No. 41991
	impellor ø 113mm H 34mm M10L pump type 1227.2711M10 rotation direction right suitable for FIR blades 6		



1			
GEV No.	500117	Ref. No.	926150 DPE2640
description	pump inlet ø 63mm outlet ø 47mm type 4225.22725 230/400V 50Hz 3 phase 1.4kW 2HP L 280mm rotation direction right FIR		
For models:	L64, LK1300, LTD220, LTDX172, LTDX222		
spare parts for	500117		
	GEV No.	510602	Ref. No. 124002 927186 RAG298
	impeller ø 110mm H 34mm rotation direction right thread M8L shaft ø 28mm seat ø 12.2mm blades 6		
	GEV No.	510693	Ref. No. 141002 80121 RAT72
	mechanical shaft seal for shaft ø 12mm slide ring ext. ø 24mm slide ring H 15.5mm slide ring int. ø 11mm counter ring mounting ø 24mm height counter ring 8mm counter ring int. ø 13.5mm		
	GEV No.	521513	Ref. No. 116002 80118
	pump cover FIR inlet ø 63mm outlet ø 47mm turn direction right ID ø 150mm inner height 32mm		
	GEV No.	524416	Ref. No. 80120
	pump cover gasket thickness 4x4mm Qty 1 pcs		







1			
GEV No.	500570	Ref. No.	75175 DPE2102
description	pump inlet ø 63mm outlet ø 47mm type 422512725 230/400V 50Hz 3 phase 1.1kW 1.5HP L 285mm rotation direction right FIR		
For models:	L63, LK1100, LT81, LTD101, LTD131, LTD171, LTD209, LTD212, LTD216		
spare parts for	500570		
	GEV No.	510693	Ref. No. 141002 80121 RAT72
	mechanical shaft seal for shaft ø 12mm slide ring ext. ø 24mm slide ring H 15.5mm slide ring int. ø 11mm counter ring mounting ø 24mm height counter ring 8mm counter ring int. ø 13.5mm		
	GEV No.	521082	Ref. No. 80881
	impeller ø 96mm H 32mm rotation direction right thread M8L		
	GEV No.	521513	Ref. No. 116002 80118
	pump cover FIR inlet ø 63mm outlet ø 47mm turn direction right ID ø 150mm inner height 32mm		
	GEV No.	524416	Ref. No. 80120
	pump cover gasket thickness 4x4mm Qty 1 pcs		







1			
GEV No.	499283	Ref. No.	75175HZ
description	pump inlet ø 63mm outlet ø 47mm type 422512760 230/400V 60Hz 3 phase 1.1kW L 290mm rotation direction right FIR		
For models:	LTD212		

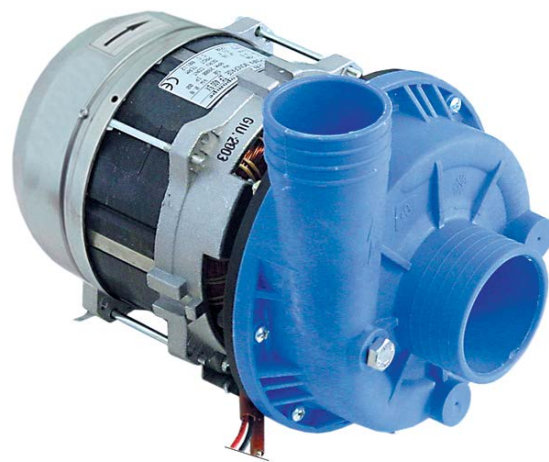


1

GEV No.	501540	Ref. No.	929123
description	pump inlet ø 63mm outlet ø 47mm type 422522726 230/400V 50Hz 3 phase 1.4kW 2HP L 280mm rotation direction right FIR		
For models:	LO80, LO80H, LOD80, LP80		
spare parts for	501540		
	GEV No.	510602	Ref. No. 124002 927186 RAG298
	impellor ø 110mm H 34mm rotation direction right thread M8L shaft ø 28mm seat ø 12.2mm blades 6		
	GEV No.	510693	Ref. No. 141002 80121 RAT72
	mechanical shaft seal for shaft ø 12mm slide ring ext. ø 24mm slide ring H 15.5mm slide ring int. ø 11mm counter ring mounting ø 24mm height counter ring 8mm counter ring int. ø 13.5mm		
	GEV No.	521513	Ref. No. 116002 80118
	pump cover FIR inlet ø 63mm outlet ø 47mm turn direction right ID ø 150mm inner high 32mm		
	GEV No.	524416	Ref. No. 80120
	pump cover gasket thickness 4x4mm Qty 1 pcs		

spare parts for	499280		
	GEV No.	510693	Ref. No. 141002 80121 RAT72
	mechanical shaft seal for shaft ø 12mm slide ring ext. ø 24mm slide ring H 15.5mm slide ring int. ø 11mm counter ring mounting ø 24mm height counter ring 8mm counter ring int. ø 13.5mm		
	GEV No.	521022	Ref. No. —
	fanwheel cover ID ø 137mm ED ø 142mm H 70mm for wash pump		
	GEV No.	524416	Ref. No. 80120
	pump cover gasket thickness 4x4mm Qty 1 pcs		
	GEV No.	698773	Ref. No. —
	pump cover inlet ø 63mm outlet ø 47mm turn direction right ø 194mm ID ø 158mm		

LGB




1

GEV No.	500556	Ref. No.	DPE219
description	pump		
For models:	L61, L62, LK1000		

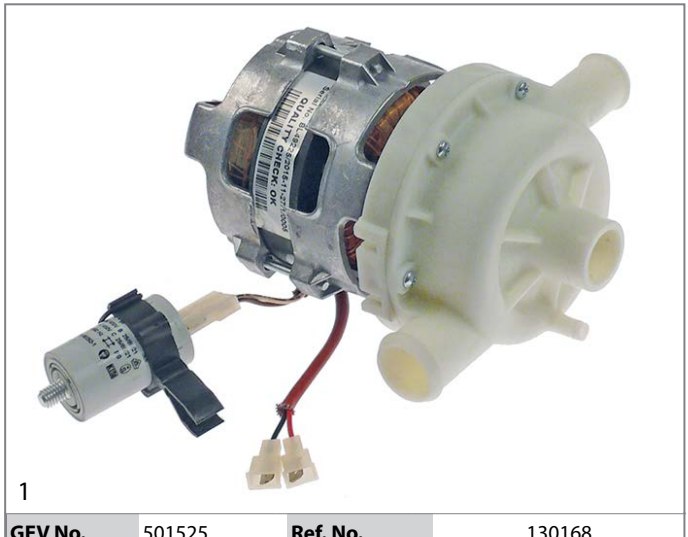







1

GEV No.	499280	Ref. No.	80115
description	pump inlet ø 63mm outlet ø 47mm type 5295.5050 230/400V 50Hz 3 phase 1.5kW L 300mm rotation direction right FIR		
For models:	LKD130, LOD202		
spare parts for	499280		
	GEV No.	502277	Ref. No. 80119
	impellor ø 111mm H 31mm thread M8L		



GEV No.	501503	Ref. No.	130166
description	pump inlet ø 28mm outlet ø 22/27mm type CF 2745 230V 50Hz 1 phase 0.19kW L 175mm rotation direction right capacitor 4µF LGB with capacitor		
For models:	LB422, LB425		
spare parts for	501503		
	GEV No.	365031	Ref. No. 206013
	operating capacitor capacity 4µF 450V tolerance 5% 50/60Hz ambient temperature max. -25 to +85°C ø 31mm L 58mm M8 plastic connection male faston 6.3mm protection		
	GEV No.	509002	Ref. No. 456083 456084
	O-ring EPDM thickness 2.62mm ID ø 82.22mm Qty 1 pcs		
	GEV No.	510703	Ref. No. 141007 80843
	mechanical shaft seal for shaft ø 13mm slide ring H 13mm height counter ring 5.5mm ED ø 26mm		
	GEV No.	698765	Ref. No. 124063
	impellor ø 70mm H 21mm rotation direction right thread M7L suitable for LGB shaft ø 13mm shaft length 20mm blades 4		
	GEV No.	698770	Ref. No. 116035
	pump cover LGB inlet ø 28mm outlet ø 22/28mm ø 108mm ID ø 84mm		



GEV No.	501525	Ref. No.	130168
description	pump inlet ø 28mm outlet ø 22/27mm type CF 3091 230V 60Hz 1 phase 0.2kW L 175mm rotation direction right capacitor 4µF LGB with capacitor		
For models:	LB422, LB425		
spare parts for	501525		
	GEV No.	365031	Ref. No. 206013
	operating capacitor capacity 4µF 450V tolerance 5% 50/60Hz ambient temperature max. -25 to +85°C ø 31mm L 58mm M8 plastic connection male faston 6.3mm protection		
	GEV No.	509002	Ref. No. 456083 456084
	O-ring EPDM thickness 2.62mm ID ø 82.22mm Qty 1 pcs		
	GEV No.	510703	Ref. No. 141007 80843
	mechanical shaft seal for shaft ø 13mm slide ring H 13mm height counter ring 5.5mm ED ø 26mm		
	GEV No.	698765	Ref. No. 124063
	impellor ø 70mm H 21mm rotation direction right thread M7L suitable for LGB shaft ø 13mm shaft length 20mm blades 4		
	GEV No.	698770	Ref. No. 116035
	pump cover LGB inlet ø 28mm outlet ø 22/28mm ø 108mm ID ø 84mm		













GEV No.	499099	Ref. No.	130163 80627
description	pump inlet ø 28mm outlet ø 26mm type CRC-R DX 230V 50Hz 1 phase 0.2kW L 175mm rotation direction left capacitor 4µF LGB		
For models:	LB425, LK620, LK621, LK625, LOD102, LOD202, LOD302, LOD304, LOD305, LOD402, LOD502, LS520-CRP, LS521, LS521-CRP-SP, LS525		
spare parts for	499099		
	GEV No.	365031	Ref. No. 206013
	operating capacitor capacity 4µF 450V tolerance 5% 50/60Hz ambient temperature max. -25 to +85°C ø 31mm L 58mm M8 plastic connection male faston 6.3mm protection		

Table continues overleaf






spare parts for 499099				
	GEV No.	509002	Ref. No.	456083 456084
O-ring EPDM thickness 2.62mm ID ø 82.22mm Qty 1 pcs				
	GEV No.	510703	Ref. No.	141007 80843
mechanical shaft seal for shaft ø 13mm slide ring H 13mm height counter ring 5.5mm ED ø 26mm				
	GEV No.	521091	Ref. No.	—
pump cover LGB inlet ø 28mm outlet ø 26mm pump type CRC-R DX				
	GEV No.	521092	Ref. No.	—
impellor ø 80mm H 25mm pump type CRC-R DX thread M6R shaft ø 13mm shaft length 20mm				









1				
GEV No.	501526	Ref. No.	80629	
description	pump inlet ø 28mm outlet ø 26mm type CRC-R DX 230V 60Hz 1 phase 0.21kW L 175mm rotation direction left capacitor 4µF LGB			
For models:	LB425, LK620, LK621, LK625, LOD102			
spare parts for 501526				
	GEV No.	365031	Ref. No.	206013
operating capacitor capacity 4µF 450V tolerance 5% 50/60Hz ambient temperature max. -25 to +85°C ø 31mm L 58mm M8 plastic connection male faston 6.3mm protection				
	GEV No.	509002	Ref. No.	456083 456084
O-ring EPDM thickness 2.62mm ID ø 82.22mm Qty 1 pcs				
	GEV No.	510703	Ref. No.	141007 80843
mechanical shaft seal for shaft ø 13mm slide ring H 13mm height counter ring 5.5mm ED ø 26mm				
	GEV No.	521091	Ref. No.	—
pump cover LGB inlet ø 28mm outlet ø 26mm pump type CRC-R DX				
	GEV No.	521092	Ref. No.	—
impellor ø 80mm H 25mm pump type CRC-R DX thread M6R shaft ø 13mm shaft length 20mm				










1				
GEV No.	500979	Ref. No.	130148	
description	pump inlet ø 28mm outlet ø 26mm type ZFC121DX 230V 50Hz 1 phase 0.25kW L 198mm rotation direction left capacitor 6.3µF LGB			
For models:	LB42BT-UK, LBDX40, LFDX50			
spare parts for 500979				
	GEV No.	365012	Ref. No.	206009
operating capacitor capacity 6.3µF 450V tolerance 5% 50Hz ambient temperature max. -25 to +85°C ø 30mm L 61mm M8 plastic connection male faston 6.3mm protection				
	GEV No.	510703	Ref. No.	141007 80843
mechanical shaft seal for shaft ø 13mm slide ring H 13mm height counter ring 5.5mm ED ø 26mm				
	GEV No.	521098	Ref. No.	—
pump cover LGB inlet ø 28mm outlet ø 26mm auxiliary pressure connection 12mm ID ø 77mm				
	GEV No.	521099	Ref. No.	—
impellor ø 72mm H 17mm thread M7R shaft ø 13mm shaft length 12mm				
	GEV No.	528800	Ref. No.	—
O-ring EPDM thickness 2.62mm ID ø 75.87mm Qty 1 pcs				











GEV No.	500351	Ref. No.	130994
description	pump inlet \varnothing 29mm outlet \varnothing 39mm type X55X 230V 50Hz 1 phase 0.8kW 1.09HP L 210mm rotation direction right capacitor 16 μ F LGB		
For models:	LF56, LF60		
spare parts for	500351		
	GEV No.	365021	Ref. No. 206004
	operating capacitor capacity 16 μ F 425V tolerance 5% 50/60Hz ambient temperature max. -25 to +85°C \varnothing 35mm L 73mm single M8 plastic connection male faston 6.3mm 416.10.99 protection		
	GEV No.	510703	Ref. No. 141007 80843
	mechanical shaft seal for shaft \varnothing 13mm slide ring H 13mm height counter ring 5.5mm ED \varnothing 26mm		
	GEV No.	518294	Ref. No. 437087
	flat gasket rubber ED \varnothing 85mm ID \varnothing 71mm thickness 2mm Qty 1 pcs		
	GEV No.	521234	Ref. No. 124052
	impeller thread M8L ED \varnothing 93mm W 16mm		
	GEV No.	523509	Ref. No. 314001
	deep-groove ball bearing type 6201-2RS shaft \varnothing 12mm ED \varnothing 32mm W 10mm with sealing discs deep-groove ball bearing DIN 625-1		
	GEV No.	532537	Ref. No. 456067
	O-ring EPDM thickness 3.53mm ID \varnothing 113.9mm Qty 1 pcs		



GEV No.	499138	Ref. No.	130993 999241
description	pump inlet \varnothing 33mm outlet \varnothing 26mm type X35X 230V 50Hz 1 phase 0.26kW L 300mm rotation direction right capacitor 6.3 μ F LGB		
For models:	LB42BT-UK, LBD40, LBDX40		
spare parts for	499138		
	GEV No.	365012	Ref. No. 206009
	operating capacitor capacity 6.3 μ F 450V tolerance 5% 50Hz ambient temperature max. -25 to +85°C \varnothing 30mm L 61mm M8 plastic connection male faston 6.3mm protection		
	GEV No.	509004	Ref. No. 124049
	impeller \varnothing 71mm H 16mm M7L rotation direction right shaft \varnothing 13mm shaft length 13mm blades 8		
	GEV No.	510703	Ref. No. 141007 80843
	mechanical shaft seal for shaft \varnothing 13mm slide ring H 13mm height counter ring 5.5mm ED \varnothing 26mm		
	GEV No.	521088	Ref. No. 116030
	pump cover LGB inlet \varnothing 33mm outlet \varnothing 26mm		
	GEV No.	521147	Ref. No. 315024
	flange		
	GEV No.	521703	Ref. No. 456038 456063
	pump cover gasket EPDM thickness 2.5mm ID \varnothing 75mm Qty 1 pcs		
	GEV No.	523501	Ref. No. 314009
	deep-groove ball bearing type 608-2RS shaft \varnothing 8mm ED \varnothing 22mm W 7mm with sealing discs deep-groove ball bearing DIN 625-1		



1

GEV No.	499100	Ref. No.	130982
description	pump inlet ø 42mm outlet ø 24/37mm type LA50 230V 50Hz 1 phase 0.47kW L 220mm rotation direction right capacitor 10µF LGB with flange and hoses		
For models:	LS522, LS525		
spare parts for	499100		
	GEV No.	365015	Ref. No. 206002 REB206002 RTFOC00701
	operating capacitor capacity 10µF 400V tolerance 5%Hz ambient temperature max. -25 to +85°C ø 35.5mm L 59mm M8 plastic connection male faston 6.3mm protection		
	GEV No.	510702	Ref. No. —
	mechanical shaft seal height counter ring 5.5mm ID ø 12mm		
	GEV No.	521024	Ref. No. 124057
	impellor ø 88mm H 30mm rotation direction right thread M7L shaft ø 12mm blades 6		
	GEV No.	698767	Ref. No. 335015
	fan blade ø 110mm H 18mm shaft intake ø 12mm plastic blades 6		
	GEV No.	698768	Ref. No. 480148
	pump cover LGB inlet ø 42mm pump type LA50 AP ø 115mm ID ø 36mm		
	GEV No.	698793	Ref. No. —
	pump cover outlet ø 24/36mm pump type LGB		
	GEV No.	698810	Ref. No. 456078
	O-ring EPDM thickness 3.56mm ID ø 112mm Qty 1 pcs		
	GEV No.	698827	Ref. No. 429074
	threaded ring LGB pump type LA50 ø 120mm ID ø 70mm		

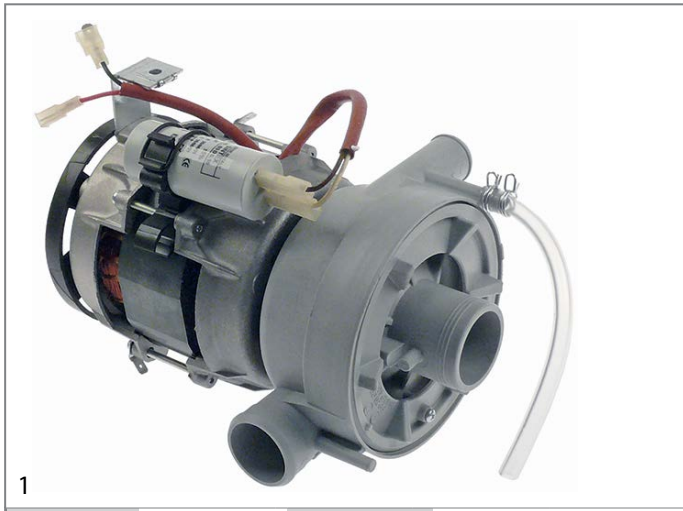









1

GEV No.	499190	Ref. No.	69120
description	pump inlet ø 42mm outlet ø 24/37mm type LA50 230V 50Hz 1 phase 0.47kW L 225mm rotation direction right capacitor 10µF LGB		
For models:	LK600		
spare parts for	499190		
	GEV No.	365015	Ref. No. 206002 REB206002 RTFOC00701
	operating capacitor capacity 10µF 400V tolerance 5%Hz ambient temperature max. -25 to +85°C ø 35.5mm L 59mm M8 plastic connection male faston 6.3mm protection		
	GEV No.	510702	Ref. No. —
	mechanical shaft seal height counter ring 5.5mm ID ø 12mm		
	GEV No.	521024	Ref. No. 124057
	impellor ø 88mm H 30mm rotation direction right thread M7L shaft ø 12mm blades 6		
	GEV No.	698767	Ref. No. 335015
	fan blade ø 110mm H 18mm shaft intake ø 12mm plastic blades 6		
	GEV No.	698768	Ref. No. 480148
	pump cover LGB inlet ø 42mm pump type LA50 AP ø 115mm ID ø 36mm		
	GEV No.	698793	Ref. No. —
	pump cover outlet ø 24/36mm pump type LGB		
	GEV No.	698810	Ref. No. 456078
	O-ring EPDM thickness 3.56mm ID ø 112mm Qty 1 pcs		
	GEV No.	698827	Ref. No. 429074
	threaded ring LGB pump type LA50 ø 120mm ID ø 70mm		



GEV No.	501484	Ref. No.	69122
description	pump inlet ø 42mm outlet ø 37/24mm type LA50 230V 50Hz 1 phase 0.47kW L 220mm rotation direction right capacitor 10µF auxiliary pressure connection 8mm LGB		
For models:	LK600, LK605		
spare parts for	501484		
	GEV No.	365015	Ref. No. 206002 REB206002 RTFOC00701
	operating capacitor capacity 10µF 400V tolerance 5%Hz ambient temperature max. -25 to +85°C ø 35.5mm L 59mm M8 plastic connection male faston 6.3mm protection		
	GEV No.	510702	Ref. No. —
	mechanical shaft seal height counter ring 5.5mm ID ø 12mm		
	GEV No.	521024	Ref. No. 124057
	impellor ø 88mm H 30mm rotation direction right thread M7L shaft ø 12mm blades 6		
	GEV No.	698767	Ref. No. 335015
	fan blade ø 110mm H 18mm shaft intake ø 12mm plastic blades 6		
	GEV No.	698768	Ref. No. 480148
	pump cover LGB inlet ø 42mm pump type LA50 AP ø 115mm ID ø 36mm		
	GEV No.	698769	Ref. No. 116032
	pump casing ø 125mm outlet ø 24/37mm		
	GEV No.	698810	Ref. No. 456078
	O-ring EPDM thickness 3.56mm ID ø 112mm Qty 1 pcs		
	GEV No.	698827	Ref. No. 429074
	threaded ring LGB pump type LA50 ø 120mm ID ø 70mm		



GEV No.	501485	Ref. No.	130977
description	pump inlet ø 42mm outlet ø 37mm type LA500 230V 50Hz 1 phase 0.47kW L 220mm rotation direction right capacitor 10µF auxiliary pressure connection 8mm LGB		
For models:	LS505M, LS505T, LS522, LS525		
spare parts for	501485		
	GEV No.	365015	Ref. No. 206002 REB206002 RTFOC00701
	operating capacitor capacity 10µF 400V tolerance 5%Hz ambient temperature max. -25 to +85°C ø 35.5mm L 59mm M8 plastic connection male faston 6.3mm protection		
	GEV No.	510702	Ref. No. —
	mechanical shaft seal height counter ring 5.5mm ID ø 12mm		
	GEV No.	521024	Ref. No. 124057
	impellor ø 88mm H 30mm rotation direction right thread M7L shaft ø 12mm blades 6		
	GEV No.	698767	Ref. No. 335015
	fan blade ø 110mm H 18mm shaft intake ø 12mm plastic blades 6		
	GEV No.	698768	Ref. No. 480148
	pump cover LGB inlet ø 42mm pump type LA50 AP ø 115mm ID ø 36mm		
	GEV No.	698769	Ref. No. 116032
	pump casing ø 125mm outlet ø 24/37mm		
	GEV No.	698810	Ref. No. 456078
	O-ring EPDM thickness 3.56mm ID ø 112mm Qty 1 pcs		
	GEV No.	698827	Ref. No. 429074
	threaded ring LGB pump type LA50 ø 120mm ID ø 70mm		



1

GEV No.	501528	Ref. No.	130976
description	pump inlet ø 42mm outlet ø 37mm type LA500 230V 60Hz 1 phase 0.46kW L 220mm rotation direction right capacitor 10µF auxiliary pressure connection 8mm LGB		
For models:	LS505M, LS505T		
spare parts for	501528		
	GEV No.	365015	Ref. No. 206002 REB206002 RTFOC00701
	operating capacitor capacity 10µF 400V tolerance 5%Hz ambient temperature max. -25 to +85°C ø 35.5mm L 59mm M8 plastic connection male faston 6.3mm protection		
	GEV No.	510702	Ref. No. —
	mechanical shaft seal height counter ring 5.5mm ID ø 12mm		
	GEV No.	521024	Ref. No. 124057
	impellor ø 88mm H 30mm rotation direction right thread M7L shaft ø 12mm blades 6		
	GEV No.	698767	Ref. No. 335015
	fan blade ø 110mm H 18mm shaft intake ø 12mm plastic blades 6		
	GEV No.	698768	Ref. No. 480148
	pump cover LGB inlet ø 42mm pump type LA50 AP ø 115mm ID ø 36mm		
	GEV No.	698769	Ref. No. 116032
	pump casing ø 125mm outlet ø 24/37mm		
	GEV No.	698810	Ref. No. 456078
	O-ring EPDM thickness 3.56mm ID ø 112mm Qty 1 pcs		
	GEV No.	698827	Ref. No. 429074
	threaded ring LGB pump type LA50 ø 120mm ID ø 70mm		









1

GEV No.	500156	Ref. No.	130109
description	pump inlet ø 50mm outlet ø 50mm type ZF400SX 230V 50Hz 1 phase 0.6kW 0.8HP L 210mm rotation direction right capacitor 16µF LGB		
For models:	LF50, LF500, LS500, LS500A, LS500G, LS500GA, LS500GPV, LS500PV, LS501, LS501A, LS501G, LS501GA, LS501GPV, LS501PV, LS505M, LS505T, LS511, LS511A, LS511PV, LS520		
spare parts for	500156		
	GEV No.	509020	Ref. No. 124031 RAG291
	impellor ø 104mm H 25mm M8L		
	GEV No.	510703	Ref. No. 141007 80843
	mechanical shaft seal for shaft ø 13mm slide ring H 13mm height counter ring 5.5mm ED ø 26mm		
	GEV No.	513713	Ref. No. 315017
	pump cover bottom part		
	GEV No.	521548	Ref. No. 116019
	pump cover LGB inlet ø 50mm outlet ø 50mm		
	GEV No.	521562	Ref. No. 116021
	pump cover		
	GEV No.	521734	Ref. No. 315022
	pump cover bottom part		
	GEV No.	523509	Ref. No. 314001
	deep-groove ball bearing type 6201-2RS shaft ø 12mm ED ø 32mm W 10mm with sealing discs deep-groove ball bearing DIN 625-1		
	GEV No.	532623	Ref. No. 80844
	O-ring EPDM thickness 2.62mm ID ø 120.32mm Qty 1 pcs		
accessories for	500156		
	GEV No.	365021	Ref. No. 206004
	operating capacitor capacity 16µF 425V tolerance 5% 50/60Hz ambient temperature max. -25 to +85°C ø 35mm L 73mm single M8 plastic connection male faston 6.3mm 416.10.99 protection		









1

GEV No.	500543	Ref. No.	130126
description	pump inlet ø 50mm outlet ø 50mm type ZF400V5X 230V 50Hz 1 phase 0.85kW 1.2HP L 245mm rotation direction right capacitor 16µF LGB		
For models:	LF55, LF550, LF551, LF55E		
spare parts for	500543		
	GEV No.	365021	Ref. No. 206004
	operating capacitor capacity 16µF 425V tolerance 5% 50/60Hz ambient temperature max. -25 to +85°C ø 35mm L 73mm single M8 plastic connection male faston 6.3mm 416.10.99 protection		
	GEV No.	509020	Ref. No. 124031 RAG291
	impellor ø 104mm H 25mm M8L		
	GEV No.	510703	Ref. No. 141007 80843
	mechanical shaft seal for shaft ø 13mm slide ring H 13mm height counter ring 5.5mm ED ø 26mm		
	GEV No.	521548	Ref. No. 116019
	pump cover LGB inlet ø 50mm outlet ø 50mm		
	GEV No.	521734	Ref. No. 315022
	pump cover bottom part		
	GEV No.	532623	Ref. No. 80844
	O-ring EPDM thickness 2.62mm ID ø 120.32mm Qty 1 pcs		



1

GEV No.	500361	Ref. No.	80112
description	pump inlet ø 60mm outlet ø 49mm type ZF400SX 230V 50Hz 1 phase 0.8kW 1HP L 210mm rotation direction right capacitor 16µF LGB		
For models:	LFD60, LK100, LK100EM, LK110, LK130, LK611, LOD102		
spare parts for	500361		
	GEV No.	365021	Ref. No. 206004
	operating capacitor capacity 16µF 425V tolerance 5% 50/60Hz ambient temperature max. -25 to +85°C ø 35mm L 73mm single M8 plastic connection male faston 6.3mm 416.10.99 protection		
	GEV No.	509020	Ref. No. 124031 RAG291
	impellor ø 104mm H 25mm M8L		
	GEV No.	510703	Ref. No. 141007 80843
	mechanical shaft seal for shaft ø 13mm slide ring H 13mm height counter ring 5.5mm ED ø 26mm		
	GEV No.	521547	Ref. No. 116013
	pump cover LGB inlet ø 60mm outlet ø 50mm supporting pressure M8 turn direction right ø 160mm ID ø 127mm inner height 36mm		
	GEV No.	521736	Ref. No. 315011
	pump cover bottom part bottom part		
	GEV No.	532623	Ref. No. 80844
	O-ring EPDM thickness 2.62mm ID ø 120.32mm Qty 1 pcs		
accessories for	500361		
	GEV No.	513264	Ref. No. 80545
	fastening angle for wash pump		



1

GEV No.	501527	Ref. No.	80113HZ
description	pump inlet ø 60mm outlet ø 49mm type ZF400SX 230V 60Hz 1 phase 0.77kW 1HP L 210mm rotation direction right capacitor 16µF LGB		
For models:	LK620, LK621, LK625		
spare parts for	501527		
	GEV No.	365021	Ref. No. 206004
	operating capacitor capacity 16µF 425V tolerance 5% 50/60Hz ambient temperature max. -25 to +85°C ø 35mm L 73mm single M8 plastic connection male faston 6.3mm 416.10.99 protection		
	GEV No.	509020	Ref. No. 124031 RAG291
	impellor ø 104mm H 25mm M8L		
	GEV No.	510703	Ref. No. 141007 80843
	mechanical shaft seal for shaft ø 13mm slide ring H 13mm height counter ring 5.5mm ED ø 26mm		
	GEV No.	521547	Ref. No. 116013
	pump cover LGB inlet ø 60mm outlet ø 50mm supporting pressure M8 turn direction right ø 160mm ID ø 127mm inner height 36mm		
	GEV No.	532623	Ref. No. 80844
	O-ring EPDM thickness 2.62mm ID ø 120.32mm Qty 1 pcs		

spare parts for	499282		
	GEV No.	510709	Ref. No. 926255 RAT211
	mechanical shaft seal		
	GEV No.	521058	Ref. No. —
	fanwheel cover suitable for LGB ID ø 138mm ED ø 142mm H 59mm plastic		
	GEV No.	521547	Ref. No. 116013
	pump cover LGB inlet ø 60mm outlet ø 50mm supporting pressure M8 turn direction right ø 160mm ID ø 127mm inner height 36mm		
	GEV No.	532623	Ref. No. 80844
	O-ring EPDM thickness 2.62mm ID ø 120.32mm Qty 1 pcs		



1






GEV No.	499126	Ref. No.	80113
description	pump inlet ø 60mm outlet ø 50mm type ZF400SX 230V 50Hz 1 phase 1.1kW L 215mm rotation direction right capacitor 16µF LGB		
For models:	LK621, LP92		
spare parts for	499126		
	GEV No.	365021	Ref. No. 206004
	operating capacitor capacity 16µF 425V tolerance 5% 50/60Hz ambient temperature max. -25 to +85°C ø 35mm L 73mm single M8 plastic connection male faston 6.3mm 416.10.99 protection		
	GEV No.	510703	Ref. No. 141007 80843
	mechanical shaft seal for shaft ø 13mm slide ring H 13mm height counter ring 5.5mm ED ø 26mm		
	GEV No.	521090	Ref. No. 80845
	impellor ø 101mm H 32mm thread M8L shaft ø 13mm shaft length 12mm		
	GEV No.	521547	Ref. No. 116013
	pump cover LGB inlet ø 60mm outlet ø 50mm supporting pressure M8 turn direction right ø 160mm ID ø 127mm inner height 36mm		
	GEV No.	532623	Ref. No. 80844
	O-ring EPDM thickness 2.62mm ID ø 120.32mm Qty 1 pcs		








1

GEV No.	499282	Ref. No.	77553
description	pump inlet ø 60mm outlet ø 49mm type ZF400VSX 220-230/380-400V 50Hz 3 phase 0.7kW L 270mm rotation direction right LGB		
For models:	LTD216, LTD220, LTD326, LTDX222, LTDX272		
spare parts for	499282		
	GEV No.	502279	Ref. No. —
	impellor H 31mm ED ø 100mm blades 6		
	GEV No.	510702	Ref. No. —
	mechanical shaft seal height counter ring 5.5mm ID ø 12mm		



GEV No.	500362	Ref. No.	926146 DPE2251R
description	pump inlet ø 62mm outlet ø 50mm type CE150SX 230/400V 50Hz 3 phase 1.1kW 1.5HP L 280mm rotation direction right LGB		
For models:	L61, L62, LK1010		
spare parts for	500362		
	GEV No.	510551	Ref. No. 456023 926084 RAG61
	pump cover gasket ID ø 158.3mm pump type 1214/1293/1225/2243/1226/1204/3473/1241 thickness 3.53mm EPDM Qty 1 pcs		
	GEV No.	510693	Ref. No. 141002 80121 RAT72
	mechanical shaft seal for shaft ø 12mm slide ring ext. ø 24mm slide ring H 15.5mm slide ring int. ø 11mm counter ring mounting ø 24mm height counter ring 8mm counter ring int. ø 13.5mm		
	GEV No.	521240	Ref. No. RAG29
	impellor ø 110mm H 32mm rotation direction left thread M8L shaft ø 20mm shaft length 10mm seat ø 8.2mm blades 6		
	GEV No.	521536	Ref. No. 926086 RAC435
	pump cover ALBA / LGB inlet ø 62mm outlet ø 50mm auxiliary pressure connection 12mm supporting pressure closed turn direction right ø 180mm ID ø 150mm inner height 38mm		
	GEV No.	602013	Ref. No. RAV400
	fan wheel ø 100mm H 28mm shaft intake ø 17.5mm plastic		



GEV No.	500360	Ref. No.	80114
description	pump inlet ø 62mm outlet ø 50mm type ZF522SX 230V 50Hz 1 phase 1.1kW 1.5HP L 220mm rotation direction right capacitor 16µF LGB		
For models:	LK100, LK110, LK130, LKDX110, LO65, LOD65, LP800-00-092, LP92		
spare parts for	500360		
	GEV No.	365021	Ref. No. 206004
	operating capacitor capacity 16µF 425V tolerance 5% 50/60Hz ambient temperature max. -25 to +85°C ø 35mm L 73mm single M8 plastic connection male faston 6.3mm 416.10.99 protection		
	GEV No.	510551	Ref. No. 456023 926084 RAG61
	pump cover gasket ID ø 158.3mm pump type 1214/1293/1225/2243/1226/1204/3473/1241 thickness 3.53mm EPDM Qty 1 pcs		
	GEV No.	510693	Ref. No. 141002 80121 RAT72
	mechanical shaft seal for shaft ø 12mm slide ring ext. ø 24mm slide ring H 15.5mm slide ring int. ø 11mm counter ring mounting ø 24mm height counter ring 8mm counter ring int. ø 13.5mm		
	GEV No.	521280	Ref. No. —
	impellor ø 107mm H 26mm thread M8L shaft ø 20mm shaft length 15mm seat ø 8.2mm blades 6		
	GEV No.	521536	Ref. No. 926086 RAC435
	pump cover ALBA / LGB inlet ø 62mm outlet ø 50mm auxiliary pressure connection 12mm supporting pressure closed turn direction right ø 180mm ID ø 150mm inner height 38mm		



1

GEV No.	501363	Ref. No.	927022 DPE190T
description	pump inlet ø 62mm outlet ø 52mm type AM5226 230/400V 50Hz 0.65kW L 295mm rotation direction left LGB		
For models:	LT121, LT150, LT151, LT152, LT161, LT202, LT221, LT271, LT362, LT91		
spare parts for	501363		
	GEV No.	510551	Ref. No. 456023 926084 RAG61
	pump cover gasket ID ø 158.3mm pump type 1214/1293/1225/2243/1226/1204/3473/1241 thickness 3.53mm EPDM Qty 1 pcs		
	GEV No.	510694	Ref. No. 926274
	mechanical shaft seal for shaft ø 13mm height counter ring 8mm ID ø 11.5mm H 16mm mounting ø 24/26mm int. ø 14mm		
	GEV No.	521141	Ref. No. —
	impellor ø 70mm H 32mm thread M8R shaft ø 20mm shaft length 9mm		
	GEV No.	521516	Ref. No. —
	pump cover LGB inlet ø 62mm outlet ø 52mm auxiliary pressure connection 12mm supporting pressure closed turn direction left ø 190mm ID ø 150mm inner height 40mm		



1

GEV No.	500733	Ref. No.	80116
description	pump inlet ø 63mm outlet ø 48mm type AM5225SX 230/400V 50Hz 3 phase 0.9kW 1.2HP L 300mm rotation direction right LGB		
For models:	LK100, LK110, LK130		













1

GEV No.	499119	Ref. No.	130987
description	pump inlet ø outlet ø 38mm type RV54 230V 50Hz 1 phase 0.8kW L 380mm rotation direction right capacitor 16µF LGB with holder		
For models:	LFD50, LFDX50, LS520-CRP, LS521, LS521-CRP-SP		
spare parts for	499119		
	GEV No.	365021	Ref. No. 206004
	operating capacitor capacity 16µF 425V tolerance 5% 50/60Hz ambient temperature max. -25 to +85°C ø 35mm L 73mm single M8 plastic connection male faston 6.3mm 416.10.99 protection		
	GEV No.	502280	Ref. No. 111034
	pump sump LGB auxiliary pressure connection 7mm supporting pressure closed pump type RV54		
	GEV No.	510703	Ref. No. 141007 80843
	mechanical shaft seal for shaft ø 13mm slide ring H 13mm height counter ring 5.5mm ED ø 26mm		
	GEV No.	521234	Ref. No. 124052
	impellor thread M8L ED ø 93mm W 16mm		
	GEV No.	523509	Ref. No. 314001
	deep-groove ball bearing type 6201-2RS shaft ø 12mm ED ø 32mm W 10mm with sealing discs deep-groove ball bearing DIN 625-1		
	GEV No.	532537	Ref. No. 456067
	O-ring EPDM thickness 3.53mm ID ø 113.9mm Qty 1 pcs		



1

GEV No.	500153	Ref. No.	999134
description	pump inlet ø outlet ø type W180SX 230V 50Hz 1 phase 0.19kW 0.26HP L 220mm rotation direction right capacitor 5µF LGB		
For models:	LB135, LB35, LB350, LB355, LB35C		
spare parts for	500153		
	GEV No.	365017	Ref. No. 206010
	operating capacitor capacity 5µF 450V tolerance 5% 50/60Hz ambient temperature max. -25 to +85°C ø 28mm L 54mm M8 plastic connection male faston 6.3mm 16.10.08 protection		
	GEV No.	510703	Ref. No. 141007 80843
	mechanical shaft seal for shaft ø 13mm slide ring H 13mm height counter ring 5.5mm ED ø 26mm		
	GEV No.	513267	Ref. No. 480054
	end cap for wash pump suitable for pump casing		
	GEV No.	513283	Ref. No. 437082
	gasket		
	GEV No.	518177	Ref. No. 111023
	drain unit thread 3/4" ID ø 35mm hose ø 24mm		
	GEV No.	518204	Ref. No. 429065
	screw connection for filter ø 67mm		
	GEV No.	518205	Ref. No. 437079 80182
	flat gasket rubber ED ø 61mm ID ø 47mm thickness 2mm Qty 1 pcs		
	GEV No.	521147	Ref. No. 315024
	flange		
	GEV No.	521221	Ref. No. 124048
	impellor ø 67mm H 16mm rotation direction right thread M7L shaft ø 13mm shaft length 12mm blades 8		
	GEV No.	528800	Ref. No. —
	O-ring EPDM thickness 2.62mm ID ø 75.87mm Qty 1 pcs		







1

GEV No.	500150	Ref. No.	999135
description	pump inlet ø outlet ø type W210SX 230V 50Hz 1 phase 0.24kW 0.33HP L 230mm rotation direction right capacitor 6.3µF LGB		
For models:	KLB40, LB140, LB40, LB400, LB405, LB40E, LB411, LB411A		
spare parts for	500150		
	GEV No.	365012	Ref. No. 206009
	operating capacitor capacity 6.3µF 450V tolerance 5% 50Hz ambient temperature max. -25 to +85°C ø 30mm L 61mm M8 plastic connection male faston 6.3mm protection		
	GEV No.	509004	Ref. No. 124049
	impellor ø 71mm H 16mm M7L rotation direction right shaft ø 13mm shaft length 13mm blades 8		
	GEV No.	510703	Ref. No. 141007 80843
	mechanical shaft seal for shaft ø 13mm slide ring H 13mm height counter ring 5.5mm ED ø 26mm		
	GEV No.	513267	Ref. No. 480054
	end cap for wash pump suitable for pump casing		
	GEV No.	513275	Ref. No. 456074
	O-ring EPDM thickness 1.78mm ID ø 82.27mm Qty 1 pcs		
	GEV No.	518177	Ref. No. 111023
	drain unit thread 3/4" ID ø 35mm hose ø 24mm		
	GEV No.	518204	Ref. No. 429065
	screw connection for filter ø 67mm		
	GEV No.	518205	Ref. No. 437079 80182
	flat gasket rubber ED ø 61mm ID ø 47mm thickness 2mm Qty 1 pcs		
	GEV No.	521147	Ref. No. 315024
	flange		

OLYMPIA


pumps











1	GEV No.	500152	Ref. No.	130122
description	pump inlet ø 44mm outlet ø 30mm type T90 230V 50Hz 1 phase 0.33kW 0.45HP L 220mm rotation direction left capacitor 8µF OLYMPIA			
For models:	LB145, LB45, LB450			
spare parts for	500152			
	GEV No.	365013	Ref. No.	206001
	operating capacitor capacity 8µF 400V tolerance 5%Hz ambient temperature max. -25 to +85°C ø 31.5mm L 55mm M8 plastic connection male faston 6.3mm protection			
	GEV No.	509007	Ref. No.	124043
	impellor ø 85mm H 20mm rotation direction left thread M10R shaft ø 12mm shaft length 7.5mm blades 12			
	GEV No.	510693	Ref. No.	141002 80121 RAT72
	mechanical shaft seal for shaft ø 12mm slide ring ext. ø 24mm slide ring H 15.5mm slide ring int. ø 11mm counter ring mounting ø 24mm height counter ring 8mm counter ring int. ø 13.5mm			
	GEV No.	521703	Ref. No.	456038 456063
	pump cover gasket EPDM thickness 2.5mm ID ø 75mm Qty 1 pcs			

booster pumps I



1	GEV No.	500359	Ref. No.	130143 DPE127
description	pump inlet ø 12 outlet ø 12 type PPL46DX 230V 50Hz 0.33kW capacitor 10µF LGB			
For models:	LFD60, LK100, LK100EM, LK110, LK130, LK611, LK622, LK622I, LKD130, LO65			
spare parts for	500359			
	GEV No.	698663	Ref. No.	—
	impellor ø 60mm H 12mm with flute shaft intake ø 12mm W 60mm suitable for LGB			


accessories for	500359			
	GEV No.	365015	Ref. No.	206002 REB206002 RTFOC00701
	operating capacitor capacity 10µF 400V tolerance 5%Hz ambient temperature max. -25 to +85°C ø 35.5mm L 59mm M8 plastic connection male faston 6.3mm protection			

1	GEV No.	500358	Ref. No.	130120 DPE125R
description	pump inlet ø 3/8" outlet ø 3/8" type PS46 230V 50Hz 0.45kW ø 100mm L 200mm capacitor 10µF LGB			
For models:	L600, LF50, LF500, LF55, LF55E, LF59, LO155, LO93, LOD93, LP155, LP93, S58			
spare parts for	500358			
	GEV No.	510713	Ref. No.	141009
	slide ring for shaft ø 12mm ED ø 24mm H 16mm			
	GEV No.	510723	Ref. No.	—
	counter ring H 8mm ED ø 26mm ID ø 13.5mm for mechanical shaft seal			
	GEV No.	698400	Ref. No.	—
	pump cover gasket pump type PS46 thickness 2mm ID ø 66mm Qty 1 pcs			
accessories for	500358			
	GEV No.	365015	Ref. No.	206002 REB206002 RTFOC00701
	operating capacitor capacity 10µF 400V tolerance 5%Hz ambient temperature max. -25 to +85°C ø 35.5mm L 59mm M8 plastic connection male faston 6.3mm protection			
	GEV No.	511279	Ref. No.	—
	hose connector brass straight thread 3/8" hose ø 12mm Qty 1 pcs			
	GEV No.	520202	Ref. No.	927015 DZR263
	hose connector nickel-plated brass straight thread 3/8" hose ø 12mm Qty 1 pcs			
	GEV No.	520677	Ref. No.	—
	hose connector brass straight thread 3/8" hose ø 13mm Qty 1 pcs			



drain pumps

ASKOLL




1

GEV No.	500210	Ref. No.	130123
description	drain pump 230V 40W		
For models:	KLB40, LB135, LB140, LB145, LB35, LB350, LB35C, LB40, LB400, LB40E, LB411, LB45, LB450, LF56, LF59, LF60, LFD50, LFDX50, LS505, LS520-CRP, LS521, LS521-CRP-SP		



1

GEV No.	499333	Ref. No.	130181 80117UL
description	drain pump 32W 220V inlet ø 30mm outlet ø 22mm 60Hz ASKOLL type R26 complete		
For models:	LB422, LB425, LK600, LK620, LK625		




1

GEV No.	501514	Ref. No.	130175
description	drain pump 40W 220-240V inlet ø 30mm outlet ø 22mm 50Hz ASKOLL type M231 XP		
For models:	LS505M, LS505T		




1

GEV No.	501541	Ref. No.	130177
description	drain pump 40W 220-240V inlet ø 30mm outlet ø 22mm 50Hz ASKOLL type M231 XP		
For models:	LB422, LS522, LS525		




1

GEV No.	499310	Ref. No.	130146
description	drain pump 40W 220V inlet ø 24mm outlet ø 22mm 50Hz ASKOLL type M231 XP complete		
For models:	LB422BT-UK, LBD40, LBDX40		




1

GEV No.	499315	Ref. No.	130178
description	drain pump inlet ø 24/30/35/39mm outlet ø 22/31mm 230V 40W 50Hz ASKOLL type M231 XP kit		
For models:	LB355, LB405, LB411, LB411A		





1

GEV No.	500214	Ref. No.	130105
description	drain pump inlet ø 30mm outlet ø 22mm 230/240V 30W 50Hz ASKOLL type R113		
For models:	LF50, LF500, LF55, LF550, LF551, LF55E, LS500, LS500GPV, LS500PV, LS501, LS501GPV, LS501PV, LS511, LS511PV, LS520		



1


GEV No.	501364	Ref. No.	999234
description	drain pump inlet ø 30mm outlet ø 22mm 230V 25W 50Hz ASKOLL type R113 conversion kit		
For models:	LFD50		
spare parts for	501364		
	GEV No.	517572	Ref. No. 144992
	backflow preventer for drain hose ø 31/21mm		



1


GEV No.	500215	Ref. No.	130138
description	drain pump inlet ø 30mm outlet ø 22mm 230V 40W 50Hz ASKOLL type M231 XP with holder		
For models:	LB140		

GRE



1


GEV No.	500247	Ref. No.	926103
description	drain pump inlet ø 34mm outlet ø 29mm 100W 230V 50Hz GRE		
For models:	LK1000		



1

GEV No.	500350	Ref. No.	DPE1108R
description	drain pump inlet ø 34mm outlet ø 29mm 100W 230V 50Hz GRE		
For models:	L600, L61, L62, L63, L64, S58		

HANNING




1

GEV No.	500363	Ref. No.	80117
description	drain pump 40W 230V		
For models:	LB425, LK100, LK100EM, LK110, LK130, LK600, LK605, LK611, LK620, LK621, LK622, LK622I, LK625, LKD130, LKDX110, LO65, LOD102, LOD65, LP800-00-092, LP92		

accessories

holders



1	GEV No.	513717	Ref. No.	035064
	description	fastening angle for drain pump		
	For models:	LF50, LF55, LF55E, LS500, LS500A, LS500G, LS500GA, LS500GPV, LS500PV, LS501, LS501A, LS501G, LS501GA, LS501GPV, LS501PV, LS505M, LS505T, LS511, LS511A, LS511PV, LS520		
	accessories for	513717		
		GEV No.	518171	Ref. No. 111019 111030 REB111019
	opposite support mounting pos. lower for wash arm support			

booster pumps II

accessories



1	GEV No.	365015	Ref. No.	206002 REB206002 RTFOC00701
	description	operating capacitor capacity 10µF 400V tolerance 5%Hz ambient temperature max. -25 to +85°C ø 35.5mm L 59mm M8 plastic connection male faston 6.3mm protection		
	For models:	BETA50, BETA53, FCE6, FCE68, FCG6, FCG68, FEMD68, FEMD68EL, FGMD68, FGMD68EL, LB45, LF50, LF500, LF55, LF55E, LF59, LFD50, LK600, LK605, LO155, LO93, LOD155, LOD93, LS505M, LS505T, LS522, LS525		



1	GEV No.	365017	Ref. No.	206010
	description	operating capacitor capacity 5µF 450V tolerance 5% 50/60Hz ambient temperature max. -25 to +85°C ø 28mm L 54mm M8 plastic connection male faston 6.3mm 16.10.08 protection		
	For models:	LB135, LB140, LB35, LB350, LB355, LB35C, LKDX110, LO65, LO80, LO80H, LOD65, LOD80, LOD80H, LP80, LP800-00-092, LP92		





1	GEV No.	365012	Ref. No.	206009
	description	operating capacitor capacity 6.3µF 450V tolerance 5% 50Hz ambient temperature max. -25 to +85°C ø 30mm L 61mm M8 plastic connection male faston 6.3mm protection		
	For models:	KLB40, LB140, LB40, LB400, LB405, LB40E, LB411, LB411A, LB42BT-UK, LBD40, LBDX40		

pumps for ice machines




1	GEV No.	601413	Ref. No.	10014
	description	fixing plate suitable for fanwheel ED ø 32mm shaft ø 7 mounting distance 26mm		
	For models:	CB955A, CB955W, ICE45A, ICE45W		

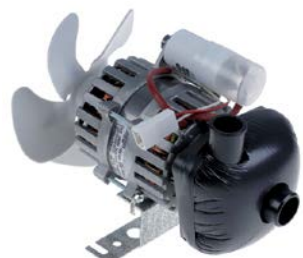





1	GEV No.	500590	Ref. No.	23377
	description	pump FIR type 4240.2300 120W 230V 50/60Hz inlet ø 22mm outlet ø 22mm L 240mm rotation direction right for ice-cube maker capacitor 5µF		
	For models:	CB955A, CB955W		
	spare parts for	500590		
		GEV No.	601412	Ref. No. 10213
		fan wheel sucking ø 154mm fan wheel mounting 25.4mm blade angle 28° W 34mm plastic		
		GEV No.	601413	Ref. No. 10014
		fixing plate suitable for fanwheel ED ø 32mm shaft ø 7 mounting distance 26mm		




			
1			
GEV No.	499341	Ref. No.	2DR100
description	pump MIGEL 100W 230V 50Hz inlet ø 23mm outlet ø 25mm L 170mm rotation direction right ice maker		
For models:	KL030A, KL030W		


			
1			
GEV No.	499003	Ref. No.	1DR037 2DR093
description	pump MIGEL type 100W 230V 50Hz inlet ø 25mm outlet ø 23mm L 170mm rotation direction right for ice maker		

			
1			
GEV No.	500165	Ref. No.	23002 RIC0002004
description	pump REBO type 63/35 120W 230V 50/60Hz inlet ø 28mm outlet ø 26mm L 180mm rotation direction right for ice-cube maker capacitor 5µF		
For models:	CB955A, CB955W, ICE45A, ICE45W		
spare parts for	500165		
	GEV No.	365017	Ref. No. 206010
operating capacitor capacity 5µF 450V tolerance 5% 50/60Hz ambient temperature max. -25 to +85°C ø 28mm L 54mm M8 plastic connection male faston 6.3mm 16.10.08 protection			
	GEV No.	601412	Ref. No. 10213
fan wheel sucking ø 154mm fan wheel mounting 25.4mm blade angle 28° W 34mm plastic			
	GEV No.	601413	Ref. No. 10014
fixing plate suitable for fanwheel ED ø 32mm shaft ø 7 mounting distance 26mm			

accessories


pump covers


			
1			
GEV No.	521563	Ref. No.	929191 RAC434
description	pump cover		
For models:	LO155, LO93, LOD155, LOD304, LOD305, LOD402, LOD502, LOD93, LP155, LP93		

			
1			
GEV No.	521570	Ref. No.	RAC436
description	pump cover		
For models:	L61, L62, LK100, LK1000, LK100EM, LK110, LK130		


pump cover gaskets

			
1			
GEV No.	513283	Ref. No.	437082
description	gasket		
For models:	LB135, LB35, LB350, LB355, LB35C, LB405		

			
1			
GEV No.	524535	Ref. No.	929180 RAG54
description	pump cover gasket thickness 4.5x4.5mm ID ø 182mm Qty 1 pcs		
For models:	LO155, LO93, LOD155, LOD304, LOD305, LOD402, LOD502, LOD93, LP155, LP93		




1

GEV No.	521081	Ref. No.	80199
description	pump cover gasket thickness 4mm Qty 1 pcs		
For models:	LK620, LK622, LK622L, LK625, LOD102		
spare parts for	521081		
		GEV No.	499281
		Ref. No.	80134
	pump inlet ø 60mm outlet ø 50mm type 4298.1404 230V 50Hz 1 phase 1.1kW L 210mm rotation direction right capacitor 12.5µF FIR		

condensators & interference suppression filters

starting capacitors

starting capacitors



1

GEV No.	365061	Ref. No.	020551-00
description	starting capacitor 220/300V 50Hz DANFOSS duty cycle 1.7/0.10% capacity 80µF for FR/NL		


operating capacitors

plastic




1

GEV No.	365015	Ref. No.	206002 REB206002 RTFOC00701
description	operating capacitor capacity 10µF 400V tolerance 5%Hz ambient temperature max. -25 to +85°C ø 35.5mm L 59mm M8 plastic connection male faston 6.3mm protection		
For models:	BETA50, BETA53, FCE6, FCE68, FCG6, FCG68, FEMD68, FEMD68EL, FGMD68, FGMD68EL, LB45, LF50, LF500, LF55, LF55E, LF59, LFD50, LK600, LK605, LO155, LO93, LOD155, LOD93, LS505M, LS505T, LS522, LS525		




1

GEV No.	365014	Ref. No.	206012 80191 DEC212L
description	operating capacitor capacity 12.5µF 450V tolerance 5%Hz ambient temperature max. -25 to +85°C ø 35mm L 70mm M8 plastic connection male faston 6.3mm 45S.C3DS.12.5 protection		
For models:	LK620, LK622, LK622L, LK625, LOD102		




1

GEV No.	365021	Ref. No.	206004
description	operating capacitor capacity 16µF 425V tolerance 5% 50/60Hz ambient temperature max. -25 to +85°C ø 35mm L 73mm single M8 plastic connection male faston 6.3mm 416.10.99 protection		
For models:	LF50, LF500, LF55, LF550, LF551, LF55E, LF56, LF60, LFD50, LFDX50, LS500, LS500A, LS500G, LS500GA, LS500GPV, LS500PV, LS501, LS501A, LS501G, LS501GA, LS501GPV, LS501PV, LS505M, LS505T, LS511, LS511A, LS511PV, LS520, LS520-CRP, LS521, LS521-CRP-SP		




1

GEV No.	365019	Ref. No.	206005 DEC220L RTFOC00053 RTFOC00700
description	operating capacitor capacity 20µF 400V tolerance 5% 50/60Hz ambient temperature max. -25 to +85°C ø 39.5mm L 70mm M8 plastic connection male faston 6.3mm 16.10.25. protection		
For models:	FCE10, FCE108, FCE20, FCG10, FCG108, FCG20, FCG6, FEC060, FEC065, FEC100, FEC200, FEM060, FEM061, FEM100, FEM101, FEM107, FEM107SC, FEM109, FEM200, FEM201, FEM207, FEM207SC, FEM209, FEM67, FEM67SC, FEM69, FEMD060, FEMD061, FEMD065, FEMD066, FEMD100, FEMD101, FEMD107, FEMD107SC, FEMD109, FEMD200, FEMD201, FEMD207, FEMD207SC, FEMD209, FEMD67, FEMD67SC, FEMD69, FEP050, FEP080, FEP160, FGC060, FGC065, FGC100, FGC200...(Other models you can see in the webshop)		



1


GEV No.	365031	Ref. No.	206013
description	operating capacitor capacity 4µF 450V tolerance 5% 50/60Hz ambient temperature max. -25 to +85°C ø 31mm L 58mm M8 plastic connection male faston 6.3mm protection		
For models:	LB422, LB425		





1


GEV No.	365017	Ref. No.	206010
description	operating capacitor capacity 5µF 450V tolerance 5% 50/60Hz ambient temperature max. -25 to +85°C ø 28mm L 54mm M8 plastic connection male faston 6.3mm 16.10.08 protection		
For models:	LB135, LB140, LB35, LB350, LB355, LB35C, LKDX110, LO65, LO80, LO80H, LOD65, LOD80, LOD80H, LP80, LP800-00-092, LP92		





 <p>1</p>			
GEV No.	365012	Ref. No.	206009
description	operating capacitor capacity 6.3µF 450V tolerance 5% 50Hz ambient temperature max. -25 to +85°C ø 30mm L 61mm M8 plastic connection male faston 6.3mm protection		
For models:	KLB40, LB140, LB40, LB400, LB405, LB40E, LB411, LB411A, LB42BT-UK, LBD40, LBDX40		

 <p>1</p>			
GEV No.	365013	Ref. No.	206001
description	operating capacitor capacity 8µF 400V tolerance 5%Hz ambient temperature max. -25 to +85°C ø 31.5mm L 55mm M8 plastic connection male faston 6.3mm protection		
For models:	LB145, LB45, LB450		


<p>metal</p>  <p>1</p>			
GEV No.	365005	Ref. No.	DEC268L
description	operating capacitor capacity 10µF 400V tolerance 5% 50/60Hz ambient temperature max. -25 to +85°C ø 35mm L 90mm M8 aluminium connection cable 300mm MKP protection IP65		
For models:	L61, L62, L63, L64, LK1000, LK1010, LK1100, LK1300, LO155, LO93, LP155, LP93, S58		

<p>filters</p> <p>interference suppression filters</p>  <p>1</p>			
GEV No.	365047	Ref. No.	926144 DEC50
description	interference suppression filter capacity 0.33µF(X2)+2x0.015µF		
For models:	KLB40, L600, L61, L62, L63, L64, LB135, LB140, LB35, LB40, LB40E, LF56, LF60, LK1000, LK1010, LK1100, LK1300, LP155, LP80, LP80H, LP93, LT150, S58		

 <p>1</p>			
GEV No.	365051	Ref. No.	RTFOC00309
description	interference suppression filter capacity 0.47uF(X2)+2x0.025uF(Y)+2x0.5mH 0.68MOhm		
For models:	FCG10, FCG20, FCG6, FEM67, FGC065, FGC200, FGM107, FGM-107SC, FGM109, FGM200, FGM201, FGM202, FGM207, FGM207SC, FGM209, FGM67, FGM67SC, FGM69, FGMD060, FGMD061, FGMD065, FGMD066, FGMD100, FGMD101, FGMD107, FGMD107SC, FGMD109, FGMD200, FGMD201, FGMD207, FGMD207SC, FGMD209, FGMD67, FGMD67SC, FGMD69, FGP050, FGP080, FGP160, JOKER FCE 6, JOKER FCE 6 AB 2002, JOKER FCG 6, JOKER FCG 6 AB 2002, JOKER FCG 10, JOKER FCG 10 AB 2002, JOKER FGM 67 SC, JOKER FGM 69, JOKER FGM107 SC, JOKER FGM109, JOKER FGM207 SC, JOKER FGM209... (Other models you can see in the webshop)		

 <p>1</p>			
GEV No.	365044	Ref. No.	RTFOC00312
description	interference suppression filter type FC701Y2F 250V 50-60Hz conductor 2 with E connection cable 200mm L 42mm ø 23mm Hmm Wmm plastic Qty 1 pcs		
For models:	EF45, EF49, EF49T, EF90, EF99, EF99T, FCE10, FCE20, FCE6, FEC065, FEC200, FEM107, FEM107SC, FEM109, FEM200, FEM201, FEM207, FEM207SC, FEM209, FEM67, FEM67SC, FEM69, FEMD060, FEMD061, FEMD065, FEMD066, FEMD100, FEMD101, FEMD107, FEMD107SC, FEMD109, FEMD200, FEMD201, FEMD207, FEMD207SC, FEMD209, FEMD67, FEMD67SC, FEMD69, FEP160, JOKER FCE 6, JOKER FCE 6 AB 2002, JOKER FCE 10, JOKER FCE 10 AB 2002, JOKER FEM 67 SC, JOKER FEM 69, JOKER FEM 69 AB 2002, JOKER FEM107 SC, JOKER FEM109, JOKER FEM109 AB 2002...(Other models you can see in the webshop)		

 <p>1</p>			
GEV No.	365048	Ref. No.	212001
description	interference suppression filter type KPB7028 275V 50/60Hz conductor 2 with E connection male faston 6.3mm L 50mm ø 38mm Hmm Wmm M8 aluminium Qty 1 pcs		
For models:	LB145, LB45, LF50, LF500, LF55E		


<p>RC circuits</p>  <p>1</p>			
GEV No.	365211	Ref. No.	C23457
description	interference suppression filter type XRY RC MKPX2 275V connection plug		
For models:	CB955A, CB955W		



fuses


fine fuses

electric components




1

GEV No.	358661	Ref. No.	RTFOC00047
description	fine fuse size ø5x20mm 0.1A fast-acting rated 250V Qty 10 pcs		
For models:	FEC060, FEC065, FEC100, FEC200, FEM060, FEM061, FEM100, FEM101, FEM200, FEM201, FEMD060, FEMD061, FEMD065, FEMD066, FEMD100, FEMD101, FEMD200, FEMD201, FEP050, FEP080, FEP160, FGC060, FGC065, FGC100, FGC200, FGM060, FGM061, FGM100, FGM101, FGM200, FGM201, FGMD060, FGMD061, FGMD065, FGMD066, FGMD100, FGMD101, FGMD200, FGMD201, FGP050, FGP080, FGP160, FMM060, FMM061, FMM100, FMM101, JOKER FEP050, JOKER FEP050 AB 2002, JOKER FEP080, JOKER FEP080 AB 2002...(Other models you can see in the webshop)		




1

GEV No.	358530	Ref. No.	926284
description	fine fuse size ø5x20mm 0.8A fast-acting rated 250V Qty 10 pcs		
For models:	LFD60, LK100, LK100EM, LK110, LK611, LKD130, LKDX110, LO155, LO65, LO80, LO80H, LO93, LOD155, LOD65, LOD80, LOD80H, LOD93, LP80, LP800-00-092, LP92, LT81, LTD101, LTD131, LTD171		




1

GEV No.	358677	Ref. No.	228004 228010
description	fine fuse size ø5x20mm 4A fast-acting rated 250V Qty 10 pcs		
For models:	LB350, LB355, LB400, LB405, LB40E, LB411, LB411A, LB422, LB42BT-UK, LB450, LBD40, LBDX40, LF55E, LF56, LF60, LFD50, LFD60, LFDX50, LK100, LK100EM, LK110, LK600, LK605, LK611, LK620, LK621, LK622, LK622I, LK625, LKD130, LKDX110, LO155, LO65, LO80, LO80H, LO93, LOD102, LOD155, LOD202, LOD302, LOD304, LOD305, LOD402, LOD502, LOD65, LOD80, LOD80H, LOD93, LP80, LP800-00-092...(Other models you can see in the webshop)		




1

GEV No.	358533	Ref. No.	RTFOC00284
description	fine fuse size ø5x20mm 6.3A fast-acting rated 250V Qty 10 pcs		
For models:	CME10-V380, CME4-V380, CME6-V380, CMFE102-V380, CMFE10-V380, CMFE6-V380, CMFG10-V380, CMFG6-V380, CMG10-V380, CMG6-V380, CYE10-V380, CYE6-V380, CYG10-V380, CYG6-V380, FCE10, FCE20, FCE6, FCG10, FCG20, FCG6, FEC065, FEC200, FEM062, FEM102, FEM107, FEM107SC, FEM109, FEM200, FEM201, FEM207, FEM207SC, FEM209, FEM67, FEM67SC, FEM69, FEMD060, FEMD061, FEMD065, FEMD066, FEMD100, FEMD101, FEMD107, FEMD107SC, FEMD109, FEMD200, FEMD201, FEMD207, FEMD207SC, FEMD209, FEMD67...(Other models you can see in the webshop)		




1

GEV No.	358693	Ref. No.	80874
description	fine fuse size ø5x20mm 2A medium lag rated 250V Qty 10 pcs		
For models:	LOD305, LOD502		




1

GEV No.	358594	Ref. No.	228012
description	fine fuse size ø5x20mm 0.16A slow-acting rated 250V Qty 10 pcs		
For models:	LK620, LK621, LK625, LOD102, LOD202, LOD302, LOD304, LOD402, LOD502, LS520-CRP, LS521, LS521-CRP-SP, LS525, LTD209, LTD212, LTD216, LTD220		




1

GEV No.	358603	Ref. No.	228011
description	fine fuse size ø5x20mm 2A slow-acting rated 250V Qty 10 pcs		
For models:	LK620, LK621, LK625, LOD102, LOD202, LOD302, LOD304, LOD402, LS520-CRP, LS521, LS521-CRP-SP, LS525, LTD209, LTD212, LTD216, LTD220		



1


GEV No.	358606	Ref. No.	228014
description	fine fuse size ø5x20mm 4A slow-acting rated 250V Qty 10 pcs		
For models:	LB355, LB405		



1

GEV No.	358760	Ref. No.	926283
description	fine fuse size ø6.3x32mm 0.315A medium lag rated 250V Qty 10 pcs		
For models:	LFD60, LK100, LK100EM, LK110, LK611, LKD130, LKDX110, LO155, LO65, LO80, LO80H, LO93, LOD155, LOD65, LOD80, LOD80H, LOD93, LP80, LP800-00-092, LP92, LT81, LTD101, LTD131, LTD171		

various





1


GEV No.	358117	Ref. No.	RIC0004491
description	set with fine fuses suitable for MBM 20x fine fuses ø5x20mm fast-acting 250V 0.5A 10x fine fuses ø5x20mm fast-acting 250V 1.25A 20x fuse holders 5x20mm mounting instructions		




fine fuse holders


			
1			
GEV No.	551234	Ref. No.	210010
description	fuse holder suitable fuse $\varnothing 5 \times 20 \text{mm}$ 1-pole 6.3A rated 600V L 52mm W 8mm H 51mm connection screw clamp cross section 4mm ²		
For models:	LB350, LB355, LB400, LB405, LB411, LB411A, LB422, LB450, LBDX40, LFD50, LFDX50, LS500, LS500A, LS500G, LS500GA, LS500GPV, LS500PV, LS501, LS501A, LS501G, LS501GA, LS501GPV, LS501PV, LS505, LS505M, LS505T, LS511, LS511A, LS511PV, LS520, LS522		

			
1			
GEV No.	550499	Ref. No.	H.228047
description	fuse holder suitable fuse $\varnothing 5 \times 20 \text{mm}$ 6.3A rated 500V		
For models:	GOLD74, LB40E, LB411, LB42BT-UK, LBD40, LBDX40, LF55E, LF56, LF60, LFD50, LFD60, LFDX50, LK100, LK100EM, LK110, LK130, LK600, LK605, LK611, LK622, LK622I, LKD130, LKDX110, LO155, LO65, LO80, LO80H, LO93, LOD155, LOD305, LOD502, LOD65, LOD80, LOD80H, LOD93, LP80, LP800-00-092, LP92, LTD209, LTD212, LTD216, LTD220, LTD316, LTD320, LTD326		

			
1			
GEV No.	550104	Ref. No.	RTFOC00048
description	fuse holder WIELAND type WK4/THSI 5 U/V0 suitable fuse $\varnothing 5 \times 30 \text{mm}$ 0.5-6mm ² top-hat rail 35mm 10A rated 600V		
For models:	CME10-V380, CME4-V380, CME6-V380, CMFE102-V380, CMFE10-V380, CMFE6-V380, CMFG10-V380, CMFG6-V380, CMG10-V380, CMG6-V380, CYE10-V380, CYE6-V380, CYG10-V380, CYG6-V380, FCE10, FCE108, FCE20, FCE6, FCE68, FCG10, FCG108, FCG20, FCG6, FCG68, FEC060, FEC065, FEC100, FEC200, FEM060, FEM061, FEM062, FEM100, FEM101, FEM102, FEM107, FEM107SC, FEM109, FEM200, FEM201, FEM207, FEM207SC, FEM209, FEM67, FEM67SC, FEM69, FEMD060, FEMD061, FEMD065, FEMD066, FEMD100...(Other models you can see in the webshop)		

			
1			
GEV No.	550519	Ref. No.	H.228048
description	cover plate suitable fuseA ratedV connection for fuse holder		
For models:	GOLD74, LB40E, LB411, LB42BT-UK, LBD40, LBDX40, LF55E, LF56, LF60, LFD50, LFD60, LFDX50, LK100, LK100EM, LK110, LK130, LK600, LK605, LK611, LK622, LK622I, LKD130, LKDX110, LO155, LO65, LO80, LO80H, LO93, LOD155, LOD305, LOD502, LOD65, LOD80, LOD80H, LOD93, LP80, LP800-00-092, LP92, LTD209, LTD212, LTD216, LTD220		

overload switches


			
1			
GEV No.	348037	Ref. No.	1LT030
description	overload switch 1-pole drop-away current 1.5A rated 240V nominal 0.05-16A connection male faston 6.3mm with plunger ambient temperature max.°C		
For models:	KF165A, KF165W, KF185A, KF185W		


electric accessories


cables


ribbon cables


group 1


			
1			
GEV No.	402970	Ref. No.	41523
description	ribbon cable 10-pole L 1200mm plug type 2 row coded Qty 1m		
For models:	LO155, LO80, LO80H, LO93, LOD155, LOD80, LOD80H, LOD93, LP80, LT81, LTD101, LTD131, LTD171		


			
1			
GEV No.	400903	Ref. No.	211009
description	ribbon cable 10-pole L 2290mm plug type FC-10P raster size 2.54mm		
For models:	LB40E, LB411, LF55E, LF56, LF60, LFD50, LFDX50, LS511		


			
1			
GEV No.	403450	Ref. No.	211013
description	ribbon cable 10-pole L 2300mm warewashing Qty 1 pcs		
For models:	LS505M, LS505T, LS511, LS511A, LS511PV, LS520-CRP, LS521, LS521-CRP-SP, LS522, LS525		

			
1			
GEV No.	403250	Ref. No.	80933 926272 DWS99
description	ribbon cable 10-pole L 3000mm plug type coded 2 row plug: number of poles 10		
For models:	LFD60, LO65, LOD102, LOD202, LOD302, LOD304, LOD305, LOD402, LOD502, LOD65, LP800-00-092, LP92		


			
1			
GEV No.	402927	Ref. No.	211011
description	ribbon cable 10-pole L 500mm plug type FC-10P raster size 2.54mm		
For models:	LB42BT-UK, LBD40, LBDX40		


			
1			
GEV No.	400902	Ref. No.	80934 DWS90
description	ribbon cable 10-pole L 750mm plug type FC-10P raster size 2.54mm		
For models:	GOLD74, LK100, LK110, LK130, LK605, LK611, LK620, LK621, LK622, LK622I, LK625, LOD202, LTD209, LTD212, LTD216, LTD220		




			
1			
GEV No.	550966	Ref. No.	RIC0002148
description	ribbon cable 26-pole L 280mm plug type FC-26P raster size 2.54mm		
For models:	FEMD108, FEMD108EL, FEMD68, FEMD68EL, FGMD108, FGMD108EL, FGMD68, FGMD68EL		



			
GEV No.	403451	Ref. No.	211017
description	ribbon cable L 2100mm Qty 1m		
For models:	LB411, LB411A, LB422, LB425		



plug connectors



			
GEV No.	551395	Ref. No.	CN6
description	female bullet \varnothing 2.5mm CuZn gal Sn Qty 1 pcs suitable for CN2, CN3, CN4		
For models:	LB40E, LB411, LB42BT-UK, LBD40, LBDX40, LF55E, LFD50, LFDX50, LS511		

			
GEV No.	551394	Ref. No.	CN7
description	female bullet \varnothing 2.8mm CuZn gal Sn Qty 1 pcs suitable for CN5		
For models:	LB40E, LB411, LB42BT-UK, LBD40, LBDX40, LF55E, LFD50, LFDX50, LS511		

			
GEV No.	400761	Ref. No.	CN5
description	plug connector 5-pole		
For models:	LB40E, LB411, LB42BT-UK, LBD40, LBDX40, LF55E, LFD50, LFDX50, LS511		
accessories for	400761		
	GEV No.	550048	Ref. No. —
	female bullet		
	GEV No.	551394	Ref. No. CN7
	female bullet \varnothing 2.8mm CuZn gal Sn Qty 1 pcs suitable for CN5		


			
GEV No.	403854	Ref. No.	CN3
description	plug connector 5-pole raster size 5mm		
For models:	LB40E, LB411, LB42BT-UK, LBD40, LBDX40, LF55E, LFD50, LFDX50, LS511		
accessories for	403854		
	GEV No.	551395	Ref. No. CN6
	female bullet \varnothing 2.5mm CuZn gal Sn Qty 1 pcs suitable for CN2, CN3, CN4		

			
GEV No.	403853	Ref. No.	CN4
description	plug connector 6-pole raster size 5mm		
For models:	LB40E, LB411, LB42BT-UK, LBD40, LBDX40, LF55E, LFD50, LFDX50, LS511		
accessories for	403853		
	GEV No.	551395	Ref. No. CN6
	female bullet \varnothing 2.5mm CuZn gal Sn Qty 1 pcs suitable for CN2, CN3, CN4		


			
GEV No.	403852	Ref. No.	CN2
description	plug connector 8-pole raster size 5mm		
For models:	LB40E, LB411, LB42BT-UK, LBD40, LBDX40, LF55E, LFD50, LFDX50, LS511		
accessories for	403852		
	GEV No.	551395	Ref. No. CN6
	female bullet \varnothing 2.5mm CuZn gal Sn Qty 1 pcs suitable for CN2, CN3, CN4		


terminals






terminal blocks


			
GEV No.	550239	Ref. No.	RTBF900045
description	lustre terminal 12-pole cross section 16mm ² max. 75A max 500V temp.-resist. 150°C		
For models:	C4EF70, C6EF70, E100, E100A, E100I, E100I9, E100I9N, E100IA, E100IT9, E100IT9N, E150, E150A, E150I, E150I9, E150I9N, E150IA, E150IT9, E150IT9N, E26, E27, E277, E277Q, E27Q, E29, E29Q, E2A, E2A77, E2A77Q, E2AR, E46, E47, E477, E477Q, E47Q, E49, E49Q, E4A, E4A77, E4A77Q, E4AR, E4F, E4F6, E4F7, E4F77, E4F7Q, E4F9, E4F9Q, E50I7, E50I77, E66...(Other models you can see in the webshop)		

connection terminals with screw/faston connections

			
GEV No.	550278	Ref. No.	53.7.0076.00
description	power terminal block 3-pole max. 40A max 400V connection \varnothing 6mm ² / F6.3 temp.-resist. 150°C cross section 6mm ²		
For models:	5RI61EM, 5RI62EM, 6BM61EM, 6BM62EM, 6BM62ET, 6BS61EM, 6BS62EM, 6CP61EM, 6CP62ET, 6FQ61E, 6FQ62E, 6FT61E, 6FT62E, 6PC61EM, 6PC62EM, 6PC62ET		

			
GEV No.	550349	Ref. No.	220010
description	power terminal block 4-pole max. 40A max 400V connection \varnothing 6mm ² / F6.3 temp.-resist. 150°C cross section 6mm ²		
For models:	LB145, LB422, LB425, LB42BT-UK, LB45, LB450, LBD40, LBDX40		





accessories for		101397	
	GEV No.	100908	Ref. No. RTCU900133
union screw thread M10x1 for pipe ø 4mm Qty 1 pcs			
	GEV No.	100909	Ref. No. RTCP800038 RTCU900019
union screw thread M10x1 for pipe ø 6mm Qty 1 pcs			
	GEV No.	101246	Ref. No. —
olive for pipe ø 4mm Qty 1 pcs			
	GEV No.	101278	Ref. No. RTCU900012
olive for pipe ø 10mm Qty 1 pcs			
	GEV No.	101286	Ref. No. RTCU900018
olive ID ø 6mm Qty 1 pcs			
	GEV No.	101300	Ref. No. RTCU700297
union nut thread M16x1.5 tube ø 10mm			
	GEV No.	101450	Ref. No. —
olive for pipe ø 8mm L 12.7mm Qty 1 pcs ED ø 10mm			
	GEV No.	101451	Ref. No. —
union nut thread M16x1.5 tube ø 8mm			
	GEV No.	110081	Ref. No. —
knob ø 70mm shaft ø 8x6.5mm shaft flat universal			
	GEV No.	112206	Ref. No. —
knob dial plate silver gas tap PEL21/22/23 t.max.°C ED ø 63mm ID ø 45.5mm			

			
1			
GEV No.	106986	Ref. No.	167069 167997
description	gas tap PEL type 21S gas inlet pipe flange ø21mm bypass nozzle ø 0mm gas outlet M16x1.5 (tube ø 10/8mm) thermocouple connection M8x1 pilot connection M10x1 shaft ø 6x4.6mm shaft L 30/23mm shaft flat upper		
For models:	BG6SF77M, G2S77, G2S77P, G2S8, G2S928P, G2S98, G2SA77, G2SA77P, G2SA98, G2SA98P, G2SF6, G2SF6G, G2SSM77, G2SSMA77, G3SF6, G3SF6G, G4S77, G4S77P, G4S8, G4S948P, G4S98, G4SA77, G4SA77P, G4SA98, G4SA98P, G4SF77, G4SF77P, G4SF8, G4SF98, G4SF98P, G4SFE77, G4SFE77P, G4SFE8, G4SFE98, G4SFEV77, G4SM77, G4SMA77, G4SMFA77, G6S77, G6S8, G6S98, G6SA77, G6SA98, G6SF77M, G6SFA77, G6SFA8, G6SFA98, G6SFEA77, G6SFEA8, G6SFEA98...(Other models you can see in the webshop)		

22S/O series			
			
1			
GEV No.	101086	Ref. No.	RTCU900011
description	gas tap PEL type 22S/O gas inlet M20x1.5 (tube ø 12mm) bypass nozzle ø 0.35mm gas outlet M20x1.5 (tube ø 12/10mm) thermocouple connection M9x1 pilot connection M10x1 shaft ø 10x8mm shaft L 25/17mm shaft flat lower		
For models:	BST2LV, BST2RV, BST6LV, BST6RV, C2A, C4A, C4F, C4FV702P, C62F, C6A, C6AV70, C6F, C6FA, C6FV70, C6FV702P, C8A, C8F, FP01V, G2S, G2SAP, G2SP, G4S, G4SAP, G4SF, G4SFE, G4SFP, G507, G5017, G6S, G6SF2, G6SFA, G6SFEA, G8S, G8SAP, G8SF2, G8SF2E, G8SF2P, GC45, GC49, GC49T, GC77, GC902V, GC992V, GC992VT, GPL45, GPL45-P, GPL49-P, GPL90, GPL90-P, GPL99-P...(Other models you can see in the webshop)		
spare parts for	101086		
	GEV No.	100259	Ref. No. RTCU700250
bypass nozzle type PEL22 bore ø 0.35mm thread M6x0.5			
	GEV No.	101058	Ref. No. —
magnet unit L 39mm D1 ø 15.4mm D2 ø 13.5mm suitable for PEL22/EGA24197 standard			
	GEV No.	101201	Ref. No. —
gas tap front part shaft ø 10x8mm shaft L 25/17mm shaft flat upper/lower suitable for PEL22			
	GEV No.	101231	Ref. No. —
thermocouple nut T1: M9x1 T2: M18x1			
	GEV No.	101240	Ref. No. —
gas connection thread M20x1.5 tube ø 12/10mm for PEL gas taps with gasket and screws horizontal			
	GEV No.	101460	Ref. No. —
O-ring ø 12.37mm D1 ø 2.62mm suitable for PEL22			
	GEV No.	101461	Ref. No. —
screw kit suitable for PEL22 Qty 4 pcs			
accessories for	101086		
	GEV No.	100908	Ref. No. RTCU900133
union screw thread M10x1 for pipe ø 4mm Qty 1 pcs			
	GEV No.	100909	Ref. No. RTCP800038 RTCU900019
union screw thread M10x1 for pipe ø 6mm Qty 1 pcs			
	GEV No.	101241	Ref. No. —
gas connection thread M20x1.5 tube ø 12/10mm for PEL gas taps vertical			
	GEV No.	101246	Ref. No. —
olive for pipe ø 4mm Qty 1 pcs			
	GEV No.	101248	Ref. No. RTCU900014
olive for pipe ø 12mm Qty 1 pcs suitable for PEL			
	GEV No.	101249	Ref. No. RTCU900016
olive for pipe ø 10mm Qty 1 pcs			
	GEV No.	101250	Ref. No. RTCU900017
union nut thread M20x1.5 for pipe ø 10mm			

Table continues overleaf



accessories for		101086		
GEV No.		Ref. No.		
	101251		RTCU900015	
union nut thread M20x1.5 for pipe ø 12mm				
	101286		RTCU900018	
olive ID ø 6mm Qty 1 pcs				
	110080		—	
knob ø 70mm shaft ø 10x8mm shaft flat universal				
	112206		—	
knob dial plate silver gas tap PEL21/22/23 t.max.°C ED ø 63mm ID ø 45.5mm				

22S/V series


GEV No.	101887	Ref. No.	160344 168001	
description	gas tap PEL type 22S/V gas inlet M20x1.5 (tube ø 12mm) bypass nozzle ø 0mm gas outlet M20x1.5 (tube ø 12/10mm) thermocouple connection M9x1 pilot connection M10x1 shaft ø 10x8mm shaft L 25/17mm shaft flat right			
For models:	G2S, G2S9, G2SA11, G4S, G4S9, G4S9-48, G4SA11, G4SF, G4SF-1, G4SF11, G4SF9, G4SF9-1, G4SF9-2, G4SFE, G4SFE9, G6S, G6S9, G6SF2, G6SF29, G6SFA, G6SFA9, G6SFEA, G6SFEA9, G6SFM, GT2SD9, GT2SDF, GT2SDF9, GT2SS9			
spare parts for	101887			
	101058		—	
magnet unit L 39mm D1 ø 15.4mm D2 ø 13.5mm suitable for PEL22/EGA24197 standard				
	101202		—	
gas tap front part shaft ø 8x10mm shaft L 25/17mm shaft flat right/left suitable for PEL22				
	101231		—	
thermocouple nut T1: M9x1 T2: M18x1				
	101236		—	
gas connection thread M20x1.5 tube ø 12/10mm for PEL gas taps vertical				
	101460		—	
O-ring ø 12.37mm D1 ø 2.62mm suitable for PEL22				
	101461		—	
screw kit suitable for PEL22 Qty 4 pcs				
accessories for	101887			
	100908		RTCU900133	
union screw thread M10x1 for pipe ø 4mm Qty 1 pcs				
	100909		RTCP800038 RTCU900019	
union screw thread M10x1 for pipe ø 6mm Qty 1 pcs				
	101246		—	
olive for pipe ø 4mm Qty 1 pcs				

accessories for		101887		
GEV No.		Ref. No.		
	101248		RTCU900014	
olive for pipe ø 12mm Qty 1 pcs suitable for PEL				
	101249		RTCU900016	
olive for pipe ø 10mm Qty 1 pcs				
	101250		RTCU900017	
union nut thread M20x1.5 for pipe ø 10mm				
	101251		RTCU900015	
union nut thread M20x1.5 for pipe ø 12mm				
	101286		RTCU900018	
olive ID ø 6mm Qty 1 pcs				
	110080		—	
knob ø 70mm shaft ø 10x8mm shaft flat universal				
	112206		—	
knob dial plate silver gas tap PEL21/22/23 t.max.°C ED ø 63mm ID ø 45.5mm				

23S/O series




























GEV No.	101091	Ref. No.	RTCP800019	
description	gas tap PEL type 23S/O gas inlet M28x1.5 (tube ø 20mm) bypass nozzle ø 0.35mm gas outlet M24x1.5 (tube ø 16mm) thermocouple connection M9x1 pilot connection M10x1 shaft ø 10x8mm shaft L 35/19mm shaft flat upper			
For models:	G100, G1009, G100A, G100I, G100I9, G100IA, G100IT9, G100T9, G150, G1509, G150A, G150I, G150I9, G150IA, G150IT9, G150T9, G175, GBR, GBRA, GC90			
spare parts for	101091			
	100455		—	
bypass nozzle type PEL23/24 bore ø 0.35mm thread M8x0.5				
	101045		—	
magnet unit T1: M9x1 T2: M22x1 L 46mm ø 18mm suitable for PEL23S M9x1				
	101244		—	
gas connection thread M24x1.5 tube ø 12/16mm horizontal for PEL gas taps				
	101336		—	
gas tap front part shaft ø 10x8mm shaft L 35/17mm shaft flat upper/lower suitable for PEL23S				
	101463		—	
screw suitable for PEL23S Qty 4 pcs				
	528455		—	
O-ring Viton thickness 2.62mm ID ø 18.72mm Qty 1 pcs				

Table continues overleaf

accessories for		101091	
	GEV No.	100908	Ref. No. RTCU900133
union screw thread M10x1 for pipe ø 4mm Qty 1 pcs			
	GEV No.	100909	Ref. No. RTCP800038 RTCU900019
union screw thread M10x1 for pipe ø 6mm Qty 1 pcs			
	GEV No.	101246	Ref. No. —
olive for pipe ø 4mm Qty 1 pcs			
	GEV No.	101252	Ref. No. —
union nut thread M24x1.5 for pipe ø 12mm			
	GEV No.	101253	Ref. No. —
union nut thread M24x1.5 PEL for pipe ø 16mm			
	GEV No.	101254	Ref. No. —
union nut thread M28x1.5 tube ø 20mm			
	GEV No.	101255	Ref. No. —
olive for pipe ø 12mm Qty 1 pcs			
	GEV No.	101256	Ref. No. RTCP800023
olive for pipe ø 16mm Qty 1 pcs			
	GEV No.	101257	Ref. No. —
olive for pipe ø 20mm Qty 1 pcs			
	GEV No.	101286	Ref. No. RTCU900018
olive ID ø 6mm Qty 1 pcs			
	GEV No.	110080	Ref. No. —
knob ø 70mm shaft ø 10x8mm shaft flat universal			
	GEV No.	112206	Ref. No. —
knob dial plate silver gas tap PEL21/22/23 t.max.°C ED ø 63mm ID ø 45.5mm			

			
1			
GEV No.	106985	Ref. No.	168000
description	gas tap PEL type 23S/O gas inlet M28x1.5 (tube ø 20mm) bypass nozzle ø 0mm gas outlet M24x1.5 (tube ø 16/12mm) thermocouple connection M9x1 pilot connection M10x1 shaft ø 10x8mm shaft L 25/17mm shaft flat upper		
For models:	G1008, G10098, G100I8, G100I98, G100T98, G1508, G15098, G150I8, G150I98, G150IT98, G5077, G50I77, GC411-SC, GC777, GC777T, GC911-SC, GTA911, GTF911		

SABAF

			
1			
GEV No.	101890	Ref. No.	170414 RTCU600016
description	gas tap SABAF type 10 gas inlet pipe flange ø 16mm bypass nozzle ø 0mm gas outlet 1/4" (tube ø 8mm) front fixing thermocouple connection plug-in connection shaft ø 8x6.5mm shaft L 26/12mm shaft flat upper		
For models:	G2S6, G4S6, G4SF6, G4SFE6, G6S6, G6SF6, G6SFA6, G6SFE6, G6SFEA6, MINIMA G2S6, MINIMA G4S6, MINIMA G4SF6, MINIMA G4SFE6, MINIMA G6S6, MINIMA G6SF6, MINIMA G6SFA6, MINIMA G6SFE6, MINIMA G6SFEA6		
spare parts for	101890		
	GEV No.	101376	Ref. No. —
gasket ID ø 8mm ED ø 12mm H 3/5mm			
	GEV No.	106723	Ref. No. —
magnet unit L 29mm D1 ø 12.5mm D2 ø 8.5mm suitable for SABAF			
accessories for	101890		
	GEV No.	101277	Ref. No. RTCU600049
olive ID ø 8mm Qty 1 pcs			
	GEV No.	101751	Ref. No. RTCU600054
bracket			
	GEV No.	520656	Ref. No. —
union nut thread 1/4" tube ø 6/8mm			
	GEV No.	560082	Ref. No. —
hexagonal screw thread M4 thread L 16mm SS WS 7 Qty 20 pcs DIN 933 / ISO 4017			

SKG






			
1			
GEV No.	101154	Ref. No.	53.1.0023.00
description	gas tap SKG without ignition flame connection		
For models:	6PC61G, 6PC62G		
spare parts for	101154		
	GEV No.	101060	Ref. No. RTCU700573
magnet unit standard L 39mm D1 ø 15.4mm D2 ø 11mm suitable for PEL20-21/JUNKERS/EGA			
accessories for	101154		
	GEV No.	101060	Ref. No. RTCU700573
magnet unit standard L 39mm D1 ø 15.4mm D2 ø 11mm suitable for PEL20-21/JUNKERS/EGA			
	GEV No.	101351	Ref. No. 53.3.0181.00
mounting strap for gas tap			

Table continues overleaf

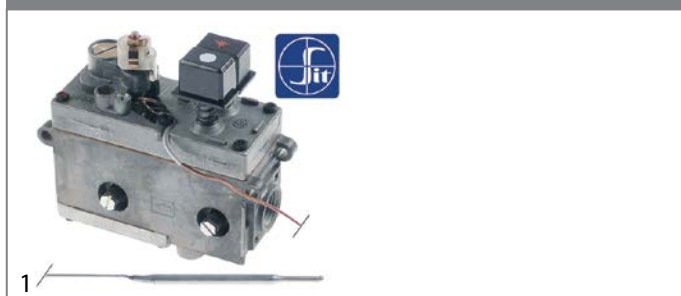


accessories for	101154		
	GEV No.	101376	Ref. No. —
	gasket ID ø 8mm ED ø 12mm H 3/5mm		



gas thermostats

SIT

710 Minisit series

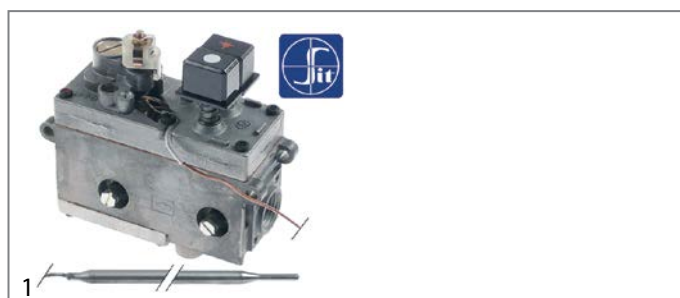





GEV No.	101135	Ref. No.	53.1.0027.00 RTCU700574 RTCU700642
description	gas thermostat SIT type MINISIT 710 t.max. 190°C 110-190°C gas inlet 1/2" gas outlet 3/8" thermocouple connection M9x1 pilot connection M10x1 probe ø 6mm probe L 102mm capillary pipe 1050mm probe type type A3 pressure controller no pressure regulator mbar gland nut		
For models:	6FQ61G, 6FQ62G, GF15+15S, GF15S, GF25+25S, GF25S, GF46, GF47, GF472V, GF47T, GF49, GF49T, GF66, GF77, GF77T, GF90, GF90-1, GF99, GF99T, MINIMA GF 46, MINIMA GF 66, OMNIA GF 47, OMNIA GF 47T, OMNIA GF 77, OMNIA GF 77T, OMNIA GF472V		

spare parts for	101135		
	GEV No.	101053	Ref. No. 53.1.0012.00
	magnet unit T1: M9x1 T2: M24x1 L 45mm ø 17mm suitable for Minisit		
	GEV No.	102118	Ref. No. —
	probe 110-190°C probe ø 6mm probe L 102mm capillary pipe 1050mm t.max. 190°C fryer probe type type A3 suitable for MINISIT 710		





accessories for	101135		
	GEV No.	100809	Ref. No. 53.6.0005.00
	O-ring EPDM thickness 2mm ID ø 21mm Qty 1 pcs		
	GEV No.	100820	Ref. No. —
	gland duct ET M14x1.5 IT M10x0.75 probe ø max. 6.5mm WS 22		
	GEV No.	100904	Ref. No. —
	locking screw M10x1 for pipe ø 4mm Qty 1 pcs		
	GEV No.	100905	Ref. No. —
	locking screw M10x1 for pipe ø 6mm Qty 1 pcs		
	GEV No.	101054	Ref. No. —
	magnet unit T1: M10x1 T2: M24x1 L 45mm ø 17mm suitable for Minisit		
	GEV No.	101136	Ref. No. —
	piezoelectric igniter suitable for Minisit with cover cap ømm connection F6.3x0.8		
	GEV No.	101137	Ref. No. 53.6.0007.00 RTCU900221
	cover cap without piezoelectric igniter		
	GEV No.	101267	Ref. No. —
	reducer IT 3/8" ET 1/2" L 21mm		

accessories for	101135		
	GEV No.	101268	Ref. No. —
	gas connection thread 3/8" angled with O-ring MINISIT 710		
	GEV No.	101269	Ref. No. —
	gas connection thread 1/2" angled with O-ring MINISIT 710		
	GEV No.	101270	Ref. No. —
	screw connection IT 3/8" ET 3/8" L 28mm		
	GEV No.	101272	Ref. No. —
	screw connection IT 1/2" ET 3/8" L 57mm		
	GEV No.	101273	Ref. No. RTCU800195
	olive for pipe ø 12mm L 9.5mm brass Qty 1 pcs suitable for universal		
	GEV No.	101274	Ref. No. —
	olive for pipe ø 16mm Qty 1 pcs		
	GEV No.	101275	Ref. No. —
	union screw thread 1/2" for pipe ø 16mm Qty 1 pcs		
	GEV No.	101276	Ref. No. —
	union screw thread 3/8" tube ø 12mm Qty 1 pcs		
	GEV No.	110068	Ref. No. 53.6.0006.00 RTCU900222
	knob suitable for Minisit ø 37mm		



GEV No.	106984	Ref. No.	167549
description	gas thermostat SIT type MINISIT 710 t.max. 190°C 110-190°C gas inlet 1/2" gas outlet 3/8" thermocouple connection M9x1 pilot connection M10x1 probe ø 6mm probe L 102mm capillary pipe 1050mm probe type type A3 pressure controller no pressure regulator mbar gland nut		
For models:	BGF777B, FG15M, FG20M, GF15+15S, GF15S, GF25+25S, GF25S, GF408, GF45, GF477, GF4772V, GF4772VB, GF4772VS, GF477B, GF477S, GF477TS, GF498B, GF777, GF777B, GF777S, GF777TS, GF90, GF908, GF998B, MG7GF477, MG7GF4772V, MG7GF477TS, MG7GF777, MG7GF777TS		
spare parts for	106984		
	GEV No.	101053	Ref. No. 53.1.0012.00
	magnet unit T1: M9x1 T2: M24x1 L 45mm ø 17mm suitable for Minisit		
	GEV No.	102118	Ref. No. —
	probe 110-190°C probe ø 6mm probe L 102mm capillary pipe 1050mm t.max. 190°C fryer probe type type A3 suitable for MINISIT 710		
accessories for	106984		
	GEV No.	110068	Ref. No. 53.6.0006.00 RTCU900222
	knob suitable for Minisit ø 37mm		

			
GEV No.	101132	Ref. No.	53.1.0026.00 RTCU900064
description	gas thermostat SIT type MINISIT 710 t.max. 340°C 100-340°C gas inlet 1/2" gas outlet 3/8" thermocouple connection M9x1 pilot connection M10x1 probe ø 5mm probe L 68mm capillary pipe 1050mm probe type type B1 pressure controller no pressure regulator mbar gland nut ignition gas no		
For models:	6FT61G, 6FT62G, C4F, C62F, C6F, C6FA, C8F, GBR7, GBR77, GBRI7, GBRI77, MG7GBR77, MG7GBRI77, OMNIA GBR7, OMNIA GBRI7		
spare parts for	101132		
	GEV No.	101053	Ref. No. 53.1.0012.00
	magnet unit T1: M9x1 T2: M24x1 L 45mm ø 17mm suitable for Minisit		
	GEV No.	102102	Ref. No. 53.1.0140.00
	probe 100-340°C probe ø 5mm probe L 68mm capillary pipe 1750mm t.max. 340°C oven/grill probe type type B1 suitable for MINISIT 710		
accessories for	101132		
	GEV No.	100809	Ref. No. 53.6.0005.00
	O-ring EPDM thickness 2mm ID ø 21mm Qty 1 pcs		
	GEV No.	100904	Ref. No. —
	locking screw M10x1 for pipe ø 4mm Qty 1 pcs		
	GEV No.	100905	Ref. No. —
	locking screw M10x1 for pipe ø 6mm Qty 1 pcs		
	GEV No.	101054	Ref. No. —
	magnet unit T1: M10x1 T2: M24x1 L 45mm ø 17mm suitable for Minisit		
	GEV No.	101136	Ref. No. —
	piezoelectric igniter suitable for Minisit with cover cap ømm connection F6.3x0.8		
	GEV No.	101137	Ref. No. 53.6.0007.00 RTCU900221
	cover cap without piezoelectric igniter		
	GEV No.	101267	Ref. No. —
	reducer IT 3/8" ET 1/2" L 21mm		
	GEV No.	101268	Ref. No. —
	gas connection thread 3/8" angled with O-ring MINISIT 710		
	GEV No.	101269	Ref. No. —
	gas connection thread 1/2" angled with O-ring MINISIT 710		
	GEV No.	101270	Ref. No. —
	screw connection IT 3/8" ET 3/8" L 28mm		
	GEV No.	101272	Ref. No. —
	screw connection IT 1/2" ET 3/8" L 57mm		
	GEV No.	101273	Ref. No. RTCU800195
	olive for pipe ø 12mm L 9.5mm brass Qty 1 pcs suitable for universal		

accessories for	101132		
	GEV No.	101274	Ref. No. —
	olive for pipe ø 16mm Qty 1 pcs		
	GEV No.	101275	Ref. No. —
	union screw thread 1/2" for pipe ø 16mm Qty 1 pcs		
	GEV No.	101276	Ref. No. —
	union screw thread 3/8" tube ø 12mm Qty 1 pcs		
	GEV No.	110068	Ref. No. 53.6.0006.00 RTCU900222
	knob suitable for Minisit ø 37mm		











			
GEV No.	101130	Ref. No.	53.1.0028.00
description	gas thermostat without cap, button and angle SIT type MINISIT 710 t.max. 100°C 30-100°C gas inlet 1/2" gas outlet 3/8" thermocouple connection M9x1 pilot connection M10x1 probe ø 5mm probe L 122mm capillary pipe 1050mm probe type type A1 pressure controller no pressure regulator mbar gland nut		
For models:	6BM61G, 6BM62G		
spare parts for	101130		
	GEV No.	101053	Ref. No. 53.1.0012.00
	magnet unit T1: M9x1 T2: M24x1 L 45mm ø 17mm suitable for Minisit		
	GEV No.	102100	Ref. No. 53.1.0142.00
	probe 30-100°C probe ø 5mm probe L 122mm capillary pipe 1050mm t.max. 100°C bain marie probe type type A1 suitable for MINISIT 710		
accessories for	101130		
	GEV No.	100809	Ref. No. 53.6.0005.00
	O-ring EPDM thickness 2mm ID ø 21mm Qty 1 pcs		
	GEV No.	100820	Ref. No. —
	gland duct ET M14x1.5 IT M10x0.75 probe ø max. 6.5mm WS 22		
	GEV No.	100904	Ref. No. —
	locking screw M10x1 for pipe ø 4mm Qty 1 pcs		
	GEV No.	100905	Ref. No. —
	locking screw M10x1 for pipe ø 6mm Qty 1 pcs		
	GEV No.	101054	Ref. No. —
	magnet unit T1: M10x1 T2: M24x1 L 45mm ø 17mm suitable for Minisit		
	GEV No.	101136	Ref. No. —
	piezoelectric igniter suitable for Minisit with cover cap ømm connection F6.3x0.8		
	GEV No.	101137	Ref. No. 53.6.0007.00 RTCU900221
	cover cap without piezoelectric igniter		

Table continues overleaf




accessories for		101130		
	GEV No.	101267	Ref. No.	—
	reducer IT 3/8" ET 1/2" L 21mm			
	GEV No.	101268	Ref. No.	—
	gas connection thread 3/8" angled with O-ring MINISIT 710			
	GEV No.	101269	Ref. No.	—
	gas connection thread 1/2" angled with O-ring MINISIT 710			
	GEV No.	101270	Ref. No.	—
	screw connection IT 3/8" ET 3/8" L 28mm			
	GEV No.	101272	Ref. No.	—
	screw connection IT 1/2" ET 3/8" L 57mm			
	GEV No.	101273	Ref. No.	RTCU800195
	GEV No.	101274	Ref. No.	—
	GEV No.	101275	Ref. No.	—
	union screw thread 1/2" for pipe ø 16mm Qty 1 pcs			
	GEV No.	101276	Ref. No.	—
	union screw thread 3/8" tube ø 12mm Qty 1 pcs			
	GEV No.	110068	Ref. No.	53.6.0006.00 RTCU900222
	knob suitable for Minisit ø 37mm			

GEV No.	101131	Ref. No.	GRCU900012	
description	gas thermostat without cap, button and angle SIT type MINISIT 710 t.max. 190°C 50-190°C gas inlet 1/2" gas outlet 3/8" thermocouple connection M9x1 pilot connection M10x1 probe ø 5mm probe L 98mm capillary pipe 1200mm probe type type A2 pressure controller no pressure regulator or bar gland nut			
For models:	GF45, GF90			
spare parts for		101131		
	GEV No.	101053	Ref. No.	53.1.0012.00
	GEV No.	102103	Ref. No.	—
accessories for		101131		
	GEV No.	100809	Ref. No.	53.6.0005.00
	GEV No.	100820	Ref. No.	—













accessories for		101131		
	GEV No.	100904	Ref. No.	—
	GEV No.	100905	Ref. No.	—
	GEV No.	101054	Ref. No.	—
	GEV No.	101136	Ref. No.	—
	GEV No.	101137	Ref. No.	53.6.0007.00 RTCU900221
	GEV No.	101267	Ref. No.	—
	GEV No.	101268	Ref. No.	—
	GEV No.	101269	Ref. No.	—
	GEV No.	101270	Ref. No.	—
	GEV No.	101272	Ref. No.	—
	GEV No.	101273	Ref. No.	RTCU800195
	GEV No.	101274	Ref. No.	—
	GEV No.	101275	Ref. No.	—
	GEV No.	101276	Ref. No.	—
	GEV No.	110068	Ref. No.	53.6.0006.00 RTCU900222
	knob suitable for Minisit ø 37mm			


accessories			
probes			
GEV No.	102102	Ref. No.	53.1.0140.00
description	probe 100-340°C probe ø 5mm probe L 68mm capillary pipe 1750mm t.max. 340°C oven/grill probe type type B1 suitable for MINISIT 710		
For models:	6FT61G, 6FT62G		



			
GEV No.	102100	Ref. No.	53.1.0142.00
description	probe 30-100°C probe ø 5mm probe L 122mm capillary pipe 1050mm t.max. 100°C bain marie probe type type A1 suitable for MINISIT 710		
For models:	6BM61G, 6BM62G		

PEL
24ST series

			
GEV No.	106667	Ref. No.	168002 RTCU800011
description	gas thermostat PEL type 24ST 100-300°C gas inlet M20x1.5 (tube ø 12mm) bypass nozzle ø 0.9mm gas outlet M20x1.5 (tube ø 12/10mm) thermocouple connection M9x1 pilot connection M10x1 capillary pipe 1200mm probe ø 6mm probe L 100mm shaft ø 10x8mm shaft L 27/17mm shaft flat upper		
For models:	G4SF, G4SF-1, G4SF11, G4SF77, G4SF9, G4SF9-1, G4SF9-2, G4SFP, G6SF2, G6SF29, G6SFA, G6SFA9, G6SFM, G8SF2, G8SF2P, GF09, GF09T, GFB09, GFT45L, GFT45LC, GFT45R, GFT45RC, GFT90L, GFT90LC, GFT90LR, GFT90LRC, GFT90R, GFT90RC, GT2SDF, GT2SDF9, GT2SFA, GTF, GTF77, GTF9, GTF91		
spare parts for	106667		
	GEV No.	100597	Ref. No. RTCU800071
	bypass nozzle type PEL23/24 bore ø 0.9mm thread M8x0.5		
	GEV No.	101058	Ref. No. —
	magnet unit L 39mm D1 ø 15.4mm D2 ø 13.5mm suitable for PEL22/EGA24197 standard		
	GEV No.	106200	Ref. No. —
	nut thread M9x1 suitable for PEL 24/25S		
accessories for	106667		
	GEV No.	100908	Ref. No. RTCU900133
	union screw thread M10x1 for pipe ø 4mm Qty 1 pcs		
	GEV No.	100909	Ref. No. RTCP800038 RTCU900019
	union screw thread M10x1 for pipe ø 6mm Qty 1 pcs		
	GEV No.	101246	Ref. No. —
	olive for pipe ø 4mm Qty 1 pcs		
	GEV No.	101248	Ref. No. RTCU900014
	olive for pipe ø 12mm Qty 1 pcs suitable for PEL		
	GEV No.	101249	Ref. No. RTCU900016
	olive for pipe ø 10mm Qty 1 pcs		
	GEV No.	101250	Ref. No. RTCU900017
	union nut thread M20x1.5 for pipe ø 10mm		
	GEV No.	101251	Ref. No. RTCU900015
	union nut thread M20x1.5 for pipe ø 12mm		
	GEV No.	101286	Ref. No. RTCU900018
	olive ID ø 6mm Qty 1 pcs		



			
GEV No.	101078	Ref. No.	RTBF800003
description	gas thermostat PEL type 24ST 55-110°C gas inlet M20x1.5 (tube ø 12mm) bypass nozzle ø 0.35mm gas outlet M20x1.5 (tube ø 12/10mm) thermocouple connection M9x1 pilot connection M10x1 capillary pipe 1200mm probe ø 6mm probe L 160mm shaft ø 10x8mm shaft L 27/17mm shaft flat upper		
For models:	GBM90		
spare parts for	101078		
	GEV No.	100455	Ref. No. —
	bypass nozzle type PEL23/24 bore ø 0.35mm thread M8x0.5		
	GEV No.	101058	Ref. No. —
	magnet unit L 39mm D1 ø 15.4mm D2 ø 13.5mm suitable for PEL22/EGA24197 standard		
	GEV No.	106200	Ref. No. —
	nut thread M9x1 suitable for PEL 24/25S		
accessories for	101078		
	GEV No.	100908	Ref. No. RTCU900133
	union screw thread M10x1 for pipe ø 4mm Qty 1 pcs		
	GEV No.	100909	Ref. No. RTCP800038 RTCU900019
	union screw thread M10x1 for pipe ø 6mm Qty 1 pcs		
	GEV No.	101246	Ref. No. —
	olive for pipe ø 4mm Qty 1 pcs		
	GEV No.	101248	Ref. No. RTCU900014
	olive for pipe ø 12mm Qty 1 pcs suitable for PEL		
	GEV No.	101249	Ref. No. RTCU900016
	olive for pipe ø 10mm Qty 1 pcs		
	GEV No.	101250	Ref. No. RTCU900017
	union nut thread M20x1.5 for pipe ø 10mm		
	GEV No.	101251	Ref. No. RTCU900015
	union nut thread M20x1.5 for pipe ø 12mm		
	GEV No.	101286	Ref. No. RTCU900018
	olive ID ø 6mm Qty 1 pcs		
	GEV No.	110079	Ref. No. —
	knob dial plate gas thermostat 1-8 silver		
	GEV No.	110080	Ref. No. —
	knob ø 70mm shaft ø 10x8mm shaft flat universal		

















24STS series



GEV No.	107209	Ref. No.	160225 168003 174035
description	gas thermostat PEL type 24STS 100-300°C gas inlet M20x1.5 (tube ø 12/10mm) bypass nozzle ø 1.2mm gas outlet M20x1.5 (tube ø 12/10mm) thermocouple connection M9x1 pilot connection M10x1 capillary pipe 1200mm probe ø 6mm probe L 100mm shaft ø 10x8mm shaft L 27/17mm shaft flat upper		
For models:	GFT45L, GFT45LC, GFT45R, GFT45RC, GFT49L, GFT49LC, GFT49R, GFT49RC, GFT90L, GFT90LC, GFT90LR, GFT90LRC, GFT90R, GFT90RC, GFT99L, GFT99LC, GFT99LR, GFT99LRC, GFT99R, GFT99RC, GFTA911L, GFTA911LC, GFTA911LR, GFTA911LRC		
spare parts for	107209		
	GEV No.	100659	Ref. No. —
	bypass nozzle type PEL23/24 bore ø 1.2mm thread M8x0.5		
	GEV No.	101058	Ref. No. —
	magnet unit L 39mm D1 ø 15.4mm D2 ø 13.5mm suitable for PEL22/EGA24197 standard		
	GEV No.	101331	Ref. No. —
	adapter suitable for PEL22 for flanged cable 10/12mm		
	GEV No.	101460	Ref. No. —
	O-ring ø 12.37mm D1 ø 2.62mm suitable for PEL22		
	GEV No.	101461	Ref. No. —
	screw kit suitable for PEL22 Qty 4 pcs		
	GEV No.	106165	Ref. No. —
	gasket ø 27mm		
	GEV No.	106200	Ref. No. —
	nut thread M9x1 suitable for PEL 24/25S		
accessories for	107209		
	GEV No.	101250	Ref. No. RTCU900017
	union nut thread M20x1.5 for pipe ø 10mm		
	GEV No.	101251	Ref. No. RTCU900015
	union nut thread M20x1.5 for pipe ø 12mm		













	GEV No.	101888	Ref. No.	160220
description	gas thermostat PEL type 24STS t.max. 90°C			
For models:	GBM45, GBM49T, GBM90, GBM99T			
spare parts for	101888			
	GEV No.	101058	Ref. No.	—
	magnet unit L 39mm D1 ø 15.4mm D2 ø 13.5mm suitable for PEL22/EGA24197 standard			

accessories for	101888			
	GEV No.	100908	Ref. No.	RTCU900133
	union screw thread M10x1 for pipe ø 4mm Qty 1 pcs			
	GEV No.	100909	Ref. No.	RTCP800038 RTCU900019
	union screw thread M10x1 for pipe ø 6mm Qty 1 pcs			
	GEV No.	101236	Ref. No.	—
	gas connection thread M20x1.5 tube ø 12/10mm for PEL gas taps vertical			
	GEV No.	101246	Ref. No.	—
	olive for pipe ø 4mm Qty 1 pcs			
	GEV No.	101248	Ref. No.	RTCU900014
	olive for pipe ø 12mm Qty 1 pcs suitable for PEL			
	GEV No.	101249	Ref. No.	RTCU900016
	olive for pipe ø 10mm Qty 1 pcs			
	GEV No.	101250	Ref. No.	RTCU900017
	union nut thread M20x1.5 for pipe ø 10mm			
	GEV No.	101251	Ref. No.	RTCU900015
	union nut thread M20x1.5 for pipe ø 12mm			
	GEV No.	101286	Ref. No.	RTCU900018
	olive ID ø 6mm Qty 1 pcs			
	GEV No.	101460	Ref. No.	—
	O-ring ø 12.37mm D1 ø 2.62mm suitable for PEL22			
	GEV No.	101461	Ref. No.	—
	screw kit suitable for PEL22 Qty 4 pcs			
	GEV No.	101465	Ref. No.	—
	union nut thread M16x1.5 for pipe ø 8mm			
	GEV No.	110079	Ref. No.	—
	knob dial plate gas thermostat 1-8 silver			
	GEV No.	110080	Ref. No.	—
	knob ø 70mm shaft ø 10x8mm shaft flat universal			



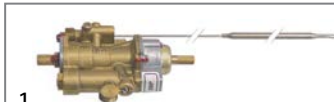
25ST series



GEV No.	101172	Ref. No.	RTCU700289
description	gas thermostat PEL type 25ST 100-300°C gas inlet M16x1.5 (tube ø 10mm) bypass nozzle ø 0.35mm gas outlet M16x1.5 (tube ø 10/8mm) thermocouple connection M9x1 pilot connection M10x1 capillary pipe 1200mm probe ø 6mm probe L 100mm shaft ø 8x6.5mm shaft L 21/15mm shaft flat upper		
For models:	G2SDM7, G2SDMF7, G2SDMFE7, G2SSM7, G2SSMF7, G2SSMFE7, G4SF7, G4SM7, G4SMFA7, G6SFA7, GBR6, GF07, GFO7, GFT106L, GFT106LC, GFT106LR, GFT106LRC, GFT117L, GFT117LC, GFT117LR, GFT117LRC, GFT46L, GFT46LC, GFT46R, GFT46RC, GFT47L, GFT47LC, GFT47R, GFT47RC, GFT66L, GFT66LC, GFT66LR, GFT66LRC, GFT66R, GFT66RC, GFT77L, GFT77LC, GFT77LR, GFT77LRC, GFT77R, GFT77RC, GT2SDFA7, GT2SSFA7, GT4SF27, GT4SFA7, GTF7, MINIMA GBR 6, MINIMA GFT 46L, MINIMA GFT 46LC, MINIMA GFT 46R...(Other models you can see in the webshop)		
spare parts for	101172		
	GEV No.	100259	Ref. No. RTCU700250
	bypass nozzle type PEL22 bore ø 0.35mm thread M6x0.5		
	GEV No.	101060	Ref. No. RTCU700573
	magnet unit standard L 39mm D1 ø 15.4mm D2 ø 11mm suitable for PEL20-21/JUNKERS/EGA		
accessories for	101172		
	GEV No.	100908	Ref. No. RTCU900133
	union screw thread M10x1 for pipe ø 4mm Qty 1 pcs		
	GEV No.	100909	Ref. No. RTCP800038 RTCU900019
	union screw thread M10x1 for pipe ø 6mm Qty 1 pcs		
	GEV No.	101246	Ref. No. —
	olive for pipe ø 4mm Qty 1 pcs		
	GEV No.	101278	Ref. No. RTCU900012
	olive for pipe ø 10mm Qty 1 pcs		
	GEV No.	101286	Ref. No. RTCU900018
	olive ID ø 6mm Qty 1 pcs		
	GEV No.	101300	Ref. No. RTCU700297
	union nut thread M16x1.5 tube ø 10mm		
	GEV No.	101450	Ref. No. —
	olive for pipe ø 8mm L 12.7mm Qty 1 pcs ED ø 10mm		
	GEV No.	101451	Ref. No. —
	union nut thread M16x1.5 tube ø 8mm		
	GEV No.	110079	Ref. No. —
	knob dial plate gas thermostat 1-8 silver		
	GEV No.	110081	Ref. No. —
	knob ø 70mm shaft ø 8x6.5mm shaft flat universal		



GEV No.	106987	Ref. No.	168005
description	gas thermostat PEL type 25ST 100-300°C gas inlet pipe flange ø21mm bypass nozzle ø 0.95mm gas outlet M16x1.5 (tube ø 10/8mm) thermocouple connection M9x1 pilot connection M10x1 capillary pipe 1200mm probe ø 6mm probe L 100mm shaft ø 8x6.5mm shaft L 26/15mm shaft flat upper pressure regulator 50mbar		
For models:	BG6SF77M, G2SF6, G2SF6G, G3SF6, G3SF6G, G6SF77M, GFT1177L, GFT1177LC, GFT1177LR, GFT1177LRC, GFT1177R, GFT1177RC, GFT408L, GFT408LC, GFT408R, GFT477L, GFT477LC, GFT477R, GFT477RC, GFT498L, GFT498LC, GFT498R, GFT777L, GFT777LC, GFT777LR, GFT777LRC, GFT777R, GFT777RC, GFT908L, GFT908LC, GFT908LR, GFT908LRC, GFT908R, GFT998L, GFT998LC, GFT998LR, GFT998LRC, GFT998R, GFTA477L, GFTA477LC, GFTA477R, GFTA477RC, GFTA498L, GFTA498LC, GFTA498R, GFTA777L, GFTA777LC, GFTA777LR, GFTA777LRC, GFTA777R...(Other models you can see in the webshop)		













GEV No.	101441	Ref. No.	RTCU700363
description	gas thermostat PEL type 25ST 30-90°C gas inlet M16x1.5 (tube ø 10mm) bypass nozzle ø 0.35mm gas outlet M16x1.5 (tube ø 10/8mm) thermocouple connection M9x1 pilot connection M10x1 capillary pipe 1200mm probe ø 6mm probe L 160mm shaft ø 8x6.5mm shaft L 21/15mm shaft flat upper		
For models:	GBM46, GBM47, GBM66, GBM77, MINIMA GBM 46, MINIMA GBM 66, OMNIA GBM 47, OMNIA GBM 77		
spare parts for	101441		
	GEV No.	100259	Ref. No. RTCU700250
	bypass nozzle type PEL22 bore ø 0.35mm thread M6x0.5		
	GEV No.	101060	Ref. No. RTCU700573
	magnet unit standard L 39mm D1 ø 15.4mm D2 ø 11mm suitable for PEL20-21/JUNKERS/EGA		
	GEV No.	106200	Ref. No. —
	nut thread M9x1 suitable for PEL 24/255		
accessories for	101441		
	GEV No.	100908	Ref. No. RTCU900133
	union screw thread M10x1 for pipe ø 4mm Qty 1 pcs		
	GEV No.	100909	Ref. No. RTCP800038 RTCU900019
	union screw thread M10x1 for pipe ø 6mm Qty 1 pcs		
	GEV No.	101246	Ref. No. —
	olive for pipe ø 4mm Qty 1 pcs		
	GEV No.	101278	Ref. No. RTCU900012
	olive for pipe ø 10mm Qty 1 pcs		
	GEV No.	101286	Ref. No. RTCU900018
	olive ID ø 6mm Qty 1 pcs		

Table continues overleaf



accessories for 101441	
	GEV No. 101300 Ref. No. RTCU700297 union nut thread M16x1.5 tube ø 10mm
	GEV No. 101450 Ref. No. — olive for pipe ø 8mm L 12.7mm Qty 1 pcs ED ø 10mm
	GEV No. 101451 Ref. No. — union nut thread M16x1.5 tube ø 8mm

SABAF

	
1	
GEV No. 101886	Ref. No. RTCU600179 RTCU600180
description	gas thermostat SABAF t.max. 300°C gas inlet pipe flange ø16mm bypass nozzle ø 0.37mm gas outlet M13x1 IT (tube ø 8mm) gas outlet 2 thermocouple connection M8x1 pilot connection capillary pipe 850mm probe ø 4mm probe L 140mm shaft ø 8x6.5mm shaft L 17/12mm shaft flat upper
For models:	G3S6, G4SF6, G4SFA6, G6SF6, G6SFA6, MINIMA G4SF6, MINIMA G6SF6, MINIMA G6SFA6
spare parts for 101886	
	GEV No. 101060 Ref. No. RTCU700573 magnet unit standard L 39mm D1 ø 15.4mm D2 ø 11mm suitable for PEL20-21/JUNKERS/EGA
	GEV No. 101376 Ref. No. — gasket ID ø 8mm ED ø 12mm H 3/5mm
accessories for 101886	
	GEV No. 101277 Ref. No. RTCU600049 olive ID ø 8mm Qty 1 pcs
	GEV No. 101477 Ref. No. — union screw thread M13x1 tube ø 8mm Qty 1 pcs
	GEV No. 101751 Ref. No. RTCU600054 bracket

gas valves and ignition boxes

gas control valves

SIT

ELETTROSIT



1

GEV No. 101126	Ref. No. RTBF800077
description	gas valve SIT type ELETTROSIT 230V gas inlet 1/2" gas outlet 1/2" thermocouple connection M9x1 pilot connection M10x1 bottom equiv. no. 0.810.136
For models:	GBR, GBRA, GBRAVI, GBRVI
spare parts for 101126	
	GEV No. 101312 Ref. No. — microswitch
	GEV No. 101352 Ref. No. — solenoid coil 230V 50Hz suitable for ELETTROSIT
accessories for 101126	
	GEV No. 100006 Ref. No. — piezoelectric igniter suitable for ELETTROSIT body plastic blowing connection ø2.4mm ø 14mm
	GEV No. 100904 Ref. No. — locking screw M10x1 for pipe ø 4mm Qty 1 pcs
	GEV No. 100905 Ref. No. — locking screw M10x1 for pipe ø 6mm Qty 1 pcs
	GEV No. 101301 Ref. No. — gas connection thread 1/2" straight ELETTROSIT screw with O-ring
	GEV No. 101303 Ref. No. — gas connection straight thread 3/4" ELETTROSIT
	GEV No. 101309 Ref. No. — extension



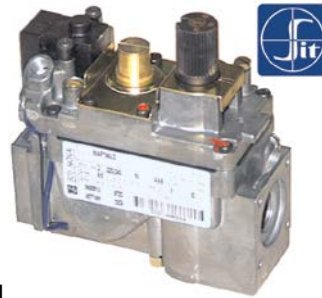
MINISIT



1			
GEV No.	101106	Ref. No.	53.1.0110.00
description	gas valve gas inlet 3/8" gas outlet 3/8" operable temperature range manual thermocouple connection M9x1 pilot connection M10x1 Minisit SIT		
For models:	6BM61G, 6BM62G, 6FQ61G, 6FQ62G, 6FT61G, 6FT62G, 6PC61G, 6PC62G		
spare parts for	101106		
	GEV No.	100809	Ref. No. 53.6.0005.00
	O-ring EPDM thickness 2mm ID ø 21mm Qty 1 pcs		
	GEV No.	101053	Ref. No. 53.1.0012.00
	magnet unit T1: M9x1 T2: M24x1 L 45mm ø 17mm suitable for Minisit		
	GEV No.	101054	Ref. No. —
	magnet unit T1: M10x1 T2: M24x1 L 45mm ø 17mm suitable for Minisit		
	GEV No.	101136	Ref. No. —
	piezoelectric igniter suitable for Minisit with cover cap ømm connection F6.3x0.8		
	GEV No.	101137	Ref. No. 53.6.0007.00 RTCU900221
	cover cap without piezoelectric igniter		
	GEV No.	110068	Ref. No. 53.6.0006.00 RTCU900222
	knob suitable for Minisit ø 37mm		
accessories for	101106		
	GEV No.	100904	Ref. No. —
	locking screw M10x1 for pipe ø 4mm Qty 1 pcs		
	GEV No.	100905	Ref. No. —
	locking screw M10x1 for pipe ø 6mm Qty 1 pcs		
	GEV No.	101267	Ref. No. —
	reducer IT 3/8" ET 1/2" L 21mm		
	GEV No.	101268	Ref. No. —
	gas connection thread 3/8" angled with O-ring MINISIT 710		
	GEV No.	101269	Ref. No. —
	gas connection thread 1/2" angled with O-ring MINISIT 710		
	GEV No.	101270	Ref. No. —
	screw connection IT 3/8" ET 3/8" L 28mm		
	GEV No.	101272	Ref. No. —
	screw connection IT 1/2" ET 3/8" L 57mm		
	GEV No.	101273	Ref. No. RTCU800195
	olive for pipe ø 12mm L 9.5mm brass Qty 1 pcs suitable for universal		

accessories for	101106		
	GEV No.	101274	Ref. No. —
	olive for pipe ø 16mm Qty 1 pcs		
	GEV No.	101275	Ref. No. —
	union screw thread 1/2" for pipe ø 16mm Qty 1 pcs		
	GEV No.	101276	Ref. No. —
	union screw thread 3/8" tube ø 12mm Qty 1 pcs		





NOVASIT



1			
GEV No.	101162	Ref. No.	RTFOC00095
description	gas valve SIT series Novasit 820 230V 50Hz gas inlet 1/2" gas outlet 1/2" thermocouple connection M9x1 pilot connection M10x1 ignition pressure 3-5mbar pressure range 3-30mbar pressure regulator connection blind equiv. no. 0.820.010		
For models:	FCG10, FCG108, FCG20, FCG6, FCG68, FGC060, FGC065, FGC100, FGC200, FGM060, FGM061, FGM100, FGM101, FGM200, FGM201, FGMD060, FGMD061, FGMD065, FGMD066, FGMD100, FGMD101, FGMD200, FGMD201, FGP050, FGP080, FGP160, FMM060, FMM061, FMM100, FMM101, GBR, GBR8, GBR9T, GBRA9T, GBRAVI9T, GBRVC98, GBRVC98T, GBRV18, GBRV198, GBRV198T, GBRV19T, JOKER FCG 6, JOKER FCG 6 AB 2002, JOKER FCG 10, JOKER FCG 10 AB 2002, JOKER FGP050, JOKER FGP050 AB 2002, JOKER FGP080, JOKER FGP080 AB 2002, JOKER FGP160		
spare parts for	101162		
	GEV No.	101065	Ref. No. RTFOC00188
	magnet unit with cable L 44mm D1 ø 30mm D2 ø 20mm suitable for NOVASIT		
	GEV No.	101313	Ref. No. —
	solenoid coil 230V 50Hz		
accessories for	101162		
	GEV No.	100006	Ref. No. —
	piezoelectric igniter suitable for ELETTROSIT body plastic blowing connection ø2.4mm ø 14mm		
	GEV No.	101305	Ref. No. —
	gas connection straight 1/2" flange 45x45mm ELETTROSIT/V4400/4600/4605 suitable for SIT/HONEYWELL hole distance 36x36mm		
	GEV No.	101306	Ref. No. —
	gas connection angled flange 45x45mm hole distance 36x36mm 1/2" ELETTROSIT/V4400/4600/4605 screw with O-ring suitable for SIT/HONEYWELL		
	GEV No.	101307	Ref. No. —
	gas connection straight flange 45x45mm hole distance 36x36mm 3/4" ELETTROSIT/V4400/4600/4605 screw with O-ring suitable for SIT/HONEYWELL		
	GEV No.	101308	Ref. No. —
	gas connection angled flange 45x45mm hole distance 36x36mm 3/4" ELETTROSIT/V4400/4600/4605 screw with O-ring suitable for SIT/HONEYWELL		










Table continues overleaf





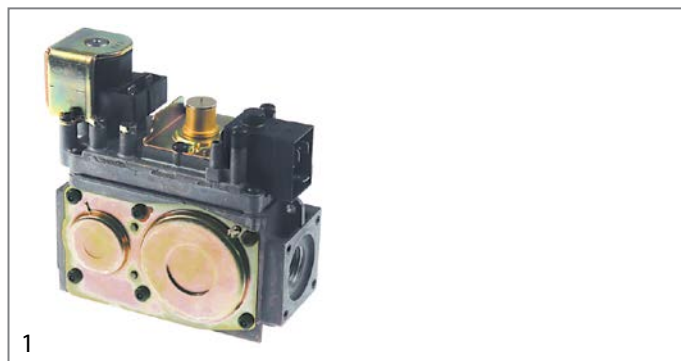
accessories for 101162	
	GEV No. 101312 Ref. No. —
microswitch	
	GEV No. 101314 Ref. No. —
solenoid coil 24V 50Hz	
	GEV No. 101317 Ref. No. —
plug with cable L 1000mm suitable for NOVASIT	
	GEV No. 101318 Ref. No. —
cover cap for solenoid coil suitable for NOVASIT	












1

GEV No.	101956	Ref. No.	16100020
description	gas valve SIT series Novasit 820 230V 50Hz gas inlet 1/2" gas outlet 1/2" thermocouple connection M9x1 pilot connection M10x1 ignition pressurebar pressure range 5-50mbar pressure regulator connection blind equiv. no. 0.820.031		
For models:	GF4771, GF4771IM, GF49-I, GF49T-I, GF777IM, GF99-I, GF99T-I		
spare parts for	101956		
	GEV No. 101065	Ref. No.	RTFOC00188
magnet unit with cable L 44mm D1 ø 30mm D2 ø 20mm suitable for NOVASIT			
	GEV No. 101313	Ref. No.	—
solenoid coil 230V 50Hz			
accessories for	101956		
	GEV No. 100006	Ref. No.	—
piezoelectric igniter suitable for ELETTROSIT body plastic blowing connection ø2.4mm ø 14mm			
	GEV No. 101305	Ref. No.	—
gas connection straight 1/2" flange 45x45mm ELETTROSIT/V4400/4600/4605 suitable for SIT/HONEYWELL hole distance 36x36mm			
	GEV No. 101306	Ref. No.	—
gas connection angled flange 45x45mm hole distance 36x36mm 1/2" ELETTROSIT/V4400/4600/4605 screw with O-ring suitable for SIT/HONEYWELL			
	GEV No. 101307	Ref. No.	—
gas connection straight flange 45x45mm hole distance 36x36mm 3/4" ELETTROSIT/V4400/4600/4605 screw with O-ring suitable for SIT/HONEYWELL			
	GEV No. 101308	Ref. No.	—
gas connection angled flange 45x45mm hole distance 36x36mm 3/4" ELETTROSIT/V4400/4600/4605 screw with O-ring suitable for SIT/HONEYWELL			
	GEV No. 101312	Ref. No.	—
microswitch			
	GEV No. 101314	Ref. No.	—
solenoid coil 24V 50Hz			

accessories for 101956	
	GEV No. 101317 Ref. No. —
plug with cable L 1000mm suitable for NOVASIT	
	GEV No. 101318 Ref. No. —
cover cap for solenoid coil suitable for NOVASIT	









1


GEV No.	106005	Ref. No.	RTFOC00258
description	gas valve SIT series Novasit 822 230V 50Hz gas inlet 1/2" gas outlet 1/2" thermocouple connection pilot connection closed ignition pressure 6-10mbar pressure range 3-30mbar pressure regulator connection blind equiv. no. 0.822.112		
For models:	FGM107SC, FGM109, FGM202, FGM207, FGM207SC, FGM209, FGM210, FGM210L, FGM67SC, FGM69, FGMD207, FGMD207SC, FGMD209, JOKER FGM 67 SC, JOKER FGM 69, JOKER FGM107 SC, JOKER FGM109, JOKER FGM207 SC, JOKER FGM209, JOKER FGMD207 SC, JOKER FGMD209		
spare parts for	106005		
	GEV No. 101313	Ref. No.	—
solenoid coil 230V 50Hz			
	GEV No. 101542	Ref. No.	—
solenoid coil 50Hz NOVA 822/826/827 suitable for NOVASIT 230V			
accessories for	106005		
	GEV No. 101305	Ref. No.	—
gas connection straight 1/2" flange 45x45mm ELETTROSIT/V4400/4600/4605 suitable for SIT/HONEYWELL hole distance 36x36mm			
	GEV No. 101306	Ref. No.	—
gas connection angled flange 45x45mm hole distance 36x36mm 1/2" ELETTROSIT/V4400/4600/4605 screw with O-ring suitable for SIT/HONEYWELL			
	GEV No. 101307	Ref. No.	—
gas connection straight flange 45x45mm hole distance 36x36mm 3/4" ELETTROSIT/V4400/4600/4605 screw with O-ring suitable for SIT/HONEYWELL			
	GEV No. 101308	Ref. No.	—
gas connection angled flange 45x45mm hole distance 36x36mm 3/4" ELETTROSIT/V4400/4600/4605 screw with O-ring suitable for SIT/HONEYWELL			
	GEV No. 101317	Ref. No.	—
plug with cable L 1000mm suitable for NOVASIT			
	GEV No. 101503	Ref. No.	—
O-ring EPDM thickness 2mm ID ø 32mm Qty 1 pcs			
	GEV No. 101924	Ref. No.	—
plug with cable L 1090mm suitable for NOVA 822/826/827			




1

GEV No.	106001	Ref. No.	RTFOC00577
description	gas valve SIT series Novasit 826 230V 50Hz gas inlet 1/2" gas outlet 1/2" thermocouple connection pilot connection closed ignition pressure 3-5mbar pressure range 2-50mbar pressure regulator connection standard equiv. no. 0.826.011 power supply for modulator 230VAC rectified		
For models:	FGM107, FGM107SC, FGM108, FGM108EL, FGM109, FGM110, FGM110L, FGM610, FGM610L, FGM67, FGM67SC, FGM68, FGM68EL, FGM69, FGMD107, FGMD107SC, FGMD108, FGMD108EL, FGMD109, FGMD67, FGMD67SC, FGMD68, FGMD68EL, FGMD69, JOKER FGM 67 SC, JOKER FGM 69, JOKER FGM107 SC, JOKER FGM109, JOKER FGM 67 SC, JOKER FGM 69, JOKER FGMD 69, JOKER FGMD107 SC, JOKER FGMD109		
spare parts for	106001		
	GEV No.	101542	Ref. No. —
	solenoid coil 50Hz NOVA 822/826/827 suitable for NOVASIT 230V		
accessories for	106001		
	GEV No.	101305	Ref. No. —
	gas connection straight 1/2" flange 45x45mm ELETTROSIT/V4400/4600/4605 suitable for SIT/HONEYWELL hole distance 36x36mm		
	GEV No.	101306	Ref. No. —
	gas connection angled flange 45x45mm hole distance 36x36mm 1/2" ELETTROSIT/V4400/4600/4605 screw with O-ring suitable for SIT/HONEYWELL		
	GEV No.	101307	Ref. No. —
	gas connection straight flange 45x45mm hole distance 36x36mm 3/4" ELETTROSIT/V4400/4600/4605 screw with O-ring suitable for SIT/HONEYWELL		
	GEV No.	101308	Ref. No. —
	gas connection angled flange 45x45mm hole distance 36x36mm 3/4" ELETTROSIT/V4400/4600/4605 screw with O-ring suitable for SIT/HONEYWELL		
	GEV No.	101859	Ref. No. —
	panel-mounted inlet with cable L 1000mm for rectifier suitable for NOVASIT		


accessories

			
1			
GEV No.	111759	Ref. No.	RTFOC00391
description	knob extension L 75mm NOVA 820/824/825 suitable for MBM		
For models:	FCE108, FCE68, FCG10, FCG108, FCG20, FCG6, FCG68, FCG065, FCG200, FGM200, FGM201, FGMD065, FGMD066, FGMD200, FGMD201, FGP050, FGP080, FGP160, JOKER FCG 6, JOKER FCG 6 AB 2002, JOKER FCG 10, JOKER FCG 10 AB 2002, JOKER FGP050, JOKER FGP050 AB 2002, JOKER FGP080, JOKER FGP080 AB 2002, JOKER FGP160		

			
1			
GEV No.	101065	Ref. No.	RTFOC00188
description	magnet unit with cable L 44mm D1 ø 30mm D2 ø 20mm suitable for NOVASIT		
For models:	FCG10, FCG6, FGP050, FGP080, FGP160, JOKER FCG 6, JOKER FCG 6 AB 2002, JOKER FCG 10, JOKER FCG 10 AB 2002, JOKER FGP050, JOKER FGP050 AB 2002, JOKER FGP080, JOKER FGP080 AB 2002, JOKER FGP160		

ignition boxes







BRAHMA









			
1			
GEV No.	106006	Ref. No.	175780 RTFOC00305 RTFOC00785
description	ignition box BRAHMA type CE11F electrodes 2 waiting time 1.5s safety time 10s 220-240V 7VA 50-60Hz		
For models:	FEM210, FEM210L, FEMD108, FEMD108EL, FGM107, FGM107SC, FGM108, FGM108EL, FGM109, FGM110, FGM110L, FGM202, FGM207, FGM207SC, FGM209, FGM210, FGM210L, FGM610, FGM610L, FGM67, FGM67SC, FGM68, FGM68EL, FGM69, FGMD107, FGMD107SC, FGMD108, FGMD108EL, FGMD109, FGMD207, FGMD207SC, FGMD209, FGMD67, FGMD67SC, FGMD68, FGMD68EL, FGMD69, FGP160, JOKER FGM 67 SC, JOKER FGM 69, JOKER FGM107 SC, JOKER FGM109, JOKER FGM207 SC, JOKER FGM209, JOKER FGMD 67 SC, JOKER FGMD 69, JOKER FGMD107 SC, JOKER FGMD109, JOKER FGMD207 SC, JOKER FGMD209		



ignition parts

pilot burners

SIT			
100 series			
 <p>1</p>			
GEV No.	107139	Ref. No.	RTCU900025
description	pilot burner SIT type 100 series 1 flame nozzle \varnothing 0.2mm gas connection mm		
For models:	BST2LV, BST2RV, BST6LV, BST6RV, C2A, C4A, C4A70, C4AV70, C4F, C4F70, C4F702P, C4FV70, C4FV702P, C62F, C6A, C6A70, C6AV70, C6F, C6F70, C6F702P, C6FA, C6FV70, C6FV702P, C8A, C8F, G2S, G2SAP, G2SP, G3S6, G4S, G4SAP, G4SF, G4SFE, G4SFP, G6S, G6SF2, G6SFA, G6SFEA, G8S, G8SAP, G8SF2, G8SF2E, G8SF2P, GT2S, GT2SD, GT2SDF, GT2SDFE, GT2SFA, GT2SFEA, TPF70...(Other models you can see in the webshop)		
spare parts for	107139		
		GEV No.	100854 Ref. No. —
	pilot burner bracket double		
		GEV No.	100885 Ref. No. —
	air mixing sleeve for pilot burner Qty 1 pcs		
		GEV No.	107160 Ref. No. —
	pilot burner cap SIT 1 flame Hmm Lmm Qty 1 pcs		
accessories for	107139		
		GEV No.	100904 Ref. No. —
	locking screw M10x1 for pipe \varnothing 4mm Qty 1 pcs		
		GEV No.	100905 Ref. No. —
	locking screw M10x1 for pipe \varnothing 6mm Qty 1 pcs		
		GEV No.	100998 Ref. No. —
	pilot burner bottom part nozzle \varnothing 0.21mm suitable for 100 series		
		GEV No.	102110 Ref. No. —
	pilot tube copper pipe \varnothing 4mm thickness 1mm L 3000mm		
		GEV No.	102111 Ref. No. —
	pilot tube copper pipe \varnothing 6mm thickness 1mm L 3000mm		

 <p>1</p>			
GEV No.	107141	Ref. No.	RTCU700372
description	pilot burner SIT type 100 series 1 flame nozzle \varnothing 0.35mm gas connection 6mm		
For models:	BG6SF77M, G2S, G2S7, G2S77, G2S77P, G2S8, G2S9, G2S928P, G2S98, G2SA11, G2SA77, G2SA77P, G2SA98, G2SA98P, G2SDM7, G2SDMF7, G2SDMFE7, G2SSM7, G2SSM77, G2SSMA77, G2SSMF7, G2SSMFE7, G4S, G4S7, G4S77, G4S77P, G4S8, G4S9, G4S9-48, G4S948P, G4S98, G4SA11, G4SA77, G4SA77P, G4SA98, G4SA98P, G4SF, G4SF-1, G4SF11, G4SF7, G4SF77, G4SF77P, G4SF8, G4SF9, G4SF9-1, G4SF9-2, G4SF98, G4SF98P, G4SFE, G4SFE7...(Other models you can see in the webshop)		
spare parts for	107141		
		GEV No.	100885 Ref. No. —
	air mixing sleeve for pilot burner Qty 1 pcs		
		GEV No.	100905 Ref. No. —
	locking screw M10x1 for pipe \varnothing 6mm Qty 1 pcs		
		GEV No.	107160 Ref. No. —
	pilot burner cap SIT 1 flame Hmm Lmm Qty 1 pcs		
accessories for	107141		
		GEV No.	100904 Ref. No. —
	locking screw M10x1 for pipe \varnothing 4mm Qty 1 pcs		
		GEV No.	106733 Ref. No. 172882 RTCU700407
	pilot burner bracket suitable for MBM		
		GEV No.	107167 Ref. No. RTCU700389
	pilot burner nozzle SIT LPG code 21 bore \varnothing 0.21mm Qty 1 pcs		
		GEV No.	107168 Ref. No. RTCU700647
	pilot burner nozzle SIT natural gas bore \varnothing 0.35mm Qty 1 pcs thread M4x0.75 WS 5		

















 <p>1</p>			
GEV No.	106906	Ref. No.	RTCU900074 RTCU900079
description	pilot burner SIT type 100 series 3 flames nozzle \varnothing 0.2mm gas connection 6mm		
For models:	BST2LV, BST2RV, C4F702P, C4FV702P, CP100, CP100A, CP150, CP150A, CP1100, CP1100A, CP1150, CP1150A, EC47, EC77, FG15, FG15+15, GBR, GBRA, GF45, GF47T, GF77T, GF90, GT, GT2S, GT2SD, GT2SDF, GT2SDFE, GT2SFA, GT2SFEA, GTF, GTFE, OMNIA EC 47, TPA, TPF		
spare parts for	106906		
		GEV No.	100245 Ref. No. 4370001
	pilot burner nozzle LPG code 20 bore \varnothing 0.2mm Qty 1 pcs thread M8x0.75		
		GEV No.	100855 Ref. No. —
	pilot burner bracket triple		


Table continues overleaf




spare parts for		106906	
	GEV No.	100885	Ref. No. —
air mixing sleeve for pilot burner Qty 1 pcs			
	GEV No.	100916	Ref. No. —
compression spring for pilot burner Qty 1 pcs			
	GEV No.	100917	Ref. No. —
gasket for pilot burner Qty 1 pcs aluminium			
	GEV No.	100918	Ref. No. —
screw for pilot burner			
	GEV No.	107162	Ref. No. —
pilot burner cap SIT 3 flames Hmm Lmm Qty 1 pcs			
	GEV No.	107701	Ref. No. —
pilot burner bottom part SIT 100 series nozzle ϕ 0.2mm			

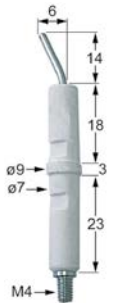
accessories for		106906	
	GEV No.	100245	Ref. No. 4370001
pilot burner nozzle LPG code 20 bore ϕ 0.2mm Qty 1 pcs thread M8x0.75			
	GEV No.	100246	Ref. No. —
pilot burner nozzle natural gas bore ϕ 0.35mm Qty 1 pcs thread M8x0.75			
	GEV No.	100904	Ref. No. —
locking screw M10x1 for pipe ϕ 4mm Qty 1 pcs			
	GEV No.	100905	Ref. No. —
locking screw M10x1 for pipe ϕ 6mm Qty 1 pcs			
	GEV No.	102110	Ref. No. —
pilot tube copper pipe ϕ 4mm thickness 1mm L 3000mm			
	GEV No.	102111	Ref. No. —
pilot tube copper pipe ϕ 6mm thickness 1mm L 3000mm			
	GEV No.	107171	Ref. No. —
pilot burner nozzle SIT natural/liquid gas bore ϕ 0.25mm Qty 1 pcs			
	GEV No.	107700	Ref. No. —
pilot burner bottom part SIT 100 series nozzle ϕ 0.25mm			
	GEV No.	107702	Ref. No. —
pilot burner bottom part SIT 100 series nozzle ϕ 0.35mm			


accessories			
pilot burner nozzles			
	1		
GEV No.	100245	Ref. No.	4370001
description pilot burner nozzle LPG code 20 bore ϕ 0.2mm Qty 1 pcs thread M8x0.75			

	1		
GEV No.	107167	Ref. No.	RTCU700389
description pilot burner nozzle SIT LPG code 21 bore ϕ 0.21mm Qty 1 pcs			
For models: G2S7, G2S9, G2SDM7, G2SDMF7, G2SDMFE7, G2SSM7, G2SSMF7, G2SSMFE7, G4S7, G4SF7, G4SFE7, G4SM7, G4SMFA7, G6S7, G6S9, G6SFA7, G6SFEA7, GT2SD7, GT2SDFA7, GT2SS7, GT2SSFA7, GT4S7, GT4SF27, GT4SF2E7, GT4SFA7, OMNIA G2S7, OMNIA G4S7, OMNIA G4SF7, OMNIA G4SFE7, OMNIA G6S7, OMNIA G6SFA7, OMNIA G6SFEA7, OMNIA GT2SD7, OMNIA GT4S7, OMNIA GT4SF27, WG2S7			

	1		
GEV No.	107168	Ref. No.	RTCU700647
description pilot burner nozzle SIT natural gas bore ϕ 0.35mm Qty 1 pcs thread M4x0.75 5			
















ignition electrodes

















	1		
GEV No.	100706	Ref. No.	RTCU800109 RTCU900073
description ignition electrode connection M4 Qty 1 pcs			
For models: BST2LV, BST2RV, BST6LV, BST6RV, C4F70, C4F702P, C4FV70, C4FV702P, C6F70, C6FV70, CP100, CP100A, CP150, CP150A, CP100, CP100A, CP1150, CP1150A, FG15, FG15+15, GBR, GBRA, GF45, GF47, GF77, GF90, GT, GT2S, GT2SD, GT2SDF, GT2SDFE, GT2SFA, GT2SFEA, GTF, GTFE, TPA, TPF70, TPFV70			

	1		
GEV No.	100707	Ref. No.	RTCP800033
description ignition electrode D1 ϕ 7mm D2 ϕ 9mm connection ϕ 2.4mm L1 14mm L2 6mm BL1 18mm BL2 3mm BL3 23mm to clip Qty 1 pcs			
For models: BG6SF77M, C4F, C62F, C6F, C6FA, C8F, FCG10, FCG108, FCG20, FCG6, FCG68, FGC060, FGC065, FGC100, FGC200, FGM060, FGM061, FGM100, FGM101, FGM200, FGM201, FGMD060, FGMD061, FGMD065, FGMD066, FGMD200, FGMD201, FGP050, FGP080, FGP160, FMM060, FMM061, FMM100, FMM101, G100, G100A, G100I, G100IA, G150, G150A, G150I, G150IA, G175, G2SDM7, G2SDMFE7, G2SF6, G2SF6G, G2SSM7, G2SSM77...(Other models you can see in the webshop)			



140 - 145 -150 series

			
GEV No.	107133	Ref. No.	RTCP800034
description	pilot burner SIT type 140 series 1 flame nozzle \varnothing mm gas connectionmm		
For models:	BG6SF77M, BST2LV, BST2RV, BST6LV, BST6RV, C4F, C62F, C6F, C6F702P, C6FA, C6FV702P, C8F, FCG10, FCG108, FCG20, FCG6, FCG68, FGC060, FGC065, FGC100, FGC200, FGM060, FGM061, FGM100, FGM101, FGM200, FGM201, FGM202, FGMD060, FGMD061, FGMD065, FGMD066, FGMD100, FGMD101, FGMD200, FGMD201, FGP050, FGP080, FGP160, FMM060, FMM061, FMM100, FMM101, FP01V, G100, G100A, G100I, G150, G150A...(Other models you can see in the webshop)		
accessories for	107133		
	GEV No.	100204	Ref. No. RTCP800058
	pilot burner nozzle SIT LPG code 14 bore \varnothing 0.18/0.20mm Qty 1 pcs suitable for 140 series		
	GEV No.	100205	Ref. No. RTCP800041
	pilot burner nozzle SIT LPG code 19 bore \varnothing 0.23/0.26mm Qty 1 pcs suitable for SIT 150 series		
	GEV No.	100206	Ref. No. RTCP800040
	pilot burner nozzle SIT natural gas code 36 bore \varnothing 0.60/0.55mm Qty 1 pcs suitable for SIT 150 series		
	GEV No.	100207	Ref. No. RTCP800059
	pilot burner nozzle SIT natural gas code 27 bore \varnothing 0.40/0.38mm suitable for SIT 140 series		
	GEV No.	100216	Ref. No. —
	pilot burner nozzle SIT natural gas code 38 bore \varnothing 0.45mm Qty 1 pcs suitable for SIT 150 series		
	GEV No.	100701	Ref. No. RIC0003189 RTCU900010
	ignition electrode connection M4 Qty 1 pcs		
	GEV No.	100897	Ref. No. —
	olive for pipe \varnothing 4mm Qty 1 pcs for pilot burner		
	GEV No.	100898	Ref. No. RTCU800183
	olive for pipe \varnothing 6mm Qty 1 pcs for pilot burner		
	GEV No.	100906	Ref. No. —
	screw connection thread M10x1 for ignition electrode brass Qty 1 pcs WS 10		
	GEV No.	100907	Ref. No. —
	screw connection thread M10x1 Qty 1 pcs type SEF 1 \varnothing mm for thermocouple		
	GEV No.	100908	Ref. No. RTCU900133
	union screw thread M10x1 for pipe \varnothing 4mm Qty 1 pcs		
	GEV No.	100909	Ref. No. RTCP800038 RTCU900019
	union screw thread M10x1 for pipe \varnothing 6mm Qty 1 pcs		
	GEV No.	102110	Ref. No. —
	pilot tube copper pipe \varnothing 4mm thickness 1mm L 3000mm		
	GEV No.	102111	Ref. No. —
	pilot tube copper pipe \varnothing 6mm thickness 1mm L 3000mm		

			
GEV No.	107114 ¹	Ref. No.	7090028 RIC0003049
description	pilot burner SIT type 140 series 2 flames nozzle \varnothing mm gas connectionmm		
For models:	GPL45, GPL45-P, GPL49-P, GPL90, GPL90-P, GPL99-P		
spare parts for	107114		
	GEV No.	100907	Ref. No. —
	screw connection thread M10x1 Qty 1 pcs type SEF 1 \varnothing mm for thermocouple		
accessories for	107114		
	GEV No.	100204	Ref. No. RTCP800058
	pilot burner nozzle SIT LPG code 14 bore \varnothing 0.18/0.20mm Qty 1 pcs suitable for 140 series		
	GEV No.	100205	Ref. No. RTCP800041
	pilot burner nozzle SIT LPG code 19 bore \varnothing 0.23/0.26mm Qty 1 pcs suitable for SIT 150 series		
	GEV No.	100206	Ref. No. RTCP800040
	pilot burner nozzle SIT natural gas code 36 bore \varnothing 0.60/0.55mm Qty 1 pcs suitable for SIT 150 series		
	GEV No.	100207	Ref. No. RTCP800059
	pilot burner nozzle SIT natural gas code 27 bore \varnothing 0.40/0.38mm suitable for SIT 140 series		
	GEV No.	100216	Ref. No. —
	pilot burner nozzle SIT natural gas code 38 bore \varnothing 0.45mm Qty 1 pcs suitable for SIT 150 series		
	GEV No.	100701	Ref. No. RIC0003189 RTCU900010
	ignition electrode connection M4 Qty 1 pcs		
	GEV No.	100801	Ref. No. —
	gasket for pilot burner Qty 1 pcs		
	GEV No.	100897	Ref. No. —
	olive for pipe \varnothing 4mm Qty 1 pcs for pilot burner		
	GEV No.	100898	Ref. No. RTCU800183
	olive for pipe \varnothing 6mm Qty 1 pcs for pilot burner		
	GEV No.	100906	Ref. No. —
	screw connection thread M10x1 for ignition electrode brass Qty 1 pcs WS 10		
	GEV No.	100908	Ref. No. RTCU900133
	union screw thread M10x1 for pipe \varnothing 4mm Qty 1 pcs		
	GEV No.	100909	Ref. No. RTCP800038 RTCU900019
	union screw thread M10x1 for pipe \varnothing 6mm Qty 1 pcs		
	GEV No.	102110	Ref. No. —
	pilot tube copper pipe \varnothing 4mm thickness 1mm L 3000mm		
	GEV No.	102111	Ref. No. —
	pilot tube copper pipe \varnothing 6mm thickness 1mm L 3000mm		











¹incl. thermocouple fitting



160 series





1

GEV No.	100049	Ref. No.	RTCU900007
description	pilot burner SIT type 160 series 2 flames nozzle \varnothing mm gas connectionmm		
For models:	BST6LV, BST6RV, EBM90, FT2GL70, FT2GR70, FT4GL, FT4GL70, FT4GLR, FT4GLR70, FT4GR, FT4GR70, GC45, GC90, GC902V		
spare parts for	100049		
	GEV No.	100907	Ref. No. —
	screw connection thread M10x1 Qty 1 pcs type SEF 1 \varnothing mm for thermocouple		
accessories for	100049		
	GEV No.	100202	Ref. No. —
	pilot burner nozzle natural gas code 41 Qty 1 pcs nozzle \varnothing 0.41mm		
	GEV No.	100203	Ref. No. —
	pilot burner nozzle LPG code 25 Qty 1 pcs nozzle \varnothing 0.25mm		
	GEV No.	100701	Ref. No. RIC0003189 RTCU900010
	ignition electrode connection M4 Qty 1 pcs		
	GEV No.	100869	Ref. No. —
	pilot burner nozzle natural gas code 51 Qty 1 pcs suitable for 160 series nozzle \varnothing 0.51mm		
	GEV No.	100906	Ref. No. —
	screw connection thread M10x1 for ignition electrode brass Qty 1 pcs WS 10		
	GEV No.	100908	Ref. No. RTCU900133
	union screw thread M10x1 for pipe \varnothing 4mm Qty 1 pcs		
	GEV No.	100909	Ref. No. RTCP800038 RTCU900019
	union screw thread M10x1 for pipe \varnothing 6mm Qty 1 pcs		
	GEV No.	101282	Ref. No. —
	olive for pipe \varnothing 4mm L 7.4mm Qty 1 pcs		
	GEV No.	101287	Ref. No. —
	olive for pipe \varnothing 6mm Qty 1 pcs		
	GEV No.	102110	Ref. No. —
	pilot tube copper pipe \varnothing 4mm thickness 1mm L 3000mm		
	GEV No.	102111	Ref. No. —
	pilot tube copper pipe \varnothing 6mm thickness 1mm L 3000mm		
	GEV No.	107650	Ref. No. 53.3.0202.00 611008 RTCU900216
	pilot burner nozzle SIT LPG code 30 Qty 1 pcs		


















1

GEV No.	100052	Ref. No.	RTBF800034
description	pilot burner SIT type 160 series 2 flames nozzle \varnothing mm gas connectionmm		
For models:	GBM45, GBM90		
spare parts for	100052		
	GEV No.	100907	Ref. No. —
	screw connection thread M10x1 Qty 1 pcs type SEF 1 \varnothing mm for thermocouple		
accessories for	100052		
	GEV No.	100202	Ref. No. —
	pilot burner nozzle natural gas code 41 Qty 1 pcs nozzle \varnothing 0.41mm		
	GEV No.	100203	Ref. No. —
	pilot burner nozzle LPG code 25 Qty 1 pcs nozzle \varnothing 0.25mm		
	GEV No.	100701	Ref. No. RIC0003189 RTCU900010
	ignition electrode connection M4 Qty 1 pcs		
	GEV No.	100801	Ref. No. —
	gasket for pilot burner Qty 1 pcs		
	GEV No.	100906	Ref. No. —
	screw connection thread M10x1 for ignition electrode brass Qty 1 pcs WS 10		
	GEV No.	100908	Ref. No. RTCU900133
	union screw thread M10x1 for pipe \varnothing 4mm Qty 1 pcs		
	GEV No.	100909	Ref. No. RTCP800038 RTCU900019
	union screw thread M10x1 for pipe \varnothing 6mm Qty 1 pcs		
	GEV No.	101282	Ref. No. —
	olive for pipe \varnothing 4mm L 7.4mm Qty 1 pcs		
	GEV No.	101287	Ref. No. —
	olive for pipe \varnothing 6mm Qty 1 pcs		
	GEV No.	102110	Ref. No. —
	pilot tube copper pipe \varnothing 4mm thickness 1mm L 3000mm		
	GEV No.	102111	Ref. No. —
	pilot tube copper pipe \varnothing 6mm thickness 1mm L 3000mm		
	GEV No.	107650	Ref. No. 53.3.0202.00 611008 RTCU900216
	pilot burner nozzle SIT LPG code 30 Qty 1 pcs		



			
GEV No.	100054	Ref. No.	53.3.0115.00
description	pilot burner SIT type 160 series 2 flames nozzle ømm gas connecti-onmm		
For models:	6FT61G, 6FT62G		
spare parts for	100054		
	GEV No.	100907	Ref. No. —
screw connection thread M10x1 Qty 1 pcs type SEF 1 ømm for thermocouple			
accessories for	100054		
	GEV No.	100202	Ref. No. —
pilot burner nozzle natural gas code 41 Qty 1 pcs nozzle ø 0.41mm			
	GEV No.	100203	Ref. No. —
pilot burner nozzle LPG code 25 Qty 1 pcs nozzle ø 0.25mm			
	GEV No.	100701	Ref. No. RIC0003189 RTCU900010
ignition electrode connection M4 Qty 1 pcs			
	GEV No.	100801	Ref. No. —
gasket for pilot burner Qty 1 pcs			
	GEV No.	100869	Ref. No. —
pilot burner nozzle natural gas code 51 Qty 1 pcs suitable for 160 series nozzle ø 0.51mm			
	GEV No.	100906	Ref. No. —
screw connection thread M10x1 for ignition electrode brass Qty 1 pcs WS 10			
	GEV No.	100908	Ref. No. RTCU900133
union screw thread M10x1 for pipe ø 4mm Qty 1 pcs			
	GEV No.	100909	Ref. No. RTCP800038 RTCU900019
union screw thread M10x1 for pipe ø 6mm Qty 1 pcs			
	GEV No.	101282	Ref. No. —
olive for pipe ø 4mm L 7.4mm Qty 1 pcs			
	GEV No.	101287	Ref. No. —
olive for pipe ø 6mm Qty 1 pcs			
	GEV No.	102110	Ref. No. —
pilot tube copper pipe ø 4mm thickness 1mm L 3000mm			
	GEV No.	102111	Ref. No. —
pilot tube copper pipe ø 6mm thickness 1mm L 3000mm			
	GEV No.	107650	Ref. No. 53.3.0202.00 611008 RTCU900216
pilot burner nozzle SIT LPG code 30 Qty 1 pcs			

















			
GEV No.	100056	Ref. No.	53.3.0110.00 RTCU700464
description	pilot burner SIT type 160 series 3 flames nozzle ømm gas connecti-onmm		
For models:	6BM61G, 6BM62G, 6FQ61G, 6FQ62G, BGF777B, FG15M, FG20M, GC66, GF15+15S, GF15S, GF25+25S, GF25S, GF408, GF408N, GF411, GF46, GF47, GF477, GF477B, GF477S, GF477TS, GF47T, GF498B, GF66, GF77, GF777, GF777B, GF777S, GF777TS, GF77T, GF908, GF908N, GF911, GF99, GF998B, MG7GF477, MG7GF477TS, MG7GF777, MG7GF777TS, MINIMA GC 66, MINIMA GF 46, MINIMA GF 66, OMNIA GF 47, OMNIA GF 47T, OMNIA GF 77, OMNIA GF 77T		
spare parts for	100056		
	GEV No.	100907	Ref. No. —
screw connection thread M10x1 Qty 1 pcs type SEF 1 ømm for thermocouple			
accessories for	100056		
	GEV No.	100202	Ref. No. —
pilot burner nozzle natural gas code 41 Qty 1 pcs nozzle ø 0.41mm			
	GEV No.	100203	Ref. No. —
pilot burner nozzle LPG code 25 Qty 1 pcs nozzle ø 0.25mm			
	GEV No.	100701	Ref. No. RIC0003189 RTCU900010
ignition electrode connection M4 Qty 1 pcs			
	GEV No.	100801	Ref. No. —
gasket for pilot burner Qty 1 pcs			
	GEV No.	100869	Ref. No. —
pilot burner nozzle natural gas code 51 Qty 1 pcs suitable for 160 series nozzle ø 0.51mm			
	GEV No.	100870	Ref. No. RTCU900134
olive for pipe ø 4mm Qty 1 pcs suitable for 160 series for pilot burner			
	GEV No.	100906	Ref. No. —
screw connection thread M10x1 for ignition electrode brass Qty 1 pcs WS 10			
	GEV No.	100908	Ref. No. RTCU900133
union screw thread M10x1 for pipe ø 4mm Qty 1 pcs			
	GEV No.	100909	Ref. No. RTCP800038 RTCU900019
union screw thread M10x1 for pipe ø 6mm Qty 1 pcs			
	GEV No.	101287	Ref. No. —
olive for pipe ø 6mm Qty 1 pcs			
	GEV No.	102110	Ref. No. —
pilot tube copper pipe ø 4mm thickness 1mm L 3000mm			
	GEV No.	102111	Ref. No. —
pilot tube copper pipe ø 6mm thickness 1mm L 3000mm			
	GEV No.	107650	Ref. No. 53.3.0202.00 611008 RTCU900216
pilot burner nozzle SIT LPG code 30 Qty 1 pcs			







POLIDORO

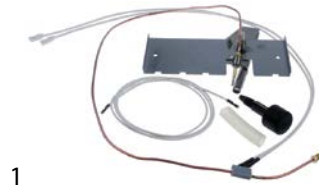
pilot burners



GEV No.	100076	Ref. No.	RTBF800363
description	pilot burner POLIDORO 3 flames natural gas code 29.2 gas connection 6mm		
spare parts for	100076		
	GEV No.	100907	Ref. No. —
	screw connection thread M10x1 Qty 1 pcs type SEF 1 0mm for thermocouple		
accessories for	100076		
	GEV No.	100000	Ref. No. —
	pilot burner nozzle POLIDORO LPG code 22 bore ø 0.22mm Qty 1 pcs		
	GEV No.	100208	Ref. No. —
	pilot burner nozzle POLIDORO LPG code 20 bore ø 0.2mm Qty 1 pcs		
	GEV No.	100209	Ref. No. —
	pilot burner nozzle POLIDORO natural gas code 40 bore ø 0.4mm Qty 1 pcs		
	GEV No.	100701	Ref. No. RIC0003189 RTCU900010
	ignition electrode connection M4 Qty 1 pcs		
	GEV No.	100906	Ref. No. —
	screw connection thread M10x1 for ignition electrode brass Qty 1 pcs WS 10		
	GEV No.	100907	Ref. No. —
	screw connection thread M10x1 Qty 1 pcs type SEF 1 0mm for thermocouple		
	GEV No.	100908	Ref. No. RTCU900133
	union screw thread M10x1 for pipe ø 4mm Qty 1 pcs		
	GEV No.	100909	Ref. No. RTCP800038 RTCU900019
	union screw thread M10x1 for pipe ø 6mm Qty 1 pcs		
	GEV No.	102110	Ref. No. —
	pilot tube copper pipe ø 4mm thickness 1mm L 3000mm		
	GEV No.	102111	Ref. No. —
	pilot tube copper pipe ø 6mm thickness 1mm L 3000mm		
	GEV No.	102508	Ref. No. —
	union screw thread M10x1 for pipe ø 4mm Qty 5 pcs		
	GEV No.	102509	Ref. No. —
	union screw thread M10x1 for pipe ø 6mm Qty 5 pcs		
	GEV No.	102699	Ref. No. —
	pilot burner nozzle POLIDORO natural gas code 25.2 bore ø 2x0.25mm Qty 1 pcs 2 bores		
	GEV No.	102795	Ref. No. —
	olive for pipe ø 4mm Qty 1 pcs		
	GEV No.	102797	Ref. No. —
	olive for pipe ø 6mm Qty 1 pcs		

accessories for	100076		
	GEV No.	106703	Ref. No. —
	pilot burner nozzle POLIDORO natural gas code 27.2 bore ø 2x0.27mm Qty 1 pcs		
	GEV No.	106704	Ref. No. —
	pilot burner nozzle POLIDORO LPG code 16.2 bore ø 2x0.16mm Qty 1 pcs		
	GEV No.	106763	Ref. No. —
	pilot burner nozzle POLIDORO natural gas code 27.2A bore ø 2x0.27mm Qty 1 pcs		
	GEV No.	106859	Ref. No. —
	pilot burner nozzle POLIDORO LPG code 24 bore ø 0.24mm Qty 1 pcs		

miscellaneous



GEV No.	101316	Ref. No.	RIC0004528
description	conversion kit for pilot burner		

accessories universal

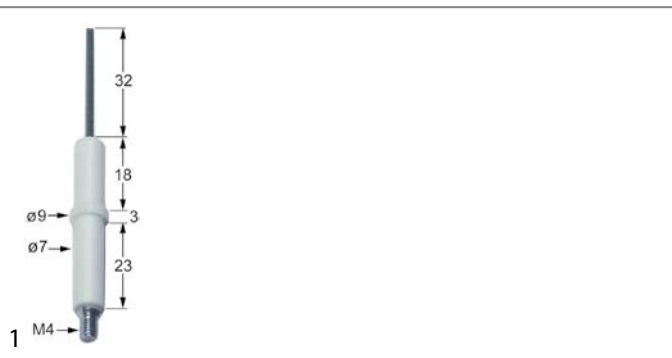
pilot burner brackets




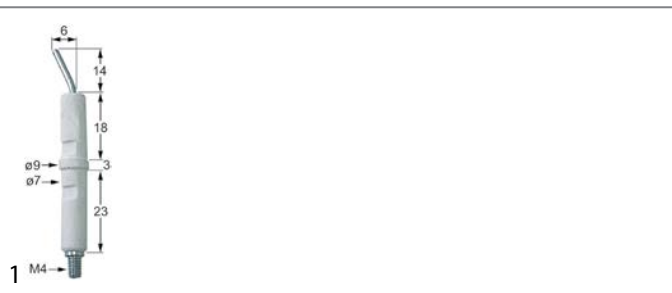
GEV No.	690798	Ref. No.	PACU701022
description	pilot burner bracket		
For models:	GBR, GBR77, GBR8, GBR9T, GBRA, GBRA9T, GBRAVI, GBRAVI9T, GBRI77, GBRCV98, GBRVI, GBRVI8, GBRVI98, GBRVI9T, MG7GBR77, MG7GBRI77		



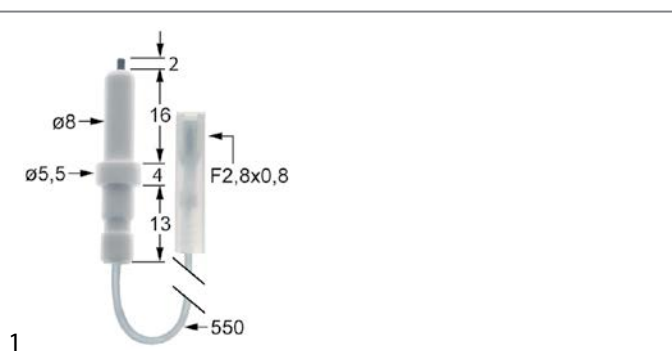
electrodes



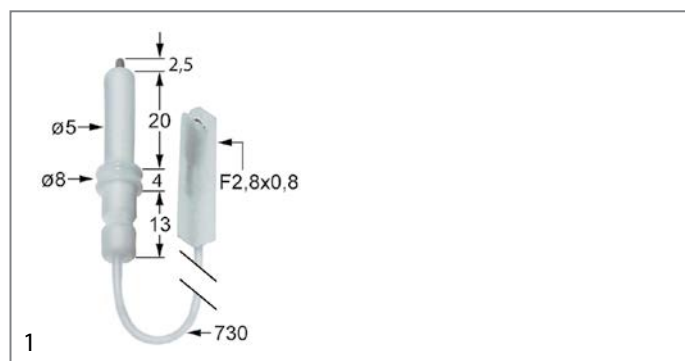
GEV No.	100701	Ref. No.	RIC0003189 RTCU900010
description	ignition electrode connection M4 Qty 1 pcs		
For models:	BGF777B, BM4G70, BST2LV, BST2RV, BST6LV, BST6RV, C6F702P, C6FV702P, FG15M, FG20M, FGM060, FGM061, FGM100, FGM101, FT2GL70, FT2GR70, FT4GL, FT4GL70, FT4GLR, FT4GLR70, FT4GR, FT4GR70, G100, G1009, G100A, G100I, G100I9, G100I9N, G100IT9, G100IT9N, G100T9, G150, G1509, G150A, G150I, G150I9, G150I9N, G150IT9, G150IT9N, G150T9, GBM45, GBM90, GC45, GC477, GC66, GC90, GC902V, GF15+15S, GF15S, GF25+25S...(Other models you can see in the webshop)		
accessories for	100701		
	GEV No.	100906	Ref. No. —
	screw connection thread M10x1 for ignition electrode brass Qty 1 pcs WS 10		



GEV No.	100706	Ref. No.	RTCU800109 RTCU900073
description	ignition electrode connection M4 Qty 1 pcs		
For models:	BST2LV, BST2RV, BST6LV, BST6RV, C4F70, C4F702P, C4FV70, C4FV702P, C6F70, C6FV70, CP100, CP100A, CP150, CP150A, CPI100, CPI100A, CPI150, CPI150A, FG15, FG15+15, GBR, GBRA, GF45, GF47, GF77, GF90, GT, GT2S, GT2SD, GT2SDF, GT2SDFE, GT2SFA, GT2SFEA, GTF, GTFE, TPA, TPF70, TPFV70		



GEV No.	100808	Ref. No.	RTCU600045
description	ignition electrode D1 ø 5.5mm cable length 550mm connection F 2.8x0.8mm D2 ø 8mm L1 2mm BL1 16mm BL2 4mm BL3 13mm		
For models:	G2S6, G4S6, G4SF6, G4SFE6, G6S6, G6SF6, G6SFA6, G6SFE6, G6SFEA6		



GEV No.	100826	Ref. No.	RTCU600046
description	ignition electrode D1 ø 5mm cable length 730mm connection F 2.8x0.8mm D2 ø 8mm L1 2.5mm BL1 20mm BL2 4mm BL3 13mm		
For models:	G2S6, G4S6, G4SF6, G4SFE6, G6S6, G6SF6, G6SFA6, G6SFE6, G6SFEA6, MINIMA G2S6, MINIMA G4S6, MINIMA G4SF6, MINIMA G4SFE6, MINIMA G6S6, MINIMA G6SF6, MINIMA G6SFA6, MINIMA G6SFE6, MINIMA G6SFEA6		



GEV No.	100871	Ref. No.	53.7.0030.00
description	ignition electrode D1 ø 7mm connection M4 to clip		
For models:	6BM61G, 6BM62G, 6FQ61G, 6FQ62G, 6FT61G, 6FT62G		



GEV No.	100707	Ref. No.	RTCP800033
description	ignition electrode D1 ø 7mm D2 ø 9mm connection ø2.4mm L1 14mm L2 6mm BL1 18mm BL2 3mm BL3 23mm to clip Qty 1 pcs		
For models:	BG6SF77M, C4F, C6F2, C6F, C6FA, C8F, FCG10, FCG108, FCG20, FCG6, FCG68, FCG060, FCG065, FCG100, FCG200, FGM060, FGM061, FGM100, FGM101, FGM200, FGM201, FGMD060, FGMD061, FGMD065, FGMD066, FGMD200, FGMD201, FGP050, FGP080, FGP160, FMM060, FMM061, FMM100, FMM101, G100, G100A, G100I, G100IA, G150, G150A, G150I, G150IA, G175, G2SDM7, G2SDMF7, G2SDMFE7, G2SF6, G2SF6G, G2SSM7, G2SSM7...(Other models you can see in the webshop)		



GEV No.	102808	Ref. No.	PAFOC00251
description	ignition electrode flange length 23mm flange width 15mm D1 ø 7mm L1 17mm L2 13mm BL1 21mm BL2 32mm fixing dimensions ø5x4mm with flange connection ø 6mm		
For models:	FGM062, FGM102, FGM107, FGM107SC, FGM108, FGM108EL, FGM110, FGM110L, FGM207, FGM610, FGM610L, FGM67, FGM67SC, FGM68, FGM68EL, FGMD108, FGMD108EL, FGMD68, FGMD68EL		

1 gas components

GEV No.	100818	Ref. No.	9353457100 RIC0002551
description	ignition electrode flange length 23mm flange width 15mm D1 ø 7mm L1 18mm L2 43mm BL1 21mm BL2 32mm fixing dimensions ø5x4mm with flange		
For models:	G4SF6, G4SFA6, G6SF6, G6SFA6, MINIMA G4SF6, MINIMA G6SF6, MINIMA G6SFA6		

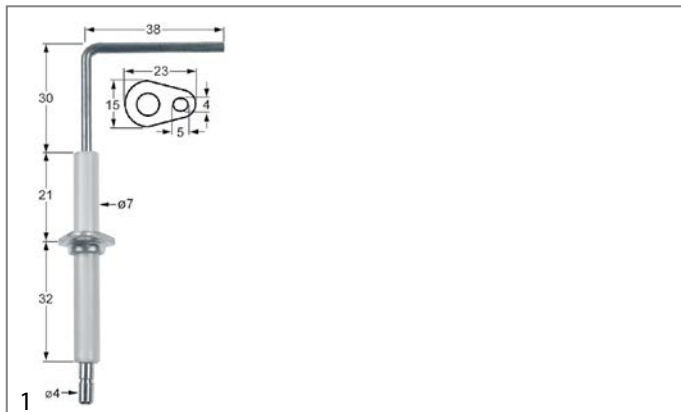
GEV No.	102807	Ref. No.	PAFOC00368 RTFOC00368
description	ignition electrode flange length 23mm flange width 15mm D1 ø 7mm L1 48mm L2 43mm BL1 21mm BL2 32mm fixing dimensions ø5x4mm with flange connection ø 4mm		
For models:	FGM202, FGM207, FGM207SC, FGM209, FGM210, FGM210L, FGMD207, FGMD207SC, FGMD209, JOKER FGM207 SC, JOKER FGM209, JOKER FGMD207 SC, JOKER FGMD209		

GEV No.	102810	Ref. No.	PAFOC00367
description	ignition electrode flange length 23mm flange width 15mm D1 ø 7mm L1 25mm L2 12mm BL1 24mm BL2 29mm fixing dimensions ø5x4mm with flange connection ø 6mm		
For models:	FEM210, FEM210L, FGM202, FGM207, FGM207SC, FGM209, FGM210, FGM210L, FGMD207, FGMD207SC, FGMD209, JOKER FGM207 SC, JOKER FGM209, JOKER FGMD207 SC, JOKER FGMD209		

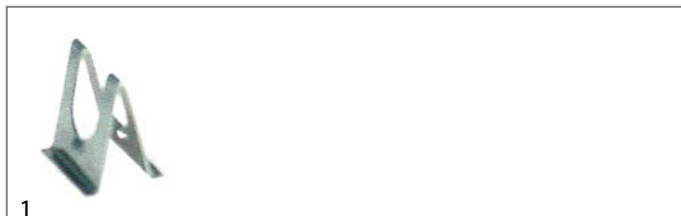
GEV No.	100735	Ref. No.	PAFOC00249
description	ignition electrode flange length 23mm flange width 15mm D1 ø 7mm L1 52mm L2 36mm BL1 24mm BL2 29mm fixing dimensions ø5x4mm with flange connection ø 4mm		
For models:	FGM062, FGM102, FGM107, FGM107SC, FGM108, FGM108EL, FGM109, FGM110, FGM110L, FGM610, FGM610L, FGM67, FGM67SC, FGM68, FGM68EL, FGMD107, FGMD107SC, FGMD108, FGMD108EL, FGMD109, FGMD67, FGMD67SC, FGMD68, FGMD68EL, FGMD69, JOKER FGM107 SC, JOKER FGM109, JOKER FGMD 67 SC, JOKER FGMD 69, JOKER FGMD107 SC, JOKER FGMD109		

GEV No.	100734	Ref. No.	PAFOC00252
description	ignition electrode flange length 23mm flange width 15mm D1 ø 7mm L1 40mm L2 12mm BL1 24mm BL2 29mm fixing dimensions ø5x4mm with flange connection ø 6mm		
For models:	FGM062, FGM102, FGM107, FGM107SC, FGM108, FGM108EL, FGM109, FGM110, FGM110L, FGM610, FGM610L, FGM67, FGM67SC, FGM68, FGM68EL, FGM69, FGMD107, FGMD107SC, FGMD108, FGMD108EL, FGMD109, FGMD67, FGMD67SC, FGMD68, FGMD68EL, FGMD69		

GEV No.	100729	Ref. No.	53.7.0027.00
description	ignition electrode L1 5mm D1 ø 8mm D2 ø 10mm BL1 41mm BL2 14mm connection F 2.8x0.8mm to clip with spring		
For models:	6PC61G, 6PC62G		



GEV No.	102809	Ref. No.	PAFOC00250
description	monitoring electrode flange length 23mm flange width 15mm D1 ø 7mm L1 30mm L2 38mm BL1 21mm BL2 32mm fixing dimensions ø5x4mm with flange connection ø 4mm		
For models:	CMFG10-V380, CMFG6-V380, CMG10-V380, CMG6-V380, CYG10-V380, CYG6-V380, FGM062, FGM102, FGM107, FGM107SC, FGM108, FGM108EL, FGM109, FGM110, FGM110L, FGM202, FGM207, FGM207SC, FGM210, FGM210L, FGM610, FGM610L, FGM67, FGM67SC, FGM68, FGM68EL, FGM69, FGMD108, FGMD108EL, FGMD68, FGMD68EL, JOKER FGM 67 SC, JOKER FGM 69, JOKER FGM107 SC, JOKER FGM109		



GEV No.	106068	Ref. No.	RTCU600047
description	spring clip for igniter		
For models:	G4SF6, G4SFE6, G6SF6, G6SFA6, G6SFE6, G6SFEA6, MINIMA G4SF6, MINIMA G4SFE6, MINIMA G6SF6, MINIMA G6SFA6, MINIMA G6SFE6, MINIMA G6SFEA6		



GEV No.	106797	Ref. No.	RTCU900215
description	union screw thread M10x1 WS 10 bore ø 7.3mm		
For models:	BG6SF77M, BGF777B, FCG10, FCG108, FCG20, FCG6, FCG68, FG15M, FG20M, FGC060, FGC065, FGC100, FGC200, FGM060, FGM061, FGM100, FGM101, FGM200, FGM201, FGM202, FGMD060, FGMD061, FGMD065, FGMD066, FGMD100, FGMD101, FGMD200, FGMD201, FGP050, FGP080, FGP160, FMM060, FMM061, FMM100, FMM101, FT4GL, FT4GLR, FT4GR, G100, G1008, G1009, G10098, G100A, G100I, G100I8, G100I9, G100I98, G100IT9, G100T9, G100T98...(Other models you can see in the webshop)		

ignition cables

pre-assembled cables



GEV No.	100026	Ref. No.	RTCU900384 RTCU900385
description	ignition cable cable length 1000mm connection ø4mm / F6.3mm		
For models:	C4F, C62F, C6F, C6FA, C8F, G2SSM77, G2SSMA77, G4SF77P, G4SM77, G4SMA77, G4SMFA77, G6SFM, GBM45, GBM46, GBM47, GBM49T, GBM66, GBM77, GBM90, GBM99T, GBR7, GBR77, GBR7I, GBR77I, GF077, GFT1177L, GFT1177LC, GFT1177LR, GFT1177LRC, GFT1177R, GFT1177RC, GFT45L, GFT45LC, GFT45R, GFT45RC, GFT477L, GFT477LC, GFT477R, GFT477RC, GFT49L, GFT49LC, GFT49R, GFT49RC, GFT777L, GFT777LC, GFT777LR, GFT777LRC, GFT777R, GFT777RC, GFT90L...(Other models you can see in the webshop)		



GEV No.	102180	Ref. No.	RTCP800043 RTCU800144
description	ignition cable cable length 1200mm connection ø2.4mm / ø2.4mm		
For models:	G100, G100A, G100I, G100IA, G150, G150A, G150I, G150IA, G175, G4SF, G4SFP, G5077, G50I7, G50I77, G6SF2, G6SFA, G6SFA9, G8SF2, G8SF2P, GC45, GC477, GC49, GC49T, GC777, GC902V, GC992V, GC992VT, GF09, GF45, GF472V, GF49, GF49T, GF90, GF90-1, GF99, GF99T, GFB09, GFT45L, GFT45LC, GFT45R, GFT45RC, GT, GT2S, GT2SD, GT2SDF, GT2SDFE, GT2SFA, GT2SFEA, GTF, GTFE...(Other models you can see in the webshop)		



GEV No.	100174	Ref. No.	9363490000 RIC0002554
description	ignition cable cable length 1500mm connection F2.8mm / F2.8mm		
For models:	G4SF6, G4SFA6, G6SF6, G6SFA6, MINIMA G4SF6, MINIMA G6SF6, MINIMA G6SFA6		



GEV No.	102163	Ref. No.	RTBF800214 RTCP800201 RTCU700005
description	ignition cable cable length 1500mm connection F2.8mm / ø2.4mm		
For models:	BST6LV, BST6RV, C4F70, C4FV70, C6F70, C6FV70, FCG10, FCG108, FCG20, FCG6, FCG68, FGP050, FGP080, FGP160, G100, G100A, G150, G150A, GBR, GBRA, GBRAVI, GBRVI, GF45, GF90, JOKER FCG 6, JOKER FCG 6 AB 2002, JOKER FCG 10, JOKER FCG 10 AB 2002, JOKER FGP050, JOKER FGP050 AB 2002, JOKER FGP080, JOKER FGP080 AB 2002, JOKER FGP160, TPA, TPF, TPF70, TPFV70		





GEV No.	102181	Ref. No.	RTCU900293
description	ignition cable cable length 1500mm connection ø2.4mm / ø2.4mm		
For models:	G6SF2, G6SF29		





GEV No.	102160	Ref. No.	RTCU800144
description	ignition cable cable length 2000mm connection ø2.4mm / ø2.4mm		





			
GEV No.	100014	Ref. No.	RTCU700361
description	ignition cable cable length 300mm connection ø2.4mm / ø2.4mm		
For models:	G2SDM7, G2SDMF7, G2SDMFE7, G2SSM7, G2SSMF7, G2SSMFE7, G4SM7, G4SMFA7, GBR6, GF4772V, GFT106L, GFT106LC, GFT106LR, GFT106LRC, GFT117L, GFT117LC, GFT117LR, GFT117LRC, GFT46L, GFT46LC, GFT46R, GFT46RC, GFT47L, GFT47LC, GFT47R, GFT47RC, GFT66L, GFT66LC, GFT66LR, GFT66LRC, GFT66R, GFT66RC, GFT77L, GFT77LC, GFT77LR, GFT77LRC, GFT77R, GFT77RC, GPL46P, GPL47, GPL477, GPL47P, GPL77, GPL777, GPL77P, GPL86P, GPLA477, GPLA777, MG7GF4772V, MINIMA GBR 6...(Other models you can see in the webshop)		


			
GEV No.	100036	Ref. No.	53.7.0025.00
description	ignition cable cable length 500mm connection F2.8mm / F2.8mm		
For models:	6PC61EM, 6PC62EM, 6PC62ET		

			
GEV No.	100166	Ref. No.	54.7.0027.00
description	ignition cable cable length 500mm connection ø2.4mm / lug M4		
For models:	6BM61G, 6BM62G, 6FQ61G, 6FQ62G, 6FT61G, 6FT62G		

			
GEV No.	100197	Ref. No.	54.7.0026.00
description	ignition cable cable length 600mm connection F2.8mm / ø2.4mm		
For models:	6PC61G, 6PC62G		


			
GEV No.	100025	Ref. No.	RTCU600312
description	ignition cable cable length 600mm connection ø4mm / F6.3mm		


			
GEV No.	100178	Ref. No.	RTBF700023 RTBF700038 RTCU900080
description	ignition cable cable length 900mm connection F2.8mm / ø2.4mm		
For models:	BM4G70, BST2LV, BST2RV, BST6LV, BST6RV, FT2GL70, FT2GR70, FT4GL, FT4GL70, FT4GLR, FT4GLR70, FT4GR, FT4GR70, G100, G1009, G100I, G100I9, G100IT9, G100T9, G150, G1509, G150I, G150I9, G150IT9, G150T9, GBM45, GBM477, GBM90, GBMA477, GBR9T, GBRA9T, GBRAVI9T, GBRVC98T, GBRVI98T, GBRVI9T, GC45, GC66, GC902V, GF09, GF09T, GF15S, GF408, GF411, GF46, GF47, GF472V, GF477, GF477TS, GF47T, GF498B...(Other models you can see in the webshop)		

			
GEV No.	100019	Ref. No.	RIC0002285 RTCU700410
description	ignition cable cable length 900mm connection ø2.4mm / ø4mm		
For models:	G2SDMF7, G2SSMF7, G4SF7, G4SMFA7, G4SMFA77, G6SFA7, G6SFA77, GF07, GFO7, GPL45-P, GPL49-P, GPL90, GPL90-P, GPL99-P, GT2SDFA7, GT2SDFA77, GT2SFA7, GT4SF27, GT4SF277, GT4SFA7, GTF7, OMNIA G4SF7, OMNIA G4SMFA7, OMNIA G6SFA7, OMNIA GF07, OMNIA GT2SDFA7, OMNIA GT4SF27, OMNIA GTF7		



piezoelectric igniters

mounting diameter 18mm


			
GEV No.	100003	Ref. No.	RTCU700190
description	piezoelectric igniter body metal blowing mounting ø 18mm connection F2.8x0.8		
For models:	G100, G100A, G100I, G100IA, G150, G150A, G150I, G150IA, G175, G4SF, G4SFP, G6SF2, G6SFA, G8SF2, G8SF2P, GBM45, GBM90, GFT45L, GFT45R, GFT90L, GFT90LR, GFT90R, GT, GT2S, GT2SD, GT2SDF, GT2SDFE, GT2SFA, GT2SFEA, GTF, GTFE		

			
GEV No.	100009	Ref. No.	53.7.0028.00
description	piezoelectric igniter body plastic blowing mounting ø 18mm connection ø2.4mm front measurements 26mm M18x1.5		
For models:	6BM61G, 6BM62G, 6FQ61G, 6FQ62G, 6FT61G, 6FT62G, 6PC61G, 6PC62G		
accessories for	100009		
	GEV No.	101339	Ref. No. —
cover cap for piezoelectric igniter			
	GEV No.	106869	Ref. No. —
cover cap for piezoelectric igniter ID ø 22mm ED ø 35mm H 25mm			
	GEV No.	107931	Ref. No. —
cover cap for piezoelectric igniter ID ø 21mm ED ø 36mm			

mounting diameter 22mm


			
GEV No.	100013	Ref. No.	RIC0000225
description	piezoelectric igniter body plastic blowing mounting ø 22mm connection ø2.4mm cable lengthmm		
For models:	GPL45-P, GPL49-P, GPL90, GPL90-P, GPL99-P		
accessories for	100013		
	GEV No.	100023	Ref. No. —
female bullet size 2.3mm 0.5-1.5mm ² CuZn t.max. 125°C Qty 20 pcs			




			
1			
GEV No.	100005	Ref. No.	RTCU700020
description	piezoelectric igniter body plastic blowing mounting ø 22mm connection ø2.4mm cable lengthmm SIT		
For models:	BGF777B, BM4G70, BST2LV, BST2RV, BST6LV, BST6RV, C4A70, C4F, C4F70, C4FV70, C62F, C6F, C6F70, C6FA, C6FV70, C8F, FT2GL70, FT2GR70, FT4GL, FT4GL70, FT4GLR, FT4GLR70, FT4GR, FT4GR70, G100, G1009, G100A, G100I, G100I9, G100IA, G100IT9, G100T9, G150, G1509, G150A, G150I, G150I9, G150IA, G150IT9, G150T9, G175, G2S6, G2SDM7, G2SDMF7, G2SDMFE7, G2SF6, G2SF6G, G2SSM7, G2SSMF7, G2SSMFE7...(Other models you can see in the webshop)		

			
1			
GEV No.	102977	Ref. No.	RIC0004096
description	piezoelectric igniter body plastic blowing mounting ø 22mm connection ø2.4mm cable lengthmm with cover cap		
For models:	BG6SF77M, G1008, G10098, G100I8, G100I98, G100T98, G1508, G15098, G150I8, G150I98, G150IT98, G2SSM77, G2SSMA77, G4SF77, G4SF77P, G4SF8, G4SF98, G4SF98P, G4SM77, G4SMA77, G4SMFA77, G50I77, G6SF77M, G6SF98M, G6SF98MG, G6SFA77, G6SFA8, G6SFA98, G6SFM8, G6SFMG8, GBM477, GBM777, GBMA477, GBMA777, GBR77, GBR177, GC408-SC, GC477, GC477-SC, GC498-SC, GC777, GC777-SC, GC777T-SC, GC9082V-SC, GC9982V-SC, GF077, GF477TS, GF777TS, GFT408L, GFT408LC...(Other models you can see in the webshop)		

miscellaneous


			
1			
GEV No.	nla ¹	Ref. No.	RTCU900056
description	piezoelectric igniter body metal connection F6.3x0.8 2 hole fixing ø 22mm		
For models:	CP100, CP100A, CP150, CP150A, CPI100, CPI100A, CPI150, CPI150A, JOKER FCG 10 AB 2002		


¹no longer available

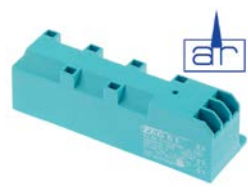
			
1			
GEV No.	nla ¹	Ref. No.	RTBF900002
description	piezoelectric igniter suitable for Minisit connection F6.3x0.8 ømm		
For models:	FG15, FG15+15, GF45, GF90		

¹no longer available

ignition units

			
1			
GEV No.	102485	Ref. No.	RTBF800129 RTCU700096
description	ignition unit outputs 2 220-240VAC 0.6VA 50-60Hz		
For models:	C4F702P, C4FV702P, C6F702P, C6FV702P, FCG10, FCG20, FCG6, FGC060, FGC100, FGC200, FGM060, FGM061, FGM100, FGM101, FGM200, FGM201, FGMD060, FGMD061, FGMD065, FGMD066, FGMD100, FGMD101, FGMD200, FGMD201, FGP050, FGP080, FGP160, FMM060, FMM061, FMM100, FMM101, G100I9N, G100IT9N, G150I9N, G150IT9N, G4SF6, G6SF6, G6SFA6, G6SFE6, G6SFEA6, GBR, GBR9T, GBRA, GBRA9T, GBRAVI, GBRAVI9T, GBRVC98T, GBRVI, GBRVI98T, GBRVI9T...(Other models you can see in the webshop)		

			
1			
GEV No.	102922	Ref. No.	RTCU600190
description	ignition unit outputs 4		
For models:	G4SF6, G4SFE6, MINIMA G4SF6, MINIMA G4SFE6		

			
1			
GEV No.	101024	Ref. No.	RTCU600191
description	ignition unit outputs 6 230VAC dimensions 112x22x34mm mounting distance 98mm inlet F6.3x0.8 outlet F2.8x0.8 type ZAG6 0.3VA 50/60Hz t.max. -20 up to +125°C		
For models:	G6SF6, G6SFA6, G6SFE6, G6SFEA6, MINIMA G6SF6, MINIMA G6SFA6, MINIMA G6SFE6, MINIMA G6SFEA6		



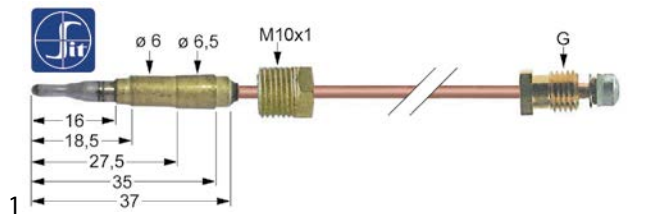
thermocouples

plug-in thermocouples

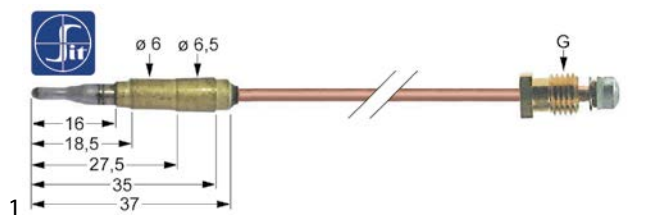
plug-in thermocouples standard

with barrel socket ø6mm

SIT



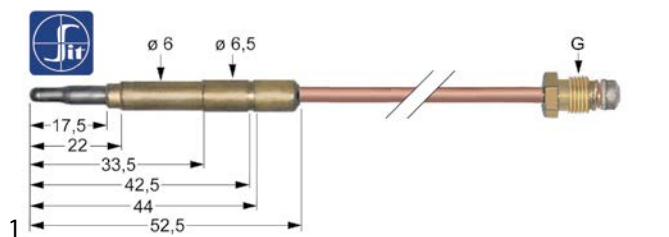
GEV No.	102944	Ref. No.	RTCU900475
description	thermocouple M9x1 L 1500mm M10x1		
For models:	BG6SF77M, G6SF2, G6SF29, G6SF77M, GC90, GT4SF27, MG7G6SF77M		



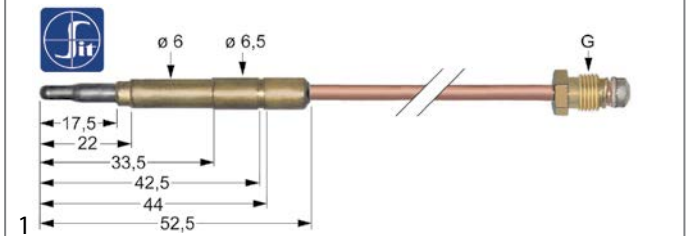
GEV No.	102923	Ref. No.	RTCU700296 RTCU900474
description	thermocouple M9x1 L 750mm plug connection ø6.0mm		
For models:	FP01V, G2SDM7, G2SDMF7, G2SDMFE7, G2SSM7, G2SSMF7, G2SSMFE7, G4SF, G4SF11, G4SF77P, G4SF9-2, G4SFP, G4SM7, G4SMFA7, G6SF77M, G6SFA, G6SFA9, G8SF2, G8SF2P, GBM45, GBM46, GBM47, GBM477, GBM49T, GBM66, GBM77, GBM777, GBM90, GBM99T, GBMA477, GBMA777, GBR6, GBR7, GBR77, GBR8, GBRI7, GBRI77, GBRVC98, GBRVI8, GBRVI98, GC408-SC, GC411-SC, GC45, GC47, GC477, GC477-SC, GC49, GC498-SC, GC49T, GC77...(Other models you can see in the webshop)		

with barrel socket ø6(6.5)mm

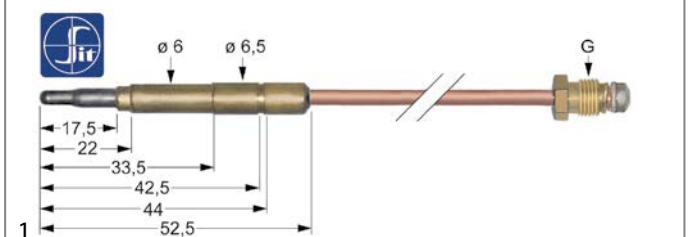
thermocouples SIT



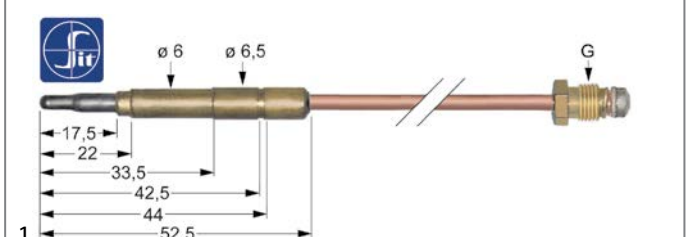
GEV No.	107613	Ref. No.	RTCU900061
description	thermocouple SIT M9x1 L 1200mm plug connection ø6.0(6.5)mm		
For models:	BST2LV, BST2RV, C4F70, C4FV70, G100, G100A, G100I, G100IA, G150, G150A, G150I, G150IA, G175, G2SDMF7, G2SSMF7, G4SF7, G4SF77, G4SF77P, G4SF8, G4SF98, G4SF98P, G4SMFA7, G4SMFA77, G507, G5077, G50I7, G50I77, G6SF7M, G6SF98M, G6SF98MG, G6SFA7, G6SFA77, G6SFA8, G6SFA98, G6SFM8, G6SFMG8, GF07, GFO7, GT2SDF8, GT2SDF7, GT2SDF77, GT2SSFA7, GT4SF27, GT4SF277, GT4SFA7, GTF7, GTF77, GTF8, GTF98, MG7G4SF77...(Other models you can see in the webshop)		



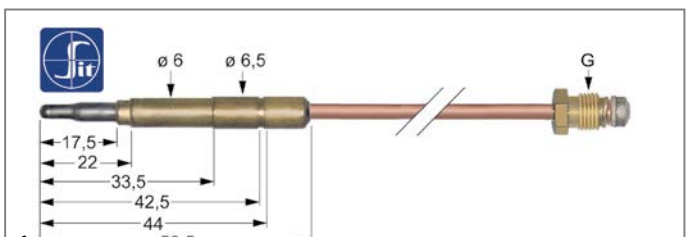
GEV No.	107614	Ref. No.	RTCU900024
description	thermocouple SIT M9x1 L 1500mm plug connection ø6.0(6.5)mm		
For models:	BST6LV, BST6RV, C4F702P, C4FV702P, C6F, C6F70, C6F702P, C6FV70, C6FV702P, G6SF2, GC90		



GEV No.	107606	Ref. No.	RTCU900021
description	thermocouple SIT M9x1 L 320mm plug connection ø6.0(6.5)mm		
For models:	C2A, C4A, C4AV70, C4F, C4F70, C62F, C6A, C6AV70, C6F, C6FA, C6FV70, C8A, C8F, G2SAP, G4SAP, G4SFP, G8SAP, G8SF2P, GBM45, TPFV70		



GEV No.	107608	Ref. No.	RTCU700148 RTCU900034 RTCU900477
description	thermocouple SIT M9x1 L 500mm plug connection ø6.0(6.5)mm		
For models:	BM4G70, BST2LV, BST2RV, BST6LV, BST6RV, C4A, C4F, C4FV702P, C62F, C6A, C6F, C6FA, C6FV702P, C8A, C8F, CP100, CP100A, CP150, CP150A, CP1100, CP1100A, CP1150, CP1150A, FT2GL70, FT2GR70, FT4GL70, FT4GLR70, FT4GR70, G1008, G10098, G100T98, G1508, G15098, G2S, G2SAP, G2SF6, G2SF6G, G2SP, G3S6, G3SF6, G3SF6G, G4S, G4SF, G4SFE, G4SFP, G6S, G6SF2, G6SFA, G6SFEA, G8S...(Other models you can see in the webshop)		



GEV No.	107609	Ref. No.	RIC0003190 RTCU900022
description	thermocouple SIT M9x1 L 600mm plug connection ø6.0(6.5)mm		
For models:	BST2LV, BST2RV, BST6LV, BST6RV, C4A, C4AV70, C4F, C4F70, C62F, C6A, C6AV70, C6F, C6FA, C6FV70, C8A, C8F, FT4GL, FT4GLR, FT4GR, G2S, G4S, G4SF, G4SFE, G6S, G6SF2, G6SFA, G6SFEA, G8S, G8SF2, G8SF2E, GPL45-P, GPL90, GPL90-P, GT2S, GT2SD, GT2SDF, GT2SDFE, GT2SFA, GT2SFEA, TPA, TPFV70		



GEV No.	107611	Ref. No.	RTCU900060
description	thermocouple SIT M9x1 L 850mm plug connection ø6.0(6.5)mm		
For models:	C4A, C4F, C62F, C6A, C6F, C6FA, C8A, C8F, G4SF, G4SFP, G6SFA, G8SF2, G8SF2P, GC45, GC902V, GF47, GF77, GT2SFA, GTF, TPF		

plug-in thermocouples with interruption

GEV No.	107863	Ref. No.	171855 RTCU700651
description	thermocouple SIT with interrupter M9x1 L 1000mm plug connection ø6.0(6.5)mm cable 820mm		
For models:	BGF777B, FG15M, FG20M, G100I8, G100I98, G150I8, G150I98, G150IT98, GF15+15S, GF15S, GF25+25S, GF25S, GF408, GF408N, GF411, GF46, GF47, GF477, GF477B, GF477S, GF477TS, GF47T, GF498B, GF66, GF77, GF777, GF777B, GF777S, GF777TS, GF77T, GF908, GF908N, GF911, GF99, GF998B, MG7GF477, MG7GF477TS, MG7GF777, MG7GF777TS, MINIMA GF 46, MINIMA GF 66, OMNIA GF 47, OMNIA GF 47T, OMNIA GF 77, OMNIA GF 77T		

GEV No.	102737	Ref. No.	175753
description	thermocouple SIT with interrupter M9x1 L 600mm plug connection ø6.0(6.5)mm F 6.3mm		
For models:	GBRVC98T, GBRVI98T, GF4772V, GF4772VB, MG7GF4772V		

GEV No.	102724	Ref. No.	176470
description	thermocouple with interrupter M9x1 L 750mm plug connection ø6.0(6.5)mm F 6.3mm		
For models:	FCG108, FCG68		

GEV No.	102094	Ref. No.	RTCU700652
description	thermocouple with interrupter M9x1 L 750mm plug connection ø6.0mm cable 280mm		
For models:	GBR9T, GBRA9T, GBRVI9T, GBRVI9T, GF45, GF472V, GF49, GF49T, GF90, GF90-1, GF99, GF99T, OMNIA GF472V		

threaded thermocouples

threaded thermocouples standard

with socket with thread M8x1



SIT

GEV No.	107633	Ref. No.	9606014100 RIC0002552
description	thermocouple SIT M8x1 L 1200mm M8x1		
For models:	G4SF6, G4SFA6, G6SF6, G6SFA6, MINIMA G4SF6, MINIMA G6SF6, MINIMA G6SFA6		
accessories for	107633		
	GEV No.	102067	Ref. No. 53.3.0098.00 9404701700
	nut thread M8x1 H 3mm brass Qty 1 pcs type SEF 1		




threaded thermocouples (miscellaneous)

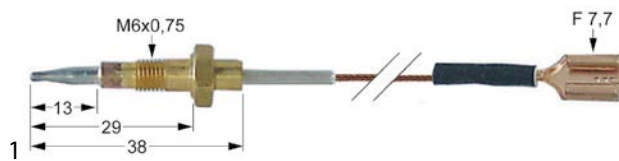


GEV No.	102138	Ref. No.	RTCU700373
description	thermocouple M9x1 L 300mm M6x0.75		
For models:	G2S, G2S7, G2S77, G2S9, G2SA77, G2SDM7, G2SDMF7, G2SDMFE7, G2SSM7, G2SSM77, G2SSMA77, G2SSMF7, G2SSMFE7, G4S, G4S7, G4S77, G4S77P, G4S9, G4S9-48, G4SA77, G4SA77P, G4SF, G4SF-1, G4SF7, G4SF77, G4SF77P, G4SF9, G4SF9-1, G4SF9-2, G4SFE, G4SFE7, G4SFE77, G4SFE77P, G4SFE9, G4SM7, G4SM77, G4SMA77, G4SM-FA7, G4SMFA77, G6S, G6S7, G6S77, G6S9, G6SA77, G6SF2, G6SF29, G6SF72P, G6SF77M, G6SF7M, G6SFA...(Other models you can see in the webshop)		
accessories for	102138		
	GEV No.	102143	Ref. No. RTCU700391
	thermocouple nut thread M6x0.75 H 12mm WS 8 brass Qty 1 pcs		
	GEV No.	102680	Ref. No. RTCU600052
	nut thread M6x0.75 H 2.6mm WS 8 brass Qty 1 pcs type SEF 2		



GEV No.	102139	Ref. No.	RTCU700374
description	thermocouple M9x1 L 500mm M6x0.75		
For models:	BG6SF77M, G100, G1009, G100A, G100I, G100I9, G100I9N, G100IT9, G100IT9N, G100T9, G150, G1509, G150A, G150I, G150I9, G150I9N, G150IT9, G150IT9N, G150T9, G2S, G2S7, G2S77, G2S77P, G2S8, G2S9, G2S928P, G2S98, G2SA11, G2SA77, G2SA77P, G2SA98, G2SA98P, G2SDM7, G2SDMF7, G2SDMFE7, G2SSM7, G2SSM77, G2SSMA77, G2SSMF7, G2SSMFE7, G4S, G4S7, G4S77, G4S77P, G4S8, G4S9, G4S9-48, G4S948P, G4S98, G4SA11...(Other models you can see in the webshop)		
accessories for	102139		
	GEV No.	102143	Ref. No. RTCU700391
	thermocouple nut thread M6x0.75 H 12mm WS 8 brass Qty 1 pcs		

threaded thermocouples with cable link



GEV No.	102243	Ref. No.	RTCU600021
description	thermocouple L 600mm		
For models:	G2S6, G4S6, G4SF6, G4SFE6, G6S6, G6SF6, G6SFA6, G6SFE6, G6SFEA6, MINIMA G2S6, MINIMA G4S6, MINIMA G4SF6, MINIMA G4SFE6, MINIMA G6S6, MINIMA G6SF6, MINIMA G6SFA6, MINIMA G6SFE6, MINIMA G6SFEA6		



GEV No.	102924	Ref. No.	RTCU600039
description	thermocouple with two-conductors L 750mm M6x0.75 F 7.7mm M4		
For models:	G2S6, G4S6, G4SF6, G4SFE6, G6S6, G6SF6, G6SFA6, G6SFE6, G6SFEA6, MINIMA G6SFE6		

extensions



GEV No.	102811	Ref. No.	RTCP800131
description	thermocouple extension thread M9x1 - M9x1 L 600mm		
For models:	G100, G1009, G100A, G100I, G100I8, G100I9, G100I98, G100IT9, G100T9, G150, G1509, G150A, G150I, G150I8, G150I9, G150I98, G150IT9, G150IT98, G150T9, G6SF98M, G6SF98MG, G6SFM8, G6SF-MG8		

accessories

nuts



GEV No.	102067	Ref. No.	53.3.0098.00 9404701700
description	nut thread M8x1 H 3mm brass Qty 1 pcs type SEF 1		
For models:	6PC61G, 6PC62G, G4SF6, G6SF6, G6SFA6, MINIMA G4SF6, MINIMA G4SFE6, MINIMA G6SF6, MINIMA G6SFA6, MINIMA G6SFE6, MINIMA G6SFEA6		




GEV No.	102143	Ref. No.	RTCU700391
description	thermocouple nut thread M6x0.75 H 12mm WS 8 brass Qty 1 pcs		
For models:	BG6SF77M, G100, G100A, G150, G150A, G2S, G2S77, G2S77P, G2S8, G2S9, G2S928P, G2S98, G2SA11, G2SA77, G2SA77P, G2SA98, G2SA98P, G2SDM7, G2SDMF7, G2SDMFE7, G2SSM7, G2SSM77, G2SSMA77, G2SSMF7, G2SSMFE7, G4S, G4S77, G4S77P, G4S8, G4S9, G4S9-48, G4S948P, G4S98, G4SA11, G4SA77, G4SA77P, G4SA98, G4SA98P, G4SF, G4SF-1, G4SF11, G4SF77, G4SF77P, G4SF8, G4SF9, G4SF9-1, G4SF9-2, G4SF98, G4SF98P, G4SFE...(Other models you can see in the webshop)		

SCREWS







GEV No.	101262	Ref. No.	RTCP900058
description	thermocouple fitting thread M10x1 Qty 1 pcs		
For models:	FG15M, FG20M, GF15+15S, GF15S, GF25+25S, GF25S, GF777, MG7GF777		








interrupters			
 <p>1</p>			
GEV No.	101265	Ref. No.	53.3.0116.00 RTCP800073
description	interrupter thread M9x1		
For models:	6FQ61G, 6FQ62G, G100, G100A, G100I, G100I9, G100IA, G100IT9, G150, G150A, G150I, G150I9, G150IA, G150IT9, G175, G4SF8, G4SF98, G4SF98P, G50I77, G6SFA8, G6SFA98, GBR8, GBRVC98, GBRV18, GBRV198, GF45, GF90, GT2SDF8, GTF8, GTF98		


gas burners




hob burners



universal hob burners			
GEV			
 <p>1</p>			
GEV No.	103068	Ref. No.	53.2.0012.00
description	burner cap ø 100mm		
For models:	6PC61G, 6PC62G		
accessories for	103068		
	GEV No.	103067	Ref. No. 53.2.0009.00
burner ring for burner cap ø 100mm			
	GEV No.	104102	Ref. No. 53.2.0006.00
burner head for burner cap ø 100mm ext. ø 130			
	GEV No.	104103	Ref. No. 53.2.0003.00
burner holder suitable for burner ø100mm with nozzle holder			

 <p>1</p>			
GEV No.	103066	Ref. No.	53.2.0011.00
description	burner cap ø 80mm		
For models:	6PC61G, 6PC62G		
accessories for	103066		
	GEV No.	103065	Ref. No. 53.2.0008.00
burner ring for burner cap ø 80mm			
	GEV No.	104100	Ref. No. 53.2.0005.00
burner head for burner cap ø 80mm			
	GEV No.	104101	Ref. No. 53.2.0002.00
burner holder for burner cap ø 80mm with nozzle holder with mixing sleeve			

 <p>1</p>			
GEV No.	104102	Ref. No.	53.2.0006.00
description	burner head for burner cap ø 100mm ext. ø 130		
For models:	6PC61G, 6PC62G		

 <p>1</p>			
GEV No.	104100	Ref. No.	53.2.0005.00
description	burner head for burner cap ø 80mm		
For models:	6PC61G, 6PC62G		
accessories for	104100		

	GEV No.	103065	Ref. No. 53.2.0008.00
burner ring for burner cap ø 80mm			
	GEV No.	103066	Ref. No. 53.2.0011.00
burner cap ø 80mm			
	GEV No.	104103	Ref. No. 53.2.0003.00
burner holder suitable for burner ø100mm with nozzle holder			

 <p>1</p>			
GEV No.	104101	Ref. No.	53.2.0002.00
description	burner holder for burner cap ø 80mm with nozzle holder with mixing sleeve		
For models:	6PC61G, 6PC62G		
accessories for	104101		
	GEV No.	103065	Ref. No. 53.2.0008.00
burner ring for burner cap ø 80mm			
	GEV No.	103066	Ref. No. 53.2.0011.00
burner cap ø 80mm			
	GEV No.	104100	Ref. No. 53.2.0005.00
burner head for burner cap ø 80mm			













 <p>1</p>			
GEV No.	104103	Ref. No.	53.2.0003.00
description	burner holder suitable for burner ø100mm with nozzle holder		
For models:	6PC61G, 6PC62G		
accessories for	104103		
	GEV No.	103067	Ref. No. 53.2.0009.00
burner ring for burner cap ø 100mm			
	GEV No.	103068	Ref. No. 53.2.0012.00
burner cap ø 100mm			

Table continues overleaf




accessories for	104103		
	GEV No.	104102	Ref. No. 53.2.0006.00
burner head for burner cap ø 100mm ext. ø 130			





	GEV No.	103067	Ref. No. 53.2.0009.00
description burner ring for burner cap ø 100mm			
For models: 6PC61G, 6PC62G			
accessories for	103067		
	GEV No.	103068	Ref. No. 53.2.0012.00
burner cap ø 100mm			
	GEV No.	104102	Ref. No. 53.2.0006.00
burner head for burner cap ø 100mm ext. ø 130			
	GEV No.	104103	Ref. No. 53.2.0003.00
burner holder suitable for burner ø100mm with nozzle holder			





	GEV No.	103065	Ref. No. 53.2.0008.00
description burner ring for burner cap ø 80mm			
For models: 6PC61G, 6PC62G			
accessories for	103065		
	GEV No.	103066	Ref. No. 53.2.0011.00
burner cap ø 80mm			
	GEV No.	104100	Ref. No. 53.2.0005.00
burner head for burner cap ø 80mm			
	GEV No.	104101	Ref. No. 53.2.0002.00
burner holder for burner cap ø 80mm with nozzle holder with mixing sleeve			

SABAF

2 series - standard

	GEV No.	105054	Ref. No. RTCU600044
description burner cap 3kW ø 100mm H 3.5mm bright finish			
For models: G2S6, G4S6, G4SF6, G4SFE6, G6S6, G6SF6, G6SFA6, G6SFE6, G6SFEA6, MINIMA G2S6, MINIMA G4S6, MINIMA G4SF6, MINIMA G4SFE6, MINIMA G6S6, MINIMA G6SF6, MINIMA G6SFA6, MINIMA G6SFE6, MINIMA G6SFEA6			
accessories for	105054		
	GEV No.	105058	Ref. No. RTCU600043
burner head 3kW for igniter ø 6mm for burner cap ø 100mm			
	GEV No.	105059	Ref. No. RTCU600017
burner lower part 3kW for igniter ø 6mm for thermocouple ø 6mm without nozzle for burner cap ø 100mm			

	GEV No.	105058	Ref. No. RTCU600043
description burner head 3kW for igniter ø 6mm for burner cap ø 100mm			
For models: G2S6, G4S6, G4SF6, G4SFE6, G6S6, G6SF6, G6SFA6, G6SFE6, G6SFEA6, MINIMA G2S6, MINIMA G4S6, MINIMA G4SF6, MINIMA G4SFE6, MINIMA G6S6, MINIMA G6SF6, MINIMA G6SFA6, MINIMA G6SFE6, MINIMA G6SFEA6			
accessories for	105058		
	GEV No.	105054	Ref. No. RTCU600044
burner cap 3kW ø 100mm H 3.5mm bright finish			
	GEV No.	105059	Ref. No. RTCU600017
burner lower part 3kW for igniter ø 6mm for thermocouple ø 6mm without nozzle for burner cap ø 100mm			
	GEV No.	107374	Ref. No. —
burner cap 3kW ø 100mm H 3.5mm matt finish			

	GEV No.	105059	Ref. No. RTCU600017
description burner lower part 3kW for igniter ø 6mm for thermocouple ø 6mm without nozzle for burner cap ø 100mm			
For models: G2S6, G4S6, G4SF6, G4SFE6, G6S6, G6SF6, G6SFA6, G6SFE6, G6SFEA6, MINIMA G2S6, MINIMA G4S6, MINIMA G4SF6, MINIMA G4SFE6, MINIMA G6S6, MINIMA G6SF6, MINIMA G6SFA6, MINIMA G6SFE6, MINIMA G6SFEA6			
accessories for	105059		
	GEV No.	105054	Ref. No. RTCU600044
burner cap 3kW ø 100mm H 3.5mm bright finish			
	GEV No.	105058	Ref. No. RTCU600043
burner head 3kW for igniter ø 6mm for burner cap ø 100mm			
	GEV No.	107374	Ref. No. —
burner cap 3kW ø 100mm H 3.5mm matt finish			

2 series - flat skirt version







	GEV No.	105054	Ref. No. RTCU600044
description burner cap 3kW ø 100mm H 3.5mm bright finish			
For models: G2S6, G4S6, G4SF6, G4SFE6, G6S6, G6SF6, G6SFA6, G6SFE6, G6SFEA6, MINIMA G2S6, MINIMA G4S6, MINIMA G4SF6, MINIMA G4SFE6, MINIMA G6S6, MINIMA G6SF6, MINIMA G6SFA6, MINIMA G6SFE6, MINIMA G6SFEA6			
accessories for	105054		
	GEV No.	105058	Ref. No. RTCU600043
burner head 3kW for igniter ø 6mm for burner cap ø 100mm			

Table continues overleaf




accessories for	105054		
	GEV No.	105059	Ref. No. RTCU600017
	burner lower part 3kW for igniter ø 6mm for thermocouple ø 6mm without nozzle for burner cap ø 100mm		



GEV No.	105059	Ref. No.	RTCU600017
description	burner lower part 3kW for igniter ø 6mm for thermocouple ø 6mm without nozzle for burner cap ø 100mm		
For models:	G2S6, G4S6, G4SF6, G4SFE6, G6S6, G6SF6, G6SFA6, G6SFE6, G6SFEA6, MINIMA G2S6, MINIMA G4S6, MINIMA G4SF6, MINIMA G4SFE6, MINIMA G6S6, MINIMA G6SF6, MINIMA G6SFA6, MINIMA G6SFE6, MINIMA G6SFEA6		
accessories for	105059		
	GEV No.	105054	Ref. No. RTCU600044
	burner cap 3kW ø 100mm H 3.5mm bright finish		
	GEV No.	105058	Ref. No. RTCU600043
	burner head 3kW for igniter ø 6mm for burner cap ø 100mm		
	GEV No.	107374	Ref. No. —
	burner cap 3kW ø 100mm H 3.5mm matt finish		




triple ring burner series - standard version



GEV No.	105063	Ref. No.	RTCU600040
description	burner cap 3.6kW ø 131mm H 4mm mounting pos. outer		
For models:	G2S6, G4S6, G4SF6, G4SFE6, G6S6, G6SF6, G6SFA6, G6SFE6, G6SFEA6, MINIMA G2S6, MINIMA G4S6, MINIMA G4SF6, MINIMA G4SFE6, MINIMA G6S6, MINIMA G6SF6, MINIMA G6SFA6, MINIMA G6SFE6, MINIMA G6SFEA6		
accessories for	105063		
	GEV No.	105064	Ref. No. RTCU600041
	burner cap 3.6kW ø 61mm H 6.5mm mounting pos. inner bright finish		
	GEV No.	105065	Ref. No. RTCU600042
	burner head 3.6kW for burner cap ø 61/131mm		
	GEV No.	105717	Ref. No. —
	burner lower part 3.6kW for igniter ø 6mm for thermocouple ø 6mm with nozzle ø 1.35mm ID ø 64mm for burner cap ø 61/131mm		
	GEV No.	105922	Ref. No. —
	burner lower part 3.6kW for igniter ø 6mm for thermocouple ø 6mm with nozzle ø 1.35mm ID ø 75mm for burner cap ø 61/131mm		

GEV No.	105064	Ref. No.	RTCU600041
description	burner cap 3.6kW ø 61mm H 6.5mm mounting pos. inner bright finish		
For models:	G2S6, G4S6, G4SF6, G4SFE6, G6S6, G6SF6, G6SFA6, G6SFE6, G6SFEA6, MINIMA G2S6, MINIMA G4S6, MINIMA G4SF6, MINIMA G4SFE6, MINIMA G6S6, MINIMA G6SF6, MINIMA G6SFA6, MINIMA G6SFE6, MINIMA G6SFEA6		
accessories for	105064		
	GEV No.	105063	Ref. No. RTCU600040
	burner cap 3.6kW ø 131mm H 4mm mounting pos. outer		
	GEV No.	105065	Ref. No. RTCU600042
	burner head 3.6kW for burner cap ø 61/131mm		
	GEV No.	105717	Ref. No. —
	burner lower part 3.6kW for igniter ø 6mm for thermocouple ø 6mm with nozzle ø 1.35mm ID ø 64mm for burner cap ø 61/131mm		
	GEV No.	105922	Ref. No. —
	burner lower part 3.6kW for igniter ø 6mm for thermocouple ø 6mm with nozzle ø 1.35mm ID ø 75mm for burner cap ø 61/131mm		



GEV No.	105065	Ref. No.	RTCU600042
description	burner head 3.6kW for burner cap ø 61/131mm		
For models:	G2S6, G4S6, G4SF6, G4SFE6, G6S6, G6SF6, G6SFA6, G6SFE6, G6SFEA6, MINIMA G2S6, MINIMA G4S6, MINIMA G4SF6, MINIMA G4SFE6, MINIMA G6S6, MINIMA G6SF6, MINIMA G6SFA6, MINIMA G6SFE6, MINIMA G6SFEA6		
accessories for	105065		
	GEV No.	105063	Ref. No. RTCU600040
	burner cap 3.6kW ø 131mm H 4mm mounting pos. outer		
	GEV No.	105064	Ref. No. RTCU600041
	burner cap 3.6kW ø 61mm H 6.5mm mounting pos. inner bright finish		
	GEV No.	105717	Ref. No. —
	burner lower part 3.6kW for igniter ø 6mm for thermocouple ø 6mm with nozzle ø 1.35mm ID ø 64mm for burner cap ø 61/131mm		








GEV No.	105123	Ref. No.	RTCU600018
description	burner lower part 3.6kW for igniter ø 7mm for thermocouple ø 6mm with nozzle ø 1.35mm ID ø 75mm for burner cap ø 61/131mm		
For models:	G2S6, G4S6, G4SF6, G4SFE6, G6S6, G6SF6, G6SFA6, G6SFE6, G6SFEA6, MINIMA G2S6, MINIMA G4S6, MINIMA G4SF6, MINIMA G4SFE6, MINIMA G6S6, MINIMA G6SF6, MINIMA G6SFA6, MINIMA G6SFE6, MINIMA G6SFEA6		
accessories for	105123		
	GEV No.	105124	Ref. No. —
	burner head 3.6kW for burner cap ø 61/131mm		





Table continues overleaf

accessories for 105123				
	GEV No.	105125	Ref. No.	—
burner cap 3.6kW ø 131mm H 7mm mounting pos. outer				
	GEV No.	105126	Ref. No.	—
burner cap 3.6kW ø 61mm H 9mm mounting pos. inner matt finish				

triple ring burner series - flat skirt version


				
1				
GEV No.	105063	Ref. No.	RTCU600040	
description	burner cap 3.6kW ø 131mm H 4mm mounting pos. outer			
For models:	G2S6, G4S6, G4SF6, G4SFE6, G6S6, G6SF6, G6SFA6, G6SFE6, G6SFEA6, MINIMA G2S6, MINIMA G4S6, MINIMA G4SF6, MINIMA G4SFE6, MINIMA G6S6, MINIMA G6SF6, MINIMA G6SFA6, MINIMA G6SFE6, MINIMA G6SFEA6			
accessories for 105063				
	GEV No.	105064	Ref. No.	RTCU600041
burner cap 3.6kW ø 61mm H 6.5mm mounting pos. inner bright finish				
	GEV No.	105065	Ref. No.	RTCU600042
burner head 3.6kW for burner cap ø 61/131mm				
	GEV No.	105717	Ref. No.	—
burner lower part 3.6kW for igniter ø 6mm for thermocouple ø 6mm with nozzle ø 1.35mm ID ø 64mm for burner cap ø 61/131mm				
	GEV No.	105922	Ref. No.	—
burner lower part 3.6kW for igniter ø 6mm for thermocouple ø 6mm with nozzle ø 1.35mm ID ø 75mm for burner cap ø 61/131mm				


				
1				
GEV No.	105064	Ref. No.	RTCU600041	
description	burner cap 3.6kW ø 61mm H 6.5mm mounting pos. inner bright finish			
For models:	G2S6, G4S6, G4SF6, G4SFE6, G6S6, G6SF6, G6SFA6, G6SFE6, G6SFEA6, MINIMA G2S6, MINIMA G4S6, MINIMA G4SF6, MINIMA G4SFE6, MINIMA G6S6, MINIMA G6SF6, MINIMA G6SFA6, MINIMA G6SFE6, MINIMA G6SFEA6			
accessories for 105064				
	GEV No.	105063	Ref. No.	RTCU600040
burner cap 3.6kW ø 131mm H 4mm mounting pos. outer				
	GEV No.	105065	Ref. No.	RTCU600042
burner head 3.6kW for burner cap ø 61/131mm				
	GEV No.	105717	Ref. No.	—
burner lower part 3.6kW for igniter ø 6mm for thermocouple ø 6mm with nozzle ø 1.35mm ID ø 64mm for burner cap ø 61/131mm				
	GEV No.	105922	Ref. No.	—
burner lower part 3.6kW for igniter ø 6mm for thermocouple ø 6mm with nozzle ø 1.35mm ID ø 75mm for burner cap ø 61/131mm				

				
1				
GEV No.	105123	Ref. No.	RTCU600018	
description	burner lower part 3.6kW for igniter ø 7mm for thermocouple ø 6mm with nozzle ø 1.35mm ID ø 75mm for burner cap ø 61/131mm			
For models:	G2S6, G4S6, G4SF6, G4SFE6, G6S6, G6SF6, G6SFA6, G6SFE6, G6SFEA6, MINIMA G2S6, MINIMA G4S6, MINIMA G4SF6, MINIMA G4SFE6, MINIMA G6S6, MINIMA G6SF6, MINIMA G6SFA6, MINIMA G6SFE6, MINIMA G6SFEA6			
accessories for 105123				
	GEV No.	105124	Ref. No.	—
burner head 3.6kW for burner cap ø 61/131mm				
	GEV No.	105125	Ref. No.	—
burner cap 3.6kW ø 131mm H 7mm mounting pos. outer				
	GEV No.	105126	Ref. No.	—
burner cap 3.6kW ø 61mm H 9mm mounting pos. inner matt finish				

accessories

reducers for pan supports

				
1				
GEV No.	210012	Ref. No.	RTCU800038	
description	reducer for pan support L 180mm W 180mm			
For models:	G2S, G2SAP, G2SP, G4S, G4SAP, G4SF, G4SFE, G4SFP, G6S, G6SF2, G6SFA, G6SFEA, G8S, G8SAP, G8SF2, G8SF2E, G8SF2P, GT2S, GT2SD			

				
1				
GEV No.	210050	Ref. No.	RTCU700028	
description	reducer for pan support L 260mm W 260mm chrome-plated steel suitable for universal			
For models:	BST2LV, BST2RV, BST6LV, BST6RV, C4A70, C4AV70, C4F70, C4F702P, C4FV70, C4FV702P, C6F70, C6F702P, C6FV70, C6FV702P, G2S, G2S7, G2S77, G2S9, G2SA11, G2SA77, G2SDM7, G2SDMF7, G2SDMFE7, G2SSM7, G2SSM77, G2SSMA77, G2SSMF7, G2SSMFE7, G3S6, G4S, G4S7, G4S77, G4S77P, G4S9, G4S9-48, G4SA11, G4SA77, G4SA77P, G4SF, G4SF-1, G4SF11, G4SF7, G4SF77, G4SF77P, G4SF9-2, G4SFE, G4SFE7, G4SFE77, G4SFE77P, G4SFE9...(Other models you can see in the webshop)			



pan supports



1

GEV No.	210113	Ref. No.	RTCU900044
description	pan support for 900		
For models:	C2A, C4A, C4F, C62F, C6A, C6F, C6FA, C8A, C8F		



1

GEV No.	210174	Ref. No.	A660024 RTCU600019
description	pan support W 285mm L 505mm		
For models:	G4S6, G4SF6, G4SFE6, G6S6, G6SF6, G6SFA6, G6SFE6, G6SFEA6, MINIMA G4S6, MINIMA G4SF6, MINIMA G4SFE6, MINIMA G6S6, MINIMA G6SF6, MINIMA G6SFA6, MINIMA G6SFE6, MINIMA G6SFEA6		



1

GEV No.	210175	Ref. No.	A770053 RTCU700274
description	pan support W 300mm L 335mm		
For models:	BG6SF77M, G2S7, G2S77, G2S77P, G2SA77, G2SA77P, G2SDM7, G2SDMF7, G2SDMFE7, G2SSM7, G2SSM77, G2SSMA77, G2SSMF7, G2SSMFE7, G4S7, G4S77, G4S77P, G4SA77, G4SA77P, G4SF7, G4SF77, G4SF77P, G4SFE7, G4SFE77, G4SFE77P, G4SFEV77, G4SM7, G4SM77, G4SMA77, G4SMFA7, G4SMFA77, G6S7, G6S77, G6SA77, G6SF72P, G6SF77M, G6SF7M, G6SFA7, G6SFA77, G6SFEA7, G6SFEA77, GT2SD7, GT2SD77, GT2SDFA7, GT2SDFA77, GT2SS7, GT2SSFA7, GT4S7, GT4S77, GT4SF27...(Other models you can see in the webshop)		




1

GEV No.	210242	Ref. No.	A660000350 A660023 RTCU600020
description	pan support W 340mm L 515mm		
For models:	G2S6, G6S6, G6SF6, G6SFA6, G6SFE6, G6SFEA6, MINIMA G2S6, MINIMA G6S6, MINIMA G6SF6, MINIMA G6SFA6, MINIMA G6SFE6, MINIMA G6SFEA6		



1

GEV No.	210177	Ref. No.	RTCU800002
description	pan support W 355mm L 445mm		
For models:	G2SAP, G4S, G4SAP, G4SF, G4SFE, G4SFP, G6S, G6SF2, G6SFA, G6SFEA, G8S, G8SAP, G8SF2, G8SF2E, G8SF2P, GT2S, GT2SD, GT2SDF, GT2SDFE, GT2SFA, GT2SFEA		
accessories for	210177		
	GEV No.	210012	Ref. No. RTCU800038
	reducer for pan support L 180mm W 180mm		



1

GEV No.	210246	Ref. No.	162954
description	pan support W 365mm L 415mm Domina/Magistra		
For models:	G2S, G4S, G4SF, G4SF-1, G4SFE, G6S, G6SF2, G6SFA, G6SFEA, G6SFM, GT2SDF		



1

GEV No.	210176	Ref. No.	160031 174189
description	pan support W 365mm L 415mm H 50mm		
For models:	G2S9, G2SA11, G4S77P, G4S9, G4S9-48, G4SA11, G4SA77P, G4SF11, G4SF77P, G4SF9, G4SF9-1, G4SF9-2, G4SFE9, G6S9, G6SF29, G6SFA9, G6SFEA9, GT2SD9, GT2SDFA9, GT2SS9		

simmering plates



1

GEV No.	109723	Ref. No.	A800011 RTCU800035
description	simmer plate L 365mm W 355mm		



air mixers



1

GEV No.	106067	Ref. No.	162717
description	air mixing tube dimensions 18x40mm		
For models:	G4SF, G6SF2, G6SF29, G6SFA, G6SFA9, G6SFM, GF09, GF09T, GFB09, GT2SDF, GT2SDFA9, GTF, GTF77, GTF9		



1

GEV No.	106066	Ref. No.	RTCU700584
description	air mixing tube dimensions 18x42mm ED 24mm		
For models:	BGF777B, FG15M, FG20M, G4SMFA77, GF15+15S, GF15S, GF25+25S, GF25S, GF408, GF408N, GF411, GF45, GF47, GF472V, GF477, GF4772V, GF4772VB, GF4772VS, GF477B, GF477S, GF49, GF498B, GF49T, GF77, GF777, GF777B, GF777S, GF90, GF90-1, GF908, GF908N, GF911, GF99, GF998B, GF99T, GFT1177L, GFT1177LC, GFT1177LR, GFT1177LRC, GFT1177R, GFT1177RC, GFT477L, GFT477LC, GFT477R, GFT477RC, GFT777L, GFT777LC, GFT777LR, GFT777LRC, GFT777R...(Other models you can see in the webshop)		



1

GEV No.	104078	Ref. No.	PACU700029
description	air mixing tube L 60mm ED 16.8mm ID 13.5mm		
For models:	BST2LV, BST2RV, BST6LV, BST6RV, C2A, C4A, C4A70, C4AV70, C4F, C4F70, C4F702P, C4FV70, C4FV702P, C62F, C6A, C6F, C6F702P, C6FA, C6FV702P, C8A, C8F, G2S, G2SAP, G2SP, G3S6, G4S, G4SAP, G4SF, G4SFE, G4SFP, G6S, G6SF2, G6SFA, G6SFEA, G8S, G8SAP, G8SF2, G8SF2E, G8SF2P, GT2S, GT2SD, GT2SDF, GT2SDFE, GT2SFA, GT2SFEA, TPF70, TPFV70		

accessories for 104078



GEV No.	103047	Ref. No.	GRCU700001 GRCU800001 RTCU700132
burner cap 70mm			



GEV No.	104072	Ref. No.	GRCU700018 GRCU700058 RTCU700124 RTCU70012Y
burner head for burner cap 70mm			



GEV No.	104075	Ref. No.	RTCU700006
burner holder for burner cap 70mm 2 x thread M5 Pos. n° 6			





1

GEV No.	104079	Ref. No.	RTCU700160
description	air mixing tube L 60mm ED 20.5mm ID 17.5mm		
For models:	C2A, C4A, C4A70, C4AV70, C4F, C4F70, C4F702P, C4FV70, C4FV702P, C62F, C6A, C6F, C6F702P, C6FA, C6FV702P, C8A, C8F, G2S, G2SAP, G2SP, G3S6, G4S, G4SAP, G4SF, G4SFE, G4SFP, G6S, G6SF2, G6SFA, G6SFEA, G8S, G8SAP, G8SF2, G8SF2E, G8SF2P, GT2S, GT2SD, GT2SDF, GT2SDFE, GT2SFA, GT2SFEA, TPF70, TPFV70		

accessories for 104079



GEV No.	103048	Ref. No.	GRCU700002 RTCU700013
burner cap 100mm with central hole			

accessories for	104079			
	GEV No.	104073	Ref. No.	GRCU700022 RTCU700010
burner head 125mm for burner cap 100mm H 110mm seat 28mm				
	GEV No.	104076	Ref. No.	RTCU700007
burner holder for burner cap 100mm seat 28.5mm thread M5 Pos. n° 7				



1

GEV No.	104080	Ref. No.	RTCU700199
description	air mixing tube L 60mm ED 24.5mm ID 21.5mm brass		
For models:	C4A, C4F, C62F, C6A, C6F, C6FA, C8A, C8F, G3S6, G4S, G4SAP, G4SF, G4SFE, G4SFP, G6S, G6SF2, G6SFA, G6SFEA, G8S, G8SAP, G8SF2, G8SF2E, G8SF2P		

accessories for 104080



GEV No.	103049	Ref. No.	GRCU700003
burner cap 125mm with central hole			



GEV No.	104074	Ref. No.	GRCU700023 RTCU700011
burner head 150mm for burner cap 125mm H 110mm seat 32mm			



GEV No.	104077	Ref. No.	RTCU700008
burner holder for burner cap 125mm H 114mm seat 32.6mm thread M5 Pos. n° 8			

bar burners

bar burners



1


GEV No.	105194	Ref. No.	RIC0002462
description	bar burner		
For models:	G4SF6, G4SFA6, G6SFA6, MINIMA G4SF6, MINIMA G6SF6, MINIMA G6SFA6		





1


GEV No.	104156	Ref. No.	RTCU700483
description	bar burner 2 row L 445mm W 200mm 0mm H 50mm chargrill stainless steel		
For models:	GPL47, GPL477, GPL47P, GPL77, GPL777, GPL77P, GPLA477, GPLA477G, GPLA777, MG7GPL477, MG7GPL777, MG7GPLA777, OMNIA GPL 47, OMNIA GPL 47P, OMNIA GPL 77, OMNIA GPL 77P		





			
1			
GEV No.	105211	Ref. No.	RTCU600070
description	bar burner 2 row L 470mm W 200mm ømm H 45mm chargrill		
For models:	GPL46P, GPL86P, MINIMA GPL 46, MINIMA GPL 46P, MINIMA GPL 86, MINIMA GPL 86P		


			
1			
GEV No.	105475	Ref. No.	RIC0002519
description	bar burner 2 row L 575mm W 225mm ømm H 45mm 11kW chargrill		
For models:	GPL45-P, GPL49-P, GPL90, GPL90-P, GPL99-P		


			
1			
GEV No.	105208	Ref. No.	RTCU700279 RTCU700744
description	bar burner 2 row L 488mm W 250mm ømm H 170mm griddle		
For models:	GFT1177L, GFT1177LC, GFT1177LR, GFT1177LRC, GFT1177R, GFT1177RC, GFT117L, GFT117LC, GFT117LR, GFT117LRC, GFT477L, GFT477LC, GFT477LR, GFT477LRC, GFT477R, GFT477RC, GFT47L, GFT47LC, GFT47R, GFT47RC, GFT777L, GFT777LC, GFT777LR, GFT777LRC, GFT777R, GFT777RC, GFT77L, GFT77LC, GFT77LR, GFT77LRC, GFT77R, GFT77RC, GFTA477L, GFTA477LC, GFTA477LR, GFTA477LRC, GFTA477R, GFTA477RC, GFTA777L, GFTA777LC, GFTA777LR, GFTA777LRC, GFTA777R, GFTA777RC, MG7GFT477L, MG7GFT477LC, MG7GFT477LR, MG7GFT477LRC, MG7GFT777L, MG7GFT777LC, MG7GFT777LR, MG7GFT777LRC, MG7GFTA477L, MG7GFTA477LC...(Other models you can see in the webshop)		


			
1			
GEV No.	105806	Ref. No.	160165
description	bar burner 3 row L 540mm W 290mm ømm griddle		
For models:	GFT408L, GFT408LC, GFT408R, GFT45L, GFT45LC, GFT45R, GFT45RC, GFT498L, GFT498LC, GFT498R, GFT49L, GFT49LC, GFT49R, GFT49RC, GFT908L, GFT908LC, GFT908LR, GFT908LRC, GFT908R, GFT908RC, GFT90L, GFT90LC, GFT90LR, GFT90LRC, GFT90R, GFT90RC, GFT998L, GFT998LC, GFT998LR, GFT998LRC, GFT998R, GFT99R, GFT99RC, GFT999L, GFT999LC, GFT999LR, GFT999LRC, GFT999R, GFT999RC, GFTA498L, GFTA498LC, GFTA498R, GFTA498RC, GFTA998L, GFTA998LC, GFTA998LR, GFTA998LRC, GFTA998R, GFTA998RC		


			
1			
GEV No.	104440	Ref. No.	162696
description	bar burner 2 row L 490mm W 330mm ømm H 40mm oven		
For models:	G4SF, G4SF-1, G4SF77, G4SF9, G4SF9-1, G4SF9-2, G6SF2, G6SF29, G6SFA, G6SFA9, GF09, GF09T, GFB09, GT2SDF, GT2SDF9, GTF, GTF9		

			
1			
GEV No.	105705	Ref. No.	RTCU700632
description	bar burner 6 row L 370mm W 560mm ømm H 50mm tilting bratt pan		
For models:	GBR7, GBR77, GBRI7, GBRI77, MG7GBR77, MG7GBRI77, OMNIA GBR7, OMNIA GBRI7		


			
1			
GEV No.	105210	Ref. No.	RTBF800031
description	bar burner 2 row L 530mm W 235mm ømm H 45mm griddle		
For models:	GFT45L, GFT45LC, GFT45R, GFT45RC, GFT90L, GFT90LC, GFT90LR, GFT90LRC, GFT90R, GFT90RC		


			
1			
GEV No.	105706	Ref. No.	RTBF900098 RTBF900098 laterale
description	bar burner 6 row L 518mm W 630mm ømm H 305mm tilting bratt pan		
For models:	GBR, GBR8, GBR9T, GBRA, GBRAVI, GBRVC98, GBRVI, GBRVI8, GBRVI98		


			
1			
GEV No.	105192	Ref. No.	RTCU700440
description	bar burner 2 row L 534mm W 220mm ømm H 175mm oven		
For models:	G2SDM7, G2SDMF7, G2SDMF7, G2SSM7, G2SSMF7, G2SSMF7, G2SSMFE7, G4SM7, G4SMFA7, OMNIA G4SMFA7		


			
1			
GEV No.	105295	Ref. No.	166220 185213
description	bar burner 7-row L 560mm W 690mm ømm H 40mm		
For models:	GBR9T, GBRA9T, GBRAVI9T, GBRVC98T, GBRVI98T, GBRVI9T		



			
1			
GEV No.	105219	Ref. No.	RTCU700320
description	bar burner ø 40mm Wmm Hmm L 192mm flange ø 61mm bain marie		
For models:	GBM46, GBM47, GBM477, GBMA477, MINIMA GBM 46, OMNIA GBM 47		


			
1			
GEV No.	105225	Ref. No.	160238
description	bar burner ø 40mm Wmm Hmm L 397mm flange ø 61mm bain marie GMB49T		
For models:	GBM90, GBM99T		

			
1			
GEV No.	104142	Ref. No.	53.1.0138.00
description	bar burner ø 40mm Wmm Hmm L 260mm flange width 42mm flange length 42mm bain marie		
For models:	6BM61G, 6BM62G		


			
1			
GEV No.	105207	Ref. No.	RTCU600003
description	bar burner ø 40mm Wmm Hmm L 405mm flange ø 61mm griddle		
For models:	GFT106L, GFT106LC, GFT106LR, GFT106LRC, GFT46L, GFT46LC, GFT46R, GFT46RC, GFT66L, GFT66LC, GFT66LR, GFT66LRC, GFT66R, GFT66RC, MINIMA GFT 46L, MINIMA GFT 46LC, MINIMA GFT 46R, MINIMA GFT 46RC, MINIMA GFT 66L, MINIMA GFT 66LC, MINIMA GFT 66LR, MINIMA GFT 66LRC, MINIMA GFT 66R, MINIMA GFT 66RC, MINIMA GFT106L, MINIMA GFT106LC, MINIMA GFT106LR, MINIMA GFT106LRC		

			
1			
GEV No.	104141	Ref. No.	53.1.0051.00
description	bar burner ø 40mm Wmm Hmm L 260mm flange width 42mm flange length 42mm griddle		
For models:	6FT61G, 6FT62G		


			
1			
GEV No.	105809	Ref. No.	GAFOC00108
description	bar burner ø 50mm Wmm Hmm L 275mm flange ø 75mm combi-steamer		
For models:	FGM060, FGM061, FGM100, FGM101, FGM107, FGM107SC, FGM108, FGM108EL, FGM109, FGM110, FGM110L, FGM610, FGM610L, FGM67, FGM67SC, FGM68, FGM68EL, FGM69, FGMD108, FGMD108EL, FGMD68, FGMD68EL, JOKER FGM 67 SC, JOKER FGM 69, JOKER FGM107 SC, JOKER FGM109		


			
1			
GEV No.	105220	Ref. No.	RTCU700321
description	bar burner ø 40mm Wmm Hmm L 310mm flange ø 61mm bain marie		
For models:	GBM66, GBM77, GBM777, GBMA777, MINIMA GBM 66, OMNIA GBM 77		


			
1			
GEV No.	105861	Ref. No.	RTFOC00211
description	bar burner ø 50mm Wmm Hmm L 280mm flange width 71mm flange ø 75mm convection oven		
For models:	FGM200, FGM201, FGM202, FGM207, FGM207SC, FGM209, FGM210, FGM210L, JOKER FGM207 SC, JOKER FGM209		

			
1			
GEV No.	105213	Ref. No.	RTCU600150
description	bar burner ø 40mm Wmm Hmm L 310mm flange ø 61mm frying pan		
For models:	GBR6, MINIMA GBR 6		




			
1			
GEV No.	105215	Ref. No.	RTBF800048
description	bar burner ø 50mm Wmm Hmm L 370mm flange width 71mm flange ø 75mm pasta cooker		
For models:	GC45, GC47, GC477, GC477-SC, GC902V, MG7GC477-SC, OMNIA GC 47		

			
1			
GEV No.	105206	Ref. No.	RTCU800039
description	bar burner ø 50mm Wmm Hmm L 537mm flange width 71mm flange ø 75mm oven		
For models:	G4SF, G6SF2, G6SFA, G8SF2, GT2SDF, GT2SFA, GTF		

			
1			
GEV No.	105998	Ref. No.	RTCU800087
description	bar burner ø 50mm Wmm Hmm L 440mm		
For models:	G4SFP, G8SF2P		

			
1			
GEV No.	105808	Ref. No.	GAFOC00073
description	bar burner ø 50mm Wmm Hmm L 560mm flange width 71mm flange ø 75mm convection oven		
For models:	FCG10, FCG108, FGC100, FGM100, FGM101, FGM102, FGM107, FGM-107SC, FGM108, FGM108EL, FGM109, FGM110, FGM110L, FGMD100, FGMD101, FGMD107, FGMD107SC, FGMD108, FGMD108EL, FGMD109, FGP080, FMM100, FMM101, JOKER FCG 10, JOKER FCG 10 AB 2002, JOKER FGM107 SC, JOKER FGM109, JOKER FGMD107 SC, JOKER FGMD109, JOKER FGP080, JOKER FGP080 AB 2002		


			
1			
GEV No.	105216	Ref. No.	RTCU700285
description	bar burner ø 50mm Wmm Hmm L 470mm flange width 71mm flange ø 75mm 1-row pasta cooker		
For models:	GC408-SC, GC411-SC, GC45, GC49, GC498-SC, GC49T, GC77, GC777, GC777-SC, GC777T, GC777T-SC, GC902V, GC9082V-SC, GC911-SC, GC992V, GC992VT, GC9982V-SC, MG7GC777-SC, OMNIA GC 77		


			
1			
GEV No.	105860	Ref. No.	RTFOC00332
description	bar burner ø 50mm Wmm Hmm L 790mm (bulb, gasket, glas) combi-steamer		
For models:	FCG20, FEM210, FEM210L, FGC200, FGM200, FGM201, FGM202, FGM207, FGM207SC, FGM209, FGM210, FGM210L, FGMD200, FGMD201, FGMD207, FGMD207SC, FGMD209, FGP160, JOKER FGM207 SC, JOKER FGM209, JOKER FGMD207 SC, JOKER FGMD209, JOKER FGP160		


			
1			
GEV No.	105807	Ref. No.	GAFOC00064
description	bar burner ø 50mm Wmm Hmm L 520mm flange width 71mm flange ø 75mm (bulb, gasket, glas) combi-steamer		
For models:	FCG6, FCG68, FGC060, FGC065, FGM060, FGM061, FGM062, FGM610, FGM610L, FGM67, FGM67SC, FGM68, FGM68EL, FGM69, FGMD060, FGMD061, FGMD065, FGMD066, FGMD67, FGMD67SC, FGMD68, FGM68EL, FGMD69, FGP050, FMM060, FMM061, JOKER FCG 6, JOKER FCG 6 AB 2002, JOKER FGM 67 SC, JOKER FGM 69, JOKER FGMD 67 SC, JOKER FGMD 69, JOKER FGP050, JOKER FGP050 AB 2002		

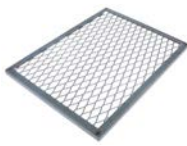
			
1			
GEV No.	105810	Ref. No.	RTCU800334
description	bar burner ø 60mm Wmm Hmm L 154mm kettle		
For models:	G100, G100A, G150, G150A		





			
1			
GEV No.	104199	Ref. No.	RTCU800335
description	bar burner ø 60mm Wmm Hmm L 240mm mounting pos. centre		
For models:	G100, G1008, G1009, G10098, G100A, G100I, G100I8, G100I9, G100I98, G100I9N, G100IT9, G100IT9N, G100T9, G100T98, G150, G1508, G1509, G15098, G150A, G150I, G150I8, G150I9, G150I98, G150I9N, G150IT9, G150IT98, G150IT9N, G150T9		


			
1			
GEV No.	104455	Ref. No.	167224
description	bar burner U-shape L 600mm W 220mm ø 25mm Hmm		
For models:	G4SF77, G4SF77P, G4SF8, G4SF98, G4SF98P, G4SMFA77, G6SFA77, G6SFA8, G6SFA98, GF077, GT2SDF8, GT2SDF77, GT4SF277, GT4S-F2E77, GTF77, GTF8, GTF98, MG7G4SF77, MG7G4SF77P, MG7G4SMFA77, MG7GTF77		


			
1			
GEV No.	105195	Ref. No.	RTCU700377
description	bar burner U-shape L 610mm W 230mm ø 25mm Hmm oven		
For models:	G2SDMF7, G2SSMF7, G4SF7, G4SMFA7, G6SFA7, GF07, GFO7, GT2S-DFA7, GT2SSFA7, GT4SF27, GT4SFA7, GTF7, OMNIA G4SF7, OMNIA G4SMFA7, OMNIA G6SFA7, OMNIA GFO7, OMNIA GT2SDF7, OMNIA GT4SF27, OMNIA GTF7		


			
1			
GEV No.	104442	Ref. No.	RIC0002516
description	chargrill grid		
For models:	GPL90, GPL99-P		

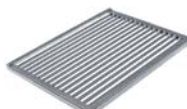
			
1			
GEV No.	210243	Ref. No.	RTCU600466
description	chargrill grid L 440mm W 355mm fish		
For models:	GPL46P, GPL86P, MINIMA GPL 46, MINIMA GPL 46P, MINIMA GPL 86, MINIMA GPL 86P		

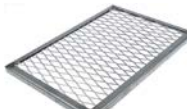
			
1			
GEV No.	210239	Ref. No.	A660000330 A660021
description	chargrill grid L 460mm W 350mm meat		
For models:	GPL46P, GPL86P, MINIMA GPL 46, MINIMA GPL 46P, MINIMA GPL 86, MINIMA GPL 86P		

			
1			
GEV No.	210241	Ref. No.	A800001211
description	chargrill grid L 585mm W 415mm fish		
For models:	GPL45-P, GPL49-P, GPL99-P		


			
1			
GEV No.	210240	Ref. No.	A800001221
description	chargrill grid L 610mm W 405mm meat		
For models:	GPL45-P, GPL49-P, GPL99-P		

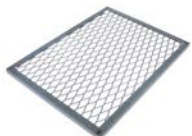
			
1			
GEV No.	211022	Ref. No.	GACU600061
description	lava rock grid L 418mm W 318mm		
For models:	GPL46P, MINIMA GPL 46, MINIMA GPL 46P		


			
1			
GEV No.	211058	Ref. No.	184028
description	lava rock grid L 418mm W 318mm		


			
1			
GEV No.	211023	Ref. No.	182779 GACU700256
description	lava rock grid L 467mm W 319mm		
For models:	GPL47, GPL477, GPL47P, GPL77, GPL777, GPL77P, GPLA477, GPLA477G, GPLA777, MG7GPL477, MG7GPL777, MG7GPLA777, OMNIA GPL 47, OMNIA GPL 47P, OMNIA GPL 77, OMNIA GPL 77P		





			
1			
GEV No.	104439	Ref. No.	RIC0002637
description	lava rock grid L 540mm W 340mm H 20mm		
For models:	GPL45, GPL45-P, GPL49-P, GPL90-P		

chargrill grids			
			
1			
GEV No.	104442	Ref. No.	RIC0002516
description	chargrill grid		
For models:	GPL90, GPL99-P		

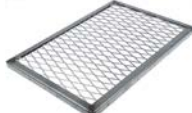
			
1			
GEV No.	210243	Ref. No.	RTCU600466
description	chargrill grid L 440mm W 355mm fish		
For models:	GPL46P, GPL86P, MINIMA GPL 46, MINIMA GPL 46P, MINIMA GPL 86, MINIMA GPL 86P		


			
1			
GEV No.	210239	Ref. No.	A660000330 A660021
description	chargrill grid L 460mm W 350mm meat		
For models:	GPL46P, GPL86P, MINIMA GPL 46, MINIMA GPL 46P, MINIMA GPL 86, MINIMA GPL 86P		

			
1			
GEV No.	210241	Ref. No.	A800001211
description	chargrill grid L 585mm W 415mm fish		
For models:	GPL45-P, GPL49-P, GPL99-P		


			
1			
GEV No.	210240	Ref. No.	A800001221
description	chargrill grid L 610mm W 405mm meat		
For models:	GPL45-P, GPL49-P, GPL99-P		


lava rock grids			
			
1			
GEV No.	211022	Ref. No.	GACU600061
description	lava rock grid L 418mm W 318mm		
For models:	GPL46P, MINIMA GPL 46, MINIMA GPL 46P		

			
1			
GEV No.	211023	Ref. No.	182779 GACU700256
description	lava rock grid L 467mm W 319mm		
For models:	GPL47, GPL477, GPL47P, GPL77, GPL777, GPL77P, GPLA477, GPLA477G, GPLA777, MG7GPL477, MG7GPL777, MG7GPLA777, OMNIA GPL 47, OMNIA GPL 47P, OMNIA GPL 77, OMNIA GPL 77P		

			
1			
GEV No.	104439	Ref. No.	RIC0002637
description	lava rock grid L 540mm W 340mm H 20mm		
For models:	GPL45, GPL45-P, GPL49-P, GPL90-P		

tube burners


			
1			
GEV No.	105227	Ref. No.	RTCU700575
description	tubular burner		
For models:	GF47, GF472V, GF49T, GF77, OMNIA GF 47, OMNIA GF 77, OMNIA GF472V		

			
1			
GEV No.	104436	Ref. No.	161819 161820
description	tubular burner L 280mm W 59mm H 53mm for fryer oval		
For models:	BGF777B, FG15M, FG20M, GF15+15S, GF15S, GF25+25S, GF25S, GF408, GF408N, GF411, GF45, GF477, GF4772V, GF4772VB, GF4772VS, GF477B, GF477S, GF49, GF498B, GF49T, GF777, GF777B, GF777S, GF90, GF90-1, GF908, GF908N, GF911, GF99, GF998B, GF99T, MG7GF477, MG7GF4772V, MG7GF777		




1

GEV No.	105859	Ref. No.	RTCU800106
description	tubular burner L 295mm W 55mm H 70mm mounting pos. centre for fryer oval		
For models:	GF45, GF90		



1

GEV No.	105229	Ref. No.	RTBF800216
description	tubular burner L 295mm W 55mm H 70mm mounting pos. left for fryer oval		
For models:	FG15, FG15+15, GF45, GF90		




1

GEV No.	105228	Ref. No.	RTBF800217
description	tubular burner L 295mm W 55mm H 70mm mounting pos. right for fryer oval		
For models:	GF45, GF90		



1

GEV No.	104140	Ref. No.	53.1.0064.00
description	tubular burner \varnothing 74mm L 165mm H 60mm round for fryer/pasta cooker		
For models:	6FQ61G, 6FQ62G		



1

GEV No.	105214	Ref. No.	RTCU700465
description	tubular burner \varnothing 74mm L 185mm H 60mm round for pasta cooker		
For models:	GC66, GF46, GF477TS, GF47T, GF66, GF777TS, GF77T, GF99, MG7G-F477TS, MG7GF777TS, MINIMA GC 66, MINIMA GF 46, MINIMA GF 66, OMNIA GF 47T, OMNIA GF 77T		

solid top burners



1

GEV No.	105812	Ref. No.	GACU700263
description	solid top burner \varnothing 120mm H 77mm L 340mm		
For models:	G507, G50I77, OMNIA G507		



1

GEV No.	105189	Ref. No.	GACU700131
description	solid top burner \varnothing 65mm H 102mm L 284mm		
For models:	GT2SD7, GT2SD77, GT2SDFA7, GT2SDFA77, GT2SS7, GT2SSFA7, GT4S7, GT4S77, GT4SF27, GT4SF277, GT4SF2E7, GT4SF2E77, GT4SFA7, GT7, GT77, GTA77, GTF7, GTF77, GTS7, MG7GT77, MG7GTA77, MG7GTF77, OMNIA GT2SD7, OMNIA GT2SDFA7, OMNIA GT4S7, OMNIA GT4SF27, OMNIA GT7, OMNIA GTF7, WGTF7		




accessories

nozzle holders



1

GEV No.	105184	Ref. No.	173320 RTCU700325
description	nozzle holder		
For models:	BG6SF77M, G2S7, G2S77, G2S77P, G2S8, G2S928P, G2S98, G2SA77, G2SA77P, G2SA98, G2SA98P, G2SDM7, G2SDMF7, G2SDMFE7, G2SSM7, G2SSM77, G2SSMA77, G2SSMF7, G2SSMFE7, G4S7, G4S77, G4S77P, G4S8, G4S948P, G4S98, G4SA77, G4SA77P, G4SA98, G4SA98P, G4SF7, G4SF77, G4SF77P, G4SF8, G4SF98, G4SF98P, G4SFE7, G4SFE77, G4SFE8, G4SFE98, G4SFEV77, G4SM7, G4SM77, G4SMA77, G4SMFA7, G4SMFA77, G6S7, G6S77, G6S8, G6S98, G6SA77...(Other models you can see in the webshop)		




2

GEV No.	105185	Ref. No.	160324
description	nozzle holder		
For models:	G2S, G2S77, G2S9, G2SA11, G2SA77, G4S, G4S77P, G4S9, G4S9-48, G4SA11, G4SA77P, G4SF, G4SF-1, G4SF11, G4SF77, G4SF77P, G4SF9, G4SF9-1, G4SF9-2, G4SFE, G4SFE9, G6S, G6S77, G6S9, G6SA77, G6SF2, G6SF29, G6SF77M, G6SFA, G6SFA9, G6SFEA, G6SFEA77, G6SFEA9, G6SFM, GT2SD9, GT2SDF, GT2SDFA9, GT2SS9, GTF911		




1

GEV No.	105566	Ref. No.	162697
description	nozzle holder		
For models:	G4SF, G4SF-1, G4SF77, G4SF77P, G4SF8, G4SF9, G4SF9-1, G4SF9-2, G4SF98, G4SF98P, G4SMFA77, G6SF2, G6SF29, G6SF98M, G6SF98MG, G6SFA, G6SFA77, G6SFA8, G6SFA9, G6SFA98, G6SFM, G6SFM8, G6SFMG8, GBM477, GBM777, GBMA477, GBMA777, GF077, GF09, GF09T, GFB09, GT2SDF, GT2SDF8, GT2SDF77, GT2SDF77P, GT2SDF77P, GTF, GTF77, GTF8, GTF9, GTF98, MG7G4SF77, MG7G4SF77P, MG7G4SMFA77, MG7GTF77		
accessories for	105566		
	GEV No.	101278	Ref. No. RTCU900012
	olive for pipe ø 10mm Qty 1 pcs		
	GEV No.	101478	Ref. No. RTCU900013
	union nut thread 3/8" for pipe ø 10mm		
	GEV No.	105567	Ref. No. RTCU900005 RTCU900203
	nut thread M16x1 H 4.5mm WS 19 zinc-coated steel Qty 1 pcs		



1

GEV No.	106064	Ref. No.	RTCU800180
description	nozzle holder		
For models:	FP01V, GBR7, GBR77, GBRI7, GBRI77, GC411-SC, GC45, GC47, GC49, GC49T, GC77, GC777, GC777T, GC902V, GC911-SC, GC992V, GC992VT, GT, GT2SD9, GT2SDF, GT2SDFA9, GT2SS9, GT99, GTF, GTF77, GTF9, GTFE, MG7GBR77, MG7GBRI77		



1


GEV No.	106065	Ref. No.	RTCU900006 RTCU900337
description	nozzle holder		
For models:	BM4G70, BST2LV, BST2RV, BST6LV, BST6RV, C2A, C4A70, C4AV70, C4F, C4F70, C4F702P, C4FV70, C4FV702P, C62F, C6A, C6A70, C6AV70, C6F, C6F70, C6F702P, C6FA, C6FV70, C6FV702P, C8A, C8F, FT4GL, FT4GLR, FT4GR, G2S, G2SAP, G2SDM7, G2SDMF7, G2SDMFE7, G2SF6, G2SF6G, G2SP, G2SSM7, G2SSMF7, G2SSMFE7, G3SF6, G3SF6G, G4S, G4SAP, G4SF, G4SF7, G4SFE, G4SFP, G4SM7, G4SMFA7, G6S...(Other models you can see in the webshop)		



1

GEV No.	107142	Ref. No.	179326
description	nozzle holder L 60mm ET M16x1 IT M10x1 tube ø 10mm		

miscellaneous



1

GEV No.	102736	Ref. No.	RTCU700128
description	nut for air mixers		
For models:	BST2LV, BST2RV, BST6LV, BST6RV, C2A, C4A, C4A70, C4AV70, C4F, C4F70, C4F702P, C4FV70, C4FV702P, C62F, C6A, C6A70, C6AV70, C6F, C6F70, C6F702P, C6FA, C6FV70, C6FV702P, C8A, C8F, G2S, G3S6, G4S, G4SAP, G4SF, G4SFE, G4SFP, G6S, G6SF2, G6SFA, G6SFEA, G8S, G8SAP, G8SF2, G8SF2E, G8SF2P, GT2S, GT2SD, GT2SDF, GT2SDFE, GT2SFA, GT2SFEA		



gas nozzles

main nozzles

gas nozzles 1/4"



1

GEV No.	106645	Ref. No.	RTFOC00278
description	gas injector thread 1/4" WS 17 bore ø 2.7mm L 16mm		
For models:	FCG6, FGC065, FGM062, FGM107SC, FGM109, FGM200, FGM201, FGM202, FGM67SC, FGM69, FGMD065, FGMD066, FGMD67, FGMD-67SC, FGMD69, FGP050		



1

GEV No.	106794	Ref. No.	RTCP800168
description	gas injector thread 1/4" WS 17 bore ø 3.2mm L 16mm		
For models:	FGM102, FGM107SC, FGM109, FGMD107SC, FGMD109, FGP080		

gas nozzles M6x0.75



1

GEV No.	106731	Ref. No.	RTCU600093
description	gas injector thread M6x0.75 WS 7 bore ø 0.73mm		



1

GEV No.	106732	Ref. No.	RTCU600102
description	gas injector thread M6x0.75 WS 7 bore ø 0.74mm		

gas nozzles M7x1



1

GEV No.	102549	Ref. No.	53.3.0490.00
description	gas injector thread M7x1 WS 10 bore ø 0.72mm		
For models:	6PC61G, 6PC62G		



1

GEV No.	102554	Ref. No.	53.3.0321.00
description	gas injector thread M7x1 WS 10 bore ø 0.82mm		
For models:	6PC61G, 6PC62G		



1

GEV No.	100518	Ref. No.	SN53301220
description	gas injector thread M7x1 WS 10 bore ø 0.85mm		



1

GEV No.	100520	Ref. No.	53.3.0491.00 RIC0003668
description	gas injector thread M7x1 WS 10 bore ø 1.2mm		
For models:	6PC61G, 6PC62G		



1

GEV No.	100522	Ref. No.	53.3.0324.00
description	gas injector thread M7x1 WS 10 bore ø 1.35mm		
For models:	6PC61G, 6PC62G		



1


GEV No.	103322	Ref. No.	53.3.0323.00
description	gas injector thread M7x1 WS 10 bore ø 1.42mm		
For models:	6PC61G, 6PC62G		





1


GEV No.	100523	Ref. No.	RIC0003669
description	gas injector thread M7x1 WS 10 bore ø 1.4mm		





 <p>1</p>			
GEV No.	100525	Ref. No.	53.3.0125.00
description	gas injector thread M7x1 WS 10 bore ø 1.6mm		
For models:	6PC61G, 6PC62G		


 <p>1</p>			
GEV No.	100474	Ref. No.	53.3.0149.00
description	gas injector thread M10x1 WS 12 bore ø 1.5mm		
For models:	6FQ61G, 6FQ62G		


gas nozzles M10x0.75			
 <p>1</p>			
GEV No.	106796	Ref. No.	611026 RTCU600341
description	gas injector thread M10x0.75 WS 10 bore ø 1.75mm		


 <p>1</p>			
GEV No.	102291	Ref. No.	RTCU700386
description	gas injector thread M10x1 WS 12 bore ø 0.85mm		


gas nozzles M10x1			
 <p>1</p>			
GEV No.	103323	Ref. No.	53.3.0311.00
description	gas injector thread M10x1 WS 11 bore ø 0.6mm inner peaked		
For models:	6BM61G		


 <p>1</p>			
GEV No.	100400	Ref. No.	03579 Fryland RTCU900244
description	gas injector thread M10x1 WS 12 bore ø 0.8mm		
For models:	G2S, G2SP, G4S, G4SAP, G4SF, G4SFE, G4SFP, G6S, G6SF2, G6SFA, G6SFEA, G8SAP, G8SF2, G8SF2E, G8SF2P, GBM47, GT2S, GT2SD, GT2SDF, GT2SDFE, GT2SFA, GT2SFEA		


 <p>1</p>			
GEV No.	100661	Ref. No.	290201850-R
description	gas injector thread M10x1 WS 12 bore ø 1.65mm		

 <p>1</p>			
GEV No.	100807	Ref. No.	RTCU900045
description	gas injector thread M10x1 WS 12 bore ø 0.95mm		
For models:	G2S7, G2S9, G2SDM7, G2SDMF7, G2SDMFE7, G2SSM7, G2SSMF7, G2SSMFE7, G4S7, G4S9, G4SF7, G4SFE7, G4SM7, G4SMFA7, G6S7, G6SFA7, G6SFEA7, GF47T, GT2SD7, GT2SDFA7, GT2SS7, GT2SSFA7, GT4S7, GT4SF27, GT4SF2E7		


 <p>1</p>			
GEV No.	100444	Ref. No.	53.3.0151.00
description	gas injector thread M10x1 WS 12 bore ø 0.8mm		
For models:	6FQ61G, 6FQ62G		


 <p>1</p>			
GEV No.	100623	Ref. No.	RTCU700032
description	gas injector thread M10x1 WS 12 bore ø 0.9mm		
For models:	BST2LV, BST2RV, BST6LV, BST6RV, C2A, C4A, C4A70, C4AV70, C4F, C4F70, C4F702P, C4FV70, C4FV702P, C62F, C6A, C6A70, C6AV70, C6F, C6F70, C6F702P, C6FA, C6FV70, C6FV702P, C8A, C8F, G2S, G2SAP, G2SP, G4S, G4SAP, G4SF, G4SFE, G4SFP, G6S, G6SF2, G6SFA, G6SFEA, G8S, G8SAP, G8SF2, G8SF2E, G8SF2P, GBM45, GT2S, GT2SD, GT2SDF, GT2SDFE, GT2SFA, GT2SFEA, SAG...(Other models you can see in the webshop)		


 <p>1</p>			
GEV No.	100471	Ref. No.	53.3.0148.00
description	gas injector thread M10x1 WS 12 bore ø 1.35mm		
For models:	6FQ61G, 6FQ62G		


			
GEV No.	100402	Ref. No.	RTCU700337 RTCU900245
description	gas injector thread M10x1 WS 12 bore ø 1.05mm		
For models:	GBM45, GBM77, OMNIA GFT 47L		


			
GEV No.	100625	Ref. No.	RTCU700468 RTCU900246
description	gas injector thread M10x1 WS 12 bore ø 1.15mm		
For models:	BST2LV, BST2RV, BST6LV, BST6RV, C2A, C4A70, C4AV70, C4F70, C4F702P, C4FV70, C4FV702P, C62F, C6A, C6A70, C6AV70, C6F, C6F70, C6F702P, C6FA, C6FV70, C6FV702P, C8A, C8F, G2S, G2S7, G2SAP, G2SDM7, G2SDMF7, G2SDMFE7, G2SP, G2SSM7, G2SSMF7, G2SSMFE7, G4S, G4S7, G4SAP, G4SF, G4SF7, G4SFE, G4SFE7, G4SFP, G4SM7, G4SMFA7, G6S, G6S7, G6SF2, G6SFA, G6SFA7, G6SFEA, G6SFEA7...(Other models you can see in the webshop)		


			
GEV No.	102684	Ref. No.	RTCU700033
description	gas injector thread M10x1 WS 12 bore ø 1.1mm		
For models:	BM4G70, GF47, GF472V, GF77		


			
GEV No.	102978	Ref. No.	RTCU900037
description	gas injector thread M10x1 WS 12 bore ø 1.25mm		
For models:	BST2LV, BST2RV, BST6LV, BST6RV, FT2GL70, FT2GR70, FT4GL70, FT4GLR70, FT4GR70, GBM90		


			
GEV No.	100404	Ref. No.	RTCU700035
description	gas injector thread M10x1 WS 12 bore ø 1.35mm		
For models:	BST2LV, BST2RV, BST6LV, BST6RV, C2A, C4A, C4A70, C4AV70, C4F, C4F70, C4F702P, C4FV70, C4FV702P, C62F, C6A, C6A70, C6AV70, C6F, C6F70, C6F702P, C6FA, C6FV70, C6FV702P, C8A, C8F, G2S, G2SAP, G2SP, G4S, G4SAP, G4SF, G4SFE, G4SFP, G6S, G6S9, G6SF2, G6SFA, G6SFEA, G8S, G8SAP, G8SF2, G8SF2E, G8SF2P, GPL47, GPL47P, GPL77, GPL77P, GT2S, GT2SD, GT2SDF...(Other models you can see in the webshop)		

			
GEV No.	100401	Ref. No.	RTCU700034
description	gas injector thread M10x1 WS 12 bore ø 1.3mm		
For models:	BST2LV, BST2RV, BST6LV, BST6RV, C4A70, C4AV70, C4F70, C4F702P, C4FV70, C4FV702P, C6F70, C6F702P, C6FV70, C6FV702P, G4S, G4SAP, G4SF, G4SFE, G4SFP, G6S, G6SF2, G6SFA, G6SFEA, G8S, G8SAP, G8SF2, G8SF2E, G8SF2P, GBM90, GFT45L, GFT45R, GFT90L, GFT90LR, GFT90R, GT2SDF, GT2SFA, GTF, SAG, TPF70, TPFV70		


			
GEV No.	106501	Ref. No.	RTCU900235
description	gas injector thread M10x1 WS 12 bore ø 1.45mm		
For models:	C4F, C62F, C6F, C6FA, C8F, FT4GL, FT4GLR, FT4GR, GF47T		


			
GEV No.	102821	Ref. No.	RTCU900229
description	gas injector thread M10x1 WS 12 bore ø 1.4mm		
For models:	G2S7, G2SDM7, G2SDMF7, G2SDMFE7, G2SSM7, G2SSMF7, G2SSMFE7, G4S7, G4SF7, G4SFE7, G4SM7, G4SMFA7, G6S7, G6SFA7, G6SFEA7, GT2SD7, GT2SFA7, GT2SS7, GT2SSFA7, GT4S7, GT4SF27, GT4SF2E7		


			
GEV No.	102687	Ref. No.	RTCU700467 RTCU900183
description	gas injector thread M10x1 WS 12 bore ø 1.55mm		
For models:	G100, G100A, G150, G150A, G2S, G2SP, G4S, G4SAP, G4SF, G4SFE, G4SFP, G6S, G6SF2, G6SFA, G6SFEA, GT2S, GT2SD, GT2SDF, GT2SDFE, GT2SFA, GT2SFEA		


			
GEV No.	102820	Ref. No.	RTCU900047
description	gas injector thread M10x1 WS 12 bore ø 1.5mm		
For models:	GBM45, GC77, GFT45L, GFT45LC, GFT45R, GFT45RC, GFT90L, GFT90LC, GFT90LR, GFT90LRC, GFT90R, GFT90RC, GT2SD7, GT2SDF, GT2SDFE, GT2SFA, GT2SFEA, GTF7, GTS7		





			
1			
GEV No.	100403	Ref. No.	RTCU700750
description	gas injector thread M10x1 WS 12 bore ø 1.7mm		
For models:	GF49T, GF90-1, GF99, GF99T		


			
1			
GEV No.	100971	Ref. No.	RTCU700038
description	gas injector thread M10x1 WS 12 bore ø 2.6mm		
For models:	BST2LV, BST2RV, C4A70, C4AV70, C4F70, C4FV70, TPF70, TPFV70		


			
1			
GEV No.	106502	Ref. No.	RTCU800048
description	gas injector thread M10x1 WS 12 bore ø 1.8mm		
For models:	C2A, C4A, C4F, C62F, C6A, C6F, C6FA, C8A, C8F		


			
1			
GEV No.	100629	Ref. No.	RTCU700037 RTCU900038
description	gas injector thread M10x1 WS 12 bore ø 2mm		
For models:	BST2LV, BST2RV, BST6LV, BST6RV, C4A, C4A70, C4AV70, C4F, C4F70, C4F702P, C4FV70, C4FV702P, C62F, C6A, C6F, C6F70, C6F702P, C6FA, C6FV70, C6FV702P, C8A, C8F, GBM90, GF25S, GPL77, GPL77P, TPF70, TPFV70		


			
1			
GEV No.	102688	Ref. No.	RTCU800243
description	gas injector thread M10x1 WS 12 bore ø 1.95mm		
For models:	G4S, G4SAP, G4SF, G4SFE, G4SFP, G6S, G6SF2, G6SFA, G6SFEA, G8S, G8SAP, G8SF2, G8SF2E, G8SF2P, GPL47, GPL47P		


			
1			
GEV No.	102550	Ref. No.	53.3.0314.01
description	gas injector thread M10x1 WS 12 bore ø 1.55mm		
For models:	6BM62G, 6FT61G, 6FT62G		


			
1			
GEV No.	102691	Ref. No.	RTCU700220
description	gas injector thread M10x1 WS 12 bore ø 1mm		
For models:	G2S, G2SP, G4S, G4SAP, G4SF, G4SFE, G4SFP, G6S, G6SF2, G6SFA, G6SFEA, G8SAP, G8SF2, G8SF2E, G8SF2P, GT2S, GT2SD, GT2SDF, GT2SDFE, GT2SFA, GT2SFEA		

			
1			
GEV No.	103199	Ref. No.	RTCU800078
description	gas injector thread M10x1 WS 12 bore ø 1.65mm		
For models:	E6A, E6AR, E6FAR, GBM45, GC902V, GC992V		

			
1			
GEV No.	100405	Ref. No.	RTCU900092
description	gas injector thread M10x1 WS 12 bore ø 2.1mm		
For models:	G4SF, G4SFP, G6SF2, G6SFA, G8SF2, G8SF2P, GT2SDF, GT2SFA, GTF		

			
1			
GEV No.	106795	Ref. No.	RTBF900017
description	gas injector thread M10x1 WS 12 bore ø 2.2mm		
For models:	C4F, C62F, C6F, C6FA, C8F, CP100, CP100A, CP150, CP150A, CPI100, CPI100A, CPI150, CPI150A		

			
1			
GEV No.	102689	Ref. No.	RTCU900226
description	gas injector thread M10x1 WS 12 bore ø 2.25mm		
For models:	G4S, G4SAP, G4SF, G4SFE, G4SFP, G6S, G6SF2, G6SFA, G6SFEA, G8SAP, G8SF2, G8SF2E, G8SF2P		

gas nozzles M12x1			
			
1			
GEV No.	100290	Ref. No.	RTCU900243
description	gas injector thread M12x1 WS 14 bore ø 1.90mm		
For models:	BST2LV, BST2RV, BST6LV, BST6RV, C4A70, C4AV70, C4F70, C4F702P, C4FV70, C4FV702P, C6A70, C6AV70, C6F70, C6F702P, C6FV70, C6FV702P, G2S, G2S7, G2SAP, G2SDM7, G2SDMF7, G2SDMFE7, G2SP, G2SM7, G2SSMF7, G2SSMFE7, G4S, G4S7, G4SAP, G4SF, G4SF7, G4SFE, G4SFE7, G4SFP, G4SM7, G4SMFA7, G6S, G6S7, G6SF2, G6SFA, G6SFA7, G6SFEA, G6SFEA7, G8S, G8SAP, G8SF2, G8SF2E, G8SF2P, GFT47L, GFT47LC...(Other models you can see in the webshop)		

pilot burner nozzles

pilot burner nozzles SIT

100 series



GEV No.	100245	Ref. No.	4370001
description	pilot burner nozzle LPG code 20 bore ø 0.2mm Qty 1 pcs thread M8x0.75		



GEV No.	107167	Ref. No.	RTCU700389
description	pilot burner nozzle SIT LPG code 21 bore ø 0.21mm Qty 1 pcs		
For models:	G2S7, G2S9, G2SDM7, G2SDMF7, G2SDMFE7, G2SSM7, G2SSMF7, G2SSMFE7, G4S7, G4SF7, G4SFE7, G4SM7, G4SMFA7, G6S7, G6S9, G6SFA7, G6SFEA7, GT2SD7, GT2SDFA7, GT2S57, GT2S5FA7, GT4S7, GT4SF27, GT4SF2E7, GT4SFA7, OMNIA G2S7, OMNIA G4S7, OMNIA G4SF7, OMNIA G4SFE7, OMNIA G6S7, OMNIA G6SFA7, OMNIA G6SFEA7, OMNIA GT2SD7, OMNIA GT4S7, OMNIA GT4SF27, WG2S7		



GEV No.	107168	Ref. No.	RTCU700647
description	pilot burner nozzle SIT natural gas bore ø 0.35mm Qty 1 pcs thread M4x0.75 WS 5		

140/150 series



GEV No.	100204	Ref. No.	RTCP800058
description	pilot burner nozzle SIT LPG code 14 bore ø 0.18/0.20mm Qty 1 pcs suitable for 140 series		
For models:	G5017		



GEV No.	100205	Ref. No.	RTCP800041
description	pilot burner nozzle SIT LPG code 19 bore ø 0.23/0.26mm Qty 1 pcs suitable for SIT 150 series		
For models:	C4F, C62F, C6F, C6FA, C8F, FCG10, FCG20, FCG6, FGC060, FGC065, FGC100, FGC200, FGM060, FGM061, FGM100, FGM101, FGM200, FGM201, FGM202, FGMD060, FGMD061, FGMD065, FGMD066, FGMD100, FGMD101, FGMD200, FGMD201, FGP050, FGP080, FGP160, FMM060, FMM061, FMM100, FMM101, G100, G100A, G100I, G100IA, G150, G150A, G150I, G150IA, G175, G2SDM7, G2SDMF7, G2SDMFE7, G2SSM7, G2SSMF7, G2SSMFE7, G4SF...(Other models you can see in the webshop)		



GEV No.	100207	Ref. No.	RTCP800059
description	pilot burner nozzle SIT natural gas code 27 bore ø 0.40/0.38mm suitable for SIT 140 series		
For models:	G2SDM7, G2SDMF7, G2SDMFE7, G2SSM7, G2SSMF7, G2SSMFE7, G4SF7, G4SM7, G4SMFA7, G5017, G6SFA7, GBM47, GBM77, GC47, GC77, GF07, GF472V, GFT47L, GFT47LC, GFT47R, GFT47RC, GFT77L, GFT77LC, GFT77LR, GFT77LRC, GFT77R, GFT77RC, GT2SD7, GT2S-DFA7, GT2SS7, GT2SSFA7, GT4S7, GT4SF27, GT4SF2E7, GTF7, GTS7, OMNIA GBM 77, OMNIA GF472V, OMNIA GFT 77L, OMNIA GFT 77LC, OMNIA GFT 77LR, OMNIA GFT 77LRC, OMNIA GFT 77R, OMNIA GFT 77RC, OMNIA GFT117L, OMNIA GFT117LC, OMNIA GFT117LR, OMNIA GFT117LRC		



GEV No.	100206	Ref. No.	RTCP800040
description	pilot burner nozzle SIT natural gas code 36 bore ø 0.60/0.55mm Qty 1 pcs suitable for SIT 150 series		
For models:	C4F, C62F, C6F, C6FA, C8F, FCG10, FCG20, FCG6, FGC060, FGC065, FGC100, FGC200, FGM060, FGM061, FGM100, FGM101, FGM200, FGM201, FGM202, FGMD060, FGMD061, FGMD065, FGMD066, FGMD100, FGMD101, FGMD200, FGMD201, FGP050, FGP080, FGP160, FMM060, FMM061, FMM100, FMM101, FP01V, G100, G100A, G100I, G100IA, G150, G150A, G150I, G150IA, G175, G4SF, G4SFP, G6SF2, G6S-FA, G8SF2, G8SF2P...(Other models you can see in the webshop)		

160 series





GEV No.	107650	Ref. No.	53.3.0202.00 611008 RTCU900216
description	pilot burner nozzle SIT LPG code 30 Qty 1 pcs		
For models:	6BM61G, 6BM62G, 6FQ61G, 6FQ62G, 6FT61G, 6FT62G, BM4G70, FT2GL70, FT2GR70, FT4GL, FT4GL70, FT4GLR, FT4GLR70, FT4GR, FT4GR70, GBM45, GBM90, GC45, GC90, GC902V, GF47T, SAG		




GEV No.	107175	Ref. No.	53.3.0204.00 RTCU900008
description	pilot burner nozzle SIT natural gas code 51 Qty 1 pcs suitable for 160 series		
For models:	6BM61G, 6BM62G, 6FQ61G, 6FQ62G, 6FT61G, 6FT62G, BM4G70, BST-6LV, BST6RV, FT2GL70, FT2GR70, FT4GL, FT4GL70, FT4GLR, FT4GLR70, FT4GR, FT4GR70, GBM45, GBM90, GC45, GC90, GC902V, GF47T, SAG		



pilot burner nozzles (other)


MBM ITALY			
			
1			
GEV No.	107167	Ref. No.	RTCU700389
description	pilot burner nozzle SIT LPG code 21 bore \varnothing 0.21mm Qty 1 pcs		
For models:	G2S7, G2S9, G2SDM7, G2SDMF7, G2SDMFE7, G2SSM7, G2SSMF7, G2SSMFE7, G4S7, G4SF7, G4SFE7, G4SM7, G4SMFA7, G6S7, G6S9, G6SFA7, G6SFEA7, GT2SD7, GT2SDFA7, GT2SS7, GT2SSFA7, GT4S7, GT4SF27, GT4SF2E7, GT4SFA7, OMNIA G2S7, OMNIA G4S7, OMNIA G4SF7, OMNIA G4SFE7, OMNIA G6S7, OMNIA G6SFA7, OMNIA G6SFEA7, OMNIA GT2SD7, OMNIA GT4S7, OMNIA GT4SF27, WG2S7		


			
1			
GEV No.	107168	Ref. No.	RTCU700647
description	pilot burner nozzle SIT natural gas bore \varnothing 0.35mm Qty 1 pcs thread M4x0.75 WS 5		


bypass nozzles


bypass nozzles EGA			
			
1			
GEV No.	100357	Ref. No.	RTBF700034
description	bypass nozzle EGA type 31248 series bore \varnothing 0.7mm		
For models:	FT4GL, FT4GLR, FT4GR		


bypass nozzles PEL20/21			
			
1			
GEV No.	100550	Ref. No.	RTCU700387
description	bypass nozzle type PEL20/21 bore \varnothing 0.55mm thread M5x0.5		


			
1			
GEV No.	100526	Ref. No.	RTCU700265
description	bypass nozzle type PEL20/21 bore \varnothing 0.5mm thread M5x0.5		


			
1			
GEV No.	100548	Ref. No.	RTCU700268
description	bypass nozzle type PEL20/21 bore \varnothing 0.65mm thread M5x0.5		


			
1			
GEV No.	100278	Ref. No.	RTCU700261
description	bypass nozzle type PEL20/21 bore \varnothing 0.75mm thread M5x0.5		


			
1			
GEV No.	100527	Ref. No.	RTCU700263
description	bypass nozzle type PEL20/21 bore \varnothing 0.85mm thread M5x0.5		
For models:	G6SFEA7		


			
1			
GEV No.	100555	Ref. No.	RTCU700271
description	bypass nozzle type PEL20/21 bore \varnothing 0.8mm thread M5x0.5		
For models:	GC47		


			
1			
GEV No.	100530	Ref. No.	RTCU700334
description	bypass nozzle type PEL20/21 bore \varnothing 1.1mm thread M5x0.5		
For models:	G6SFEA7, GC47		

			
1			
GEV No.	100394	Ref. No.	4399247-R
description	bypass nozzle type PEL20/21 bore \varnothing 1.25mm thread M5x0.5		


			
1			
GEV No.	100534	Ref. No.	4399238-R
description	bypass nozzle type PEL20/21 bore \varnothing 1.4mm thread M5x0.5		


			
1			
GEV No.	100529	Ref. No.	RTCU700338
description	bypass nozzle type PEL20/21 bore \varnothing 1mm thread M5x0.5		
For models:	GPL47, GPL47P, GPL77, GPL77P		


bypass nozzles PEL22			
			
1			
GEV No.	100259	Ref. No.	RTCU700250
description	bypass nozzle type PEL22 bore \varnothing 0.35mm thread M6x0.5		


			
1			
GEV No.	100390	Ref. No.	RTBF800210
description	bypass nozzle type PEL22 bore \varnothing 0.5mm thread M6x0.5		
For models:	GBM77		





			
GEV No.	100428	Ref. No.	RTCU800175
description	bypass nozzle type PEL22 bore ø 0.65mm thread M6x0.5		
For models:	GFT117L, GFT117LC, GFT117LR, GFT117LRC, GFT47L, GFT47LC, GFT47R, GFT47RC, GFT77L, GFT77LC, GFT77LR, GFT77LRC, GFT77R, GFT77RC, OMNIA GFT 47L, OMNIA GFT 47LC, OMNIA GFT 47R, OMNIA GFT 47RC, OMNIA GFT 77L, OMNIA GFT 77LC, OMNIA GFT 77LR, OMNIA GFT 77LRC, OMNIA GFT 77R, OMNIA GFT 77RC, OMNIA GFT117L, OMNIA GFT117LC, OMNIA GFT117LR, OMNIA GFT117LRC		

			
GEV No.	100432	Ref. No.	RTCU800232
description	bypass nozzle type PEL22 bore ø 0.75mm thread M6x0.5		
For models:	G4SF, G6SFA, G8SF2, GT2SDF, GT2SFA, GTF		


			
GEV No.	100410	Ref. No.	RTCU800241
description	bypass nozzle type PEL22 bore ø 0.85mm thread M6x0.5		
For models:	G4SF, G6SFA, G8SF2, GT2SDF, GT2SFA, GTF		


			
GEV No.	100434	Ref. No.	RTCU700336
description	bypass nozzle type PEL22 bore ø 0.95mm thread M6x0.5		
For models:	G507, G5017		


			
GEV No.	100436	Ref. No.	RTCU900287
description	bypass nozzle type PEL22 bore ø 1.1mm thread M6x0.5		


			
GEV No.	106499	Ref. No.	RTCU700661
description	bypass nozzle type PEL22 bore ø 1.3mm thread M6x0.5		

bypass nozzles PEL23/24


			
GEV No.	100448	Ref. No.	RTCU800045
description	bypass nozzle type PEL23/24 bore ø 0.5mm thread M8x0.5		


			
GEV No.	100493	Ref. No.	RTCU700388
description	bypass nozzle type PEL23/24 bore ø 0.7mm thread M8x0.5		
For models:	G2SDM7, G2SDMF7, G2SDMFE7, G2SSM7, G2SSMF7, G2SSMFE7, G4SF7, G4SM7, G4SMFA7, G6SFA7, GF07, GT2SDFA7, GT2SFA7, GT4SF27, GTF7		

			
GEV No.	100597	Ref. No.	RTCU800071
description	bypass nozzle type PEL23/24 bore ø 0.9mm thread M8x0.5		
For models:	G4SF, G4SFP, G6SF2, G6SFA, G8SF2, G8SF2P, GT2SFA, GTF		

			
GEV No.	100628	Ref. No.	RTCU700207
description	bypass nozzle type PEL23/24 bore ø 1.05mm thread M8x0.5		
For models:	GC77		

bypass nozzles SABAF



			
GEV No.	106730	Ref. No.	RTCU600098
description	bypass nozzle bore ø 0.38mm thread M4x0.5 SABAF		

			
GEV No.	106586	Ref. No.	RTCU600108
description	bypass nozzle bore ø 0.5mm thread M4x0.5 SABAF		





auxiliary gas parts




screw connections



olives


			
GEV No.	101249	Ref. No.	RTCU900016
description	olive for pipe ø 10mm Qty 1 pcs		
For models:	BST2LV, BST2RV, BST6LV, BST6RV, C2A, C4A, C4A70, C4AV70, C4F, C4F70, C4F702P, C4FV70, C4FV702P, C62F, C6A, C6A70, C6AV70, C6F, C6F70, C6F702P, C6FA, C6FV70, C6FV702P, C8A, C8F, FT2GL70, FT2GR70, FT4GL, FT4GL70, FT4GLR, FT4GLR70, FT4GR, FT4GR70, G2S, G2SAP, G2SP, G4S, G4SAP, G4SF, G4SF-1, G4SF11, G4SF77, G4SF9, G4SF9-1, G4SF9-2, G4SFE, G4SFP, G6S, G6SF2, G6SF29...(Other models you can see in the webshop)		
accessories for	101249		
	GEV No.	101250	Ref. No. RTCU900017
union nut thread M20x1.5 for pipe ø 10mm			






			
1			
GEV No.	101278	Ref. No.	RTCU900012
description	olive for pipe ø 10mm Qty 1 pcs		
For models:	BG6SF77M, BM4G70, BST2LV, BST2RV, BST6LV, BST6RV, C2A, C4A, C4A70, C4AV70, C4F, C4F70, C4F702P, C4FV70, C4FV702P, C62F, C6A, C6A70, C6AV70, C6F, C6F70, C6F702P, C6FA, C6FV70, C6FV702P, C8A, C8F, CP100, CP100A, CP150, CP150A, CPI100, CPI100A, CPI150, CPI150A, E100, E100A, E100I, E100I8, E100I9, E100I98, E100I9N, E100IA, E100IT9, E100IT9N, E150, E150A, E150I, E150I8, E150I9...(Other models you can see in the webshop)		
accessories for	101278		
	GEV No.	100943	Ref. No. —
union nut thread M17x1 tube ø 10mm			
	GEV No.	101300	Ref. No. RTCU700297
union nut thread M16x1.5 tube ø 10mm			
	GEV No.	101478	Ref. No. RTCU900013
union nut thread 3/8" for pipe ø 10mm			


			
1			
GEV No.	101273	Ref. No.	RTCU800195
description	olive for pipe ø 12mm L 9.5mm brass Qty 1 pcs suitable for universal		
For models:	FG15M, FG20M, FP01V, G1008, G10098, G100I8, G100I98, G100T98, G1508, G15098, G150I8, G150I98, G150IT98, G507, G50I7, G50I77, GBR7, GBR77, GBRI7, GBRI77, GC411-SC, GC45, GC47, GC49, GC49T, GC77, GC902V, GC911-SC, GC992V, GC992VT, GF15+15S, GF15S, GF25+25S, GF25S, GF477, GF4772V, GF477TS, GF777, GT, GT2SD9, GT2SDF, GT2SDFA9, GT2SS9, GT4S77, GT99, GTA911, GTF, GTF77, GTF9, GTF911...(Other models you can see in the webshop)		
accessories for	101273		
	GEV No.	100944	Ref. No. —
union nut thread M18x1.5 for pipe ø 12mm			
	GEV No.	101276	Ref. No. —
union screw thread 3/8" tube ø 12mm Qty 1 pcs			



			
1			
GEV No.	101248	Ref. No.	RTCU900014
description	olive for pipe ø 12mm Qty 1 pcs suitable for PEL		
For models:	BST2LV, BST2RV, BST6LV, BST6RV, C2A, C4A, C4A70, C4AV70, C4F, C4F70, C4F702P, C4FV70, C4FV702P, C62F, C6A, C6F, C6F70, C6F702P, C6FA, C6FV70, C6FV702P, C8A, C8F, G1008, G10098, G100I8, G100I98, G100T98, G1508, G15098, G150I8, G150I98, G150IT98, G2S, G2S9, G2SA11, G2SAP, G2SP, G4S, G4S9, G4S9-48, G4SA11, G4SAP, G4SF, G4SF-1, G4SF11, G4SF9, G4SF9-1, G4SF9-2, G4SFE...(Other models you can see in the webshop)		
accessories for	101248		
	GEV No.	101251	Ref. No. RTCU900015
union nut thread M20x1.5 for pipe ø 12mm			




			
1			
GEV No.	106798	Ref. No.	RTCP900088
description	olive for pipe ø 14mm L 7mm brass Qty 1 pcs ED ø 16mm		
For models:	CP100, CP100A, CP150, CP150A, CPI100, CPI100A, CPI150, CPI150A, FCG10, FCG20, FCG6, FEM060, FEM061, FEM062, FEM100, FEM101, FEM102, FEM107, FEM107SC, FEM108, FEM108EL, FEM109, FEM110, FEM110L, FEM200, FEM201, FEM202, FEM207, FEM207SC, FEM209, FEM210, FEM210L, FEM610, FEM610L, FEM67, FEM67SC, FEM68, FEM68EL, FEM69, FEMD108, FEMD108EL, FEMD68, FEMD68EL, FGC060, FGC065, FGC100, FGC200, FGM060, FGM061, FGM062...(Other models you can see in the webshop)		


			
1			
GEV No.	101256	Ref. No.	RTCP800023
description	olive for pipe ø 16mm Qty 1 pcs		
For models:	G100, G1009, G100A, G100I, G100I9, G100I9N, G100IA, G100IT9, G100IT9N, G100T9, G150, G1509, G150A, G150I, G150I9, G150I9N, G150IA, G150IT9, G150IT9N, G150T9, G175, GBR8, GBRVC98, GBRV18, GBRV198, GF408N, GF908N, OMNIA GFT 47L, OMNIA GFT 47LC, OMNIA GFT 47R, OMNIA GFT 47RC		
accessories for	101256		
	GEV No.	101253	Ref. No. —
union nut thread M24x1.5 PEL for pipe ø 16mm			


			
1			
GEV No.	106598	Ref. No.	53.3.0102.00
description	olive for pipe ø 18mm Qty 1 pcs ED ø 21mm		
For models:	6BM61EM, 6BM61G, 6BM62EM, 6BM62ET, 6BM62G, 6CP61EM, 6CP62ET, 6FQ61E, 6FQ61G, 6FQ62E, 6FQ62G		

			
1			
GEV No.	100870	Ref. No.	RTCU900134
description	olive for pipe ø 4mm Qty 1 pcs suitable for 160 series for pilot burner		
For models:	BM4G70, BST2LV, BST2RV, BST6LV, BST6RV, FT2GL70, FT2GR70, FT4GL, FT4GL70, FT4GLR, FT4GLR70, FT4GR, FT4GR70, GBM45, GBM90, GBR, GBRA, GBRAVI, GBRVI, GC45, GC90, GC902V, GFT45L, GFT45LC, GFT45R, GFT45RC, GFT90L, GFT90LC, GFT90LR, GFT90LRC, GFT90R, GFT90RC, SAG		


			
GEV No.	100898	Ref. No.	RTCU800183
description	olive for pipe ø 6mm Qty 1 pcs for pilot burner		
For models:	BG6SF77M, C4F, C62F, C6F, C6FA, C8F, FCE10, FCE20, FCG10, FCG108, FCG20, FCG6, FCG68, FEC060, FEC065, FEC100, FEC200, FEM060, FEM061, FEM062, FEM100, FEM101, FEM102, FEM200, FEM201, FEM202, FEMD060, FEMD061, FEMD065, FEMD066, FEMD100, FEMD101, FEMD107SC, FEMD109, FEMD200, FEMD201, FEMD67SC, FEMD69, FEP050, FEP080, FEP160, FG15, FG15+15, FGC060, FGC065, FGC100, FGC200, FGM060, FGM061, FGM062...(Other models you can see in the webshop)		
accessories for	100898		
			
GEV No.	100909	Ref. No.	RTCP800038 RTCU900019
union screw thread M10x1 for pipe ø 6mm Qty 1 pcs			



			
GEV No.	101286	Ref. No.	RTCU900018
description	olive ID ø 6mm Qty 1 pcs		
For models:	BG6SF77M, BST2LV, BST2RV, BST6LV, BST6RV, C2A, C4A, C4A70, C4AV70, C4F, C4F70, C4F702P, C4FV70, C4FV702P, C62F, C6A, C6A70, C6AV70, C6F, C6F70, C6F702P, C6FA, C6FV70, C6FV702P, C8A, C8F, FCE6, FCG10, FCG20, FCG6, FEM107, FEM107SC, FEM109, FEM110, FEM110L, FEM207, FEM207SC, FEM209, FEM210, FEM210L, FEM610, FEM610L, FEM67, FEM67SC, FEM69, FEMD107, FEMD107SC, FEMD109, FEMD207, FEMD207SC...(Other models you can see in the webshop)		
accessories for	101286		
			
GEV No.	100909	Ref. No.	RTCP800038 RTCU900019
union screw thread M10x1 for pipe ø 6mm Qty 1 pcs			
			
GEV No.	101464	Ref. No.	—
union nut thread M12x1 for pipe ø 6mm			

			
GEV No.	106799	Ref. No.	RTBF800137
description	olive L 6.5mm brass Qty 1 pcs ID ø 14.3mm ED ø 16.5mm		
For models:	FCG10, FCG108, FCG6, FCG68, FEM108, FEM108EL, FEM110, FEM110L, FEM610, FEM610L, FEM68, FEM68EL, FEMD108, FEMD108EL, FEMD68, FEMD68EL, FGC060, FGC065, FGC100, FGC200, FGM060, FGM061, FGM062, FGM100, FGM101, FGM102, FGM107, FGM107SC, FGM108, FGM108EL, FGM109, FGM110, FGM110L, FGM200, FGM201, FGM202, FGM207, FGM207SC, FGM209, FGM210, FGM210L, FGM610, FGM610L, FGM67, FGM67SC, FGM68, FGM68EL, FGM69, FGMD060, FGMD061...(Other models you can see in the webshop)		

union nuts			
			
GEV No.	102960	Ref. No.	RTBF800015
description	union nut thread 1/2" WS 24 brass for pipe ø 14mm		
For models:	FCG10, FCG108, FCG6, FCG68, FEM108, FEM108EL, FEM110, FEM110L, FEM610, FEM610L, FEM68, FEM68EL, FEMD108, FEMD108EL, FEMD68, FEMD68EL, FGC060, FGC065, FGC100, FGC200, FGM060, FGM061, FGM062, FGM100, FGM101, FGM102, FGM107, FGM107SC, FGM108, FGM108EL, FGM109, FGM110, FGM110L, FGM200, FGM201, FGM202, FGM207, FGM207SC, FGM209, FGM210, FGM210L, FGM610, FGM610L, FGM67, FGM67SC, FGM68, FGM68EL, FGM69, FGMD060, FGMD061...(Other models you can see in the webshop)		


			
GEV No.	101478	Ref. No.	RTCU900013
description	union nut thread 3/8" for pipe ø 10mm		
For models:	BG6SF77M, BM4G70, BST2LV, BST2RV, BST6LV, BST6RV, C2A, C4A, C4A70, C4AV70, C4F, C4F70, C4F702P, C4FV70, C4FV702P, C62F, C6A, C6A70, C6AV70, C6F, C6F70, C6F702P, C6FA, C6FV70, C6FV702P, C8A, C8F, CP100, CP100A, CP150, CP150A, CP1100, CP1100A, CP1150, CP1150A, E100I, E100I8, E100I9, E100I98, E100I9N, E100IA, E100IT9, E100IT9N, E150I, E150I8, E150I9, E150I98, E150I9N, E150IA, E150IT9...(Other models you can see in the webshop)		

			
GEV No.	101484	Ref. No.	RTCU800339
description	union nut thread M10x1 WS 12 Qty 1 pcs for pipe ø 6mm		
For models:	G100, G1008, G1009, G10098, G100A, G100I, G100I8, G100I9, G100I98, G100I9N, G100IT9, G100IT9N, G100T9, G100T98, G150, G1508, G1509, G15098, G150A, G150I, G150I8, G150I9, G150I98, G150I9N, G150IT9, G150IT98, G150IT9N, G150T9		


			
GEV No.	101300	Ref. No.	RTCU700297
description	union nut thread M16x1.5 tube ø 10mm		
For models:	BG6SF77M, FG15M, FG20M, FP01V, G2S7, G2S77, G2S77P, G2S8, G2S928P, G2S98, G2SA77, G2SA77P, G2SA98, G2SA98P, G2SDM7, G2SDMF7, G2SDMFE7, G2SF6, G2SF6G, G2SSM7, G2SSM77, G2SSMA77, G2SSMF7, G2SSMFE7, G3SF6, G3SF6G, G4S7, G4S77, G4S77P, G4S8, G4S948P, G4S98, G4SA77, G4SA77P, G4SA98, G4SA98P, G4SF7, G4SF77, G4SF77P, G4SF8, G4SF98, G4SF98P, G4SFE7, G4SFE77, G4SFE77P, G4SFE8, G4SFE98, G4SFEV77, G4SM7, G4SM77...(Other models you can see in the webshop)		
accessories for	101300		
			
GEV No.	101278	Ref. No.	RTCU900012
olive for pipe ø 10mm Qty 1 pcs			








			
1			
GEV No.	101250	Ref. No.	RTCU900017
description	union nut thread M20x1.5 for pipe ø 10mm		
For models:	BST2LV, BST2RV, BST6LV, BST6RV, C2A, C4A, C4A70, C4AV70, C4F, C4F70, C4F702P, C4FV70, C4FV702P, C62F, C6A, C6A70, C6AV70, C6F, C6F70, C6F702P, C6FA, C6FV70, C6FV702P, C8A, C8F, FT4GL, FT4GLR, FT4GR, G2S, G2SAP, G2SP, G4S, G4SAP, G4SF, G4SF-1, G4SF11, G4SF77, G4SF9, G4SF9-1, G4SF9-2, G4SFE, G4SFP, G6S, G6SF2, G6SF29, G6SFA, G6SFA9, G6SFEA, G8S, G8SAP...(Other models you can see in the webshop)		
accessories for	101250		
			
GEV No.	101249	Ref. No.	RTCU900016
olive for pipe ø 10mm Qty 1 pcs			






			
1			
GEV No.	101251	Ref. No.	RTCU900015
description	union nut thread M20x1.5 for pipe ø 12mm		
For models:	BST2LV, BST2RV, BST6LV, BST6RV, C2A, C4A, C4A70, C4AV70, C4F, C4F70, C4F702P, C4FV70, C4FV702P, C62F, C6A, C6A70, C6AV70, C6F, C6F70, C6F702P, C6FA, C6FV70, C6FV702P, C8A, C8F, FP01V, G1008, G10098, G100I8, G100I98, G100T98, G1508, G15098, G150I8, G150I98, G150IT98, G2S, G2S9, G2SA11, G2SAP, G2SP, G4S, G4S9, G4S9-48, G4SA11, G4SAP, G4SF, G4SF-1, G4SF11, G4SF9...(Other models you can see in the webshop)		
accessories for	101251		
			
GEV No.	101248	Ref. No.	RTCU900014
olive for pipe ø 12mm Qty 1 pcs suitable for PEL			

union screws

			
1			
GEV No.	106597	Ref. No.	53.3.0101.00
description	union screw thread 3/4" for pipe ø 18mm L 20mm Qty 1 pcs WS 27		
For models:	6BM61EM, 6BM61G, 6BM62EM, 6BM62ET, 6BM62G, 6CP61EM, 6CP62ET, 6FQ61E, 6FQ61G, 6FQ62E, 6FQ62G		

			
1			
GEV No.	100908	Ref. No.	RTCU900133
description	union screw thread M10x1 for pipe ø 4mm Qty 1 pcs		
For models:	BM4G70, BST2LV, BST2RV, BST6LV, BST6RV, FT2GL70, FT2GR70, FT4GL70, FT4GLR70, FT4GR70, GBM45, GBM90, GBR, GBRA, GBRAVI, GBRVI, GC45, GC902V, GFT45L, GFT45LC, GFT45R, GFT45RC, GFT90L, GFT90LC, GFT90LR, GFT90LRC, GFT90R, GFT90RC, SAG		
accessories for	100908		
			
GEV No.	100897	Ref. No.	—
olive for pipe ø 4mm Qty 1 pcs for pilot burner			

accessories for	100908		
			
GEV No.	101246	Ref. No.	—
olive for pipe ø 4mm Qty 1 pcs			
			
GEV No.	101280	Ref. No.	—
olive for pipe ø 4mm Qty 1 pcs			
			
GEV No.	101282	Ref. No.	—
olive for pipe ø 4mm L 7.4mm Qty 1 pcs			

			
1			
GEV No.	100909	Ref. No.	RTCP800038 RTCU900019
description	union screw thread M10x1 for pipe ø 6mm Qty 1 pcs		
For models:	BG6SF77M, BGF777B, BST2LV, BST2RV, BST6LV, BST6RV, C2A, C4A, C4A70, C4AV70, C4F, C4F70, C4F702P, C4FV70, C4FV702P, C62F, C6A, C6A70, C6AV70, C6F, C6F70, C6F702P, C6FA, C6FV70, C6FV702P, C8A, C8F, FGM060, FGM061, FGM100, FGM101, FGM200, FGM201, FGM202, FP01V, G100, G1008, G1009, G10098, G100A, G100I, G100I8, G100I9, G100I98, G100IA, G100T9, G100T98, G150, G1508, G1509...(Other models you can see in the webshop)		
accessories for	100909		
			
GEV No.	100898	Ref. No.	RTCU800183
olive for pipe ø 6mm Qty 1 pcs for pilot burner			
			
GEV No.	101286	Ref. No.	RTCU900018
olive ID ø 6mm Qty 1 pcs			
			
GEV No.	101287	Ref. No.	—
olive for pipe ø 6mm Qty 1 pcs			
			
GEV No.	101288	Ref. No.	—
olive for pipe ø 6mm L 6mm aluminium Qty 1 pcs ED ø 8.5mm			



gas lines

main gas lines

producer-specific



1

GEV No.	109101	Ref. No.	160636 163542
description	gas line tube ø 14mm L 390mm		
For models:	GF45, GF49, GF49T, GF90, GF90-1, GF99, GF99T		

consumables

lava rocks / ceramic briquetts



1

GEV No.	211001	Ref. No.	A800001170 A800100
description	lava rocks Qty package content 9kg		
For models:	GPL46P, GPL47, GPL47P, GPL77, GPL77P, GPL86P, MINIMA GPL 86, MINIMA GPL 86P, OMNIA GPL 47, OMNIA GPL 47P, OMNIA GPL 77, OMNIA GPL 77P		

equipment-specific units

for vegetable slicers

miscellaneous



1

GEV No.	699128	Ref. No.	927095
description	shaft sealing ED ø 40mm ID ø 30mm H 7mm plastic for vegetable slicer		
For models:	LT161, LT221, LT271, LT272, LT362		

for ice-cube maker

drain systems

drain fittings



1

GEV No.	695620	Ref. No.	10472
description	drain fitting straight connection 24mm for ice maker		
For models:	CB955A, CB955W		



1

GEV No.	695039	Ref. No.	10471
description	drain fitting thread M30x2 L 40.7mm straight connection 17mm for ice-cube maker		
For models:	CB955A, CB955W		

overflow pipes



1

GEV No.	695622	Ref. No.	10305
description	lid for overflow pipe tube ø 34mm		
For models:	CB955A, CB955W		
accessories for	695622		



GEV No.	695086	Ref. No.	10133
description	overflow pipe tube ø 20.5mm pipe length 88.6mm		



1

GEV No.	695086	Ref. No.	10133
description	overflow pipe tube ø 20.5mm pipe length 88.6mm		
For models:	CB955A, CB955W		
accessories for	695086		



GEV No.	532517	Ref. No.	20233
description	O-ring silicone thickness 1.78mm ID ø 17.17mm Qty 1 pcs		



GEV No.	695059	Ref. No.	10007
description	hose connector for ice-cube maker		



GEV No.	695537	Ref. No.	13006
description	gasket silicone ED ø 40mm ID ø 30mm thickness 2mm Qty 1 pcs		

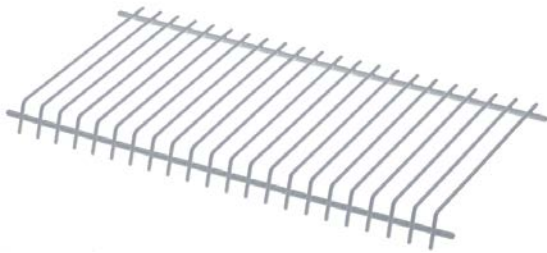


GEV No.	695622	Ref. No.	10305
description	lid for overflow pipe tube ø 34mm		



ice chutes

slide grates



1			
GEV No.	692769	Ref. No.	D12008
description	slide grate for ice-cube type A L 435mm W 207mm H 26mm		
For models:	ICE45A, ICE45W		

filters



1			
GEV No.	694878	Ref. No.	18106
description	filter L 230mm W 190mm thickness 1mm		
For models:	CB955A, CB955W, ICE45A, ICE45W		

spray systems

miscellaneous

spray arms



1			
GEV No.	694669	Ref. No.	2LV017
description	spray arm L 330mm nozzles 8		
For models:	KL030A, KL030W		

doors

magnets



1			
GEV No.	691806	Ref. No.	RTTAV00093
description	door magnet ø 22mm Lmm thread M5 thread L 10mm		
For models:	BGF777B, E47, E47Q, E4F7, E4F7Q, E67, E67Q, E6FA7, E6FA7Q, EC47, EC49, EC49T, EC77, EC777, EC777T, EC992VT, EF12+12S, EF12S, EF25+25S, EF25S, EF47, EF472V, EF477, EF49T, EF77, EF777, EF99, EF99T, EMT477, EMT777, FG15M, FG20M, G4SMFA7, G6SFA7, G6SFA77, G6SFEA7, GC47, GC49T, GC77, GC902V, GC992V, GC992VT, GF15+15S, GF15S, GF25+25S, GF25S, GF47, GF472V, GF4772VB, GF4772VS...(Other models you can see in the webshop)		

doors



1			
GEV No.	695514	Ref. No.	C10297
description	door for ice-cube maker W 447mm H 217mm thickness 22mm		
For models:	ICE45A, ICE45W		



1			
GEV No.	695515	Ref. No.	C10275
description	door for ice-cube maker W 675mm H 307mm thickness 28mm		
For models:	CB955A, CB955W		

curtains

with holder



1			
GEV No.	695507	Ref. No.	C22035
description	curtain for ice maker W 433mm H 165mm with holder shaft length 438mm shaft ø 7.5mm		
For models:	ICE45A, ICE45W		



1			
GEV No.	695508	Ref. No.	C22059
description	curtain for ice maker W 660mm H 165mm with holder shaft length 665mm shaft ø 7.5mm		
For models:	CB955A, CB955W		

suction system

intake filters



GEV No.	695532	Ref. No.	20005
description	round filters ø 28mm H 60mm		
For models:	CB955A, CB955W, ICE45A, ICE45W		

gaskets

miscellaneous



GEV No.	695534	Ref. No.	13143
description	gasket silicone ED ø 36mm ID ø 23.5mm thickness 3mm Qty 1 pcs		
For models:	CB955A, CB955W		



GEV No.	695537	Ref. No.	13006
description	gasket silicone ED ø 40mm ID ø 30mm thickness 2mm Qty 1 pcs		
For models:	CB955A, CB955W		

accessories for

GEV No.	695059	Ref. No.	10007
description	hose connector for ice-cube maker		

housing and bezels

ventilation grilles



GEV No.	694877	Ref. No.	C10205
description	bezel for aspiration with filter L 260mm W 22mm H 252mm mounting pos. front		
For models:	CB955A, CB955W, ICE45A, ICE45W		

hoses

formed hoses

straight

silicone hoses



GEV No.	530757	Ref. No.	13108
description	silicone hose ID ø 13mm ED ø 19mm L 0.24m t.max. 200°C for ice-cube maker		
For models:	ICE45A, ICE45W		



GEV No.	530759	Ref. No.	13110
description	silicone hose ID ø 13mm ED ø 19mm L 0.35m t.max. 200°C for ice-cube maker		
For models:	CB955A, CB955W		



GEV No.	530740	Ref. No.	13141
description	silicone hose ID ø 16mm ED ø 23mm L 0.61m t.max. 200°C for ice-cube maker		
For models:	CB955A, CB955W		

form L



GEV No.	695107	Ref. No.	13005
description	formed hose L-shape for ice-cube maker ID ø 17mm ED ø 23.5mm L 70mm W 50mm		
For models:	CB955A, CB955W, ICE45A, ICE45W		


form U


group 1






GEV No.	530747	Ref. No.	13058
description	formed hose U-shape for ice-cube maker ID ø 17/23mm ED ø 25/31mm L 610mm W 120mm		
For models:	CB955A, CB955W		





group 2			
			
1			
GEV No.	695099	Ref. No.	13021
description	formed hose U-shape for ice-cube maker ID ø 17/26mm ED ø 25/32mm L 460mm W 100mm		
For models:	ICE45A, ICE45W		


			
1			
GEV No.	530746	Ref. No.	13059
description	formed hose U-shape for ice-cube maker ID ø 18/27mm ED ø 25/32mm L 670mm W 90mm		
For models:	CB955A, CB955W		

hose connectors			
with thread			
			
1			
GEV No.	695059	Ref. No.	10007
description	hose connector for ice-cube maker		
For models:	ICE45A, ICE45W		
accessories for	695059		
	GEV No.	695537	Ref. No.
			13006
	 gasket silicone ED ø 40mm ID ø 30mm thickness 2mm Qty 1 pcs		


without thread			
			
1			
GEV No.	695527	Ref. No.	C26452
description	hose connector 3-way for hose for ice-cube maker		
For models:	CB955A, CB955W, ICE45W		


miscellaneous			
			
1			
GEV No.	695533	Ref. No.	10404
description	butt splice connector thread M23x1.5 for hose ID 18mm		
For models:	CB955A, CB955W		

			
1			
GEV No.	695536	Ref. No.	10096
description	nut for drain assembly		
For models:	CB955A, CB955W		

			
1			
GEV No.	695535	Ref. No.	10405
description	nut for ice-cube maker thread M23x1.5		
For models:	CB955A, CB955W		

for espresso machines

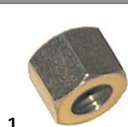
brewing units			
filter holder gaskets			
O-rings			
			
1			
GEV No.	510409	Ref. No.	167956 929046 CGG55
description	O-ring EPDM thickness 5.34mm ID ø 56.52mm Qty 1 pcs		
For models:	E100I9N, E100IT9N, E150I9N, E150IT9N, FEM107, FEM108, FEM108EL, FEM110, FEM110L, FEM207, FEM210, FEM210L, FEM220, FEM220L, FEM240, FEM240L, FEM610, FEM610L, FEM67, FEM68, FEM68EL, FEMD108, FEMD108EL, FEMD68, FEMD68EL, LT121, LT150, LT151, LT152, LT161, LT202, LT221, LT271, LT272, LT362, LT91		

steam/water taps			
steam/water pipes			
accessories			
gaskets			
			
1			
GEV No.	510893	Ref. No.	456015
description	O-ring EPDM thickness 2.62mm ID ø 9.92mm Qty 1 pcs		
For models:	LB145, LB425, LB45, LB450, LF50, LF500, LF55E, LF59, LK1000, LK621, LS500, LS500A, LS500G, LS500GA, LS500GPV, LS500PV, LS501, LS501A, LS501G, LS501GA, LS501GPV, LS501PV, LS505, LS505M, LS505T, LS511, LS511A, LS511PV, LS520		



pipes

union nuts



1

GEV No.	101478	Ref. No.	RTCU900013
description	union nut thread 3/8" for pipe ø 10mm		
For models:	BG65F77M, BM4G70, BST2LV, BST2RV, BST6LV, BST6RV, C2A, C4A, C4A70, C4AV70, C4F, C4F70, C4F702P, C4FV70, C4FV702P, C62F, C6A, C6A70, C6AV70, C6F, C6F70, C6F702P, C6FA, C6FV70, C6FV702P, C8A, C8F, CP100, CP100A, CP150, CP150A, CPI100, CPI100A, CPI150, CPI150A, E100I, E100I8, E100I9, E100I98, E100I9N, E100IA, E100IT9, E100IT9N, E150I, E150I8, E150I9, E150I98, E150I9N, E150IA, E150IT9... (Other models you can see in the webshop)		

for coffee grinders



1

GEV No.	345742	Ref. No.	RTBF900277
description	microswitch with lever 250V 16A 1CO connection male faston 6.3mm L 55mm ambient temperature max. 120°C mounting distance 22mm actuating force: 75g lever length 46mm		
For models:	EF46, EF66, FEC023, FEMD023, MINIMA EF 46, MINIMA EF 66, PLANET FEC023, PLANET FEMD023		

for bain marie

drain systems



1

GEV No.	515060	Ref. No.	3600077 RIC0002701
description	drain fitting thread 3/4" H 18mm ID ø 20mm ED ø 38mm		
For models:	BC2G, BC3G, BC4G, BC6G, EC11803		

for deep fryers

door magnets



1

GEV No.	690524	Ref. No.	ric0001384 RTBF300233
description	door magnet L 87mm W 18mm H 15mm mounting distance 73mm for folding door hinge		

EQUIPMENT-SPECIFIC UNITS MBM-ITALIEN

miscellaneous



1

GEV No.	970588	Ref. No.	PACU700774
description	filter		
For models:	EF47, EF472V, EF77, GF47, GF472V, GF77		

for grills

sumps



1

GEV No.	693808	Ref. No.	PACU600292
description	grease collecting tray		
For models:	GPL46P, MINIMA GPL 46, MINIMA GPL 46P		

for convection ovens/combi-steamers

injection pipes




1

GEV No.	693632	Ref. No.	RTFOC00706
description	injection pipe		
For models:	FCE6, FCG6, JOKER FCE 6, JOKER FCE 6 AB 2002, JOKER FCG 6, JOKER FCG 6 AB 2002		




1

GEV No.	693633	Ref. No.	RTFOC0695
description	injection pipe		

1

GEV No.	693648	Ref. No.	RTFOC00408
description	injection pipe		
For models:	FEC065, FEM610, FEM610L, FEM67, FEM68, FEM68EL, FEMD065, FEMD066, FEMD67, FEMD67SC, FEMD68, FEMD68EL, FEMD69, FGC065, FGM610, FGM610L, FGM67, FGM68, FGM68EL, FGMD065, FGMD066, FGMD67, FGMD67SC, FGMD68, FGMD68EL, FGMD69, JOKER FEMD 67 SC, JOKER FEMD 69, JOKER FGMD 67 SC, JOKER FGMD 69		




1

GEV No.	693629	Ref. No.	RTFOC00487
description	injector pipe		
For models:	FEM610, FEM610L, FEM67, FEM67SC, FEP050, FGM610, FGM610L, FGM67, FGM67SC, FGM69, FGP050, JOKER FEP050, JOKER FEP050 AB 2002, JOKER FGM 67 SC, JOKER FGM 69, JOKER FGP050, JOKER FGP050 AB 2002		



1


GEV No.	693630	Ref. No.	RTFOC00313
description	injector pipe		
For models:	FEC200, FEM200, FEM201, FEM202, FEM207, FEM207SC, FEM209, FEM210, FEM210L, FEMD200, FEMD201, FEMD207, FEMD207SC, FEMD209, FEP160, FGC200, FGM200, FGM201, FGM202, FGM207, FGM207SC, FGM209, FGM210, FGM210L, FGMD200, FGMD201, FGMD207, FGMD207SC, FGMD209, FGP160, JOKER FEM207 SC, JOKER FEM209, JOKER FEMD207 SC, JOKER FEMD209, JOKER FEP160, JOKER FGM207 SC, JOKER FGM209, JOKER FGMD207 SC, JOKER FGMD209, JOKER FGP160		



1

GEV No.	693631	Ref. No.	RTFOC00492
description	injector pipe		
For models:	FEM107, FEM107SC, FEM108, FEM108EL, FEM109, FEM110, FEM110L, FEMD107, FEMD107SC, FEMD108, FEMD108EL, FEMD109, FEP080, FGM107, FGM107SC, FGM108, FGM108EL, FGM109, FGM110, FGM110L, FGMD107, FGMD107SC, FGMD108, FGMD108EL, FGMD109, FGP080, JOKER FEM107 SC, JOKER FEM109, JOKER FEM109 AB 2002, JOKER FEMD107 SC, JOKER FEMD109, JOKER FEP080, JOKER FEP080 AB 2002, JOKER FGM107 SC, JOKER FGM109, JOKER FGMD107 SC, JOKER FGMD109, JOKER FGP080, JOKER FGP080 AB 2002		

filters



1

GEV No.	700397	Ref. No.	GAFOC00027
description	drain filter		
For models:	FCE10, FCE108, FCE20, FCE6, FCE68, FCG10, FCG108, FCG20, FCG6, FCG68, FEC060, FEC100, FEC200, FEM060, FEM061, FEM062, FEM100, FEM101, FEM102, FEM107, FEM107SC, FEM108, FEM108EL, FEM109, FEM110, FEM110L, FEM200, FEM201, FEM202, FEM207, FEM207SC, FEM209, FEM210, FEM210L, FEM610, FEM610L, FEM67, FEM67SC, FEM68, FEM68EL, FEM69, FEMD060, FEMD061, FEMD100, FEMD101, FEMD107, FEMD107SC, FEMD108, FEMD108EL, FEMD109...(Other models you can see in the webshop)		

door mechanics

door bumpers



1

GEV No.	693798	Ref. No.	161477
description	door bumper		
For models:	FCE10, FCE20, FCE6, FCG10, FCG20, FCG6, FEM107, FEM107SC, FEM108, FEM108EL, FEM109, FEM110, FEM110L, FEM207, FEM207SC, FEM210, FEM210L, FEM610, FEM610L, FEM67, FEM67SC, FEM68, FEM68EL, FEM69, FEMD107, FEMD107SC, FEMD108, FEMD108EL, FEMD109, FEMD207, FEMD207SC, FEMD67, FEMD67SC, FEMD68, FEMD68EL, FEMD69, FEP050, FEP080, FEP160, FGM107, FGM107SC, FGM108, FGM108EL, FGM110, FGM110L, FGM207, FGM207SC, FGM210, FGM210L, FGM610...(Other models you can see in the webshop)		

accessories



GEV No.	890866	Ref. No.	RTFOC00401
description	bush for door handle		
For models:	FCE10, FCE6, FCG10, FCG20, FCG6, FEM107SC, FEM109, FEM207SC, FEM209, FEM67SC, FEM69, FEMD107SC, FEMD109, FEMD207SC, FEMD209, FEMD67SC, FEMD69, FEP050, FEP080, FEP160, FGM107SC, FGM109, FGM207SC, FGM209, FGM67SC, FGM69, FGMD107SC, FGMD109, FGMD207, FGMD207SC, FGMD209, FGMD67SC, FGMD69, FGP050, FGP080, FGP160, JOKER FCE 6, JOKER FCE 10, JOKER FCG 6, JOKER FCG 10, JOKER FEM 67 SC, JOKER FEM 69, JOKER FEM107 SC, JOKER FEM109, JOKER FEM207 SC, JOKER FEM209, JOKER FEMD 67 SC, JOKER FEMD 69, JOKER FEMD107 SC, JOKER FEMD109...(Other models you can see in the webshop)		

miscellaneous



GEV No.	693634	Ref. No.	RTFOC00156
description	atomizer		
For models:	FEC100, FEC200, FEM100, FEM101, FEM102, FEM200, FEM201, FEM202, FEM207, FEM207SC, FEM209, FEM210, FEM210L, FEMD100, FEMD101, FEMD200, FEMD201, FEMD207, FEMD207SC, FEMD209, FEP080, FEP160, FGC100, FGC200, FGM100, FGM101, FGM102, FGM200, FGM201, FGM202, FGM207, FGM207SC, FGM209, FGMD100, FGMD101, FGMD200, FGMD201, FGMD207, FGMD207SC, FGMD209, FGP080, FGP160, FMM100, FMM101, JOKER FEM207 SC, JOKER FEM209, JOKER FEMD207 SC, JOKER FEMD209, JOKER FEP160, JOKER FGM207 SC...(Other models you can see in the webshop)		



GEV No.	693635	Ref. No.	168344 RTFOC00437
description	atomizer		
For models:	FEC065, FEM107SC, FEM109, FEM610, FEM610L, FEM67, FEM67SC, FEM68, FEM68EL, FEM69, FEMD065, FEMD066, FEMD107SC, FEMD109, FEMD67, FEMD67SC, FEMD68, FEMD68EL, FEMD69, FEP050, FEP080, FGM107SC, FGM109, FGM610, FGM610L, FGM67, FGM67SC, FGM68, FGM68EL, FGM69, FGMD107SC, FGMD109, FGMD67, FGMD67SC, FGMD68, FGMD68EL, FGMD69, FGP050, FGP080, JOKER FEM 67 SC, JOKER FEM 69, JOKER FEM 69 AB 2002, JOKER FEM107 SC, JOKER FEM109, JOKER FEMD 67 SC, JOKER FEMD 69, JOKER FEMD107 SC, JOKER FEMD109, JOKER FEP050, JOKER FEP050 AB 2002...(Other models you can see in the webshop)		

EQUIPMENT-SPECIFIC UNITS MBM-ITALIEN



GEV No.	693798	Ref. No.	161477
description	door bumper		
For models:	FCE10, FCE20, FCE6, FCG10, FCG20, FCG6, FEM107, FEM107SC, FEM108, FEM108EL, FEM109, FEM110, FEM110L, FEM207, FEM207SC, FEM210, FEM210L, FEM610, FEM610L, FEM67, FEM67SC, FEM68, FEM68EL, FEM69, FEMD107, FEMD107SC, FEMD108, FEMD108EL, FEMD109, FEMD207, FEMD207SC, FEMD67, FEMD67SC, FEMD68, FEMD68EL, FEMD69, FEP050, FEP080, FEP160, FGM107, FGM107SC, FGM108, FGM108EL, FGM110, FGM110L, FGM207, FGM207SC, FGM210, FGM210L, FGM610...(Other models you can see in the webshop)		



GEV No.	693788	Ref. No.	RTFOC00212
description	valve steam vent valve		
For models:	FEM060, FEM061, FEM062, FEM100, FEM101, FEM102, FEM107, FEM108, FEM108EL, FEM110, FEM110L, FEM200, FEM201, FEM202, FEM207, FEM210, FEM210L, FEM610, FEM610L, FEM67, FEM68, FEM68EL, FEMD108, FEMD108EL, FEMD68, FEMD68EL, FGM060, FGM061, FGM062, FGM100, FGM101, FGM102, FGM107, FGM107SC, FGM108, FGM108EL, FGM110, FGM110L, FGM200, FGM201, FGM202, FGM207, FGM210, FGM210L, FGM610, FGM610L, FGM67, FGM67SC, FGM68, FGM68EL...(Other models you can see in the webshop)		


for tilting bratt pans

gearboxes



GEV No.	693642	Ref. No.	RTBF900109
description	gearbox motor shaft \varnothing 19mm flange \varnothing 118mm transmission l=1/60 drive shaft \varnothing 30mm flange \varnothing 1 80mm fixing dimensions 105mm type VU-70		
For models:	EBR, EBRA, EBRAVI, EBRVI, GBR, GBRA, GBRAVI, GBRVI		

spindles



1

GEV No.	693638	Ref. No.	182078 RTCU700510
description	threaded rod		
For models:	EBR7, EBR77, EBR8, EBRI7, EBRI77, EBRVC98, EBRVI8, EBRVI98, GBR7, GBR77, GBR8, GBRI7, GBRI77, GBRVC98, GBRVI8, GBRVI98, MG7EBR77, MG7EBRI77, MG7GBR77, MG7GBRI77, OMNIA EBR7, OMNIA EBRI7, OMNIA GBR7, OMNIA GBRI7		

miscellaneous



1

GEV No.	693639	Ref. No.	RTCU700514
description	threaded bush for tilting bratt pan		
For models:	EBR7, EBR77, EBRI7, GBR7, GBR77, GBRI7, GBRI77, OMNIA EBR7, OMNIA EBRI7, OMNIA GBR7, OMNIA GBRI7		

for ovens

doors



1

GEV No.	691253	Ref. No.	PACU700569
description	oven door		
For models:	E4F7, E4F7Q, E6FA7, E6FA7Q, EF07, EF07V, EFO7, EFO7V, EVC4F7, G2SDMF7, G2SDMFE7, G2SSMF7, G2SSMFE7, G4SF7, G4SFE7, G4SMFA7, G6SFA7, G6SFEA7, GF07, GFO7, GT2SDFA7, GT2SSFA7, GT4SF27, GT4SF2E7, GT4SFA7, GTF7		

for pizza ovens

miscellaneous




1

GEV No.	700908	Ref. No.	PACU700177
description	bottom plate L 580mm W 535mm H 17mm thickness 3.5mm		
For models:	C4EF70, C6EF70		

for sliding doors

stand-offs



1

GEV No.	690468	Ref. No.	011359-00-R
description	distance washer		

for dishwashers

containers

container lids



1

GEV No.	510109	Ref. No.	480006
description	lid for salt tank		
For models:	LB42BT-UK, LBD40, LBDX40, LF56, LF60, LFD50, LFDX50, LS520-CRP, LS521		




1

GEV No.	510110	Ref. No.	429012
description	lid for salt tank		
For models:	LB42BT-UK, LBD40, LBDX40, LF56, LF60, LFD50, LFDX50, LS520-CRP, LS521, LS521-CRP-SP		

salt tanks







1			
GEV No.	524177	Ref. No.	480005
description	lid ø 69mm H 20mm for salt tank ID ø 50mm		
For models:	KLB40, LB135, LB140, LB145, LB35, LB350, LB35C, LB40, LB400, LB405, LB40E, LB411, LB411A, LB422, LB425, LB45, LBD40, LF50, LF500, LF55, LF550, LF551, LF55E, LF56, LF59, LF60, LFD50, LS500, LS500A, LS500GA, LS501, LS501A, LS501GA, LS505M, LS505T, LS511, LS511A, LS520		
accessories for	524177		
	GEV No.	524148	Ref. No. —
	O-ring EPDM thickness 3.53mm ID ø 40.86mm Qty 1 pcs		



1			
GEV No.	510018	Ref. No.	429011
description	nut ø 92mm H 10.5mm for salt tank ID ø 64mm		
For models:	KLB40, LB135, LB140, LB145, LB35, LB350, LB35C, LB40, LB400, LB405, LB40E, LB411, LB411A, LB422, LB45, LF50, LF500, LF55, LF550, LF551, LF55E, LF56, LF59, LF60, LFD50, LS500, LS500A, LS500GA, LS501, LS501A, LS501GA, LS505M, LS505T, LS511, LS511A, LS520		



1			
GEV No.	510032	Ref. No.	406998
description	salt tank without gasket new model		
For models:	KLB40, LB135, LB140, LB145, LB35, LB350, LB35C, LB40, LB400, LB405, LB40E, LB411, LB411A, LB422, LB45, LF50, LF500, LF55, LF550, LF551, LF55E, LF56, LF59, LF60, LFD50, LS500, LS500A, LS500GA, LS501, LS501A, LS501GA, LS505M, LS505T, LS511, LS511A, LS520		
spare parts for	510032		
	GEV No.	506015	Ref. No. 456052
	O-ring EPDM thickness 3.53mm ID ø 39.69mm Qty 1 pcs		
	GEV No.	510018	Ref. No. 429011
	nut ø 92mm H 10.5mm for salt tank ID ø 64mm		
	GEV No.	510071	Ref. No. 437034
	flat gasket rubber ED ø 81mm ID ø 68mm thickness 3mm for salt tank Qty 1 pcs		

spare parts for	510032		
	GEV No.	524177	Ref. No. 480005
	lid ø 69mm H 20mm for salt tank ID ø 50mm		

accessories



1			
GEV No.	517802	Ref. No.	466008
description	extension for salt tank Qty 1 pcs L 78mm ID ø 38mm		
For models:	LB425		



1			
GEV No.	510071	Ref. No.	437034
description	flat gasket rubber ED ø 81mm ID ø 68mm thickness 3mm for salt tank Qty 1 pcs		
For models:	KLB40, LB135, LB140, LB145, LB35, LB350, LB35C, LB40, LB400, LB405, LB40E, LB411, LB411A, LB422, LB42BT-UK, LB45, LBD40, LBDX40, LF50, LF500, LF55, LF550, LF551, LF55E, LF56, LF59, LF60, LFD50, LFDX50, LS500, LS500A, LS500GA, LS501, LS501A, LS501GA, LS505M, LS505T, LS511, LS511A, LS520, LS520-CRP, LS521, LS521-CRP-SP		

boilers

boilers for dishwashers




1			
GEV No.	513241	Ref. No.	926026 DAB290
description	boiler		
For models:	L600, L61, L62, L63, LK1000, LK1010, S58		




1			
GEV No.	513242	Ref. No.	DAB296
description	boiler		
For models:	L64, LK1100, LK1300		



			
1			
GEV No.	513243	Ref. No.	80389
description	boiler		
For models:	GOLD74, LK100, LK100EM, LK110, LK130, LK611, LKD130, LO65		

			
1			
GEV No.	518373	Ref. No.	104027
description	boiler		
For models:	LB145		


			
1			
GEV No.	518375	Ref. No.	104033
description	boiler		
For models:	LBD40		

			
1			
GEV No.	518376	Ref. No.	104047.SO
description	boiler		
For models:	LB45		

			
1			
GEV No.	518378	Ref. No.	104030
description	boiler		
For models:	LF550, LF551, LF59		

			
1			
GEV No.	518576	Ref. No.	104050
description	boiler		
For models:	LF55, LF55E, LFD60		

			
1			
GEV No.	513709	Ref. No.	104056
description	boiler ø 110mm L 295mm		
For models:	KLB40, LB350, LB355, LB400, LB405, LB411, LB411A, LB422		

			
1			
GEV No.	501512	Ref. No.	104063
description	boiler ø 110mm L 300mm hose ø 6/11mm		
For models:	LB425		

			
1			
GEV No.	518235	Ref. No.	104060
description	boiler ø 145mm L 405mm flange 3 hole flange		
For models:	LK600, LK605, LK622, LK622I, LS500, LS500A, LS500G, LS500GA, LS500GPV, LS500PV, LS501, LS501A, LS501G, LS501GA, LS501GPV, LS501PV, LS505, LS505M, LS505T, LS511, LS511A, LS511PV, LS520, LS522		

			
1			
GEV No.	501511	Ref. No.	104061
description	boiler ø 145mm L 420mm hose ø 18/27mm		
For models:	LK620, LK621, LK625, LOD102, LOD202, LOD302, LOD304, LOD402, LS520-CRP, LS521, LS521-CRP-SP, LS525		






			
1			
GEV No.	518377	Ref. No.	104026
description	boiler ø 150mm L 360mm		
For models:	LF50, LF500, LF55		

			
1			
GEV No.	517447	Ref. No.	982019
description	boiler ø 155mm L 405mm inlet ø 11		
For models:	LFDX50		


			
1			
GEV No.	517455	Ref. No.	41230
description	boiler ø 210mm L 405mm		
For models:	LO155, LO93, LOD155, LP155, LP80, LP80H, LP93		


			
1			
GEV No.	698808	Ref. No.	43550
description	boiler ø 210mm L 500mm		
For models:	LOD305, LOD502		


			
1			
GEV No.	518588	Ref. No.	104039
description	boiler with heating element 2600W 230V ø 110mm L 295mm		
For models:	LB135, LB140		
spare parts for	518588		
	GEV No.	513709	Ref. No.
			104056
	boiler ø 110mm L 295mm		

			
1			
GEV No.	518098	Ref. No.	104043.SO 104044.SO
description	boiler with safety thermostat 2600W 230V ø 110mm L 295mm W 110mm H 115mm connection 11mm hose ø 6mm with thermostat inlet ø 11mm		
For models:	LB135, LB140, LB35, LB35C, LB40, LB40E		
spare parts for	518098		
	GEV No.	390233	Ref. No.
			236039 926189 DRT140
	bi-metal safety thermostat hole distance 24mm switch-off temp. 110°C 1NC 1-pole 16A connection F6.3 2 hole fixing without holder		
	GEV No.	390319	Ref. No.
			236048
	bi-metal thermostat hole distance 23.8mm switch-off temp. 80°C 1NC 1-pole 16A connection F6.3 2 hole fixing		
	GEV No.	418642	Ref. No.
			230113
	heating element 2600W 230V mounting ø 38.5mm heating circuits 1 L 260mm W 33mm H 24mm number of thermostat sleeves 1 thermostat sleeves ø 7mm length thermostat sleeves 175mm thermostat sleeve eccentric, non clinging tube ø 6.5mm hole distance 57mm 3 hole flange connection male faston 6.3mm immersion heater		
	GEV No.	521120	Ref. No.
			456075
	O-ring EPDM thickness 5.34mm ID ø 37.47mm Qty 1 pcs		

accessories

			
1			
GEV No.	518348	Ref. No.	468117 REB468117
description	hose connector		
For models:	L600, L61, L62, L63, L64, LF50, LF500, LF55, LF550, LF551, LF55E, LK1000, LK1010, LK1100, LK1300, LO155, LO80, LO80H, LO93, LOD155, LOD80, LOD80H, LOD93, LP155, LP80, LP80H, LP93, S58		

			
1			
GEV No.	507451	Ref. No.	926027 DAR49
description	insulating mat for boiler L 455mm W 405mm thickness 6mm		
For models:	L600, L61, L62, L63, L64, LK1000, LK1010, S58		

			
1			
GEV No.	517799	Ref. No.	143228
description	pipe for boiler ø 9mm L 245mm		
For models:	KLB40, LB35, LB350, LB355, LB35C, LB40, LB400, LB405, LB40E, LB411, LB411A, LB422, LB45, LB450		



gaskets



GEV No.	698802	Ref. No.	35510
description	gasket L 65mm W 10mm H 4mm thickness 4mm		
For models:	LFD60, LO65, LOD102, LOD65, LP800-00-092, LP92		

softener cartridges

softening columns



GEV No.	530395	Ref. No.	117007
description	softener 4-fold L 380mm W 180mm		
For models:	LB350, LB400, LB405, LB411, LB411A, LB422, LS500, LS500A, LS500GA, LS501, LS501A, LS501GA, LS505M, LS505T, LS511A, LS520		

spare parts and accessories



GEV No.	692041	Ref. No.	023415-00
description	mounting clip		
For models:	A140N2, A70N1, AX140B2, AX140N2, AX70B1, AX70N1, B140N2, B70N1, BX140B2, BX1420N2, BX70B1, BX70N1, D140B2, D140DN2, D140DNB2, D140DNP2, D140DNP3, D140N2, D140N2V, D140P2, D70B1, D70N1, D70N1V, D70P1, DX70B1V		

housing and bezels

fascias



GEV No.	518581	Ref. No.	480099
description	end cap for control panel mounting pos. left		
For models:	LF500		



GEV No.	518582	Ref. No.	480100
description	end cap for control panel mounting pos. right		
For models:	LF500		

flanges



GEV No.	699252	Ref. No.	75057
description	flange H 40mm ø 130mm mounting pos. lower		
For models:	LT81, LTD101, LTD131, LTD171, LTD209, LTD212, LTD216, LTD220, LTD316, LTD320, LTD326, LTDX172, LTDX222, LTDX272		




GEV No.	699251	Ref. No.	75141
description	flange H 65mm ø 130mm mounting pos. upper		
For models:	LT81, LTD101, LTD131, LTD171, LTD209, LTD212, LTD216, LTD220, LTD316, LTD320, LTD326, LTDX172, LTDX222, LTDX272		

miscellaneous



GEV No.	513000	Ref. No.	480057
description	lid rubber ED ø 27mm		
For models:	LB145, LB45, LB450, LF50, LF500, LF55, LF550, LF551, LF55E, LK1000, LS500, LS500A, LS500G, LS500GA, LS500GPV, LS500PV, LS501, LS501A, LS501G, LS501GA, LS501GPV, LS501PV, LS505M, LS505T, LS511, LS511A, LS511PV, LS520, LS520-CRP		




			
1			
GEV No.	513708	Ref. No.	480058
description	lid rubber ø 17mm mounting ø 17mm		
For models:	LB42BT-UK, LBD40, LBDX40, LF50, LF500, LF55, LF550, LF551, LF55E, LS500, LS500A, LS500G, LS500GA, LS500GPV, LS500PV, LS501, LS501A, LS501G, LS501GA, LS501GPV, LS501PV, LS505M, LS505T, LS511, LS511A, LS511PV, LS520		


gearboxes


			
1			
GEV No.	518634	Ref. No.	927102
description	gearbox motor shaft ø 14mm flange ø 160mm drive shaft ø 25mm type VF49A60		
For models:	LT161, LT221, LT81, LTD101, LTD209, LTD212		

hood mechanics for dishwashers


<p>bolts</p> 			
1			
GEV No.	513200	Ref. No.	80131
description	screw bolt hood mechanics		
For models:	GOLD74, LK100, LK110, LK130, LKD130, LKDX110		

bushes


			
1			
GEV No.	518561	Ref. No.	36426
description	bush hood mechanics mounting pos. inner		
For models:	L61, L62, L63, L64, LK1000, LK1010, LK1100, LK1300		

			
1			
GEV No.	518562	Ref. No.	36425
description	bush hood mechanics mounting pos. outer		
For models:	L61, L62, L63, L64, LK1000, LK1010, LK1100, LK1300		


<p>spring holders</p> 			
1			
GEV No.	513205	Ref. No.	926004
description	spring holder hood mechanics		
For models:	LK1000		


			
1			
GEV No.	518563	Ref. No.	36429
description	spring holder hood mechanics		
For models:	L61, L62, L63, L64, LK1000, LK1010, LK1100, LK1300		

springs

			
1			
GEV No.	517448	Ref. No.	926108
description	tension spring ø 30mm total length 505mm wire gauge ø 5.5mm for hood mechanics Qty 1 pcs		
For models:	GOLD74, LK100, LK110, LK130, LK611, LK620, LK621, LK622I, LK625, LKD130, LKDX110		

guide bars

			
1			
GEV No.	513724	Ref. No.	80068 80069
description	guide bar L 590mm hood mechanics		
For models:	GOLD74, LK100, LK100EM, LK110, LK130, LK600, LK605, LK611, LK620, LK621, LK622, LK622I, LK625, LKD130, LKDX110		

			
1			
GEV No.	698803	Ref. No.	41038
description	sliding rail L 458mm mounting pos. rear W 21mm H 20mm		
For models:	LO155, LO80, LO80H, LO93, LOD155, LOD202, LOD80, LOD80H, LOD93, LP155, LP80, LP80H, LP93		



hood handles



1

GEV No.	513719	Ref. No.	80027
description	hood handle		
For models:	GOLD74, LK100, LK100EM, LK110, LK130, LK600, LK605, LK611, LK622, LKD130, LKDX110		

hood handle supports



1

GEV No.	513202	Ref. No.	80190
description	bearing for hood handle plastic		
For models:	GOLD74, LK100, LK100EM, LK110, LK130, LK600, LK605, LK611, LK620, LK621, LK622, LK622I, LK625, LKD130, LKDX110		



1

GEV No.	513192	Ref. No.	926243 DWP910
description	guide for hood handle		
For models:	L61, L62, L63, L64, LK100EM, LK600, LK605, LK611, LK620, LK621, LK622, LK622I, LK625		

rollers



1

GEV No.	518539	Ref. No.	926006
description	roller hood mechanics complete		
For models:	LK1000		



1

GEV No.	513201	Ref. No.	80132
description	roller ø 36/42mm H 34mm hood mechanics plastic grey hole ø 12mm		
For models:	GOLD74, LK100, LK110, LK130, LKD130, LKDX110		

miscellaneous



1

GEV No.	513198	Ref. No.	80130
description	base for roller ED ø 64mm ID ø 8.5mm hood mechanics grey		
For models:	GOLD74, LK100, LK110, LK130, LKD130, LKDX110		



1

GEV No.	698811	Ref. No.	41100
description	door bumper ED ø 20mm H 20mm		
For models:	LOD402, LOD502		




1

GEV No.	508375	Ref. No.	80105
description	fixing support		
For models:	GOLD74, LFD60, LK100, LK100EM, LK110, LK130, LK600, LK605, LK611, LK620, LK621, LK622, LK622I, LK625, LKD130, LKDX110, LO65, LOD102, LOD65, LP800-00-092, LP92		



1

GEV No.	518537	Ref. No.	926003
description	handle holder hood mechanics		
For models:	LK1000		



1

GEV No.	513274	Ref. No.	80998
description	hexagonal screw thread M4 plastic WS 7 thread L 6mm		
For models:	GOLD74, LK100, LK100EM, LK110, LK600, LK605, LK611, LK620, LK621, LK622, LK622I, LK625, LKD130, LKDX110		



1

GEV No.	518538	Ref. No.	926002
description	opposite support hood mechanics		
For models:	LK1000		

basket guides


guide bars



1

GEV No.	530558	Ref. No.	015039
description	guide bar mounting pos. left L 422mm W 43mm H 39mm		
For models:	KLB40, LB140, LB40, LB400, LB405, LB40E, LB411, LB411A		

basket holders



1

GEV No.	699347	Ref. No.	75076
description	buffer for basket transport L 25m ø 17.5mm		
For models:	LT81, LTD101, LTD131, LTD171, LTD209, LTD212, LTD216, LTD220, LTD316, LTD320, LTD326, LTDX172, LTDX222, LTDX272		



1

GEV No.	699344	Ref. No.	75058
description	roller for basket H 35mm ø 45mm		
For models:	LT81, LTD101, LTD131, LTD171, LTD209, LTD212, LTD216, LTD220, LTD316, LTD320, LTD326, LTDX172, LTDX222, LTDX272		


air traps

air traps



1




GEV No.	518488	Ref. No.	107005	
description	air trap			
For models:	KLB40, LB135, LB140, LB145, LB35, LB350, LB355, LB35C, LB40, LB400, LB405, LB40E, LB411, LB411A, LB45, LB450, LF50, LF500, LF55, LF550, LF551, LF55E, LF59, LK1000, LS500, LS500A, LS500G, LS500GA, LS500GPV, LS500PV, LS501, LS501A, LS501G, LS501GA, LS501GPV, LS501PV, LS505, LS505M, LS505T, LS511, LS511A, LS511PV, LS520			
accessories for	518488			
	GEV No.	504618	Ref. No.	3600035 RIC0004173 RTCU700623
	O-ring EPDM thickness 2.62mm ID ø 15.54mm Qty 1 pcs			
	GEV No.	510075	Ref. No.	437019
	flat gasket rubber ED ø 22mm ID ø 13mm thickness 1.5mm Qty 1 pcs			
	GEV No.	510106	Ref. No.	468029
	hose connector for air trap			








1


GEV No.	518641	Ref. No.	984007
description	air trap complete ø 34mm H 70mm hose ø 6mm		
For models:	LS505M, LS505T		




			
GEV No.	519499	Ref. No.	107012
description	air trap L 46mm W 35mm H 72mm thread 3/4" hose ø 5.5mm plastic		
For models:	LB42BT-UK, LBD40, LBDX40, LFD50, LFDX50, LK611, LK620, LK621, LK622, LK622I, LK625, LOD102, LOD202, LOD302, LOD304, LOD305, LOD402, LOD502, LS520-CRP, LS521, LS521-CRP-SP		
accessories for	519499		
	GEV No.	516261	Ref. No. 437098
	flat gasket rubber ED ø 33mm ID ø 25mm thickness 2.5mm for air trap Qty 1 pcs		
	GEV No.	519498	Ref. No. 417120
	nut thread 3/4" H 10mm WS 30 plastic Qty 1 pcs		


			
GEV No.	518200	Ref. No.	984005 REB984005
description	air trap ø 34mm H 78mm hose ø 6mm plastic		
For models:	GOLD74, KLB40, L600, L61, L62, L63, L64, LB135, LB140, LB145, LB35, LB350, LB355, LB35C, LB40, LB400, LB405, LB40E, LB411, LB411A, LB45, LB450, LF50, LF500, LF55, LF550, LF551, LF55E, LF59, LFD60, LK100, LK1000, LK100EM, LK1010, LK110, LK1100, LK130, LK1300, LKD130, LKDX110, LO155, LO65, LO80, LO80H, LO93, LOD155, LOD65, LOD80, LOD80H, LP155...(Other models you can see in the webshop)		
spare parts for	518200		
	GEV No.	504618	Ref. No. 3600035 RIC0004173 RTC0700623
	O-ring EPDM thickness 2.62mm ID ø 15.54mm Qty 1 pcs		
	GEV No.	510075	Ref. No. 437019
	flat gasket rubber ED ø 22mm ID ø 13mm thickness 1.5mm Qty 1 pcs		
	GEV No.	510106	Ref. No. 468029
	hose connector for air trap		


			
GEV No.	511959	Ref. No.	107014
description	air trap ø 42mm hose ø 6mm plastic		
For models:	LB422, LB425, LK600, LK605, LS522, LS525		

			
GEV No.	511993	Ref. No.	107013
description	air trap ø 43mm H 33mm hose ø 6mm plastic		
For models:	LB422, LB425, LK600, LK605, LS522, LS525		


			
GEV No.	524810	Ref. No.	144027 144032
description	air trap W 95mm H 150mm hose ø 6/8mm plastic		
For models:	LB425, LK620, LK621, LK625, LOD102, LOD202, LOD302, LOD304, LOD305, LOD402, LOD502, LS520-CRP, LS521, LS521-CRP-SP, LS525		

air trap accessories


			
GEV No.	510075	Ref. No.	437019
description	flat gasket rubber ED ø 22mm ID ø 13mm thickness 1.5mm Qty 1 pcs		
For models:	KLB40, LB135, LB140, LB145, LB35, LB350, LB355, LB35C, LB40, LB400, LB405, LB40E, LB411, LB411A, LB45, LB450, LF50, LF500, LF55, LF550, LF551, LF55E, LF59, LK1000, LS500, LS500A, LS500G, LS500GA, LS500GPV, LS500PV, LS501, LS501A, LS501G, LS501GA, LS501GPV, LS501PV, LS505, LS505M, LS505T, LS511, LS511A, LS511PV, LS520		

			
GEV No.	510106	Ref. No.	468029
description	hose connector for air trap		
For models:	KLB40, LB135, LB140, LB145, LB35, LB350, LB355, LB35C, LB40, LB400, LB405, LB40E, LB411, LB411A, LB45, LB450, LF50, LF500, LF55, LF550, LF551, LF55E, LF59, LK1000, LK600, LK605, LS500, LS500A, LS500G, LS500GA, LS500GPV, LS500PV, LS501, LS501A, LS501G, LS501GA, LS501GPV, LS501PV, LS505, LS505M, LS505T, LS511, LS511A, LS511PV, LS520, LS522, LS525		


mechanics for flight type dishwashers

			
GEV No.	699351	Ref. No.	75231
description	cover for eccentrics plastic D1 ø 147mm D2 ø 32.6mm		
For models:	LT81, LTD101, LTD131, LTD171, LTD209, LTD212, LTD216, LTD220, LTD316, LTD320, LTD326, LTDX172, LTDX222, LTDX272		




1 


GEV No.	504423	Ref. No.	927048
description	protector L 230mm W 95mm H 16mm hole ø 25x7mm thickness 4mm		
For models:	LT161, LT221, LT271, LT272, LT362, LT81, LTD101, LTD131, LTD171, LTD316, LTD320, LTD326, LTDX172, LTDX222, LTDX272		

1 

GEV No.	504389	Ref. No.	927092 DWR120
description	roller for transport system L 30mm ID ø 16mm ED ø 30mm		
For models:	LT121, LT150, LT151, LT152, LT161, LT202, LT221, LT271, LT272, LT362, LT91		

1 

GEV No.	524511	Ref. No.	927082 DNR1
description	roller for transport system W 20mm ED ø 24.5mm hole ø 8mm		
For models:	LT121, LT150, LT151, LT152, LT161, LT202, LT221, LT271, LT272, LT362, LT91		

1 


GEV No.	511996	Ref. No.	927083 DAN35SB
description	tappet for dishwasher right L 62mm W 52mm H 19mm hole ø 12mm		
For models:	LT121, LT150, LT151, LT152, LT161, LT202, LT221, LT271, LT272, LT362, LT91		

pulleys

1 

GEV No.	693828	Ref. No.	RTBF900124
description	round belt pulley disc ø 212mm single shaft intake ø 19mm groove depth 11mm disc width 16mm groove width 10mm overall width 26mm shaft ø 48mm		
For models:	EBR, EBRA, EBRAVI, EBRVI, GBR, GBRA, GBRAVI, GBRVI		

pipes

1 

GEV No.	698771	Ref. No.	42028
description	aspiration tube tube ø 60.5mm L 87mm ID ø 57mm		
For models:	LOD402, LOD502, LTD209, LTD212, LTD216, LTD220, LTD316, LTD320, LTD326		

1 

GEV No.	698805	Ref. No.	43560
description	T-piece for dishwasher tube ø 27mm L 115mm		
For models:	LOD305, LOD502		

backflow preventers


1 

GEV No.	698704	Ref. No.	144993
description	air valve for drain hose D1 ø 21mm D2 ø 10.5mm		
For models:	LB425, LK621		


1 


GEV No.	698703	Ref. No.	144995
description	air valve for drain hose D1 ø 21mm D2 ø 6mm ID ø 17mm		
For models:	LK600, LK605		




 <p>1</p>			
GEV No.	518297	Ref. No.	144011
description	backflow preventer		
For models:	LBD40, LF50, LF500, LF55, LF550, LF551, LF55E, LS500, LS500A, LS500G, LS500GA, LS500GPV, LS500PV, LS501, LS501A, LS501G, LS501GA, LS501GPV, LS501PV, LS505M, LS505T, LS511, LS511A, LS511PV, LS520		


 <p>1</p>			
GEV No.	514502	Ref. No.	144030
description	backflow preventer plastic hose ø 11mm		
For models:	LB355, LB405, LB422, LS505M, LS505T, LS522		

 <p>1</p>			
GEV No.	518486	Ref. No.	144010 144010NT REB144010NT
description	backflow preventer connection 1/2" dishwasher hose ø 12mm		
For models:	GOLD74, KLB40, L61, L62, L63, L64, LB135, LB140, LB145, LB35, LB350, LB355, LB35C, LB40, LB400, LB405, LB40E, LB411, LB411A, LB422, LB425, LB45, LB450, LF56, LF59, LF60, LFD50, LFD60, LK100, LK1000, LK100EM, LK1010, LK110, LK1100, LK130, LK1300, LK600, LK605, LK611, LK622, LK622I, LKD130, LO65, LS505, LT121, LT150, LT151, LT152, LT161, LT202...(Other models you can see in the webshop)		


<p>accessories</p>			
 <p>1</p>			
GEV No.	511997	Ref. No.	476008
description	ball for back flow restrictor ø 8mm plastic		
For models:	LB422, LB425, LBD40, LBDX40, LFDX50, LK600, LK605, LK621, LS505M, LS505T, LS521, LS521-CRP-SP, LS522, LS525		

<p>miscellaneous</p>			
 <p>1</p>			
GEV No.	513139	Ref. No.	DWP725
description	connecting fitting		
For models:	S58		

 <p>1</p>			
GEV No.	517572	Ref. No.	144992
description	backflow preventer for drain hose ø 31/21mm		
For models:	LB422, LB425, LS505M, LS505T		

 <p>1</p>			
GEV No.	518241	Ref. No.	480087
description	cover		
For models:	KLB40, LB140, LB355, LB400, LB405, LB411, LB411A, LBD40, LBDX40		

 <p>1</p>			
GEV No.	512446	Ref. No.	144991
description	backflow preventer hose ø 11mm		
For models:	LS522, LS525		

 <p>1</p>			
GEV No.	518184	Ref. No.	325047
description	extension		
For models:	LB42BT-UK, LBD40, LBDX40		



1

GEV No.	519481	Ref. No.	927110 DWB934
description	heater battery L 440mm W 260mm H 195mm		
For models:	LT121, LT150, LT151, LT152, LT161, LT202, LT221, LT271, LT272, LT362, LT81, LT91, LTD101, LTD131, LTD171, LTDX172, LTDX222, LTDX272		



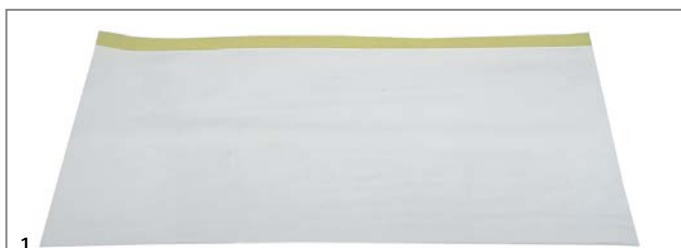
1

GEV No.	698872	Ref. No.	480153
description	lid for housing H 8mm D1 ø 27mm D2 ø 17mm		
For models:	LB422, LB425		



1

GEV No.	698716	Ref. No.	CWP2
description	PCB support L 34mm		
For models:	GOLD74, LK100, LK110, LK130, LK600, LK605, LK611, LK622, LK622I, LO155, LO65, LO80, LO80H, LO93, LOD202, LOD302, LOD304, LOD402		



1

GEV No.	343006	Ref. No.	214086
description	protective film for dishwasher self-adhesive L 485mm W 360mm Qty 1 pcs		
For models:	LBD40, LBDX40, LF50, LF500, LF56, LF59, LF60, LFD50, LFDX50, LK600, LK605, LS500, LS500A, LS500PV, LS501, LS501A, LS501PV, LS505		



1

GEV No.	698871	Ref. No.	419036
description	spacer for PCB L 18mm W 6mm D1 ø 6mm D2 ø 3mm		
For models:	LB40E, LB411, LB411A, LB422, LB425, LB42BT-UK, LBD40, LBDX40, LF55E, LF56, LF60, LFD50, LFDX50, LK620, LK621, LK622, LK622I, LK625, LOD102, LOD202, LOD302, LOD304, LOD305, LOD402, LOD502, LS511, LS511A, LS511PV, LS520-CRP, LS521, LS521-CRP-SP, LS522, LS525, LTD209, LTD212, LTD216, LTD220		

1			
GEV No.	698875	Ref. No.	461028
description	spacer for PCB L 19mm D1 ø 10mm		
For models:	LB355, LB405, LK605, LS522, LS525		

door mechanics

spare parts and accessories



1

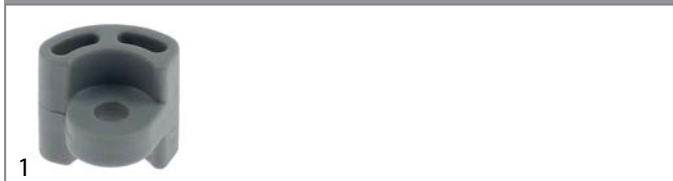
GEV No.	507579	Ref. No.	75064
description	catch hook for door		
For models:	LTD171, LTD216, LTD220, LTD316, LTD320, LTD326, LTDX172, LTDX222, LTDX272		



1

GEV No.	507580	Ref. No.	75226
description	catch hook for door		
For models:	LT81, LTD101, LTD131, LTD171, LTD209, LTD212, LTD216, LTD220, LTD316, LTD320, LTD326, LTDX172, LTDX222, LTDX272		

spring holders



1

GEV No.	551324	Ref. No.	307014
description	spring holder H 16mm L 17mm W 20mm		
For models:	LS522, LS525		

springs

miscellaneous





1

GEV No.	698809	Ref. No.	449058
description	spring L 170mm W 75mm		
For models:	LS522, LS525		





tension springs


1 			
GEV No.	701154	Ref. No.	449063
description	tension spring ø 10.5mm total length 200mm wire gauge ø 1.3mm for door mechanism		
For models:	LS522, LS525		

1 			
GEV No.	701227	Ref. No.	449057 H.227855 H.231937
description	tension spring ø 10mm total length 155mm wire gauge ø 1.1mm L1 60mm L2 11mm for door mechanism		
For models:	LF56, LF60, LFD50, LFDX50, LS520-CRP, LS521, LS521-CRP-SP		

linkage



1 			
GEV No.	698800	Ref. No.	44593
description	bar L 670mm thread M6/M10 ø 10mm		
For models:	LOD302, LOD304, LOD305, LOD402, LOD502		

1 			
GEV No.	518558	Ref. No.	DAT43
description	door pin complete with threaded shaft tie bar		
For models:	L600, S58		



1 			
GEV No.	518362	Ref. No.	304024
description	door pin door pin		
For models:	LF56, LF60, LFD50, LFDX50, LS520-CRP, LS521, LS521-CRP-SP		

1 			
GEV No.	518355	Ref. No.	304021
description	door pin stop rod		
For models:	LB145, LB45, LB450, LF50, LF500, LF55, LF550, LF551, LF55E, LF59, LS500, LS500A, LS500G, LS500GA, LS500GPV, LS500PV, LS501, LS501A, LS501G, LS501GA, LS501GPV, LS501PV, LS505, LS505M, LS505T, LS511, LS511A, LS511PV, LS520		


threaded shafts


1 			
GEV No.	518559	Ref. No.	DWP380
description	threaded shaft		
For models:	L600, S58		
accessories for	518559		
	GEV No.	518560	Ref. No. —
retaining ring E D1 ø 7mm D2 ø 14mm DIN 6799			

sliding plates


1 			
GEV No.	519407	Ref. No.	DAP74
description	sliding plate dimensions 60x15mm		
For models:	S58		
accessories for	519407		
	GEV No.	519406	Ref. No. DAP83
gasket for sliding plate dimensions 69x16mm			

1 			
GEV No.	517801	Ref. No.	307012
description	sliding plate L 75mm W 12mm H 10mm		
For models:	LF56, LF60, LFD50, LFD60, LFDX50, LO65, LOD102, LOD65, LP800-00-092, LP92, LS520-CRP, LS521, LS521-CRP-SP		

1 			
GEV No.	518356	Ref. No.	307003
description	sliding plate sliding plate		
For models:	LB145, LB45, LB450, LF50, LF500, LF55, LF550, LF551, LF55E, LF59, LS500, LS500A, LS500G, LS500GA, LS500GPV, LS500PV, LS501, LS501A, LS501G, LS501GA, LS501GPV, LS501PV, LS505, LS505M, LS505T, LS511, LS511A, LS511PV, LS520		

1 			
GEV No.	518353	Ref. No.	307005
description	stop plastic for door L 60mm W 12.5mm H 10mm		
For models:	KLB40, LB140, LB40, LB400, LB405, LB40E, LB411, LB411A		

hinges

1 			
GEV No.	504797	Ref. No.	35060
description	door hinge mounting pos. left ø 10mm L 70mm		
For models:	LFD60, LO65, LOD102, LOD65, LP800-00-092, LP92		



1

GEV No.	518301	Ref. No.	311019
description	door hinge mounting pos. left/right		
For models:	LB145, LB45, LB450, LF50, LF500, LF55, LF550, LF551, LF55E, LF59, LS500, LS500A, LS500G, LS500GA, LS500GPV, LS500PV, LS501, LS501A, LS501G, LS501GA, LS501GPV, LS501PV, LS505, LS505M, LS505T, LS511, LS511A, LS511PV, LS520		



2

GEV No.	518122	Ref. No.	030157
description	hinge complete for dishwasher L 588mm		
For models:	LF56, LF60, LFD50, LFDX50, LS520-CRP, LS521, LS521-CRP-SP		



1

GEV No.	510090	Ref. No.	449036
description	spring door lock spring mounting pos. door lock		
For models:	KLB40, LB135, LB140, LB35, LB350, LB355, LB35C, LB40, LB400, LB405, LB40E, LB411, LB411A, LB422, LB425		

hinge camps



1

GEV No.	518262	Ref. No.	311009
description	hinge camp mounting pos. left		
For models:	KLB40, LB135, LB140, LB35, LB350, LB355, LB35C, LB40, LB400, LB405, LB40E, LB411, LB411A		



1

GEV No.	518261	Ref. No.	311008
description	hinge camp mounting pos. right		
For models:	KLB40, LB135, LB140, LB35, LB350, LB355, LB35C, LB40, LB400, LB405, LB40E, LB411, LB411A		

hinge pins



1

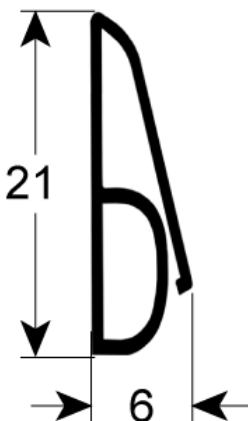
GEV No.	518264	Ref. No.	325034
description	hinge pin hinge pin		
For models:	KLB40, LB140, LB40, LB400, LB405, LB40E, LB411, LB411A, LB422, LB425		



1

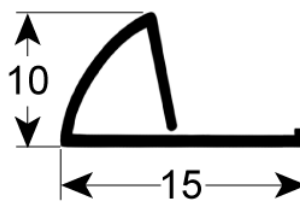
GEV No.	518267	Ref. No.	325036
description	hinge pin hinge pin		
For models:	LB145, LB45, LB450, LF50, LF500, LF55, LF550, LF551, LF55E, LF59, LS500, LS500A, LS500G, LS500GA, LS500GPV, LS500PV, LS501, LS501A, LS501G, LS501GA, LS501GPV, LS501PV, LS505, LS505M, LS505T, LS511, LS511A, LS511PV, LS520		

door seals



1

GEV No.	512459	Ref. No.	43383
description	door seal L 1400mm W 21mm		
For models:	LOD502		



1

GEV No.	512461	Ref. No.	437109
description	door seal L 450mm W 17mm		
For models:	LB422, LB425		



GEV No.	512472	Ref. No.	35017
description	door seal L 625mm W 21mm		
For models:	LOD102		

GEV No.	512471	Ref. No.	41583
description	door seal L 740mm W 21mm		
For models:	LOD202, LOD302		

GEV No.	512460	Ref. No.	42783
description	door seal L 800mm W 21mm		
For models:	LOD402		

door guides

GEV No.	698744	Ref. No.	307015
description	door guides L 109mm W 24.5mm H 18mm mounting pos. left/right		
For models:	LS522, LS525		

GEV No.	698743	Ref. No.	307016
description	door guides L 88.5mm W 14mm H 6.3mm		
For models:	LB422, LB425		

GEV No.	698797	Ref. No.	310013
description	guide L 30mm W 17mm H 17mm mounting pos. right/left		
For models:	LS522, LS525		

door frames

GEV No.	901694	Ref. No.	41197
description	frame for door mounting pos. upper W 34mm L 595mm SS mounting distance 225mm		
For models:	LO80, LO80H, LOD202, LOD302, LOD80, LP80, LP80H		

door bumpers

GEV No.	518066	Ref. No.	417041
description	door bumper end stop		
For models:	LB145, LB45, LB450, LF50, LF500, LF55, LF550, LF551, LF55E, LF59, LS500, LS500A, LS500G, LS500GA, LS500GPV, LS500PV, LS501, LS501A, LS501G, LS501GA, LS501GPV, LS501PV, LS505, LS505M, LS505T, LS511, LS511A, LS511PV, LS520		



1
GEV No. 518354 **Ref. No.** 028078

description door bumper slotted hole disc

For models: KLB40, LB140, LB40, LB400, LB405, LB40E, LB411, LB411A, LF60, LFD50, LFDX50

door shafts



1
GEV No. 513140 **Ref. No.** DWP37

description door shaft

For models: L600, S58



1
GEV No. 518263 **Ref. No.** 304017

description door shaft

For models: LB135, LB35, LB350, LB355, LB35C

locks



1
GEV No. 518242 **Ref. No.** 329012

description door catch

For models: KLB40, LB135, LB140, LB35, LB350, LB355, LB35C, LB40, LB400, LB405, LB40E, LB411, LB411A, LB422, LB425



1
GEV No. 518244 **Ref. No.** 994011

description door catch catch



1
GEV No. 513138 **Ref. No.** 994012
 DWS30

description door catch with nut door locking catch

For models: BETA50, BETA53, L600, LB145, LB45, LB450, LF50, LF500, LF55, LF550, LF551, LF55E, LF59, LS500, LS500A, LS500G, LS500GA, LS500GPV, LS500PV, LS501, LS501A, LS501G, LS501GA, LS501GPV, LS501PV, LS505, LS505M, LS505T, LS511, LS511A, LS511PV, LS520, S58



1
GEV No. 518245 **Ref. No.** 325030

description spigot door catch

For models: LB145, LB45, LB450, LF50, LF500, LF55, LF550, LF551, LF55E, LF59



1
GEV No. 518298 **Ref. No.** 325066

description spigot door catch

For models: LS500, LS500A, LS500G, LS500GA, LS500GPV, LS500PV, LS501, LS501A, LS501G, LS501GA, LS501GPV, LS501PV, LS505, LS505M, LS505T, LS511, LS511A, LS511PV, LS520

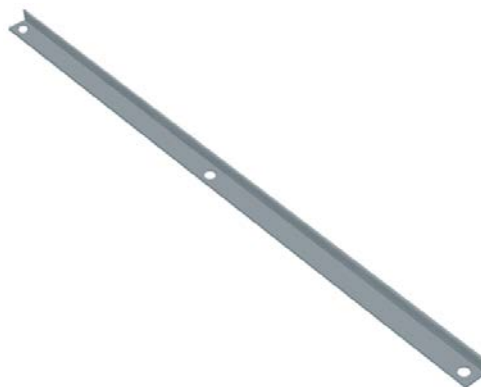
miscellaneous



1
GEV No. 513203 **Ref. No.** 80277

description bracket for lever

For models: GOLD74, LK100, LK100EM, LK110, LK130, LK600, LK605, LK611, LK620, LK621, LK622, LK622I, LK625, LKD130, LKDX110





1
GEV No. 518247 **Ref. No.** 033291


description fastening angle for door seal

For models: LB135, LB35, LB350, LB355, LB35C





			
1			
GEV No.	518249	Ref. No.	033294
description	fastening angle for door seal		
For models:	KLB40, LB140, LB40, LB400, LB405, LB40E, LB411, LB411A		


			
1			
GEV No.	519406	Ref. No.	DAP83
description	gasket for sliding plate dimensions 69x16mm		
For models:	L600, S58		


			
1			
GEV No.	518522	Ref. No.	311013
description	hinge hinge		
For models:	LB42BT-UK, LBD40, LBDX40		


			
1			
GEV No.	513204	Ref. No.	80275
description	opposite support for spring \varnothing 28mm L 100mm		
For models:	GOLD74, LK100, LK100EM, LK110, LK130, LK600, LK605, LK611, LK620, LK621, LK622, LK622I, LK625, LKD130, LKDX110		


			
1			
GEV No.	698708	Ref. No.	486224
description	screw ED \varnothing 8.5mm ID \varnothing 4.8mm L 12mm thread M5		
For models:	LF56, LF60, LFD50, LFDX50, LS520-CRP, LS521, LS521-CRP-SP		

			
1			
GEV No.	698748	Ref. No.	35013
description	side panel for door L 235mm W 100mm thickness 2mm		
For models:	LFD60, LO65, LOD102, LOD65, LP800-00-092, LP92		

screw connections			
			
1			
GEV No.	519498	Ref. No.	417120
description	nut thread 3/4" H 10mm WS 30 plastic Qty 1 pcs		
For models:	LB42BT-UK, LBD40, LBDX40, LFD50, LFDX50, LK611, LK620, LK621, LK622, LK622I, LK625, LOD102, LOD202, LOD302, LOD304, LOD305, LOD402, LOD502, LS511, LS511A, LS511PV, LS520-CRP, LS521, LS521-CRP-SP		

			
1			
GEV No.	698874	Ref. No.	417119
description	nut thread M3 H 3.5mm plastic Qty 1 pcs for PCB		
For models:	LB40E, LB411, LB411A, LB422, LB425, LB42BT-UK, LBD40, LBDX40, LF55E, LF56, LF60, LFD50, LFDX50, LK620, LK621, LK622, LK622I, LK625, LOD102, LOD202, LOD302, LOD304, LOD305, LOD402, LOD502, LS511, LS511A, LS511PV, LS520-CRP, LS521, LS521-CRP-SP, LS522, LS525, LTD209, LTD212, LTD216, LTD220		

			
1			
GEV No.	698705	Ref. No.	429075
description	screw H 14mm WS 22 Qty 1 pcs plastic for air valve		
For models:	LK621, LS522, LS525		

			
1			
GEV No.	698876	Ref. No.	486078
description	screw thread M6x30mm Qty 1 pcs SS		
For models:	LOD202, LOD302, LOD304, LOD305, LOD402, LOD502, LT81, LTD101, LTD131, LTD171, LTD209, LTD212, LTD216, LTD220, LTD316, LTD320, LTD326, LTDX172, LTDX222, LTDX272		

curtains

curtains



GEV No.	533008	Ref. No.	75120
description	curtain W 540mm H 405mm plastic thickness 1.3mm		
For models:	LT81, LTD101, LTD131, LTD171, LTD209, LTD212, LTD216, LTD220, LTD316, LTD320, LTD326, LTDX172, LTDX222, LTDX272		
accessories for	533008		
	GEV No.	Ref. No.	75121
	curtain rod L 545mm ø 8mm		



GEV No.	533018	Ref. No.	77120
description	curtain W 585mm H 400mm		
For models:	LTD216, LTD220, LTD320, LTD326		



GEV No.	533007	Ref. No.	75123
description	curtain W 620mm H 250mm thickness 1.4mm		
For models:	LT81, LTD101, LTD131, LTD171, LTD209, LTD212, LTD216, LTD220, LTD316, LTD320, LTD326, LTDX172, LTDX222, LTDX272		

curtain rods



GEV No.	533009	Ref. No.	75121
description	curtain rod L 545mm ø 8mm		
For models:	LT81, LTD101, LTD131, LTD171, LTD209, LTD212, LTD216, LTD220, LTD316, LTD320, LTD326, LTDX172, LTDX222, LTDX272		



GEV No.	533019	Ref. No.	75124
description	curtain rod L 620mm ø 8mm		
For models:	LT81, LTD101, LTD131, LTD171, LTD209, LTD212, LTD216, LTD220, LTD316, LTD320, LTD326, LTDX172, LTDX222, LTDX272		

washing and rinsing systems



GEV No.	513271	Ref. No.	412028
description	connector holder grey		
For models:	KLB40, LB135, LB140, LB35, LB35C, LB40, LB40E, LF50, LF55, LF55E		



GEV No.	517568	Ref. No.	41064
description	counterflange for wash arm support ø 69mm ID ø 63mm H 35mm mounting distance 64mm hole ø 7mm		
For models:	LO155, LO80, LO80H, LO93, LOD155, LOD202, LOD302, LOD304, LOD305, LOD402, LOD502, LOD80, LOD80H, LOD93, LP155, LP80, LP80H, LP93		

accessories for	517568		
	GEV No.	Ref. No.	42053
	extension for rinsing shaft ø 16mm H 122mm thread L 12mm WS 19		

	GEV No.	Ref. No.	926252 CGR4275
	O-ring EPDM thickness 3.53mm ID ø 69.85mm Qty 1 pcs		

	GEV No.	Ref. No.	41185
	throttle disc ø 71.5mm hole ø 17/22mm		






GEV No.	517441	Ref. No.	41064CP
description	counterflange for wash arm support with throttle disc ø 70mm ID ø 63mm L 110mm W 89mm H 35mm		
For models:	LO155, LO80, LO80H, LO93, LOD155, LOD202, LOD302, LOD304, LOD305, LOD402, LOD502, LOD80, LOD80H, LOD93, LP80		


spare parts for	517441		
	GEV No.	Ref. No.	41185
	throttle disc ø 71.5mm hole ø 17/22mm		


Table continues overleaf





accessories for 517441			
	GEV No. 531605	Ref. No. 42053	
extension for rinsing shaft ø 16mm H 122mm thread L 12mm WS 19			
	GEV No. 532603	Ref. No. 926252 CGR4275	
O-ring EPDM thickness 3.53mm ID ø 69.85mm Qty 1 pcs			


			
1			
GEV No. 518473	Ref. No. 927084		
description disc ID ø 12.2mm ED ø 19.3mm thickness 1.3mm			
For models: LT161, LT221, LT271, LT272, LT362			


			
1			
GEV No. 518461	Ref. No. 303029		
description flange for wash arm support			
For models: LF50, LF500, LF55, LF550, LF551, LF55E, LS500, LS500A, LS500G, LS500GA, LS500GPV, LS500PV, LS501, LS501A, LS501G, LS501GA, LS501GPV, LS501PV, LS505M, LS505T, LS511, LS511A, LS511PV, LS520			


			
1			
GEV No. 507545	Ref. No. 437091		
description flat gasket PTFE ED ø 13mm ID ø 7mm thickness 0.65mm Qty 1 pcs			
For models: LB42BT-UK, LBD40, LBDX40, LF56, LF59, LF60, LFD50, LFDX50, LS521			


			
1			
GEV No. 518240	Ref. No. 437078		
description flat gasket rubber ED ø 33mm ID ø 17mm thickness 1.5mm Qty 1 pcs			
For models: KLB40, LB135, LB140, LB35, LB350, LB355, LB35C, LB40, LB400, LB405, LB40E, LB411, LB411A, LB42BT-UK, LBD40, LBDX40, LFDX50, LKDX110, LO155, LO65, LO80, LO80H, LO93, LOD155, LOD65, LOD80, LOD80H, LOD93, LP80, LP800-00-092, LP92, LS522, LS525			


			
1			
GEV No. 507541	Ref. No. 437102		
description flat gasket rubber ED ø 74mm ID ø 57mm thickness 2mm Qty 1 pcs			
For models: LB425, LK600, LK605, LS505M, LS505T, LS522, LS525			


			
1			
GEV No. 518444	Ref. No. 199051 480008		
description flow control valve for wash arm ø 16mm H 20mm			
For models: KLB40, LB140, LB40, LB400, LB40E, LB411, LB411A			


			
1			
GEV No. 513228	Ref. No. 926035 CGM3		
description gasket			
For models: L61, L62, L63, L64, LK1000, LK1010, LK1100, LK1300			

			
1			
GEV No. 513277	Ref. No. 437080		
description gasket			
For models: KLB40, LB140, LB355, LB40, LB400, LB405, LB40E, LB411, LB411A, LB422, LS505M, LS505T, LS522			

			
1			
GEV No. 518594	Ref. No. 437037		
description gasket for rinse connection			
For models: LB145, LB45, LB450			


			
1			
GEV No. 518071	Ref. No. 80178		
description gasket for wash arm support L 109mm W 68mm			
For models: GOLD74, LK100, LK100EM, LK110, LK130, LK600, LK605, LK611, LK620, LK621, LK622, LK622I, LK625, LKD130, LKDX110			

			
1			
GEV No. 518116	Ref. No. H.172986-19		
description gasket for wash arm support rubber ø 60mm ID ø 47mm thickness 1mm			
For models: LF56, LF59, LF60, LFD50, LFDX50			




1

GEV No.	518595	Ref. No.	111001
description	hose connector double		
For models:	LB145, LB45, LB450		




1

GEV No.	513158	Ref. No.	80365
description	knurled nut		
For models:	GOLD74, LK100, LK100EM, LK110, LK621, LO65, LOD155, LOD202, LOD302, LOD304, LOD305, LOD80, LOD80H, LOD93, LP80		




1

GEV No.	518286	Ref. No.	472068
description	knurled nut		
For models:	LF56, LF59, LF60, LFD50, LFDX50, LS521		




1

GEV No.	518665	Ref. No.	454006
description	knurled nut mounting pos. upper/lateral \varnothing 19.65mm H 4mm thread M5		
For models:	LB350, LB400, LB411		




1

GEV No.	517444	Ref. No.	80697
description	knurled nut thread M10x1 \varnothing 25mm H 4mm SS		
For models:	LB355, LB405, LB411, LB411A, LB422, LB425, LK605, LK622, LK622I, LK625, LS500, LS500A, LS500PV, LS501, LS501A, LS501PV, LS505M, LS505T, LS511, LS511A, LS511PV, LS520-CRP, LS521-CRP-SP, LS522, LS525		




1

GEV No.	518238	Ref. No.	143173 143268 REB143173
description	manifold \varnothing 12mm L 98mm		
For models:	BETA50, BETA53, GOLD74, L600, L61, L62, L63, L64, LB135, LB140, LB145, LB35, LB40, LB40E, LB422, LB425, LB42BT-UK, LB45, LB450, LBD40, LBDX40, LF50, LF500, LF55, LF550, LF551, LF55E, LF56, LF59, LF60, LFDX50, LK100, LK1000, LK100EM, LK1010, LK110, LK1100, LK130, LK1300, LK600, LK605, LK611, LK620, LK621, LK622, LK622I, LK625, LKD130, LKDX110, LO155...(Other models you can see in the webshop)		



1

GEV No.	518181	Ref. No.	429053
description	nut		
For models:	LB42BT-UK, LBD40, LBDX40		




1

GEV No.	518593	Ref. No.	417039
description	nut for rinse pipe		
For models:	LB145, LB45, LB450		



1


GEV No.	517454	Ref. No.	308031
description	nut for wash arm ED \varnothing 35mm thickness 11mm plastic		
For models:	LB411, LB411A, LFD50, LFDX50, LK600, LS500, LS500A, LS500G, LS500GA, LS500GPV, LS500PV, LS501, LS501A, LS501G, LS501GA, LS501GPV, LS501PV, LS505, LS511, LS511A, LS511PV, LS520, LS520-CRP, LS521, LS521-CRP-SP		





1


GEV No.	518637	Ref. No.	429073
description	nut for wash arm support thread M56x2		
For models:	LB425, LK600, LK605, LS505M, LS505T, LS522, LS525		





			
1			
GEV No.	513026	Ref. No.	CDO112
description	nut thread 1/2" SS H 14mm WS 24 Qty 1 pcs		
For models:	L61, L62, L63, L64, LK1000, LK1010, LK1100, LK1300		


			
1			
GEV No.	513259	Ref. No.	111026
description	rinse arm support mounting pos. upper		
For models:	KLB40, LB140, LB40, LB400, LB40E, LB411, LB411A		


			
1			
GEV No.	518596	Ref. No.	417038
description	nut wash pipe		
For models:	KLB40, LB140, LB145, LB40, LB400, LB40E, LB411, LB411A, LB45, LB450		


			
1			
GEV No.	518434	Ref. No.	429050
description	rinse arm support mounting pos. upper		
For models:	KLB40, LB135, LB140, LB35, LB350, LB355, LB35C, LB40, LB400, LB405, LB40E, LB411, LB411A, LB42BT-UK, LBDX40, LFDX50, LKDX110, LO155, LO65, LO80, LO80H, LO93, LOD155, LOD65, LOD80, LOD80H, LOD93, LP80, LP800-00-092, LP92		

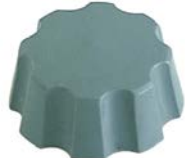
			
1			
GEV No.	518086	Ref. No.	80174
description	opposite support		
For models:	LK600, LK605, LK611, LK620, LK621, LK622, LK622I, LK625		


			
1			
GEV No.	518443	Ref. No.	468165
description	rinse arm support mounting pos. upper		
For models:	KLB40, LB135, LB140, LB35, LB350, LB355, LB35C, LB40, LB400, LB405, LB40E, LB411, LB411A, LB42BT-UK, LBDX40, LFDX50, LK621, LKDX110, LO155, LO65, LO80, LO80H, LO93, LOD155, LOD65, LOD80, LOD80H, LOD93, LP80, LP800-00-092, LP92, LS522, LS525, LT81, LTD101, LTD131, LTD171, LTDX172, LTDX222, LTDX272		


			
1			
GEV No.	518091	Ref. No.	80181
description	opposite support		
For models:	GOLD74, LK100, LK100EM, LK110, LK130, LO65		


			
1			
GEV No.	518125	Ref. No.	143240
description	rinse hose ø 17.5mm		
For models:	LF50, LF55, LF55E, LS500, LS500A, LS500G, LS500GA, LS500GPV, LS500PV, LS501, LS501A, LS501G, LS501GA, LS501GPV, LS501PV, LS505M, LS505T, LS511, LS511A, LS511PV, LS520		


			
1			
GEV No.	518089	Ref. No.	80184
description	retaining ring for wash arm ID ø 40mm ED ø 44mm thickness 3mm		
For models:	GOLD74, LK100, LK100EM, LK110, LK130, LK600, LK620, LK621, LO65, LOD102, LOD65, LP800-00-092, LP92		


			
1			
GEV No.	518003	Ref. No.	447030 447128
description	screw cap		
For models:	LB145, LB45, LB450, LF50, LF500, LF55, LF550, LF551, LF55E, LS500, LS500A, LS500G, LS500GA, LS500GPV, LS500PV, LS501, LS501A, LS501G, LS501GA, LS501GPV, LS501PV, LS505, LS511, LS511A, LS511PV, LS520		


			
1			
GEV No.	524811	Ref. No.	303037
description	ring for wash arm ID ø 41mm ED ø 45mm thickness 3mm plastic		
For models:	LK605, LK622, LK622I, LK625, LS522, LS525		


			
1			
GEV No.	513286	Ref. No.	80281
description	screw connection		
For models:	LFD60, LK100, LK100EM, LK110, LK611, LK620, LK621, LK622, LK622I, LK625, LKD130, LKDX110, LO65, LOD102, LOD65, LP800-00-092, LP92		


			
1			
GEV No.	518288	Ref. No.	429069
description	screw connection		
For models:	LF56, LF59, LF60, LFD50, LFDX50, LS505, LS520-CRP, LS521, LS522, LS525		


			
1			
GEV No.	510011	Ref. No.	429008
description	screw connection plastic		
For models:	KLB40, LB135, LB140, LB145, LB35, LB350, LB355, LB35C, LB40, LB400, LB405, LB40E, LB411, LB411A, LB45, LB450		


			
1			
GEV No.	517443	Ref. No.	80623
description	slide ring for rinse arm mounting pos. upper/lower PTFE ED ø 22mm ID ø 9.5mm thickness 1mm		
For models:	LB355, LB405, LB411, LB411A, LB422, LB425, LS500, LS500A, LS500PV, LS501, LS501A, LS501PV, LS505M, LS505T, LS511, LS511A, LS511PV, LS520-CRP, LS521-CRP-SP, LS522, LS525		


			
1			
GEV No.	518485	Ref. No.	419030
description	spacer rod		
For models:	LB145, LB45, LB450		


			
1			
GEV No.	513270	Ref. No.	80316
description	throttle disc		
For models:	GOLD74, LFD60, LK100, LK100EM, LK110, LK130, LK611, LK620, LK621, LK622, LK622I, LK625, LKD130, LKDX110, LO65, LOD102, LOD65, LP800-00-092, LP92		

			
1			
GEV No.	518284	Ref. No.	199053
description	throttle disc		
For models:	LF56, LF60, LFD50, LFDX50, LS520-CRP, LS521, LS521-CRP-SP		


			
1			
GEV No.	518337	Ref. No.	199039
description	throttle disc		
For models:	LF500		


			
1			
GEV No.	518458	Ref. No.	199045
description	throttle disc		
For models:	LF50, LF500, LF55, LF550, LF551, LF55E		


			
1			
GEV No.	518459	Ref. No.	199043
description	throttle disc		
For models:	LF50, LF500, LF55, LF550, LF551, LF55E, LK1000		


			
1			
GEV No.	518032	Ref. No.	199027
description	throttle disc ED ø 34mm ID ø 13.2mm thickness 1mm		
For models:	LF50, LF55, LF55E		





			
1			
GEV No.	510112	Ref. No.	454002
description	Thumb screw thread M10 thread L 10mm ø 22mm H 4.5mm SS		
For models:	LB145, LB45, LB450, LF50, LF500, LF55, LF550, LF551, LF55E, LS500, LS500A, LS500G, LS500GA, LS500GPV, LS500PV, LS501, LS501A, LS501G, LS501GA, LS501GPV, LS501PV, LS505, LS511, LS511A, LS511PV, LS520		


			
1			
GEV No.	518484	Ref. No.	449045
description	wash arm support for stationary arms mounting pos. upper		
For models:	KLB40, LB140, LB145, LB40, LB400, LB40E, LB411, LB411A, LB45, LB450		


			
1			
GEV No.	513229	Ref. No.	926036 DAC14
description	wash arm support mounting pos. upper		
For models:	L61, L62, L63, L64, LK1000, LK1010, LK1100, LK1300		

			
1			
GEV No.	518580	Ref. No.	115129
description	wash arm support mounting pos. upper		
For models:	LF59, LS505		

			
1			
GEV No.	513714	Ref. No.	80237
description	wash pipe		
For models:	GOLD74, LK100, LK100EM, LK110, LK130, LK611, LK620, LK621, LK622, LK622I, LK625, LKD130, LKDX110, LO65		
spare parts for	513714		
	GEV No.	518141	Ref. No.
			80179
	wash arm support thread M46x2 ø 44mm ID ø 39mm L 112.5mm W 86mm hole ø 12mm		


			
1			
GEV No.	518633	Ref. No.	115128 115139
description	wash pipe		
For models:	LF56, LF60, LFD50, LFDX50, LS520-CRP, LS521, LS521-CRP-SP		



			
1			
GEV No.	518645	Ref. No.	115140
description	wash pipe L 690mm		
For models:	LS522, LS525		

			
1			
GEV No.	519493	Ref. No.	75165
description	wash pipe ø 48mm L 617mm plastic		
For models:	LT81, LTD101, LTD131, LTD171, LTD209, LTD212, LTD216, LTD220, LTD320, LTD326, LTDX222, LTDX272		

knobs


universal knobs

			
1			
GEV No.	110253	Ref. No.	8335612010-R RTFOC00251
description	knob switch zero mark t.max.°C ø 50mm shaft ø 6x4.6mm shaft flat upper black		
For models:	FGM107SC, FGM109, FGM67SC, FGM69, JOKER FGM 67 SC, JOKER FGM 69, JOKER FGM107 SC, JOKER FGM109		

			
1			
GEV No.	111934	Ref. No.	3700057
description	knob thermostat t.max. 90°C ø 50mm shaft ø 6x4.6mm shaft flat upper black temperature range 30-90°C rotation 270°		
For models:	BC2G, BC3G, BC4G, BC6G		
accessories for	111934		
	GEV No.	110135	Ref. No.
			—
	rosette knob up to ø 52mm		


producer-specific knobs

MBM ITALY




1

GEV No.	110041	Ref. No.	RTCU900028
description	knob gas tap with ignition flame ø 65mm shaft ø 10x8mm shaft flat left black		
For models:	BST2LV, BST2RV, BST6LV, BST6RV, C2A, C4A, C4A70, C4AV70, C4F, C4F70, C4F702P, C4FV70, C4FV702P, C62F, C6A, C6A70, C6AV70, C6F, C6F70, C6F702P, C6FA, C6FV70, C6FV702P, C8A, C8F, SAG, TPA, TPF70, TPFV70		




1

GEV No.	110040	Ref. No.	RTCU700031
description	knob gas thermostat 1-8 ø 65mm shaft ø 8x6.5mm shaft flat lower red		




1

GEV No.	110766	Ref. No.	RTCU700031
description	knob gas thermostat 1-8 ø 65mm shaft ø 8x6.5mm shaft flat lower red		
For models:	BST2LV, BST2RV, BST6LV, BST6RV, C4F70, C4FV70, C6F70, C6FV70, FT2GL70, FT2GR70, FT4GL, FT4GL70, FT4GLR, FT4GLR70, FT4GR, FT4GR70, TPF70, TPFV70		




1

GEV No.	110768	Ref. No.	RTCU700075
description	knob switch 7-position ø 65mm shaft ø 6x4.6mm shaft flat upper black		
For models:	C4EF70, C6EF70		




1

GEV No.	110297	Ref. No.	RTCU800014
description	knob gas tap with ignition flame ø 76mm shaft ø 10x8mm shaft flat left black		
For models:	G100, G100A, G100I, G100IA, G150, G150A, G150I, G150IA, G175, G2S, G2SAP, G2SP, G4S, G4SAP, G4SF, G4SFE, G4SFP, G6S, G6SF2, G6SFA, G6SFEA, G8S, G8SAP, G8SF2, G8SF2E, G8SF2P, GC45, GC90, GC902V, GPL45, GPL90, GT, GT2S, GT2SD, GT2SDF, GT2SDFE, GT2SFA, GT2SFEA, GTF, GTFE		





1

GEV No.	112094	Ref. No.	164360 168852
description	knob gas tap with ignition flame ø 76mm shaft ø 10x8mm shaft flat upper black		
For models:	G100, G100I, G150, G150I, G2S, G4S, G4SF, G4SF-1, G4SFE, G6S, G6SF2, G6SFA, G6SFEA, G6SFM, GC45, GC902V, GPL45-P, GPL90-P, GT, GT2SDF, GTF		





1

GEV No.	112091	Ref. No.	164377
description	knob switch 0-1 ø 76mm shaft ø 6x4.6mm shaft flat right black		
For models:	EF45, EF90		
accessories for	112091		
	GEV No.	550132	Ref. No. RTCU900304
knob spring ø 6x4.6mm Qty 10 pcs			





1

GEV No.	110827	Ref. No.	RTCU800062
description	knob switch 0-1 ø 76mm shaft ø 6x4.6mm shaft flat upper black		
For models:	EBM45, EBM90, EBR, EBRA, EBRAVI, EBRVI, EF45, EF90, GBR, GBRA, GBRAVI, GBRVI		
accessories for	110827		
	GEV No.	550132	Ref. No. RTCU900304
knob spring ø 6x4.6mm Qty 10 pcs			






1

GEV No.	112090	Ref. No.	164374
description	knob switch 4-position ø 76mm shaft ø 6x4.6mm shaft flat right black		
For models:	E100I, E150I, EC45, EC902V		
accessories for	112090		
	GEV No.	550132	Ref. No. RTCU900304
	knob spring ø 6x4.6mm Qty 10 pcs		





1

GEV No.	110807	Ref. No.	RTCP800104
description	knob switch 4-position ø 76mm shaft ø 6x4.6mm shaft flat upper black		
For models:	E100, E100A, E100I, E100IA, E150, E150A, E150I, E150IA, EC45, EC902V		
accessories for	110807		
	GEV No.	550132	Ref. No. RTCU900304
	knob spring ø 6x4.6mm Qty 10 pcs		




1

GEV No.	112095	Ref. No.	164388
description	knob switch 7-position ø 76mm shaft ø 6x4.6mm shaft flat right black		
For models:	E2A, E4A, E4F, E6FA		
accessories for	112095		
	GEV No.	550132	Ref. No. RTCU900304
	knob spring ø 6x4.6mm Qty 10 pcs		




1

GEV No.	110769	Ref. No.	RTCU800059
description	knob switch 7-position ø 76mm shaft ø 6x4.6mm shaft flat upper black		
For models:	E2A, E2AR, E4A, E4AR, E4F, E6A, E6AR, E6FAR		




1

GEV No.	112087	Ref. No.	164362 168853
description	knob water cold ø 76mm shaft ø 10x8mm shaft flat upper		
For models:	E100I, E150I, EBM45, EBM90, EC45, EC902V, G100, G100I, G150, G150I, GBM45, GBM90, GC45, GC902V		




1

GEV No.	112096	Ref. No.	164390
description	knob water hot ø 76mm shaft ø 10x8mm shaft flat upper		
For models:	E100I, E150I, G100, G100I, G150, G150I		



1

GEV No.	112093	Ref. No.	164393 168856
description	knob gas thermostat 1-8 ø 76mm shaft ø 10x8mm shaft flat left		
For models:	G6SF2		



1

GEV No.	110298	Ref. No.	RTCU800018 RTCU800019
description	knob gas thermostat 1-8 ø 76mm shaft ø 10x8mm shaft flat left red		
For models:	G4SF, G4SFP, G6SF2, G6SFA, G8SF2, G8SF2P, GBM90, GFT45L, GFT45LC, GFT45R, GFT45RC, GFT47L, GFT47LC, GFT47R, GFT47RC, GFT77L, GFT77LC, GFT77LR, GFT77LRC, GFT77R, GFT77RC, GFT90L, GFT90LC, GFT90LR, GFT90LRC, GFT90R, GFT90RC, GT2SDF, GT2SFA, GTF		



1

GEV No.	112086	Ref. No.	164396 168858
description	knob gas thermostat t.max. 90°C 45-90°C ø 76mm shaft ø 10x8mm shaft flat upper red		
For models:	EBM90, GBM45, GBM90		



1

GEV No.	112089	Ref. No.	164392 168855
description	knob thermostat 1-8 ø 76mm shaft ø 10x8mm shaft flat lower red		
For models:	G4SF, G4SF-1, G6SFA, G6SFM, GT2SDF, GTF		



1

GEV No.	112092	Ref. No.	164395
description	knob thermostat 1-8 ø 76mm shaft ø 10x8mm shaft flat upper red		
For models:	GFT45L, GFT45LC, GFT45R, GFT45RC, GFT90L, GFT90LC, GFT90LR, GFT90LRC, GFT90R, GFT90RC		



1

GEV No.	111760	Ref. No.	RTBF800085
description	knob thermostat 1-8 t.max.°C ø 76mm shaft ø 8x5.5mm shaft flat upper		
For models:	EBR, EBRA, EBRAVI, EBRVI, GBR, GBRA, GBRAVI, GBRVI		



1

GEV No.	112814	Ref. No.	173970
description	knob thermostat ø 76mm shaft ø 6x4.6mm shaft flat left		



1

GEV No.	112088	Ref. No.	164376
description	knob thermostat t.max. 200°C ø 76mm shaft ø 6x4.6mm shaft flat right red temperature range 60-200°C		
For models:	EF45, EF90		



1

GEV No.	110826	Ref. No.	RTCU800060
description	knob thermostat t.max. 200°C ø 76mm shaft ø 6x4.6mm shaft flat upper red temperature range 60-200°C		
For models:	EF45, EF90		



1

GEV No.	112097	Ref. No.	164389
description	knob thermostat t.max. 300°C ø 76mm shaft ø 6x4.6mm shaft flat right red temperature range 50-300°C		
For models:	E4F, EFT45L, EFT45LC, EFT45R, EFT45RC, EFT90L, EFT90LC, EFT90LR, EFT90LRC, EFT90R, EFT90RC, G4SFE, G6SFEA		



1

GEV No.	110299	Ref. No.	RTCU700076 RTCU800103
description	knob thermostat t.max. 300°C ø 76mm shaft ø 6x4.6mm shaft flat upper red temperature range 50-300°C rotation 270°		
For models:	C4EF70, C6EF70, E4F, E6FAR, E6FM, EBR, EBRA, EFT45L, EFT45LC, EFT45R, EFT45RC, EFT90L, EFT90LC, EFT90LR, EFT90LRC, EFT90R, EFT90RC, G4SFE, G6SFEA, G8SF2, G8SF2E, GC90, GT2SDFE, GT2SFEA, GTFE		



1			
GEV No.	112099	Ref. No.	164391
description	knob thermostat t.max. 90°C ø 76mm shaft ø 6x4.6mm shaft flat upper		
For models:	EBM45		

1			
GEV No.	111928	Ref. No.	RTCU700276
description	knob without symbol ø 70mm		
For models:	MINIMA E26, MINIMA E46, MINIMA E4F6, MINIMA E66, MINIMA E6F6, MINIMA E6FA6, MINIMA EBM 46, MINIMA EBM 66, OMNIA E4F7, OMNIA E4F7Q, OMNIA E6FA7, OMNIA E6FA7Q, OMNIA EBM 47, OMNIA EBM 77, OMNIA EF07, OMNIA EVC4F7, OMNIA G4SFE7, OMNIA G6SFEA7		

1			
GEV No.	112665	Ref. No.	168868
description	knob without symbol ø 70mm shaft ø 10x8mm shaft flat left/right black		


1			
GEV No.	112104	Ref. No.	168877
description	knob without symbol ø 70mm shaft ø 6x4.6mm shaft flat upper		
For models:	G2SF6G, G3SF6G		

1							
GEV No.	112663	Ref. No.	168878				
description	knob without symbol ø 70mm shaft ø 6x4.6mm shaft flat upper/lower						
For models:	EBR77, EC66, EFP01, MG7AQE477, MG7AQE777, MG7E277Q, MG7E2A77, MG7E2A77Q, MG7E2AP77Q, MG7E477, MG7E477Q, MG7E4A77, MG7E4A77Q, MG7E4AP77Q, MG7E4F77, MG7E4F77Q, MG7E4FP77Q, MG7E4FVP77Q, MG7E50177, MG7E6A77, MG7E6A77Q, MG7E6FA77Q, MG7EA477I, MG7EA777I, MG7EBM477, MG7EBMA477, MG7EBR77, MG7EBRI77, MG7EC477-SC, MG7EC777-SC, MG7EF477, MG7EF4772V, MG7EF4772VT, MG7EF477T, MG7EF777, MG7EF777T, MG7EFT477L, MG7EFT477LC, MG7EFT477R, MG7EFT777L, MG7EFT777LC, MG7EFT777LR, MG7EFT777LRC, MG7EFT777R, MG7EFTA477L, MG7EFTA477LC, MG7EFTA477R, MG7EFTA777L, MG7EFTA777LC, MG7EFTA777LR...(Other models you can see in the webshop)						
accessories for	112663						
		<table border="1"> <tr> <td>GEV No.</td> <td>112782</td> <td>Ref. No.</td> <td>RTCU600194</td> </tr> </table>	GEV No.	112782	Ref. No.	RTCU600194	knob dial plate oven t.max. 270°C 60-270°C rotation 270° turn direction left ED ø 62mm ID ø 42mm grey
GEV No.	112782	Ref. No.	RTCU600194				

1			
GEV No.	112196	Ref. No.	168863
description	knob without symbol ø 70mm shaft ø 8x6.5mm shaft flat left		
For models:	GFT106L, GFT106LC, GFT106LR, GFT106LRC, GFT46L, GFT46LC, GFT46R, GFT46RC, GFT66L, GFT66LC, GFT66LR, GFT66LRC, GFT66R, GFT66RC		


1			
GEV No.	112664	Ref. No.	168573
description	knob without symbol ø 70mm shaft ø 8x6.5mm shaft flat left/right black		


			
1			
GEV No.	111929	Ref. No.	168861 RTCU700275
description	knob without symbol ø 70mm shaft ø 8x6.5mm shaft flat upper		
For models:	G2SF6, G2SF6G, G3SF6, G3SF6G, G6SF7M, GT4SF27, MINIMA G2S6, MINIMA G4S6, MINIMA G4SF6, MINIMA G4SFE6, MINIMA G6S6, MINIMA G6SF6, MINIMA G6SFA6, MINIMA G6SFE6, MINIMA G6SFEA6, OMNIA G4SF7, OMNIA G4SFE7, OMNIA G4SMFA7, OMNIA G6SFA7, OMNIA G6SFEA7, OMNIA GC 47, OMNIA GPL 47, OMNIA GPL 47P, OMNIA GT2SD7, OMNIA GT2SDFa7, OMNIA GT4S7, OMNIA GT4SF27, OMNIA GT7, OMNIA GTF7		


			
2			
GEV No.	112662	Ref. No.	168867
description	knob without symbol ø 70mm shaft ø 8x6.5mm shaft flat upper/lower		
For models:	FP01V, G2S6, G4S6, G6S6, MG7G2S77, MG7G2SA77, MG7G4S77, MG7G4S77P, MG7G4SA77, MG7G4SA77P, MG7G4SF77, MG7G4SF77P, MG7G4SFE77, MG7G4SFEV77, MG7G4SMFA77, MG7G6S77, MG7G6SA77, MG7G6SF77M, MG7G6SFA77, MG7G6SFEA77, MG7GC477-SC, MG7GC777-SC, MG7GFT477L, MG7GFT477LC, MG7GFT477R, MG7GFT777L, MG7GFT777LC, MG7GFT777LR, MG7GFT777LRC, MG7GFT777R, MG7GFTA477L, MG7GFTA477LC, MG7GFTA477R, MG7GFTA777L, MG7GFTA777LC, MG7GFTA777LR, MG7GFTA777LRC, MG7GFTA777R, MG7GPL477, MG7GPL777, MG7GPLA777, MG7GT77, MG7GTA77, MG7GTF77		


			
1			
GEV No.	110791	Ref. No.	RTCU700463
description	knob energy regulator 1-3 ø 70mm shaft ø 6x4.6mm shaft flat upper green		
For models:	EPL46, EPL66, EVC26, EVC27, EVC46, EVC47, EVC47F, MINIMA EPL 46, MINIMA EPL 66, MINIMA EVC26, MINIMA EVC46, OMNIA EVC27, OMNIA EVC47, OMNIA EVC47F		


			
1			
GEV No.	110792	Ref. No.	RTCU700612
description	knob energy regulator 1-3 ø 70mm shaft ø 6x4.6mm shaft flat upper green		
For models:	EVC26, EVC46, MINIMA EVC26, MINIMA EVC46, OMNIA EVC27, OMNIA EVC47		

			
1			
GEV No.	111826	Ref. No.	169882 RTCU700352
description	knob gas tap with ignition flame ø 70mm shaft ø 10x8mm shaft flat left green		
For models:	FP01V, G507, G50I7, GC77, OMNIA G507, OMNIA G50I7, OMNIA GC 77		

			
1			
GEV No.	110799	Ref. No.	RTCU700489
description	knob gas tap with ignition flame ø 70mm shaft ø 8x6.5mm shaft flat left black		
For models:	GC66, GPL46P, GPL86P, MINIMA GC 66, MINIMA GPL 46, MINIMA GPL 46P, MINIMA GPL 86, MINIMA GPL 86P		


			
1			
GEV No.	110757	Ref. No.	RTCU700308
description	knob gas tap with ignition flame ø 70mm shaft ø 8x6.5mm shaft flat upper		
For models:	G2S7, G2SDM7, G2SDMF7, G2SDMFE7, G2SSM7, G2SSMF7, G2SSMFE7, G4S7, G4SF7, G4SFE7, G4SM7, G4SMFA7, G6S7, G6SF72P, G6SFA7, G6SFEA7, GC47, GPL47, GPL47P, GPL77, GPL77P, GT2SD7, GT2SDFa7, GT2SS7, GT2SSFA7, GT4S7, GT4SF27, GT4SF2E7, GT4SFA7, GT7, GTF7, GTS7, OMNIA G2S7, OMNIA G4S7, OMNIA G4SF7, OMNIA G4SFE7, OMNIA G4SMFA7, OMNIA G6S7, OMNIA G6SFA7, OMNIA G6SFEA7, OMNIA GC 47, OMNIA GPL 47, OMNIA GPL 47P, OMNIA GPL 77, OMNIA GPL 77P, OMNIA GT2SD7, OMNIA GT2SDFa7, OMNIA GT4S7, OMNIA GT4SF27, OMNIA GT7...(Other models you can see in the webshop)		

			
1			
GEV No.	110744	Ref. No.	RTCU600064
description	knob gas tap without ignition flame ø 70mm shaft ø 8x6.5mm shaft flat upper		
For models:	E4F6, E6FA6, G2S6, G4S6, G4SF6, G4SFE6, G6S6, G6SF6, G6SFA6, G6SFE6, G6SFEA6, MINIMA G2S6, MINIMA G4S6, MINIMA G4SF6, MINIMA G4SFE6, MINIMA G6S6, MINIMA G6SF6, MINIMA G6SFA6, MINIMA G6SFE6, MINIMA G6SFEA6		


1

GEV No.	110797	Ref. No.	RTCU600033
description	knob gas thermostat 1-8 ø 70mm shaft ø 8x6.5mm shaft flat upper		
For models:	GBM46, GBM66, GBR6, GFT106L, GFT106LC, GFT106LR, GFT106LRC, GFT46L, GFT46LC, GFT46R, GFT46RC, GFT66L, GFT66LC, GFT66LR, GFT66LRC, GFT66R, GFT66RC, MINIMA GBM 46, MINIMA GBM 66, MINIMA GBR 6, MINIMA GFT 46L, MINIMA GFT 46LC, MINIMA GFT 46R, MINIMA GFT 46RC, MINIMA GFT 66L, MINIMA GFT 66LC, MINIMA GFT 66LR, MINIMA GFT 66LRC, MINIMA GFT 66R, MINIMA GFT 66RC, MINIMA GFT106L, MINIMA GFT106LC, MINIMA GFT106LR, MINIMA GFT106LRC		




1

GEV No.	110794	Ref. No.	RTCU600195
description	knob oven ø 70mm shaft ø 6x4.6mm shaft flat upper green		
For models:	E4F6, E6F6, E6FA6, G4SFE6, G6SFE6, G6SFEA6, MINIMA E4F6, MINIMA E6F6, MINIMA E6FA6, MINIMA G4SFE6, MINIMA G6SFE6, MINIMA G6SFEA6		




1

GEV No.	110759	Ref. No.	170422 RTCU700344
description	knob gas thermostat 1-8 ø 70mm shaft ø 8x6.5mm shaft flat upper green		
For models:	G2SDM7, G2SDMF7, G2SDMFE7, G2SSM7, G2SSMF7, G2SSMFE7, G4SF7, G4SM7, G4SMFA7, G6SFA7, GBM47, GBM77, GF07, GFO7, GFT117L, GFT117LC, GFT117LR, GFT117LRC, GFT47L, GFT47LC, GFT47R, GFT47RC, GFT77L, GFT77LC, GFT77LR, GFT77LRC, GFT77R, GFT77RC, GT2SDFA7, GT2SSFA7, GT4SF27, GT4SFA7, GTF7, OMNIA G4SF7, OMNIA G4SMFA7, OMNIA G6SFA7, OMNIA GBM 47, OMNIA GBM 77, OMNIA GF07, OMNIA GFT 47L, OMNIA GFT 47LC, OMNIA GFT 47R, OMNIA GFT 47RC, OMNIA GFT 77L, OMNIA GFT 77LC, OMNIA GFT 77R, OMNIA GFT 77RC, OMNIA GFT117L...(Other models you can see in the webshop)		




1

GEV No.	110795	Ref. No.	RTCU700453
description	knob oven ø 70mm shaft ø 6x4.6mm shaft flat upper green		
For models:	EF07V, EFO7V, OMNIA EF07V		




1

GEV No.	110820	Ref. No.	RTCU700421
description	knob switch 0-1 ø 70mm shaft ø 6x4.6mm shaft flat upper turquoise		
For models:	EBM46, EBM47, EBM66, EBM77, EBR7, EBRI7, ECC46, EF47, EF472V, EF472VT, EF47T, EF77, EF77T, MINIMA EBM 46, MINIMA EBM 66, MINIMA ECC 46, OMNIA EBM 47, OMNIA EBM 77, OMNIA EBR7, OMNIA EBRI7, OMNIA EF 47, OMNIA EF 47T, OMNIA EF 77, OMNIA EF 77T, OMNIA EF472V, OMNIA EF472VT		




1

GEV No.	111974	Ref. No.	169885
description	knob gas thermostat t.max. 280°C 140-280°C ø 70mm shaft ø 6x4.6mm shaft flat upper black		



1

GEV No.	110806	Ref. No.	RTCU700436
description	knob switch 4-position ø 70mm shaft ø 6x4.6mm shaft flat upper green		
For models:	E5017, EC47, EC66, EC77, MINIMA EC 66, OMNIA EC 47, OMNIA EC 77		



1

GEV No.	110793	Ref. No.	169885 (old version) RTCU600177 (old version)
description	knob gas thermostat t.max. 280°C ø 70mm shaft ø 6x4.6mm shaft flat upper green temperature range 140-280°C		



1

GEV No.	110767	Ref. No.	RTCU700403
description	knob switch 7-position ø 70mm shaft ø 6x4.6mm shaft flat upper		
For models:	E26, E27, E27Q, E46, E47, E47Q, E4F6, E4F7, E4F7Q, E66, E67, E67Q, E6F6, E6FA6, E6FA7, E6FA7Q, G6SF6, G6SFA6, G6SFE6, G6SFEA6, MINIMA E26, MINIMA E46, MINIMA E4F6, MINIMA E66, MINIMA E6F6, MINIMA E6FA6, OMNIA E27, OMNIA E27Q, OMNIA E47, OMNIA E47Q, OMNIA E4F7, OMNIA E4F7Q, OMNIA E67, OMNIA E67Q, OMNIA E6FA7, OMNIA E6FA7Q		



2

GEV No.	110823	Ref. No.	RTCU700594
description	knob thermostat t.max. 200°C 60-200°C ø 70mm shaft ø 6x4.6mm shaft flat upper		
For models:	EF46, EF47, EF472V, EF472VT, EF47T, EF66, EF77, EF77T, MINIMA EF 46, MINIMA EF 66, OMNIA EF 47, OMNIA EF 47T, OMNIA EF 77, OMNIA EF 77T, OMNIA EF472V, OMNIA EF472VT		



1

GEV No.	110796	Ref. No.	RTCU700437
description	knob thermostat t.max. 300°C 50-300°C ø 70mm shaft ø 6x4.6mm shaft flat upper		
For models:	E4F7, E4F7Q, E6FA7, E6FA7Q, EF07, EFO7, EVC4F7, G2SDMFE7, G2SMFE7, G4SFE7, G6SFEA7, GT4SF2E7, OMNIA E4F7, OMNIA E4F7Q, OMNIA E6FA7, OMNIA E6FA7Q, OMNIA EF07, OMNIA G4SFE7, OMNIA G6SFEA7		



1

GEV No.	110802	Ref. No.	RTCU700434
description	knob thermostat t.max. 300°C ø 70mm shaft ø 6x4.6mm shaft flat upper green temperature range 50-300°C rotation 270°		
For models:	EBR6, EBR7, EBRI7, EFT106L, EFT106LC, EFT106LR, EFT106LRC, EFT46L, EFT46LC, EFT46R, EFT46RC, EFT47L, EFT47LC, EFT47R, EFT47RC, EFT66L, EFT66LC, EFT66LR, EFT66LRC, EFT66R, EFT66RC, EFT77L, EFT77LC, EFT77LR, EFT77LRC, EFT77R, EFT77RC, MINIMA EBR 6, MINIMA EFT 46L, MINIMA EFT 46LC, MINIMA EFT 46R, MINIMA EFT 46RC, MINIMA EFT 66L, MINIMA EFT 66LC, MINIMA EFT 66LR, MINIMA EFT 66LRC, MINIMA EFT 66R, MINIMA EFT 66RC, MINIMA EFT 106L, MINIMA EFT 106LC, MINIMA EFT 106LR, MINIMA EFT 106LRC, OMNIA EBR7, OMNIA EBRI7, OMNIA EFT 47L, OMNIA EFT 47LC, OMNIA EFT 47R, OMNIA EFT 47RC, OMNIA EFT 77L, OMNIA EFT 77LC... (Other models you can see in the webshop)		



1

GEV No.	112101	Ref. No.	RTCU700644
description	knob thermostat t.max. 400°C ø 70mm shaft ø 6x4.6mm shaft flat upper green temperature range 60-400°C		
For models:	ECFT46, ECFT66, MINIMA ECFT 46, MINIMA ECFT 66		



1

GEV No.	110809	Ref. No.	RTCU700420
description	knob thermostat t.max. 90°C ø 75mm shaft ø 6x4.6mm shaft flat upper black temperature range 30-90°C thermostat		
For models:	EBM46, EBM47, EBM66, EBM77, MINIMA EBM 46, MINIMA EBM 66, OMNIA EBM 47, OMNIA EBM 77		



1

GEV No.	111756	Ref. No.	RTCU700482
description	knob water cold ø 70mm shaft ø 10x8mm shaft flat left		
For models:	E50I7, G507, G50I7, OMNIA G507, OMNIA G50I7, OMNIA GPL 47P, OMNIA GPL 77, OMNIA GPL 77P		



1


GEV No.	111804	Ref. No.	RTCU700435
description	knob dial plate 0-1 t.max.°C°C		





1


GEV No.	112854	Ref. No.	RTCU700462
description	knob dial plate 0-3 ED ø 62mm ID ø 42mm		

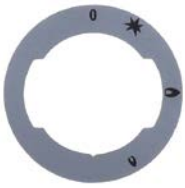



			
1			
GEV No.	111808	Ref. No.	RTCU700613
description	knob dial plate 0-3 t.max.°C ED ø 62mm ID ø 42mm black		


			
1			
GEV No.	111921	Ref. No.	RTCU600063
description	knob dial plate gas tap without ignition flame ED ø 62mm ID ø 42mm		
For models:	MINIMA G2S6, MINIMA G4S6, MINIMA G4SF6, MINIMA G4SFE6, MINIMA G6S6, MINIMA G6SF6, MINIMA G6SFA6, MINIMA G6SFE6, MINIMA G6SFEA6		


			
1			
GEV No.	111920	Ref. No.	RTCU700309
description	knob dial plate gas tap with ignition flame t.max.°C ED ø 62mm ID ø 42mm black		
For models:	G6SF7M, GT4SF27, OMNIA G4SF7, OMNIA G4SFE7, OMNIA G4SMFA7, OMNIA G6SFA7, OMNIA G6SFEA7, OMNIA GC 47, OMNIA GPL 47, OMNIA GPL 47P, OMNIA GT2SD7, OMNIA GT2SDFA7, OMNIA GT4S7, OMNIA GT4SF27, OMNIA GT7, OMNIA GTF7		


			
1			
GEV No.	112205	Ref. No.	RTCU700343
description	knob dial plate gas thermostat 1-8 t.max.°C		
For models:	GFT106L, GFT106LC, GFT106LR, GFT106LRC, GFT46L, GFT46LC, GFT46R, GFT46RC, GFT66L, GFT66LC, GFT66LR, GFT66LRC, GFT66R, GFT66RC		


			
1			
GEV No.	112669	Ref. No.	168345
description	knob dial plate gas tap with ignition flame t.max.°C ED ø 62mm ID ø 42mm grey		
For models:	FP01V		

			
1			
GEV No.	112782	Ref. No.	RTCU600194
description	knob dial plate oven t.max. 270°C 60-270°C rotation 270° turn direction left ED ø 62mm ID ø 42mm grey		

			
1			
GEV No.	112693	Ref. No.	168202
description	knob dial plate gas tap with ignition flame t.max.°C ED ø 62mm ID ø 42mm grey		
For models:	BG6SF77M, MG7G2S77, MG7G2SA77, MG7G4S77, MG7G4S77P, MG7G4SA77, MG7G4SA77P, MG7G4SF77, MG7G4SF77P, MG7G4SFE77, MG7G4SFEV77, MG7G4SMFA77, MG7G6S77, MG7G6SA77, MG7G6SF77M, MG7G6SFA77, MG7G6SFEA77, MG7GC477-SC, MG7GC777-SC, MG7GPL477, MG7GPL777, MG7GPLA777, MG7GT77, MG7GTA77, MG7GTF77		


			
1			
GEV No.	111919	Ref. No.	RTCU700347
description	knob dial plate oven t.max. 300°C 150-300°C ED ø 62mm ID ø 42mm		
For models:	OMNIA E6FA7, OMNIA E6FA7Q, OMNIA EF07, OMNIA EVC4F7, OMNIA G4SFE7, OMNIA G6SFEA7		

			
1			
GEV No.	112098	Ref. No.	RTCU700350
description	knob dial plate switch 4-position ED ø 62mm ID ø 42mm		




1

GEV No.	111922	Ref. No.	RTCU700346
description	knob dial plate switch 7-position t.max.°C ED ø 62mm ID ø 42mm		
For models:	MINIMA E26, MINIMA E46, MINIMA E4F6, MINIMA E66, MINIMA E6F6, MINIMA E6FA6, OMNIA E4F7, OMNIA E4F7Q, OMNIA E6FA7, OMNIA E6FA7Q		




1

GEV No.	112812	Ref. No.	180584
description	knob dial plate t.max. 280°C 140-280°C ED ø 62mm ID ø 42mm		




1

GEV No.	112165	Ref. No.	166694
description	knob dial plate thermostat t.max. 200°C 100-200°C		




1

GEV No.	111807	Ref. No.	RTCU700349
description	knob dial plate thermostat t.max. 300°C 50-300°C rotation 270° turn direction left ED ø 62mm ID ø 42mm grey		




1

GEV No.	112770	Ref. No.	168501
description	knob dial plate thermostat t.max. 300°C 50-300°C rotation 270° turn direction left ED ø 62mm ID ø 42mm silver		




1

GEV No.	112905	Ref. No.	RTCU700645
description	knob dial plate thermostat t.max. 400°C 60-400°C ED ø 62mm ID ø 42mm		




1

GEV No.	111918	Ref. No.	RTCU700348
description	knob dial plate thermostat t.max. 90°C 30-90°C ED ø 62mm ID ø 42mm		
For models:	MINIMA EBM 46, MINIMA EBM 66, OMNIA EBM 47, OMNIA EBM 77		




1


GEV No.	112790	Ref. No.	171435
description	knob t.max.°C ø 72mm shaft ø 10x8mm shaft flat upper chrome 2		
For models:	E100I98, E150I98, E50I77, EBM498T, EBM998T, EBMA498, EBMA998, EC477-SC, EC498-SC, EC498T-SC, EC777-SC, EC9982V-SC, EC9982VT-SC, G10098, G100I98, G100T98, G15098, G150I98, G150T98, G50I77, GC477, GC477-SC, GC498-SC, GC777, GC777-SC, GC777T-SC, GC9982V-SC		




1


GEV No.	112802	Ref. No.	171433
description	knob t.max.°C ø 72mm shaft ø 10x8mm shaft flat upper chrome 8		
For models:	G10098, G100I98, G100T98, G15098, G150I98, G150T98, G2SA11, G4SA11, G4SF11, G50I77, GC411-SC, GC777, GC911-SC, GFTA911L, GFTA911LC, GFTA911LR, GFTA911LRC, GTA911, GTF911		

 <p>1</p>			
GEV No.	112799	Ref. No.	174332
description	knob dial plate ignition/large/small t.max.°C°C ED ø 138mm ID ø 123mm shaft flat silver		
For models:	G10098, G100I98, G100T98, G15098, G150I98, G150IT98, G2S77, G2S77P, G2S928P, G2S98, G2SA11, G2SA77, G2SA77P, G2SA98, G2S-A98P, G4S77, G4S77P, G4S948P, G4S98, G4SA11, G4SA77, G4SA77P, G4SA98, G4SA98P, G4SF11, G4SF77, G4SF77P, G4SF98, G4SF98P, G4S-FE77, G4SFE98, G4SFEV77, G50I77, G6S77, G6S98, G6SA77, G6SA98, G6SF77M, G6SF98M, G6SF98MG, G6SFA77, G6SFA98, G6SFEA77, G6SFEA98, GC411-SC, GC477, GC477-SC, GC498-SC, GC777, GC777-SC...(Other models you can see in the webshop)		

 <p>2</p>			
GEV No.	112791	Ref. No.	174333
description	knob dial plate water t.max.°C°C ED ø 138mm ID ø 123mm silver/blue		
For models:	E100I98, E150I98, E50I77, EBM498T, EBM998T, EBMA498, EBMA998, EC477-SC, EC498-SC, EC498T-SC, EC777-SC, EC9982V-SC, EC9982VT-SC, G10098, G100I98, G100T98, G15098, G150I98, G150IT98, G50I77, GC477, GC477-SC, GC498-SC, GC777, GC777-SC, GC777T-SC, GC9982V-SC		


 <p>1</p>			
GEV No.	112856	Ref. No.	174334
description	knob dial plate water t.max.°C°C ED ø 138mm ID ø 123mm silver/red		
For models:	E100I98, E150I98, E50I77, G10098, G100I98, G100T98, G15098, G150I98, G150IT98, G50I77		


 <p>1</p>			
GEV No.	112067	Ref. No.	165927 168848
description	knob without symbol ø 70mm shaft ø 10x8mm shaft flat upper black		
For models:	G1009, G100I9, G100IT9, G100T9, G1509, G150I9, G150IT9, G150T9, G2S9, G4S9, G4S9-48, G4SF77, G4SF9-2, G4SFE9, G6S9, G6SF29, G6S-FA9, G6SFEA9, GBM477, GBM49T, GBM99T, GBMA477, GC49, GC49T, GC992V, GC992VT, GFT49L, GFT49LC, GFT49R, GFT49RC, GFT99L, GFT99LC, GFT99LR, GFT99LRC, GFT99R, GFT99RC, GPL49-P, GPL99-P, GT2SD9, GT2SDFA9, GT2SS9, GT99, GTF9		


 <p>1</p>			
GEV No.	112771	Ref. No.	160323
description	knob without symbol ø 70mm shaft ø 6x4.6mm shaft flat right		

 <p>1</p>			
GEV No.	112069	Ref. No.	165926
description	knob dial plate without symbol ø 70mm black		
For models:	E100I9, E100IT9, E150I9, E150IT9, E29, E29Q, E49, E49Q, E4F9, E4F9Q, E69, E69Q, E6FA9, EBM49T, EBM99T, EBR9T, EBRA9T, EBRAVI9T, EBR-VI9T, EC49, EC49T, EC992V, EC992VT, EF09, EF49, EF49T, EF99, EF99T, EFB09, EFT49L, EFT49LC, EFT49R, EFT49RC, G4SFE9, G6SFEA9, GBR9T, GBRA9T, GBRAVI9T, GBRVI9T		

 <p>1</p>			
GEV No.	112184	Ref. No.	168847
description	knob dial plate without symbol ø 70mm shaft ø 6x4.6mm shaft flat right black		
For models:	E100I9N, E100IT9N, E150I9N, E150IT9N, E277, E277Q, E2A77, E2A77Q, E477, E477Q, E4A77, E4A77Q, E4F77, E50I77, E677Q, E6FA77, EBM477, EBMA477, EBR77, EC477, EC777, EC777T, ECC477, ECCA477, EF077, EF477, EF4772V, EF4772VT, EF477T, EF777, EF777T, EFT477L, EFT477LC, EFT477R, EFT477RC, EFT777L, EFT777LC, EFT777LR, EFT777LRC, EFT777R, EFT777RC, EFTA477L, EFTA477LC, EFTA477R, EFTA477RC, EFTA777L, EFTA777LC, EFTA777LR, EFTA777LRC, EFTA777R...		


 <p>1</p>			
GEV No.	112180	Ref. No.	168848 169310
description	knob gas tap with ignition flame ø 70mm shaft ø 10x8mm shaft flat upper black		
For models:	E50I77, G5077, G50I77		

 <p>1</p>			
GEV No.	112182	Ref. No.	170145
description	knob gas thermostat t.max. 90°C 0-90°C ø 70mm shaft ø 10x8mm shaft flat upper black		




1

GEV No.	112082	Ref. No.	160900
description	knob switch 0-1 ø 70mm shaft ø 6x4.6mm shaft flat right black		
For models:	EF99, EF99T, GBR9T		



1

GEV No.	112083	Ref. No.	160902
description	knob thermostat t.max. 200°C ø 70mm shaft ø 6x4.6mm shaft flat right black temperature range 10x9°C		
For models:	EF99, EF99T		




1

GEV No.	112084	Ref. No.	160439
description	knob thermostat t.max. 90°C ø 70mm shaft ø 6x4.6mm shaft flat right black temperature range 30-90°C		
For models:	EBM49T, EBM99T		




1

GEV No.	112181	Ref. No.	170150
description	knob water cold ø 70mm shaft ø 10x8mm shaft flat upper		



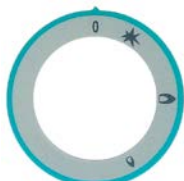
1

GEV No.	112085	Ref. No.	160953
description	knob water hot ø 70mm shaft ø 10x8mm shaft flat upper		
For models:	G100I9, G150I9		




1

GEV No.	112773	Ref. No.	160899
description	knob dial plate 1 t.max.°C ED ø 70mm		



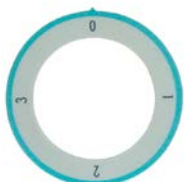
1

GEV No.	112076	Ref. No.	164581
description	knob dial plate gas tap with ignition flame t.max.°C°C		
For models:	G1009, G100I9, G100IT9, G100T9, G1509, G150I9, G150IT9, G150T9, G2S9, G4S9, G4S9-48, G4SF77, G4SF9-2, G4SFE9, G6S9, G6SF29, G6SFA9, G6SFEA9, GC49, GC49T, GC992V, GC992VT, GPL49-P, GPL99-P, GT2SD9, GT2SDFA9, GT2SS9, GT99, GTF9		



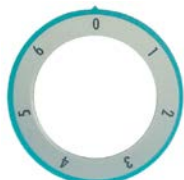
1

GEV No.	112077	Ref. No.	164582
description	knob dial plate gas thermostat t.max. 310°C 145-310°C		
For models:	GFT49L, GFT49LC, GFT49R, GFT49RC, GFT99L, GFT99LC, GFT99LR, GFT99LRC, GFT99R, GFT99RC		



1


GEV No.	112073	Ref. No.	164604
description	knob dial plate switch 4-position		
For models:	E100I9, E100IT9, E150I9, E150IT9, EC49, EC49T, EC992V, EC992VT		

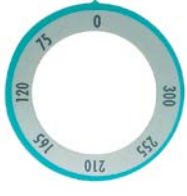



1


GEV No.	112074	Ref. No.	164577 169912
description	knob dial plate switch 7-position		
For models:	E277, E277Q, E29, E29Q, E2A77, E2A77Q, E477, E477Q, E49, E49Q, E4A77, E4A77Q, E4F77, E4F9, E4F9Q, E677Q, E69Q, E6FA77, E6FA9, HE4F77		




			
1			
GEV No.	112682	Ref. No.	169904
description	knob dial plate thermostat t.max. 200°C 100-200°C rotation 270° ED ø 50mm ID ø 34mm		
For models:	EF4772V, EF4772VT		


			
1			
GEV No.	112075	Ref. No.	164584
description	knob dial plate thermostat t.max. 300°C 75-300°C		
For models:	EBR9T, EBRA9T, EBRAVI9T, EBRVI9T, EFT49L, EFT49LC, EFT49R, EFT49RC, EFT99L, EFT99LC, EFT99LR, EFT99LRC, EFT99R, EFT99RC, GBR9T, GBRA9T, GBRAVI9T, GBRVI9T		


			
1			
GEV No.	112072	Ref. No.	164580
description	knob dial plate water cold		
For models:	E100I9, E100IT9, E150I9, E150IT9, EBM49T, EBM99T, EC49, EC49T, EC992V, EC992VT, G1009, G100I9, G100IT9, G100T9, G1509, G150I9, G150IT9, G150T9, GBM49T, GBM99T, GC49, GC49T, GC992V, GC992VT		


			
1			
GEV No.	112071	Ref. No.	164586
description	knob dial plate water hot		
For models:	E100I9, E100IT9, E150I9, E150IT9, G1009, G100I9, G100IT9, G100T9, G1509, G150I9, G150IT9, G150T9		


			
1			
GEV No.	112066	Ref. No.	161671
description	knob without symbol ø 70mm shaft ø 8x6.5mm shaft flat upper		
For models:	G4SF9, G4SF9-1, G6SFA9, GF09, GF09T, GTF9		

			
1			
GEV No.	110758	Ref. No.	160464
description	knob gas tap with ignition flame ø 70mm shaft ø 10x8mm shaft flat upper		
For models:	G100I9, G150I9, G2S9, G4S9, G4SF9, G4SF9-1, G4SFE9, G6S9, G6SF29, G6SFA9, G6SFEA9, GC49T, GC992V, GC992VT, GT2SD9, GT2SS9, GT99, GTF9		

			
1			
GEV No.	110800	Ref. No.	160540
description	knob gas thermostat t.max. 310°C 145-310°C ø 75mm shaft ø 10x8mm shaft flat lower black		
For models:	GFT49L, GFT49LC, GFT49R, GFT49RC, GFT99L, GFT99LC, GFT99LR, GFT99LRC, GFT99R, GFT99RC		

			
1			
GEV No.	112065	Ref. No.	160442
description	knob switch 4-position ø 70mm shaft ø 6x4.6mm shaft flat right black		
For models:	EC49, EC49T, EC992VT		

			
1			
GEV No.	110789	Ref. No.	160343
description	knob switch 7-position ø 68mm shaft ø 6x4.6mm shaft flat right		
For models:	E29, E29Q, E49, E49Q, E4F9, E4F9Q, E69, E69Q, E6FA9		

			
1			
GEV No.	112064	Ref. No.	163875
description	knob thermostat t.max. 300°C ø 70mm shaft ø 6x4.6mm shaft flat right black temperature range 100-300°C		
For models:	E4F9, E4F9Q, E6FA9, EF09, EFB09, G4SFE9, G6SFEA9		



GEV No.	110798	Ref. No.	160440
description	knob thermostat t.max. 300°C ø 70mm shaft ø 6x4.6mm shaft flat right temperature range 75-300°C rotation 270° thermostat		
For models:	EFT49L, EFT49LC, EFT49R, EFT49RC, EFT99L, EFT99LC, EFT99LR, EFT99LRC, EFT99R, EFT99RC, GBR9T		



GEV No.	110808	Ref. No.	160472
description	knob water cold ø 68mm shaft ø 10x8mm shaft flat upper		
For models:	EBM49T, EBM99T, EC49, EC49T, EC992VT, G100I9, G150I9, GBM49T, GBM99T, GC49T, GC992V, GC992VT		



GEV No.	110295	Ref. No.	RTFOC00055
description	knob switch zero mark ø 55mm shaft ø 6x4.6mm shaft flat upper black		
For models:	FEC060, FEC065, FEC100, FEM060, FEM061, FEM100, FEM101, FEMD060, FEMD061, FEMD065, FEMD066, FEMD100, FEMD101, FEP050, FEP080, FGC060, FGC065, FGC100, FGM060, FGM061, FGM100, FGM101, FGMD060, FGMD061, FGMD065, FGMD066, FGMD100, FGMD101, FGP050, FGP080, FMM060, FMM061, FMM100, FMM101		



GEV No.	111757	Ref. No.	RTFOC00361
description	knob switch zero mark ø 56mm shaft ø 6x4.6mm shaft flat upper green		
For models:	FCE10, FCE6, FCG10, FCG20, FCG6, FEC023, FEC200, FEM107SC, FEM200, FEM201, FEM207SC, FEM67, FEM67SC, FEMD023, FEMD107SC, FEMD200, FEMD201, FEMD207, FEMD207SC, FEMD67SC, FEP050, FEP080, FEP160, FGC200, FGM107SC, FGM200, FGM201, FGM207SC, FGM67SC, FGMD107SC, FGMD200, FGMD201, FGMD207, FGMD207SC, FGMD67SC, FGP050, FGP080, FGP160, JOKER FCE 6, JOKER FCE 10, JOKER FCG 6, JOKER FCG 10, JOKER FEM 67 SC, JOKER FEM107 SC, JOKER FEM207 SC, JOKER FEMD 67 SC, JOKER FEMD107 SC, JOKER FEMD207 SC, JOKER FEP050, JOKER FEP080...(Other models you can see in the webshop)		



GEV No.	112070	Ref. No.	160910
description	knob zero mark ø 56mm shaft ø 6x4.6mm shaft flat upper silver		
For models:	FCE10, FCE6, FCG10, FCG6, FEM107, FEM107SC, FEMD107, FEMD107SC, FEMD67, FEMD67SC, FEP050, FEP080, FGMD107SC, FGMD67, FGMD67SC, FGP050, FGP080, JOKER FCE 6 AB 2002, JOKER FCE 10 AB 2002, JOKER FCG 6 AB 2002, JOKER FCG 10 AB 2002, JOKER FEP050 AB 2002, JOKER FEP080 AB 2002, JOKER FGP050 AB 2002, JOKER FGP080 AB 2002		



GEV No.	112011	Ref. No.	161796 164649
description	knob switch zero mark ø 41mm shaft ø 6x4.6mm shaft flat upper black		
For models:	EF12+12B, EF12+12S, EF12B, EF12S, EF20BP, EF25+25S, EF25S, EF6+6BM, EF60BP, EF6BM, EF8+8B, EF8B, EF8BM		




GEV No.	111449	Ref. No.	RTCU600389
description	knob zero mark ø 41mm shaft ø 5x5mm shaft flat upper/lower black		



GEV No.	112793	Ref. No.	169340+169348
description	knob 0-1 t.max.°C ø 70mm shaft ø 6x4.6mm shaft flat universal black		




GEV No.	111455	Ref. No.	169340+169353
description	knob 4-position t.max.°C ø 70mm shaft ø 6x4.6mm shaft flat universal black		


1

GEV No.	111465	Ref. No.	169340+169363
description	knob 7-position t.max.°C ø 70mm shaft ø 6x4.6mm shaft flat universal black		




1

GEV No.	112738	Ref. No.	169338+169366
description	knob water cold t.max.°C ø 70mm shaft ø 10x8mm shaft flat universal black		




1

GEV No.	111456	Ref. No.	169337+169355 169337+172032
description	knob gas tap with ignition flame ø 70mm shaft ø 8x6mm black		




1

GEV No.	112696	Ref. No.	169336+171520
description	knob gas tap with ignition flame t.max.°C ø 70mm shaft ø 10x8mm shaft flat universal black		



1


GEV No.	111457	Ref. No.	169377+169340
description	knob thermostat 100-200°C ø 70mm shaft ø 6x4.6mm shaft flat right black		



1

GEV No.	112785	Ref. No.	169340+169371
description	knob thermostat t.max. 300°C 100-300°C ø 70mm shaft ø 6x4.6mm shaft flat universal black		

miscellaneous




1

GEV No.	112068	Ref. No.	165925 168846
description	knob hot water ø 70mm shaft ø 10x8mm shaft flat upper		
For models:	E100I9, E100I9N, E100IT9, E100IT9N, E150I9, E150I9N, E150IT9, E150IT9N, EBM49T, EBM99T, EC477, EC49, EC49T, EC777, EC777T, EC992V, EC992VT, G1009, G100I9, G100I9N, G100IT9, G100IT9N, G100T9, G1509, G150I9, G150I9N, G150IT9, G150IT9N, G150T9, GBM49T, GC477, GC49, GC49T, GC777, GC777T, GC992V, GC992VT, LX7EC4		

accessories


button springs



1

GEV No.	550132	Ref. No.	RTCU900304
description	knob spring ø 6x4.6mm Qty 10 pcs		
For models:	GBR, GBRA, GBRAVI, GBRVI		

gaskets



1

GEV No.	112078	Ref. No.	RTCU800185
description	gasket knob		
For models:	?AQE477, AQE777, E100I8, E100I98, E150I8, E150I98, E277, E277Q, E29, E298AQ, E298Q, E29Q, E2A, E2A77, E2A77Q, E2AP77Q, E2AP8, E477, E477Q, E49, E498AQ, E498Q, E49Q, E4A, E4A77, E4A77Q, E4A8, E4AP77Q, E4AP8, E4F, E4F6, E4F77, E4F77Q, E4F8, E4F9, E4F98Q, E4F9Q, E4FP77Q, E4FP8, E50I77, E677Q, E69, E698AQ, E698Q, E69Q, E6A77Q, E6F6, E6FA, E6FA6, E6FA77...(Other models you can see in the webshop)		





handles and hand wheels

hand wheels

hand wheels



GEV No.	690556	Ref. No.	162816 164461
description	hand wheel ø 130mm D1 ø 32mm bore ø 14mm thread M6 hole distance 8mm groove widthmm L1 22mm L2 50mm handle length 70mm with folding handle		
For models:	EBR9T, EBRVC98T, EBRVI98T, EBRVI9T, GBR9T, GBRVC98T, GBRVI98T, GBRVI9T		
accessories for	690556		
	GEV No.	504733	Ref. No. —
	grub screw thread M4 L 5mm stainless steel DIN 913 intake internal hexagon WS 2 Qty 1 pcs		
	GEV No.	560336	Ref. No. —
	lock washer ID ø 4.2mm ED ø 8mm SS DIN127 Qty 1 pcs for thread M4		



GEV No.	690555	Ref. No.	RTBF800093
description	hand wheel ø 200mm D1 ø 50mm bore ø 20mm thread M6 hole distance 7mm groove width 6mm L1 40mm L2 43mm handle length 85mm with folding handle		
For models:	EBR, EBR7, EBRA, EBRAVI, EBRI7, EBRVI, GBR, GBR7, GBRA, GBRAVI, GBRI7, GBRVI, OMNIA EBR7, OMNIA EBRI7, OMNIA GBR7, OMNIA GBRI7		

cone handles



GEV No.	110704	Ref. No.	RTCU700413
description	cone handle thread M6 ø 16mm L 25mm plastic black		
For models:	EBM408, EBM46, EBM47, EBM477, EBM498T, EBM66, EBM77, EBM777, EBM908, EBM998T, EBMA477, EBMA498, EBMA777, EBMA998, EC66, EF46, EF472VT, EF4772VT, EF477T, EF47T, EF66, EF777T, EF77T, FEC023, FEMD023, GBM46, GBM47, GBM66, GBM77, GBM777, GBMA777, GC66, GF46, GF477TS, GF47T, GF66, GF777TS, GF77T, GF99, MG7EBM477, MG7EBMA477, MG7EF4772VT, MG7EF477T, MG7EF777T, MG7GF477TS, MG7GF777TS, MINIMA EBM 46, MINIMA EBM 66, MINIMA EC 66, MINIMA EF 46...(Other models you can see in the webshop)		

mushroom cap handles



GEV No.	111407	Ref. No.	160470
description	mushroom cap handle thread M8x1.25 handle ø 34mm L 24mm black bain marie		
For models:	EBM49T, EBM99T, GBM477, GBM49T, GBM99T, GBMA477		

handle bars

consoles



GEV No.	692197	Ref. No.	RTCU900413
description	console for handle tube ø 17x43mm		
For models:	MG7E4F77, MG7E4F77Q, MG7E4FP77Q, MG7E4FVP77Q, MG7E6FA77Q, MG7EC477-SC, MG7EC777-SC, MG7EF477, MG7EF4772V, MG7EF777, MG7ETF77, MG7EVC4F77, MG7G4SF77, MG7G4SF77P, MG7G4SFE77, MG7G4SFEV77, MG7G4SMFA77, MG7G6SF77M, MG7G6SFA77, MG7G6SFEA77, MG7GC477-SC, MG7GC777-SC, MG7GF477, MG7GF4772V, MG7GF777, MG7GTF77		

handle rails

end caps




GEV No.	518532	Ref. No.	480091
description	end cap mounting pos. left		
For models:	LB140		




GEV No.	518534	Ref. No.	480097
description	end cap mounting pos. left		
For models:	LF500		




			
1			
GEV No.	518531	Ref. No.	480092
description	end cap mounting pos. right		
For models:	LB140		

bracket handles

			
1			
GEV No.	693810	Ref. No.	9636273200 RIC0002479
description	pull handle		
For models:	E4F6, E6F6, E6FA6, G4SF6, G4SFA6, G4SFE6, G6SF6, G6SFA6, G6SFE6, G6SF6A6, MINIMA E4F6, MINIMA E6FA6, MINIMA G4SF6, MINIMA G4SFE6, MINIMA G6SF6, MINIMA G6SFE6, MINIMA G6SF6A6		

			
1			
GEV No.	692161	Ref. No.	160270
description	pull handle L 141mm H 23mm W 15mm		
For models:	EC498T-SC, EC49T, EC777T, EC992VT, EC9982VT-SC, EF49, EF498T, EF49T, EF998T, EF99T, EFT45L, EFT45LC, EFT45R, EFT45RC, EFT477L, EFT477LC, EFT477R, EFT477RC, EFT49L, EFT49LC, EFT49R, EFT49RC, EFT777L, EFT777LC, EFT777LR, EFT777LRC, EFT777R, EFT777RC, EFT90L, EFT90LC, EFT90LR, EFT90LRC, EFT90R, EFT90RC, EFT99L, EFT99LC, EFT99LR, EFT99LRC, EFT99R, EFT99RC, EFTA477L, EFTA477LC, EFTA477R, EFTA477RC, EFTA777L, EFTA777LC, EFTA777LR, EFTA777LRC, EFTA777R, EFTA777RC...(Other models you can see in the webshop)		

			
1			
GEV No.	700900	Ref. No.	RTFOC00633
description	pull handle L 445mm H 40mm mounting distance 407mm ø 16mm		
For models:	FEC023, FEMD023		

lever handles

			
1			
GEV No.	540871	Ref. No.	RTCU900492
description	lever handle cold water suitable for intake tap		
For models:	EC66, GC66, MINIMA EC 66, MINIMA GC 66		

door handles

			
1			
GEV No.	692543	Ref. No.	168205 PACU800131
description	door handle L 620mm W 59mm H 14mm SS		
For models:	E4F, E6FA, E6FAR, G4SF, G4SF-1, G4SFE, G4SFP, G6SFA, G6SFEA, G8SF2, G8SF2E, G8SF2P, GT2SDF, GT2SDFE, GT2SFA, GT2SFEA, GTF, GTFE		


accessories

			
1			
GEV No.	890878	Ref. No.	RTFOC00402
description	bush		



1

GEV No.	690981	Ref. No.	160911
description	bush for door handle		
For models:	FCE10, FCE20, FCE6, FCG10, FCG20, FCG6, FEM107, FEM107SC, FEM109, FEM110, FEM110L, FEM207, FEM207SC, FEM210, FEM210L, FEM220L, FEM610, FEM610L, FEM67, FEM67SC, FEM69, FEMD107, FEMD107SC, FEMD109, FEMD207, FEMD207SC, FEMD67, FEMD67SC, FEMD69, FEP050, FEP080, FEP160, FGM107, FGM107SC, FGM110, FGM110L, FGM207, FGM207SC, FGM210, FGM210L, FGM610, FGM610L, FGM67, FGM67SC, FGMD107, FGMD107SC, FGMD207, FGMD207SC, FGMD67, FGMD67SC...(Other models you can see in the webshop)		



1


GEV No.	890866	Ref. No.	RTFOC00401
description	bush for door handle		
For models:	FCE10, FCE6, FCG10, FCG20, FCG6, FEM107SC, FEM109, FEM207SC, FEM209, FEM67SC, FEM69, FEMD107SC, FEMD109, FEMD207SC, FEMD209, FEMD67SC, FEMD69, FEP050, FEP080, FEP160, FGM107SC, FGM109, FGM207SC, FGM209, FGM67SC, FGM69, FGMD107SC, FGMD109, FGMD207, FGMD207SC, FGMD209, FGMD67SC, FGMD69, FGP050, FGP080, FGP160, JOKER FCE 6, JOKER FCE 10, JOKER FCG 6, JOKER FCG 10, JOKER FEM 67 SC, JOKER FEM 69, JOKER FEM107 SC, JOKER FEM109, JOKER FEM207 SC, JOKER FEM209, JOKER FEMD 67 SC, JOKER FEMD 69, JOKER FEMD107 SC, JOKER FEMD109...(Other models you can see in the webshop)		

locks

locking devices


producer-specific

MBM ITALY



1


GEV No.	690462	Ref. No.	01349400R	
description	key cylinder ø 23mm thread M19x1 mounting measurements 16.5x19mm hub 38-45mm shaft ø 11mm thread L 12mm			
For models:	M140BTA, M140BTAG, M140BTAH2, M140BTAP, M140BTH, M140BTHG, M140BTHH2, M140BTHP, M140BTJ, M140BTJG, M140BTJH2, M140BTJP, M140TNA, M140TNAG, M140TNAH2, M140TNAP, M140TNH, M140TNHG, M140TNHH2, M140TNHP, M140TNJ, M140TNJG, M140TNJH2, M140TNJP, M140TPJ, M140TPJH2, M70BTA, M70BTAG, M70BTAH, M70BTAP, M70BTH, M70BTHG, M70BTHH, M70BTHP, M70BTJ, M70BTJG, M70BTJH, M70BTJP, M70TNA, M70TNAG, M70TNAH, M70TNAP, M70TNH, M70TNHG, M70TNHH, M70TNHP, M70TNJ, M70TNJG, M70TNJH, M70TNJP...(Other models you can see in the webshop)			
spare parts for	690462			
	GEV No.	691589	Ref. No.	—
	spare keys for key cylinder 690462 key number 9233			



1

GEV No.	690461	Ref. No.	01348600R
description	key cylinder straight thread M19x1 rotation 90° cam length 54mm cam width 16mm		

electromagnetic closer



1

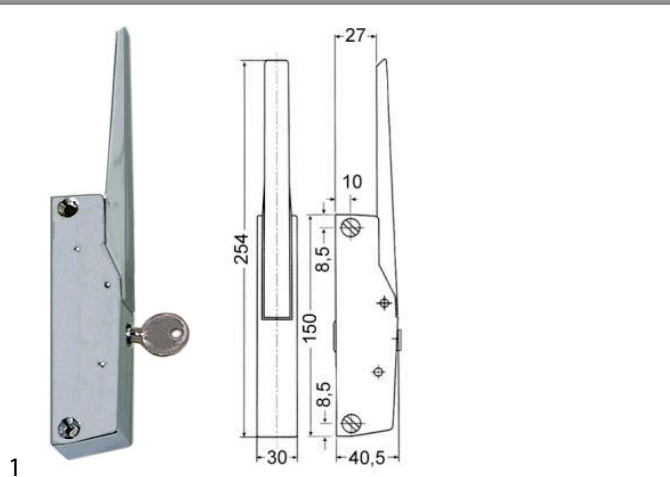
GEV No.	890867	Ref. No.	RTFOC00648
description	door lock		
For models:	FEC023, FEMD023, PLANET FEC023, PLANET FEMD023		



edgmount latches

handle latches

CAFF/FERMOD

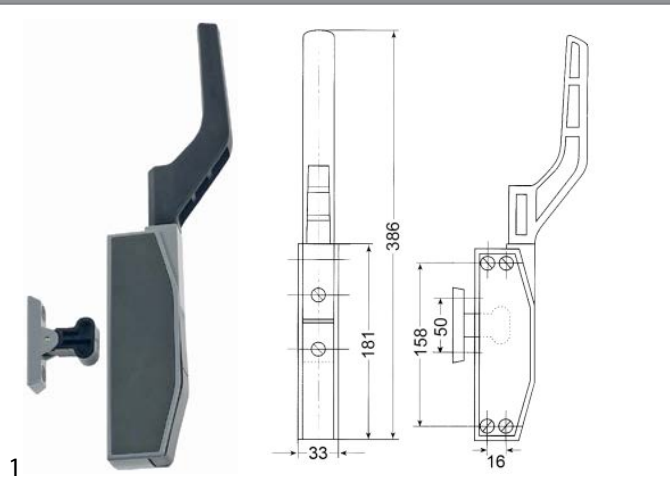


GEV No.	690413	Ref. No.	795CRR
description	handle latch L 150mm mounting distance 133mm lockable refrigeration units G 795		
accessories for	690413		
	GEV No.	690418	Ref. No. —
	door catch L 36mm W 19mm H 29mm mounting distance 12mm zinc-coated steel for refrigeration units		
	GEV No.	690419	Ref. No. —
	door catch L 52mm W 20mm H 30mm mounting distance 26-37mm zamak for refrigeration units		
	GEV No.	700435	Ref. No. —
	door catch L 58mm W 20mm H 35mm mounting distance 42mm zamak for refrigeration units		

walk-in fridge catches

INTERKLIMAT

1800 series



GEV No.	690457	Ref. No.	1825R
description	handle latch mounting distance 158mm L 181mm refrigeration units external lock type 1825 suitable for 1850		

espagnolette locks

universal

GEV No.	690046	Ref. No.	RTFOC00057
description	console H1 14.5mm H2 10mm L 94mm W 40mm		
For models:	FCE10, FCE20, FCE6, FCG10, FCG20, FCG6, FEC060, FEC100, FEC200, FEM060, FEM061, FEM062, FEM100, FEM101, FEM102, FEM107, FEM107SC, FEM109, FEM110, FEM110L, FEM200, FEM201, FEM202, FEM207, FEM207SC, FEM209, FEM210, FEM210L, FEM220, FEM220L, FEM240, FEM240L, FEM610, FEM610L, FEM67, FEM67SC, FEM69, FEMD060, FEMD061, FEMD100, FEMD101, FEMD107, FEMD107SC, FEMD109, FEMD200, FEMD201, FEMD207, FEMD207SC, FEMD209, FEMD67...(Other models you can see in the webshop)		


GEV No.	693797	Ref. No.	RTFOC00005
description	console upper/lower for cam		
For models:	FCE10, FCE20, FCE6, FCG10, FCG20, FCG6, FEC060, FEC100, FEC200, FEM060, FEM061, FEM062, FEM100, FEM101, FEM102, FEM107, FEM107SC, FEM109, FEM110, FEM110L, FEM200, FEM201, FEM202, FEM207, FEM207SC, FEM209, FEM210, FEM210L, FEM220, FEM220L, FEM240, FEM240L, FEM610, FEM610L, FEM67, FEM67SC, FEM69, FEMD060, FEMD061, FEMD100, FEMD101, FEMD107, FEMD107SC, FEMD109, FEMD200, FEMD201, FEMD207, FEMD207SC, FEMD209, FEMD67...(Other models you can see in the webshop)		


GEV No.	690040	Ref. No.	RTFOC00009
description	door catch with roller H 42mm L 40mm W 40mm zinc die cast mounting distance 26mm type 0751 series		
For models:	FCE10, FCE20, FCE6, FCG10, FCG20, FCG6, FEC060, FEC100, FEC200, FEM060, FEM061, FEM062, FEM100, FEM101, FEM102, FEM107, FEM107SC, FEM109, FEM110, FEM110L, FEM200, FEM201, FEM202, FEM207, FEM207SC, FEM209, FEM210, FEM210L, FEM610, FEM610L, FEM67, FEM67SC, FEM69, FEMD060, FEMD061, FEMD100, FEMD101, FEMD107, FEMD107SC, FEMD109, FEMD200, FEMD201, FEMD207, FEMD207SC, FEMD209, FEMD67, FEMD67SC, FEMD69, FEP050, FEP080...(Other models you can see in the webshop)		


producer-specific

MBM





GEV No.	691212	Ref. No.	170831
description	bush for door handle H 19mm ED ø 40mm ID ø 16mm mounting distance 30mm		
For models:	FEM107, FEM110, FEM110L, FEM207, FEM210, FEM210L, FEM220, FEM220L, FEM240, FEM240L, FEM610, FEM610L, FEM67, FGM107, FGM110, FGM110L, FGM207, FGM210, FGM210L, FGM610, FGM610L, FGM67		

			
1			
GEV No.	690046	Ref. No.	RTFOC00057
description	console H1 14.5mm H2 10mm L 94mm W 40mm		
For models:	FCE10, FCE20, FCE6, FCG10, FCG20, FCG6, FEC060, FEC100, FEC200, FEM060, FEM061, FEM062, FEM100, FEM101, FEM102, FEM107, FEM107SC, FEM109, FEM110, FEM110L, FEM200, FEM201, FEM202, FEM207, FEM207SC, FEM209, FEM210, FEM210L, FEM220, FEM220L, FEM240, FEM240L, FEM610, FEM610L, FEM67, FEM67SC, FEM69, FEMD060, FEMD061, FEMD100, FEMD101, FEMD107, FEMD107SC, FEMD109, FEMD200, FEMD201, FEMD207, FEMD207SC, FEMD209, FEMD67...(Other models you can see in the webshop)		

			
1			
GEV No.	693797	Ref. No.	RTFOC00005
description	console upper/lower for cam		
For models:	FCE10, FCE20, FCE6, FCG10, FCG20, FCG6, FEC060, FEC100, FEC200, FEM060, FEM061, FEM062, FEM100, FEM101, FEM102, FEM107, FEM107SC, FEM109, FEM110, FEM110L, FEM200, FEM201, FEM202, FEM207, FEM207SC, FEM209, FEM210, FEM210L, FEM220, FEM220L, FEM240, FEM240L, FEM610, FEM610L, FEM67, FEM67SC, FEM69, FEMD060, FEMD061, FEMD100, FEMD101, FEMD107, FEMD107SC, FEMD109, FEMD200, FEMD201, FEMD207, FEMD207SC, FEMD209, FEMD67...(Other models you can see in the webshop)		

			
1			
GEV No.	690040	Ref. No.	RTFOC00009
description	door catch with roller H 42mm L 40mm W 40mm zinc die cast mounting distance 26mm type 0751 series		
For models:	FCE10, FCE20, FCE6, FCG10, FCG20, FCG6, FEC060, FEC100, FEC200, FEM060, FEM061, FEM062, FEM100, FEM101, FEM102, FEM107, FEM107SC, FEM109, FEM110, FEM110L, FEM200, FEM201, FEM202, FEM207, FEM207SC, FEM209, FEM210, FEM210L, FEM610, FEM610L, FEM67, FEM67SC, FEM69, FEMD060, FEMD061, FEMD100, FEMD101, FEMD107, FEMD107SC, FEMD109, FEMD200, FEMD201, FEMD207, FEMD207SC, FEMD209, FEMD67, FEMD67SC, FEMD69, FEP050, FEP080...(Other models you can see in the webshop)		

			
1			
GEV No.	690865	Ref. No.	RTFOC00360
description	door handle		
For models:	FCE10, FCE6, FCG10, FCG20, FCG6, FEC200, FEM107SC, FEM109, FEM200, FEM201, FEM202, FEM207SC, FEM209, FEM67SC, FEM69, FEMD107SC, FEMD109, FEMD200, FEMD201, FEMD207SC, FEMD209, FEMD67SC, FEMD69, FEP050, FEP080, FEP160, FGC200, FGM107SC, FGM109, FGM200, FGM201, FGM202, FGM207SC, FGM209, FGM67SC, FGM69, FGMD107SC, FGMD109, FGMD200, FGMD201, FGMD207, FGMD207SC, FGMD209, FGMD67SC, FGMD69, FGP050, FGP080, FGP160, JOKER FCE 6, JOKER FCE 10...(Other models you can see in the webshop)		
accessories for	690865		
	GEV No.	890866	Ref. No. RTFOC00401
bush for door handle			

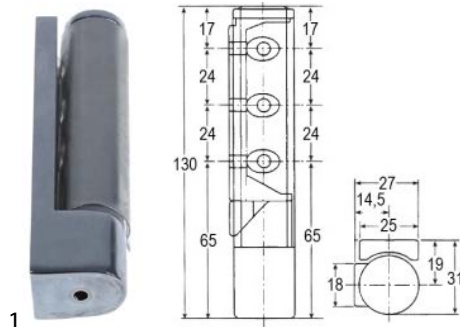
			
1			
GEV No.	690761	Ref. No.	RIC0004434
description	door handle handle ø 40mm grey shaft 8x8mm handle length 140mm		
spare parts for	690761		
	GEV No.	691212	Ref. No. 170831
bush for door handle H 19mm ED ø 40mm ID ø 16mm mounting distance 30mm			
	GEV No.	890868	Ref. No. RTFOC00337
ring inner for door latch ø 16/20mm ID ø 11mm H 6mm			
	GEV No.	890869	Ref. No. RTFOC00338
ring outer for door latch ø 20mm ID ø 11mm H 3mm			

			
1			
GEV No.	691213	Ref. No.	170919 F.FCV/2 MBM
description	door handle handle ø 40mm grey shaft 8x8mm shaft L 48mm handle length 140mm		
For models:	FEM107, FEM110, FEM110L, FEM207, FEM210, FEM210L, FEM220, FEM220L, FEM240, FEM240L, FEM610, FEM610L, FEM67, FGM107, FGM110, FGM110L, FGM207, FGM210, FGM210L, FGM610, FGM610L, FGM67		
accessories for	691213		
	GEV No.	691212	Ref. No. 170831
bush for door handle H 19mm ED ø 40mm ID ø 16mm mounting distance 30mm			
	GEV No.	890868	Ref. No. RTFOC00337
ring inner for door latch ø 16/20mm ID ø 11mm H 6mm			
	GEV No.	890869	Ref. No. RTFOC00338
ring outer for door latch ø 20mm ID ø 11mm H 3mm			

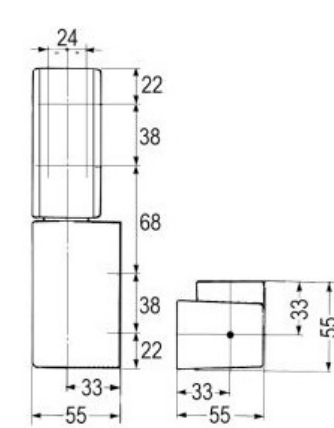
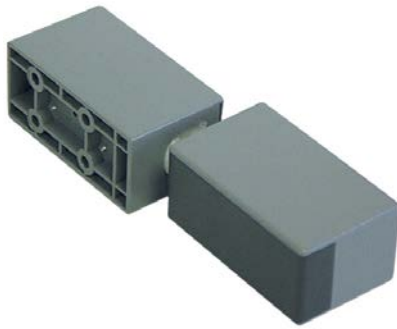
hinges

edgemoount hinges

CAFF/FERMOD



GEV No.	690436	Ref. No.	430CRR
description	edgemoount hinge L 130mm W 27mm mounting distance 48mm hinging left/right with gradient chrome-plated refrigeration units series G 430 centre of rotation 19mm		
accessories for	690436		
	GEV No.	690395	Ref. No.
			—
	base plate for type 300/303 thickness 5mm L 100mm		



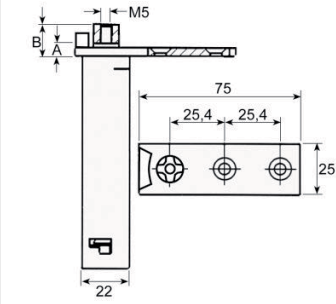
GEV No.	690458	Ref. No.	910R
description	edgemoount hinge L 188mm mounting distance 38mm hinging left/right with gradient series G 915		
accessories for	690458		
	GEV No.	691642	Ref. No.
			—
	base plate thickness 5mm plastic L 98mm W 49mm		

spring assisted hinges

universal

CAFF/FERMOD

group 2



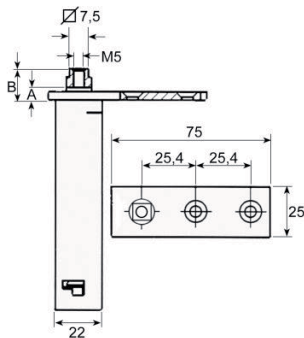
GEV No.	690494	Ref. No.	621083
description	spring assisted hinge series 175 mounting pos. left/right torx L 75mm W 25.6mm H 100mm A 4mm B 11mm mounting measurements 22x22mm intake torx refrigeration units mounting distance 25mm		
For models:	M76-BT-1400lt, M76-BT-700lt, M76-TN-1400lt, M76-TN-700lt		

INTERKLIMAT

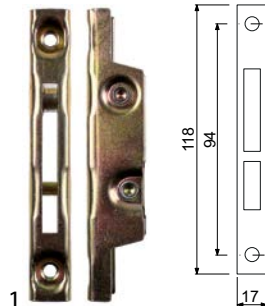
hinges



1



GEV No.	690714	Ref. No.	022104-00
description	spring assisted hinge series 28XC mounting pos. left/right L 75mm W 25mm H 103mm A 8mm B 11mm intake 7.5x7.5 refrigeration units mounting distance 25mm		
For models:	A140N2, A70N1, AX140B2, AX140N2, AX70B1, AX70N1, B140N2, B70N1, BX140B2, BX1420N2, BX70B1, BX70N1, D140B2, D140DN2, D140DNB2, D140DNP2, D140DNP3, D140N2, D140N2V, D70B1, D70DN2, D70DNB2, D70N1, D70N1V, D70P1, DX70B1V		



1

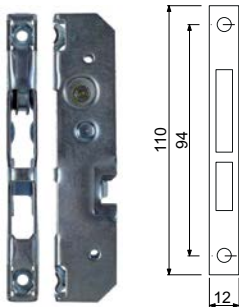
GEV No.	700001	Ref. No.	RTCU900004
description	opposite support L 118mm W 17mm mounting distance 94mm		
For models:	BG6SF77M, BST2LV, BST2RV, BST6LV, BST6RV, C4EF70, C4F, C4F70, C4FV70, C62F, C6EF70, C6F, C6F70, C6FA, C6FV70, C8F, E4F, E4F7, E4F77, E4F77Q, E4F7Q, E4F8, E4F9, E4F98Q, E4F9Q, E4FP77Q, E4FP8, E6FA, E6FA7, E6FA77, E6FA77Q, E6FA7Q, E6FA8, E6FA9, E6FA98Q, E6FA9Q, E6FAR, E6FM, E6FM8, EF07, EF077, EF07V, EF09, EF0V77, EFB09, EFO7, EFO7V, ETF77, EVC4F7, EVC4F77...(Other models you can see in the webshop)		



1

GEV No.	700396	Ref. No.	9626107200 RIC0002546
description	opposite support oven hinge		
For models:	E6F6, G6SF6, G6SFE6, MINIMA E6F6, MINIMA G6SF6, MINIMA G6SFE6, MINIMA G6SFEA6		

oven hinges




1

GEV No.	700003	Ref. No.	9626105200 RIC0002448
description	opposite support L 110mm W 12mm mounting distance 94mm		
For models:	E4F6, E6FA6, G4SF6, G4SFA6, G4SFE6, G6SFA6, G6SFEA6, MINIMA E4F6, MINIMA E6FA6, MINIMA G4SF6, MINIMA G4SFE6, MINIMA G6SFA6		





1

GEV No.	694504	Ref. No.	RIC0002135
description	oven hinge mounting distance 118mm lever length 125mm spring thickness 4mm spring length 60mm L 155mm mounting pos. right W 21mm with hook C 12mm D 120mm		
For models:	G6SF6		





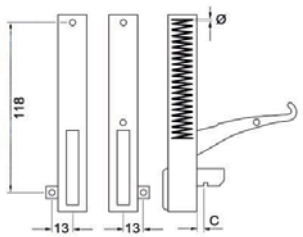
1

GEV No.	690700	Ref. No.	09980699512 RIC0003282
description	oven hinge mounting distance 118mm lug mounting 13mm lever length 119mm groove distance 12mm spring thickness 4mm mounting ear position left/right spring length 60mm L 155mm W 20mm FEP040		
accessories for	690700		
	GEV No.	700003	Ref. No. 9626105200 RIC0002448
opposite support L 110mm W 12mm mounting distance 94mm			





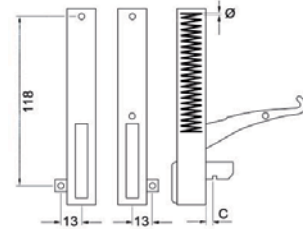
1

GEV No.	690498	Ref. No.	9626107000
description	oven hinge mounting distance 118mm lug mounting 13mm lever length 119mm groove distance 12mm spring thickness 4mm mounting ear position right spring length 59mm L 155mm W 21mm		
For models:	E6F6, G6SF6, G6SFE6, MINIMA E6F6, MINIMA G6SF6, MINIMA G6SFE6, MINIMA G6SFEA6		
accessories for	690498		
	GEV No.	700003	Ref. No. 9626105200 RIC0002448
opposite support L 110mm W 12mm mounting distance 94mm			






1

GEV No.	700013	Ref. No.	9626105100 RIC0002134
description	oven hinge mounting distance 118mm lug mounting 13mm lever length 119mm groove distance 13mm spring thickness 3.5mm mounting ear position left spring length 60mm L 154mm		
For models:	E4F6, E6FA6, G4SF6, G4SFA6, G4SFE6, G6SFA6, G6SFEA6, MINIMA E4F6, MINIMA E6FA6, MINIMA G4SF6, MINIMA G4SFE6, MINIMA G6SFA6		
accessories for	700013		
	GEV No.	700003	Ref. No. 9626105200 RIC0002448
opposite support L 110mm W 12mm mounting distance 94mm			

1


GEV No.	700014	Ref. No.	9626105000 RIC0002133
description	oven hinge mounting distance 118mm mounting distance 2mm lug mounting 13mm lever length 119mm groove distance 13mm spring thickness 3.5mm mounting ear position right spring length 60mm L 154mm		
For models:	E4F6, E6FA6, G4SF6, G4SFA6, G4SFE6, G6SFA6, G6SFEA6, MINIMA E4F6, MINIMA E6FA6, MINIMA G4SF6, MINIMA G4SFE6, MINIMA G6SFA6		
accessories for	700014		
	GEV No.	700003	Ref. No. 9626105200 RIC0002448
opposite support L 110mm W 12mm mounting distance 94mm			

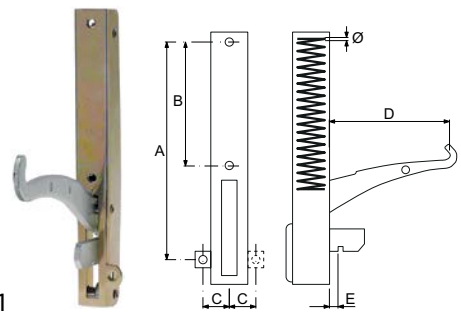




1

GEV No.	694505	Ref. No.	9626107100 RIC0002136
description	oven hinge mounting distance 118mm mounting distance 2mm lug mounting 13mm lever length 125mm groove distance 12mm spring thickness 4mm mounting ear position left spring length 59mm L 155mm W 21mm with hook		
For models:	E6F6, G6SF6, G6SFE6, MINIMA G6SF6, MINIMA G6SFE6, MINIMA G6SFEA6		




			
GEV No.	700006	Ref. No.	RTC900027
description	oven hinge mounting distance 173mm mounting distance 2 105mm lug mounting 14mm lever length 120mm groove distance 11mm spring thickness 3.5mm mounting ear position left spring length 112mm W 25mm		
For models:	BST2LV, BST2RV, BST6LV, BST6RV, C4EF70, C4F, C4F70, C4FV70, C62F, C6EF70, C6F, C6F70, C6FA, C6FV70, C8F, E4F, E4F7, E4F77, E4F77Q, E4F7Q, E4F8, E4F98Q, E4FP77Q, E4FP8, E6FA7, E6FA77, E6FA77Q, E6FA7Q, E6FA8, E6FA98Q, E6FAR, EF07, EF077, EF07V, EF0V77, EFO7, EFO7V, ETF77, EVC4F7, EVC4F77, G2SDMF7, G2SDMFE7, G2SF6, G2SF6G, G2SSMF7, G2SSMFE7, G3SF6, G3SF6G, G4SF, G4SF7...(Other models you can see in the webshop)		
accessories for	700006		
			
GEV No.	700001	Ref. No.	RTC900004
description	opposite support L 118mm W 17mm mounting distance 94mm		
			
GEV No.	700007	Ref. No.	RTC900026 RTC900396
description	oven hinge mounting distance 173mm mounting distance 2 105mm lug mounting 14mm lever length 120mm groove distance 11mm spring thickness 3.5mm mounting ear position right spring length 112mm W 25mm		


			
GEV No.	700007	Ref. No.	RTC900026 RTC900396
description	oven hinge mounting distance 173mm mounting distance 2 105mm lug mounting 14mm lever length 120mm groove distance 11mm spring thickness 3.5mm mounting ear position right spring length 112mm W 25mm		
For models:	BG6SF77M, BST2LV, BST2RV, BST6LV, BST6RV, C4EF70, C4F, C4F70, C4FV70, C62F, C6EF70, C6F, C6F70, C6FA, C6FV70, C8F, E4F, E4F7, E4F77, E4F77Q, E4F7Q, E4F8, E4F9, E4F98Q, E4F9Q, E4FP77Q, E4FP8, E6FA, E6FA7, E6FA77, E6FA77Q, E6FA7Q, E6FA8, E6FA9, E6FA98Q, E6FA9Q, E6FAR, E6FM, E6FM8, EF07, EF077, EF07V, EF09, EF0V77, EFB09, EFO7, EFO7V, ETF77, EVC4F7, EVC4F77...(Other models you can see in the webshop)		
accessories for	700007		
			
GEV No.	700001	Ref. No.	RTC900004
description	opposite support L 118mm W 17mm mounting distance 94mm		
			
GEV No.	700006	Ref. No.	RTC900027
description	oven hinge mounting distance 173mm mounting distance 2 105mm lug mounting 14mm lever length 120mm groove distance 11mm spring thickness 3.5mm mounting ear position left spring length 112mm W 25mm		

door bearing



GEV No.	693647	Ref. No.	PAFOC00394
description	door hinge bottom left		
For models:	FCE10, FCE6, FCG10, FCG6, FEM107SC, FEM109, FEM67SC, FEM69, FEMD107SC, FEMD109, FEMD67SC, FEMD69, FEP050, FEP080, FGM107SC, FGM109, FGM67SC, FGM69, FGMD107SC, FGMD109, FGMD67SC, FGMD69, FGP050, FGP080		


			
GEV No.	700902	Ref. No.	GACU600077
description	hinge L 54mm W 26mm H 29mm mounting pos. left with bolt		

			
GEV No.	700901	Ref. No.	GACU600076
description	hinge L 54mm W 26mm H 29mm mounting pos. right with bolt		


			
GEV No.	690979	Ref. No.	161387
description	hinge bearing mounting pos. bottom left without bolt		
For models:	FCE10, FCE6, FCG10, FCG6, FEM107, FEM107SC, FEM109, FEM110, FEM110L, FEM610, FEM610L, FEM67, FEM67SC, FEM69, FEMD107, FEMD107SC, FEMD109, FEMD67, FEMD67SC, FEMD69, FEP050, FEP080, FGM107, FGM107SC, FGM110, FGM110L, FGM610, FGM610L, FGM67, FGM67SC, FGMD107, FGMD107SC, FGMD67, FGMD67SC, FGMD69, FGP050, FGP080, JOKER FCE 6 AB 2002, JOKER FCE 10 AB 2002, JOKER FCG 6 AB 2002, JOKER FCG 10 AB 2002, JOKER FEM 69 AB 2002, JOKER FEM109 AB 2002, JOKER FEP050 AB 2002, JOKER FEP080 AB 2002, JOKER FGP050 AB 2002, JOKER FGP080 AB 2002		




GEV No.	690988	Ref. No.	PABF900104
description	hinge bearing mounting pos. bottom left without bolt		
For models:	C2A, C4A, C6A, C6FA, C8A, E2A, E2AR, E4A, E4AR, E6A, E6AR, E6FAR, EBM45, EBM90, EC45, EC902V, EF45, EF90, EFT45L, EFT45LC, EFT45R, EFT45RC, EFT90L, EFT90LC, EFT90LR, EFT90LRC, EFT90R, EFT90RC, G2S, G2SAP, G2SP, G4S, G6S, G6SFA, G6SFEA, GBM45, GBM90, GC45, GC90, GC902V, GF45, GF90, GFT45L, GFT45LC, GFT45R, GFT45RC, GFT90L, GFT90LC, GFT90LR, GFT90LRC...(Other models you can see in the webshop)		



GEV No.	690983	Ref. No.	RTCP800030
description	hinge bearing mounting pos. right without bolt		
For models:	E100, E100I, E150, E150I, EBR, EBRA, EBRAVI, EBRVI, G100, G100A, G100I, G100IA, G150, G150A, G150I, G150IA, G175, G175I, GBR, GBRA, GBRAVI, GBRVI		




GEV No.	690464	Ref. No.	O1156100R
description	hinge bearing mounting pos. bottom left/upper right with bolt		




GEV No.	690986	Ref. No.	162198
description	hinge bearing mounting pos. upper left with bolt		
For models:	E6FA, E6FA77, E6FA9, E6FA9Q, EBM45, EBM90, EC45, EC477, EC49, EC777, EC777T, EC902V, EC992V, EF45, EF477, EF4772V, EF49, EF777, EF90, EF99, EMT477, EMT777, G4SMFA77, G6SFA, G6SFA77, G6SFA9, G6SFEA, G6SFEA9, GBM45, GBM90, GC45, GC477, GC49, GC777, GC777T, GC902V, GC992V, GF45, GF4772VB, GF4772VS, GF477B, GF477S, GF49, GF777B, GF777S, GF90, GF90-1, GF99, GF99T, GPL45-P...(Other models you can see in the webshop)		




GEV No.	690978	Ref. No.	PAFOC00583
description	hinge bearing mounting pos. bottom right with bolt		
For models:	FCE10, FCE6, FCG10, FCG6, FEM107, FEM107SC, FEM109, FEM110, FEM110L, FEM210, FEM210L, FEM610, FEM610L, FEM67, FEM67SC, FEM69, FEMD107, FEMD107SC, FEMD109, FEMD67, FEMD67SC, FEMD69, FEP050, FEP080, FGM107, FGM107SC, FGM109, FGM110, FGM110L, FGM210, FGM210L, FGM610, FGM610L, FGM67, FGM67SC, FGM69, FGMD107, FGMD107SC, FGMD109, FGMD67, FGMD67SC, FGMD69, FGP050, FGP080, JOKER FCE 6, JOKER FCE 6 AB 2002, JOKER FCE 10, JOKER FCE 10 AB 2002, JOKER FCG 6, JOKER FCG 6 AB 2002...(Other models you can see in the webshop)		



GEV No.	690987	Ref. No.	GAFOC00254
description	hinge bearing mounting pos. upper left with bolt		
For models:	FCG20, FEM207SC, FEMD207SC, FEMD209, FEP160, FGM207SC, FGM209, FGMD207, FGMD207SC, FGMD209, FGP160, JOKER FEM207 SC, JOKER FEMD207 SC, JOKER FEMD209, JOKER FEP160, JOKER FGM207 SC, JOKER FGM209, JOKER FGMD207 SC, JOKER FGMD209, JOKER FGP160		



GEV No.	690984	Ref. No.	RTCP800028
description	hinge bearing mounting pos. left without bolt		
For models:	E100, E100I, E150, E150I, EBR, EBRA, EBRAVI, EBRVI, G100, G100A, G100I, G150, G150A, G150I, G175, G175I, GBR, GBRA, GBRAVI, GBRVI		



GEV No.	690989	Ref. No.	GACU800038
description	hinge bearing mounting pos. upper left with bolt		
For models:	C4A, C6A, C8A, E4A, E4AR, E6A, E6AR, EBM90, EC902V, EF90, EFT90L, EFT90LC, EFT90LR, EFT90LRC, EFT90R, EFT90RC, G4S, G6S, GBM90, GC90, GC902V, GF90, GFT90L, GFT90LC, GFT90LR, GFT90LRC, GFT90R, GFT90RC, GPL90, GT, GT2S, GT2SD, TPA		





1

GEV No.	693636	Ref. No.	GAFOC00030
description	hinge bearing mounting pos. upper left with bolt		
For models:	FCE10, FCE20, FCE6, FCG10, FCG20, FCG6, FEC060, FEC065, FEC100, FEC200, FEM060, FEM061, FEM062, FEM100, FEM101, FEM102, FEM107, FEM107SC, FEM109, FEM110, FEM110L, FEM200, FEM201, FEM202, FEM207, FEM207SC, FEM210, FEM210L, FEM610, FEM610L, FEM67, FEM67SC, FEM69, FEMD060, FEMD061, FEMD065, FEMD066, FEMD100, FEMD101, FEMD107, FEMD107SC, FEMD109, FEMD200, FEMD201, FEMD207, FEMD207SC, FEMD67, FEMD67SC, FEMD69, FEP050...(Other models you can see in the webshop)		




1

GEV No.	693795	Ref. No.	GAFOC00213 GAFOC00255
description	hinge bearing mounting pos. upper right with bolt		
For models:	FCE10, FCE6, FCG10, FCG20, FCG6, FEM107, FEM107SC, FEM109, FEM110, FEM110L, FEM207SC, FEM209, FEM210, FEM210L, FEM610, FEM610L, FEM67, FEM67SC, FEM69, FEMD107, FEMD107SC, FEMD109, FEMD207SC, FEMD209, FEMD67, FEMD67SC, FEMD69, FEP050, FEP080, FEP160, FGM107, FGM107SC, FGM109, FGM110, FGM110L, FGM207SC, FGM209, FGM210, FGM210L, FGM610, FGM610L, FGM67, FGM67SC, FGM69, FGMD107, FGMD107SC, FGMD109, FGMD207, FGMD207SC, FGMD209...(Other models you can see in the webshop)		




2

GEV No.	690463	Ref. No.	01156300R RIC0002971
description	hinge bearing mounting pos. upper left/bottom right with bolt		



1

GEV No.	690465	Ref. No.	01157600R
description	hinge bearing with bolt		




1

GEV No.	690985	Ref. No.	162199 176895
description	hinge bearing mounting pos. upper right		
For models:	BGF777B, E6FA, E6FA77, E6FA77Q, E6FA8, E6FA9, E6FA98Q, E6FA9Q, EBM45, EBM90, EC408-SC, EC45, EC477, EC477-SC, EC49, EC498-SC, EC498T-SC, EC777, EC777-SC, EC777T, EC902V, EC9082V-SC, EC992V, EC9982V-SC, EC9982VT-SC, EF408, EF45, EF477, EF4772V, EF49, EF498, EF4982V, EF498L, EF498T, EF777, EF90, EF908, EF99, EF998, EF998L, EF998T, EMT477, EMT777, G4SMFA77, G6SFA, G6SFA77, G6SFA8, G6SFA9, G6SFA98, G6SFEA...(Other models you can see in the webshop)		


accessories

miscellaneous



1

GEV No.	693826	Ref. No.	RTCP800027
description	spring guide for hinge		
For models:	E100, E100I, E150, E150I, EBR, EBRA, EBRAVI, EBRVI, G100, G100A, G100I, G100IA, G150, G150A, G150I, G150IA, G175I, GBR, GBRA, GBRAVI, GBRVI		



1

GEV No.	690990	Ref. No.	GACU800037
description	hinge bearing mounting pos. upper right with bolt		
For models:	C2A, C4A, C6A, C6FA, C8A, E2A, E2AR, E4A, E4AR, E6A, E6AR, E6FAR, EBM45, EBM90, EC902V, EF45, EF90, EFT45L, EFT45LC, EFT45R, EFT45RC, EFT90L, EFT90LC, EFT90LR, EFT90LRC, EFT90R, EFT90RC, G2S, G2SAP, G2SP, G4S, G6S, G6SFA, G6SFEA, GBM45, GBM90, GC45, GC90, GC902V, GF45, GF90, GFT45L, GFT45LC, GFT45R, GFT45RC, GFT90L, GFT90LC, GFT90LR, GFT90LRC, GFT90R...(Other models you can see in the webshop)		

pullouts


drawer slides

producer-specific



1


GEV No.	690721	Ref. No.	01513600R
description	drawer slide L 490mm pull-out length 410mm Qty 1 pair W 20mm H 33mm mounting pos. right/left for refrigerated counters 600mm		



1

GEV No.	690722	Ref. No.	01468200R
description	drawer slide L 590mm pull-out length 570mm Qty 1 pair W 17mm H 62mm mounting pos. right/left for refrigerated counter 700mm		

spare parts for 690722

GEV No.	690750	Ref. No.	—
	stop fortelescopic rail L 20mm plastic H 12mm D 9mm		

rollers

rollers



GEV No.	690466	Ref. No.	01000600R
description	roller rollerø 25mm B1 6mm overall width 10mm A 25mm B 6mm C 10mm D 6mm E 10mm plastic bearing ball bearing		



GEV No.	518363	Ref. No.	499078
description	roller rollerø 36mm B1 10mm overall width 22mm A 36mm B 10mm C 22mm ø 20.5mm plastic tread plastic		
For models:	LB42BT-UK, LBD40, LBDX40, LF56, LF60, LFD50, LFDX50, LS520-CRP, LS521, LS521-CRP-SP		

roller with holder



GEV No.	690955	Ref. No.	2330706
description	roller rollerø 28mm B1 6mm with holder SS/Nylon mounting pos. upper bearing slide bearing Qty 1 pcs H 5mm L 62mm mounting distance 25/45mm		
For models:	BC3G, BC4G, BC6G		

fittings for catering equipment

outlet taps

producer-specific

miscellaneous



GEV No.	540862	Ref. No.	RTCU600422
description	lever for outlet tap thread M6 ET - M6 ET		
For models:	EBM46, EBM66, EF46, EF66, GBM46, GBM66, GF46, GF66, GF99, MINIMA EBM 46, MINIMA EBM 66, MINIMA EF 46, MINIMA EF 66, MINIMA GBM 46, MINIMA GBM 66, MINIMA GF 46, MINIMA GF 66		



GEV No.	540864	Ref. No.	RTCU700412
description	lever for outlet tap thread M6 ET - M6 ET		
For models:	EBM47, EBM477, EBM77, EBM777, EBMA477, EBMA777, EC66, EF472VT, EF4772VT, EF477T, EF47T, EF777T, EF77T, GBM47, GBM77, GBM777, GBMA777, GC66, GF477TS, GF47T, GF777TS, GF77T, MG7EBM477, MG7EBMA477, MG7EF4772VT, MG7EF477T, MG7EF777T, MG7GF477TS, MG7GF777TS, MINIMA EC 66, MINIMA GC 66, OMNIA EBM 47, OMNIA EBM 77, OMNIA EF 47T, OMNIA EF 77T, OMNIA EF472VT, OMNIA GBM 47, OMNIA GBM 77, OMNIA GF 47T, OMNIA GF 77T		

lid hinges

ELECTROLUX



GEV No.	700395	Ref. No.	165897 RTBF800080
description	lid hinge		
For models:	EBR, EBRA, EBRAVI, EBRVI, GBR, GBR9T, GBRA, GBRAVI, GBRVI		

inlet taps



GEV No.	514048	Ref. No.	RTCU600075
description	ball valve connection 1/2" complete total length 55mm mounting pos. any brass H 30mm L 55mm rosette ø 70mm rosette thread G2 M22x1		
For models:	E100I, E100I8, E100I9, E100I98, E100I9N, E100IT9N, E150I, E150I8, E150I9, E150I98, E150I9N, E150IT9, E150IT9N, E50I7, E50I77, EBR7, EBR77, EBR8, EBRI7, EBRI77, EBRVC98, EBRV8, EBRVI98, EC66, G100I, G100I8, G100I9, G100I98, G100I9N, G100IT9, G100IT9N, G150I, G150I8, G150I9, G150I98, G150I9N, G150IT9, G150IT98, G150IT9N, G5077, G50I7, G50I77, GBR7, GBR77, GBR8, GBRI7, GBRI77, GBRVC98, GBRV8, GBRVI98...(Other models you can see in the webshop)		
spare parts for	514048		



GEV No.	540871	Ref. No.	RTCU900492
description	lever handle cold water suitable for intake tap		



drain taps

brass

drain taps



1	GEV No.	540275	Ref. No.	RTCP900004
	description	drain tap 2" IT with union nut A 90mm B 151mm B1 80mm chrome-plated brass		
	For models:	CP100, CP100A, CP150, CP150A, CPI100, CPI100A, CPI150, CPI150A, E100, E100A, E100I, E100I9, E100IA, E100IT9, E150, E150A, E150I, E150I9, E150IA, E150IT9, G100, G1009, G100A, G100I, G100I9, G100IA, G100IT9, G100T9, G150, G1509, G150A, G150I, G150I9, G150IA, G150IT9, G150T9, G175, G175I		
	spare parts for	540275		
	GEV No.	540214	Ref. No.	—
	description	handle ID ø 6mm L 145mm		
	accessories for	540275		
	GEV No.	529484	Ref. No.	—
	description	flat gasket fibre ED ø 58mm ID ø 50mm thickness 2mm Qty 1 pcs		
	GEV No.	542448	Ref. No.	—
	description	gasket silicone 60x49x2 for drain tap 2"		



1	GEV No.	540276	Ref. No.	RTCP700001
	description	drain tap connection with union nut thread 1 1/2"		
	For models:	E50I7, E50I77, G507, G5077, G50I7, G50I77, MG7E50I77, OMNIA G507, OMNIA G50I7		
	spare parts for	540276		
	GEV No.	532374	Ref. No.	—
	description	O-ring silicone thickness 5.34mm ID ø 43.82mm Qty 10 pcs		
	accessories for	540276		
	GEV No.	514251	Ref. No.	—
	description	gasket fibre ED ø 46mm ID ø 38mm thickness 2mm Qty 1 pcs		

accessories



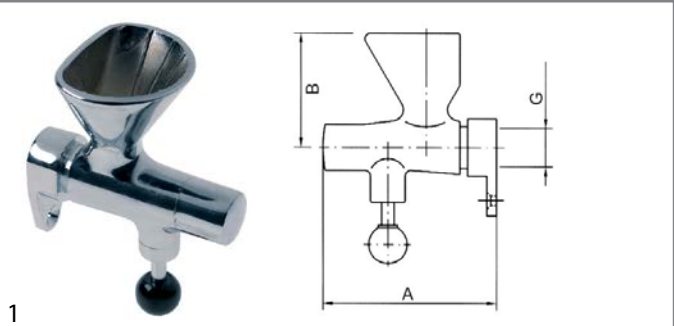
1	GEV No.	540797	Ref. No.	RTCP900018
	description	rosette for drain tap 2"		
	For models:	CP100, CP100A, CP150, CP150A, CPI100, CPI100A, CPI150, CPI150A, E100, E100A, E100I, E100I8, E100I9, E100I98, E100I9N, E100IA, E100IT9, E100IT9N, E150, E150A, E150I, E150I8, E150I9, E150I98, E150I9N, E150IA, E150IT9, E150IT9N, G100, G1008, G1009, G10098, G100A, G100I, G100I8, G100I9, G100I98, G100I9N, G100IA, G100IT9, G100IT9N, G100T9, G100T98, G150, G1508, G1509, G15098, G150A, G150I, G150I8...(Other models you can see in the webshop)		



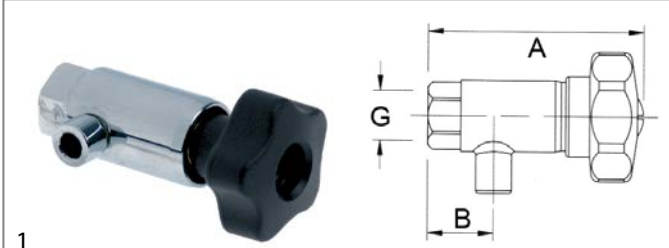
1	GEV No.	693793	Ref. No.	160927
	description	screw-in socket for drain tap T1: 2"		
	For models:	E100I, E100I9, E100IT9, E150I, E150I9, E150IT9, G100, G1009, G100I, G100I9, G100IT9, G100T9, G150, G1509, G150I, G150I9, G150IT9, G150T9		

test taps

test taps




1	GEV No.	540079	Ref. No.	RTCP800066
	description	funnel thread 1/2" IT W 90mm W1 60mm		
	For models:	E100I, E100IA, E150I, E150IA, G100I, G100IA, G150I, G150IA, G175I		



1

GEV No.	540206	Ref. No.	RTCP800065
description	test tap thread 3/8" IT W 78mm W1 20mm head ø 37mm head thickness 15mm		
For models:	CPI100, CPI100A, CPI150, CPI150A, E100I, E100I8, E100I9, E100I98, E100I9N, E100IA, E100IT9, E100IT9N, E150I, E150I8, E150I9, E150I98, E150I9N, E150IA, E150IT9, E150IT9N, E50I7, E50I77, G100I, G100I8, G100I9, G100I98, G100I9N, G100IA, G100IT9, G100IT9N, G150I, G150I8, G150I9, G150I98, G150I9N, G150IA, G150IT9, G150IT98, G150IT9N, G175I, G50I7, G50I77, MG7E50I77, OMNIA G50I7		

safety valves




1

GEV No.	540722	Ref. No.	RTCP900014
description	safety valve with outlet for lid		
For models:	CP100A, CP150A, CPI100A, CPI150A, E100A, E100IA, E150A, E150IA, G100, G100A, G100IA, G150, G150A, G150IA, G175I		

filters

device filters



1

GEV No.	970666	Ref. No.	013524-00-R
description	air filter L 265mm W 252mm H 12mm metal for condenser		

equipment feet and end caps

equipment feet


with screw mounting

universal




1

GEV No.	700868	Ref. No.	73100 DWP128U
description	equipment foot tube ø 64mm thread M12 thread L 25mm H 155-235mm SS size 2 1/2" Qty 1 pcs		
For models:	L61, L62, L63, L64, LK605, LK622, LK625, LTD212		




1

GEV No.	700761	Ref. No.	20613
description	equipment foot tube ø 50mm thread M10 thread L 12mm H 130-180mm SS size 2" Qty 1 pcs		
For models:	CB955A, CB955W		



1

GEV No.	700826	Ref. No.	168350 177851
description	equipment foot tube ø 59mm thread M10 H 94-140mm stainless steel Qty 1 pcs		
For models:	EF12+12S, EF12S, EF25+25S, EF25S, FG15M, FG20M, GF15+15S, GF15S, GF25+25S, GF25S		





1


GEV No.	513287	Ref. No.	79028 926117
description	equipment foot tube ø 60mm thread M12 thread L 33mm H 155-235mm SS size 2" Qty 1 pcs		
For models:	LF59, LF60, LFD50, LFD60, LFDX50, LK100, LK100EM, LK110, LK130, LK600, LK605, LK611, LK620, LK621, LK622, LK622I, LKD130, LKDX110, LS505, LT81, LTD101, LTD131, LTD171, LTD209, LTD212, LTD216, LTD220, LTD316, LTD320, LTD326, LTDX172, LTDX222, LTDX272		



screw-in feet

 <p>1</p>			
GEV No.	695601	Ref. No.	461010
description	equipment foot thread M17 thread L 23mm ø 24mm H 11mm plastic WS 24 Qty 1 pcs		
For models:	KLB40, LB135, LB140, LB35, LB350, LB355, LB35C, LB40, LB400, LB405, LB40E, LB411, LB411A, LB422, LB425		

 <p>1</p>			
GEV No.	513284	Ref. No.	461019
description	equipment foot thread M8 thread L 20mm ø 30mm H 12mm Qty 1 pcs		
For models:	LB145, LB42BT-UK, LB45, LB450, LBD40, LBDX40, LF50, LF500, LF55, LF550, LF551, LF55E, LF56, LF60, LFD50, LFDX50, LS500, LS500A, LS500G, LS500GA, LS500GPV, LS500PV, LS501, LS501A, LS501G, LS501GA, LS501GPV, LS501PV, LS505M, LS505T, LS511, LS511A, LS511PV, LS520, LS520-CRP, LS521, LS521-CRP-SP		

 <p>1</p>			
GEV No.	970370	Ref. No.	RTBF800009
description	fryer basket L1 290mm W1 330mm H1 120mm		
For models:	EF45, EF90, GF45, GF90		


 <p>1</p>			
GEV No.	970358	Ref. No.	A800000210 A800003 RTBF800316
description	fryer basket L1 290mm W1 330mm H1 120mm L2 507mm H2 175mm H3 220mm chrome-plated steel		
For models:	EF45, EF90		


baskets

fryer baskets


MBM ITALY

 <p>1</p>			
GEV No.	970421	Ref. No.	A660000310 A660019
description	fryer basket L1 280mm W1 225mm H1 115mm		
For models:	EF46, EF66, GF46, GF477TS, GF66, GF777TS, GF99, MG7GF477TS, MG7GF777TS, MINIMA EF 46, MINIMA EF 66, MINIMA GF 46, MINIMA GF 66		

 <p>1</p>			
GEV No.	970427	Ref. No.	A770000140 A770045
description	fryer basket L1 295mm W1 120mm H1 120mm		
For models:	EF47, EF472V, EF472VT, EF4772V, EF4772VT, EF47T, GF47, GF472V, GF4772V, GF4772VB, GF4772VS, GF47T, GF77, GF77T, MG7EF4772V, MG7EF4772VT, MG7GF4772V, OMNIA EF472V, OMNIA EF472VT, OMNIA GF 47T, OMNIA GF 77T, OMNIA GF472V		


 <p>1</p>			
GEV No.	970371	Ref. No.	A800000200 RTBF800010
description	fryer basket L1 285mm W1 160mm H1 120mm		
For models:	EF90, GF90		

 <p>1</p>			
GEV No.	970428	Ref. No.	A770000150 A770046
description	fryer basket L1 295mm W1 260mm H1 120mm		
For models:	BGF777B, EF472V, EF477, EF477T, EF47T, EF77, EF777, EF777T, EF77T, GF47, GF477, GF477B, GF477S, GF477TS, GF47T, GF77, GF777, GF777B, GF777S, GF777TS, GF77T, MG7EF477, MG7EF477T, MG7EF777, MG7EF777T, MG7GF477, MG7GF777, OMNIA EF 47T, OMNIA EF 77, OMNIA EF 77T, OMNIA GF 47, OMNIA GF 47T, OMNIA GF 77, OMNIA GF 77T		



1

GEV No.	970522	Ref. No.	160037
description	fryer basket L1 360mm W1 130mm H1 135mm		
For models:	EF90, EF908, EF99, EF998, EF998T, EF99T, GF90, GF90-1, GF908, GF908N, GF99, GF998B, GF99T		



1

GEV No.	970523	Ref. No.	160038
description	fryer basket L1 360mm W1 270mm H1 135mm		
For models:	EF408, EF45, EF49, EF498, EF498T, EF49T, EF90, EF908, EF99, EF998, EF998T, EF99T, GF408, GF408N, GF45, GF49, GF498B, GF49T, GF90, GF90-1, GF908, GF908N, GF99, GF998B, GF99T		

pasta baskets
MBM ITALY




1

GEV No.	970426	Ref. No.	A80000790 B800004
description	pasta basket L1 160mm W1 145mm H1 215mm H3 427mm stainless steel mounting pos. left		




1

GEV No.	970425	Ref. No.	A800000780 B800003
description	pasta basket L1 160mm W1 145mm H1 215mm H3 427mm stainless steel mounting pos. right		



1

GEV No.	970333	Ref. No.	A800001260 A800104
description	pasta basket L1 160mm W1 290mm H1 215mm H3 335mm stainless steel		
For models:	EC45, EC49, EC49T, EC902V, EC992V, EC992VT, GC45, GC49, GC49T, GC902V, GC992V, GC992VT		



1

GEV No.	970433	Ref. No.	A800001270 A800105
description	pasta basket L1 240mm W1 290mm H1 215mm H3 357mm stainless steel		



1

GEV No.	970422	Ref. No.	A770000120 A770049
description	pasta basket L1 290mm W1 145mm H1 215mm L2 502mm H2 295mm H3 342mm stainless steel		




1

GEV No.	970423	Ref. No.	A80000810 B800006
description	pasta basket L1 290mm W1 160mm H1 215mm H3 348mm stainless steel		



1

GEV No.	970431	Ref. No.	A770000130 A770050
description	pasta basket L1 495mm W1 290mm H1 215mm H3 357mm stainless steel		



1

GEV No.	970424	Ref. No.	A80000800 B800005
description	pasta basket L1 290mm W1 97mm H1 215mm L2 505mm H2 295mm H3 325mm stainless steel		



1

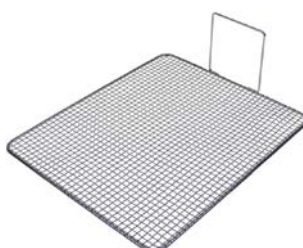
GEV No.	970429	Ref. No.	A800001300 A800108
description	pasta basket ø 145mm H1 205mm H3 370mm stainless steel		



1

GEV No.	970332	Ref. No.	A660000370
description	pasta basket L1 300mm W1 115mm H1 125mm H3 235mm stainless steel		
For models:	EC66, GC66, MINIMA EC 66, MINIMA GC 66		

crumb screens




1

GEV No.	970737	Ref. No.	RTCU700448
description	crumb screen L 327mm W 267mm H 105mm for fryer		
For models:	BGF777B, EF472V, EF477, EF477T, EF47T, EF77, EF777, EF777T, EF77T, GF47, GF477, GF477B, GF477S, GF477TS, GF47T, GF77, GF777, GF777B, GF777S, GF777TS, GF77T, MG7EF477, MG7EF477T, MG7EF777, MG7EF777T, MG7GF477, MG7GF777		



1

GEV No.	970432	Ref. No.	A8000820
description	pasta basket L1 325mm W1 290mm H1 215mm stainless steel		



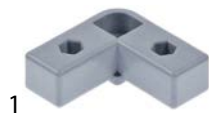
1

GEV No.	970521	Ref. No.	160036
description	crumb screen L 382mm W 272mm H 130mm suitable for fryer		
For models:	EF408, EF45, EF49, EF498, EF498L, EF498T, EF49T, EF90, EF908, EF99, EF998, EF998L, EF998T, EF99T, GF408, GF408N, GF45, GF49, GF498B, GF49T, GF90, GF90-1, GF908, GF908N, GF99, GF998B, GF99T		

warewashing baskets

accessories

sliding corners



GEV No.	970820	Ref. No.	75075
description	sliding corner L 44mm W 44mm H 17mm		
For models:	LT81, LTD101, LTD131, LTD171, LTD209, LTD212, LTD216, LTD220, LTD316, LTD320, LTD326, LTDX172, LTDX222, LTDX272		

accessories for	970556		
	GEV No.	690332	Ref. No. —
	shelf support L 31/28mm W 22mm H 17mm SS with hook Qty 1 pcs		
	GEV No.	694700	Ref. No. —
	shelf support L 31/28mm W 22mm H 18mm SS Qty 12 pcs		
	GEV No.	694701	Ref. No. —
	shelf support L 31/28mm W 22mm H 17mm SS with hook Qty 12 pcs		



GEV No.	970557	Ref. No.	OA000-00-021
description	grate W 555mm D 670mm plastic-coated steel with hinge camp crossing wires 2 suitable for refrigerator		
For models:	D140B2, D140DN2, D140DNB2, D140DNP2, D140DNP3, D140N2, D140N2V, D70B1, D70DN2, D70DNB2, D70N1, D70N1V, DX70B1V		
accessories for	970557		
	GEV No.	690330	Ref. No. —
	rack L 1000mm W 22mm H 4mm aperture 3x8mm hole distance 12.5mm stainless steel		
	GEV No.	694700	Ref. No. —
	shelf support L 31/28mm W 22mm H 18mm SS Qty 12 pcs		
	GEV No.	694701	Ref. No. —
	shelf support L 31/28mm W 22mm H 17mm SS with hook Qty 12 pcs		

producer-specific



GEV No.	210244	Ref. No.	RTCU700341
description	chargrill grid W 530mm D 630mm H 30mm SS crossing wires 2		
For models:	E4F, E4F7, E4F77, E4F77Q, E4F7Q, E4F8, E4F9, E4F98Q, E4F9Q, E4F-P77Q, E4FP8, E6FA, E6FA7, E6FA77, E6FA77Q, E6FA7Q, E6FA8, E6FA9, E6FA98Q, E6FA9Q, EF07, EF077, EF09, EFB09, EFO7, ETF77, EVC4F7, EVC4F77, G2SDMF7, G2SDMFE7, G2SSMF7, G2SSMFE7, G4SF, G4SF-1, G4SF7, G4SF77, G4SF77P, G4SF8, G4SF9, G4SF9-1, G4SF9-2, G4SF98, G4SF98P, G4SFE, G4SFE7, G4SFE77, G4SFE77P, G4SFE8, G4SFE9, G4SFE98...(Other models you can see in the webshop)		

shelves and shelf rails

grates

universal

without upstand




GEV No.	970125	Ref. No.	OA000-00-023
description	grate W 325mm D 530mm GN 1/1 plastic-coated steel crossing wires 1 white suitable for refrigerator		
accessories for	970125		
	GEV No.	690330	Ref. No. —
	rack L 1000mm W 22mm H 4mm aperture 3x8mm hole distance 12.5mm stainless steel		
	GEV No.	694700	Ref. No. —
	shelf support L 31/28mm W 22mm H 18mm SS Qty 12 pcs		
	GEV No.	694701	Ref. No. —
	shelf support L 31/28mm W 22mm H 17mm SS with hook Qty 12 pcs		

with upstand




GEV No.	970556	Ref. No.	AGCU ZAG0000372
description	grate W 530mm D 650mm GN 2/1 plastic-coated steel with hinge camp wire gauge frame 9mm lengthwise wires gauge 5mm crossing wires 2 white suitable for refrigerator		
accessories for	970556		
	GEV No.	690330	Ref. No. —
	rack L 1000mm W 22mm H 4mm aperture 3x8mm hole distance 12.5mm stainless steel		


1

GEV No.	970707	Ref. No.	RTCU800029
description	grate W 325mm H 55mm chrome-plated steel for oven L 675mm wire gauge frame 7mm lengthwise wires gauge 6mm crossing wires 1		
For models:	E2A, E2AR, E4AR, E6AR, E6FAR, EBM45, G2S, G2SAP, G2SP, G6SFA, G6SFEA, GBM45, GT2SDF, GT2SDFE, GT2SFA, GT2SFEA		



1

GEV No.	970706	Ref. No.	RTCU700030
description	grate W 530mm D 580mm H 55mm chrome-plated steel for oven wire gauge frame 7mm lengthwise wires gauge 4.9mm crossing wires 1		
For models:	BM4G70, BST2LV, BST2RV, BST6LV, BST6RV, C4A70, C4AV70, C4EF70, C4F70, C4F702P, C4FV70, C4FV702P, C6EF70, C6F70, C6FV70, TPF70, TPFV70		



1

GEV No.	970733	Ref. No.	RTCU800028
description	grate W 534mm D 675mm H 55mm chrome-plated steel with hinge camp wire gauge frame 6.8mm lengthwise wires gauge 5.8mm crossing wires 1		
For models:	C4F, C62F, C6F, C6FA, C8F, E4F, E6FAR, G4SF, G4SFE, G6SF2, G6SFA, G6SFEA, G8SF2, G8SF2E, GT2SDF, GT2SDFE, GT2SFA, GT2SFEA, GTF, GTFE		

shelf rails and supports

producer-specific




1

GEV No.	692243	Ref. No.	010912-02
description	guide L 580mm W 16mm inner height 19mm mounting measurements 552mm mounting pos. left		




1

GEV No.	692244	Ref. No.	010911-02
description	guide L 580mm W 16mm inner height 19mm mounting measurements 552mm mounting pos. right		



1

GEV No.	690734	Ref. No.	0A00000800
description	pair of setting bar L-shape L 780mm W 40mm H 24mm		




1

GEV No.	695088	Ref. No.	AAG0000437 OA000-SK-033
description	pair of setting bar U-shape L 570mm W 19mm inner height 20mm suitable for new Skin-Series		

gaskets

refrigeration gaskets

miscellaneous



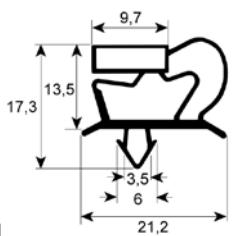
1

GEV No.	900613	Ref. No.	01783000R
description	bottom gasket L 780mm		

GEV No.	900365	Ref. No.	01746900R
description	bottom gasket L 810mm		

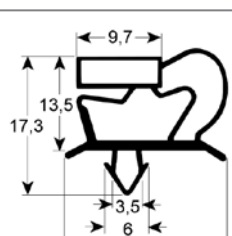
plug-in gaskets
profile 9048

We offer custom-made gaskets for this profile



GEV No.	900712	Ref. No.	RIC0001943
description	refrigeration gasket profile 9048 W 595mm L 1590mm plug size		

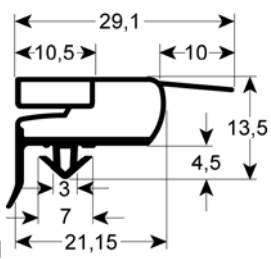
GEV No.	902100	Ref. No.	025178-00R
description	refrigeration gasket profile 9048 W 621mm L 1464mm plug size		



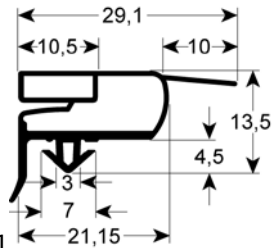
GEV No.	902100	Ref. No.	025178-00R
description	refrigeration gasket profile 9048 W 621mm L 1464mm plug size		
For models:	M140BTA, M140BTAG, M140BTAH2, M140BTAP, M140BTH, M140BTHG, M140BTHH2, M140BTHP, M140BTJ, M140BTJG, M140BTJH2, M140BTJP, M140TNA, M140TNAG, M140TNAH2, M140TNAP, M140TNH, M140TNHG, M140TNHH2, M140TNHP, M140TNJ, M140TNJG, M140TNJH2, M140TNJP, M140TPJ, M140TPJH2, M70BTA, M70BTAG, M70BTAH, M70BTAP, M70BTH, M70BTHG, M70BTHH, M70BTHP, M70BTJ, M70BTJG, M70BTJH, M70BTJP, M70TNA, M70TNAG, M70TNAH, M70TNAP, M70TNH, M70TNHG, M70TNHH, M70TNHP, M70TNJ, M70TNJG, M70TNJH, M70TNJP...(Other models you can see in the webshop)		

profile 9773

We offer custom-made gaskets for this profile

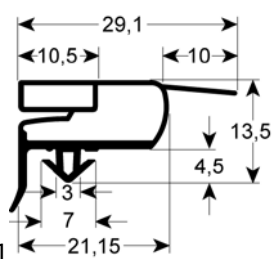


GEV No.	900603	Ref. No.	011536-00Gu
description	refrigeration gasket profile 9773 W 675mm L 740mm plug size		



GEV No.	900335	Ref. No.	011535-00 01153500R RIC0002058 RIC0002903
description	refrigeration gasket profile 9773 W 690mm L 1550mm external size W1 677mm L1 1537mm plug size		
For models:	A140N2, A70N1, AX140B2, AX140N2, AX70B1, AX70N1, B140N2, B70N1, BX140B2, BX1420N2, BX70B1, BX70N1, D140B2, D140DN2, D140DNB2, D140DNP2, D140DNP3, D70B1, D70DN2, D70DNB2, D70N1, D70P1		

GEV No.	900334	Ref. No.	01153700R RIC0002904
description	refrigeration gasket profile 9773 W 690mm L 745mm external size W1 677mm L1 732mm plug size		

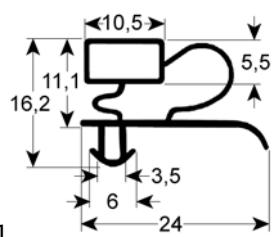


GEV No.	900334	Ref. No.	01153700R RIC0002904
description	refrigeration gasket profile 9773 W 690mm L 745mm external size W1 677mm L1 732mm plug size		

GEV No.	900343	Ref. No.	01746400R
description	refrigeration gasket profile 9333 W 687mm L 1554mm plug size glass door refrigeration		

profile 9333

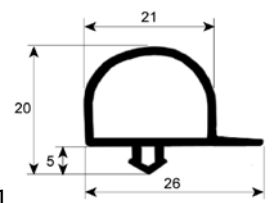
We offer custom-made gaskets for this profile



GEV No.	900343	Ref. No.	01746400R
description	refrigeration gasket profile 9333 W 687mm L 1554mm plug size glass door refrigeration		

GEV No.	900364	Ref. No.	01746800R
description	refrigeration gasket profile 9990 W 695mm L 1825mm external size short side open		

profile 9990



GEV No.	900364	Ref. No.	01746800R
description	refrigeration gasket profile 9990 W 695mm L 1825mm external size short side open		

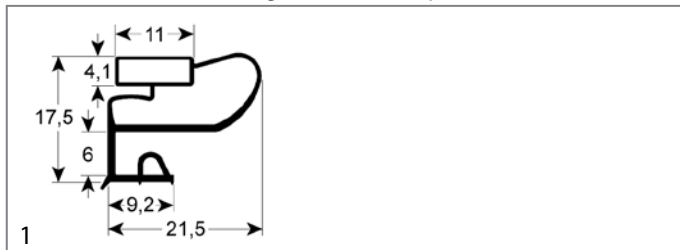
GEV No.	900364	Ref. No.	01746800R
description	refrigeration gasket profile 9990 W 695mm L 1825mm external size short side open		



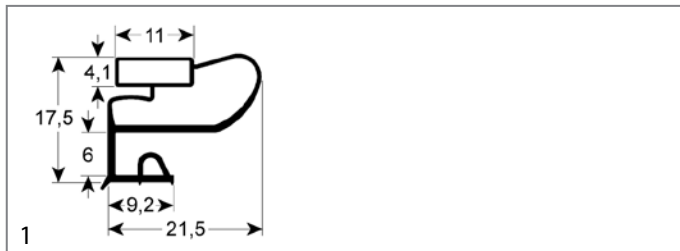
screw-in gaskets

profile 9663

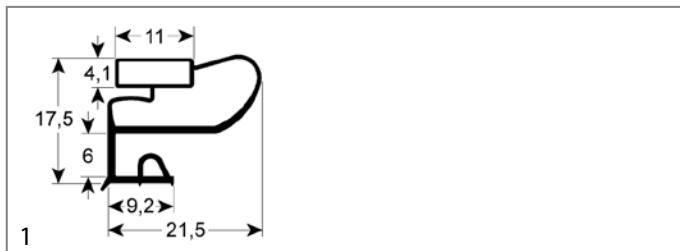
We offer custom-made gaskets for this profile



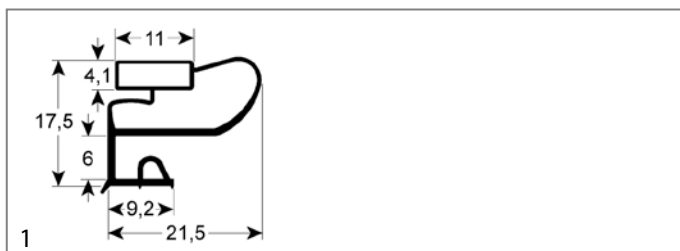
GEV No.	901981	Ref. No.	01710300R
description	refrigeration gasket profile 9663 W 182mm L 424mm external size		



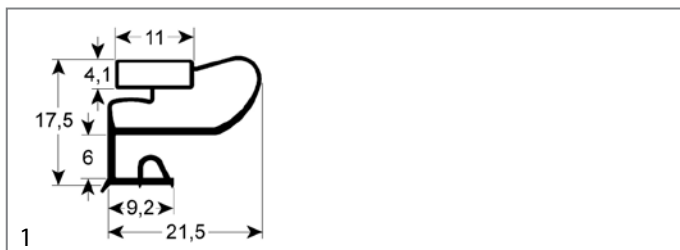
GEV No.	902177	Ref. No.	01710900R
description	refrigeration gasket profile 9663 W 182mm L 629mm external size		



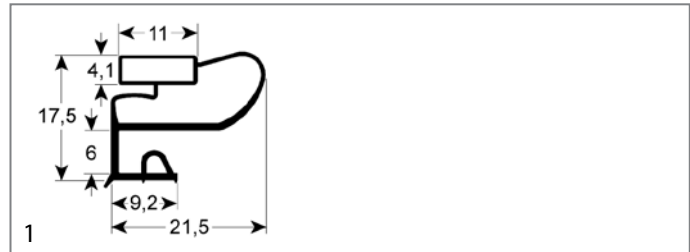
GEV No.	902169	Ref. No.	01236500R 012365-01R
description	refrigeration gasket profile 9663 W 185mm L 390mm external size		



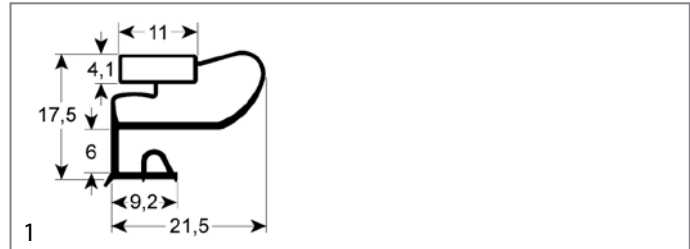
GEV No.	902178	Ref. No.	01711000R
description	refrigeration gasket profile 9663 W 198mm L 629mm external size		



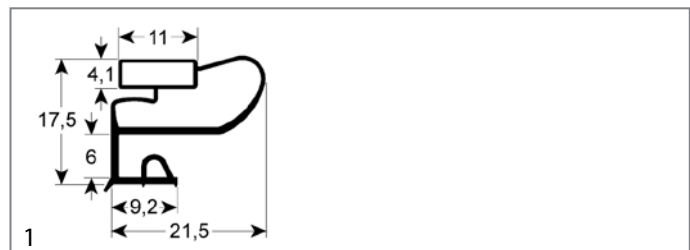
GEV No.	902171	Ref. No.	012361-00 01236100R
description	refrigeration gasket profile 9663 W 205mm L 390mm external size		



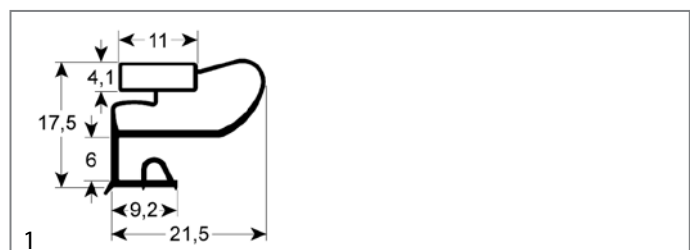
GEV No.	902180	Ref. No.	01346400R
description	refrigeration gasket profile 9663 W 250mm L 420mm external size		



GEV No.	901980	Ref. No.	017102-00 01710200R 025698-00R
description	refrigeration gasket profile 9663 W 302mm L 424mm external size		
For models:	AX250xxx, AX400xxx, B250xxx, B400xxx, B550xxx, BX250xxx, BX400xxx, BX550xxx		



GEV No.	902176	Ref. No.	01710800R 017108-01
description	refrigeration gasket profile 9663 W 302mm L 629mm external size		



GEV No.	902170	Ref. No.	01236300R 025696-00 025696-00R
description	refrigeration gasket profile 9663 W 310mm L 390mm external size white		

GEV No.	902172	Ref. No.	012362-00 01236200R
description	refrigeration gasket profile 9663 W 390mm L 435mm external size		

GEV No.	902173	Ref. No.	012364-00 01236400R 025695-00R
description	refrigeration gasket profile 9663 W 390mm L 645mm external size white		

GEV No.	902174	Ref. No.	017105-00 01710500R
description	refrigeration gasket profile 9663 W 420mm L 420mm external size		

GEV No.	901893	Ref. No.	01288900R RIC0002336
description	refrigeration gasket profile 9663 W 422mm L 538mm external size		

GEV No.	901879	Ref. No.	017104-00 01710400R
description	refrigeration gasket profile 9663 W 424mm L 198mm external size		

GEV No.	901979	Ref. No.	017101-00 017101-00R
description	refrigeration gasket profile 9663 W 424mm L 630mm external size		
For models:	AX250xxx, AX400xxx, B250xxx, B400xxx, B550xxx, BX250xxx, BX400xxx, BX550xxx		

GEV No.	902179	Ref. No.	01710600R
description	refrigeration gasket profile 9663 W 499mm L 630mm external size		

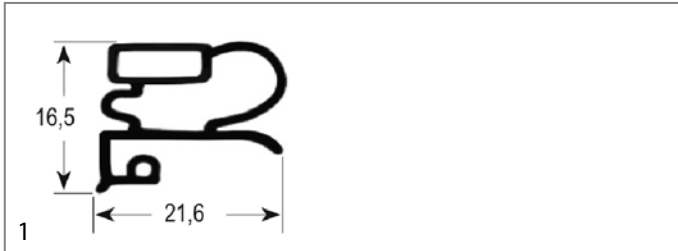
GEV No.	902168	Ref. No.	01288801R
description	refrigeration gasket profile 9663 W 535mm L 675mm external size size 2/1		

GEV No.	902175	Ref. No.	01710700R
description	refrigeration gasket profile 9663 W 629mm L 630mm external size		



profile 9030

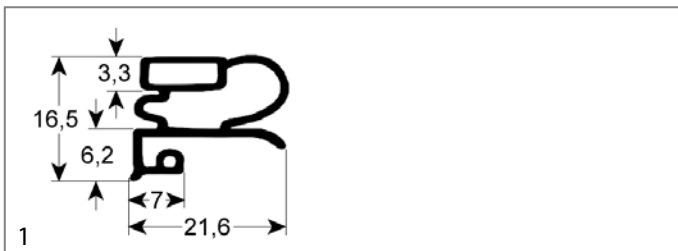
We offer custom-made gaskets for this profile



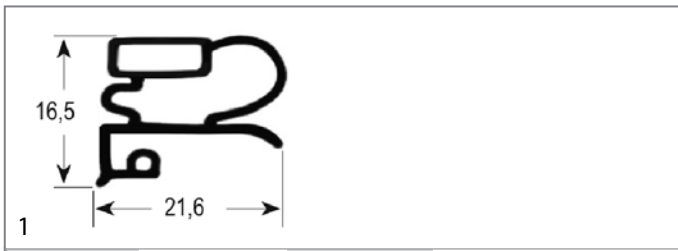
GEV No.	900542	Ref. No.	3965045 RIC0002086
description	refrigeration gasket profile 9030 W 410mm L 430mm external size		



GEV No.	901273	Ref. No.	025699-00R
description	refrigeration gasket profile 9030 W 422mm L 540mm external size		



GEV No.	901948	Ref. No.	02569700R
description	refrigeration gasket profile 9030 W 424mm L 630mm external size		



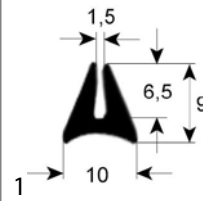
GEV No.	901010	Ref. No.	014052
description	refrigeration gasket profile 9030 W 598mm L 635mm external size		

gaskets for heated units

window seals



GEV No.	900299	Ref. No.	161487
description	window gasket		
For models:	FCE6, FCG6, FEM67, FEM67SC, FEM69, FEMD67, FEMD67SC, FEMD69, FEP050, FGMD67, FGMD67SC, FGMD69, FGP050, JOKER FCE 6 AB 2002, JOKER FCG 6 AB 2002, JOKER FEM 69 AB 2002, JOKER FEP050 AB 2002, JOKER FGP050 AB 2002		

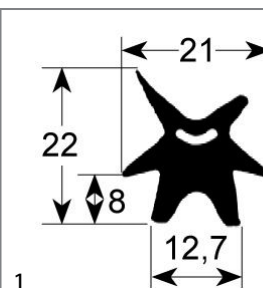


GEV No.	900460	Ref. No.	MPGOM03P00
description	window gasket profile 1600 Qty supplied by meter		
For models:	FCE10, FCE6, FCG10, FCG20, FCG6, FEC060, FEC065, FEC100, FEC200, FEM060, FEM061, FEM062, FEM100, FEM101, FEM102, FEM107, FEM107SC, FEM109, FEM110, FEM110L, FEM200, FEM201, FEM202, FEM207, FEM207SC, FEM209, FEM210, FEM210L, FEM610, FEM610L, FEM67, FEM67SC, FEM69, FEMD060, FEMD061, FEMD065, FEMD066, FEMD100, FEMD101, FEMD107SC, FEMD109, FEMD200, FEMD201, FEMD207SC, FEMD209, FEMD67SC, FEMD69, FEP050, FEP080, FEP160...(Other models you can see in the webshop)		

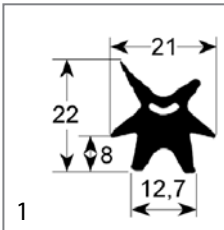
door seals



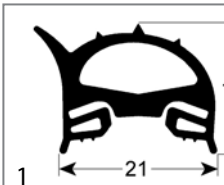
GEV No.	901165	Ref. No.	RTFOC00758
description	door seal L 1500mm Qty 1 suitable for MBM		
For models:	FEC023, FEMD023		



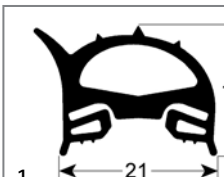
GEV No.	900760	Ref. No.	PAFOC00574 RTFOC00093
description	door seal profile 2405 W 470mm L 670mm external size Qty 1		
For models:	FEC060, FEM060, FEM061, FEM062, FEMD060, FEMD061, FEP050, FGC060, FGM060, FGM061, FGM062, FGMD060, FGMD061, FGP050, FMM060, FMM061		




GEV No.	900761	Ref. No.	PAFOC00575 RTFOC00094
description	door seal profile 2405 W 670mm L 700mm external size Qty 1		
For models:	FEC060, FEC100, FEC200, FEM060, FEM061, FEM100, FEM101, FEM102, FEM200, FEM201, FEM202, FEMD060, FEMD061, FEMD100, FEMD101, FEMD200, FEMD201, FEP050, FEP080, FEP160, FGC100, FGC200, FGM100, FGM101, FGM102, FGM200, FGM201, FGM202, FGMD100, FGMD101, FGMD200, FGMD201, FGP080, FGP160, FMM100, FMM101		



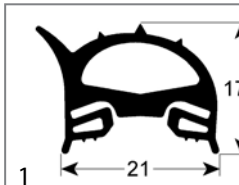
GEV No.	900457	Ref. No.	RTFOC00414 RTFOC00723
description	door seal profile 2510 W 475mm L 625mm external size Qty 1		
For models:	FCE6, FCG6, FEC065, FEMD065, FEMD066, FEMD67, FEMD67SC, FEMD69, FGC065, FGMD065, FGMD066, FGMD67, FGMD67SC, FGMD69, JOKER FCE 6, JOKER FCE 6 AB 2002, JOKER FCG 6, JOKER FCG 6 AB 2002, JOKER FEMD 67 SC, JOKER FEMD 69, JOKER FGMD 67 SC, JOKER FGMD 69		



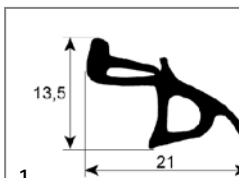
GEV No.	900458	Ref. No.	RTFOC00721
description	door seal profile 2510 W 485mm L 700mm external size Qty 1		
For models:	FEM610, FEM610L, FEM67, FEM67SC, FEM69, FEP050, FGM610, FGM610L, FGM67, FGM67SC, FGM69, FGP050, JOKER FEM 67 SC, JOKER FEM 69, JOKER FEM 69 AB 2002, JOKER FEP050, JOKER FEP050 AB 2002, JOKER FGM 67 SC, JOKER FGM 69, JOKER FGP050, JOKER FGP050 AB 2002		



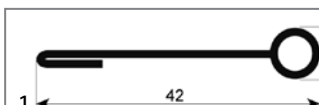
GEV No.	902444	Ref. No.	162007
description	door seal profile 2510 W 670mm L 775mm external size		



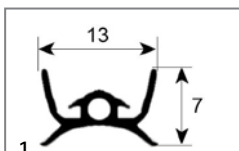
GEV No.	900459	Ref. No.	173827 RTFOC00722
description	door seal profile 2510 W 680mm L 730mm external size Qty 1		
For models:	FCE10, FCE20, FCG10, FCG20, FEM107, FEM107SC, FEM109, FEM110, FEM110L, FEM207, FEM207SC, FEM209, FEM210, FEM210L, FEMD107, FEMD107SC, FEMD109, FEMD207, FEMD207SC, FEMD209, FEP080, FEP160, FGM107, FGM107SC, FGM109, FGM110, FGM110L, FGM207, FGM207SC, FGM209, FGM210, FGM210L, FGMD107, FGMD107SC, FGMD109, FGMD207, FGMD207SC, FGMD209, FGP080, FGP160, JOKER FCE 10, JOKER FCE 10 AB 2002, JOKER FCG 10, JOKER FCG 10 AB 2002, JOKER FEM107 SC, JOKER FEM109 AB 2002, JOKER FEM207 SC, JOKER FEM209, JOKER FEMD107 SC, JOKER FEMD109...(Other models you can see in the webshop)		



GEV No.	900251	Ref. No.	9686373100 RICO002340
description	door seal profile 2920 L 1410mm Qty 1		
For models:	E4F6, E6FA6, G4SF6, G4SFA6, G4SFE6, G6SFA6, G6SFEA6, MINIMA E4F6, MINIMA E6FA6, MINIMA G4SF6, MINIMA G4SFE6, MINIMA G6SFA6		



GEV No.	901166	Ref. No.	MPGOM00P00
description	door seal profile 2922 W 43mm L 1310mm Qty 1 suitable for MBM		
For models:	C6F702P, C6FV702P		



GEV No.	900297	Ref. No.	163888
description	door seal profile 2928 L 307mm Qty 1		
For models:	E4F, E4F77, E4F77Q, E4F8, E4F9, E4F98Q, E4F9Q, E4FP77Q, E4FP8, E6FA, E6FA77, E6FA77Q, E6FA8, E6FA9, E6FA98Q, E6FA9Q, E6FM8, EF077, EF09, EF0V77, EFB09, ETF77, EVC4F77, G4SF, G4SF-1, G4SF77, G4SF77P, G4SF8, G4SF9, G4SF9-1, G4SF9-2, G4SF98, G4SF98P, G4SFE, G4SFE77, G4SFE77P, G4SFE8, G4SFE9, G4SFE98, G4SFEV77, G4SMFA77, G6SF2, G6SF29, G6SF98M, G6SF98MG, G6SFA, G6SFA77, G6SFA8, G6SFA9, G6SFA98...(Other models you can see in the webshop)		



GEV No.	900296	Ref. No.	163889
description	door seal profile 2928 L 580mm Qty 1		
For models:	E4F, E4F8, E4F9, E4F98Q, E4F9Q, E4FP8, E6FA, E6FA8, E6FA9, E6FA98Q, E6FA9Q, E6FM8, EF09, EFB09, G4SF, G4SF-1, G4SF77, G4SF8, G4SF9, G4SF9-1, G4SF9-2, G4SF98, G4SF98P, G4SFE, G4SFE8, G4SFE9, G4SFE98, G6SF2, G6SF29, G6SFA, G6SFA8, G6SFA9, G6SFA98, G6SFEA, G6SFEA8, G6SFEA9, G6SFEA98, GF09, GF09T, GFB09, GT2SDF, GT2SDF8, GT2SDF9, GTF, GTF77, GTF8, GTF9, GTF98		

GEV No.	900259	Ref. No.	167479 PACU700011
description	door seal profile 2969 L 1650mm Qty 1		
For models:	BST2LV, BST2RV, BST6LV, BST6RV, C4EF70, C4F70, C4FV70, C6EF70, C6F70, C6FV70, TPF70, TPFV70		

door seals with fixing hook

GEV No.	900231 ¹	Ref. No.	9686375000 RIC0002547 RIC0003123
description	door seal L 590mm W 300mm 3-sided long side open with mounting clip		
For models:	E6F6, G6SF6, G6SFE6, MINIMA E6F6, MINIMA G6SF6, MINIMA G6SFE6, MINIMA G6SFEA6		

¹3-sided, long side open

GEV No.	902182	Ref. No.	LA70044730 R70044730
description	door seal L 760mm W 550mm 4-sided with 14 mounting clips		


GEV No.	901658	Ref. No.	RIC0004731
description	door seal profile 2928 L 590mm W 305mm 3-sided incl. metal rail		
spare parts for	901658		
GEV No.	900296	Ref. No.	163889
description	door seal profile 2928 L 580mm Qty 1		
GEV No.	900297	Ref. No.	163888
description	door seal profile 2928 L 307mm Qty 1		

GEV No.	900252	Ref. No.	RTCU800097
description	door seal W 530mm 3-sided H 330mm		
For models:	C4F, C4F702P, C4FV702P, C6F, C6FA, C8F, E4F, E4F7, E4F7Q, E6FA7, E6FA7Q, E6FAR, EF07, EF07V, EFO7, EFO7V, EVC4F7, G2SDMF7, G2SDMFE7, G2SSMF7, G2SSMFE7, G4SF, G4SF7, G4SFE, G4SFE7, G4SFP, G4SMFA7, G6SF2, G6SFA, G6SFA7, G6SFEA, G6SFEA7, G8SF2, G8SF2E, G8SF2P, GF07, GFO7, GT2SDF, GT2SDF7, GT2SDFE, GT2SFA, GT2SFEA, GT2SSFA7, GT4SF27, GT4SF2E7, GT4SFA7, GTF, GTF7, GTFE, OMNIA E4F7...(Other models you can see in the webshop)		

GEV No.	901434	Ref. No.	R70044040
description	door seal W 600mm with 6 mounting clips H 400mm		


door gaskets (wire reinforced)

GEV No.	900300	Ref. No.	9686374100 RIC0002678
description	oven gasket wire reinforced L 430mm W 265mm		
For models:	G4SF6, G4SFA6, G6SFA6, MINIMA E4F6, MINIMA E6FA6, MINIMA G4SF6, MINIMA G4SFE6, MINIMA G6SFA6		




GEV No.	900280	Ref. No.	9686374200 RIC0002550
description	oven gasket wire reinforced L 575mm W 265mm		
For models:	E6F6, G6SFE6, G6SFE6, MINIMA E6F6, MINIMA G6SFE6, MINIMA G6SFEA6		

gaskets for control panels



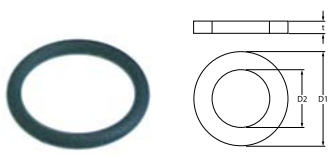
GEV No.	900789	Ref. No.	161411
description	oven gasket for control panel W 29mm L 1340mm		
For models:	FCE10, FCE108, FCE20, FCE6, FCE68, FCG10, FCG108, FCG20, FCG6, FCG68, FEM107, FEM107SC, FEM108, FEM108EL, FEM109, FEM110, FEM110L, FEM207, FEM207SC, FEM210, FEM210L, FEM220, FEM220L, FEM240, FEM240L, FEM610, FEM610L, FEM67, FEM67SC, FEM68, FEM68EL, FEM69, FEMD107, FEMD107SC, FEMD108, FEMD108EL, FEMD109, FEMD207, FEMD207SC, FEMD67, FEMD67SC, FEMD68, FEMD68EL, FEMD69, FEP050, FEP080, FEP160, FGM107, FGM107SC, FGM108...(Other models you can see in the webshop)		

miscellaneous

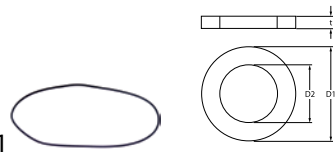


GEV No.	698892	Ref. No.	164738
description	gasket W 16mm L 595mm Qty 1 mounting pos. upper		
For models:	E4F77, E4F77Q, E4FP77Q, E6FA77, E6FA77Q, EF077, EF0V77, ETF77, EVC4F77, G4SF77, G4SF77P, G4SFE77, G4SFE77P, G4SFEV77, G4SMFA77, G6SFA77, G6SFEA77, GF077, GT2SDFA77, GT4SF27, GT4SF277, GT4SF2E77, GTF77, HE4F77, MG7E4F77, MG7E4F77Q, MG7E4FP77Q, MG7E4FVP77Q, MG7E6FA77Q, MG7ETF77, MG7EVC4F77, MG7G4SF77, MG7G4SF77P, MG7G4SFE77, MG7G4SFEV77, MG7G4SMFA77, MG7G6SFA77, MG7G6SFEA77, MG7GTF77		

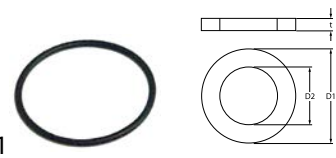
O-rings



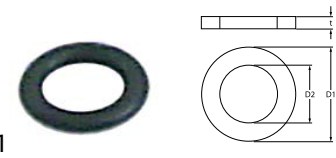
GEV No.	361304	Ref. No.	456042
description	O-ring EPDM ID ø 11.11mm thickness 1.78mm Qty 1 pcs for type DIB3E/DIB5E		
For models:	LB35, LB35C, LB40, LB40E		



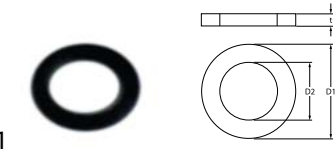
GEV No.	521717	Ref. No.	REB456031
description	O-ring EPDM thickness 1.78mm ID ø 120.37mm Qty 1 pcs		
For models:	BETA50, BETA53		




GEV No.	513057	Ref. No.	927094 CGR2112
description	O-ring EPDM thickness 1.78mm ID ø 28.3mm Qty 1 pcs		
For models:	LT121, LT150, LT151, LT152, LT161, LT202, LT221, LT271, LT272, LT362, LT91		



GEV No.	505045	Ref. No.	456009
description	O-ring EPDM thickness 1.78mm ID ø 5.28mm Qty 1 pcs		
For models:	LB135, LB140		



GEV No.	528485	Ref. No.	456060
description	O-ring EPDM thickness 1.78mm ID ø 6.07mm Qty 1 pcs		
For models:	LB411, LB411A, LB42BT-UK, LBD40, LBDX40, LF50, LF55, LF55E, LF56, LF60, LFD50, LFD60, LFDX50, LK100, LK100EM, LK110, LK600, LK611, LK621, LOD102, LOD155, LOD202, LOD302, LOD304, LOD305, LOD80, LOD80H, LOD93, LP80, LS500, LS500A, LS500PV, LS501, LS501A, LS501PV, LS511, LS511A, LS511PV, LS520-CRP, LS521, LS521-CRP-SP		



GEV No.	510303	Ref. No.	456030 CGR106
description	O-ring EPDM thickness 1.78mm ID ø 6.75mm Qty 1 pcs		
For models:	BETA50, BETA53, L61, L62, L63, L64, LB35, LB350, LB35C, LB40, LB400, LB40E, LB411, LF50, LF55, LF55E, LF59, LK1100, LK1300, LK600, LK620, LK621, LO155, LO80, LO80H, LO93, LOD102, LOD202, LOD302, LOD402, LOD502, LP155, LP80, LP80H, LP93, LS500, LS500A, LS500G, LS500GA, LS500GPV, LS500PV, LS501, LS501A, LS501G, LS501GA, LS501GPV, LS501PV, LS505, LS511, LS520...(Other models you can see in the webshop)		



GEV No.	510177	Ref. No.	456018 CGR2031
description	O-ring EPDM thickness 1.78mm ID \varnothing 7.66mm Qty 1 pcs		
For models:	LB400, LT121, LT150, LT151, LT152, LT161, LT202, LT221, LT271, LT272, LT362, LT91		

GEV No.	532623	Ref. No.	80844
description	O-ring EPDM thickness 2.62mm ID \varnothing 120.32mm Qty 1 pcs		
For models:	LK611, LK621, LP92		

GEV No.	513275	Ref. No.	456074
description	O-ring EPDM thickness 1.78mm ID \varnothing 82.27mm Qty 1 pcs		
For models:	KLB40, LB35, LB350, LB355, LB35C, LB40, LB400, LB405, LB40E, LB411, LB411A		

GEV No.	504618	Ref. No.	3600035 RIC0004173 RTCU700623
description	O-ring EPDM thickness 2.62mm ID \varnothing 15.54mm Qty 1 pcs		
For models:	BC2G, BC3G, BC4G, BC6G, EC408-SC, EC477-SC, EC498-SC, EC498T-SC, EC777-SC, EC9082V-SC, EC9982V-SC, EC9982VT-SC, GF47T, GF77T, MG7EC477-SC, MG7EC777-SC		

GEV No.	504574	Ref. No.	456019
description	O-ring EPDM thickness 1.78mm ID \varnothing 9.25mm Qty 1 pcs		
For models:	KLB40, LB135, LB140, LB35, LB350, LB355, LB35C, LB40, LB400, LB405, LB40E, LB411, LB411A, LK600, LK620, LOD102, LOD202, LOD302, LOD402, LOD502, LS500, LS500A, LS500PV, LS501, LS501A, LS501PV, LS511, LS511A, LS511PV, LS520-CRP, LS521-CRP-SP		

GEV No.	532058	Ref. No.	456071
description	O-ring EPDM thickness 2.62mm ID \varnothing 23.81mm Qty 10 pcs		
For models:	LB405		

GEV No.	529412	Ref. No.	456006
description	O-ring EPDM thickness 2.62mm ID \varnothing 10.78mm Qty 1 pcs		
For models:	KLB40, LB35, LB350, LB355, LB35C, LB40, LB400, LB405, LB40E, LB411, LB411A		

GEV No.	504561	Ref. No.	456073
description	O-ring EPDM thickness 2.62mm ID \varnothing 29.82mm Qty 1 pcs		
For models:	LB422, LB425, LK600, LK605, LS522, LS525		

GEV No.	518227	Ref. No.	456020
description	O-ring EPDM thickness 2.62mm ID \varnothing 12.37mm Qty 1 pcs		
For models:	KLB40, LB135, LB140, LB145, LB35, LB350, LB355, LB35C, LB40, LB400, LB405, LB40E, LB411, LB411A, LB45, LB450, LF50, LF500, LF55, LF550, LF551, LF55E, LF59, LK1000, LK600, LK605, LS500, LS500A, LS500G, LS500GA, LS500GPV, LS500PV, LS501, LS501A, LS501G, LS501GA, LS501GPV, LS501PV, LS505, LS505M, LS505T, LS511, LS511A, LS511PV, LS520, LS522, LS525		

GEV No.	512056	Ref. No.	929061
description	O-ring EPDM thickness 2.62mm ID \varnothing 50.47mm Qty 1 pcs		
For models:	LK1000		

GEV No.	518275	Ref. No.	456066 CGR2025
description	O-ring EPDM thickness 2.62mm ID ø 6.02mm Qty 1 pcs		
For models:	LF56, LF60, LK100, LK100EM, LK110, LO65		

GEV No.	509002	Ref. No.	456083 456084
description	O-ring EPDM thickness 2.62mm ID ø 82.22mm Qty 1 pcs		
For models:	LB422, LB425		

GEV No.	510893	Ref. No.	456015
description	O-ring EPDM thickness 2.62mm ID ø 9.92mm Qty 1 pcs		
For models:	LB145, LB425, LB45, LB450, LF50, LF500, LF55E, LF59, LK1000, LK621, LS500, LS500A, LS500G, LS500GA, LS500GPV, LS500PV, LS501, LS501A, LS501G, LS501GA, LS501GPV, LS501PV, LS505, LS505M, LS505T, LS511, LS511A, LS511PV, LS520		

GEV No.	510554	Ref. No.	456024 RAG62
description	O-ring EPDM thickness 2mm ID ø 120mm Qty 1 pcs		
For models:	L61, L62, LF500, LK100, LK1000, LK100EM, LK110, LK130		

GEV No.	100809	Ref. No.	53.6.0005.00
description	O-ring EPDM thickness 2mm ID ø 21mm Qty 1 pcs		
For models:	6BM61G, 6BM62G, 6FQ61G, 6FQ62G, 6FT61G, 6FT62G, 6PC61G, 6PC62G		

GEV No.	361311	Ref. No.	456072
description	O-ring EPDM thickness 2mm ID ø 6mm Qty 1 pcs for type N6		
For models:	LS511, LS511A, LS511PV		


GEV No.	532537	Ref. No.	456067
description	O-ring EPDM thickness 3.53mm ID ø 113.9mm Qty 1 pcs		
For models:	LF56, LF60, LFD50, LFDX50, LS520-CRP, LS521, LS521-CRP-SP		

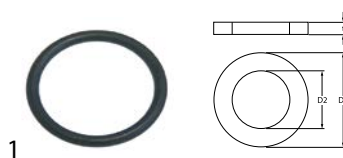
GEV No.	510072	Ref. No.	456016
description	O-ring EPDM thickness 3.53mm ID ø 32.93mm Qty 1 pcs		
For models:	GOLD74, LB140, LB35, LB40, LB40E, LB45, LF50, LF500, LF55, LF550, LF551, LF55E, LF56, LF59, LF60, LK100, LK1000, LK100EM, LK110, LK130, LK611, LKD130, LO80, LO80H, LOD202, LOD302, LOD80, LOD80H, LP80, LS505		

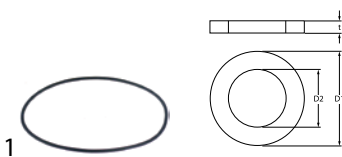
GEV No.	506015	Ref. No.	456052
description	O-ring EPDM thickness 3.53mm ID ø 39.69mm Qty 1 pcs		
For models:	KLB40, LB135, LB140, LB145, LB35, LB350, LB35C, LB40, LB400, LB405, LB40E, LB411, LB411A, LB422, LB425, LB42BT-UK, LB45, LBD40, LBDX40, LF50, LF55, LF55E, LF56, LF59, LF60, LFD50, LS500, LS500A, LS500GA, LS501, LS501A, LS501GA, LS505M, LS505T, LS511, LS511A, LS520		


GEV No.	518175	Ref. No.	456061
description	O-ring EPDM thickness 3.53mm ID ø 49.21mm Qty 1 pcs		
For models:	KLB40, LB135, LB140, LB35, LB350, LB355, LB35C, LB40, LB400, LB405, LB40E, LB411, LB411A		

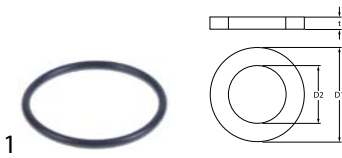


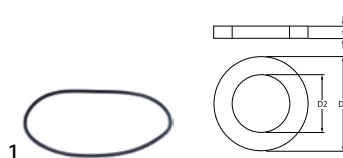
			
GEV No.	532603	Ref. No.	926252 CGR4275
description	O-ring EPDM thickness 3.53mm ID ø 69.85mm Qty 1 pcs		
For models:	LO155, LO80, LO80H, LO93, LOD155, LOD202, LOD302, LOD304, LOD305, LOD402, LOD502, LOD80, LOD80H, LOD93, LP155, LP80, LP80H, LP93		

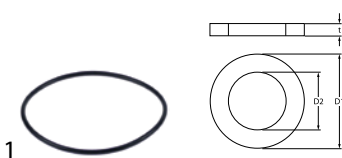
			
GEV No.	510408	Ref. No.	456002 456079 REB456002
description	O-ring EPDM thickness 5.34mm ID ø 47mm Qty 1 pcs		
For models:	BETA50, BETA53, GOLD74, L600, L61, L62, L63, L64, LB425, LBD40, LF55, LF550, LF551, LF55E, LF59, LFD60, LK100, LK1000, LK100EM, LK1010, LK110, LK1100, LK130, LK1300, LK600, LK605, LK611, LK620, LK621, LK622, LK622I, LK625, LKD130, LKDX110, LO155, LO65, LO80, LO80H, LO93, LOD102, LOD155, LOD202, LOD302, LOD304, LOD305, LOD402, LOD502, LOD65, LOD80, LOD80H...(Other models you can see in the webshop)		


			
GEV No.	698810	Ref. No.	456078
description	O-ring EPDM thickness 3.56mm ID ø 112mm Qty 1 pcs		
For models:	LK600, LK605, LS505M, LS505T, LS522, LS525		

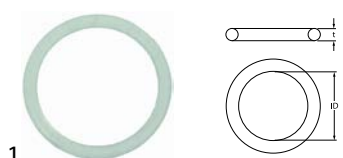
			
GEV No.	510409	Ref. No.	167956 929046 CGG55
description	O-ring EPDM thickness 5.34mm ID ø 56.52mm Qty 1 pcs		
For models:	E100I9N, E100IT9N, E150I9N, E150IT9N, FEM107, FEM108, FEM108EL, FEM110, FEM110L, FEM207, FEM210, FEM210L, FEM220, FEM220L, FEM240, FEM240L, FEM610, FEM610L, FEM67, FEM68, FEM68EL, FEMD108, FEMD108EL, FEMD68, FEMD68EL, LT121, LT150, LT151, LT152, LT161, LT202, LT221, LT271, LT272, LT362, LT91		

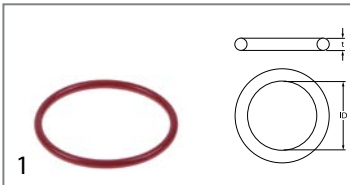
			
GEV No.	532718	Ref. No.	80816
description	O-ring EPDM thickness 4mm ID ø 80mm Qty 1 pcs		
For models:	LO65, LO80, LO80H, LOD155, LOD65, LOD80, LOD80H, LP80, LP800-00-092, LP92, LTD316, LTD320, LTD326, LTDX172, LTDX222, LTDX272		

			
GEV No.	510551	Ref. No.	456023 926084 RAG61
description	pump cover gasket ID ø 158.3mm pump type 1214/1293/1225/2243/1226/1204/3473/1241 thickness 3.53mm EPDM Qty 1 pcs		
For models:	GOLD74, L61, L62, LK100, LK1010, LK110, LK130, LKDX110, LO65, LO80, LO80H, LOD302, LOD65, LOD80, LOD80H, LP80, LP800-00-092, LP92, LT121, LT150, LT151, LT152, LT161, LT202, LT221, LT271, LT272, LT362, LT81, LT91, LTD101, LTD131, LTD171, LTD209, LTD212, LTD216, LTD220, LTD316, LTD320, LTD326, LTDX172, LTDX222, LTDX272		

			
GEV No.	532543	Ref. No.	456076
description	O-ring EPDM thickness 5.34mm ID ø 136.5mm Qty 1 pcs		
For models:	LK600, LK605, LS505M, LS505T, LS522, LS525		

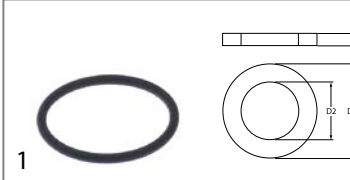
			
GEV No.	521120	Ref. No.	456075
description	O-ring EPDM thickness 5.34mm ID ø 37.47mm Qty 1 pcs		
For models:	KLB40, LB350, LB355, LB400, LB405, LB411, LB411A, LB422, LB425, LB450		

silicone			
			
GEV No.	532517	Ref. No.	20233
description	O-ring silicone thickness 1.78mm ID ø 17.17mm Qty 1 pcs		
For models:	CB955A, CB955W		

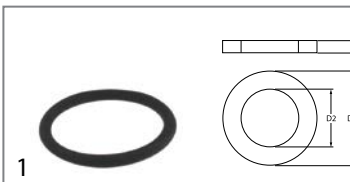


GEV No.	532594	Ref. No.	927097 CGR155
description	O-ring silicone thickness 3.53mm ID ø 50.8mm Qty 1 pcs		
For models:	LT121, LT150, LT151, LT152, LT161, LT202, LT221, LT271, LT272, LT362, LT91		


Viton




GEV No.	532625	Ref. No.	456081
description	O-ring Viton thickness 2.62mm ID ø 28.25mm Qty 1 pcs		
For models:	LK600, LK605, LS505M, LS505T, LS522, LS525		



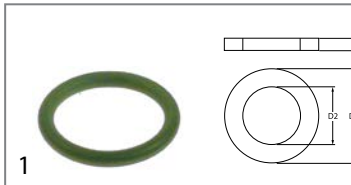
GEV No.	528155	Ref. No.	927337 CGR4131NT
description	O-ring Viton thickness 3.53mm ID ø 32.93mm Qty 1 pcs		
For models:	LK611, LK620, LK622, LK622I, LK625, LOD102, LOD202, LOD302, LT121, LT151, LT152, LT161, LT202, LT221, LT271, LT272, LT362, LT91, LTD212		



GEV No.	510245	Ref. No.	RTBF800320
description	O-ring Viton thickness 3.53mm ID ø 50.8mm Qty 1 pcs		
For models:	EF45, EF90		




GEV No.	510243	Ref. No.	RTBF800321 RTCU700565
description	O-ring Viton thickness 3.53mm ID ø 55.56mm Qty 1 pcs		
For models:	EF408, EF45, EF46, EF47, EF472V, EF472VT, EF477, EF4772V, EF4772VT, EF477T, EF47T, EF49, EF498, EF4982V, EF498L, EF498T, EF49T, EF66, EF77, EF777, EF777T, EF77T, EF90, EF908, EF99, EF998, EF998L, EF998T, EF99T, MG7EF477, MG7EF4772V, MG7EF4772VT, MG7EF477T, MG7EF777, MG7EF777T, MINIMA EF 46, MINIMA EF 66, OMNIA EF 47, OMNIA EF 47T, OMNIA EF 77, OMNIA EF 77T, OMNIA EF472V		




GEV No.	530533	Ref. No.	456080
description	O-ring Viton thickness 3mm ID ø 20mm Qty 1 pcs		
For models:	LB422, LB425		

sealing washers


fibre gaskets




GEV No.	518541	Ref. No.	437021 REB437021
description	flat gasket FIBER ED ø 12mm ID ø 8mm thickness 1.5mm Qty 1 pcs		
For models:	BETA50, BETA53, L600, L61, L62, L63, L64, LF50, LF500, LF55, LF550, LF551, LF55E, LK1000, LK1010, LK1100, LK1300, LO155, LO80, LO80H, LO93, LOD155, LOD80, LOD80H, LOD93, LP155, LP80, LP80H, LP93, S58		



GEV No.	529349	Ref. No.	437030
description	flat gasket FIBER ED ø 22mm ID ø 16.5mm thickness 2mm for thread 3/8" Qty 1 pcs		
For models:	KLB40, LB135, LB140, LB145, LB35, LB350, LB35C, LB40, LB400, LB45, LB450, LF50, LF500, LF59, LS500, LS500A, LS500G, LS500GA, LS500GPV, LS500PV, LS501, LS501A, LS501G, LS501GA, LS501GPV, LS501PV, LS505, LS505M, LS505T, LS520		





GEV No.	506241	Ref. No.	CGF17
description	flat gasket FIBER ED ø 24mm ID ø 16mm thickness 2mm Qty 1 pcs		
For models:	L61, L62, L63, L64, LK1000, LK1010, LK1100, LK1300, LP155, LP80, LP80H, LP93, LTD316, LTD320, LTD326, LTDX172, LTDX222, LTDX272		





GEV No.	518393	Ref. No.	437042
description	flat gasket FIBER ED ø 24mm ID ø 17mm thickness 2mm Qty 1 pcs		
For models:	LB45, LF50, LF500, LF55, LF55E, LF59, LK1000		





			
1			
GEV No.	510074	Ref. No.	437025
description	flat gasket FIBER ED ø 35mm ID ø 27mm thickness 1.5mm Qty 1 pcs		
For models:	LB42BT-UK, LBDX40, LFD50, LFDX50, LKDX110, LO155, LO65, LO80, LO80H, LO93, LOD155, LOD65, LOD80, LOD80H, LOD93, LP80, LP800-00-092, LP92		


			
1			
GEV No.	510417	Ref. No.	437002
description	flat gasket fibre ED ø 20mm ID ø 14mm thickness 2mm Qty 1 pcs		
For models:	LF500, LK1000		


			
1			
GEV No.	540796	Ref. No.	RTCP900025
description	gasket fibre ED ø 60mm ID ø 50mm thickness 2mm for outlet tap Qty 1 pcs		
For models:	CP100, CP100A, CP150, CP150A, CPI100, CPI100A, CPI150, CPI150A, E100, E100A, E100I, E100IA, E150, E150A, E150I, E150IA, G100, G100A, G100I, G100IA, G150, G150A, G150I, G150IA, G175, G175I		


rubber gaskets			
			
1			
GEV No.	505396	Ref. No.	437107
description	flat gasket rubber ED ø 109mm ID ø 86mm thickness 2.5mm Qty 1 pcs		
For models:	LB422, LB425		


			
1			
GEV No.	519547	Ref. No.	437041
description	flat gasket rubber ED ø 14.4mm ID ø 15.5mm thickness 2mm Qty 1 pcs size 3/4"		
For models:	KLB40, LB135, LB140, LB145, LB35, LB350, LB355, LB35C, LB40, LB400, LB405, LB40E, LB411, LB411A, LB42BT-UK, LB45, LB450, LBD40, LBDX40, LF50, LF500, LF55, LF550, LF551, LF55E, LF56, LF59, LF60, LFD50, LFDX50, LK1000, LK600, LK605, LS500, LS500A, LS500G, LS500GA, LS500GPV, LS500PV, LS501, LS501A, LS501G, LS501GA, LS501GPV, LS501PV, LS505, LS505M, LS505T, LS511, LS511A...(Other models you can see in the webshop)		


			
1			
GEV No.	510075	Ref. No.	437019
description	flat gasket rubber ED ø 22mm ID ø 13mm thickness 1.5mm Qty 1 pcs		
For models:	KLB40, LB135, LB140, LB145, LB35, LB350, LB355, LB35C, LB40, LB400, LB405, LB40E, LB411, LB411A, LB45, LB450, LF50, LF500, LF55, LF550, LF551, LF55E, LF59, LK1000, LS500, LS500A, LS500G, LS500GA, LS500GPV, LS500PV, LS501, LS501A, LS501G, LS501GA, LS501GPV, LS501PV, LS505, LS505M, LS505T, LS511, LS511A, LS511PV, LS520		


			
1			
GEV No.	507544	Ref. No.	75402
description	flat gasket rubber ED ø 29mm ID ø 17mm thickness 1mm Qty 1 pcs		
For models:	LK621		


			
1			
GEV No.	505397	Ref. No.	437083
description	flat gasket rubber ED ø 32mm ID ø 19.5mm thickness 1.5mm Qty 1 pcs		
For models:	LB422, LB425, LBD40, LBDX40, LFDX50, LK600, LK605, LK621, LS505M, LS505T, LS521, LS521-CRP-SP, LS522, LS525		


			
1			
GEV No.	518240	Ref. No.	437078
description	flat gasket rubber ED ø 33mm ID ø 17mm thickness 1.5mm Qty 1 pcs		
For models:	KLB40, LB135, LB140, LB35, LB350, LB355, LB35C, LB40, LB400, LB405, LB40E, LB411, LB411A, LB42BT-UK, LBD40, LBDX40, LFDX50, LKDX110, LO155, LO65, LO80, LO80H, LO93, LOD155, LOD65, LOD80, LOD80H, LOD93, LP80, LP800-00-092, LP92, LS522, LS525		


			
1			
GEV No.	516261	Ref. No.	437098
description	flat gasket rubber ED ø 33mm ID ø 25mm thickness 2.5mm for air trap Qty 1 pcs		
For models:	LB42BT-UK, LBD40, LBDX40, LFD50, LFDX50, LK611, LK620, LK621, LK622, LK622I, LK625, LOD102, LOD202, LOD302, LOD304, LOD305, LOD402, LOD502, LS520-CRP, LS521, LS521-CRP-SP		


			
1			
GEV No.	510876	Ref. No.	437104
description	flat gasket rubber ED ø 45mm ID ø 33mm thickness 3mm Qty 1 pcs		
For models:	LB425, LK620, LK621, LK625, LOD102, LOD202, LOD302, LOD304, LOD305, LOD402, LOD502, LS520-CRP, LS521, LS521-CRP-SP, LS525		


			
1			
GEV No.	513059	Ref. No.	437063 CGG42
description	flat gasket rubber ED ø 52mm ID ø 40mm thickness 3mm Qty 1 pcs		
For models:	BETA50, BETA53, L63, L64, LB145, LB45, LB450, LF50, LF500, LF55, LF550, LF551, LF55E, LK1100, LK1300, LS500, LS500A, LS500G, LS500GA, LS500GPV, LS500PV, LS501, LS501A, LS501G, LS501GA, LS501GPV, LS501PV, LS505M, LS505T, LS511, LS511A, LS511PV, LS520, LT121, LT150, LT151, LT152, LT161, LT202, LT221, LT271, LT272, LT362, LT91, LTD316, LTD320, LTD326, LTDX172, LTDX222, LTDX272		


			
GEV No.	518205	Ref. No.	437079 80182
description	flat gasket rubber ED ø 61mm ID ø 47mm thickness 2mm Qty 1 pcs		
For models:	GOLD74, KLB40, LB135, LB140, LB35, LB350, LB355, LB35C, LB40, LB400, LB405, LB40E, LB411, LB411A, LB422, LB42BT-UK, LBD40, LBDX40, LF56, LF60, LFD50, LFD60, LFDX50, LK100, LK100EM, LK110, LK130, LK611, LK620, LK621, LK622, LK622I, LK625, LKD130, LKDX110, LO65, LOD102, LOD65, LP800-00-092, LP92, LS505, LS520-CRP, LS521, LS521-CRP-SP		


			
GEV No.	507541	Ref. No.	437102
description	flat gasket rubber ED ø 74mm ID ø 57mm thickness 2mm Qty 1 pcs		
For models:	LB425, LK600, LK605, LS505M, LS505T, LS522, LS525		


			
GEV No.	510071	Ref. No.	437034
description	flat gasket rubber ED ø 81mm ID ø 68mm thickness 3mm for salt tank Qty 1 pcs		
For models:	KLB40, LB135, LB140, LB145, LB35, LB350, LB35C, LB40, LB400, LB405, LB40E, LB411, LB411A, LB422, LB42BT-UK, LB45, LBD40, LBDX40, LF50, LF500, LF55, LF550, LF551, LF55E, LF56, LF59, LF60, LFD50, LFDX50, LS500, LS500A, LS500GA, LS501, LS501A, LS501GA, LS505M, LS505T, LS511, LS511A, LS520, LS520-CRP, LS521, LS521-CRP-SP		


			
GEV No.	518294	Ref. No.	437087
description	flat gasket rubber ED ø 85mm ID ø 71mm thickness 2mm Qty 1 pcs		
For models:	LF56, LF60, LFD50, LFDX50, LS520-CRP, LS521, LS521-CRP-SP		


			
GEV No.	518060	Ref. No.	456040 REB456040
description	gasket rubber ED ø 132mm ID ø 122mm thickness 5mm		
For models:	GOLD74, L600, L61, L62, LF59, LFD60, LK100, LK1000, LK100EM, LK1010, LK110, LK130, LK611, LK620, LK621, LK622, LK622I, LK625, LKD130, LKDX110, LO65, LO80, LO80H, LOD102, LOD202, LOD302, LOD65, LOD80, LOD80H, LP80, LP800-00-092, LP80H, LP92, LS505		


plastic gaskets			
			
GEV No.	695538	Ref. No.	13007
description	gasket plastic ED ø 40mm ID ø 30mm thickness 2mm Qty 1 pcs		
For models:	CB955A, CB955W		

PTFE gaskets			
			
GEV No.	507545	Ref. No.	437091
description	flat gasket PTFE ED ø 13mm ID ø 7mm thickness 0.65mm Qty 1 pcs		
For models:	LB42BT-UK, LBD40, LBDX40, LF56, LF59, LF60, LFD50, LFDX50, LS521		

			
GEV No.	510012	Ref. No.	437008
description	flat gasket PTFE ED ø 16.5mm ID ø 12.5mm thickness 1.5mm Qty 1 pcs equiv. no. 437008		
For models:	KLB40, LB135, LB140, LB145, LB35, LB350, LB355, LB35C, LB40, LB400, LB405, LB40E, LB411, LB411A, LB45, LB450		

			
GEV No.	513725	Ref. No.	437100
description	flat gasket PTFE ED ø 21.2mm ID ø 19mm thickness 0.5mm Qty 1 pcs		
For models:	LF50, LF55, LF55E, LS500, LS500A, LS500G, LS500GA, LS500GPV, LS500PV, LS501, LS501A, LS501G, LS501GA, LS501GPV, LS501PV, LS505, LS511, LS511A, LS511PV, LS520		

			
GEV No.	518346	Ref. No.	437090
description	flat gasket PTFE ED ø 22mm ID ø 9.2mm thickness 1mm Qty 1 pcs equiv. no. 437090 suitable for COLGED		
For models:	LB42BT-UK, LBD40, LBDX40, LF56, LF59, LF60, LFD50, LFDX50, LS521		

			
GEV No.	518180	Ref. No.	303018
description	flat gasket PTFE ED ø 40mm ID ø 35mm thickness 3mm Qty 1 pcs equiv. no. 303018/371450-166 suitable for COLGED, HOBART		
For models:	KLB40, LB135, LB140, LB35, LB350, LB355, LB35C, LB40, LB400, LB405, LB40E, LB411, LB411A, LB422, LB425, LB42BT-UK, LBD40, LBDX40		

silicone gaskets



GEV No.	695534	Ref. No.	13143
description	gasket silicone ED ø 36mm ID ø 23.5mm thickness 3mm Qty 1 pcs		
For models:	CB955A, CB955W		



GEV No.	695537	Ref. No.	13006
description	gasket silicone ED ø 40mm ID ø 30mm thickness 2mm Qty 1 pcs		
For models:	CB955A, CB955W		

accessories for 695537



GEV No.	695059	Ref. No.	10007
description	hose connector for ice-cube maker		

sealing cords

square



GEV No.	693740	Ref. No.	163292
description	sealing cord square size 14x14mm t.max. 550°C braided L 5m		
For models:	GBR8, GBRVC98, GBRV18, GBRV198, GFT1177L, GFT1177LC, GFT1177LR, GFT1177LRC, GFT1177R, GFT1177RC, GFT908L, GFT908LC, GFT908LR, GFT908LRC, GFT908R, GFT90L, GFT90LC, GFT90LR, GFT90LRC, GFT90R, GFT90RC, GFT998L, GFT998LC, GFT998LR, GFT998LRC, GFT998R, GFT99L, GFT99LC, GFT99LR, GFT99LRC, GFT99R, GFT99RC, GFTA998L, GFTA998LC, GFTA998LR, GFTA998LRC, GFTA998R, GT, GT2SD9, GT2SDF, GT2SDF8, GT2SDF9, GT2SS9, GT4SF277, GT4SF2E77, GT77, GT99, GT998, GTA77, GTA8...(Other models you can see in the webshop)		

shaft gaskets

shaft gaskets



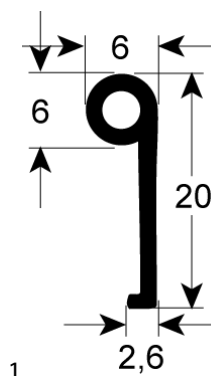
GEV No.	699128	Ref. No.	927095
description	shaft sealing ED ø 40mm ID ø 30mm H 7mm plastic for vegetable slicer		
For models:	LT161, LT221, LT271, LT272, LT362		



GEV No.	698755	Ref. No.	314011
description	shaft sealing ID ø 9mm ED ø 10mm for wash pump		
For models:	LB422, LB425		
spare parts for	698755		
	GEV No.	501503	Ref. No.
			130166
description	pump inlet ø 28mm outlet ø 22/27mm type CF 2745 230V 50Hz 1 phase 0.19kW L 175mm rotation direction right capacitor 4µF LGB with capacitor		

special gaskets

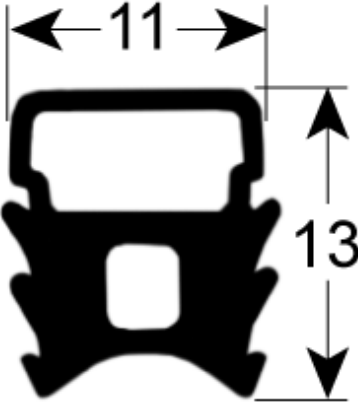
door seals for dishwashers



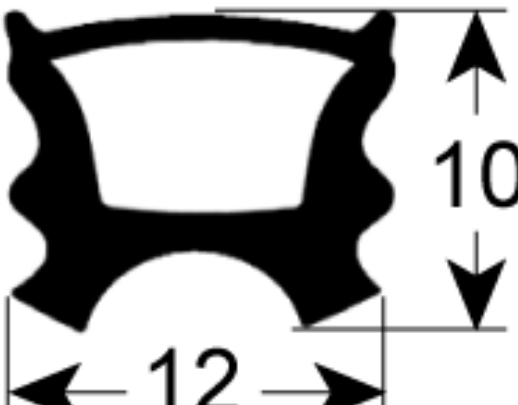
GEV No.	518123	Ref. No.	41247
description	door seal L 1050mm W 6mm H 20mm Qty 1		
For models:	LO155, LO80, LO80H, LO93, LOD155, LOD202, LOD302, LOD304, LOD305, LOD80, LOD80H, LOD93, LP155, LP80, LP80H, LP93		



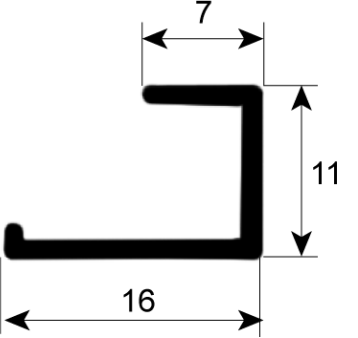
GEV No.	518252	Ref. No.	437071
description	door seal L 1165mm dishwasher		
For models:	LB42BT-UK, LBD40, LBDX40		



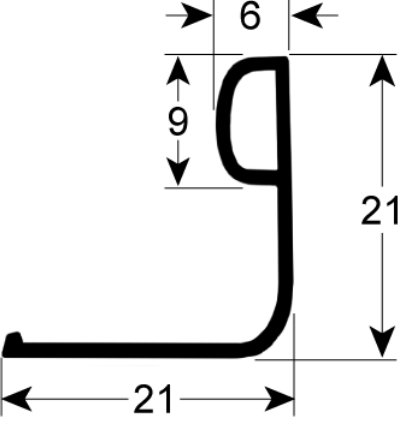
GEV No.	518088	Ref. No.	437088 437097
description	door seal L 1370mm		
For models:	LF56, LF60, LFD50, LFDX50, LS520-CRP, LS521		



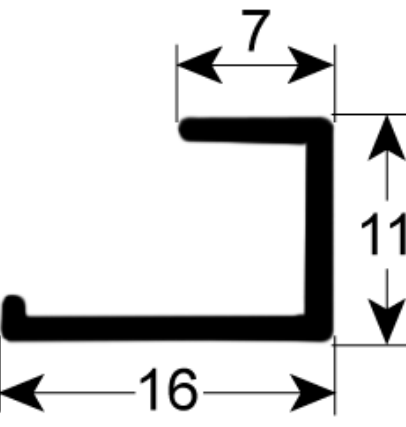
GEV No.	518613	Ref. No.	437103
description	door seal L 555mm W 395mm for dishwasher 3-sided		
For models:	LS522, LS525		



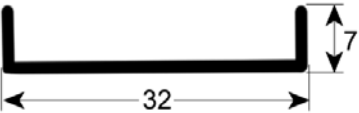
GEV No.	518246	Ref. No.	437057
description	door seal L 395mm dishwasher suitable for ELETTRORBAR, WOLK equiv. no. 437057		
For models:	LB135, LB35, LB350, LB355, LB35C		



GEV No.	518300	Ref. No.	REB437075
description	door seal L 590mm dishwasher suitable for ELETTRORBAR, WOLK equiv. no. 437075		
For models:	L600, S58		



GEV No.	518248	Ref. No.	437058
description	door seal L 430mm dishwasher suitable for ELETTRORBAR, WOLK equiv. no. 437058		
For models:	KLB40, LB140, LB40, LB400, LB405, LB40E, LB411, LB411A		



GEV No.	518536	Ref. No.	437052 437081
description	door seal L 590mm W 32mm dishwasher suitable for ELETTRORBAR, WOLK equiv. no. 437052		
For models:	LF50, LF500, LF55, LF550, LF551, LF55E, LF59, LS500, LS500A, LS500G, LS500GA, LS500GPV, LS500PV, LS501, LS501A, LS501G, LS501GA, LS501GPV, LS501PV, LS505, LS505M, LS505T, LS511, LS511A, LS511PV, LS520		




miscellaneous



1

GEV No.	511999	Ref. No.	75168
description	gasket for flange ED ϕ 123mm ID ϕ 46mm rubber thickness 3mm hole distance 53mm		
For models:	LT81, LTD101, LTD131, LTD171, LTD209, LTD212, LTD216, LTD220, LTD316, LTD320, LTD326, LTDX172, LTDX222, LTDX272		



1


GEV No.	519406	Ref. No.	DAP83
description	gasket for sliding plate dimensions 69x16mm		
For models:	L600, S58		

gaskets for wash arm support



1

GEV No.	518025	Ref. No.	437014
description	gasket D1 ϕ 50mm D2 ϕ 82mm thickness 2mm with 6 holes wash arm support equiv. no. 437014 suitable for COLGED		
For models:	LB145, LB45, LB450, LF50, LF500, LF55, LF550, LF551, LF55E, LF59, LK1000, LS500, LS500A, LS500G, LS500GA, LS500GPV, LS500PV, LS501, LS501A, LS501G, LS501GA, LS501GPV, LS501PV, LS505, LS505M, LS505T, LS511, LS511A, LS511PV, LS520		




1

GEV No.	518649	Ref. No.	437108
description	gasket D1 ϕ 64mm D2 ϕ 49mm thickness 2mm wash arm support		
For models:	LB422, LB425		



1

GEV No.	518339	Ref. No.	437064
description	gasket D2 ϕ 50mm thickness 2mm with 3 screw holes wash arm support equiv. no. 437064 suitable for COLGED hole ϕ 50mm hole distance 67mm		
For models:	LF50, LF500, LF55, LF550, LF551, LF55E, LFD60, LO65, LO80, LO80H, LOD102, LOD202, LOD302, LOD65, LOD80, LP80, LP800-00-092, LP92, LS500, LS500A, LS500G, LS500GA, LS500GPV, LS500PV, LS501, LS501A, LS501G, LS501GA, LS501GPV, LS501PV, LS505M, LS505T, LS511, LS511A, LS511PV, LS520		



1

GEV No.	518402	Ref. No.	437050
description	gasket with 3 screw holes wash arm support hole distance 61mm D2 ϕ 34mm thickness 2.5mm hole ϕ 34mm		
For models:	LT81, LTD101, LTD131, LTD171, LTD209, LTD212, LTD216, LTD220, LTD316, LTD320, LTD326, LTDX172, LTDX222, LTDX272		

refrigeration cycle components


valves

expansion valves









DANFOSS

valves

type TN2/TEN2



1

GEV No.	750012	Ref. No.	01460700R	
description	expansion valve DANFOSS type TN2 coolant R134a angled 90° thermostatically controlled inlet 3/8" SAE outlet 1/2" SAE p max 34bar -40 up to +10°C capillary pipe 1500mm			
accessories for	750012			
	GEV No.	750020	Ref. No.	—
	nozzle insert size 0X type 068-2002 T/TE 2 DANFOSS			
	GEV No.	750021	Ref. No.	01348500R
	nozzle insert size 00 type 068-2003 T/TE 2 DANFOSS			
	GEV No.	750022	Ref. No.	—
	nozzle insert size 01 type 068-2010 T/TE 2 DANFOSS			
	GEV No.	750023	Ref. No.	—
	nozzle insert size 02 type 068-2015 T/TE 2 DANFOSS			
	GEV No.	750024	Ref. No.	—
	nozzle insert size 03 type 068-2006 T/TE 2 DANFOSS			
	GEV No.	750483	Ref. No.	—
	nozzle insert size 04 type 068-2007 T2/TE2 DANFOSS			
	GEV No.	750484	Ref. No.	—
	nozzle insert size 05 type 068-2008 T2/TE2 DANFOSS			
	GEV No.	750485	Ref. No.	—
	nozzle insert size 06 type 068-2009 T2/TE2 DANFOSS			

type TS2/TE2



GEV No.	750014	Ref. No.	01859700R
description	expansion valve DANFOSS type TS2 coolant R404a/R507 angled 90° thermostatically controlled inlet 3/8" SAE outlet 1/2" SAE p max 34bar -40 up to +10°C capillary pipe 1500mm		

accessories for	750014			
	GEV No.	750020	Ref. No.	—
	nozzle insert size 0X type 068-2002 T/TE 2 DANFOSS			
	GEV No.	750021	Ref. No.	01348500R
	nozzle insert size 00 type 068-2003 T/TE 2 DANFOSS			
	GEV No.	750022	Ref. No.	—
	nozzle insert size 01 type 068-2010 T/TE 2 DANFOSS			
	GEV No.	750023	Ref. No.	—
	nozzle insert size 02 type 068-2015 T/TE 2 DANFOSS			
	GEV No.	750024	Ref. No.	—
	nozzle insert size 03 type 068-2006 T/TE 2 DANFOSS			
	GEV No.	750483	Ref. No.	—
	nozzle insert size 04 type 068-2007 T2/TE2 DANFOSS			
	GEV No.	750484	Ref. No.	—
	nozzle insert size 05 type 068-2008 T2/TE2 DANFOSS			
	GEV No.	750485	Ref. No.	—
	nozzle insert size 06 type 068-2009 T2/TE2 DANFOSS			

type TX2/TEX2



GEV No.	750010	Ref. No.	01352700R
description	expansion valve DANFOSS type TX2 coolant R22/R407c angled 90° thermostatically controlled inlet 3/8" SAE outlet 1/2" SAE p max 34bar -40 up to +10°C capillary pipe 1500mm		

nozzle inserts



GEV No.	750021	Ref. No.	01348500R
description	nozzle insert size 00 type 068-2003 T/TE 2 DANFOSS		

Schrader valves

valve bodies



GEV No.	750097	Ref. No.	14007
description	valve body for Schrader valve thread 1/4" SAE connection 6mm soldering connection		
For models:	CB955A, CB955W, ICE45A, ICE45W		

valve inserts



GEV No.	750098	Ref. No.	14005
description	Schrader valve CASTEL 8394/B R22		
For models:	CB955A, CB955W, ICE45A, ICE45W		

filter driers

CASTEL

STANDARD series

suitable for refrigerants R12, R22, R134a, R404A, R407C, R410A, R502, R507



GEV No.	750038	Ref. No.	14089
description	dryer type 4303/2S connection ODS 1/4"-ODM 3/8" 50cm ³ p max 45bar -40 up to +80°C		
For models:	CB955A, CB955W		



miscellaneous


			
1			
GEV No.	750075	Ref. No.	14009
description	dryer size 12g ø 16mm L 120mm connection 3/6,3mm		
For models:	ICE45A, ICE45W		

evaporators

for fridges

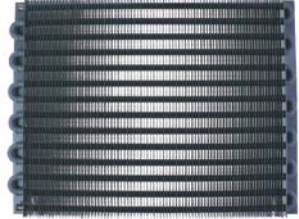
producer-specific

			
1			
GEV No.	750123	Ref. No.	01264502R 01564501R 01564602R 02316700
description	evaporator L 380mm W 110mm H 150mm total length 400mm aluminium		
For models:	AX140B2, AX70B1, BX140B2, BX70B1		

 <p>Image not available</p>			
1			
GEV No.	750283	Ref. No.	FEQ321201Y Q32-1201Y
description	evaporator L 390mm W 315mm H 315mm H2 210mm		

			
1			
GEV No.	750124	Ref. No.	01152800R 02054001 020540-01R
description	evaporator L 420mm W 390mm H 35mm total length 470mm overall width 450mm overall height 40mm		
For models:	AX250xxx, AX400xxx, B250xxx, B400xxx, B550xxx, BX250xxx, BX400xxx, BX550xxx		

			
1			
GEV No.	750120	Ref. No.	01152900R 01152901R 01152902R
description	evaporator L 455mm W 100mm H 150mm total length 490mm overall height 230mm mounting distance 1 435mm mounting distance 2 80mm		

			
1			
GEV No.	750126	Ref. No.	01314500R
description	evaporator L 465mm W 360mm H 25mm		

			
1			
GEV No.	750121	Ref. No.	01153000R
description	evaporator L 610mm W 100mm H 150mm		

for ice-cube maker

for ice cube maker

			
1			
GEV No.	750201	Ref. No.	D10046
description	evaporator for ice-cube maker 36 cubes L 440mm W 190mm H 40mm		
For models:	ICE45A, ICE45W		

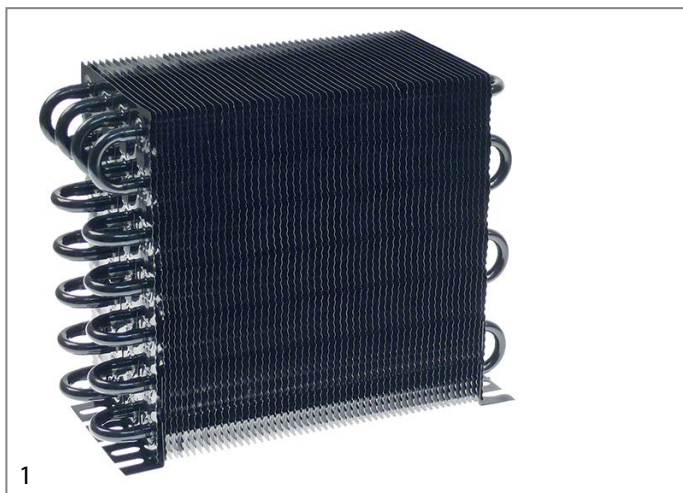


1

GEV No.	750202	Ref. No.	D10047
description	evaporator for ice-cube maker 60 cubes L 665mm W 190mm H 40mm		
For models:	CB955A, CB955W		

condensors

condensors



1

GEV No.	750661	Ref. No.	20019
description	condenser W 215mm D 270mm H 117mm Qty 1 pcs		
For models:	ICE45A		

condensors water-cooled



1

GEV No.	750392	Ref. No.	14034
description	condenser tube ø 15mm water-cooled ø 255mm mounting distance 128mm		
For models:	CB955W		

transmission technology and ball bearings

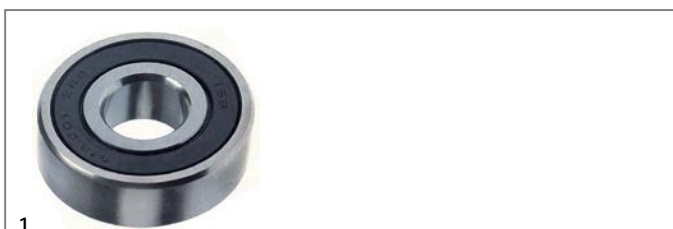
ball bearings

deep-groove ball bearings 2RS




1

GEV No.	523501	Ref. No.	314009
description	deep-groove ball bearing type 608-2RS shaft ø 8mm ED ø 22mm W 7mm with sealing discs deep-groove ball bearing DIN 625-1		
For models:	KLB40, LB135, LB140, LB35, LB350, LB355, LB35C, LB40, LB400, LB405, LB40E, LB411, LB411A, LB42BT-UK, LBD40, LBDX40		



1

GEV No.	523509	Ref. No.	314001
description	deep-groove ball bearing type 6201-2RS shaft ø 12mm ED ø 32mm W 10mm with sealing discs deep-groove ball bearing DIN 625-1		
For models:	LB140, LB145, LB45, LB450, LF50, LF500, LF55, LF550, LF551, LF55E, LF56, LF60, LFD50, LFDX50, LK1000, LS500, LS500A, LS500G, LS500GA, LS500GPV, LS500PV, LS501, LS501A, LS501G, LS501GA, LS501GPV, LS501PV, LS505M, LS505T, LS511, LS511A, LS511PV, LS520, LS520-CRP, LS521, LS521-CRP-SP		

1

GEV No.	523513	Ref. No.	13000016 13000316
description	deep-groove ball bearing type 6205-2RS shaft ø 25mm ED ø 52mm W 15mm with sealing discs deep-groove ball bearing DIN 625-1		

flange bearings




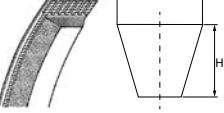
1

GEV No.	693637	Ref. No.	RTCU700504
description	flange bearing type UCF204 shaft ø 20mm W 60mm 2 hole flange hole distance 90mm H 34mm L 114mm		
For models:	EBR7, EBR77, EBR8, EBR9T, EBRA9T, EBRAVI9T, EBRI7, EBRI77, EBRVC98, EBRVC98T, EBRVI8, EBRVI98, EBRVI98T, EBRVI9T, GBR7, GBR77, GBR8, GBR9T, GBRA9T, GBRAVI9T, GBRI7, GBRI77, GBRVC98, GBRVC98T, GBRVI8, GBRVI98, GBRVI98T, GBRVI9T, MG7EBR77, MG7EBRI77, MG7GBR77, MG7GBRI77, OMNIA EBR7, OMNIA EBRI7		

drive belts

V-belts


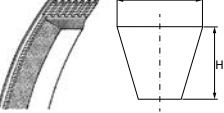
profile Z/10

1

GEV No.	693400	Ref. No.	RTBF900125
description	V-belt belt width 10mm L 915mm H 6mm CODE Z36 profile Z/10		
For models:	EBR, EBRA, EBRAVI, EBRVI, GBR, GBRA, GBRAVI, GBRVI		

profile A/13





1

GEV No.	698519	Ref. No.	1TR036
description	V-belt belt width 13mm L 700mm H 8mm CODE A27 1/2 profile A/13		
For models:	KF165A, KF165W, KF185A, KF185W		


springs

torsion springs




1

GEV No.	690371	Ref. No.	01157200R
description	torsion spring ø 16.5mm wire gauge ø 2.6mm L1 32mm L2 101mm L3 13mm mounting pos. left		




1

GEV No.	690370	Ref. No.	01157300R
description	torsion spring ø 16.5mm wire gauge ø 2.6mm L1 35mm L2 101mm L3 16mm mounting pos. right		




1

GEV No.	693628	Ref. No.	RTCU700476
description	torsion spring ø 30.5mm wire gauge ø 4.8mm L1 30mm L2 196mm L3 14mm		
For models:	E50I7, E50I77, G507, G5077, G50I7, G50I77, MG7E50I77, OMNIA G507, OMNIA G50I7		



1


GEV No.	693627	Ref. No.	RTBF800103
description	torsion spring ø 38.8mm wire gauge ø 7.2mm L1 33mm L2 280mm L3 20mm		
For models:	EBR, EBR8, EBR9T, EBRA, EBRA9T, EBRAVI, EBRAVI9T, EBRVC98, EBRVC98T, EBRVI, EBRVI8, EBRVI98, EBRVI98T, EBRVI9T, GBR, GBR8, GBR9T, GBRA, GBRA9T, GBRAVI, GBRAVI9T, GBRVC98, GBRVC98T, GBRVI, GBRVI8, GBRVI98, GBRVI98T, GBRVI9T		



1


GEV No.	693626	Ref. No.	RTCP800026
description	torsion spring ø 38mm wire gauge ø 6.1mm L1 21mm L2 282mm L3 36mm		
For models:	E100, E100I, E100I8, E100I9, E100I98, E100I9N, E100IT9, E100IT9N, E150, E150I, E150I8, E150I9, E150I98, E150I9N, E150IT9, E150IT9N, EBR7, EBR77, EBRI7, EBRI77, G 150, G100, G1008, G1009, G10098, G100A, G100I, G100I8, G100I9, G100I98, G100I9N, G100IA, G100IT9, G100IT9N, G100T9, G100T98, G150, G1508, G1509, G15098, G150A, G150I, G150I8, G150I9, G150I98, G150I9N, G150IA, G150IT9, G150IT98, G150IT9N...(Other models you can see in the webshop)		

compression springs




1

GEV No.	690372	Ref. No.	01157400R
description	compression spring ø 20.6mm L 135mm wire gauge ø 2.9mm		



GEV No.	696750	Ref. No.	927244 CMT13
description	compression spring ø 20mm L 89.5mm wire gauge ø 2mm windings 14 zinc-coated steel		
For models:	LT121, LT150, LT151, LT152, LT161, LT202, LT221, LT271, LT272, LT362, LT81, LT91, LTD101, LTD131, LTD171, LTD209, LTD212, LTD216, LTD220, LTD316, LTD320, LTD326, LTDX172, LTDX222, LTDX272		


spring compressors



GEV No.	513119	Ref. No.	926009 DAG332
description	spring compressor		
For models:	GOLD74, L61, L62, L63, L64, LK100, LK1000, LK100EM, LK1010, LK110, LK1100, LK130, LK1300, LK600, LK605, LK611, LK620, LK621, LK622, LK622I, LK625, LK130, LKDX110		

gas tension springs


gas tension springs




GEV No.	701299	Ref. No.	35070
description	gas tension spring 50N hub 150mm D1 ø 15mm D2 ø 6mm hole distance 365.5mm hole ø 6.5mm L 380mm		
For models:	LFD60, LO65, LOD102, LOD65, LP800-00-092, LP92		

roller springs


roller springs




GEV No.	511910	Ref. No.	927267 DWK1ALFA
description	roller spring complete incl. holder W 39mm ID ømm lug length 67mm		
For models:	LT121, LT150, LT151, LT152, LT161, LT202, LT221, LT271, LT272, LT362, LT91		




GEV No.	518029	Ref. No.	927268 CMT84 DWK2ALFA
description	roller spring complete incl. holder W 50mm ID ømm lug length 68mm		
For models:	LT150, LT271, LT362		



GEV No.	517449	Ref. No.	75271
description	roller spring L 95mm W 66mm		
For models:	LT81, LTD101, LTD131, LTD171, LTD209, LTD212, LTD216, LTD220, LTD316, LTD320, LTD326, LTDX172, LTDX222, LTDX272		




GEV No.	517452	Ref. No.	CMT82
description	roller spring W 38.5mm ID ø 24mm lug lengthmm mounting distance 22mm		
For models:	LT121, LT150, LT151, LT152, LT202, LT91		




GEV No.	517450	Ref. No.	77560
description	roller spring W 51mm ID ø 31mm lug length 90mm		
For models:	LTD171, LTD216, LTD220, LTD320, LTD326, LTDX222, LTDX272		


tension springs



GEV No.	701154	Ref. No.	449063
description	tension spring ø 10.5mm total length 200mm wire gauge ø 1.3mm for door mechanism		
For models:	LS522, LS525		





GEV No.	518260	Ref. No.	449049
description	tension spring ø 10mm total length 145mm wire gauge ø 1mm		
For models:	LB42BT-UK, LBD40, LBDX40, LF56, LF60, LFD50, LFDX50, LS520-CRP, LS521, LS521-CRP-SP		




GEV No.	701227	Ref. No.	449057 H.227855 H.231937
description	tension spring ø 10mm total length 155mm wire gauge ø 1.1mm L1 60mm L2 11mm for door mechanism		
For models:	LF56, LF60, LFD50, LFDX50, LS520-CRP, LS521, LS521-CRP-SP		



1 			
GEV No.	513206	Ref. No.	926007 CMT549
description	tension spring \varnothing 29.8mm total length 513mm wire gauge \varnothing 5.8mm		
For models:	GOLD74, L61, L62, L63, L64, LK100, LK1000, LK100EM, LK1010, LK110, LK1100, LK130, LK1300, LK600, LK605, LK622		


1 			
GEV No.	517448	Ref. No.	926108
description	tension spring \varnothing 30mm total length 505mm wire gauge \varnothing 5.5mm for hood mechanics Qty 1 pcs		
For models:	GOLD74, LK100, LK110, LK130, LK611, LK620, LK621, LK622I, LK625, LK625, LKDX110		

1 			
GEV No.	517451	Ref. No.	35020
description	tension spring \varnothing 8mm total length 150mm wire gauge \varnothing 1mm Qty 1 pcs		
For models:	LFD60, LO65, LOD102, LOD65, LP800-00-092, LP92		



kitchen accessories

gastronorm

bridges

1 			
GEV No.	693484	Ref. No.	2300306
description	bridge for Gastronorm container L1 530mm L2 510mm SS W 22mm H 19.5mm Qty 1 pcs thickness 0.75mm		
For models:	BC2G, BC3G, BC4G, BC6G, EC11803		

manometers

1 			
GEV No.	541062	Ref. No.	RTCP900063
description	manometer \varnothing 63mm pressure range 0 up to 1bar connection marking adjustable kettle thread 1/4"		
For models:	CPI100, CPI100A, CPI150, CPI150A, E100I, E100I9, E100I9N, E100IA, E100IT9N, E150I, E150I9, E150I9N, E150IA, E150IT9, E150IT9N, E50I7, G100I, G100I9, G100I9N, G100IA, G100IT9, G100IT9N, G150I, G150I9, G150I9N, G150IA, G150IT9, G150IT9N, G175I, G50I7, OMNIA G50I7		
spare parts for	541062		
		GEV No.	541130 Ref. No. —
	glass panel \varnothing 58mm thickness 2mm		

dosing pumps

peristaltic dosing pumps

MICRODOS

built-in version



without control

1 			
GEV No.	361685	Ref. No.	176473
description	dosing pump MICRODOS without control 3l/h 230VAC detergent hose \varnothing 4x6mm hose Santoprene suction level 1.5m horizontal/vertical type MP3 counter pressure 1bar		
For models:	CME10-V380, CME4-V380, CME6-V380, CMFE102-V380, CMFE10-V380, CMFE6-V380, CMFG10-V380, CMFG6-V380, CMG10-V380, CMG6-V380, FEM108, FEM108EL, FEM210L, FEM220, FEM220L, FEM240, FEM240L, FEM68, FEM68EL, FEMD108, FEMD108EL, FEMD68, FEMD68EL, FGM108, FGM108EL, FGM210L, FGM68, FGM68EL, FGM108, FGM-D108EL, FGM68, FGM68EL		
spare parts for	361685		
		GEV No.	361284 Ref. No. —
	pump hose detergent ID \varnothing 6.25mm ED \varnothing 10.55mm hose \varnothing 4x6mm hose type Santoprene with connections Shore 55°		

SEKO

built-in version

with frequency control

1 			
GEV No.	361767 ¹	Ref. No.	209021
description	dosing pump SEKO 3l/h 230VAC detergent hose \varnothing 4x6mm hose type K hose Santoprene suction level 1.5m type NBR 3 8W built-in version peristaltic pump		
For models:	KLB40, LB350, LB400, LB411, LB411A, LB450, LBD40, LBDX40, LFD50, LFDX50, LK600, LK605, LK611, LK622, LK622I, LS500, LS500A, LS500PV, LS501, LS501A, LS501PV, LS505, LS511, LS511A, LS511PV, LS520, LS521		
spare parts for	361767		
		GEV No.	361815 Ref. No. —
	pump hose detergent hose \varnothing 6x10mm hose \varnothing 4x6mm hose type K hose Santoprene type SEKO		

¹incl. inlet and conveyor hose




1

GEV No.	361215	Ref. No.	209016 DWD4PD
description	dosing pump SEKO frequency control 0.3-3.0l/h 230VAC detergent hose ø 4x6mm hose type K hose Santoprene suction level 1.5m type PBR protection IP55 dimensions 100x67x68mm power input 3.5W		
For models:	L61, L62, L63, L64, LB135, LB140, LB145, LB35, LB35C, LB40, LB40E, LB42BT-UK, LB45, LBD40, LBDX40, LF50, LF500, LF55E, LF56, LF59, LF60, LFD50, LFD60, LFDX50, LK100, LK1000, LK100EM, LK1010, LK110, LK1100, LK130, LK1300, LK611, LKD130, LKDX110, LO155, LO65, LO80, LO80H, LO93, LOD65, LOD80, LOD80H, LOD93, LP155, LP80, LP800-00-092, LP80H, LP92, LP93		
spare parts for	361215		
	GEV No.	361136	Ref. No. —
	roller assembly for dosing pump hole ø 4.8x4mm		
	GEV No.	361226	Ref. No. —
	PCB L 59mm W 26mm electronic control		
	GEV No.	361815	Ref. No. —
	pump hose detergent hose ø 6x10mm hose ø 4x6mm hose type K hose Santoprene type SEKO		
accessories for	361215		
	GEV No.	361142	Ref. No. —
	mounting set detergent hose type 4x6mm hose length 2m PVC 2x hose/container filter/tank intake transparent		
	GEV No.	520090	Ref. No. 143194
	PVC hose ID ø 4mm ED ø 6mm L 2m thickness 1mm t.max. 60°C transparent		
	GEV No.	520091	Ref. No. —
	nylon hose ID ø 4mm ED ø 6mm L 2m thickness 1mm operating p. 10bar burst p. 50bar t.max. 100°C transparent		




1

GEV No.	361949	Ref. No.	209037
description	dosing pump SEKO frequency control 0.4l/h 230VAC rinse aid hose ø 4x6mm hose type E hose Sekobril suction level 1.5m type NBR 0.4		
For models:	LB355, LB405		
accessories for	361949		
	GEV No.	361925	Ref. No. 143266
	pump hose SEKO rinse aid hose ø 3x8mm with backflow preventer hose ø 6mm hose type E hose Sekobril		




1

GEV No.	361948	Ref. No.	209029 209038
description	dosing pump SEKO frequency control 3l/h 230VAC detergent hose ø 4x6mm hose type L hose Santoprene suction level 1.5m type NBR 3		
For models:	LB355, LB405, LS500G, LS500GA, LS500GPV, LS501G, LS501GA, LS501GPV, LS505M, LS505T, LS522		
spare parts for	361948		
	GEV No.	362004	Ref. No. 143267
	dosing hose SEKO detergent hose ø 6x9mm hose length 138mm hose ø 4x6mm hose type L hose Santoprene		

without control




1

GEV No.	361902	Ref. No.	209028 209039 999296
description	dosing pump SEKO 3l/h 230VAC detergent hose ø 4x6mm hose type L hose Santoprene suction level 1.5m type NPG 3		
For models:	LB422, LB425, LK622, LK622I, LK625, LS521-CRP-SP, LS522, LS525		
spare parts for	361902		
	GEV No.	362004	Ref. No. 143267
	dosing hose SEKO detergent hose ø 6x9mm hose length 138mm hose ø 4x6mm hose type L hose Santoprene		




1


GEV No.	361929 ¹	Ref. No.	209024 209033 209036 999309
description	dosing pump SEKO without control 0.4l/h 230VAC rinse aid hose ø 4x6mm hose type E hose Sekobril suction level 1.5m type NPG 0.4 8W cable length 45mm built-in version with backflow preventer		
For models:	LB422, LB425, LK620, LK621, LK622, LK622I, LK625, LOD102, LOD202, LOD302, LOD304, LOD305, LOD402, LOD502, LS520-CRP, LS521, LS521-CRP-SP, LS522, LS525		
spare parts for	361929		
	GEV No.	361925	Ref. No. 143266
	pump hose SEKO rinse aid hose ø 3x8mm with backflow preventer hose ø 6mm hose type E hose Sekobril		

¹with accessories




spare parts			
			
1			
GEV No.	698712	Ref. No.	143219 143258
description	dosing hose SEKO detergent hose ø 4x8.6mm hose ø 4x6mm hose type H hose Santoprene		
For models:	KLB40, LB35, LB350, LB355, LB35C, LB40, LB400, LB405, LB40E, LB411, LB411A, LB422, LB425, LB42BT-UK, LB45, LB450, LBD40, LBDX40, LF50, LF55E, LF56, LF59, LF60, LFD50, LFDX50, LK600, LK605, LS500, LS500A, LS500G, LS500GA, LS500GPV, LS500PV, LS501, LS501A, LS501G, LS501GA, LS501GPV, LS501PV, LS505, LS505M, LS505T, LS511, LS511A, LS511PV, LS520, LS520-CRP, LS521, LS522, LS525		


			
1			
GEV No.	362004	Ref. No.	143267
description	dosing hose SEKO detergent hose ø 6x9mm hose length 138mm hose ø 4x6mm hose type L hose Santoprene		
For models:	LB355, LB405, LS505M, LS505T, LS521-CRP-SP		

			
1			
GEV No.	698710 ¹	Ref. No.	143261
description	dosing hose SEKO rinse aid hose ø 5x10mm hose length 116mm with backflow preventer hose ø 4x6mm hose type F hose Sekobril		
For models:	LB422, LB425, LS522, LS525		


¹with backflow preventer


			
1			
GEV No.	361135	Ref. No.	143251
description	pump hose SEKO rinse aid hose ø 3x8mm hose ø 4x6mm hose type D hose Sekobril		
For models:	LS520-CRP, LS521		

spare parts for			
361135			
	GEV No.	361866	Ref. No.
			—
	union nut for hose connector ø 17mm		

			
1			
GEV No.	361925 ¹	Ref. No.	143266
description	pump hose SEKO rinse aid hose ø 3x8mm with backflow preventer hose ø 6mm hose type E hose Sekobril		
For models:	LB355, LB405, LS521-CRP-SP		

¹with backflow preventer


piston pumps			
spare parts			
			
1			
GEV No.	361113	Ref. No.	201002 REB201002
description	solenoid coil 230VAC for type DB2		
For models:	BETA50, BETA53, LB140, LB145, LB45, LF500, LF550, LF551, LK1000		

			
1			
GEV No.	510298	Ref. No.	144012
description	lip valve dosing pump suitable for DB2/DS5		
For models:	LB140, LB35, LB35C, LB40, LB40E, LB42BT-UK, LB45, LBD40, LBDX40, LF50, LF500, LF55, LF550, LF551, LF55E, LF56, LF59, LF60, LFD50, LFDX50		

membrane dosing pumps

self-priming

LANG

spare parts			
			
1			
GEV No.	361311	Ref. No.	456072
description	O-ring EPDM thickness 2mm ID ø 6mm Qty 1 pcs for type N6		
For models:	LS511, LS511A, LS511PV		

accessories




			
1			
GEV No.	101286	Ref. No.	RTCU900018
description	olive ID ø 6mm Qty 1 pcs		
For models:	BG65F77M, BST2LV, BST2RV, BST6LV, BST6RV, C2A, C4A, C4A70, C4AV70, C4F, C4F70, C4F702P, C4FV70, C4FV702P, C62F, C6A, C6A70, C6AV70, C6F, C6F70, C6F702P, C6FA, C6FV70, C6FV702P, C8A, C8F, FCE6, FCG10, FCG20, FCG6, FEM107, FEM107SC, FEM109, FEM110, FEM110L, FEM207, FEM207SC, FEM209, FEM210, FEM210L, FEM610, FEM610L, FEM67, FEM67SC, FEM69, FEMD107, FEMD107SC, FEMD109, FEMD207, FEMD207SC...(Other models you can see in the webshop)		
accessories for	101286		
	GEV No.	100909	Ref. No.
			RTCP800038 RTCU900019
	union screw thread M10x1 for pipe ø 6mm Qty 1 pcs		

Table continues overleaf











accessories for	101286		
	GEV No.	101464	Ref. No.
			—
	union nut thread M12x1 for pipe ø 6mm		

SEKO





GEV No.	361364 ¹	Ref. No.	209025 926278 DWD3
description	dosing pump type DIB5E self-sucking rinse aid pump rate 0-5cm ³ per stroke pressure connection ø 4x6mm suction connection ø 4x6mm SEKO supporting pressure closed		
For models:	GOLD74, KLB40, LB355, LB400, LB405, LB411, LB411A, LB450, LBD40, LFD50, LFD60, LK100, LK100EM, LK110, LK130, LK600, LK605, LK611, LKD130, LO65, LS500, LS500A, LS500GPV, LS500PV, LS501, LS501A, LS501GPV, LS501PV, LS505, LS505M, LS505T, LS511, LS511A, LS511PV, LS520		

spare parts for 361364


	GEV No.	361301	Ref. No.	—
	hose connector for type DIB3E/DIB5E			
	GEV No.	361302	Ref. No.	—
	valve bush for type DIB3E/DIB5E			
	GEV No.	361304	Ref. No.	456042
	O-ring EPDM ID ø 11.11mm thickness 1.78mm Qty 1 pcs for type DIB3E/DIB5E			
	GEV No.	361305	Ref. No.	—
	valve disc for type DIB3E/DIB5E DIB3P/DIB5P			
	GEV No.	361306	Ref. No.	—
	membrane for type DIB3E/DIB5E ø 49mm hole ø 5mm			
	GEV No.	361307	Ref. No.	—
	membrane dosing pump ø 68mm hole ø 6mm for type DIB3P/DIB5P			
	GEV No.	361459	Ref. No.	—
	hose connector ø 6mm for dosing pump			
	GEV No.	361481	Ref. No.	—
	lip valve for type DIB3P/DIB5P DIB3E/DIB5E			

accessories for 361364

	GEV No.	361240	Ref. No.	—
	hose connector 1-way hose ø 6mm plastic connection M10x1			
	GEV No.	361241	Ref. No.	—
	hose connector 1-way hose ø 9mm plastic connection M10x1			


¹auxiliary pressure connection closed

spare parts

	1		
GEV No.	361304	Ref. No.	456042
description	O-ring EPDM ID ø 11.11mm thickness 1.78mm Qty 1 pcs for type DIB3E/DIB5E		
For models:	LB35, LB35C, LB40, LB40E		

various

spare parts

	1		
GEV No.	510298	Ref. No.	144012
description	lip valve dosing pump suitable for DB2/DS5		
For models:	LB140, LB35, LB35C, LB40, LB40E, LB42BT-UK, LB45, LBD40, LBDX40, LF50, LF500, LF55, LF550, LF551, LF55E, LF56, LF59, LF60, LFD50, LFDX50		



self-priming with supporting pressure


ELETTROBAR




GEV No.	361362	Ref. No.	987023
description	dosing pump rinse aid pressure connection ø 6mm pressure connection 6		
For models:	LB135, LB140, LB35, LB350, LB35C, LB40, LB40E, LB42BT-UK, LB45, LBD40, LBDX40, LF50, LF500, LF55, LF550, LF551, LF55E, LF56, LF59, LF60, LFD50, LFDX50		

spare parts for 361362

	GEV No.	361363	Ref. No.	199012
	membrane			
	GEV No.	510298	Ref. No.	144012
	lip valve dosing pump suitable for DB2/DS5			


	1		
GEV No.	510298	Ref. No.	144012
description	lip valve dosing pump suitable for DB2/DS5		
For models:	LB140, LB35, LB35C, LB40, LB40E, LB42BT-UK, LB45, LBD40, LBDX40, LF50, LF500, LF55, LF550, LF551, LF55E, LF56, LF59, LF60, LFD50, LFDX50		



			
1			
GEV No.	361363	Ref. No.	199012
description	membrane		
For models:	LB140, LB35, LB350, LB35C, LB40, LB40E, LB42BT-UK, LB45, LBD40, LBDX40, LF50, LF500, LF55, LF550, LF551, LF55E, LF56, LF59, LF60, LFD50, LFDX50		



GERMAC






spare parts


			
1			
GEV No.	510298	Ref. No.	144012
description	lip valve dosing pump suitable for DB2/DS5		
For models:	LB140, LB35, LB35C, LB40, LB40E, LB42BT-UK, LB45, LBD40, LBDX40, LF50, LF500, LF55, LF550, LF551, LF55E, LF56, LF59, LF60, LFD50, LFDX50		

SEKO

			
1			
GEV No.	362013	Ref. No.	929198
description	dosing pump type DIB P with auxiliary pressure connection for dishwashers pump rate 0-3cm ³ per stroke pressure connection ø 4x6mm suction connection ø 4x6mm auxiliary pressure connection 10mm SEKO		
For models:	LBDX40, LFDX50, LKDX110, LO155, LO65, LO80, LO80H, LO93, LOD65, LOD80, LOD80H, LOD93, LP80, LP800-00-092, LP92		


			
1			
GEV No.	361039	Ref. No.	DWD4
description	dosing pump type DIB5P with auxiliary pressure connection rinse aid 0-5cm ³ per stroke/h pressure connection ø 4x6mm suction connection ø 4x6mm auxiliary pressure connection 10mm SEKO		
For models:	LP155, LP80, LP80H, LP93		
spare parts for	361039		
	GEV No.	361301	Ref. No. —
	hose connector for type DIB3E/DIB5E		

spare parts for	361039		
	GEV No.	361302	Ref. No. —
	valve bush for type DIB3E/DIB5E		
	GEV No.	361304	Ref. No. 456042
	O-ring EPDM ID ø 11.11mm thickness 1.78mm Qty 1 pcs for type DIB3E/DIB5E		
	GEV No.	361305	Ref. No. —
	valve disc for type DIB3E/DIB5E DIB3P/DIB5P		
	GEV No.	361307	Ref. No. —
	membrane dosing pump ø 68mm hole ø 6mm for type DIB3P/DIB5P		
	GEV No.	361481	Ref. No. —
	lip valve for type DIB3P/DIB5P DIB3E/DIB5E		

			
1			
GEV No.	361304	Ref. No.	456042
description	O-ring EPDM ID ø 11.11mm thickness 1.78mm Qty 1 pcs for type DIB3E/DIB5E		
For models:	LB35, LB35C, LB40, LB40E		

accessories

container filters

			
1			
GEV No.	513043	Ref. No.	121017 CWF1F
description	container filter hose ø 4mm		
For models:	BETA50, BETA53, KLB40, L600, L61, L62, L63, L64, LB135, LB140, LB145, LB35, LB350, LB35C, LB40, LB400, LB40E, LB411, LB42BT-UK, LB45, LB450, LBD40, LBDX40, LF50, LF500, LF55, LF550, LF551, LF55E, LF56, LF59, LF60, LFD50, LFDX50, LK1000, LK1010, LK1100, LK1300, LS500, LS500A, LS500GPV, LS500PV, LS501, LS501A, LS501GPV, LS501PV, LS505, LS511, LS511A, LS511PV...(Other models you can see in the webshop)		

			
1			
GEV No.	361141	Ref. No.	121075 68010 68011
description	container filter with weight ceramic hose ø 4mm		
For models:	KLB40, L61, L62, L63, L64, LB135, LB140, LB145, LB35, LB350, LB35C, LB40, LB400, LB40E, LB411, LB42BT-UK, LB45, LB450, LBD40, LBDX40, LF50, LF500, LF55E, LF56, LF59, LF60, LFD50, LFDX50, LK1000, LK1010, LK1100, LK1300, LK600, LK620, LK621, LO155, LO80, LO80H, LO93, LOD102, LOD155, LOD202, LOD302, LOD304, LOD305, LOD402, LOD502, LOD80, LOD80H, LOD93...(Other models you can see in the webshop)		



1

GEV No.	361462	Ref. No.	121993
description	container filter with weight SS hose ø 4x6mm		
For models:	LB355, LB405, LB411, LB411A, LB422, LB425, LK600, LK605, LK620, LK625, LS500, LS500A, LS500PV, LS501, LS501A, LS501PV, LS505M, LS505T, LS511, LS511A, LS511PV, LS521-CRP-SP, LS522, LS525		

hoses

silicone hoses



1

GEV No.	520242	Ref. No.	143235
description	silicone hose for peristaltic pump ID ø 4mm ED ø 7mm L 5m thickness 1.5mm t.max. 200°C Shore A 55° transparent dosing Qty 5m		
For models:	LB422, LB425, LB42BT-UK, LBDX40, LFDX50, LS520-CRP, LS521, LS521-CRP-SP, LS522, LS525		

PVC hoses



1

GEV No.	520090	Ref. No.	143194
description	PVC hose ID ø 4mm ED ø 6mm L 2m thickness 1mm t.max. 60°C transparent		
For models:	KLB40, LB135, LB140, LB145, LB35, LB350, LB355, LB35C, LB40, LB400, LB405, LB40E, LB411, LB411A, LB422, LB425, LB42BT-UK, LB45, LB450, LBD40, LBDX40, LF50, LF500, LF55E, LF56, LF59, LF60, LFD50, LFDX50, LK1000, LK600, LK605, LK620, LK621, LK625, LOD102, LOD202, LOD302, LOD304, LOD402, LS500, LS500A, LS500G, LS500GA, LS500G-PV, LS500PV, LS501, LS501A, LS501G, LS501GA...(Other models you can see in the webshop)		

accessories for

GEV No.	361058	Ref. No.	—
----------------	--------	-----------------	---



container filter with non-return valve SS hose ø 4x6mm ø 20mm L 56mm

GEV No.	361066	Ref. No.	—
----------------	--------	-----------------	---



container filter straight SS hose ø 4x6mm L 37mm non return valve ball valve

GEV No.	361106	Ref. No.	—
----------------	--------	-----------------	---



container filter with weight and non-return valve SS hose ø 4x6mm ø 21mm L 51mm non return valve lip valve

GEV No.	361141	Ref. No.	121075 68010 68011
----------------	--------	-----------------	--------------------------



container filter with weight ceramic hose ø 4mm

GEV No.	361230	Ref. No.	—
----------------	--------	-----------------	---



container filter with weight stainless steel hose ø 4x6mm

GEV No.	361462	Ref. No.	121993
----------------	--------	-----------------	--------



container filter with weight SS hose ø 4x6mm

GEV No.	361728	Ref. No.	—
----------------	--------	-----------------	---



container filter with 4m 4x6 hose SS hose ø 4x6mm hose length 4000mm

tank inlets



1

GEV No.	361270	Ref. No.	468151 999104 DZR150 DZR150NT
description	tank inlet SS M12 hose ø 4mm		
For models:	KLB40, L600, L61, L62, L63, L64, LB135, LB140, LB145, LB35, LB350, LB355, LB35C, LB40, LB400, LB405, LB40E, LB411, LB411A, LB422, LB425, LB42BT-UK, LB45, LB450, LBD40, LBDX40, LF50, LF500, LF55E, LF56, LF59, LF60, LFD50, LFDX50, LK100, LK1000, LK100EM, LK110, LK1100, LK130, LK1300, LK600, LK605, LK611, LK620, LK621, LK622, LK622I, LK625, LKD130...(Other models you can see in the webshop)		

miscellaneous



1

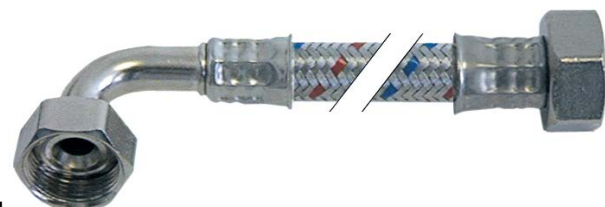
GEV No.	521735	Ref. No.	466005
description	spacer piece for rinse aid pump		
For models:	LB35, LB350, LB35C, LB40, LB40E, LB42BT-UK, LBD40, LBDX40, LF56, LF60, LFD50, LFDX50		

hoses

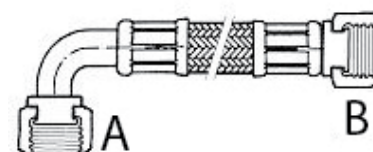
supply hoses

stainless steel flexi hoses

universal hoses



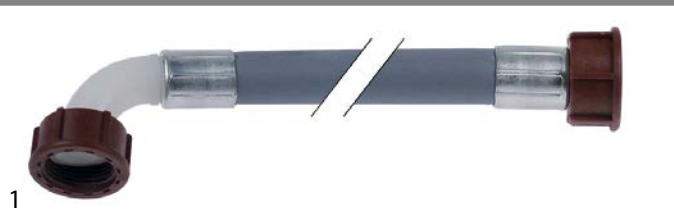
1





GEV No.	520008	Ref. No.	143112
description	flex hose SS braid straight-curved DN12 connection 1: 3/4" connection 2: 3/4" L 1500mm approval DVGW operating p. 10bar test pressure 32bar burst p. 95bar		
For models:	LK1000		
accessories for	520008		
GEV No.	520054	Ref. No.	—
description	flat gasket rubber ED ø 23.5mm ID ø 14mm thickness 2.3mm Qty 10 pcs		



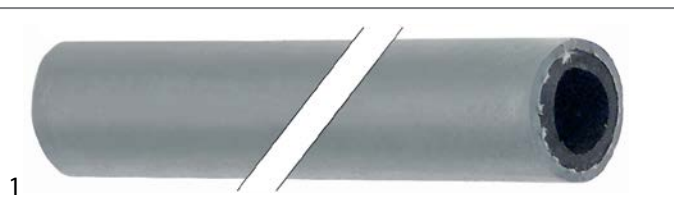
PVC supply hoses




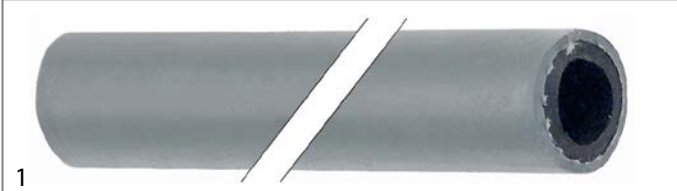
GEV No.	520010	Ref. No.	143170
description	supply hose PVC straight-curved DN13 connections 3/4" L 1500mm operating p. 10bar burst p. 32bar t.max. 90°C blue approval VDE flat seal		
For models:	LB135, LB140, LB145, LB35, LB350, LB355, LB35C, LB40, LB405, LB40E, LB422, LB425, LB45, LF50, LF500, LF55, LF550, LF551, LF55E, LF56, LF59, LF60, LFD50, LFDX50, LS520-CRP, LS521, LS521-CRP-SP, LS522		
accessories for	520010		
	GEV No.	520053	Ref. No. —
	screen connection 3/4" D1 ø 26mm D2 ø 15mm Qty 10 pcs rubber thickness 8mm		
	GEV No.	520054	Ref. No. —
	flat gasket rubber ED ø 23.5mm ID ø 14mm thickness 2.3mm Qty 10 pcs		



GEV No.	520011	Ref. No.	929169 RAT32
description	supply hose PVC straight-curved DN13 connections 3/4" L 2000mm operating p. 10bar burst p. 32bar t.max. 90°C approval VDE flat seal		
For models:	KLB40, L600, L61, L62, L63, L64, LB350, LB400, LB405, LB411, LB411A, LB450, LK600, LK605, LK620, LK621, LK625, LO155, LO80, LO80H, LO93, LOD102, LOD155, LOD202, LOD302, LOD304, LOD305, LOD402, LOD502, LOD80, LOD80H, LOD93, LP155, LP80, LP80H, LP93, LS500, LS500A, LS500G, LS500GA, LS500GPV, LS500PV, LS501, LS501A, LS501G, LS501GA, LS501GPV, LS501PV, LS505, LS505M...(Other models you can see in the webshop)		



GEV No.	520015	Ref. No.	143004
description	supply hose ID ø 10mm ED ø 17mm L 5m operating p. 20bar burst p. 60bar t.max. 95°C grey Qty 5m		
For models:	LB135, LB140, LB145, LB35, LB40, LB40E, LB422, LB425, LB45, LB450, LBD40, LBDX40, LF50, LF500, LF55, LF550, LF551, LF55E, LF56, LF59, LF60, LFD50, LFDX50, LK1000, LS500, LS500A, LS500G, LS500GA, LS500GPV, LS500PV, LS501, LS501A, LS501G, LS501GA, LS501GPV, LS501PV, LS505, LS505M, LS505T, LS511, LS511A, LS511PV, LS520, LS520-CRP, LS521, LS521-CRP-SP, LS522, LS525		
accessories for	520015		
	GEV No.	504377	Ref. No. —
	hose connector grommet ø 23mm grommet length 25mm total length 55mm for water filling		



GEV No.	520016	Ref. No.	SPG17 SPG61
description	supply hose ID ø 13mm ED ø 20mm L 40m operating p. 20bar burst p. 60bar t.max. 95°C grey Qty 40m		
For models:	BETA50, BETA53, L600, L61, L62, L63, L64, LK1000, LK1010, LK1100, LK1300, LP155, LP80, LP80H, LP93, LT121, LT150, LT151, LT152, LT202, LT91, S58		

drain hoses




GEV No.	513718	Ref. No.	143120
description	drain hose DN19 L 1500mm straight ø inside 24mm straight ext. ø 28mm outer hose ø 23mm		
For models:	KLB40, LB135, LB140, LB35, LB350, LB355, LB35C, LB40, LB400, LB405, LB40E, LB411, LB411A, LB422, LB425		




GEV No.	530587	Ref. No.	DZS14 REB143178
description	drain hose DN28 L 2000mm straight ø inside 32mm straight ext. ø 40mm outer hose ø 35mm		
For models:	BETA50, BETA53, LT121, LT150, LT151, LT152, LT202, LT91		




GEV No.	518068	Ref. No.	143136 DZS155
description	drain hose DN34 L 2000mm elbow ø inside 50mm elbow ext. ø 59mm inner hose ø 35mm outer hose ø 42mm PVC		
For models:	GOLD74, L600, L61, L62, L63, L64, LF59, LFD60, LK100, LK1000, LK100EM, LK1010, LK110, LK1100, LK130, LK1300, LK611, LK620, LK622, LK622I, LK625, LKD130, LO65, LO80, LO80H, LOD102, LOD202, LOD302, LOD65, LOD80, LOD80H, LP80, LP800-00-092, LP80H, LP92, LS505, S58		

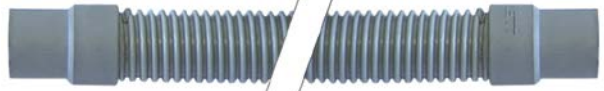
GEV No.	530373	Ref. No.	127077
description	drain hose L 680mm elbow \varnothing inside 20mm outer hose \varnothing 24mm		
For models:	LFDX50, LS521, LS521-CRP-SP		




GEV No.	513258	Ref. No.	127044
description	drain hose DN19 L 270mm A int. \varnothing 22mm A ext. \varnothing 28mm B int. \varnothing 24mm B ext. \varnothing 28mm outer hose \varnothing 22mm		
For models:	LF50, LF500, LF55, LF550, LF551, LF55E, LS500, LS500GPV, LS500PV, LS501, LS501GPV, LS501PV, LS505M, LS505T, LS511, LS511PV, LS520		




GEV No.	518219	Ref. No.	127037
description	drain hose DN19 L 630mm A int. \varnothing 20mm A ext. \varnothing 27mm B int. \varnothing 21mm B ext. \varnothing 28mm outer hose \varnothing 24mm		
For models:	LF50, LF500, LF55, LF550, LF551, LF55E, LF56, LF59, LF60, LFD50, LS500, LS500GPV, LS500PV, LS501, LS501GPV, LS501PV, LS505, LS505M, LS505T, LS511, LS511PV, LS520, LS520-CRP		



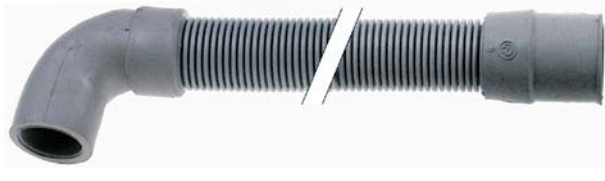
GEV No.	530616	Ref. No.	DZS151
description	drain hose L 1500mm A int. \varnothing 25mm B int. \varnothing 25mm outer hose \varnothing 32mm		
For models:	L600, L61, L62, L63, L64, LK600, LK620, LK622, LK622I, LK625, LOD102, S58		




GEV No.	530374	Ref. No.	127086
description	drain hose L 160mm DN19 A int. \varnothing 28mm A ext. \varnothing 34mm B int. \varnothing 28mm B ext. \varnothing 34mm outer hose \varnothing 24mm		
For models:	LFD50, LFDX50, LS520-CRP, LS521, LS521-CRP-SP		




GEV No.	530372	Ref. No.	80702
description	drain hose DN19 L 1000mm straight \varnothing inside 21mm straight ext. \varnothing 27mm elbow \varnothing inside 21mm elbow ext. \varnothing 28mm outer hose \varnothing 24mm		
For models:	LK621, LKDX110		




GEV No.	530819	Ref. No.	143137
description	drain hose DN20 L 2500mm straight \varnothing inside 19mm straight ext. \varnothing 24mm elbow \varnothing inside 22mm elbow ext. \varnothing 27mm outer hose \varnothing 24mm		
For models:	KLB40, LB135, LB140, LB145, LB35, LB350, LB355, LB35C, LB40, LB400, LB405, LB40E, LB411, LB411A, LB422, LB425, LB42BT-UK, LB45, LB450, LBD40, LBDX40, LF500, LFDX50, LK1000, LK621, LKDX110, LS505M, LS505T, LS521, LS521-CRP-SP, LS522, LS525		




GEV No.	518638	Ref. No.	143252
description	drain hose DN24 L 1700mm straight \varnothing inside 28mm straight ext. \varnothing 34mm elbow \varnothing inside 28mm elbow ext. \varnothing 34mm outer hose \varnothing 30mm		
For models:	LK600, LK605, LS505M, LS505T, LS522, LS525		



GEV No.	518652	Ref. No.	70097
description	drain hose DN24 L 600mm straight \varnothing inside 30mm straight ext. \varnothing 34mm elbow \varnothing inside 29mm elbow ext. \varnothing 33mm outer hose \varnothing 29mm		
For models:	LK600		



GEV No.	518078	Ref. No.	127032
description	drain hose DN34 L 500mm straight \varnothing inside 40mm straight ext. \varnothing 48mm elbow \varnothing inside 50mm elbow ext. \varnothing 58mm outer hose \varnothing 42mm		
For models:	LK1000		





1

GEV No.	518654	Ref. No.	127056
description	drain hose DN34 L 600mm straight ø inside 30mm straight ext. ø 40mm elbow ø inside 51mm elbow ext. ø 61mm outer hose ø 34mm		
For models:	LK620, LK621, LK622, LK622I, LK625, LKDX110, LOD102		

industrial hoses

Niplaflex hoses



1


GEV No.	570561	Ref. No.	143182
description	pressure hose ID ø 10mm ED ø 17mm L 40m thickness 3.5mm operating p. 10bar burst p. 30bar t.max. 110°C		
For models:	LB145, LB45, LBD40, LF50, LF500, LF55, LF550, LF551, LF55E, LF56, LF59, LF60, LFD50		



1

GEV No.	530562	Ref. No.	143010
description	pressure hose ID ø 13mm ED ø 21mm L 5m operating p. 10bar burst p. 30bar t.max. 110°C		
For models:	GOLD74, LK100, LK100EM, LK110, LK130, LK600, LK605, LK611, LK620, LK621, LK622, LK622I, LK625, LKDX130, LKDX110, LO155, LO65, LO80, LO80H, LO93, LOD155, LOD202, LOD302, LOD304, LOD305, LOD402, LOD502, LOD65, LOD80, LOD80H, LOD93, LP80, LP800-00-092, LP92, LT161, LT221, LT271, LT272, LT362, LT81, LTD101, LTD131, LTD171, LTD209, LTD212, LTD216, LTD220, LTD316, LTD320, LTD326...(Other models you can see in the webshop)		

pressure control hoses



1

GEV No.	530560	Ref. No.	143005 143131 SPG10
description	pressure control hose ID ø 5mm ED ø 9mm L 5m operating p. 30bar burst p. 90bar temp.-resist. 60°C		
For models:	BETA50, BETA53, KLB40, LB135, LB140, LB145, LB35, LB350, LB355, LB35C, LB40, LB400, LB405, LB40E, LB411, LB411A, LB422, LB425, LB42BT-UK, LB45, LB450, LBD40, LBDX40, LF50, LF500, LF55, LF550, LF551, LF55E, LF56, LF59, LF60, LFD50, LFDX50, LK1000, LK600, LK605, LK611, LK620, LK621, LK622, LK622I, LK625, LKDX110, LO155, LO65, LO80, LO80H, LO93, LOD102...(Other models you can see in the webshop)		

PVC hoses

PVC hoses without fabric



1

GEV No.	520383	Ref. No.	H.775601
description	PVC hose ID ø 4mm ED ø 6mm L 2m thickness 1mm t.max. 60°C blue		
For models:	KLB40, LB355, LB400, LB405, LB411, LB411A, LB422, LB425, LB450, LK600, LK605, LK620, LK621, LK625, LOD102, LOD202, LOD302, LOD304, LOD305, LOD402, LOD502, LS500, LS500A, LS500GPV, LS500PV, LS501, LS501A, LS501GPV, LS501PV, LS505, LS505M, LS505T, LS511, LS511A, LS511PV, LS520, LS520-CRP, LS521, LS521-CRP-SP, LS522, LS525		
accessories for	520383		
	GEV No.	361058	Ref. No. —
	container filter with non-return valve SS hose ø 4x6mm ø 20mm L 56mm		
	GEV No.	361066	Ref. No. —
	container filter straight SS hose ø 4x6mm L 37mm non return valve ball valve		
	GEV No.	361106	Ref. No. —
	container filter with weight and non-return valve SS hose ø 4x6mm ø 21mm L 51mm non return valve lip valve		
	GEV No.	361141	Ref. No. 121075 68010 68011
	container filter with weight ceramic hose ø 4mm		
	GEV No.	361230	Ref. No. —
	container filter with weight stainless steel hose ø 4x6mm		
	GEV No.	361462	Ref. No. 121993
	container filter with weight SS hose ø 4x6mm		
	GEV No.	361728	Ref. No. —
	container filter with 4m 4x6 hose SS hose ø 4x6mm hose length 4000mm		



1

GEV No.	520090	Ref. No.	143194
description	PVC hose ID ø 4mm ED ø 6mm L 2m thickness 1mm t.max. 60°C transparent		
For models:	KLB40, LB135, LB140, LB145, LB35, LB350, LB355, LB35C, LB40, LB400, LB405, LB40E, LB411, LB411A, LB422, LB425, LB42BT-UK, LB45, LB450, LBD40, LBDX40, LF50, LF500, LF55E, LF56, LF59, LF60, LFD50, LFDX50, LK1000, LK600, LK605, LK620, LK621, LK625, LOD102, LOD202, LOD302, LOD304, LOD402, LS500, LS500A, LS500G, LS500GA, LS500GPV, LS500PV, LS501, LS501A, LS501G, LS501GA...(Other models you can see in the webshop)		
accessories for	520090		
	GEV No.	361058	Ref. No. —
	container filter with non-return valve SS hose ø 4x6mm ø 20mm L 56mm		
	GEV No.	361066	Ref. No. —
	container filter straight SS hose ø 4x6mm L 37mm non return valve ball valve		
	GEV No.	361106	Ref. No. —
	container filter with weight and non-return valve SS hose ø 4x6mm ø 21mm L 51mm non return valve lip valve		

Table continues overleaf



accessories for		520090		
	GEV No.	361141	Ref. No.	121075 68010 68011
container filter with weight ceramic hose ø 4mm				
	GEV No.	361230	Ref. No.	—
container filter with weight stainless steel hose ø 4x6mm				
	GEV No.	361462	Ref. No.	121993
container filter with weight SS hose ø 4x6mm				
	GEV No.	361728	Ref. No.	—
container filter with 4m 4x6 hose SS hose ø 4x6mm hose length 4000mm				

1				
GEV No.	520027	Ref. No.	143013 143028 REB143013	
description	PVC hose ID ø 4mm ED ø 7mm L 10m thickness 1.5mm t.max. 60°C transparent			
For models:	BETA50, BETA53, LB135, LB140, LB145, LB35, LB350, LB355, LB35C, LB40, LB405, LB40E, LB411, LB411A, LB42BT-UK, LB45, LBD40, LBDX40, LF50, LF500, LF55, LF550, LF551, LF55E, LF56, LF59, LF60, LFD50, LFDX50, LK1000, LK600, LK605, LK621, LKDX110, LS500, LS500A, LS500G, LS500GA, LS500GPV, LS500PV, LS501, LS501A, LS501G, LS501GA, LS501GPV, LS501PV, LS505, LS505M, LS505T, LS511...(Other models you can see in the webshop)			

1				
GEV No.	520935	Ref. No.	H.165168	
description	PVC hose ID ø 6mm ED ø 9mm L 1m transparent warewashing			
For models:	LB422, LB425, LFD50, LFDX50, LK620, LK625, LOD402, LOD502, LS505M, LS505T, LS520-CRP, LS521, LS521-CRP-SP, LS525			

silicone hoses

without fabric

1				
GEV No.	520242	Ref. No.	143235	
description	silicone hose for peristaltic pump ID ø 4mm ED ø 7mm L 5m thickness 1.5mm t.max. 200°C Shore A 55° transparent dosing Qty 5m			
For models:	LB422, LB425, LB42BT-UK, LBDX40, LFDX50, LS520-CRP, LS521, LS521-CRP-SP, LS522, LS525			

1				
GEV No.	530757	Ref. No.	13108	
description	silicone hose ID ø 13mm ED ø 19mm L 0.24m t.max. 200°C for ice-cube maker			
For models:	ICE45A, ICE45W			

1				
GEV No.	530759	Ref. No.	13110	
description	silicone hose ID ø 13mm ED ø 19mm L 0.35m t.max. 200°C for ice-cube maker			
For models:	CB955A, CB955W			

1				
GEV No.	530740	Ref. No.	13141	
description	silicone hose ID ø 16mm ED ø 23mm L 0.61m t.max. 200°C for ice-cube maker			
For models:	CB955A, CB955W			

1				
GEV No.	520842	Ref. No.	143253	
description	silicone hose ID ø 3mm ED ø 6mm L 1m thickness 1.5mm t.max. 200°C brown			
For models:	LK621, LOD202, LOD302, LOD304, LOD305, LOD402, LOD502, LS521, LS521-CRP-SP			

for peristaltic pumps

1				
GEV No.	520242	Ref. No.	143235	
description	silicone hose for peristaltic pump ID ø 4mm ED ø 7mm L 5m thickness 1.5mm t.max. 200°C Shore A 55° transparent dosing Qty 5m			
For models:	LB422, LB425, LB42BT-UK, LBDX40, LFDX50, LS520-CRP, LS521, LS521-CRP-SP, LS522, LS525			




formed hoses

straight




1

GEV No.	518303	Ref. No.	127065
description	formed hose		
For models:	LF56, LF60, LFD50, LFDX50, LS520-CRP, LS521, LS521-CRP-SP		




1

GEV No.	518519	Ref. No.	127054
description	formed hose dishwasher straight equiv. no. 127054		
For models:	KLB40, LB135, LB140, LB35, LB350, LB355, LB35C, LB40, LB400, LB405, LB40E, LB411, LB411A		



1

GEV No.	518213	Ref. No.	143009
description	formed hose dishwasher straight equiv. no. 143009		
For models:	LB145, LB45, LB450		




1

GEV No.	518223	Ref. No.	127022
description	formed hose dishwasher straight mounting pos. lower equiv. no. 127022		
For models:	LB145, LB45, LB450		




1

GEV No.	518070	Ref. No.	127026
description	formed hose dishwasher straight mounting pos. upper equiv. no. 127026		
For models:	LF50, LF500, LF55, LF550, LF551, LF55E, LF59, LS500, LS500A, LS500G, LS500GA, LS500GPV, LS500PV, LS501, LS501A, LS501G, LS501GA, LS501GPV, LS501PV, LS505, LS505M, LS505T, LS511, LS511A, LS511PV, LS520		




1

GEV No.	518381	Ref. No.	127035
description	formed hose dishwasher straight mounting pos. upper equiv. no. 127035		
For models:	LF500, LF550, LF551		




1

GEV No.	518380	Ref. No.	127036 80189
description	formed hose ext. ø 53 ID ø 43mm L 65mm dishwasher straight mounting pos. upper equiv. no. 127036		
For models:	LF50, LF500, LF55, LF550, LF551, LF55E, LK100, LK100EM, LK110, LK611, LK620, LK621, LK622, LK625, LK625, LKD130, LKDX110, LOD102, LS500, LS500A, LS500G, LS500GA, LS500GPV, LS500PV, LS501, LS501A, LS501G, LS501GA, LS501GPV, LS501PV, LS505M, LS505T, LS511, LS511A, LS511PV, LS520		



1

GEV No.	513294	Ref. No.	41525 43149
description	formed hose hose ext. ø 20mm ID ø 13mm hose int. ø 25mm L 1350mm		
For models:	LK620, LK621, LK625, LKDX110, LO65, LO80, LO80H, LOD102, LOD155, LOD202, LOD302, LOD304, LOD305, LOD402, LOD502, LOD65, LOD80, LOD80H, LP80, LP800-00-092, LP92, LTD316, LTD320, LTD326, LTDX172, LTDX222, LTDX272		



1

GEV No.	504795	Ref. No.	127096
description	formed hose L 47mm warewashing		
For models:	LK620, LK621, LS520-CRP, LS521, LS521-CRP-SP, LS525		



form L



1

GEV No.	518302	Ref. No.	127064
description	formed hose		
For models:	LF56, LF60, LFD50, LFDX50, LS520-CRP, LS521, LS521-CRP-SP		



1

GEV No.	513311	Ref. No.	127128
description	formed hose end piece A ext. \varnothing 17mm end piece A int. \varnothing 10mm AD2 \varnothing 17mm \varnothing end piece B 10mm L 112mm		
For models:	LB422		



1

GEV No.	513299	Ref. No.	127090
description	formed hose end piece A ext. \varnothing 18mm end piece A int. \varnothing 10mm AD2 \varnothing 18mm \varnothing end piece B 10mm L 435mm		
For models:	LS522		



1

GEV No.	513302	Ref. No.	127107
description	formed hose end piece A ext. \varnothing 18mm end piece A int. \varnothing 10mm AD2 \varnothing 18mm \varnothing end piece B 10mm L 450mm		
For models:	LB422		



1

GEV No.	518639	Ref. No.	143237
description	formed hose end piece A ext. \varnothing 18mm end piece A int. \varnothing 11mm AD2 \varnothing 18mm \varnothing end piece B 11mm L 460mm		
For models:	KLB40, LB35, LB350, LB40, LB400, LB405, LB40E, LB411, LB411A, LF56, LF60		



1

GEV No.	513310	Ref. No.	43565
description	formed hose end piece A ext. \varnothing 35mm end piece A int. \varnothing 27mm AD2 \varnothing 35mm \varnothing end piece B 27mm L 115mm		
For models:	LOD305, LOD502		



1

GEV No.	513305	Ref. No.	35603
description	formed hose end piece A ext. \varnothing 51mm end piece A int. \varnothing 44mm AD2 \varnothing 42mm \varnothing end piece B 33mm L 300mm		
For models:	LFD60, LO65, LOD102, LOD65, LP800-00-092, LP92		



1

GEV No.	513251	Ref. No.	80187
description	formed hose end piece A ext. \varnothing 59mm end piece A int. \varnothing 47mm AD2 \varnothing 58mm \varnothing end piece B 46mm warewashing L-shape equiv. no. 80187 mounting pos. upper		
For models:	GOLD74, LK130, LKD130, LTD101, LTD131, LTD171, LTD209, LTD212, LTD216, LTD220		



1

GEV No.	518124	Ref. No.	927016 DZG52
description	formed hose end piece A ext. \varnothing 61mm end piece A int. \varnothing 49mm AD2 \varnothing 65mm \varnothing end piece B 53mm L 290mm rubber Qty 1 for dishwasher L-shape outflow		
For models:	LT121, LT150, LT151, LT152, LT161, LT202, LT221, LT271, LT272, LT362, LT91		



1

GEV No.	503178	Ref. No.	127106
description	formed hose for drain pump warewashing		
For models:	LB422, LB425		



1

GEV No.	503179	Ref. No.	127120
description	formed hose for drain pump warewashing		
For models:	LB422, LB425		




			
1			
GEV No.	503180	Ref. No.	41560
description	formed hose for drain pump warewashing		
For models:	LOD202, LOD302		

			
1			
GEV No.	503181	Ref. No.	127084
description	formed hose for drain pump warewashing		
For models:	LS522, LS525		


			
1			
GEV No.	503175	Ref. No.	127134
description	formed hose for intake body warewashing		
For models:	LS505M, LS505T		

			
1			
GEV No.	513250	Ref. No.	80188
description	formed hose ID ø 48mm ED ø 60mm thickness 6mm L1 235mm L2 140mm L-shape		
For models:	LFD60, LK100, LK100EM, LK110, LK611, LK620, LK621, LK622, LK622I, LK625, LKDX110, LO65, LOD102, LOD65, LP800-00-092, LP92, LT81, LTD316, LTD320, LTD326, LTDX222, LTDX272		

			
1			
GEV No.	513254	Ref. No.	80186
description	formed hose L 340mm warewashing L-shape equiv. no. 80186 ID ø 60mm		
For models:	GOLD74, LFD60, LK100, LK100EM, LK110, LK130, LK611, LK620, LK621, LK622, LK622I, LK625, LKD130, LKDX110, LO65, LOD102, LOD202, LOD302, LOD65, LP800-00-092, LP92, LTD171, LTD216, LTD220, LTD320, LTD326, LTDX222, LTDX272		

			
1			
GEV No.	503176	Ref. No.	127098
description	formed hose warewashing		
For models:	LOD302, LOD304, LOD305, LOD402, LOD502, LS520-CRP, LS521, LS521-CRP-SP, LS525		

			
1			
GEV No.	503177	Ref. No.	127111
description	formed hose warewashing		
For models:	LB425		

			
1			
GEV No.	518216	Ref. No.	127001
description	formed hose warewashing L-shape equiv. no. 127001 mounting pos. upper		
For models:	LB145, LB45		

			
1			
GEV No.	518225	Ref. No.	127041
description	formed hose warewashing L-shape equiv. no. 127041		
For models:	LF50, LF500, LF55, LF550, LF551, LF55E, LS500, LS500A, LS500G, LS500GA, LS500GPV, LS500PV, LS501, LS501A, LS501G, LS501GA, LS501GPV, LS501PV, LS505M, LS505T, LS511, LS511A, LS511PV, LS520		

			
1			
GEV No.	518224	Ref. No.	127042
description	formed hose warewashing L-shape equiv. no. 127042		
For models:	LB145, LB45, LB450		



1

GEV No.	513245	Ref. No.	926032 DZG441
description	formed hose warewashing L-shape equiv. no. 926032, DZG441		
For models:	L61, L62, L63, L64, LK1000, LK1010, LK1100, LK1300		



1

GEV No.	513134	Ref. No.	926034 DZG47
description	formed hose warewashing L-shape equiv. no. 926034, DZG47		
For models:	L600, L61, L62, LK1000, LK1010, S58		



1

GEV No.	513135	Ref. No.	926056 DZG461
description	formed hose warewashing L-shape equiv. no. 926056, DZG461		
For models:	L600, L63, L64, LK1100, LK1300, LO155, LO80, LO80H, LO93, LOD155, LOD304, LOD402, LOD502, LOD80, LOD80H, LOD93, LP155, LP80, LP80H, LP93, LT121, LT150, LT151, LT152, LT161, LT202, LT221, LT271, LT272, LT362, LT81, LT91, LTD101, LTD131, LTD171, LTD209, LTD212, LTD216, LTD220, LTD316, LTD320, LTD326, LTDX172, LTDX222, LTDX272, S58		



1

GEV No.	513246	Ref. No.	926157 DZG6162
description	formed hose warewashing L-shape equiv. no. 926157, DZG6162		
For models:	L61, L62, LK1000, LK1010		



1

GEV No.	513075	Ref. No.	929164 DZG60
description	formed hose warewashing L-shape equiv. no. DZG60, 929164		
For models:	LO155, LO80, LO80H, LO93, LOD155, LOD304, LOD305, LOD402, LOD502, LOD80, LOD80H, LOD93, LP155, LP80, LP80H, LP93, LT81, LTD101, LTD131, LTD171, LTD209, LTD212, LTD216, LTD220, LTD316, LTD320, LTD326, LTDX172, LTDX222, LTDX272		

with branch



1

GEV No.	511929	Ref. No.	143239
description	formed hose ext. ø 17 L 430mm plastic black Qty 1		
For models:	KLB40, LB35, LB350, LB355, LB35C, LB40, LB400, LB405, LB40E, LB411, LB411A		



1

GEV No.	513247	Ref. No.	DZG6364
description	formed hose warewashing equiv. no. 926158, DZG6364 mounting pos. upper with piggyback		
For models:	L63, L64, LK1100, LK1300		



form S



1

GEV No.	512450	Ref. No.	127116
description	formed hose ED ø 29mm hose int. ø 21mm warewashing		
For models:	LB425		



1

GEV No.	513244	Ref. No.	926033 DZG63
description	formed hose S-shape warewashing equiv. no. 926033, DZG63		
For models:	L61, L62, LK1000, LK1010		




1

GEV No.	512454	Ref. No.	127105
description	formed hose for drain pump warewashing		
For models:	LB422, LB425		



1

GEV No.	512449	Ref. No.	127092
description	formed hose warewashing		
For models:	LS522, LS525		




1

GEV No.	513237	Ref. No.	127121
description	formed hose for drain pump warewashing		
For models:	LB422, LB425		




1

GEV No.	512452	Ref. No.	127122
description	formed hose warewashing		
For models:	LB422, LB425		




1

GEV No.	513312	Ref. No.	127114
description	formed hose ID ø 10mm hose ext. ø 17mm ED ø 17mm hose int. ø 10mm L 115mm		
For models:	LB425		



1

GEV No.	512453	Ref. No.	127112
description	formed hose warewashing		
For models:	LB425		



1

GEV No.	513300	Ref. No.	127093
description	formed hose ID ø 30mm hose ext. ø 35mm ED ø 27mm hose int. ø 21mm L 460mm		
For models:	LS522, LS525		

form U



1

GEV No.	513233	Ref. No.	127087
description	formed hose D1 ø 30mm D2 ø 30mm for drain pump rubber warewashing		
For models:	LK600, LS522, LS525		



1

GEV No.	513297	Ref. No.	127109
description	formed hose ext. ø 30 D1 ø 25mm D2 ø 11mm L 860mm		
For models:	LB425		



1

GEV No.	698840	Ref. No.	44354
description	formed hose ext. ø 40.5 D1 ø 32.5mm D2 ø 42.5mm L 1210mm warewashing Qty 1		
For models:	LOD302		



1

GEV No.	698842	Ref. No.	127133
description	formed hose ext. ø 44 D1 ø 34mm D2 ø 34mm L 630mm warewashing Qty 1		
For models:	LS505M, LS505T		



1

GEV No.	513315	Ref. No.	43555
description	formed hose ext. ø 52 D1 ø 44mm L 1200mm		
For models:	LOD304, LOD305, LOD402, LOD502		



1

GEV No.	513314	Ref. No.	41554
description	formed hose ext. ø 52 D1 ø 46mm D2 ø 42mm L 1000mm		
For models:	LOD202		



1

GEV No.	518517	Ref. No.	127050
description	formed hose for drain pump D1 ø 28mm D2 ø 21mm warewashing U-shape		
For models:	LF50, LF500, LF55, LF550, LF551, LF55E, LS500, LS500GPV, LS500PV, LS501, LS501GPV, LS501PV, LS505M, LS505T, LS511, LS511PV, LS520		



1

GEV No.	513199	Ref. No.	69068
description	formed hose for drain pump warewashing		
For models:	LK620, LK621, LK625, LOD102, LOD202, LOD302, LOD304, LOD402, LS520-CRP, LS521, LS521-CRP-SP, LS525		



1

GEV No.	513232	Ref. No.	127115
description	formed hose for drain pump warewashing		
For models:	LB422, LB425		



1


GEV No.	513234	Ref. No.	127123
description	formed hose for drain pump warewashing		
For models:	LB425		



1

GEV No.	513260	Ref. No.	143242
description	formed hose warewashing		
For models:	KLB40, LB35, LB35C, LB40, LB40E, LB411		



			
1			
GEV No.	513278	Ref. No.	127136
description	formed hose warewashing		
For models:	LS505M, LS505T		

miscellaneous


			
1			
GEV No.	513303	Ref. No.	127135
description	formed hose end piece A ext. ø 28mm end piece A int. ø 20mm AD2 ø 28mm ø end piece B 20mm L 410mm		
For models:	LS505M, LS505T		

			
1			
GEV No.	513293	Ref. No.	143236
description	formed hose ext. ø 18 ID ø 11mm L 535mm dishwasher		
For models:	KLB40, LB35, LB350, LB40, LB400, LB405, LB40E, LB411, LB411A		


			
1			
GEV No.	513306	Ref. No.	127085
description	formed hose ext. ø 43 ID ø 34mm ED ø 23mm D1 ø 32mm L 140mm		
For models:	LK600, LK605, LS505M, LS505T, LS522, LS525		

			
1			
GEV No.	698841	Ref. No.	69020
description	formed hose ext. ø 44.5 ID ø 34.5mm ED ø 53mm D1 ø 43mm		
For models:	LK600, LK605		

			
1			
GEV No.	513307	Ref. No.	127082
description	formed hose ext. ø 47 ID ø 39mm ED ø 47mm D1 ø 39mm L 82mm		
For models:	LK600, LK605, LS505M, LS505T, LS522, LS525		

			
1			
GEV No.	513235	Ref. No.	127108
description	formed hose for boiler warewashing		
For models:	LB422		

			
1			
GEV No.	517800	Ref. No.	127097
description	formed hose ID ø 11/25mm ED ø 18/29mm warewashing		
For models:	LS520-CRP, LS521, LS521-CRP-SP, LS525		

			
1			
GEV No.	513169	Ref. No.	127091
description	formed hose warewashing		
For models:	LS522		

			
1			
GEV No.	513236	Ref. No.	127118
description	formed hose warewashing		
For models:	LB425		

			
1			
GEV No.	513252	Ref. No.	127129
description	formed hose warewashing		
For models:	LB422		




1

GEV No.	513263	Ref. No.	127124
description	formed hose warewashing		
For models:	LB422, LB425		



1

GEV No.	513279	Ref. No.	127126
description	formed hose warewashing		
For models:	LB422		



1

GEV No.	513280	Ref. No.	127113
description	formed hose warewashing		
For models:	LB425		




1

GEV No.	513716	Ref. No.	127053
description	pressure hose warewashing		
For models:	KLB40, LB140, LB40, LB400, LB40E, LB411, LB411A		

for dishwashers


pressure hoses



1


GEV No.	698807	Ref. No.	143263
description	rinse hose ext. ø 18 ID ø 11mm		
For models:	LS505M, LS505T		

ventilation hoses



1

GEV No.	698717	Ref. No.	H.775611-001
description	PVC hose ext. ø 14 L 1044mm PVC D1 ø 10mm		
For models:	LK621, LS522, LS525		



1


GEV No.	513265	Ref. No.	143189
description	ventilation hose ext. ø 17 ID ø 14mm L 75mm warewashing back-flow restrictor		
For models:	LBD40, LF50, LF500, LF55, LF550, LF551, LF55E, LS500, LS500A, LS500G, LS500GA, LS500GPV, LS500PV, LS501, LS501A, LS501G, LS501GA, LS501GPV, LS501PV, LS505M, LS505T, LS511, LS511A, LS511PV, LS520		

miscellaneous



1

GEV No.	511633	Ref. No.	999231
description	conversion kit		
For models:	LF59		




1

GEV No.	530770	Ref. No.	929171 SPG2230
description	hose ED ø 30mm ID ø 20mm L 1050mm rubber black Qty 1		
For models:	LK620, LK625, LKDX110, LO155, LO65, LO80, LO80H, LO93, LOD102, LOD155, LOD202, LOD302, LOD304, LOD305, LOD402, LOD502, LOD65, LOD80, LOD80H, LOD93, LP155, LP80, LP800-00-092, LP80H, LP92, LP93		




			
1			
GEV No.	698706	Ref. No.	127095
description	hose ED ø 31mm ID ø 25mm L 34mm plastic for rinsing		
For models:	LB425, LK620, LK621, LK625, LOD102, LOD202, LOD302, LOD304, LOD305, LOD402, LOD502, LS520-CRP, LS521, LS521-CRP-SP, LS525		

nickel-plated brass			
			
1			
GEV No.	520202	Ref. No.	927015 DZR263
description	hose connector nickel-plated brass straight thread 3/8" hose ø 12mm Qty 1 pcs		
For models:	L61, L62, L63, L64, LK1000, LK1010, LK1100, LK1300, LO155, LO93, LOD155, LOD93, LP155, LP93, LT121, LT150, LT151, LT152, LT161, LT202, LT221, LT271, LT272, LT362, LT81, LT91, LTD101, LTD131, LTD171, LTD209, LTD212, LTD216, LTD220, LTD316, LTD320, LTD326, LTDX172, LTDX222, LTDX272		


fittings, hose and pipe connectors


hose connectors


without screw connection

			
1			
GEV No.	541109	Ref. No.	035031
description	Y-piece plastic hose ø 8-6-8mm for pressure switch		
For models:	LB42BT-UK, LBD40, LBDX40, LF50, LF500, LF55E, LF56, LF59, LF60, LFD50, LS500, LS500A, LS500G, LS500GA, LS500GPV, LS500PV, LS501, LS501A, LS501G, LS501GA, LS501GPV, LS501PV, LS505, LS505M, LS505T, LS511, LS511A, LS511PV, LS520, LS520-CRP		

producer-specific


			
1			
GEV No.	695533	Ref. No.	10404
description	butt splice connector thread M23x1.5 for hose ID 18mm		
For models:	CB955A, CB955W		

			
1			
GEV No.	518347	Ref. No.	468149
description	T-piece plastic hose ø 10-10-10mm 3-way		
For models:	LF500		

			
1			
GEV No.	504388	Ref. No.	468205
description	hose connector grommet ø 10.5mm grommet length 15mm total length 26mm plastic for drain hose		
For models:	LB425, LK621, LS522, LS525		

hose connectors

brass

			
1			
GEV No.	513253	Ref. No.	108006 DZR2915
description	hose connector brass angled thread 1/4" hose ø 12mm Qty 1 pcs		
For models:	BETA50, BETA53, L600, L61, L62, L63, L64, LBD40, LF55, LF550, LF551, LF55E, LF59, LK1000, LK1010, LK1100, LK1300, LT121, LT151, LT152, LT161, LT202, LT221, LT271, LT272, LT362, LT91, LTD216, S58		




valves and tank inlets

ball valves

universal

mini ball valves



GEV No.	520296	Ref. No.	RTFOC00136
description	ball valve connection 1/2" IT - 1/2" IT DN10 total length 47mm chrome-plated brass		
For models:	FEM060, FEM061, FEM062, FEM100, FEM101, FEM102, FEM200, FEM201, FEM202, FGM060, FGM061, FGM062, FGM100, FGM101, FGM102, FGM200, FGM201, FGM202, FMM060, FMM061, FMM100, FMM101		
accessories for	520296		
	GEV No.	515040	Ref. No. —
	drain fitting size 1/2" usable heightmm overall height 16mm ED ø 28mm chrome-plated brass		

ball valves with lever handle



GEV No.	540758	Ref. No.	160596
description	ball valve connection 1" IT - 1" ET DN25 total length 90mm with lever handle handle length 95mm		
For models:	EC45, EC49, EC49T, EC902V, EC992V, EC992VT, EF45, EF49, EF49T, EF90, EF99, EF99T, GC45, GC477, GC49, GC49T, GC777, GC902V, GC992V, GC992VT, GF45, GF49T		



GEV No.	514325	Ref. No.	RTBF800073 RTBF800219 RTBF800220 RTBF800221
description	ball valve connection 1" IT - 1" IT DN25 total length 83mm with lever handle		
For models:	EC45, EC47, EC477, EC77, EC902V, EC992VT, EF45, EF47, EF472V, EF77, EF90, FG15, FG15+15, GC411-SC, GC45, GC47, GC477, GC49, GC77, GC777, GC777T, GC90, GC902V, GC911-SC, GF45, GF47, GF472V, GF49, GF49T, GF77, GF90, GF90-1, GF99, GF99T, LX7EC4, OMNIA EC 47, OMNIA EC 77, OMNIA EF 47, OMNIA EF 77, OMNIA EF472V, OMNIA GC 47, OMNIA GC 77, OMNIA GF 47, OMNIA GF 77, OMNIA GF472V		



GEV No.	514360	Ref. No.	3600259
description	ball valve connection 1/2" IT - 1/2" IT DN15 total length 49mm		
For models:	BC2G, BC3G, BC4G, BC6G		



GEV No.	520280	Ref. No.	RTBF800027 RTBF900040 RTBF900041
description	ball valve connection 1/2" IT - 1/2" IT DN15 total length 50mm with lever handle handle length 85mm		
For models:	BM4G70, EBM45, EBM90, GBM45, GBM90		

producer-specific

MBM ITALY





GEV No.	514074	Ref. No.	160214
description	ball valve connection 1/2" ET - 3/4" ET angled, with elbow connection		
For models:	EBM408, EBM498T, EBM49T, EBM908, EBM998T, EBM99T, EBMA498, EBMA998, GBM477, GBM49T, GBM99T, GBMA477		




GEV No.	540870	Ref. No.	RTCU600076
description	ball valve inlet 3/4" IT outlet 3/4" IT L 70mm without handle shaft ø 10x7mm		
For models:	EC66, GC66, MINIMA EC 66, MINIMA GC 66		




			
1			
GEV No.	514266	Ref. No.	168006 RTCP700003
description	ball valve inlet 3/8" ET outlet 3/8" ET DN10 L 68mm without handle shaft ø 10x8mm		
For models:	E100I, E100I8, E100I9, E100I98, E100I9N, E100IT9, E100IT9N, E150I, E150I8, E150I9, E150I98, E150I9N, E150IT9, E150IT9N, E50I7, E50I77, EBM408, EBM45, EBM498T, EBM49T, EBM90, EBM908, EBM998T, EBM99T, EBMA498, EBMA998, EC45, EC477, EC49, EC49T, EC777, EC777T, EC992V, EC992VT, G100, G1008, G1009, G10098, G100I, G100I8, G100I9, G100I98, G100I9N, G100IT9, G100IT9N, G100T9, G100T98, G150, G1508, G1509...(Other models you can see in the webshop)		
accessories for	514266		
			
GEV No.	112738	Ref. No.	169338+169366
description	knob water cold t.max.°C ø 70mm shaft ø 10x8mm shaft flat universal black		

<h3>ball valves electric</h3>			
			
1			
GEV No.	401386 ¹	Ref. No.	RTFOC00550
description	ball valve inlet 1/2" IT outlet 1/2" IT 230V L 60mm 50/60Hz off-current open mode of operation electric connection cable 450mm IT 1/2"		
For models:	FEM107, FEM107SC, FEM109, FEM207, FEM207SC, FEM209, FEM67, FEM67SC, FEM69, FGM107, FGM107SC, FGM109, FGM207, FGM207SC, FGM209, FGM67, FGM67SC, FGM69, JOKER FEM 67 SC, JOKER FEM 69, JOKER FEM 69 AB 2002, JOKER FEM107 SC, JOKER FEM109, JOKER FEM109 AB 2002, JOKER FEM207 SC, JOKER FEM209, JOKER FGM 67 SC, JOKER FGM 69, JOKER FGM107 SC, JOKER FGM109, JOKER FGM207 SC, JOKER FGM209		
spare parts for	401386		
			
GEV No.	401246	Ref. No.	RTFOC00559
description	gear motor for ball valve 230V L 75mm 50/60Hz W 60mm H 72mm TCR shaft ø 31mm		

¹off-current open

			
1			
GEV No.	401246	Ref. No.	RTFOC00559
description	gear motor for ball valve 230V L 75mm 50/60Hz W 60mm H 72mm TCR shaft ø 31mm		

<h3>shut-off valves</h3>			
<h4>producer-specific</h4>			
<h4>MBM ITALY</h4>			
			
1			
GEV No.	540868	Ref. No.	RTCP800018
description	shut-off valve connection 1/2" 1/2" total length 25mm mounting pos. rosette thread G2 27x19G shaft ø M4x0.7 ITmm		
For models:	E100, E100A, E100I, E100IA, E150, E150A, E150I, E150IA, EBR, EBRA, EBRAVI, EBRVI, EC45, EC47, EC77, EC902V, G100, G100A, G100I, G100IA, G150, G150A, G150I, G150IA, G175, GBR, GBRA, GBRAVI, GBRVI, GC45, GC47, GC77, GC90, GC902V, OMNIA EC 47, OMNIA EC 77, OMNIA GC 47, OMNIA GC 77		
spare parts for	540868		
			
GEV No.	514084	Ref. No.	—
description	nut thread 27x19G WS 34		

<h3>accessories</h3>			
			
1			
GEV No.	540866	Ref. No.	RTCU900491
description	rosette		
For models:	EC66, GC66, MINIMA EC 66, MINIMA GC 66		






<h3>inlet taps</h3>			
			
1			
GEV No.	542005	Ref. No.	RTCP800024
description	inlet spout connection 1/2" ET tube ø 18mm projection 105mm overall height 130mm spout height 70mm rotation 360°		
For models:	E100, E100A, E100I, E100I8, E100I9, E100I98, E100I9N, E100IA, E100IT9, E100IT9N, E150, E150A, E150I, E150I8, E150I9, E150I98, E150I9N, E150IA, E150IT9, E150IT9N, E50I7, E50I77, G100, G1008, G1009, G10098, G100A, G100I, G100I8, G100I9, G100I98, G100I9N, G100IA, G100IT9, G100IT9N, G100T9, G100T98, G150, G1508, G1509, G15098, G150A, G150I, G150I8, G150I9, G150I98, G150I9N, G150IA, G150IT9, G150IT98...(Other models you can see in the webshop)		
accessories for	542005		
			
GEV No.	511470	Ref. No.	—
description	nut thread 1/2" ø 40mm H 8mm WS 25 brass Qty 1 pcs		


Table continues overleaf

accessories for	542005		
	GEV No.	511474	Ref. No. —
	flat washer for thread 1/2"		
	GEV No.	511477	Ref. No. —
	flat gasket rubber ED ø 42mm ID ø 21mm thickness 2mm Qty 1 pcs		

	1		
GEV No.	542006	Ref. No.	RTBF800041
description	inlet spout connection 3/8" ET tube ø 16mm H1 90mm H2 40mm L 80mm pipe connection ø 10mm 1/2" ET		
For models:	EBR, EBRA, EBRAVI, EBRVI, EC45, EC49, EC49T, EC902V, EC992V, EC992VT, GBR, GBRA, GBRAVI, GBRVI, GC45, GC49, GC49T, GC90, GC902V, GC992V, GC992VT, MG7EC477-SC, MG7EC777-SC, MG7GC477-SC, MG7GC777-SC		


	1		
GEV No.	542007	Ref. No.	RTBF900039
description	inlet tap connection 1/2" ET		
For models:	EBM45, EBM90, EBR9T, EBRA9T, EBRAVI9T, EBRVC98T, EBRVI98T, EBRVI9T, GBM45, GBM90, GBR9T, GBRA9T, GBRAVI9T, GBRVC98T, GBRVI98T, GBRVI9T		

tank inlets

	1		
GEV No.	693483	Ref. No.	3600032
description	tank inlet connection 1/2" WS 27 L1 12mm L2 20mm		
For models:	BC2G, BC3G, BC4G, BC6G, EC11803		

water softeners

manual softener


	1		
GEV No.	530128	Ref. No.	922011
description	base suitable for type LT/BP		

water cycle components


pressure reduction valves


pressure reduction valves

universal

	1		
GEV No.	520868	Ref. No.	927150 UAA6
description	pressure reduction valve OR series PN40 connection 1/2" setting range 1-7bar p max 40bar t.max. 80°C brass		
For models:	LT121, LT150, LT151, LT152, LT161, LT202, LT221, LT271, LT272, LT362, LT81, LT91, LTD101, LTD131, LTD171, LTD209, LTD212, LTD216, LTD220, LTD316, LTD320, LTD326, LTDX172, LTDX222, LTDX272		

producer-specific

	1		
GEV No.	541183	Ref. No.	GRFOC00274
description	pressure controller Metal Work connection 1/4" setting range 0-1bar with manometer		
For models:	FEMD107, FEMD107SC, FEMD109, FEMD207SC, FEMD209, FEMD67, FEMD67SC, FEMD69, FGMD107, FGMD107SC, FGMD109, FGMD207, FGMD207SC, FGMD209, JOKER FEMD207 SC, JOKER FEMD209, JOKER FGMD207 SC, JOKER FGMD209		

1

GEV No.	541184	Ref. No.	RTFOC00624
description	pressure controller Metal Work series Bit MRA connection 1/4" default setting bar setting range 0-2bar p max 13bar t.max. 50°C plastic		
For models:	CME10-V380, CME4-V380, CME6-V380, CMFE102-V380, CMFE10-V380, CMFE6-V380, CMFG10-V380, CMFG6-V380, FEM107, FEM108, FEM108EL, FEM110, FEM110L, FEM207, FEM210, FEM210L, FEM220, FEM220L, FEM240, FEM240L, FEM610, FEM610L, FEM67, FEM68, FEM68EL, FEMD107, FEMD107SC, FEMD108, FEMD108EL, FEMD109, FEMD67, FEMD67SC, FEMD68, FEMD68EL, FEMD69, FGM107, FGM108, FGM108EL, FGM110, FGM110L, FGM207, FGM210, FGM210L, FGM610, FGM610L, FGM67, FGM68, FGM68EL, FGM6107SC, FGM6108...(Other models you can see in the webshop)		

supply filters



1

GEV No.	520261	Ref. No.	927078
description	supply filter thread 1/2" IT - 1/2" IT total length 58mm red brass mesh opening 0.4mm		
For models:	LT161, LT221, LT271, LT272, LT362		

ancillary products

clamps

hose clamps

DIN 3017 - W2



1

GEV No.	520117	Ref. No.	CFS1A
description	hose clamp stainless steel ø 40-60mm width 9mm Qty 5 pcs DIN 3017		
For models:	LK600, LK605, LK611, LK620, LK621, LK622, LK622I, LK625, LOD102		

DIN 3017 - W4



1


GEV No.	520120	Ref. No.	927322
description	hose clamp SS W4 ø 12-20mm width 9mm Qty 1 pcs DIN 3017		
For models:	LK600, LK605, LK620, LK621, LK625, LOD102, LOD202, LOD302, LOD304, LOD305, LOD402, LOD502		

double wire clamps



1

GEV No.	513268	Ref. No.	423011
description	hose clamp ø 8-10mm wire gauge ø 1mm Qty 1 pcs		
For models:	LB135, LB140, LF50, LF500, LF55, LF550, LF551, LF55E, LF56, LF59, LF60, LFD50, LFDX50, LS500, LS500A, LS500G, LS500GA, LS500GPV, LS500PV, LS501, LS501A, LS501G, LS501GA, LS501GPV, LS501PV, LS505, LS505M, LS505T, LS511, LS511A, LS511PV, LS520		




1

GEV No.	560503	Ref. No.	CFF10073
description	hose clamp ø 8-10mm wire gauge ø 1mm Qty 1 pcs		
For models:	LK621, LOD202, LOD302, LOD304, LOD305, LOD402, LOD502		

pipes

miscellaneous



1

GEV No.	693827	Ref. No.	PABF800292
description	water pipe		
For models:	EBR, EBRA, EBRAVI, EBRVI, GBR, GBRA, GBRAVI, GBRVI		

measuring equipment

thermometers

built-in thermometers

ø40mm



GEV No.	541037	Ref. No.	DET16L
description	thermometer mounting ø 40mm t.max. 120°C 0 up to +120°C probe ø 6.5mm probe L 25mm capillary pipe 2000mm		
For models:	L61, L62, L63, L64		

ø52mm



GEV No.	541413	Ref. No.	3700039
description	thermometer mounting ø 52mm t.max. 120°C 0 up to +120°C probe ø 6mm probe L 36mm capillary pipe 1500mm		
For models:	BC2G, BC3G, BC4G, BC6G		



GEV No.	542122	Ref. No.	161827
description	thermometer mounting ø 52mm t.max. 250°C 0-250°C probe ø 6mm probe L 21mm capillary pipe 500mm		
For models:	E100I, E100I9, E100IT9, E150I, E150I9, E150IT9, FG15M, FG20M, G100I, G100I9, G100IT9, G150I, G150I9, G150IT9, G50I77, GF15+15S, GF15S, GF25+25S, GF25S, OMNIA G50I7		

fastening material

screws

hexagonal screws



GEV No.	560080	Ref. No.	RTMIN00124
description	hexagonal screw thread M4 thread L 8mm SS WS 7 Qty 20 pcs DIN 933 / ISO 4017		
For models:	G2S77, G2SA11, G2SA77, G4SA11, G4SF, G4SF-1, G4SF77, G4SF9-1, G4SF9-2, G4SFE, G4SFE9, G6SF2, G6SF29, G6SFA9, G6SFEA9, GT2SD77, GT2SDFA9, GT4S77		

knurled screws



GEV No.	510112	Ref. No.	454002
description	Thumb screw thread M10 thread L 10mm ø 22mm H 4.5mm SS		
For models:	LB145, LB45, LB450, LF50, LF500, LF55, LF550, LF551, LF55E, LS500, LS500A, LS500G, LS500GA, LS500GPV, LS500PV, LS501, LS501A, LS501G, LS501GA, LS501GPV, LS501PV, LS505, LS511, LS511A, LS511PV, LS520		

miscellaneous



GEV No.	513194	Ref. No.	CVI1185
description	screw		
For models:	L61, L62, L63, L64, LK1000, LK1010, LK1100, LK1300, LT121, LT150, LT151, LT152, LT202, LT91		


nuts

knurled nuts




GEV No.	517444	Ref. No.	80697
description	knurled nut thread M10x1 ø 25mm H 4mm SS		
For models:	LB355, LB405, LB411, LB411A, LB422, LB425, LK605, LK622, LK622I, LK625, LS500, LS500A, LS500PV, LS501, LS501A, LS501PV, LS505M, LS505T, LS511, LS511A, LS511PV, LS520-CRP, LS521-CRP-SP, LS522, LS525		




			
1			
GEV No.	518028	Ref. No.	454004 CVG5E
description	knurled nut thread M5 ø 25mm H 4mm SS		
For models:	BETA50, BETA53, KLB40, L600, L61, L62, L63, L64, LB135, LB140, LB35, LB35C, LB40, LB40E, LF50, LF500, LF55, LF550, LF551, LF55E, LK1000, LK1010, LK1100, LK1300, LO155, LO80, LO80H, LO93, LP155, LP80, LP80H, LP93		


hexagonal nuts


DIN 982 (self-locking, tall version)


			
1			
GEV No.	560660	Ref. No.	CDI205AU
description	hexagonal nut thread M5 H 5.4mm zinc-coated steel WS 8 Qty 20 pcs DIN/ISO DIN 982 self-locking		


hexagonal nuts metric (without norm)

			
1			
GEV No.	521134	Ref. No.	417017
description	hexagonal nut thread M14x1 SS		
For models:	KLB40, LB135, LB140, LB145, LB35, LB350, LB35C, LB40, LB400, LB45, LB450, LF50, LF500, LF59, LK1000, LS500, LS500A, LS500G, LS500GA, LS500GPV, LS500PV, LS501, LS501A, LS501G, LS501GA, LS501GPV, LS501PV, LS505, LS505M, LS505T, LS520		


			
1			
GEV No.	513266	Ref. No.	417104
description	nut		
For models:	KLB40, LB135, LB140, LB35, LB350, LB355, LB35C, LB40, LB400, LB405, LB40E, LB411, LB411A		

			
1			
GEV No.	105567	Ref. No.	RTCU900005 RTCU900203
description	nut thread M16x1 H 4.5mm WS 19 zinc-coated steel Qty 1 pcs		
For models:	BM4G70, BST2LV, BST2RV, BST6LV, BST6RV, C2A, C4A, C4A70, C4AV70, C4F, C4F70, C4F702P, C4FV70, C4FV702P, C62F, C6A, C6A70, C6AV70, C6F, C6F70, C6F702P, C6FA, C6FV70, C6FV702P, C8A, C8F, EBM47, EBM77, FT2GL70, FT2GR70, FT4GL, FT4GL70, FT4GLR, FT4GLR70, FT4GR, FT4GR70, G2S, G2SAP, G2SDM7, G2SDMF7, G2SDMFE7, G2SP, G2SSM7, G2SSMF7, G2SSMFE7, G4S, G4SF, G4SF-1, G4SF11, G4SF7... (Other models you can see in the webshop)		

			
1			
GEV No.	102680	Ref. No.	RTCU600052
description	nut thread M6x0.75 H 2.6mm WS 8 brass Qty 1 pcs type SEF 2		
For models:	G2S6, G4S6, G4SF6, G4SFE6, G6S6, G6SF6, G6SFA6, G6SFE6, G6SFEA6		

			
1			
GEV No.	102067	Ref. No.	53.3.0098.00 9404701700
description	nut thread M8x1 H 3mm brass Qty 1 pcs type SEF 1		
For models:	6PC61G, 6PC62G, G4SF6, G6SF6, G6SFA6, MINIMA G4SF6, MINIMA G4SFE6, MINIMA G6SF6, MINIMA G6SFA6, MINIMA G6SFE6, MINIMA G6SFEA6		

hexagonal nuts inch thread

			
1			
GEV No.	513025	Ref. No.	929047 CDO113
description	nut thread 1/2" nickel-plated brass H 7.5mm WS 27 Qty 1 pcs		
For models:	LT121, LT150, LT151, LT152, LT161, LT202, LT221, LT271, LT272, LT362, LT91		

union nuts

			
1			
GEV No.	520475	Ref. No.	RTFOC00020
description	union nut thread M10x1 H 11mm steel WS 17 Qty 1 pcs		
For models:	FCE10, FCE20, FCE6, FCG10, FCG20, FCG6, FEC023, FEC060, FEC065, FEC100, FEC200, FEM060, FEM061, FEM062, FEM100, FEM101, FEM102, FEM107, FEM107SC, FEM109, FEM110, FEM110L, FEM200, FEM201, FEM202, FEM207, FEM207SC, FEM209, FEM210, FEM210L, FEM610, FEM610L, FEM67, FEM67SC, FEM69, FEMD023, FEMD060, FEMD061, FEMD065, FEMD066, FEMD100, FEMD101, FEMD107, FEMD107SC, FEMD109, FEMD200, FEMD201, FEMD207, FEMD207SC, FEMD209...(Other models you can see in the webshop)		

miscellaneous



GEV No.	513197	Ref. No.	CDI206AU
description	nut		
For models:	L61, L62, L63, L64, LK1000, LK1010, LK1100, LK1300, LT121, LT151, LT152, LT202, LT91		

washers

washers

miscellaneous



GEV No.	513223	Ref. No.	CWD52
description	disc		
For models:	L61, L62, L63, L64		

fasteners

clamps

hose clamps

DIN 3017 - W2



GEV No.	520117	Ref. No.	CFS1A
description	hose clamp stainless steel ϕ 40-60mm width 9mm Qty 5 pcs DIN 3017		
For models:	LK600, LK605, LK611, LK620, LK621, LK622, LK622I, LK625, LOD102		

DIN 3017 - W4



GEV No.	520120	Ref. No.	927322
description	hose clamp SS W4 ϕ 12-20mm width 9mm Qty 1 pcs DIN 3017		
For models:	LK600, LK605, LK620, LK621, LK625, LOD102, LOD202, LOD302, LOD304, LOD305, LOD402, LOD502		

double wire clamps



GEV No.	513268	Ref. No.	423011
description	hose clamp ϕ 8-10mm wire gauge ϕ 1mm Qty 1 pcs		
For models:	LB135, LB140, LF50, LF500, LF55, LF550, LF551, LF55E, LF56, LF59, LF60, LFD50, LFDX50, LS500, LS500A, LS500G, LS500GA, LS500GPV, LS500PV, LS501, LS501A, LS501G, LS501GA, LS501GPV, LS501PV, LS505, LS505M, LS505T, LS511, LS511A, LS511PV, LS520		



GEV No.	560503	Ref. No.	CFF10073
description	hose clamp ϕ 8-10mm wire gauge ϕ 1mm Qty 1 pcs		
For models:	LK621, LOD202, LOD302, LOD304, LOD305, LOD402, LOD502		

retaining rings

DIN 471



GEV No.	510244	Ref. No.	RTMIN00283
description	retaining ring shaft ϕ 60mm thickness 2mm steel DIN 471		
For models:	EF408, EF45, EF46, EF477, EF4772V, EF4772VT, EF477T, EF49, EF498, EF4982V, EF498L, EF498T, EF49T, EF66, EF777, EF777T, EF90, EF908, EF99, EF998, EF998L, EF998T, EF99T, MG7EF477, MG7EF4772V, MG7EF4772VT, MG7EF477T, MG7EF777, MG7EF777T, MINIMA EF 46, MINIMA EF 66		




GEV No.	110087	Ref. No.	499066
description	retaining ring shaft ϕ 8mm DIN 471		
For models:	LK1000		


DIN 6799



GEV No.	518557	Ref. No.	CWA5D5I
description	retaining ring E D1 ϕ 5mm D2 ϕ 11mm SS DIN 6799 thickness 0.7mm		
For models:	L600, 558		




			
GEV No.	507015	Ref. No.	CWA5D7
description	retaining ring E D1 ø 7mm D2 ø 14mm SS DIN 6799 thickness 0.9mm for shaft ø 8-11mm		
For models:	L600, S58		

DIN 7993			
			
GEV No.	518308	Ref. No.	303019 REB303019
description	retaining ring DIN 7993 for drain assembly thickness 3mm ED ø 57mm		
For models:	BETA50, BETA53, L63, L64, LB145, LB45, LB450, LF50, LF500, LF55, LF550, LF551, LF55E, LK1100, LK1300, LS500, LS500GPV, LS500PV, LS501, LS501GPV, LS501PV, LS505M, LS505T, LS511, LS511PV, LS520		


consumables


lava rocks / ceramic briquettes


			
GEV No.	211001	Ref. No.	A800001170 A800100
description	lava rocks Qty package content 9kg		
For models:	GPL46P, GPL47, GPL47P, GPL77, GPL77P, GPL86P, MINIMA GPL 86, MINIMA GPL 86P, OMNIA GPL 47, OMNIA GPL 47P, OMNIA GPL 77, OMNIA GPL 77P		


fuses


fine fuses


			
GEV No.	358661	Ref. No.	RTFOC00047
description	fine fuse size ø5x20mm 0.1A fast-acting rated 250V Qty 10 pcs		
For models:	FEC060, FEC065, FEC100, FEC200, FEM060, FEM061, FEM100, FEM101, FEM200, FEM201, FEMD060, FEMD061, FEMD065, FEMD066, FEMD100, FEMD101, FEMD200, FEMD201, FEP050, FEP080, FEP160, FGC060, FGC065, FGC100, FGC200, FGM060, FGM061, FGM100, FGM101, FGM200, FGM201, FGMD060, FGMD061, FGMD065, FGMD066, FGMD100, FGMD101, FGMD200, FGMD201, FGP050, FGP080, FGP160, FMM060, FMM061, FMM100, FMM101, JOKER FEP050, JOKER FEP050 AB 2002, JOKER FEP080, JOKER FEP080 AB 2002...(Other models you can see in the webshop)		

			
GEV No.	358530	Ref. No.	926284
description	fine fuse size ø5x20mm 0.8A fast-acting rated 250V Qty 10 pcs		
For models:	LFD60, LK100, LK100EM, LK110, LK611, LKD130, LKDX110, LO155, LO65, LO80, LO80H, LO93, LOD155, LOD65, LOD80, LOD80H, LOD93, LP80, LP800-00-092, LP92, LT81, LTD101, LTD131, LTD171		

			
GEV No.	358677	Ref. No.	228004 228010
description	fine fuse size ø5x20mm 4A fast-acting rated 250V Qty 10 pcs		
For models:	LB350, LB355, LB400, LB405, LB40E, LB411, LB411A, LB422, LB42BT-UK, LB450, LBD40, LBDX40, LF55E, LF56, LF60, LFD50, LFD60, LFDX50, LK100, LK100EM, LK110, LK600, LK605, LK611, LK620, LK621, LK622, LK622L, LK625, LKD130, LKDX110, LO155, LO65, LO80, LO80H, LO93, LOD102, LOD155, LOD202, LOD302, LOD304, LOD305, LOD402, LOD502, LOD65, LOD80, LOD80H, LOD93, LP80, LP800-00-092...(Other models you can see in the webshop)		

			
GEV No.	358533	Ref. No.	RTFOC00284
description	fine fuse size ø5x20mm 6.3A fast-acting rated 250V Qty 10 pcs		
For models:	CME10-V380, CME4-V380, CME6-V380, CMFE102-V380, CMFE10-V380, CMFE6-V380, CMFG10-V380, CMFG6-V380, CMG10-V380, CMG6-V380, CYE10-V380, CYE6-V380, CYG10-V380, CYG6-V380, FCE10, FCE20, FCE6, FCG10, FCG20, FCG6, FEC065, FEC200, FEM062, FEM102, FEM107, FEM107SC, FEM109, FEM200, FEM201, FEM207, FEM207SC, FEM209, FEM67, FEM67SC, FEM69, FEMD060, FEMD061, FEMD065, FEMD066, FEMD100, FEMD101, FEMD107, FEMD107SC, FEMD109, FEMD200, FEMD201, FEMD207, FEMD207SC, FEMD209, FEMD67...(Other models you can see in the webshop)		

			
GEV No.	358693	Ref. No.	80874
description	fine fuse size ø5x20mm 2A medium lag rated 250V Qty 10 pcs		
For models:	LOD305, LOD502		

			
GEV No.	358594	Ref. No.	228012
description	fine fuse size ø5x20mm 0.16A slow-acting rated 250V Qty 10 pcs		
For models:	LK620, LK621, LK625, LOD102, LOD202, LOD302, LOD304, LOD402, LOD502, LS520-CRP, LS521, LS521-CRP-SP, LS525, LTD209, LTD212, LTD216, LTD220		



1

GEV No.	358603	Ref. No.	228011
description	fine fuse size ø5x20mm 2A slow-acting rated 250V Qty 10 pcs		
For models:	LK620, LK621, LK625, LOD102, LOD202, LOD302, LOD304, LOD402, LS520-CRP, LS521, LS521-CRP-SP, LS525, LTD209, LTD212, LTD216, LTD220		



1

GEV No.	358606	Ref. No.	228014
description	fine fuse size ø5x20mm 4A slow-acting rated 250V Qty 10 pcs		
For models:	LB355, LB405		

ø6.3x32mm 250V



1

GEV No.	358760	Ref. No.	926283
description	fine fuse size ø6.3x32mm 0.315A medium lag rated 250V Qty 10 pcs		
For models:	LFD60, LK100, LK100EM, LK110, LK611, LKD130, LKDX110, LO155, LO65, LO80, LO80H, LO93, LOD155, LOD65, LOD80, LOD80H, LOD93, LP80, LP800-00-092, LP92, LT81, LTD101, LTD131, LTD171		

fine fuse holders

1			
GEV No.	550519	Ref. No.	H.228048
description	cover plate suitable fuseA ratedV connection for fuse holder		
For models:	GOLD74, LB40E, LB411, LB42BT-UK, LBD40, LBDX40, LF55E, LF56, LF60, LFD50, LFD60, LFDX50, LK100, LK100EM, LK110, LK130, LK600, LK605, LK611, LK622, LK622I, LKD130, LKDX110, LO155, LO65, LO80, LO80H, LO93, LOD155, LOD305, LOD502, LOD65, LOD80, LOD80H, LOD93, LP80, LP800-00-092, LP92, LTD209, LTD212, LTD216, LTD220		

A

alarm devices	57
axial fans	86

B

ball valves	274
ball valves electric	80, 275
bar burners	152
bi-metal thermostats	24, 25
booster pumps I	109
booster pumps II	112

C

cables	117
cam switches	42
ceramic heaters	12
clamps	277, 280
coil heating elements	12
cold air circulating fans (complete)	88
compressors	85
condensators & interference suppression filters	114
consumables	281
contact heaters	12
contactors	57
container filters	259
control equipment	47
control thermostats	25, 32
cross flow fans	89

D

defrost timers	57
door gaskets (wire reinforced)	239
door seals	237
door seals for dishwashers	247
door seals with fixing hook	239
dosing pumps	255
double wire clamps	277, 280
drain hoses	261
drain pumps	110

E

edgemount hinges	220
edgemount latches	217
electric accessories	117
electric timers	56
electrodes	83
electromagnetic closer	216
electronic controllers	63
energy regulators	24
espagnolette locks	217
evaporators	251
expansion valves	249

F

fans	86
fasteners	280
fastening material	278
filter driers	250
filters	115
fine fuses	281
flow meters	85
foil heating elements	20
formed hoses	265
fuses	116, 281

G

gas burners	147
gas control valves	129
gas lines	170
gas nozzles	160
gas taps	119
gas thermostats	123
gaskets for control panels	240
gaskets for heated units	237
gaskets for wash arm support	249
gastronorm	255
grates	232

H

halogen lamp	51
handle latches	217
heating cables	11
heating elements	3
heating elements for bain maries	4
heating elements for chargrills	11
heating elements for condensate evaporation	10
heating elements for convection	18
heating elements for defrosting	9
heating elements for fryers	5
heating elements for frying pans	5
heating elements for griddles	9
heating elements for heated cabinets	11
heating elements for heating bridges	11
heating elements for ovens	3
heating elements for pasta cookers	10
heating elements for refrigeration	9
heating elements for salamanders/toasters	11
heating elements for tilting bratt pan	10
hexagonal nuts	279
hexagonal screws	278
hob burners	147
hose clamps	277, 280
hose connectors	273, 273
hoses	260
hot air fans	91

hot air motors	89	pressure switches	80
hot plates	22	probe clips	36
I		probes	66
ignition boxes	132	programme timers	54
ignition cables	141	pump hoses	260
ignition units	143	pumps	93
immersion heating elements	12	pumps for ice machines	112
indicator lights	48	push/momentary push switches	38
indicator lights (complete)	48	PVC hoses	263
industrial hoses	263	PVC supply hoses	261
inlet spouts	275	R	
inlet taps	275	radiation heaters	19
K		refrigeration cycle components	249
knurled nuts	278	refrigeration fans	87
knurled screws	278	refrigeration gaskets	233
L		refrigeration motors universal	87
lamps	48	refrigeration thermostats	35
lava rocks / ceramic briquetts	170, 281	relays	61
LED	50	retaining rings	280
light bulbs	50	ribbon cables	117
M		rocker/momentary rocker switches	37
magnetic switches	45	rotary switches	45
manual softener	276	S	
measuring equipment	278	safety bi-metal thermostats	24
mechanical timers	57	safety thermostats	29, 34
microswitches	39	Schrader valves	250
motors	92	screw-in gaskets	235
N		screws	278
Niplaflex hoses	263	sealing cords	247
nuts	278	sealing washers	244
O		shaft gaskets	247
operating capacitors	114	shelves and shelf rails	232
O-rings	240	shut-off valves	275
oven hinges	221	silicone hoses	260, 264
oven lamps	51	solenoid valves	73
P		solid state relays	60
piezoelectric igniters	142	solid top burners	158
pillar taps	276	spring assisted hinges	220
pilot burners	133	spring clips	36
plug connectors	118	stainless steel flexi hoses	260
plug-in gaskets	234	starting capacitors	114
plunger sockets	36	supply filters	277, 277
position switches	40	supply hoses	260
pressure control hoses	263	switches and momentary switches	37
pressure hoses	272	system switches (ROLD)	40
pressure reduction valves	276, 276	T	
		tank inlets	260, 276
		temperature probes	66
		terminals	118
		thermocouples	144

thermostats	24
time relays	62
timers	54
transformers	63
tube burners	157

U

union nuts	279
universal hoses	260
universal probes	66

V

valves and tank inlets	274
ventilation hoses	272

W

walk-in fridge catches	217
wash and rinse pumps	93
washers	280
water cycle components	276
water softeners	276
window seals	237