



GAS COMPONENTS



ELECTRIC COMPONENTS



WATER TECHNOLOGY



MECHANICAL COMPONENTS



TOOLS

Spare parts suitable for

MITO

Find the complete and up-to-date range of products in our GEV Webshop



Manufacturer catalogue

The most important spare parts and accessories arranged clearly for every manufacturer

- ✓ Complete product range and all appliance data always up to date in the GEV Webshop
- ✓ Alphabetical Index at the end of the catalogue

GEV Webshop

www.gev-online.co.uk

www.gev-online.com



- 🔍 Add to Favourites
- 🔍 Sign In with email address and usual password
- 🔍 Easy-order – place several items in your basket at the same time
- 🔍 Quick Item search – no login needed



heating elements

heating elements for ovens



1

| | | | |
|--------------------|---|-----------------|-------|
| GEV No. | 418759 | Ref. No. | 10645 |
| description | heating element 1800W 230V heating circuits 1 L 360mm W 390mm L1 95mm L2 265mm W1 165mm W2 60mm flange length 100mm flange width 23mm hole distance 86mm bridge length 485mm hole ø 3.3mm tube ø 6.3mm connection male faston 6.3mm connection length 10mm windings 4 rectangular flange dry heating element mounting thread M4 | | |

heating elements for heated cabinets



1



| | | | |
|--------------------|---|-----------------|-------|
| GEV No. | 419065 | Ref. No. | 10602 |
| description | heating element 1400W 230V heating circuits 1 L 375mm W 140mm connection length 30mm connection male faston 6.3mm tube ø 6.3mm 2 hole fixing thread M10x1 dry heating element L1 45mm L2 75mm L3 255mm W1 45mm W2 50mm mounting distance 44mm | | |

immersion heating elements

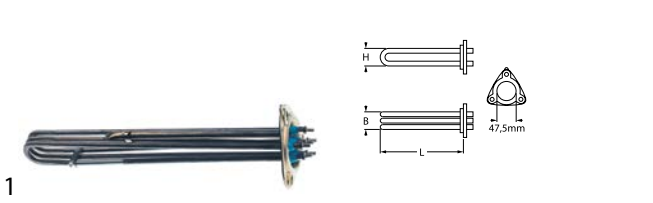
3 hole flange ø47.5mm



1

| | | | |
|---|--|-----------------|-------------------|
| GEV No. | 418136 | Ref. No. | 3434 |
| description | heating element 4360W 240V mounting ø 47.5mm heating circuits 3 L 310mm W 31mm H 35mm number of thermostat sleeves 1 thermostat sleeves ø 7mm length thermostat sleeves 200mm thermostat sleeve clinging tube ø 6.3mm hole distance 62mm hole ø 8mm connection M4 3 hole flange immersion heater | | |
| spare parts for | 418136 | | |
|  | GEV No. | 510408 | Ref. No. — |
| | O-ring EPDM thickness 5.34mm ID ø 47mm Qty 1 pcs | | |
| accessories for | 418136 | | |
|  | GEV No. | 510408 | Ref. No. — |
| | O-ring EPDM thickness 5.34mm ID ø 47mm Qty 1 pcs | | |
|  | GEV No. | 510562 | Ref. No. — |
| | O-ring silicone thickness 5.34mm ID ø 47mm Qty 1 pcs | | |

with expansion flange 70 x 18mm



1

| | | | |
|--------------------|--|-----------------|-------|
| GEV No. | 418137 | Ref. No. | 10622 |
| description | heating element 3000W 230V heating circuits 1 flange 70x18mm L 220mm W 65mm Hmm connection male faston 6.3mm tube ø 8.5mm immersion heater expansion flange connection length 34mm | | |



1

| | | | |
|--------------------|--|-----------------|-------|
| GEV No. | 418138 | Ref. No. | 10620 |
| description | heating element 6000W 230V heating circuits 1 flange 70x18mm L 445mm W 68mm connection male faston 6.3mm tube ø 8.5mm immersion heater expansion flange connection length 34mm | | |

heating elements for convection



1

| | | | |
|--------------------|--|-----------------|-------------------|
| GEV No. | 418129 | Ref. No. | 10638 40400038 |
| description | heating element 16000W 230V heating circuits 3 ID ø 337mm ED ø 358mm L 450mm H 100mm L1 84mm W1 108mm H1 15mm H2 85mm flange length 142mm flange width 25mm hole distance 64mm connection M4 tube ø 8.5mm convection heating element hole ø 6mm rectangular flange | | |



1

| | | | |
|--------------------|---|-----------------|-------|
| GEV No. | 418127 | Ref. No. | 10641 |
| description | heating element 16000W 230V heating circuits 3 ID ø 390mm ED ø 410mm L 430mm H 99mm L1 15mm W1 100mm H1 15mm H2 84mm flange length 142mm flange width 25mm hole distance 63mm connection M4 tube ø 8.5mm convection heating element hole ø 6mm rectangular flange | | |



1

| | | | |
|--------------------|--|-----------------|----|
| GEV No. | 418133 | Ref. No. | 22 |
| description | heating element 2000W 220V heating circuits 1 ID \varnothing 187mm ED \varnothing 200mm L 215mm H 25mm L1 15mm W1 60mm H1 5mm H2 20mm flange length 100mm flange width 22mm hole distance 86mm connection male faston 6.3mm connection length 37mm tube \varnothing 6.5mm convection heating element hole \varnothing 5mm rectangular flange | | |



1

| | | | |
|--------------------|--|-----------------|-----|
| GEV No. | 416412 | Ref. No. | 159 |
| description | heating element 2500W 230V heating circuits 1 ID \varnothing 188mm ED \varnothing 200mm L 215mm H 30mm L1 3mm W1 53mm H1 5mm H2 25mm flange length 100mm flange width 22mm hole distance 86mm connection male faston 6.3mm | | |



1

| | | | |
|--------------------|--|-----------------|-----|
| GEV No. | 418134 | Ref. No. | 508 |
| description | heating element 3300W 240V heating circuits 1 ID \varnothing 185mm ED \varnothing 200mm L 215mm H 30mm W1 60mm H1 5mm H2 25mm flange length 100mm flange width 22mm hole distance 85mm connection male faston 6.3mm connection length 22mm tube \varnothing 6.5mm convection heating element hole \varnothing 5mm rectangular flange | | |



1

| | | | |
|--------------------|--|-----------------|-------|
| GEV No. | 418130 | Ref. No. | 10601 |
| description | heating element 3900W 230V heating circuits 3 ID \varnothing 175mm ED \varnothing 245mm L 285mm H 32mm L1 60mm W1 62mm H1 10mm H2 26mm flange length 93mm flange width 22mm hole distance 77mm connection male faston 6.3mm connection length 61mm tube \varnothing 6.5mm convection heating element hole \varnothing 5mm rectangular flange | | |



1

| | | | |
|--------------------|--|-----------------|------|
| GEV No. | 418131 | Ref. No. | 1023 |
| description | heating element 6000W 230V heating circuits 3 ID \varnothing 217mm ED \varnothing 231mm L 271mm H 90mm L1 41mm W1 103mm H1 24mm H2 66mm flange length 140mm flange width 22mm hole distance 63mm tube \varnothing 6.3mm convection heating element hole \varnothing 5mm rectangular flange | | |



1

| | | | |
|--------------------|--|-----------------|---------------|
| GEV No. | 418132 | Ref. No. | 3016 3016A |
| description | heating element 7350W 230V heating circuits 3 ID \varnothing 250mm ED \varnothing 265mm L 277mm H 75mm L1 17mm W1 102mm H1 12mm H2 67mm flange length 143mm flange width 25mm hole distance 7mm connection M4 tube \varnothing 6.5mm convection heating element hole \varnothing 63mm rectangular flange | | |



1



| | | | |
|--------------------|--|-----------------|-------|
| GEV No. | 418753 | Ref. No. | 10628 |
| description | heating element 8000W 230V heating circuits 3 ID \varnothing 287mm ED \varnothing 300mm L 345mm H 90mm L1 39mm H1 20mm H2 67mm flange length 142mm flange width 25mm hole distance 12.7mm connection M4 connection length 67mm tube \varnothing 6.5mm convection heating element hole \varnothing 7mm rectangular flange | | |



1

| | | | |
|--------------------|--|-----------------|-------|
| GEV No. | 418128 | Ref. No. | 10633 |
| description | heating element 9000W 230V heating circuits 3 ID \varnothing 500mm ED \varnothing 515mm L 535mm H 95mm L1 13mm W1 105mm H1 15mm H2 80mm flange length 142mm flange width 25mm hole distance 64mm connection M4 tube \varnothing 8.5mm convection heating element hole \varnothing 6mm rectangular flange | | |



| | | | |
|---|---|-----------------|-------------------|
|  | | | |
| 1 | | | |
| GEV No. | 418135 | Ref. No. | 1126 |
| description | heating element 920W 230V heating circuits 1 ID ø 200mm ED ø 215mm L 255mm H 40mm thread 1/4" connection male faston 6.3mm 2 hole fixing mounting distance 24mm tube ø 8.5mm convection heating element | | |
| accessories for | 418135 | | |
|  | GEV No. | 361182 | Ref. No. — |
| | nut thread 1/4" H 5mm nickel-plated brass WS 17 Qty 1 pcs | | |
|  | GEV No. | 510417 | Ref. No. — |
| | flat gasket fibre ED ø 20mm ID ø 14mm thickness 2mm Qty 1 pcs | | |
|  | GEV No. | 520228 | Ref. No. — |
| | tooth lock washer ID ø 15.3mm ED ø 24mm steel Qty 1 pcs for thread M14 | | |
|  | GEV No. | 550262 | Ref. No. — |
| | flat gasket copper ED ø 20mm ID ø 14mm thickness 2mm | | |

| | | | |
|--|---|-----------------|------|
|  | | | |
| 1 | | | |
| GEV No. | 418139 | Ref. No. | 1466 |
| description | heating element 3500W 240V heating circuits 1 L 620mm W 120mm L1 33mm L2 587mm W2 90mm flange length 70mm flange width 22mm hole distance 56mm connection length 100mm connection M4 tube ø 8.5mm hole ø 6mm W1 30mm rectangular flange convection heating element windings 2 | | |

energy regulators

EGO

1-circuit

| | | | |
|---|---|-----------------|-----|
|  | | | |
| 1 | | | |
| GEV No. | 380015 | Ref. No. | 280 |
| description | energy regulator 230V 13A single-circuit turn direction right shaft ø 6x4.6mm shaft L 23mm mounting thread M4 power release 6-100% no. 50.57021.010 | | |

thermostats

control and safety thermostats

EGO

control thermostats

55.10/19_ series

| | | | |
|--|--|-----------------|-------|
|  | | | |
| 1 | | | |
| GEV No. | 375647 | Ref. No. | 10005 |
| description | thermostat t.max. 110°C temperature range 31-110°C 1-pole 1NO 16A probe ø 6mm probe L 133mm capillary pipe 870mm capillary pipe isolated gland nut shaft ø 6x4.6mm shaft L 23mm shaft position upper rotation 318° | | |

| | | | |
|---|--|-----------------|--------------------|
|  | | | |
| 1 | | | |
| GEV No. | 390068 | Ref. No. | 283 3529 596 |
| description | thermostat t.max. 269°C temperature range 55-269°C 1-pole 1CO 16A probe ø 3.1mm probe L 219mm capillary pipe 1280mm capillary pipe isolated 1270mm gland nut shaft ø 6x4.6mm shaft L 23mm shaft position upper rotation 318° | | |

| | | | |
|--|--|-----------------|----|
|  | | | |
| 1 | | | |
| GEV No. | 375002 | Ref. No. | 26 |
| description | thermostat t.max. 320°C temperature range 55-320°C 1-pole 1NO 16A probe ø 3.1mm probe L 226mm capillary pipe 870mm capillary pipe isolated 850mm gland nut shaft L 23mm shaft position upper rotation 270° | | |



safety thermostats

55.10/19_ series

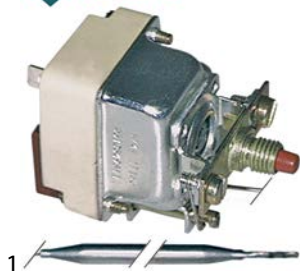

| | | | |
|---|---|-----------------|-------------------|
| GEV No. | 375250 | Ref. No. | 3528 599 |
| description | safety thermostat capillary pipe 870mm probe ø 6mm 1-pole probe L 129mm 16A capillary pipe isolatedmm gland nut switch-off temp. 130°C probe SS | | |
| spare parts for | 375250 | | |
|  | GEV No. | 551083 | Ref. No. — |
| cap for safety thermostat thread M8x1 | | | |



| | | | |
|--------------------|--|-----------------|-----|
| GEV No. | 376008 | Ref. No. | 166 |
| description | safety thermostat switch-off temp. 352°C 1-pole 16A probe ø 3mm probe L 200mm capillary pipe 885mm capillary pipe isolated 780mm gland nut probe | | |

55.32_ series



| | | | |
|--------------------|--|-----------------|--------------|
| GEV No. | 375649 | Ref. No. | 3019 3023 |
| description | safety thermostat switch-off temp. 160°C 3-pole 20A probe ø 6mm probe L 87mm capillary pipe 890mm capillary pipe isolated 880mm gland nut probe SS | | |

CAEM

control thermostats

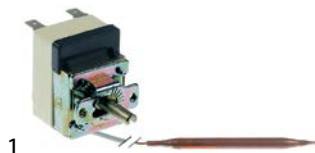

| | | | |
|--------------------|---|-----------------|-------|
| GEV No. | 375645 | Ref. No. | 10008 |
| description | thermostat t.max. 120°C temperature range 30-120°C 1-pole 1CO 16A probe ø 6mm probe L 110mm capillary pipe 1600mm capillary pipe isolated 1550mm gland nut shaft ø 6x4.6mm shaft L 22mm shaft position upper rotation 270° probe material copper 250V | | |

switches and momentary switches

push/momentary push switches

28.5x77.5mm



| | | | |
|--------------------|--|-----------------|-------|
| GEV No. | 346365 | Ref. No. | 10044 |
| description | switch combination momentary/latching mounting measurements 28.5x77.5mm black 2CO/2CO 250V 16A with indicator connection male faston 6.3mm ambient temperature max. 85°C protection IP40 | | |



| | | | |
|--------------------|---|-----------------|-------|
| GEV No. | 346363 | Ref. No. | 10043 |
| description | switch combination with indicator mounting measurements 28.5x77.5mm black 2CO/2CO 250V 16A connection male faston 6.3mm ambient temperature max. 85°C protection IP40 | | |

microswitches

non-standard





| | | | |
|--------------------|------------------------|-----------------|-------|
| GEV No. | 348019 | Ref. No. | 70201 |
| description | microswitch with cable | | |





system switches (ROLD)

| | | | |
|---|------------------|-----------------|------|
|  | | | |
| 1 | | | |
| GEV No. | 345721 | Ref. No. | 3471 |
| description | blank cap holder | | |

| | | | |
|---|---|-----------------|-------|
|  | | | |
| 1 | | | |
| GEV No. | 345537 | Ref. No. | 10313 |
| description | element holder mounting measurements 20.6x16.4mm grey arched for push buttons 13x17mm | | |

| | | | |
|---|---|-----------------|------|
|  | | | |
| 1 | | | |
| GEV No. | 346201 | Ref. No. | 3468 |
| description | element holder mounting measurements 28.5x77.5mm grey three-fold element holder | | |

| | | | |
|---|---|-----------------|------|
|  | | | |
| 1 | | | |
| GEV No. | 345606 | Ref. No. | 3474 |
| description | momentary switch unit 2CO 250V 16A connection male faston 6.3mm | | |

| | | | |
|---|-------------------------|-----------------|------|
|  | | | |
| 1 | | | |
| GEV No. | 345133 | Ref. No. | 3470 |
| description | push button ø 23mm grey | | |

| | | | |
|---|-----------------------------------|-----------------|------|
|  | | | |
| 1 | | | |
| GEV No. | 346211 | Ref. No. | 3469 |
| description | push button ø 23mm grey with lens | | |

| | | | |
|---|-------------------------------|-----------------|-------|
|  | | | |
| 1 | | | |
| GEV No. | 345539 | Ref. No. | 10312 |
| description | push button size 17x13mm grey | | |

| | | | |
|---|-------------------------------------|-----------------|------|
|  | | | |
| 1 | | | |
| GEV No. | 346364 | Ref. No. | 3472 |
| description | rotary disc red/white disc ø 20.6mm | | |

| | | | |
|--|--|-----------------|------|
|  | | | |
| 1 | | | |
| GEV No. | 345605 | Ref. No. | 3473 |
| description | switch 2CO 250V 16A connection male faston 6.3mm | | |

cam switches

4 operating positions

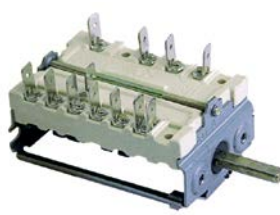
| | | | |
|---|---|-----------------|-----|
|  | | | |
| 1 | | | |
| GEV No. | 300010 | Ref. No. | 281 |
| description | cam switch 4 operating positions 2NO/2CO sequence 0-1-2-3 16A shaft ø 6x4.6mm shaft L 23mm connection male faston 6.3mm ceramic | | |

5 operating positions

| | | | |
|--|---|-----------------|------|
|  | | | |
| 1 | | | |
| GEV No. | 347652 | Ref. No. | 3018 |
| description | cam switch 5 operating positions 5NO/2CO sequence 0-1-2-3-4 16A shaft ø 6x4.6mm shaft L 23mm connection male faston 6.3mm plastic | | |

10 operating positions



| | | | |
|--------------------|--|-----------------|-------|
| 1 | | | |
| GEV No. | 301205 | Ref. No. | 10027 |
| description | cam switch 10 operating positions 5NO/1CO sequence 0-1-2-3-4-5-6-7-8-9 16A shaft ø 6x4.6mm shaft L 23mm connection male faston 6.3mm ceramic | | |

operation switches



| | | | |
|--------------------|---|-----------------|----|
| 1 | | | |
| GEV No. | 300153 | Ref. No. | 38 |
| description | cam switch 3 operating positions operation switch 16A sequence 0-1-2 shaft ø 6x4.6mm shaft L 23mm connection male faston 6.3mm plastic ambient temperature max. 240°C | | |

magnetic switches

accessories

magnets



| | | | |
|--------------------|---|-----------------|-------|
| 1 | | | |
| GEV No. | 348007 | Ref. No. | 10420 |
| description | magnet ø 23mm Lmm H 10mm Wmm ID ø 4.5mm ED ø 23mm M3 hole ø 4.5mm | | |

encoders and potentiometers



| | | | |
|--------------------|----------------------|-----------------|----------------|
| 1 | | | |
| GEV No. | 401592 | Ref. No. | 10527 10566 |
| description | potentiometer 10KOhm | | |

lamps

indicator lights

indicator lights (complete)

ø10mm

with plug-in socket



| | | | |
|--------------------|--|-----------------|-----|
| 1 | | | |
| GEV No. | 359139 | Ref. No. | 631 |
| description | indicator light ø 10mm green 230V connection male faston 6.3mm Qty 1 pcs | | |



| | | | |
|--------------------|--|-----------------|-----|
| 1 | | | |
| GEV No. | 359138 | Ref. No. | 591 |
| description | indicator light ø 10mm red 230V connection male faston 6.3mm Qty 1 pcs | | |



| | | | |
|--------------------|---|-----------------|-----|
| 1 | | | |
| GEV No. | 359140 | Ref. No. | 592 |
| description | indicator light ø 10mm yellow 230V connection male faston 6.3mm Qty 1 pcs | | |

screw-on/push-on fit

light bulbs

for ovens



| | | | |
|--------------------|--|-----------------|------------|
| 1 | | | |
| GEV No. | 359610 | Ref. No. | 35.0003.01 |
| description | light bulb t.max. 300°C socket E14 15W 230V ø 22mm L 47mm lens L 20mm for oven lamp type Philips | | |



| | | | |
|--------------------|--|-----------------|------|
| 1 | | | |
| GEV No. | 359612 | Ref. No. | 3546 |
| description | light bulb t.max. 300°C socket E14 25W 230V ø 25mm L 56mm lens L 30mm for oven lamp type Philips | | |



halogen lamp

for socket G4 / G6.35 / G9



| | | | |
|--------------------|--|-----------------|-------|
| GEV No. | 359599 | Ref. No. | 10307 |
| description | halogen lamp socket G4 12V 20W temp.-resist. 500°C | | |

oven lamps

universal oven lamps

mounting diameter 35.5mm



| | | | |
|--------------------|--|-----------------|------------|
| GEV No. | 359701 | Ref. No. | 35.0002.01 |
| description | lamp socket socket E14 220-230V mounting ø 35.5mm connection male faston 6.3mm 15W | | |

accessories for 359701

| | | | | |
|---|----------------|--------|-----------------|---|
| | GEV No. | 359705 | Ref. No. | — |
| oven lamp glass thr.ø 33.5mm ø 52mm hard glas temp.-resist. 350°C | | | | |

| | | | | |
|---|----------------|--------|-----------------|------------|
| | GEV No. | 359709 | Ref. No. | 35.0001.01 |
| oven lamp glass thr.ø 33.5mm ø 42mm hard glas temp.-resist. 350°C | | | | |

| | | | | |
|---|----------------|--------|-----------------|---------|
| | GEV No. | 359721 | Ref. No. | 0812.01 |
| gasket silicone ED ø 48mm ID ø 39.5mm thickness 5mm Qty 1 pcs | | | | |

| | | | | |
|---|----------------|--------|-----------------|---|
| | GEV No. | 359942 | Ref. No. | — |
| oven lamp glass thr.ø 33.5mm ø 41mm hard glas temp.-resist. 350°C | | | | |



| | | | |
|--------------------|---|-----------------|------------|
| GEV No. | 359709 | Ref. No. | 35.0001.01 |
| description | oven lamp glass thr.ø 33.5mm ø 42mm hard glas temp.-resist. 350°C | | |



| | | | |
|--------------------|---|-----------------|---------|
| GEV No. | 359721 | Ref. No. | 0812.01 |
| description | gasket silicone ED ø 48mm ID ø 39.5mm thickness 5mm Qty 1 pcs | | |

mounting diameter 47.8mm



| | | | |
|--------------------|--|-----------------|-------|
| GEV No. | 359703 | Ref. No. | 10340 |
| description | oven lamp mounting ø 47.8mm 230V 15W socket E14 temp.-resist. 300°C connection male faston 6.3mm hard glas | | |

spare parts for 359703

| | | | | |
|--|----------------|--------|-----------------|------------|
| | GEV No. | 359610 | Ref. No. | 35.0003.01 |
| light bulb t.max. 300°C socket E14 15W 230V ø 22mm L 47mm lens L 20mm for oven lamp type Philips | | | | |

| | | | | |
|---|----------------|--------|-----------------|---|
| | GEV No. | 359725 | Ref. No. | — |
| oven lamp glass thread ø 44mm H 43mm ø 54mm hard glas temp.-resist. 350°C | | | | |

55x70mm



| | | | |
|--------------------|---|-----------------|-------|
| GEV No. | 359297 | Ref. No. | 10306 |
| description | frame L 95mm W 81mm mounting distance 68/83mm thickness 6mm | | |

accessories for 359297

| | | | | |
|---|----------------|--------|-----------------|-------|
| | GEV No. | 359299 | Ref. No. | 10304 |
| gasket L 91mm W 77mm hole ø 3mm for oven lamp | | | | |



| | | | |
|--------------------|---|-----------------|-------|
| GEV No. | 359299 | Ref. No. | 10304 |
| description | gasket L 91mm W 77mm hole ø 3mm for oven lamp | | |

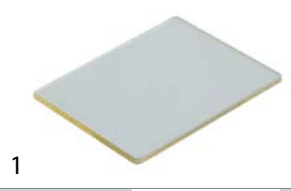









| | | | |
|--------------------|--|-----------------|-------|
| GEV No. | 359296 | Ref. No. | 10305 |
| description | lamp glass L 74mm W 58mm thickness 3mm | | |



55x100mm



1

| | | | |
|--|--|-----------------|-------------------------------|
| GEV No. | 359698 | Ref. No. | 3542 |
| description | lamp socket L 100mm W 55mm socket E14 connection male faston 6.3mm | | |
| spare parts for | 359698 | | |
|  | GEV No. | 358119 | Ref. No. — |
| | frame L 118mm W 72mm mounting distance 143mm for bulb socket | | |
|  | GEV No. | 358122 | Ref. No. — |
| | gasket L 112mm W 68mm silicone thickness 3mm for bulb socket | | |
|  | GEV No. | 358123 | Ref. No. — |
| | lamp glass L 112mm W 68mm | | |
|  | GEV No. | 359612 | Ref. No. 3546 |
| | light bulb t.max. 300°C socket E14 25W 230V ø 25mm L 56mm lens L 30mm for oven lamp type Philips | | |
|  | GEV No. | 359714 | Ref. No. 3543 |
| | gasket for bulb socket | | |
|  | GEV No. | 359715 | Ref. No. 3544 |
| | lamp glass L 110mm W 65mm thickness 5mm | | |
|  | GEV No. | 359716 | Ref. No. 1265A 3545 |
| | frame for bulb socket | | |
| accessories for | 359698 | | |
|  | GEV No. | 359612 | Ref. No. 3546 |
| | light bulb t.max. 300°C socket E14 25W 230V ø 25mm L 56mm lens L 30mm for oven lamp type Philips | | |
|  | GEV No. | 359938 | Ref. No. — |
| | borosilicate glass L 115mm W 69mm | | |



1

| | | | |
|--------------------|-----------------------|-----------------|---------------|
| GEV No. | 359716 | Ref. No. | 1265A 3545 |
| description | frame for bulb socket | | |



1

| | | | |
|--------------------|------------------------|-----------------|------|
| GEV No. | 359714 | Ref. No. | 3543 |
| description | gasket for bulb socket | | |











1

| | | | |
|--------------------|---|-----------------|------|
| GEV No. | 359715 | Ref. No. | 3544 |
| description | lamp glass L 110mm W 65mm thickness 5mm | | |



1

| | | | |
|---|--|-----------------|-------------------------------|
| GEV No. | 359698 | Ref. No. | 3542 |
| description | lamp socket L 100mm W 55mm socket E14 connection male faston 6.3mm | | |
| spare parts for | 359698 | | |
|  | GEV No. | 358119 | Ref. No. — |
| | frame L 118mm W 72mm mounting distance 143mm for bulb socket | | |
|  | GEV No. | 358122 | Ref. No. — |
| | gasket L 112mm W 68mm silicone thickness 3mm for bulb socket | | |
|  | GEV No. | 358123 | Ref. No. — |
| | lamp glass L 112mm W 68mm | | |
|  | GEV No. | 359612 | Ref. No. 3546 |
| | light bulb t.max. 300°C socket E14 25W 230V ø 25mm L 56mm lens L 30mm for oven lamp type Philips | | |
|  | GEV No. | 359714 | Ref. No. 3543 |
| | gasket for bulb socket | | |
|  | GEV No. | 359715 | Ref. No. 3544 |
| | lamp glass L 110mm W 65mm thickness 5mm | | |
|  | GEV No. | 359716 | Ref. No. 1265A 3545 |
| | frame for bulb socket | | |
| accessories for | 359698 | | |
|  | GEV No. | 359612 | Ref. No. 3546 |
| | light bulb t.max. 300°C socket E14 25W 230V ø 25mm L 56mm lens L 30mm for oven lamp type Philips | | |
|  | GEV No. | 359938 | Ref. No. — |
| | borosilicate glass L 115mm W 69mm | | |



lamps

light bulbs



| | | | |
|--------------------|--|-----------------|------------|
| GEV No. | 359610 | Ref. No. | 35.0003.01 |
| description | light bulb t.max. 300°C socket E14 15W 230V ø 22mm L 47mm lens L 20mm for oven lamp type Philips | | |



| | | | |
|--------------------|--|-----------------|------|
| GEV No. | 359612 | Ref. No. | 3546 |
| description | light bulb t.max. 300°C socket E14 25W 230V ø 25mm L 56mm lens L 30mm for oven lamp type Philips | | |

halogen lamps

for socket G4 / G6.35 / G9



| | | | |
|--------------------|--|-----------------|-------|
| GEV No. | 359599 | Ref. No. | 10307 |
| description | halogen lamp socket G4 12V 20W temp.-resist. 500°C | | |

sockets

G4 / G5,3 / G6,35



| | | | |
|--------------------|---|-----------------|-------|
| GEV No. | 359646 | Ref. No. | 10308 |
| description | lamp socket socket G4/G5.3/G6.35 24V ø 17mm H 15mm connection cable 130mm mounting distance 26mm for halogen lamp holder length 31mm cable length 130mm | | |

timers

programme timers



| | | | |
|------------------------|---|-----------------|----------------|
| GEV No. | 360339 | Ref. No. | 10039 10042 |
| description | timer FIBER P25 engines 1 chambers 1 operation time 20s 230V shaft ø 6x4.6mm shaft L 20mm manuf. no. P255J01C1N4 motor type M51BJ0R6400 | | |
| spare parts for | 360339 | | |

| | | | | |
|---|--|--------|-----------------|---|
|  | GEV No. | 360673 | Ref. No. | — |
| | motor kit pinion ø 6.8mm teeth 15 230V voltage AC 50/60Hz turn direction clockwise motor ø 48mm H 18.5mm motor type UDS-40NE1RNZ165 cable length 150mm with holder | | | |

mechanical timers



| | | | |
|--------------------|---|-----------------|----|
| GEV No. | 350003 | Ref. No. | 39 |
| description | timer M2 with bell 2-pole operation time 120min impulse mechanical 2NO at 250V 16A permanent position no shaft ø 6x4.6mm shaft 6x4.6mm shaft L 23mm mounting distance 28mm connection lateral | | |

| | | | | |
|---|--|--------|-----------------|---|
| accessories for | 350003 | | | |
|  | GEV No. | 110366 | Ref. No. | — |
| | knob switch zero mark t.max.°C°C ø 44mm shaft ø 6x4.6mm shaft flat upper black | | | |

| | | | | |
|---|--|--------|-----------------|---|
|  | GEV No. | 111199 | Ref. No. | — |
| | dial plate graduation 120min permanent position no rotation 0-330° ø 60mm timers knob ø 45mm | | | |



| | | | |
|--------------------|--|-----------------|------------|
| GEV No. | 350008 | Ref. No. | 3433 50 |
| description | timer M2 with bell 2-pole operation time 120min impulse mechanical 2NO at 250V 16A permanent position yes shaft ø 6x4.6mm shaft 6x4.6mm shaft L 24mm mounting distance 28mm connection lateral | | |

alarm devices

alarm units



| | | | |
|--------------------|---|-----------------|-----|
| GEV No. | 350081 | Ref. No. | 636 |
| description | alarm device 9-15VDC H 14.5mm wall-mounted version 75dB protection IPx0 | | |

buzzers



| | | | |
|--------------------|--|-----------------|------|
| GEV No. | 350050 | Ref. No. | 1553 |
| description | buzzer 230VAC connection male faston 6.3mm screw mounting thread M4 60dB | | |



contactors

SIEMENS

power contactors



1

| | | | |
|----------------|--------|-----------------|-------|
| GEV No. | 380645 | Ref. No. | 10004 |
|----------------|--------|-----------------|-------|

| | |
|--------------------|--|
| description | power contactor 230VAC with auxiliary contacts |
|--------------------|--|



1

| | | | |
|----------------|--------|-----------------|-------|
| GEV No. | 380389 | Ref. No. | 10001 |
|----------------|--------|-----------------|-------|

| | |
|--------------------|--|
| description | power contactor resistive load 22A 230VAC (AC3/400V) 9A/4kW main contacts 3NO auxiliary contacts 1NO connection screw connection type 3RT10-16-1AP01 |
|--------------------|--|

overload switches



1

| | | | |
|----------------|--------|-----------------|-------|
| GEV No. | 381002 | Ref. No. | 10003 |
|----------------|--------|-----------------|-------|

| | |
|--------------------|--|
| description | overload switch setting range 1.8-2.5A |
|--------------------|--|

relays

power relays

with male contacts

female contact 2.0mm



1

| | | | |
|----------------|--------|-----------------|-------|
| GEV No. | 380642 | Ref. No. | 10504 |
|----------------|--------|-----------------|-------|

| | |
|--------------------|---|
| description | power relays 230VAC connection 2.0 plug-in connection |
|--------------------|---|

| | |
|------------------------|--------|
| accessories for | 380642 |
|------------------------|--------|



| | | | |
|----------------|--------|-----------------|-------|
| GEV No. | 380378 | Ref. No. | 10509 |
|----------------|--------|-----------------|-------|

| | |
|--------------------|---|
| description | relay socket 2-pole 55/85 dimensions 70.5x30x27mm 250V voltage AC 10A FINDER manuf. no. 94.72 |
|--------------------|---|



| | | | |
|----------------|--------|-----------------|---|
| GEV No. | 380384 | Ref. No. | — |
|----------------|--------|-----------------|---|

| | |
|--------------------|---|
| description | relay socket 2-pole contacts male faston 2.8mm 250V voltage AC 10A W 23mm for |
|--------------------|---|



| | | | |
|----------------|--------|-----------------|---|
| GEV No. | 380399 | Ref. No. | — |
|----------------|--------|-----------------|---|

| | |
|--------------------|--|
| description | relay socket 4-pole dimensions 76.2x27x86.1mm 250V voltage AC 1A FINDER manuf. no. 94.94.3 |
|--------------------|--|

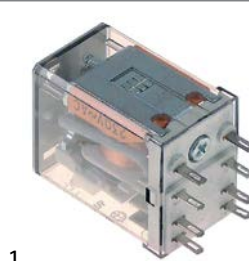

1

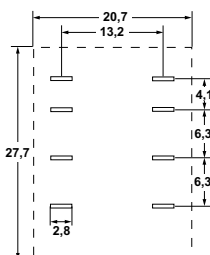

| | | | |
|----------------|--------|-----------------|-------|
| GEV No. | 380377 | Ref. No. | 10507 |
|----------------|--------|-----------------|-------|

| | |
|--------------------|--|
| description | power relays FINDER 220-240VAC 10A 2CO connection F2 plug-in connection manuf. no. 55.32.8.230.0000 94.92.3 250V |
|--------------------|--|

| | |
|------------------------|--------|
| accessories for | 380377 |
|------------------------|--------|



| | | | |
|----------------|--------|-----------------|---|
| GEV No. | 380341 | Ref. No. | — |
|----------------|--------|-----------------|---|

| | |
|--------------------|--|
| description | relay socket 4-pole contacts 12 300V voltage AC 6A Italiana Relè manuf. no. ZMD4 |
|--------------------|--|



| | | | |
|----------------|--------|-----------------|-------|
| GEV No. | 380378 | Ref. No. | 10509 |
|----------------|--------|-----------------|-------|

| | |
|--------------------|---|
| description | relay socket 2-pole 55/85 dimensions 70.5x30x27mm 250V voltage AC 10A FINDER manuf. no. 94.72 |
|--------------------|---|



| | | | |
|----------------|--------|-----------------|---|
| GEV No. | 380384 | Ref. No. | — |
|----------------|--------|-----------------|---|

| | |
|--------------------|---|
| description | relay socket 2-pole contacts male faston 2.8mm 250V voltage AC 10A W 23mm for |
|--------------------|---|



| | | | |
|----------------|--------|-----------------|---|
| GEV No. | 380399 | Ref. No. | — |
|----------------|--------|-----------------|---|

| | |
|--------------------|--|
| description | relay socket 4-pole dimensions 76.2x27x86.1mm 250V voltage AC 1A FINDER manuf. no. 94.94.3 |
|--------------------|--|



relay sockets



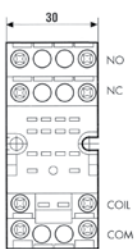

1

| | | | |
|--------------------|--------------|-----------------|-------|
| GEV No. | 380641 | Ref. No. | 10505 |
| description | relay socket | | |

1

| | | | |
|------------------------|---|-----------------|--------|
| GEV No. | 380378 | Ref. No. | 10509 |
| description | relay socket 2-pole 55/85 dimensions 70.5x30x27mm 250V voltage AC 10A FINDER manuf. no. 94.72 | | |
| accessories for | 380378 | | |
| |  | GEV No. | 380804 |
| | | Ref. No. | — |
| | support bracket | | |



1

| | | | |
|--------------------|--|-----------------|-------|
| GEV No. | 380638 | Ref. No. | 10503 |
| description | relay socket 8-pole dimensions 51x41x23mm 250V 10A FINDER manuf. no. 90.26 | | |

level relays

GICAR





1

| | | | |
|--------------------|--|-----------------|-------|
| GEV No. | 401224 | Ref. No. | 10532 |
| description | level relay 230V connection F6.3 type RL30/3ES/F/G | | |

time relays





1

| | | | |
|------------------------|--|-----------------|--------|
| GEV No. | 380329 | Ref. No. | 10508 |
| description | time relay FIBER 85.02.8.240 time range 0.05s - 100h 230-240VAC 10A mounting measurements 20.6x27.7mm 2CO connection 2.0 | | |
| accessories for | 380329 | | |
| |  | GEV No. | 380378 |
| | | Ref. No. | 10509 |
| | relay socket 2-pole 55/85 dimensions 70.5x30x27mm 250V voltage AC 10A FINDER manuf. no. 94.72 | | |
| |  | GEV No. | 380803 |
| | | Ref. No. | — |
| | relay socket 2-pole dimensions 76.2x27x86.1mm 250V voltage AC 10A FINDER manuf. no. 94.92.3 | | |



1

| | | | |
|------------------------|---|-----------------|--------|
| GEV No. | 380639 | Ref. No. | 10501 |
| description | time relay TECNOLOGIC RTR12DS06S time range 6s 230VAC 5A mounting measurements 34x34mm 1CO connection plug-in connection round 8-pole | | |
| accessories for | 380639 | | |
| |  | GEV No. | 380638 |
| | | Ref. No. | 10503 |
| | relay socket 8-pole dimensions 51x41x23mm 250V 10A FINDER manuf. no. 90.26 | | |



1

| | | | |
|------------------------|--|-----------------|--------|
| GEV No. | 380640 | Ref. No. | 10502 |
| description | time relay TECNOLOGIC RTR12DS60S time range 60s 230VAC 5A 1CO connection plug-in connection round 8-pole | | |
| accessories for | 380640 | | |
| |  | GEV No. | 380638 |
| | | Ref. No. | 10503 |
| | relay socket 8-pole dimensions 51x41x23mm 250V 10A FINDER manuf. no. 90.26 | | |



transformers

open transformers

with clamp terminal



| | | | |
|--------------------|---|-----------------|----------------|
| 1 | | | |
| GEV No. | 401229 | Ref. No. | 10323 10324 |
| description | transformer primary 230V secondary 12V 63VA | | |

encapsulated transformers

PMA



| | | | |
|--------------------|--|-----------------|-----|
| 1 | | | |
| GEV No. | 379196 | Ref. No. | 635 |
| description | transformer primary 230VAC secondary 12VAC 10VA secondary 0.8A connection screw 50Hz | | |



| | | | |
|--------------------|---|-----------------|------|
| 1 | | | |
| GEV No. | 379054 | Ref. No. | 1551 |
| description | transformer primary 230VAC secondary 12VAC 3VA secondary 0.25A H 40mm L 45mm W 50mm connection screw 50/60Hz type 153/M | | |





electronic controllers

EVCO - EVERY CONTROL

universal controllers

built-in version



| | | | |
|---|--|-----------------|---------------------|
| 1 | | | |
| GEV No. | 378131 | Ref. No. | 1549 |
| description | electronic controller EVERY CONTROL EVK411M mounting measurements 71x29mm 12V voltage AC/DC NTC/PTC/Pt100/Pt1000 relay outputs 1 CO-16A(8) NTC/PTC/Pt100/Pt1000/TC(J,K)/mV/mA yes protection IP65 dependent on probe°C display 3½ digits | | |
| accessories for | 378131 | | |
| | GEV No. | 379050 | Ref. No. 634 |
|  | temperature probe Pt100 cable Vetrotex probe -200 up to +600°C cable -50 up to +350°C probe ø6x100mm cable length 2.7m without screw connection 3-wire | | |
| | GEV No. | 379160 | Ref. No. — |
|  | temperature probe NTC 10kOhm cable thermoplastic probe -40 up to +110°C cable -40 up to +110°C probe ø6x14mm cable length 1.5m without screw connection 2-wire | | |
| | GEV No. | 379781 | Ref. No. — |
|  | temperature probe PTC 1kOhm cable thermoplastic probe -50 up to +150°C cable -40 up to +110°C probe ø6x14mm cable length 1.5m without screw connection 2-wire | | |
| | GEV No. | 379944 | Ref. No. — |
|  | temperature probe Pt1000 cable Vetrotex probe -70 up to +500°C cable -50 up to +350°C connection 2-wire thread probe ø6x180mm cable length 1.7m | | |

SHANGFANG

accessories



| | | | |
|--------------------|---|-----------------|------|
| 1 | | | |
| GEV No. | 379054 | Ref. No. | 1551 |
| description | transformer primary 230VAC secondary 12VAC 3VA secondary 0.25A H 40mm L 45mm W 50mm connection screw 50/60Hz type 153/M | | |



probes

universal probes

temperature probes



1

| | | | |
|--------------------|--|-----------------|-----|
| GEV No. | 379050 ¹ | Ref. No. | 634 |
| description | temperature probe Pt100 cable Vetrotex probe -200 up to +600°C cable -50 up to +350°C probe ø6x100mm cable length 2.7m without screw connection 3-wire | | |

¹3-wire



1

| | | | |
|--------------------|--|-----------------|-------|
| GEV No. | 378067 | Ref. No. | 70401 |
| description | temperature probe PTC 1kOhm cable silicone probe -50 up to +150°C cable -50 up to +180°C probe ø6x40mm cable length 2m without screw connection 2-wire | | |

producer-specific probes

probes



1

| | | | |
|--------------------|--|-----------------|-------|
| GEV No. | 402154 | Ref. No. | 10411 |
| description | temperature probe Pt100 cable silicone probe -100 up to 450°C cable -50 up to +180°C connection 3-wire thread 1/8" probe ø6x35mm cable length 1.5m | | |

core probes



1

| | | | |
|--------------------|--|-----------------|-------|
| GEV No. | 379945 | Ref. No. | 10402 |
| description | core temperature probe Pt100 cable PTFE probe -40 up to +250°C cable -40 up to +250°C connection plug probe ø3.5x100mm thread cable length 0.5m handle ø 10mm handle length 80mm | | |



1

| | | | |
|--------------------|--|-----------------|-------|
| GEV No. | 379946 | Ref. No. | 10401 |
| description | core temperature probe Pt100 cable PTFE probe -40 up to +250°C cable -40 up to +250°C connection plug probe ø3.5x100mm thread cable length 0.7m handle ø 10mm handle length 80mm | | |



1

| | | | |
|--------------------|--|-----------------|----------------|
| GEV No. | 379947 | Ref. No. | 10405 10406 |
| description | core temperature probe Pt100 cable PTFE probe -40 up to +250°C cable -40 up to +250°C connection plug probe ø3.5x100mm thread cable length 1.2m handle ø 10mm handle length 80mm | | |



1

| | | | |
|--------------------|---|-----------------|-------|
| GEV No. | 379350 ¹ | Ref. No. | 70404 |
| description | core temperature probe PTC 1kOhm cable silicone probe -40 up to +120°C cable -50 up to +180°C connection plug probe ø4x100mm thread cable length 1.7m handle ø 8mm handle length 120/35mm L1 120mm L2 130mm | | |

¹multipoint probe



1

| | | | |
|--------------------|--|-----------------|--------|
| GEV No. | 379662 ¹ | Ref. No. | 70402A |
| description | core temperature probe PTC 1kOhm cable silicone probe -40 up to +120°C cable -50 up to +180°C connection plug probe ø4x70mm thread cable length 1.3m handle ø 16mm handle length 120mm L1 120mm L2 130mm | | |

¹multipoint probe



1

| | | | |
|--------------------|---|-----------------|--------|
| GEV No. | 379806 ¹ | Ref. No. | 70405A |
| description | core temperature probe PTC 1kOhm cable silicone probe -40 up to +120°C cable -50 up to +180°C connection plug probe ø5x70mm thread cable length 1.2m handle ø 16mm handle length 125mm L1 170mm L2 65mm | | |

¹multipoint probe



1 

| | | | |
|--------------------|--|-----------------|------|
| GEV No. | 379948 | Ref. No. | 3566 |
| description | core temperature probe thermocouple J (Fe-CuNi) cable SS corrugated hose probe -40 up to +250°C cable -40 up to +250°C connection 1/8" probe ø3.5x100mm thread 1/8" cable length 1.8m handle ø 10mm handle length 80mm | | |

1 

| | | | |
|--------------------|---|-----------------|------|
| GEV No. | 379951 | Ref. No. | 3567 |
| description | temperature probe thermocouple J (Fe-CuNi) cable SS corrugated hose probe -40 up to +250°C cable -40 up to +250°C connection 2-wire probe ø3.5x100mm thread 1/8" cable length 2.1m handle ø 10mm handle length 80mm | | |

PCBs

1 

| | | | |
|--------------------|-------------|-----------------|-------|
| GEV No. | 401042 | Ref. No. | 10029 |
| description | display PCB | | |

1 

| | | | |
|--------------------|------------|-----------------|-------|
| GEV No. | 401245 | Ref. No. | 10536 |
| description | keypad PCB | | |

1 

| | | | |
|--------------------|------------|-----------------|-------|
| GEV No. | 401569 | Ref. No. | 10563 |
| description | keypad PCB | | |

1 

| | | | |
|--------------------|------------|-----------------|-------|
| GEV No. | 403061 | Ref. No. | 10513 |
| description | keypad PCB | | |

electronics

EPROMS

1 

| | | | |
|--------------------|----------------------|-----------------|-------|
| GEV No. | 403201 | Ref. No. | 10547 |
| description | EPROM type FOCABO 59 | | |

1 

| | | | |
|--------------------|----------------------|-----------------|-------|
| GEV No. | 403062 | Ref. No. | 10550 |
| description | EPROM type FOCABO P5 | | |

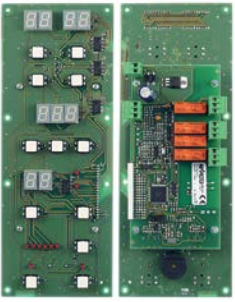
1

| | | | |
|--------------------|---------------------------------------|-----------------|-----|
| GEV No. | 401219 | Ref. No. | 614 |
| description | keypad PCB convection oven FC06/12/20 | | |



1

| | | | |
|--------------------|--------|-----------------|-------|
| GEV No. | 402318 | Ref. No. | 10555 |
| description | PCB | | |



1

| | | | |
|--------------------|---|-----------------|-------|
| GEV No. | 402930 | Ref. No. | 10565 |
| description | PCB combi-steamer LCM06/M100 L 110mm W 80mm Fan Reversal Card | | |





1

| | | | |
|--------------------|---|-----------------|-------|
| GEV No. | 403473 | Ref. No. | 10672 |
| description | PCB combi-steamer LCM06/M100 L 95mm W 79mm H 43mm Fan Reversal Card | | |



1

| | | | | |
|---|--|-----------------|-----------------|-------|
| GEV No. | 401566 | Ref. No. | 10524 | |
| description | power PCB without EPROM type CQB 324(02) | | | |
| accessories for | 401566 | | | |
|  | GEV No. | 403062 | Ref. No. | 10550 |
| | EPROM type FOCABO P5 | | | |
|  | GEV No. | 403201 | Ref. No. | 10547 |
| | EPROM type FOCABO 59 | | | |

solenoid valves

solenoid valves (water)

RPE



1

| | | | |
|--------------------|---|-----------------|------|
| GEV No. | 374021 | Ref. No. | 1363 |
| description | solenoid valve double straight 230VAC inlet 3/4" outlet 10mm DN10 RPE | | |



1

| | | | |
|--------------------|---|-----------------|-----|
| GEV No. | 374017 | Ref. No. | 282 |
| description | solenoid valve single straight 230VAC inlet 3/4" outlet 10mm input 6l/min DN10 RPE polyamide flow regulating valve inlet white membranes NBR pressure range 0.2-10bar | | |

reducers

outlet side



1

| | | | |
|--------------------|--|-----------------|-------|
| GEV No. | 371269 | Ref. No. | 13001 |
| description | reducer flow rate 0.07-0.14l/min brown | | |



1

| | | | |
|--------------------|--------------------------------|-----------------|-----|
| GEV No. | 371266 | Ref. No. | 289 |
| description | reducer flow rate 0.2l/min red | | |



1

| | | | |
|--------------------|--|-----------------|------------|
| GEV No. | 371268 | Ref. No. | 290 295 |
| description | reducer flow rate 0.32-0.42l/min green | | |

solenoid valves with reducers

4-fold



| | | | |
|---|---|-----------------|-------------------|
| GEV No. | 374026 | Ref. No. | 13003 |
| description | solenoid valve 4-fold straight 230VAC inlet 3/4" outlet 11.5mm duty cycle 100% RPE plastic pressure range 0.2-10bar | | |
| spare parts for | 374026 | | |
|  | GEV No. | 371015 | Ref. No. — |
| | solenoid coil RPE 230VAC 8.4VA 50/60Hz seat ø 9mm connection male faston 6.3mm | | |

metal

CEME

solenoid valves



| | | | |
|--------------------|---|-----------------|-------|
| GEV No. | 370348 | Ref. No. | 11022 |
| description | solenoid valve 2-ways 230VAC connection 1/2" L 60mm t.max. 90°C membranes NBR p max 10bar p min 0.25bar brass | | |

ball valves electric



| | | | |
|--------------------|---|-----------------|-------|
| GEV No. | 401233 | Ref. No. | 10036 |
| description | ball valve inlet 1/2" IT outlet 1/2" IT 230V 50/60Hz mode of operation electric W 60mm H 99mm cable 4-pole 2.5W 4-pole duty cycle 50% | | |

electrodes



| | | | |
|--------------------|--|-----------------|------|
| GEV No. | 401225 | Ref. No. | 3680 |
| description | level electrode M12 ET - 1/8" ET total length 124/127/139mm probe L 91/95/104mm insulated probe length 42mm set 3-piece connection male faston 6.3mm ø 2.5mm | | |

| | | | |
|--------------------|---|-----------------|------|
| GEV No. | 401226 | Ref. No. | 3681 |
| description | level electrode M12x1 total length 150/160/171mm probe L 117/127/138mm insulated probe length 20mm set 3-piece connection male faston 6.3mm ø 2.5mm | | |

| | | | |
|--------------------|---|-----------------|------|
| GEV No. | 401227 | Ref. No. | 3683 |
| description | level electrode M12x1 total length 80/86/98mm probe L 48/53/65mm insulated probe length 20mm set 3-piece connection male faston 6.3mm ø 2.5mm | | |



| | | | |
|--------------------|---|-----------------|------|
| GEV No. | 401228 | Ref. No. | 3572 |
| description | level electrode total length 175mm connection male faston 6.3mm ø 2.5mm | | |

fans

axial fans

import



| | | | |
|---|--|-----------------|-------------------|
| GEV No. | 601080 ¹ | Ref. No. | 10724 |
| description | axial fan L 119mm W 119mm H 38mm 230VAC 50/60Hz 23/20W bearing ball bearing connection male faston 2.8mm metal ADDA fan wheel ø 110mm temp.-resist. 70°C | | |
| accessories for | 601080 | | |
|  | GEV No. | 550898 | Ref. No. — |
| | connecting cable cable length 2000mm connection F 2.8 connection distance 7.9mm for axial flow fan | | |
|  | GEV No. | 692519 | Ref. No. — |
| | guard L 120mm W 120mm plastic | | |

¹with ball bearings





1

| | | | |
|---|---|-----------------|-------------------|
| GEV No. | 601130 ¹ | Ref. No. | 10721 |
| description | axial fan L 80mm W 80mm H 25mm 230VAC 50/60Hz 13/14W bearing ball bearing connection male faston 2.8mm metal ADDA fan wheel ø 75mm temp.-resist. 70°C airflow 30.6m ³ /h | | |
| accessories for | 601130 | | |
|  | GEV No. | 550898 | Ref. No. — |
| | connecting cable cable length 2000mm connection F 2.8 connection distance 7.9mm for axial flow fan | | |

¹with ball bearings



1

| | | | |
|---|---|-----------------|-------------------|
| GEV No. | 601081 ¹ | Ref. No. | 10720 |
| description | axial fan L 80mm W 80mm H 38mm 230VAC 50/60Hz 14/13.5W bearing ball bearing connection male faston 2.8mm metal ADDA fan wheel ø 75mm temp.-resist. 70°C | | |
| accessories for | 601081 | | |
|  | GEV No. | 691102 | Ref. No. — |
| | guard ø 75mm mounting distance 71mm for axial fan 80mm | | |

¹with ball bearings

refrigeration fans

cooling motors (complete)



1

| | | | |
|--------------------|--|-----------------|-------|
| GEV No. | 694178 | Ref. No. | 70701 |
| description | fan 220-240V 16W 50-60Hz fan wheel ø 250mm connection with cable mounting distance 300mm | | |

cold air circulating fans (complete)

ebm-papst

A4D series

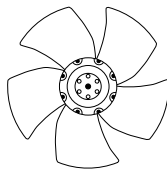
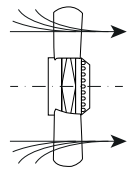
1

| | | | |
|--------------------|---|-----------------|-------|
| GEV No. | 601628 | Ref. No. | 70705 |
| description | fan A4D500-AM03-01 fan wheel ø 500mm blades 5 400V 50Hz 720W 1390rpm cable length 450mm rotation direction left ebm-papst sucking | | |

A4E series

1

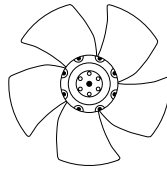
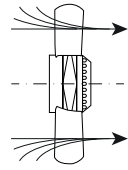
| | | | |
|--------------------|---|-----------------|-------|
| GEV No. | 601684 | Ref. No. | 70702 |
| description | fan A4E350-AA06-54 fan wheel ø 350mm blades 5 230V 50/60Hz 145W 1380/1540rpm cable length 450mm ebm-papst blowing suitable capacitor 5µF/400VµF | | |

1

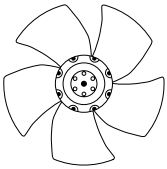
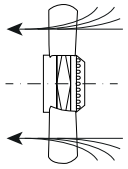
| | | | |
|--------------------|--|-----------------|-------|
| GEV No. | 602045 | Ref. No. | 70704 |
| description | fan A4E450-AP01-01 fan wheel ø 450mm blades 5 230V 50/60Hz 245/355W mounting distance 65mm 1400/1600rpm connection 4-wire cable length 500mm rotation direction left ebm-papst sucking suitable capacitor MLR25PRLµF | | |

ZIEHL-ABEGG

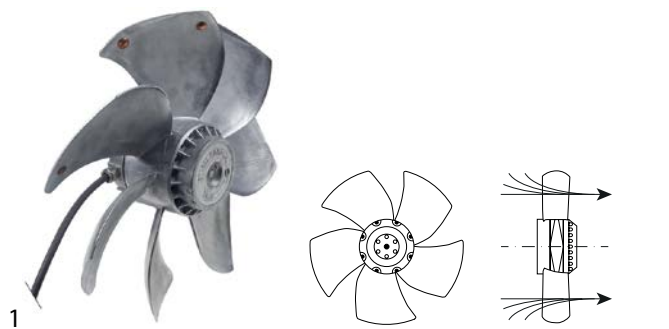

| | | | |
|--------------------|---|-----------------|-------|
| GEV No. | 601726 | Ref. No. | 70706 |
| description | fan fan wheel ø 360mm 230V 50/60Hz 200/310W cable length 2600mm ZIEHL-ABEGG complete H 118mm type FE035-4EA.0F.A7 | | |

hot air motors



| | | | |
|--------------------|---|-----------------|-----|
| GEV No. | 550757 | Ref. No. | 693 |
| description | counterflange for fan motor ED ø 48mm int. ø 1 24mm int. ø 2 15mm thickness 5mm brass | | |



| | | | |
|--------------------|---|-----------------|-----|
| GEV No. | 550854 | Ref. No. | 691 |
| description | counterflange for fan motor ED ø 60mm int. ø 1 34.5mm int. ø 2 24.6mm thickness 5.1mm brass | | |



| | | | |
|--------------------|---|-----------------|-------|
| GEV No. | 601046 | Ref. No. | 0840B |
| description | fan motor 220/380V 3 phase 50/60Hz 0.75kW 1350/1650rpm speeds 1 L1 185mm L2 42mm L3 47mm D1 ø 24mm D2 ø 20mm M12L IT 1.9/3.3A Cos(fi) 0.83 at 50Hz 200-240/346-415V at 60Hz 200-277/346-480V at 50Hz 1350rpm at 60Hz 1650rpm type ST80/4 no. 661512 | | |

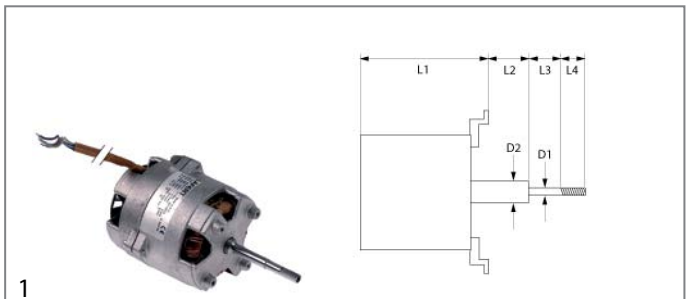

| | | | |
|------------------------|---|-----------------|-------|
| GEV No. | 601354 | Ref. No. | 1100C |
| description | fan motor 220-240V 1 phase 50Hz 0.11kW 2760rpm speeds 1 L1 130mm L2 32mm L3 30mm L4 18mm D1 ø 7/8mm D2 ø 9mm M4R IT 0.9A at 50Hz 230V at 50Hz 2760rpm suitable capacitor 4µF type LM63 shaft flat length 17mm | | |
| accessories for | 601354 | | |
| GEV No. | 365031 | Ref. No. | — |
| description | operating capacitor capacity 4µF 450V tolerance 5% 50/60Hz ambient temperature max. -25 to +85°C ø 31mm L 58mm M8 plastic connection male faston 6.3mm protection | | |
| GEV No. | 601061 | Ref. No. | — |
| description | fan wheel D1 ø 160mm H1 60mm blades 15 D2 ø 18mm D3 ø 18mm H2 35mm | | |

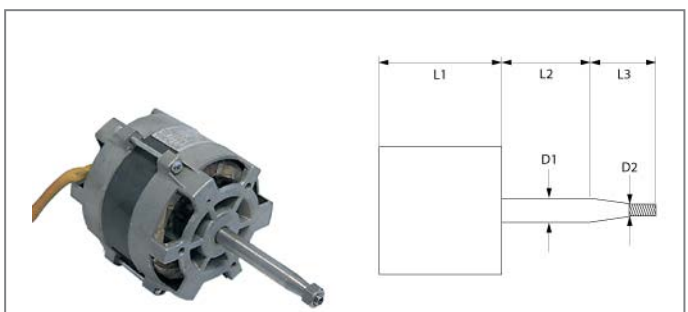

| | | | |
|------------------------|--|-----------------|-----|
| GEV No. | 601043 | Ref. No. | 764 |
| description | fan motor 220-240V 1 phase 50Hz 0.37/0.07kW 0.1/0.5HP 1400/2700rpm speeds 2 L1 123mm L2 107mm L3 15mm D1 ø 15mm D2 ø 12mm M10L ET 2/0.7A suitable capacitor 20µF/250V at 50Hz 1400/2700rpm type 1057 | | |
| accessories for | 601043 | | |
| GEV No. | 365019 | Ref. No. | 775 |
| description | operating capacitor capacity 20µF 400V tolerance 5% 50/60Hz ambient temperature max. -25 to +85°C ø 39.5mm L 70mm M8 plastic connection male faston 6.3mm 16.10.25. protection | | |

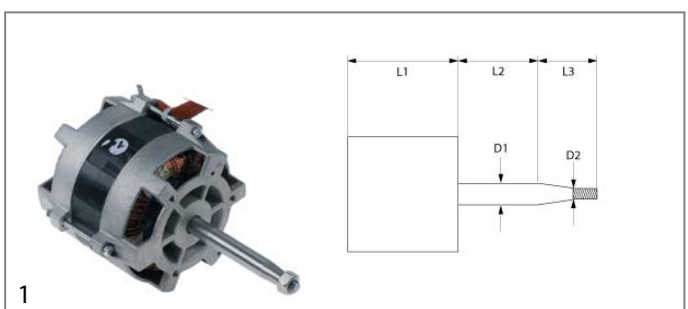

| | | | |
|------------------------|---|-----------------|-------|
| GEV No. | 601166 | Ref. No. | 10705 |
| description | fan motor 220-240V 1 phase 50Hz 0.37kW 2700rpm speeds 1 L1 123mm L2 77mm L3 30mm D1 ø 15mm D2 ø 12mm M10L ET 2A suitable capacitor 12.5µF/450V at 50Hz 2700rpm type 1057.2157 | | |
| spare parts for | 601166 | | |
| GEV No. | 365014 | Ref. No. | — |
| description | operating capacitor capacity 12.5µF 450V tolerance 5%Hz ambient temperature max. -25 to +85°C ø 35mm L 70mm M8 plastic connection male faston 6.3mm 45S.C3DS.12.5 protection | | |

Table continues overleaf



| | | | |
|---|--|--------|----------------------|
| accessories for | 601166 | | |
|  | GEV No. | 601165 | Ref. No. 1118 |
| | fan wheel D1 ø 160mm H1 60mm blades 15 D2 ø 16mm D3 ø 16mm H2 29mm | | |

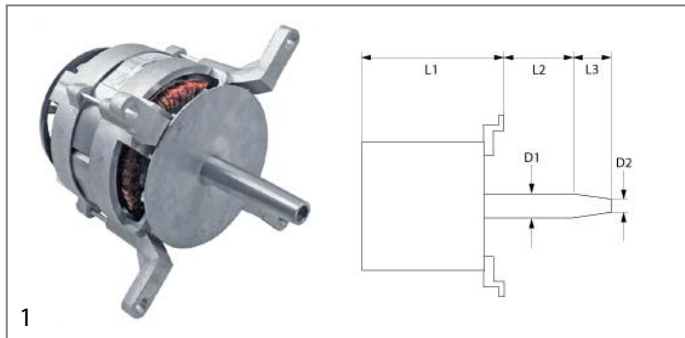

| | | | |
|--------------------|---|-----------------|-------|
| GEV No. | 499185 | Ref. No. | 0841B |
| description | fan motor 380-415V 3 phase 50/60Hz 0.13/0.55kW 700/1350rpm speeds 2 L1 170mm L2 49mm L3 45mm D1 ø 24mm D2 ø 20mm M12x1.75 4P/8P type FB100L | | |

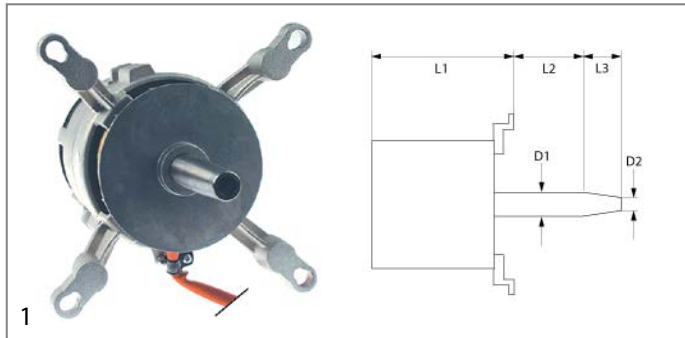

| | | | |
|--------------------|--|-----------------|-----|
| GEV No. | 500652 | Ref. No. | 841 |
| description | fan motor 380-415V 3 phase 50Hz 0.13/0.55kW 700/1350rpm speeds 2 L1 188mm L2 44mm L3 48mm D1 ø 24mm D2 ø 20mm M12L ITA Cos(φ) 0.13/0.55 at 50Hz 700/1350rpm 4P/8P type FB80 4/8 no. 390133 | | |



| | | | |
|--------------------|--|-----------------|------|
| GEV No. | 514507 | Ref. No. | 1104 |
| description | fan wheel blades 15 D1 ø 160mm D2 ø 11mm D3 ø 16mm H1 60mm H2 18mm | | |



| | | | |
|--------------------|--|-----------------|-------|
| GEV No. | 601067 | Ref. No. | 15007 |
| description | fan wheel D1 ø 150mm H1 38mm blades 36 D2 ø 6mm D3 ø 6mm H2 14mm | | |



| | | | |
|--------------------|--|-----------------|------|
| GEV No. | 601165 | Ref. No. | 1118 |
| description | fan wheel D1 ø 160mm H1 60mm blades 15 D2 ø 16mm D3 ø 16mm H2 29mm | | |



| | | | |
|--------------------|--|-----------------|-----|
| GEV No. | 601060 | Ref. No. | 758 |
| description | fan wheel D1 ø 180mm H1 60mm blades 16 D2 ø 11mm D3 ø 16mm H2 30mm | | |



| | | | |
|--------------------|--|-----------------|-------|
| GEV No. | 601064 | Ref. No. | 15016 |
| description | fan wheel D1 ø 220mm H1 78mm blades 20 D2 ø 11.5mm D3 ø 16.5mm H2 30mm | | |

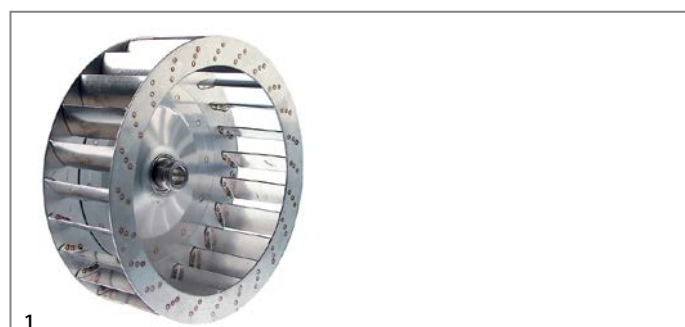

| | | | |
|--------------------|---|-----------------|------|
| GEV No. | 601224 | Ref. No. | 3196 |
| description | fan wheel D1 ø 300mm H1 100mm blades 24 D2 ø 19.5mm D3 ø 23mm H2 46mm | | |





1

| | | | |
|--------------------|---|-----------------|-----|
| GEV No. | 601063 | Ref. No. | 759 |
| description | fan wheel D1 ø 350mm H1 100mm blades 24 D2 ø 19.5mm D3 ø 23mm H2 46mm | | |



1

| | | | |
|--------------------|--|-----------------|-----|
| GEV No. | 691810 | Ref. No. | 692 |
| description | flange for fan motor ED ø 48mm int. ø 1 19.5mm int. ø 2 15mm thickness 3.5mm brass | | |



1

| | | | |
|--------------------|--|-----------------|-----|
| GEV No. | 550852 | Ref. No. | 690 |
| description | flange for fan motor ED ø 60mm int. ø 1 28.5mm int. ø 2 24.5mm thickness 3.5mm brass | | |



1

| | | | |
|--------------------|--|-----------------|-----|
| GEV No. | 550853 | Ref. No. | 688 |
| description | gasket for fan motor ID ø 24mm ED ø 29mm thickness 3mm | | |

hot air fans

miscellaneous



1

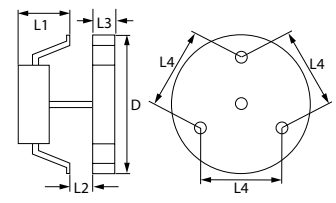

| | | | |
|---|--|-----------------|-------------------|
| GEV No. | 601125 | Ref. No. | 0016A 10731 |
| description | hot air fan 220-240V 45W 50/60Hz L1 70mm L2 11mm L3 25mm L4 87mm fan wheel ø 150mm FIME type C30R0479CLF | | |
| accessories for | 601125 | | |
|  | GEV No. | 550879 | Ref. No. — |
| | insulation ø 130mm thickness 3mm hole ø 20mm for hot air fan | | |

pumps

drain pumps

ASKOLL



1

| | | | |
|--------------------|----------------|-----------------|------|
| GEV No. | 500565 | Ref. No. | 3363 |
| description | drain pump 30W | | |



condensators & interference suppression filters

operating capacitors

plastic



1

| | | | |
|--------------------|--|-----------------|-----|
| GEV No. | 365019 | Ref. No. | 775 |
| description | operating capacitor capacity 20µF 400V tolerance 5% 50/60Hz ambient temperature max. -25 to +85°C ø 39.5mm L 70mm M8 plastic connection male faston 6.3mm 16.10.25. protection | | |

electric accessories

cables

ribbon cables

group 1



1

| | | | |
|--------------------|--|-----------------|-------|
| GEV No. | 400228 | Ref. No. | 70528 |
| description | ribbon cable 16-pole L 600mm plug type FC-16P raster size 2.54mm | | |



1

| | | | |
|--------------------|---|-----------------|------|
| GEV No. | 402841 | Ref. No. | 3443 |
| description | ribbon cable 26-pole L 1000mm plug type FC-26P raster size 2.54mm with insulation | | |

cable harnesses



1

| | | | |
|--------------------|---|-----------------|-------|
| GEV No. | 551191 | Ref. No. | 11029 |
| description | cable harness for thermal fuse 1.5mm ² 2-pole L 100mm white plug type Faston 6.3mm | | |

terminals

porcelain clamps



1

| | | | |
|--------------------|---|-----------------|-------|
| GEV No. | 550112 | Ref. No. | 10360 |
| description | porcelain terminal block 2-pole 2.5mm ² max. 10A max 250V t.max. 200°C L 22mm W 17mm H 15mm mounting distance mm Qty 1 pcs | | |

gas valves and ignition boxes

gas control valves

HONEYWELL



1

| | | | | |
|------------------------|--|-----------------|-----------------|---|
| GEV No. | 106004 | Ref. No. | 11017 | |
| description | gas valve type VK4105C 220-240V 50/60Hz gas inlet flange 32x32mm gas outlet flange 32x32mm thermocouple connection pilot connection pressure range 15-60mbar max 60mbar operator type pressure controller type V5306E 1234 1 suitable for HONEYWELL flange 32x32mm | | | |
| accessories for | 106004 | | | |
| | GEV No. | 102845 | Ref. No. | — |
| | gas connection angled 1/2" flange 32x32mm hole distance 24x24mm Tandem | | | |
| | GEV No. | 102846 | Ref. No. | — |
| | gas connection straight 1/2" flange 32x32mm hole distance 24x24mm suitable for Tandem | | | |

SIT





ELETTROSIT



1







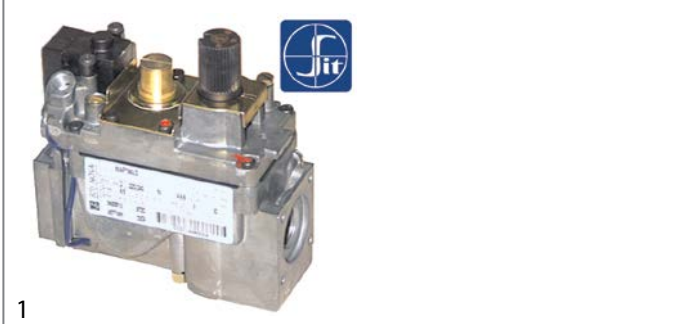

| | | | | |
|------------------------|--|-----------------|-----------------|---|
| GEV No. | 101127 | Ref. No. | 766 | |
| description | gas valve SIT type ELETTROSIT 230V gas inlet 3/4" gas outlet 3/4" thermocouple connection M9x1 pilot connection M10x1 lateral equiv. no. 0.810.175 | | | |
| spare parts for | 101127 | | | |
| | GEV No. | 101312 | Ref. No. | — |
| | microswitch | | | |
| | GEV No. | 101352 | Ref. No. | — |
| | solenoid coil 230V 50Hz suitable for ELETTROSIT | | | |
| accessories for | 101127 | | | |
| | GEV No. | 100006 | Ref. No. | — |
| | piezoelectric igniter suitable for ELETTROSIT body plastic blowing connection ø2.4mm ø 14mm | | | |
| | GEV No. | 100904 | Ref. No. | — |
| | locking screw M10x1 for pipe ø 4mm Qty 1 pcs | | | |



Table continues overleaf

| accessories for 101127 | | | | |
|---|--|--------|----------|---|
|  | GEV No. | 100905 | Ref. No. | — |
| | locking screw M10x1 for pipe ø 6mm Qty 1 pcs | | | |
|  | GEV No. | 101301 | Ref. No. | — |
| | gas connection thread 1/2" straight ELETTROSIT screw with O-ring | | | |
|  | GEV No. | 101303 | Ref. No. | — |
| | gas connection straight thread 3/4" ELETTROSIT | | | |
|  | GEV No. | 101309 | Ref. No. | — |
| | extension | | | |

NOVASIT



| | | | | |
|---|--|-----------------|----------|---|
| 1 | | | | |
| GEV No. | 101162 | Ref. No. | 3015 | |
| description | gas valve SIT series Novasit 820 230V 50Hz gas inlet 1/2" gas outlet 1/2" thermocouple connection M9x1 pilot connection M10x1 ignition pressure 3-5mbar pressure range 3-30mbar pressure regulator connection blind equiv. no. 0.820.010 | | | |
| spare parts for | 101162 | | | |
|  | GEV No. | 101065 | Ref. No. | — |
| | magnet unit with cable L 44mm D1 ø 30mm D2 ø 20mm suitable for NOVASIT | | | |
|  | GEV No. | 101313 | Ref. No. | — |
| | solenoid coil 230V 50Hz | | | |
| accessories for | 101162 | | | |
|  | GEV No. | 100006 | Ref. No. | — |
| | piezoelectric igniter suitable for ELETTROSIT body plastic blowing connection ø2.4mm ø 14mm | | | |
|  | GEV No. | 101305 | Ref. No. | — |
| | gas connection straight 1/2" flange 45x45mm ELETTROSIT/V4400/4600/4605 suitable for SIT/HONEYWELL hole distance 36x36mm | | | |
|  | GEV No. | 101306 | Ref. No. | — |
| | gas connection angled flange 45x45mm hole distance 36x36mm 1/2" ELETTROSIT/V4400/4600/4605 screw with O-ring suitable for SIT/HONEYWELL | | | |
|  | GEV No. | 101307 | Ref. No. | — |
| | gas connection straight flange 45x45mm hole distance 36x36mm 3/4" ELETTROSIT/V4400/4600/4605 screw with O-ring suitable for SIT/HONEYWELL | | | |
|  | GEV No. | 101308 | Ref. No. | — |
| | gas connection angled flange 45x45mm hole distance 36x36mm 3/4" ELETTROSIT/V4400/4600/4605 screw with O-ring suitable for SIT/HONEYWELL | | | |
|  | GEV No. | 101312 | Ref. No. | — |
| | microswitch | | | |
|  | GEV No. | 101314 | Ref. No. | — |
| | solenoid coil 24V 50Hz | | | |

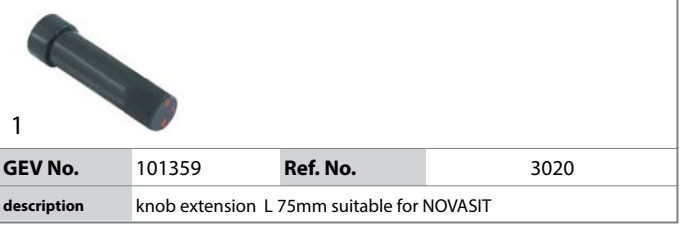

| accessories for 101162 | | | | |
|---|--|--------|----------|---|
|  | GEV No. | 101317 | Ref. No. | — |
| | plug with cable L 1000mm suitable for NOVASIT | | | |
|  | GEV No. | 101318 | Ref. No. | — |
| | cover cap for solenoid coil suitable for NOVASIT | | | |

accessories

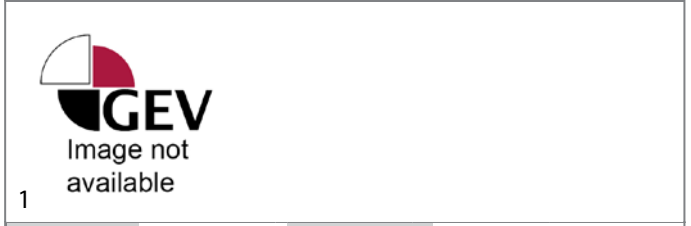

| | | | | |
|--------------------|--|-----------------|------|--|
| 1 |  | | | |
| GEV No. | 101359 | Ref. No. | 3020 | |
| description | knob extension L 75mm suitable for NOVASIT | | | |

SIGMA



| | | | | |
|---|--|-----------------|----------|---|
| 1 | | | | |
| GEV No. | 107499 | Ref. No. | 11140 | |
| description | gas valve 230V 50Hz gas inlet 3/4" gas outlet 3/4" SIT equiv. no. 0.848.049 | | | |
| spare parts for | 107499 | | | |
|  | GEV No. | 106214 | Ref. No. | — |
| | solenoid coil 230V 50Hz Sigma | | | |
| accessories for | 107499 | | | |
|  | GEV No. | 107222 | Ref. No. | — |
| | plug for solenoid valve 3-pole cable length 1070mm | | | |









| | | | | |
|---|---|-----------------|----------|---|
| 1 |  | | | |
| GEV No. | 107498 | Ref. No. | 11009 | |
| description | gas valve type Sigma 230V 50Hz gas inlet 1/2" gas outlet 1/2" pressure range 2-50mbar | | | |
| spare parts for | 107498 | | | |
|  | GEV No. | 106214 | Ref. No. | — |
| | solenoid coil 230V 50Hz Sigma | | | |
| accessories for | 107498 | | | |
|  | GEV No. | 107222 | Ref. No. | — |
| | plug for solenoid valve 3-pole cable length 1070mm | | | |



TANDEM



| | | | | |
|---|--|-----------------|-----------------|---|
| 1 | | | | |
| GEV No. | 101984 | Ref. No. | 11002 | |
| description | gas valve 230V 50Hz gas inlet 1/2" gas outlet 1/2" pilot connection level slow ignition ignition times pressure range 2-50mbar power supply for modulator 230VAC rectified Tandem equiv. no. 0.836.010 | | | |
| spare parts for | 101984 | | | |
|  | GEV No. | 101379 | Ref. No. | — |
| | solenoid coil 230V 50Hz suitable for Tandem | | | |
| accessories for | 101984 | | | |
|  | GEV No. | 101274 | Ref. No. | — |
| | olive for pipe ø 16mm Qty 1 pcs | | | |
|  | GEV No. | 101275 | Ref. No. | — |
| | union screw thread 1/2" for pipe ø 16mm Qty 1 pcs | | | |
|  | GEV No. | 101925 | Ref. No. | — |
| | plug with O-ring thread M10x1 for pilot burner suitable for NOVASIT | | | |
|  | GEV No. | 102845 | Ref. No. | — |
| | gas connection angled 1/2" flange 32x32mm hole distance 24x24mm Tandem | | | |
|  | GEV No. | 102846 | Ref. No. | — |
| | gas connection straight 1/2" flange 32x32mm hole distance 24x24mm suitable for Tandem | | | |
|  | GEV No. | 102847 | Ref. No. | — |
| | O-ring | | | |

ignition boxes

HONEYWELL



| | | | | |
|---|--|-----------------|-----------------|---|
| 1 | | | | |
| GEV No. | 101165 | Ref. No. | 11003 11020 | |
| description | ignition box HONEYWELL type S4560A 1008 equiv. no. S4560A 1008 electrodes 1 waiting time 0s safety time 10s 220-240V 10VA 50Hz | | | |
| spare parts for | 101165 | | | |
|  | GEV No. | 358696 | Ref. No. | — |
| | fine fuse size ø5x20mm 4A medium lag rated 250V Qty 10 pcs | | | |

Honeywell



| | | | | |
|--------------------|---|-----------------|-------|--|
| 1 | | | | |
| GEV No. | 102367 | Ref. No. | 11016 | |
| description | ignition box HONEYWELL type S4565A 2092 1 electrodes 3 waiting times safety time 10s 220-240V 4VA 50/60Hz | | | |

SIT



| | | | | |
|--------------------|---|-----------------|-------|--|
| 1 | | | | |
| GEV No. | 102309 | Ref. No. | 11010 | |
| description | ignition box SIT type 537ABC electrodes 3 waiting time 1.5s safety time 10s 230V 10VA 50-60Hz protection IP44 | | | |

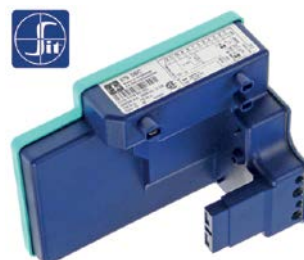

| | | | | |
|--------------------|--|-----------------|-------|--|
| 1 | | | | |
| GEV No. | 107497 | Ref. No. | 11147 | |
| description | ignition box SIT type 579DBC electrodes 1 waiting time 1s safety time 5s 220/240V 12VA 50/60Hz | | | |

ignition parts

pilot burners

SIT

100 series



| | | | |
|----------------|--------|-----------------|-----|
| GEV No. | 106906 | Ref. No. | 836 |
|----------------|--------|-----------------|-----|

description pilot burner SIT type 100 series 3 flames nozzle \varnothing 0.2mm gas connection 6mm

spare parts for 106906

| | | | |
|----------------|--------|-----------------|---|
| GEV No. | 100245 | Ref. No. | — |
|----------------|--------|-----------------|---|

description pilot burner nozzle LPG code 20 bore \varnothing 0.2mm Qty 1 pcs thread M8x0.75

| | | | |
|----------------|--------|-----------------|---|
| GEV No. | 100855 | Ref. No. | — |
|----------------|--------|-----------------|---|

description pilot burner bracket triple

| | | | |
|----------------|--------|-----------------|---|
| GEV No. | 100885 | Ref. No. | — |
|----------------|--------|-----------------|---|

description air mixing sleeve for pilot burner Qty 1 pcs

| | | | |
|----------------|--------|-----------------|---|
| GEV No. | 100916 | Ref. No. | — |
|----------------|--------|-----------------|---|

description compression spring for pilot burner Qty 1 pcs

| | | | |
|----------------|--------|-----------------|---|
| GEV No. | 100917 | Ref. No. | — |
|----------------|--------|-----------------|---|

description gasket for pilot burner Qty 1 pcs aluminium

| | | | |
|----------------|--------|-----------------|---|
| GEV No. | 100918 | Ref. No. | — |
|----------------|--------|-----------------|---|

description screw for pilot burner

| | | | |
|----------------|--------|-----------------|---|
| GEV No. | 107162 | Ref. No. | — |
|----------------|--------|-----------------|---|

description pilot burner cap SIT 3 flames Hmm Lmm Qty 1 pcs

| | | | |
|----------------|--------|-----------------|---|
| GEV No. | 107701 | Ref. No. | — |
|----------------|--------|-----------------|---|

description pilot burner bottom part SIT 100 series nozzle \varnothing 0.2mm

accessories for 106906

| | | | |
|----------------|--------|-----------------|---|
| GEV No. | 100245 | Ref. No. | — |
|----------------|--------|-----------------|---|

description pilot burner nozzle LPG code 20 bore \varnothing 0.2mm Qty 1 pcs thread M8x0.75

| | | | |
|----------------|--------|-----------------|---|
| GEV No. | 100246 | Ref. No. | — |
|----------------|--------|-----------------|---|

description pilot burner nozzle natural gas bore \varnothing 0.35mm Qty 1 pcs thread M8x0.75

| | | | |
|----------------|--------|-----------------|---|
| GEV No. | 100904 | Ref. No. | — |
|----------------|--------|-----------------|---|

description locking screw M10x1 for pipe \varnothing 4mm Qty 1 pcs

| | | | |
|----------------|--------|-----------------|---|
| GEV No. | 100905 | Ref. No. | — |
|----------------|--------|-----------------|---|

description locking screw M10x1 for pipe \varnothing 6mm Qty 1 pcs

| | | | |
|----------------|--------|-----------------|---|
| GEV No. | 102110 | Ref. No. | — |
|----------------|--------|-----------------|---|

description pilot tube copper pipe \varnothing 4mm thickness 1mm L 3000mm

| | | | |
|----------------|--------|-----------------|---|
| GEV No. | 102111 | Ref. No. | — |
|----------------|--------|-----------------|---|

description pilot tube copper pipe \varnothing 6mm thickness 1mm L 3000mm

| | | | |
|------------------------|--|-----------------|---|
| accessories for | 106906 | | |
| GEV No. | 107171 | Ref. No. | — |
| description | pilot burner nozzle SIT natural/liquid gas bore \varnothing 0.25mm Qty 1 pcs | | |
| GEV No. | 107700 | Ref. No. | — |
| description | pilot burner bottom part SIT 100 series nozzle \varnothing 0.25mm | | |
| GEV No. | 107702 | Ref. No. | — |
| description | pilot burner bottom part SIT 100 series nozzle \varnothing 0.35mm | | |

accessories

ignition electrodes

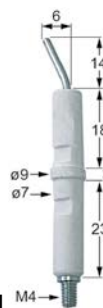

| | | | |
|----------------|--------|-----------------|-----|
| GEV No. | 100706 | Ref. No. | 832 |
|----------------|--------|-----------------|-----|

description ignition electrode connection M4 Qty 1 pcs

electrodes

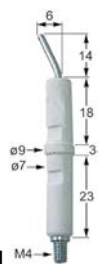

| | | | |
|----------------|--------|-----------------|-----|
| GEV No. | 100706 | Ref. No. | 832 |
|----------------|--------|-----------------|-----|

description ignition electrode connection M4 Qty 1 pcs



| | | | |
|----------------|--------|-----------------|----------------|
| GEV No. | 102342 | Ref. No. | 11001 11007 |
|----------------|--------|-----------------|----------------|

description ignition electrode flange length 24mm flange width 17mm D1 \varnothing 9.5mm L1 48mm L2 13mm L3 15mm BL1 24mm BL2 35mm fixing dimensions \varnothing 4.5mm with flange connection \varnothing 4mm



ignition cables

pre-assembled cables



| | | | | |
|--|----------------|--------|-----------------|------|
| 1 | GEV No. | 100026 | Ref. No. | 3958 |
| description ignition cable cable length 1000mm connection ø4mm / F6.3mm | | | | |



| | | | | |
|--|----------------|--------|-----------------|------|
| 1 | GEV No. | 102190 | Ref. No. | 3974 |
| description ignition cable cable length 1500mm connection ø4mm / F2.8mm | | | | |



| | | | | |
|--|----------------|--------|-----------------|------|
| 1 | GEV No. | 102270 | Ref. No. | 3959 |
| description ignition cable cable length 1500mm connection ø4mm / F6.3mm | | | | |



| | | | | |
|---|----------------|--------|-----------------|------|
| 1 | GEV No. | 102155 | Ref. No. | 3973 |
| description ignition cable cable length 900mm connection ø4mm / F2.8mm | | | | |

ignition units



| | | | | |
|---|----------------|--------|-----------------|-----|
| 1 | GEV No. | 101002 | Ref. No. | 825 |
| description ignition unit outputs 2 230VAC dimensions 88x23x34mm mounting distance 73mm inlet F6.3x0.8 outlet F2.8x0.8 0.6VA 50/60Hz | | | | |

thermocouples

plug-in thermocouples

plug-in thermocouples standard

with barrel socket ø6(6.5)mm

thermocouples SIT

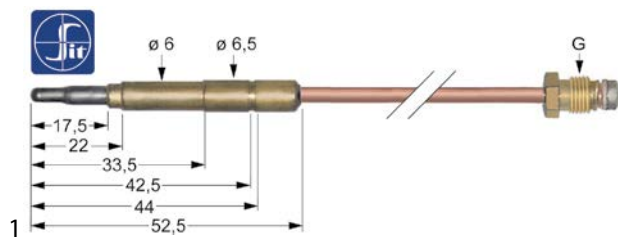

| | | | | |
|---|----------------|--------|-----------------|------|
| 1 | GEV No. | 107612 | Ref. No. | 1668 |
| description thermocouple SIT M9x1 L 1000mm plug connection ø6.0(6.5)mm | | | | |

gas burners

bar burners

bar burners



| | | | | |
|--|----------------|--------|-----------------|-------|
| 1 | GEV No. | 105788 | Ref. No. | 0767A |
| description bar burner 1-row ø 50mm Wmm Hmm L 483mm flange width 71mm convection oven flange ø 75mm | | | | |



| | | | | |
|---|----------------|--------|-----------------|-----|
| 1 | GEV No. | 105787 | Ref. No. | 768 |
| description bar burner ø 40mm Wmm Hmm L 415mm flange width 43mm flange length 43mm convection oven | | | | |



| | | | | |
|---|----------------|--------|-----------------|------|
| 1 | GEV No. | 105790 | Ref. No. | 3131 |
| description bar burner ø 50mm Wmm Hmm L 325mm flange width 57mm flange length 57mm convection oven | | | | |



| | | | | |
|---|----------------|--------|-----------------|----------------|
| 1 | GEV No. | 105791 | Ref. No. | 11031 11032 |
| description bar burner ø 50mm Wmm Hmm L 375mm flange width 57mm flange length 57mm convection oven | | | | |



| | | | | |
|--|----------------|--------|-----------------|---------------|
| 1 | GEV No. | 105789 | Ref. No. | 11030 1361 |
| description bar burner ø 50mm Wmm Hmm L 618mm flange width 71mm convection oven flange ø 75mm | | | | |

equipment-specific units

for convection ovens/combi-steamers

injection pipes



1

| | | | |
|--------------------|--|-----------------|------|
| GEV No. | 692310 | Ref. No. | 3872 |
| description | injection pipe for convection oven ED ø 8mm ID ø 6mm L 180mm | | |

glass panels



1

| | | | |
|--------------------|---|-----------------|-------|
| GEV No. | 693985 | Ref. No. | 15196 |
| description | glass panel L 443mm W 543mm thickness 4mm | | |



1

| | | | |
|--------------------|---|-----------------|----------------|
| GEV No. | 691937 | Ref. No. | 15202 15205 |
| description | glass panel L 543mm W 442mm thickness 4mm | | |



1

| | | | |
|--------------------|---|-----------------|-------|
| GEV No. | 694355 | Ref. No. | 15146 |
| description | glass panel L 745mm W 355mm thickness 4mm | | |

for ovens

glass panels



1

| | | | |
|--------------------|---|-----------------|-------|
| GEV No. | 691812 | Ref. No. | 15190 |
| description | glass panel L 432mm W 346mm thickness 4mm | | |

handles and hand wheels

mushroom cap handles



1

| | | | |
|--------------------|--|-----------------|-----|
| GEV No. | 111411 | Ref. No. | 382 |
| description | mushroom cap handle thread M6 handle ø 26mm ø 17mm L 17mm plastic black matt | | |

locks

handle latches





universal

outside fixing

locks



1

| | | | |
|---|---|-----------------|-----------------------|
| GEV No. | 694065 | Ref. No. | 90199 |
| description | door handle for headed units L 145mm W 40mm H 62mm spring length 33mm outer black | | |
| spare parts for | 694065 | | |
|  | GEV No. | 514390 | Ref. No. 15057 |
| | spring for door handle ø 6mm L 54mm W 27.5mm | | |
|  | GEV No. | 694734 | Ref. No. — |
| | door handle L 165mm W 40mm H 25mm black | | |
|  | GEV No. | 694735 | Ref. No. — |
| | cap ø 32mm black | | |
| accessories for | 694065 | | |
|  | GEV No. | 694066 | Ref. No. 3772 |
| | door catch with spigot 2-stage L 28mm W 14mm H 15mm H1 16mm total length 51mm thread M8 thread L 23mm stainless steel | | |
|  | GEV No. | 694067 | Ref. No. — |
| | door catch with spigot 1-stage L 26mm total length 51mm thread M8 | | |



edgmount latches

handle latches

CAFF/FERMOD

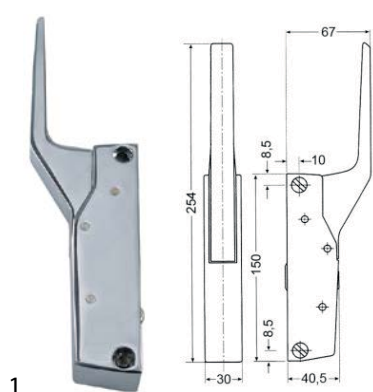

| | | | |
|----------------|--------|-----------------|------|
| GEV No. | 700060 | Ref. No. | 1496 |
|----------------|--------|-----------------|------|

description handle latch L 150mm mounting distance 133mm non lockable heated units G 791

accessories for 700060

| | | | | |
|--|----------------|--------|-----------------|------|
| | GEV No. | 700061 | Ref. No. | 1500 |
| description door catch L 58mm W 20mm H 35mm mounting distance 42mm chrome-plated brass for headed units | | | | |

| | | | | |
|---|----------------|--------|-----------------|---|
| | GEV No. | 700062 | Ref. No. | — |
| description handle protection heated units | | | | |

door catches



| | | | |
|----------------|--------|-----------------|------|
| GEV No. | 700061 | Ref. No. | 1500 |
|----------------|--------|-----------------|------|

description door catch L 58mm W 20mm H 35mm mounting distance 42mm chrome-plated brass for headed units

accessories for 700061

| | | | | |
|--|----------------|--------|-----------------|---|
| | GEV No. | 690414 | Ref. No. | — |
| description handle latch L 150mm mounting distance 133mm non lockable refrigeration units G 791 | | | | |

snap locks

universal



| | | | |
|----------------|--------|-----------------|-----|
| GEV No. | 690864 | Ref. No. | 285 |
|----------------|--------|-----------------|-----|

description door catch L 38mm W 13mm H 21mm mounting distance 28mm zamak with spigot



| | | | |
|--------------------|--|-----------------|-------|
| GEV No. | 690863 | Ref. No. | 0285B |
| description | snap lock L 60mm W 16mm mounting distance 48mm spring thickness 1.5mm without door catch zamak | | |



| | | | |
|--------------------|--|-----------------|-------|
| GEV No. | 690903 | Ref. No. | 0117B |
| description | snap lock L 69mm W 13mm H 20mm mounting distance 57mm complete with door catch nickel-plated brass | | |

hinges

oven hinges

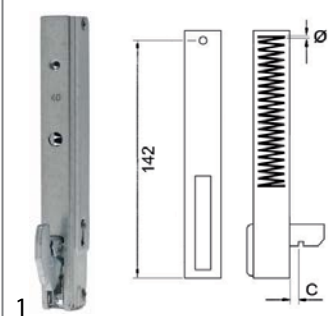

| | | | |
|----------------|--------|-----------------|-------|
| GEV No. | 700390 | Ref. No. | 15062 |
|----------------|--------|-----------------|-------|

description oven hinge mounting distance 142mm mounting distance 2mm lug mountingmm lever lengthmm groove distance 12mm spring thickness 3mm mounting ear position spring length 116mm L 170mm mounting pos. left/right W 22mm

door bearing





| | | | |
|--------------------|--|-----------------|-------|
| GEV No. | 514306 | Ref. No. | 0045D |
| description | hinge bearing mounting pos. bottom left without bolt | | |





| | | | |
|--------------------|--|-----------------|-------|
| GEV No. | 514308 | Ref. No. | 1004A |
| description | hinge bearing mounting pos. bottom left without bolt | | |

| | |
|---|--|
|  | |
| 1 | |
| GEV No. | 514310 |
| Ref. No. | 0321.05 |
| description | hinge bearing mounting pos. bottom left without bolt |

| | |
|---|--|
|  | |
| 1 | |
| GEV No. | 514313 |
| Ref. No. | 12025 |
| description | hinge bearing mounting pos. lower without bolt |

| | |
|---|--|
|  | |
| 1 | |
| GEV No. | 514315 |
| Ref. No. | 30082 |
| description | hinge bearing mounting pos. lower without bolt |

| | |
|--|---|
|  | |
| 1 | |
| GEV No. | 514305 |
| Ref. No. | 0046B |
| description | hinge bearing mounting pos. upper left without bolt |

| | |
|---|---|
|  | |
| 1 | |
| GEV No. | 514307 |
| Ref. No. | 1003A 12178 |
| description | hinge bearing mounting pos. upper left without bolt |

| | |
|---|---|
|  | |
| 1 | |
| GEV No. | 514309 |
| Ref. No. | 0322C |
| description | hinge bearing mounting pos. upper left without bolt |

| | |
|--|---|
|  | |
| 1 | |
| GEV No. | 514311 |
| Ref. No. | 15.0007.01 |
| description | hinge bearing mounting pos. upper left without bolt |

| | |
|--|---|
|  | |
| 1 | |
| GEV No. | 514312 |
| Ref. No. | 12024 |
| description | hinge bearing mounting pos. upper left without bolt |

| | |
|--|---|
|  | |
| 1 | |
| GEV No. | 514314 |
| Ref. No. | 30083 |
| description | hinge bearing mounting pos. upper left without bolt |

gaskets

refrigeration gaskets

plug-in gaskets

profile 9048

We offer custom-made gaskets for this profile

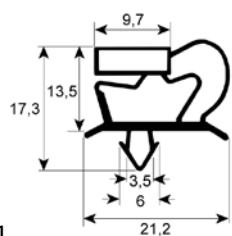
| | |
|--|---|
|  | |
| 1 | |
| GEV No. | 900345 |
| Ref. No. | 74001 |
| description | refrigeration gasket profile 9048 W 410mm L 670mm plug size for blast chiller |

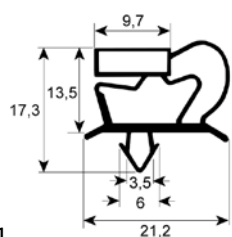
| | |
|--|---|
|  | |
| 1 | |
| GEV No. | 901211 |
| Ref. No. | 74002 |
| description | refrigeration gasket profile 9048 W 555mm L 705mm plug size for blast chiller |

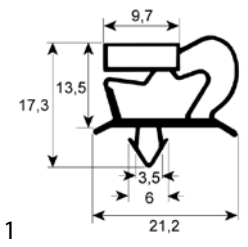
| | | | |
|---|---|-----------------|-------|
|  | | | |
| GEV No. | 901209 | Ref. No. | 74003 |
| description | refrigeration gasket profile 9048 W 710mm L 835mm plug size for blast chiller | | |

gaskets for heated units

window seals

| | | | |
|---|---|-----------------|-------|
|  | | | |
| GEV No. | 900463 | Ref. No. | 30093 |
| description | window gasket profile 1650 L 1110mm Qty 1 | | |

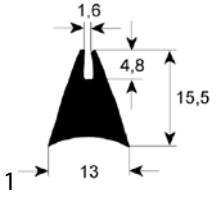

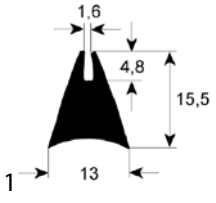
| | | | |
|--|---|-----------------|--------------------|
|  | | | |
| GEV No. | 900472 | Ref. No. | 1441 490 498 |
| description | window gasket profile 1650 L 1700mm Qty 1 | | |

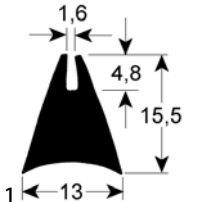

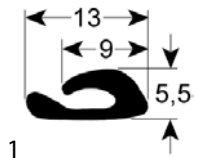
| | | | |
|---|---|-----------------|-------------|
|  | | | |
| GEV No. | 900473 | Ref. No. | 1444 489 |
| description | window gasket profile 1650 L 2250mm Qty 1 | | |

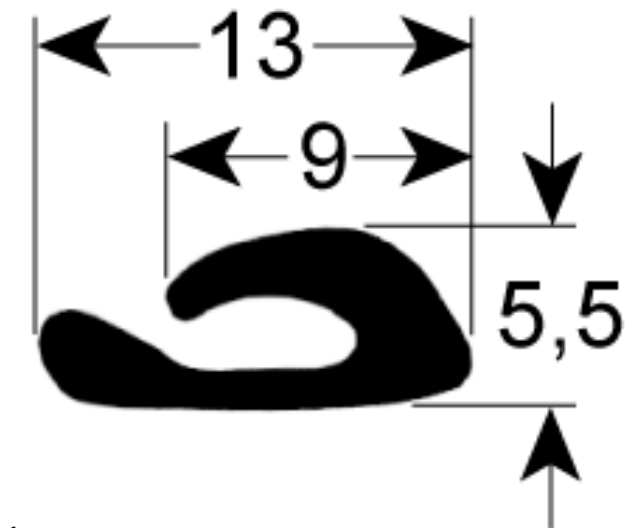
| | | | |
|---|--|-----------------|-----|
|  | | | |
| GEV No. | 900881 | Ref. No. | N/A |
| description | window gasket profile 1650 Qty supplied by meter | | |

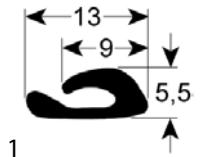
| | | | |
|--|---|-----------------|-------|
|  | | | |
| GEV No. | 900469 | Ref. No. | 14017 |
| description | window gasket profile 1880 L 1385mm Qty 1 | | |

| | | | |
|--|---|-----------------|------|
|  | | | |
| GEV No. | 902550 | Ref. No. | 0032 |
| description | window gasket profile 1880 L 5170mm Qty 1 | | |

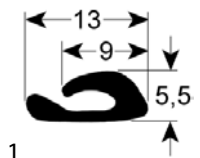
| | | | |
|--|--|-----------------|-------|
|  | | | |
| GEV No. | 900470 | Ref. No. | 14018 |
| description | window gasket profile 1880 L 520mm Qty 1 | | |
| accessories for | 900470 | | |
| | GEV No. | Ref. No. | 14019 |
| |  window gasket profile 1880 L 680mm Qty 1 | | |

| | | | |
|--|--|-----------------|-------|
|  | | | |
| GEV No. | 900471 | Ref. No. | 14019 |
| description | window gasket profile 1880 L 680mm Qty 1 | | |
| accessories for | 900470 | | |
| | GEV No. | Ref. No. | 14018 |
| |  window gasket profile 1880 L 520mm Qty 1 | | |

1

| | | | |
|--------------------|--|-----------------|-------|
| GEV No. | 902549 | Ref. No. | 60327 |
| description | window gasket profile 1880 L 730mm Qty 1 | | |

1

| | | | |
|--------------------|--|-----------------|-------|
| GEV No. | 900882 | Ref. No. | 14002 |
| description | window gasket profile 1880 Qty supplied by meter | | |

door seals

1

| | | | |
|--------------------|--------------------------------------|-----------------|-------|
| GEV No. | 900461 | Ref. No. | 30099 |
| description | door seal profile 2400 L 380mm Qty 1 | | |

1

| | | | |
|--------------------|--|-----------------|------|
| GEV No. | 901325 | Ref. No. | 1443 |
| description | door seal profile 2400 L 410mm external size | | |

1

| | | | |
|--------------------|--------------------------------------|-----------------|-------|
| GEV No. | 900462 | Ref. No. | 30098 |
| description | door seal profile 2400 L 410mm Qty 1 | | |

1

| | | | |
|--------------------|--|-----------------|------|
| GEV No. | 901324 | Ref. No. | 1442 |
| description | door seal profile 2400 L 620mm external size | | |

1

| | | | |
|--------------------|--------------------------------------|-----------------|------|
| GEV No. | 902551 | Ref. No. | 1446 |
| description | door seal profile 2400 L 695mm Qty 1 | | |



| | | | |
|--------------------|--|-----------------|-----|
| GEV No. | 900883 | Ref. No. | N/A |
| description | door seal profile 2400 Qty supplied by meter | | |

| | | | |
|--------------------|--|-----------------|------|
| GEV No. | 900683 | Ref. No. | 3351 |
| description | door seal profile 2400 W 475mm L 645mm Qty 1 | | |

| | | | |
|--------------------|--|-----------------|-------|
| GEV No. | 900934 | Ref. No. | 0271B |
| description | door seal profile 2400 Qty supplied by meter | | |

| | | | |
|--------------------|--|-----------------|-----|
| GEV No. | 900465 | Ref. No. | 323 |
| description | door seal profile 2400 W 480mm L 700mm external size Qty 1 | | |

| | | | |
|--------------------|--|-----------------|-----|
| GEV No. | 900480 | Ref. No. | N/A |
| description | door seal profile 2400 W 390mm L 400mm external size Qty 1 | | |

| | | | |
|--------------------|--|-----------------|--------------|
| GEV No. | 900468 | Ref. No. | 1217 3352 |
| description | door seal profile 2400 W 640mm L 800mm external size Qty 1 | | |

| | | | |
|--------------------|--|-----------------|------|
| GEV No. | 900464 | Ref. No. | 1093 |
| description | door seal profile 2400 W 420mm L 645mm external size Qty 1 | | |

| | | | |
|--------------------|---|-----------------|-------|
| GEV No. | 900475 | Ref. No. | 14013 |
| description | door seal profile 2400 W 685mm L 1465mm external size Qty 1 | | |

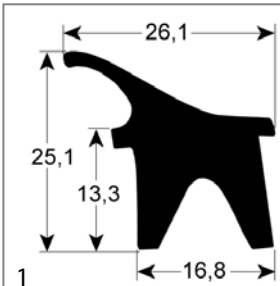

| | | | |
|--------------------|--|-----------------|-------|
| GEV No. | 900474 | Ref. No. | 14014 |
| description | door seal profile 2400 W 685mm L 805mm external size Qty 1 | | |

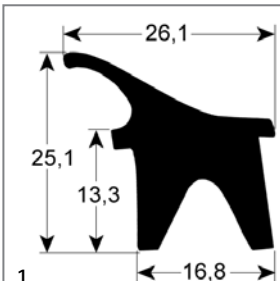

| | | | |
|--------------------|--|-----------------|-----|
| GEV No. | 900466 | Ref. No. | 324 |
| description | door seal profile 2400 W 700mm L 915mm external size Qty 1 | | |

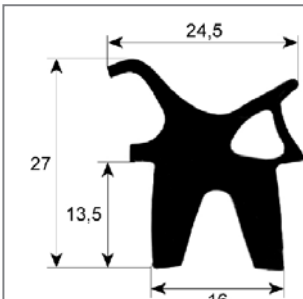

| | | | |
|--|--|-----------------|-----------------|
| GEV No. | 900478 | Ref. No. | 14020 |
| description | door seal profile 2415 L 1465mm mounting pos. left/right Qty 1 | | |
| accessories for | 900478 | | |
|  | GEV No. | 900479 | Ref. No. |
| | | | 14021 |
| | door seal profile 2415 L 635mm mounting pos. upper/lower Qty 1 | | |

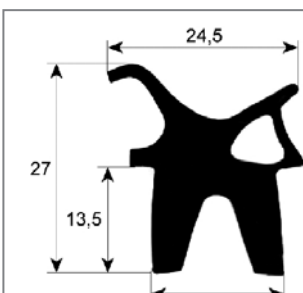

| | | | |
|--|--|-----------------|-----------------|
| GEV No. | 901302 | Ref. No. | 14029 |
| description | door seal profile 2415 L 543mm mounting pos. left/right Qty 1 | | |
| accessories for | 901302 | | |
|  | GEV No. | 901300 | Ref. No. |
| | | | 14028 |
| | door seal profile 2415 L 675mm mounting pos. upper/lower Qty 1 | | |

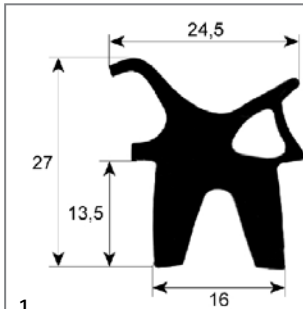

| | | | |
|---|--|-----------------|-----------------|
| GEV No. | 900479 | Ref. No. | 14021 |
| description | door seal profile 2415 L 635mm mounting pos. upper/lower Qty 1 | | |
| accessories for | 900479 | | |
|  | GEV No. | 900478 | Ref. No. |
| | | | 14020 |
| | door seal profile 2415 L 1465mm mounting pos. left/right Qty 1 | | |

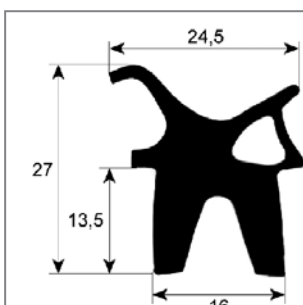

| | | | |
|---|--|-----------------|-----------------|
| GEV No. | 901300 | Ref. No. | 14028 |
| description | door seal profile 2415 L 675mm mounting pos. upper/lower Qty 1 | | |
| accessories for | 901300 | | |
|  | GEV No. | 901302 | Ref. No. |
| | | | 14029 |
| | door seal profile 2415 L 543mm mounting pos. left/right Qty 1 | | |

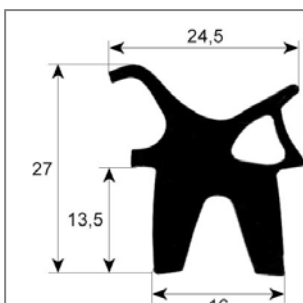

| | | | |
|---|--|-----------------|--|
| GEV No. | 900476 | Ref. No. | 14012 |
| description | door seal profile 2415 L 695mm mounting pos. upper/lower Qty 1 | | |
| accessories for | 900476 | | |
|  | GEV No. | 900477 | Ref. No. |
| | | | 14011 14012 14013 14014 14021 14028 |
| | door seal profile 2415 L 805mm mounting pos. left/right Qty 1 | | |

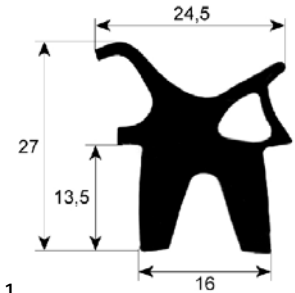
| | | | |
|---|--|-----------------|--|
| GEV No. | 900477 | Ref. No. | 14011 14012 14013 14014 14021 14028 |
| description | door seal profile 2415 L 805mm mounting pos. left/right Qty 1 | | |
| accessories for | 900477 | | |
|  | GEV No. | 900476 | Ref. No. 14012 |
| description | door seal profile 2415 L 695mm mounting pos. upper/lower Qty 1 | | |

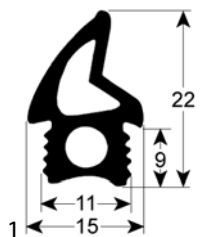

| | | | |
|--------------------|---------------------------------|-----------------|-------|
| GEV No. | 900879 | Ref. No. | 60320 |
| description | door seal profile 2768 L 2020mm | | |

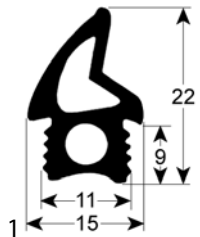

| | | | |
|--------------------|---------------------------------|-----------------|-------|
| GEV No. | 901713 | Ref. No. | 60321 |
| description | door seal profile 2768 L 2700mm | | |

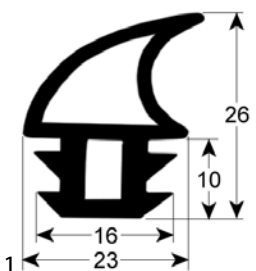

| | | | |
|--------------------|---|-----------------|-------|
| GEV No. | 902166 | Ref. No. | 14082 |
| description | door seal profile 2749 W 660mm L 1450mm external size suitable for FOINOX | | |

door seals with fixing hook



| | | | |
|--------------------|---|-----------------|-----|
| GEV No. | 900811 | Ref. No. | 161 |
| description | door seal L 320mm W 240mm external size | | |

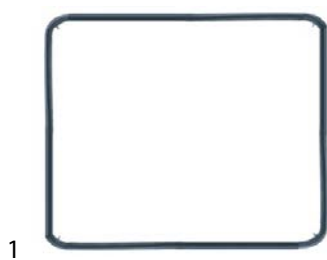

| | | | |
|--------------------|---|-----------------|-----|
| GEV No. | 900810 | Ref. No. | 162 |
| description | door seal L 360mm W 290mm with 8 mounting clips external size | | |

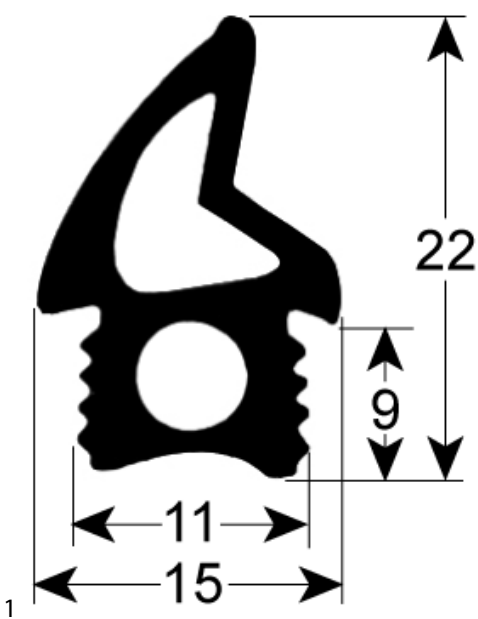

| | | | |
|--------------------|---------------------------------------|-----------------|-------|
| GEV No. | 902548 | Ref. No. | 61558 |
| description | door seal profile 2768 L 1952mm Qty 1 | | |



| | | | |
|--------------------|---|-----------------|-------|
| GEV No. | 900307 | Ref. No. | 14070 |
| description | door seal L 480mm W 380mm type ECG Speedy external size | | |



1

| | | | |
|--------------------|--|-----------------|-------|
| GEV No. | 901299 | Ref. No. | 14076 |
| description | door seal W 620mm with mounting clip H 360mm | | |



1

| | | | |
|--------------------|--|-----------------|-------|
| GEV No. | 901342 | Ref. No. | 14073 |
| description | oven gasket L 620mm W 270mm with 10 mounting clips plug size | | |

sealing washers

silicone gaskets



1

| | | | |
|--------------------|---|-----------------|---------|
| GEV No. | 359721 | Ref. No. | 0812.01 |
| description | gasket silicone ED ø 48mm ID ø 39.5mm thickness 5mm Qty 1 pcs | | |

shaft gaskets

shaft gaskets



1

| | | | |
|--------------------|----------------------|-----------------|-----|
| GEV No. | 698247 | Ref. No. | 689 |
| description | shaft seal ID ø 15mm | | |

evaporators

for fridges

producer-specific



1

| | | | |
|--------------------|--|-----------------|-------|
| GEV No. | 750301 | Ref. No. | 71041 |
| description | evaporator L 700mm W 440mm H 100mm suitable for FOINOX | | |

hose reels and spray guns

spray guns



1

| | | | | |
|---|--|-----------------|-----------------|---|
| GEV No. | 691048 | Ref. No. | 1518.01 | |
| description | spray gun for appliances 1/2" ET L 225mm type STAR | | | |
| spare parts for | 691048 | | | |
|  | GEV No. | 507309 | Ref. No. | — |
| | O-ring EPDM thickness 2.62mm ID ø 17.13mm Qty 1 pcs | | | |
|  | GEV No. | 510322 | Ref. No. | — |
| | O-ring EPDM thickness 1.78mm ID ø 17.17mm Qty 1 pcs | | | |
|  | GEV No. | 524055 | Ref. No. | — |
| | flat gasket rubber ED ø 18mm ID ø 12mm thickness 2mm Qty 1 pcs | | | |
|  | GEV No. | 528485 | Ref. No. | — |
| | O-ring EPDM thickness 1.78mm ID ø 6.07mm Qty 1 pcs | | | |
|  | GEV No. | 528494 | Ref. No. | — |
| | gasket rubber ED ø 13mm ID ø 4mm thickness 4mm Qty 1 pcs | | | |



valves and tank inlets

ball valves

ball valves electric



1

| | | | |
|--------------------|---|-----------------|-------|
| GEV No. | 401233 | Ref. No. | 10036 |
| description | ball valve inlet 1/2" IT outlet 1/2" IT 230V 50/60Hz mode of operation electric W 60mm H 99mm cable 4-pole 2.5W 4-pole duty cycle 50% | | |

measuring equipment

thermometers

built-in thermometers

ø52mm



1

| | | | |
|--------------------|--|-----------------|------------|
| GEV No. | 541077 | Ref. No. | 593 594 |
| description | thermometer mounting ø 52mm t.max. 350°C +50 up to +350°C probe ø 6mm probe L 30mm capillary pipe 1000mm built-in depth 28mm | | |

fastening material

screws

hexagonal screws



1

| | | | |
|--------------------|---|-----------------|-------|
| GEV No. | 560083 | Ref. No. | 17120 |
| description | hexagonal screw thread M5 thread L 10mm SS WS 8 Qty 20 pcs DIN 933 / ISO 4017 | | |

fasteners

roll pins



1

| | | | |
|--------------------|-----------------------|-----------------|------|
| GEV No. | 691637 | Ref. No. | 3780 |
| description | roll pin ø 3mm L 20mm | | |

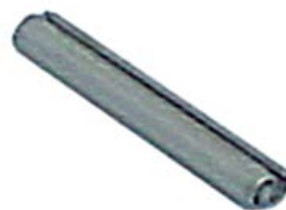

1

| | | | |
|--------------------|-----------------------|-----------------|-------|
| GEV No. | 504003 | Ref. No. | 17022 |
| description | roll pin ø 3mm L 24mm | | |

| | | | |
|---|--------|---------------------------------|----|
| A | | I | |
| alarm devices | 11 | ignition boxes | 25 |
| axial fans | 18 | ignition cables | 27 |
| B | | ignition units | 27 |
| ball valves | 37 | immersion heating elements | 3 |
| ball valves electric | 18, 37 | indicator lights | 8 |
| bar burners | 27 | indicator lights (complete) | 8 |
| C | | L | |
| cables | 23 | lamps | 8 |
| cam switches | 7 | light bulbs | 8 |
| cold air circulating fans (complete) | 19 | M | |
| condensators & interference suppression filters | 23 | magnetic switches | 8 |
| contactors | 12 | measuring equipment | 37 |
| control thermostats | 5 | mechanical timers | 11 |
| D | | microswitches | 6 |
| door catches | 29 | O | |
| door seals | 32 | operating capacitors | 23 |
| door seals with fixing hook | 35 | oven hinges | 29 |
| drain pumps | 22 | oven lamps | 9 |
| E | | P | |
| edgemount latches | 29 | pilot burners | 26 |
| electric accessories | 23 | plug-in gaskets | 30 |
| electrodes | 18 | probes | 15 |
| electronic controllers | 14 | programme timers | 11 |
| energy regulators | 5 | pumps | 22 |
| evaporators | 36 | push/momentary push switches | 6 |
| F | | R | |
| fans | 18 | refrigeration fans | 19 |
| fasteners | 37 | refrigeration gaskets | 30 |
| fastening material | 37 | relays | 12 |
| G | | ribbon cables | 23 |
| gas burners | 27 | roll pins | 37 |
| gas control valves | 23 | S | |
| gaskets for heated units | 31 | safety thermostats | 6 |
| H | | screws | 37 |
| halogen lamp | 9 | sealing washers | 36 |
| handle latches | 29 | shaft gaskets | 36 |
| heating elements | 3 | snap locks | 29 |
| heating elements for convection | 3 | solenoid valves | 17 |
| heating elements for heated cabinets | 3 | spray guns | 36 |
| heating elements for ovens | 3 | spray guns with external thread | 36 |
| hexagonal screws | 37 | switches and momentary switches | 6 |
| hot air fans | 22 | system switches (ROLD) | 7 |
| hot air motors | 20 | T | |
| | | temperature probes | 15 |

| | |
|---------------|----|
| terminals | 23 |
| thermocouples | 27 |
| thermostats | 5 |
| time relays | 13 |
| timers | 11 |
| transformers | 14 |

U

| | |
|------------------|----|
| universal probes | 15 |
|------------------|----|

V

| | |
|------------------------|----|
| valves and tank inlets | 37 |
|------------------------|----|

W

| | |
|--------------|----|
| window seals | 31 |
|--------------|----|