



GAS COMPONENTS



ELECTRIC COMPONENTS



WATER TECHNOLOGY



MECHANICAL COMPONENTS



TOOLS

Spare parts suitable for

MKN

Find the complete and up-to-date range of products in our GEV Webshop



Manufacturer catalogue

The most important spare parts and accessories arranged clearly for every manufacturer

- ✓ Complete product range and all appliance data always up to date in the GEV Webshop
- ✓ Alphabetical Index at the end of the catalogue

GEV Webshop

www.gev-online.co.uk

www.gev-online.com



- 🔍 Add to Favourites
- 🔍 Sign In with email address and usual password
- 🔍 Easy-order – place several items in your basket at the same time
- 🔍 Quick Item search – no login needed



heating elements

heating elements for ovens

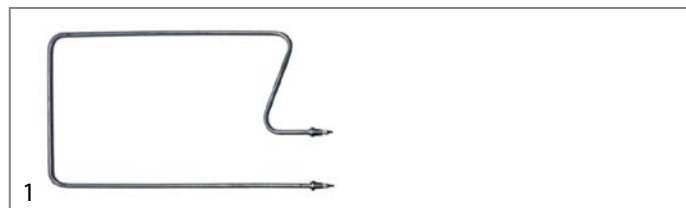

| | | | |
|------------------------|--|-----------------|------------------------|
| GEV No. | 415783 | Ref. No. | 574066 |
| description | heating element 1200W 380V heating circuits 1 L 510mm W 295mm L1 37mm L2 467mm W1 180mm W2 115mm mounting distance 106mm thread M14x1.5 tube ø 8.5mm connection M4 mounting pos. lower-outer dry heating element 2 hole fixing | | |
| accessories for | 415783 | | |
| | GEV No. | 510417 | Ref. No. — |
| | flat gasket fibre ED ø 20mm ID ø 14mm thickness 2mm Qty 1 pcs | | |
| | GEV No. | 520228 | Ref. No. — |
| | tooth lock washer ID ø 15.3mm ED ø 24mm steel Qty 1 pcs for thread M14 | | |
| | GEV No. | 520230 | Ref. No. — |
| | nut thread M14x1.5 H 5mm WS 19 zinc-coated steel Qty 1 pcs | | |
| | GEV No. | 521101 | Ref. No. 113000 |
| | nut thread M14x1.5 H 5mm WS 19 SS Qty 1 pcs | | |
| | GEV No. | 550262 | Ref. No. — |
| | flat gasket copper ED ø 20mm ID ø 14mm thickness 2mm | | |

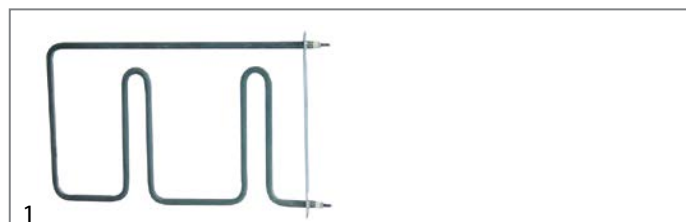

| | | | |
|--------------------|---|-----------------|--------|
| GEV No. | 416448 | Ref. No. | 574089 |
| description | heating element 1275W 230V L 325mm W 202mm flange length 225mm flange width 20mm hole distance 219mm tube ø 8.5mm heating circuits 1 hole ø 5.5mm connection M4 mounting pos. lower rectangular flange dry heating element oven | | |
| For models: | 0522101-01, 0522101-02, 0522101-03, 0522101-04, 1323208-00, 1323208-01, 1323208-02, 1323208-03, 1323208-04, 1323210-00, 1323210-01, 1323210-02, 1323210-03, 1323210-04, 1323403-00, 1323403K00, 1323506-00, 1323506-01, 1323506A00, 1323506A01, 1323517-00, 1323517A00, 1363403-00, 1363403-01, 1363403-02, 1363403-03, 1363403-04, 1363403-05, 1363415-05, 1422102-01, 1422102-02, 1422102-03, 1422102-04, 1422102-05, 1422104-05, 2123203-01, 2123203-02, 2123203-03, 2123203-04, 2123203-05, 2123203-06, 2123203-07, 2123203-08, 2123203A01, 2123203A02, 2123203A03, 2123203A04, 2123204-01, 2123204-02, 2123204-03... (Other models you can see in the webshop) | | |



| | | | |
|------------------------|---|-----------------|------------------------|
| GEV No. | 415784 | Ref. No. | 574067 |
| description | heating element 1300W 380V heating circuits 1 L 442mm W 190mm L1 110mm L2 332mm W1 117mm W2 73mm mounting distance 65mm thread M14x1.5 tube ø 8.5mm connection M4 mounting pos. lower-inner dry heating element 2 hole fixing | | |
| accessories for | 415784 | | |
| | GEV No. | 510417 | Ref. No. — |
| | flat gasket fibre ED ø 20mm ID ø 14mm thickness 2mm Qty 1 pcs | | |
| | GEV No. | 520228 | Ref. No. — |
| | tooth lock washer ID ø 15.3mm ED ø 24mm steel Qty 1 pcs for thread M14 | | |
| | GEV No. | 521101 | Ref. No. 113000 |
| | nut thread M14x1.5 H 5mm WS 19 SS Qty 1 pcs | | |
| | GEV No. | 550262 | Ref. No. — |
| | flat gasket copper ED ø 20mm ID ø 14mm thickness 2mm | | |

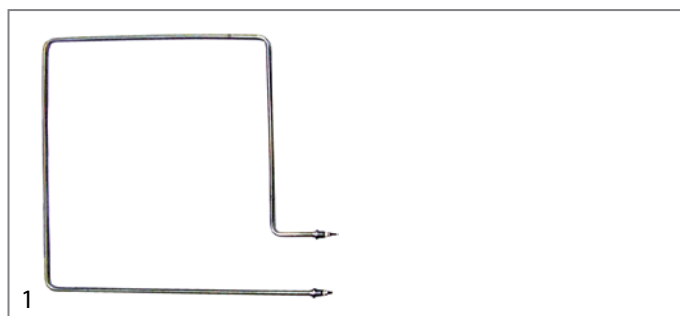



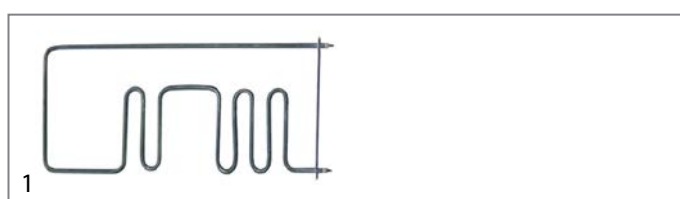

| | | | |
|--------------------|--|-----------------|--------|
| GEV No. | 415787 | Ref. No. | 574081 |
| description | heating element 1450W 400V heating circuits 1 L 502mm W 455mm L1 75mm L2 427mm W1 357mm W2 98mm mounting distance 90mm thread M14x1.5 tube ø 8.5mm connection M4 mounting pos. lower-outer 2 hole fixing | | |
| For models: | 0522101-00, 1422102-00, 2123203-00, 2123203A00, 2123204-00, 2123204A00, 2163403-00, 2163403-01, 2163406-00, 2163406-01, 2163417-00, 2163420-00 | | |

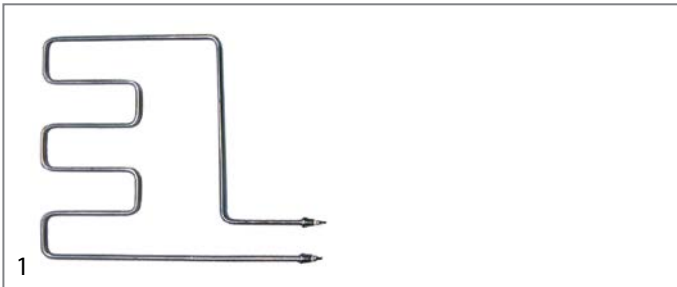





| | | | |
|--------------------|---|-----------------|--------|
| GEV No. | 415570 | Ref. No. | 574087 |
| description | heating element 1500W 230V L 470mm W 200mm flange length 225mm flange width 20mm hole distance 214mm tube ø 8.3mm heating circuits 1 hole ø 6mm connection M4 mounting pos. lower rectangular flange dry heating element oven | | |
| For models: | 0522102-01, 0522102-02, 0522102-03, 0522102-04, 0722101-06, 1422101-01, 1422101-02, 1422101-03, 1422101-04, 1422101-05, 1422101-06, 1422106-05, 1422106-06, 1422301-01, 2023114-00, 2023118-00, 2023119-00, 2023203-01, 2023203-02, 2023203-03, 2023203-04, 2023203-05, 2023203-06, 2023203-07, 2023203A01, 2023203A02, 2023203A03, 2023205-01, 2023205-02, 2023205-03, 2023205-04, 2023205-05, 2023205-06, 2023205-07, 2023205A01, 2023205A02, 2023205A03, 2023207-00, 2023207-01, 2023207-02, 2023207-03, 2023207-04, 2023207-05, 2023406-00, 2023503-02, 2023503-03, 2023503-04, 2023503-05, 2023503-06, 2023503-07... (Other models you can see in the webshop) | | |

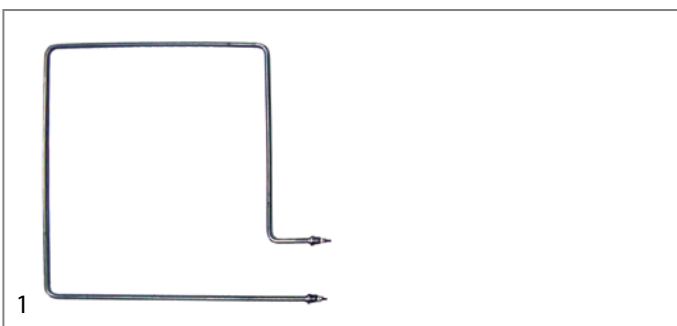

| | | | | |
|---|--|-----------------|----------|--------|
| GEV No. | 415786 | Ref. No. | 574082 | |
| description | heating element 1500W 380V heating circuits 1 L 432mm W 392mm L1 135mm L2 302mm W1 322mm W2 70mm mounting distance 61mm thread M14x1.5 tube ø 8.6mm connection M4 mounting pos. upper inner dry heating element oven 2 hole fixing | | | |
| For models: | 0522101-00, 1422102-00, 2123203-00, 2123203A00, 2123204-00, 2123204A00, 2163403-00, 2163403-01, 2163406-00, 2163406-01, 2163417-00, 2163420-00 | | | |
| accessories for | 415786 | | | |
|  | GEV No. | 510417 | Ref. No. | — |
| | flat gasket fibre ED ø 20mm ID ø 14mm thickness 2mm Qty 1 pcs | | | |
|  | GEV No. | 520228 | Ref. No. | — |
| | tooth lock washer ID ø 15.3mm ED ø 24mm steel Qty 1 pcs for thread M14 | | | |
|  | GEV No. | 520230 | Ref. No. | — |
| | nut thread M14x1.5 H 5mm WS 19 zinc-coated steel Qty 1 pcs | | | |
|  | GEV No. | 521101 | Ref. No. | 113000 |
| | nut thread M14x1.5 H 5mm WS 19 SS Qty 1 pcs | | | |
|  | GEV No. | 550262 | Ref. No. | — |
| | flat gasket copper ED ø 20mm ID ø 14mm thickness 2mm | | | |



| | | | | |
|---|--|-----------------|----------|---|
| GEV No. | 415785 | Ref. No. | 574083 | |
| description | heating element 1500W 380V heating circuits 1 L 505mm W 463mm L1 75mm L2 430mm W1 357mm W2 98mm mounting distance 90mm thread M14x1.5 tube ø 8.5mm connection M4 mounting pos. upper outer dry heating element 2 hole fixing | | | |
| For models: | 0522101-00, 1422102-00, 2123203-00, 2123203A00, 2123204-00, 2123204A00, 2163403-00, 2163403-01, 2163406-00, 2163406-01, 2163417-00, 2163420-00 | | | |
| spare parts for | 415785 | | | |
|  | GEV No. | 510417 | Ref. No. | — |
| | flat gasket fibre ED ø 20mm ID ø 14mm thickness 2mm Qty 1 pcs | | | |
| accessories for | 415785 | | | |
|  | GEV No. | 520228 | Ref. No. | — |
| | tooth lock washer ID ø 15.3mm ED ø 24mm steel Qty 1 pcs for thread M14 | | | |
|  | GEV No. | 520230 | Ref. No. | — |
| | nut thread M14x1.5 H 5mm WS 19 zinc-coated steel Qty 1 pcs | | | |



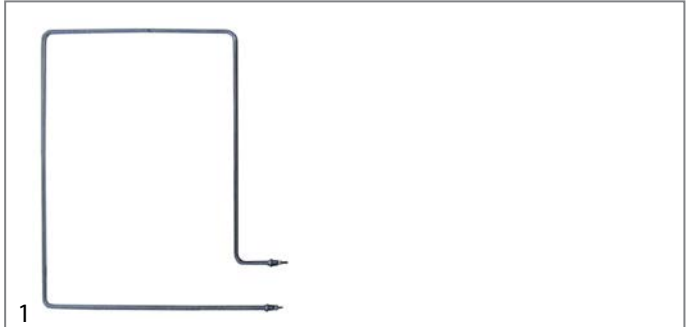

| | | | | |
|---|--|--------|----------|--------|
| accessories for | 415785 | | | |
|  | GEV No. | 521101 | Ref. No. | 113000 |
| | nut thread M14x1.5 H 5mm WS 19 SS Qty 1 pcs | | | |
|  | GEV No. | 550262 | Ref. No. | — |
| | flat gasket copper ED ø 20mm ID ø 14mm thickness 2mm | | | |

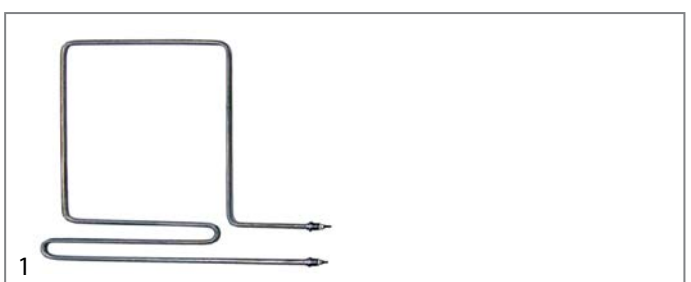







| | | | |
|--------------------|--|-----------------|--------|
| GEV No. | 415810 | Ref. No. | 574068 |
| description | heating element 1500W 400V heating circuits 1 L 495mm W 635mm L1 75mm L2 420mm W1 515mm W2 120mm mounting distance 100mm thread M14x1.5 tube ø 8.5mm connection M4 mounting pos. upper outer 2 hole fixing | | |
| For models: | 0522102-00, 1422101-00, 2023203-00, 2023203A00, 2023205-00, 2023205A00, 2023503-00, 2023503-01, 2023503A00, 2023503A01, 2063403-00, 2063403-01, 2063406-00, 2063406-01, 2063415-00, 2063415-01, 2063418-00, 2063418-01, 2063502-00, 2063502-01, 2063507-00, 2063507-01, 2063509-00, 2063509-01, 2083202A00, 2083502B00, 2083502B01, 2083502C00, 2083502C01 | | |





| | | | |
|--------------------|---|-----------------|--------|
| GEV No. | 415788 | Ref. No. | 574080 |
| description | heating element 1700W 380V heating circuits 1 L 475mm W 386mm L1 140mm L2 295mm L3 40mm W1 320mm W2 66mm mounting distance 58mm thread M14x1.5 tube ø 8.5mm connection M4 mounting pos. lower-inner dry heating element 2 hole fixing | | |
| For models: | 0522101-00, 1422102-00, 2123203-00, 2123203A00, 2123204-00, 2123204A00, 2163403-00, 2163403-01, 2163406-00, 2163406-01, 2163417-00, 2163420-00 | | |



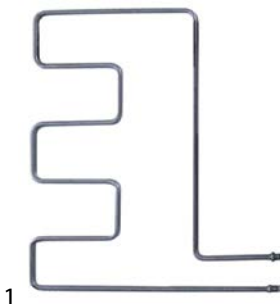

| | | | | |
|---|--|--------|----------|--------|
| accessories for | 415788 | | | |
|  | GEV No. | 510417 | Ref. No. | — |
| | flat gasket fibre ED ø 20mm ID ø 14mm thickness 2mm Qty 1 pcs | | | |
|  | GEV No. | 520228 | Ref. No. | — |
| | tooth lock washer ID ø 15.3mm ED ø 24mm steel Qty 1 pcs for thread M14 | | | |
|  | GEV No. | 520230 | Ref. No. | — |
| | nut thread M14x1.5 H 5mm WS 19 zinc-coated steel Qty 1 pcs | | | |
|  | GEV No. | 521101 | Ref. No. | 113000 |
| | nut thread M14x1.5 H 5mm WS 19 SS Qty 1 pcs | | | |
|  | GEV No. | 550262 | Ref. No. | — |
| | flat gasket copper ED ø 20mm ID ø 14mm thickness 2mm | | | |







| | | | |
|---|--|-----------------|------------------------|
| GEV No. | 415812 | Ref. No. | 574070 574076 |
| description | heating element 1700W 400V heating circuits 1 L 495mm W 635mm L1 75mm L2 420mm W1 515mm W2 120mm mounting distance 110mm thread M14x1.5 tube ø 8.5mm connection M4 mounting pos. lower-outer dry heating element 2 hole fixing | | |
| For models: | 0522102-00, 1422101-00, 2023203-00, 2023203A00, 2023205-00, 2023205A00, 2023503-00, 2023503-01, 2023503A00, 2023503A01, 2063403-00, 2063403-01, 2063406-00, 2063406-01, 2063415-00, 2063415-01, 2063418-00, 2063418-01, 2063502-00, 2063502-01, 2063507-00, 2063507-01, 2063509-00, 2063509-01, 2083202A00, 2083502B00, 2083502B01, 2083502C00, 2083502C01 | | |
| accessories for | 415812 | | |
|  | GEV No. | 510417 | Ref. No. — |
| | flat gasket fibre ED ø 20mm ID ø 14mm thickness 2mm Qty 1 pcs | | |
|  | GEV No. | 520228 | Ref. No. — |
| | tooth lock washer ID ø 15.3mm ED ø 24mm steel Qty 1 pcs for thread M14 | | |
|  | GEV No. | 520230 | Ref. No. — |
| | nut thread M14x1.5 H 5mm WS 19 zinc-coated steel Qty 1 pcs | | |
|  | GEV No. | 521101 | Ref. No. 113000 |
| | nut thread M14x1.5 H 5mm WS 19 SS Qty 1 pcs | | |
|  | GEV No. | 550262 | Ref. No. — |
| | flat gasket copper ED ø 20mm ID ø 14mm thickness 2mm | | |



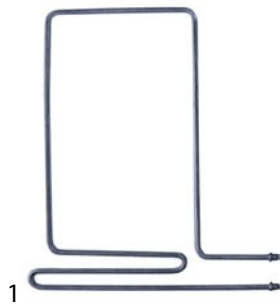



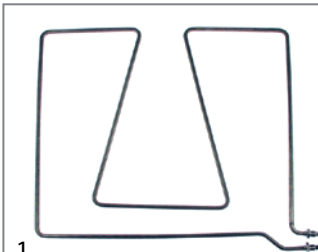

| | | | |
|---|--|-----------------|-------------------|
| GEV No. | 415811 | Ref. No. | 574069 |
| description | heating element 1700W 400V L 447mm W 540mm L1 137mm L2 310mm W1 474mm W2 66mm mounting distance 58mm thread M14x1.5 tube ø 8.5mm connection M4 mounting pos. upper inner 2 hole fixing | | |
| For models: | 0522102-00, 1422101-00, 2023203-00, 2023203A00, 2023205-00, 2023205A00, 2023503-00, 2023503-01, 2023503A00, 2023503A01, 2063403-00, 2063403-01, 2063406-00, 2063406-01, 2063415-00, 2063415-01, 2063418-00, 2063418-01, 2063502-00, 2063502-01, 2063507-00, 2063507-01, 2063509-00, 2063509-01, 2083202A00, 2083502B00, 2083502B01, 2083502C00, 2083502C01 | | |
| accessories for | 415811 | | |
|  | GEV No. | 510417 | Ref. No. — |
| | flat gasket fibre ED ø 20mm ID ø 14mm thickness 2mm Qty 1 pcs | | |

| | | | |
|---|--|--------|------------------------|
| accessories for | 415811 | | |
|  | GEV No. | 520228 | Ref. No. — |
| | tooth lock washer ID ø 15.3mm ED ø 24mm steel Qty 1 pcs for thread M14 | | |
|  | GEV No. | 520230 | Ref. No. — |
| | nut thread M14x1.5 H 5mm WS 19 zinc-coated steel Qty 1 pcs | | |
|  | GEV No. | 521101 | Ref. No. 113000 |
| | nut thread M14x1.5 H 5mm WS 19 SS Qty 1 pcs | | |
|  | GEV No. | 550262 | Ref. No. — |
| | flat gasket copper ED ø 20mm ID ø 14mm thickness 2mm | | |







| | | | |
|---|--|-----------------|------------------------|
| GEV No. | 415813 | Ref. No. | 574071 |
| description | heating element 1950W 400V heating circuits 1 L 467mm W 520mm L1 140mm L2 290mm L3 37mm W1 465mm W2 55mm mounting distance 45mm thread M14x1.5 tube ø 8.5mm connection M4 mounting pos. lower-inner dry heating element 2 hole fixing | | |
| For models: | 0522102-00, 1422101-00, 2023203-00, 2023203A00, 2023205-00, 2023205A00, 2023503-00, 2023503-01, 2023503A00, 2023503A01, 2063403-00, 2063403-01, 2063406-00, 2063406-01, 2063415-00, 2063415-01, 2063418-00, 2063418-01, 2063502-00, 2063502-01, 2063507-00, 2063507-01, 2063509-00, 2063509-01, 2083202A00, 2083502B00, 2083502B01, 2083502C00, 2083502C01 | | |
| accessories for | 415813 | | |
|  | GEV No. | 510417 | Ref. No. — |
| | flat gasket fibre ED ø 20mm ID ø 14mm thickness 2mm Qty 1 pcs | | |
|  | GEV No. | 520228 | Ref. No. — |
| | tooth lock washer ID ø 15.3mm ED ø 24mm steel Qty 1 pcs for thread M14 | | |
|  | GEV No. | 521101 | Ref. No. 113000 |
| | nut thread M14x1.5 H 5mm WS 19 SS Qty 1 pcs | | |
|  | GEV No. | 550262 | Ref. No. — |
| | flat gasket copper ED ø 20mm ID ø 14mm thickness 2mm | | |

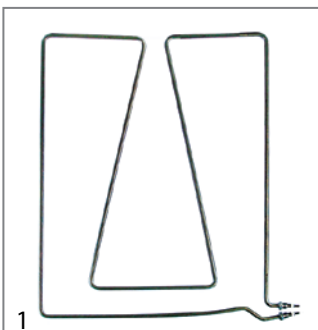





| | | | |
|---|--|-----------------|------------------------|
| GEV No. | 418296 | Ref. No. | 574138 |
| description | heating element 2000W 230V heating circuits 1 L 554mm W 508mm L1 55mm L2 494mm W1 460mm W2 48mm mounting distance 44mm thread M14x1.5 tube ø 8.5mm connection M4 mounting pos. upper oven heating element 2 hole fixing | | |
| For models: | 0522101-04, 1323208-04, 1323210-03, 1323210-04, 1323403-00, 1323403K00, 1323506-00, 1323506-01, 1323506A00, 1323506A01, 1323517-00, 1323517A00, 1363403-03, 1363403-04, 1363403-05, 1363415-05, 1422102-04, 1422102-05, 2123203-08, 2123204-08, 2123208A02, 2123208A03, 2123403-00, 2123403K00, 2123503-06, 2123503-07, 2123503A06, 2123503A07, 2123506-00, 2123506-01, 2123506A00, 2123506A01, 2163403-07, 2163403-08, 2163403-09, 2163406-07, 2163406-08, 2163406-09 | | |
| accessories for | 418296 | | |
|  | GEV No. | 510417 | Ref. No. — |
| | flat gasket fibre ED ø 20mm ID ø 14mm thickness 2mm Qty 1 pcs | | |
|  | GEV No. | 520228 | Ref. No. — |
| | tooth lock washer ID ø 15.3mm ED ø 24mm steel Qty 1 pcs for thread M14 | | |
|  | GEV No. | 520230 | Ref. No. — |
| | nut thread M14x1.5 H 5mm WS 19 zinc-coated steel Qty 1 pcs | | |
|  | GEV No. | 521101 | Ref. No. 113000 |
| | nut thread M14x1.5 H 5mm WS 19 SS Qty 1 pcs | | |
|  | GEV No. | 550262 | Ref. No. — |
| | flat gasket copper ED ø 20mm ID ø 14mm thickness 2mm | | |

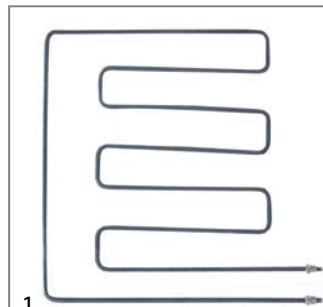

| | | | |
|---|--|-----------------|-------------------|
| GEV No. | 418325 | Ref. No. | 574139 |
| description | heating element 2400W 230V heating circuits 1 L 530mm W 665mm L1 30mm L2 500mm W1 605mm W2 60mm mounting distance 52mm thread M14x1.5 tube ø 8.5mm connection M4 mounting pos. upper dry heating element 2 hole fixing | | |
| For models: | 0522102-04, 0722101-06, 1422101-04, 1422101-05, 1422101-06, 1422301-01, 2023114-00, 2023118-00, 2023119-00, 2023203-07, 2023205-07, 2023207-03, 2023207-04, 2023207-05, 2023406-00, 2023503-10, 2023503-11, 2023503-12, 2023503-13, 2023503A10, 2023503A11, 2023503A12, 2023503A13, 2063403-08, 2063403-09, 2063403-10, 2063406-08, 2063406-09, 2063406-10, 2063415-05, 2063418-05, 2063502-08, 2063502-09, 2063502-10, 2063507-08, 2063507-09, 3023205-00, 3023406-00 | | |
| accessories for | 418325 | | |
|  | GEV No. | 510417 | Ref. No. — |
| | flat gasket fibre ED ø 20mm ID ø 14mm thickness 2mm Qty 1 pcs | | |

| | | | |
|---|--|--------|------------------------|
| accessories for | 418325 | | |
|  | GEV No. | 520228 | Ref. No. — |
| | tooth lock washer ID ø 15.3mm ED ø 24mm steel Qty 1 pcs for thread M14 | | |
|  | GEV No. | 520230 | Ref. No. — |
| | nut thread M14x1.5 H 5mm WS 19 zinc-coated steel Qty 1 pcs | | |
|  | GEV No. | 521101 | Ref. No. 113000 |
| | nut thread M14x1.5 H 5mm WS 19 SS Qty 1 pcs | | |
|  | GEV No. | 550262 | Ref. No. — |
| | flat gasket copper ED ø 20mm ID ø 14mm thickness 2mm | | |



| | | | |
|---|---|-----------------|------------------------|
| GEV No. | 416447 | Ref. No. | 574088 |
| description | heating element 2450W 230V heating circuits 1 L 495mm W 510mm L1 65mm L2 430mm W1 440mm W2 70mm mounting distance 62mm thread M14x1.5 tube ø 8.5mm connection M4 mounting pos. upper dry heating element 2 hole fixing | | |
| For models: | 0522101-01, 0522101-02, 0522101-03, 1323208-00, 1323208-01, 1323208-02, 1323208-03, 1323210-00, 1323210-01, 1323210-02, 1363403-00, 1363403-01, 1363403-02, 1422102-01, 1422102-02, 1422102-03, 2123203-01, 2123203-02, 2123203-03, 2123203-04, 2123203-05, 2123203-06, 2123203-07, 2123203A01, 2123203A02, 2123203A03, 2123203A04, 2123204-01, 2123204-02, 2123204-03, 2123204-04, 2123204-05, 2123204-06, 2123204-07, 2123204A01, 2123204A02, 2123204A03, 2123204A04, 2123208-00, 2123208-01, 2123208A00, 2123208A01, 2123503-00, 2123503-01, 2123503-02, 2123503-03, 2123503-04, 2123503-05, 2123503A00, 2123503A01... (Other models you can see in the webshop) | | |
| accessories for | 416447 | | |
|  | GEV No. | 510417 | Ref. No. — |
| | flat gasket fibre ED ø 20mm ID ø 14mm thickness 2mm Qty 1 pcs | | |
|  | GEV No. | 520228 | Ref. No. — |
| | tooth lock washer ID ø 15.3mm ED ø 24mm steel Qty 1 pcs for thread M14 | | |
|  | GEV No. | 521101 | Ref. No. 113000 |
| | nut thread M14x1.5 H 5mm WS 19 SS Qty 1 pcs | | |
|  | GEV No. | 550262 | Ref. No. — |
| | flat gasket copper ED ø 20mm ID ø 14mm thickness 2mm | | |



| | | | |
|------------------------|---|-----------------|------------------------|
| <p>1</p> | | | |
| GEV No. | 415904 | Ref. No. | 574086 |
| description | heating element 2900W 230V heating circuits 1 L 490mm W 680mm L1 70mm L2 420mm W1 630mm W2 50mm mounting distance 42mm thread M14x1.5 tube ø 8.5mm connection M4 mounting pos. upper 2 hole fixing | | |
| For models: | 0522102-01, 0522102-02, 0522102-03, 1422101-01, 1422101-02, 1422101-03, 2023203-01, 2023203-02, 2023203-03, 2023203-04, 2023203-05, 2023203-06, 2023203A01, 2023203A02, 2023203A03, 2023205-01, 2023205-02, 2023205-03, 2023205-04, 2023205-05, 2023205-06, 2023205A01, 2023205A02, 2023205A03, 2023207-00, 2023207-01, 2023207-02, 2023503-02, 2023503-03, 2023503-04, 2023503-05, 2023503-06, 2023503-07, 2023503-08, 2023503-09, 2023503A02, 2023503A03, 2023503A04, 2023503A05, 2023503A06, 2023503A07, 2023503A08, 2023503A09, 2063403-02, 2063403-03, 2063403-04, 2063403-05, 2063403-06, 2063403-07, 2063406-02... (Other models you can see in the webshop) | | |
| accessories for | 415904 | | |
| | GEV No. | 510417 | Ref. No. — |
| | flat gasket fibre ED ø 20mm ID ø 14mm thickness 2mm Qty 1 pcs | | |
| | GEV No. | 520228 | Ref. No. — |
| | tooth lock washer ID ø 15.3mm ED ø 24mm steel Qty 1 pcs for thread M14 | | |
| | GEV No. | 521101 | Ref. No. 113000 |
| | nut thread M14x1.5 H 5mm WS 19 SS Qty 1 pcs | | |
| | GEV No. | 550262 | Ref. No. — |
| | flat gasket copper ED ø 20mm ID ø 14mm thickness 2mm | | |

| | | | |
|------------------------|---|-----------------|------------------------|
| <p>1</p> | | | |
| GEV No. | 415781 | Ref. No. | 574064 |
| description | heating element 900W 380V heating circuits 1 L 497mm W 313mm L1 80mm L2 417mm W1 180mm W2 133mm mounting distance 126mm thread M14x1.5 tube ø 8.5mm connection M4 mounting pos. upper outer dry heating element 2 hole fixing | | |
| accessories for | 415781 | | |
| | GEV No. | 510417 | Ref. No. — |
| | flat gasket fibre ED ø 20mm ID ø 14mm thickness 2mm Qty 1 pcs | | |
| | GEV No. | 520228 | Ref. No. — |
| | tooth lock washer ID ø 15.3mm ED ø 24mm steel Qty 1 pcs for thread M14 | | |
| | GEV No. | 520230 | Ref. No. — |
| | nut thread M14x1.5 H 5mm WS 19 zinc-coated steel Qty 1 pcs | | |
| | GEV No. | 521101 | Ref. No. 113000 |
| | nut thread M14x1.5 H 5mm WS 19 SS Qty 1 pcs | | |

| | | | |
|------------------------|--|--------|-------------------|
| accessories for | 415781 | | |
| | GEV No. | 550262 | Ref. No. — |
| | flat gasket copper ED ø 20mm ID ø 14mm thickness 2mm | | |





| | | | |
|------------------------|--|-----------------|------------------------|
| <p>1</p> | | | |
| GEV No. | 415782 | Ref. No. | 574065 |
| description | heating element 950W 380V L 452mm W 185mm L1 135mm L2 317mm W1 122mm W2 63mm mounting distance 56mm thread M14x1.5 tube ø 8.5mm connection M4 mounting pos. upper inner dry heating element oven 2 hole fixing | | |
| accessories for | 415782 | | |
| | GEV No. | 510417 | Ref. No. — |
| | flat gasket fibre ED ø 20mm ID ø 14mm thickness 2mm Qty 1 pcs | | |
| | GEV No. | 520228 | Ref. No. — |
| | tooth lock washer ID ø 15.3mm ED ø 24mm steel Qty 1 pcs for thread M14 | | |
| | GEV No. | 520230 | Ref. No. — |
| | nut thread M14x1.5 H 5mm WS 19 zinc-coated steel Qty 1 pcs | | |
| | GEV No. | 521101 | Ref. No. 113000 |
| | nut thread M14x1.5 H 5mm WS 19 SS Qty 1 pcs | | |
| | GEV No. | 550262 | Ref. No. — |
| | flat gasket copper ED ø 20mm ID ø 14mm thickness 2mm | | |

heating elements for bain maries

| | | | |
|------------------------|---|-----------------|------------------------|
| <p>1</p> | | | |
| GEV No. | 415449 | Ref. No. | 573007 |
| description | heating element 1000W 220V heating circuits 1 L 290mm W 177mm connection M4 tube ø 8.5mm 2 hole fixing thread M14x1.5 immersion heater H 18mm mounting distance 162mm | | |
| For models: | 1820501-00, 18208011-0 | | |
| accessories for | 415449 | | |
| | GEV No. | 510417 | Ref. No. — |
| | flat gasket fibre ED ø 20mm ID ø 14mm thickness 2mm Qty 1 pcs | | |
| | GEV No. | 520228 | Ref. No. — |
| | tooth lock washer ID ø 15.3mm ED ø 24mm steel Qty 1 pcs for thread M14 | | |
| | GEV No. | 520230 | Ref. No. — |
| | nut thread M14x1.5 H 5mm WS 19 zinc-coated steel Qty 1 pcs | | |
| | GEV No. | 521101 | Ref. No. 113000 |
| | nut thread M14x1.5 H 5mm WS 19 SS Qty 1 pcs | | |
| | GEV No. | 521103 | Ref. No. — |
| | nut thread M4 H 3mm WS 7 brass Qty 20 pcs | | |

Table continues overleaf









| | | | |
|---|---|--------|-----------------|
| accessories for | 415449 | | |
|  | GEV No. | 521104 | Ref. No. — |
| | washer ID ø 4.3mm ED ø 8mm thickness 0.5mm brass Qty 20 pcs for thread M4 | | |
|  | GEV No. | 550262 | Ref. No. — |
| | flat gasket copper ED ø 20mm ID ø 14mm thickness 2mm | | |
|  | GEV No. | 560111 | Ref. No. 120017 |
| | plain washer ID ø 4.3mm ED ø 9mm thickness 0.8mm SS Qty 20 pcs DIN 125A for thread M4 | | |
|  | GEV No. | 560131 | Ref. No. — |
| | hexagonal nut thread M4 H 3.2mm WS 7 SS DIN/ISO DIN 934 / ISO 4032/8673 Qty 20 pcs | | |











| | | | |
|---|---|----------|--------|
|  | 1 | | |
| GEV No. | 418302 | Ref. No. | 573015 |
| description | heating element 1000W 230V heating circuits 1 L 412mm W 100mm flange length 122mm flange width 20mm hole distance 112mm connection length 82mm connection male faston 6.3mm tube ø 8.5mm rectangular flange hole ø 5.4mm dry heating element bain marie | | |
| For models: | 1220501-01, 1220802-00, 1220802-01, 1320501-00, 1320501A00, 1320802-00, 1320802A00, 1420501-02, 1420504-02, 1420801-01, 1420803-01, 2020505-02, 2020505-03, 2120501-03, 2120501-04, 2120510-00, 3020505-02 | | |



| | | | |
|---|--|----------|-----------------|
|  | 1 | | |
| GEV No. | 415816 | Ref. No. | 573002 |
| description | heating element 1000W 230V heating circuits 1 L 445mm W 135mm connection M4 tube ø 8.5mm 2 hole fixing thread M14x1.5 immersion heater mounting distance 126mm | | |
| spare parts for | 415816 | | |
|  | GEV No. | 510417 | Ref. No. — |
| | flat gasket fibre ED ø 20mm ID ø 14mm thickness 2mm Qty 1 pcs | | |
| accessories for | 415816 | | |
|  | GEV No. | 520228 | Ref. No. — |
| | tooth lock washer ID ø 15.3mm ED ø 24mm steel Qty 1 pcs for thread M14 | | |
|  | GEV No. | 520230 | Ref. No. — |
| | nut thread M14x1.5 H 5mm WS 19 zinc-coated steel Qty 1 pcs | | |
|  | GEV No. | 521101 | Ref. No. 113000 |
| | nut thread M14x1.5 H 5mm WS 19 SS Qty 1 pcs | | |
|  | GEV No. | 521103 | Ref. No. — |
| | nut thread M4 H 3mm WS 7 brass Qty 20 pcs | | |
|  | GEV No. | 521104 | Ref. No. — |
| | washer ID ø 4.3mm ED ø 8mm thickness 0.5mm brass Qty 20 pcs for thread M4 | | |
|  | GEV No. | 550262 | Ref. No. — |
| | flat gasket copper ED ø 20mm ID ø 14mm thickness 2mm | | |
|  | GEV No. | 560111 | Ref. No. 120017 |
| | plain washer ID ø 4.3mm ED ø 9mm thickness 0.8mm SS Qty 20 pcs DIN 125A for thread M4 | | |
|  | GEV No. | 560131 | Ref. No. — |
| | hexagonal nut thread M4 H 3.2mm WS 7 SS DIN/ISO DIN 934 / ISO 4032/8673 Qty 20 pcs | | |

| | | | |
|--|---|----------|--------|
|  | 1 | | |
| GEV No. | 420420 | Ref. No. | 574145 |
| description | heating element 1200W 230V heating circuits 1 L 545mm W 40mm connection F6.3 tube ø 8.5mm | | |
| For models: | 0021130A00, 0021130A01, 1022512-00, 1022603-00, 1220402-00, 1220402-01, 1222603-00, 1320402-00, 1320402-01, 1322603-00, 1322604-00, 1420402-00, 1420402-01, 1420403-01, 1420403-02, 1420403B02, 1420405-00, 1422701-00, 1422702-00, 1520402-00, 1520402-01, 1520403-00, 1520403-01, 1522603-00, 1522603-01, 2020402-00, 2020402-01, 2020403-00, 2020403-01, 2021409-00, 2021409-01, 2021409-02, 2021409B00, 2021409B01, 2021409B02, 2021419-00, 2021419B00, 2021440-00, 2021440-03, 2021440-04, 2021440-05, 2021440A02, 2021440A03, 2021440A04, 2021440A05, 2021440B03, 2021440B04, 2021440B05, 2021440C02, 2021440C03... (Other models you can see in the webshop) | | |

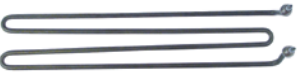

| | | | |
|--|---|----------|--------|
|  | 1 | | |
| GEV No. | 418303 | Ref. No. | 574107 |
| description | heating element 1200W 230V L 510mm W 45mm Hmm connection male faston 6.3mm dry heating element heating circuits 1 tube ø 8.5mm connection distance 35mm | | |
| For models: | 0021135A00, 1220504-01, 1222601-00, 1320504-01, 1320504-02, 1322601-00, 1420509-01, 1422601-00, 1422602-00, 2020506-01, 2021401-04, 2021401-05, 2021401-06, 2021401-07, 2021401-08, 2021401-09, 2021401A03, 2021401A04, 2021401A06, 2021401A07, 2021401A08, 2021401A09, 2021401B03, 2021401B04, 2021401B06, 2021401B07, 2021401B08, 2021401B09, 2021401C03, 2021401C04, 2021401C06, 2021401C07, 2021401C08, 2021401C09, 2021402-04, 2021402-05, 2021402-06, 2021402-07, 2021402-08, 2021402A03, 2021402A04, 2021402A06, 2021402A07, 2021402A08, 2021402B03, 2021402B04, 2021402B06, 2021402B07, 2021402B08, 2021402C03... (Other models you can see in the webshop) | | |

| | | | |
|--|--|----------|-----------------|
|  | 1 | | |
| GEV No. | 415420 | Ref. No. | 573000 |
| description | heating element 1500W 220V heating circuits 1 L 443mm W 114mm connection M4 tube ø 8.5mm 2 hole fixing thread M14x1.5 H 22mm mounting distance 105mm | | |
| accessories for | 415420 | | |
|  | GEV No. | 510417 | Ref. No. — |
| | flat gasket fibre ED ø 20mm ID ø 14mm thickness 2mm Qty 1 pcs | | |
|  | GEV No. | 520228 | Ref. No. — |
| | tooth lock washer ID ø 15.3mm ED ø 24mm steel Qty 1 pcs for thread M14 | | |
|  | GEV No. | 520230 | Ref. No. — |
| | nut thread M14x1.5 H 5mm WS 19 zinc-coated steel Qty 1 pcs | | |
|  | GEV No. | 521101 | Ref. No. 113000 |
| | nut thread M14x1.5 H 5mm WS 19 SS Qty 1 pcs | | |
|  | GEV No. | 550262 | Ref. No. — |
| | flat gasket copper ED ø 20mm ID ø 14mm thickness 2mm | | |

| | | | |
|---|--|-----------------|--------|
|  | | | |
| GEV No. | 415421 | Ref. No. | 573004 |
| description | heating element 1500W 220V heating circuits 1 L 445mm W 135mm connection M4 tube ø 8.5mm 2 hole fixing thread M14x1.5 immersion heater L1 20mm L2 50mm L3 380mm W1 20mm W2 117mm mounting distance 129mm | | |
| For models: | 0220501-00, 0220502-00, 0220503-00, 1420501-00, 1420502-00, 1420504-00, 1420505-00, 2020501-00, 2020501-01, 20205011-0, 2020502-00, 2020505-00, 2120501-00, 2120501-01, 2120502-00, 2120502-01, 3020501-00, 3020502-00, 3020505-00 | | |
| spare parts for | 415421 | | |
|  | | | |
| GEV No. | 510407 | Ref. No. | — |
| description | flat gasket fibre ED ø 78mm ID ø 60mm thickness 2mm for heating element for thread 2" Qty 1 pcs | | |
| accessories for | 415421 | | |
|  | | | |
| GEV No. | 510417 | Ref. No. | — |
| description | flat gasket fibre ED ø 20mm ID ø 14mm thickness 2mm Qty 1 pcs | | |
|  | | | |
| GEV No. | 520228 | Ref. No. | — |
| description | tooth lock washer ID ø 15.3mm ED ø 24mm steel Qty 1 pcs for thread M14 | | |
|  | | | |
| GEV No. | 520230 | Ref. No. | — |
| description | nut thread M14x1.5 H 5mm WS 19 zinc-coated steel Qty 1 pcs | | |
|  | | | |
| GEV No. | 521101 | Ref. No. | 113000 |
| description | nut thread M14x1.5 H 5mm WS 19 SS Qty 1 pcs | | |
|  | | | |
| GEV No. | 521103 | Ref. No. | — |
| description | nut thread M4 H 3mm WS 7 brass Qty 20 pcs | | |
|  | | | |
| GEV No. | 521104 | Ref. No. | — |
| description | washer ID ø 4.3mm ED ø 8mm thickness 0.5mm brass Qty 20 pcs for thread M4 | | |
|  | | | |
| GEV No. | 550262 | Ref. No. | — |
| description | flat gasket copper ED ø 20mm ID ø 14mm thickness 2mm | | |
|  | | | |
| GEV No. | 560111 | Ref. No. | 120017 |
| description | plain washer ID ø 4.3mm ED ø 9mm thickness 0.8mm SS Qty 20 pcs DIN 125A for thread M4 | | |
|  | | | |
| GEV No. | 560131 | Ref. No. | — |
| description | hexagonal nut thread M4 H 3.2mm WS 7 SS DIN/ISO DIN 934 / ISO 4032/8673 Qty 20 pcs | | |

| | | | |
|---|--|-----------------|--------|
|  | | | |
| GEV No. | 419055 | Ref. No. | 573020 |
| description | heating element 1750W 400V heating circuits 1 L 490mm W 88.5mm connection M4 tube ø 8.5mm dry heating element W1 10mm W2 75mm 2 hole fixing thread M14x1.5 H 72mm mounting distance 55mm | | |
| For models: | 1221501-00, 1221501-01, 1221501-02, 1321501-00, 1321501-01, 1321501-02, 1321501-03, 1421501-01, 1421501-02, 1421503-01, 1421503-02, 1521501-00, 2121501-01, 2121501-02 | | |
| accessories for | 419055 | | |
|  | | | |
| GEV No. | 520230 | Ref. No. | — |
| description | nut thread M14x1.5 H 5mm WS 19 zinc-coated steel Qty 1 pcs | | |
|  | | | |
| GEV No. | 521103 | Ref. No. | — |
| description | nut thread M4 H 3mm WS 7 brass Qty 20 pcs | | |

| | | | |
|---|--|-----------------|---|
| accessories for | 419055 | | |
|  | | | |
| GEV No. | 529480 | Ref. No. | — |
| description | flat gasket copper ED ø 18mm ID ø 14mm thickness 1.5mm | | |

| | | | |
|---|--|-----------------|--------|
|  | | | |
| GEV No. | 415419 | Ref. No. | 573006 |
| description | heating element 2000W 230V heating circuits 1 L 405mm W 218.5mm connection M4 tube ø 8.5mm 2 hole fixing thread M14x1.5 immersion heater mounting distance 210mm | | |
| For models: | 20205033-0, 2020504-00 | | |
| spare parts for | 415419 | | |
|  | | | |
| GEV No. | 510417 | Ref. No. | — |
| description | flat gasket fibre ED ø 20mm ID ø 14mm thickness 2mm Qty 1 pcs | | |
| accessories for | 415419 | | |
|  | | | |
| GEV No. | 520228 | Ref. No. | — |
| description | tooth lock washer ID ø 15.3mm ED ø 24mm steel Qty 1 pcs for thread M14 | | |
|  | | | |
| GEV No. | 521101 | Ref. No. | 113000 |
| description | nut thread M14x1.5 H 5mm WS 19 SS Qty 1 pcs | | |
|  | | | |
| GEV No. | 521103 | Ref. No. | — |
| description | nut thread M4 H 3mm WS 7 brass Qty 20 pcs | | |
|  | | | |
| GEV No. | 521104 | Ref. No. | — |
| description | washer ID ø 4.3mm ED ø 8mm thickness 0.5mm brass Qty 20 pcs for thread M4 | | |
|  | | | |
| GEV No. | 550262 | Ref. No. | — |
| description | flat gasket copper ED ø 20mm ID ø 14mm thickness 2mm | | |
|  | | | |
| GEV No. | 560111 | Ref. No. | 120017 |
| description | plain washer ID ø 4.3mm ED ø 9mm thickness 0.8mm SS Qty 20 pcs DIN 125A for thread M4 | | |
|  | | | |
| GEV No. | 560131 | Ref. No. | — |
| description | hexagonal nut thread M4 H 3.2mm WS 7 SS DIN/ISO DIN 934 / ISO 4032/8673 Qty 20 pcs | | |









| | | | |
|--|---|-----------------|--------|
|  | | | |
| GEV No. | 415821 | Ref. No. | 573012 |
| description | heating element 3000W 230V heating circuits 1 L 420mm W 125mm connection M4 tube ø 8.5mm 2 hole fixing thread M14x1.5 immersion heater H 20mm mounting distance 117mm | | |
| spare parts for | 415821 | | |
|  | | | |
| GEV No. | 510417 | Ref. No. | — |
| description | flat gasket fibre ED ø 20mm ID ø 14mm thickness 2mm Qty 1 pcs | | |
| accessories for | 415821 | | |
|  | | | |
| GEV No. | 520228 | Ref. No. | — |
| description | tooth lock washer ID ø 15.3mm ED ø 24mm steel Qty 1 pcs for thread M14 | | |

Table continues overleaf







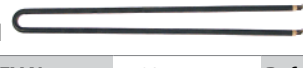

| | | | |
|---|---|--------|-----------------|
| accessories for | 415821 | | |
|  | GEV No. | 520230 | Ref. No. — |
| | nut thread M14x1.5 H 5mm WS 19 zinc-coated steel Qty 1 pcs | | |
|  | GEV No. | 521101 | Ref. No. 113000 |
| | nut thread M14x1.5 H 5mm WS 19 SS Qty 1 pcs | | |
|  | GEV No. | 521103 | Ref. No. — |
| | nut thread M4 H 3mm WS 7 brass Qty 20 pcs | | |
|  | GEV No. | 521104 | Ref. No. — |
| | washer ID ø 4.3mm ED ø 8mm thickness 0.5mm brass Qty 20 pcs for thread M4 | | |
|  | GEV No. | 550262 | Ref. No. — |
| | flat gasket copper ED ø 20mm ID ø 14mm thickness 2mm | | |
|  | GEV No. | 560111 | Ref. No. 120017 |
| | plain washer ID ø 4.3mm ED ø 9mm thickness 0.8mm SS Qty 20 pcs DIN 125A for thread M4 | | |
|  | GEV No. | 560131 | Ref. No. — |
| | hexagonal nut thread M4 H 3.2mm WS 7 SS DIN/ISO DIN 934 / ISO 4032/8673 Qty 20 pcs | | |

| | | | |
|---|--|-----------------|-----------------|
|  | 1 | | |
| GEV No. | 415780 | Ref. No. | 573096 |
| description | heating element 3000W 230V heating circuits 1 L 465mm W 140mm connection M4 tube ø 8.5mm 2 hole fixing thread M14x1.5 immersion heater L1 25mm L2 40mm L3 400mm W1 25mm W2 105mm mounting distance 125mm | | |
| For models: | 0220802-00, 1420801-00, 1420803-00 | | |
| spare parts for | 415780 | | |
|  | GEV No. | 510417 | Ref. No. — |
| | flat gasket fibre ED ø 20mm ID ø 14mm thickness 2mm Qty 1 pcs | | |
| accessories for | 415780 | | |
|  | GEV No. | 520228 | Ref. No. — |
| | tooth lock washer ID ø 15.3mm ED ø 24mm steel Qty 1 pcs for thread M14 | | |
|  | GEV No. | 520230 | Ref. No. — |
| | nut thread M14x1.5 H 5mm WS 19 zinc-coated steel Qty 1 pcs | | |
|  | GEV No. | 521101 | Ref. No. 113000 |
| | nut thread M14x1.5 H 5mm WS 19 SS Qty 1 pcs | | |
|  | GEV No. | 550262 | Ref. No. — |
| | flat gasket copper ED ø 20mm ID ø 14mm thickness 2mm | | |





| | | | |
|---|--|-----------------|--------|
|  | 1 | | |
| GEV No. | 418314 | Ref. No. | 573011 |
| description | heating element 950W 230V heating circuits 1 L 390mm W 36mm connection male faston 6.3mm tube ø 8.5mm dry heating element | | |
| For models: | 1220504-01, 1222601-00, 1320504-01, 1320504-02, 1322601-00, 1420509-01, 1422601-00, 1422602-00, 2020506-01, 2022601-00, 2022601-01, 2120504-01, 2122601-00, 2122601-01, 2122602-00 | | |

heating elements for frying pans





| | | | |
|--|---|-----------------|--------|
|  | 1 | | |
| GEV No. | 418279 | Ref. No. | 574113 |
| description | heating element 1200W 230V L 502mm W 50mm connection male faston 6.3mm tube ø 8.5mm dry heating element H 58mm | | |
| For models: | 0221107-00, 0221107A00, 0221108-00, 0221109-00, 0221109A00, 0221110-00, 1121117-00, 1121117-01, 1121117A00, 1121118-00, 1121118-01, 1121119-00, 1121119A00, 1121120-00, 1121121-00, 1121121A00, 1121135A01, 1221103-00, 1221103-01, 1221103-02, 1221103-04, 1221103A00, 1221103A01, 1221103A02, 1221103B00, 1221103B01, 1221103B02, 1221103B04, 1221103J00, 1221103J01, 1221104-00, 1221104-01, 1221104A00, 1221104A01, 1221104B00, 1221104B01, 1221104J00, 1221104J01, 1221105-00, 1221105-01, 1221105-02, 1221105A00, 1221105A01, 1221105A02, 1221105B00, 1221105B01, 1221105B02, 1221106-00, 1221106-01, 1221106A00... (Other models you can see in the webshop) | | |

| | | | |
|---|--|-----------------|--------------------------------|
|  | 1 | | |
| GEV No. | 415767 | Ref. No. | 573054 573054/113000/121216 |
| description | heating element 1500W 230V heating circuits 1 L 425mm W 250mm H 58mm W1 50mm W2 150mm L1 60mm L2 365mm thread M14x1.5 mounting distance 142mm windings 3 tube ø 8.5mm connection M4 dry heating element 2 hole fixing for stockpot | | |
| accessories for | 415767 | | |
|  | GEV No. | 510417 | Ref. No. — |
| | flat gasket fibre ED ø 20mm ID ø 14mm thickness 2mm Qty 1 pcs | | |
|  | GEV No. | 520228 | Ref. No. — |
| | tooth lock washer ID ø 15.3mm ED ø 24mm steel Qty 1 pcs for thread M14 | | |
|  | GEV No. | 520230 | Ref. No. — |
| | nut thread M14x1.5 H 5mm WS 19 zinc-coated steel Qty 1 pcs | | |
|  | GEV No. | 521101 | Ref. No. 113000 |
| | nut thread M14x1.5 H 5mm WS 19 SS Qty 1 pcs | | |
|  | GEV No. | 521103 | Ref. No. — |
| | nut thread M4 H 3mm WS 7 brass Qty 20 pcs | | |
|  | GEV No. | 521104 | Ref. No. — |
| | washer ID ø 4.3mm ED ø 8mm thickness 0.5mm brass Qty 20 pcs for thread M4 | | |
|  | GEV No. | 550262 | Ref. No. — |
| | flat gasket copper ED ø 20mm ID ø 14mm thickness 2mm | | |
|  | GEV No. | 560111 | Ref. No. 120017 |
| | plain washer ID ø 4.3mm ED ø 9mm thickness 0.8mm SS Qty 20 pcs DIN 125A for thread M4 | | |
|  | GEV No. | 560131 | Ref. No. — |
| | hexagonal nut thread M4 H 3.2mm WS 7 SS DIN/ISO DIN 934 / ISO 4032/8673 Qty 20 pcs | | |

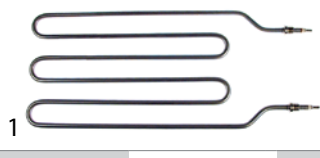
| | | | |
|---|---|-----------------|------------------------|
| GEV No. | 415768 | Ref. No. | 573055 |
| description | heating element 2500W 230V L 425mm W 220mm connection M4 tube ø 8.5mm 2 hole fixing thread M14x1.5 dry heating element for stockpot L1 65mm L2 360mm W1 43mm W2 134mm H 60mm windings 4 mounting distance 126mm | | |
| For models: | 0221202-00, 1421201-00, 1421203-00 | | |
| accessories for | 415768 | | |
|  | GEV No. | 510417 | Ref. No. — |
| | flat gasket fibre ED ø 20mm ID ø 14mm thickness 2mm Qty 1 pcs | | |
|  | GEV No. | 520228 | Ref. No. — |
| | tooth lock washer ID ø 15.3mm ED ø 24mm steel Qty 1 pcs for thread M14 | | |
|  | GEV No. | 520230 | Ref. No. — |
| | nut thread M14x1.5 H 5mm WS 19 zinc-coated steel Qty 1 pcs | | |
|  | GEV No. | 521101 | Ref. No. 113000 |
| | nut thread M14x1.5 H 5mm WS 19 SS Qty 1 pcs | | |
|  | GEV No. | 550262 | Ref. No. — |
| | flat gasket copper ED ø 20mm ID ø 14mm thickness 2mm | | |



| | | | |
|---|--|-----------------|------------------------|
| GEV No. | 418316 | Ref. No. | 574104 |
| description | heating element 1500W 230V heating circuits 1 L 455mm W 212mm connection M4 tube ø 8.5mm 2 hole fixing thread M14x1.5 dry heating element chip scuttle L1 40mm L2 35mm L3 380mm W1 32mm W2 147mm mounting distance 138mm | | |
| For models: | 0221001H00 | | |
| accessories for | 418316 | | |
|  | GEV No. | 510417 | Ref. No. — |
| | flat gasket fibre ED ø 20mm ID ø 14mm thickness 2mm Qty 1 pcs | | |
|  | GEV No. | 520228 | Ref. No. — |
| | tooth lock washer ID ø 15.3mm ED ø 24mm steel Qty 1 pcs for thread M14 | | |
|  | GEV No. | 520230 | Ref. No. — |
| | nut thread M14x1.5 H 5mm WS 19 zinc-coated steel Qty 1 pcs | | |
|  | GEV No. | 521101 | Ref. No. 113000 |
| | nut thread M14x1.5 H 5mm WS 19 SS Qty 1 pcs | | |
|  | GEV No. | 550262 | Ref. No. — |
| | flat gasket copper ED ø 20mm ID ø 14mm thickness 2mm | | |

heating elements for chip scuttles



| | | | |
|---|---|-----------------|------------------------|
| GEV No. | 418315 | Ref. No. | 574054 |
| description | heating element 1000W 230V heating circuits 1 L 385mm W 68mm connection M4 tube ø 8.5mm 2 hole fixing thread M14x1.5 immersion heater chip scuttle mounting distance 60mm | | |
| accessories for | 418315 | | |
|  | GEV No. | 510417 | Ref. No. — |
| | flat gasket fibre ED ø 20mm ID ø 14mm thickness 2mm Qty 1 pcs | | |
|  | GEV No. | 520228 | Ref. No. — |
| | tooth lock washer ID ø 15.3mm ED ø 24mm steel Qty 1 pcs for thread M14 | | |
|  | GEV No. | 520230 | Ref. No. — |
| | nut thread M14x1.5 H 5mm WS 19 zinc-coated steel Qty 1 pcs | | |
|  | GEV No. | 521101 | Ref. No. 113000 |
| | nut thread M14x1.5 H 5mm WS 19 SS Qty 1 pcs | | |
|  | GEV No. | 550262 | Ref. No. — |
| | flat gasket copper ED ø 20mm ID ø 14mm thickness 2mm | | |

heating elements for fryers

2 hole fixing

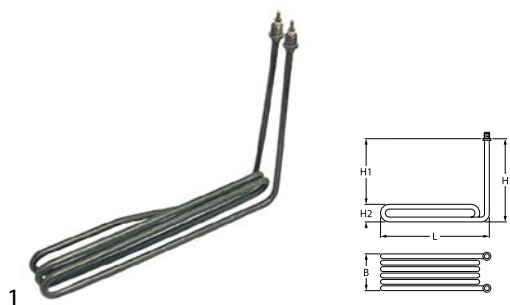



| | | | |
|---|---|-----------------|-------------------|
| GEV No. | 415423 | Ref. No. | 572118 |
| description | heating element 2000W 230V heating circuits 1 L 320mm W 40mm H 215mm H1 175mm H2 40mm thread M14x1.5 tube ø 8.5mm mounting distance 30mm windings 3 2 hole fixing connection M4 connection length 20mm immersion heater SS | | |
| For models: | 0220301-00, 0220301D00, 0220302-00, 0220302A00, 0220302A01, 0220302A02, 0220302A03, 0220302D00, 0220302F00, 0220304-00, 0220305-00, 0720325-03, 0720325-04, 0720332P00, 0720332R00, 1220301-00, 1220301-01, 1220301-02, 1220301-03, 1220301-04, 1220301D00, 1220301D01, 1220301J00, 1220301J01, 1220301J02, 1220301J03, 1220302-00, 1220302-01, 1220302D00, 1220303-00, 1220303-01, 1220303-02, 1220303-03, 1220303-04, 1220303-05, 1220303A00, 1220303A01, 1220303A02, 1220303A03, 1220303D00, 1220303D01, 1220303D02, 1220303F01, 1220303F02, 1220303F03, 1220303I00, 1220303I01, 1220303I02, 1220303J01, 1220303J02... (Other models you can see in the webshop) | | |
| spare parts for | 415423 | | |
|  | GEV No. | 510417 | Ref. No. — |
| | flat gasket fibre ED ø 20mm ID ø 14mm thickness 2mm Qty 1 pcs | | |





Table continues overleaf

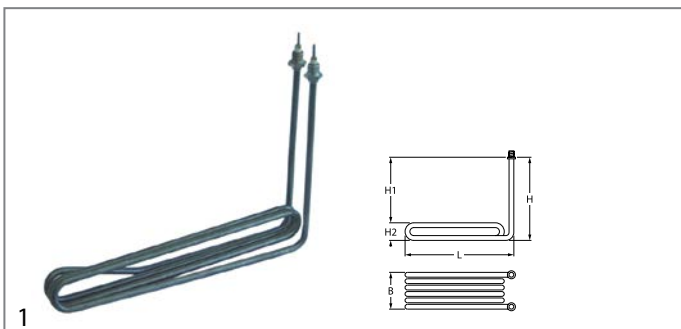





| accessories for | | 415423 | | |
|---|---------|--------|----------|--------|
|  | GEV No. | 520228 | Ref. No. | — |
| tooth lock washer ID \varnothing 15.3mm ED \varnothing 24mm steel Qty 1 pcs for thread M14 | | | | |
|  | GEV No. | 520230 | Ref. No. | — |
| nut thread M14x1.5 H 5mm WS 19 zinc-coated steel Qty 1 pcs | | | | |
|  | GEV No. | 521101 | Ref. No. | 113000 |
| nut thread M14x1.5 H 5mm WS 19 SS Qty 1 pcs | | | | |
|  | GEV No. | 521103 | Ref. No. | — |
| nut thread M4 H 3mm WS 7 brass Qty 20 pcs | | | | |
|  | GEV No. | 521104 | Ref. No. | — |
| washer ID \varnothing 4.3mm ED \varnothing 8mm thickness 0.5mm brass Qty 20 pcs for thread M4 | | | | |
|  | GEV No. | 550262 | Ref. No. | — |
| flat gasket copper ED \varnothing 20mm ID \varnothing 14mm thickness 2mm | | | | |
|  | GEV No. | 560111 | Ref. No. | 120017 |
| plain washer ID \varnothing 4.3mm ED \varnothing 9mm thickness 0.8mm SS Qty 20 pcs DIN 125A for thread M4 | | | | |
|  | GEV No. | 560131 | Ref. No. | — |
| hexagonal nut thread M4 H 3.2mm WS 7 SS DIN/ISO DIN 934 / ISO 4032/8673 Qty 20 pcs | | | | |

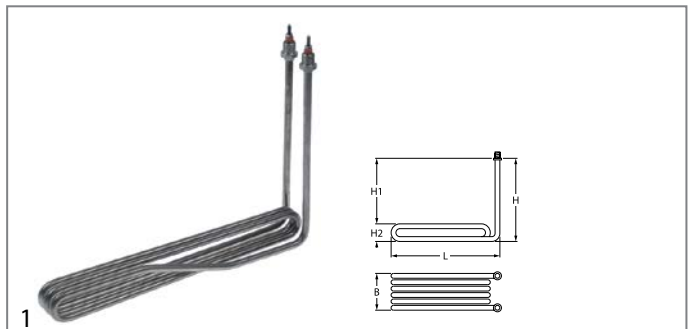

| GEV No. | 415728 | Ref. No. | 572124 572124 (old version) | |
|--|---|----------|--------------------------------|--------|
| description | heating element 3300W 230V heating circuits 1 L 315mm W 33mm H 216mm H1 170mm H2 46mm thread M14x1.5 tube \varnothing 8.5mm mounting distance 30mm windings 3 2 hole fixing connection M4 connection length 22mm immersion heater | | | |
| For models: | 0220301B00, 0220301B01, 0220301B02, 0220302A00, 0220302B00, 0220302B01, 0220302B02, 0220302C00, 0220302C01, 0220302C02, 0220302C03, 0220302E00, 0220302E01, 0220302H00, 0220302H01, 0220304-00, 0220305-00, 0720325B03, 0720325B04, 1220301B00, 1220301B01, 1220301B02, 1220301B03, 1220301B04, 1220301E00, 1220301E01, 1220302B00, 1220302B01, 1220302E00, 1220303B00, 1220303B01, 1220303B02, 1220303B03, 1220303B04, 1220303B05, 1220303C00, 1220303C01, 1220303C02, 1220303C03, 1220303E00, 1220303E01, 1220303E02, 1220303H00, 1220303H01, 1220303H02, 1220303H03, 1220303K00, 1220303K01, 1220304B00, 1220304B01... (Other models you can see in the webshop) | | | |
| accessories for | 415728 | | | |
|  | GEV No. | 520228 | Ref. No. | — |
| tooth lock washer ID \varnothing 15.3mm ED \varnothing 24mm steel Qty 1 pcs for thread M14 | | | | |
|  | GEV No. | 520230 | Ref. No. | — |
| nut thread M14x1.5 H 5mm WS 19 zinc-coated steel Qty 1 pcs | | | | |
|  | GEV No. | 521101 | Ref. No. | 113000 |
| nut thread M14x1.5 H 5mm WS 19 SS Qty 1 pcs | | | | |
|  | GEV No. | 521103 | Ref. No. | — |
| nut thread M4 H 3mm WS 7 brass Qty 20 pcs | | | | |

| accessories for | | 415728 | | |
|---|---------|--------|----------|--------|
|  | GEV No. | 521104 | Ref. No. | — |
| washer ID \varnothing 4.3mm ED \varnothing 8mm thickness 0.5mm brass Qty 20 pcs for thread M4 | | | | |
|  | GEV No. | 550262 | Ref. No. | — |
| flat gasket copper ED \varnothing 20mm ID \varnothing 14mm thickness 2mm | | | | |
|  | GEV No. | 560111 | Ref. No. | 120017 |
| plain washer ID \varnothing 4.3mm ED \varnothing 9mm thickness 0.8mm SS Qty 20 pcs DIN 125A for thread M4 | | | | |
|  | GEV No. | 560131 | Ref. No. | — |
| hexagonal nut thread M4 H 3.2mm WS 7 SS DIN/ISO DIN 934 / ISO 4032/8673 Qty 20 pcs | | | | |



| GEV No. | 417729 | Ref. No. | 572124 (new version) | |
|---|---|----------|----------------------|--------|
| description | heating element 3300W 230V heating circuits 1 L 315mm W 33mm H 216mm H1 170mm H2 46mm thread M14x1.5 tube \varnothing 8.5mm mounting distance 30mm windings 3 2 hole fixing connection M4 connection length 22mm immersion heater | | | |
| accessories for | 417729 | | | |
|  | GEV No. | 520228 | Ref. No. | — |
| tooth lock washer ID \varnothing 15.3mm ED \varnothing 24mm steel Qty 1 pcs for thread M14 | | | | |
|  | GEV No. | 520230 | Ref. No. | — |
| nut thread M14x1.5 H 5mm WS 19 zinc-coated steel Qty 1 pcs | | | | |
|  | GEV No. | 521101 | Ref. No. | 113000 |
| nut thread M14x1.5 H 5mm WS 19 SS Qty 1 pcs | | | | |
|  | GEV No. | 521103 | Ref. No. | — |
| nut thread M4 H 3mm WS 7 brass Qty 20 pcs | | | | |
|  | GEV No. | 521104 | Ref. No. | — |
| washer ID \varnothing 4.3mm ED \varnothing 8mm thickness 0.5mm brass Qty 20 pcs for thread M4 | | | | |
|  | GEV No. | 550262 | Ref. No. | — |
| flat gasket copper ED \varnothing 20mm ID \varnothing 14mm thickness 2mm | | | | |
|  | GEV No. | 560111 | Ref. No. | 120017 |
| plain washer ID \varnothing 4.3mm ED \varnothing 9mm thickness 0.8mm SS Qty 20 pcs DIN 125A for thread M4 | | | | |
|  | GEV No. | 560131 | Ref. No. | — |
| hexagonal nut thread M4 H 3.2mm WS 7 SS DIN/ISO DIN 934 / ISO 4032/8673 Qty 20 pcs | | | | |

| | | | |
|------------------------|---|-----------------|------------------------------------|
| | | | |
| GEV No. | 415769 | Ref. No. | 572121 572121+2x113000+2x121216 |
| description | heating element 3300W 230V heating circuits 1 L 320mm W 80mm H 214mm H1 176mm H2 38mm thread M14x1.5 tube ø 8.5mm mounting distance 70mm windings 5 2 hole fixing connection M4 immersion heater | | |
| For models: | 0220303-00, 0220303-01, 0220303A00, 0220303A01, 0220303A02, 0220303A03, 0220303D00, 0220303D01, 0220303H00, 0220303H01, 0220306-00, 1220305-00, 1220305-01, 1220305-02, 1220305-03, 1220305-04, 1220305-05, 1220305-06, 1220305-07, 1220305A00, 1220305A01, 1220305A02, 1220305A03, 1220305A04, 1220305A05, 1220305D00, 1220305D01, 1220305D02, 1220305D03, 1220305D04, 1220305F01, 1220305F02, 1220305F03, 1220305F04, 1220305F05, 1220305J01, 1220305J02, 1220306-00, 1220306-01, 1220306A01, 1220306A02, 1220306A03, 1220306A04, 1220306D00, 1220306F00, 1220306F01, 1220306F02, 1220306F03, 1220329-00, 1220329-01... (Other models you can see in the webshop) | | |
| spare parts for | 415769 | | |
| | GEV No. | 510417 | Ref. No. — |
| | flat gasket fibre ED ø 20mm ID ø 14mm thickness 2mm Qty 1 pcs | | |
| accessories for | 415769 | | |
| | GEV No. | 521103 | Ref. No. — |
| | nut thread M4 H 3mm WS 7 brass Qty 20 pcs | | |
| | GEV No. | 521104 | Ref. No. — |
| | washer ID ø 4.3mm ED ø 8mm thickness 0.5mm brass Qty 20 pcs for thread M4 | | |
| | GEV No. | 560111 | Ref. No. 120017 |
| | plain washer ID ø 4.3mm ED ø 9mm thickness 0.8mm SS Qty 20 pcs DIN 125A for thread M4 | | |
| | GEV No. | 560131 | Ref. No. — |
| | hexagonal nut thread M4 H 3.2mm WS 7 SS DIN/ISO DIN 934 / ISO 4032/8673 Qty 20 pcs | | |

| | | | |
|------------------------|---|-----------------|------------------------------------|
| | | | |
| GEV No. | 415779 | Ref. No. | 572128 572128+2x113000+2x121216 |
| description | heating element 3300W 230V heating circuits 1 L 323mm W 70mm H 222mm H1 180mm H2 42mm thread M14x1.5 tube ø 10mm mounting distance 50mm windings 4 2 hole fixing connection M4 immersion heater | | |
| For models: | 0220303B00, 0220303B01, 0220303C00, 0220303C01, 0220303C02, 0220303E00, 0220303E01, 0220306-00, 1220305B00, 1220305B01, 1220305B02, 1220305B03, 1220305C00, 1220305C01, 1220305C02, 1220305C03, 1220305C04, 1220305E00, 1220305E01, 1220305E02, 1220305E03, 1220305H00, 1220305H01, 1220305H02, 1220305H03, 1220305H04, 1220306C02, 1220306H01, 1320305B00, 1320305B01, 1320305B02, 1320305B03, 1320305C00, 1320305C01, 1320305C02, 1320305C03, 1320305E00, 1320305E01, 1320305E02, 1320305E03, 1320305E04, 1320305H00, 1320305H01, 1320305H02, 1320305H03, 1320305H04, 1320306C02, 1320306H02, 1420303B00, 1420303B02... (Other models you can see in the webshop) | | |
| accessories for | 415779 | | |
| | GEV No. | 521101 | Ref. No. 113000 |
| | nut thread M14x1.5 H 5mm WS 19 SS Qty 1 pcs | | |
| | GEV No. | 521103 | Ref. No. — |
| | nut thread M4 H 3mm WS 7 brass Qty 20 pcs | | |
| | GEV No. | 521104 | Ref. No. — |
| | washer ID ø 4.3mm ED ø 8mm thickness 0.5mm brass Qty 20 pcs for thread M4 | | |
| | GEV No. | 560111 | Ref. No. 120017 |
| | plain washer ID ø 4.3mm ED ø 9mm thickness 0.8mm SS Qty 20 pcs DIN 125A for thread M4 | | |
| | GEV No. | 560131 | Ref. No. — |
| | hexagonal nut thread M4 H 3.2mm WS 7 SS DIN/ISO DIN 934 / ISO 4032/8673 Qty 20 pcs | | |

| | | | |
|------------------------|---|-----------------|-----------------|
| | | | |
| GEV No. | 415815 | Ref. No. | 572135 |
| description | heating element 3560W 230V heating circuits 1 L 490mm W 35mm H 260mm H1 220mm H2 40mm thread M14x1.5 tube ø 8.5mm mounting distance 25mm windings 3 2 hole fixing connection M5 connection length 20mm immersion heater fryer | | |
| For models: | 2020303-00, 2020303-01, 2020303-02, 2020303-03, 2020303-04, 2020303A00, 2020310-00, 2020310-01, 2020310-02, 2020310-03, 2020310A00, 2020310A01, 2020310A02, 2020310A03, 2020311-00, 2020311-01, 2020311-02, 2020311-03, 2020311A00, 2020311A01, 2020311A02, 2020311A03, 2020312A00, 2020312A01, 2020312A02, 2020314-01, 2020314-02, 2020314-03, 2020314A01, 2020314A02, 2020314A03, 2020315-01, 2020315-02, 2020315-03, 2020315A01, 2020315A02, 2020315A03, 2020339A00, 2020339A01, 2020340A00, 2020340A01, 2020341-00, 2020341A00, 2020342-00, 2020342A00, 3020310-00, 3020310-01, 3020310A00, 3020310A01, 3020311-00... (Other models you can see in the webshop) | | |
| accessories for | 415815 | | |
| | | GEV No. 528401 | Ref. No. — |
| | flat gasket fibre ED ø 22mm ID ø 16mm thickness 2mm Qty 1 pcs | | |
| | | GEV No. 560112 | Ref. No. 120022 |
| | plain washer ID ø 5.3mm ED ø 10mm thickness 1mm SS Qty 20 pcs DIN 125A for thread M5 | | |
| | | GEV No. 560132 | Ref. No. — |
| | hexagonal nut thread M5 H 4mm WS 8 SS DIN/ISO DIN 934 / ISO 4032/8673 Qty 20 pcs | | |

| | | | |
|------------------------|--|-----------------|-----------------|
| | | | |
| GEV No. | 417533 | Ref. No. | 572121(old) |
| description | heating element 3300W 230V heating circuits 1 L 320mm W 80mm H 220mm W1 20mm W2 47mm H1 175mm H2 42mm thread M14x1.25 tube ø 10mm 2 hole fixing immersion heater | | |
| accessories for | 417533 | | |
| | | GEV No. 521103 | Ref. No. — |
| | nut thread M4 H 3mm WS 7 brass Qty 20 pcs | | |
| | | GEV No. 521104 | Ref. No. — |
| | washer ID ø 4.3mm ED ø 8mm thickness 0.5mm brass Qty 20 pcs for thread M4 | | |
| | | GEV No. 560111 | Ref. No. 120017 |
| | plain washer ID ø 4.3mm ED ø 9mm thickness 0.8mm SS Qty 20 pcs DIN 125A for thread M4 | | |
| | | GEV No. 560131 | Ref. No. — |
| | hexagonal nut thread M4 H 3.2mm WS 7 SS DIN/ISO DIN 934 / ISO 4032/8673 Qty 20 pcs | | |

| | | | |
|------------------------|---|-----------------|-----------------|
| | | | |
| GEV No. | 418366 | Ref. No. | 572098 |
| description | heating element 2000W 230V heating circuits 1 mounting pos. centre L 260mm W 260mm H 223mm 2 hole fixing connection M4 fryer L1 20mm L2 40mm L3 200mm W1 88mm W2 84mm H1 33mm H2 190mm tube ø 8.5mm thread M14x1.5 mounting distance 75mm connection length 13mm windings 3 | | |
| For models: | 0520302A00, 0520302A01 | | |
| accessories for | 418366 | | |
| | | GEV No. 361182 | Ref. No. — |
| | nut thread 1/4" H 5mm nickel-plated brass WS 17 Qty 1 pcs | | |
| | | GEV No. 510417 | Ref. No. — |
| | flat gasket fibre ED ø 20mm ID ø 14mm thickness 2mm Qty 1 pcs | | |
| | | GEV No. 520228 | Ref. No. — |
| | tooth lock washer ID ø 15.3mm ED ø 24mm steel Qty 1 pcs for thread M14 | | |
| | | GEV No. 521103 | Ref. No. — |
| | nut thread M4 H 3mm WS 7 brass Qty 20 pcs | | |
| | | GEV No. 521104 | Ref. No. — |
| | washer ID ø 4.3mm ED ø 8mm thickness 0.5mm brass Qty 20 pcs for thread M4 | | |
| | | GEV No. 550262 | Ref. No. — |
| | flat gasket copper ED ø 20mm ID ø 14mm thickness 2mm | | |
| | | GEV No. 560111 | Ref. No. 120017 |
| | plain washer ID ø 4.3mm ED ø 9mm thickness 0.8mm SS Qty 20 pcs DIN 125A for thread M4 | | |
| | | GEV No. 560131 | Ref. No. — |
| | hexagonal nut thread M4 H 3.2mm WS 7 SS DIN/ISO DIN 934 / ISO 4032/8673 Qty 20 pcs | | |

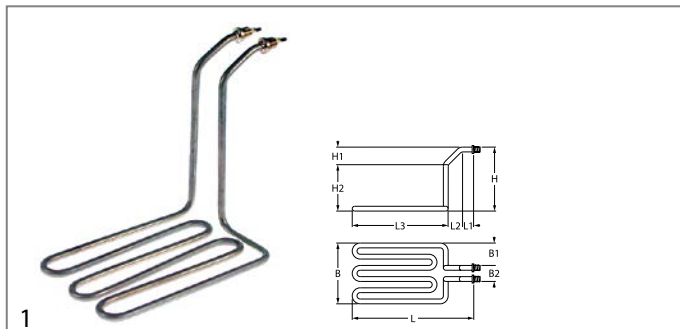

| | | | |
|------------------------|--|-----------------|------------------------|
| GEV No. | 418368 | Ref. No. | 572099 |
| description | heating element 2000W 230V heating circuits 1 mounting pos. left L 285mm W 160mm H 210mm 2 hole fixing connection M4 immersion heater L1 15mm L2 45mm L3 225mm W1 95mm W2 65mm H1 35mm H2 175mm tube \varnothing 8.5mm thread M14x1.5 mounting distance 51mm connection length 30mm windings 3 | | |
| For models: | 0520302A00, 0520302A01 | | |
| accessories for | 418368 | | |
| | GEV No. | 510417 | Ref. No. — |
| | flat gasket fibre ED \varnothing 20mm ID \varnothing 14mm thickness 2mm Qty 1 pcs | | |
| | GEV No. | 520228 | Ref. No. — |
| | tooth lock washer ID \varnothing 15.3mm ED \varnothing 24mm steel Qty 1 pcs for thread M14 | | |
| | GEV No. | 520230 | Ref. No. — |
| | nut thread M14x1.5 H 5mm WS 19 zinc-coated steel Qty 1 pcs | | |
| | GEV No. | 521101 | Ref. No. 113000 |
| | nut thread M14x1.5 H 5mm WS 19 SS Qty 1 pcs | | |
| | GEV No. | 521103 | Ref. No. — |
| | nut thread M4 H 3mm WS 7 brass Qty 20 pcs | | |
| | GEV No. | 521104 | Ref. No. — |
| | washer ID \varnothing 4.3mm ED \varnothing 8mm thickness 0.5mm brass Qty 20 pcs for thread M4 | | |
| | GEV No. | 550262 | Ref. No. — |
| | flat gasket copper ED \varnothing 20mm ID \varnothing 14mm thickness 2mm | | |
| | GEV No. | 560111 | Ref. No. 120017 |
| | plain washer ID \varnothing 4.3mm ED \varnothing 9mm thickness 0.8mm SS Qty 20 pcs DIN 125A for thread M4 | | |
| | GEV No. | 560131 | Ref. No. — |
| | hexagonal nut thread M4 H 3.2mm WS 7 SS DIN/ISO DIN 934 / ISO 4032/8673 Qty 20 pcs | | |

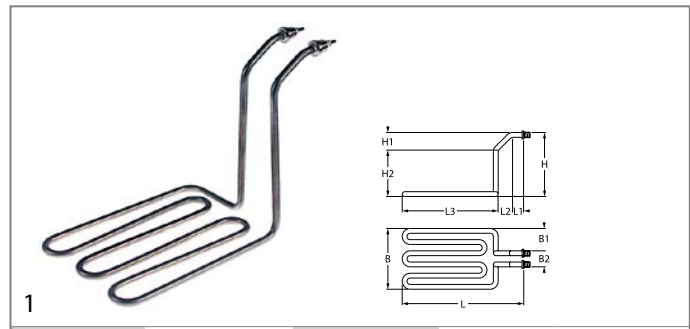

| | | | |
|------------------------|--|-----------------|------------------------|
| GEV No. | 418367 | Ref. No. | 572097 |
| description | heating element 2000W 230V heating circuits 1 mounting pos. right L 285mm W 160mm H 210mm 2 hole fixing connection M4 fryer heaters L1 15mm L2 45mm L3 225mm W1 95mm W2 65mm H1 35mm H2 175mm tube \varnothing 8.5mm thread M14x1.5 mounting distance 51mm connection length 30mm windings 3 | | |
| For models: | 0520302A00, 0520302A01 | | |
| accessories for | 418367 | | |
| | GEV No. | 510417 | Ref. No. — |
| | flat gasket fibre ED \varnothing 20mm ID \varnothing 14mm thickness 2mm Qty 1 pcs | | |
| | GEV No. | 520228 | Ref. No. — |
| | tooth lock washer ID \varnothing 15.3mm ED \varnothing 24mm steel Qty 1 pcs for thread M14 | | |
| | GEV No. | 520230 | Ref. No. — |
| | nut thread M14x1.5 H 5mm WS 19 zinc-coated steel Qty 1 pcs | | |
| | GEV No. | 521101 | Ref. No. 113000 |
| | nut thread M14x1.5 H 5mm WS 19 SS Qty 1 pcs | | |
| | GEV No. | 521103 | Ref. No. — |
| | nut thread M4 H 3mm WS 7 brass Qty 20 pcs | | |
| | GEV No. | 521104 | Ref. No. — |
| | washer ID \varnothing 4.3mm ED \varnothing 8mm thickness 0.5mm brass Qty 20 pcs for thread M4 | | |
| | GEV No. | 550262 | Ref. No. — |
| | flat gasket copper ED \varnothing 20mm ID \varnothing 14mm thickness 2mm | | |
| | GEV No. | 560111 | Ref. No. 120017 |
| | plain washer ID \varnothing 4.3mm ED \varnothing 9mm thickness 0.8mm SS Qty 20 pcs DIN 125A for thread M4 | | |
| | GEV No. | 560131 | Ref. No. — |
| | hexagonal nut thread M4 H 3.2mm WS 7 SS DIN/ISO DIN 934 / ISO 4032/8673 Qty 20 pcs | | |

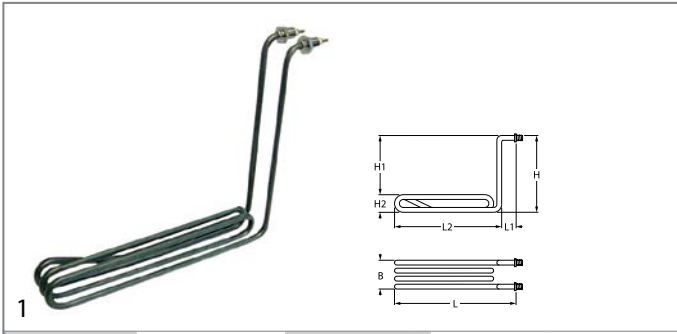

| | | | |
|--------------------|---|-----------------|------------------|
| GEV No. | 415422 | Ref. No. | 572062 572064 |
| description | heating element 2000W 230V heating circuits 1 L 300mm W 40mm H 240mm L1 20mm L2 280mm H1 195mm H2 45mm thread M14x1.5 mounting distance 25mm tube ø 8.5mm 2 hole fixing connection M4 connection length 20mm immersion heater windings 3 SS | | |

| | | | | |
|------------------------|---|--------|----------|--------|
| accessories for | 415422 | | | |
| | GEV No. | 510417 | Ref. No. | — |
| | flat gasket fibre ED ø 20mm ID ø 14mm thickness 2mm Qty 1 pcs | | | |
| | GEV No. | 520228 | Ref. No. | — |
| | tooth lock washer ID ø 15.3mm ED ø 24mm steel Qty 1 pcs for thread M14 | | | |
| | GEV No. | 520230 | Ref. No. | — |
| | nut thread M14x1.5 H 5mm WS 19 zinc-coated steel Qty 1 pcs | | | |
| | GEV No. | 521101 | Ref. No. | 113000 |
| | nut thread M14x1.5 H 5mm WS 19 SS Qty 1 pcs | | | |
| | GEV No. | 521103 | Ref. No. | — |
| | nut thread M4 H 3mm WS 7 brass Qty 20 pcs | | | |
| | GEV No. | 521104 | Ref. No. | — |
| | washer ID ø 4.3mm ED ø 8mm thickness 0.5mm brass Qty 20 pcs for thread M4 | | | |
| | GEV No. | 550262 | Ref. No. | — |
| | flat gasket copper ED ø 20mm ID ø 14mm thickness 2mm | | | |
| | GEV No. | 560111 | Ref. No. | 120017 |
| | plain washer ID ø 4.3mm ED ø 9mm thickness 0.8mm SS Qty 20 pcs DIN 125A for thread M4 | | | |
| | GEV No. | 560131 | Ref. No. | — |
| | hexagonal nut thread M4 H 3.2mm WS 7 SS DIN/ISO DIN 934 / ISO 4032/8673 Qty 20 pcs | | | |

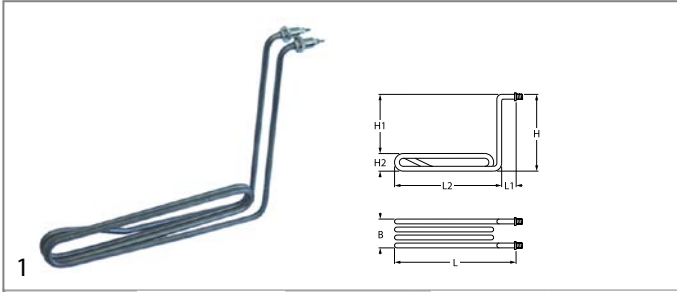

| | | | |
|--------------------|---|-----------------|-----|
| GEV No. | 415746 | Ref. No. | N/A |
| description | heating element 3300W 230V heating circuits 1 L 320mm W 40mm H 250mm L1 20mm L2 300mm H1 210mm H2 40mm thread M14x1.5 tube ø 8.5mm 2 hole fixing connection M4 fryer heaters windings 3 | | |

| | | | | |
|------------------------|---|--------|----------|---|
| accessories for | 415746 | | | |
| | GEV No. | 510417 | Ref. No. | — |
| | flat gasket fibre ED ø 20mm ID ø 14mm thickness 2mm Qty 1 pcs | | | |

| | | | | |
|------------------------|---|--------|----------|--------|
| accessories for | 415746 | | | |
| | GEV No. | 520228 | Ref. No. | — |
| | tooth lock washer ID ø 15.3mm ED ø 24mm steel Qty 1 pcs for thread M14 | | | |
| | GEV No. | 520230 | Ref. No. | — |
| | nut thread M14x1.5 H 5mm WS 19 zinc-coated steel Qty 1 pcs | | | |
| | GEV No. | 521101 | Ref. No. | 113000 |
| | nut thread M14x1.5 H 5mm WS 19 SS Qty 1 pcs | | | |
| | GEV No. | 521103 | Ref. No. | — |
| | nut thread M4 H 3mm WS 7 brass Qty 20 pcs | | | |
| | GEV No. | 521104 | Ref. No. | — |
| | washer ID ø 4.3mm ED ø 8mm thickness 0.5mm brass Qty 20 pcs for thread M4 | | | |
| | GEV No. | 550262 | Ref. No. | — |
| | flat gasket copper ED ø 20mm ID ø 14mm thickness 2mm | | | |
| | GEV No. | 560111 | Ref. No. | 120017 |
| | plain washer ID ø 4.3mm ED ø 9mm thickness 0.8mm SS Qty 20 pcs DIN 125A for thread M4 | | | |
| | GEV No. | 560131 | Ref. No. | — |
| | hexagonal nut thread M4 H 3.2mm WS 7 SS DIN/ISO DIN 934 / ISO 4032/8673 Qty 20 pcs | | | |

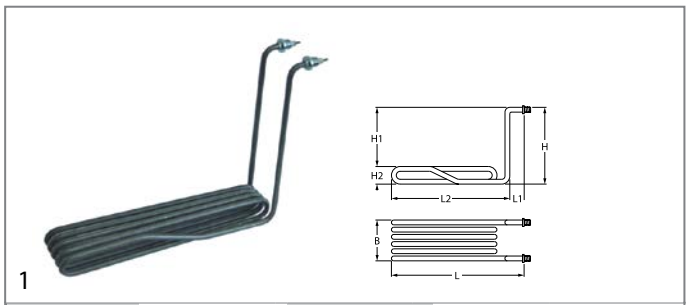



| | | | |
|--------------------|---|-----------------|--------|
| GEV No. | 415819 | Ref. No. | 572049 |
| description | heating element 3300W 230V heating circuits 1 L 339mm W 68mm H 235mm L1 17mm L2 322mm H1 200mm H2 35mm thread M14x1.5 mounting distance 60mm tube ø 8.5mm 2 hole fixing connection M4 immersion heater windings 5 | | |

| | | | | |
|------------------------|---|--------|----------|--------|
| accessories for | 415819 | | | |
| | GEV No. | 510417 | Ref. No. | — |
| | flat gasket fibre ED ø 20mm ID ø 14mm thickness 2mm Qty 1 pcs | | | |
| | GEV No. | 520228 | Ref. No. | — |
| | tooth lock washer ID ø 15.3mm ED ø 24mm steel Qty 1 pcs for thread M14 | | | |
| | GEV No. | 520230 | Ref. No. | — |
| | nut thread M14x1.5 H 5mm WS 19 zinc-coated steel Qty 1 pcs | | | |
| | GEV No. | 521101 | Ref. No. | 113000 |
| | nut thread M14x1.5 H 5mm WS 19 SS Qty 1 pcs | | | |
| | GEV No. | 521103 | Ref. No. | — |
| | nut thread M4 H 3mm WS 7 brass Qty 20 pcs | | | |
| | GEV No. | 521104 | Ref. No. | — |
| | washer ID ø 4.3mm ED ø 8mm thickness 0.5mm brass Qty 20 pcs for thread M4 | | | |

Table continues overleaf



| | | | | |
|---|---------|--------|----------|--------|
| accessories for 415819 | | | | |
|  | GEV No. | 550262 | Ref. No. | — |
| flat gasket copper ED ø 20mm ID ø 14mm thickness 2mm | | | | |
|  | GEV No. | 560111 | Ref. No. | 120017 |
| plain washer ID ø 4.3mm ED ø 9mm thickness 0.8mm SS Qty 20 pcs DIN 125A for thread M4 | | | | |
|  | GEV No. | 560131 | Ref. No. | — |
| hexagonal nut thread M4 H 3.2mm WS 7 SS DIN/ISO DIN 934 / ISO 4032/8673 Qty 20 pcs | | | | |

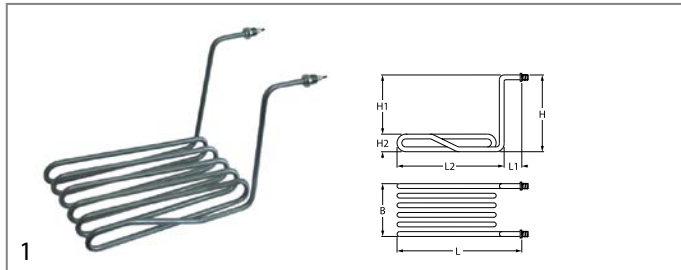

| | | | |
|--------------------|---|-----------------|--|
| GEV No. | 415764 | Ref. No. | 572168 572168+ 2 x 113000+ 2 x 121216 |
| description | heating element 3300W 230V heating circuits 1 L 320mm W 138mm H 182mm L1 56mm L2 264mm H1 145mm H2 37mm thread M14x1.5 mounting distance 124mm tube ø 8.5mm 2 hole fixing connection M4 immersion heater windings 6 | | |
| For models: | 1820301-00, 1820301-01, 1820301-02 | | |

| | | | | |
|---|---------|--------|----------|--------|
| accessories for 415764 | | | | |
|  | GEV No. | 510417 | Ref. No. | — |
| flat gasket fibre ED ø 20mm ID ø 14mm thickness 2mm Qty 1 pcs | | | | |
|  | GEV No. | 520228 | Ref. No. | — |
| tooth lock washer ID ø 15.3mm ED ø 24mm steel Qty 1 pcs for thread M14 | | | | |
|  | GEV No. | 520230 | Ref. No. | — |
| nut thread M14x1.5 H 5mm WS 19 zinc-coated steel Qty 1 pcs | | | | |
|  | GEV No. | 521101 | Ref. No. | 113000 |
| nut thread M14x1.5 H 5mm WS 19 SS Qty 1 pcs | | | | |
|  | GEV No. | 521103 | Ref. No. | — |
| nut thread M4 H 3mm WS 7 brass Qty 20 pcs | | | | |
|  | GEV No. | 521104 | Ref. No. | — |
| washer ID ø 4.3mm ED ø 8mm thickness 0.5mm brass Qty 20 pcs for thread M4 | | | | |
|  | GEV No. | 550262 | Ref. No. | — |
| flat gasket copper ED ø 20mm ID ø 14mm thickness 2mm | | | | |
|  | GEV No. | 560111 | Ref. No. | 120017 |
| plain washer ID ø 4.3mm ED ø 9mm thickness 0.8mm SS Qty 20 pcs DIN 125A for thread M4 | | | | |
|  | GEV No. | 560131 | Ref. No. | — |
| hexagonal nut thread M4 H 3.2mm WS 7 SS DIN/ISO DIN 934 / ISO 4032/8673 Qty 20 pcs | | | | |

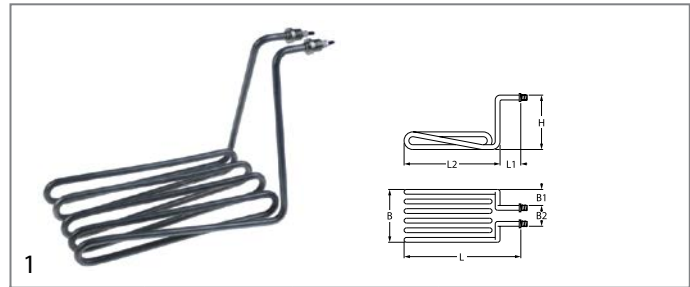

| | | | |
|--------------------|---|-----------------|--------|
| GEV No. | 418857 | Ref. No. | 572088 |
| description | heating element 2500W 230V heating circuits 1 L 290mm W 155mm H 198mm L1 44mm L2 246mm W1 50mm W2 55mm H1 162mm H2 36mm tube ø 8.5mm connection M4 thread M14x1.5 2 hole fixing windings 5 mounting distance 46mm immersion heater connection length 30mm | | |

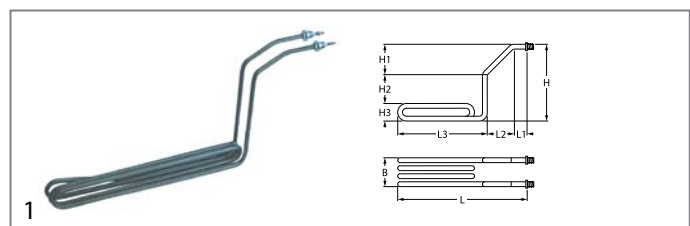

| | | | |
|--------------------|--|-----------------|--------|
| GEV No. | 415713 | Ref. No. | 572069 |
| description | heating element 2000W 220V heating circuits 1 L 465mm W 40mm H 205mm 2 hole fixing connection M4 fryer heaters L1 60mm L2 55mm L3 350mm H1 35mm H2 129mm H3 41mm tube ø 8.5mm thread M14x1.5 mounting distance 25mm connection length 20mm | | |

| | | | | |
|--|---------|--------|----------|---|
| spare parts for 415713 | | | | |
|  | GEV No. | 510417 | Ref. No. | — |
| flat gasket fibre ED ø 20mm ID ø 14mm thickness 2mm Qty 1 pcs | | | | |

| | | | | |
|---|---------|--------|----------|--------|
| accessories for 415713 | | | | |
|  | GEV No. | 520228 | Ref. No. | — |
| tooth lock washer ID ø 15.3mm ED ø 24mm steel Qty 1 pcs for thread M14 | | | | |
|  | GEV No. | 520230 | Ref. No. | — |
| nut thread M14x1.5 H 5mm WS 19 zinc-coated steel Qty 1 pcs | | | | |
|  | GEV No. | 521101 | Ref. No. | 113000 |
| nut thread M14x1.5 H 5mm WS 19 SS Qty 1 pcs | | | | |
|  | GEV No. | 521103 | Ref. No. | — |
| nut thread M4 H 3mm WS 7 brass Qty 20 pcs | | | | |
|  | GEV No. | 521104 | Ref. No. | — |
| washer ID ø 4.3mm ED ø 8mm thickness 0.5mm brass Qty 20 pcs for thread M4 | | | | |
|  | GEV No. | 550262 | Ref. No. | — |
| flat gasket copper ED ø 20mm ID ø 14mm thickness 2mm | | | | |
|  | GEV No. | 560111 | Ref. No. | 120017 |
| plain washer ID ø 4.3mm ED ø 9mm thickness 0.8mm SS Qty 20 pcs DIN 125A for thread M4 | | | | |
|  | GEV No. | 560131 | Ref. No. | — |
| hexagonal nut thread M4 H 3.2mm WS 7 SS DIN/ISO DIN 934 / ISO 4032/8673 Qty 20 pcs | | | | |

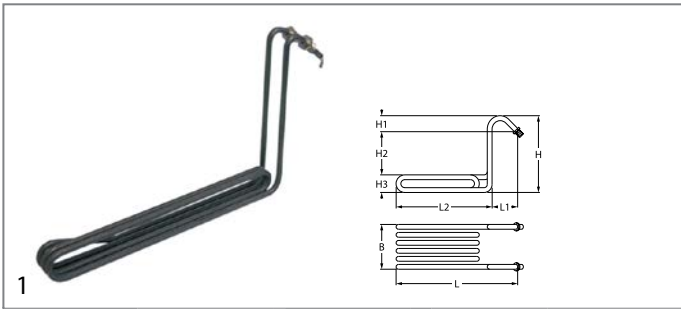

| | | | |
|----------------|--------|-----------------|--------|
| GEV No. | 415710 | Ref. No. | 572076 |
|----------------|--------|-----------------|--------|

description heating element 2000W 230V heating circuits 1 L 370mm W 30mm H 235mm L1 25mm L2 355mm H2 195mm H3 40mm thread M14x1.5 mounting distance 35mm tube ø 8.5mm 2 hole fixing connection male faston 6.3mm immersion heater windings 3

spare parts for 415710

| | | | |
|----------------|--------|-----------------|---|
| GEV No. | 510417 | Ref. No. | — |
|----------------|--------|-----------------|---|

 flat gasket fibre ED ø 20mm ID ø 14mm thickness 2mm Qty 1 pcs

accessories for 415710

| | | | |
|----------------|--------|-----------------|---|
| GEV No. | 520228 | Ref. No. | — |
|----------------|--------|-----------------|---|

 tooth lock washer ID ø 15.3mm ED ø 24mm steel Qty 1 pcs for thread M14

| | | | |
|----------------|--------|-----------------|---|
| GEV No. | 520230 | Ref. No. | — |
|----------------|--------|-----------------|---|

 nut thread M14x1.5 H 5mm WS 19 zinc-coated steel Qty 1 pcs

| | | | |
|----------------|--------|-----------------|--------|
| GEV No. | 521101 | Ref. No. | 113000 |
|----------------|--------|-----------------|--------|

 nut thread M14x1.5 H 5mm WS 19 SS Qty 1 pcs

| | | | |
|----------------|--------|-----------------|---|
| GEV No. | 550262 | Ref. No. | — |
|----------------|--------|-----------------|---|

 flat gasket copper ED ø 20mm ID ø 14mm thickness 2mm



| | | | |
|----------------|--------|-----------------|--------|
| GEV No. | 418311 | Ref. No. | 572026 |
|----------------|--------|-----------------|--------|

description heating element 3300W 230V heating circuits 1 mounting pos. centre L 490mm W 300mm H 190mm 2 hole fixing connection M4 fryer heaters L1 60mm L2 430mm W1 113mm W2 75mm tube ø 8.5mm thread M14x1.5 mounting distance 68mm windings 4

accessories for 418311

| | | | |
|----------------|--------|-----------------|---|
| GEV No. | 510417 | Ref. No. | — |
|----------------|--------|-----------------|---|

 flat gasket fibre ED ø 20mm ID ø 14mm thickness 2mm Qty 1 pcs

| | | | |
|----------------|--------|-----------------|---|
| GEV No. | 520228 | Ref. No. | — |
|----------------|--------|-----------------|---|

 tooth lock washer ID ø 15.3mm ED ø 24mm steel Qty 1 pcs for thread M14

| | | | |
|----------------|--------|-----------------|---|
| GEV No. | 520230 | Ref. No. | — |
|----------------|--------|-----------------|---|

 nut thread M14x1.5 H 5mm WS 19 zinc-coated steel Qty 1 pcs

| | | | |
|----------------|--------|-----------------|--------|
| GEV No. | 521101 | Ref. No. | 113000 |
|----------------|--------|-----------------|--------|

 nut thread M14x1.5 H 5mm WS 19 SS Qty 1 pcs

| | | | |
|----------------|--------|-----------------|---|
| GEV No. | 521103 | Ref. No. | — |
|----------------|--------|-----------------|---|

 nut thread M4 H 3mm WS 7 brass Qty 20 pcs

accessories for 418311

| | | | |
|----------------|--------|-----------------|---|
| GEV No. | 521104 | Ref. No. | — |
|----------------|--------|-----------------|---|

 washer ID ø 4.3mm ED ø 8mm thickness 0.5mm brass Qty 20 pcs for thread M4

| | | | |
|----------------|--------|-----------------|---|
| GEV No. | 550262 | Ref. No. | — |
|----------------|--------|-----------------|---|

 flat gasket copper ED ø 20mm ID ø 14mm thickness 2mm

| | | | |
|----------------|--------|-----------------|--------|
| GEV No. | 560111 | Ref. No. | 120017 |
|----------------|--------|-----------------|--------|

 plain washer ID ø 4.3mm ED ø 9mm thickness 0.8mm SS Qty 20 pcs DIN 125A for thread M4

| | | | |
|----------------|--------|-----------------|---|
| GEV No. | 560131 | Ref. No. | — |
|----------------|--------|-----------------|---|

 hexagonal nut thread M4 H 3.2mm WS 7 SS DIN/ISO DIN 934 / ISO 4032/8673 Qty 20 pcs

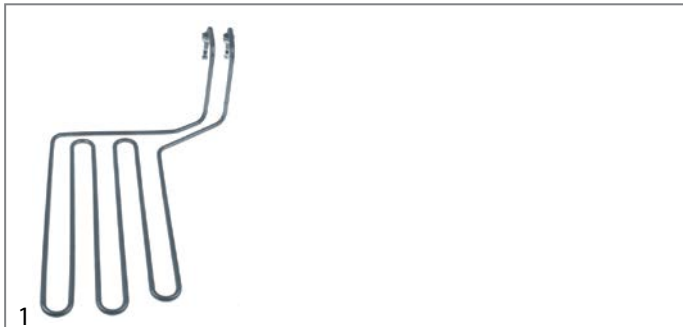

| | | | |
|----------------|--------|-----------------|--------|
| GEV No. | 418313 | Ref. No. | 572027 |
|----------------|--------|-----------------|--------|

description heating element 3300W 230V heating circuits 1 mounting pos. left L 500mm W 335mm H 170mm 2 hole fixing connection M4 fryer heaters L1 100mm L2 410mm W1 135mm W2 200mm tube ø 8.5mm thread M14x1.5 mounting distance 50mm connection length 46mm windings 3

accessories for 418313

| | | | |
|----------------|--------|-----------------|---|
| GEV No. | 510417 | Ref. No. | — |
|----------------|--------|-----------------|---|

 flat gasket fibre ED ø 20mm ID ø 14mm thickness 2mm Qty 1 pcs

| | | | |
|----------------|--------|-----------------|---|
| GEV No. | 520228 | Ref. No. | — |
|----------------|--------|-----------------|---|

 tooth lock washer ID ø 15.3mm ED ø 24mm steel Qty 1 pcs for thread M14

| | | | |
|----------------|--------|-----------------|---|
| GEV No. | 520230 | Ref. No. | — |
|----------------|--------|-----------------|---|

 nut thread M14x1.5 H 5mm WS 19 zinc-coated steel Qty 1 pcs

| | | | |
|----------------|--------|-----------------|--------|
| GEV No. | 521101 | Ref. No. | 113000 |
|----------------|--------|-----------------|--------|

 nut thread M14x1.5 H 5mm WS 19 SS Qty 1 pcs

| | | | |
|----------------|--------|-----------------|---|
| GEV No. | 521103 | Ref. No. | — |
|----------------|--------|-----------------|---|

 nut thread M4 H 3mm WS 7 brass Qty 20 pcs

| | | | |
|----------------|--------|-----------------|---|
| GEV No. | 521104 | Ref. No. | — |
|----------------|--------|-----------------|---|

 washer ID ø 4.3mm ED ø 8mm thickness 0.5mm brass Qty 20 pcs for thread M4

| | | | |
|----------------|--------|-----------------|---|
| GEV No. | 550262 | Ref. No. | — |
|----------------|--------|-----------------|---|

 flat gasket copper ED ø 20mm ID ø 14mm thickness 2mm









| | | | |
|----------------|--------|-----------------|--------|
| GEV No. | 560111 | Ref. No. | 120017 |
|----------------|--------|-----------------|--------|

 plain washer ID ø 4.3mm ED ø 9mm thickness 0.8mm SS Qty 20 pcs DIN 125A for thread M4

| | | | |
|----------------|--------|-----------------|---|
| GEV No. | 560131 | Ref. No. | — |
|----------------|--------|-----------------|---|

 hexagonal nut thread M4 H 3.2mm WS 7 SS DIN/ISO DIN 934 / ISO 4032/8673 Qty 20 pcs





| | | | |
|---|---|-----------------|------------------------|
|  | | | |
| 1 | | | |
| GEV No. | 418312 | Ref. No. | 572025 |
| description | heating element 3300W 230V mounting pos. right L 500mm W 335mm H 170mm 2 hole fixing connection M4 fryer heaters L1 100mm L2 410mm W1 135mm W2 200mm tube ø 8.5mm thread M14x1.5 mounting distance 50mm connection length 46mm windings 3 | | |
| accessories for | 418312 | | |
|  | GEV No. | 510417 | Ref. No. — |
| | flat gasket fibre ED ø 20mm ID ø 14mm thickness 2mm Qty 1 pcs | | |
|  | GEV No. | 520228 | Ref. No. — |
| | tooth lock washer ID ø 15.3mm ED ø 24mm steel Qty 1 pcs for thread M14 | | |
|  | GEV No. | 520230 | Ref. No. — |
| | nut thread M14x1.5 H 5mm WS 19 zinc-coated steel Qty 1 pcs | | |
|  | GEV No. | 521101 | Ref. No. 113000 |
| | nut thread M14x1.5 H 5mm WS 19 SS Qty 1 pcs | | |
|  | GEV No. | 521103 | Ref. No. — |
| | nut thread M4 H 3mm WS 7 brass Qty 20 pcs | | |
|  | GEV No. | 521104 | Ref. No. — |
| | washer ID ø 4.3mm ED ø 8mm thickness 0.5mm brass Qty 20 pcs for thread M4 | | |
|  | GEV No. | 550262 | Ref. No. — |
| | flat gasket copper ED ø 20mm ID ø 14mm thickness 2mm | | |
|  | GEV No. | 560111 | Ref. No. 120017 |
| | plain washer ID ø 4.3mm ED ø 9mm thickness 0.8mm SS Qty 20 pcs DIN 125A for thread M4 | | |
|  | GEV No. | 560131 | Ref. No. — |
| | hexagonal nut thread M4 H 3.2mm WS 7 SS DIN/ISO DIN 934 / ISO 4032/8673 Qty 20 pcs | | |

heating elements for griddles

| | | | |
|---|---|-----------------|--------|
|  | | | |
| 1 | | | |
| GEV No. | 419246 | Ref. No. | 574156 |
| description | heating element 1200W 230V heating circuits 1 L 534mm W 36mm H 65mm tube ø 8.5mm connection 6.3x0.8 | | |
| For models: | 0721134-01, 0721134A01, 0721172A01, 0721173A01, 0721174A01, 0721175A01, 1021130A00, 1021135A00, 1221130J00, 1221141-00, 1221141A00, 1221156A00, 1222507-00, 1222509-00, 1321130-00, 1321130A00, 1321131-00, 1321131A00, 1321141-00, 1321141A00, 1322507-00, 1322509-00, 1421126B00, 1421127B00, 1421130B00, 1421131-00, 1421131A00, 1421131B00, 1421134-00, 1421134-01, 1421134A00, 1421134A01, 1421139-00, 1421139A00, 1421139B00, 1421141-00, 1421141A00, 1421141B00, 1421143B01, 1421144B01, 1421145B01, 1421149B00, 1421149B01, 1421150B00, 1421150B01, 1421151B00, 1421151B01, 1421155B02, 1421156B02, 1421157B02... (Other models you can see in the webshop) | | |

| | | | |
|--|---|-----------------|--------|
|  | | | |
| 1 | | | |
| GEV No. | 415446 | Ref. No. | 203550 |
| description | heating element 1250W 230V heating circuits 1 L 450mm W 65mm H 60mm tube ø 6.5mm W1 43mm W2 25mm connection male faston 6.3mm connection length 24mm connection distance 19mm dry heating element | | |

| | | | |
|--|---|-----------------|--------|
|  | | | |
| 1 | | | |
| GEV No. | 415425 | Ref. No. | 574099 |
| description | heating element 1250W 230V heating circuits 1 L 470mm W 64mm H 60mm tube ø 6.5mm L1 230mm connection male faston 6.3mm connection length 25mm connection distance 15mm dry heating element | | |
| For models: | 0221101-00, 0221101-01, 0221101A00, 0221101A01, 0221102-00, 0221102-01, 0221103-00, 0221103-01, 0221104-00, 0221104-01, 0221104A00, 0221104A01, 0221105-00, 0221105-01, 0221106-00, 0221106-01, 1221101-00, 1221101A00, 1221101B00, 1221102-00, 1221102A00, 1221102B00, 1421101-00, 1421101A00, 1421102-00, 1421103-00, 1421104-00, 1421104A00, 1421105-00, 1421106-00, 1421107-00, 1421107A00, 1421108-00, 1421109-00, 1421110-00, 1421110A00, 1421111-00, 1421112-00, 2021101-00, 20211011-0, 2021101A00, 2021102-00, 20211022-0, 2021103-00, 20211033-0, 2021104-00, 20211044-0, 2021104A00, 2021105-00, 20211055-0... (Other models you can see in the webshop) | | |

| | | | |
|---|--|-----------------|--------|
|  | | | |
| 1 | | | |
| GEV No. | 420543 | Ref. No. | 574162 |
| description | heating element 2000W 400V heating circuits 1 L 320mm W 120mm H 144mm tube ø 6.5mm | | |
| For models: | 1423502-02, 1423502A02, 1423525A00, 1423527A00, 1523502A00, 2023502-07, 2023502A07, 2023503-13, 2023503A13, 2023525A00, 2223502-00, 2223502A00, 3023502-06, 3023502A06 | | |

| | | | |
|--|--|-----------------|--------|
|  | | | |
| 1 | | | |
| GEV No. | 418295 | Ref. No. | 574109 |
| description | heating element 300W 230V heating circuits 1 L 481mm W 108mm H 50mm tube ø 8.5mm connection M4 connection distance 100mm dry heating element | | |
| For models: | 2123202A00, 2123202A01, 2123203A00, 2123203A01, 2123203A02, 2123203A03, 2123203A04, 2123204A00, 2123204A01, 2123204A02, 2123204A03, 2123204A04 | | |



heating elements for large hobs



| | | | |
|--------------------|---|-----------------|--------|
| GEV No. | 420361 | Ref. No. | 574151 |
| description | heating element 4300W 400V heating circuits 1 L 450mm W 280mm H 100mm connection cable tube ø 13x6mm cable length 430mm dry heating element | | |
| For models: | 2021115-00, 2021115-01, 2021115-02, 2021115-03, 2021115-04, 2221115-00, 2221115-01 | | |



| | | | |
|--------------------|--|-----------------|--------|
| GEV No. | 418255 | Ref. No. | 574114 |
| description | heating element 600W 80V heating circuits 1 L 332mm W 54mm H 54mm tube ø 8.5mm mounting pos. connection male faston 6.3mm connection distance 45mm windings 1 dry heating element suitable for MKN series 700 | | |
| For models: | 2020406A01, 2120406A00, 2120406A01, 2123502-00, 2123502-01, 2123502-02, 2123502A00, 2123502A01, 2123502A02, 2123503-00, 2123503-01, 2123503-02, 2123503-03, 2123503-04, 2123503-05, 2123503-06, 2123503A00, 2123503A01, 2123503A03, 2123503A04, 2123503A05, 2123503A06, 4228801-00, 4228801-01 | | |

heating elements for tilting bratt pan



| | | | |
|--------------------|---|-----------------|--------|
| GEV No. | 418303 | Ref. No. | 574107 |
| description | heating element 1200W 230V L 510mm W 45mm Hmm connection male faston 6.3mm dry heating element heating circuits 1 tube ø 8.5mm connection distance 35mm | | |
| For models: | 0021135A00, 1220504-01, 1222601-00, 1320504-01, 1320504-02, 1322601-00, 1420509-01, 1422601-00, 1422602-00, 2020506-01, 2021401-04, 2021401-05, 2021401-06, 2021401-07, 2021401-08, 2021401-09, 2021401A03, 2021401A04, 2021401A06, 2021401A07, 2021401A08, 2021401A09, 2021401B03, 2021401B04, 2021401B06, 2021401B07, 2021401B08, 2021401B09, 2021401C03, 2021401C04, 2021401C06, 2021401C07, 2021401C08, 2021401C09, 2021402-04, 2021402-05, 2021402-06, 2021402-07, 2021402-08, 2021402A03, 2021402A04, 2021402A06, 2021402A07, 2021402A08, 2021402B03, 2021402B04, 2021402B06, 2021402B07, 2021402B08, 2021402C03... (Other models you can see in the webshop) | | |



| | | | |
|--------------------|---|-----------------|--------|
| GEV No. | 415475 | Ref. No. | 574084 |
| description | heating element 1670W 230V L 110mm W 430mm H 45mm connection M4 dry heating element heating circuits 1 tube ø 8.5mm W1 200mm W2 30mm mounting pos. inner connection distance 22mm | | |

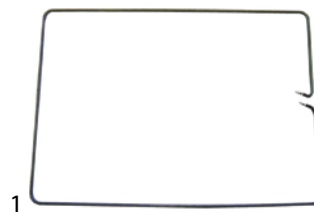

| | | | |
|--------------------|--|-----------------|--------|
| GEV No. | 415476 | Ref. No. | 574085 |
| description | heating element 1670W 230V L 650mm W 470mm H 35mm connection M4 dry heating element heating circuits 1 tube ø 8.5mm W2 45mm mounting pos. outer connection distance 37mm | | |



| | | | |
|--------------------|---|-----------------|--------|
| GEV No. | 415477 | Ref. No. | 574102 |
| description | heating element 1670W 230V L 95mm W 465mm H 45mm connection M4 dry heating element heating circuits 1 tube ø 8.5mm W1 220mm W2 25mm connection distance 16mm | | |
| For models: | 2021401-00, 2021401-01, 2021401-02, 2021401-03, 2021401A00, 2021401A01, 2021401A02, 2021401B00, 2021401B01, 2021401B02, 2021401C00, 2021401C01, 2021401C02, 2021402-00, 2021402-01, 2021402-02, 2021402-03, 2021402A00, 2021402A01, 2021402A02, 2021402B00, 2021402B01, 2021402B02, 2021402C00, 2021402C01, 2021402C02, 2021403-00, 2021403-01, 2021403-02, 20214033-0, 2021403A00, 2021403A01, 2021403B00, 2021403B01, 2021403C01, 2021404-00, 2021404-01, 2021404-02, 20214044-0, 2021404A00, 2021404A01, 2021404B00, 2021404B01, 2021404C00, 2021404C01, 2021405-00, 20214055-0, 2021405B00, 2021406-00, 20214066-0... (Other models you can see in the webshop) | | |

heating elements for pasta cookers

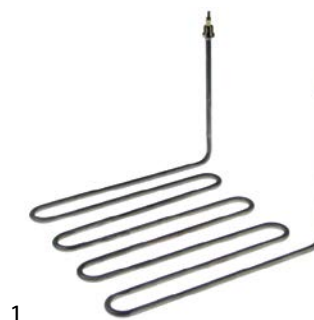













| | | | |
|---|--|-----------------|-------------------|
| GEV No. | 418326 | Ref. No. | 327649 572170 |
| description | heating element 3300W 400V heating circuits 1 L 315mm W 310mm H 215mm 2 hole fixing connection M4 thread M14x1.5 tube ø 8.5mm stainless steel mounting distance 302mm connection length 21mm pasta cooker immersion heater | | |
| For models: | 1320401-00, 1320401-01, 1420401-00, 1420401-01, 2020401-00, 2020401-01, 2120401-00, 2120401-01 | | |
| spare parts for | 418326 | | |
|  | GEV No. | 510417 | Ref. No. — |
| | flat gasket fibre ED ø 20mm ID ø 14mm thickness 2mm Qty 1 pcs | | |

Table continues overleaf











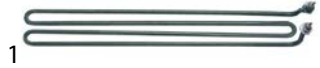



| | |
|---|---|
| accessories for 418326 | |
|  | GEV No. 520228 Ref. No. — tooth lock washer ID ø 15.3mm ED ø 24mm steel Qty 1 pcs for thread M14 |
|  | GEV No. 520230 Ref. No. — nut thread M14x1.5 H 5mm WS 19 zinc-coated steel Qty 1 pcs |
|  | GEV No. 521101 Ref. No. 113000 nut thread M14x1.5 H 5mm WS 19 SS Qty 1 pcs |
|  | GEV No. 550262 Ref. No. — flat gasket copper ED ø 20mm ID ø 14mm thickness 2mm |

heating elements for rechauds

| | |
|---|--|
|  | |
| 1 | |
| GEV No. 415767 | Ref. No. 573054 573054/113000/121216 |
| description | heating element 1500W 230V heating circuits 1 L 425mm W 250mm H 58mm W1 50mm W2 150mm L1 60mm L2 365mm thread M14x1.5 mounting distance 142mm windings 3 tube ø 8.5mm connection M4 dry heating element 2 hole fixing for stockpot |
| accessories for 415767 | |
|  | GEV No. 510417 Ref. No. — flat gasket fibre ED ø 20mm ID ø 14mm thickness 2mm Qty 1 pcs |
|  | GEV No. 520228 Ref. No. — tooth lock washer ID ø 15.3mm ED ø 24mm steel Qty 1 pcs for thread M14 |
|  | GEV No. 520230 Ref. No. — nut thread M14x1.5 H 5mm WS 19 zinc-coated steel Qty 1 pcs |
|  | GEV No. 521101 Ref. No. 113000 nut thread M14x1.5 H 5mm WS 19 SS Qty 1 pcs |
|  | GEV No. 521103 Ref. No. — nut thread M4 H 3mm WS 7 brass Qty 20 pcs |
|  | GEV No. 521104 Ref. No. — washer ID ø 4.3mm ED ø 8mm thickness 0.5mm brass Qty 20 pcs for thread M4 |
|  | GEV No. 550262 Ref. No. — flat gasket copper ED ø 20mm ID ø 14mm thickness 2mm |
|  | GEV No. 560111 Ref. No. 120017 plain washer ID ø 4.3mm ED ø 9mm thickness 0.8mm SS Qty 20 pcs DIN 125A for thread M4 |
|  | GEV No. 560131 Ref. No. — hexagonal nut thread M4 H 3.2mm WS 7 SS DIN/ISO DIN 934 / ISO 4032/8673 Qty 20 pcs |

heating elements for chargrills

| | |
|--|---|
|  | |
| 1 | |
| GEV No. 415522 | Ref. No. 574091 |
| description | heating element 800W 380V L 480mm W 68mm H 74mm thread M14x1.5 mounting distance 37mm tube ø 8.5mm connection M4 heating circuits 1 2 hole fixing dry heating element W1 10mm W2 48mm |
| accessories for 415522 | |
|  | GEV No. 510417 Ref. No. — flat gasket fibre ED ø 20mm ID ø 14mm thickness 2mm Qty 1 pcs |
|  | GEV No. 520228 Ref. No. — tooth lock washer ID ø 15.3mm ED ø 24mm steel Qty 1 pcs for thread M14 |
|  | GEV No. 520230 Ref. No. — nut thread M14x1.5 H 5mm WS 19 zinc-coated steel Qty 1 pcs |
|  | GEV No. 521101 Ref. No. 113000 nut thread M14x1.5 H 5mm WS 19 SS Qty 1 pcs |
|  | GEV No. 550262 Ref. No. — flat gasket copper ED ø 20mm ID ø 14mm thickness 2mm |

| | |
|---|--|
|  | |
| 1 | |
| GEV No. 415427 | Ref. No. 574027 |
| description | heating element 820W 95V L 504mm W 33mm H 105mm 2 hole fixing mounting distance 27mm connection M4 L1 27mm L2 477mm heating circuits 1 tube ø 8.5mm dry heating element thread M14x1.5 |
| accessories for 415427 | |
|  | GEV No. 510417 Ref. No. — flat gasket fibre ED ø 20mm ID ø 14mm thickness 2mm Qty 1 pcs |
|  | GEV No. 520228 Ref. No. — tooth lock washer ID ø 15.3mm ED ø 24mm steel Qty 1 pcs for thread M14 |
|  | GEV No. 520230 Ref. No. — nut thread M14x1.5 H 5mm WS 19 zinc-coated steel Qty 1 pcs |
|  | GEV No. 521101 Ref. No. 113000 nut thread M14x1.5 H 5mm WS 19 SS Qty 1 pcs |
|  | GEV No. 550262 Ref. No. — flat gasket copper ED ø 20mm ID ø 14mm thickness 2mm |









| | | | |
|---|---|-----------------|------------------------|
|  | | | |
| GEV No. | 415426 | Ref. No. | 574097 |
| description | heating element 870W 95V L 495mm W 35mm H 73mm thread M14x1.5 mounting distance 35mm tube ø 8.5mm connection M4 heating circuits 1 connection length 20mm 2 hole fixing dry heating element | | |
| For models: | 0221501-00, 0221502-00, 1421501-00, 1421502-00, 1421503-00, 1421504-00, 2121501-00, 2121502-00 | | |
| accessories for | 415426 | | |
|  | GEV No. | 510417 | Ref. No. — |
|  | GEV No. | 520228 | Ref. No. — |
|  | GEV No. | 520230 | Ref. No. — |
|  | GEV No. | 521101 | Ref. No. 113000 |
|  | GEV No. | 550262 | Ref. No. — |

heating elements for salamanders/toast-

| | | | |
|---|---|-----------------|------------------------|
|  | | | |
| GEV No. | 415730 | Ref. No. | N/A |
| description | heating element 1100W 230V L 275mm W 143mm 2 hole fixing thread M14x1.5 mounting distance 137mm connection M4 dry heating element tube ø 8.5mm heating circuits 1 | | |
| accessories for | 415730 | | |
|  | GEV No. | 510417 | Ref. No. — |
|  | GEV No. | 520228 | Ref. No. — |
|  | GEV No. | 520230 | Ref. No. — |
|  | GEV No. | 521101 | Ref. No. 113000 |
|  | GEV No. | 521103 | Ref. No. — |
|  | GEV No. | 521104 | Ref. No. — |
|  | GEV No. | 550262 | Ref. No. — |
|  | GEV No. | 560111 | Ref. No. 120017 |

| | | | |
|---|----------------|--------|-------------------|
| accessories for | 415730 | | |
|  | GEV No. | 560131 | Ref. No. — |

| | | | |
|---|---|-----------------|------------------------|
|  | | | |
| GEV No. | 415418 | Ref. No. | 203556 574095 |
| description | heating element 1650W 230V L 260mm W 250mm 2 hole fixing thread M14x1.5 mounting distance 243mm connection male faston 6.3mm dry heating element tube ø 6.5mm heating circuits 1 connection length 20mm H 6.5mm | | |
| For models: | 00217022-0, 0521702-00, 0521702-01, 0521702-02, 0521702-03, 0521702-04, 0521702C04 | | |
| accessories for | 415418 | | |
|  | GEV No. | 510417 | Ref. No. — |
|  | GEV No. | 520228 | Ref. No. — |
|  | GEV No. | 520230 | Ref. No. — |
|  | GEV No. | 521101 | Ref. No. 113000 |
|  | GEV No. | 550262 | Ref. No. — |











| | | | |
|--|---|-----------------|-------------------|
|  | | | |
| GEV No. | 415514 | Ref. No. | 574116 720003 |
| description | heating element 1650W 230V L 315mm W 200mm 2 hole fixing thread M14x1.5 mounting distance 193mm connection M4 dry heating element tube ø 6.3mm heating circuits 1 H 6.3mm | | |
| For models: | 0521704-04, 0521704-05, 0521704-06, 0521704-07 | | |
| spare parts for | 415514 | | |
|  | GEV No. | 510417 | Ref. No. — |
| accessories for | 415514 | | |
|  | GEV No. | 520228 | Ref. No. — |
|  | GEV No. | 520230 | Ref. No. — |

Table continues overleaf

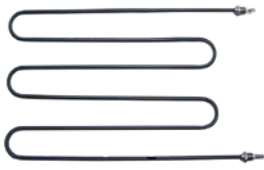

| | |
|---|---|
| accessories for 415514 | |
|  | GEV No. 521101 Ref. No. 113000 nut thread M14x1.5 H 5mm WS 19 SS Qty 1 pcs |
|  | GEV No. 521103 Ref. No. — nut thread M4 H 3mm WS 7 brass Qty 20 pcs |
|  | GEV No. 521104 Ref. No. — washer ID ø 4.3mm ED ø 8mm thickness 0.5mm brass Qty 20 pcs for thread M4 |
|  | GEV No. 550262 Ref. No. — flat gasket copper ED ø 20mm ID ø 14mm thickness 2mm |
|  | GEV No. 560111 Ref. No. 120017 plain washer ID ø 4.3mm ED ø 9mm thickness 0.8mm SS Qty 20 pcs DIN 125A for thread M4 |
|  | GEV No. 560131 Ref. No. — hexagonal nut thread M4 H 3.2mm WS 7 SS DIN/ISO DIN 934 / ISO 4032/8673 Qty 20 pcs |

| | |
|--|---|
|  1 | |
| GEV No. 415519 | Ref. No. 574035 |
| description | heating element 2000W 230V L 615mm W 100mm 2 hole fixing thread M14x1.5 mounting distance 87mm connection M4 dry heating element tube ø 8.5mm heating circuits 1 connection length 58mm |
| accessories for 415519 | |
|  | GEV No. 510417 Ref. No. — flat gasket fibre ED ø 20mm ID ø 14mm thickness 2mm Qty 1 pcs |
|  | GEV No. 520228 Ref. No. — tooth lock washer ID ø 15.3mm ED ø 24mm steel Qty 1 pcs for thread M14 |
|  | GEV No. 520230 Ref. No. — nut thread M14x1.5 H 5mm WS 19 zinc-coated steel Qty 1 pcs |
|  | GEV No. 521101 Ref. No. 113000 nut thread M14x1.5 H 5mm WS 19 SS Qty 1 pcs |
|  | GEV No. 521103 Ref. No. — nut thread M4 H 3mm WS 7 brass Qty 20 pcs |
|  | GEV No. 521104 Ref. No. — washer ID ø 4.3mm ED ø 8mm thickness 0.5mm brass Qty 20 pcs for thread M4 |
|  | GEV No. 550262 Ref. No. — flat gasket copper ED ø 20mm ID ø 14mm thickness 2mm |
|  | GEV No. 560111 Ref. No. 120017 plain washer ID ø 4.3mm ED ø 9mm thickness 0.8mm SS Qty 20 pcs DIN 125A for thread M4 |
|  | GEV No. 560131 Ref. No. — hexagonal nut thread M4 H 3.2mm WS 7 SS DIN/ISO DIN 934 / ISO 4032/8673 Qty 20 pcs |

| | |
|---|--|
|  1 | |
| GEV No. 415417 | Ref. No. 203553 574094 |
| description | heating element 2500W 230V L 425mm W 260mm 2 hole fixing thread M14x1.5 mounting distance 247mm connection male faston 6.3mm dry heating element tube ø 6.5mm heating circuits 1 H 6.5mm |
| For models: | 0521701-00, 0521701-01 |
| spare parts for 415417 | |
|  | GEV No. 510417 Ref. No. — flat gasket fibre ED ø 20mm ID ø 14mm thickness 2mm Qty 1 pcs |
| accessories for 415417 | |
|  | GEV No. 520228 Ref. No. — tooth lock washer ID ø 15.3mm ED ø 24mm steel Qty 1 pcs for thread M14 |
|  | GEV No. 520230 Ref. No. — nut thread M14x1.5 H 5mm WS 19 zinc-coated steel Qty 1 pcs |
|  | GEV No. 521101 Ref. No. 113000 nut thread M14x1.5 H 5mm WS 19 SS Qty 1 pcs |
|  | GEV No. 550262 Ref. No. — flat gasket copper ED ø 20mm ID ø 14mm thickness 2mm |











| | |
|---|--|
|  1 | |
| GEV No. 415817 | Ref. No. 574032 574032+2x113000+2x121216 |
| description | heating element 3300W 230V L 490mm W 260mm 2 hole fixing thread M14x1.5 mounting distance 252mm connection M4 dry heating element tube ø 8.5mm heating circuits 1 connection length 20mm H 8.5mm |
| spare parts for 415817 | |
|  | GEV No. 510417 Ref. No. — flat gasket fibre ED ø 20mm ID ø 14mm thickness 2mm Qty 1 pcs |
| accessories for 415817 | |
|  | GEV No. 520228 Ref. No. — tooth lock washer ID ø 15.3mm ED ø 24mm steel Qty 1 pcs for thread M14 |
|  | GEV No. 520230 Ref. No. — nut thread M14x1.5 H 5mm WS 19 zinc-coated steel Qty 1 pcs |
|  | GEV No. 521101 Ref. No. 113000 nut thread M14x1.5 H 5mm WS 19 SS Qty 1 pcs |

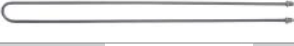



Table continues overleaf











| accessories for 415817 | | | | |
|---|---------|--------|----------|--------|
|  | GEV No. | 521103 | Ref. No. | — |
| nut thread M4 H 3mm WS 7 brass Qty 20 pcs | | | | |
|  | GEV No. | 521104 | Ref. No. | — |
| washer ID ø 4.3mm ED ø 8mm thickness 0.5mm brass Qty 20 pcs for thread M4 | | | | |
|  | GEV No. | 550262 | Ref. No. | — |
| flat gasket copper ED ø 20mm ID ø 14mm thickness 2mm | | | | |
|  | GEV No. | 560111 | Ref. No. | 120017 |
| plain washer ID ø 4.3mm ED ø 9mm thickness 0.8mm SS Qty 20 pcs DIN 125A for thread M4 | | | | |
|  | GEV No. | 560131 | Ref. No. | — |
| hexagonal nut thread M4 H 3.2mm WS 7 SS DIN/ISO DIN 934 / ISO 4032/8673 Qty 20 pcs | | | | |







heating elements for heating bridges

| 1  | | | | |
|---|--|----------|----------|--------|
| GEV No. | 416444 | Ref. No. | 574059 | |
| description | heating element 1000W 230V heating circuits 1 L 627mm W 70mm connection length 20mm connection M4 tube ø 8.5mm 2 hole fixing thread M14x1.5 dry heating element heated bridge mounting distance 62mm | | | |
| For models: | 0524302-00, 0524302-01 | | | |
| accessories for 416444 | | | | |
|  | GEV No. | 510417 | Ref. No. | — |
| flat gasket fibre ED ø 20mm ID ø 14mm thickness 2mm Qty 1 pcs | | | | |
|  | GEV No. | 520228 | Ref. No. | — |
| tooth lock washer ID ø 15.3mm ED ø 24mm steel Qty 1 pcs for thread M14 | | | | |
|  | GEV No. | 520230 | Ref. No. | — |
| nut thread M14x1.5 H 5mm WS 19 zinc-coated steel Qty 1 pcs | | | | |
|  | GEV No. | 521101 | Ref. No. | 113000 |
| nut thread M14x1.5 H 5mm WS 19 SS Qty 1 pcs | | | | |
|  | GEV No. | 550262 | Ref. No. | — |
| flat gasket copper ED ø 20mm ID ø 14mm thickness 2mm | | | | |

| 1  | | | | |
|---|--|----------|----------|---|
| GEV No. | 416445 | Ref. No. | 574060 | |
| description | heating element 1400W 230V heating circuits 1 L 875mm W 70mm connection length 20mm connection M4 tube ø 8.5mm 2 hole fixing thread M14x1.5 dry heating element heated bridge mounting distance 62mm | | | |
| For models: | 0524303-00, 0524303-01 | | | |
| accessories for 416445 | | | | |
|  | GEV No. | 510417 | Ref. No. | — |
| flat gasket fibre ED ø 20mm ID ø 14mm thickness 2mm Qty 1 pcs | | | | |
|  | GEV No. | 520228 | Ref. No. | — |
| tooth lock washer ID ø 15.3mm ED ø 24mm steel Qty 1 pcs for thread M14 | | | | |
|  | GEV No. | 520230 | Ref. No. | — |
| nut thread M14x1.5 H 5mm WS 19 zinc-coated steel Qty 1 pcs | | | | |

| accessories for 416445 | | | | |
|---|---------|--------|----------|--------|
|  | GEV No. | 521101 | Ref. No. | 113000 |
| nut thread M14x1.5 H 5mm WS 19 SS Qty 1 pcs | | | | |
|  | GEV No. | 550262 | Ref. No. | — |
| flat gasket copper ED ø 20mm ID ø 14mm thickness 2mm | | | | |



| 1  | | | | |
|--|---|----------|----------|--------|
| GEV No. | 416446 | Ref. No. | 574061 | |
| description | heating element 1800W 230V heating circuits 1 L 1125mm W 70mm connection length 19mm connection M4 tube ø 8.5mm 2 hole fixing thread M14x1.5 dry heating element heated bridge mounting distance 61mm | | | |
| For models: | 0524304-00, 0524304-01 | | | |
| accessories for 416446 | | | | |
|  | GEV No. | 510417 | Ref. No. | — |
| flat gasket fibre ED ø 20mm ID ø 14mm thickness 2mm Qty 1 pcs | | | | |
|  | GEV No. | 520228 | Ref. No. | — |
| tooth lock washer ID ø 15.3mm ED ø 24mm steel Qty 1 pcs for thread M14 | | | | |
|  | GEV No. | 520230 | Ref. No. | — |
| nut thread M14x1.5 H 5mm WS 19 zinc-coated steel Qty 1 pcs | | | | |
|  | GEV No. | 521101 | Ref. No. | 113000 |
| nut thread M14x1.5 H 5mm WS 19 SS Qty 1 pcs | | | | |
|  | GEV No. | 550262 | Ref. No. | — |
| flat gasket copper ED ø 20mm ID ø 14mm thickness 2mm | | | | |



| 1  | | | | |
|--|--|----------|----------|--------|
| GEV No. | 416443 | Ref. No. | 574058 | |
| description | heating element 600W 230V heating circuits 1 L 375mm W 67mm connection M4 tube ø 8.5mm 2 hole fixing thread M14x1.5 dry heating element heated bridge mounting distance 59mm | | | |
| For models: | 0524301-00, 0524301-01 | | | |
| accessories for 416443 | | | | |
|  | GEV No. | 510417 | Ref. No. | — |
| flat gasket fibre ED ø 20mm ID ø 14mm thickness 2mm Qty 1 pcs | | | | |
|  | GEV No. | 520228 | Ref. No. | — |
| tooth lock washer ID ø 15.3mm ED ø 24mm steel Qty 1 pcs for thread M14 | | | | |
|  | GEV No. | 520230 | Ref. No. | — |
| nut thread M14x1.5 H 5mm WS 19 zinc-coated steel Qty 1 pcs | | | | |
|  | GEV No. | 521101 | Ref. No. | 113000 |
| nut thread M14x1.5 H 5mm WS 19 SS Qty 1 pcs | | | | |
|  | GEV No. | 550262 | Ref. No. | — |
| flat gasket copper ED ø 20mm ID ø 14mm thickness 2mm | | | | |



ceramic heaters

245x60mm







| | | | |
|---|--|-----------------|------------|
|  | | | |
| 1 | | | |
| GEV No. | 415104 | Ref. No. | 203055 |
| description | ceramic emitter 1000W 230V cable beaded cord L 245mm W 60mm H 35mm | | |
| For models: | 0220601-00, 1220601-00, 1320601-00, 1320601-01, 1420601-00, 1420701-00, 1420702-00, 1520601-00, 2020601-00, 2020601-01, 2120601-00, 2120601-01 | | |
| spare parts for | 415104 | | |
| |  | GEV No. 415109 | Ref. No. — |
| | spring clip | | |
| accessories for | 415104 | | |
| |  | GEV No. 415110 | Ref. No. — |
| | reflector L 245mm W 95mm H 31mm thickness 0.75mm hole ø 15x40mm | | |

| | | | |
|--|---|-----------------|------------------|
|  | | | |
| 1 | | | |
| GEV No. | 415568 | Ref. No. | 573106 720011 |
| description | heating element 800W 230V heating circuits 1 L 220mm W 66mm tube ø 8.5mm connection male faston 6.3mm connection length 27mm immersion heater expansion flange TD ø 8mm flange 70x18mm | | |
| For models: | 1422802B04, 1422802B05, 1422802B06, 1422802B07, 1422802B08, 1422804B04, 1422804B05, 1422804B06, 1422804B07, 1422804B08, 1422805B04, 1422805B05, 1422805B06, 1422805B07, 1422805B08, 1422807B00, 1422807B01, 1422807B02, 1422807B03, 1422807B04, 1422831-00, 1422832-00, 1422833-00, 1422834-00, 1422902-00, 1422902-01, 1422902-02, 1422902-03, 1422902-04, 1422908-00, 1422910-00, 1423901-00, 1423901-01, 1423901-02, 1423902-00, 1423902-01, 1423902-02, 1423903-00, 1423903-01, 1423903-02, 2022801-02, 2022801-03, 2022801A02, 2022801A03, 2022801B02, 2022801B03, 2022801C02, 2022801C03, 2022802-02, 2022802-03... (Other models you can see in the webshop) | | |
| accessories for | 415568 | | |
| |  | GEV No. 375044 | Ref. No. 203185 |
| | safety thermostat switch-off temp. 178°C 1-pole 16A probe ø 4mm probe L 91mm capillary pipe 1730mm capillary pipe isolated 1600mm gland nut probe with sealing sleeve screw connection M8x1 sealing sleeve 8.6x32mm | | |

immersion heating elements

with expansion flange 70 x 18mm

| | | | |
|---|---|-----------------|------------------|
|  | | | |
| 1 | | | |
| GEV No. | 415569 | Ref. No. | 573108 720012 |
| description | heating element 5000W 230V heating circuits 2 L 272mm W 65mm H 29mm tube ø 8.5mm connection male faston 6.3mm immersion heater expansion flange flange 70x18mm | | |
| For models: | 2022801-02, 2022801-03, 2022801A02, 2022801A03, 2022801B02, 2022801B03, 2022801C02, 2022801C03, 2022802-02, 2022802-03, 2022802A02, 2022802A03, 2022802B02, 2022802B03, 2022802C02, 2022802C03, 2022803-02, 2022803-03, 2022803A02, 2022803A03, 2022803B02, 2022803B03, 2022803C02, 2022803C03, 2022804-02, 2022804-03, 2022804A02, 2022804A03, 2022804B02, 2022804B03, 2022804C02, 2022804C03, 2022805-02, 2022805-03, 2022805A02, 2022805A03, 2022805B02, 2022805B03, 2022805C02, 2022805C03, 2122801-02, 2122801-03, 2122801A02, 2122801A03, 2122801B02, 2122801B03, 2122801C02, 2122801C03, 2122802-02, 2122802-03... (Other models you can see in the webshop) | | |

| | | | |
|--|---|-----------------|------------------|
|  | | | |
| 1 | | | |
| GEV No. | 415402 | Ref. No. | 537081 573075 |
| description | heating element 6000W 400/230V heating circuits 3 thread 1½" L 425mm W 35mm H 35mm thermostat sleeves ø 7mm length thermostat sleeves 330mm thermostat sleeve centre not clinging tube ø 8.5mm connection M4 immersion heater flange with thread WS 60 no original spare part number of thermostat sleeves 1 | | |
| For models: | 14228011-0, 14228022-0, 14228033-0, 14228044-0, 14228055-0, 2022801-00, 2022801-01, 20228011-0, 20228011-1, 2022801A00, 2022801A01, 2022801B00, 2022801B01, 2022801C00, 2022801C01, 2022802-00, 2022802-01, 20228022-0, 20228022-1, 2022802A00, 2022802A01, 2022802B00, 2022802B01, 2022802C00, 2022802C01, 2022803-00, 2022803-01, 20228033-0, 20228033-1, 2022803A00, 2022803A01, 2022803B00, 2022803B01, 2022803C00, 2022803C01, 2022804-00, 2022804-01, 20228044-0, 20228044-1, 2022804A00, 2022804A01, 2022804B00, 2022804B01, 2022804C00, 2022804C01, 2022805-00, 2022805-01, 20228055-0, 20228055-1, 2022805A00... (Other models you can see in the webshop) | | |
| spare parts for | 415402 | | |
| |  | GEV No. 510406 | Ref. No. — |
| | flat gasket fibre ED ø 60mm ID ø 48mm thickness 3mm for thread 1½" Qty 1 pcs | | |
| accessories for | 415402 | | |
| |  | GEV No. 510424 | Ref. No. — |
| | gasket copper ED ø 55mm ID ø 48mm thickness 2.2mm Centellen for thread 1½" | | |
| |  | GEV No. 520211 | Ref. No. — |
| | reducer thread 2" ET - 1½" IT brass | | |
| |  | GEV No. 520212 | Ref. No. — |
| | hexagonal nut thread 1½" brass WS 60 H 8mm | | |
| |  | GEV No. 550361 | Ref. No. — |
| | blind flange ø 58mm thread 1½" | | |

| | | | |
|---|---|-----------------|--------|
|  | | | |
| 1 | | | |
| GEV No. | 419053 | Ref. No. | 573107 |
| description | heating element 5000W 400V heating circuits 2 L 272mm W 65mm tube ø 8.5mm connection male faston 6.3mm connection length 38mm immersion heater expansion flange flange 70x18mm | | |
| For models: | 1422802B04, 1422802B05, 1422802B06, 1422802B07, 1422802B08, 1422804B04, 1422804B05, 1422804B06, 1422804B07, 1422804B08, 1422805B04, 1422805B05, 1422805B06, 1422805B07, 1422805B08, 1422807B00, 1422807B01, 1422807B02, 1422807B03, 1422807B04, 1422831-00, 1422832-00, 1422833-00, 1422834-00, 1422902-00, 1422902-01, 1422902-02, 1422902-03, 1422902-04, 1422908-00, 1422910-00, 1423901-00, 1423901-01, 1423901-02, 1423902-00, 1423902-01, 1423902-02, 1423903-00, 1423903-01, 1423903-02, 2022802B04, 2022802B05, 2022802B06, 2022802B07, 2022802B08, 2022802B09, 2022802B10, 2022802C07, 2022802C08, 2022802C09... (Other models you can see in the webshop) | | |



heating elements for convection





1

| | | | |
|--------------------|--|-----------------|--------|
| GEV No. | 419248 | Ref. No. | 574183 |
| description | heating element 15300W 440V heating circuits 6 ID \varnothing 450mm ED \varnothing 530mm L 540mm H 113mm W1 96mm H1 23mm H2 90mm flange length 130mm flange width 70mm connection length 100mm tube \varnothing 6.5mm cable length 1200mm dry heating element with fixing flange | | |





1

| | | | |
|---|--|-----------------|------------------------|
| GEV No. | 418750 | Ref. No. | 574177 |
| description | heating element 15400W 400V heating circuits 6 ID \varnothing 450mm ED \varnothing 530mm L 540mm H 113mm W1 96mm H1 23mm H2 90mm flange length 130mm flange width 70mm connection length 100mm tube \varnothing 6.5mm cable length 1200mm dry heating element with fixing flange | | |
| For models: | CGE11-L, CGE11-R, CGE12-L, CGE12-R, CGE21-L, CGE21-R, CGE61-L, CGE61-R, CSE11-L, CSE11-R, CSE11-R-DG, CSE21-L, CSE21-R, CSE21-R-DG, CSE61-L, CSE61-R, CSE61-R-DG, CSE62-L, CSE62-R, CSE62-R-DG | | |
| accessories for | 418750 | | |
|  | GEV No. | 550639 | Ref. No. 211083 |
| | gasket L 130mm W 70mm thickness 1mm for heating element | | |



1

| | | | |
|---|---|-----------------|------------------------|
| GEV No. | 418748 | Ref. No. | 574181 |
| description | heating element 20400W 400V heating circuits 6 ID \varnothing 450mm ED \varnothing 525mm L 107mm H 113mm W1 97mm H1 28mm H2 85mm flange length 130mm flange width 70mm hole distance 119mm connection length 100mm tube \varnothing 6.5mm cable length 1200mm dry heating element hole \varnothing 6mm with fixing flange | | |
| For models: | CGE12-L, CGE12-R, CGE62-L, CGE62-R, CSE62-L, CSE62-R | | |
| accessories for | 418748 | | |
|  | GEV No. | 550639 | Ref. No. 211083 |
| | gasket L 130mm W 70mm thickness 1mm for heating element | | |



1

| | | | |
|--------------------|---|-----------------|--------|
| GEV No. | 418751 | Ref. No. | 574189 |
| description | heating element 30000W 400V heating circuits 6 ID \varnothing 380mm ED \varnothing 450mm L 535mm H 120mm W1 99mm H1 20mm H2 100mm flange length 130mm flange width 70mm connection length 100mm tube \varnothing 8mm cable length 1200mm dry heating element with fixing flange | | |
| For models: | CGE11-L, CGE11-R, CGE12-L, CGE12-R, CGE22-L, CGE22-R, CGE62-L, CGE62-R, CSE12-L, CSE12-R, CSE12-R-DG, CSE22-L, CSE22-R, CSE22-R-DG | | |



1

| | | | |
|--------------------|--|-----------------|--------|
| GEV No. | 420336 | Ref. No. | 574160 |
| description | heating element 9900W 230V heating circuits 3 ID \varnothing 450mm ED \varnothing 465mm L 500mm H 104mm L1 30mm W1 96mm H1 13mm H2 91mm flange length 130mm flange width 70mm hole distance 55/50mm connection M4 tube \varnothing 6.3mm convection heating element hole \varnothing 7mm flange connection | | |
| For models: | CGE61-L, CGE61-R, CGE62-L, CGE62-R, CSE61-L, CSE61-R, CSE62-L, CSE62-R | | |



1

| | | | |
|---|---|-----------------|------------------------|
| GEV No. | 418749 | Ref. No. | 574176 |
| description | heating element 9900W 400V heating circuits 3 ID \varnothing 450mm ED \varnothing 465mm L 500mm H 115mm L1 35mm W1 96mm H1 26mm H2 89mm flange length 130mm flange width 70mm connection length 100mm tube \varnothing 6.5mm cable length 1200mm dry heating element with fixing flange | | |
| For models: | CGE11-L, CGE11-R, CGE61-L, CGE61-R, CSE61-L, CSE61-R, CSE61-R-DG, CSE62-L, CSE62-R, CSE62-R-DG | | |
| accessories for | 418749 | | |
|  | GEV No. | 550639 | Ref. No. 211083 |
| | gasket L 130mm W 70mm thickness 1mm for heating element | | |



radiation heaters

square

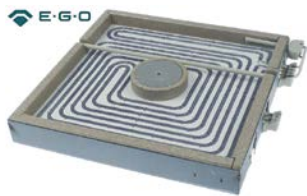

| | | | |
|------------------------|--|-----------------|-------------------|
| GEV No. | 490009 ¹ | Ref. No. | 203037 |
| description | radiation heater L 300mm W 300mm 4000W 400V connections 3+2 square with pan detection EGO | | |
| For models: | 0723405-01, 0723405-02, 0723409-01, 0723409-02, 0723413-02, 0723414-02, 1023410-00, 1423404-00, 1423404-01, 1423405-00, 1423405-01, 1423405-02, 1423409-00, 1423409-01, 1423409-02, 1423413-02, 1423414-02, 1424819-00, 1424826-00, 1523405-00, 1523405-01, 1523409-00, 1523409-01, 1523410-00, 2023206-00, 2023206-01, 2023206-02, 2023207-00, 2023207-01, 2023207-02, 2023207-03, 2023207-04, 2023207-05, 2023405-00, 2023405D00, 2023406-00, 2023407-00, 2023407-01, 2023409-00, 3023206-00, 3023206-01, 3023206-02, 3023405-00, 3023406-00, 3023409-00 | | |
| spare parts for | 490009 | | |
| | GEV No. | 499157 | Ref. No. — |
| | protection pipe for temperature probe ceramic L 297mm ED ø 7mm ID ø 5mm | | |

¹with pan detection

1-circuit



| | | | |
|--------------------|--|-----------------|--------|
| GEV No. | 490093 | Ref. No. | 203047 |
| description | radiation heater ø 230mm 2100W 230V | | |
| For models: | 1223202-00, 2123207-00, 2123208-00, 2123208-01 | | |



| | | | |
|--------------------|--|-----------------|--------|
| GEV No. | 490043 | Ref. No. | 202799 |
| description | radiation heater ø 230mm 2300W 230V heating circuits 1 H 32mm energy regulation with temperature signalization with ribbon heater connections 2+2 connection type male faston 6.3mm horizontal EGO | | |
| For models: | 1023401K00, 1223401K00, 1223401L00, 1223402K00, 1323401K00, 1323402K00, 1323403K00, 1423402K01, 1523401K00, 1523402-00, 1523402K00, 2123401K00, 2123402K00, 2123403K00 | | |

hot plates

square & rectangular

with radiused edge



| | | | |
|--------------------|---|-----------------|--------|
| GEV No. | 490065 | Ref. No. | 203068 |
| description | hot plate dimensions 220x220mm 2000W 230V with spill ring connection 4 screw clamps protector no square | | |



| | | | |
|--------------------|---|-----------------|------------------|
| GEV No. | 490067 | Ref. No. | 203051 203076 |
| description | hot plate dimensions 220x220mm 2000W 400V with spill ring connection 4 screw clamps protector no square | | |

| | | | |
|------------------------|--|--------|------------------------|
| For models: | 0223202-00, 1223201-00, 1223207-00, 1323201-00, 1323207-00, 1323208-00, 1323208-01, 1323208-02, 1424802-00, 1424808-00, 1424808-01, 1424811-00, 1424811-01, 2123201-00, 2123201-01, 2123202-00, 2123202-01, 2123202A00, 2123202A01, 2123203-00, 2123203-01, 2123203-02, 2123203-03, 2123203-04, 2123203A00, 2123203A01, 2123203A02, 2123203A03, 2123203A04, 2123204-00, 2123204-01, 2123204-02, 2123204-03, 2123204-04, 2123204A00, 2123204A01, 2123204A02, 2123204A03, 2123204A04, 2123209-00 | | |
| accessories for | 490067 | | |
| | GEV No. | 693464 | Ref. No. 211047 |
| | sealing cord ø 10mm Qty supplied by meter | | |



| | | | |
|--------------------|--|-----------------|--------|
| GEV No. | 490068 ¹ | Ref. No. | 203071 |
| description | hot plate dimensions 220x220mm 2600W 400V with spill ring connection 4 screw clamps protector yes square | | |
| For models: | 1223201-01, 1223207-01, 1323201-01, 1323201-02, 1323207-02, 1323208-03, 1323208-04, 1424802-01, 1424802-02, 1424808-02, 1424808-03, 1424811-02, 1424811-03, 2123201-02, 2123201-03, 2123201-04, 2123202-02, 2123202-03, 2123203-05, 2123203-06, 2123203-07, 2123203-08, 2123204-05, 2123204-06, 2123204-07, 2123204-08, 2123209-01, 2123209-02 | | |

¹incl. protector



1

| | | | |
|--------------------|--|-----------------|------------------|
| GEV No. | 490128 ¹ | Ref. No. | 203053 203065 |
| description | hot plate dimensions 300x300mm 2500W 400V with spill ring connection 4 screw clamps protector yes square | | |
| For models: | 1424809-00, 1424809-01, 1424809-02, 1424809-0, 1424812-00, 1424812-01, 1424812-02, 1424813-00, 1424813-01, 1424813-02, 2023201-00, 2023201-01, 2023201-02, 2023201-03, 20232011-0, 20232011-1, 2023202-00, 2023202-01, 2023202-02, 20232022-0, 20232022-1, 2023203-00, 2023203-01, 2023203-02, 2023203-03, 2023203-04, 2023203-05, 2023203-06, 2023203-07, 20232033-0, 20232033-1, 2023204-00, 2023204-01, 2023204-02, 20232044-0, 20232044-1, 2023205-00, 2023205-01, 2023205-02, 2023205-03, 2023205-04, 2023205-05, 2023205-06, 2023205-07, 20232055-0, 20232055-1, 3023201-00, 3023201-01, 3023201-02, 3023202-00... (Other models you can see in the webshop) | | |

¹incl. protector



1

| | | | |
|--------------------|--|-----------------|--------|
| GEV No. | 490071 ¹ | Ref. No. | 203776 |
| description | hot plate dimensions 300x300mm 4000W 230V with spill ring connection 4 screw clamps protector yes square | | |

¹incl. protector



1

| | | | |
|--------------------|---|-----------------|--------|
| GEV No. | 490074 ¹ | Ref. No. | 203054 |
| description | hot plate dimensions 300x300mm 4000W 400V with spill ring connection 4 screw clamps protector yes square | | |
| For models: | 1424809-00, 1424809-01, 1424809-02, 1424809-0, 1424812-00, 1424812-01, 1424812-02, 1424813-00, 1424813-01, 1424813-02, 2023201-00, 2023201-01, 2023201-02, 2023201-03, 20232011-0, 20232011-1, 2023201A00, 2023201A01, 2023202-00, 2023202-01, 2023202-02, 20232022-0, 20232022-1, 2023202A00, 2023202A01, 2023203-00, 2023203-01, 2023203-02, 2023203-03, 2023203-04, 2023203-05, 2023203-06, 2023203-07, 20232033-0, 20232033-1, 2023203A00, 2023203A01, 2023203A02, 2023203A03, 2023204-00, 2023204-01, 2023204-02, 2023204-0, 20232044-1, 2023204A00, 2023204A01, 2023205-00, 2023205-01, 2023205-02, 2023205-03... (Other models you can see in the webshop) | | |

¹incl. protector

tiltable



1

| | | | |
|--------------------|---|-----------------|--------|
| GEV No. | 490088 | Ref. No. | 203075 |
| description | hot plate dimensions 300x300mm 2500W 400V with cast edge tilt boiling plate connection 4 screw clamps H 43mm square | | |
| For models: | 2023302-00, 2023303-00, 2023304-00, 2023305-00 | | |

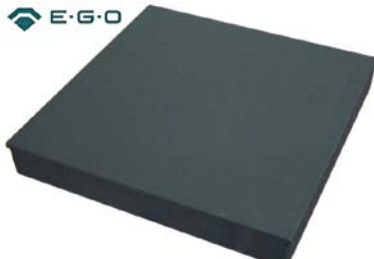

1

| | | | |
|--------------------|---|-----------------|--------|
| GEV No. | 490090 | Ref. No. | 203108 |
| description | hot plate dimensions 300x300mm 4000W 400V with cast edge tilt boiling plate connection 4 screw clamps H 43mm square | | |
| For models: | 2023302-00, 2023303-00, 2023304-00, 2023305-00 | | |

round
with radiused edge
for domestic and commercial kitchens



1

| | | | |
|--------------------|--|-----------------|--------|
| GEV No. | 490011 | Ref. No. | 203073 |
| description | hot plate ø 145mm 1000W 400V connection 4 screw clamps with 8mm spill ring | | |
| For models: | 0520901-00 | | |



1

| | | | |
|--------------------|--|-----------------|--------|
| GEV No. | 490014 | Ref. No. | 203064 |
| description | hot plate ø 180mm 1500W 230V connection 4 screw clamps with 8mm spill ring | | |



| | | | |
|---|--|-----------------|--------|
|  | | | |
| 1 | | | |
| GEV No. | 490015 | Ref. No. | 203058 |
| description | hot plate ø 180mm 1500W 400V connection 4 screw clamps with 8mm spill ring | | |

| | | | |
|---|--|-----------------|--------|
|  | | | |
| 1 | | | |
| GEV No. | 490017 | Ref. No. | 203062 |
| description | hot plate ø 180mm 2000W 400V connection 4 screw clamps with 8mm spill ring | | |

| | | | |
|---|--|-----------------|--------|
|  | | | |
| 1 | | | |
| GEV No. | 490018 | Ref. No. | 203066 |
| description | hot plate ø 220mm 2000W 230V connection 4 screw clamps with 8mm spill ring | | |
| For models: | 1424816-00 | | |

| | | | |
|---|--|-----------------|--------|
|  | | | |
| 1 | | | |
| GEV No. | 490019 | Ref. No. | 203059 |
| description | hot plate ø 220mm 2000W 400V connection 4 screw clamps with 8mm spill ring | | |

energy regulators

EGO

1-circuit

| | | | |
|---|---|-----------------|--------|
|  | | | |
| 1 | | | |
| GEV No. | 380015 | Ref. No. | 203160 |
| description | energy regulator 230V 13A single-circuit turn direction right shaft ø 6x4.6mm shaft L 23mm mounting thread M4 power release 6-100% no. 50.57021.010 | | |
| For models: | 00217022-0, 0221001H00, 0221202-00, 0221501-00, 0221502-00, 0521701-00, 0521701-01, 0521702-00, 0521702-01, 0521702-02, 0521702-03, 0521702-04, 0521702B03, 0521702B04, 0521702C04, 0521704-04, 0521704-05, 0521704-06, 0521704-07, 0521705-00, 0521705-01, 1022603-00, 1023401-00, 1023401K00, 1220402-00, 1220402-01, 1221501-00, 1221501-01, 1221501-02, 1222603-00, 1223202A00, 1223202A01, 1223202J00, 1223202J01, 1223209-00, 1223209-01, 1223401-00, 1223401J00, 1223401K00, 1223401L00, 1223402-00, 1223402K00, 1320402-00, 1320402-01, 1321501-00, 1321501-01, 1321501-02, 1321501-03, 1322603-00, 1323202A00... (Other models you can see in the webshop) | | |

| | | | |
|--|--|-----------------|--------|
|  | | | |
| 1 | | | |
| GEV No. | 380013 | Ref. No. | 203161 |
| description | energy regulator 400V 7A single-circuit turn direction right shaft ø 6x4.6mm mounting thread M4 no. 50.57031.010 | | |
| For models: | 0521702A02, 0521702A03, 0521702A04, 0723412K01, 1423412K01 | | |

thermostats

bi-metal thermostats

safety bi-metal thermostats

| | | | |
|---|--|-----------------|--------|
|  | | | |
| 1 | | | |
| GEV No. | 378659 | Ref. No. | 202806 |
| description | bi-metal safety thermostat hole distance 24mm switch-off temp. 320°C NC 1-pole 16A 400V connection with cable cable length 120mm with fixing sheet | | |
| For models: | CGE11-L, CGE11-R, CGE12-L, CGE12-R, CGE21-L, CGE21-R, CGE22-L, CGE22-R, CGG11-L, CGG11-R, CGG12-L, CGG12-R, CGG21-L, CGG21-R, CGG22-L, CGG22-R, CSE11-L, CSE11-R, CSE11-R-DG, CSE12-L, CSE12-R, CSE12-R-DG, CSE21-L, CSE21-R, CSE21-R-DG, CSE22-L, CSE22-R, CSE22-R-DG, CSE61-L, CSE61-R, CSE61-R-DG, CSG11-L, CSG11-R, CSG11-R-DG, CSG12-L, CSG12-R, CSG12-R-DG, CSG21-L, CSG21-R, CSG21-R-DG, CSG22-L, CSG22-R, CSG22-R-DG | | |

bi-metal thermostats

| | | | |
|---|---|-----------------|--------|
|  | | | |
| 1 | | | |
| GEV No. | 390160 | Ref. No. | 203255 |
| description | bi-metal thermostat hole distance 30mm switch-off temp. 90°C 1NO 1-pole 10A connection F6.3 | | |
| For models: | 1422802B04, 1422802B05, 1422802B06, 1422802B07, 1422802B08, 1422804B04, 1422804B05, 1422804B06, 1422804B07, 1422804B08, 1422805B04, 1422805B05, 1422805B06, 1422805B07, 1422805B08, 1422807B00, 1422807B01, 1422807B02, 1422807B03, 1422807B04, 1422831-00, 1422832-00, 1422833-00, 1422834-00, 1422902-00, 1422902-01, 1422902-02, 1422902-03, 1422902-04, 1422908-00, 1422910-00, 1462802B00, 1462802B01, 1462802B02, 1462802B03, 1462802B04, 1462802B05, 1462804B00, 1462804B01, 1462804B02, 1462804B03, 1462804B04, 1462804B05, 1462831-00, 1462832-00, 1462833-00, 1462834-00, 1462835-00, 1462836-00, 1462837-00... (Other models you can see in the webshop) | | |



| | | | |
|--------------------|--|-----------------|--------|
| GEV No. | 390767 | Ref. No. | 203523 |
| description | bi-metal thermostat switch-off temp. 60°C 1NC 1-pole connection F6.3 | | |
| For models: | 0723104B03, 0723105B03, 0723405-01, 0723405-02, 0723409-02, 0723412K01, 0723413-02, 0723414-02, 1412833-00, 1412833-01, 1412834-00, 1412834-01, 1412910-00, 1412910-01, 1422701-01, 1422701-02, 1422701-03, 1422702-01, 1422702-02, 1422702-03, 1422703-00, 1422703-01, 1422703-02, 1422704-00, 1422704-01, 1422704-02, 1422705-00, 1422705-01, 1422705-02, 1422706-00, 1422706-01, 1422706-02, 1422707-00, 1422707-01, 1422707-02, 1422708-00, 1422708-01, 1422708-02, 1423104B03, 1423105B03, 1423402-00, 1423402K01, 1423405-00, 1423405-01, 1423405-02, 1423409-02, 1423412K01, 1423413-02, 1423414-02, 1423502-00... (Other models you can see in the webshop) | | |

control and safety thermostats

EGO

control thermostats

55.10/19_ series



| | | | |
|--------------------|---|-----------------|--------|
| GEV No. | 375001 | Ref. No. | 203498 |
| description | thermostat t.max. 112°C temperature range 30-110°C 1-pole 1NO 16A probe ø 6mm probe L 130mm capillary pipe 900mm capillary pipe isolated gland nut M9x1 shaft L 23mm shaft position upper rotation 270° | | |
| For models: | 1224002-00, 1224002-01, 1224003-00, 1224003-01, 1224004-00, 1224004-01, 1224005-00, 1224005-01, 1224006-00, 1224006-01, 1224007-00, 1224007-01, 1224008-00, 1224008-01, 1224009-00, 1224009-01 | | |

55.13_ series



| | | | |
|--------------------|--|-----------------|--------|
| GEV No. | 390161 | Ref. No. | 203167 |
| description | thermostat t.max. 114°C temperature range 36-114°C 1-pole 1NO 16A probe ø 31/36mm probe Lmm capillary pipe 870mm capillary pipe isolated 800mm gland nut shaft ø 6x4.6mm shaft L 23mm shaft position upper rotation 270° with knob probe (boiling plate) | | |
| For models: | 1422802B04, 1422802B05, 1422802B06, 1422802B07, 1422802B08, 1422804B04, 1422804B05, 1422804B06, 1422804B07, 1422804B08, 1422805B04, 1422805B05, 1422805B06, 1422805B07, 1422805B08, 1422807B00, 1422807B01, 1422807B02, 1422807B03, 1422807B04, 1422831-00, 1422832-00, 1422902-00, 1422902-01, 1422902-02, 1422902-03, 1422902-04, 1422908-00, 1462802B00, 1462802B01, 1462802B02, 1462802B03, 1462802B04, 1462802B05, 1462804B00, 1462804B01, 1462804B02, 1462804B03, 1462804B04, 1462804B05, 1462831-00, 1462832-00, 1462835-00, 1462836-00, 1462837-00, 1462908-00, 2022801-01, 2022801-02, 2022801-03, 2022801A01... (Other models you can see in the webshop) | | |



| | | | |
|--------------------|---|-----------------|--------|
| GEV No. | 375760 | Ref. No. | 203490 |
| description | thermostat t.max. 116°C temperature range 36-116°C 1-pole 1NO 16A probe ø 6mm probe L 113mm capillary pipe 870mm capillary pipe isolated 350mm gland nut M9x1 shaft ø 6x4.6mm shaft L 23mm shaft position upper rotation 270° | | |
| For models: | 0720504-04, 1020510-00, 1120510-00, 1120510-01, 1220501-00, 1220501-01, 1220501-02, 1220502-00, 1220502-01, 1220503-00, 1220504-01, 1220802-00, 1220802-01, 1222601-00, 1320501-00, 1320501A00, 1320501A01, 1320502-00, 1320502A00, 1320502A01, 1320504-01, 1320504-02, 1320802-00, 1320802A00, 1322601-00, 1420501-00, 1420501-01, 1420501-02, 1420501-03, 1420502-00, 1420502-01, 1420502-02, 1420504-00, 1420504-01, 1420504-02, 1420504-03, 1420504-04, 1420505-00, 1420505-01, 1420505-02, 1420509-01, 1420801-01, 1420803-01, 1422601-00, 1422602-00, 1520501-00, 1820501-00, 1820801-0, 2020501-01, 2020501-02... (Other models you can see in the webshop) | | |



| | | | |
|--------------------|--|-----------------|--------|
| GEV No. | 375952 | Ref. No. | 203760 |
| description | thermostat t.max. 150°C temperature range 30-150°C 1-pole 1NO 16A probe ø 6mm probe L 84mm capillary pipe 850mm capillary pipe isolatedmm gland nut shaft ø 6x4.6mm shaft L 23mm shaft position upper rotation 270° 380V | | |
| For models: | 1022603-00, 1220402-00, 1220402-01, 1222603-00, 1320402-00, 1320402-01, 1322603-00, 1420402-00, 1420402-01, 1420405-00, 1520402-00, 1520402-01, 1520403-00, 1520403-01, 1522603-00, 1522603-01, 2020402-00, 2020402-01, 2022603-00, 2120402-00, 2120402-01, 2420403-00, 2420403-01, 3020402-00, 3020402-01 | | |

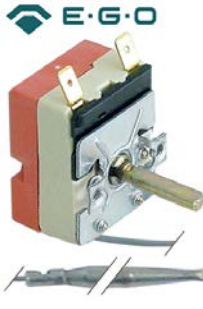

| | | | |
|--------------------|---|-----------------|--------|
| GEV No. | 375193 | Ref. No. | 203248 |
| description | thermostat t.max. 300°C temperature range 50-300°C 1-pole 1NO 16A probe ø 4mm probe L 91mm capillary pipe 1130mm capillary pipe isolated 1100mm gland nut shaft L 23mm shaft position upper rotation 270° | | |
| For models: | 0021130A00, 0021130A01, 0021135A00, 0522101-02, 0522102-02, 0721134-01, 0721134A01, 0721172A01, 0721173A01, 0721174A01, 0721175A01, 1121117-00, 1121117-01, 1121117A00, 1121118-00, 1121118-01, 1121119-00, 1121119A00, 1121120-00, 1121121-00, 1121121A00, 1121135A01, 1221103-04, 1221103B04, 1221105-00, 1221105-01, 1221105-02, 1221105A00, 1221105A01, 1221105A02, 1221105B00, 1221105B01, 1221105B02, 1221106-00, 1221106-01, 1221106A00, 1221106A01, 1221106B00, 1221106B01, 1221107-00, 1221107-01, 1221107-02, 1221108-00, 1221108-01, 1221108-02, 1221109-00, 1221109-01, 1221110-00, 1221110-01, 1221111-00... (Other models you can see in the webshop) | | |



| | | | |
|--------------------|--|-----------------|--------|
| GEV No. | 375401 | Ref. No. | 203662 |
| description | thermostat t.max. 185°C temperature range 97-185°C 1-pole 1NO 16A probe ø 6mm probe L 87mm capillary pipe 1430mm capillary pipe isolated 1100mm gland nut M9x1 shaft ø 6x4.6mm shaft L 23mm shaft position upper rotation 270° | | |



| | | | |
|--------------------|--|-----------------|------------------|
| GEV No. | 375505 | Ref. No. | 203177 203500 |
| description | thermostat t.max. 320°C temperature range 50-320°C 1-pole 1NO 16A probe ø 3mm probe L 160mm capillary pipe 870mm capillary pipe isolatedmm gland nut shaft ø 6x4.6mm shaft L 23mm shaft position upper rotation 270° | | |
| For models: | 1424816-00, 1821101-00 | | |



| | | | |
|--------------------|---|-----------------|------------------|
| GEV No. | 375747 | Ref. No. | 203067 203662 |
| description | thermostat t.max. 190°C temperature range 97-190°C 1-pole 1NO 16A probe ø 6mm probe L 87mm capillary pipe 1430mm capillary pipe isolated 1100mm gland nut M9x1 shaft ø 6x4.6mm shaft L 23mm shaft position upper rotation 270° | | |
| For models: | 0520303-02, 0720325-03, 0720325-04, 0720325B03, 0720325B04, 1220301-00, 1220301-01, 1220301-02, 1220301-03, 1220301-04, 1220301B00, 1220301B01, 1220301B02, 1220301B03, 1220301B04, 1220301D00, 1220301D01, 1220301E00, 1220301E01, 1220301J00, 1220301J01, 1220301J02, 1220301J03, 1220303-00, 1220303-01, 1220303-02, 1220303-03, 1220303-04, 1220303-05, 1220303A00, 1220303A01, 1220303A02, 1220303A03, 1220303B00, 1220303B01, 1220303B02, 1220303B03, 1220303B04, 1220303B05, 1220303C00, 1220303C01, 1220303C02, 1220303C03, 1220303D00, 1220303D01, 1220303D02, 1220303E00, 1220303E01, 1220303E02, 1220303F01... (Other models you can see in the webshop) | | |

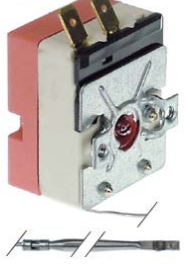

| | | | |
|--------------------|---|-----------------|--------|
| GEV No. | 375717 | Ref. No. | 203176 |
| description | thermostat t.max. 82°C temperature range fixed 40°C 1NO 16A probe ø 3mm probe L 156mm capillary pipe 600mm capillary pipe isolated 600mm gland nut shaft ø 6x4.6mm shaft L 8.5mm shaft position right° rotation 180° outer switch eccentric 1/2"-3/4" | | |
| For models: | 1223209-00, 1223209-01, 1223402-00, 1223402K00, 1323209-00, 1323209-01, 1323209-02, 1323209-03, 1323210-00, 1323210-01, 1323210-02, 1323210-03, 1323210-04, 1323402-00, 1323402K00, 1323403-00, 1323403K00, 2023206-00, 2023206-01, 2023207-00, 2023207-01, 2023207-02, 2023207-03, 2023207-04, 2023503-04, 2023503-05, 2023503-06, 2023503-07, 2023503-08, 2023503-09, 2023503-10, 2023503A04, 2023503A05, 2023503A06, 2023503A07, 2023503A08, 2023503A09, 2023503A10, 2123207A00, 2123208A00, 2123208A01, 2123208A02, 2123503-01, 2123503-02, 2123503-03, 2123503-04, 2123503-05, 2123503-06, 2123503A01, 2123503A03... (Other models you can see in the webshop) | | |



| | | | |
|--------------------|--|-----------------|--------|
| GEV No. | 375400 | Ref. No. | 203173 |
| description | thermostat t.max. 90°C temperature range 30-90°C 1-pole 1CO 16A probe ø 6mm probe L 98mm capillary pipe 2380mm capillary pipe isolated 1700mm gland nut M9x1 shaft ø 6x4.6mm shaft L 18mm shaft position upper rotation 270° | | |



| | | | |
|--------------------|---|-----------------|--------|
| GEV No. | 390036 | Ref. No. | 203173 |
| description | thermostat t.max. 90°C temperature range 30-90°C 1-pole capillary pipe isolated gland nut | | |
| For models: | 20628022-0, 20628022-1, 20628033-0, 20628044-0, 20629011-0, 20629022-0 | | |

55.34_ series



| | | | |
|--------------------|---|-----------------|--------|
| GEV No. | 375021 | Ref. No. | 203486 |
| description | thermostat t.max. 110°C temperature range 32-110°C 3-pole 3CO 16A probe ø 6mm probe L 138mm capillary pipe 2980mm capillary pipe isolated 2200mm gland nut M9x1 shaft ø 6x4.6mm shaft L 23mm shaft position upper rotation 270° | | |
| For models: | 14228011-0, 14228022-0, 14228033-0, 14228044-0, 14228055-0, 2022801-00, 20228011-0, 20228011-1, 2022801A00, 2022801B00, 2022801C00, 2022802-00, 20228022-0, 20228022-1, 2022802A00, 2022802C00, 2022803-00, 20228033-0, 20228033-1, 2022803A00, 2022803B00, 2022803C00, 2022804-00, 20228044-0, 20228044-1, 2022804A00, 2022804B00, 2022804C00, 2022805-00, 20228055-0, 20228055-1, 2022805A00, 2022805B00, 2022805C00, 2022806-00, 20228066-0, 20228066-1, 2022806A00, 2022806B00, 2022806C00, 2022807-00, 20228077-0, 20228077-1, 2022807A00, 2022807B00, 2022807C00, 2022901-00, 20229011-0, 20229011-1, 2022901A00... (Other models you can see in the webshop) | | |



| | | | |
|--------------------|---|-----------------|--------|
| GEV No. | 375143 | Ref. No. | 203491 |
| description | thermostat t.max. 110°C temperature range 32-110°C 3-pole 3NO 16A probe ø 6mm probe L 138mm capillary pipe 1480mm capillary pipe isolated 1100mm gland nut M9x1 shaft ø 6x4.6mm shaft L 23mm shaft position upper rotation 270° | | |
| For models: | 0220501-00, 0220502-00, 0220503-00, 0220802-00, 0520901-00, 1420801-00, 1420803-00, 2020501-00, 20205011-0, 2020502-00, 20205033-0, 2020504-00, 2120501-00, 2120502-00, 3020502-00 | | |



| | | | |
|--------------------|---|-----------------|--------|
| GEV No. | 375735 | Ref. No. | 203661 |
| description | thermostat t.max. 180°C temperature range 100-180°C 3-pole 3NO 16A probe ø 6mm probe L 133mm capillary pipe 2300mm capillary pipe isolated 450mm gland nut M9x1 shaft ø 6x4.6mm shaft L 23mm shaft position upper rotation 270° | | |
| For models: | 0520303-02, 0720332R00, 0720332V00, 1420332P01, 1420332P02, 1420332P03, 1420332R00, 1420332R01, 1420332R02, 1420332R03, 1420332T01, 1420332T02, 1420332T03, 1420332V01, 1420332V02, 1420332V03, 1420333P01, 1420333P02, 1420333R00, 1420333R01, 1420333R02, 1420333T01, 1420333T02, 1420333V01, 1420333V02, 1420334P00, 1420334P01, 1420334P02, 1420334P03, 1420334P04, 1420334R02, 1420334R03, 1420334R04, 1420334T02, 1420334T03, 1420334T04, 1420334V01, 1420334V02, 1420334V03, 1420334V04, 1420334W02, 1420334W03, 1420334W04, 1420334Y02, 1420334Y03, 1420334Y04, 1420344R00, 1420344R01, 1420344R02, 1520332P00... (Other models you can see in the webshop) | | |



| | | | |
|--------------------|---|-----------------|--------|
| GEV No. | 375097 | Ref. No. | 203497 |
| description | thermostat t.max. 195°C temperature range 95-195°C 3-pole 3NO 16A probe ø 6mm probe L 117mm capillary pipe 1780mm capillary pipe isolated 1400mm gland nut M9x1 shaft ø 6x4.6mm shaft L 23mm shaft position upper rotation 270° | | |



| | | | |
|--------------------|--|-----------------|--------|
| GEV No. | 375504 | Ref. No. | 203499 |
| description | thermostat t.max. 220°C temperature range 95-220°C 3-pole 3NO 16A probe ø 6mm probe L 117mm capillary pipe 1480mm capillary pipe isolated 1100mm gland nut shaft ø 6x4.6mm shaft L 23mm shaft position upper rotation 270° | | |



| | | | |
|--------------------|--|-----------------|--------|
| GEV No. | 375022 | Ref. No. | 200496 |
| description | thermostat t.max. 180°C temperature range 95-180°C 3-pole 3NO 16A probe ø 6mm probe L 133mm capillary pipe 1780mm capillary pipe isolated 1400mm gland nut M9x1 shaft ø 6x4.6mm shaft L 23mm rotation 270° | | |



| | | | |
|--------------------|---|-----------------|--------|
| GEV No. | 375025 | Ref. No. | 203488 |
| description | thermostat t.max. 300°C temperature range 50-300°C 3-pole 3CO 16A probe ø 6mm probe L 77mm capillary pipe 2980mm capillary pipe isolated 2260mm gland nut shaft ø 6x4.6mm shaft L 23mm shaft position upper rotation 270° | | |



| | | | |
|--------------------|---|-----------------|------------------|
| GEV No. | 375512 | Ref. No. | 203487 203496 |
| description | thermostat t.max. 185°C temperature range 95-185°C 3-pole 3NO 16A probe ø 6mm probe L 133mm capillary pipe 2430mm capillary pipe isolated 1100mm gland nut M9x1 shaft ø 6x4.6mm shaft L 23mm shaft position upper rotation 270° | | |
| For models: | 0120101-00, 0120101C00, 0120105-00, 0120105C00, 0220301-00, 0220301B00, 0220301B01, 0220301B02, 0220301D00, 0220302-00, 0220302A00, 0220302A01, 0220302A02, 0220302A03, 0220302B00, 0220302B01, 0220302B02, 0220302C00, 0220302C01, 0220302C02, 0220302C03, 0220302D00, 0220302E00, 0220302E01, 0220302F00, 0220302H00, 0220302H01, 0220303-00, 0220303-01, 0220303A00, 0220303A01, 0220303A02, 0220303A03, 0220303B00, 0220303B01, 0220303C00, 0220303C01, 0220303C02, 0220303D00, 0220303D01, 0220303E00, 0220303E01, 0220303H00, 0220303H01, 0220304-00, 0220305-00, 0220306-00, 0520302-00, 0520303-00, 0520303-01... (Other models you can see in the webshop) | | |



| | | | |
|--------------------|--|-----------------|--------|
| GEV No. | 375390 | Ref. No. | 203565 |
| description | thermostat t.max. 300°C temperature range 50-300°C 3-pole 3NO 16A probe ø 4mm probe L 292mm capillary pipe 880mm capillary pipe isolated 800mm gland nut shaft ø 6x4.6mm shaft L 23mm shaft position upper | | |
| For models: | 0522101-04, 0522102-04, 0722101-06, 1323208-04, 1323210-03, 1323210-04, 1323403-00, 1323403K00, 1323506-00, 1323506-01, 1323506A00, 1323506A01, 1323517-00, 1323517A00, 1363403-03, 1363403-04, 1363403-05, 1363415-05, 1422101-04, 1422101-05, 1422101-06, 1422102-04, 1422102-05, 1422104-05, 1422105-05, 1422106-05, 1422106-06, 1422107-05, 1422107-06, 1422301-01, 2023114-00, 2023118-00, 2023119-00, 2023203-07, 2023205-07, 2023207-03, 2023207-04, 2023207-05, 2023406-00, 2023503-10, 2023503-11, 2023503-12, 2023503-13, 2023503A10, 2023503A11, 2023503A12, 2023503A13, 2023512A00, 2063403-08, 2063403-09... (Other models you can see in the webshop) | | |



| | | | |
|---|--|-----------------|-------------------|
| GEV No. | 375038 | Ref. No. | 203494 |
| description | thermostat t.max. 300°C temperature range 50-300°C 3-pole 3NO 16A probe ø 6mm probe L 79mm capillary pipe 1740mm capillary pipe isolated 800mm gland nut shaft ø 6x4.6mm shaft L 23mm shaft position upper rotation 270° | | |
| For models: | 0221101-00, 0221101-01, 0221101A00, 0221101A01, 0221102-00, 0221102-01, 0221103-00, 0221103-01, 0221104-00, 0221104-01, 0221104A00, 0221104A01, 0221105-00, 0221105-01, 0221106-00, 0221106-01, 0221107-00, 0221107A00, 0221108-00, 0221109-00, 0221109A00, 0221110-00, 0522101-00, 0522101-01, 0522101-03, 0522102-00, 0522102-01, 0522102-03, 1221101-00, 1221101A00, 1221101B00, 1221102-00, 1221102A00, 1221102B00, 1221103-00, 1221103-01, 1221103-02, 1221103A00, 1221103A01, 1221103A02, 1221103B00, 1221103B01, 1221103B02, 1221103J00, 1221103J01, 1221104-00, 1221104-01, 1221104A00, 1221104A01, 1221104B00... (Other models you can see in the webshop) | | |
| accessories for | 375038 | | |
|  | GEV No. | 110123 | Ref. No. — |
| | knob thermostat t.max. 300°C ø 50mm shaft ø 6x4.6mm shaft flat upper black temperature range 50-300°C rotation 270° | | |



| | | | |
|--------------------|--|-----------------|--------|
| GEV No. | 375026 | Ref. No. | 203406 |
| description | thermostat t.max. 350°C temperature range 100-350°C 3-pole 3NO 16A probe ø 6mm probe L 77mm capillary pipe 2430mm capillary pipe isolated 1100mm gland nut shaft ø 6x4.6mm shaft L 23mm shaft position upper rotation 270° | | |
| For models: | 2023501-00, 2023501A00, 2023502-00, 2023502A00, 2023503-00, 2023503A00, 2083501B00, 2083501C00, 2083502B00, 2083502C00 | | |

55.40_ series

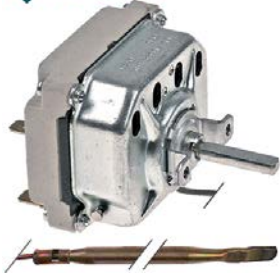

| | | | |
|--------------------|--|-----------------|--------|
| GEV No. | 375096 | Ref. No. | 203407 |
| description | thermostat t.max. 450°C temperature range 100-450°C 4-pole 4NO 16A probe ø 3.9mm probe L 163mm capillary pipe 1180mm capillary pipe isolated 850mm gland nut shaft ø 6x4.6mm shaft L 23mm shaft position upper rotation 270° | | |
| For models: | 1223215-00, 1223215A00, 1223216-00, 1223216A00, 1223504A00, 1223504A01, 1223505-00, 1223505-01, 1223505A00, 1223505A01, 1323504-00, 1323504-01, 1323504A00, 1323504A01, 1323505-00, 1323505-01, 1323505A00, 1323505A01, 1323506-00, 1323506-01, 1323506A00, 1323506A01, 1323515-00, 1323515A00, 1323516-00, 1323516A00, 1323517-00, 1323517A00, 1423501-00, 1423501-01, 1423501A00, 1423501A01, 1423502-00, 1423502-01, 1423502-02, 1423502A00, 1423502A01, 1423502A02, 1423504-00, 1423504-01, 1423504A00, 1423504A01, 1423505-00, 1423505-01, 1423505A00, 1423505A01, 1423507A00, 1423508A00, 1423524A00, 1423525A00... (Other models you can see in the webshop) | | |



safety thermostats

51._series





| | | | |
|--------------------|--|-----------------|--------|
| GEV No. | 375518 | Ref. No. | 203479 |
| description | safety thermostat switch-off temp. 213°C 1-pole 0.5A probe ø 6mm probe L 119mm capillary pipe 890mm capillary pipe isolatedmm gland nut probe SS | | |
| For models: | 0260301-00, 0260301-01, 0260302-00, 0260302-01, 1260301-00, 1260301-01, 1260302-00, 1260302-01, 1460302-00, 1460302-01, 1460302-02, 2060301-00, 2060301-01, 2060301-02, 20628022-2, 20628033-1, 20628033-2, 20628044-1, 20628044-2, 20629011-1, 20629011-2, 20629022-1, 20629022-2 | | |

55.13._series



| | | | |
|---|---|-----------------|------------------------|
| GEV No. | 375519 | Ref. No. | 203480 |
| description | safety thermostat switch-off temp. 130°C 1-pole 1NO 16A probe ø 6mm probe L 129mm capillary pipe 830mm capillary pipe isolatedmm gland nut mounting thread M8x1 probe SS | | |
| For models: | 1462802B00, 1462802B01, 1462802B02, 1462802B03, 1462802B04, 1462802B05, 1462804B00, 1462804B01, 1462804B02, 1462804B03, 1462804B04, 1462804B05, 1462831-00, 1462832-00, 1462833-00, 1462834-00, 1462835-00, 1462836-00, 1462837-00, 1462838-00, 1462839-00, 1462840-00, 1462908-00, 1462910-00, 2062801-00, 2062801-01, 2062801-02, 2062801-03, 2062801-04, 2062801-05, 2062801-06, 2062801A00, 2062801A01, 2062801A02, 2062801A03, 2062801A04, 2062801A05, 2062801A06, 2062801B00, 2062801B01, 2062801B02, 2062801B03, 2062801B04, 2062801B05, 2062801B06, 2062801C00, 2062801C01, 2062801C02, 2062801C03, 2062801C04... (Other models you can see in the webshop) | | |
| accessories for | 375519 | | |
|  | GEV No. | 102067 | Ref. No. 201524 |
| | nut thread M8x1 H 3mm brass Qty 1 pcs type SEF 1 | | |



| | | | |
|--|---|-----------------|------------------------|
| GEV No. | 375044 | Ref. No. | 203185 |
| description | safety thermostat switch-off temp. 178°C 1-pole 16A probe ø 4mm probe L 91mm capillary pipe 1730mm capillary pipe isolated 1600mm gland nut probe with sealing sleeve screw connection M8x1 sealing sleeve 8.6x32mm | | |
| For models: | 1422802B04, 1422802B05, 1422802B06, 1422802B07, 1422802B08, 1422804B04, 1422804B05, 1422804B06, 1422804B07, 1422804B08, 1422805B04, 1422805B05, 1422805B06, 1422805B07, 1422805B08, 1422807B00, 1422807B01, 1422807B02, 1422807B03, 1422807B04, 1422831-00, 1422832-00, 1422833-00, 1422834-00, 1422902-00, 1422902-01, 1422902-02, 1422902-03, 1422902-04, 1422908-00, 1422910-00, 1423901-00, 1423901-01, 1423901-02, 1423902-00, 1423902-01, 1423902-02, 1423903-00, 1423903-01, 1423903-02, 2022801-02, 2022801-03, 2022801A02, 2022801A03, 2022801B02, 2022801B03, 2022801C02, 2022801C03, 2022802-02, 2022802-03... (Other models you can see in the webshop) | | |
| accessories for | 375044 | | |
|  | GEV No. | 102067 | Ref. No. 201524 |
| | nut thread M8x1 H 3mm brass Qty 1 pcs type SEF 1 | | |
|  | GEV No. | 551083 | Ref. No. — |
| | cap for safety thermostat thread M8x1 | | |

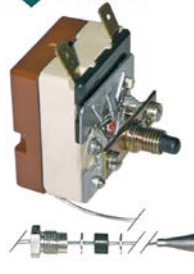

| | | | |
|--------------------|--|-----------------|------------------|
| GEV No. | 390124 | Ref. No. | 203165 203492 |
| description | safety thermostat switch-off temp. 246°C 1-pole 1NO 16A probe ø 6mm probe L 77mm capillary pipe 830mm capillary pipe isolatedmm gland nut M9x1 probe | | |
| For models: | 1220501-01, 1220802-00, 1220802-01, 1320501-00, 1320501A00, 1320802-00, 1320802A00, 1420801-01, 1420803-01, 1820301-00, 1820301-01, 1820301-02, 2120510-00, 2120510-01 | | |



55.31_series

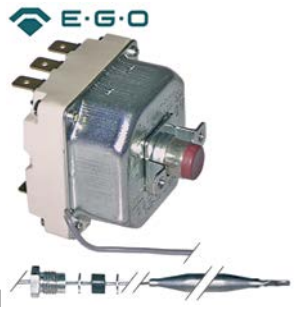

| | | | |
|--------------------|---|-----------------|--------|
| GEV No. | 375524 | Ref. No. | 203493 |
| description | safety thermostat switch-off temp. 135°C 3-pole 20A probe ø 6mm probe L 173mm capillary pipe 1430mm capillary pipe isolated 800mm gland nut M9x1 probe SS | | |
| For models: | 1320401-00, 1320401-01, 1420401-00, 1420401-01, 2020401-00, 2020401-01, 2120401-00, 2120401-01 | | |



| | | | |
|--------------------|---|-----------------|------------------|
| GEV No. | 375521 | Ref. No. | 203482 203483 |
| description | safety thermostat switch-off temp. 240°C 3-pole 20A probe ø 6mm probe L 177mm capillary pipe 2380mm capillary pipe isolated 1100mm gland nut M9x1 probe SS | | |
| For models: | 0120101-00, 0120101C00, 0120105-00, 0120105C00, 0220301-00, 0220301B00, 0220301B01, 0220301B02, 0220301D00, 0220302-00, 0220302A00, 0220302A01, 0220302A02, 0220302A03, 0220302B00, 0220302B01, 0220302B02, 0220302C00, 0220302C01, 0220302C02, 0220302C03, 0220302D00, 0220302E00, 0220302E01, 0220302F00, 0220303-00, 0220303-01, 0220303A00, 0220303A01, 0220303A02, 0220303A03, 0220303B00, 0220303B01, 0220303C00, 0220303C01, 0220303C02, 0220303D00, 0220303D01, 0220303E00, 0220303E01, 0220304-00, 0220305-00, 0220306-00, 0520302-00, 0520303-00, 0520303-01, 0522101-01, 0522102-01, 1420301-00, 1420301B00... (Other models you can see in the webshop) | | |

55.32_series



| | | | |
|--------------------|--|-----------------|--------|
| GEV No. | 375375 | Ref. No. | 900081 |
| description | safety thermostat switch-off temp. 230°C 3-pole 20A probe ø 6mm probe L 94mm capillary pipe 900mm capillary pipe isolated 670mm gland nut M10x1 probe SS | | |



| | | | |
|--------------------|---|-----------------|--------|
| GEV No. | 375392 | Ref. No. | 203484 |
| description | safety thermostat switch-off temp. 360°C 3-pole 1CO/2NC 20A probe ø 4mm probe L 120mm capillary pipe 1490mm capillary pipe isolated 1450mm gland nut probe SS | | |
| For models: | 0021130A00, 0021130A01, 0021135A00, 0221101-01, 0221101A01, 0221102-01, 0221103-01, 0221104-01, 0221104A01, 0221105-01, 0221106-01, 0221107-00, 0221107A00, 0221108-00, 0221109-00, 0221109A00, 0221110-00, 0522101-00, 0522102-00, 0721134-01, 0721134A01, 0721172A01, 0721173A01, 0721174A01, 0721175A01, 1022603-00, 1121117-00, 1121117-01, 1121117A00, 1121118-00, 1121118-01, 1121119-00, 1121119A00, 1121120-00, 1121121-00, 1121121A00, 1121135A01, 1220402-00, 1220402-01, 1221101-00, 1221101A00, 1221101B00, 1221102-00, 1221102A00, 1221102B00, 1221103-00, 1221103-01, 1221103-02, 1221103-04, 1221103A00... (Other models you can see in the webshop) | | |

55.33_series



| | | | |
|--------------------|---|-----------------|--------|
| GEV No. | 375746 | Ref. No. | 203489 |
| description | safety thermostat switch-off temp. 230°C 3-pole 20A probe ø 6mm probe L 117mm capillary pipe 1470mm capillary pipe isolated 1100mm gland nut M9x1 probe SS | | |
| For models: | 0120101-01, 0120101-02, 0120101-03, 0120101-04, 0120101D00, 0120101D01, 0120101D02, 0120101D04, 0120105-01, 0120105-02, 0120105-03, 0120105-04, 0120105D00, 0120105D01, 0120105D02, 0120105D04, 0220302H00, 0220302H01, 0220303H00, 0220303H01, 0520302-01, 0520302-02, 0520302A00, 0520302A01, 0520303-02, 0720325-03, 0720325-04, 0720325B03, 0720325B04, 1220301-00, 1220301-01, 1220301-02, 1220301-03, 1220301-04, 1220301B00, 1220301B01, 1220301B02, 1220301B03, 1220301B04, 1220301D00, 1220301D01, 1220301E00, 1220301E01, 1220301J00, 1220301J01, 1220301J02, 1220301J03, 1220302-00, 1220302-01, 1220302B00... (Other models you can see in the webshop) | | |

| | | | |
|---|---|-----------------|--------|
|   | | | |
| GEV No. | 375516 | Ref. No. | 203183 |
| description | safety thermostat switch-off temp. 250°C 3-pole 20A probe ø 6mm probe L 107mm capillary pipe 1470mm capillary pipe isolated 1100mm gland nut M9x1 probe SS | | |
| For models: | 0522101-02, 0522101-03, 0522101-04, 0522102-02, 0522102-03, 0522102-04, 0722101-06, 1220504-01, 1221107-00, 1221108-00, 1320504-01, 1320504-02, 1321107-00, 1323208-00, 1323208-01, 1323208-02, 1323208-03, 1323208-04, 1323210-00, 1323210-01, 1323210-02, 1323210-03, 1323210-04, 1323403-00, 1323403K00, 1323506-00, 1323506-01, 1323506A00, 1323506A01, 1323517-00, 1323517A00, 1363403-00, 1363403-01, 1363403-02, 1363403-03, 1363403-04, 1363403-05, 1363415-05, 1420509-01, 1421122-00, 1422101-02, 1422101-03, 1422101-04, 1422101-05, 1422101-06, 1422102-02, 1422102-03, 1422102-04, 1422102-05, 1422104-05... (Other models you can see in the webshop) | | |

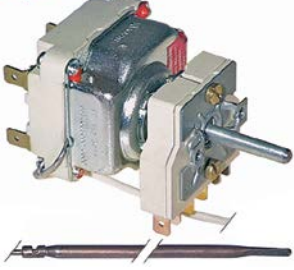

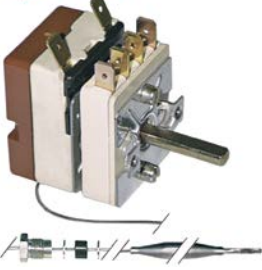
| | | | |
|--|---|-----------------|--------|
| <p>55.34_ series</p>   | | | |
| GEV No. | 375246 | Ref. No. | 203408 |
| description | thermostat t.max. 645°C temperature range 100-615/645°C 2-pole 2NO 16A probe ø 4mm probe L 230mm capillary pipe 1100mm capillary pipe isolated 600mm gland nut shaft ø 6x4.6mm shaft L 25mm shaft position lower rotation 270° outer switch 2NO probe material copper | | |
| For models: | 0723405-01, 0723405-02, 0723409-01, 0723409-02, 0723413-02, 0723414-02, 1023410-00, 1423404-00, 1423404-01, 1423405-00, 1423405-01, 1423405-02, 1423409-00, 1423409-01, 1423409-02, 1423413-02, 1423414-02, 1423510A00, 1423511A00, 1423526A00, 1423527A00, 1424819-00, 1424826-00, 1523405-00, 1523405-01, 1523409-00, 1523409-01, 1523410-00, 2023206-00, 2023206-01, 2023206-02, 2023207-00, 2023207-01, 2023207-02, 2023207-03, 2023207-04, 2023207-05, 2023405-00, 2023405D00, 2023406-00, 2023409-00, 2023511A00, 2023512A00, 2061409B00, 2061409B01, 2061411B00, 2061411B01, 3023206-00, 3023206-01, 3023206-02... (Other models you can see in the webshop) | | |

| | | | |
|--|--|-----------------|--------|
| <p>control thermostats with operation switch</p> <p>55.13_ series</p>   | | | |
| GEV No. | 375052 | Ref. No. | 203481 |
| description | thermostat t.max. 195°C temperature range 140-195°C 1-pole 1NO 16A probe ø 6mm probe L 77mm capillary pipe 830mm capillary pipe isolated 500mm gland nut M9x1 shaft ø 6x4.6mm shaft L 23mm shaft position upper rotation 270° outer switch 2NO | | |
| For models: | 0120101-01, 0120101-02, 0120101-03, 0120101-04, 0120101D00, 0120101D01, 0120101D02, 0120101D04, 0120105-01, 0120105-02, 0120105-03, 0120105-04, 0120105D00, 0120105D01, 0120105D02, 0120105D04, 0520302-01, 0520302-02, 0520302A00, 0520302A01, 1820301-00, 1820301-01, 1820301-02, 2160501-00 | | |

| | | | |
|---|---|-----------------|------------------|
| <p>accessories</p> <p>probe clips</p> <p>clamps</p> <p>for thermostat</p>  | | | |
| GEV No. | 550878 | Ref. No. | 208057 575077 |
| description | probe clip for pipe ømm for probe ø 6mm Qty 1 pcs | | |
| For models: | 0120101-00, 0120101-01, 0120101-02, 0120101-03, 0120101-04, 0120101C00, 0120101D00, 0120101D01, 0120101D02, 0120101D04, 0120105-00, 0120105-01, 0120105-02, 0120105-03, 0120105-04, 0120105C00, 0120105D00, 0120105D01, 0120105D02, 0120105D04, 0120202-00, 0120203-00, 0220301-00, 0220301B00, 0220301B01, 0220301B02, 0220301D00, 0220302-00, 0220302B00, 0220302B01, 0220302B02, 0220302D00, 0220302E00, 0220302E01, 0220302F00, 0220302H00, 0220302H01, 0220303-00, 0220303-01, 0220303B00, 0220303B01, 0220303D00, 0220303D01, 0220303E00, 0220303E01, 0220303H00, 0220303H01, 0220501-00, 0220502-00, 0220503-00... (Other models you can see in the webshop) | | |





| | | | |
|---|---|-----------------|------------------|
|  | | | |
| 1 | | | |
| GEV No. | 550877 | Ref. No. | 208058 575076 |
| description | probe clip for pipe ømm for probe ø 8mm Qty 1 pcs | | |
| For models: | 0120101-00, 0120101-01, 0120101-02, 0120101-03, 0120101-04, 0120101C00, 0120101D00, 0120101D01, 0120101D02, 0120101D04, 0120105-00, 0120105-01, 0120105-02, 0120105-03, 0120105-04, 0120105C00, 0120105D00, 0120105D01, 0120105D02, 0120105D04, 0120202-00, 0120202-01, 0120203-00, 0120203-01, 0220301-00, 0220301B00, 0220301B01, 0220301B02, 0220301D00, 0220302-00, 0220302B00, 0220302B01, 0220302B02, 0220302D00, 0220302E00, 0220302E01, 0220302F00, 0220302H00, 0220302H01, 0220303-00, 0220303-01, 0220303B00, 0220303B01, 0220303D00, 0220303D01, 0220303E00, 0220303E01, 0220303H00, 0220303H01, 0220501-00... (Other models you can see in the webshop) | | |

| | | | |
|---|---|-----------------|------------------------|
|  | | | |
| 1 | | | |
| GEV No. | 550556 | Ref. No. | 208062 |
| description | probe clip for pipe ø 2x8.5mm for probe ømm for heating elements spacing 25mm Qty 1 pcs L 37mm W 10mm | | |
| For models: | 0120101-00, 0120101-01, 0120101-02, 0120101-03, 0120101-04, 0120101C00, 0120101D00, 0120101D01, 0120101D02, 0120101D04, 0120105-00, 0120105-01, 0120105-02, 0120105-03, 0120105-04, 0120105C00, 0120105D00, 0120105D01, 0120105D02, 0120105D04, 0120202-00, 0120203-00, 0520302A00, 0520302A01, 0720504-04, 1020510-00, 1120510-00, 1120510-01, 1220303A00, 1220303A01, 1220303A02, 1220303A03, 1220303C00, 1220303C01, 1220303C02, 1220303C03, 1220303F01, 1220303F02, 1220303F03, 1220303H00, 1220303H01, 1220303H02, 1220303H03, 1220304A00, 1220304A01, 1220304A02, 1220304C00, 1220304C01, 1220304C02, 1220304F00... (Other models you can see in the webshop) | | |
| accessories for | 550556 | | |
|  | GEV No. | 550557 | Ref. No. 208063 |
| spacer piece | | | |

| | | | |
|---|---|-----------------|----------------------------|
|  | | | |
| 1 | | | |
| GEV No. | 550135 | Ref. No. | 208059 575022 945071 |
| description | probe clip for pipe ø 8.5mm for probe ø 6mm L 25mm Qty 10 pcs | | |
| For models: | 0021130A00, 0021130A01, 0021135A00, 0120101-00, 0120101-01, 0120101-02, 0120101C00, 0120101D00, 0120101D01, 0120105-01, 0120105-02, 0120105D00, 0120105D01, 0120201-00, 0120201-01, 0220301-00, 0220301B00, 0220301B01, 0220301B02, 0220301D00, 0220302-00, 0220302B00, 0220302B01, 0220302B02, 0220302D00, 0220302E00, 0220302E01, 0220302F00, 0220302H00, 0220302H01, 0220303-00, 0220303-01, 0220303B00, 0220303B01, 0220303D00, 0220303D01, 0220303E00, 0220303E01, 0220303H00, 0220303H01, 0221101-01, 0221101A01, 0221102-01, 0221103-01, 0221104-01, 0221104A01, 0221105-01, 0221106-01, 0221107-00, 0221107A00... (Other models you can see in the webshop) | | |

| | | | |
|--|--|-----------------|--------|
| protective pipes for capillary pipes | | | |
|  | | | |
| Image not available | | | |
| 1 | | | |
| GEV No. | 550391 | Ref. No. | 935211 |
| description | protective pipe for capillaries | | |
| For models: | 0220501-00, 0220502-00, 0220503-00, 0220802-00, 0522101-00, 0522101-01, 0522101-02, 0522101-03, 0522102-00, 0522102-01, 0522102-02, 0522102-03, 1323208-00, 1323208-01, 1323208-02, 1323208-03, 1323210-00, 1323210-01, 1323210-02, 1363403-00, 1363403-01, 1363403-02, 1420501-00, 1420502-00, 1420504-00, 1420505-00, 1420801-00, 1420803-00, 1422101-00, 1422101-01, 1422101-02, 1422101-03, 1422102-00, 1422102-01, 1422102-02, 1422102-03, 14621011-0, 2020501-00, 2020501-01, 20205011-0, 2020502-00, 2020503-0, 2020504-00, 2020505-00, 2023203-00, 2023203-01, 2023203-02, 2023203-03, 2023203-04, 2023203-05... (Other models you can see in the webshop) | | |

| | | | |
|---|--|-----------------|--------|
|  | | | |
| 1 | | | |
| GEV No. | 550385 | Ref. No. | 541673 |
| description | protective pipe for capillaries thread M10x1 H1 120mm L1 50mm L2 125mm | | |
| For models: | 0120101-00, 0120101-01, 0120101-02, 0120101-03, 0120101-04, 0120101C00, 0120101D00, 0120101D01, 0120101D02, 0120101D04 | | |

| | | | |
|---|--|-----------------|--------|
|  | | | |
| 1 | | | |
| GEV No. | 550386 | Ref. No. | 541674 |
| description | protective pipe for capillaries thread M10x1 H1 148mm L1 46mm L2 100mm | | |
| For models: | 0120105-00, 0120105-01, 0120105-02, 0120105-03, 0120105-04, 0120105C00, 0120105D00, 0120105D01, 0120105D02, 0120105D04 | | |

| | | | |
|---|---|-----------------|------------------|
|  | | | |
| 1 | | | |
| GEV No. | 551107 | Ref. No. | 935206 935526 |
| description | protective pipe for capillaries thread M10x1 H1 200mm H2 12mm L1 190mm L2 95mm | | |
| For models: | 0220301-00, 0220301B00, 0220301B01, 0220301B02, 0220301D00, 0220302-00, 0220302A00, 0220302A01, 0220302A02, 0220302A03, 0220302B00, 0220302B01, 0220302B02, 0220302C00, 0220302C01, 0220302C02, 0220302C03, 0220302D00, 0220302E00, 0220302E01, 0220302F00, 0220302H00, 0220302H01, 0220303-00, 0220303-01, 0220303A00, 0220303A01, 0220303A02, 0220303A03, 0220303B00, 0220303B01, 0220303C00, 0220303C01, 0220303C02, 0220303D00, 0220303D01, 0220303E00, 0220303E01, 0220303H00, 0220303H01, 0220304-00, 0220305-00, 0220306-00, 0720325-03, 0720325-04, 0720325B03, 0720325B04, 0720332P00, 0720332R00, 0720332T00... (Other models you can see in the webshop) | | |



| | | | |
|---|--|-----------------|--------|
|  | | | |
| 1 | | | |
| GEV No. | 550380 | Ref. No. | 541219 |
| description | protective pipe for capillaries thread M10x1 H1 215mm H2 190mm L1 67mm L2 30mm | | |
| For models: | 0520302-00, 0520302-01, 0520302-02 | | |

| | | | |
|---|---|-----------------|------------------|
| plunger sockets | | | |
|  | | | |
| 1 | | | |
| GEV No. | 550285 | Ref. No. | 541221 935211 |
| description | protection pipe thread M12x0.75 IT M9x1 ET M12x0.75 L 66mm SS single ø 10mm | | |

switches and momentary switches

rocker/momentary rocker switches

| | | | |
|--|---|-----------------|------------------|
| 30x22mm | | | |
|  | | | |
| 1 | | | |
| GEV No. | 301060 | Ref. No. | 203235 301060 |
| description | rocker switch mounting measurements 30x22mm red 2NO 250V 16A illuminated connection male faston 6.3mm ambient temperature max. 125/55°C protection IP40 | | |
| For models: | 0521705-01, 0521706-00, 1224002-00, 1224002-01, 1224003-00, 1224003-01, 1224004-00, 1224004-01, 1224005-00, 1224005-01, 1224006-00, 1224006-01, 1224007-00, 1224007-01, 1224008-00, 1224008-01, 1224009-00, 1224009-01, 2020339A00, 2020339A01, 2062801-00, 2062801A00, 2062801B00, 2062801C00, 2062802-00, 20628022-2, 2062802A00, 2062802B00, 2062802C00, 2062803-00, 20628033-1, 20628033-2, 2062803A00, 2062803B00, 2062803C00, 2062804-00, 20628044-1, 20628044-2, 2062804A00, 2062804B00, 2062804C00, 2062806-00, 2062806A00, 2062806B00, 2062806B01, 2062806B02, 2062806B03, 2062806C00, 2062806C01, 2062806C02... (Other models you can see in the webshop) | | |

push/momentary push switches

| | | | |
|---|---|-----------------|--------|
| 30x22mm | | | |
|  | | | |
| 1 | | | |
| GEV No. | 301048 ¹ | Ref. No. | 203320 |
| description | push switch mounting measurements 30x22mm yellow 2NO 250V 16A illuminated connection male faston 6.3mm ambient temperature max. 85°C protection IP40 latching | | |
| For models: | 20628022-0, 20628022-1, 20628033-0, 20628044-0, 20629011-0, 20629022-0 | | |

¹illuminated

accessories

push buttons

| | | | |
|---|--|-----------------|--------|
|  | | | |
| 1 | | | |
| GEV No. | 348214 | Ref. No. | 207186 |
| description | button for display PCB transparent suitable for MKN ED ø 16mm H 4.8mm for combi-steamer | | |
| For models: | CSE11-L, CSE11-R, CSE11-R-DG, CSE12-L, CSE12-R, CSE12-R-DG, CSE21-L, CSE21-R, CSE21-R-DG, CSE22-L, CSE22-R, CSE22-R-DG, CSE61-L, CSE61-R, CSE61-R-DG, CSE62-L, CSE62-R, CSE62-R-DG, CSG11-L, CSG11-R, CSG11-R-DG, CSG12-L, CSG12-R, CSG12-R-DG, CSG21-L, CSG21-R, CSG21-R-DG, CSG22-L, CSG22-R, CSG22-R-DG, CSG61-L, CSG61-R, CSG61-R-DG, CSG62-L, CSG62-R, CSG62-R-DG | | |

microswitches

lever actuated

| | | | |
|---|---|-----------------|--------|
|  | | | |
| 1 | | | |
| GEV No. | 346456 | Ref. No. | 203340 |
| description | microswitch with lever 250V 0.1A 1CO connection male faston 6.3mm L 36mm ambient temperature max. 85°C mounting distance 22mm type CHERRY D41Y actuating force: 25g lever length 26mm | | |
| For models: | 0521706-00, 1220304A00, 1220304A01, 1220304A02, 1220304C00, 1220304C01, 1220304C02, 1220304F00, 1220304F01, 1220304H00, 1220304H01, 1220306A00, 1220306A01, 1220306A02, 1220306A03, 1220306A04, 1220306C00, 1220306C01, 1220306C02, 1220306C03, 1220306C04, 1220306F00, 1220306F01, 1220306F02, 1220306F03, 1220306H00, 1220306H01, 1220306H02, 1220306H03, 1320304A00, 1320304A01, 1320304A02, 1320304C00, 1320304C01, 1320304C02, 1320304F00, 1320304F01, 1320304F02, 1320304F03, 1320304F04, 1320304H00, 1320304H01, 1320304H02, 1320304H03, 1320304H04, 1320306A01, 1320306A02, 1320306A03, 1320306C01, 1320306C02... (Other models you can see in the webshop) | | |

| | | | |
|---|---|-----------------|--------|
|  | | | |
| 1 | | | |
| GEV No. | 345255 | Ref. No. | 203334 |
| description | microswitch with lever 250V 16A 1CO connection male faston 6.3mm L 35mm L1 28mm ambient temperature max. 125°C mounting distance 22mm actuating force: 136g lever length 27mm | | |
| For models: | 0220301-00, 0220301B00, 0220301B01, 0220301B02, 0220301D00, 0220302-00, 0220302A00, 0220302A01, 0220302A02, 0220302A03, 0220302B00, 0220302B01, 0220302B02, 0220302C00, 0220302C01, 0220302C02, 0220302C03, 0220302D00, 0220302E00, 0220302E01, 0220302F00, 0220302H00, 0220302H01, 0220303-00, 0220303-01, 0220303A00, 0220303A01, 0220303A02, 0220303A03, 0220303B00, 0220303B01, 0220303C00, 0220303C01, 0220303C02, 0220303D00, 0220303D01, 0220303E00, 0220303E01, 0220303H00, 0220303H01, 1420301-00, 1420301B00, 1420302-00, 1420302A00, 1420302B00, 1420302C00, 1420303-00, 1420303A00, 1420303B00, 1420303C00... (Other models you can see in the webshop) | | |



1

| | | | |
|--------------------|---|-----------------|--------|
| GEV No. | 345702 | Ref. No. | 203339 |
| description | microswitch with lever 250V 6A 1CO connection male faston 6.3mm L 35mm ambient temperature max. 85°C mounting distance 22mm actuating force: 60g | | |
| For models: | 0720325-03, 0720325-04, 0720325B03, 0720325B04, 0720332P00, 0720332R00, 0720332T00, 0720332V00, 1220301-00, 1220301-01, 1220301-02, 1220301-03, 1220301-04, 1220301B00, 1220301B01, 1220301B02, 1220301B03, 1220301B04, 1220301D00, 1220301D01, 1220301E00, 1220301E01, 1220301J00, 1220301J01, 1220301J02, 1220301J03, 1220302-00, 1220302-01, 1220302B00, 1220302B01, 1220302D00, 1220302E00, 1220303-00, 1220303-01, 1220303-02, 1220303-03, 1220303-04, 1220303-05, 1220303A00, 1220303A01, 1220303A02, 1220303A03, 1220303B00, 1220303B01, 1220303B02, 1220303B03, 1220303B04, 1220303B05, 1220303C00, 1220303C01... (Other models you can see in the webshop) | | |

pin-plunger actuated

miscellaneous



1

| | | | |
|--------------------|--|-----------------|--------|
| GEV No. | 347023 | Ref. No. | 203232 |
| description | microswitch 250V 16A connection screw connection ambient temperature max. 125°C mounting distance 96mm | | |
| For models: | 2020307A00 | | |

float switches



1

| | | | |
|--------------------|---|-----------------|--------|
| GEV No. | 401464 | Ref. No. | 203210 |
| description | float switch thread M46x2 1NO ø 44mm L 140mm mounting ø 46mm 250V 5A cable cable length 2000mm | | |
| For models: | 14228011-0, 14228022-0, 14228033-0, 14228044-0, 14228055-0, 2022801-00, 2022801-01, 2022801A00, 2022801A01, 2022801B00, 2022801B01, 2022801C00, 2022801C01, 2022802-00, 2022802-01, 2022802A00, 2022802A01, 2022802B00, 2022802B01, 2022802C00, 2022802C01, 2022803-00, 2022803-01, 2022803A00, 2022803A01, 2022803B00, 2022803B01, 2022803C00, 2022803C01, 2022804-00, 2022804-01, 2022804A00, 2022804A01, 2022804B00, 2022804B01, 2022804C00, 2022804C01, 2022805-00, 2022805-01, 2022805A00, 2022805A01, 2022805B00, 2022805B01, 2022805C00, 2022805C01, 2022806-00, 2022806A00, 2022806B00, 2022806B01, 2022806B02... (Other models you can see in the webshop) | | |

cam switches

on/off



1

| | | | |
|--------------------|---|-----------------|--------|
| GEV No. | 347953 | Ref. No. | 203958 |
| description | cam switch 4 operating positions 2NO sequence 0-1-0-1 16A shaft ø 6x4.6mm shaft L 23mm connection male faston 6.3mm ON-OFF plastic | | |
| For models: | 0524301-01, 0524302-01, 0524303-01, 0524304-01, 0721134-01, 0721134A01, 0721172A01, 0721173A01, 0721174A01, 0721175A01, 1221103-04, 1221103B04, 1221130J00, 1221135A04, 1221135J00, 1221136A04, 1221141-00, 1221141A00, 1221156A00, 1222507-00, 1222509-00, 1321130-00, 1321130A00, 1321131-00, 1321131A00, 1321135A03, 1321136A03, 1321141-00, 1321141A00, 1322507-00, 1322509-00, 1421117-03, 1421118-03, 1421126B00, 1421127B00, 1421130B00, 1421131-00, 1421131A00, 1421131B00, 1421139-00, 1421139A00, 1421139B00, 1421141-00, 1421141A00, 1421141B00, 1421143B01, 1421144B01, 1421145B01, 1421149B00, 1421149B01... (Other models you can see in the webshop) | | |



1

| | | | |
|--------------------|---|-----------------|--------|
| GEV No. | 300021 | Ref. No. | 203563 |
| description | cam switch 4 operating positions 4NO sequence 0-1-0-1 16A shaft ø 6x4.6mm shaft L 23mm connection screw ceramic | | |
| For models: | 0120101-00, 0120101C00, 0120105-00, 0120105C00, 0220301-00, 0220301B00, 0220301B01, 0220301B02, 0220301D00, 0220302-00, 0220302A00, 0220302A01, 0220302A02, 0220302A03, 0220302C00, 0220302C01, 0220302C02, 0220302C03, 0220302D00, 0220302F00, 0220302H00, 0220302H01, 0220303B00, 0220303B01, 0220303C00, 0220303C01, 0220303C02, 0220303E00, 0220303E01, 0220303H00, 0220303H01, 0220304-00, 0220305-00, 0220306-00, 0220501-00, 0220502-00, 0220503-00, 0220601-00, 0220802-00, 0221001H00, 0221202-00, 0221501-00, 0221502-00, 0520302-00, 0520303-00, 0520303-01, 0520303-02, 0520901-00, 0522101-01, 0522101-02... (Other models you can see in the webshop) | | |



1

| | | | |
|--------------------|---|-----------------|--------|
| GEV No. | 300102 | Ref. No. | 203564 |
| description | cam switch 4 operating positions 4NO sequence 0-1-0-1 32A shaft ø 6x4.6mm shaft L 23mm connection screw ceramic | | |
| For models: | 0021130A00, 0021130A01, 0021135A00, 0220302B00, 0220302B01, 0220302B02, 0220302E00, 0220302E01, 0220303-00, 0220303-01, 0220303A00, 0220303A01, 0220303A02, 0220303A03, 0220303D00, 0220303D01, 0220306-00, 0221101-00, 0221101-01, 0221101A00, 0221101A01, 0221102-00, 0221102-01, 0221103-00, 0221103-01, 0221104-00, 0221104-01, 0221104A00, 0221104A01, 0221105-00, 0221105-01, 0221106-00, 0221106-01, 0221107-00, 0221107A00, 0221108-00, 0221109-00, 0221109A00, 0221110-00, 0522101-00, 0522102-00, 0723104-03, 0723104A03, 0723104B03, 0723405-01, 0723405-02, 0723409-01, 0723409-02, 0723412K01, 0723413-02... (Other models you can see in the webshop) | | |

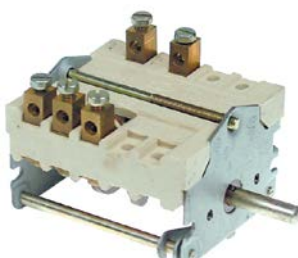

1

| | | | |
|--------------------|--|-----------------|--------|
| GEV No. | 300192 | Ref. No. | 203216 |
| description | cam switch 4-position sequence 0-3-2-1 32A shaft ø 6x4.6mm connection screw clamp 2-pole | | |
| For models: | 2023302-00, 2023303-00, 2023304-00, 2023305-00 | | |

4-position

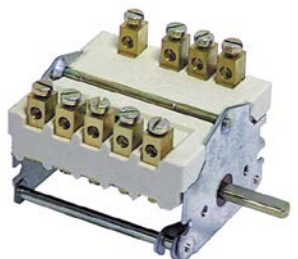

1

| | | | |
|--------------------|---|-----------------|--------|
| GEV No. | 300104 | Ref. No. | 203074 |
| description | cam switch 4 operating positions 3NO/1CO sequence 0-1-2-3 32A shaft ø 6x4.6mm shaft L 23mm connection screw ceramic | | |

7-position



1

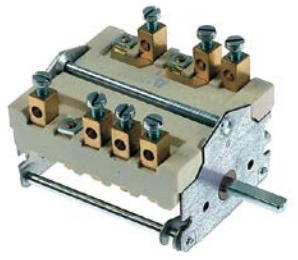

| | | | |
|--------------------|---|-----------------|--------|
| GEV No. | 300025 | Ref. No. | 203224 |
| description | cam switch 7 operating positions 1NO/2CO sequence 0-1-2-3-4-5-6 16A shaft ø 6x4.6mm shaft L 23mm connection screw 7-position ceramic | | |
| For models: | 0223202-00, 1223201-00, 1223201-01, 1223202-00, 1223207-00, 1223207-01, 1323201-00, 1323201-01, 1323201-02, 1323207-00, 1323207-02, 1323208-00, 1323208-01, 1323208-02, 1323208-03, 1323208-04, 1424802-00, 1424802-01, 1424802-02, 1424808-00, 1424808-01, 1424808-02, 1424808-03, 1424809-00, 1424809-01, 1424809-02, 1424809-03, 1424811-00, 1424811-01, 1424811-02, 1424811-03, 1424812-00, 1424812-01, 1424812-02, 1424813-00, 1424813-01, 1424813-02, 1424816-00, 18232011-0, 2023201-00, 2023201-01, 2023201-02, 2023201-03, 20232011-0, 20232011-1, 2023201A00, 2023201A01, 2023202-00, 2023202-01, 2023202-02... (Other models you can see in the webshop) | | |



1

| | | | |
|--------------------|---|-----------------|------------------|
| GEV No. | 300194 | Ref. No. | 203223 203228 |
| description | cam switch 4 operating positions 4NO sequence 0-1-2-3 16A shaft ø 6x4.6mm shaft L 23mm connection screw 4-position ceramic | | |
| For models: | 0522101-03, 0522101-04, 0522102-03, 0522102-04, 0722101-06, 1323208-02, 1323208-03, 1323208-04, 1323210-00, 1323210-01, 1323210-02, 1323210-03, 1323210-04, 1323403-00, 1323403K00, 1323506-00, 1323506-01, 1323506A00, 1323506A01, 1323517-00, 1323517A00, 1363403-02, 1363403-03, 1363403-04, 1363403-05, 1363415-05, 1422101-03, 1422101-04, 1422101-05, 1422101-06, 1422102-03, 1422102-04, 1422102-05, 1422104-05, 1422104A05, 1422105-05, 1422105A05, 1422106-05, 1422106-06, 1422106A05, 1422106A06, 1422107-05, 1422107-06, 1422107A05, 1422107A06, 1422301-01, 2023114-00, 2023118-00, 2023119-00, 2023203-05... (Other models you can see in the webshop) | | |

accessories for 300025

| | | | | |
|---|---|--------|-----------------|---|
|  | GEV No. | 112172 | Ref. No. | — |
| | knob universal ø 70mm black without adaptor/dial plate | | | |
|  | GEV No. | 112213 | Ref. No. | — |
| | knob dial plate silver switch 7-position t.max.°C ED ø 63mm ID ø 45.5mm | | | |
|  | GEV No. | 112311 | Ref. No. | — |
| | knob adapter shaft ø 6x4.6mm L 0mm with spring | | | |



1

| | | | |
|--------------------|---|-----------------|--------|
| GEV No. | 300106 | Ref. No. | 203560 |
| description | cam switch 7 operating positions 1NO/2CO sequence 0-1-2-3-4-5-6 32A shaft ø 6x4.6mm shaft L 23mm connection screw 7-position shaft flat upper | | |
| For models: | 1320401-00, 1320401-01, 1420401-00, 1420401-01, 2020401-00, 2020401-01, 2120401-00, 2120401-01 | | |



4 operating positions

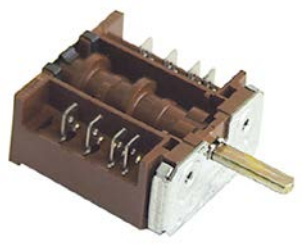

| | | | |
|--------------------|--|-----------------|--------|
| GEV No. | 300170 | Ref. No. | 203414 |
| description | cam switch 4 operating positions 3NO sequence 0-1-2-3 16A shaft ø 6x4.6mm shaft L 23mm connection male faston 6.3mm | | |
| For models: | 1220504-01, 1222601-00, 1320504-01, 1320504-02, 1322601-00, 1420509-01, 1422601-00, 1422602-00, 1422802B04, 1422802B05, 1422802B06, 1422802B07, 1422802B08, 1422804B04, 1422804B05, 1422804B06, 1422804B07, 1422804B08, 1422805B04, 1422805B05, 1422805B06, 1422805B07, 1422805B08, 1422807B00, 1422807B01, 1422807B02, 1422807B03, 1422807B04, 1422831-00, 1422832-00, 1422902-00, 1422902-01, 1422902-02, 1422902-03, 1422902-04, 1422908-00, 1462802B00, 1462802B01, 1462802B02, 1462802B03, 1462802B04, 1462802B05, 1462804B00, 1462804B01, 1462804B02, 1462804B03, 1462804B04, 1462804B05, 2020506-01, 2022601-00... (Other models you can see in the webshop) | | |



| | | | |
|--------------------|--|-----------------|--------|
| GEV No. | 300195 | Ref. No. | 203156 |
| description | cam switch 4 operating positions 6NO sequence 0-1-2-3 16A shaft ø 6x4.6mm shaft L 23mm connection male faston 6.3mm | | |
| For models: | 1220304-00, 1220304-01, 1220304A00, 1220304A01, 1220304A02, 1220304B00, 1220304B01, 1220304C00, 1220304C01, 1220304C02, 1220304D00, 1220304E00, 1220304F00, 1220304F01, 1220304H00, 1220304H01, 1320304-00, 1320304-01, 1320304A00, 1320304A01, 1320304A02, 1320304B00, 1320304B01, 1320304C00, 1320304C01, 1320304C02, 1320304D00, 1320304D01, 1320304E00, 1320304E01, 1320304F00, 1320304F01, 1320304F02, 1320304F03, 1320304F04, 1320304H00, 1320304H01, 1320304H02, 1320304H03, 1320304H04, 2022801-02, 2022801-03, 2022801A02, 2022801A03, 2022801B02, 2022801B03, 2022801C02, 2022801C03, 2022802-02, 2022802-03... (Other models you can see in the webshop) | | |

with potentiometer



| | | | |
|--------------------|--|-----------------|--------|
| GEV No. | 347952 | Ref. No. | 203894 |
| description | cam switch 16 operating positions 3NO sequence 0-16 16A shaft ø 6x4.6mm shaft L 23mm connection male faston 2.8mm incl code pcb cable lengthmm codedOhm plastic | | |
| For models: | 0723104-03, 0723104A03, 0723104B03, 0723105-03, 0723105A03, 0723105B03, 1023101-00, 1023101-01, 1023106-00, 1023106-01, 1023111-00, 1023111-01, 1223101-00, 1223101-01, 1223101-02, 1223103-00, 1223103-01, 1223103-02, 1223106-00, 1223106-01, 1223106-02, 1223111-00, 1223203-03, 1223211-01, 1323101-00, 1323101-01, 1323101-02, 1323103-00, 1323103-01, 1323103-02, 1323106-00, 1323203-02, 1323211-02, 1423101-00, 1423101-01, 1423101-02, 1423101A00, 1423101A01, 1423103-00, 1423103-01, 1423103-02, 1423103A00, 1423103A01, 1423104-00, 1423104-01, 1423104-02, 1423104-03, 1423104A00, 1423104A01, 1423104A03... (Other models you can see in the webshop) | | |

rotary switches

MOELLER/EATON



| | | | |
|--------------------|--|-----------------|--------|
| GEV No. | 347954 | Ref. No. | 203969 |
| description | rotary switch 3 0-1-2 sets of contacts 4 type T0-2-15512 400V 16A shaft ø 5.8x6.9mm shaft L 27mm shaft square connection screw | | |

miscellaneous



| | | | |
|--------------------|--|-----------------|--------|
| GEV No. | 346440 | Ref. No. | 203227 |
| description | rotary switch sets of contacts 3 2 0-1 type B15R A-XF-X-XX 380V 10A shaft ø 5x5mm shaft L 21mm shaft square connection screw | | |

magnetic switches

28.5x19mm

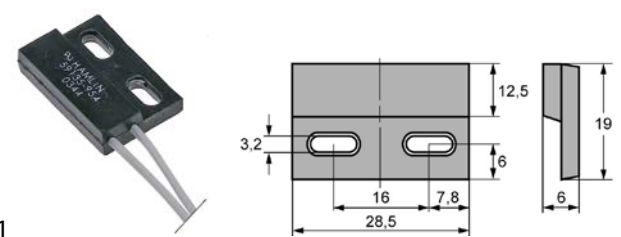

| | | | |
|--------------------|--|-----------------|--------|
| GEV No. | 345219 | Ref. No. | 203028 |
| description | magnetic switch L 28.5mm W 19mm 1NO 230V 0.5A P max. 10W connection cable cable length 800mm | | |
| For models: | 0120101-01, 0120101-02, 0120101-03, 0120101-04, 0120101D00, 0120101D01, 0120101D02, 0120101D04, 0120105-01, 0120105-02, 0120105-03, 0120105-04, 0120105D00, 0120105D01, 0120105D02, 0120105D04, 0520302-01, 0520302-02, 0520302A00, 0520302A01, 0520303-01, 0520303-02, 1423901-00, 1423901-01, 1423901-02, 1423902-00, 1423902-01, 1423902-02, 1423903-00, 1423903-01, 1423903-02, 1424101-00, 1424101-01, 1424102-00, 1424102-01, 1424103-00, 1424104-00, 1820301-01, 1820301-02, 2012827-01, 2012827-02, 2012828-00, 2012828-01, 2012828-02, 2012828-03, 2012828-04, 2012828-05, 2012829-00, 2012829-01, 2012829-02... (Other models you can see in the webshop) | | |



29x19mm



1

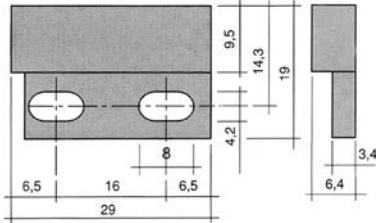

| | | | |
|--------------------|---|-----------------|--------|
| GEV No. | 345808 | Ref. No. | 202722 |
| description | magnetic switch L 29mm W 19mm 1CO 150V 0.5A P max. 10W connection cable length 1000mm | | |
| For models: | CCE60, CCE63, CGE11-L, CGE11-R, CGE12-L, CGE12-R, CGE21-L, CGE21-R, CGE22-L, CGE22-R, CGE61-L, CGE61-R, CGE62-L, CGE62-R, CGG11-L, CGG11-R, CGG12-L, CGG12-R, CGG21-L, CGG21-R, CGG22-L, CGG22-R, CGG61-L, CGG61-R, CGG62-L, CGG62-R, CPE60, CPE63, CSE11-L, CSE11-R, CSE11-R-DG, CSE12-L, CSE12-R, CSE12-R-DG, CSE21-L, CSE21-R, CSE21-R-DG, CSE22-L, CSE22-R, CSE22-R-DG, CSE61-L, CSE61-R, CSE61-R-DG, CSE62-L, CSE62-R, CSE62-R-DG, CSG11-L, CSG11-R, CSG11-R-DG, CSG12-L...(Other models you can see in the webshop) | | |



1

| | | | |
|--------------------|---|-----------------|----------|
| GEV No. | 348213 | Ref. No. | 10013771 |
| description | magnetic switch L 29mm W 19mm 1NO 0.5A P max. 10W connection plug cable length 500mm 200VDC | | |

accessories

magnets



1

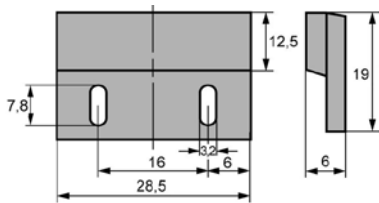

| | | | |
|--------------------|---|-----------------|--------|
| GEV No. | 345700 | Ref. No. | 203031 |
| description | magnet ømm L 29mm H 6.5mm W 19mm hole distance 16mm M3 hole ø 3.5mm | | |

control equipment

MOELLER/EATON

signal element



1

| | | | |
|--------------------|--|-----------------|--------|
| GEV No. | 347524 | Ref. No. | 203110 |
| description | signal element mounting measurements ø22mm with socket element blue with light bulb 130V | | |
| For models: | 0220302A00, 0220302A01, 0220302A02, 0220302A03, 0220302C00, 0220302C01, 0220302C02, 0220302C03, 0220302H00, 0220302H01, 0220303A00, 0220303A01, 0220303A02, 0220303A03, 0220303C00, 0220303C01, 0220303C02, 0220303H00, 0220303H01, 0220304-00, 0220305-00, 0220306-00 | | |

button plates with symbol



1

| | | | |
|--------------------|-------------------------------------|-----------------|--------|
| GEV No. | 346464 | Ref. No. | 203303 |
| description | button plate black automatic/manual | | |

switches (complete)

rotary switches





1

| | | | |
|--------------------|--|-----------------|--------|
| GEV No. | 346463 | Ref. No. | 203350 |
| description | rotary selector mounting measurements ø22mm black 3NO sequence 1-0-2 | | |
| For models: | 2013004B01, 2013004B02, 2013004B03, 2013004B04, 2013004B05, 2013008B01, 2013008B02, 2013008B03, 2013008B04, 2013008B05, 2013010B01, 2013010B02, 2013010B03, 2013010B04, 2013010B05, 2013018B00, 2013018B01, 2013018B02, 2013018B03, 2013018B04, 2020303-00, 2020303-01, 2020303-02, 2020303-03, 2020303-04, 2020303A00, 2020310-00, 2020310-01, 2020310-02, 2020310-03, 2020310A00, 2020310A01, 2020310A02, 2020310A03, 2020311-00, 2020311-01, 2020311-02, 2020311-03, 2020311A00, 2020311A01, 2020311A02, 2020311A03, 2020312A00, 2020312A01, 2020312A02, 2020314-01, 2020314-02, 2020314-03, 2020314A01, 2020314A02...(Other models you can see in the webshop) | | |

| | | | | |
|------------------------|--|--------|-----------------|---|
| spare parts for | 346463 | | | |
| | GEV No. | 346292 | Ref. No. | — |
| | GEV No. | 346293 | Ref. No. | — |
| | GEV No. | 346462 | Ref. No. | — |
| | momentary selector switch mounting measurements ø22mm black/white 330°-0°-30° momentary/momentary sequence 1-0-2 | | | |



| | | | |
|---|---|-----------------|--------|
|  | | | |
| GEV No. | 346486 | Ref. No. | 203365 |
| description | rotary selector mounting measurements ø22mm black sequence 1-0-2 | | |
| For models: | 2021404-00, 2021404-01, 2021404-02, 2021404-03, 2021404-04, 2021404A00, 2021404A01, 2021404A02, 2021404B00, 2021404B01, 2021404B02, 2021404C00, 2021404C01, 2021404C02, 2021406-00, 2021406-01, 2021406-02, 2021406B00, 2021406B01, 2023002-00, 2023002-01, 2023002-02, 2023002A00, 2023002B00, 2023002C00, 2023004-00, 2023004-01, 2023004-02, 2023004A00, 2023004B00, 2023004B01, 2023004B02, 2023004B03, 2023004B04, 2023004B05, 2023004B06, 2023004B07, 2023004C00, 2023006-00, 2023006-01, 2023006-02, 2023006A00, 2023006B00, 2023006C00, 2023008-00, 2023008-01, 2023008-02, 2023008A00, 2023008B00, 2023008C00, 2023008B01... (Other models you can see in the webshop) | | |

| | | | |
|---|---|-----------------|--------|
|  | | | |
| GEV No. | 346461 | Ref. No. | 203367 |
| description | rotary switch mounting measurements ø22mm black latching 1NC/1NO sequence 0-1 | | |
| For models: | 2020303-00, 2020303-01, 2020303-02, 2020303-03, 2020303-04, 2020303A00, 2020310-00, 2020310-01, 2020310-02, 2020310-03, 2020310A00, 2020310A01, 2020310A02, 2020310A03, 2020311-00, 2020311-01, 2020311-02, 2020311-03, 2020311A00, 2020311A01, 2020311A02, 2020311A03, 2020312A00, 2020312A01, 2020312A02, 2020314-01, 2020314-02, 2020314-03, 2020314A01, 2020314A02, 2020314A03, 2020315-01, 2020315-02, 2020315-03, 2020315A01, 2020315A02, 2020315A03, 2020339A00, 2020339A01, 2020340A00, 2020340A01, 2020341-00, 2020341A00, 2020342-00, 2020342A00, 3020310-00, 3020310-01, 3020310A00, 3020310A01, 3020311-00... (Other models you can see in the webshop) | | |

push/momentary push switches

| | | | |
|---|---|-----------------|--------|
|  | | | |
| GEV No. | 346465 ¹ | Ref. No. | 203304 |
| description | momentary push switch mounting measurements ø22mm black 1NC/1NO lifting countersink momentary | | |

¹lift/decline

| | | | |
|---|---|-----------------|--------|
|  | | | |
| GEV No. | 346489 | Ref. No. | 203313 |
| description | momentary push switch mounting measurements ø22mm yellow illuminated, 80-264V 1NC/1NO momentary | | |
| For models: | 1424824-00, 1424824-01, 1462802B00, 1462802B01, 1462802B02, 1462802B03, 1462802B04, 1462802B05, 1462804B00, 1462804B01, 1462804B02, 1462804B03, 1462804B04, 1462804B05, 1462831-00, 1462832-00, 1462833-00, 1462834-00, 1462835-00, 1462836-00, 1462837-00, 1462838-00, 1462839-00, 1462840-00, 1462908-00, 1462910-00, 2061401-05, 2061401-06, 2061401-07, 2061401-08, 2061401A05, 2061401A06, 2061401A07, 2061401A08, 2061401B05, 2061401B06, 2061401B07, 2061401B08, 2061401C05, 2061401C06, 2061401C07, 2061401C08, 2061402-05, 2061402-06, 2061402-07, 2061402A05, 2061402A06, 2061402A07, 2061402B05, 2061402B06... (Other models you can see in the webshop) | | |

lamps

| | | | |
|--|---|-----------------|-------------------|
|  | | | |
| GEV No. | 359606 | Ref. No. | 203120 |
| description | neon light bulb socket Ba9s 220V 2W clear ø 10mm L 28mm | | |
| For models: | 1424824-00, 1462802B00, 1462804B00, 2061401-05, 2061401A05, 2061401B05, 2061401C05, 2061402-05, 2061402A05, 2061402B05, 2061402C05, 2061403-00, 2061403-01, 2061403-02, 2061403-03, 2061403-04, 2061403A00, 2061403A02, 2061403A03, 2061403B00, 2061403B02, 2061403B03, 2061403C00, 2061403C02, 2061403C03, 2061404-00, 2061404-01, 2061404-02, 2061404-03, 2061404-04, 2061404A00, 2061404A02, 2061404A03, 2061404B00, 2061404B02, 2061404B03, 2061404C00, 2061404C02, 2061404C03, 2061405-00, 2061405-01, 2061405-02, 2061405B00, 2061405B01, 2061405B02, 2061406-00, 2061406-01, 2061406-02, 2061406B00, 2061406B01... (Other models you can see in the webshop) | | |
| accessories for | 359606 | | |
|  | GEV No. | 359832 | Ref. No. — |
| lamp socket mounting measurements ø16.2mm socket Ba9s connection male faston 6.3mm | | | |
|  | GEV No. | 359853 | Ref. No. — |
| lamp socket mounting measurements ø18.2mm socket Ba9s connection male faston 6.3mm | | | |

encoders and potentiometers

| | | | |
|---|---|-----------------|--------|
|  | | | |
| GEV No. | 347952 | Ref. No. | 203894 |
| description | cam switch 16 operating positions 3NO sequence 0-16 16A shaft ø 6x4.6mm shaft L 23mm connection male faston 2.8mm incl code pcb cable lengthmm codedOhm plastic | | |
| For models: | 0723104-03, 0723104A03, 0723104B03, 0723105-03, 0723105A03, 0723105B03, 1023101-00, 1023101-01, 1023106-00, 1023106-01, 1023111-00, 1023111-01, 1223101-00, 1223101-01, 1223101-02, 1223103-00, 1223103-01, 1223103-02, 1223106-00, 1223106-01, 1223106-02, 1223111-00, 1223203-03, 1223211-01, 1323101-00, 1323101-01, 1323101-02, 1323103-00, 1323103-01, 1323103-02, 1323103-03, 1323103-04, 1423101-00, 1423101-01, 1423101-02, 1423101A00, 1423101A01, 1423103-00, 1423103-01, 1423103-02, 1423103A00, 1423103A01, 1423104-00, 1423104-01, 1423104-02, 1423104-03, 1423104A00, 1423104A01, 1423104A03... (Other models you can see in the webshop) | | |

| | | | |
|--|--|-----------------|--------|
|  | | | |
| GEV No. | 401968 | Ref. No. | 203733 |
| description | potentiometer with momentary function | | |
| For models: | CCE60, CCE63, CGE11-L, CGE11-R, CGE12-L, CGE12-R, CGE21-L, CGE21-R, CGE22-L, CGE22-R, CGE61-L, CGE61-R, CGE62-L, CGE62-R, CGG11-L, CGG11-R, CGG12-L, CGG12-R, CGG21-L, CGG21-R, CGG22-L, CGG22-R, CGG61-L, CGG61-R, CGG62-L, CGG62-R, CPE60, CPE63, CSE11-L, CSE11-R, CSE12-L, CSE12-R, CSE21-L, CSE21-R, CSE22-L, CSE22-R, CSE61-L, CSE61-R, CSE62-L, CSE62-R, CSG11-L, CSG11-R, CSG12-L, CSG12-R, CSG61-L, CSG61-R, CSG62-L, CSG62-R | | |

lamps

indicator lights

indicator lights 2-piece (lens and indicator lamp)

indicator light lenses

ø10mm (type SRZ-4)

| | | | |
|--|---|-----------------|--------|
|  <p>1</p> | | | |
| GEV No. | 359121 | Ref. No. | 203107 |
| description | indicator light housings mounting measurements ø10mm yellow arrow Qty 1 pcs | | |

indicator lamps for socket type SRZ / SDK / SDY / SFK



| | | | |
|--|--|-----------------|--------|
|  <p>1</p> | | | |
| GEV No. | 359132 | Ref. No. | 203107 |
| description | indicator lamp green 250V connection male faston 6.3mm protection IP54 ambient temperature max. 85°C | | |

indicator lights 3-piece (housing, lens and bulb)

lamps

neon light bulbs

| | | | |
|--|---|-----------------|--------|
|  <p>1</p> | | | |
| GEV No. | 359606 | Ref. No. | 203120 |
| description | neon light bulb socket Ba9s 220V 2W clear ø 10mm L 28mm | | |
| For models: | 1424824-00, 1462802B00, 1462804B00, 2061401-05, 2061401A05, 2061401B05, 2061401C05, 2061402-05, 2061402A05, 2061402B05, 2061402C05, 2061403-00, 2061403-01, 2061403-02, 2061403-03, 20614033-0, 2061403A00, 2061403A02, 2061403A03, 2061403B00, 2061403B02, 2061403B03, 2061403C00, 2061403C02, 2061403C03, 2061404-00, 2061404-01, 2061404-02, 2061404-03, 20614044-0, 2061404A00, 2061404A02, 2061404A03, 2061404B00, 2061404B02, 2061404B03, 2061404C00, 2061404C02, 2061404C03, 2061405-00, 2061405-01, 2061405-02, 2061405B00, 2061405B01, 2061405B02, 2061406-00, 2061406-01, 2061406-02, 2061406B00, 2061406B01... (Other models you can see in the webshop) | | |

| | | | | |
|---|--|--------|-----------------|---|
| accessories for | 359606 | | | |
|  | GEV No. | 359832 | Ref. No. | — |
| | lamp socket mounting measurements ø16.2mm socket Ba9s connection male faston 6.3mm | | | |
|  | GEV No. | 359853 | Ref. No. | — |
| | lamp socket mounting measurements ø18.2mm socket Ba9s connection male faston 6.3mm | | | |

| | | | |
|--|---|-----------------|------------------|
|  <p>1</p> | | | |
| GEV No. | 359603 | Ref. No. | 203106 359106 |
| description | neon light bulb socket E14 380V clear ø 14mm L 30mm | | |
| For models: | 0522101-00 | | |

indicator lights (complete)

ø10mm

with plug-in socket

| | | | |
|--|---------------------------------|-----------------|--------|
|  <p>1</p> | | | |
| GEV No. | 359864 | Ref. No. | 203107 |
| description | indicator light ø 10mm 230V red | | |

ø16mm

with plug-in socket

| | | | |
|--|--|-----------------|--------|
|  <p>1</p> | | | |
| GEV No. | 359094 | Ref. No. | 203711 |
| description | indicator light ø 16mm 400V yellow cable length 200mm cable material silicone wire | | |
| For models: | 00217022-0, 0520302-00, 0520901-00, 0521701-00, 0521701-01, 0521702-00, 0521702-01, 0521702-02, 0521702-03, 0521702-04, 0521702A02, 0521702A03, 0521702A04, 0521702B03, 0521702B04, 0521702C04 | | |

| | | | |
|--|--|-----------------|--------|
|  <p>1</p> | | | |
| GEV No. | 359093 | Ref. No. | 203429 |
| description | indicator light ø 16mm 400V white cable length 200mm cable material silicone wire | | |
| For models: | 0120101-00, 0120101-01, 0120101-02, 0120101-03, 0120101-04, 0120101C00, 0120101D00, 0120101D01, 0120101D02, 0120101D04, 0120105-00, 0120105-01, 0120105-02, 0120105-03, 0120105-04, 0120105C00, 0120105D00, 0120105D01, 0120105D02, 0120105D04, 0520302-00, 0520302-01, 0520302-02, 0520302A00, 0520302A01 | | |

ø22mm

| | | | |
|--|---|-----------------|--------|
|  <p>1</p> | | | |
| GEV No. | 357020 | Ref. No. | 203103 |
| description | indicator light ø 22mm white 230-440V connection screw temp.-resist. 125°C LED | | |
| For models: | 0021130A00, 0021130A01, 0021135A00, 0120201-00, 0120201-01, 0120202-00, 0120202-01, 0120203-00, 0120203-01, 0220301-00, 0220301B00, 0220301B01, 0220301B02, 0220301D00, 0220302-00, 0220302A00, 0220302A01, 0220302A02, 0220302A03, 0220302B00, 0220302B01, 0220302B02, 0220302C00, 0220302C01, 0220302C02, 0220302C03, 0220302D00, 0220302E00, 0220302E01, 0220302F00, 0220302H00, 0220302H01, 0220303-00, 0220303-01, 0220303A00, 0220303A01, 0220303A02, 0220303A03, 0220303B00, 0220303B01, 0220303C00, 0220303C01, 0220303C02, 0220303D00, 0220303D01, 0220303E00, 0220303E01, 0220303H00, 0220303H01, 0220304-00... (Other models you can see in the webshop) | | |



| | | | |
|---|---|-----------------|--------|
|  | | | |
| 1 | | | |
| GEV No. | 357263 | Ref. No. | 203893 |
| description | indicator light ø 22mm white 24V connection male faston 2.8mm plastic | | |
| For models: | 0723104-03, 0723104A03, 0723104B03, 0723105-03, 0723105A03, 0723105B03, 1023101-00, 1023101-01, 1023106-00, 1023106-01, 1023111-00, 1023111-01, 1223101-00, 1223101-01, 1223101-02, 1223103-00, 1223103-01, 1223103-02, 1223106-00, 1223106-01, 1223106-02, 1223111-00, 1223203-03, 1223211-01, 1323101-00, 1323101-01, 1323101-02, 1323103-00, 1323103-01, 1323103-02, 1323106-00, 1323203-02, 1323211-02, 1423101-00, 1423101-01, 1423101-02, 1423101A00, 1423101A01, 1423103-00, 1423103-01, 1423103-02, 1423103A00, 1423103A01, 1423104-00, 1423104-01, 1423104-02, 1423104-03, 1423104A00, 1423104A01, 1423104A03... (Other models you can see in the webshop) | | |

| | | | |
|---|---|-----------------|--------|
|  | | | |
| 1 | | | |
| GEV No. | 357021 | Ref. No. | 203101 |
| description | indicator light ø 22mm yellow 230-440V connection screw temp.-resist. 125°C LED | | |
| For models: | 0220302F00, 0520303-00, 0520303-01, 0520303-02, 1220303I00, 1220303I01, 1220303I02, 14228011-0, 14228022-0, 1422802B04, 1422802B05, 1422802B06, 1422802B07, 1422802B08, 14228033-0, 14228044-0, 1422804B04, 1422804B05, 1422804B06, 1422804B07, 1422804B08, 14228055-0, 1422805B04, 1422805B05, 1422805B06, 1422805B07, 1422805B08, 1422807B00, 1422807B01, 1422807B02, 1422807B03, 1422807B04, 1422831-00, 1422832-00, 1422833-00, 1422834-00, 1422902-00, 1422902-01, 1422902-02, 1422902-03, 1422902-04, 1422908-00, 1422910-00, 2012813-00, 2012907-00, 2012907-01, 2022801-00, 2022801-01, 2022801-02, 2022801-03... (Other models you can see in the webshop) | | |

screw-on/push-on fit

neon light bulbs

| | | | |
|---|---|-----------------|-------------------|
|  | | | |
| 1 | | | |
| GEV No. | 359606 | Ref. No. | 203120 |
| description | neon light bulb socket Ba9s 220V 2W clear ø 10mm L 28mm | | |
| For models: | 1424824-00, 1462802B00, 1462804B00, 2061401-05, 2061401A05, 2061401B05, 2061401C05, 2061402-05, 2061402A05, 2061402B05, 2061402C05, 2061403-00, 2061403-01, 2061403-02, 2061403-03, 20614033-0, 2061403A00, 2061403A02, 2061403A03, 2061403B00, 2061403B02, 2061403B03, 2061403C00, 2061403C02, 2061403C03, 2061404-00, 2061404-01, 2061404-02, 2061404-03, 20614044-0, 2061404A00, 2061404A02, 2061404A03, 2061404B00, 2061404B02, 2061404B03, 2061404C00, 2061404C02, 2061404C03, 2061405-00, 2061405-01, 2061405-02, 2061405B00, 2061405B01, 2061405B02, 2061406-00, 2061406-01, 2061406-02, 2061406B00, 2061406B01... (Other models you can see in the webshop) | | |
| accessories for | 359606 | | |
|  | GEV No. | 359832 | Ref. No. — |
| | lamp socket mounting measurements ø16.2mm socket Ba9s connection male faston 6.3mm | | |
|  | GEV No. | 359853 | Ref. No. — |
| | lamp socket mounting measurements ø18.2mm socket Ba9s connection male faston 6.3mm | | |

| | | | |
|---|---|-----------------|------------------|
|  | | | |
| 1 | | | |
| GEV No. | 359603 | Ref. No. | 203106 359106 |
| description | neon light bulb socket E14 380V clear ø 14mm L 30mm | | |
| For models: | 0522101-00 | | |

halogen lamp

for socket G4 / G6.35 / G9

| | | | |
|--|--|-----------------|--------|
|  | | | |
| 1 | | | |
| GEV No. | 357191 | Ref. No. | 202620 |
| description | halogen lamp socket G4 12V 10W temp.-resist. 300°C OSRAM HALOSTAR OVEN | | |
| For models: | CCE60, CCE63, CGE11-L, CGE11-R, CGE12-L, CGE12-R, CGE21-L, CGE21-R, CGE22-L, CGE22-R, CGE61-L, CGE61-R, CGE62-L, CGE62-R, CGG11-L, CGG11-R, CGG12-L, CGG12-R, CGG21-L, CGG21-R, CGG22-L, CGG22-R, CGG61-L, CGG61-R, CGG62-L, CGG62-R, CPE60, CPE63, CSE11-L, CSE11-R, CSE11-R-DG, CSE12-L, CSE12-R, CSE12-R-DG, CSE21-L, CSE21-R, CSE21-R-DG, CSE22-L, CSE22-R, CSE22-R-DG, CSE61-L, CSE61-R, CSE61-R-DG, CSE62-L, CSE62-R, CSE62-R-DG, CSG11-L, CSG11-R, CSG11-R-DG, CSG12-L... (Other models you can see in the webshop) | | |

| | | | |
|--|--|-----------------|--------|
|  | | | |
| 1 | | | |
| GEV No. | 359599 | Ref. No. | 203679 |
| description | halogen lamp socket G4 12V 20W temp.-resist. 500°C | | |
| For models: | CCE60, CCE63, CGE11-L, CGE11-R, CGE12-L, CGE12-R, CGE21-L, CGE21-R, CGE22-L, CGE22-R, CGE61-L, CGE61-R, CGE62-L, CGE62-R, CGG11-L, CGG11-R, CGG12-L, CGG12-R, CGG21-L, CGG21-R, CGG22-L, CGG22-R, CGG61-L, CGG61-R, CGG62-L, CGG62-R, CPE60, CPE63, CSE11-L, CSE11-R, CSE11-R-DG, CSE12-L, CSE12-R, CSE12-R-DG, CSE21-L, CSE21-R, CSE21-R-DG, CSE22-L, CSE22-R, CSE22-R-DG, CSE61-L, CSE61-R, CSE61-R-DG, CSE62-L, CSE62-R, CSE62-R-DG, CSG11-L, CSG11-R, CSG11-R-DG, CSG12-L... (Other models you can see in the webshop) | | |

oven lamps

producer-specific oven lamps

MKN



1

| | | | |
|------------------------|--|-----------------|-----------------|
| GEV No. | 693050 | Ref. No. | 211128 |
| description | gasket graphite D1 ø 71mm D2 ø 94mm thickness 1mm suitable for MKN Qty 1 pcs | | |
| For models: | CGE11-L, CGE11-R, CGE12-L, CGE12-R, CGE21-L, CGE21-R, CGE22-L, CGE22-R, CGE61-L, CGE61-R, CGE62-L, CGE62-R, CGG11-L, CGG11-R, CGG12-L, CGG12-R, CGG21-L, CGG21-R, CGG22-L, CGG22-R, CGG61-L, CGG61-R, CGG62-L, CGG62-R, CSE11-L, CSE11-R, CSE11-R-DG, CSE12-L, CSE12-R, CSE12-R-DG, CSE21-L, CSE21-R, CSE21-R-DG, CSE22-L, CSE22-R, CSE22-R-DG, CSE61-L, CSE61-R, CSE61-R-DG, CSE62-L, CSE62-R, CSE62-R-DG, CSG11-L, CSG11-R, CSG11-R-DG, CSG12-L, CSG12-R, CSG12-R-DG, CSG21-L, CSG21-R...(Other models you can see in the webshop) | | |
| accessories for | 693050 | | |
| | GEV No. | 694294 | Ref. No. |
| | | | 216115 |
| | glass panel ø 90mm thickness 8mm | | |



1

| | | | |
|------------------------|--|-----------------|-----------------|
| GEV No. | 699482 | Ref. No. | 211146 |
| description | gasket suitable for MKN combi-steamer mounting pos. for lens ED ø 105mm ID ø 71mm graphite thickness 1mm | | |
| For models: | CGE21-L, CGE21-R, CGE22-L, CGE22-R, CGG21-L, CGG21-R, CGG22-L, CGG22-R, CSE11-L, CSE11-R, CSE11-R-DG, CSE12-L, CSE12-R, CSE12-R-DG, CSE21-L, CSE21-R, CSE21-R-DG, CSE22-L, CSE22-R, CSE22-R-DG, CSE61-L, CSE61-R, CSE61-R-DG, CSE62-L, CSE62-R, CSE62-R-DG, CSG11-L, CSG11-R, CSG11-R-DG, CSG12-L, CSG12-R, CSG12-R-DG, CSG21-L, CSG21-R, CSG21-R-DG, CSG22-L, CSG22-R, CSG22-R-DG, CSG61-L, CSG61-R, CSG61-R-DG, CSG62-L, CSG62-R, CSG62-R-DG | | |
| accessories for | 699482 | | |
| | GEV No. | 694294 | Ref. No. |
| | | | 216115 |
| | glass panel ø 90mm thickness 8mm | | |



1

| | | | |
|------------------------|--|-----------------|-----------------|
| GEV No. | 694294 | Ref. No. | 216115 |
| description | glass panel ø 90mm thickness 8mm | | |
| For models: | CGE11-L, CGE11-R, CGE12-L, CGE12-R, CGE21-L, CGE21-R, CGE22-L, CGE22-R, CGE61-L, CGE61-R, CGE62-L, CGE62-R, CGG11-L, CGG11-R, CGG12-L, CGG12-R, CGG21-L, CGG21-R, CGG22-L, CGG22-R, CGG61-L, CGG61-R, CGG62-L, CGG62-R, CSE11-L, CSE11-R, CSE11-R-DG, CSE12-L, CSE12-R, CSE12-R-DG, CSE21-L, CSE21-R, CSE21-R-DG, CSE22-L, CSE22-R, CSE22-R-DG, CSE61-L, CSE61-R, CSE61-R-DG, CSE62-L, CSE62-R, CSE62-R-DG, CSG11-L, CSG11-R, CSG11-R-DG, CSG12-L, CSG12-R, CSG12-R-DG, CSG21-L, CSG21-R...(Other models you can see in the webshop) | | |
| accessories for | 694294 | | |
| | GEV No. | 693050 | Ref. No. |
| | | | 211128 |
| | gasket graphite D1 ø 71mm D2 ø 94mm thickness 1mm suitable for MKN Qty 1 pcs | | |

| | | | |
|------------------------|--|--------|-----------------|
| accessories for | 694294 | | |
| | GEV No. | 699482 | Ref. No. |
| | | | 211146 |
| | gasket suitable for MKN combi-steamer mounting pos. for lens ED ø 105mm ID ø 71mm graphite thickness 1mm | | |



1

| | | | |
|--------------------|---|-----------------|--------|
| GEV No. | 357184 | Ref. No. | 203678 |
| description | lamp socket socket G4 cable length 130mm connection male faston 6.3mm ø 17mm H 9mm mounting distance 12mm mounting thread M3 Qty 1 pcs | | |
| For models: | CCE60, CCE63, CGE11-L, CGE11-R, CGE12-L, CGE12-R, CGE21-L, CGE21-R, CGE22-L, CGE22-R, CGE61-L, CGE61-R, CGE62-L, CGE62-R, CGG11-L, CGG11-R, CGG12-L, CGG12-R, CGG21-L, CGG21-R, CGG22-L, CGG22-R, CGG61-L, CGG61-R, CGG62-L, CGG62-R, CPE60, CPE63, CSE11-L, CSE11-R, CSE11-R-DG, CSE12-L, CSE12-R, CSE12-R-DG, CSE21-L, CSE21-R, CSE21-R-DG, CSE22-L, CSE22-R, CSE22-R-DG, CSE61-L, CSE61-R, CSE61-R-DG, CSE62-L, CSE62-R, CSE62-R-DG, CSG11-L, CSG11-R, CSG11-R-DG, CSG12-L...(Other models you can see in the webshop) | | |

lamps

halogen lamps

for socket G4 / G6.35 / G9



1

| | | | |
|--------------------|---|-----------------|--------|
| GEV No. | 357191 | Ref. No. | 202620 |
| description | halogen lamp socket G4 12V 10W temp.-resist. 300°C OSRAM HALOSTAR OVEN | | |
| For models: | CCE60, CCE63, CGE11-L, CGE11-R, CGE12-L, CGE12-R, CGE21-L, CGE21-R, CGE22-L, CGE22-R, CGE61-L, CGE61-R, CGE62-L, CGE62-R, CGG11-L, CGG11-R, CGG12-L, CGG12-R, CGG21-L, CGG21-R, CGG22-L, CGG22-R, CGG61-L, CGG61-R, CGG62-L, CGG62-R, CPE60, CPE63, CSE11-L, CSE11-R, CSE11-R-DG, CSE12-L, CSE12-R, CSE12-R-DG, CSE21-L, CSE21-R, CSE21-R-DG, CSE22-L, CSE22-R, CSE22-R-DG, CSE61-L, CSE61-R, CSE61-R-DG, CSE62-L, CSE62-R, CSE62-R-DG, CSG11-L, CSG11-R, CSG11-R-DG, CSG12-L...(Other models you can see in the webshop) | | |



1

| | | | |
|--------------------|---|-----------------|--------|
| GEV No. | 359599 | Ref. No. | 203679 |
| description | halogen lamp socket G4 12V 20W temp.-resist. 500°C | | |
| For models: | CCE60, CCE63, CGE11-L, CGE11-R, CGE12-L, CGE12-R, CGE21-L, CGE21-R, CGE22-L, CGE22-R, CGE61-L, CGE61-R, CGE62-L, CGE62-R, CGG11-L, CGG11-R, CGG12-L, CGG12-R, CGG21-L, CGG21-R, CGG22-L, CGG22-R, CGG61-L, CGG61-R, CGG62-L, CGG62-R, CPE60, CPE63, CSE11-L, CSE11-R, CSE11-R-DG, CSE12-L, CSE12-R, CSE12-R-DG, CSE21-L, CSE21-R, CSE21-R-DG, CSE22-L, CSE22-R, CSE22-R-DG, CSE61-L, CSE61-R, CSE61-R-DG, CSE62-L, CSE62-R, CSE62-R-DG, CSG11-L, CSG11-R, CSG11-R-DG, CSG12-L...(Other models you can see in the webshop) | | |



timers

digital timers



| | | | |
|--------------------|--|-----------------|--------|
| 1 | | | |
| GEV No. | 381461 | Ref. No. | 203383 |
| description | digital switch clock STÖRK-TRONIK ST64-31.07HF time range 0-999h 230 16A 1NO mounting measurements 60mm display 3 digits built-in depth 62mm | | |
| For models: | 2021115-00, 2021115-01, 2021115-02, 2021115-03, 2021115-04, 2221115-00, 2221115-01 | | |



| | | | |
|--------------------|--|-----------------|------------------|
| 1 | | | |
| GEV No. | 360347 | Ref. No. | 203237 845436 |
| description | timer electronic 15min | | |
| For models: | 0220302A03, 0220302C03, 0220302H01, 0220303A03, 0220303C02, 0220303H01 | | |



| | | | |
|--------------------|---|-----------------|--------|
| 1 | | | |
| GEV No. | 360348 | Ref. No. | 203324 |
| description | timer electronic 15min | | |
| For models: | 0220302A03, 0220302C03, 0220302H01, 0220303A03, 0220303C02, 0220303H01, 1220303A00, 1220303A01, 1220303A02, 1220303A03, 1220303C00, 1220303C01, 1220303C02, 1220303C03, 1220303F01, 1220303F02, 1220303F03, 1220303H00, 1220303H01, 1220303H02, 1220303H03, 1220305A00, 1220305A01, 1220305A02, 1220305A03, 1220305A04, 1220305A05, 1220305C00, 1220305C01, 1220305C02, 1220305C03, 1220305C04, 1220305C05, 1220305F01, 1220305F02, 1220305F03, 1220305F04, 1220305F05, 1220305H00, 1220305H01, 1220305H02, 1220305H03, 1220305H04, 1220305H05, 1320303A00, 1320303A01, 1320303A02, 1320303C00, 1320303C01, 1320303C02... (Other models you can see in the webshop) | | |

alarm devices

buzzers



| | | | |
|--------------------|---|-----------------|--------|
| 1 | | | |
| GEV No. | 350050 | Ref. No. | 203325 |
| description | buzzer 230VAC connection male faston 6.3mm screw mounting thread M4 60dB | | |
| For models: | 0220302A00, 0220302A01, 0220302C00, 0220302C01, 0220303A00, 0220303A01, 0220303C00, 0220304-00, 0220305-00, 0220306-00, 0720332P00, 0720332R00, 0720332T00, 0720332V00, 1420332P01, 1420332P02, 1420332P03, 1420332R00, 1420332R01, 1420332R02, 1420332R03, 1420332T01, 1420332T02, 1420332T03, 1420332V01, 1420332V02, 1420332V03, 1420333P01, 1420333P02, 1420333R00, 1420333R01, 1420333R02, 1420333T01, 1420333T02, 1420333V01, 1420333V02, 1420334P00, 1420334P01, 1420334P02, 1420334P03, 1420334P04, 1420334R02, 1420334R03, 1420334R04, 1420334T02, 1420334T03, 1420334T04, 1420334V01, 1420334V02, 1420334V03... (Other models you can see in the webshop) | | |



| | | | |
|--------------------|--|-----------------|--------|
| 1 | | | |
| GEV No. | 350221 | Ref. No. | 202775 |
| description | buzzer 5-28VDC connection F6.3 mounting ø 40mm | | |
| For models: | CSE61-L, CSE61-R, CSE61-R-DG, CSE62-L, CSE62-R, CSE62-R-DG | | |

contactors

MOELLER/EATON

power contactors



| | | | |
|--------------------|---|-----------------|--------|
| 1 | | | |
| GEV No. | 380492 | Ref. No. | 203203 |
| description | contactor resistive load 35A 230VAC main contacts 3NO | | |
| For models: | 0220302H00, 0220302H01, 0220303B01, 0220303C01, 0220303C02, 0220303E01, 0220303H00, 0220303H01, 0723105-03, 0723105A03, 0723105B03, 1220305B02, 1220305B03, 1220305B04, 1220305C00, 1220305C01, 1220305C02, 1220305C03, 1220305C04, 1220305C05, 1220305E00, 1220305E01, 1220305E02, 1220305E03, 1220305E04, 1220305H00, 1220305H01, 1220305H02, 1220305H03, 1220305H04, 1220305H05, 1220305K00, 1220330B00, 1220330B01, 1320305B02, 1320305B03, 1320305C00, 1320305C01, 1320305C02, 1320305C03, 1320305E00, 1320305E01, 1320305E02, 1320305E03, 1320305E04, 1320305E05, 1320305H00, 1320305H01, 1320305H02, 1320305H03... (Other models you can see in the webshop) | | |



1

| | | | |
|--------------------|---|-----------------|--------|
| GEV No. | 380493 | Ref. No. | 203206 |
| description | contactor resistive load 55A 230VAC main contacts 3NO | | |
| For models: | 0220303B00, 0220303B01, 0220303C00, 0220303C01, 0220303C02, 0220303E00, 0220303E01, 0220306-00, 14228044-0, 14228055-0, 2020314-01, 2020314A01, 2020315-01, 2020315A01, 2022804-00, 2022804-01, 20228044-0, 20228044-1, 2022804A00, 2022804A01, 2022804B00, 2022804B01, 2022804C00, 2022804C01, 2022805-00, 2022805-01, 20228055-0, 20228055-1, 2022805A00, 2022805A01, 2022805B00, 2022805B01, 2022805C00, 2022805C01, 2022807-00, 20228077-0, 20228077-1, 2022807A00, 2022807B00, 2022807B01, 2022807B02, 2022807C00, 2022807C01, 2022807C02, 2023007-00, 20230077-0, 20230077-1, 2023007A00, 2023007B00, 2023007C00... (Other models you can see in the webshop) | | |



1

| | | | |
|--------------------|--|-----------------|--------|
| GEV No. | 380167 | Ref. No. | 203209 |
| description | power contactor resistive load 66A 230VAC (AC3/400V) 50A/22kW main contacts 3NO auxiliary contacts 1NO connection screw connection type DILM 50 | | |
| For models: | 2022901-00, 20229011-0, 20229011-1, 2022901A00, 2022901B00, 2022901B01, 2022901B02, 2022901C00, 2022901C01, 2022901C02, 2023009-00, 20230099-0, 20230099-1, 2023009A00, 2023009B00, 2023009C00, 2023010-00, 20230100-0, 20230100-1, 2023010A00, 2023010B00, 2023010C00, 2022901B01, 3022901C01, 3022901C00, 3022901C01, 3023009-00, 3023009A00, 3023009B00, 3023009C00, 3023010-00, 3023010A00, 3023010B00, 3023010C00 | | |



1

| | | | |
|--------------------|---|-----------------|--------|
| GEV No. | 380497 | Ref. No. | 203026 |
| description | power contactor resistive load 20A 230VAC (AC3/400V) 9A/4kW main contacts 4NO auxiliary contacts connection screw connection type DILEM 4 | | |
| For models: | 0120101-01, 0120101-02, 0120101-03, 0120101-04, 0120101D00, 0120101D01, 0120101D02, 0120101D04, 0120105-01, 0120105-02, 0120105-03, 0120105-04, 0120105D00, 0120105D01, 0120105D02, 0120105D04, 0220301B02, 0220302B02, 0220302C02, 0220302C03, 0220302E01, 0220303-01, 0220303A02, 0220303A03, 0220303D01, 0520302-01, 0520302-02, 0520302A00, 0520302A01, 0520303-01, 0520303-02, 1220301-00, 1220301-01, 1220301-02, 1220301-03, 1220301-04, 1220301B00, 1220301B01, 1220301B02, 1220301B03, 1220301B04, 1220301D00, 1220301D01, 1220301E00, 1220301E01, 1220301J00, 1220301J01, 1220301J02, 1220301J03, 1220303-00... (Other models you can see in the webshop) | | |

auxiliary contacts



1

| | | | |
|--------------------|---|-----------------|--------|
| GEV No. | 381113 | Ref. No. | 203213 |
| description | auxiliary contact contacts 2NO AC15 4A for contactors DILM(C)7-32 connection screw type DILA-XHI20 | | |
| For models: | 1422804B04, 1422804B05, 1422804B06, 1422804B07, 1422804B08, 1422805B04, 1422805B05, 1422805B06, 1422805B07, 1422805B08, 1422807B00, 1422807B01, 1422807B02, 1422807B03, 1422807B04, 1422902-00, 1422902-01, 1422902-02, 1422902-03, 1422902-04, 2022804B04, 2022804B05, 2022804B06, 2022804B07, 2022804B08, 2022804B09, 2022804B10, 2022804C07, 2022804C08, 2022804C09, 2022804C10, 2022804D00, 2022804D01, 2022804D02, 2022805B04, 2022805B05, 2022805B06, 2022805B07, 2022805B08, 2022805B09, 2022805B10, 2022805C07, 2022805C08, 2022805C09, 2022805C10, 2022805D00, 2022805D01, 2022807B03, 2022807B04, 2022807B05... (Other models you can see in the webshop) | | |



1

| | | | |
|--------------------|---|-----------------|--------|
| GEV No. | 381197 | Ref. No. | 203432 |
| description | power contactor resistive load 20A 400VAC (AC3/400V) 9A/4kW main contacts 4NO auxiliary contacts connection screw connection type DILEM 4 | | |
| For models: | 0721172A01, 0721173A01, 0721174A01, 0721175A01, 0723105-03, 0723105A03, 0723105B03, 1221156A00, 1421143B01, 1421144B01, 1421145B01, 1421149B00, 1421149B01, 1421150B00, 1421150B01, 1421151B00, 1421151B01, 1421155B02, 1421156B02, 1421157B02, 1421158A00, 1421158B00, 1421158B01, 1421158B02, 1421159A00, 1421159B00, 1421159B01, 1421159B02, 1421160A00, 1421160B00, 1421160B01, 1421160B02, 1421164B01, 1421165B01, 1421166B01, 1421167B02, 1421168B02, 1421169B02, 1421176B00, 1421177B00, 1421178B00, 1422513B00, 1422513B01, 1422515B01, 1422515B02, 1423103-02, 1423103A01, 1423105-02, 1423105-03, 1423105A01... (Other models you can see in the webshop) | | |

TELEMECANIQUE (Schneider Electric)

power contactors



1

| | | | |
|--------------------|--|-----------------|--------|
| GEV No. | 381484 | Ref. No. | 203986 |
| description | power contactor resistive load 125A 230 (AC3/400V) 37kW main contacts 3NO auxiliary contacts 1NO/1NC connection screw type LC1D80116 | | |
| For models: | CGE11-L, CGE11-R, CGE22-L, CGE22-R, CGE61-L, CGE61-R, CSE11-L, CSE11-R, CSE22-L, CSE22-R, CSE22-R-DG, CSE61-L, CSE61-R | | |



1

| | | | |
|--------------------|---|-----------------|--------|
| GEV No. | 381486 | Ref. No. | 203971 |
| description | power contactor resistive load 20A (AC3/400V) 4kW main contacts 2x3NO auxiliary contacts 2x1NO connection screw type LC2K0910P7 | | |
| For models: | CGE11-L, CGE11-R, CGE21-L, CGE21-R, CGE61-L, CGE61-R, CPE63, CSE11-L, CSE11-R, CSE11-R-DG, CSE12-L, CSE12-R, CSE12-R-DG, CSE21-L, CSE21-R, CSE21-R-DG, CSE22-L, CSE22-R, CSE22-R-DG, CSE61-L, CSE61-R, CSE61-R-DG, CSE62-L, CSE62-R, CSE62-R-DG | | |



1

| | | | |
|--------------------|---|-----------------|--------|
| GEV No. | 380965 | Ref. No. | 203744 |
| description | power contactor resistive load 20A 230VAC (AC3/400V) 6A/2.2kW main contacts 3NO auxiliary contacts 1NO connection screw connection type LC1K0610P7+ | | |
| For models: | 0720325-03, 0720325-04, 0720325B03, 0720325B04, 0721134-01, 0721134A01, 1022603-00, 1220327-00, 1220327-01, 1220327B01, 1220329-00, 1220329-01, 1220402-00, 1220402-01, 1221103-04, 1221103B04, 1221130J00, 1221135A04, 1221135J00, 1221136A04, 1221141-00, 1221141A00, 1222507-00, 1222509-00, 1222603-00, 1320323-00, 1320323B00, 1320327-00, 1320327A00, 1320327A01, 1320327A02, 1320327B00, 1320327C00, 1320327C01, 1320327C02, 1320329-00, 1320329-01, 1320329A00, 1320329A01, 1320329A02, 1320335C00, 1320402-00, 1320402-01, 1321130-00, 1321130A00, 1321131-00, 1321131A00, 1321135A03, 1321136A03, 1321141-00... (Other models you can see in the webshop) | | |



1

| | | | |
|--------------------|--|-----------------|--------|
| GEV No. | 380479 | Ref. No. | 203676 |
| description | power contactor resistive load 25A 230VAC (AC3/400V) 9A/4kW main contacts 3NO auxiliary contacts 1NO/1NC connection screw connection type LC1D09P7 | | |
| For models: | CGE11-L, CGE11-R, CGE21-L, CGE21-R, CGE61-L, CGE61-R, CSE11-L, CSE11-R, CSE21-L, CSE21-R, CSE61-L, CSE61-R | | |



1

| | | | |
|--------------------|---|-----------------|--------|
| GEV No. | 380976 | Ref. No. | 203675 |
| description | power contactor resistive load 32A 230VAC (AC3/400V) 18A/7.5kW main contacts 3NO auxiliary contacts 1NO/1NC connection screw connection | | |
| For models: | 0720332P00, 0720332R00, 0720332T00, 0720332V00, 1220305B05, 1220305B06, 1220305B07, 1220305K01, 1220305K02, 1220305K03, 1220329B00, 1220329B01, 1320329B00, 1320329B01, 1320329C00, 1320329C01, 1320329C02, 1420329B00, 1420329B01, 1420329C00, 1420329C01, 1420332P01, 1420332P02, 1420332P03, 1420332R00, 1420332R01, 1420332R02, 1420332R03, 1420332T01, 1420332T02, 1420332T03, 1420332V01, 1420332V02, 1420332V03, 1420333P01, 1420333P02, 1420333R00, 1420333R01, 1420333R02, 1420333T01, 1420333T02, 1420333V01, 1420333V02, 1420334P00, 1420334P01, 1420334P02, 1420334P03, 1420334P04, 1420334R02, 1420334R03... (Other models you can see in the webshop) | | |



1

| | | | |
|--------------------|---|-----------------|--------|
| GEV No. | 380980 | Ref. No. | 203985 |
| description | power contactor resistive load 50A 230VAC (AC3/400V) 32A/15kW main contacts 3NO auxiliary contacts 1NO/1NC connection screw connection type LC1D32P7 | | |
| For models: | 1420334T02, 1420334T03, 1420334T04, 1420334V01, 1420334V02, 1420334V03, 1420334V04, 1420334W02, 1420334W03, 1420334W04, 1420334Y02, 1420334Y03, 1420334Y04, 1520334T03, 1520334T04, 1520334T05, 1520334V02, 1520334V03, 1520334V04, 1520334V05, 1520334W03, 1520334W04, 1520334W05, 1520334Y03, 1520334Y04, 1520334Y05, 2020334T00, 2020334T01, 2020334V00, 2020334V01, 2020346V00, 2020349V00, 2020349V01, 2020349V02, 2020349V03, 2022909-02, 2220334T00, 2220334T01, 2220334T02, 2220334T03, 2220334T04, 2220334V01, 2220334V02, 2220334V03, 2220334V04, 2420334T00, 2420334T01, 2420334T02, 2420334T03, 2420334V00... (Other models you can see in the webshop) | | |



TRIPUS (Eichhoff)

small relay switches



| | | | |
|--------------------|---|-----------------|--------|
| 1 | | | |
| GEV No. | 380121 | Ref. No. | 203219 |
| description | small relay switch 230V main contacts 3NO/1NC auxiliary contacts knob ø70mm (227-piece) connection Faston 6.3mm type E3250 resistive load 16A | | |
| For models: | 0221501-00, 0221502-00, 1421501-00, 1421502-00, 1421503-00, 1421504-00, 2121501-00, 2121502-00 | | |

miscellaneous

accessories



| | | | |
|--------------------|---|-----------------|--------|
| 1 | | | |
| GEV No. | 550875 | Ref. No. | 203225 |
| description | jumper for auxiliary contact | | |
| For models: | 0120101-01, 0120101-02, 0120101-03, 0120101-04, 0120101D00, 0120101D01, 0120101D02, 0120101D04, 0120105-01, 0120105-02, 0120105-03, 0120105-04, 0120105D00, 0120105D01, 0120105D02, 0120105D04, 0520302-01, 0520302-02, 0520302A00, 0520302A01, 1320401-01, 1420401-01, 1422804B04, 1422804B05, 1422804B06, 1422804B07, 1422804B08, 1422805B04, 1422805B05, 1422805B06, 1422805B07, 1422805B08, 1422807B00, 1422807B01, 1422807B02, 1422807B03, 1422807B04, 1422902-00, 1422902-01, 1422902-02, 1422902-03, 1422902-04, 2020401-01, 2021115-00, 2021115-01, 2021115-02, 2021115-03, 2021115-04, 2022804B04, 2022804B05... (Other models you can see in the webshop) | | |

power contactors



| | | | |
|--------------------|---|-----------------|--------|
| 1 | | | |
| GEV No. | 380165 | Ref. No. | 203423 |
| description | power contactor | | |
| For models: | 1422701-00, 1422702-00, 1422802B04, 1422802B05, 1422802B06, 1422802B07, 1422802B08, 1422804B04, 1422804B05, 1422804B06, 1422804B07, 1422804B08, 1422805B04, 1422805B05, 1422805B06, 1422805B07, 1422805B08, 1422807B00, 1422807B01, 1422807B02, 1422807B03, 1422807B04, 1422831-00, 1422832-00, 1422833-00, 1422834-00, 1422902-00, 1422902-01, 1422902-02, 1422902-03, 1422902-04, 1422908-00, 1422910-00, 1423901-00, 1423901-01, 1423901-02, 1423902-00, 1423902-01, 1423902-02, 1423903-00, 1423903-01, 1423903-02, 2020308-00, 2021123A00, 2021411-00, 2021412C00, 2021413-00, 2021413B00, 2021414C00, 2021417-00... (Other models you can see in the webshop) | | |

solid state relays

CROUZET



| | | | |
|--------------------|--|-----------------|--------|
| 1 | | | |
| GEV No. | 403534 | Ref. No. | 203668 |
| description | solid state relay CROUZET 1 phase 100A 48-660V 4-32VDC L 58mm W 49mm new edition screw type 84137140 | | |
| For models: | CCE60, CCE63, CGE11-L, CGE11-R, CGE12-L, CGE12-R, CGE21-L, CGE21-R, CGE22-L, CGE22-R, CGE61-L, CGE61-R, CGE62-L, CGE62-R, CPE60, CPE63, CSE11-L, CSE11-R, CSE11-R-DG, CSE12-L, CSE12-R, CSE12-R-DG, CSE21-L, CSE21-R, CSE21-R-DG, CSE22-L, CSE22-R, CSE22-R-DG, CSE61-L, CSE61-R, CSE61-R-DG, CSE62-L, CSE62-R, CSE62-R-DG | | |



| | | | |
|--------------------|--|-----------------|--------|
| 1 | | | |
| GEV No. | 403535 | Ref. No. | 203669 |
| description | solid state relay CROUZET 1 phase 10A 24-280V 90-280VAC L 58mm W 49mm new edition screw type 84137001 | | |
| For models: | CGE11-L, CGE11-R, CGE12-L, CGE12-R, CGE21-L, CGE21-R, CGE22-L, CGE22-R, CGE61-L, CGE61-R, CGE62-L, CGE62-R, CGG11-L, CGG11-R, CGG12-L, CGG12-R, CGG21-L, CGG21-R, CGG22-L, CGG22-R, CGG61-L, CGG61-R, CGG62-L, CGG62-R, CSE11-L, CSE11-R, CSE12-L, CSE12-R, CSE21-L, CSE21-R, CSE22-L, CSE22-R, CSE61-L, CSE61-R, CSE62-L, CSE62-R, CSG11-L, CSG11-R, CSG11-R-DG, CSG12-L, CSG12-R, CSG12-R-DG, CSG21-L, CSG21-R, CSG22-L, CSG22-R, CSG61-L, CSG61-R | | |

heat-conducting foils



| | | | |
|--------------------|---|-----------------|--------|
| 1 | | | |
| GEV No. | 401676 | Ref. No. | 203671 |
| description | heat-conducting foil L 57mm W 45mm | | |
| For models: | CGE11-L, CGE11-R, CGE12-L, CGE12-R, CGE21-L, CGE21-R, CGE22-L, CGE22-R, CGE61-L, CGE61-R, CGE62-L, CGE62-R, CGG11-L, CGG11-R, CGG12-L, CGG12-R, CGG21-L, CGG21-R, CGG22-L, CGG22-R, CGG61-L, CGG61-R, CGG62-L, CGG62-R, CPE63, CSE11-L, CSE11-R, CSE11-R-DG, CSE12-L, CSE12-R, CSE21-L, CSE21-R, CSE22-L, CSE22-R, CSE61-L, CSE61-R, CSE61-R-DG, CSE62-L, CSE62-R, CSG11-L, CSG11-R, CSG12-L, CSG12-R, CSG21-L, CSG21-R, CSG22-L, CSG22-R, CSG61-L, CSG61-R | | |



relays

flasher relays



1

| GEV No. | 380392 | Ref. No. | 203308 |
|-------------|--|----------|--------|
| description | flasher relay 230V | | |
| For models: | 0220302A00, 0220302A01, 0220302A02, 0220302A03, 0220302C00, 0220302C01, 0220302C02, 0220302C03, 0220302H00, 0220302H01, 0220303A00, 0220303A01, 0220303A02, 0220303A03, 0220303C00, 0220303C01, 0220303C02, 0220304-00, 0220305-00, 0220306-00, 1220303A00, 1220303A01, 1220303A02, 1220303C00, 1220303C01, 1220303C02, 1220303F01, 1220303F02, 1220303H00, 1220303H01, 1220303H02, 1220305A00, 1220305A01, 1220305A02, 1220305A03, 1220305C00, 1220305C01, 1220305C02, 1220305C03, 1220305F01, 1220305F02, 1220305F03, 1220305H00, 1220305H01, 1220305H02, 1220305H03, 1320303A00, 1320303A01, 1320303A02, 1320303C00... (Other models you can see in the webshop) | | |

power relays

with special fixing



1

| GEV No. | 380441 | Ref. No. | 202732 |
|-------------|--|----------|--------|
| description | power relays SCHRACK 230VAC 16A 2NO connection coded plug manuf. no. 0419 110301 00 2-pole | | |
| For models: | 0521702B03, 0521702B04, 0521704-07, 1221134A01 | | |

level relays

GICAR



1

| GEV No. | 400017 | Ref. No. | 203063 |
|-------------|---|----------|--------|
| description | level relay 230V voltage AC 50/60Hz 11-pole 50/60A connection plug-in connection round 11-pole type RL30/1E/2C/11 | | |

miscellaneous



1

| GEV No. | 380495 | Ref. No. | 203419 |
|-------------|--|----------|--------|
| description | level relay 220-240V type RM4 LA32M | | |
| For models: | 1422802B04, 1422802B05, 1422802B06, 1422802B07, 1422802B08, 1422804B04, 1422804B05, 1422804B06, 1422804B07, 1422804B08, 1422805B04, 1422805B05, 1422805B06, 1422805B07, 1422805B08, 1422807B00, 1422807B01, 1422807B02, 1422807B03, 1422807B04, 1422902-00, 1422902-01, 1422902-02, 1422902-03, 1422902-04, 1462802B00, 1462802B01, 1462802B02, 1462802B03, 1462802B04, 1462802B05, 1462804B00, 1462804B01, 1462804B02, 1462804B03, 1462804B04, 1462804B05, 1462831-00, 1462832-00, 1462835-00, 1462836-00, 1462837-00, 1462908-00, 2022802B04, 2022802B05, 2022802B06, 2022802B07, 2022802B08, 2022802B09, 2022802B10... (Other models you can see in the webshop) | | |



1

| GEV No. | 400068 | Ref. No. | 203175 |
|-------------|--|----------|--------|
| description | level relay 230V voltage AC type 75.03000.050 | | |
| For models: | 2022801-02, 2022801-03, 2022801A02, 2022801A03, 2022801B02, 2022801B03, 2022801C02, 2022801C03, 2022802-02, 2022802-03, 2022802A02, 2022802A03, 2022802B02, 2022802B03, 2022802C02, 2022802C03, 2022803-02, 2022803-03, 2022803A02, 2022803A03, 2022803B02, 2022803B03, 2022803C02, 2022803C03, 2022804-02, 2022804-03, 2022804A02, 2022804A03, 2022804B02, 2022804B03, 2022804C02, 2022804C03, 2022805-02, 2022805-03, 2022805A02, 2022805A03, 2022805B02, 2022805B03, 2022805C02, 2022805C03, 2062801-01, 2062801-02, 2062801-03, 2062801-04, 2062801-05, 2062801-06, 2062801A01, 2062801A02, 2062801A03, 2062801A04... (Other models you can see in the webshop) | | |

time relays

time relays



1

| | | | |
|--------------------|---|-----------------|--------|
| GEV No. | 381092 | Ref. No. | 203437 |
| description | time relay 0.05s-100h | | |
| For models: | 1462802B01, 1462802B02, 1462802B03, 1462802B04, 1462802B05, 1462804B01, 1462804B02, 1462804B03, 1462804B04, 1462804B05, 2012828-00, 2012828-01, 2012828-02, 2012828-03, 2012828-04, 2012828-05, 2012829-00, 2012829-01, 2012829-02, 2022828-01, 2022828-02, 2022828-03, 2022828-04, 2022828-05, 2022828-06, 2023003B01, 2023003B02, 2023003B03, 2023003B04, 2023003B05, 2023003B06, 2023003B07, 2023004B01, 2023004B02, 2023004B03, 2023004B04, 2023004B05, 2023004B06, 2023004B07, 2023007B01, 2023007B02, 2023007B03, 2023007B04, 2023007B05, 2023007B06, 2023007B07, 2023008B01, 2023008B02, 2023008B03, 2023008B04... (Other models you can see in the webshop) | | |

miscellaneous



1

| | | | |
|--------------------|---|-----------------|--------|
| GEV No. | 381093 | Ref. No. | 203753 |
| description | power relays 1CO 230V voltage AC/DC 0.0001-6A connection screw clamp DIN rail | | |
| For models: | 0720332P00, 0720332R00, 0720332T00, 0720332V00, 1420332P01, 1420332P02, 1420332P03, 1420332R00, 1420332R01, 1420332R02, 1420332R03, 1420332T01, 1420332T02, 1420332T03, 1420332V01, 1420332V02, 1420332V03, 1420333P01, 1420333P02, 1420333R00, 1420333R01, 1420333R02, 1420333T01, 1420333T02, 1420333V01, 1420333V02, 1420334P00, 1420334P01, 1420334P02, 1420334P03, 1420334P04, 1420334R02, 1420334R03, 1420334R04, 1420334T02, 1420334T03, 1420334T04, 1420334V01, 1420334V02, 1420334V03, 1420334V04, 1420334W02, 1420334W03, 1420334W04, 1420334Y02, 1420334Y03, 1420334Y04, 1420344R00, 1420344R01, 1420344R02... (Other models you can see in the webshop) | | |



1

| | | | |
|--------------------|---|-----------------|--------|
| GEV No. | 381465 | Ref. No. | 203735 |
| description | remote control module 440V capacity 47nF 3x2MOhm DIN rail | | |
| For models: | CCE60, CCE63, CGE11-L, CGE11-R, CGE12-L, CGE12-R, CGE21-L, CGE21-R, CGE22-L, CGE22-R, CGE61-L, CGE61-R, CGE62-L, CGE62-R, CGG11-L, CGG11-R, CGG12-L, CGG12-R, CGG61-L, CGG61-R, CGG62-L, CGG62-R, CPE60, CPE63, CSE11-L, CSE11-R, CSE11-R-DG, CSE12-L, CSE12-R, CSE12-R-DG, CSE21-L, CSE21-R, CSE21-R-DG, CSE22-L, CSE22-R, CSE22-R-DG, CSE61-L, CSE61-R, CSE61-R-DG, CSE62-L, CSE62-R, CSE62-R-DG, CSG11-L, CSG11-R, CSG11-R-DG, CSG12-L, CSG12-R, CSG12-R-DG, CSG21-L, CSG21-R... (Other models you can see in the webshop) | | |

transformers

open transformers

with clamp terminal



1

| | | | |
|--------------------|--|-----------------|--------|
| GEV No. | 403900 | Ref. No. | 202604 |
| description | control transformer primary 208-600VAC secondary 2x115VAC 460VA secondary 2A H 133mm L 150mm W 112mm 50/60Hz type EI 150N/49/F | | |
| For models: | CSE61-L, CSE61-R, CSE61-R-DG, CSE62-L, CSE62-R, CSE62-R-DG | | |



1

| | | | |
|--------------------|--|-----------------|----------|
| GEV No. | 403875 | Ref. No. | 10015147 |
| description | transformer 750VA H 143mm L 110mm W 150mm connection grip connection 50-60Hz | | |



1

| | | | |
|--------------------|---|-----------------|-------------------------|
| GEV No. | 403303 | Ref. No. | 202608 202608+202725 |
| description | transformer primary 110-250VAC secondary 230VAC 100VA connection plug 50/60Hz | | |
| For models: | CGE11-L, CGE11-R, CGE12-L, CGE12-R, CGE21-L, CGE21-R, CGE22-L, CGE22-R, CGE61-L, CGE61-R, CGE62-L, CGE62-R, CGG11-L, CGG11-R, CGG12-L, CGG12-R, CGG21-L, CGG21-R, CGG22-L, CGG22-R, CGG61-L, CGG61-R, CGG62-L, CGG62-R, CSE11-L, CSE11-R, CSE11-R-DG, CSE12-L, CSE12-R, CSE12-R-DG, CSE21-L, CSE21-R, CSE21-R-DG, CSE22-L, CSE22-R, CSE22-R-DG, CSE61-L, CSE61-R, CSE61-R-DG, CSE62-L, CSE62-R, CSE62-R-DG, CSG11-L, CSG11-R, CSG11-R-DG, CSG12-L, CSG12-R, CSG12-R-DG, CSG21-L, CSG21-R... (Other models you can see in the webshop) | | |



1

| | | | |
|--------------------|--|-----------------|--------|
| GEV No. | 400791 | Ref. No. | 203999 |
| description | transformer primary 120/200/220/230V secondary 24V 108VA 50/60Hz | | |
| For models: | CGG11-L, CGG11-R, CGG12-L, CGG12-R, CGG21-L, CGG21-R, CGG22-L, CGG22-R, CGG61-L, CGG61-R, CGG62-L, CGG62-R, CSG11-L, CSG11-R, CSG11-R-DG, CSG12-L, CSG12-R, CSG12-R-DG, CSG21-L, CSG21-R, CSG21-R-DG, CSG22-L, CSG22-R, CSG22-R-DG, CSG61-L, CSG61-R, CSG61-R-DG, CSG62-L, CSG62-R, CSG62-R-DG | | |

with plug connection



1

| | | | |
|--------------------|---|-----------------|----------|
| GEV No. | 403845 | Ref. No. | 10013658 |
| description | transformer primary 110-250VAC secondary 18VAC 100VA H 103mm L 80mm W 100mm connection plug 50/60Hz for combi-steamer | | |



1

| | | | |
|--------------------|---|-----------------|--------|
| GEV No. | 400792 | Ref. No. | 203818 |
| description | transformer primary 200/208/220/230/240/250V secondary 4.2/10.7/21V 162VA 50/60Hz | | |
| For models: | 815166, CGE11-L, CGE11-R, CGE12-L, CGE12-R, CGE21-L, CGE21-R, CGE22-L, CGE22-R, CGE61-L, CGE61-R, CGE62-L, CGE62-R, CGG11-L, CGG11-R, CGG12-L, CGG12-R, CGG21-L, CGG21-R, CGG22-L, CGG22-R, CGG61-L, CGG61-R, CGG62-L, CGG62-R, CPE63, CSE11-L, CSE11-R, CSE11-R-DG, CSE12-L, CSE12-R, CSE12-R-DG, CSE21-L, CSE21-R, CSE21-R-DG, CSE22-L, CSE22-R, CSE22-R-DG, CSE61-L, CSE61-R, CSE61-R-DG, CSE62-L, CSE62-R, CSE62-R-DG, CSG11-L, CSG11-R, CSG11-R-DG, CSG12-L, CSG12-R, CSG12-R-DG...(Other models you can see in the webshop) | | |

for lighting



1

| | | | |
|--------------------|--|-----------------|--------|
| GEV No. | 403306 | Ref. No. | 203749 |
| description | transformer primary 230VAC secondary 11.5VAC 50VA secondary 4A connection screw L 165mm W 45mm H 37mm 50/60Hz mounting distance 155mm for lighting | | |
| For models: | CGE11-L, CGE11-R, CGE22-L, CGE22-R, CGE61-L, CGE61-R, CPE63, CSE11-L, CSE11-R, CSE22-L, CSE22-R, CSE61-L, CSE61-R | | |



1

| | | | |
|--------------------|---|-----------------|--------|
| GEV No. | 403305 | Ref. No. | 203670 |
| description | transformer primary 200-250VAC secondary 215/230VAC 92VA connection plug 50/60Hz | | |
| For models: | CGE11-L, CGE11-R, CGE12-L, CGE12-R, CGE22-L, CGE22-R, CGE61-L, CGE61-R, CPE63, CSE11-L, CSE11-R, CSE12-L, CSE12-R, CSE22-L, CSE22-R, CSE61-L, CSE61-R | | |

probes

producer-specific probes

probes

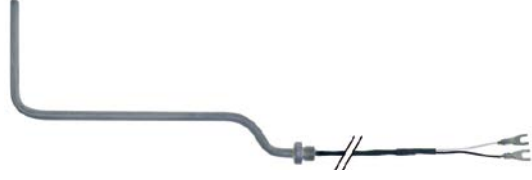

1

| | | | |
|--------------------|---|-----------------|--------|
| GEV No. | 379997 | Ref. No. | 203602 |
| description | temperature probe thermocouple J (Fe-CuNi) cable PTFE probe -50 up to +750°C cable -40 up to +250°C connection 2-wire thread M10x1 probe ø6x80/180mm cable length 1.4m | | |
| For models: | 1220302-00, 1220302-01, 1220302B00, 1220302B01, 1220302D00, 1220302E00, 1220304-00, 1220304-01, 1220304A00, 1220304A01, 1220304A02, 1220304B00, 1220304B01, 1220304C00, 1220304C01, 1220304C02, 1220304D00, 1220304E00, 1220304F00, 1220304F01, 1220304H00, 1220304H01, 1220306-00, 1220306-01, 1220306A00, 1220306A01, 1220306A02, 1220306A03, 1220306A04, 1220306B00, 1220306B01, 1220306C00, 1220306C01, 1220306C02, 1220306C03, 1220306C04, 1220306D00, 1220306E00, 1220306F00, 1220306F01, 1220306F02, 1220306F03, 1220306H00, 1220306H01, 1220306H02, 1220306H03, 1320302-00, 1320302-01, 1320302B00, 1320302B01... (Other models you can see in the webshop) | | |





1

| | | | |
|--------------------|--|-----------------|------------------|
| GEV No. | 403304 | Ref. No. | 203980 203981 |
| description | transformer primary 440VAC secondary 230VAC 500VA connection screw clamp 50/60Hz | | |
| For models: | CGE11-L, CGE11-R, CGE22-L, CGE22-R, CGE61-L, CGE61-R, CSE11-L, CSE11-R, CSE22-L, CSE22-R, CSE61-L, CSE61-R | | |

| | | | |
|---|---|-----------------|--------|
|  | | | |
| GEV No. | 378120 | Ref. No. | 203991 |
| description | temperature probe thermocouple K (NiCr-Ni) cable PTFE probe -50 up to 1150°C cable -40 up to +250°C connection 2-wire thread M8x1 probe ø1.5x18mm cable length 1.6m | | |
| For models: | CGE11-L, CGE11-R, CGE12-L, CGE12-R, CGE21-L, CGE21-R, CGE22-L, CGE22-R, CGE61-L, CGE61-R, CGE62-L, CGE62-R, CGG11-L, CGG11-R, CGG12-L, CGG12-R, CGG21-L, CGG21-R, CGG22-L, CGG22-R, CGG61-L, CGG61-R, CGG62-L, CGG62-R, CPE63, CSE11-L, CSE11-R, CSE22-L, CSE22-R, CSE61-L, CSE61-R | | |

| | | | |
|---|---|-----------------|--------|
|  | | | |
| GEV No. | 378121 | Ref. No. | 203689 |
| description | temperature probe thermocouple K (NiCr-Ni) cable PTFE probe -50 up to 1150°C cable -40 up to +250°C connection 2-wire thread M8x1 probe ø1.5x18mm cable length 3.2m | | |
| For models: | CCE60, CCE63, CGE11-L, CGE11-R, CGE12-L, CGE12-R, CGE21-L, CGE21-R, CGE22-L, CGE22-R, CGE61-L, CGE61-R, CGE62-L, CGE62-R, CGG11-L, CGG11-R, CGG12-L, CGG12-R, CGG21-L, CGG21-R, CGG22-L, CGG22-R, CGG61-L, CGG61-R, CGG62-L, CGG62-R, CPE60, CPE63, CSE11-L, CSE11-R, CSE11-R-DG, CSE12-L, CSE12-R, CSE12-R-DG, CSE21-L, CSE21-R, CSE21-R-DG, CSE22-L, CSE22-R, CSE22-R-DG, CSE61-L, CSE61-R, CSE61-R-DG, CSE62-L, CSE62-R, CSE62-R-DG, CSG11-L, CSG11-R, CSG11-R-DG, CSG12-L...(Other models you can see in the webshop) | | |

| | | | |
|---|--|-----------------|----------|
|  | | | |
| GEV No. | 378658 | Ref. No. | 10013519 |
| description | temperature probe thermocouple K (NiCr-Ni) cable PTFE probe -50 up to 1150°C cable -40 up to +250°C connection coded plug probe 1.6x45 cable length 1.6m | | |

| | | | |
|---|--|-----------------|--------|
|  | | | |
| GEV No. | 378122 | Ref. No. | 203693 |
| description | temperature probe thermocouple K (NiCr-Ni) cable silicone probe -50 up to 1150°C cable -50 up to +180°C connection 2-wire thread M10x1 probe ø3.5x13mm cable length 1.5m | | |
| For models: | CCE60, CCE63, CGE11-L, CGE11-R, CGE12-L, CGE12-R, CGE61-L, CGE61-R, CGE62-L, CGE62-R, CGG11-L, CGG11-R, CGG12-L, CGG12-R, CGG61-L, CGG61-R, CGG62-L, CGG62-R, CPE60, CPE63, CSE11-L, CSE11-R, CSE11-R-DG, CSE12-L, CSE12-R, CSE12-R-DG, CSE61-L, CSE61-R, CSE61-R-DG, CSE62-L, CSE62-R, CSE62-R-DG, CSG11-L, CSG11-R, CSG11-R-DG, CSG12-L, CSG12-R, CSG12-R-DG, CSG61-L, CSG61-R, CSG61-R-DG, CSG62-L, CSG62-R, CSG62-R-DG | | |

| | | | |
|---|--|-----------------|--------|
|  | | | |
| GEV No. | 378123 | Ref. No. | 203990 |
| description | temperature probe thermocouple K (NiCr-Ni) cable silicone probe -50 up to 1150°C cable -50 up to +180°C connection 2-wire thread M10x1 probe ø3.5x13mm cable length 2.3m | | |
| For models: | CGE11-L, CGE11-R, CGE21-L, CGE21-R, CGE22-L, CGE22-R, CGE61-L, CGE61-R, CGG21-L, CGG21-R, CGG22-L, CGG22-R, CSE11-L, CSE11-R, CSE21-L, CSE21-R, CSE21-R-DG, CSE22-L, CSE22-R, CSE22-R-DG, CSE61-L, CSE61-R, CSG21-L, CSG21-R, CSG21-R-DG, CSG22-L, CSG22-R, CSG22-R-DG | | |

core probes

| | | | |
|--|--|-----------------|--------|
|  | | | |
| GEV No. | 378537 | Ref. No. | 202738 |
| description | core temperature probe multipoint probe cable PTFE probe -40 up to +250°C cable -40 up to +250°C connection 5-wire probe ø4x100mm thread 1/4" cable length 1.8m handle ø 11mm handle length 75mm | | |
| For models: | CCE60, CCE63, CPE60, CPE63 | | |

| | | | |
|--|--|-----------------|----------|
|  | | | |
| GEV No. | 378657 | Ref. No. | 10013578 |
| description | core temperature probe multipoint probe cable PTFE probe -40 up to +250°C cable -40 up to +250°C connection plug probe ø4x100mm thread 1/4" cable length 0.8m handle ø 11mm handle length 75mm for combi-steamer | | |

| | | | |
|---|--|-----------------|----------|
|  | | | |
| GEV No. | 378650 | Ref. No. | 10013579 |
| description | core temperature probe multipoint probe cable PTFE probe -40 up to +250°C cable -40 up to +250°C connection plug probe ø4x100mm thread 1/4" cable length 1.2m handle ø 11mm handle length 75mm for combi-steamer | | |

| | | | |
|--|---|-----------------|----------|
|  | | | |
| GEV No. | 378651 | Ref. No. | 10015666 |
| description | core temperature probe multipoint probe cable PTFE probe -40 up to +250°C cable -40 up to +250°C connection plug probe ø4x100mm thread 1/4" cable length 1.2m handle ø 11mm handle length 75mm for combi-steamer SS-reinforced/strip-wound hose | | |



| | | | |
|--|---|-----------------|----------|
|  | | | |
| GEV No. | 378541 | Ref. No. | 10013518 |
| description | core temperature probe multipoint probe cable PTFE probe -40 up to +250°C cable -40 up to +250°C connection plug probe ø4x100mm thread cable length 1.1m handle ø 11mm handle length 75mm | | |



| | | | |
|--------------------|---|-----------------|----------|
| GEV No. | 378538 | Ref. No. | 10013516 |
| description | core temperature probe Pt100 cable PTFE probe -40 up to +250°C cable -40 up to +250°C connection plug probe ø4x100mm thread 1/4" cable length 1.8m handle ø 11mm handle length 75mm | | |

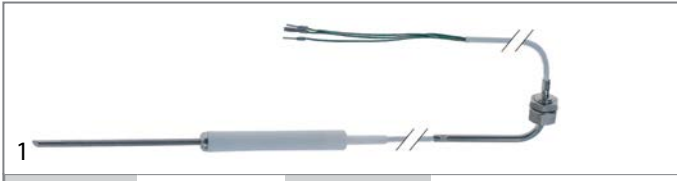

| | | | |
|--------------------|--|-----------------|--------|
| GEV No. | 378124 ¹ | Ref. No. | 203697 |
| description | core temperature probe thermocouple K (NiCr-Ni) cable PTFE probe -40 up to +250°C cable -40 up to +250°C connection 5-wire probe ø4x100mm thread 1/4" cable length 1.5m handle ø 12mm handle length 90mm | | |
| For models: | CCE60, CCE63, CGE11-L, CGE11-R, CGE12-L, CGE12-R, CGE61-L, CGE61-R, CGE62-L, CGE62-R, CGG11-L, CGG11-R, CGG12-L, CGG12-R, CGG61-L, CGG61-R, CGG62-L, CGG62-R, CPE60, CPE63, CSE11-L, CSE11-R, CSE11-R-DG, CSE12-L, CSE12-R, CSE12-R-DG, CSE61-L, CSE61-R, CSE61-R-DG, CSE62-L, CSE62-R, CSE62-R-DG, CSG11-L, CSG11-R, CSG11-R-DG, CSG12-L, CSG12-R, CSG12-R-DG, CSG61-L, CSG61-R, CSG61-R-DG, CSG62-L, CSG62-R, CSG62-R-DG | | |

¹multipoint probe

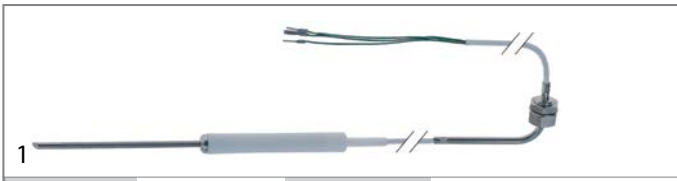

| | | | |
|--------------------|--|-----------------|--------|
| GEV No. | 378125 ¹ | Ref. No. | 203688 |
| description | core temperature probe thermocouple K (NiCr-Ni) cable PTFE probe -40 up to +250°C cable -40 up to +250°C connection 5-wire probe ø4x100mm thread 1/4" cable length 1.9m handle ø 12mm handle length 90mm | | |
| For models: | CCE60, CCE63, CGE21-L, CGE21-R, CGE22-L, CGE22-R, CGG21-L, CGG21-R, CGG22-L, CGG22-R, CPE60, CPE63, CSE21-L, CSE21-R, CSE21-R-DG, CSE22-L, CSE22-R, CSE22-R-DG, CSG21-L, CSG21-R, CSG21-R-DG, CSG22-L, CSG22-R, CSG22-R-DG | | |

¹multipoint probe

accessories

fasteners



| | | | |
|--------------------|---|-----------------|--------|
| GEV No. | 551022 | Ref. No. | 208032 |
| description | probe clip | | |
| For models: | CGE11-L, CGE11-R, CGE12-L, CGE12-R, CGE21-L, CGE21-R, CGE22-L, CGE22-R, CGE61-L, CGE61-R, CGE62-L, CGE62-R, CGG11-L, CGG11-R, CGG12-L, CGG12-R, CGG21-L, CGG21-R, CGG22-L, CGG22-R, CGG61-L, CGG61-R, CGG62-L, CGG62-R, CPE63, CSE11-L, CSE11-R, CSE12-L, CSE12-R, CSE21-L, CSE21-R, CSE21-R-DG, CSE22-L, CSE22-R, CSE22-R-DG, CSE61-L, CSE61-R, CSE62-L, CSE62-R, CSG11-L, CSG11-R, CSG11-R-DG, CSG12-L, CSG12-R, CSG12-R-DG, CSG21-L, CSG21-R, CSG21-R-DG, CSG22-L, CSG22-R...(Other models you can see in the webshop) | | |

screw connections



| | | | |
|--------------------|---|-----------------|--------|
| GEV No. | 381514 | Ref. No. | 205183 |
| description | screw connection kit for temperature probe | | |
| For models: | CGE11-L, CGE11-R, CGE12-L, CGE12-R, CGE21-L, CGE21-R, CGE22-L, CGE22-R, CGE61-L, CGE61-R, CGE62-L, CGE62-R, CGG11-L, CGG11-R, CGG12-L, CGG12-R, CGG21-L, CGG21-R, CGG22-L, CGG22-R, CGG61-L, CGG61-R, CGG62-L, CGG62-R, CPE63, CSE11-L, CSE11-R, CSE12-L, CSE12-R, CSE21-L, CSE21-R, CSE21-R-DG, CSE22-L, CSE22-R, CSE22-R-DG, CSE61-L, CSE61-R, CSE62-L, CSE62-R, CSG11-L, CSG11-R, CSG11-R-DG, CSG12-L, CSG12-R, CSG12-R-DG, CSG21-L, CSG21-R, CSG21-R-DG, CSG22-L, CSG22-R...(Other models you can see in the webshop) | | |

miscellaneous

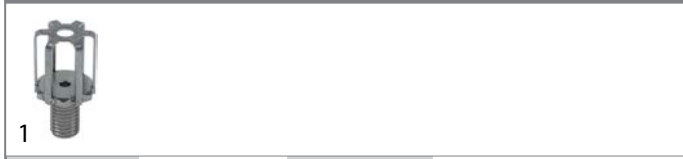

| | | | |
|--------------------|---|-----------------|--------|
| GEV No. | 381515 | Ref. No. | 205327 |
| description | protector for temperature probe ø 24.5mm H 28mm SS M12 | | |
| For models: | CCE60, CCE63, CGE11-L, CGE11-R, CGE12-L, CGE12-R, CGE21-L, CGE21-R, CGE22-L, CGE22-R, CGE61-L, CGE61-R, CGE62-L, CGE62-R, CGG11-L, CGG11-R, CGG12-L, CGG12-R, CGG21-L, CGG21-R, CGG22-L, CGG22-R, CGG61-L, CGG61-R, CGG62-L, CGG62-R, CPE60, CPE63, CSE11-L, CSE11-R, CSE11-R-DG, CSE12-L, CSE12-R, CSE12-R-DG, CSE61-L, CSE61-R, CSE61-R-DG, CSE62-L, CSE62-R, CSE62-R-DG, CSG11-L, CSG11-R, CSG11-R-DG, CSG12-L, CSG12-R, CSG12-R-DG, CSG21-L, CSG21-R, CSG21-R-DG, CSG22-L...(Other models you can see in the webshop) | | |

electronics

electronics accessories



| | | | |
|--------------------|---|-----------------|--------|
| GEV No. | 694973 | Ref. No. | 207097 |
| description | button for display PCB ø 15mm grey | | |
| For models: | CGE11-L, CGE11-R, CGE12-L, CGE12-R, CGE21-L, CGE21-R, CGE22-L, CGE22-R, CGE61-L, CGE61-R, CGE62-L, CGE62-R, CGG11-L, CGG11-R, CGG12-L, CGG12-R, CGG21-L, CGG21-R, CGG22-L, CGG22-R, CGG61-L, CGG61-R, CGG62-L, CGG62-R, CPE63, CSE11-L, CSE11-R, CSE12-L, CSE12-R, CSE21-L, CSE21-R, CSE22-L, CSE22-R, CSE61-L, CSE61-R, CSE62-L, CSE62-R, CSG11-L, CSG11-R, CSG12-L, CSG12-R, CSG21-L, CSG21-R, CSG22-L, CSG22-R, CSG61-L, CSG61-R, CSG62-L, CSG62-R | | |

1

| | | | |
|--------------------|--|-----------------|--------|
| GEV No. | 348214 | Ref. No. | 207186 |
| description | button for display PCB transparent suitable for MKN ED ø 16mm H 4.8mm for combi-steamer | | |
| For models: | CSE11-L, CSE11-R, CSE11-R-DG, CSE12-L, CSE12-R, CSE12-R-DG, CSE21-L, CSE21-R, CSE21-R-DG, CSE22-L, CSE22-R, CSE22-R-DG, CSE61-L, CSE61-R, CSE61-R-DG, CSE62-L, CSE62-R, CSE62-R-DG, CSG11-L, CSG11-R, CSG11-R-DG, CSG12-L, CSG12-R, CSG12-R-DG, CSG21-L, CSG21-R, CSG21-R-DG, CSG22-L, CSG22-R, CSG22-R-DG, CSG61-L, CSG61-R, CSG61-R-DG, CSG62-L, CSG62-R, CSG62-R-DG | | |

rectifiers



1

| | | | |
|--------------------|---|-----------------|--------|
| GEV No. | 400851 | Ref. No. | 203442 |
| description | rectifier 420V 10A | | |
| For models: | 2013004B01, 2013004B02, 2013004B03, 2013004B04, 2013004B05, 2013008B01, 2013008B02, 2013008B03, 2013008B04, 2013008B05, 2013010B01, 2013010B02, 2013010B03, 2013010B04, 2013010B05, 2013018B00, 2013018B01, 2013018B02, 2013018B03, 2013018B04, 2021442-02, 2021442-03, 2021442A00, 2021442A01, 2021442A02, 2021442A03, 2021442B02, 2021442B03, 2021442C00, 2021442C01, 2021442C02, 2021442C03, 2021443-02, 2021443-03, 2021443-04, 2021443-05, 2021443A02, 2021443A03, 2021443A04, 2021443A05, 2021443B02, 2021443B03, 2021443B04, 2021443B05, 2021443C00, 2021443C01, 2021443C02, 2021443C03, 2021443C04, 2021443C05... (Other models you can see in the webshop) | | |

frequency converters



1

| | | | |
|--------------------|---|-----------------|--------------------|
| GEV No. | 403214 | Ref. No. | 10012693 203784 |
| description | frequency converter with fan tray for hot air motors 100-240V L 135mm W 110mm H 135mm output frequency 0-100Hz input frequency 47-63Hz | | |
| For models: | CGE11-L, CGE11-R, CGE12-L, CGE12-R, CGE21-L, CGE21-R, CGE22-L, CGE22-R, CGE61-L, CGE61-R, CGE62-L, CGE62-R, CGG11-L, CGG11-R, CGG12-L, CGG12-R, CGG21-L, CGG21-R, CGG22-L, CGG22-R, CGG61-L, CGG61-R, CGG62-L, CGG62-R, CPE60, CSE11-L, CSE11-R, CSE12-L, CSE12-R, CSE21-L, CSE21-R, CSE22-L, CSE22-R, CSE61-L, CSE61-R, CSE62-L, CSE62-R, CSG11-L, CSG11-R, CSG11-R-DG, CSG12-L, CSG12-R, CSG12-R-DG, CSG21-L, CSG21-R, CSG21-R-DG, CSG22-L, CSG22-R, CSG22-R-DG, CSG61-L... (Other models you can see in the webshop) | | |

PCBs



1

| | | | |
|--------------------|---|-----------------|--------|
| GEV No. | 401447 | Ref. No. | 203128 |
| description | control PCB | | |
| For models: | 1220302-00, 1220302-01, 1220302B00, 1220302B01, 1220302D00, 1220302E00, 1220304-00, 1220304-01, 1220304A00, 1220304A01, 1220304A02, 1220304B00, 1220304B01, 1220304C00, 1220304C01, 1220304C02, 1220304D00, 1220304E00, 1220304F00, 1220304F01, 1220304H00, 1220304H01, 1220306-00, 1220306-01, 1220306A00, 1220306A01, 1220306A02, 1220306A03, 1220306A04, 1220306B00, 1220306B01, 1220306C00, 1220306C01, 1220306C02, 1220306C03, 1220306C04, 1220306D00, 1220306E00, 1220306F00, 1220306F01, 1220306F02, 1220306F03, 1220306H00, 1220306H01, 1220306H02, 1220306H03, 1320302-00, 1320302-01, 1320302B00, 1320302B01... (Other models you can see in the webshop) | | |

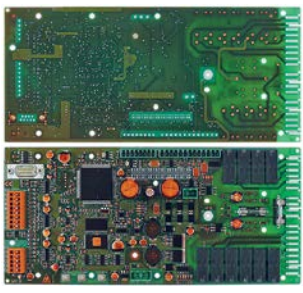

1

| | | | |
|--------------------|--|-----------------|--------|
| GEV No. | 403807 | Ref. No. | 202676 |
| description | control PCB combi-steamer Hans Dampf L 250mm W 115mm | | |
| For models: | CCE60, CCE63, CSE11-L, CSE11-R, CSE11-R-DG, CSE12-L, CSE12-R, CSE12-R-DG, CSE21-L, CSE21-R, CSE21-R-DG, CSE22-L, CSE22-R, CSE22-R-DG, CSE61-L, CSE61-R, CSE61-R-DG, CSE62-L, CSE62-R, CSE62-R-DG, CSG11-L, CSG11-R, CSG11-R-DG, CSG12-L, CSG12-R, CSG12-R-DG, CSG21-L, CSG21-R, CSG21-R-DG, CSG22-L, CSG22-R, CSG22-R-DG, CSG61-L, CSG61-R, CSG61-R-DG, CSG62-L, CSG62-R, CSG62-R-DG | | |



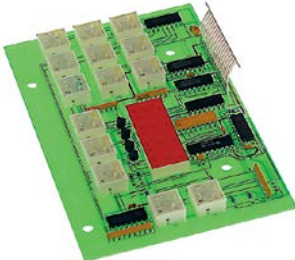

2

| | | | |
|--------------------|--|-----------------|--------|
| GEV No. | 403808 | Ref. No. | 202788 |
| description | controller for USB MKN L 64.5mm W 31.5mm | | |
| For models: | CGE11-L, CGE11-R, CGE12-L, CGE12-R, CGE21-L, CGE21-R, CGE22-L, CGE22-R, CGE61-L, CGE61-R, CGE62-L, CGE62-R, CGG11-L, CGG11-R, CGG12-L, CGG12-R, CGG21-L, CGG21-R, CGG22-L, CGG22-R, CGG61-L, CGG61-R, CGG62-L, CGG62-R | | |



1

| | | | |
|---|---|-----------------|------------------------|
| GEV No. | 401445 | Ref. No. | 203124 |
| description | keypad PCB | | |
| For models: | 1220302-00, 1220302-01, 1220302B00, 1220302B01, 1220302D00, 1220302E00, 1220304-00, 1220304-01, 1220304A00, 1220304A01, 1220304A02, 1220304B00, 1220304B01, 1220304C00, 1220304C01, 1220304C02, 1220304D00, 1220304E00, 1220304F00, 1220304F01, 1220304H00, 1220304H01, 1220306-00, 1220306-01, 1220306A00, 1220306A01, 1220306A02, 1220306A03, 1220306A04, 1220306B00, 1220306B01, 1220306C00, 1220306C01, 1220306C02, 1220306C03, 1220306C04, 1220306D00, 1220306E00, 1220306F00, 1220306F01, 1220306F02, 1220306F03, 1220306H00, 1220306H01, 1220306H02, 1220306H03, 1320302-00, 1320302-01, 1320302B00, 1320302B01... (Other models you can see in the webshop) | | |
| accessories for | 401445 | | |
|  | GEV No. | 401446 | Ref. No. 055055 |
| | keypad foil L 170mm W 70mm buttons 14 | | |



1

| | | | |
|--------------------|--|-----------------|--------|
| GEV No. | 403034 | Ref. No. | 203746 |
| description | keypad PCB | | |
| For models: | CGE11-L, CGE11-R, CGE22-L, CGE22-R, CGE61-L, CGE61-R, CSE11-L, CSE11-R, CSE21-L, CSE21-R, CSE22-L, CSE22-R, CSE61-L, CSE61-R, CSG21-L, CSG21-R, CSG22-L, CSG22-R | | |



1

| | | | |
|--------------------|--|-----------------|--------|
| GEV No. | 401697 | Ref. No. | 202690 |
| description | keypad PCB combi-steamer Hans Dampf | | |
| For models: | CSE11-L, CSE11-R, CSE11-R-DG, CSE12-L, CSE12-R, CSE12-R-DG, CSE21-L, CSE21-R, CSE21-R-DG, CSE22-L, CSE22-R, CSE22-R-DG, CSE61-L, CSE61-R, CSE61-R-DG, CSE62-L, CSE62-R, CSE62-R-DG, CSG11-L, CSG11-R, CSG11-R-DG, CSG12-L, CSG12-R, CSG12-R-DG, CSG21-L, CSG21-R, CSG21-R-DG, CSG22-L, CSG22-R, CSG22-R-DG, CSG61-L, CSG61-R, CSG61-R-DG, CSG62-L, CSG62-R, CSG62-R-DG | | |



1

| | | | |
|--------------------|--|-----------------|--------|
| GEV No. | 401698 | Ref. No. | 203745 |
| description | keypad PCB combi-steamer Hans Dampf | | |
| For models: | CGE11-L, CGE11-R, CGE12-L, CGE12-R, CGE21-L, CGE21-R, CGE22-L, CGE22-R, CGE61-L, CGE61-R, CGE62-L, CGE62-R, CGG11-L, CGG11-R, CGG12-L, CGG12-R, CGG21-L, CGG21-R, CGG22-L, CGG22-R, CGG61-L, CGG61-R, CGG62-L, CGG62-R, CSE11-L, CSE11-R, CSE12-L, CSE12-R, CSE22-L, CSE22-R, CSE61-L, CSE61-R, CSE62-L, CSE62-R, CSG11-L, CSG11-R, CSG12-L, CSG12-R, CSG61-L, CSG61-R, CSG62-L, CSG62-R | | |

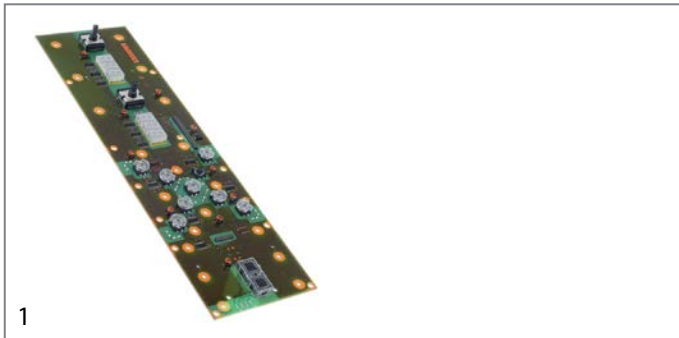

| | | | |
|--------------------|--|-----------------|--------|
| GEV No. | 403307 | Ref. No. | 202128 |
| description | keypad PCB combi-steamer JUNIOR L 410mm W 115mm buttons 10 | | |
| For models: | CCE60, CCE63, CPE60, CPE63 | | |

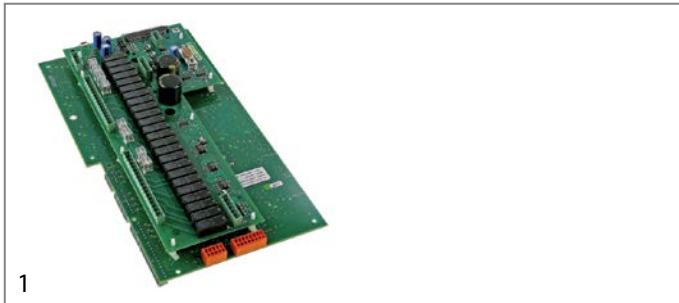

| | | | |
|--------------------|--|-----------------|--------|
| GEV No. | 401969 | Ref. No. | 203766 |
| description | PCB | | |
| For models: | CGE11-L, CGE11-R, CGE12-L, CGE12-R, CGE21-L, CGE21-R, CGE22-L, CGE22-R, CGE61-L, CGE61-R, CGE62-L, CGE62-R, CGG11-L, CGG11-R, CGG12-L, CGG12-R, CGG21-L, CGG21-R, CGG22-L, CGG22-R, CGG61-L, CGG61-R, CGG62-L, CGG62-R, CSE11-L, CSE11-R, CSE61-L, CSE61-R | | |



| | | | |
|--------------------|--|-----------------|--------|
| GEV No. | 401393 | Ref. No. | 203306 |
| description | PCB 230V | | |
| For models: | 1023401-00, 1223202A00, 1223202A01, 1223202J00, 1223202J01, 1223209-00, 1223209-01, 1223401-00, 1223401J00, 1223402-00, 1323202A00, 1323202A01, 1323202A02, 1323209-00, 1323209-01, 1323209-02, 1323209-03, 1323210-00, 1323210-01, 1323210-02, 1323210-03, 1323210-04, 1323401-00, 1323402-00, 1323403-00, 1423401-00, 1423402-00, 1424818A00, 1424824-00, 1424824-01, 1424825-00, 1523401-00, 1523402-00, 2023212-00, 2023401-00, 2123207A00, 2123207A01, 2123208A00, 2123208A01, 2123208A02, 2123208A03, 2123210-00, 2123401-00, 2123402-00, 2123403-00, 3023401-00 | | |

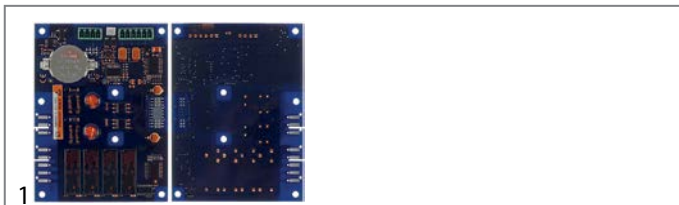

| | | | |
|--------------------|--|-----------------|--------|
| GEV No. | 403806 | Ref. No. | 202698 |
| description | PCB combi-steamer Hans Dampf L 115mm W 87mm | | |
| For models: | CSG11-L, CSG11-R, CSG11-R-DG, CSG12-L, CSG12-R, CSG12-R-DG, CSG21-L, CSG21-R, CSG21-R-DG, CSG22-L, CSG22-R, CSG22-R-DG, CSG61-L, CSG61-R, CSG61-R-DG, CSG62-L, CSG62-R, CSG62-R-DG | | |



| | | | |
|--------------------|--|-----------------|--------|
| GEV No. | 403809 | Ref. No. | 202600 |
| description | PCB for combi-steamer Hans Dampf L 28mm W 27mm for ignition electrode | | |
| For models: | CGG11-L, CGG11-R, CGG12-L, CGG12-R, CGG21-L, CGG21-R, CGG22-L, CGG22-R, CGG61-L, CGG61-R, CGG62-L, CGG62-R, CSG11-L, CSG11-R, CSG12-L, CSG12-R, CSG21-L, CSG21-R, CSG22-L, CSG22-R, CSG61-L, CSG61-R, CSG62-L, CSG62-R | | |

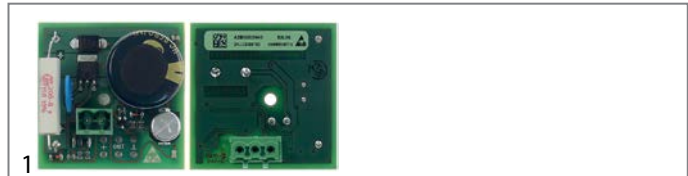

| | | | |
|--------------------|-------------------------------------|-----------------|--------|
| GEV No. | 403869 | Ref. No. | 203773 |
| description | PCB for combi-steamer L 50mm W 50mm | | |
| For models: | CPE63 | | |

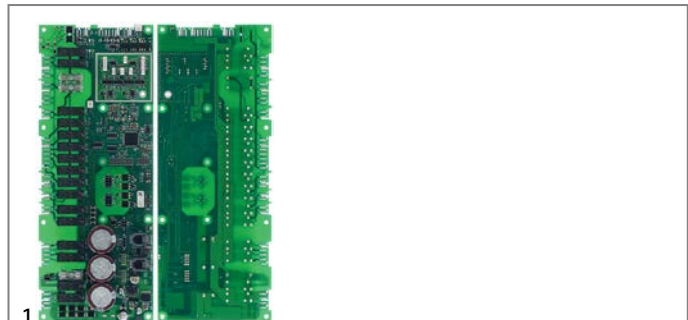

| | | | |
|--------------------|---------------------|-----------------|----------|
| GEV No. | 403876 | Ref. No. | 10013404 |
| description | PCB L 320mm W 125mm | | |

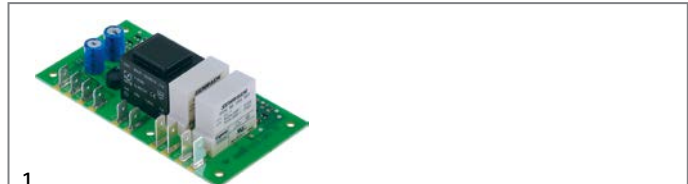

| | | | |
|--------------------|--|-----------------|--------|
| GEV No. | 400074 | Ref. No. | 203911 |
| description | PCB pyroceram range 2023206-00 400V | | |
| For models: | 0723405-01, 0723405-02, 0723409-01, 0723409-02, 0723413-02, 0723414-02, 1023410-00, 1423404-00, 1423404-01, 1423405-00, 1423405-01, 1423405-02, 1423409-00, 1423409-01, 1423409-02, 1423413-02, 1423414-02, 1424819-00, 1424826-00, 1523405-00, 1523405-01, 1523409-00, 1523409-01, 1523410-00, 2023206-00, 2023206-01, 2023206-02, 2023207-00, 2023207-01, 2023207-02, 2023207-03, 2023207-04, 2023207-05, 2023405-00, 2023405D00, 2023406-00, 2023407-00, 2023407-01, 2023409-00, 3023206-00, 3023206-01, 3023206-02, 3023405-00, 3023406-00, 3023409-00 | | |

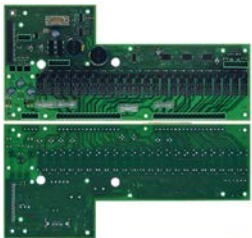

| | | | |
|--------------------|--|-----------------|--------|
| GEV No. | 403872 | Ref. No. | 203747 |
| description | relay PCB for combi-steamer L 320mm W 150mm | | |
| For models: | CCE60, CCE63, CGE11-L, CGE11-R, CGE12-L, CGE12-R, CGE21-L, CGE21-R, CGE22-L, CGE22-R, CGE61-L, CGE61-R, CGE62-L, CGE62-R, CGG11-L, CGG11-R, CGG12-L, CGG12-R, CGG21-L, CGG21-R, CGG22-L, CGG22-R, CGG61-L, CGG61-R, CGG62-L, CGG62-R, CPE60, CPE63, CSE11-L, CSE11-R, CSE12-L, CSE12-R, CSE21-L, CSE21-R, CSE22-L, CSE22-R, CSE61-L, CSE61-R, CSE62-L, CSE62-R, CSG21-L, CSG21-R, CSG22-L, CSG22-R, CSG61-L, CSG61-R, CSG62-L, CSG62-R | | |



| | | | |
|--------------------|--|-----------------|----------|
| GEV No. | 403877 | Ref. No. | 10013402 |
| description | touch panel mounting frame inclusive L 400mm W 208mm | | |

keypads

front foils



| | | | |
|--------------------|---|-----------------|--------|
| GEV No. | 401446 | Ref. No. | 055055 |
| description | keypad foil L 170mm W 70mm buttons 14 | | |
| For models: | 1220302-00, 1220302-01, 1220302B00, 1220302B01, 1220302D00, 1220302E00, 1220304-00, 1220304-01, 1220304A00, 1220304A01, 1220304A02, 1220304B00, 1220304B01, 1220304C00, 1220304C01, 1220304C02, 1220304D00, 1220304E00, 1220304F00, 1220304F01, 1220304H00, 1220304H01, 1220306-00, 1220306-01, 1220306A00, 1220306A01, 1220306A02, 1220306A03, 1220306A04, 1220306B00, 1220306B01, 1220306C00, 1220306C01, 1220306C02, 1220306C03, 1220306C04, 1220306D00, 1220306E00, 1220306F00, 1220306F01, 1220306F02, 1220306F03, 1220306H00, 1220306H01, 1220306H02, 1220306H03, 1320302-00, 1320302-01, 1320302B00, 1320302B01... (Other models you can see in the webshop) | | |

solenoid valves

solenoid valves (water)

INTERELEKTRIK

medium temperature: 90°C 90°C 60°C
 ambient temperature: 60°C 25°C 60°C
 duty cycle: 40% 100% 100%

with reducers



| | | | |
|--------------------|---|-----------------|--------|
| GEV No. | 370747 | Ref. No. | 201142 |
| description | solenoid valve double straight 220-240VAC inlet 3/4" outlet 10.5mm INTERELEKTRIK plastic output B 3l/min flow regulating valve outlet B red | | |
| For models: | CGE11-L, CGE11-R, CGE12-L, CGE12-R, CGE61-L, CGE61-R, CGE62-L, CGE62-R, CPE63, CSE11-L, CSE11-R, CSE12-L, CSE12-R, CSE61-L, CSE61-R, CSE62-L, CSE62-R | | |





| | | | |
|--------------------|---|-----------------|--------|
| GEV No. | 370843 | Ref. No. | 203663 |
| description | solenoid valve single straight 220-240 inlet 3/4" outlet 1/2" input 2l/min DN8 t.max. 90°C duty cycle 100% INTERELEKTRIK plastic flow regulating valve inlet yellow total length 84.5mm | | |
| For models: | 1422807B03, 1422807B04, 1422831-00, 1422832-00, 1422833-00, 1422834-00, 1422902-03, 1422902-04, 1422908-00, 1422910-00, 1423901-00, 1423901-01, 1423901-02, 1423902-00, 1423902-01, 1423902-02, 1423903-00, 1423903-01, 1423903-02, 1424101-00, 1424101-01, 1424102-00, 1424102-01, 1424103-00, 1424104-00, 1462831-00, 1462832-00, 1462833-00, 1462834-00, 1462835-00, 1462836-00, 1462837-00, 1462838-00, 1462839-00, 1462840-00, 1462908-00, 1462910-00, 2013901-00, 2013901-01, 2013901-02, 2013901-03, 2013902-00, 2013902-01, 2013902-02, 2013902-03, 2013903-00, 2013903-01, 2013903-02, 2013903-03, 2022802B08... (Other models you can see in the webshop) | | |



| | | | |
|--------------------|--|-----------------|--------|
| GEV No. | 370746 | Ref. No. | 201140 |
| description | solenoid valve single straight 220-240VAC inlet 3/4" outlet 10.5mm output 3l/min INTERELEKTRIK plastic flow regulating valve outlet red | | |
| For models: | CGE11-L, CGE11-R, CGE12-L, CGE12-R, CGE61-L, CGE61-R, CGE62-L, CGE62-R, CSE11-L, CSE11-R, CSE12-L, CSE12-R, CSE61-L, CSE61-R, CSE62-L, CSE62-R | | |



| | | | |
|---|--|-----------------|--------|
|  | | | |
| 1 | | | |
| GEV No. | 370144 | Ref. No. | 201160 |
| description | solenoid valve single straight 230VAC outlet 10.5mm t.max. 90°C plastic inlet 3/4"mm | | |
| For models: | CGE11-L, CGE11-R, CGE12-L, CGE12-R, CGE21-L, CGE21-R, CGE22-L, CGE22-R, CGE61-L, CGE61-R, CGE62-L, CGE62-R, CGG11-L, CGG11-R, CGG12-L, CGG12-R, CGG21-L, CGG21-R, CGG22-L, CGG22-R, CGG61-L, CGG61-R, CGG62-L, CGG62-R, CSE11-L, CSE11-R, CSE11-R-DG, CSE12-L, CSE12-R, CSE12-R-DG, CSE21-L, CSE21-R, CSE21-R-DG, CSE22-L, CSE22-R, CSE22-R-DG, CSE61-L, CSE61-R, CSE61-R-DG, CSE62-L, CSE62-R, CSE62-R-DG, CSG11-L, CSG11-R, CSG11-R-DG, CSG12-L, CSG12-R, CSG21-L, CSG21-R, CSG21-R-DG...(Other models you can see in the webshop) | | |

| | | | |
|--|--|-----------------|--------|
|  | | | |
| 1 | | | |
| GEV No. | 370308 | Ref. No. | 203832 |
| description | valve unit 24VDC | | |
| For models: | CGE11-L, CGE11-R, CGE12-L, CGE12-R, CGE21-L, CGE21-R, CGE22-L, CGE22-R, CGE61-L, CGE61-R, CGE62-L, CGE62-R, CGG11-L, CGG11-R, CGG12-L, CGG12-R, CGG21-L, CGG21-R, CGG22-L, CGG22-R, CGG61-L, CGG61-R, CGG62-L, CGG62-R, CSE11-L, CSE11-R, CSE11-R-DG, CSE12-L, CSE12-R, CSE12-R-DG, CSE21-L, CSE21-R, CSE21-R-DG, CSE22-L, CSE22-R, CSE22-R-DG, CSE61-L, CSE61-R, CSE61-R-DG, CSE62-L, CSE62-R, CSE62-R-DG, CSG11-L, CSG11-R, CSG11-R-DG, CSG12-L, CSG12-R, CSG12-R-DG, CSG21-L, CSG21-R, CSG21-R-DG...(Other models you can see in the webshop) | | |

MÜLLER

medium temperature: 90°C
duty cycle: 100%

spare parts and accessories

miscellaneous

| | | | |
|---|--|-----------------|----------|
|  | | | |
| 1 | | | |
| GEV No. | 371002 | Ref. No. | 10011599 |
| description | solenoid valve holder MÜLLER flange support | | |
| For models: | CSE11-L, CSE11-R, CSE11-R-DG, CSE12-L, CSE12-R, CSE12-R-DG, CSE21-L, CSE21-R, CSE21-R-DG, CSE22-L, CSE22-R, CSE22-R-DG, CSE61-L, CSE61-R, CSE61-R-DG, CSE62-L, CSE62-R, CSE62-R-DG, CSG11-L, CSG11-R, CSG11-R-DG, CSG12-L, CSG12-R, CSG12-R-DG, CSG21-L, CSG21-R, CSG21-R-DG, CSG22-L, CSG22-R, CSG22-R-DG, CSG61-L, CSG61-R, CSG61-R-DG, CSG62-L, CSG62-R, CSG62-R-DG | | |

various

| | | | |
|---|--|-----------------|--------|
|  | | | |
| 1 | | | |
| GEV No. | 370307 | Ref. No. | 203831 |
| description | valve unit 24VDC | | |
| For models: | CGE21-L, CGE21-R, CGE22-L, CGE22-R, CGG21-L, CGG21-R, CGG22-L, CGG22-R, CSE11-L, CSE11-R, CSE11-R-DG, CSE12-L, CSE12-R, CSE12-R-DG, CSE21-L, CSE21-R, CSE21-R-DG, CSE22-L, CSE22-R, CSE22-R-DG, CSE61-L, CSE61-R, CSE61-R-DG, CSE62-L, CSE62-R, CSE62-R-DG, CSG11-L, CSG11-R, CSG11-R-DG, CSG12-L, CSG12-R, CSG12-R-DG, CSG21-L, CSG21-R, CSG21-R-DG, CSG22-L, CSG22-R, CSG22-R-DG, CSG61-L, CSG61-R, CSG61-R-DG, CSG62-L, CSG62-R, CSG62-R-DG | | |

metal

PARKER

solenoid valves (various)

| | | | |
|--|---|-----------------|--------|
|  | | | |
| 1 | | | |
| GEV No. | 370749 | Ref. No. | 201153 |
| description | solenoid valve 2-ways 230VAC inlet 1/8" outlet 1/8" connection 1/8" L 30mm PARKER type series WB4.5 membranes Viton p max 10bar 50/60Hz brass | | |
| For models: | CPE63 | | |

solenoid valves (various)

| | | | |
|---|--|-----------------|--------|
|  | | | |
| 1 | | | |
| GEV No. | 370175 | Ref. No. | 201657 |
| description | solenoid valve 2-ways 230VAC connection 1/4" brass | | |
| For models: | 1422802B04, 1422802B05, 1422802B06, 1422804B04, 1422804B05, 1422804B06, 1422805B04, 1422805B05, 1422805B06, 1422807B00, 1422807B01, 1422807B02, 1422902-00, 1422902-01, 1422902-02, 1462802B00, 1462802B01, 1462802B02, 1462802B03, 1462802B04, 1462802B05, 1462804B00, 1462804B01, 1462804B02, 1462804B03, 1462804B04, 1462804B05, 2022801-02, 2022801-03, 2022801A02, 2022801A03, 2022801B02, 2022801B03, 2022801C02, 2022801C03, 2022802-02, 2022802-03, 2022802A02, 2022802A03, 2022802B02, 2022802B03, 2022802B04, 2022802B05, 2022802B06, 2022802B07, 2022802C02, 2022802C03, 2022802C07, 2022803-02, 2022803-03...(Other models you can see in the webshop) | | |



| | | | |
|---|---|-----------------|--------|
|  | | | |
| 1 | | | |
| GEV No. | 370748 | Ref. No. | 201141 |
| description | solenoid valve 2-ways 230VAC inlet 1/8" outlet 1/8" L 40mm p max 10bar 50Hz brass | | |
| For models: | CGE11-L, CGE11-R, CGE12-L, CGE12-R, CGE21-L, CGE21-R, CGE22-L, CGE22-R, CGE61-L, CGE61-R, CGE62-L, CGE62-R, CGG11-L, CGG11-R, CGG12-L, CGG12-R, CGG21-L, CGG21-R, CGG22-L, CGG22-R, CGG61-L, CGG61-R, CGG62-L, CGG62-R, CPE63, CSE11-L, CSE11-R, CSE12-L, CSE12-R, CSE21-L, CSE21-R, CSE22-L, CSE22-R, CSE61-L, CSE61-R, CSE62-L, CSE62-R, CSG11-L, CSG11-R, CSG12-L, CSG12-R, CSG21-L, CSG21-R, CSG22-L, CSG22-R, CSG61-L, CSG61-R | | |

| | | | |
|--|--|-----------------|----------|
|  | | | |
| 1 | | | |
| GEV No. | 371002 | Ref. No. | 10011599 |
| description | solenoid valve holder MÜLLER flange support | | |
| For models: | CSE11-L, CSE11-R, CSE11-R-DG, CSE12-L, CSE12-R, CSE12-R-DG, CSE21-L, CSE21-R, CSE21-R-DG, CSE22-L, CSE22-R, CSE22-R-DG, CSE61-L, CSE61-R, CSE61-R-DG, CSE62-L, CSE62-R, CSE62-R-DG, CSG11-L, CSG11-R, CSG11-R-DG, CSG12-L, CSG12-R, CSG12-R-DG, CSG21-L, CSG21-R, CSG21-R-DG, CSG22-L, CSG22-R, CSG22-R-DG, CSG61-L, CSG61-R, CSG61-R-DG, CSG62-L, CSG62-R, CSG62-R-DG | | |

solenoid valves (gas)

| | | | |
|---|--|-----------------|--------|
| DUNGS | | | |
|  | | | |
| 1 | | | |
| GEV No. | 102379 ¹ | Ref. No. | 201529 |
| description | solenoid valve 230VAC connection 1/2" L 76mm DUNGS p max 0.2bar p min 0bar reg. no. 63AQ0626 gas inlet 1/2" gas outlet 1/2" | | |
| For models: | 2061403-00, 2061403-01, 20614033-0, 2061403A00, 2061403B00, 2061403C00, 2061404-00, 2061404-01, 20614044-0, 2061404A00, 2061404B00, 2061404C00, 2061405-00, 2061405B00, 2061406-00, 2061406B00, 20628033-0, 20628044-0, 20629011-0, 20629022-0, 3061403-00, 3061403A00, 3061403B00, 3061403C00, 3061404-00, 3061404A00, 3061404B00, 3061404C00, 3061405-00, 3061405B00, 3061405B01, 3061406-00, 3061406B00 | | |

¹aluminium housing

Solenoid valve - accessories

| | | | |
|---|---|-----------------|--------|
|  | | | |
| 1 | | | |
| GEV No. | 371001 | Ref. No. | 204532 |
| description | solenoid valve holder | | |
| For models: | 1422807B03, 1422807B04, 1422831-00, 1422832-00, 1422833-00, 1422834-00, 1422902-03, 1422902-04, 1422908-00, 1422910-00, 1462831-00, 1462832-00, 1462833-00, 1462834-00, 1462835-00, 1462836-00, 1462837-00, 1462838-00, 1462839-00, 1462840-00, 1462908-00, 1462910-00, 2022802B08, 2022802B09, 2022802B10, 2022802C08, 2022802C09, 2022802C10, 2022802D00, 2022802D01, 2022802D02, 2022804B08, 2022804B09, 2022804B10, 2022804C08, 2022804C09, 2022804C10, 2022804D00, 2022804D01, 2022804D02, 2022805B08, 2022805B09, 2022805B10, 2022805C08, 2022805C09, 2022805C10, 2022805D00, 2022805D01, 2022807B06, 2022807B07... (Other models you can see in the webshop) | | |

pressure switches for steam control

| | | | |
|---|---|-----------------|--------|
|  | | | |
| 1 | | | |
| GEV No. | 541139 | Ref. No. | 203399 |
| description | pressure control ø 45mm pressure connection vertical steam control pressure range 0.8/0.65bar connection 1/4" pressure connection 1/4" | | |
| For models: | 1422802B04, 1422802B05, 1422802B06, 1422802B07, 1422802B08, 1422804B04, 1422804B05, 1422804B06, 1422804B07, 1422804B08, 1422805B04, 1422805B05, 1422805B06, 1422805B07, 1422805B08, 1422807B00, 1422807B01, 1422807B02, 1422807B03, 1422807B04, 1422831-00, 1422832-00, 1422833-00, 1422834-00, 1422902-00, 1422902-01, 1422902-02, 1422902-03, 1422902-04, 1422908-00, 1422910-00, 1462802B00, 1462802B01, 1462802B02, 1462802B03, 1462802B04, 1462802B05, 1462804B00, 1462804B01, 1462804B02, 1462804B03, 1462804B04, 1462804B05, 1462831-00, 1462832-00, 1462835-00, 1462836-00, 1462837-00, 1462908-00, 2022802B04... (Other models you can see in the webshop) | | |

| | | | |
|--|---|-----------------|--------|
|  | | | |
| 1 | | | |
| GEV No. | 541022 | Ref. No. | 203439 |
| description | pressure control steam control pressure connection vertical pressure range adjustable 0.25-4.5bar connection 1/4" pressure connection 1/4" IT | | |
| For models: | 14228011-0, 14228022-0, 14228033-0, 14228044-0, 14228055-0, 2022801-00, 2022801-01, 2022801-02, 2022801-03, 20228011-0, 20228011-1, 2022801A00, 2022801A01, 2022801A02, 2022801A03, 2022801B00, 2022801B01, 2022801B02, 2022801B03, 2022801C00, 2022801C01, 2022801C02, 2022801C03, 2022802-00, 2022802-01, 2022802-02, 2022802-03, 20228022-0, 20228022-1, 2022802A00, 2022802A01, 2022802A02, 2022802A03, 2022802B00, 2022802B01, 2022802B02, 2022802B03, 2022802C00, 2022802C01, 2022802C02, 2022802C03, 2022803-00, 2022803-01, 2022803-02, 2022803-03, 20228033-0, 20228033-1, 2022803A00, 2022803A01, 2022803A02... (Other models you can see in the webshop) | | |





for combi-steamers

| | | | |
|---|--|-----------------|--------|
|  | | | |
| 1 | | | |
| GEV No. | 543037 | Ref. No. | 202601 |
| description | pressure control ø 23mm pressure range 15/25mbar connection 9mm 42V 2A | | |
| For models: | CCE60, CCE63, CPE60, CPE63 | | |

| | | | |
|---|---|-----------------|----------------------|
|  | | | |
| 1 | | | |
| GEV No. | 542407 | Ref. No. | 10011816 10017027 |
| description | pressure control triggering pressure 100bar 48V 0.5A 1/4" | | |

electrodes

| | | | |
|---|--|-----------------|--------|
|  | | | |
| 1 | | | |
| GEV No. | 400122 | Ref. No. | 230867 |
| description | level electrode 1/4" probe L 102mm insulated probe length 95mm | | |

| | | | |
|---|--|-----------------|--------------------------------------|
|  | | | |
| 1 | | | |
| GEV No. | 401409 | Ref. No. | 203858 203859 203867 845591 |
| description | level electrode 1/4" total length 132mm probe L 102mm insulated probe length 95mm connection F6.3 ø 3mm | | |
| spare parts for | 401409 | | |
| | GEV No. | 401458 | Ref. No. 203601 |
| |  level electrode M10x1 total length 132mm probe L 112mm insulated probe length 105mm connection F6.3 1/8" | | |

| | | | |
|--|---|-----------------|--------|
|  | | | |
| 1 | | | |
| GEV No. | 401458 | Ref. No. | 203601 |
| description | level electrode M10x1 total length 132mm probe L 112mm insulated probe length 105mm connection F6.3 1/8" | | |
| For models: | 1422802B04, 1422802B05, 1422802B06, 1422802B07, 1422802B08, 1422804B04, 1422804B05, 1422804B06, 1422804B07, 1422804B08, 1422805B04, 1422805B05, 1422805B06, 1422805B07, 1422805B08, 1422807B00, 1422807B01, 1422807B02, 1422807B03, 1422807B04, 1422831-00, 1422832-00, 1422833-00, 1422834-00, 1422902-00, 1422902-01, 1422902-02, 1422902-03, 1422902-04, 1422908-00, 1422910-00, 1423901-00, 1423901-01, 1423901-02, 1423902-00, 1423902-01, 1423902-02, 1423903-00, 1423903-01, 1423903-02, 1462802B01, 1462802B02, 1462802B03, 1462802B04, 1462802B05, 1462804B01, 1462804B02, 1462804B03, 1462804B04, 1462804B05... (Other models you can see in the webshop) | | |

flow meters and flow sensors

flow meters

| | | | |
|---|--|-----------------|--------|
| <p>GICAR</p> | | | |
|  | | | |
| 1 | | | |
| GEV No. | 403873 | Ref. No. | 203687 |
| description | flow meter thread M10x1 plastic nominal-ø 2mm approval NSF Qmax. 2.3l/min | | |
| For models: | CGE11-L, CGE11-R, CGE12-L, CGE12-R, CGE21-L, CGE21-R, CGE22-L, CGE22-R, CGE61-L, CGE61-R, CGE62-L, CGE62-R, CGG11-L, CGG11-R, CGG12-L, CGG12-R, CGG21-L, CGG21-R, CGG22-L, CGG22-R, CGG61-L, CGG61-R, CGG62-L, CGG62-R, CSE11-L, CSE11-R, CSE12-L, CSE12-R, CSE21-L, CSE21-R, CSE22-L, CSE22-R, CSE61-L, CSE61-R, CSE62-L, CSE62-R, CSG11-L, CSG11-R, CSG12-L, CSG12-R, CSG21-L, CSG21-R, CSG22-L, CSG22-R, CSG61-L, CSG61-R | | |





fans

axial fans

ebm-papst



| | | | |
|--|---|-----------------|-------------------|
| GEV No. | 601030 ¹ | Ref. No. | 203155 |
| description | axial fan L 119mm W 119mm H 38mm 230VAC 50Hz 18W bearing ball bearing manuf. no. 4656Z metal connection male faston 2.8mm ebm-papst fan wheel ø 110mm temp.-resist. 75°C | | |
| For models: | 0723104B03, 0723105B03, 1223204-00, 1223204-01, 1223204-02, 1223205-00, 1223205-01, 1223205-02, 1223206-00, 1223206-01, 1223206-02, 1223212-00, 1223214-00, 1423104B03, 1423105B03, 2023114-00, 2023118-00, 2023119-00, 2023206-00, 2023206-01, 2023207-00, 2023207-01, 2023207-02, 2023207-03, 2023207-04, 2023503-04, 2023503-05, 2023503-06, 2023503-07, 2023503-08, 2023503-09, 2023503-10, 2023503A04, 2023503A05, 2023503A06, 2023503A07, 2023503A08, 2023503A09, 2023503A10, 2123207A00, 2123208A00, 2123208A01, 2123208A02, 2123503-01, 2123503-02, 2123503-03, 2123503-04, 2123503-05, 2123503-06, 2123503A01... (Other models you can see in the webshop) | | |
| accessories for | 601030 | | |
|  | GEV No. | 550898 | Ref. No. — |
| | connecting cable cable length 2000mm connection F 2.8 connection distance 7.9mm for axial flow fan | | |
|  | GEV No. | 692497 | Ref. No. — |
| | guard ø 105mm mounting distance 150mm for axial fan ebm-papst-mm | | |

¹with ball bearings



| | | | |
|--------------------|--|-----------------|--------|
| GEV No. | 601715 ¹ | Ref. No. | 203819 |
| description | axial fan L 119mm W 119mm H 38mm 230VAC 50Hz 18W bearing ball bearing manuf. no. 4656ZW metal connection cable 310mm ebm-papst fan wheel ø 110mm temp.-resist. 75°C | | |
| For models: | CCE60, CCE63, CGG21-L, CGG21-R, CGG22-L, CGG22-R, CPE60, CPE63, CSE11-L, CSE11-R, CSE11-R-DG, CSE12-L, CSE12-R, CSE12-R-DG, CSE61-L, CSE61-R, CSE61-R-DG, CSE62-L, CSE62-R, CSE62-R-DG, CSG11-L, CSG11-R, CSG11-R-DG, CSG12-L, CSG12-R, CSG12-R-DG, CSG21-L, CSG21-R, CSG21-R-DG, CSG22-L, CSG22-R, CSG22-R-DG, CSG61-L, CSG61-R, CSG61-R-DG, CSG62-L, CSG62-R, CSG62-R-DG | | |

¹with ball bearings

import



| | | | |
|---|---|-----------------|-------------------|
| GEV No. | 601130 ¹ | Ref. No. | 203152 |
| description | axial fan L 80mm W 80mm H 25mm 230VAC 50/60Hz 13/14W bearing ball bearing connection male faston 2.8mm metal ADDA fan wheel ø 75mm temp.-resist. 70°C airflow 30.6m ³ /h | | |
| accessories for | 601130 | | |
|  | GEV No. | 550898 | Ref. No. — |
| | connecting cable cable length 2000mm connection F 2.8 connection distance 7.9mm for axial flow fan | | |

¹with ball bearings

hot air motors

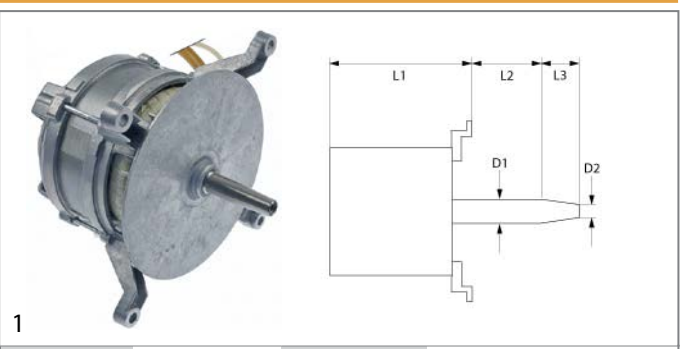

| | | | |
|--------------------|--|-----------------|--------|
| GEV No. | 601862 | Ref. No. | 203977 |
| description | fan motor 200-230V 3 phase 50Hz 0.45/0.65kW 700/1400rpm speeds 2 L1 145mm L2 35mm L3 35mm 0.7/2A D1 ø 17mm D2 ø 13.5mm | | |
| For models: | CGE11-L, CGE11-R, CGE12-L, CGE12-R, CGE61-L, CGE61-R, CGE62-L, CGE62-R, CSE11-L, CSE11-R, CSE12-L, CSE12-R, CSE61-L, CSE61-R, CSE62-L, CSE62-R | | |



| | | | |
|--------------------|--|-----------------|--------|
| GEV No. | 501583 | Ref. No. | 202745 |
| description | fan motor 200-240V 50/60Hz 3000/3600rpm L1 125mm L2 35mm L3 15mm ø 100mm 0.5/0,7A type L5tw2 - 695 D1 ø 8mm D2 ø 8x7.5mm | | |
| For models: | CCE60, CCE63, CPE60, CPE63 | | |



| | | | |
|--|--|-----------------|--------|
|  <p>1</p> | | | |
| GEV No. | 602153 | Ref. No. | 202673 |
| description | fan motor 200-480V 3 phase 50/60Hz 0.6-0.82kW 1380/1650rpm speeds 1 L1 151mm L2 67mm L3 35mm ø 160mm M10 IT 2.8/1.6A at 50Hz 200-415V at 60Hz 200-480V at 50Hz 1380rpm at 60Hz 1650rpm type L9Fw4D-678 no. C6 D1 ø 17mm D2 ø 13.5mm with shaft sealing | | |
| For models: | CSE11-L, CSE11-R, CSE11-R-DG, CSE12-L, CSE12-R, CSE12-R-DG, CSE21-L, CSE21-R, CSE21-R-DG, CSE22-L, CSE22-R, CSE22-R-DG, CSE61-L, CSE61-R, CSE61-R-DG, CSE62-L, CSE62-R, CSE62-R-DG | | |

| | | | |
|---|--|-----------------|--------|
|  <p>1</p> | | | |
| GEV No. | 514512 | Ref. No. | 062002 |
| description | fan wheel blades 12 D1 ø 350mm D2 ø 13mm D3 ø 16mm H1 115mm H2 32mm H3 4.5mm | | |
| For models: | CGE11-L, CGE11-R, CGE12-L, CGE12-R, CGE21-L, CGE21-R, CGE22-L, CGE22-R, CGE61-L, CGE61-R, CGE62-L, CGE62-R, CGG11-L, CGG11-R, CGG12-L, CGG12-R, CGG21-L, CGG21-R, CGG22-L, CGG22-R, CSE11-L, CSE11-R, CSE11-R-DG, CSE12-L, CSE12-R, CSE12-R-DG, CSE21-L, CSE21-R, CSE21-R-DG, CSE22-L, CSE22-R, CSE22-R-DG, CSE61-L, CSE61-R, CSE61-R-DG, CSE62-L, CSE62-R, CSE62-R-DG, CSG11-L, CSG11-R, CSG11-R-DG, CSG12-L, CSG12-R, CSG12-R-DG, CSG21-L, CSG21-R, CSG21-R-DG, CSG22-L, CSG22-R, CSG22-R-DG | | |

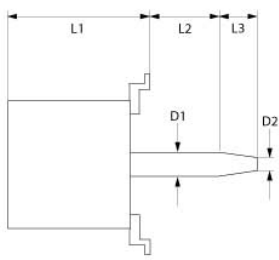
| | | | |
|--|--|-----------------|--------|
|   <p>1</p> | | | |
| GEV No. | 601485 | Ref. No. | 203771 |
| description | fan motor 240V 3 phase 60Hz 0.68kW 1730rpm speeds 1 L1 150mm L2 24mm L3 35mm M10R IT 2.9A power input 870W at 60Hz 1730rpm type L9DFw4D-596 no. W6 D1 ø 17mm D2 ø 13mm | | |
| For models: | CGE11-L, CGE11-R, CGE12-L, CGE12-R, CGE21-L, CGE21-R, CGE22-L, CGE22-R, CGE61-L, CGE61-R, CGE62-L, CGE62-R, CGG11-L, CGG11-R, CGG12-L, CGG12-R, CGG21-L, CGG21-R, CGG22-L, CGG22-R, CGG61-L, CGG61-R, CGG62-L, CGG62-R, CSE11-L, CSE11-R, CSE12-L, CSE12-R, CSE21-L, CSE21-R, CSE22-L, CSE22-R, CSE61-L, CSE61-R, CSE62-L, CSE62-R, CSG11-L, CSG11-R, CSG11-R-DG, CSG12-L, CSG12-R, CSG12-R-DG, CSG21-L, CSG21-R, CSG21-R-DG, CSG22-L, CSG22-R, CSG22-R-DG, CSG61-L, CSG61-R...(Other models you can see in the webshop) | | |

| | | | |
|--|---|-----------------|--------|
|  <p>1</p> | | | |
| GEV No. | 514513 | Ref. No. | 062008 |
| description | fan wheel blades 45 D1 ø 197mm D2 ø 13mm D3 ø 15mm H1 43mm H2 23mm H3 3mm | | |
| For models: | CCE60, CPE60 | | |

| | | | |
|--|--|-----------------|--------|
|  <p>1</p> | | | |
| GEV No. | 514511 | Ref. No. | 062005 |
| description | fan wheel blades 12 D1 ø 280mm D2 ø 13mm D3 ø 16mm H1 110mm H2 31mm H3 4.5mm | | |
| For models: | CGG61-L, CGG61-R, CGG62-L, CGG62-R, CSG61-L, CSG61-R, CSG61-R-DG, CSG62-L, CSG62-R, CSG62-R-DG | | |

| | | | |
|--|--|-----------------|--------|
|  <p>1</p> | | | |
| GEV No. | 699359 | Ref. No. | 945446 |
| description | flange ED ø 60mm int. ø 1 22mm SS M4 | | |
| For models: | CGE11-L, CGE11-R, CGE12-L, CGE12-R, CGE21-L, CGE21-R, CGE22-L, CGE22-R, CGE61-L, CGE61-R, CGE62-L, CGE62-R, CGG11-L, CGG11-R, CGG12-L, CGG12-R, CGG21-L, CGG21-R, CGG22-L, CGG22-R, CGG61-L, CGG61-R, CGG62-L, CGG62-R, CPE63, CSE11-L, CSE11-R, CSE11-R-DG, CSE12-L, CSE12-R, CSE12-R-DG, CSE21-L, CSE21-R, CSE21-R-DG, CSE22-L, CSE22-R, CSE22-R-DG, CSE61-L, CSE61-R, CSE61-R-DG, CSE62-L, CSE62-R, CSE62-R-DG, CSG11-L, CSG11-R, CSG11-R-DG, CSG12-L, CSG12-R, CSG12-R-DG, CSG21-L...(Other models you can see in the webshop) | | |

| | | | |
|--|--|-----------------|--------|
|  <p>1</p> | | | |
| GEV No. | 699364 | Ref. No. | 204681 |
| description | flange for combi-steamer ED ø 50mm int. ø 1 24mm int. ø 2 19mm thickness 7mm SS | | |
| For models: | CCE60, CGE11-L, CGE11-R, CGE12-L, CGE12-R, CGE21-L, CGE21-R, CGE22-L, CGE22-R, CGE61-L, CGE61-R, CGE62-L, CGE62-R, CGG11-L, CGG11-R, CGG12-L, CGG12-R, CGG21-L, CGG21-R, CGG22-L, CGG22-R, CGG61-L, CGG61-R, CGG62-L, CGG62-R, CPE60, CSE11-L, CSE11-R, CSE11-R-DG, CSE12-L, CSE12-R, CSE12-R-DG, CSE21-L, CSE21-R, CSE21-R-DG, CSE22-L, CSE22-R, CSE22-R-DG, CSE61-L, CSE61-R, CSE61-R-DG, CSE62-L, CSE62-R, CSE62-R-DG, CSG11-L, CSG11-R, CSG11-R-DG, CSG12-L, CSG12-R, CSG12-R-DG, CSG21-L, CSG21-R...(Other models you can see in the webshop) | | |



| | | |
|---|--|------------------------|
|  | | |
| GEV No. | 699363 | Ref. No. 204423 |
| description | flange for combi-steamer ED ø 57mm int. ø 1 24mm int. ø 2 19mm thickness 7mm SS | |
| For models: | CGE11-L, CGE11-R, CGE12-L, CGE12-R, CGE21-L, CGE21-R, CGE22-L, CGE22-R, CGE61-L, CGE61-R, CGE62-L, CGE62-R, CGG11-L, CGG11-R, CGG12-L, CGG12-R, CGG21-L, CGG21-R, CGG22-L, CGG22-R, CGG61-L, CGG61-R, CGG62-L, CGG62-R, CSE11-L, CSE11-R, CSE11-R-DG, CSE12-L, CSE12-R, CSE12-R-DG, CSE21-L, CSE21-R, CSE21-R-DG, CSE22-L, CSE22-R, CSE22-R-DG, CSE61-L, CSE61-R, CSE61-R-DG, CSE62-L, CSE62-R, CSE62-R-DG, CSG11-L, CSG11-R, CSG11-R-DG, CSG12-L, CSG12-R, CSG12-R-DG, CSG21-L, CSG21-R...(Other models you can see in the webshop) | |

| | | |
|---|---|------------------------|
|  | | |
| GEV No. | 699360 | Ref. No. 945661 |
| description | flange for combi-steamer int. ø 1 22mm int. ø 2 8.5mm thickness 4mm SS L 53mm W 50mm M4 | |
| For models: | CCE60, CCE63, CGE11-L, CGE11-R, CGE12-L, CGE12-R, CGE21-L, CGE21-R, CGE22-L, CGE22-R, CGE61-L, CGE61-R, CGE62-L, CGE62-R, CGG11-L, CGG11-R, CGG12-L, CGG12-R, CGG21-L, CGG21-R, CGG22-L, CGG22-R, CGG61-L, CGG61-R, CGG62-L, CGG62-R, CPE60, CPE63, CSE11-L, CSE11-R, CSE11-R-DG, CSE12-L, CSE12-R, CSE12-R-DG, CSE21-L, CSE21-R, CSE21-R-DG, CSE22-L, CSE22-R, CSE22-R-DG, CSE61-L, CSE61-R, CSE61-R-DG, CSE62-L, CSE62-R, CSE62-R-DG, CSG11-L, CSG11-R, CSG11-R-DG, CSG12-L...(Other models you can see in the webshop) | |

radial fans

| | | |
|---|--|------------------------|
|  | | |
| GEV No. | 601181 | Ref. No. 203994 |
| description | radial fan 230V voltage AC 50Hz 100W H1 170mm L1 175mm D1 ø 50mm W1 115mm W2 40mm H2 45mm | |
| For models: | 1462831-00, 1462832-00, 1462833-00, 1462834-00, 1462835-00, 1462836-00, 1462837-00, 1462838-00, 1462839-00, 1462840-00, 1462908-00, 1462910-00, 2062831-00, 2062832-00, 2062833-00, 2062834-00, 2062835-00, 2062835-01, 2062836-00, 2062836-01, 2062837-00, 2062837-01, 2062838-00, 2062838-01, 2062839-00, 2062839-01, 2062840-00, 2062840-01, 2062908-00, 2062910-00, 2162835-00, 2162835-01, 2162838-00, 2162838-01, 3062831-00, 3062832-00, 3062833-00, 3062834-00, 3062835-00, 3062836-00, 3062837-00, 3062838-00, 3062839-00, 3062840-00, 3062908-00, 3062910-00, CGG11-L, CGG11-R, CGG12-L, CGG12-R...(Other models you can see in the webshop) | |

| | | |
|---|--|------------------------|
| <p>miscellaneous</p>  | | |
| GEV No. | 601475 | Ref. No. 203926 |
| description | radial fan 230V voltage AC 50/60Hz 20W H1 180mm L1 180mm D1 ø 86mm W1 40mm W2 34mm H2 122mm W3 40mm H3 172mm | |
| For models: | 1424833-01, 1424834-01, 1424835-01, 1424836-01, 2023210-01, 2023211-01, CGE11-L, CGE11-R, CGE12-L, CGE12-R, CGE21-L, CGE21-R, CGE22-L, CGE22-R, CGE61-L, CGE61-R, CGE62-L, CGE62-R, CGG11-L, CGG11-R, CGG12-L, CGG12-R, CGG21-L, CGG21-R, CGG22-L, CGG22-R, CGG61-L, CGG61-R, CGG62-L, CGG62-R, CSE11-L, CSE11-R, CSE11-R-DG, CSE12-L, CSE12-R, CSE12-R-DG, CSE21-L, CSE21-R, CSE21-R-DG, CSE22-L, CSE22-R, CSE22-R-DG, CSE61-L, CSE61-R, CSE61-R-DG, CSE62-L, CSE62-R, CSE62-R-DG, CSG11-L, CSG11-R...(Other models you can see in the webshop) | |

accessories universal

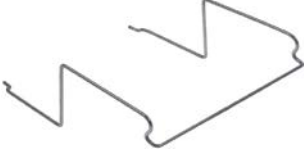
| | | |
|---|--|------------------------|
|  | | |
| GEV No. | 521183 | Ref. No. 204607 |
| description | support bracket L 125mm W 105mm fan for HDECOD61 | |
| For models: | CSE11-L, CSE11-R, CSE11-R-DG, CSE12-L, CSE12-R, CSE12-R-DG, CSE61-L, CSE61-R, CSE61-R-DG, CSE62-L, CSE62-R, CSE62-R-DG, CSG11-L, CSG11-R, CSG11-R-DG, CSG12-L, CSG12-R, CSG12-R-DG, CSG61-L, CSG61-R, CSG61-R-DG, CSG62-L, CSG62-R, CSG62-R-DG | |



motors

gear motors

for grills



| | | | |
|--------------------|--|-----------------|--------|
| GEV No. | 500801 | Ref. No. | 203039 |
| description | gear motor 230V | | |
| For models: | 1220303A00, 1220303A01, 1220303A02, 1220303A03, 1220303C00, 1220303C01, 1220303C02, 1220303C03, 1220303F01, 1220303F02, 1220303F03, 1220303H00, 1220303H01, 1220303H02, 1220303H03, 1220304A00, 1220304A01, 1220304A02, 1220304C00, 1220304C01, 1220304C02, 1220304F00, 1220304F01, 1220304H00, 1220304H01, 1220305A00, 1220305A01, 1220305A02, 1220305A03, 1220305A04, 1220305A05, 1220305C00, 1220305C01, 1220305C02, 1220305C03, 1220305C04, 1220305C05, 1220305F01, 1220305F02, 1220305F03, 1220305F04, 1220305F05, 1220305H00, 1220305H01, 1220305H02, 1220305H03, 1220305H04, 1220305H05, 1220306A00, 1220306A01... (Other models you can see in the webshop) | | |

spindle motors

miscellaneous



| | | | |
|--------------------|------------------------------------|-----------------|--------|
| GEV No. | 500665 | Ref. No. | 203157 |
| description | spindle motor | | |
| For models: | 2020303-00, 2020303-01, 2020303-02 | | |



| | | | |
|--------------------|------------------------|-----------------|--------|
| GEV No. | 500666 | Ref. No. | 203388 |
| description | spindle motor | | |
| For models: | 2020303-03, 2020303-04 | | |

| | | | |
|--------------------|--|-----------------|--------|
| GEV No. | 500667 | Ref. No. | 203144 |
| description | spindle motor | | |
| For models: | 2021402-02, 2021402-03, 2021402-04, 2021402-05, 2021402-06, 2021402-07, 2021402-08, 2021402A01, 2021402A02, 2021402A03, 2021402A04, 2021402A06, 2021402A07, 2021402A08, 2021402B01, 2021402B02, 2021402B03, 2021402B04, 2021402B06, 2021402B07, 2021402B08, 2021402C01, 2021402C02, 2021402C03, 2021402C04, 2021402C06, 2021402C07, 2021402C08, 2021404-00, 2021404-01, 2021404-02, 2021404-03, 2021404-04, 2021404-05, 2021404-06, 2021404A-0, 2021404A00, 2021404A01, 2021404A02, 2021404A04, 2021404A05, 2021404A06, 2021404B00, 2021404B01, 2021404B02, 2021404B04, 2021404B05, 2021404B06, 2021404C00, 2021404C01... (Other models you can see in the webshop) | | |

| | | | |
|--------------------|--|-----------------|--------|
| GEV No. | 500668 | Ref. No. | 203147 |
| description | spindle motor | | |
| For models: | 2021402-00, 2021402-01, 2021402A00, 2021402B00, 2021402C00, 2061402-00, 2061402-01, 2061402A00, 2061402B00, 2061402C00 | | |

pumps

drain pumps

HANNING



| | | | |
|--------------------|--|-----------------|--------|
| GEV No. | 499302 | Ref. No. | 203788 |
| description | drain pump inlet ø 24mm outlet ø 24mm 220-240V 30W 50Hz HANNING type DPS25-303 | | |
| For models: | CPE63 | | |



magnetic-drive pumps



1

| | | | |
|--------------------|---|-----------------|--------|
| GEV No. | 500696 | Ref. No. | 203825 |
| description | magnetic-drive pump HANNING type DP040-025 30W 230V 50Hz inlet ø 24mm outlet ø 11mm L 130mm | | |
| For models: | CCE60, CCE63, CGE11-L, CGE11-R, CGE12-L, CGE12-R, CGE21-L, CGE21-R, CGE22-L, CGE22-R, CGE61-L, CGE61-R, CGE62-L, CGE62-R, CGG11-L, CGG11-R, CGG12-L, CGG12-R, CGG21-L, CGG21-R, CGG22-L, CGG22-R, CGG61-L, CGG61-R, CGG62-L, CGG62-R, CPE60, CPE63, CSE11-L, CSE11-R, CSE11-R-DG, CSE12-L, CSE12-R, CSE12-R-DG, CSE21-L, CSE21-R, CSE21-R-DG, CSE22-L, CSE22-R, CSE22-R-DG, CSE61-L, CSE61-R, CSE61-R-DG, CSE62-L, CSE62-R, CSE62-R-DG, CSG11-L, CSG11-R, CSG11-R-DG, CSG12-L...(Other models you can see in the webshop) | | |



1

| | | | |
|--------------------|---|-----------------|--------|
| GEV No. | 499303 | Ref. No. | 203826 |
| description | magnetic-drive pump HANNING type DP040-028 65W 208-240V 60Hz inlet ø 24mm outlet ø 11mm L 140mm | | |
| For models: | CCE60, CCE63, CGE11-L, CGE11-R, CGE12-L, CGE12-R, CGE21-L, CGE21-R, CGE22-L, CGE22-R, CGE61-L, CGE61-R, CGE62-L, CGE62-R, CGG11-L, CGG11-R, CGG12-L, CGG12-R, CGG21-L, CGG21-R, CGG22-L, CGG22-R, CGG61-L, CGG61-R, CGG62-L, CGG62-R, CPE60, CPE63, CSE11-L, CSE11-R, CSE11-R-DG, CSE12-L, CSE12-R, CSE12-R-DG, CSE21-L, CSE21-R, CSE21-R-DG, CSE22-L, CSE22-R, CSE22-R-DG, CSE61-L, CSE61-R, CSE61-R-DG, CSE62-L, CSE62-R, CSE62-R-DG, CSG11-L, CSG11-R, CSG11-R-DG, CSG12-L...(Other models you can see in the webshop) | | |

filters

RC circuits



1

| | | | |
|--------------------|--|-----------------|--------|
| GEV No. | 381485 | Ref. No. | 203743 |
| description | RC circuit type LA4DA2U 110-240V Qty 1 pcs | | |
| For models: | CGE21-L, CGE21-R, CGE22-L, CGE22-R, CSE21-L, CSE21-R, CSE21-R-DG, CSE22-L, CSE22-R, CSE22-R-DG | | |



1

| | | | |
|--------------------|---|-----------------|--------|
| GEV No. | 380049 | Ref. No. | 203683 |
| description | RC circuit type LAD4RCU 110-250V | | |
| For models: | 0720332R00, 0720332V00, 1220329B00, 1220329B01, 1320329B00, 1320329B01, 1320329C01, 1320329C02, 1420329B00, 1420329B01, 1420329C00, 1420329C01, 1422701-02, 1422701-03, 1422702-02, 1422702-03, 1422703-01, 1422703-02, 1422704-01, 1422704-02, 1422705-01, 1422705-02, 1422706-01, 1422706-02, 1422707-01, 1422707-02, 1422708-01, 1422708-02, 1423901-00, 1423901-01, 1423901-02, 1423902-00, 1423902-01, 1423902-02, 1423903-00, 1423903-01, 1423903-02, 1424101-01, 1424102-01, 1424103-00, 1424104-00, 2012828-00, 2012828-01, 2012828-02, 2012828-03, 2012828-04, 2012828-05, 2020329B01, 2020329B02, 2020329C01... | | |

fuses

fine fuses



1

| | | | |
|--------------------|--|-----------------|--------|
| GEV No. | 358598 | Ref. No. | 202776 |
| description | fine fuse size ø5x20mm 0.63A slow-acting rated 250V Qty 10 pcs | | |
| For models: | 0720332R00, 0720332V00 | | |



1

| | | | |
|--------------------|---|-----------------|--------|
| GEV No. | 358599 | Ref. No. | 203720 |
| description | fine fuse size ø5x20mm 0.8A slow-acting rated 250V Qty 10 pcs | | |
| For models: | 0521702B03, 0521702B04, 2022828-01, 2022828-02, 2022828-03, 2022828-04, 2022828-05, 2022828-06, 3022828-03, 3022828-04, 3022828-05, 3022828-06, 3022828-07, CGE11-L, CGE11-R, CGE12-L, CGE12-R, CGE21-L, CGE21-R, CGE22-L, CGE22-R, CGE61-L, CGE61-R, CGE62-L, CGE62-R, CPE63, CSE11-L, CSE11-R, CSE12-L, CSE12-R, CSE21-L, CSE21-R, CSE22-L, CSE22-R, CSE61-L, CSE61-R, CSE62-L, CSE62-R | | |

condensators & interference suppression filters

operating capacitors

plastic



1

| | | | |
|--------------------|---|-----------------|--------|
| GEV No. | 365031 | Ref. No. | 202742 |
| description | operating capacitor capacity 4µF 450V tolerance 5% 50/60Hz ambient temperature max. -25 to +85°C ø 31mm L 58mm M8 plastic connection male faston 6.3mm protection | | |
| For models: | CCE60, CCE63, CPE60, CPE63 | | |



| | | | |
|---|--|-----------------|--------|
|  | | | |
| 1 | | | |
| GEV No. | 358601 | Ref. No. | 203722 |
| description | fine fuse size ø5x20mm 1.25A slow-acting rated 250V Qty 10 pcs | | |
| For models: | CCE60, CCE63, CGE12-L, CGE12-R, CGE62-L, CGE62-R, CGG11-L, CGG11-R, CGG12-L, CGG12-R, CGG21-L, CGG21-R, CGG22-L, CGG22-R, CGG61-L, CGG61-R, CGG62-L, CGG62-R, CPE60, CPE63, CSE12-L, CSE12-R, CSE62-L, CSE62-R, CSG11-L, CSG11-R, CSG11-R-DG, CSG12-L, CSG12-R, CSG12-R-DG, CSG21-L, CSG21-R, CSG21-R-DG, CSG22-L, CSG22-R, CSG22-R-DG, CSG61-L, CSG61-R, CSG61-R-DG, CSG62-L, CSG62-R, CSG62-R-DG | | |

| | | | |
|--|---|-----------------|--------|
|  | | | |
| 1 | | | |
| GEV No. | 358607 | Ref. No. | 203473 |
| description | fine fuse size ø5x20mm 6.3A slow-acting rated 250V Qty 10 pcs | | |
| For models: | 1422701-01, 1422701-02, 1422701-03, 1422702-01, 1422702-02, 1422702-03, 1422802B04, 1422802B05, 1422802B06, 1422802B07, 1422802B08, 1422804B04, 1422804B05, 1422804B06, 1422804B07, 1422804B08, 1422805B04, 1422805B05, 1422805B06, 1422805B07, 1422805B08, 1422807B00, 1422807B01, 1422807B02, 1422807B03, 1422807B04, 1422902-00, 1422902-01, 1422902-02, 1422902-03, 1422902-04, 2013004B01, 2013004B02, 2013004B03, 2013004B04, 2013004B05, 2013008B01, 2013008B02, 2013008B03, 2013008B04, 2013008B05, 2013010B01, 2013010B02, 2013010B03, 2013010B04, 2013010B05, 2013018B00, 2013018B01, 2013018B02, 2013018B03... (Other models you can see in the webshop) | | |

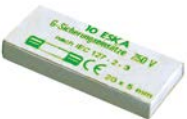
| | | | |
|---|---|-----------------|--------|
|  | | | |
| 1 | | | |
| GEV No. | 358608 | Ref. No. | 203996 |
| description | fine fuse size ø5x20mm 10A slow-acting rated 250V Qty 10 pcs | | |
| For models: | CGE11-L, CGE11-R, CGE12-L, CGE12-R, CGE21-L, CGE21-R, CGE22-L, CGE22-R, CGE61-L, CGE61-R, CGE62-L, CGE62-R, CGG11-L, CGG11-R, CGG12-L, CGG12-R, CGG21-L, CGG21-R, CGG22-L, CGG22-R, CGG61-L, CGG61-R, CGG62-L, CGG62-R, CPE63, CSE11-L, CSE11-R, CSE11-R-DG, CSE12-L, CSE12-R, CSE12-R-DG, CSE21-L, CSE21-R, CSE21-R-DG, CSE22-L, CSE22-R, CSE22-R-DG, CSE61-L, CSE61-R, CSE61-R-DG, CSE62-L, CSE62-R, CSE62-R-DG, CSG11-L, CSG11-R, CSG11-R-DG, CSG12-L, CSG12-R, CSG12-R-DG, CSG21-L... (Other models you can see in the webshop) | | |

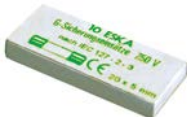
| | | | |
|--|---|-----------------|--------|
|  | | | |
| 1 | | | |
| GEV No. | 358704 | Ref. No. | 203741 |
| description | fine fuse size ø5x20mm 8A slow-acting rated 250V Qty 10 pcs | | |

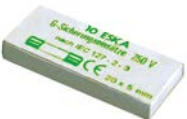
| | | | |
|--|---|-----------------|--------|
|  | | | |
| 1 | | | |
| GEV No. | 358603 | Ref. No. | 203474 |
| description | fine fuse size ø5x20mm 2A slow-acting rated 250V Qty 10 pcs | | |
| For models: | 0220302A00, 0220302A01, 0220302A02, 0220302A03, 0220302C00, 0220302C01, 0220302C02, 0220302C03, 0220303A00, 0220303A01, 0220303A02, 0220303A03, 0220303B00, 0220303B01, 0220303C00, 0220303C01, 0220303C02, 0220303E00, 0220303E01, 0220304-00, 0220305-00, 0220306-00, 0221501-00, 0221502-00, 0720332P00, 0720332R00, 0720332T00, 0720332V00, 1220307-00, 1220307-01, 1220308-00, 1220326-00, 1220326-01, 1220326B00, 1220326B01, 1220327-00, 1220327-01, 1220327B01, 1220329-00, 1220329-01, 1220329B00, 1220329B01, 1221112-00, 1320323-00, 1320323B00, 1320327-00, 1320327A00, 1320327A01, 1320327A02, 1320327B00... (Other models you can see in the webshop) | | |

fine fuse holders

| | | | |
|--|---|-----------------|--------|
|  | | | |
| 1 | | | |
| GEV No. | 551378 | Ref. No. | 203635 |
| description | fuse holder for USIG suitable fuse 5x20/5x25/5x30 1-pole 6.3A rated 400V L 45.4mm W 9.9mm H 32mm connection plug-in connection Phönix Control ST-SI | | |
| For models: | 0220302A00, 0220302A01, 0220302A02, 0220302A03, 0220302C00, 0220302C01, 0220302C02, 0220302C03, 0220302H00, 0220302H01, 0220303A00, 0220303A01, 0220303A02, 0220303A03, 0220303C00, 0220303C01, 0220303C02, 0220303H00, 0220303H01, 0220304-00, 0220305-00, 0220306-00, 0221501-00, 0221502-00, 0521702B03, 0521702B04, 0720332P00, 0720332R00, 0720332T00, 0720332V00, 1220307-00, 1220307-01, 1220308-00, 1220326-00, 1220326-01, 1220326B00, 1220326B01, 1220327-00, 1220327-01, 1220327B01, 1220329-00, 1220329-01, 1220329B00, 1220329B01, 1221112-00, 1320323-00, 1320323B00, 1320327-00, 1320327A00, 1320327A01... (Other models you can see in the webshop) | | |

| | | | |
|---|--|-----------------|--------|
|  | | | |
| 1 | | | |
| GEV No. | 358605 | Ref. No. | 203742 |
| description | fine fuse size ø5x20mm 3.15A slow-acting rated 250V Qty 10 pcs | | |

screw locks

D0-system (NEOZED)

| | | | |
|---|--|-----------------|--------|
|  | | | |
| 1 | | | |
| GEV No. | 358045 | Ref. No. | 203739 |
| description | fuse size D02 35A rated 250/400V E18 ø 15mm L 36mm Qty 10 pcs | | |
| For models: | CGE21-L, CGE21-R, CGG11-L, CGG11-R, CGG12-L, CGG12-R, CGG61-L, CGG61-R, CSE12-L, CSE12-R, CSE12-R-DG, CSE21-L, CSE21-R, CSE21-R-DG, CSG11-L, CSG11-R, CSG11-R-DG | | |



electric accessories

plugs - couplings - power sockets

CEE plugs with cable



| | | | |
|--------------------|--|-----------------|--------|
| GEV No. | 551433 | Ref. No. | 203830 |
| description | connecting cable CEE 5-pole contacts 3P+N+E max. 63A max 415V 16mm ² 4.25m straight protection IP67 for combi-steamer | | |
| For models: | CGE11-L, CGE11-R, CGE12-L, CGE12-R, CGE61-L, CGE61-R, CGE62-L, CGE62-R, CGG11-L, CGG11-R, CGG12-L, CGG12-R, CGG61-L, CGG61-R, CGG62-L, CGG62-R | | |

cables

accessories

cable glands

cable glands



| | | | |
|--------------------|---|-----------------|--------|
| GEV No. | 551448 | Ref. No. | 203452 |
| description | cable gland mounting ø 20.6mm plastic Qty 1 pcs | | |
| For models: | 0522101-00, 0522101-01, 0522101-02, 0522101-03, 0522101-04, 0522102-00, 0522102-01, 0522102-02, 0522102-03, 0522102-04, 1303701-01, 1303702-01, 1303703-01, 1303704-00, 1303705-00, 1320301D02, 1320301E02, 1320303D03, 1320303E03, 1320303F03, 1320303F04, 1320303H03, 1320303H04, 1320304F03, 1320304F04, 1320304H03, 1320304H04, 1320305D04, 1320305D05, 1320305E04, 1320305E05, 1320305F04, 1320305F05, 1320305F06, 1320305H04, 1320305H05, 1320305H06, 1320306F04, 1320306F05, 1320306F06, 1320306H04, 1320306H05, 1320306H06, 1320321-00, 1320321-01, 1320321-02, 1320321B00, 1320321B01, 1320321B02, 1320323-00... (Other models you can see in the webshop) | | |

ribbon cables

group 2



| | | | |
|--------------------|---|-----------------|--------|
| GEV No. | 551411 | Ref. No. | 203916 |
| description | connection cable 8-pole L 1000mm plug type RJ45 | | |
| For models: | 0723104-03, 0723104A03, 0723104B03, 0723105-03, 0723105A03, 0723105B03, 1023101-00, 1023101-01, 1023106-00, 1023106-01, 1223101-00, 1223101-01, 1223101-02, 1223103-00, 1223103-01, 1223103-02, 1223106-00, 1223106-01, 1223106-02, 1223111-00, 1223203-03, 1223211-01, 1323101-01, 1323101-02, 1323103-01, 1323103-02, 1323106-00, 1423101-00, 1423101-01, 1423101-02, 1423101A00, 1423101A01, 1423103-00, 1423103-01, 1423103-02, 1423103A00, 1423103A01, 1423104-00, 1423104-01, 1423104-02, 1423104-03, 1423104A00, 1423104A01, 1423104A03, 1423104B03, 1423105-00, 1423105-01, 1423105-02, 1423105-03, 1423105A00... (Other models you can see in the webshop) | | |

group 11



| | | | |
|--------------------|-----------------------------|-----------------|--------|
| GEV No. | 551353 | Ref. No. | 033047 |
| description | ribbon cable 40-pole L 60mm | | |

connection cables

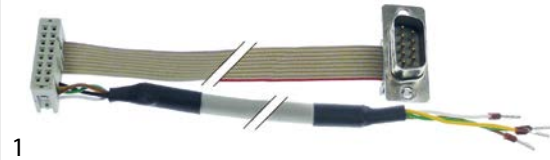

| | | | |
|--------------------|--|-----------------|--------|
| GEV No. | 579003 | Ref. No. | 033057 |
| description | connection cable L 1030mm 13-pole for USB | | |
| For models: | CGE21-L, CGE21-R, CGE22-L, CGE22-R, CGE61-L, CGE61-R, CGE62-L, CGE62-R, CGG21-L, CGG21-R, CGG22-L, CGG22-R, CGG61-L, CGG61-R, CGG62-L, CGG62-R | | |

terminals and connectors

insulated

inline splice connectors





| | | | |
|--------------------|---|-----------------|--------|
| GEV No. | 550158 | Ref. No. | 203080 |
| description | butt splice connector 0.5-1.5mm ² Cu gal Sn insulation PVC red t.max. 75°C Qty 100 pcs | | |
| For models: | 0220302H00, 0220302H01, 0220303H00, 0220303H01, 0520303-02, 0521704-04, 0521704-05, 0521704-06, 0521704-07, 1423502-00, 1423502-01, 1423502-02, 1423502A00, 1423502A01, 1423502A02, 1423505-00, 1423505-01, 1423505A00, 1423505A01, 1424815-04, 1424815A04, 1424817-00, 1424817A00, 2020314-01, 2020314-02, 2020314-03, 2020314A01, 2020314A02, 2020314A03, 2020315-01, 2020315-02, 2020315-03, 2020315A01, 2020315A02, 2020315A03, 2020341-00, 2020341A00, 2020342-00, 2020342A00, 2020406A01, 2023502-05, 2023502-06, 2023502A05, 2023502A06, 2023503-07, 2023503-11, 2023503-12, 2023503A07, 2023503A11, 2023503A12... (Other models you can see in the webshop) | | |





| | | | |
|---|---|-----------------|--------|
| not insulated | | | |
| female fastons | | | |
| iron nickel-plated | | | |
|  | | | |
| 1 | | | |
| GEV No. | 550001 | Ref. No. | 203089 |
| description | female faston size 6.3x0.8mm 1.0-2.5mm ² straight Fe gal Ni t.max. 340°C Qty 100 pcs | | |
| For models: | 0220302A00, 0220302A01, 0220302A02, 0220302A03, 0220302C00, 0220302C01, 0220302C02, 0220302C03, 0220303A00, 0220303A01, 0220303A02, 0220303A03, 0220303C00, 0220303C01, 0220303C02, 0220304-00, 0220305-00, 0220306-00, 1423901-00, 1423901-01, 1423901-02, 1423902-00, 1423902-01, 1423902-02, 1423903-00, 1423903-01, 1423903-02, 1462802B00, 1462802B01, 1462802B02, 1462802B03, 1462802B04, 1462802B05, 1462804B00, 1462804B01, 1462804B02, 1462804B03, 1462804B04, 1462804B05, 1462831-00, 1462832-00, 1462835-00, 1462836-00, 1462837-00, 1462908-00, 2013901-00, 2013901-01, 2013901-02, 2013901-03, 2013902-00... (Other models you can see in the webshop) | | |

| | | | |
|---|--|-----------------|--------|
| plug connectors | | | |
|  | | | |
| 1 | | | |
| GEV No. | 551450 | Ref. No. | 203732 |
| description | plug connector 4-pole male faston 6.3mm L 52mm | | |
| For models: | CGE11-L, CGE11-R, CGE12-L, CGE12-R, CGE21-L, CGE21-R, CGE22-L, CGE22-R, CGE61-L, CGE61-R, CGE62-L, CGE62-R, CGG11-L, CGG11-R, CGG12-L, CGG12-R, CGG21-L, CGG21-R, CGG22-L, CGG22-R, CGG61-L, CGG61-R, CGG62-L, CGG62-R, CSE11-L, CSE11-R, CSE12-L, CSE12-R, CSE21-L, CSE21-R, CSE21-R-DG, CSE22-L, CSE22-R, CSE22-R-DG, CSG11-L, CSG11-R, CSG11-R-DG, CSG12-L, CSG12-R, CSG12-R-DG, CSG21-L, CSG21-R, CSG21-R-DG, CSG22-L, CSG22-R, CSG22-R-DG, CSG61-L, CSG61-R, CSG61-R-DG, CSG62-L... (Other models you can see in the webshop) | | |

| | | | |
|---|--|-----------------|--------|
|  | | | |
| 1 | | | |
| GEV No. | 551452 | Ref. No. | 203731 |
| description | plug connector 4-pole male faston 6.3mm L 54mm | | |
| For models: | CCE60, CCE63, CGE11-L, CGE11-R, CGE12-L, CGE12-R, CGE21-L, CGE21-R, CGE22-L, CGE22-R, CGE61-L, CGE61-R, CGE62-L, CGE62-R, CGG11-L, CGG11-R, CGG12-L, CGG12-R, CGG21-L, CGG21-R, CGG22-L, CGG22-R, CGG61-L, CGG61-R, CGG62-L, CGG62-R, CPE60, CPE63, CSE11-L, CSE11-R, CSE11-R-DG, CSE12-L, CSE12-R, CSE12-R-DG, CSE21-L, CSE21-R, CSE21-R-DG, CSE22-L, CSE22-R, CSE22-R-DG, CSE61-L, CSE61-R, CSE61-R-DG, CSE62-L, CSE62-R, CSE62-R-DG, CSG11-L, CSG11-R, CSG11-R-DG, CSG12-L... (Other models you can see in the webshop) | | |

| | | | |
|---|--|-----------------|--------|
|  | | | |
| 1 | | | |
| GEV No. | 551354 | Ref. No. | 202689 |
| description | plug connector 50-pole raster size 2mm | | |
| For models: | CCE60, CCE63, CPE60, CPE63, CSE11-L, CSE11-R, CSE11-R-DG, CSE12-L, CSE12-R, CSE12-R-DG, CSE21-L, CSE21-R, CSE21-R-DG, CSE22-L, CSE22-R, CSE22-R-DG, CSE61-L, CSE61-R, CSE61-R-DG, CSE62-L, CSE62-R, CSE62-R-DG, CSG11-L, CSG11-R, CSG11-R-DG, CSG12-L, CSG12-R, CSG12-R-DG, CSG21-L, CSG21-R, CSG21-R-DG, CSG22-L, CSG22-R, CSG22-R-DG, CSG61-L, CSG61-R, CSG61-R-DG, CSG62-L, CSG62-R, CSG62-R-DG | | |

| | | | |
|---|--|-----------------|--------|
| terminals | | | |
| connection terminals with screw/faston connections | | | |
|  | | | |
| 1 | | | |
| GEV No. | 551372 | Ref. No. | 203287 |
| description | connection terminal 3-pole max. 16A max 400V connection ø2.5mm ² / F6.3 temp.-resist. 150°C | | |
| For models: | 0521704-00, 0521704-01, 0521704-02, 0521704-03, 0521704-04, 0521704-05, 0521704-06, 0521704-07, 0521704A00, 0521704A01, 0521705-00, 0521705-01, 0521706-00, 1220501-00, 1220501-01, 1220501-02, 1220502-00, 1220502-01, 1220601-00, 1220802-00, 1220802-01, 1320501-00, 1320502-00, 1320601-00, 1320802-00, 1520501-00, 1520601-00 | | |

| | | | |
|--|---|-----------------|--------|
|  | | | |
| 1 | | | |
| GEV No. | 550110 | Ref. No. | 203264 |
| description | power terminal block 5-pole max. 40A max 250V connection M6/ male faston 6.3mm temp.-resist. 130°C | | |
| For models: | 0021130A00, 0021130A01, 0021135A00, 0220301-00, 0220301B00, 0220301B01, 0220301B02, 0220301D00, 0220302-00, 0220302A00, 0220302A01, 0220302A02, 0220302A03, 0220302B00, 0220302B01, 0220302B02, 0220302C00, 0220302C01, 0220302C02, 0220302C03, 0220302D00, 0220302E00, 0220302E01, 0220302F00, 0220302H00, 0220302H01, 0220303-00, 0220303-01, 0220303A00, 0220303A01, 0220303A02, 0220303A03, 0220303D00, 0220303D01, 0220303H00, 0220303H01, 0220304-00, 0220305-00, 0220306-00, 0220501-00, 0220502-00, 0220503-00, 0220601-00, 0220802-00, 0221001H00, 0221101-00, 0221101-01, 0221101A00, 0221101A01, 0221102-00... (Other models you can see in the webshop) | | |

| | | | |
|--|---|-----------------|--------|
| PCB terminal blocks | | | |
|  | | | |
| 1 | | | |
| GEV No. | 551355 | Ref. No. | 203690 |
| description | PCB terminal block 5-pole raster size 3.8mm cross section 1.5mm ² | | |
| For models: | CGE11-L, CGE11-R, CGE12-L, CGE12-R, CGE21-L, CGE21-R, CGE22-L, CGE22-R, CGE61-L, CGE61-R, CGE62-L, CGE62-R, CGG11-L, CGG11-R, CGG12-L, CGG12-R, CGG21-L, CGG21-R, CGG22-L, CGG22-R, CGG61-L, CGG61-R, CGG62-L, CGG62-R, CPE60, CPE63, CSE11-L, CSE11-R, CSE11-R-DG, CSE12-L, CSE12-R, CSE12-R-DG, CSE21-L, CSE21-R, CSE21-R-DG, CSE22-L, CSE22-R, CSE22-R-DG, CSE61-L, CSE61-R, CSE61-R-DG, CSE62-L, CSE62-R, CSE62-R-DG, CSG11-L, CSG11-R, CSG11-R-DG, CSG12-L, CSG12-R, CSG12-R-DG... (Other models you can see in the webshop) | | |



rail-mounted terminals

WIELAND

accessories



| | | | |
|--------------------|---|-----------------|--------|
| GEV No. | 550370 | Ref. No. | 203273 |
| description | terminal block end bracket clampsmm ² | | |
| For models: | 0220302H00, 0220302H01, 0220303H00, 0220303H01, 0720332R00, 0720332V00, 1220305B00, 1220305B01, 1220305B02, 1220305B03, 1220305B04, 1220305B05, 1220305B06, 1220305B07, 1220305C00, 1220305C01, 1220305C02, 1220305C03, 1220305C04, 1220305C05, 1220305E02, 1220305E03, 1220305E04, 1220305H00, 1220305H01, 1220305H02, 1220305H03, 1220305H04, 1220305H05, 1220327-01, 1220327B01, 1220329-00, 1220329-01, 1220329B00, 1220329B01, 1223205-00, 1223205-01, 1223205-02, 1223211-00, 1320305B00, 1320305B01, 1320305B02, 1320305B03, 1320305C00, 1320305C01, 1320305C02, 1320305C03, 1320305E02, 1320305E03, 1320305H00... (Other models you can see in the webshop) | | |

miscellaneous



| | | | |
|--------------------|---|-----------------|--------|
| GEV No. | 551377 | Ref. No. | 203634 |
| description | fuse holder Phönix Control type USIG 0.5-16mm ² DIN rail black W 10.2mm L 61mm for fuse holder 10A rated 500V | | |
| For models: | 0220302A00, 0220302A01, 0220302A02, 0220302A03, 0220302C00, 0220302C01, 0220302C02, 0220302C03, 0220302H00, 0220302H01, 0220303A00, 0220303A01, 0220303A02, 0220303A03, 0220303C00, 0220303C01, 0220303C02, 0220303H00, 0220303H01, 0220304-00, 0220305-00, 0220306-00, 0221501-00, 0221502-00, 0521702B03, 0521702B04, 0720332P00, 0720332R00, 0720332T00, 0720332V00, 1220307-00, 1220307-01, 1220308-00, 1220326-00, 1220326-01, 1220326B00, 1220326B01, 1220327-00, 1220327-01, 1220327B01, 1220329-00, 1220329-01, 1220329B00, 1220329B01, 1221112-00, 1320323-00, 1320323B00, 1320327-00, 1320327A00, 1320327A01... (Other models you can see in the webshop) | | |



| | | | |
|--------------------|---|-----------------|--------|
| GEV No. | 551356 | Ref. No. | 203271 |
| description | rail-mounted terminal Phönix Control type UK10 6-10mm ² W 8mm L 43mm max. 50A max 500V | | |
| For models: | 0220303B00, 0220303B01, 0220303C00, 0220303C01, 0220303C02, 0220303E00, 0220303E01, 0220306-00, 0521702B03, 0521702B04, 0720332P00, 0720332R00, 0720332T00, 0720332V00, 1120510-00, 1120510-01, 1220307-00, 1220307-01, 1220308-00, 1220326-00, 1220326-01, 1220326B00, 1220326B01, 1220503-00, 1221112-00, 1223204-00, 1223204-01, 1223204-02, 1223205-00, 1223205-01, 1223205-02, 1223206-00, 1223206-01, 1223206-02, 1223211-00, 1223212-00, 1223214-00, 1323211-00, 1323211-01, 1420332P01, 1420332P02, 1420332P03, 1420332R00, 1420332R01, 1420332R02, 1420332R03, 1420332T01, 1420332T02, 1420332T03, 1420332V01... (Other models you can see in the webshop) | | |



| | | | |
|--------------------|---|-----------------|--------|
| GEV No. | 551373 | Ref. No. | 203620 |
| description | rail-mounted terminal Phönix Control type UK16 0.5-16mm ² top-hat rail 35mm grey W 10.2mm L 42.5mm | | |
| For models: | 0221502-00, 0720332P00, 0720332R00, 0720332T00, 0720332V00, 1420332P01, 1420332P02, 1420332P03, 1420332R00, 1420332R01, 1420332R02, 1420332R03, 1420332T01, 1420332T02, 1420332T03, 1420332V01, 1420332V02, 1420332V03, 1420333P01, 1420333P02, 1420333R00, 1420333R01, 1420333R02, 1420333T01, 1420333T02, 1420333V01, 1420333V02, 1420334P00, 1420334P01, 1420334P02, 1420334P03, 1420334P04, 1420334R02, 1420334R03, 1420334R04, 1420334T02, 1420334T03, 1420334T04, 1420334V01, 1420334V02, 1420334V03, 1420334V04, 1420334W02, 1420334W03, 1420334W04, 1420334Y02, 1420334Y03, 1420334Y04, 1420344R00, 1420344R01... (Other models you can see in the webshop) | | |





| | | | |
|--------------------|---|-----------------|--------|
| GEV No. | 551375 | Ref. No. | 203622 |
| description | rail-mounted terminal Phönix Control type UK35 0.75-35mm ² DIN rail grey W 15.1mm L 62mm | | |
| For models: | 1422802B04, 1422802B05, 1422802B06, 1422802B07, 1422802B08, 1422804B04, 1422804B05, 1422804B06, 1422804B07, 1422804B08, 1422805B04, 1422805B05, 1422805B06, 1422805B07, 1422805B08, 1422807B00, 1422807B01, 1422807B02, 1422807B03, 1422807B04, 1422902-00, 1422902-01, 1422902-02, 1422902-03, 1422902-04, 2020308-00, 2020314-01, 2020314A01, 2020315-01, 2020315A01, 2021123A00, 2021411-00, 2021412C00, 2021413-00, 2021413B00, 2021415B00, 2021416B00, 2021417-00, 2021417B00, 2021418B00, 2021419-00, 2021419B00, 2022801-02, 2022801-03, 2022801A02, 2022801A03, 2022801B02, 2022801B03, 2022801C02, 2022801C03... (Other models you can see in the webshop) | | |



| | | | |
|--------------------|---|-----------------|--------|
| GEV No. | 551371 | Ref. No. | 203279 |
| description | rail-mounted terminal Phönix Control type USLKG10 0.5-10mm ² yellow/green for DIN rail 35mm H 45mm 1-pole | | |
| For models: | 0220303B00, 0220303B01, 0220303C00, 0220303C01, 0220303C02, 0220303E00, 0220303E01, 0220306-00, 0521702B03, 0521702B04, 0720332P00, 0720332R00, 0720332T00, 0720332V00, 1120510-00, 1120510-01, 1220303A00, 1220303A01, 1220303A02, 1220303C00, 1220303C01, 1220303C02, 1220303F01, 1220303F02, 1220303F03, 1220303H00, 1220303H01, 1220303H02, 1220303H03, 1220305A00, 1220305A01, 1220305A02, 1220305A03, 1220305A04, 1220305A05, 1220305B03, 1220305B04, 1220305B05, 1220305B06, 1220305B07, 1220305C04, 1220305C05, 1220305E03, 1220305E04, 1220305F01, 1220305F02, 1220305F03, 1220305F04, 1220305F05, 1220305K00... (Other models you can see in the webshop) | | |



| | | | |
|---|---|-----------------|--------|
|  | | | |
| 1 | | | |
| GEV No. | 551374 | Ref. No. | 203621 |
| description | rail-mounted terminal Phönix Control type USLKG16 0.5-16mm ² yellow/green W 10.2mm L 42.5mm for DIN rail 35mm H 45mm 1-pole | | |
| For models: | 0720332P00, 0720332R00, 0720332T00, 0720332V00, 1420332P01, 1420332P02, 1420332P03, 1420332R00, 1420332R01, 1420332R02, 1420332R03, 1420332T01, 1420332T02, 1420332T03, 1420332V01, 1420332V02, 1420332V03, 1420333P01, 1420333P02, 1420333R00, 1420333R01, 1420333R02, 1420333T01, 1420333T02, 1420333V01, 1420333V02, 1420334P00, 1420334P01, 1420334P02, 1420334P03, 1420334P04, 1420334R02, 1420334R03, 1420334R04, 1420334T02, 1420334T03, 1420334T04, 1420334V01, 1420334V02, 1420334V03, 1420334V04, 1420334W02, 1420334W03, 1420334W04, 1420334Y02, 1420334Y03, 1420334Y04, 1420344R00, 1420344R01, 1420344R02... (Other models you can see in the webshop) | | |

| | | | |
|---|---|-----------------|--------|
|  | | | |
| 1 | | | |
| GEV No. | 551376 | Ref. No. | 203633 |
| description | rail-mounted terminal Phönix Control type USLKG35 0.75-35mm ² DIN rail yellow/green W 15mm L 50mm for DIN rail 35mm H 62mm 1-pole | | |
| For models: | 1422802B04, 1422802B05, 1422802B06, 1422802B07, 1422802B08, 1422804B04, 1422804B05, 1422804B06, 1422804B07, 1422804B08, 1422805B04, 1422805B05, 1422805B06, 1422805B07, 1422805B08, 1422807B00, 1422807B01, 1422807B02, 1422807B03, 1422807B04, 1422902-00, 1422902-01, 1422902-02, 1422902-03, 1422902-04, 2020308-00, 2020314-01, 2020314A01, 2020315-01, 2020315A01, 2021123A00, 2021411-00, 2021412C00, 2021413-00, 2021413B00, 2021415B00, 2021416B00, 2021417-00, 2021417B00, 2021418B00, 2021419-00, 2021419B00, 2022801-02, 2022801-03, 2022801A02, 2022801A03, 2022801B02, 2022801B03, 2022801C02, 2022801C03... (Other models you can see in the webshop) | | |

electronic magnets

| | | | |
|---|--|-----------------|--------|
|  | | | |
| 1 | | | |
| GEV No. | 400793 | Ref. No. | 203672 |
| description | lifting magnet 205V voltage DC | | |
| For models: | CCE60, CCE63, CGE11-L, CGE11-R, CGE12-L, CGE12-R, CGE21-L, CGE21-R, CGE22-L, CGE22-R, CGE61-L, CGE61-R, CGE62-L, CGE62-R, CGG11-L, CGG11-R, CGG12-L, CGG12-R, CGG21-L, CGG21-R, CGG22-L, CGG22-R, CGG61-L, CGG61-R, CGG62-L, CGG62-R, CPE60, CPE63, CSE11-L, CSE11-R, CSE11-R-DG, CSE12-L, CSE12-R, CSE12-R-DG, CSE21-L, CSE21-R, CSE21-R-DG, CSE22-L, CSE22-R, CSE22-R-DG, CSE61-L, CSE61-R, CSE61-R-DG, CSE62-L, CSE62-R, CSE62-R-DG, CSG11-L, CSG11-R, CSG11-R-DG, CSG12-L... (Other models you can see in the webshop) | | |

gas taps









PEL











22S/V series

| | | | | |
|---|---|-----------------|-------------------|--------|
|  | | | | |
| 1 | | | | |
| GEV No. | 101457 | Ref. No. | 201515 Alternativ | |
| description | gas tap alternatives to JUNKERS type CH110 gas inlet M20x1.5 (tube ø 12mm) bypass nozzle ø 0.35mm gas outlet M20x1.5 (tube ø 12/10mm) thermocouple connection M8x1 pilot connection M10x1 shaft ø 10mm shaft L 25mm shaft flat with pipe outlet | | | |
| spare parts for | 101457 | | | |
|  | GEV No. | 100259 | Ref. No. | — |
| | bypass nozzle type PEL22 bore ø 0.35mm thread M6x0.5 | | | |
|  | GEV No. | 100908 | Ref. No. | — |
| | union screw thread M10x1 for pipe ø 4mm Qty 1 pcs | | | |
|  | GEV No. | 101058 | Ref. No. | 201526 |
| | magnet unit L 39mm D1 ø 15.4mm D2 ø 13.5mm suitable for PEL22/ EGA24197 standard | | | |
|  | GEV No. | 101200 | Ref. No. | — |
| | gas tap front part shaft ø 10mm shaft L 25mm shaft flat suitable for 22S/O | | | |
|  | GEV No. | 101230 | Ref. No. | — |
| | thermocouple nut T1: M8x1 T2: M18x1 aluminium | | | |
|  | GEV No. | 101241 | Ref. No. | — |
| | gas connection thread M20x1.5 tube ø 12/10mm for PEL gas taps vertical | | | |
|  | GEV No. | 101246 | Ref. No. | — |
| | olive for pipe ø 4mm Qty 1 pcs | | | |
|  | GEV No. | 101460 | Ref. No. | — |
| | O-ring ø 12.37mm D1 ø 2.62mm suitable for PEL22 | | | |
|  | GEV No. | 101461 | Ref. No. | — |
| | screw kit suitable for PEL22 Qty 4 pcs | | | |
| accessories for | 101457 | | | |
|  | GEV No. | 100945 | Ref. No. | — |
| | roll pin ø 3.2mm L 10mm | | | |
|  | GEV No. | 101218 | Ref. No. | — |
| | shaft extension JUNKERS | | | |
|  | GEV No. | 101219 | Ref. No. | — |
| | shaft extension L 25mm JUNKERS | | | |
|  | GEV No. | 101231 | Ref. No. | — |
| | thermocouple nut T1: M9x1 T2: M18x1 | | | |
|  | GEV No. | 101248 | Ref. No. | — |
| | olive for pipe ø 12mm Qty 1 pcs suitable for PEL | | | |

Table continues overleaf

| accessories for | | 101457 | |
|---|---------|--------|-----------------|
|  | GEV No. | 101249 | Ref. No. — |
| olive for pipe ø 10mm Qty 1 pcs | | | |
|  | GEV No. | 101250 | Ref. No. — |
| union nut thread M20x1.5 for pipe ø 10mm | | | |
|  | GEV No. | 101251 | Ref. No. — |
| union nut thread M20x1.5 for pipe ø 12mm | | | |
|  | GEV No. | 101290 | Ref. No. — |
| thermocouple nut T1: M10x1 T2: M18x1 suitable for PEL20/21 | | | |
|  | GEV No. | 110064 | Ref. No. — |
| knob | | | |
|  | GEV No. | 110066 | Ref. No. — |
| knob screw | | | |
|  | GEV No. | 550396 | Ref. No. 204109 |
| shaft extension L 25mm JUNKERS | | | |



| | | | |
|---|--|-----------------|-----------------|
|  | | | |
| 1 | | | |
| GEV No. | 101793 | Ref. No. | 201163 |
| description | gas tap PEL type 225/V gas inlet M20x1.5 (tube ø 12mm) bypass nozzle ø 0.9mm gas outlet M20x1.5 (tube ø 12/10mm) thermocouple connection M8x1 pilot connection M10x1 shaft ø 6x4.6mm shaft L 45/20mm shaft flat upper | | |
| For models: | 1261301-02, 1261602-02, 1261602-03, 1261604-03, 1263405-01, 1361301-03, 1361602-01, 1361602-02, 1361604-02, 1363405-01, 1461602-00, 1463501-05, 2061301-01, 2061602-00, 2061602-01, 2061603-02, 2061604-01, 2063501-06, 2063502-10, 2063503-07, 3061602-00, 3063501-04 | | |
| spare parts for | | 101793 | |
|  | GEV No. | 100433 | Ref. No. 201164 |
| bypass nozzle type PEL22 bore ø 0.9mm thread M6x0.5 | | | |
|  | GEV No. | 100908 | Ref. No. — |
| union screw thread M10x1 for pipe ø 4mm Qty 1 pcs | | | |
|  | GEV No. | 101058 | Ref. No. 201526 |
| magnet unit L 39mm D1 ø 15.4mm D2 ø 13.5mm suitable for PEL22/ EGA24197 standard | | | |
|  | GEV No. | 101212 | Ref. No. — |
| gas tap spindle for gas tap suitable for PEL22 | | | |
|  | GEV No. | 101230 | Ref. No. — |
| thermocouple nut T1: M8x1 T2: M18x1 aluminium | | | |
|  | GEV No. | 101241 | Ref. No. — |
| gas connection thread M20x1.5 tube ø 12/10mm for PEL gas taps vertical | | | |
|  | GEV No. | 101246 | Ref. No. — |
| olive for pipe ø 4mm Qty 1 pcs | | | |

| spare parts for | | 101793 | |
|---|---------|--------|-----------------|
|  | GEV No. | 101460 | Ref. No. — |
| O-ring ø 12.37mm D1 ø 2.62mm suitable for PEL22 | | | |
|  | GEV No. | 101461 | Ref. No. — |
| screw kit suitable for PEL22 Qty 4 pcs | | | |
| accessories for | | 101793 | |
|  | GEV No. | 100908 | Ref. No. — |
| union screw thread M10x1 for pipe ø 4mm Qty 1 pcs | | | |
|  | GEV No. | 100909 | Ref. No. — |
| union screw thread M10x1 for pipe ø 6mm Qty 1 pcs | | | |
|  | GEV No. | 101240 | Ref. No. — |
| gas connection thread M20x1.5 tube ø 12/10mm for PEL gas taps with gasket and screws horizontal | | | |
|  | GEV No. | 101246 | Ref. No. — |
| olive for pipe ø 4mm Qty 1 pcs | | | |
|  | GEV No. | 101248 | Ref. No. — |
| olive for pipe ø 12mm Qty 1 pcs suitable for PEL | | | |
|  | GEV No. | 101249 | Ref. No. — |
| olive for pipe ø 10mm Qty 1 pcs | | | |
|  | GEV No. | 101250 | Ref. No. — |
| union nut thread M20x1.5 for pipe ø 10mm | | | |
|  | GEV No. | 101251 | Ref. No. — |
| union nut thread M20x1.5 for pipe ø 12mm | | | |
|  | GEV No. | 101286 | Ref. No. 201571 |
| olive ID ø 6mm Qty 1 pcs | | | |

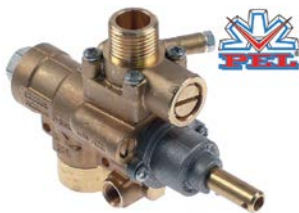

23S/V series



| | | | |
|---|---|-----------------|-----------------------------|
| GEV No. | 101630 | Ref. No. | 201516 201516 Alternativ |
| description | gas tap PEL type 23S/V gas inlet 1/2" IT bypass nozzle ø 0.35mm gas outlet 1/2" MT (tube ø 14mm) thermocouple connection M10x1 pilot connection M10x1 shaft ø 10mm shaft L 25mm shaft flat | | |
| For models: | 1463501-01, 1463501-02, 2061401-00, 2061401-01, 2061401A00, 2061401B00, 2061401C00, 2061402-00, 2061402-01, 2061402A00, 2061402B00, 2061402C00, 2062801-00, 2062801A00, 2062801B00, 2062801C00, 2062802-00, 2062802-0, 20628022-0, 20628022-1, 20628022-2, 2062802A00, 2062802B00, 2062802C00, 2062803-00, 20628033-0, 20628033-1, 20628033-2, 2062803A00, 2062803B00, 2062803C00, 2062804-00, 20628044-0, 20628044-1, 20628044-2, 2062804A00, 2062804B00, 2062804C00, 2062806-00, 2062806A00, 2062806B00, 2062806B01, 2062806B02, 2062806B03, 2062806C00, 2062806C01, 2062806C02, 2062806C03, 20629011-00, 20629011-0, 20629011-1... (Other models you can see in the webshop) | | |
| spare parts for | 101630 | | |
|  | GEV No. | 100455 | Ref. No. — |
| bypass nozzle type PEL23/24 bore ø 0.35mm thread M8x0.5 | | | |
|  | GEV No. | 101059 | Ref. No. — |
| magnet unit T1: M10x1 T2: M22x1 L 46mm ø 18mm suitable for PEL23S M10x1 | | | |
|  | GEV No. | 102767 | Ref. No. — |
| gas tap front part shaft ø 10mm shaft L 26.5mm shaft flat suitable for PEL23S | | | |
| accessories for | 101630 | | |
|  | GEV No. | 100908 | Ref. No. — |
| union screw thread M10x1 for pipe ø 4mm Qty 1 pcs | | | |
|  | GEV No. | 100909 | Ref. No. — |
| union screw thread M10x1 for pipe ø 6mm Qty 1 pcs | | | |
|  | GEV No. | 100945 | Ref. No. — |
| roll pin ø 3.2mm L 10mm | | | |
|  | GEV No. | 101218 | Ref. No. — |
| shaft extension JUNKERS | | | |
|  | GEV No. | 101219 | Ref. No. — |
| shaft extension L 25mm JUNKERS | | | |
|  | GEV No. | 101246 | Ref. No. — |
| olive for pipe ø 4mm Qty 1 pcs | | | |
|  | GEV No. | 101286 | Ref. No. 201571 |
| olive ID ø 6mm Qty 1 pcs | | | |
|  | GEV No. | 110064 | Ref. No. — |
| knob | | | |
|  | GEV No. | 110066 | Ref. No. — |
| knob screw | | | |

| | | | |
|---|----------------|--------|------------------------|
| accessories for | 101630 | | |
|  | GEV No. | 550396 | Ref. No. 204109 |
| shaft extension L 25mm JUNKERS | | | |

alternatives to EGA

GPEL21 series

with nozzle outlet



| | | | |
|--------------------|--|-----------------|--------|
| GEV No. | 106576 | Ref. No. | 201137 |
| description | gas tap alternatives to EGA type GPEL21D gas inlet M15x1 (tube ø 10mm) external nozzle ø 1.55mm internal nozzle ø 1.35mm bypass nozzle ø 0.4mm mixing pipe connection thermocouple connection M8x1 pilot connection M10x1 shaft ø 6x4.6mm shaft L 30/23mm shaft flat upper | | |













| | | | |
|--------------------|--|-----------------|--------|
| GEV No. | 101663 | Ref. No. | 201148 |
| description | gas tap alternatives to EGA type GPEL21D gas inlet M15x1 (tube ø 10mm) external nozzle ø 2.05mm internal nozzle ø 1.85mm bypass nozzle ø 0.5mm mixing pipe connection thermocouple connection M8x1 pilot connection M10x1 shaft ø 6x4.6mm shaft L 31/23mm shaft flat upper | | |

| | | | |
|---|----------------|--------|------------------------|
| spare parts for | 101663 | | |
|  | GEV No. | 100060 | Ref. No. — |
| pilot burner JUNKERS type CB505070 2 flames natural gas nozzle no.4 gas connection 4mm with primary air | | | |
|  | GEV No. | 100244 | Ref. No. 201837 |
| internal nozzle bore ø 1.85mm suitable for EGA 23268,26400,26440 | | | |
|  | GEV No. | 100303 | Ref. No. 201836 |
| gas injector thread M12x1 WS 14 bore ø 2.05mm | | | |
|  | GEV No. | 100408 | Ref. No. — |
| bypass nozzle type PEL20/21 bore ø 0.35mm thread M5x0.5 | | | |
|  | GEV No. | 100908 | Ref. No. — |
| union screw thread M10x1 for pipe ø 4mm Qty 1 pcs | | | |
|  | GEV No. | 100926 | Ref. No. — |
| centring piece thread M17x1 | | | |
|  | GEV No. | 100927 | Ref. No. — |
| torsion spring L 2.8-8.0mm for internal nozzle ø 3mm bore ømm | | | |
|  | GEV No. | 100942 | Ref. No. — |
| union nut thread M15x1 for pipe ø 10mm | | | |



Table continues overleaf



















| spare parts for | | 101663 | |
|--|---------|--------|------------|
|  | GEV No. | 101230 | Ref. No. — |
| thermocouple nut T1: M8x1 T2: M18x1 aluminium | | | |
|  | GEV No. | 101246 | Ref. No. — |
| olive for pipe ø 4mm Qty 1 pcs | | | |
|  | GEV No. | 101278 | Ref. No. — |
| olive for pipe ø 10mm Qty 1 pcs | | | |
|  | GEV No. | 101526 | Ref. No. — |
| O-ring Viton thickness 1.78mm ID ø 4.48mm Qty 1 pcs | | | |
|  | GEV No. | 101593 | Ref. No. — |
| adjusting screw for internal nozzle thread M8x0.75 | | | |
|  | GEV No. | 101803 | Ref. No. — |
| gas tap front part shaft ø 6x4.6mm shaft L 30/23mm shaft flat upper/lower suitable for PEL21 | | | |

| accessories for | | 101663 | |
|---|---------|--------|-----------------|
|  | GEV No. | 100909 | Ref. No. — |
| union screw thread M10x1 for pipe ø 6mm Qty 1 pcs | | | |
|  | GEV No. | 100942 | Ref. No. — |
| union nut thread M15x1 for pipe ø 10mm | | | |
|  | GEV No. | 101278 | Ref. No. — |
| olive for pipe ø 10mm Qty 1 pcs | | | |
|  | GEV No. | 101286 | Ref. No. 201571 |
| olive ID ø 6mm Qty 1 pcs | | | |
|  | GEV No. | 110078 | Ref. No. — |
| knob without symbol ø 70mm shaft ø 6x4.6mm shaft flat universal | | | |
|  | GEV No. | 112206 | Ref. No. — |
| knob dial plate silver gas tap PEL21/22/23 t.max.°C ED ø 63mm ID ø 45.5mm | | | |



| | | | |
|---|---|-----------------|--|
| GEV No. | 101606 | Ref. No. | 201742 Alternativ 201743 Alternativ 201830 Alternativ 201835 Alternativ |
| description | gas tap alternatives to EGA type GPEL21D with nozzle outlet (without nozzle) gas inlet M15x1 (tube ø 10mm) external nozzle ømm internal nozzle ømm bypass nozzle ø 0.35mm mixing pipe connection M17x1 thermocouple connection M8x1 pilot connection M10x1 shaft ø 6x4.6mm shaft L 31/23mm shaft flat upper | | |
| spare parts for | | 101606 | |
|  | GEV No. | 100408 | Ref. No. — |
| bypass nozzle type PEL20/21 bore ø 0.35mm thread M5x0.5 | | | |
|  | GEV No. | 100927 | Ref. No. — |
| torsion spring L 2.8-8.0mm for internal nozzle ø 3mm bore ømm | | | |

| spare parts for | | 101606 | |
|--|---------|--------|---------------------------|
|  | GEV No. | 101060 | Ref. No. 201527 201531 |
| magnet unit standard L 39mm D1 ø 15.4mm D2 ø 11mm suitable for PEL20-21/JUNKERS/EGA | | | |
|  | GEV No. | 101230 | Ref. No. — |
| thermocouple nut T1: M8x1 T2: M18x1 aluminium | | | |
|  | GEV No. | 101526 | Ref. No. — |
| O-ring Viton thickness 1.78mm ID ø 4.48mm Qty 1 pcs | | | |
|  | GEV No. | 101593 | Ref. No. — |
| adjusting screw for internal nozzle thread M8x0.75 | | | |
|  | GEV No. | 101803 | Ref. No. — |
| gas tap front part shaft ø 6x4.6mm shaft L 30/23mm shaft flat upper/lower suitable for PEL21 | | | |

| accessories for | | 101606 | |
|---|---------|--------|-----------------|
|  | GEV No. | 100908 | Ref. No. — |
| union screw thread M10x1 for pipe ø 4mm Qty 1 pcs | | | |
|  | GEV No. | 100909 | Ref. No. — |
| union screw thread M10x1 for pipe ø 6mm Qty 1 pcs | | | |
|  | GEV No. | 100926 | Ref. No. — |
| centring piece thread M17x1 | | | |
|  | GEV No. | 100927 | Ref. No. — |
| torsion spring L 2.8-8.0mm for internal nozzle ø 3mm bore ømm | | | |
|  | GEV No. | 100942 | Ref. No. — |
| union nut thread M15x1 for pipe ø 10mm | | | |
|  | GEV No. | 100943 | Ref. No. — |
| union nut thread M17x1 tube ø 10mm | | | |
|  | GEV No. | 101246 | Ref. No. — |
| olive for pipe ø 4mm Qty 1 pcs | | | |
|  | GEV No. | 101278 | Ref. No. — |
| olive for pipe ø 10mm Qty 1 pcs | | | |
|  | GEV No. | 101286 | Ref. No. 201571 |
| olive ID ø 6mm Qty 1 pcs | | | |
|  | GEV No. | 110078 | Ref. No. — |
| knob without symbol ø 70mm shaft ø 6x4.6mm shaft flat universal | | | |
|  | GEV No. | 112206 | Ref. No. — |
| knob dial plate silver gas tap PEL21/22/23 t.max.°C ED ø 63mm ID ø 45.5mm | | | |



with pipe outlet



1





| | | | |
|--------------------|---|-----------------|--------|
| GEV No. | 106575 | Ref. No. | 201136 |
| description | gas tap alternatives to EGA type GPEL21R gas inlet M15x1 (tube ø 10mm) bypass nozzle ø 0.6mm gas outlet M17x1 (tube ø 10mm) thermocouple connection M8x1 pilot connection M10x1 shaft ø 6x4.6mm shaft L 30/23mm shaft flat upper gas outlet M17x1 (tube ø 10mm)mm | | |



1

| | | | |
|---|--|-----------------|---|
| GEV No. | 101605 | Ref. No. | 201737 Alternativ 201755 Alternativ 201760 Alternativ |
| description | gas tap alternatives to EGA type GPEL21R with pipe outlet gas inlet M15x1 (tube ø 10mm) bypass nozzle ø 0.35mm gas outlet M17x1 (tube ø 10mm) thermocouple connection M8x1 pilot connection M10x1 shaft ø 6x4.6mm shaft L 30/23mm shaft flat upper | | |
| spare parts for | 101605 | | |
|  | GEV No. | 100408 | Ref. No. — |
| | bypass nozzle type PEL20/21 bore ø 0.35mm thread M5x0.5 | | |
|  | GEV No. | 101060 | Ref. No. 201527 201531 |
| | magnet unit standard L 39mm D1 ø 15.4mm D2 ø 11mm suitable for PEL20-21/JUNKERS/EGA | | |
|  | GEV No. | 101230 | Ref. No. — |
| | thermocouple nut T1: M8x1 T2: M18x1 aluminium | | |
|  | GEV No. | 101803 | Ref. No. — |
| | gas tap front part shaft ø 6x4.6mm shaft L 30/23mm shaft flat upper/lower suitable for PEL21 | | |
| accessories for | 101605 | | |
|  | GEV No. | 100908 | Ref. No. — |
| | union screw thread M10x1 for pipe ø 4mm Qty 1 pcs | | |
|  | GEV No. | 100909 | Ref. No. — |
| | union screw thread M10x1 for pipe ø 6mm Qty 1 pcs | | |
|  | GEV No. | 100926 | Ref. No. — |
| | centring piece thread M17x1 | | |
|  | GEV No. | 100942 | Ref. No. — |
| | union nut thread M15x1 for pipe ø 10mm | | |
|  | GEV No. | 100943 | Ref. No. — |
| | union nut thread M17x1 tube ø 10mm | | |
|  | GEV No. | 101246 | Ref. No. — |
| | olive for pipe ø 4mm Qty 1 pcs | | |

accessories for 101605

| | | | | |
|---|--|--------|-----------------|--------|
|  | GEV No. | 101278 | Ref. No. | — |
| | olive for pipe ø 10mm Qty 1 pcs | | | |
|  | GEV No. | 101286 | Ref. No. | 201571 |
| | olive ID ø 6mm Qty 1 pcs | | | |
|  | GEV No. | 110078 | Ref. No. | — |
| | knob without symbol ø 70mm shaft ø 6x4.6mm shaft flat universal | | | |
|  | GEV No. | 112206 | Ref. No. | — |
| | knob dial plate silver gas tap PEL21/22/23 t.max. °C ED ø 63mm ID ø 45.5mm | | | |

GPEL22 series

with nozzle outlet



1





















| | | | |
|---|--|-----------------|--|
| GEV No. | 101622 | Ref. No. | 201740 Alternativ 201741 Alternativ |
| description | gas tap alternatives to EGA type PEL22S with nozzle outlet (without nozzle) gas inlet M18x1.5 (tube ø 12mm) external nozzle ømm internal nozzle ømm bypass nozzle ø 0.35mm mixing pipe connection M22x1 thermocouple connection M8x1 pilot connection M10x1 shaft ø 6x4.6mm shaft L 35/21mm shaft flat upper | | |
| spare parts for | 101622 | | |
|  | GEV No. | 100259 | Ref. No. — |
| | bypass nozzle type PEL22 bore ø 0.35mm thread M6x0.5 | | |
|  | GEV No. | 100927 | Ref. No. — |
| | torsion spring L 2.8-8.0mm for internal nozzle ø 3mm bore ømm | | |
|  | GEV No. | 101058 | Ref. No. 201526 |
| | magnet unit L 39mm D1 ø 15.4mm D2 ø 13.5mm suitable for PEL22/EGA24197 standard | | |
|  | GEV No. | 101230 | Ref. No. — |
| | thermocouple nut T1: M8x1 T2: M18x1 aluminium | | |
|  | GEV No. | 101460 | Ref. No. — |
| | O-ring ø 12.37mm D1 ø 2.62mm suitable for PEL22 | | |
|  | GEV No. | 101527 | Ref. No. — |
| | O-ring Viton thickness 1.78mm ID ø 6.75mm Qty 1 pcs | | |
|  | GEV No. | 101594 | Ref. No. — |
| | adjusting screw for internal nozzle thread M10x0.75 | | |
|  | GEV No. | 101823 | Ref. No. — |
| | gas tap front part shaft ø 6x4.6mm shaft L 35/21mm shaft flat upper/lower suitable for PEL22 | | |
| accessories for | 101622 | | |
|  | GEV No. | 100908 | Ref. No. — |
| | union screw thread M10x1 for pipe ø 4mm Qty 1 pcs | | |

Table continues overleaf









| accessories for 101622 | | | | |
|---|---------|--------|----------|--------|
|  | GEV No. | 100909 | Ref. No. | — |
| union screw thread M10x1 for pipe ø 6mm Qty 1 pcs | | | | |
|  | GEV No. | 100944 | Ref. No. | — |
| union nut thread M18x1.5 for pipe ø 12mm | | | | |
|  | GEV No. | 101246 | Ref. No. | — |
| olive for pipe ø 4mm Qty 1 pcs | | | | |
|  | GEV No. | 101273 | Ref. No. | 201594 |
| olive for pipe ø 12mm L 9.5mm brass Qty 1 pcs suitable for universal | | | | |
|  | GEV No. | 101286 | Ref. No. | 201571 |
| olive ID ø 6mm Qty 1 pcs | | | | |
|  | GEV No. | 110078 | Ref. No. | — |
| knob without symbol ø 70mm shaft ø 6x4.6mm shaft flat universal | | | | |
|  | GEV No. | 112206 | Ref. No. | — |
| knob dial plate silver gas tap PEL21/22/23 t.max.°C ED ø 63mm ID ø 45.5mm | | | | |

| with pipe outlet | | | | |
|--|--|----------|----------|--------|
|  | 1 | | | |
| GEV No. | 106396 ¹ | Ref. No. | 201786 | |
| description | gas tap type GPEL22R with pipe outlet gas inlet M18x1.5 (tube ø 12mm) bypass nozzle ø 0.35mm gas outlet M18x1.5 (tube ø 12mm) thermocouple connection M8x1 pilot connection M10x1 shaft ø 6x4.6mm shaft L 35/21mm shaft flat upper | | | |
| For models: | 2063413-02, 2063414-03, 2063415-05, 2063416-02, 2063417-03, 2063418-05, 2063419-02 | | | |
| spare parts for | 106396 | | | |
|  | GEV No. | 100259 | Ref. No. | — |
| bypass nozzle type PEL22 bore ø 0.35mm thread M6x0.5 | | | | |
|  | GEV No. | 101058 | Ref. No. | 201526 |
| magnet unit L 39mm D1 ø 15.4mm D2 ø 13.5mm suitable for PEL22/ EGA24197 standard | | | | |
|  | GEV No. | 101230 | Ref. No. | — |
| thermocouple nut T1: M8x1 T2: M18x1 aluminium | | | | |
|  | GEV No. | 101823 | Ref. No. | — |
| gas tap front part shaft ø 6x4.6mm shaft L 35/21mm shaft flat upper/lower suitable for PEL22 | | | | |
| accessories for 106396 | | | | |
|  | GEV No. | 100908 | Ref. No. | — |
| union screw thread M10x1 for pipe ø 4mm Qty 1 pcs | | | | |
|  | GEV No. | 100909 | Ref. No. | — |
| union screw thread M10x1 for pipe ø 6mm Qty 1 pcs | | | | |

¹incl. union nuts and olives





| accessories for 106396 | | | | |
|---|---------|--------|----------|--------|
|  | GEV No. | 100944 | Ref. No. | — |
| union nut thread M18x1.5 for pipe ø 12mm | | | | |
|  | GEV No. | 101246 | Ref. No. | — |
| olive for pipe ø 4mm Qty 1 pcs | | | | |
|  | GEV No. | 101273 | Ref. No. | 201594 |
| olive for pipe ø 12mm L 9.5mm brass Qty 1 pcs suitable for universal | | | | |
|  | GEV No. | 101286 | Ref. No. | 201571 |
| olive ID ø 6mm Qty 1 pcs | | | | |

JUNKERS

| | | | | |
|---|---|----------|----------|------------------|
|  | 1 | | | |
| GEV No. | nla ¹ | Ref. No. | 201515 | |
| description | gas tap JUNKERS type CH120 gas inlet M20x1.5 bypass nozzle ø 0.35mm gas outlet M20x1.5 thermocouple connection M8x1 pilot connection M10x1 shaft ø 10mm shaft L 20.7mm shaft flat | | | |
| For models: | 0260501-00, 0261101-00, 0261101-01, 0261102-00, 0261102-01, 0261103-00, 0261103-01, 0261301-00, 0261601-00, 1261301-00, 1261301-01, 1261601-00, 1261601-01, 1261602-00, 1261602-01, 1263405-00, 1361301-00, 1361301-01, 1361301-02, 1361601-00, 1361601-01, 1361601-02, 1361602-00, 1363405-00, 1461601-00, 1463501-00, 1463501-03, 1463501-04, 20611011-0, 20611022-0, 20611033-0, 2061104-00, 20611044-0, 2061105-00, 20611055-0, 2061106-00, 20611066-0, 2061603-00, 2061603-01, 2063501-00, 2063501-05, 20635011-0, 2063502-00, 2063502-09, 20635022-0, 2063503-00, 2063503-05, 2063503-06, 20635033-0, 2063504-00... (Other models you can see in the webshop) | | | |
| spare parts for | 101128 | | | |
|  | GEV No. | 101060 | Ref. No. | 201527 201531 |
| magnet unit standard L 39mm D1 ø 15.4mm D2 ø 11mm suitable for PEL20-21/JUNKERS/EGA | | | | |
|  | GEV No. | 101230 | Ref. No. | — |
| thermocouple nut T1: M8x1 T2: M18x1 aluminium | | | | |
|  | GEV No. | 345200 | Ref. No. | — |
| microswitch with plunger | | | | |
| accessories for 101128 | | | | |
|  | GEV No. | 100945 | Ref. No. | — |
| roll pin ø 3.2mm L 10mm | | | | |
|  | GEV No. | 101219 | Ref. No. | — |
| shaft extension L 25mm JUNKERS | | | | |
|  | GEV No. | 101281 | Ref. No. | 201560 |
| olive for pipe ø 4mm L 8.7mm Qty 1 pcs suitable for CB 502/503 | | | | |
|  | GEV No. | 101284 | Ref. No. | 201827 |
| olive for pipe ø 4mm Qty 1 pcs | | | | |

¹no longer available
Table continues overleaf



| accessories for | | 101128 | | |
|---|-----------------|----------------------------|-----------|---------|
| GEV No. | | 101285 | Ref. No. | — |
|  | union screw | thread M8x1 for pipe ø 4mm | Qty 1 pcs | JUNKERS |
|  | knob | | | |
|  | knob screw | | | |
|  | shaft extension | L 25mm | JUNKERS | |

| accessories for | | 101457 | | |
|---|------------------|--------------------------------|--------------|------------------|
| GEV No. | | 101218 | Ref. No. | — |
|  | shaft extension | JUNKERS | | |
|  | shaft extension | L 25mm | JUNKERS | |
|  | thermocouple nut | T1: M9x1 T2: M18x1 | | |
|  | olive | for pipe ø 12mm | Qty 1 pcs | suitable for PEL |
|  | olive | for pipe ø 10mm | Qty 1 pcs | |
|  | union nut | thread M20x1.5 for pipe ø 10mm | | |
|  | union nut | thread M20x1.5 for pipe ø 12mm | | |
|  | thermocouple nut | T1: M10x1 T2: M18x1 | suitable for | PEL20/21 |
|  | knob | | | |
|  | knob screw | | | |
|  | shaft extension | L 25mm | JUNKERS | |

alternatives to JUNKERS

|  <p>1</p> | | | | |
|--|---|--------------------------------|---------------------------------------|--|
| GEV No. | 101457 | Ref. No. | 201515 Alternativ | |
| description | gas tap alternatives to JUNKERS type CH110 gas inlet M20x1.5 (tube ø 12mm) bypass nozzle ø 0.35mm gas outlet M20x1.5 (tube ø 12/10mm) thermocouple connection M8x1 pilot connection M10x1 shaft ø 10mm shaft L 25mm shaft flat with pipe outlet | | | |
| spare parts for | | 101457 | | |
|  | bypass nozzle | type PEL22 bore ø 0.35mm | thread M6x0.5 | |
|  | union screw | thread M10x1 for pipe ø 4mm | Qty 1 pcs | |
|  | magnet unit | L 39mm D1 ø 15.4mm D2 ø 13.5mm | suitable for PEL22/ EGA24197 standard | |
|  | gas tap front part | shaft ø 10mm shaft L 25mm | shaft flat suitable for 22S/O | |
|  | thermocouple nut | T1: M8x1 T2: M18x1 | aluminium | |
|  | gas connection | thread M20x1.5 tube ø 12/10mm | for PEL gas taps vertical | |
|  | olive | for pipe ø 4mm | Qty 1 pcs | |
|  | O-ring | ø 12.37mm D1 ø 2.62mm | suitable for PEL22 | |
|  | screw kit | suitable for PEL22 | Qty 4 pcs | |
| accessories for | | 101457 | | |
|  | roll pin | ø 3.2mm L 10mm | | |



|  <p>1</p> | | | | |
|---|---|-----------------------------|-------------------|--|
| GEV No. | 101630 | Ref. No. | 201516 Alternativ | |
| description | gas tap PEL type 23S/V gas inlet 1/2" IT bypass nozzle ø 0.35mm gas outlet 1/2" MT (tube ø 14mm) thermocouple connection M10x1 pilot connection M10x1 shaft ø 10mm shaft L 25mm shaft flat | | | |
| For models: | 1463501-01, 1463501-02, 2061401-00, 2061401-01, 2061401A00, 2061401B00, 2061401C00, 2061402-00, 2061402-01, 2061402A00, 2061402B00, 2061402C00, 2062801-00, 2062801A00, 2062801B00, 2062801C00, 2062802-00, 20628022-0, 20628022-1, 20628022-2, 2062802A00, 2062802B00, 2062802C00, 2062803-00, 20628033-0, 20628033-1, 20628033-2, 2062803A00, 2062803B00, 2062803C00, 2062804-00, 20628044-0, 20628044-1, 20628044-2, 2062804A00, 2062804B00, 2062804C00, 2062806-00, 2062806A00, 2062806B00, 2062806B01, 2062806B02, 2062806B03, 2062806C00, 2062806C01, 2062806C02, 2062806C03, 2062901-00, 20629011-0, 20629011-1... (Other models you can see in the webshop) | | | |
| spare parts for | | 101630 | | |
|  | bypass nozzle | type PEL23/24 bore ø 0.35mm | thread M8x0.5 | |

Table continues overleaf





| | | | |
|---|---------|--------|-----------------|
| spare parts for 101630 | | | |
|  | GEV No. | 101059 | Ref. No. — |
| magnet unit T1: M10x1 T2: M22x1 L 46mm ø 18mm suitable for PEL23S M10x1 | | | |
|  | GEV No. | 102767 | Ref. No. — |
| gas tap front part shaft ø 10mm shaft L 26.5mm shaft flat suitable for PEL23S | | | |
| accessories for 101630 | | | |
|  | GEV No. | 100908 | Ref. No. — |
| union screw thread M10x1 for pipe ø 4mm Qty 1 pcs | | | |
|  | GEV No. | 100909 | Ref. No. — |
| union screw thread M10x1 for pipe ø 6mm Qty 1 pcs | | | |
|  | GEV No. | 100945 | Ref. No. — |
| roll pin ø 3.2mm L 10mm | | | |
|  | GEV No. | 101218 | Ref. No. — |
| shaft extension JUNKERS | | | |
|  | GEV No. | 101219 | Ref. No. — |
| shaft extension L 25mm JUNKERS | | | |
|  | GEV No. | 101246 | Ref. No. — |
| olive for pipe ø 4mm Qty 1 pcs | | | |
|  | GEV No. | 101286 | Ref. No. 201571 |
| olive ID ø 6mm Qty 1 pcs | | | |
|  | GEV No. | 110064 | Ref. No. — |
| knob | | | |
|  | GEV No. | 110066 | Ref. No. — |
| knob screw | | | |
|  | GEV No. | 550396 | Ref. No. 204109 |
| shaft extension L 25mm JUNKERS | | | |

EGA









24197 series









gas taps



| | | | |
|---|--|-----------------|------------------|
| GEV No. | 106044 | Ref. No. | 201740 201741 |
| description | gas tap EGA type 24197 series | | |
| For models: | 0263401-00, 0263401-01, 2063413-00, 2063413-01, 2063414-00, 2063414-01, 2063414-02, 2063415-00, 2063415-01, 2063415-02, 2063415-03, 2063415-04, 2063416-00, 2063416-01, 2063417-00, 2063417-01, 2063417-02, 2063418-00, 2063418-01, 2063418-02, 2063418-03, 2063418-04, 2063419-00, 2063419-01, 2163415-00, 2163416-00, 2163416-01, 2163417-00, 2163417-01, 2163417-02, 2163417-03, 2163418-00, 2163418-01, 2163419-00, 2163419-01, 2163420-00, 2163420-01, 2163420-02, 2163420-03, 2163421-00, 2163421-01, 3063413-00, 3063414-00, 3063417-00 | | |
| spare parts for 106044 | | | |
|  | GEV No. | 101058 | Ref. No. 201526 |
| magnet unit L 39mm D1 ø 15.4mm D2 ø 13.5mm suitable for PEL22/ EGA24197 standard | | | |
| accessories for 106044 | | | |
|  | GEV No. | 100944 | Ref. No. — |
| union nut thread M18x1.5 for pipe ø 12mm | | | |
|  | GEV No. | 101273 | Ref. No. 201594 |
| olive for pipe ø 12mm L 9.5mm brass Qty 1 pcs suitable for universal | | | |
|  | GEV No. | 101284 | Ref. No. 201827 |
| olive for pipe ø 4mm Qty 1 pcs | | | |
|  | GEV No. | 101285 | Ref. No. — |
| union screw thread M8x1 for pipe ø 4mm Qty 1 pcs JUNKERS | | | |



| 26440 series | | | |
|---|---|-----------------|--------------------------------------|
| gas taps | | | |
|  Image not available 1 | | | |
| GEV No. | 106045 | Ref. No. | 201742 201743 201830 201835 |
| description | gas tap EGA type 26440 series | | |
| For models: | 1464802-01, 1464803-01, 1464803-02, 1464808-01, 1464808-02, 1464809-01, 1464809-02, 1464810-01, 1464811-01, 2063401-00, 2063401-01, 2063401-02, 2063401-03, 2063401-04, 20634011-0, 2063402-00, 2063402-01, 2063402-02, 2063402-03, 2063402-04, 20634022-0, 2063403-00, 2063403-01, 2063403-02, 2063403-03, 2063403-04, 2063403-05, 2063403-06, 2063403-07, 2063403-08, 2063404-00, 2063404-01, 2063404-02, 2063404-03, 2063404-04, 2063404-05, 2063405-00, 2063405-01, 2063405-02, 2063405-03, 2063405-04, 20634055-0, 2063406-00, 2063406-01, 2063406-02, 2063406-03, 2063406-04, 2063406-05, 2063406-06, 2063406-07... (Other models you can see in the webshop) | | |
| spare parts for | 106045 | | |
|  | GEV No. | 101060 | Ref. No. 201527 201531 |
| | magnet unit standard L 39mm D1 ø 15.4mm D2 ø 11mm suitable for PEL20-21/JUNKERS/EGA | | |
| accessories for | 106045 | | |
|  | GEV No. | 100926 | Ref. No. — |
| | centring piece thread M17x1 | | |
|  | GEV No. | 100942 | Ref. No. — |
| | union nut thread M15x1 for pipe ø 10mm | | |
|  | GEV No. | 101278 | Ref. No. — |
| | olive for pipe ø 10mm Qty 1 pcs | | |
|  | GEV No. | 101284 | Ref. No. 201827 |
| | olive for pipe ø 4mm Qty 1 pcs | | |
|  | GEV No. | 101285 | Ref. No. — |
| | union screw thread M8x1 for pipe ø 4mm Qty 1 pcs JUNKERS | | |
|  | GEV No. | 101394 | Ref. No. — |
| | nut thread M17x1 H 3mm WS 19 brass Qty 1 pcs | | |

| | | | |
|--|--|-----------------|----------------------------------|
|  Image not available 1 | | | |
| GEV No. | 106046 | Ref. No. | 201760 |
| description | gas tap EGA type 26440 series | | |
| For models: | 1263401-00, 1263402-00, 1263404-00, 1363401-00, 1363402-00, 1363402-01, 1363403-00, 1363403-01, 1363403-02, 1363403-03, 1363404-00, 1363404-01, 1464803-02, 1464808-02, 1464809-02, 2063401-03, 2063401-04, 2063402-04, 2063403-07, 2063403-08, 2063404-04, 2063404-05, 2063405-04, 2063406-07, 2063406-08, 2063407-04, 2063407-05, 3063401-02, 3063402-02, 3063405-02 | | |
| spare parts for | 106046 | | |
|  | GEV No. | 101060 | Ref. No. 201527 201531 |
| | magnet unit standard L 39mm D1 ø 15.4mm D2 ø 11mm suitable for PEL20-21/JUNKERS/EGA | | |
| accessories for | 106046 | | |
|  | GEV No. | 100926 | Ref. No. — |
| | centring piece thread M17x1 | | |
|  | GEV No. | 100942 | Ref. No. — |
| | union nut thread M15x1 for pipe ø 10mm | | |
|  | GEV No. | 101278 | Ref. No. — |
| | olive for pipe ø 10mm Qty 1 pcs | | |
|  | GEV No. | 101284 | Ref. No. 201827 |
| | olive for pipe ø 4mm Qty 1 pcs | | |
|  | GEV No. | 101285 | Ref. No. — |
| | union screw thread M8x1 for pipe ø 4mm Qty 1 pcs JUNKERS | | |
|  | GEV No. | 101394 | Ref. No. — |
| | nut thread M17x1 H 3mm WS 19 brass Qty 1 pcs | | |



| | | | |
|--|--|-----------------|----------------------------------|
|  Image not available 1 | | | |
| GEV No. | 106047 | Ref. No. | 201737 201755 |
| description | gas tap EGA type 26440 series | | |
| For models: | 1261101-00, 1261101-01, 1261102-00, 1261102-01, 1361101-00, 1361101-01, 1361101-02, 1361102-00, 1361102-01, 1361102-02, 1461101-01, 1461102-01, 1461104-01, 1461104-02, 1461105-01, 1461105-02, 1461109-01, 1461109A01, 1461109A02, 2061101-01, 2061101-02, 2061102-01, 2061102-02, 2061107-00, 2061107-01, 2061107A00, 2061107A01, 2161101-01, 2161101-02, 2161102-01, 2161102-02, 3061101-00, 3061102-00, 3061107-00, 3061107A00 | | |
| spare parts for | 106047 | | |
|  | GEV No. | 101060 | Ref. No. 201527 201531 |
| | magnet unit standard L 39mm D1 ø 15.4mm D2 ø 11mm suitable for PEL20-21/JUNKERS/EGA | | |
|  | GEV No. | 101230 | Ref. No. — |
| | thermocouple nut T1: M8x1 T2: M18x1 aluminium | | |

Table continues overleaf

| accessories for | | 106047 | | |
|---|---------|--------|----------|--------|
|  | GEV No. | 100926 | Ref. No. | — |
| centring piece thread M17x1 | | | | |
|  | GEV No. | 100942 | Ref. No. | — |
| union nut thread M15x1 for pipe ø 10mm | | | | |
|  | GEV No. | 101278 | Ref. No. | — |
| olive for pipe ø 10mm Qty 1 pcs | | | | |
|  | GEV No. | 101284 | Ref. No. | 201827 |
| olive for pipe ø 4mm Qty 1 pcs | | | | |
|  | GEV No. | 101285 | Ref. No. | — |
| union screw thread M8x1 for pipe ø 4mm Qty 1 pcs JUNKERS | | | | |
|  | GEV No. | 101394 | Ref. No. | — |
| nut thread M17x1 H 3mm WS 19 brass Qty 1 pcs | | | | |







| | | | | |
|--|--|-----------------|----------|--------|
|  | | | | |
| GEV No. | 106037 ¹ | Ref. No. | 201543 | |
| description | gas thermostat SIT type MINISIT 710 t.max. 200°C 60-200°C gas inlet 3/8" gas outlet 3/8" thermocouple connection M10x1 pilot connection M10x1 probe ø 5mm probe L 100mm capillary pipe 1150mm probe type type D2 pressure controller yes pressure regulator 3-18mbar gland nut M14x1.5 | | | |
| For models: | 0260301-01, 0260302-01, 1260301-00, 1260301-01, 1260302-00, 1260302-01, 1460302-00, 1460302-01, 1460302-02, 2060301-00, 2060301-01, 2060301-02 | | | |
| spare parts for | 106037 | | | |
|  | GEV No. | 100809 | Ref. No. | — |
| O-ring EPDM thickness 2mm ID ø 21mm Qty 1 pcs | | | | |
|  | GEV No. | 101054 | Ref. No. | — |
| magnet unit T1: M10x1 T2: M24x1 L 45mm ø 17mm suitable for Minisit | | | | |
|  | GEV No. | 101136 | Ref. No. | 201535 |
| piezoelectric igniter suitable for Minisit with cover cap ømm connection F6.3x0.8 | | | | |
|  | GEV No. | 101505 | Ref. No. | — |
| gas connection thread 3/8" angled without O-ring MINISIT 710 | | | | |
|  | GEV No. | 101516 | Ref. No. | — |
| flat-headed bolt thread M4 thread L 16mm SS DIN 7985/ISO 7045 Qty 1 pcs | | | | |
|  | GEV No. | 110068 | Ref. No. | — |
| knob suitable for Minisit ø 37mm | | | | |
| accessories for | 106037 | | | |
|  | GEV No. | 102844 | Ref. No. | — |
| probe 60-200°C probe ø 5mm probe L 98mm capillary pipe 1050mm t.max. 200°C fryer probe type type D2 suitable for MINISIT 710 gland nut M14x1.5 | | | | |

¹gland box M14x1,5







gas thermostats

SIT

710 Minisit series

| | | | | |
|---|---|-----------------|----------|--------|
|  | | | | |
| GEV No. | 106038 | Ref. No. | 201591 | |
| description | gas thermostat SIT type MINISIT 710 t.max. 100°C 30-100°C pressure controller yes | | | |
| For models: | 1460503-01, 2060501-00, 2060501-01, 20605011-0, 2160501-00, 2160501-01 | | | |
| spare parts for | 106038 | | | |
|  | GEV No. | 100908 | Ref. No. | — |
| union screw thread M10x1 for pipe ø 4mm Qty 1 pcs | | | | |
|  | GEV No. | 101136 | Ref. No. | 201535 |
| piezoelectric igniter suitable for Minisit with cover cap ømm connection F6.3x0.8 | | | | |
|  | GEV No. | 101284 | Ref. No. | 201827 |
| olive for pipe ø 4mm Qty 1 pcs | | | | |
|  | GEV No. | 107564 | Ref. No. | — |
| piezoelectric igniter body plastic blowing connection F6.3x0.8 ø 22mm | | | | |
| accessories for | 106038 | | | |
|  | GEV No. | 110068 | Ref. No. | — |
| knob suitable for Minisit ø 37mm | | | | |



| | | | |
|---|---|-----------------|------------------------|
| GEV No. | 106018 | Ref. No. | 201564 |
| description | gas thermostat SIT type MINISIT 710 t.max. 340°C 120-340°C gas inlet 1/2" gas outlet 3/8" thermocouple connection M10x1 pilot connection M10x1 probe ø 5mm probe L 68mm capillary pipe 1050mm probe type type B1 pressure controller yes pressure regulator 15-30mbar gland nut | | |
| For models: | 1461101-00, 1461102-00, 1461103-00, 1462101-01, 1462101-02, 1462101-03, 1462101-04, 1462102-00, 1462102-01, 1462102-02, 1462102-03, 2061101-00, 2061102-00, 2061103-00, 2061401-02, 2061401-03, 2061401-04, 2061401A01, 2061401A02, 2061401A03, 2061401B01, 2061401B02, 2061401B03, 2061401C01, 2061401C02, 2061401C03, 2061402-02, 2061402-03, 2061402-04, 2061402A01, 2061402A02, 2061402A03, 2061402B01, 2061402B02, 2061402B03, 2061402C01, 2061402C02, 2061402C03, 2063404-01, 2063404-02, 2063404-03, 2063404-04, 2063404-05, 2063404-06, 2063404-07, 2063407-01, 2063407-02, 2063407-03, 2063407-04, 2063407-05... (Other models you can see in the webshop) | | |
| spare parts for | 106018 | | |
|  | GEV No. | 101054 | Ref. No. — |
| | magnet unit T1: M10x1 T2: M24x1 L 45mm ø 17mm suitable for Minisit | | |
|  | GEV No. | 101136 | Ref. No. 201535 |
| | piezoelectric igniter suitable for Minisit with cover cap ømm connection F6.3x0.8 | | |
| accessories for | 106018 | | |
|  | GEV No. | 101273 | Ref. No. 201594 |
| | olive for pipe ø 12mm L 9.5mm brass Qty 1 pcs suitable for universal | | |
|  | GEV No. | 101274 | Ref. No. — |
| | olive for pipe ø 16mm Qty 1 pcs | | |
|  | GEV No. | 101275 | Ref. No. — |
| | union screw thread 1/2" for pipe ø 16mm Qty 1 pcs | | |
|  | GEV No. | 101276 | Ref. No. — |
| | union screw thread 3/8" tube ø 12mm Qty 1 pcs | | |
|  | GEV No. | 101278 | Ref. No. — |
| | olive for pipe ø 10mm Qty 1 pcs | | |
|  | GEV No. | 101279 | Ref. No. — |
| | union screw thread 3/8" for pipe ø 10mm Qty 1 pcs | | |

MERTIK

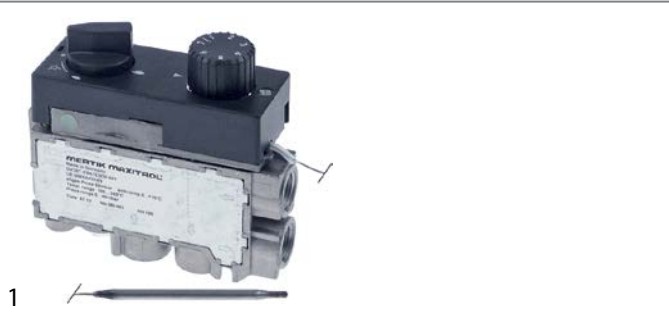

| | | | |
|---|--|-----------------|-------------------|
| GEV No. | 107514 | Ref. No. | 201799 |
| description | gas thermostat MERTIK t.max. 340°C 100-340°C gas inlet bottom 3/8" gas inlet lateral 3/8" gas outlet bottom 3/8" gas outlet lateral 3/8" thermocouple connection M8x1 pilot connection M10x1 capillary pipe 720mm probe ø 4mm probe L 68mm cable lengthmm gland nut | | |
| For models: | 1261101-02, 1261102-02, 1361101-03, 1361102-03, 1461101-03, 1461102-03, 1461104-03, 1461105-03, 1461109-02, 1461109A02, 1561110-00, 2061101-03, 2061101-04, 2061101-05, 2061102-03, 2061102-04, 2061102-05, 2061103-04, 2061107-02, 2061107A02, 2161101-03, 2161102-03, 3061107-02, 3061107A02 | | |
| spare parts for | 107514 | | |
|  | GEV No. | 106221 | Ref. No. — |
| | magnet unit L 32mm D1 ø 19mm D2 ø 14mm suitable for MERTIK | | |

MP_JUNKERS

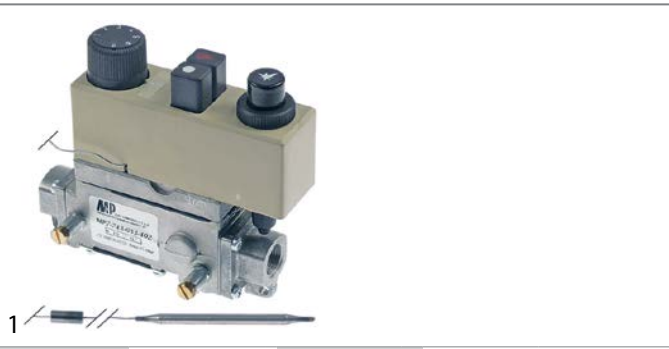





| | | | |
|---|--|-----------------|----------------------------------|
| GEV No. | 106024 | Ref. No. | 201557 |
| description | gas thermostat type 7743-633-402 t.max. 300°C 170-300°C gas inlet 3/8" straight gas outlet 3/8" straight thermocouple connection M10x1 probe ø 6mm probe L 100mm capillary pipe 820mm pressure regulatormbar MP-Junkers pilot connection M8x1 pressure controller no | | |
| For models: | 1462101-00, 14621011-0, 1462102-00_V2, 2063404-00, 2063407-00, 2063503-00, 2063505-00, 2163404-00, 2163407-00 | | |
| spare parts for | 106024 | | |
|  | GEV No. | 100111 | Ref. No. — |
| | piezoelectric igniter body plastic blowing mounting ø 22mm connection F6.3x0.8 cable lengthmm | | |
|  | GEV No. | 100115 | Ref. No. — |
| | union nut ID ø M22x1mm | | |
|  | GEV No. | 101060 | Ref. No. 201527 201531 |
| | magnet unit standard L 39mm D1 ø 15.4mm D2 ø 11mm suitable for PEL20-21/JUNKERS/EGA | | |
| accessories for | 106024 | | |
|  | GEV No. | 101273 | Ref. No. 201594 |
| | olive for pipe ø 12mm L 9.5mm brass Qty 1 pcs suitable for universal | | |

Table continues overleaf



| | | | |
|---|---------|--------|------------|
| accessories for 106024 | | | |
|  | GEV No. | 101276 | Ref. No. — |
| union screw thread 3/8" tube ø 12mm Qty 1 pcs | | | |

gas valves and ignition boxes

gas control valves

HONEYWELL









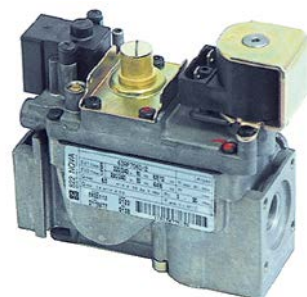

| | | | | |
|---|--|--------|-----------------|--------|
| 1 | GEV No. | 106012 | Ref. No. | 201181 |
| description | gas valve type VK4115V 220-240V 50/60Hz gas inlet flange 32x32mm gas outlet flange 32x32mm thermocouple connection pilot connection pressure range 15-60mbar max 60mbar operator type HONEYWELL flange 32x32mm | | | |
| For models: | CGG11-L, CGG11-R, CGG12-L, CGG12-R, CGG21-L, CGG21-R, CGG22-L, CGG22-R, CGG61-L, CGG61-R, CGG62-L, CGG62-R, CSG11-L, CSG11-R, CSG11-R-DG, CSG12-L, CSG12-R, CSG12-R-DG, CSG21-L, CSG21-R, CSG21-R-DG, CSG22-L, CSG22-R, CSG22-R-DG, CSG61-L, CSG61-R, CSG61-R-DG, CSG62-L, CSG62-R, CSG62-R-DG | | | |
| accessories for 106012 | | | | |
|  | GEV No. | 102845 | Ref. No. | — |
| gas connection angled 1/2" flange 32x32mm hole distance 24x24mm Tandem | | | | |
|  | GEV No. | 102846 | Ref. No. | — |
| gas connection straight 1/2" flange 32x32mm hole distance 24x24mm suitable for Tandem | | | | |

SIT

NOVASIT



| | | | | |
|---|--|--------|-----------------|--------|
| 1 | GEV No. | 101540 | Ref. No. | 201016 |
| description | gas valve SIT series Novasit 822 230V 50Hz gas inlet 1/2" gas outlet 1/2" thermocouple connection pilot connection closed ignition pressure 3-5mbar pressure range 3-30mbar pressure regulator connection blind equiv. no. 0.822.113 | | | |
| spare parts for 101540 | | | | |
|  | GEV No. | 101313 | Ref. No. | — |
| solenoid coil 230V 50Hz | | | | |
|  | GEV No. | 101542 | Ref. No. | — |
| solenoid coil 50Hz NOVA 822/826/827 suitable for NOVASIT 230V | | | | |

| | | | |
|---|---------|--------|------------|
| accessories for 101540 | | | |
|  | GEV No. | 101305 | Ref. No. — |
| gas connection straight 1/2" flange 45x45mm ELETTROSIT/V4400/4600/4605 suitable for SIT/HONEYWELL hole distance 36x36mm | | | |
|  | GEV No. | 101306 | Ref. No. — |
| gas connection angled flange 45x45mm hole distance 36x36mm 1/2" ELETTROSIT/V4400/4600/4605 screw with O-ring suitable for SIT/HONEYWELL | | | |
|  | GEV No. | 101307 | Ref. No. — |
| gas connection straight flange 45x45mm hole distance 36x36mm 3/4" ELETTROSIT/V4400/4600/4605 screw with O-ring suitable for SIT/HONEYWELL | | | |
|  | GEV No. | 101308 | Ref. No. — |
| gas connection angled flange 45x45mm hole distance 36x36mm 3/4" ELETTROSIT/V4400/4600/4605 screw with O-ring suitable for SIT/HONEYWELL | | | |
|  | GEV No. | 101317 | Ref. No. — |
| plug with cable L 1000mm suitable for NOVASIT | | | |
|  | GEV No. | 101503 | Ref. No. — |
| O-ring EPDM thickness 2mm ID ø 32mm Qty 1 pcs | | | |
|  | GEV No. | 101924 | Ref. No. — |
| plug with cable L 1090mm suitable for NOVA 822/826/827 | | | |

| | | | | |
|---|---|--------|-----------------|--------|
| 1 | GEV No. | 101914 | Ref. No. | 201717 |
| description | gas valve SIT series Novasit 822 230V 50Hz gas inlet 1/2" gas outlet 1/2" thermocouple connection pilot connection closed ignition pressure 3-30mbar pressure range 3-30mbar pressure regulator connection blind equiv. no. 0.822.144 | | | |
| For models: | 2061401-05, 2061401-06, 2061401-07, 2061401-08, 2061401A05, 2061401A06, 2061401A07, 2061401A08, 2061401B05, 2061401B06, 2061401B07, 2061401B08, 2061401C05, 2061401C06, 2061401C07, 2061401C08, 2061402-05, 2061402-06, 2061402-07, 2061402A05, 2061402A06, 2061402A07, 2061402B05, 2061402B06, 2061402B07, 2061402C05, 2061402C06, 2061402C07, 2062801-06, 2062801A06, 2062801B06, 2062801C06, 2062802-06, 2062802A06, 2062802B06, 2062802C06, 2062803-06, 2062803A06, 2062803B06, 2062803C06, 2062804-06, 2062804A06, 2062804B06, 2062804C06, 2161401-03, 2161401-04, 2161401-05, 2161401-06, 2161401A03, 2161401A04... (Other models you can see in the webshop) | | | |
| spare parts for 101914 | | | | |
|  | GEV No. | 101313 | Ref. No. | — |
| solenoid coil 230V 50Hz | | | | |
|  | GEV No. | 101542 | Ref. No. | — |
| solenoid coil 50Hz NOVA 822/826/827 suitable for NOVASIT 230V | | | | |
| accessories for 101914 | | | | |
|  | GEV No. | 101305 | Ref. No. | — |
| gas connection straight 1/2" flange 45x45mm ELETTROSIT/V4400/4600/4605 suitable for SIT/HONEYWELL hole distance 36x36mm | | | | |

Table continues overleaf



| accessories for | | 101914 | |
|-----------------|--|----------|---|
| GEV No. | 101306 | Ref. No. | — |
| | gas connection angled flange 45x45mm hole distance 36x36mm 1/2" ELETROSIT/V4400/4600/4605 screw with O-ring suitable for SIT/HONEYWELL | | |
| | gas connection straight flange 45x45mm hole distance 36x36mm 3/4" ELETROSIT/V4400/4600/4605 screw with O-ring suitable for SIT/HONEYWELL | | |
| | gas connection angled flange 45x45mm hole distance 36x36mm 3/4" ELETROSIT/V4400/4600/4605 screw with O-ring suitable for SIT/HONEYWELL | | |
| | O-ring EPDM thickness 2mm ID ø 32mm Qty 1 pcs | | |
| | plug with cable L 1090mm suitable for NOVA 822/826/827 | | |

| accessories for | | 101984 | |
|-----------------|--------|----------|---|
| GEV No. | 102847 | Ref. No. | — |
| | O-ring | | |

ignition boxes

DUNGS



| GEV No. | 102378 | Ref. No. | 201643 201662 201699 201735 |
|--------------------|---|----------|--------------------------------------|
| description | ignition box type DGAI.73 model 10.1.0TCL electrodes 2 starting time <10s waiting time >3s safety time <1s 230V 50/60Hz ignition cable male faston 2.8mm DUNGS protection IP20 DGAI.73 | | |
| For models: | 1462802B00, 1462802B01, 1462802B02, 1462802B03, 1462802B04, 1462802B05, 1462804B00, 1462804B01, 1462804B02, 1462804B03, 1462804B04, 1462804B05, 2061401-05, 2061401-06, 2061401-07, 2061401-08, 2061401A05, 2061401A06, 2061401A07, 2061401A08, 2061401B05, 2061401B06, 2061401B07, 2061401B08, 2061401C05, 2061401C06, 2061401C07, 2061401C08, 2061402-05, 2061402-06, 2061402-07, 2061402A05, 2061402A06, 2061402A07, 2061402B05, 2061402B06, 2061402B07, 2061402C05, 2061402C06, 2061402C07, 2061403-00, 2061403-02, 2061403-03, 2061403-04, 2061403-05, 20614033-0, 2061403A02, 2061403A03, 2061403A04, 2061403A05... (Other models you can see in the webshop) | | |

TANDEM



| GEV No. | 101984 | Ref. No. | 201718 |
|---|---|----------|--------|
| description | gas valve 230V 50Hz gas inlet 1/2" gas outlet 1/2" pilot connection level slow ignition ignition times pressure range 2-50mbar power supply for modulator 230VAC rectified Tandem equiv. no. 0.836.010 | | |
| For models: | 1462802B00, 1462802B01, 1462802B02, 1462802B03, 1462802B04, 1462802B05, 1462804B00, 1462804B01, 1462804B02, 1462804B03, 1462804B04, 1462804B05, 2061403-02, 2061403-03, 2061403-04, 2061403-05, 2061403A02, 2061403A03, 2061403A04, 2061403A05, 2061403B02, 2061403B03, 2061403B04, 2061403B05, 2061403C02, 2061403C03, 2061403C04, 2061403C05, 2061404-02, 2061404-03, 2061404-04, 2061404-05, 2061404A02, 2061404A03, 2061404A04, 2061404A05, 2061404B02, 2061404B03, 2061404B04, 2061404B05, 2061404C02, 2061404C03, 2061404C04, 2061404C05, 2061405-01, 2061405-02, 2061405-03, 2061405-04, 2061405B01, 2061405B02... (Other models you can see in the webshop) | | |
| spare parts for | 101984 | | |
| | GEV No. 101379 | Ref. No. | — |
| solenoid coil 230V 50Hz suitable for Tandem | | | |
| accessories for | 101984 | | |
| | GEV No. 101274 | Ref. No. | — |
| olive for pipe ø 16mm Qty 1 pcs | | | |
| | GEV No. 101275 | Ref. No. | — |
| union screw thread 1/2" for pipe ø 16mm Qty 1 pcs | | | |
| | GEV No. 101925 | Ref. No. | — |
| plug with O-ring thread M10x1 for pilot burner suitable for NOVASIT | | | |
| | GEV No. 102845 | Ref. No. | — |
| gas connection angled 1/2" flange 32x32mm hole distance 24x24mm Tandem | | | |
| | GEV No. 102846 | Ref. No. | — |
| gas connection straight 1/2" flange 32x32mm hole distance 24x24mm suitable for Tandem | | | |

HONEYWELL



| GEV No. | 106607 | Ref. No. | 201180 |
|--------------------|--|----------|--------|
| description | cover for ignition box | | |
| For models: | CGG11-L, CGG11-R, CGG12-L, CGG12-R, CGG21-L, CGG21-R, CGG22-L, CGG22-R, CGG61-L, CGG61-R, CGG62-L, CGG62-R, CSG11-L, CSG11-R, CSG11-R-DG, CSG12-L, CSG12-R, CSG12-R-DG, CSG21-L, CSG21-R, CSG21-R-DG, CSG22-L, CSG22-R, CSG22-R-DG, CSG61-L, CSG61-R, CSG61-R-DG, CSG62-L, CSG62-R, CSG62-R-DG | | |

Honeywell



1

| | | | |
|--------------------|--|-----------------|--------|
| GEV No. | 106606 | Ref. No. | 201179 |
| description | ignition box HONEYWELL type S4575B 1025 electrodes 3 waiting times safety time 5s 230-240V 4VA 50/60Hz | | |
| For models: | CGG11-L, CGG11-R, CGG12-L, CGG12-R, CGG21-L, CGG21-R, CGG22-L, CGG22-R, CGG61-L, CGG61-R, CGG62-L, CGG62-R, CSG11-L, CSG11-R, CSG11-R-DG, CSG12-L, CSG12-R, CSG12-R-DG, CSG21-L, CSG21-R, CSG21-R-DG, CSG22-L, CSG22-R, CSG22-R-DG, CSG61-L, CSG61-R, CSG61-R-DG, CSG62-L, CSG62-R, CSG62-R-DG | | |

gas solenoid valves

DUNGS



1

| | | | |
|--------------------|--|-----------------|--------|
| GEV No. | 102379 ¹ | Ref. No. | 201529 |
| description | solenoid valve 230VAC connection 1/2" L 76mm DUNGS p max 0.2bar p min 0bar reg. no. 63AQ0626 gas inlet 1/2" gas outlet 1/2" | | |
| For models: | 2061403-00, 2061403-01, 20614033-0, 2061403A00, 2061403B00, 2061403C00, 2061404-00, 2061404-01, 20614044-0, 2061404A00, 2061404B00, 2061404C00, 2061405-00, 2061405B00, 2061406-00, 2061406B00, 20628033-0, 20628044-0, 20629011-0, 20629022-0, 3061403-00, 3061403A00, 3061403B00, 3061403C00, 3061404-00, 3061404A00, 3061404B00, 3061404C00, 3061405-00, 3061405B00, 3061405B01, 3061406-00, 3061406B00 | | |

¹aluminium housing

ignition parts

pilot burners

JUNKERS

CB 502 series

pilot burners



1

















| | | | |
|---|--|-----------------|--|
| GEV No. | 100085 | Ref. No. | 201598 |
| description | pilot burner JUNKERS type CB502031 natural gas nozzle no.6 gas connection 6mm with primary air | | |
| For models: | 0260301-00, 0260301-01, 0260302-00, 0260302-01, 0260501-00, 0261101-00, 0261101-01, 0261102-00, 0261102-01, 0261103-00, 0261103-01, 0261301-00, 0261601-00, 1461101-00, 1461102-00, 1461103-00, 1462101-00, 1462101-01, 1462101-02, 14621011-0, 1462102-00, 1462102-00_V2, 1462102-01, 2060301-00, 2061101-00, 20611011-0, 2061102-00, 20611022-0, 2061103-00, 20611033-0, 2061104-00, 20611044-0, 2061105-00, 20611055-0, 2061106-00, 20611066-0, 2061401-02, 2061401-03, 2061401-04, 2061401A01, 2061401A02, 2061401A03, 2061401B01, 2061401B02, 2061401B03, 2061401C01, 2061401C02, 2061401C03, 2061402-02, 2061402-03... (Other models you can see in the webshop) | | |
| spare parts for | 100085 | | |
|  | GEV No. | 100227 | Ref. No. — |
| | pilot burner nozzle natural gas gas pressure 25mbar code 6 Qty 1 pcs suitable for JUNKERS CB50203_ | | |
|  | GEV No. | 100704 | Ref. No. 201570 201572 201578 |
| | ignition electrode D1 ø 9mm connection M4 D2 ø 11mm L1 17mm L2 17mm BL1 13mm BL2 4mm BL3 22mm | | |
|  | GEV No. | 100909 | Ref. No. — |
| | union screw thread M10x1 for pipe ø 6mm Qty 1 pcs | | |
|  | GEV No. | 101287 | Ref. No. — |
| | olive for pipe ø 6mm Qty 1 pcs | | |
|  | GEV No. | 101292 | Ref. No. — |
| | union screw for igniter suitable for CB 502/505 Qty 1 pcs | | |
|  | GEV No. | 101295 | Ref. No. — |
| | clamping collet for thermocouple suitable for CB 502/505 Qty 1 pcs | | |
| accessories for | 100085 | | |
|  | GEV No. | 100220 | Ref. No. 201547 |
| | pilot burner nozzle LPG gas pressure 50mbar code 2 Qty 1 pcs suitable for JUNKERS CB503_ | | |
|  | GEV No. | 100221 | Ref. No. — |
| | pilot burner nozzle LPG gas pressure 30mbar code 29 Qty 1 pcs suitable for JUNKERS CB50203_ | | |
|  | GEV No. | 100222 | Ref. No. 201641 |
| | pilot burner nozzle LPG gas pressure 50mbar code 5 Qty 1 pcs suitable for JUNKERS CB50203_ | | |
|  | GEV No. | 100223 | Ref. No. — |
| | pilot burner nozzle natural gas gas pressure 20mbar code 3 Qty 1 pcs suitable for JUNKERS CB503_ | | |





Table continues overleaf



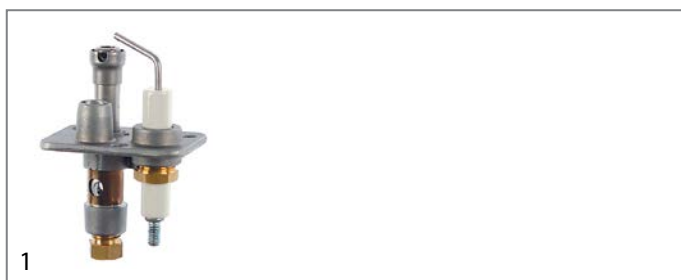









| accessories for | | 100085 | | |
|---|---|--------|----------|--------|
| GEV No. | | 100224 | Ref. No. | — |
|  | pilot burner nozzle natural gas gas pressure 25mbar code 26 Qty 1 pcs suitable for JUNKERS CB503_ | | | |
|  | pilot burner nozzle LPG gas pressure 30mbar code 39 Qty 1 pcs suitable for JUNKERS CB503_ | | | |
|  | pilot burner nozzle LPG gas pressure 50mbar code 15 suitable for JUNKERS | | | |
|  | pilot burner nozzle town gas gas pressure 8mbar code 4 Qty 1 pcs suitable for JUNKERS CB50203_ | | | |
|  | olive for pipe ø 4mm L 8.7mm Qty 1 pcs suitable for CB 502/503 | | | 201560 |
|  | union screw thread M10x1 for pipe ø 4mm Qty 1 pcs | | | 201692 |



| GEV No. | 102843 | Ref. No. | 520917 520997 |
|--------------------|---|----------|------------------|
| description | pilot burner JUNKERS type CB502031 natural gas nozzle no.6 gas pressure 25mbar gas connection 6mm with primary air | | |
| For models: | 0261101-01, 0261102-01, 0261103-01, 2060301-00, 2061104-00, 2061105-00, 2061106-00, 2062801-00, 2062801A00, 2062801B00, 2062801C00, 2062802-00, 2062802-0, 20628022-1, 20628022-2, 2062802A00, 2062802B00, 2062802C00, 2062803-00, 20628033-0, 20628033-2, 2062803A00, 2062803B00, 2062803C00, 2062804-00, 20628044-0, 20628044-2, 2062804A00, 2062804B00, 2062804C00, 2062901-00, 20629011-0, 20629011-2, 2062901A00, 2062901B00, 2062901B01, 2062901B02, 2062901C00, 2062901C01, 2062901C02, 2062902-00, 20629022-0, 20629022-2, 2062902A00, 2062902B00, 2062902B01, 2062902B02, 2062902C00, 2062902C01, 2062902C02 | | |

| spare parts for | | 102843 | | |
|---|--|--------|----------|----------------------------|
| GEV No. | | 100227 | Ref. No. | — |
|  | pilot burner nozzle natural gas gas pressure 25mbar code 6 Qty 1 pcs suitable for JUNKERS CB50203_ | | | |
|  | ignition electrode D1 ø 9mm connection M4 D2 ø 11mm L1 17mm L2 17mm BL1 13mm BL2 4mm BL3 22mm | | | 201570 201572 201578 |
|  | union screw thread M10x1 for pipe ø 6mm Qty 1 pcs | | | — |
|  | olive for pipe ø 6mm Qty 1 pcs | | | — |
|  | union screw for igniter suitable for CB 502/505 Qty 1 pcs | | | — |



| accessories for | | 102843 | | |
|---|--|--------|----------|--------|
| GEV No. | | 100220 | Ref. No. | 201547 |
|  | pilot burner nozzle LPG gas pressure 50mbar code 2 Qty 1 pcs suitable for JUNKERS CB503_ | | | |

| accessories for | | 102843 | | |
|--|---|--------|----------|--------|
| GEV No. | | 100221 | Ref. No. | — |
|  | pilot burner nozzle LPG gas pressure 30mbar code 29 Qty 1 pcs suitable for JUNKERS CB50203_ | | | |
|  | pilot burner nozzle LPG gas pressure 50mbar code 5 Qty 1 pcs suitable for JUNKERS CB50203_ | | | 201641 |
|  | pilot burner nozzle natural gas gas pressure 20mbar code 3 Qty 1 pcs suitable for JUNKERS CB503_ | | | — |
|  | pilot burner nozzle natural gas gas pressure 25mbar code 26 Qty 1 pcs suitable for JUNKERS CB503_ | | | — |
|  | pilot burner nozzle LPG gas pressure 30mbar code 39 Qty 1 pcs suitable for JUNKERS CB503_ | | | — |
|  | pilot burner nozzle LPG gas pressure 50mbar code 15 suitable for JUNKERS | | | — |
|  | pilot burner nozzle town gas gas pressure 8mbar code 4 Qty 1 pcs suitable for JUNKERS CB50203_ | | | — |
|  | olive for pipe ø 4mm L 8.7mm Qty 1 pcs suitable for CB 502/503 | | | 201560 |
|  | union screw thread M10x1 for pipe ø 4mm Qty 1 pcs | | | 201692 |

CB 503 series

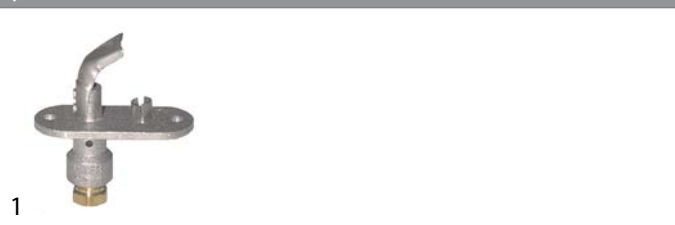
pilot burners



| GEV No. | 100121 | Ref. No. | 201544 | |
|---|--|----------|----------|--------|
| description | pilot burner JUNKERS type CB503002 natural gas gas pressure 15mbar | | | |
| spare parts for | 100121 | | | |
|  | GEV No. | 100223 | Ref. No. | — |
| | | | | |
|  | GEV No. | 101281 | Ref. No. | 201560 |
| | | | | |
|  | GEV No. | 101283 | Ref. No. | 201692 |
| | | | | |























| accessories for | | 100121 | | |
|---|---|--------|----------|--------|
| GEV No. | | 100220 | Ref. No. | 201547 |
|  | pilot burner nozzle LPG gas pressure 50mbar code 2 Qty 1 pcs suitable for JUNKERS CB503_ | | | |
|  | pilot burner nozzle LPG gas pressure 30mbar code 29 Qty 1 pcs suitable for JUNKERS CB50203_ | | | — |

Table continues overleaf



| accessories for | | 100121 | | |
|--|---------|--------|----------|--------|
|  | GEV No. | 100222 | Ref. No. | 201641 |
| pilot burner nozzle LPG gas pressure 50mbar code 5 Qty 1 pcs suitable for JUNKERS CB50203_ | | | | |
|  | GEV No. | 100224 | Ref. No. | — |
| pilot burner nozzle natural gas gas pressure 25mbar code 26 Qty 1 pcs suitable for JUNKERS CB503_ | | | | |
|  | GEV No. | 100226 | Ref. No. | — |
| pilot burner nozzle LPG gas pressure 50mbar code 15 suitable for JUNKERS | | | | |
|  | GEV No. | 100227 | Ref. No. | — |
| pilot burner nozzle natural gas gas pressure 25mbar code 6 Qty 1 pcs suitable for JUNKERS CB50203_ | | | | |
|  | GEV No. | 100228 | Ref. No. | — |
| pilot burner nozzle town gas gas pressure 8mbar code 4 Qty 1 pcs suitable for JUNKERS CB50203_ | | | | |
|  | GEV No. | 100909 | Ref. No. | — |
| union screw thread M10x1 for pipe ø 6mm Qty 1 pcs | | | | |
|  | GEV No. | 101287 | Ref. No. | — |
| olive for pipe ø 6mm Qty 1 pcs | | | | |

| | | | | |
|--|--|-----------------|----------|--------|
|  | | | | |
| 1 | | | | |
| GEV No. | 100058 | Ref. No. | 201544 | |
| description | pilot burner JUNKERS type CB503006 natural gas nozzle no.26 gas connection 4mm | | | |
| spare parts for | 100058 | | | |
|  | GEV No. | 100224 | Ref. No. | — |
| pilot burner nozzle natural gas gas pressure 25mbar code 26 Qty 1 pcs suitable for JUNKERS CB503_ | | | | |
|  | GEV No. | 101281 | Ref. No. | 201560 |
| olive for pipe ø 4mm L 8.7mm Qty 1 pcs suitable for CB 502/503 | | | | |
|  | GEV No. | 101283 | Ref. No. | 201692 |
| union screw thread M10x1 for pipe ø 4mm Qty 1 pcs | | | | |
| accessories for | 100058 | | | |
|  | GEV No. | 100220 | Ref. No. | 201547 |
| pilot burner nozzle LPG gas pressure 50mbar code 2 Qty 1 pcs suitable for JUNKERS CB503_ | | | | |
|  | GEV No. | 100221 | Ref. No. | — |
| pilot burner nozzle LPG gas pressure 30mbar code 29 Qty 1 pcs suitable for JUNKERS CB50203_ | | | | |
|  | GEV No. | 100222 | Ref. No. | 201641 |
| pilot burner nozzle LPG gas pressure 50mbar code 5 Qty 1 pcs suitable for JUNKERS CB50203_ | | | | |
|  | GEV No. | 100223 | Ref. No. | — |
| pilot burner nozzle natural gas gas pressure 20mbar code 3 Qty 1 pcs suitable for JUNKERS CB503_ | | | | |
|  | GEV No. | 100226 | Ref. No. | — |
| pilot burner nozzle LPG gas pressure 50mbar code 15 suitable for JUNKERS | | | | |
|  | GEV No. | 100227 | Ref. No. | — |
| pilot burner nozzle natural gas gas pressure 25mbar code 6 Qty 1 pcs suitable for JUNKERS CB50203_ | | | | |

| accessories for | | 100058 | | |
|--|---------|--------|----------|---|
|  | GEV No. | 100228 | Ref. No. | — |
| pilot burner nozzle town gas gas pressure 8mbar code 4 Qty 1 pcs suitable for JUNKERS CB50203_ | | | | |
|  | GEV No. | 100909 | Ref. No. | — |
| union screw thread M10x1 for pipe ø 6mm Qty 1 pcs | | | | |
|  | GEV No. | 101287 | Ref. No. | — |
| olive for pipe ø 6mm Qty 1 pcs | | | | |
|  | GEV No. | 102110 | Ref. No. | — |
| pilot tube copper pipe ø 4mm thickness 1mm L 3000mm | | | | |
|  | GEV No. | 102111 | Ref. No. | — |
| pilot tube copper pipe ø 6mm thickness 1mm L 3000mm | | | | |

producer-specific pilot burners

MKN

EA_ , HL_ , SL_ , Optima700 series













| | | | | |
|---|--|-----------------|----------|------------------|
|  | | | | |
| 1 | | | | |
| GEV No. | 102841 | Ref. No. | 201681 | |
| description | pilot burner SIT type 160 series 2 flames natural gas nozzle ø 0.41mm gas connection 4mm nozzle no.41 | | | |
| For models: | 1260301-00, 1260301-01, 1260302-00, 1260302-01, 1261301-00, 1261301-01, 1261301-02, 1261601-00, 1261601-01, 1361301-00, 1361301-01, 1361301-02, 1361301-03, 1361601-00, 1361601-01, 1361601-02, 1460302-01, 1460302-02, 1461601-00, 2060301-01, 2060301-02, 2061301-01 | | | |
| spare parts for | 102841 | | | |
|  | GEV No. | 100202 | Ref. No. | — |
| pilot burner nozzle natural gas code 41 Qty 1 pcs nozzle ø 0.41mm | | | | |
|  | GEV No. | 100701 | Ref. No. | 201690 201691 |
| ignition electrode connection M4 Qty 1 pcs | | | | |
|  | GEV No. | 100906 | Ref. No. | 201693 |
| screw connection thread M10x1 for ignition electrode brass Qty 1 pcs WS 10 | | | | |
|  | GEV No. | 100907 | Ref. No. | — |
| screw connection thread M10x1 Qty 1 pcs type SEF 1 ømm for thermocouple | | | | |
|  | GEV No. | 100908 | Ref. No. | — |
| union screw thread M10x1 for pipe ø 4mm Qty 1 pcs | | | | |
|  | GEV No. | 101282 | Ref. No. | — |
| olive for pipe ø 4mm L 7.4mm Qty 1 pcs | | | | |
| accessories for | 102841 | | | |
|  | GEV No. | 100203 | Ref. No. | — |
| pilot burner nozzle LPG code 25 Qty 1 pcs nozzle ø 0.25mm | | | | |







Table continues overleaf







| accessories for | | 102841 | | |
|---|---|--------|----------|---|
| GEV No. | | 100869 | Ref. No. | — |
|  | pilot burner nozzle natural gas code 51 Qty 1 pcs suitable for 160 series nozzle ø 0.51mm | | | |
|  | union screw thread M10x1 for pipe ø 6mm Qty 1 pcs | 100909 | Ref. No. | — |
|  | olive for pipe ø 6mm Qty 1 pcs | 101287 | Ref. No. | — |
|  | pilot burner nozzle SIT LPG code 30 Qty 1 pcs | 107650 | Ref. No. | — |



| GEV No. | 102840 | Ref. No. | 201680 |
|--------------------|---|----------|--------|
| description | pilot burner SIT type 160 series 2 flames nozzle ø 0.41mm gas connection 6mm with igniter | | |
| For models: | 1260501-00, 1261101-00, 1261101-01, 1261101-02, 1261102-00, 1261102-01, 1261102-02, 1261602-00, 1261602-01, 1261602-02, 1261602-03, 1261604-03, 1360501-00, 1360501-01, 1361101-00, 1361101-01, 1361101-02, 1361101-03, 1361102-00, 1361102-01, 1361102-02, 1361102-03, 1361602-00, 1361602-01, 1361602-02, 1361604-02, 1460503-01, 1461101-01, 1461101-02, 1461101-03, 1461102-01, 1461102-02, 1461102-03, 1461104-01, 1461104-02, 1461104-03, 1461105-01, 1461105-02, 1461105-03, 1461109-01, 1461109-02, 1461109A01, 1461109A02, 1461602-00, 1462101-03, 1462101-04, 1462102-02, 1462102-03, 1561110-00, 2061101-01... (Other models you can see in the webshop) | | |

| spare parts for | | 102840 | | |
|---|--|--------|----------|------------------|
|  | pilot burner nozzle natural gas code 41 Qty 1 pcs nozzle ø 0.41mm | 100202 | Ref. No. | — |
|  | ignition electrode connection M4 Qty 1 pcs | 100701 | Ref. No. | 201690 201691 |
|  | screw connection thread M10x1 for ignition electrode brass Qty 1 pcs WS 10 | 100906 | Ref. No. | 201693 |
|  | screw connection thread M10x1 Qty 1 pcs type SEF 1 ømm for thermocouple | 100907 | Ref. No. | — |
|  | union screw thread M10x1 for pipe ø 6mm Qty 1 pcs | 100909 | Ref. No. | — |
|  | olive for pipe ø 6mm Qty 1 pcs | 101287 | Ref. No. | — |



| accessories for | | 102840 | | |
|---|---|--------|----------|---|
|  | pilot burner nozzle LPG code 25 Qty 1 pcs nozzle ø 0.25mm | 100203 | Ref. No. | — |
|  | pilot burner nozzle natural gas code 51 Qty 1 pcs suitable for 160 series nozzle ø 0.51mm | 100869 | Ref. No. | — |



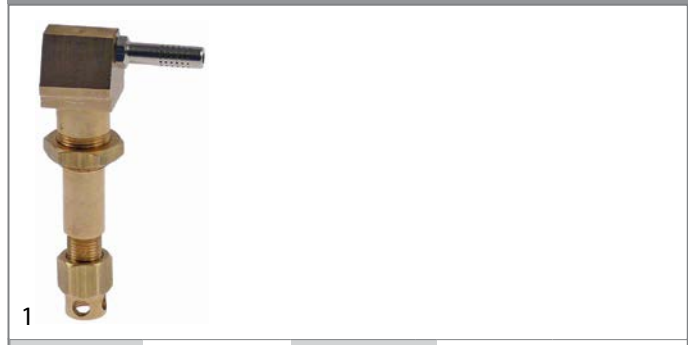

| accessories for | | 102840 | | |
|---|---|--------|----------|---|
|  | union screw thread M10x1 for pipe ø 4mm Qty 1 pcs | 100908 | Ref. No. | — |
|  | olive for pipe ø 4mm L 7.4mm Qty 1 pcs | 101282 | Ref. No. | — |
|  | pilot burner nozzle SIT LPG code 30 Qty 1 pcs | 107650 | Ref. No. | — |

Universal series



| GEV No. | 100088 | Ref. No. | 201820 |
|--------------------|---|----------|--------|
| description | pilot burner EGA type B | | |
| For models: | 0263401-00, 0263401-01, 1263401-00, 1263402-00, 1263402-01, 1263402-02, 1263404-00, 1263404-01, 1263404-02, 1263405-00, 1263405-01, 1263413-02, 1263414-02, 1363401-00, 1363402-00, 1363402-01, 1363402-02, 1363403-00, 1363403-01, 1363403-02, 1363403-03, 1363403-04, 1363403-05, 1363404-00, 1363404-01, 1363404-02, 1363404-03, 1363405-00, 1363405-01, 1363413-03, 1363415-05, 1464802-01, 1464802-02, 1464803-01, 1464803-02, 1464803-03, 1464808-01, 1464808-02, 1464808-03, 1464809-01, 1464809-02, 1464809-03, 1464810-01, 1464810-02, 1464811-01, 1464811-02, 1464812-00, 1464812-01, 1464812-02, 2063401-00... (Other models you can see in the webshop) | | |

| spare parts for | | 100088 | | |
|---|---|--------|----------|--------|
|  | pilot burner head thread M7x0.75mm thread L 5mm ED ø 6mm ID ø 4.4mm total length 30mm L 20mm WS 8 | 100961 | Ref. No. | 201819 |
|  | nut thread M15x1 H 3mm WS 19 brass Qty 1 pcs | 101345 | Ref. No. | — |

| accessories for | | 100088 | | |
|---|--|--------|----------|------------------|
|  | pilot burner nozzle LPG bore ø 0.2mm thread M8x0.75 T1: M8x1 | 100270 | Ref. No. | 201821 |
|  | pilot burner nozzle natural gas bore ø 0.3mm | 100271 | Ref. No. | 201822 |
|  | cover for pilot burner | 100960 | Ref. No. | 201040 575286 |
|  | union nut thread M8x1 for pipe ø 4mm | 101259 | Ref. No. | — |
|  | olive for pipe ø 4mm Qty 1 pcs | 101284 | Ref. No. | 201827 |



| | | | |
|---|-------------------------|-----------------|----------------------------------|
| GEV No. | 103183 | Ref. No. | N/A |
| description | pilot burner EGA type B | | |
| spare parts for | 103183 | | |
|  | GEV No. | 100960 | Ref. No. 201040 575286 |
| cover for pilot burner | | | |

electrodes

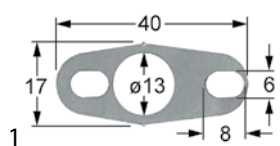

| | | | |
|--------------------|--|-----------------|--------|
| GEV No. | 107886 | Ref. No. | 911589 |
| description | bracket for glow electrode plate L 40mm W 17mm bore ø 13mm | | |
| For models: | CGG11-L, CGG11-R, CGG12-L, CGG12-R, CGG21-L, CGG21-R, CGG22-L, CGG22-R, CGG61-L, CGG61-R, CGG62-L, CGG62-R, CSG11-L, CSG11-R, CSG11-R-DG, CSG12-L, CSG12-R, CSG12-R-DG, CSG21-L, CSG21-R, CSG21-R-DG, CSG22-L, CSG22-R, CSG22-R-DG, CSG61-L, CSG61-R, CSG61-R-DG, CSG62-L, CSG62-R, CSG62-R-DG | | |



| | | | |
|---|--|-----------------|------------------------------------|
| GEV No. | 102289 | Ref. No. | 201176 201176+ 211137+ 2x211143 |
| description | glow plug mounting distance 28mm cable length 600mm connection male faston 2.8mm | | |
| For models: | CGG11-L, CGG11-R, CGG12-L, CGG12-R, CGG21-L, CGG21-R, CGG22-L, CGG22-R, CGG61-L, CGG61-R, CGG62-L, CGG62-R, CSG11-L, CSG11-R, CSG11-R-DG, CSG12-L, CSG12-R, CSG12-R-DG, CSG21-L, CSG21-R, CSG21-R-DG, CSG22-L, CSG22-R, CSG22-R-DG, CSG61-L, CSG61-R, CSG61-R-DG, CSG62-L, CSG62-R, CSG62-R-DG | | |
| spare parts for | 102289 | | |
|  | GEV No. | 691609 | Ref. No. 211143 |
| gasket graphite ED ø 150mm ID ø 115mm thickness 2mm Qty 1 pcs | | | |

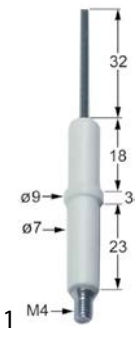

| | | | |
|---|--|-----------------|------------------------|
| GEV No. | 100701 | Ref. No. | 201690 201691 |
| description | ignition electrode connection M4 Qty 1 pcs | | |
| accessories for | 100701 | | |
|  | GEV No. | 100906 | Ref. No. 201693 |
| screw connection thread M10x1 for ignition electrode brass Qty 1 pcs WS 10 | | | |

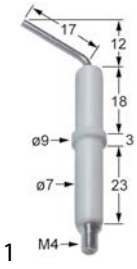

| | | | |
|--------------------|--|-----------------|--------|
| GEV No. | 100719 | Ref. No. | 201577 |
| description | ignition electrode D1 ø 7mm D2 ø 9mm connection M4 L1 12mm L2 17mm BL1 18mm BL2 3mm BL3 23mm | | |
| For models: | 2061403-00, 20614033-0 | | |

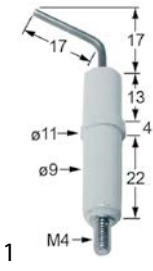

| | | | |
|--------------------|---|-----------------|----------------------------|
| GEV No. | 100704 | Ref. No. | 201570 201572 201578 |
| description | ignition electrode D1 ø 9mm connection M4 D2 ø 11mm L1 17mm L2 17mm BL1 13mm BL2 4mm BL3 22mm | | |



| | | | |
|--------------------|--|-----------------|--------|
| GEV No. | 100703 | Ref. No. | 636700 |
| description | ignition electrode D1 ø 9mm connection M4 D2 ø 11mm L1 8mm BL1 13mm BL2 4mm BL3 22mm to clip | | |

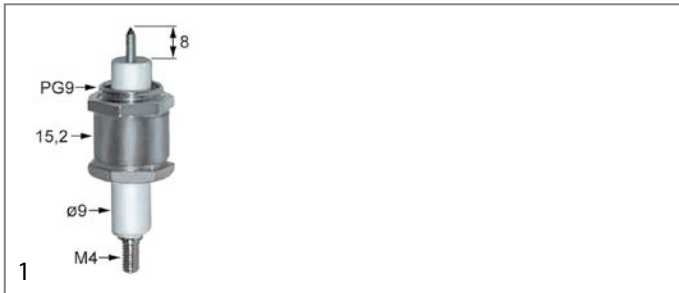

| | | | |
|--------------------|--|-----------------|--------|
| GEV No. | 100741 | Ref. No. | 201597 |
| description | ignition electrode D1 ø9mm L1 8mm connection M4 PG9 | | |
| For models: | 14621011-0, 1463501-00, 1463501-01, 2060501-00, 2060501-01, 20605011-0, 2061401-00, 2061401-01, 2061401A00, 2061401B00, 2061401C00, 2061402-00, 2061402-01, 2061402A00, 2061402B00, 2061402C00, 2063501-00, 2063501-01, 20635011-0, 2063502-00, 2063502-01, 2063502-02, 20635022-0, 2063503-00, 2063503-01, 20635033-0, 2063504-00, 2063504-01, 20635044-0, 2063505-00, 20635055-0, 2063506-00, 2063506-01, 20635066-0, 2063507-00, 2063507-01, 2063507-02, 20635077-0, 2063508-00, 2063508-01, 20635088-0, 2063509-00, 2063509-01, 2063509-02 | | |

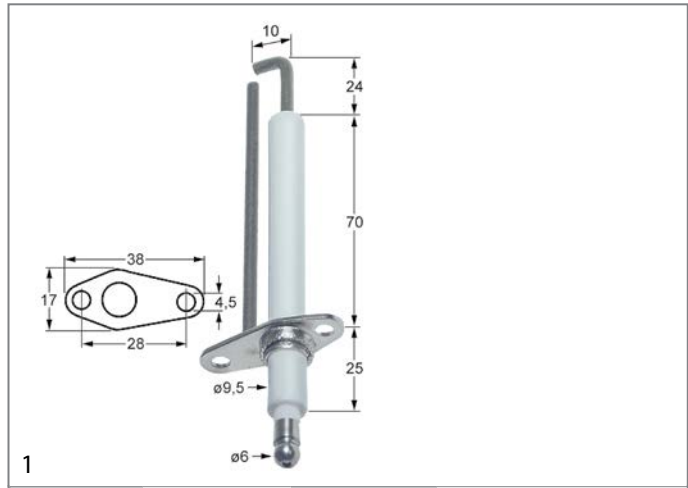

| | | | |
|--------------------|---|-----------------|--------|
| GEV No. | 102268 | Ref. No. | 201719 |
| description | ignition electrode flange length 38mm flange width 17mm D1 ø 9.5mm L1 24mm L2 10mm BL1 70mm BL2 25mm fixing dimensions ø4.5mm mounting distance 28mm with flange with earthing contact connection ø 6mm | | |
| For models: | 1462802B00, 1462802B01, 1462802B02, 1462802B03, 1462802B04, 1462802B05, 1462804B00, 1462804B01, 1462804B02, 1462804B03, 1462804B04, 1462804B05, 2061409B00, 2061409B01, 2061411B00, 2062801-06, 2062801A06, 2062801B06, 2062801C06, 2062802-06, 2062802A06, 2062802B06, 2062802B07, 2062802B08, 2062802B09, 2062802B10, 2062802B11, 2062802B12, 2062802B13, 2062802C06, 2062803-06, 2062803A06, 2062803B06, 2062803C06, 2062804-06, 2062804A06, 2062804B06, 2062804B07, 2062804B08, 2062804B09, 2062804B10, 2062804B11, 2062804B12, 2062804B13, 2062804C06, 2062807B00, 2062807B01, 2062807B02, 2062807B03, 2062808B00... (Other models you can see in the webshop) | | |

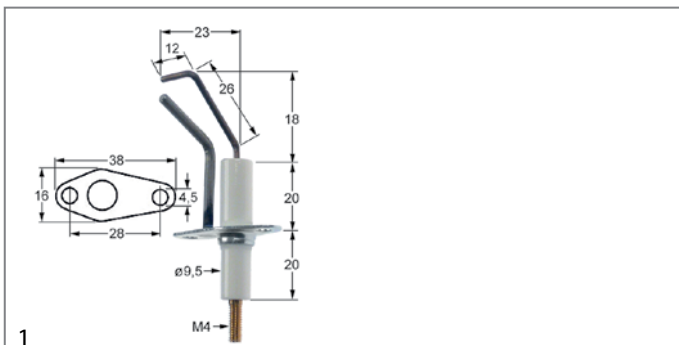

| | | | |
|--------------------|---|-----------------|--------|
| GEV No. | 102834 | Ref. No. | 201639 |
| description | ignition electrode flange length 38mm flange width 16mm D1 ø 9.5mm L1 18mm L2 23mm L4 26mm L3 12mm BL1 20mm BL2 20mm connection M4 fixing dimensions ø4.5mm mounting distance 28mm with flange with earthing contact | | |
| For models: | 1463501-02, 1463501-03, 1463501-04, 1463501-05, 2061401-05, 2061401-06, 2061401-07, 2061401-08, 2061401A05, 2061401A06, 2061401A07, 2061401A08, 2061401B05, 2061401B06, 2061401B07, 2061401B08, 2061401C05, 2061401C06, 2061401C07, 2061401C08, 2061402-05, 2061402-06, 2061402-07, 2061402A05, 2061402A06, 2061402A07, 2061402B05, 2061402B06, 2061402B07, 2061402C05, 2061402C06, 2061402C07, 2061403-01, 2061403-02, 2061403-03, 2061403-04, 2061403-05, 20614033-0, 2061403A00, 2061403A02, 2061403A03, 2061403A04, 2061403A05, 2061403B00, 2061403B02, 2061403B03, 2061403B04, 2061403B05, 2061403C00, 2061403C02... (Other models you can see in the webshop) | | |

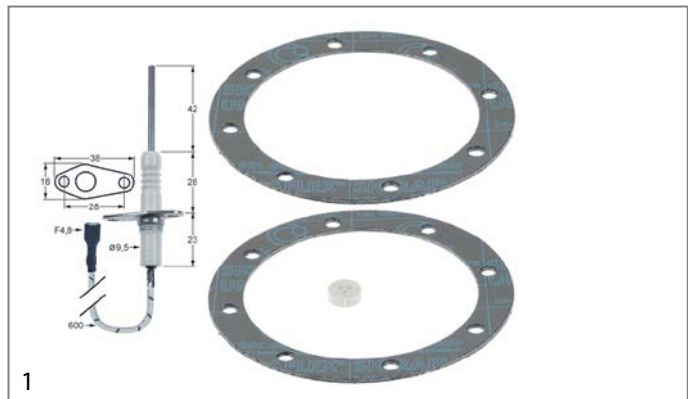

| | | | |
|--------------------|--|-----------------|--------|
| GEV No. | 102290 | Ref. No. | 201177 |
| description | monitoring electrode flange length 38mm D1 ø 9.5mm flange width 16mm L1 42mm BL1 28mm BL2 23mm connection F4.8x0.8 cable length 600mm fixing dimensions 28mm | | |
| For models: | CGG11-L, CGG11-R, CGG12-L, CGG12-R, CGG21-L, CGG21-R, CGG22-L, CGG22-R, CGG61-L, CGG61-R, CGG62-L, CGG62-R, CSG11-L, CSG11-R, CSG11-R-DG, CSG12-L, CSG12-R, CSG12-R-DG, CSG21-L, CSG21-R, CSG21-R-DG, CSG22-L, CSG22-R, CSG22-R-DG, CSG61-L, CSG61-R, CSG61-R-DG, CSG62-L, CSG62-R, CSG62-R-DG | | |



| | | | |
|--------------------|--|-----------------|--------|
| GEV No. | 100906 | Ref. No. | 201693 |
| description | screw connection thread M10x1 for ignition electrode brass Qty 1 pcs WS 10 | | |



ignition cables

pre-assembled cables



| | | | |
|--------------------|--|-----------------|--------|
| GEV No. | 102164 | Ref. No. | 203422 |
| description | ignition cable cable length 1000mm connection F6.3mm / lug M4 | | |
| For models: | 1260301-00, 1260301-01, 1260302-00, 1260302-01, 1260501-00, 1261101-01, 1261101-02, 1261102-01, 1261102-02, 1261301-00, 1261301-01, 1261301-02, 1261601-01, 1261602-00, 1261602-01, 1261602-02, 1261602-03, 1261604-03, 1360501-00, 1360501-01, 1361101-01, 1361101-02, 1361101-03, 1361102-01, 1361102-02, 1361102-03, 1361301-00, 1361301-01, 1361301-02, 1361301-03, 1361601-01, 1361601-02, 1361602-00, 1361602-01, 1361602-02, 1361604-02, 1460302-01, 1460302-02, 1460503-01, 1461101-02, 1461101-03, 1461102-02, 1461102-03, 1461104-02, 1461104-03, 1461105-02, 1461105-03, 1461109-01, 1461109-02, 1461109A01... (Other models you can see in the webshop) | | |

piezoelectric igniters

mounting diameter 22mm



| | | | |
|--------------------|--|-----------------|--------|
| GEV No. | 105209 ¹ | Ref. No. | 910736 |
| description | piezoelectric igniter body plastic blowing mounting ø 22mm connection F6.3x0.8 cable length 200mm | | |
| For models: | 1260501-00, 1261101-00, 1261101-01, 1261101-02, 1261102-00, 1261102-01, 1261102-02, 1261301-00, 1261301-01, 1261301-02, 1261601-00, 1261601-01, 1261602-00, 1261602-01, 1261602-02, 1261602-03, 1261604-03, 1360501-00, 1360501-01, 1361101-00, 1361101-01, 1361101-02, 1361101-03, 1361102-00, 1361102-01, 1361102-02, 1361102-03, 1361301-00, 1361301-01, 1361301-02, 1361301-03, 1361601-00, 1361601-01, 1361601-02, 1361602-00, 1361602-01, 1361602-02, 1361604-02, 1461101-01, 1461101-02, 1461101-03, 1461102-01, 1461102-02, 1461102-03, 1461104-01, 1461104-02, 1461104-03, 1461105-01, 1461105-02, 1461105-03... (Other models you can see in the webshop) | | |

¹cable length 200mm



| | | | |
|---|--|-----------------|------------------|
| GEV No. | 100039 | Ref. No. | 201519 201537 |
| description | piezoelectric igniter body plastic blowing mounting ø 22mm connection F6.3x0.8 cable lengthmm | | |
| For models: | 1260501-00, 1261101-00, 1261101-01, 1261101-02, 1261102-00, 1261102-01, 1261102-02, 1261301-00, 1261301-01, 1261301-02, 1261601-00, 1261601-01, 1261602-00, 1261602-01, 1261602-02, 1261602-03, 1261604-03, 1360501-00, 1360501-01, 1361101-00, 1361101-01, 1361101-02, 1361101-03, 1361102-00, 1361102-01, 1361102-02, 1361102-03, 1361301-00, 1361301-01, 1361301-02, 1361301-03, 1361601-00, 1361601-01, 1361601-02, 1361602-00, 1361602-01, 1361602-02, 1361604-02, 1461101-01, 1461101-02, 1461101-03, 1461102-01, 1461102-02, 1461102-03, 1461104-01, 1461104-02, 1461104-03, 1461105-01, 1461105-02, 1461105-03... (Other models you can see in the webshop) | | |
| accessories for | 100039 | | |
|  | GEV No. | 100115 | Ref. No. |
| | | | — |
| | union nut ID ø M22x1mm | | |

miscellaneous



| | | | |
|--------------------|--|-----------------|--------|
| GEV No. | nla ¹ | Ref. No. | 201536 |
| description | piezoelectric igniter body metal connection F6.3x0.8 2 hole fixing ø 22mm | | |
| For models: | 0260501-00, 0261101-00, 0261101-01, 0261102-00, 0261102-01, 0261103-00, 0261103-01, 0261301-00, 0261601-00, 0261401-00, 0261401-01, 0261401A00, 0261401B00, 0261401C00, 0261402-00, 0261402-01, 0261402A00, 0261402B00, 0261402C00 | | |

¹no longer available



| | | | |
|--|---|-----------------|-----------------|
| GEV No. | nla ¹ | Ref. No. | 201535 |
| description | piezoelectric igniter suitable for Minisit with cover cap ømm connection F6.3x0.8 | | |
| spare parts for | 101136 | | |
|  | GEV No. | 100001 | Ref. No. |
| | | | — |
| | piezoelectric igniter suitable for Minisit connection F6.3x0.8 ømm | | |

¹no longer available

thermocouples

plug-in thermocouples

plug-in thermocouples standard

with barrel socket ø5mm - type Junkers with aluminised tip

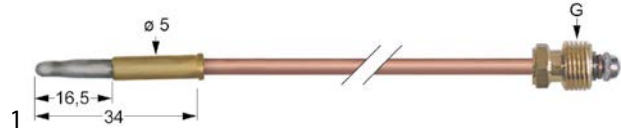

| | | | |
|--------------------|---|-----------------|--------|
| GEV No. | 102132 | Ref. No. | 201513 |
| description | thermocouple M10x1 L 1000mm plug connection ø5.0mm | | |
| For models: | 0260301-01, 0260302-01, 1461101-00, 1461102-00, 1461103-00, 1462101-00, 1462101-01, 1462101-02, 14621011-0, 1462102-00, 1462102-00_V2, 1462102-01, 2061101-00, 2061102-00, 2061103-00, 2061401-02, 2061401-03, 2061401-04, 2061401A01, 2061401A02, 2061401A03, 2061401B01, 2061401B02, 2061401B03, 2061401C01, 2061401C02, 2061401C03, 2061402-02, 2061402-03, 2061402-04, 2061402A01, 2061402A02, 2061402A03, 2061402B01, 2061402B02, 2061402B03, 2061402C01, 2061402C02, 2061402C03, 2062806-00, 2062806A00, 2062806B00, 2062806B01, 2062806B02, 2062806B03, 2062806C00, 2062806C01, 2062806C02, 2062806C03, 2063404-00... (Other models you can see in the webshop) | | |

with barrel socket ø6mm

SIT

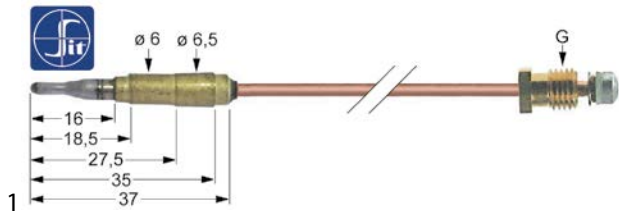

GEV No. 102267 **Ref. No.** 201670

description thermocouple M8x1 L 850mm plug connection ø6.0mm

For models: 1260501-00, 1261101-00, 1261101-01, 1261101-02, 1261102-00, 1261102-01, 1261102-02, 1261602-00, 1261602-01, 1261602-02, 1261602-03, 1261604-03, 1360501-00, 1360501-01, 1361101-00, 1361101-01, 1361101-02, 1361101-03, 1361102-00, 1361102-01, 1361102-02, 1361102-03, 1361602-00, 1361602-01, 1361602-02, 1361604-02, 1460503-01, 1461101-01, 1461101-02, 1461101-03, 1461102-01, 1461102-02, 1461102-03, 1461104-01, 1461104-02, 1461104-03, 1461105-01, 1461105-02, 1461105-03, 1461109-01, 1461109-02, 1461109A01, 1461109A02, 1461602-00, 1462101-03, 1462101-04, 1462102-02, 1462102-03, 1561110-00, 2061101-01... (Other models you can see in the webshop)

with barrel socket ø6(6.5)mm

thermocouples SIT

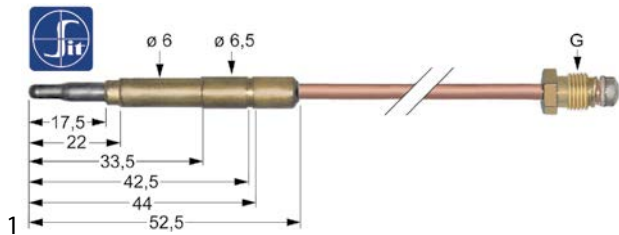

GEV No. 107617 **Ref. No.** 201669

description thermocouple SIT M10x1 L 600mm plug connection ø6.0(6.5)mm

For models: 1260301-00, 1260301-01, 1260302-00, 1260302-01, 1460302-01, 1460302-02, 2060301-01, 2060301-02

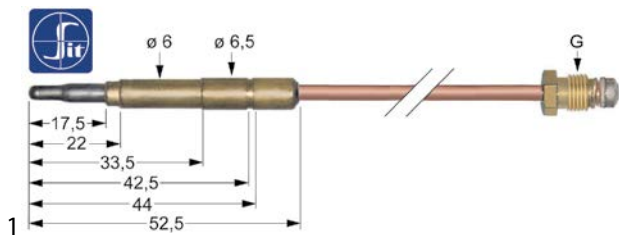

GEV No. 107601 **Ref. No.** 201668

description thermocouple SIT M8x1 L 600mm plug connection ø6.0(6.5)mm

For models: 1261301-00, 1261301-01, 1261301-02, 1261601-00, 1261601-01, 1361301-00, 1361301-01, 1361301-02, 1361301-03, 1361601-00, 1361601-01, 1361601-02, 1461601-00, 2061301-01

threaded thermocouples

threaded thermocouples standard

with socket with thread M8x1

SIT

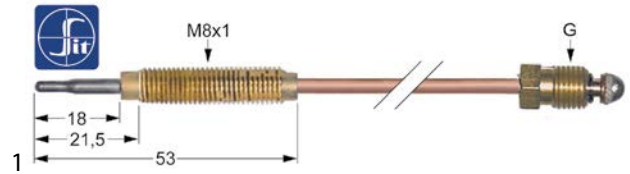

GEV No. 107645 **Ref. No.** 201538

description thermocouple SIT M10x1 L 1500mm M8x1

accessories for 107645

GEV No. 102067 **Ref. No.** 201524

nut thread M8x1 H 3mm brass Qty 1 pcs type SEF 1

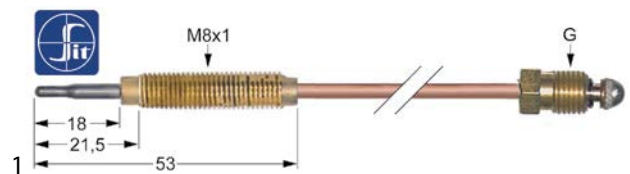

GEV No. 107643 **Ref. No.** 201533

description thermocouple SIT M10x1 L 600mm M8x1

accessories for 107643

GEV No. 102067 **Ref. No.** 201524

nut thread M8x1 H 3mm brass Qty 1 pcs type SEF 1

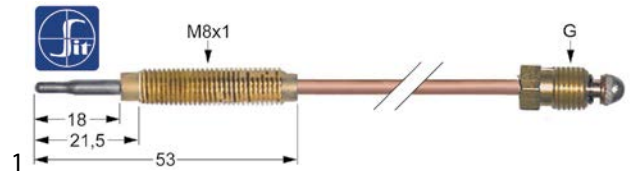

GEV No. 107632 **Ref. No.** 201352, 201532, 201539

description thermocouple SIT M8x1 L 1000mm M8x1

For models: 0261301-00, 0263401-00, 0263401-01, 1263401-00, 1263402-00, 1263402-01, 1263402-02, 1263404-00, 1263404-01, 1263404-02, 1263405-00, 1263405-01, 1263413-02, 1263414-02, 1363401-00, 1363402-00, 1363402-01, 1363402-02, 1363403-00, 1363403-01, 1363403-02, 1363403-03, 1363403-04, 1363403-05, 1363404-00, 1363404-01, 1363404-02, 1363404-03, 1363405-00, 1363405-01, 1363413-03, 1363415-05, 1463501-04, 1463501-05, 1464802-01, 1464802-02, 1464803-01, 1464803-02, 1464803-03, 1464808-01, 1464808-02, 1464808-03, 1464809-01, 1464809-02, 1464809-03, 1464810-01, 1464810-02, 1464811-01, 1464811-02, 1464812-00... (Other models you can see in the webshop)

accessories for 107632

GEV No. 102067 **Ref. No.** 201524

nut thread M8x1 H 3mm brass Qty 1 pcs type SEF 1

| | | | |
|------------------------|--|-----------------|---------------|
| GEV No. | 107633 | Ref. No. | 201534 |
| description | thermocouple SIT M8x1 L 1200mm M8x1 | | |
| For models: | 1463501-00 | | |
| accessories for | 107633 | | |
| | GEV No. | Ref. No. | 201524 |
| | nut thread M8x1 H 3mm brass Qty 1 pcs type SEF 1 | | |

| | | | |
|--------------------|------------------------------------|-----------------|--------|
| GEV No. | 107629 | Ref. No. | 201530 |
| description | thermocouple SIT M8x1 L 450mm M8x1 | | |

accessories

displays

| | | | |
|--------------------|--|-----------------|--------|
| GEV No. | 101414 | Ref. No. | 201554 |
| description | display soldering connection | | |
| For models: | 2062801-00, 2062801A00, 2062801B00, 2062801C00, 2062802-00, 20628022-0, 20628022-1, 20628022-2, 2062802A00, 2062802B00, 2062802C00, 2062803-00, 20628033-0, 20628033-1, 20628033-2, 2062803A00, 2062803B00, 2062803C00, 2062804-00, 20628044-0, 20628044-1, 20628044-2, 2062804A00, 2062804B00, 2062804C00, 2062806-00, 2062806A00, 2062806B00, 2062806B01, 2062806B02, 2062806B03, 2062806C00, 2062806C01, 2062806C02, 2062806C03, 2062901-00, 20629011-0, 20629011-1, 20629011-2, 2062901A00, 2062901B00, 2062901B01, 2062901B02, 2062901B03, 2062901B04, 2062901B05, 2062901C00, 2062901C01, 2062901C02, 2062901C03... (Other models you can see in the webshop) | | |

nuts

| | | | |
|--------------------|--|-----------------|--------|
| GEV No. | 102067 | Ref. No. | 201524 |
| description | nut thread M8x1 H 3mm brass Qty 1 pcs type SEF 1 | | |
| For models: | 0260301-00, 0260302-00, 0260501-00, 0261101-00, 0261101-01, 0261102-00, 0261102-01, 0261103-00, 0261103-01, 0261301-00, 0261601-00, 0263401-00, 0263401-01, 1263401-00, 1263402-00, 1263402-01, 1263402-02, 1263404-00, 1263404-01, 1263404-02, 1263405-00, 1263405-01, 1263413-02, 1263414-02, 1363401-00, 1363402-00, 1363402-01, 1363402-02, 1363403-00, 1363403-01, 1363403-02, 1363403-03, 1363403-04, 1363403-05, 1363404-00, 1363404-01, 1363404-02, 1363404-03, 1363405-00, 1363405-01, 1363413-03, 1363415-05, 14621011-0, 1462831-00, 1462832-00, 1462833-00, 1462834-00, 1462835-00, 1462836-00, 1462837-00... (Other models you can see in the webshop) | | |

| | | | |
|--------------------|--|-----------------|--------|
| GEV No. | 100965 | Ref. No. | 201525 |
| description | thermocouple nut thread M8x1 H 15mm WS 11 brass Qty 1 pcs | | |
| For models: | 0263401-00, 0263401-01, 1263401-00, 1263402-00, 1263402-01, 1263402-02, 1263404-00, 1263404-01, 1263404-02, 1263405-00, 1263405-01, 1263413-02, 1263414-02, 1363401-00, 1363402-00, 1363402-01, 1363402-02, 1363403-00, 1363403-01, 1363403-02, 1363403-03, 1363403-04, 1363403-05, 1363404-00, 1363404-01, 1363404-02, 1363404-03, 1363405-00, 1363405-01, 1363413-03, 1363415-05, 1464802-01, 1464802-02, 1464803-01, 1464803-02, 1464803-03, 1464808-01, 1464808-02, 1464808-03, 1464809-01, 1464809-02, 1464809-03, 1464810-01, 1464810-02, 1464811-01, 1464811-02, 1464812-00, 1464812-01, 1464812-02, 2063401-00... (Other models you can see in the webshop) | | |

screws

| | | | |
|--------------------|--|-----------------|--------|
| GEV No. | 101262 | Ref. No. | 201123 |
| description | thermocouple fitting thread M10x1 Qty 1 pcs | | |
| For models: | 1462101-03, 1462101-04, 2062901B02, 2062901C02, 2062902B02, 2062902C02, 2063404-05, 2063404-06, 2063404-07, 2063407-05, 2063407-06, 2063407-07, 2063416-02, 2063419-02, 2063503-06, 2063503-07, 2063508-05, 2063508-06 | | |

interrupters

| | | | |
|--------------------|--|-----------------|------------------|
| GEV No. | 101258 | Ref. No. | 201478 203478 |
| description | interrupter thread M10x1 | | |
| For models: | 0260301-00, 0260301-01, 0260302-00, 0260302-01, 1260301-00, 1260301-01, 1260302-00, 1260302-01, 1460302-00, 1460302-01, 1460302-02, 2060301-00, 2060301-01, 2060301-02, 20628022-0, 20628022-1, 20628022-2, 20628033-0, 20628033-1, 20628033-2, 20628044-0, 20628044-1, 20628044-2, 20629011-0, 20629011-1, 20629011-2, 20629022-0, 20629022-1, 20629022-2, 2160501-00 | | |

ignition bridges

| | | | |
|--------------------|--|-----------------|--------|
| GEV No. | 104296 | Ref. No. | 201620 |
| description | ignition bridge L 330mm | | |
| For models: | 14621011-0, 2060501-00, 2060501-01, 20605011-0 | | |



| | | | |
|---|-------------------------|-----------------|--------|
|  | | | |
| GEV No. | 105930 | Ref. No. | 201612 |
| description | ignition bridge L 530mm | | |

gas burners

hob burners

producer-specific hob burners

MKN

burner head 29mm

| | | | |
|---|--|-----------------|--------|
|  | | | |
| GEV No. | 104214 | Ref. No. | 201863 |
| description | air mixing tube ID ø 12mm C | | |
| For models: | 1260501-00, 1263401-00, 1263402-00, 1263402-01, 1263402-02, 1263404-00, 1263404-01, 1263404-02, 1263413-02, 1263414-02, 1360501-00, 1360501-01, 1363401-00, 1363402-00, 1363402-01, 1363402-02, 1363403-00, 1363403-01, 1363403-02, 1363403-03, 1363403-04, 1363403-05, 1363404-00, 1363404-01, 1363404-02, 1363404-03, 1363413-03, 1363415-05, 1460503-01, 1464802-01, 1464802-02, 1464803-01, 1464803-02, 1464803-03, 1464808-01, 1464808-02, 1464808-03, 1464809-01, 1464809-02, 1464809-03, 1464810-01, 1464810-02, 1464811-01, 1464811-02, 2063401-00, 2063401-01, 2063401-02, 2063401-03, 2063401-04, 2063401-05... (Other models you can see in the webshop) | | |

| | | | |
|---|--|-----------------|--------|
|  | | | |
| GEV No. | 104215 | Ref. No. | 201864 |
| description | air mixing tube ID ø 14mm D | | |
| For models: | 0261601-00, 1261301-00, 1261301-01, 1261301-02, 1261601-00, 1261601-01, 1261602-00, 1261602-01, 1261602-02, 1261602-03, 1261604-03, 1263402-00, 1263402-01, 1263402-02, 1263404-00, 1263404-01, 1263404-02, 1263413-02, 1263414-02, 1361301-00, 1361301-01, 1361301-02, 1361301-03, 1361601-00, 1361601-01, 1361601-02, 1361602-00, 1361602-01, 1361602-02, 1361604-02, 1363402-00, 1363402-01, 1363402-02, 1363403-00, 1363403-01, 1363403-02, 1363403-03, 1363403-04, 1363403-05, 1363404-00, 1363404-01, 1363404-02, 1363404-03, 1363413-03, 1363415-05, 1461601-00, 1461602-00, 14621011-0, 1462802B00, 1462804B00... (Other models you can see in the webshop) | | |

| | | | |
|---|--|-----------------|--------|
|  | | | |
| GEV No. | 103090 | Ref. No. | 201618 |
| description | burner cap C ø 78mm | | |
| For models: | 0263401-00, 0263401-01, 1263401-00, 1263402-00, 1263402-01, 1263402-02, 1263404-00, 1263404-01, 1263404-02, 1263413-02, 1263414-02, 1363401-00, 1363402-00, 1363402-01, 1363402-02, 1363403-00, 1363403-01, 1363403-02, 1363403-03, 1363403-04, 1363403-05, 1363404-00, 1363404-01, 1363404-02, 1363404-03, 1363413-03, 1363415-05, 1464802-01, 1464802-02, 1464803-01, 1464803-02, 1464803-03, 1464808-01, 1464808-02, 1464808-03, 1464809-01, 1464809-02, 1464809-03, 1464810-01, 1464810-02, 1464811-01, 1464811-02, 2063401-00, 2063401-01, 2063401-02, 2063401-03, 2063401-04, 2063401-05, 2063401-06, 20634011-0... (Other models you can see in the webshop) | | |

| | | | |
|---|--|-----------------|--------|
|  | | | |
| GEV No. | 104362 | Ref. No. | 201619 |
| description | burner cap D ø 94mm with central hole | | |
| For models: | 2063401-00, 20634011-0, 2063402-00, 20634022-0, 2063403-00, 2063404-00, 2063405-00, 20634055-0, 2063406-00, 2063407-00, 2063413-00, 2063414-00, 2063415-00, 2063417-00, 2063418-00, 2083202A00, 2083501B00, 2083501C00, 2083502B00, 2083502B01, 2083502C00, 2083502C01 | | |

| | | | |
|--|--|-----------------|------------------|
|  | | | |
| GEV No. | 104088 | Ref. No. | 201855 550069 |
| description | burner head C for burner cap ø 78mm H 29mm | | |
| For models: | 0263401-00, 2063401-00, 20634011-0, 2063402-00, 20634022-0, 2063403-00, 2063404-00, 2063405-00, 20634055-0, 2063406-00, 2063407-00, 2063413-00, 2063414-00, 2063415-00, 2063417-00, 2063418-00, 2163401-00, 2163402-00, 2163403-00, 2163404-00, 2163405-00, 2163406-00, 2163407-00 | | |

| | | | |
|---|--|-----------------|------------------|
|  | | | |
| GEV No. | 104089 | Ref. No. | 201856 550070 |
| description | burner head D for burner cap ø 94mm H 29mm | | |
| For models: | 2063401-00, 20634011-0, 2063402-00, 20634022-0, 2063403-00, 2063404-00, 2063405-00, 20634055-0, 2063406-00, 2063407-00, 2063413-00, 2063414-00, 2063415-00, 2063417-00, 2063418-00, 2083202A00, 2083501B00, 2083501C00, 2083502B00, 2083502B01, 2083502C00, 2083502C01 | | |

| | | | |
|---|--|-----------------|--------|
|  | | | |
| GEV No. | 104098 | Ref. No. | 201842 |
| description | burner lower part | | |
| For models: | 1263401-00, 1263402-00, 1263402-01, 1263402-02, 1263404-00, 1263404-01, 1263404-02, 1263413-02, 1263414-02, 1363401-00, 1363402-00, 1363402-01, 1363402-02, 1363403-00, 1363403-01, 1363403-02, 1363403-03, 1363403-04, 1363403-05, 1363404-00, 1363404-01, 1363404-02, 1363404-03, 1363413-03, 1363415-05, 1464802-01, 1464802-02, 1464803-01, 1464803-02, 1464803-03, 1464808-01, 1464808-02, 1464808-03, 1464809-01, 1464809-02, 1464809-03, 1464810-01, 1464810-02, 1464811-01, 1464811-02, 2063401-00, 2063401-01, 2063401-02, 2063401-03, 2063401-04, 2063401-05, 2063401-06, 20634011-0, 2063402-00, 2063402-01... (Other models you can see in the webshop) | | |



1

| | | | |
|--------------------|-------------------|-----------------|--------|
| GEV No. | 104099 | Ref. No. | 201843 |
| description | burner lower part | | |



2

| | | | |
|--------------------|--|-----------------|--------|
| GEV No. | 104205 | Ref. No. | 211020 |
| description | gasket C for burner head | | |
| For models: | 0263401-00, 0263401-01, 1263401-00, 1263402-00, 1263402-01, 1263402-02, 1263404-00, 1263404-01, 1263404-02, 1263413-02, 1263414-02, 1363401-00, 1363402-00, 1363402-01, 1363402-02, 1363403-00, 1363403-01, 1363403-02, 1363403-03, 1363403-04, 1363403-05, 1363404-00, 1363404-01, 1363404-02, 1363404-03, 1363413-03, 1363415-05, 1464802-01, 1464802-02, 1464803-01, 1464803-02, 1464803-03, 1464808-01, 1464808-02, 1464808-03, 1464809-01, 1464809-02, 1464809-03, 1464810-01, 1464810-02, 1464811-01, 1464811-02, 2063401-00, 2063401-01, 2063401-02, 2063401-03, 2063401-04, 2063401-05, 2063401-06, 20634011-0... (Other models you can see in the webshop) | | |



1

| | | | |
|--------------------|--|-----------------|--------|
| GEV No. | 104206 | Ref. No. | 211021 |
| description | gasket D for burner head | | |
| For models: | 1464803-02, 1464803-03, 1464808-02, 1464808-03, 1464809-02, 1464809-03, 2063401-00, 2063401-03, 2063401-04, 2063401-05, 2063401-06, 20634011-0, 2063402-00, 2063402-04, 2063402-05, 2063402-06, 20634022-0, 2063403-00, 2063403-07, 2063403-08, 2063403-09, 2063403-10, 2063404-00, 2063404-04, 2063404-05, 2063404-06, 2063404-07, 2063405-00, 2063405-04, 2063405-05, 2063405-06, 20634055-0, 2063406-00, 2063406-07, 2063406-08, 2063406-09, 2063406-10, 2063407-00, 2063407-04, 2063407-05, 2063407-06, 2063407-07, 2063413-00, 2063413-02, 2063414-00, 2063414-03, 2063415-00, 2063415-05, 2063416-02, 2063417-00... (Other models you can see in the webshop) | | |



1

| | | | |
|--------------------|--|-----------------|--------|
| GEV No. | 104212 | Ref. No. | 211018 |
| description | O-ring Viton thickness 3mm ID ø 32.5mm Qty 1 pcs | | |
| For models: | 0263401-00, 0263401-01, 1220501-00, 1220501-01, 1220501-02, 1220502-00, 1220502-01, 1220802-00, 1220802-01, 1222507-00, 1222509-00, 1263401-00, 1263402-00, 1263402-01, 1263402-02, 1263404-00, 1263404-01, 1263404-02, 1263413-02, 1263414-02, 1320501-00, 1320502-00, 1320802-00, 1322507-00, 1322509-00, 1363401-00, 1363402-00, 1363402-01, 1363402-02, 1363403-00, 1363403-01, 1363403-02, 1363403-03, 1363403-04, 1363403-05, 1363404-00, 1363404-01, 1363404-02, 1363404-03, 1363413-03, 1363415-05, 1422513B00, 1422513B01, 1422515B01, 1422515B02, 1422701-00, 1422701-01, 1422701-02, 1422701-03, 1422702-00... (Other models you can see in the webshop) | | |



1

| | | | |
|--------------------|--|-----------------|--------|
| GEV No. | 104204 | Ref. No. | 204457 |
| description | spacer piece | | |
| For models: | 1464803-01, 1464803-02, 1464803-03, 1464808-01, 1464808-02, 1464808-03, 1464809-01, 1464809-02, 1464809-03, 2063401-00, 2063401-01, 2063401-02, 2063401-03, 2063401-04, 2063401-05, 2063401-06, 20634011-0, 2063402-00, 2063402-01, 2063402-02, 2063402-03, 2063402-04, 2063402-05, 2063402-06, 20634022-0, 2063403-00, 2063403-01, 2063403-02, 2063403-03, 2063403-04, 2063403-05, 2063403-06, 2063403-07, 2063403-08, 2063403-09, 2063403-10, 2063404-00, 2063404-01, 2063404-02, 2063404-03, 2063404-04, 2063404-05, 2063404-06, 2063404-07, 2063405-00, 2063405-01, 2063405-02, 2063405-03, 2063405-04, 2063405-05... (Other models you can see in the webshop) | | |



1

| | | | |
|--------------------|--|-----------------|--------|
| GEV No. | 104213 | Ref. No. | 201845 |
| description | venturi C/D | | |
| For models: | 1263401-00, 1263402-00, 1263402-01, 1263402-02, 1263404-00, 1263404-01, 1263404-02, 1263413-02, 1263414-02, 1363401-00, 1363402-00, 1363402-01, 1363402-02, 1363403-00, 1363403-01, 1363403-02, 1363403-03, 1363403-04, 1363403-05, 1363404-00, 1363404-01, 1363404-02, 1363404-03, 1363413-03, 1363415-05, 1464802-01, 1464802-02, 1464803-01, 1464803-02, 1464803-03, 1464808-01, 1464808-02, 1464808-03, 1464809-01, 1464809-02, 1464809-03, 1464810-01, 1464810-02, 1464811-01, 1464811-02, 2063401-00, 2063401-01, 2063401-02, 2063401-03, 2063401-04, 2063401-05, 2063401-06, 20634011-0, 2063402-00, 2063402-01... (Other models you can see in the webshop) | | |

burner head 34mm



1

| | | | |
|--------------------|--|-----------------|--------|
| GEV No. | 104214 | Ref. No. | 201863 |
| description | air mixing tube ID ø 12mm C | | |
| For models: | 1260501-00, 1263401-00, 1263402-00, 1263402-01, 1263402-02, 1263404-00, 1263404-01, 1263404-02, 1263413-02, 1263414-02, 1360501-00, 1360501-01, 1363401-00, 1363402-00, 1363402-01, 1363402-02, 1363403-00, 1363403-01, 1363403-02, 1363403-03, 1363403-04, 1363403-05, 1363404-00, 1363404-01, 1363404-02, 1363404-03, 1363413-03, 1363415-05, 1460503-01, 1464802-01, 1464802-02, 1464803-01, 1464803-02, 1464803-03, 1464808-01, 1464808-02, 1464808-03, 1464809-01, 1464809-02, 1464809-03, 1464810-01, 1464810-02, 1464811-01, 1464811-02, 2063401-00, 2063401-01, 2063401-02, 2063401-03, 2063401-04, 2063401-05... (Other models you can see in the webshop) | | |





1

| | | | |
|--------------------|--|-----------------|--------|
| GEV No. | 104215 | Ref. No. | 201864 |
| description | air mixing tube ID ø 14mm D | | |
| For models: | 0261601-00, 1261301-00, 1261301-01, 1261301-02, 1261601-00, 1261601-01, 1261602-00, 1261602-01, 1261602-02, 1261602-03, 1261604-03, 1263402-00, 1263402-01, 1263402-02, 1263404-00, 1263404-01, 1263404-02, 1263413-02, 1263414-02, 1361301-00, 1361301-01, 1361301-02, 1361301-03, 1361601-00, 1361601-01, 1361601-02, 1361602-00, 1361602-01, 1361602-02, 1361604-02, 1363402-00, 1363402-01, 1363402-02, 1363403-00, 1363403-01, 1363403-02, 1363403-03, 1363403-04, 1363403-05, 1363404-00, 1363404-01, 1363404-02, 1363404-03, 1363413-03, 1363415-05, 1461601-00, 1461602-00, 14621011-0, 1462802B00, 1462804B00... (Other models you can see in the webshop) | | |





| | | | |
|---|--|-----------------|--------|
|  | | | |
| GEV No. | 104606 | Ref. No. | 201767 |
| description | air mixing tube ID ø 16mm E | | |
| For models: | 1464803-02, 1464803-03, 1464808-02, 1464808-03, 1464809-02, 1464809-03, 2063401-03, 2063401-04, 2063401-05, 2063401-06, 2063402-04, 2063402-05, 2063402-06, 2063403-07, 2063403-08, 2063403-09, 2063403-10, 2063404-04, 2063404-05, 2063404-06, 2063404-07, 2063405-04, 2063405-05, 2063405-06, 2063406-07, 2063406-08, 2063406-09, 2063406-10, 2063407-04, 2063407-05, 2063407-06, 2063407-07, 2063413-02, 2063414-03, 2063415-05, 2063416-02, 2063417-03, 2063418-05, 2063419-02, 3063401-02, 3063401-03, 3063401-04, 3063402-02, 3063402-03, 3063402-04, 3063405-02, 3063405-03, 3063405-04 | | |

| | | | |
|---|---|-----------------|--------|
|  | | | |
| GEV No. | 103090 | Ref. No. | 201618 |
| description | burner cap C ø 78mm | | |
| For models: | 0263401-00, 0263401-01, 1263401-00, 1263402-00, 1263402-01, 1263402-02, 1263404-00, 1263404-01, 1263404-02, 1263413-02, 1263414-02, 1363401-00, 1363402-00, 1363402-01, 1363402-02, 1363403-00, 1363403-01, 1363403-02, 1363403-03, 1363403-04, 1363403-05, 1363404-00, 1363404-01, 1363404-02, 1363404-03, 1363413-03, 1363415-05, 1464802-01, 1464802-02, 1464803-01, 1464803-02, 1464803-03, 1464808-01, 1464808-02, 1464808-03, 1464809-01, 1464809-02, 1464809-03, 1464810-01, 1464810-02, 1464811-01, 1464811-02, 2063401-00, 2063401-01, 2063401-02, 2063401-03, 2063401-04, 2063401-05, 2063401-06, 20634011-0... (Other models you can see in the webshop) | | |

| | | | |
|---|---|-----------------|--------|
|  | | | |
| GEV No. | 103092 | Ref. No. | 201661 |
| description | burner cap D ø 87mm | | |
| For models: | 1263402-00, 1263402-01, 1263402-02, 1263404-00, 1263404-01, 1263404-02, 1263413-02, 1263414-02, 1363402-00, 1363402-01, 1363402-02, 1363403-00, 1363403-01, 1363403-02, 1363403-03, 1363403-04, 1363403-05, 1363404-00, 1363404-01, 1363404-02, 1363404-03, 1363413-03, 1363415-05, 1464802-01, 1464802-02, 1464803-01, 1464803-02, 1464803-03, 1464808-01, 1464808-02, 1464808-03, 1464809-01, 1464809-02, 1464809-03, 1464810-01, 1464810-02, 1464811-01, 1464811-02, 2063401-01, 2063401-02, 2063402-01, 2063402-02, 2063402-03, 2063402-04, 2063402-05, 2063402-06, 2063403-01, 2063403-02, 2063403-03, 2063403-04, 2063403-05, 2063403-06... (Other models you can see in the webshop) | | |

| | | | |
|---|--|-----------------|--------|
|  | | | |
| GEV No. | 105620 | Ref. No. | 201769 |
| description | burner cap E ø 114mm with central hole bore ø 2.7mm | | |
| For models: | 1464803-02, 1464803-03, 1464808-02, 1464808-03, 1464809-02, 1464809-03, 2063401-03, 2063401-04, 2063401-05, 2063401-06, 2063402-04, 2063402-05, 2063402-06, 2063403-07, 2063403-08, 2063403-09, 2063403-10, 2063404-04, 2063404-05, 2063404-06, 2063404-07, 2063405-04, 2063405-05, 2063405-06, 2063406-07, 2063406-08, 2063406-09, 2063406-10, 2063407-04, 2063407-05, 2063407-06, 2063407-07, 2063413-02, 2063414-03, 2063415-05, 2063416-02, 2063417-03, 2063418-05, 2063419-02, 3063401-02, 3063401-03, 3063401-04, 3063402-02, 3063402-03, 3063402-04, 3063405-02, 3063405-03, 3063405-04 | | |

| | | | |
|--|---|-----------------|--------|
|  | | | |
| GEV No. | 104207 | Ref. No. | 201102 |
| description | burner head C for burner cap ø 78mm H 34mm | | |
| For models: | 0263401-01, 1263401-00, 1263402-00, 1263402-01, 1263402-02, 1263404-00, 1263404-01, 1263404-02, 1263413-02, 1263414-02, 1363401-00, 1363402-00, 1363402-01, 1363402-02, 1363403-00, 1363403-01, 1363403-02, 1363403-03, 1363403-04, 1363403-05, 1363404-00, 1363404-01, 1363404-02, 1363404-03, 1363413-03, 1363415-05, 1464802-01, 1464802-02, 1464803-01, 1464803-02, 1464803-03, 1464808-01, 1464808-02, 1464808-03, 1464809-01, 1464809-02, 1464809-03, 1464810-01, 1464810-02, 1464811-01, 1464811-02, 2063401-01, 2063401-02, 2063401-03, 2063401-04, 2063401-05, 2063401-06, 2063402-01, 2063402-02, 2063402-03... (Other models you can see in the webshop) | | |

| | | | |
|--|---|-----------------|--------|
|  | | | |
| GEV No. | 104208 | Ref. No. | 201104 |
| description | burner head D for burner cap ø 87mm H 34mm | | |
| For models: | 1263402-00, 1263402-01, 1263402-02, 1263404-00, 1263404-01, 1263404-02, 1263413-02, 1263414-02, 1363402-00, 1363402-01, 1363402-02, 1363403-00, 1363403-01, 1363403-02, 1363403-03, 1363403-04, 1363403-05, 1363404-00, 1363404-01, 1363404-02, 1363404-03, 1363413-03, 1363415-05, 1464802-01, 1464802-02, 1464803-01, 1464803-02, 1464803-03, 1464808-01, 1464808-02, 1464808-03, 1464809-01, 1464809-02, 1464809-03, 1464810-01, 1464810-02, 1464811-01, 1464811-02, 2063401-01, 2063401-02, 2063402-01, 2063402-02, 2063402-03, 2063402-04, 2063402-05, 2063402-06, 2063403-01, 2063403-02, 2063403-03, 2063403-04, 2063403-05, 2063403-06... (Other models you can see in the webshop) | | |
| accessories for | 104208 | | |
| |  | GEV No. | 103092 |
| | | Ref. No. | 201661 |
| | burner cap D ø 87mm | | |

| | | | |
|--|--|-----------------|--------|
|  | | | |
| GEV No. | 104453 | Ref. No. | 201157 |
| description | burner head D for burner cap ø 87mm H 41mm | | |





| | | | |
|---|--|-----------------|--------|
|  | | | |
| 1 | | | |
| GEV No. | 104604 | Ref. No. | 201768 |
| description | burner head E for burner cap ø 114mm H 34mm | | |
| For models: | 1464803-02, 1464803-03, 1464808-02, 1464808-03, 1464809-02, 1464809-03, 2063401-03, 2063401-04, 2063401-05, 2063401-06, 2063402-04, 2063402-05, 2063402-06, 2063403-07, 2063403-08, 2063403-09, 2063403-10, 2063404-04, 2063404-05, 2063404-06, 2063404-07, 2063405-04, 2063405-05, 2063405-06, 2063406-07, 2063406-08, 2063406-09, 2063406-10, 2063407-04, 2063407-05, 2063407-06, 2063407-07, 2063413-02, 2063414-03, 2063415-05, 2063416-02, 2063417-03, 2063418-05, 2063419-02, 3063401-02, 3063401-03, 3063401-04, 3063402-02, 3063402-03, 3063402-04, 3063405-02, 3063405-03, 3063405-04 | | |

| | | | |
|---|---|-----------------|--------|
|  | | | |
| 2 | | | |
| GEV No. | 104098 | Ref. No. | 201842 |
| description | burner lower part | | |
| For models: | 1263401-00, 1263402-00, 1263402-01, 1263402-02, 1263404-00, 1263404-01, 1263404-02, 1263413-02, 1263414-02, 1363401-00, 1363402-00, 1363402-01, 1363402-02, 1363403-00, 1363403-01, 1363403-02, 1363403-03, 1363403-04, 1363403-05, 1363404-00, 1363404-01, 1363404-02, 1363404-03, 1363413-03, 1363415-05, 1464802-01, 1464802-02, 1464803-01, 1464803-02, 1464803-03, 1464808-01, 1464808-02, 1464808-03, 1464809-01, 1464809-02, 1464809-03, 1464810-01, 1464810-02, 1464811-01, 1464811-02, 2063401-00, 2063401-01, 2063401-02, 2063401-03, 2063401-04, 2063401-05, 2063401-06, 20634011-0, 2063402-00, 2063402-01... (Other models you can see in the webshop) | | |

| | | | |
|---|---|-----------------|--------|
|  | | | |
| 1 | | | |
| GEV No. | 104205 | Ref. No. | 211020 |
| description | gasket C for burner head | | |
| For models: | 0263401-00, 0263401-01, 1263401-00, 1263402-00, 1263402-01, 1263402-02, 1263404-00, 1263404-01, 1263404-02, 1263413-02, 1263414-02, 1263401-00, 1363402-00, 1363402-01, 1363402-02, 1363403-00, 1363403-01, 1363403-02, 1363403-03, 1363403-04, 1363403-05, 1363404-00, 1363404-01, 1363404-02, 1363404-03, 1363413-03, 1363415-05, 1464802-01, 1464802-02, 1464803-01, 1464803-02, 1464803-03, 1464808-01, 1464808-02, 1464808-03, 1464809-01, 1464809-02, 1464809-03, 1464810-01, 1464810-02, 1464811-01, 1464811-02, 2063401-00, 2063401-01, 2063401-02, 2063401-03, 2063401-04, 2063401-05, 2063401-06, 20634011-0, 2063402-00, 2063402-01... (Other models you can see in the webshop) | | |

| | | | |
|--|---|-----------------|--------|
|  | | | |
| 1 | | | |
| GEV No. | 104206 | Ref. No. | 211021 |
| description | gasket D for burner head | | |
| For models: | 1464803-02, 1464803-03, 1464808-02, 1464808-03, 1464809-02, 1464809-03, 2063401-00, 2063401-03, 2063401-04, 2063401-05, 2063401-06, 2063401-07, 2063402-00, 2063402-04, 2063402-05, 2063402-06, 2063402-07, 2063403-08, 2063403-09, 2063403-10, 2063404-00, 2063404-04, 2063404-05, 2063404-06, 2063404-07, 2063405-00, 2063405-04, 2063405-05, 2063405-06, 2063405-07, 2063406-00, 2063406-07, 2063406-08, 2063406-09, 2063406-10, 2063407-00, 2063407-04, 2063407-05, 2063407-06, 2063407-07, 2063413-00, 2063413-02, 2063414-00, 2063414-03, 2063415-00, 2063415-05, 2063416-02, 2063417-00... (Other models you can see in the webshop) | | |

| | | | |
|---|---|-----------------|--------|
|  | | | |
| 1 | | | |
| GEV No. | 104212 | Ref. No. | 211018 |
| description | O-ring Viton thickness 3mm ID ø 32.5mm Qty 1 pcs | | |
| For models: | 0263401-00, 0263401-01, 1220501-00, 1220501-01, 1220501-02, 1220502-00, 1220502-01, 1220802-00, 1220802-01, 1222507-00, 1222509-00, 1263401-00, 1263402-00, 1263402-01, 1263402-02, 1263404-00, 1263404-01, 1263404-02, 1263413-02, 1263414-02, 1320501-00, 1320502-00, 1320802-00, 1322507-00, 1322509-00, 1363401-00, 1363402-00, 1363402-01, 1363402-02, 1363403-00, 1363403-01, 1363403-02, 1363403-03, 1363403-04, 1363403-05, 1363404-00, 1363404-01, 1363404-02, 1363404-03, 1363413-03, 1363415-05, 1422513B00, 1422513B01, 1422515B01, 1422515B02, 1422701-00, 1422701-01, 1422701-02, 1422701-03, 1422702-00... (Other models you can see in the webshop) | | |

| | | | |
|---|---|-----------------|--------|
|  | | | |
| 1 | | | |
| GEV No. | 104204 | Ref. No. | 204457 |
| description | spacer piece | | |
| For models: | 1464803-01, 1464803-02, 1464803-03, 1464808-01, 1464808-02, 1464808-03, 1464809-01, 1464809-02, 1464809-03, 2063401-00, 2063401-01, 2063401-02, 2063401-03, 2063401-04, 2063401-05, 2063401-06, 20634011-0, 2063402-00, 2063402-01, 2063402-02, 2063402-03, 2063402-04, 2063402-05, 2063402-06, 2063402-07, 2063403-00, 2063403-01, 2063403-02, 2063403-03, 2063403-04, 2063403-05, 2063403-06, 2063403-07, 2063403-08, 2063403-09, 2063403-10, 2063404-00, 2063404-01, 2063404-02, 2063404-03, 2063404-04, 2063404-05, 2063404-06, 2063404-07, 2063405-00, 2063405-01, 2063405-02, 2063405-03, 2063405-04, 2063405-05... (Other models you can see in the webshop) | | |

| | | | |
|---|---|-----------------|--------|
|  | | | |
| 1 | | | |
| GEV No. | 104213 | Ref. No. | 201845 |
| description | venturi C/D | | |
| For models: | 1263401-00, 1263402-00, 1263402-01, 1263402-02, 1263404-00, 1263404-01, 1263404-02, 1263413-02, 1263414-02, 1363401-00, 1363402-00, 1363402-01, 1363402-02, 1363403-00, 1363403-01, 1363403-02, 1363403-03, 1363403-04, 1363403-05, 1363404-00, 1363404-01, 1363404-02, 1363404-03, 1363413-03, 1363415-05, 1464802-01, 1464802-02, 1464803-01, 1464803-02, 1464803-03, 1464808-01, 1464808-02, 1464808-03, 1464809-01, 1464809-02, 1464809-03, 1464810-01, 1464810-02, 1464811-01, 1464811-02, 2063401-00, 2063401-01, 2063401-02, 2063401-03, 2063401-04, 2063401-05, 2063401-06, 20634011-0, 2063402-00, 2063402-01... (Other models you can see in the webshop) | | |





| | | | |
|---|--|-----------------|--------|
|  | | | |
| GEV No. | 104605 | Ref. No. | 201766 |
| description | venturi E long | | |
| For models: | 1464803-02, 1464803-03, 1464808-02, 1464808-03, 1464809-02, 1464809-03, 2063401-03, 2063401-04, 2063401-05, 2063401-06, 2063402-04, 2063402-05, 2063402-06, 2063403-07, 2063403-08, 2063403-09, 2063403-10, 2063404-04, 2063404-05, 2063404-06, 2063404-07, 2063405-04, 2063405-05, 2063405-06, 2063406-07, 2063406-08, 2063406-09, 2063406-10, 2063407-04, 2063407-05, 2063407-06, 2063407-07, 2063413-02, 2063414-03, 2063415-05, 2063416-02, 2063417-03, 2063418-05, 2063419-02, 3063401-02, 3063401-03, 3063401-04, 3063402-02, 3063402-03, 3063402-04, 3063405-02, 3063405-03, 3063405-04 | | |

| | | | |
|---|-----------------|-----------------|--------|
|  | | | |
| GEV No. | 105926 | Ref. No. | 201876 |
| description | venturi E short | | |

pan supports

| | | | |
|--|---|-----------------|--------|
|  | | | |
| GEV No. | 210227 | Ref. No. | 201877 |
| description | pan support W 275mm L 350mm | | |
| For models: | 0263401-01, 1263401-00, 1263402-00, 1263402-01, 1263402-02, 1263404-00, 1263404-01, 1263404-02, 1263413-02, 1263414-02, 1363401-00, 1363402-00, 1363402-01, 1363402-02, 1363403-00, 1363403-01, 1363403-02, 1363403-03, 1363403-04, 1363403-05, 1363404-00, 1363404-01, 1363404-02, 1363404-03, 1363413-03, 1363415-05, 1464802-01, 1464802-02, 1464810-01, 1464810-02, 1464811-01, 1464811-02, 2163401-01, 2163401-02, 2163401-03, 2163401-04, 2163401-05, 2163402-01, 2163402-02, 2163402-03, 2163402-04, 2163402-05, 2163403-01, 2163403-02, 2163403-03, 2163403-04, 2163403-05, 2163403-06, 2163403-07, 2163403-08... (Other models you can see in the webshop) | | |

| | | | |
|---|---|-----------------|----------------------------|
|  | | | |
| GEV No. | 210228 | Ref. No. | 201866 201878 445035 |
| description | pan support W 350mm L 350mm H 35mm | | |
| For models: | 1464803-01, 1464808-01, 1464809-01, 2063401-00, 2063401-01, 2063401-02, 20634011-0, 2063402-00, 2063402-01, 2063402-02, 2063402-03, 20634022-0, 2063403-00, 2063403-01, 2063403-02, 2063403-03, 2063403-04, 2063403-05, 2063403-06, 2063404-00, 2063404-01, 2063404-02, 2063404-03, 2063405-00, 2063405-01, 2063405-02, 2063405-03, 20634055-0, 2063406-00, 2063406-01, 2063406-02, 2063406-03, 2063406-04, 2063406-05, 2063406-06, 2063407-00, 2063407-01, 2063407-02, 2063407-03, 2063413-00, 2063413-01, 2063414-00, 2063414-01, 2063414-02, 2063415-00, 2063415-01, 2063415-02, 2063415-03, 2063415-04, 2063416-00... (Other models you can see in the webshop) | | |

| | | | |
|--|--|-----------------|--------|
|  | | | |
| GEV No. | 210231 | Ref. No. | 206001 |
| description | pan support W 370mm L 700mm | | |
| For models: | 1464803-02, 1464803-03, 1464808-02, 1464808-03, 1464809-02, 1464809-03, 2063401-03, 2063401-04, 2063401-05, 2063401-06, 2063402-04, 2063402-05, 2063402-06, 2063403-07, 2063403-08, 2063403-09, 2063403-10, 2063404-04, 2063404-05, 2063404-06, 2063404-07, 2063405-04, 2063405-05, 2063405-06, 2063406-07, 2063406-08, 2063406-09, 2063406-10, 2063407-04, 2063407-05, 2063407-06, 2063407-07, 2063413-02, 2063414-03, 2063415-05, 2063416-02, 2063417-03, 2063418-05, 2063419-02, 3063401-02, 3063401-03, 3063401-04, 3063402-02, 3063402-03, 3063402-04, 3063405-02, 3063405-03, 3063405-04 | | |

reducers for pan supports

| | | | |
|--|--|-----------------|--------|
|  | | | |
| GEV No. | 210015 | Ref. No. | 201848 |
| description | reducer for pan support L 250mm W 250mm chrome-plated steel suitable for MKN | | |

accessories

reducers for pan supports

| | | | |
|--|--|-----------------|--------|
|  | | | |
| GEV No. | 210015 | Ref. No. | 201848 |
| description | reducer for pan support L 250mm W 250mm chrome-plated steel suitable for MKN | | |



pan supports



1

| | | | |
|--------------------|--|-----------------|--------|
| GEV No. | 210227 | Ref. No. | 201877 |
| description | pan support W 275mm L 350mm | | |
| For models: | 0263401-01, 1263401-00, 1263402-00, 1263402-01, 1263402-02, 1263404-00, 1263404-01, 1263404-02, 1263413-02, 1263414-02, 1363401-00, 1363402-00, 1363402-01, 1363402-02, 1363403-00, 1363403-01, 1363403-02, 1363403-03, 1363403-04, 1363403-05, 1363404-00, 1363404-01, 1363404-02, 1363404-03, 1363413-03, 1363415-05, 1464802-01, 1464802-02, 1464810-01, 1464810-02, 1464811-01, 1464811-02, 2163401-01, 2163401-02, 2163401-03, 2163401-04, 2163401-05, 2163402-01, 2163402-02, 2163402-03, 2163402-04, 2163402-05, 2163403-01, 2163403-02, 2163403-03, 2163403-04, 2163403-05, 2163403-06, 2163403-07, 2163403-08... (Other models you can see in the webshop) | | |



2

| | | | |
|--------------------|--|-----------------|----------------------------|
| GEV No. | 210228 | Ref. No. | 201866 201878 445035 |
| description | pan support W 350mm L 350mm H 35mm | | |
| For models: | 1464803-01, 1464808-01, 1464809-01, 2063401-00, 2063401-01, 2063401-02, 2063401-0, 2063402-00, 2063402-01, 2063402-02, 2063402-03, 2063402-02, 2063403-00, 2063403-01, 2063403-02, 2063403-03, 2063403-04, 2063403-05, 2063403-06, 2063404-00, 2063404-01, 2063404-02, 2063404-03, 2063405-00, 2063405-01, 2063405-02, 2063405-03, 2063405-0, 2063406-00, 2063406-01, 2063406-02, 2063406-03, 2063406-04, 2063406-05, 2063406-06, 2063407-00, 2063407-01, 2063407-02, 2063407-03, 2063413-00, 2063413-01, 2063414-00, 2063414-01, 2063414-02, 2063415-00, 2063415-01, 2063415-02, 2063415-03, 2063415-04, 2063416-00... (Other models you can see in the webshop) | | |



1

| | | | |
|--------------------|--|-----------------|--------|
| GEV No. | 210231 | Ref. No. | 206001 |
| description | pan support W 370mm L 700mm | | |
| For models: | 1464803-02, 1464803-03, 1464808-02, 1464808-03, 1464809-02, 1464809-03, 2063401-03, 2063401-04, 2063401-05, 2063401-06, 2063402-04, 2063402-05, 2063402-06, 2063403-07, 2063403-08, 2063403-09, 2063403-10, 2063404-04, 2063404-05, 2063404-06, 2063404-07, 2063405-04, 2063405-05, 2063405-06, 2063406-07, 2063406-08, 2063406-09, 2063406-10, 2063407-04, 2063407-05, 2063407-06, 2063407-07, 2063413-02, 2063414-03, 2063415-05, 2063416-02, 2063417-03, 2063418-05, 2063419-02, 3063401-02, 3063401-03, 3063401-04, 3063402-02, 3063402-03, 3063402-04, 3063405-02, 3063405-03, 3063405-04 | | |

air mixers



1

| | | | |
|--------------------|---|-----------------|--------|
| GEV No. | 104210 | Ref. No. | 201541 |
| description | air mixing sleeve L 40mm ED ø 42mm ID ø 40mm SS | | |
| For models: | 0263401-00, 0263401-01 | | |



1

| | | | |
|--------------------|--|-----------------|--------|
| GEV No. | 104214 | Ref. No. | 201863 |
| description | air mixing tube ID ø 12mm C | | |
| For models: | 1260501-00, 1263401-00, 1263402-00, 1263402-01, 1263402-02, 1263404-00, 1263404-01, 1263404-02, 1263413-02, 1263414-02, 1360501-00, 1360501-01, 1363401-00, 1363402-00, 1363402-01, 1363402-02, 1363403-00, 1363403-01, 1363403-02, 1363403-03, 1363403-04, 1363403-05, 1363404-00, 1363404-01, 1363404-02, 1363404-03, 1363413-03, 1363415-05, 1460503-01, 1464802-01, 1464802-02, 1464803-01, 1464803-02, 1464803-03, 1464808-01, 1464808-02, 1464808-03, 1464809-01, 1464809-02, 1464809-03, 1464810-01, 1464810-02, 1464811-01, 1464811-02, 2063401-00, 2063401-01, 2063401-02, 2063401-03, 2063401-04, 2063401-05... (Other models you can see in the webshop) | | |



1

| | | | |
|--------------------|--|-----------------|--------|
| GEV No. | 104215 | Ref. No. | 201864 |
| description | air mixing tube ID ø 14mm D | | |
| For models: | 0261601-00, 1261301-00, 1261301-01, 1261301-02, 1261601-00, 1261601-01, 1261602-00, 1261602-01, 1261602-02, 1261602-03, 1261604-03, 1263402-00, 1263402-01, 1263402-02, 1263404-00, 1263404-01, 1263404-02, 1263413-02, 1263414-02, 1361301-00, 1361301-01, 1361301-02, 1361301-03, 1361601-00, 1361601-01, 1361601-02, 1361602-00, 1361602-01, 1361602-02, 1361604-02, 1363402-00, 1363402-01, 1363402-02, 1363403-00, 1363403-01, 1363403-02, 1363403-03, 1363403-04, 1363403-05, 1363404-00, 1363404-01, 1363404-02, 1363404-03, 1363413-03, 1363415-05, 1461601-00, 1461602-00, 14621011-0, 1462802B00, 1462804B00... (Other models you can see in the webshop) | | |



1

| | | | |
|--------------------|--|-----------------|--------|
| GEV No. | 104606 | Ref. No. | 201767 |
| description | air mixing tube ID ø 16mm E | | |
| For models: | 1464803-02, 1464803-03, 1464808-02, 1464808-03, 1464809-02, 1464809-03, 2063401-03, 2063401-04, 2063401-05, 2063401-06, 2063402-04, 2063402-05, 2063402-06, 2063403-07, 2063403-08, 2063403-09, 2063403-10, 2063404-04, 2063404-05, 2063404-06, 2063404-07, 2063405-04, 2063405-05, 2063405-06, 2063406-07, 2063406-08, 2063406-09, 2063406-10, 2063407-04, 2063407-05, 2063407-06, 2063407-07, 2063413-02, 2063414-03, 2063415-05, 2063416-02, 2063417-03, 2063418-05, 2063419-02, 3063401-02, 3063401-03, 3063401-04, 3063402-02, 3063402-03, 3063402-04, 3063405-02, 3063405-03, 3063405-04 | | |



1

| | | | |
|--------------------|-----------------|-----------------|--------|
| GEV No. | 105926 | Ref. No. | 201876 |
| description | venturi E short | | |



bar burners

bar burners



| | | | |
|--------------------|--|-----------------|--------|
| GEV No. | 105889 | Ref. No. | 201608 |
| description | bar burner 1-row ømm W 28mm H 42mm L 295mm oven with ignition bridge | | |
| For models: | 0261101-01, 0261102-01, 0261103-01, 1261101-00, 1261101-01, 1261101-02, 1261102-00, 1261102-01, 1261102-02, 1361101-00, 1361101-01, 1361101-02, 1361101-03, 1361102-00, 1361102-01, 1361102-02, 1361102-03, 1461101-00, 1461101-01, 1461101-02, 1461101-03, 1461102-00, 1461102-01, 1461102-02, 1461102-03, 1461103-00, 1461104-01, 1461104-02, 1461104-03, 1461105-01, 1461105-02, 1461105-03, 1461109-01, 1461109-02, 1461109A01, 1461109A02, 1462102-00, 1462102-00_V2, 1462102-01, 1462102-02, 1462102-03, 1561110-00, 2061101-00, 2061101-01, 2061101-02, 2061101-03, 2061101-04, 2061101-05, 2061102-00, 2061102-01... (Other models you can see in the webshop) | | |



| | | | |
|--------------------|---|-----------------|--------|
| GEV No. | 105935 | Ref. No. | 201617 |
| description | bar burner 2 row L 265mm W 120mm ømm H 73mm fryer | | |
| For models: | 0260301-00, 0260301-01 | | |



| | | | |
|--------------------|---|-----------------|--------|
| GEV No. | 105936 | Ref. No. | 201686 |
| description | bar burner 2 row L 268mm W 170mm ømm H 50mm fryer | | |
| For models: | 1260301-00, 1260301-01 | | |

spare parts for 105936



| | | | |
|--|--------|-----------------|---|
| GEV No. | 100412 | Ref. No. | — |
| burner nozzle thread 1/8" 4 slits for flame spreader | | | |



| | | | |
|--------------------|--|-----------------|--------|
| GEV No. | 105931 | Ref. No. | 201687 |
| description | bar burner 2 row L 405mm W 170mm ømm H 50mm fryer | | |
| For models: | 1260302-00, 1260302-01, 1460302-01, 1460302-02, 2060301-01, 2060301-02 | | |

spare parts for 105931



| | | | |
|--|--------|-----------------|---|
| GEV No. | 100412 | Ref. No. | — |
| burner nozzle thread 1/8" 4 slits for flame spreader | | | |



| | | | |
|--------------------|--|-----------------|--------|
| GEV No. | 105890 | Ref. No. | 810121 |
| description | bar burner 2 row L 460mm W 310mm ømm H 30mm bain marie | | |
| For models: | 14621011-0, 2060501-00, 2060501-01, 20605011-0 | | |



| | | | |
|--------------------|---|-----------------|--------|
| GEV No. | 105923 | Ref. No. | 201604 |
| description | bar burner 4 flames ømm W 125mm H 100mm L 300mm | | |



| | | | |
|--------------------|--|-----------------|--------|
| GEV No. | 105906 | Ref. No. | 201007 |
| description | bar burner 4 row L 405mm W 250mm ømm H 40mm | | |
| For models: | 1462101-01, 1462101-02, 1462101-03, 1462101-04, 2063404-01, 2063404-02, 2063404-03, 2063404-04, 2063404-05, 2063404-06, 2063404-07, 2063407-01, 2063407-02, 2063407-03, 2063407-04, 2063407-05, 2063407-06, 2063407-07, 2063416-00, 2063416-01, 2063416-02, 2063419-00, 2063419-01, 2063419-02, 2063503-01, 2063503-02, 2063503-03, 2063503-04, 2063503-05, 2063503-06, 2063503-07, 2063508-00, 2063508-01, 2063508-02, 2063508-03, 2063508-04, 2063508-05, 2063508-06 | | |





| | | | |
|--------------------|--|-----------------|--------|
| GEV No. | 105925 | Ref. No. | 811906 |
| description | bar burner 4 row L 510mm W 255mm ømm H 145mm | | |
| For models: | 1261601-00, 1261601-01, 1261602-00, 1261602-01, 1261602-02, 1261602-03, 1261604-03, 1361601-00, 1361601-01, 1361601-02, 1361602-00, 1361602-01, 1361602-02, 1361604-02, 1461601-00, 1461602-00, 2061602-00, 2061602-01, 2061603-00, 2061603-01, 2061603-02, 2061604-01, 3061602-00 | | |





| | | | |
|---|--|-----------------|--------|
|  | | | |
| 1 | | | |
| GEV No. | 104426 | Ref. No. | 811507 |
| description | bar burner 4 row L 670mm W 338mm ømm H 70mm kettle | | |
| For models: | 1462802B00, 2062801-04, 2062801-05, 2062801-06, 2062801A04, 2062801A05, 2062801A06, 2062801B04, 2062801B05, 2062801B06, 2062801C04, 2062801C05, 2062801C06, 2062802-04, 2062802-05, 2062802-06, 2062802A04, 2062802A05, 2062802A06, 2062802B04, 2062802B05, 2062802B06, 2062802B07, 2062802C04, 2062802C05, 2062802C06, 3062801-00, 3062801-01, 3062801A00, 3062801A01, 3062801B00, 3062801B01, 3062801C00, 3062801C01, 3062802-00, 3062802-01, 3062802A00, 3062802A01, 3062802B00, 3062802B01, 3062802B02, 3062802C00, 3062802C01 | | |

| | | | |
|---|--|-----------------|--------|
|  | | | |
| 2 | | | |
| GEV No. | 104428 | Ref. No. | 811512 |
| description | bar burner 6 row L 660mm W 335mm ømm H 70mm kettle | | |
| For models: | 1462804B00, 2062803-04, 2062803-05, 2062803-06, 2062803A04, 2062803A05, 2062803A06, 2062803B04, 2062803B05, 2062803B06, 2062803C04, 2062803C05, 2062803C06, 2062804-04, 2062804-05, 2062804-06, 2062804A04, 2062804A05, 2062804A06, 2062804B04, 2062804B05, 2062804B06, 2062804B07, 2062804C04, 2062804C05, 2062804C06, 3062803-00, 3062803-01, 3062803A00, 3062803A01, 3062803B00, 3062803B01, 3062803C00, 3062803C01, 3062804-00, 3062804-01, 3062804A00, 3062804A01, 3062804B00, 3062804B01, 3062804B02, 3062804C00, 3062804C01 | | |

| | | | |
|---|--|-----------------|--------|
|  | | | |
| Image not available | | | |
| 1 | | | |
| GEV No. | 105603 | Ref. No. | 201627 |
| description | bar burner 6 row tilting bratt pan | | |
| For models: | 2061401-00, 2061401-01, 2061401A00, 2061401B00, 2061401C00, 2061402-00, 2061402-01, 2061402A00, 2061402B00, 2061402C00, 2061403-00, 2061403-01, 2061403-0, 2061403A00, 2061403B00, 2061403C00, 2061404-00, 2061404-01, 2061404-0, 2061404A00, 2061404B00, 2061404C00, 3061403-00, 3061403-01, 3061403A00, 3061403B00, 3061403C00, 3061404-00, 3061404A00, 3061404B00, 3061404C00 | | |

| | | | |
|---|---|-----------------|--------|
|  | | | |
| 1 | | | |
| GEV No. | 105924 | Ref. No. | 201602 |
| description | bar burner 8 flames ømm W 30mm H 65mm L 285mm | | |

| | | | |
|--|--|-----------------|--------|
|  | | | |
| 1 | | | |
| GEV No. | 104200 | Ref. No. | 201505 |
| description | bar burner ømm W 28mm H 42mm L 295mm flange width 35mm flange length 70mm kettle | | |
| For models: | 0261101-01, 0261102-01, 0261103-01, 1261101-00, 1261101-01, 1261101-02, 1261102-00, 1261102-01, 1261102-02, 1361101-00, 1361101-01, 1361101-02, 1361101-03, 1361102-00, 1361102-01, 1361102-02, 1361102-03, 1461101-00, 1461101-01, 1461101-02, 1461101-03, 1461102-00, 1461102-01, 1461102-02, 1461102-03, 1461103-00, 1461104-01, 1461104-02, 1461104-03, 1461105-01, 1461105-02, 1461105-03, 1461109-01, 1461109-02, 1461109A01, 1461109A02, 1462102-00, 1462102-00_V2, 1462102-01, 1462102-02, 1462102-03, 1561110-00, 2061101-00, 2061101-01, 2061101-02, 2061101-03, 2061101-04, 2061101-05, 2061102-00, 2061102-01... (Other models you can see in the webshop) | | |

| | | | |
|--|---|-----------------|------------------|
|  | | | |
| 1 | | | |
| GEV No. | 104202 | Ref. No. | 201507 201728 |
| description | bar burner ømm W 28mm H 53mm L 385mm flange width 35mm flange length 70mm tilting bratt pan | | |
| For models: | 2061401-05, 2061401-06, 2061401-07, 2061401-08, 2061401A05, 2061401A06, 2061401A07, 2061401A08, 2061401B05, 2061401B06, 2061401B07, 2061401B08, 2061401C05, 2061401C06, 2061401C07, 2061401C08, 2061402-05, 2061402-06, 2061402-07, 2061402A05, 2061402A06, 2061402A07, 2061402B05, 2061402B06, 2061402B07, 2061402C05, 2061402C06, 2061402C07, 2061403-03, 2061403-04, 2061403-05, 2061403A03, 2061403A04, 2061403A05, 2061403B03, 2061403B04, 2061403B05, 2061403C03, 2061403C04, 2061403C05, 2061404-03, 2061404-04, 2061404-05, 2061404A03, 2061404A04, 2061404A05, 2061404B03, 2061404B04, 2061404B05, 2061404C03... (Other models you can see in the webshop) | | |

| | | | |
|--|---|-----------------|--------|
|  | | | |
| 1 | | | |
| GEV No. | 104201 | Ref. No. | 201506 |
| description | bar burner with ignition bridge ømm W 28mm H 42mm L 295mm flange width 35mm flange length 70mm kettle | | |
| For models: | 2062801-00, 2062801A00, 2062801B00, 2062801C00, 2062802-00, 2062802-2, 2062802A00, 2062802B00, 2062802C00, 2062901B03, 2062901B04, 2062901B05, 2062901C03, 2062901C04, 2062901C05 | | |







| | | | |
|---|--|-----------------|--------|
|  | | | |
| 1 | | | |
| GEV No. | 105907 | Ref. No. | 201611 |
| description | bar burner with ignition bridge ømm W 28mm H 42mm L 385mm flange width 35mm flange length 70mm tilting bratt pan | | |
| For models: | 1462101-00, 14621011-0, 2061401-02, 2061401-03, 2061401-04, 2061401A01, 2061401A02, 2061401A03, 2061401B01, 2061401B02, 2061401B03, 2061401C01, 2061401C02, 2061401C03, 2061402-02, 2061402-03, 2061402-04, 2061402A01, 2061402A02, 2061402A03, 2061402B01, 2061402B02, 2061402B03, 2061402C01, 2061402C02, 2061402C03, 2063404-00, 2063407-00, 2063503-00, 2063505-00 | | |

| | | | |
|--|---|-----------------|--------|
|  | | | |
| 1 | | | |
| GEV No. | 104203 | Ref. No. | 201508 |
| description | bar burner with ignition bridge ømm W 28mm H 53mm L 390mm flange width 35mm flange length 70mm kettle | | |
| For models: | 2062803-00, 20628033-2, 2062803A00, 2062803B00, 2062803C00, 2062804-00, 20628044-2, 2062804A00, 2062804B00, 2062804C00, 2062806-00, 2062806A00, 2062806B00, 2062806B01, 2062806B02, 2062806B03, 2062806C00, 2062806C01, 2062806C02, 2062806C03, 2062901-00, 20629011-2, 2062901A00, 2062901B00, 2062901B01, 2062901B02, 2062901B03, 2062901B04, 2062901B05, 2062901C00, 2062901C01, 2062901C02, 2062901C03, 2062901C04, 2062901C05, 2062902-00, 20629022-2, 2062902A00, 2062902B00, 2062902B01, 2062902B02, 2062902B03, 2062902B04, 2062902B05, 2062902C00, 2062902C01, 2062902C02, 2062902C03, 2062902C04, 2062902C05... (Other models you can see in the webshop) | | |

| | | | |
|---|---|-----------------|--------|
|  | | | |
| 2 | | | |
| GEV No. | 105908 | Ref. No. | 201720 |
| description | bar burner with ignition bridge ømm W 28mm H 42mm L 385mm flange width 35mm flange length 70mm tilting bratt pan | | |
| For models: | 2061401-05, 2061401-06, 2061401-07, 2061401-08, 2061401A05, 2061401A06, 2061401A07, 2061401A08, 2061401B05, 2061401B06, 2061401B07, 2061401B08, 2061401C05, 2061401C06, 2061401C07, 2061401C08, 2061402-05, 2061402-06, 2061402-07, 2061402A05, 2061402A06, 2061402A07, 2061402B05, 2061402B06, 2061402B07, 2061402C05, 2061402C06, 2061402C07, 2061403-02, 2061403-03, 2061403-04, 2061403-05, 2061403A02, 2061403A03, 2061403A04, 2061403A05, 2061403B02, 2061403B03, 2061403B04, 2061403B05, 2061403C02, 2061403C03, 2061403C04, 2061403C05, 2061404-02, 2061404-03, 2061404-04, 2061404-05, 2061404A02, 2061404A03... (Other models you can see in the webshop) | | |

round burners

| | | | |
|---|---|--|--------|
|  | | | |
| 1 | | | |
| GEV No. | 105893 | Ref. No. | 201622 |
| description | round burner ø 250mm 20-25kW | | |
| For models: | 1463501-00, 1463501-01, 1463501-02, 1463501-03, 1463501-04, 1463501-05, 2063501-00, 2063501-01, 2063501-02, 2063501-03, 2063501-04, 2063501-05, 2063501-06, 20635011-0, 2063502-00, 2063502-01, 2063502-02, 2063502-03, 2063502-04, 2063502-05, 2063502-06, 2063502-07, 2063502-08, 2063502-09, 2063502-10, 20635022-0, 2063503-00, 2063503-01, 2063503-02, 2063503-03, 2063503-04, 2063503-05, 2063503-06, 2063503-07, 20635033-0, 2063504-00, 2063504-01, 2063504-02, 2063504-03, 20635044-0, 2063505-00, 20635055-0, 2063506-00, 2063506-01, 2063506-02, 2063506-03, 2063506-04, 2063506-05, 20635066-0, 2063507-00... (Other models you can see in the webshop) | | |
| spare parts for | 105893 | | |
| |  | GEV No. | 102761 |
| | | Ref. No. | 205267 |
| | | locking screw thread 3/8" WS 17 | |
| |  | GEV No. | 102762 |
| | | Ref. No. | 205268 |
| | | locking screw with test nipple thread 3/8" WS 17 | |
| |  | GEV No. | 528520 |
| | | Ref. No. | 211004 |
| | | gasket copper ED ø 22mm ID ø 16mm thickness 2mm | |

| | | | |
|---|---|-----------------|--------|
|  | | | |
| 1 | | | |
| GEV No. | 105937 | Ref. No. | 201729 |
| description | bar burner with ignition bridge ømm W 28mm H 42mm L 385mm flange width 35mm flange length 70mm tilting bratt pan | | |
| For models: | 2061401-05, 2061401-06, 2061401-07, 2061401-08, 2061401A05, 2061401A06, 2061401A07, 2061401A08, 2061401B05, 2061401B06, 2061401B07, 2061401B08, 2061401C05, 2061401C06, 2061401C07, 2061401C08, 2061402-05, 2061402-06, 2061402-07, 2061402A05, 2061402A06, 2061402A07, 2061402B05, 2061402B06, 2061402B07, 2061402C05, 2061402C06, 2061402C07, 2161401-03, 2161401-04, 2161401-05, 2161401-06, 2161401A03, 2161401A04, 2161401A05, 2161401A06, 2161401B03, 2161401B04, 2161401B05, 2161401B06, 2161401C03, 2161401C04, 2161401C05, 2161401C06, 2161402-03, 2161402-04, 2161402-05, 2161402A03, 2161402A04, 2161402A05... (Other models you can see in the webshop) | | |



forced air burners



1

| | | | |
|--------------------|--|-----------------|--------|
| GEV No. | 107842 | Ref. No. | 201178 |
| description | burner L 150mm ø 50mm 20kW combi-steamer | | |
| For models: | CGG11-L, CGG11-R, CGG12-L, CGG12-R, CGG21-L, CGG21-R, CGG22-L, CGG22-R, CGG61-L, CGG61-R, CGG62-L, CGG62-R, CSG11-L, CSG11-R, CSG11-R-DG, CSG12-L, CSG12-R, CSG12-R-DG, CSG21-L, CSG21-R, CSG21-R-DG, CSG22-L, CSG22-R, CSG22-R-DG, CSG61-L, CSG61-R, CSG61-R-DG, CSG62-L, CSG62-R, CSG62-R-DG | | |



1

| | | | |
|--------------------|--|-----------------|--------|
| GEV No. | 107877 | Ref. No. | 201174 |
| description | connecting fitting for burner MKN combi-steamer | | |
| For models: | CGG61-L, CGG61-R, CGG62-L, CGG62-R, CSG61-L, CSG61-R, CSG61-R-DG, CSG62-L, CSG62-R, CSG62-R-DG | | |



1

| | | | |
|--------------------|--|-----------------|--------|
| GEV No. | 107878 | Ref. No. | 201172 |
| description | connecting fitting for burner MKN combi-steamer | | |
| For models: | CGG11-L, CGG11-R, CGG12-L, CGG12-R, CGG21-L, CGG21-R, CGG22-L, CGG22-R, CSG11-L, CSG11-R, CSG11-R-DG, CSG12-L, CSG12-R, CSG12-R-DG, CSG21-L, CSG21-R, CSG21-R-DG, CSG22-L, CSG22-R, CSG22-R-DG | | |



1

| | | | |
|--------------------|--|-----------------|--------|
| GEV No. | 108150 | Ref. No. | 201182 |
| description | venturi MKN combi-steamer with gasket | | |
| For models: | CGG11-L, CGG11-R, CGG12-L, CGG12-R, CGG21-L, CGG21-R, CGG22-L, CGG22-R, CGG61-L, CGG61-R, CGG62-L, CGG62-R, CSG11-L, CSG11-R, CSG11-R-DG, CSG12-L, CSG12-R, CSG12-R-DG, CSG21-L, CSG21-R, CSG21-R-DG, CSG22-L, CSG22-R, CSG22-R-DG, CSG61-L, CSG61-R, CSG61-R-DG, CSG62-L, CSG62-R, CSG62-R-DG | | |

accessories

nozzle holders



1

| | | | |
|--------------------|--|-----------------|--------|
| GEV No. | 106882 | Ref. No. | 201581 |
| description | nozzle holder external nozzle ø 2.1mm internal nozzle ø 1.9mm complete with nozzle tube ø 12mm | | |
| For models: | 2063413-02, 2063414-03, 2063415-05, 2063416-02, 2063417-03, 2063418-05, 2063419-02 | | |



1

| | | | |
|--------------------|---|-----------------|----------------------------|
| GEV No. | 107523 | Ref. No. | 10013991 10013991-ZF01X |
| description | nozzle holder external nozzle ø 2.9mm internal nozzle ø 2.9mm ET M17x1 IT M12x1 M12x1 tube ø 10mm | | |



1

| | | | |
|--------------------|--|-----------------|--------|
| GEV No. | 101595 | Ref. No. | 201667 |
| description | nozzle holder external nozzle ø bore ø1.55mm internal nozzle ø bore ø1.35mm | | |
| For models: | 1263401-00, 1263402-00, 1263402-01, 1263402-02, 1263404-00, 1263404-01, 1263404-02, 1263413-02, 1263414-02, 1363401-00, 1363402-00, 1363402-01, 1363402-02, 1363403-00, 1363403-01, 1363403-02, 1363403-03, 1363403-04, 1363403-05, 1363404-00, 1363404-01, 1363404-02, 1363404-03, 1363413-03, 1363415-05 | | |



1

| | | | |
|--------------------|--|-----------------|--------|
| GEV No. | 101858 | Ref. No. | 201723 |
| description | nozzle holder external nozzle ø bore ø2.05mm internal nozzle ø bore ø1.85mm | | |
| For models: | 1263402-00, 1263402-01, 1263402-02, 1263404-00, 1263404-01, 1263404-02, 1263413-02, 1263414-02, 1363402-00, 1363402-01, 1363402-02, 1363403-00, 1363403-01, 1363403-02, 1363403-03, 1363403-04, 1363403-05, 1363404-00, 1363404-01, 1363404-02, 1363404-03, 1363413-03, 1363415-05 | | |





| | | | |
|---|---|-----------------|--------|
|  | | | |
| 1 | | | |
| GEV No. | 102771 | Ref. No. | 201772 |
| description | nozzle holder external nozzle ø bore ø2.35mm internal nozzle ø bore ø2.00mm | | |
| For models: | 1263405-00, 1263405-01, 1363405-00, 1363405-01, 1464803-02, 1464803-03, 1464808-02, 1464808-03, 1464809-02, 1464809-03, 1464812-00, 1464812-01, 1464812-02, 2063401-03, 2063401-04, 2063401-05, 2063401-06, 2063402-04, 2063402-05, 2063402-06, 2063403-07, 2063403-08, 2063403-09, 2063403-10, 2063404-04, 2063404-05, 2063404-06, 2063404-07, 2063405-04, 2063405-05, 2063405-06, 2063406-07, 2063406-08, 2063406-09, 2063406-10, 2063407-04, 2063407-05, 2063407-06, 2063407-07, 2063420-00, 2063420-01, 2063420-02, 2163422-00, 2163422-01, 2163422-02, 3063401-02, 3063401-03, 3063401-04, 3063402-02, 3063402-03... (Other models you can see in the webshop) | | |

| | | | |
|---|--|-----------------|--------|
|  | | | |
| 1 | | | |
| GEV No. | 101546 | Ref. No. | 202185 |
| description | nozzle holder with cap pipe outlet ø M17x1mm nozzle mounting M12x1 | | |

gas nozzles

main nozzles

| | | | |
|---|---|-----------------|-----|
| <h4>gas nozzles 1/8"</h4> | | | |
|  | | | |
| 1 | | | |
| GEV No. | 100431 | Ref. No. | N/A |
| description | gas injector thread 1/8" bore ø 1.3mm LPG | | |

| | | | |
|---|---------------------------------------|-----------------|--------|
|  | | | |
| 1 | | | |
| GEV No. | 106826 | Ref. No. | 201585 |
| description | gas injector thread 1/8" bore ø 1.9mm | | |

| | | | |
|---|---|-----------------|-----|
|  | | | |
| 1 | | | |
| GEV No. | 100430 | Ref. No. | N/A |
| description | gas injector thread 1/8" bore ø 2.2mm natural gas | | |

| | | | |
|--|---|-----------------|--------|
| <h4>gas nozzles M12x1</h4> | | | |
|  | | | |
| 1 | | | |
| GEV No. | 100301 | Ref. No. | 201831 |
| description | gas injector thread M12x1 WS 14 bore ø 1.55mm | | |
| For models: | 1263402-00, 1263402-01, 1263402-02, 1263404-00, 1263404-01, 1263404-02, 1263413-02, 1263414-02, 1363402-00, 1363402-01, 1363402-02, 1363403-00, 1363403-01, 1363403-02, 1363403-03, 1363403-04, 1363403-05, 1363404-00, 1363404-01, 1363404-02, 1363404-03, 1363413-03, 1363415-05, 1464803-02, 1464803-03, 1464808-02, 1464808-03, 1464809-02, 1464809-03, 1464810-01, 1464810-02, 1464811-01, 1464811-02, 2063401-03, 2063401-04, 2063401-05, 2063401-06, 2063402-04, 2063402-05, 2063402-06, 2063403-07, 2063403-08, 2063403-09, 2063403-10, 2063404-04, 2063404-05, 2063404-06, 2063404-07, 2063405-04, 2063405-05... (Other models you can see in the webshop) | | |

| | | | |
|--|---|-----------------|--------|
|  | | | |
| 1 | | | |
| GEV No. | 100303 | Ref. No. | 201836 |
| description | gas injector thread M12x1 WS 14 bore ø 2.05mm | | |
| For models: | 1263402-00, 1263402-01, 1263402-02, 1263404-00, 1263404-01, 1263404-02, 1263413-02, 1263414-02, 1363402-00, 1363402-01, 1363402-02, 1363403-00, 1363403-01, 1363403-02, 1363403-03, 1363403-04, 1363403-05, 1363404-00, 1363404-01, 1363404-02, 1363404-03, 1363413-03, 1363415-05, 1464808-02, 1464808-03, 1464809-02, 1464809-03, 1464810-01, 1464810-02, 1464811-01, 1464811-02, 2063402-04, 2063402-05, 2063402-06, 2063403-07, 2063403-08, 2063403-09, 2063403-10, 2063404-04, 2063404-05, 2063404-06, 2063404-07, 2063405-04, 2063405-05, 2063405-06, 2063406-07, 2063406-08, 2063406-09, 2063406-10, 2063407-04... (Other models you can see in the webshop) | | |

| | | | |
|--|--|-----------------|--------|
|  | | | |
| 1 | | | |
| GEV No. | 100309 | Ref. No. | 201773 |
| description | gas injector thread M12x1 WS 14 bore ø 2.30mm | | |
| For models: | 1464803-02, 1464803-03, 1464808-02, 1464808-03, 1464809-02, 1464809-03, 2063401-03, 2063401-04, 2063401-05, 2063401-06, 2063402-04, 2063402-05, 2063402-06, 2063403-07, 2063403-08, 2063403-09, 2063403-10, 2063404-04, 2063404-05, 2063404-06, 2063404-07, 2063405-04, 2063405-05, 2063405-06, 2063406-07, 2063406-08, 2063406-09, 2063406-10, 2063407-04, 2063407-05, 2063407-06, 2063407-07, 3063401-02, 3063401-03, 3063401-04, 3063402-02, 3063402-03, 3063402-04, 3063405-02, 3063405-03, 3063405-04 | | |

| | | | |
|--|--|-----------------|--------|
|  | | | |
| 1 | | | |
| GEV No. | 106329 | Ref. No. | 201858 |
| description | gas injector thread M12x1 WS 14 bore ø 2.80mm | | |
| For models: | 1263402-02, 1263404-02, 1263413-02, 1263414-02, 1363403-05, 1363404-03, 1363413-03, 1363415-05 | | |



gas nozzles M15x1



1

| | | | |
|--------------------|---|-----------------|--------|
| GEV No. | 100337 | Ref. No. | 201808 |
| description | gas injector thread M15x1 bore ø 1.60mm WS 17 | | |



1

| | | | |
|--------------------|---|-----------------|--------|
| GEV No. | 100338 | Ref. No. | 201810 |
| description | gas injector thread M15x1 bore ø 2.10mm WS 17 | | |



1

| | | | |
|--------------------|--|-----------------|--------|
| GEV No. | 100331 | Ref. No. | 201812 |
| description | gas injector thread M15x1 bore ø 2.70mm WS 17 | | |
| For models: | 0263401-00, 0263401-01, 2063413-00, 2063413-01, 2063414-00, 2063414-01, 2063414-02, 2063415-00, 2063415-01, 2063415-02, 2063415-03, 2063415-04, 2063416-00, 2063416-01, 2063417-00, 2063417-01, 2063417-02, 2063418-00, 2063418-01, 2063418-02, 2063418-03, 2063418-04, 2063419-00, 2063419-01, 2163415-00, 2163416-00, 2163416-01, 2163417-00, 2163417-01, 2163417-02, 2163417-03, 2163418-00, 2163418-01, 2163419-00, 2163419-01, 2163420-00, 2163420-01, 2163420-02, 2163420-03, 2163421-00, 2163421-01, 3063413-00, 3063414-00, 3063417-00 | | |



1

| | | | |
|--------------------|--|-----------------|--------|
| GEV No. | 100334 | Ref. No. | 201811 |
| description | gas injector thread M15x1 bore ø 3.50mm WS 17 | | |
| For models: | 2063413-00, 2063413-01, 2063413-02, 2063414-00, 2063414-01, 2063414-02, 2063414-03, 2063415-00, 2063415-01, 2063415-02, 2063415-03, 2063415-04, 2063415-05, 2063416-00, 2063416-01, 2063416-02, 2063417-00, 2063417-01, 2063417-02, 2063417-03, 2063418-00, 2063418-01, 2063418-02, 2063418-03, 2063418-04, 2063418-05, 2063419-00, 2063419-01, 2063419-02, 2163415-00, 2163416-00, 2163416-01, 2163417-00, 2163417-01, 2163417-02, 2163417-03, 2163418-00, 2163418-01, 2163419-00, 2163419-01, 2163420-00, 2163420-01, 2163420-02, 2163420-03, 2163421-00, 2163421-01, 3063413-00, 3063414-00, 3063417-00 | | |

pilot burner nozzles

pilot burner nozzles JUNKERS

CB 50203_/503_ series



1

| | | | |
|--------------------|--|-----------------|--------|
| GEV No. | 100220 | Ref. No. | 201547 |
| description | pilot burner nozzle LPG gas pressure 50mbar code 2 Qty 1 pcs suitable for JUNKERS CB503_ | | |



1

| | | | |
|--------------------|---|-----------------|--------|
| GEV No. | 100222 | Ref. No. | 201641 |
| description | pilot burner nozzle LPG gas pressure 50mbar code 5 Qty 1 pcs suitable for JUNKERS CB50203_ | | |
| For models: | 1462101-02, 1462101-03, 1462102-01, 1462102-02, 1463501-04, 1463501-05, 2060501-01, 2062806B02, 2062806B03, 2062806C02, 2062806C03, 2062901B02, 2062901B03, 2062901B04, 2062901B05, 2062901C02, 2062901C03, 2062901C04, 2062901C05, 2062902B02, 2062902B03, 2062902B04, 2062902B05, 2062902C02, 2062902C03, 2062902C04, 2062902C05, 2063404-04, 2063407-04, 2063501-03, 2063502-04, 2063502-05, 2063502-06, 2063502-07, 2063502-08, 2063502-09, 2063502-10, 2063503-03, 2063503-04, 2063503-05, 2063503-06, 2063503-07, 2063504-03, 2063506-03, 2063506-04, 2063506-05, 2063507-04, 2063507-05, 2063507-06, 2063507-07... (Other models you can see in the webshop) | | |



1

| | | | |
|--------------------|--|-----------------|--------|
| GEV No. | 102524 | Ref. No. | 201546 |
| description | pilot burner nozzle natural gas gas pressure 25mbar code 26 Qty 10 pcs suitable for CB 503 | | |



pilot burner nozzles SIT

160 series

| | | | |
|--------------------|--|-----------------|--------|
| <p>1</p> | | | |
| GEV No. | 107172 | Ref. No. | 201671 |
| description | pilot burner nozzle SIT LPG code 25 Qty 1 pcs | | |
| For models: | 1260301-00, 1260301-01, 1260302-00, 1260302-01, 1260501-00, 1261101-00, 1261101-01, 1261101-02, 1261102-00, 1261102-01, 1261102-02, 1261301-00, 1261301-01, 1261301-02, 1261601-00, 1261601-01, 1261602-00, 1261602-01, 1261602-02, 1261602-03, 1261604-03, 1360501-00, 1360501-01, 1361101-00, 1361101-01, 1361101-02, 1361101-03, 1361102-00, 1361102-01, 1361102-02, 1361102-03, 1361301-00, 1361301-01, 1361301-02, 1361301-03, 1361601-00, 1361601-01, 1361601-02, 1361602-01, 1361602-02, 1361604-02, 1460302-01, 1460302-02, 1460503-01, 1461101-01, 1461101-02, 1461101-03, 1461102-01, 1461102-02... (Other models you can see in the webshop) | | |

| | | | |
|--------------------|--|-----------------|--------|
| <p>1</p> | | | |
| GEV No. | 100270 | Ref. No. | 201821 |
| description | pilot burner nozzle LPG bore \varnothing 0.2mm thread M8x0.75 T1: M8x1 | | |
| For models: | 1263402-00, 1263402-01, 1263402-02, 1263404-00, 1263404-01, 1263404-02, 1263405-00, 1263405-01, 1263413-02, 1263414-02, 1363402-00, 1363402-01, 1363402-02, 1363403-00, 1363403-01, 1363403-02, 1363403-03, 1363403-04, 1363403-05, 1363404-00, 1363404-01, 1363404-02, 1363404-03, 1363405-00, 1363405-01, 1363413-03, 1363415-05, 1464803-02, 1464803-03, 1464808-02, 1464808-03, 1464809-02, 1464809-03, 1464810-01, 1464810-02, 1464811-01, 1464811-02, 1464812-00, 1464812-01, 1464812-02, 2063401-03, 2063401-04, 2063401-05, 2063401-06, 2063402-04, 2063402-05, 2063402-06, 2063403-07, 2063403-08, 2063403-09... (Other models you can see in the webshop) | | |

| | | | |
|--------------------|--|-----------------|--------|
| <p>2</p> | | | |
| GEV No. | 107174 | Ref. No. | 201672 |
| description | pilot burner nozzle SIT natural gas code 41 Qty 1 pcs | | |
| For models: | 1260301-00, 1260301-01, 1260302-00, 1260302-01, 1260501-00, 1261101-01, 1261101-02, 1261102-01, 1261102-02, 1261301-00, 1261301-01, 1261301-02, 1261601-00, 1261601-01, 1261602-01, 1261602-02, 1261602-03, 1261604-03, 1360501-00, 1360501-01, 1361101-01, 1361101-02, 1361101-03, 1361102-01, 1361102-02, 1361102-03, 1361301-00, 1361301-01, 1361301-02, 1361301-03, 1361601-00, 1361601-01, 1361601-02, 1361602-00, 1361602-01, 1361602-02, 1361604-02, 1460302-01, 1460302-02, 1460503-01, 1461101-02, 1461101-03, 1461102-02, 1461102-03, 1461104-02, 1461104-03, 1461105-02, 1461105-03, 1461109-01... (Other models you can see in the webshop) | | |

| | | | |
|--------------------|--|-----------------|--------|
| <p>1</p> | | | |
| GEV No. | 100272 | Ref. No. | 201805 |
| description | pilot burner nozzle natural gas bore \varnothing 0.35mm | | |
| For models: | 1263402-00, 1263402-01, 1263402-02, 1263404-00, 1263404-01, 1263404-02, 1263405-00, 1263405-01, 1263413-02, 1263414-02, 1363402-00, 1363402-01, 1363402-02, 1363403-00, 1363403-01, 1363403-02, 1363403-03, 1363403-04, 1363403-05, 1363404-00, 1363404-01, 1363404-02, 1363404-03, 1363405-00, 1363405-01, 1363413-03, 1363415-05, 1464803-02, 1464803-03, 1464808-02, 1464808-03, 1464809-02, 1464809-03, 1464810-01, 1464810-02, 1464811-01, 1464811-02, 1464812-00, 1464812-01, 1464812-02, 2063401-03, 2063401-04, 2063401-05, 2063401-06, 2063402-04, 2063402-05, 2063402-06, 2063403-07, 2063403-08, 2063403-09... (Other models you can see in the webshop) | | |

| | | | |
|--------------------|--|-----------------|--------|
| <p>1</p> | | | |
| GEV No. | 100271 | Ref. No. | 201822 |
| description | pilot burner nozzle natural gas bore \varnothing 0.3mm | | |

pilot burner nozzles (other)

MKN

| | | | |
|--------------------|--|-----------------|--------|
| <p>1</p> | | | |
| GEV No. | 106228 | Ref. No. | 201806 |
| description | pilot burner nozzle bore \varnothing 0.6mm | | |
| For models: | 0263401-00, 0263401-01, 1263402-02, 1263404-02, 1263413-02, 1263414-02, 1363403-05, 1363404-03, 1363413-03, 1363415-05, 2063413-00, 2063413-01, 2063413-02, 2063414-00, 2063414-01, 2063414-02, 2063414-03, 2063415-00, 2063415-01, 2063415-02, 2063415-03, 2063415-04, 2063415-05, 2063416-00, 2063416-01, 2063416-02, 2063417-00, 2063417-01, 2063417-02, 2063417-03, 2063418-00, 2063418-01, 2063418-02, 2063418-03, 2063418-04, 2063418-05, 2063419-00, 2063419-01, 2063419-02, 2163401-00, 2163402-00, 2163403-00, 2163404-00, 2163405-00, 2163406-00, 2163407-00, 2163415-00, 2163416-00, 2163416-01, 2163417-00... (Other models you can see in the webshop) | | |

bypass nozzles

bypass nozzles EGA

| | | | |
|--------------------|--|-----------------|--------|
| <p>1</p> | | | |
| GEV No. | 106825 | Ref. No. | 201833 |
| description | bypass nozzle EGA bore \varnothing 0.37mm | | |
| For models: | 1260501-00, 1263402-00, 1263404-00, 1360501-00, 1360501-01, 1363402-00, 1363402-01, 1363403-00, 1363403-01, 1363403-02, 1363403-03, 1363404-00, 1363404-01, 1464803-02, 1464808-02, 1464809-02, 1464810-01, 1464811-01, 2063401-03, 2063401-04, 2063402-04, 2063403-07, 2063403-08, 2063404-04, 2063404-05, 2063405-04, 2063406-07, 2063406-08, 2063407-04, 2063407-05, 2163401-02, 2163401-03, 2163402-03, 2163403-06, 2163403-07, 2163404-03, 2163404-04, 2163405-03, 2163406-06, 2163406-07, 2163407-03, 2163407-04, 3063401-02, 3063402-02, 3063405-02 | | |

| | | | |
|---|---|-----------------|--------|
|  | | | |
| GEV No. | 100356 | Ref. No. | 201757 |
| description | bypass nozzle EGA type 31248 series bore ø 0.55mm total length 23mm ø 5mm thread M5x0.5 | | |
| For models: | 1460503-01, 1462101-01, 1462101-02, 1462101-03, 1462101-04, 1462102-00, 1462102-01, 1462102-02, 1462102-03, 2063404-01, 2063404-02, 2063404-03, 2063404-04, 2063404-05, 2063404-06, 2063404-07, 2063407-01, 2063407-02, 2063407-03, 2063407-04, 2063407-05, 2063407-06, 2063407-07, 2063416-00, 2063416-01, 2063416-02, 2063419-00, 2063419-01, 2063419-02, 2063503-01, 2063503-02, 2063503-03, 2063503-04, 2063503-05, 2063503-06, 2063503-07, 2063508-00, 2063508-01, 2063508-02, 2063508-03, 2063508-04, 2063508-05, 2063508-06, 2160501-00, 2160501-01, 2163404-01, 2163404-02, 2163404-03, 2163404-04, 2163404-05... (Other models you can see in the webshop) | | |

| | | | |
|---|--|-----------------|--------|
|  | | | |
| GEV No. | 100354 | Ref. No. | 201817 |
| description | bypass nozzle EGA type 31248 series bore ø 0.5mm | | |
| For models: | 1263402-00, 1263404-00, 1363402-00, 1363402-01, 1363403-00, 1363403-01, 1363403-02, 1363403-03, 1363404-00, 1363404-01, 1464808-02, 1464809-02, 1464810-01, 1464811-01, 2063402-04, 2063403-07, 2063403-08, 2063404-04, 2063404-05, 2063405-04, 2063406-07, 2063406-08, 2063407-04, 2063407-05, 2163401-02, 2163401-03, 2163402-03, 2163403-06, 2163403-07, 2163404-03, 2163404-04, 2163405-03, 2163406-06, 2163406-07, 2163407-03, 2163407-04, 3063402-02, 3063405-02 | | |

| | | | |
|---|--|-----------------|--------|
|  | | | |
| GEV No. | 100368 | Ref. No. | 201816 |
| description | bypass nozzle EGA type 31248 series bore ø 0.6mm | | |
| For models: | 1464803-02, 1464808-02, 1464809-02, 2063401-03, 2063401-04, 2063402-04, 2063403-07, 2063403-08, 2063404-04, 2063404-05, 2063405-04, 2063406-07, 2063406-08, 2063407-04, 2063407-05, 3063401-02, 3063402-02, 3063405-02 | | |

| | | | |
|---|--|-----------------|--------|
|  | | | |
| GEV No. | 100346 | Ref. No. | 201818 |
| description | bypass nozzle EGA type 31248 series bore ø 0.85mm | | |
| For models: | 1464812-00, 1464812-01, 2063420-00, 2063420-01, 2163422-00, 2163422-01 | | |

| | | | |
|---|--|-----------------|--------|
|  | | | |
| GEV No. | 100348 | Ref. No. | 201814 |
| description | bypass nozzle EGA type 31248 series bore ø 1.1mm | | |
| For models: | 1462101-00, 1462101-0, 1462102-00_V2, 2063404-00, 2063407-00, 2063503-00, 2063505-00, 2163404-00, 2163407-00 | | |

| | | | |
|---|--|-----------------|--------|
|  | | | |
| GEV No. | 100349 | Ref. No. | 201874 |
| description | bypass nozzle EGA type 31248 series bore ø 1.8mm | | |
| For models: | 1462102-00_V2, 2163404-00, 2163407-00 | | |

| | | | |
|---|--|-----------------|--------|
|  | | | |
| GEV No. | 100362 | Ref. No. | 201754 |
| description | bypass nozzle EGA type 31248 series bore ø 1mm | | |
| For models: | 1261301-00, 1261301-01, 1261601-00, 1261601-01, 1261602-00, 1261602-01, 1361301-00, 1361301-01, 1361301-02, 1361601-00, 1361601-01, 1361601-02, 1361602-00, 1461601-00, 2061603-00, 2061603-01 | | |

| | | | |
|---|---|-----------------|--------|
| bypass nozzles PEL20/21 | | | |
|  | | | |
| GEV No. | 100553 | Ref. No. | 201796 |
| description | bypass nozzle type PEL20/21 bore ø 0.4mm thread M5x0.5 | | |
| For models: | 1263402-01, 1263402-02, 1263404-01, 1263404-02, 1263413-02, 1263414-02, 1363402-02, 1363403-04, 1363403-05, 1363404-02, 1363404-03, 1363413-03, 1363415-05, 1464803-03, 1464808-03, 1464809-03, 1464810-02, 1464811-02, 2063401-05, 2063401-06, 2063402-05, 2063402-06, 2063403-09, 2063403-10, 2063404-06, 2063404-07, 2063405-05, 2063405-06, 2063406-09, 2063406-10, 2063407-06, 2063407-07, 2163401-04, 2163401-05, 2163402-04, 2163402-05, 2163403-08, 2163403-09, 2163404-05, 2163404-06, 2163405-04, 2163405-05, 2163406-08, 2163406-09, 2163407-05, 2163407-06, 3063401-03, 3063401-04, 3063402-03, 3063402-04... (Other models you can see in the webshop) | | |

| | | | |
|---|--|-----------------|--------|
|  | | | |
| GEV No. | 100551 | Ref. No. | 201798 |
| description | bypass nozzle type PEL20/21 bore ø 0.6mm thread M5x0.5 | | |
| For models: | 1464803-03, 1464808-03, 1464809-03, 2063401-05, 2063401-06, 2063402-05, 2063402-06, 2063403-09, 2063403-10, 2063404-06, 2063404-07, 2063405-05, 2063405-06, 2063406-09, 2063406-10, 2063407-06, 2063407-07, 3063401-03, 3063401-04, 3063402-03, 3063402-04, 3063405-03, 3063405-04 | | |

| | | | |
|---|--|-----------------|--------|
|  | | | |
| GEV No. | 100528 | Ref. No. | 201239 |
| description | bypass nozzle type PEL20/21 bore ø 0.9mm thread M5x0.5 | | |
| For models: | 1464812-02, 2063420-02, 2163422-02 | | |

| | | | |
|---|--|-----------------|--------|
| bypass nozzles PEL22 | | | |
|  | | | |
| GEV No. | 100281 | Ref. No. | 201143 |
| description | bypass nozzle type PEL22 bore ø 0.4mm thread M6x0.5 | | |
| For models: | 2063413-02, 2063414-03, 2063415-05, 2063416-02, 2063417-03, 2063418-05, 2063419-02, CGE11-L, CGE11-R, CGE61-L, CGE61-R, CSE11-L, CSE11-R, CSE61-L, CSE61-R | | |

| | | | |
|---|---|-----------------|--------|
|  | | | |
| GEV No. | 100392 | Ref. No. | 201169 |
| description | bypass nozzle type PEL22 bore ø 0.6mm thread M6x0.5 | | |
| For models: | 2063413-02, 2063414-03, 2063415-05, 2063416-02, 2063417-03, 2063418-05, 2063419-02, CPE63 | | |

| | | | |
|---|--|-----------------|--------|
|  | | | |
| GEV No. | 100433 | Ref. No. | 201164 |
| description | bypass nozzle type PEL22 bore ø 0.9mm thread M6x0.5 | | |
| For models: | 1261301-02, 1261602-02, 1261602-03, 1261604-03, 1263405-01, 1361301-03, 1361602-01, 1361602-02, 1361604-02, 1363405-01, 1461602-00, 1463501-05, 2061301-01, 2061602-00, 2061602-01, 2061603-02, 2061604-01, 2063501-06, 2063502-10, 2063503-07, 3061602-00 | | |





| | | | |
|---|--|-----------------|--------|
|  | | | |
| 1 | | | |
| GEV No. | 100407 | Ref. No. | 201166 |
| description | bypass nozzle type PEL22 bore \varnothing 1mm thread M6x0.5 | | |
| For models: | 1261301-02, 1261602-02, 1261602-03, 1261604-03, 1361301-03, 1361602-01, 1361602-02, 1361604-02, 1461602-00, 2061301-01, 2061602-00, 2061602-01, 2061603-02, 2061604-01, 3061602-00 | | |

internal nozzles

internal nozzles for EGA gas taps/nozzle holders

EGA 24197/24362

| | | | |
|---|--|-----------------|--------|
|  | | | |
| 1 | | | |
| GEV No. | 100340 | Ref. No. | 201593 |
| description | internal nozzle bore \varnothing 0.85mm type EGA/PEL22 | | |

| | | | |
|---|---|-----------------|--------|
|  | | | |
| 1 | | | |
| GEV No. | 100492 | Ref. No. | 201800 |
| description | internal nozzle bore \varnothing 0.8mm type EGA/PEL22 | | |
| For models: | 0263401-00, 0263401-01 | | |

| | | | |
|--|--|-----------------|--------|
|  | | | |
| 1 | | | |
| GEV No. | 100341 | Ref. No. | 201695 |
| description | internal nozzle bore \varnothing 1.15mm type EGA/PEL22 | | |

| | | | |
|---|--|-----------------|--------|
|  | | | |
| 1 | | | |
| GEV No. | 100342 | Ref. No. | 201801 |
| description | internal nozzle bore \varnothing 1.4mm type EGA/PEL22 | | |
| For models: | 2063413-02, 2063414-03, 2063415-05, 2063416-02, 2063417-03, 2063418-05, 2063419-02 | | |

| | | | |
|---|--|-----------------|--------|
|  | | | |
| 1 | | | |
| GEV No. | 100345 | Ref. No. | 201803 |
| description | internal nozzle bore \varnothing 1.9mm type EGA/PEL22 | | |
| For models: | 2063413-02, 2063414-03, 2063415-05, 2063416-02, 2063417-03, 2063418-05, 2063419-02 | | |

| | | | |
|---|---|-----------------|--------|
|  | | | |
| 1 | | | |
| GEV No. | 100343 | Ref. No. | 201802 |
| description | internal nozzle bore \varnothing 1mm type EGA/PEL22 | | |
| For models: | 14621011-0 | | |

| | | | |
|---|--|-----------------|----------|
|  | | | |
| 1 | | | |
| GEV No. | 107502 | Ref. No. | 10013937 |
| description | internal nozzle bore \varnothing 2.7mm | | |

| | | | |
|--|--|-----------------|----------|
|  | | | |
| 1 | | | |
| GEV No. | 107501 | Ref. No. | 10013936 |
| description | internal nozzle bore \varnothing 2mm | | |

EGA 26400/26440/23268

| | | | |
|---|---|-----------------|--------|
|  | | | |
| 1 | | | |
| GEV No. | 100311 | Ref. No. | 201834 |
| description | internal nozzle bore \varnothing 0.80mm suitable for EGA26400/26440 | | |
| For models: | 1263401-00, 1263402-00, 1263402-01, 1263402-02, 1263404-00, 1263404-01, 1263404-02, 1263413-02, 1263414-02, 1363401-00, 1363402-00, 1363402-01, 1363402-02, 1363403-00, 1363403-01, 1363403-02, 1363403-03, 1363403-04, 1363403-05, 1363404-00, 1363404-01, 1363404-02, 1363404-03, 1363413-03, 1363415-05, 1464803-02, 1464803-03, 1464808-02, 1464808-03, 1464809-02, 1464809-03, 1464810-01, 1464810-02, 1464811-01, 1464811-02, 2063401-03, 2063401-04, 2063401-05, 2063401-06, 2063402-04, 2063402-05, 2063402-06, 2063403-07, 2063403-08, 2063403-09, 2063403-10, 2063404-04, 2063404-05, 2063404-06, 2063404-07... (Other models you can see in the webshop) | | |

| | | | |
|---|---|-----------------|--------|
|  | | | |
| 1 | | | |
| GEV No. | 100321 | Ref. No. | 201823 |
| description | internal nozzle bore \varnothing 0.90mm suitable for EGA26400/26440 | | |
| For models: | 1263401-00, 1263402-00, 1263402-01, 1263402-02, 1263404-00, 1263404-01, 1263404-02, 1263413-02, 1263414-02, 1363401-00, 1363402-00, 1363402-01, 1363402-02, 1363403-00, 1363403-01, 1363403-02, 1363403-03, 1363403-04, 1363403-05, 1363404-00, 1363404-01, 1363404-02, 1363404-03, 1363413-03, 1363415-05, 1464803-02, 1464803-03, 1464808-02, 1464808-03, 1464809-02, 1464809-03, 1464810-01, 1464810-02, 1464811-01, 1464811-02, 2063401-03, 2063401-04, 2063401-05, 2063401-06, 2063402-04, 2063402-05, 2063402-06, 2063403-07, 2063403-08, 2063403-09, 2063403-10, 2063404-04, 2063404-05, 2063404-06, 2063404-07... (Other models you can see in the webshop) | | |

| | | | |
|---|---|-----------------|--------|
|  | | | |
| 1 | | | |
| GEV No. | 100312 | Ref. No. | 201839 |
| description | internal nozzle bore \varnothing 1.05mm suitable for EGA26400/26440 | | |
| For models: | 1263402-00, 1263402-01, 1263402-02, 1263404-00, 1263404-01, 1263404-02, 1263413-02, 1263414-02, 1363402-00, 1363402-01, 1363402-02, 1363403-00, 1363403-01, 1363403-02, 1363403-03, 1363403-04, 1363403-05, 1363404-00, 1363404-01, 1363404-02, 1363404-03, 1363413-03, 1363415-05, 1464808-02, 1464808-03, 1464809-02, 1464809-03, 1464810-01, 1464810-02, 1464811-01, 1464811-02, 2063402-04, 2063402-05, 2063402-06, 2063403-07, 2063403-08, 2063403-09, 2063403-10, 2063404-04, 2063404-05, 2063404-06, 2063404-07, 2063405-04, 2063405-05, 2063405-06, 2063406-07, 2063406-08, 2063406-09, 2063406-10, 2063407-04... (Other models you can see in the webshop) | | |



| | | | |
|---|--|-----------------|--------|
|  | | | |
| 1 | | | |
| GEV No. | 100313 | Ref. No. | 201697 |
| description | internal nozzle bore \varnothing 1.20mm suitable for EGA26400/26440 | | |
| For models: | 1464803-02, 1464803-03, 1464808-02, 1464808-03, 1464809-02, 1464809-03, 2063401-03, 2063401-04, 2063401-05, 2063401-06, 2063402-04, 2063402-05, 2063402-06, 2063403-07, 2063403-08, 2063403-09, 2063403-10, 2063404-04, 2063404-05, 2063404-06, 2063404-07, 2063405-04, 2063405-05, 2063405-06, 2063406-07, 2063406-08, 2063406-09, 2063406-10, 2063407-04, 2063407-05, 2063407-06, 2063407-07, 3063401-02, 3063401-03, 3063401-04, 3063402-02, 3063402-03, 3063402-04, 3063405-02, 3063405-03, 3063405-04 | | |

| |
|---|
| 1  |
| GEV No. 107870 Ref. No. 201765 |
| description internal nozzle bore ø 1.25mm suitable for EGA26400/26440 |
| For models: 1263405-00, 1263405-01, 1363405-00, 1363405-01, 1464812-00, 1464812-01, 1464812-02, 2063420-00, 2063420-01, 2063420-02, 2163422-00, 2163422-01, 2163422-02 |

| |
|---|
| 1  |
| GEV No. 106510 Ref. No. 201770 |
| description internal nozzle bore ø 1.30mm suitable for EGA26400/26440 |
| For models: 1464803-02, 1464803-03, 1464808-02, 1464808-03, 1464809-02, 1464809-03, 2063401-03, 2063401-04, 2063401-05, 2063401-06, 2063402-04, 2063402-05, 2063402-06, 2063403-07, 2063403-08, 2063403-09, 2063403-10, 2063405-04, 2063405-05, 2063405-06, 2063406-07, 2063406-08, 2063406-09, 2063406-10, 3063401-02, 3063401-03, 3063401-04, 3063402-02, 3063402-03, 3063402-04, 3063405-02, 3063405-03, 3063405-04 |

| |
|--|
| 1  |
| GEV No. 100238 Ref. No. 201832 |
| description internal nozzle bore ø 1.35mm suitable for EGA 23268,26400,26440 |
| For models: 1263402-00, 1263402-01, 1263402-02, 1263404-00, 1263404-01, 1263404-02, 1263413-02, 1263414-02, 1363402-00, 1363402-01, 1363402-02, 1363403-00, 1363403-01, 1363403-02, 1363403-03, 1363403-04, 1363403-05, 1363404-00, 1363404-01, 1363404-02, 1363404-03, 1363413-03, 1363415-05, 1464803-02, 1464803-03, 1464808-02, 1464808-03, 1464809-02, 1464809-03, 1464810-01, 1464810-02, 1464811-01, 1464811-02, 2063401-03, 2063401-04, 2063401-05, 2063401-06, 2063402-04, 2063402-05, 2063402-06, 2063403-07, 2063403-08, 2063403-09, 2063403-10, 2063404-04, 2063404-05, 2063404-06, 2063404-07, 2063405-04, 2063405-05... (Other models you can see in the webshop) |

| |
|--|
| 1  |
| GEV No. 106480 Ref. No. 201824 |
| description internal nozzle bore ø 1.5mm suitable for EGA26400/26440 |
| For models: 1263401-00, 1263402-00, 1263402-01, 1263404-00, 1263404-01, 1363401-00, 1363402-00, 1363402-01, 1363403-00, 1363403-01, 1363403-02, 1363403-03, 1363403-04, 1363404-00, 1363404-01, 1363404-02, 1464803-02, 1464808-02, 1464809-02, 1464810-01, 1464811-01, 2063401-03, 2063401-04, 2063401-05, 2063402-04, 2063402-05, 2063403-07, 2063403-08, 2063403-09, 2063404-04, 2063404-05, 2063404-06, 2063405-04, 2063405-05, 2063406-07, 2063406-08, 2063406-09, 2063407-04, 2063407-05, 2063407-06, 2163401-02, 2163401-03, 2163401-04, 2163402-03, 2163402-04, 2163403-06, 2163403-07, 2163403-08, 2163404-03, 2163404-04... (Other models you can see in the webshop) |

| |
|---|
| 1  |
| GEV No. 100951 Ref. No. 10016562 |
| description internal nozzle bore ø 1.75mm suitable for EGA26400/26440 |
| accessories for 100951 |
|  GEV No. 100927 Ref. No. — |
| torsion spring L 2.8-8.0mm for internal nozzle ø 3mm bore ømm |

| |
|--|
| 1  |
| GEV No. 100244 Ref. No. 201837 |
| description internal nozzle bore ø 1.85mm suitable for EGA 23268,26400,26440 |
| For models: 1263402-00, 1263402-01, 1263402-02, 1263404-00, 1263404-01, 1263404-02, 1263413-02, 1263414-02, 1363402-00, 1363402-01, 1363402-02, 1363403-00, 1363403-01, 1363403-02, 1363403-03, 1363403-04, 1363403-05, 1363404-00, 1363404-01, 1363404-02, 1363404-03, 1363413-03, 1363415-05, 1464808-02, 1464808-03, 1464809-02, 1464809-03, 1464810-01, 1464810-02, 1464811-01, 1464811-02, 2063402-04, 2063402-05, 2063402-06, 2063403-07, 2063403-08, 2063403-09, 2063403-10, 2063404-04, 2063404-05, 2063404-06, 2063404-07, 2063406-08, 2063406-09, 2063406-10, 2063407-04... (Other models you can see in the webshop) |

| |
|---|
| 1  |
| GEV No. 100314 Ref. No. 10016563 |
| description internal nozzle bore ø 1.90mm suitable for EGA26400/26440 |

| |
|--|
| 1  |
| GEV No. 100274 Ref. No. 201694 |
| description internal nozzle bore ø 2.00mm suitable for EGA26400/26440 |
| For models: 1263402-00, 1263402-01, 1263404-00, 1263404-01, 1363402-00, 1363402-01, 1363403-00, 1363403-01, 1363403-02, 1363403-03, 1363403-04, 1363404-00, 1363404-01, 1363404-02, 1464803-02, 1464803-03, 1464808-02, 1464808-03, 1464809-02, 1464809-03, 1464810-01, 1464811-01, 1464811-02, 2063401-05, 2063402-04, 2063402-05, 2063402-06, 2063403-07, 2063403-08, 2063403-09, 2063403-10, 2063404-04, 2063404-05, 2063404-06, 2063404-07, 2063405-04, 2063405-05, 2063405-06, 2063406-07, 2063406-08, 2063406-09, 2063406-10, 2063407-04, 2063407-05, 2063407-06, 2063407-07, 2063413-02... (Other models you can see in the webshop) |

| |
|---|
| 1  |
| GEV No. 100317 Ref. No. 201771 |
| description internal nozzle bore ø 2.20mm suitable for EGA26400/26440 |
| For models: 1263405-00, 1263405-01, 1363405-00, 1363405-01, 1464803-02, 1464808-02, 1464809-02, 1464812-00, 1464812-01, 2063401-03, 2063401-04, 2063401-05, 2063402-04, 2063402-05, 2063403-07, 2063403-08, 2063403-09, 2063404-04, 2063404-05, 2063404-06, 2063405-04, 2063405-05, 2063406-07, 2063406-08, 2063406-09, 2063407-04, 2063407-05, 2063407-06, 2063420-00, 2063420-01, 2063420-02, 2163422-00, 2163422-01, 2163422-02, 3063401-02, 3063401-03, 3063402-02, 3063402-03, 3063405-02, 3063405-03 |

| |
|---|
| 1  |
| GEV No. 100678 Ref. No. 10016564 |
| description internal nozzle bore ø 2.50mm suitable for EGA26400/26440 |





auxiliary gas parts



screw connections

test nipple screws

| | | | |
|---|---|-----------------|--------|
|  | | | |
| 1 | | | |
| GEV No. | 102762 | Ref. No. | 205268 |
| description | locking screw with test nipple thread 3/8" WS 17 | | |
| For models: | 1261101-00, 1261101-01, 1261101-02, 1261102-00, 1261102-01, 1261102-02, 1361101-00, 1361101-01, 1361101-02, 1361101-03, 1361102-00, 1361102-01, 1361102-02, 1361102-03, 1461101-01, 1461101-02, 1461101-03, 1461102-01, 1461102-02, 1461102-03, 1461104-01, 1461104-02, 1461104-03, 1461105-01, 1461105-02, 1461105-03, 1461109-01, 1461109-02, 1461109A01, 1461109A02, 1462802B00, 1462804B00, 1463501-02, 1463501-03, 1463501-04, 1463501-05, 1561110-00, 2061101-01, 2061101-02, 2061101-03, 2061101-04, 2061101-05, 2061102-01, 2061102-02, 2061102-03, 2061102-04, 2061102-05, 2061103-04, 2061107-00, 2061107-01... (Other models you can see in the webshop) | | |

olives

| | | | |
|---|---|-----------------|-------------------|
|  | | | |
| 1 | | | |
| GEV No. | 101273 | Ref. No. | 201594 |
| description | olive for pipe ø 12mm L 9.5mm brass Qty 1 pcs suitable for universal | | |
| For models: | 1422802B04, 1422802B05, 1422802B06, 1422802B07, 1422802B08, 1422804B04, 1422804B05, 1422804B06, 1422804B07, 1422804B08, 1422805B04, 1422805B05, 1422805B06, 1422805B07, 1422805B08, 1462802B00, 1462802B01, 1462802B02, 1462802B03, 1462802B04, 1462802B05, 1462804B00, 1462804B01, 1462804B02, 1462804B03, 1462804B04, 1462804B05, 1462831-00, 1462832-00, 1462833-00, 1462834-00, 1462835-00, 1462836-00, 1462837-00, 1462838-00, 1462839-00, 1462840-00, 1462908-00, 1462910-00, 2022802B04, 2022802B05, 2022802B06, 2022802B07, 2022802B08, 2022802B09, 2022802B10, 2022802C07, 2022802C08, 2022802C09, 2022802C10... (Other models you can see in the webshop) | | |
| accessories for | 101273 | | |
|  | GEV No. | 100944 | Ref. No. — |
| | union nut thread M18x1.5 for pipe ø 12mm | | |
|  | GEV No. | 101276 | Ref. No. — |
| | union screw thread 3/8" tube ø 12mm Qty 1 pcs | | |

| | | | |
|---|--|-----------------|------------------------|
|  | | | |
| 1 | | | |
| GEV No. | 101281 | Ref. No. | 201560 |
| description | olive for pipe ø 4mm L 8.7mm Qty 1 pcs suitable for CB 502/503 | | |
| For models: | 0260301-00, 0260301-01, 0260302-00, 0260302-01, 0260501-00, 0261101-00, 0261101-01, 0261102-00, 0261102-01, 0261103-00, 0261103-01, 0261301-00, 0261601-00, 1261601-01, 1261602-00, 1261602-01, 1261602-02, 1261602-03, 1261604-03, 1361601-01, 1361601-02, 1361602-00, 1361602-01, 1361602-02, 1361604-02, 1460302-00, 1461101-00, 1461102-00, 1461103-00, 1461602-00, 1462101-00, 1462101-01, 1462101-02, 1462101-03, 1462101-04, 1462101-10, 1462102-00, 1462102-00_V2, 1462102-01, 1463501-02, 1463501-03, 1463501-04, 1463501-05, 2060301-00, 2060501-00, 2060501-01, 2060501-10, 2061101-00, 2061101-10, 2061102-00... (Other models you can see in the webshop) | | |
| accessories for | 101281 | | |
|  | GEV No. | 101283 | Ref. No. 201692 |
| | union screw thread M10x1 for pipe ø 4mm Qty 1 pcs | | |

| | | | |
|---|--|-----------------|-------------------|
|  | | | |
| 1 | | | |
| GEV No. | 101284 | Ref. No. | 201827 |
| description | olive for pipe ø 4mm Qty 1 pcs | | |
| For models: | 1261601-01, 1261602-00, 1261602-01, 1261602-02, 1261602-03, 1261604-03, 1361601-01, 1361601-02, 1361602-00, 1361602-01, 1361602-02, 1361604-02 | | |
| accessories for | 101284 | | |
|  | GEV No. | 101259 | Ref. No. — |
| | union nut thread M8x1 for pipe ø 4mm | | |
|  | GEV No. | 101285 | Ref. No. — |
| | union screw thread M8x1 for pipe ø 4mm Qty 1 pcs JUNKERS | | |
|  | GEV No. | 101294 | Ref. No. — |
| | union nut thread M10x1 for pipe ø 4mm WS 14 L 12mm Qty 1 pcs | | |



| | | | |
|---|---|-----------------|--------|
|  | | | |
| 1 | | | |
| GEV No. | 100870 | Ref. No. | 201696 |
| description | olive for pipe ø 4mm Qty 1 pcs suitable for 160 series for pilot burner | | |

| | | | |
|--|--|-----------------|--------|
|  | | | |
| 1 | | | |
| GEV No. | 101879 | Ref. No. | 201828 |
| description | olive for pipe ø 5mm Qty 1 pcs | | |
| For models: | 0260301-01, 0260302-01, 1260301-00, 1260301-01, 1260302-00, 1260302-01, 1460302-00, 1460302-01, 1460302-02, 2060301-00, 2060301-01, 2060301-02 | | |

| | | | |
|---|---|-----------------|-------------------|
|  | | | |
| 1 | | | |
| GEV No. | 101286 | Ref. No. | 201571 |
| description | olive ID ø 6mm Qty 1 pcs | | |
| For models: | 0260301-00, 0260301-01, 0260302-00, 0260302-01, 1260301-00, 1260301-01, 1260302-00, 1260302-01, 1412831-00, 1412832-00, 1412833-00, 1412833-01, 1412834-00, 1412834-01, 1412908-00, 1412910-00, 1412910-01, 1422802B04, 1422802B05, 1422802B06, 1422802B07, 1422802B08, 1422804B04, 1422804B05, 1422804B06, 1422804B07, 1422804B08, 1422805B04, 1422805B05, 1422805B06, 1422805B07, 1422805B08, 1422807B00, 1422807B01, 1422807B02, 1422807B03, 1422807B04, 1422831-00, 1422832-00, 1422833-00, 1422834-00, 1422902-00, 1422902-01, 1422902-02, 1422902-03, 1422902-04, 1422908-00, 1422910-00, 1423901-00, 1423901-01... (Other models you can see in the webshop) | | |
| accessories for | 101286 | | |
|  | GEV No. | 100909 | Ref. No. — |
| | union screw thread M10x1 for pipe ø 6mm Qty 1 pcs | | |
|  | GEV No. | 101464 | Ref. No. — |
| | union nut thread M12x1 for pipe ø 6mm | | |



1 gas components

union nuts

| | | | |
|---|--------------------------------------|-----------------|-------------------|
|  | | | |
| 1 | | | |
| GEV No. | 101300 | Ref. No. | 021513 |
| description | union nut thread M16x1.5 tube ø 10mm | | |
| accessories for | 101300 | | |
|  | GEV No. | 101278 | Ref. No. — |
| olive for pipe ø 10mm Qty 1 pcs | | | |

union screws

| | | | |
|---|--|-----------------|--------|
|  | | | |
| 1 | | | |
| GEV No. | 100906 | Ref. No. | 201693 |
| description | screw connection thread M10x1 for ignition electrode brass Qty 1 pcs WS 10 | | |

| | | | |
|---|---|-----------------|-------------------|
|  | | | |
| 1 | | | |
| GEV No. | 101283 | Ref. No. | 201692 |
| description | union screw thread M10x1 for pipe ø 4mm Qty 1 pcs | | |
| accessories for | 101283 | | |
|  | GEV No. | 101282 | Ref. No. — |
| olive for pipe ø 4mm L 7.4mm Qty 1 pcs | | | |

| | | | |
|---|---|-----------------|--------|
|  | | | |
| 1 | | | |
| GEV No. | 101878 | Ref. No. | 945054 |
| description | union screw thread M10x1 for pipe ø 5mm Qty 1 pcs for ignition gas pipe | | |

locking screws

| | | | |
|---|---|-----------------|--------|
|  | | | |
| 1 | | | |
| GEV No. | 102761 | Ref. No. | 205267 |
| description | locking screw thread 3/8" WS 17 | | |
| For models: | 1261101-00, 1261101-01, 1261101-02, 1261102-00, 1261102-01, 1261102-02, 1361101-00, 1361101-01, 1361101-02, 1361101-03, 1361102-00, 1361102-01, 1361102-02, 1361102-03, 1461101-01, 1461101-02, 1461101-03, 1461102-01, 1461102-02, 1461102-03, 1461104-01, 1461104-02, 1461104-03, 1461105-01, 1461105-02, 1461105-03, 1461109-01, 1461109-02, 1461109A01, 1461109A02, 1462802B00, 1462804B00, 1463501-03, 1463501-04, 1463501-05, 1561110-00, 2061101-01, 2061101-02, 2061101-03, 2061101-04, 2061101-05, 2061102-01, 2061102-02, 2061102-03, 2061102-04, 2061102-05, 2061103-04, 2061107-00, 2061107-01, 2061107-02... (Other models you can see in the webshop) | | |

| | | | |
|---|---|-----------------|--------|
|  | | | |
| 1 | | | |
| GEV No. | 102762 | Ref. No. | 205268 |
| description | locking screw with test nipple thread 3/8" WS 17 | | |
| For models: | 1261101-00, 1261101-01, 1261101-02, 1261102-00, 1261102-01, 1261102-02, 1361101-00, 1361101-01, 1361101-02, 1361101-03, 1361102-00, 1361102-01, 1361102-02, 1361102-03, 1461101-01, 1461101-02, 1461101-03, 1461102-01, 1461102-02, 1461102-03, 1461104-01, 1461104-02, 1461104-03, 1461105-01, 1461105-02, 1461105-03, 1461109-01, 1461109-02, 1461109A01, 1461109A02, 1462802B00, 1462804B00, 1463501-02, 1463501-03, 1463501-04, 1463501-05, 1561110-00, 2061101-01, 2061101-02, 2061101-03, 2061101-04, 2061101-05, 2061102-01, 2061102-02, 2061102-03, 2061102-04, 2061102-05, 2061103-04, 2061107-00, 2061107-01... (Other models you can see in the webshop) | | |

gas ball valves

with DIN-DVGW approval

| | | | |
|---|---|-----------------|-----------------------------------|
|  | | | |
| 1 | | | |
| GEV No. | 520508 | Ref. No. | 201159+203813 201752 845951 |
| description | gas ball valve straight inlet 3/4" IT outlet 3/4" IT DN20 L 109mm approval DIN-DVGW gas | | |
| For models: | 1462802B00, 1462802B01, 1462804B00, 1462804B01, 1464812-00, 1464812-01, 2061401-02, 2061401-03, 2061401-04, 2061401-05, 2061401-06, 2061401A01, 2061401A02, 2061401A03, 2061401A05, 2061401A06, 2061401B01, 2061401B02, 2061401B03, 2061401B05, 2061401B06, 2061401C01, 2061401C02, 2061401C03, 2061401C05, 2061401C06, 2061402-02, 2061402-03, 2061402-04, 2061402-05, 2061402-06, 2061402A01, 2061402A02, 2061402A03, 2061402A05, 2061402A06, 2061402B01, 2061402B02, 2061402B03, 2061402B05, 2061402B06, 2061402C01, 2061402C02, 2061402C03, 2061402C05, 2061402C06, 2061403-00, 2061403-01, 2061403-02, 2061403-03... (Other models you can see in the webshop) | | |

consumables

lava rocks / ceramic briquetts

| | | | |
|--|--|-----------------|--------|
|  | | | |
| 1 | | | |
| GEV No. | 211100 | Ref. No. | 201517 |
| description | ceramic briquetts size 53x53x24 | | |
| For models: | 0261601-00, 1261601-00, 1261601-01, 1261602-00, 1261602-01, 1261602-02, 1261602-03, 1261604-03, 1361601-00, 1361601-01, 1361601-02, 1361602-00, 1361602-01, 1361602-02, 1361604-02, 1461601-00, 1461602-00, 2061602-00, 2061602-01, 2061603-00, 2061603-01, 2061603-02, 2061604-01, 3061602-00 | | |



equipment-specific units

for griddles

spare parts and accessories



| | | | |
|--------------------|--|-----------------|--------|
| GEV No. | 692883 | Ref. No. | 203898 |
| description | distance washers for griddle ø 14mm L 25.5mm stainless steel | | |

for convection ovens/combi-steamers

drain units

drip rails



| | | | |
|--------------------|--|-----------------|--------|
| GEV No. | 692765 | Ref. No. | 202125 |
| description | drip rail L 620mm plastic with support plate W 38mm hole ø 5mm for combi-steamer | | |
| For models: | CSE11-R, CSE11-R-DG, CSE12-R, CSE12-R-DG, CSE61-R, CSE61-R-DG, CSE62-R, CSE62-R-DG, CSG11-R-DG, CSG12-R-DG, CSG61-R, CSG61-R-DG, CSG62-R, CSG62-R-DG | | |

spare parts for

| | | | |
|--------------------|---|-----------------|--------|
| GEV No. | 696808 | Ref. No. | 204615 |
| description | support bracket zinc-plated sheet steel | | |



| | | | |
|--------------------|---------------------------|-----------------|----------|
| GEV No. | 694975 | Ref. No. | 10013386 |
| description | drip rail L 630mm plastic | | |

accessories



| | | | |
|--------------------|--|-----------------|--------|
| GEV No. | 696808 | Ref. No. | 204615 |
| description | support bracket zinc-plated sheet steel | | |
| For models: | CGE11-L, CGE11-R, CGE12-L, CGE12-R, CGE61-L, CGE61-R, CGE62-L, CGE62-R, CGG11-L, CGG11-R, CGG12-L, CGG12-R, CGG61-L, CGG61-R, CGG62-L, CGG62-R, CSE11-L, CSE11-R, CSE11-R-DG, CSE12-L, CSE12-R, CSE12-R-DG, CSE61-L, CSE61-R, CSE61-R-DG, CSE62-L, CSE62-R, CSE62-R-DG, CSG11-L, CSG11-R, CSG11-R-DG, CSG12-L, CSG12-R, CSG12-R-DG, CSG61-L, CSG61-R, CSG61-R-DG, CSG62-L, CSG62-R, CSG62-R-DG | | |



| | | | |
|--------------------|--|-----------------|--------|
| GEV No. | 696814 | Ref. No. | 204416 |
| description | support bracket zinc-plated sheet steel | | |
| For models: | CGE11-L, CGE11-R, CGE12-L, CGE12-R, CGE21-L, CGE21-R, CGE22-L, CGE22-R, CGE61-L, CGE61-R, CGE62-L, CGE62-R, CGG11-L, CGG11-R, CGG12-L, CGG12-R, CGG61-L, CGG61-R, CGG62-L, CGG62-R, CSE11-L, CSE11-R, CSE12-L, CSE12-R, CSE21-L, CSE21-R, CSE22-L, CSE22-R, CSE61-L, CSE61-R, CSE62-L, CSE62-R, CSG11-L, CSG11-R, CSG12-L, CSG12-R, CSG61-L, CSG61-R, CSG62-L, CSG62-R | | |





| | | | |
|--------------------|--|-----------------|--------|
| GEV No. | 696812 | Ref. No. | 205309 |
| description | bush ID ø 10mm L 15mm WS 19 thread ø M16x1mm | | |
| For models: | CGG11-L, CGG11-R, CGG12-L, CGG12-R, CGG21-L, CGG21-R, CGG22-L, CGG22-R, CGG61-L, CGG61-R, CGG62-L, CGG62-R, CSG11-L, CSG11-R, CSG11-R-DG, CSG12-L, CSG12-R, CSG12-R-DG, CSG21-L, CSG21-R, CSG21-R-DG, CSG22-L, CSG22-R, CSG22-R-DG, CSG61-L, CSG61-R, CSG61-R-DG, CSG62-L, CSG62-R, CSG62-R-DG | | |



| | | | |
|--------------------|--|-----------------|--------|
| GEV No. | 696813 | Ref. No. | 204057 |
| description | bush ID ø 12mm ED ø 14mm L 10mm | | |
| For models: | CGE11-L, CGE11-R, CGE12-L, CGE12-R, CGE21-L, CGE21-R, CGE22-L, CGE22-R, CGE61-L, CGE61-R, CGE62-L, CGE62-R, CGG11-L, CGG11-R, CGG12-L, CGG12-R, CGG21-L, CGG21-R, CGG22-L, CGG22-R, CGG61-L, CGG61-R, CGG62-L, CGG62-R, CSE11-L, CSE11-R, CSE11-R-DG, CSE12-L, CSE12-R, CSE12-R-DG, CSE21-L, CSE21-R, CSE21-R-DG, CSE22-L, CSE22-R, CSE22-R-DG, CSE61-L, CSE61-R, CSE61-R-DG, CSE62-L, CSE62-R, CSE62-R-DG, CSG11-L, CSG11-R, CSG11-R-DG, CSG12-L, CSG12-R, CSG12-R-DG, CSG21-L, CSG21-R...(Other models you can see in the webshop) | | |



| | | | |
|---|---|-----------------|--------|
|  | | | |
| 1 | | | |
| GEV No. | 551451 | Ref. No. | 203820 |
| description | spacer bush ID ø 2.5mm ED ø 9.5mm L 15mm plastic | | |
| For models: | CCE60, CCE63, CGE11-L, CGE11-R, CGE12-L, CGE12-R, CGE21-L, CGE21-R, CGE22-L, CGE22-R, CGE61-L, CGE61-R, CGE62-L, CGE62-R, CGG11-L, CGG11-R, CGG12-L, CGG12-R, CGG21-L, CGG21-R, CGG22-L, CGG22-R, CGG61-L, CGG61-R, CGG62-L, CGG62-R, CPE60, CPE63, CSE11-L, CSE11-R, CSE11-R-DG, CSE12-L, CSE12-R, CSE12-R-DG, CSE21-L, CSE21-R, CSE21-R-DG, CSE22-L, CSE22-R, CSE22-R-DG, CSE61-L, CSE61-R, CSE61-R-DG, CSE62-L, CSE62-R, CSE62-R-DG, CSG11-L, CSG11-R, CSG11-R-DG, CSG12-L...(Other models you can see in the webshop) | | |

| | | | |
|---|--|-----------------|--------|
|  | | | |
| 1 | | | |
| GEV No. | 696810 | Ref. No. | 203899 |
| description | spacer bush ID ø 4.5mm ED ø 10mm L 8.5mm | | |

| | | | |
|---|--|-----------------|--------|
|  | | | |
| 1 | | | |
| GEV No. | 696803 | Ref. No. | 203897 |
| description | spacer bush ID ø 6.2mm ED ø 10mm L 3mm stainless steel | | |

injection pipes

| | | | |
|---|--|-----------------|--------|
|  | | | |
| 1 | | | |
| GEV No. | 692826 | Ref. No. | 935545 |
| description | supply tube for combi-steamer water inlet pipe connection 10/13 1/2" / 3/4" | | |
| For models: | CGG11-L, CGG11-R, CGG12-L, CGG12-R, CGG21-L, CGG21-R, CGG22-L, CGG22-R, CSG11-L, CSG11-R, CSG11-R-DG, CSG12-L, CSG12-R, CSG12-R-DG, CSG21-L, CSG21-R, CSG21-R-DG, CSG22-L, CSG22-R, CSG22-R-DG | | |

| | | | |
|---|--|-----------------|-----------------|
|  | | | |
| 1 | | | |
| GEV No. | 692825 | Ref. No. | 10011101 |
| description | water pipe for combi-steamer ED ø 10mm ID ø 8mm | | |
| For models: | CGE11-L, CGE11-R, CGE12-L, CGE12-R, CGE21-L, CGE21-R, CGE22-L, CGE22-R, CGE61-L, CGE61-R, CGE62-L, CGE62-R, CGG11-L, CGG11-R, CGG12-L, CGG12-R, CGG21-L, CGG21-R, CGG22-L, CGG22-R, CGG61-L, CGG61-R, CGG62-L, CGG62-R, CSE11-L, CSE11-R, CSE11-R-DG, CSE12-L, CSE12-R, CSE12-R-DG, CSE61-L, CSE61-R, CSE61-R-DG, CSE62-L, CSE62-R, CSE62-R-DG, CSG11-L, CSG11-R, CSG11-R-DG, CSG12-L, CSG12-R, CSG12-R-DG, CSG21-L, CSG21-R, CSG21-R-DG, CSG22-L, CSG22-R, CSG22-R-DG, CSG61-L, CSG61-R...(Other models you can see in the webshop) | | |
| accessories for | 692825 | | |
| | GEV No. | 699481 | Ref. No. |
| | | | 10011098 |
|  | | | |
| | gasket suitable for MKN combi-steamer L 58mm W 22mm ID ø 13mm graphite thickness 1.5mm | | |

| | | | |
|--|--|-----------------|--------|
|  | | | |
| 1 | | | |
| GEV No. | 692823 | Ref. No. | 204580 |
| description | water pipe for combi-steamer ED ø 15mm ID ø 12mm | | |
| For models: | CGE21-L, CGE21-R, CGE22-L, CGE22-R, CGG21-L, CGG21-R, CGG22-L, CGG22-R, CSE21-L, CSE21-R, CSE21-R-DG, CSE22-L, CSE22-R, CSE22-R-DG, CSG21-L, CSG21-R, CSG21-R-DG, CSG22-L, CSG22-R, CSG22-R-DG | | |

| | | | |
|--|--|-----------------|--------|
|  | | | |
| 1 | | | |
| GEV No. | 692824 | Ref. No. | 935550 |
| description | water pipe for combi-steamer ED ø 15mm ID ø 12mm | | |
| For models: | CGG61-L, CGG61-R, CGG62-L, CGG62-R, CSG61-L, CSG61-R, CSG61-R-DG, CSG62-L, CSG62-R, CSG62-R-DG | | |

| | | | |
|--|--|-----------------|--------|
|  | | | |
| 1 | | | |
| GEV No. | 692822 | Ref. No. | 204430 |
| description | water pipe for fan wheel for combi-steamer ED ø 15mm ID ø 12mm HD6.x-HD20.x | | |
| For models: | CGE11-L, CGE11-R, CGE12-L, CGE12-R, CGE21-L, CGE21-R, CGE22-L, CGE22-R, CGE61-L, CGE61-R, CGE62-L, CGE62-R, CSE11-L, CSE11-R, CSE11-R-DG, CSE12-L, CSE12-R, CSE12-R-DG, CSE21-L, CSE21-R, CSE21-R-DG, CSE22-L, CSE22-R, CSE22-R-DG, CSE61-L, CSE61-R, CSE61-R-DG, CSE62-L, CSE62-R, CSE62-R-DG | | |

spare parts and accessories

| | | | |
|---|---|-----------------|--------|
|  | | | |
| 1 | | | |
| GEV No. | 699338 | Ref. No. | 202726 |
| description | battery Lithium H 8mm ø 24.5mm 3V CR2477N | | |
| For models: | CCE60, CCE63, CPE60, CPE63 | | |

| | | | |
|--------------------|--|-----------------|--------|
| GEV No. | 696807 | Ref. No. | 204429 |
| description | bracket for cartridge ø 45mm | | |
| For models: | CCE60, CCE63, CGE11-L, CGE11-R, CGE12-L, CGE12-R, CGE21-L, CGE21-R, CGE22-L, CGE22-R, CGE61-L, CGE61-R, CGE62-L, CGE62-R, CGG11-L, CGG11-R, CGG12-L, CGG12-R, CGG21-L, CGG21-R, CGG22-L, CGG22-R, CGG61-L, CGG61-R, CGG62-L, CGG62-R, CPE60, CPE63, CSE11-L, CSE11-R, CSE11-R-DG, CSE12-L, CSE12-R, CSE12-R-DG, CSE61-L, CSE61-R, CSE61-R-DG, CSE62-L, CSE62-R, CSE62-R-DG, CSG11-L, CSG11-R, CSG11-R-DG, CSG12-L, CSG12-R, CSG12-R-DG, CSG61-L, CSG61-R, CSG61-R-DG, CSG62-L, CSG62-R, CSG62-R-DG | | |



| | | | |
|--------------------|--|-----------------|--------|
| GEV No. | 850129 | Ref. No. | 055101 |
| description | insulating mat for combi-steamer L 490mm W 320mm H 15mm cut-out 80x100mm | | |



| | | | |
|--------------------|--|-----------------|--------|
| GEV No. | 542435 | Ref. No. | 201170 |
| description | cover H 25mm ø 57mm | | |
| For models: | CGE11-L, CGE11-R, CGE12-L, CGE12-R, CGE21-L, CGE21-R, CGE22-L, CGE22-R, CGE61-L, CGE61-R, CGE62-L, CGE62-R, CGG11-L, CGG11-R, CGG12-L, CGG12-R, CGG21-L, CGG21-R, CGG22-L, CGG22-R, CGG61-L, CGG61-R, CGG62-L, CGG62-R, CSE11-L, CSE11-R, CSE11-R-DG, CSE12-L, CSE12-R, CSE12-R-DG, CSE21-L, CSE21-R, CSE21-R-DG, CSE22-L, CSE22-R, CSE22-R-DG, CSE61-L, CSE61-R, CSE61-R-DG, CSE62-L, CSE62-R, CSE62-R-DG, CSG11-L, CSG11-R, CSG11-R-DG, CSG12-L, CSG12-R, CSG12-R-DG, CSG21-L, CSG21-R...(Other models you can see in the webshop) | | |



| | | | |
|--------------------|--|-----------------|--------|
| GEV No. | 696802 | Ref. No. | 203724 |
| description | spacer for PCB H 10.5mm plastic ball port ø 3.3mm | | |
| For models: | CGE11-L, CGE11-R, CGE12-L, CGE12-R, CGE21-L, CGE21-R, CGE22-L, CGE22-R, CGE61-L, CGE61-R, CGE62-L, CGE62-R, CGG11-L, CGG11-R, CGG12-L, CGG12-R, CGG21-L, CGG21-R, CGG22-L, CGG22-R, CGG61-L, CGG61-R, CGG62-L, CGG62-R, CPE60, CPE63, CSE11-L, CSE11-R, CSE12-L, CSE12-R, CSE21-L, CSE21-R, CSE22-L, CSE22-R, CSE61-L, CSE61-R, CSE62-L, CSE62-R, CSG11-L, CSG11-R, CSG12-L, CSG12-R, CSG21-L, CSG21-R, CSG22-L, CSG22-R, CSG61-L, CSG61-R, CSG62-L, CSG62-R | | |



| | | | |
|--------------------|--|-----------------|--------|
| GEV No. | 696804 | Ref. No. | 203681 |
| description | cover cap L 39mm ø 12mm ID ø 9.6mm | | |
| For models: | CCE60, CCE63, CGE11-L, CGE11-R, CGE12-L, CGE12-R, CGE21-L, CGE21-R, CGE22-L, CGE22-R, CGE61-L, CGE61-R, CGE62-L, CGE62-R, CGG11-L, CGG11-R, CGG12-L, CGG12-R, CGG21-L, CGG21-R, CGG22-L, CGG22-R, CGG61-L, CGG61-R, CGG62-L, CGG62-R, CPE60, CPE63, CSE11-L, CSE11-R, CSE11-R-DG, CSE12-L, CSE12-R, CSE12-R-DG, CSE21-L, CSE21-R, CSE21-R-DG, CSE22-L, CSE22-R, CSE22-R-DG, CSE61-L, CSE61-R, CSE61-R-DG, CSE62-L, CSE62-R, CSE62-R-DG, CSG11-L, CSG11-R, CSG11-R-DG, CSG12-L, CSG12-R, CSG12-R-DG, CSG21-L, CSG21-R...(Other models you can see in the webshop) | | |

filters



| | | | |
|--------------------|--|-----------------|--------|
| GEV No. | 692893 | Ref. No. | 201134 |
| description | screen H 14mm ø 19.5mm plastic | | |
| For models: | 1422807B03, 1422807B04, 1422831-00, 1422832-00, 1422833-00, 1422834-00, 1422902-03, 1422902-04, 1422908-00, 1422910-00, 1423901-00, 1423901-01, 1423901-02, 1423902-00, 1423902-01, 1423902-02, 1423903-00, 1423903-01, 1423903-02, 1462831-00, 1462832-00, 1462833-00, 1462834-00, 1462835-00, 1462836-00, 1462837-00, 1462838-00, 1462839-00, 1462840-00, 1462908-00, 1462910-00, 2022802B08, 2022802B09, 2022802B10, 2022802C08, 2022802C09, 2022802C10, 2022802D00, 2022802D01, 2022802D02, 2022804B08, 2022804B09, 2022804B10, 2022804C08, 2022804C09, 2022804C10, 2022804D00, 2022804D01, 2022804D02, 2022805B08...(Other models you can see in the webshop) | | |



| | | | |
|--------------------|--|-----------------|--------|
| GEV No. | 551449 | Ref. No. | 202755 |
| description | distance washers L 20mm ø 17.5mm plastic | | |
| For models: | CCE60, CCE63, CPE60, CPE63 | | |

housing and bezels



| | | | |
|--------------------|---|-----------------|--------|
| GEV No. | 694972 | Ref. No. | 866789 |
| description | bracket L 52mm W 28mm H 115mm | | |
| For models: | CCE60, CCE63, CGE11-L, CGE11-R, CGE12-L, CGE12-R, CGE21-L, CGE21-R, CGE22-L, CGE22-R, CGE61-L, CGE61-R, CGE62-L, CGE62-R, CGG11-L, CGG11-R, CGG12-L, CGG12-R, CGG21-L, CGG21-R, CGG22-L, CGG22-R, CGG61-L, CGG61-R, CGG62-L, CGG62-R, CPE60, CPE63, CSE11-L, CSE11-R, CSE11-R-DG, CSE12-L, CSE12-R, CSE12-R-DG, CSE21-L, CSE21-R, CSE21-R-DG, CSE22-L, CSE22-R, CSE22-R-DG, CSE61-L, CSE61-R, CSE61-R-DG, CSE62-L, CSE62-R, CSE62-R-DG, CSG11-L, CSG11-R, CSG11-R-DG, CSG12-L...(Other models you can see in the webshop) | | |



| | | | |
|--------------------|--|-----------------|--------|
| 1 | | | |
| GEV No. | 699337 | Ref. No. | 202782 |
| description | cover cap for USB L 38mm W 29mm | | |
| For models: | CGE11-L, CGE11-R, CGE12-L, CGE12-R, CGE21-L, CGE21-R, CGE22-L, CGE22-R, CGE61-L, CGE61-R, CGE62-L, CGE62-R, CGG11-L, CGG11-R, CGG12-L, CGG12-R, CGG21-L, CGG21-R, CGG22-L, CGG22-R, CGG61-L, CGG61-R, CGG62-L, CGG62-R, CPE60, CPE63 | | |

cleaning system

nozzles



| | | | |
|--------------------|--|-----------------|--------|
| 1 | | | |
| GEV No. | 694665 | Ref. No. | 201146 |
| description | nozzle thread 1/4" ET H 57mm for cleaning system | | |
| For models: | CGE11-L, CGE11-R, CGE12-L, CGE12-R, CGE21-L, CGE21-R, CGE22-L, CGE22-R, CGE61-L, CGE61-R, CGE62-L, CGE62-R, CSE11-L, CSE11-R, CSE12-L, CSE12-R, CSE21-L, CSE21-R, CSE22-L, CSE22-R, CSE61-L, CSE61-R, CSE62-L, CSE62-R | | |



| | | | |
|--------------------|--|-----------------|--------|
| 1 | | | |
| GEV No. | 694664 | Ref. No. | 201152 |
| description | nozzle thread 1/4" ET WS 17 H 37mm for cleaning system | | |
| For models: | CPE63 | | |

screw connections



| | | | |
|--------------------|--|-----------------|--------|
| 1 | | | |
| GEV No. | 362008 | Ref. No. | 205293 |
| description | connecting piece 1/2" - 3/4" L 100.5mm plastic | | |
| For models: | CGE11-L, CGE11-R, CGE12-L, CGE12-R, CGE21-L, CGE21-R, CGE22-L, CGE22-R, CGE61-L, CGE61-R, CGE62-L, CGE62-R, CGG11-L, CGG11-R, CGG12-L, CGG12-R, CGG21-L, CGG21-R, CGG22-L, CGG22-R, CGG61-L, CGG61-R, CGG62-L, CGG62-R, CSE11-L, CSE11-R, CSE11-R-DG, CSE12-L, CSE12-R, CSE12-R-DG, CSE21-L, CSE21-R, CSE21-R-DG, CSE22-L, CSE22-R, CSE22-R-DG, CSE61-L, CSE61-R, CSE61-R-DG, CSE62-L, CSE62-R, CSE62-R-DG, CSG11-L, CSG11-R, CSG11-R-DG, CSG12-L, CSG12-R, CSG12-R-DG, CSG21-L, CSG21-R...(Other models you can see in the webshop) | | |

service kits



| | | | |
|--------------------|---|-----------------|--------|
| 1 | | | |
| GEV No. | 381514 | Ref. No. | 205183 |
| description | screw connection kit for temperature probe | | |
| For models: | CGE11-L, CGE11-R, CGE12-L, CGE12-R, CGE21-L, CGE21-R, CGE22-L, CGE22-R, CGE61-L, CGE61-R, CGE62-L, CGE62-R, CGG11-L, CGG11-R, CGG12-L, CGG12-R, CGG21-L, CGG21-R, CGG22-L, CGG22-R, CGG61-L, CGG61-R, CGG62-L, CGG62-R, CPE63, CSE11-L, CSE11-R, CSE12-L, CSE12-R, CSE21-L, CSE21-R, CSE21-R-DG, CSE22-L, CSE22-R, CSE22-R-DG, CSE61-L, CSE61-R, CSE62-L, CSE62-R, CSG11-L, CSG11-R, CSG11-R-DG, CSG12-L, CSG12-R, CSG12-R-DG, CSG21-L, CSG21-R, CSG21-R-DG, CSG22-L, CSG22-R...(Other models you can see in the webshop) | | |

drip water trays



| | | | |
|--------------------|--|-----------------|--------|
| 1 | | | |
| GEV No. | 692725 | Ref. No. | 202138 |
| description | gutter for model 10.x L 605mm W 50mm H 20mm plastic | | |
| For models: | CGE11-L, CGE11-R, CGE12-L, CGE12-R, CGE61-R, CGE62-R, CGG11-L, CGG11-R, CGG12-L, CGG12-R, CGG21-R, CGG21-R, CGG22-L, CGG22-R, CGG61-L, CGG61-R, CGG62-L, CGG62-R, CSE11-L, CSE12-L, CSG11-L, CSG11-R, CSG12-L, CSG12-R, CSG61-L, CSG62-L | | |

door mechanics

door handles



| | | | |
|--------------------|--|-----------------|--------|
| 1 | | | |
| GEV No. | 696815 | Ref. No. | 207102 |
| description | door handle for combi-steamer L 142mm W 36mm H 55mm grey plastic | | |
| For models: | CCE60, CCE63, CPE60, CPE63 | | |



miscellaneous

| | | | |
|---|--|-----------------|--------|
|  | | | |
| 1 | | | |
| GEV No. | 691608 | Ref. No. | 211137 |
| description | boiler gasket silicone ED ø 15mm suitable for MKN | | |
| For models: | CGG11-L, CGG11-R, CGG12-L, CGG12-R, CGG21-L, CGG21-R, CGG22-L, CGG22-R, CGG61-L, CGG61-R, CGG62-L, CGG62-R, CSG11-L, CSG11-R, CSG11-R-DG, CSG12-L, CSG12-R, CSG12-R-DG, CSG21-L, CSG21-R, CSG21-R-DG, CSG22-L, CSG22-R, CSG22-R-DG, CSG61-L, CSG61-R, CSG61-R-DG, CSG62-L, CSG62-R, CSG62-R-DG | | |

| | | | |
|---|--|-----------------|--------|
|  | | | |
| 1 | | | |
| GEV No. | 692850 | Ref. No. | 211166 |
| description | cap gasket HDECOD623 D1 ø 19mm D2 ø 5mm ø 15mm | | |
| For models: | CCE60, CCE63, CPE60, CPE63 | | |

| | | | |
|--|---|-----------------|--------|
|  | | | |
| 1 | | | |
| GEV No. | 694663 | Ref. No. | 203356 |
| description | duct bore ø 30mm D1 ø 33.5mm D2 ø 30mm plastic H 12mm | | |
| For models: | 0220302A00, 0220302A01, 0220302A02, 0220302A03, 0220302C00, 0220302C01, 0220302C02, 0220302C03, 0220303A00, 0220303A01, 0220303A02, 0220303A03, 0220303C00, 0220303C01, 0220303C02, 0220304-00, 0220305-00, 0220306-00, 0720332R00, 0720332V00, 0723405-01, 0723405-02, 0723412K01, 0723414-02, 1220302-00, 1220302-01, 1220302B00, 1220302B01, 1220302D00, 1220302E00, 1220304-00, 1220304-01, 1220304A00, 1220304A01, 1220304A02, 1220304B00, 1220304B01, 1220304C00, 1220304C01, 1220304C02, 1220304D00, 1220304E00, 1220304F00, 1220304F01, 1220304H00, 1220304H01, 1220306-00, 1220306-01, 1220306A00, 1220306A01... (Other models you can see in the webshop) | | |

| | | | |
|---|--|-----------------|--------|
|  | | | |
| 1 | | | |
| GEV No. | 694988 | Ref. No. | 204428 |
| description | grommet connection bush Hans Dampf for spray gun | | |
| For models: | CGE11-L, CGE11-R, CGE12-L, CGE12-R, CGE21-L, CGE21-R, CGE22-L, CGE22-R, CGE61-L, CGE61-R, CGE62-L, CGE62-R, CGG11-L, CGG11-R, CGG12-L, CGG12-R, CGG21-L, CGG21-R, CGG22-L, CGG22-R, CGG61-L, CGG61-R, CGG62-L, CGG62-R, CSE11-L, CSE11-R, CSE11-R-DG, CSE12-L, CSE12-R, CSE12-R-DG, CSE21-L, CSE21-R, CSE21-R-DG, CSE22-L, CSE22-R, CSE22-R-DG, CSE61-L, CSE61-R, CSE61-R-DG, CSE62-L, CSE62-R, CSE62-R-DG, CSG11-L, CSG11-R, CSG11-R-DG, CSG12-L, CSG12-R, CSG12-R-DG, CSG21-L, CSG21-R...(Other models you can see in the webshop) | | |

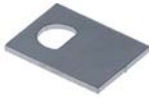
| | | | |
|---|--|-----------------|--------|
|  | | | |
| 1 | | | |
| GEV No. | 694661 | Ref. No. | 866324 |
| description | lever for stop bore ø 6x4.6mm L 17mm W 13mm thickness 1mm | | |
| For models: | 0021130A00, 0021130A01, 0021135A00, 2021115-00, 2021115-01, 2021115-02, 2021115-03, 2021115-04, 2221115-00, 2221115-01 | | |

| | | | |
|--|--|-----------------|--------|
|  | | | |
| 1 | | | |
| GEV No. | 692813 | Ref. No. | 201135 |
| description | screen for drain D1 ø 90mm | | |
| For models: | CGE11-L, CGE11-R, CGE12-L, CGE12-R, CGE21-L, CGE21-R, CGE22-L, CGE22-R, CGE61-L, CGE61-R, CGE62-L, CGE62-R, CGG11-L, CGG11-R, CGG12-L, CGG12-R, CGG21-L, CGG21-R, CGG22-L, CGG22-R, CGG61-L, CGG61-R, CGG62-L, CGG62-R, CSE11-L, CSE11-R, CSE11-R-DG, CSE12-L, CSE12-R, CSE12-R-DG, CSE21-L, CSE21-R, CSE21-R-DG, CSE22-L, CSE22-R, CSE22-R-DG, CSE61-L, CSE61-R, CSE61-R-DG, CSE62-L, CSE62-R, CSE62-R-DG, CSG11-L, CSG11-R, CSG11-R-DG, CSG12-L, CSG12-R, CSG12-R-DG, CSG21-L, CSG21-R...(Other models you can see in the webshop) | | |

for tilting bratt pans

spare parts and accessories

| | | | |
|--|---------------------------------|-----------------|--------|
|  | | | |
| 1 | | | |
| GEV No. | 693493 | Ref. No. | 204576 |
| description | bush L 49mm ID ø 16mm ext. ø 20 | | |

spindles

| | | | |
|--|---|-----------------|--------|
|  | | | |
| 1 | | | |
| GEV No. | 514365 | Ref. No. | 110115 |
| description | threaded rod | | |
| For models: | 2021403-00, 2021403-01, 2021403-02, 2021403-03, 2021403-04, 2021403-05, 2021403-06, 20214033-0, 2021403A00, 2021403A01, 2021403A02, 2021403A04, 2021403A05, 2021403A06, 2021403B00, 2021403B01, 2021403B02, 2021403B04, 2021403B05, 2021403B06, 2021403C01, 2021403C02, 2021403C04, 2021403C05, 2021403C06, 2021405-00, 2021405-01, 2021405-02, 2021405-03, 20214055-0, 2021405B00, 2021405B01, 2021405B02, 2021405B03, 2021413-00, 2021413B00, 2021415B00, 2021432C00, 2023001-00, 20230011-0, 20230011-1, 2023001A00, 2023001B00, 2023001C00, 2023003-00, 20230033-0, 20230033-1, 2023003A00, 2023003B00, 2023003C00... (Other models you can see in the webshop) | | |

miscellaneous



| | | | |
|--------------------|--|-----------------|--------|
| GEV No. | 514366 | Ref. No. | 113118 |
| description | threaded bush | | |
| For models: | 2021403-00, 2021403-01, 2021403-02, 2021403-03, 2021403-04, 2021403-05, 2021403-06, 20214033-0, 2021403A00, 2021403A01, 2021403A02, 2021403A04, 2021403A05, 2021403A06, 2021403B00, 2021403B01, 2021403B02, 2021403B04, 2021403B05, 2021403B06, 2021403C01, 2021403C02, 2021403C04, 2021403C05, 2021403C06, 2021405-00, 2021405-01, 2021405-02, 2021405-03, 20214055-0, 2021405B00, 2021405B01, 2021405B02, 2021405B03, 2021413-00, 2021413B00, 2021415B00, 2021432C00, 2023001-00, 20230011-0, 20230011-1, 2023001A00, 2023001B00, 2023001C00, 2023003-00, 20230033-0, 20230033-1, 2023003A00, 2023003B00, 2023003C00... (Other models you can see in the webshop) | | |

for boiling pans

gearboxes



| | | | |
|--------------------|--|-----------------|--------|
| GEV No. | 514365 | Ref. No. | 110115 |
| description | threaded rod | | |
| For models: | 2021403-00, 2021403-01, 2021403-02, 2021403-03, 2021403-04, 2021403-05, 2021403-06, 20214033-0, 2021403A00, 2021403A01, 2021403A02, 2021403A04, 2021403A05, 2021403A06, 2021403B00, 2021403B01, 2021403B02, 2021403B04, 2021403B05, 2021403B06, 2021403C01, 2021403C02, 2021403C04, 2021403C05, 2021403C06, 2021405-00, 2021405-01, 2021405-02, 2021405-03, 20214055-0, 2021405B00, 2021405B01, 2021405B02, 2021405B03, 2021413-00, 2021413B00, 2021415B00, 2021432C00, 2023001-00, 20230011-0, 20230011-1, 2023001A00, 2023001B00, 2023001C00, 2023003-00, 20230033-0, 20230033-1, 2023003A00, 2023003B00, 2023003C00... (Other models you can see in the webshop) | | |

knobs

producer-specific knobs

MKN

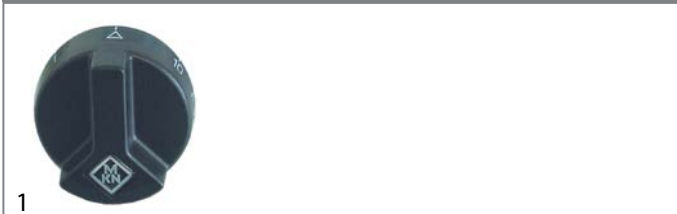

| | | | |
|--------------------|---|-----------------|----------------------------|
| GEV No. | 110640 | Ref. No. | 209230 209236 209917 |
| description | knob energy regulator 1-10 t.max. °C ø 53mm shaft ø 6x4.6mm shaft flat right black | | |
| For models: | 00217022-0, 0521701-00, 0521701-01, 0521702-00, 0521702-01, 0521702-02, 0521702-03, 0521702-04, 0521702A02, 0521702A03, 0521702A04, 0521702B03, 0521702B04, 0521702C04, 0521704-0, 0521704-00, 0521704-01, 0521704-02, 0521704-03, 0521704-04, 0521704-05, 0521704-06, 0521704-07, 0521705-00, 0521705-01 | | |



| | | | |
|--------------------|--|-----------------|--------------------------------------|
| GEV No. | 110637 | Ref. No. | 209227 209233 209909 209911 |
| description | knob ON-OFF t.max. °C ø 54mm shaft ø 6x4.6mm shaft flat upper black | | |
| For models: | 0021130A00, 0021130A01, 0021135A00, 0120101-00, 0120101C00, 0120105-00, 0120105C00, 0220302F00, 0520302-00, 0520303-00, 0520303-01, 0520303-02, 0520901-00, 0522101-01, 0522101-02, 0522102-00, 0522102-01, 0522102-02, 1323208-00, 1323208-01, 1363403-00, 1422101-00, 1422101-01, 1422101-02, 1422102-00, 1422102-01, 1422102-02, 1424816-00, 1820301-00, 1820301-01, 2063403-00, 2063403-01, 2063403-02, 2063403-03, 2063403-04, 2063403-05, 2063406-00, 2063406-01, 2063406-02, 2063406-03, 2063406-04, 2063406-05, 2063415-00, 2063415-01, 2063415-02, 2063415-03, 2063415-04, 2063418-00, 2063418-01, 2063418-02... (Other models you can see in the webshop) | | |



| | | | |
|--------------------|--|-----------------|------------------|
| GEV No. | 111887 | Ref. No. | 209226 209914 |
| description | knob switch 7-position ø 53mm shaft ø 6x4.6mm shaft flat upper black | | |
| For models: | 1424816-00, 18232011-0 | | |

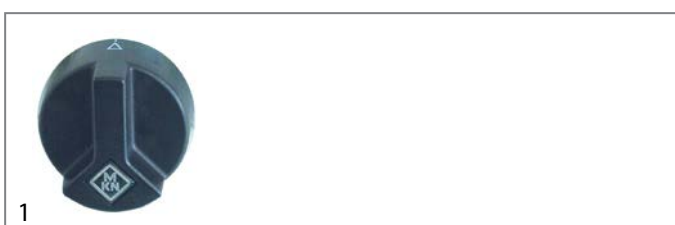

| | | | |
|--------------------|--|-----------------|------------------|
| GEV No. | 110638 | Ref. No. | 209229 209910 |
| description | knob thermostat t.max. 110°C ø 53mm shaft ø 6x4.6mm shaft flat upper black temperature range 30-110°C | | |
| For models: | 0520901-00, 1224002-00, 1224002-01, 1224003-00, 1224003-01, 1224004-00, 1224004-01, 1224005-00, 1224005-01, 1224006-00, 1224006-01, 1224007-00, 1224007-01, 1224008-00, 1224008-01, 1224009-00, 1224009-01, 1820501-00, 18208011-0 | | |

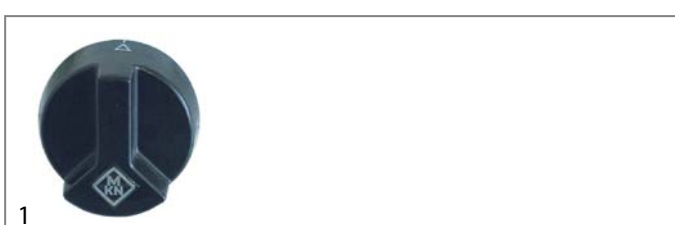



| | | | |
|--------------------|--|-----------------|----------------------------|
| GEV No. | 110636 | Ref. No. | 209232 209233 209911 |
| description | knob thermostat t.max. 185°C ø 53mm shaft ø 6x4.6mm shaft flat upper black temperature range 100-185°C rotation 270° | | |

| | | | |
|---|---|-----------------|------------------|
|  | | | |
| 1 | | | |
| GEV No. | 110641 | Ref. No. | 209228 209912 |
| description | knob thermostat t.max. 300°C ø 52mm shaft ø 6x4.6mm shaft flat upper black temperature range 50-300°C rotation 270° | | |
| For models: | 0021130A00, 0021130A01, 0021135A00, 0522101-01, 0522101-02, 0522102-00, 0522102-01, 0522102-02, 1323208-00, 1323208-01, 1363403-00, 1422101-00, 1422101-01, 1422101-02, 1422102-00, 1422102-01, 1422102-02, 1424816-00, 1821101-00, 2063403-00, 2063403-01, 2063403-02, 2063403-03, 2063403-04, 2063403-05, 2063406-00, 2063406-01, 2063406-02, 2063406-03, 2063406-04, 2063406-05, 2063415-00, 2063415-01, 2063415-02, 2063415-03, 2063415-04, 2063418-00, 2063418-01, 2063418-02, 2063418-03, 2063418-04, 2063502-00, 2063502-01, 2063502-02, 2063502-03, 2063502-04, 2063502-05, 2063502-06, 2063507-00, 2063507-01... (Other models you can see in the webshop) | | |

| | | | |
|--|---|-----------------|--------|
|  | | | |
| 1 | | | |
| GEV No. | 111867 ¹ | Ref. No. | 209906 |
| description | knob gas tap with ignition flame t.max.°C ø 65mm shaft ø 6x4.6mm shaft flat left black for EGA24197/PEL | | |
| For models: | 0260501-00, 0261101-00, 0261101-01, 0261102-00, 0261102-01, 0261103-00, 0261103-01, 0261301-00, 0261601-00, 0263401-00, 0263401-01, 1261301-00, 1261301-01, 1261301-02, 1261601-00, 1261601-01, 1261602-00, 1261602-01, 1261602-02, 1261602-03, 1261604-03, 1263405-00, 1263405-01, 1361301-00, 1361301-01, 1361301-02, 1361301-03, 1361601-00, 1361601-01, 1361601-02, 1361602-00, 1361602-01, 1361602-02, 1361604-02, 1363405-00, 1363405-01, 1461601-00, 1461602-00, 1463501-00, 1463501-01, 1463501-02, 1463501-03, 1463501-04, 1463501-05, 2061301-01, 2061401-00, 2061401-01, 2061401A00, 2061401B00, 2061401C00... (Other models you can see in the webshop) | | |

¹for EGA24197/PEL

| | | | |
|---|---|-----------------|--------|
|  | | | |
| 1 | | | |
| GEV No. | 112731 | Ref. No. | 209239 |
| description | knob thermostat t.max.°C 30-70°C ø 53mm shaft ø 6x4.6mm shaft flat left black | | |
| For models: | 0120201-01, 0120202-01, 0120203-01 | | |

| | | | |
|--|---|-----------------|--------|
|  | | | |
| 1 | | | |
| GEV No. | 111433 | Ref. No. | 209282 |
| description | knob gas tap with ignition flame t.max.°C ø 65mm shaft ø 6x4.6mm shaft flat lower black | | |
| For models: | 1263402-01, 1263402-02, 1263404-01, 1263404-02, 1263413-02, 1263414-02, 1363402-02, 1363403-04, 1363403-05, 1363404-02, 1363404-03, 1363413-03, 1363415-05, 1464802-02, 1464803-03, 1464808-03, 1464809-03, 1464810-02, 1464811-02, 1464812-01, 1464812-02, 2063401-05, 2063401-06, 2063402-05, 2063402-06, 2063403-09, 2063403-10, 2063404-06, 2063404-07, 2063405-05, 2063405-06, 2063406-09, 2063406-10, 2063407-06, 2063407-07, 2063420-01, 2063420-02, 2163401-04, 2163401-05, 2163402-04, 2163402-05, 2163403-08, 2163403-09, 2163404-05, 2163404-06, 2163405-04, 2163405-05, 2163406-08, 2163406-09, 2163407-05... (Other models you can see in the webshop) | | |

| | | | |
|---|---|-----------------|--------|
|  | | | |
| 1 | | | |
| GEV No. | 111862 | Ref. No. | 209904 |
| description | knob energy regulator 1-10 t.max.°C ø 65mm shaft ø 6x4.6mm shaft flat upper black | | |
| For models: | 0221001H00, 0221202-00, 0221501-00, 0221502-00, 1022603-00, 1023401-00, 1023401K00, 1220402-00, 1220402-01, 1221501-00, 1221501-01, 1221501-02, 1222603-00, 1223202A00, 1223202A01, 1223202J00, 1223202J01, 1223203-00, 1223203-01, 1223203-02, 1223204-00, 1223204-01, 1223204-02, 1223205-00, 1223205-01, 1223205-02, 1223206-00, 1223206-01, 1223206-02, 1223209-00, 1223209-01, 1223211-00, 1223212-00, 1223213-00, 1223214-00, 1223401-00, 1223401J00, 1223401K00, 1223401L00, 1223402-00, 1223402K00, 1320402-00, 1320402-01, 1321501-00, 1321501-01, 1321501-02, 1321501-03, 1322603-00, 1323202A00, 1323202A01... (Other models you can see in the webshop) | | |

| | | | |
|--|--|-----------------|--------|
|  | | | |
| 1 | | | |
| GEV No. | 111863 ¹ | Ref. No. | 209907 |
| description | knob gas tap with ignition flame t.max.°C ø 65mm shaft ø 6x4.6mm shaft flat right black for EGA24197/PEL | | |
| For models: | 0263401-00, 0263401-01, 2063413-00, 2063413-01, 2063413-02, 2063414-03, 2063415-05, 2063416-02, 2063417-03, 2063418-05, 2063419-02, 2163415-00, 3063413-00 | | |

¹for EGA24197/PEL

| | | | |
|---|--|-----------------|--------|
|  | | | |
| 1 | | | |
| GEV No. | 111902 ¹ | Ref. No. | 209944 |
| description | knob gas tap with ignition flame t.max.°C°C ø 65mm shaft ø 6x4.6mm shaft flat right black for EGA26400 | | |
| For models: | 1260501-00, 1360501-00, 1360501-01 | | |

¹for EGA26440

| | | | |
|---|--|-----------------|--------|
|  | | | |
| 1 | | | |
| GEV No. | 111864 ¹ | Ref. No. | 209908 |
| description | knob gas tap with ignition flame t.max.°C°C ø 65mm shaft ø 6x4.6mm shaft flat upper black for EGA24197/PEL | | |
| For models: | 20611011-0, 20611022-0, 20611033-0, 2061104-00, 20611044-0, 2061105-00, 20611055-0, 2061106-00, 20611066-0, 2063501-00, 2063501-01, 2063501-02, 2063501-03, 2063501-04, 2063501-05, 2063501-06, 2063501-1-0, 2063502-00, 2063502-01, 2063502-02, 2063502-03, 2063502-04, 2063502-05, 2063502-06, 2063502-07, 2063502-08, 2063502-09, 2063502-10, 20635022-0, 2063503-00, 2063503-01, 2063503-02, 2063503-03, 2063503-04, 2063503-05, 2063503-06, 2063503-07, 20635033-0, 2063504-00, 2063504-01, 2063504-02, 2063504-03, 20635044-0, 2063505-00, 20635055-0, 2063506-01, 2063506-02, 2063506-03, 2063506-04, 2063506-05... (Other models you can see in the webshop) | | |

¹for EGA24197/PEL

| | | | |
|---|---|-----------------|--------|
|  | | | |
| 1 | | | |
| GEV No. | 111886 ¹ | Ref. No. | 209013 |
| description | knob gas tap with ignition flame t.max.°C°C ø 65mm shaft ø 6x4.6mm shaft flat upper black for EGA26400 | | |
| For models: | 1263401-00, 1263402-00, 1263404-00, 1363401-00, 1363402-00, 1363402-01, 1363403-00, 1363403-01, 1363403-02, 1363403-03, 1363404-00, 1363404-01, 1464802-01, 1464803-01, 1464803-02, 1464808-01, 1464808-02, 1464809-01, 1464809-02, 1464810-01, 1464811-01, 1464812-00, 2063401-00, 2063401-01, 2063401-02, 2063401-03, 2063401-04, 20634011-0, 2063402-00, 2063402-01, 2063402-02, 2063402-03, 2063402-04, 20634022-0, 2063403-00, 2063403-01, 2063403-02, 2063403-03, 2063403-04, 2063403-05, 2063403-06, 2063403-07, 2063403-08, 2063404-00, 2063404-01, 2063404-02, 2063404-03, 2063404-04, 2063404-05, 2063405-00... (Other models you can see in the webshop) | | |

¹for EGA26440

| | | | |
|--|---|-----------------|--------|
|  | | | |
| 1 | | | |
| GEV No. | 111781 | Ref. No. | 209051 |
| description | knob OECCO/HAND t.max.°C°C ø 65mm shaft ø 6x4.6mm shaft flat upper | | |
| For models: | 1023401-00, 1023410-00, 1223202A00, 1223202A01, 1223202J00, 1223202J01, 1223209-00, 1223209-01, 1223401-00, 1223401J00, 1223402-00, 1323202A00, 1323202A01, 1323202A02, 1323209-00, 1323209-01, 1323209-02, 1323209-03, 1323210-00, 1323210-01, 1323210-02, 1323210-03, 1323210-04, 1323401-00, 1323402-00, 1323403-00, 1423401-00, 1423402-00, 1423404-00, 1423404-01, 1423405-00, 1423405-01, 1423405-02, 1423409-00, 1423409-01, 1423409-02, 1423414-02, 1424818A00, 1424819-00, 1424825-00, 1424826-00, 1523401-00, 1523402-00, 1523405-00, 1523405-01, 1523409-00, 1523409-01, 1523410-00, 2023206-00, 2023206-01... (Other models you can see in the webshop) | | |

| | | | |
|--|---|-----------------|--------|
|  | | | |
| 1 | | | |
| GEV No. | 111889 | Ref. No. | 209248 |
| description | knob oven TH/BH/TH+BH t.max.°C°C ø 65mm shaft ø 6x4.6mm shaft flat right black | | |
| For models: | 0522101-03, 0522101-04, 0522102-03, 0522102-04, 1323208-02, 1323208-03, 1323208-04, 1323210-00, 1323210-01, 1323210-02, 1323210-03, 1323210-04, 1323403-00, 1323403K00, 1323506-00, 1323506-01, 1323506A00, 1323506A01, 1323517-00, 1323517A00, 1363403-01, 1363403-02, 1363403-03, 1363403-04, 1363403-05, 1363415-05, 1422101-03, 1422101-04, 1422101-05, 1422101-06, 1422102-03, 1422102-04, 1422102-05, 1422104-05, 1422104A05, 1422105-05, 1422105A05, 1422106-05, 1422106-06, 1422106A05, 1422106A06, 1422107-05, 1422107-06, 1422107A05, 1422107A06, 1422301-01, 2023114-00, 2023118-00, 2023119-00, 2023203-05... (Other models you can see in the webshop) | | |

| | | | |
|--|--|-----------------|--------|
|  | | | |
| 1 | | | |
| GEV No. | 112526 | Ref. No. | 209481 |
| description | knob potentiometer t.max.°C°C ø 71mm shaft ø 6x4.6mm shaft flat upper with spring | | |
| For models: | CGE11-L, CGE11-R, CGE12-L, CGE12-R, CGE21-L, CGE21-R, CGE22-L, CGE22-R, CGE61-L, CGE61-R, CGE62-L, CGE62-R, CGG11-L, CGG11-R, CGG12-L, CGG12-R, CGG21-L, CGG21-R, CGG22-L, CGG22-R, CGG61-L, CGG61-R, CGG62-L, CGG62-R, CPE60, CPE63, CSE11-L, CSE11-R, CSE12-L, CSE12-R, CSE21-L, CSE21-R, CSE22-L, CSE22-R, CSE61-L, CSE61-R, CSE62-L, CSE62-R, CSG11-L, CSG11-R, CSG12-L, CSG12-R, CSG21-L, CSG21-R, CSG22-L, CSG22-R, CSG61-L, CSG61-R, CSG62-L, CSG62-R | | |

| | | | |
|---|---|-----------------|--------|
|  | | | |
| 1 | | | |
| GEV No. | 111778 | Ref. No. | 209900 |
| description | knob switch 0-1-0-1 t.max.°C ø 65mm shaft ø 6x4.6mm shaft flat upper black | | |
| For models: | 0220301-00, 0220301B00, 0220301B01, 0220301B02, 0220301D00, 0220302-00, 0220302A00, 0220302A01, 0220302A02, 0220302A03, 0220302B00, 0220302B01, 0220302B02, 0220302C00, 0220302C01, 0220302C02, 0220302C03, 0220302D00, 0220302E00, 0220302E01, 0220302H00, 0220302H01, 0220303-00, 0220303-01, 0220303A00, 0220303A01, 0220303A02, 0220303A03, 0220303B00, 0220303B01, 0220303C00, 0220303C01, 0220303C02, 0220303D00, 0220303D01, 0220303E00, 0220303E01, 0220303H00, 0220303H01, 0220304-00, 0220305-00, 0220306-00, 0220501-00, 0220502-00, 0220503-00, 0220601-00, 0220802-00, 0221001H00, 0221101-00, 0221101-01... (Other models you can see in the webshop) | | |

| | | | |
|--|--|-----------------|--------|
|  | | | |
| 1 | | | |
| GEV No. | 111800 | Ref. No. | 209222 |
| description | knob t.max.°C ø 65mm shaft ø 6x4.6mm shaft flat upper black | | |
| For models: | 1461101-02, 1461102-02, 1461104-02, 1461105-02, 1461109-01, 1461109A01, 1461109A02, 2061107-01, 2061107A01, 3061101-01, 3061101-02, 3061102-01, 3061102-02, 3061107-01, 3061107A01 | | |

| | | | |
|---|---|-----------------|--------|
|  | | | |
| 1 | | | |
| GEV No. | 110198 | Ref. No. | 209012 |
| description | knob switch 4-position t.max.°C ø 65mm shaft ø 6x4.6mm shaft flat upper black | | |
| For models: | 1220304-00, 1220304-01, 1220304A00, 1220304A01, 1220304A02, 1220304B00, 1220304B01, 1220304C00, 1220304C01, 1220304C02, 1220304D00, 1220304E00, 1220304F00, 1220304F01, 1220304H00, 1220304H01, 1220504-01, 1222601-00, 1320304-00, 1320304-01, 1320304A00, 1320304A01, 1320304A02, 1320304B00, 1320304B01, 1320304C00, 1320304C01, 1320304C02, 1320304D00, 1320304D01, 1320304E00, 1320304E01, 1320304F00, 1320304F01, 1320304F02, 1320304F03, 1320304F04, 1320304H00, 1320304H01, 1320304H02, 1320304H03, 1320304H04, 1320504-01, 1320504-02, 1322601-00, 1420509-01, 1422601-00, 1422602-00, 1422802B04, 1422802B05... (Other models you can see in the webshop) | | |

| | | | |
|--|--|-----------------|--------|
|  | | | |
| 1 | | | |
| GEV No. | 111780 | Ref. No. | 209052 |
| description | knob thermostat 1-10 t.max.°C ø 65mm shaft ø 6x4.6mm shaft flat upper | | |
| For models: | 1023410-00, 1423404-00, 1423404-01, 1423405-00, 1423405-01, 1423405-02, 1423409-00, 1423409-01, 1423409-02, 1423414-02, 1424819-00, 1424826-00, 1523405-00, 1523405-01, 1523409-00, 1523409-01, 1523410-00, 2023206-00, 2023206-01, 2023206-02, 2023207-00, 2023207-01, 2023207-02, 2023207-03, 2023207-04, 2023207-05, 2023405-00, 2023405D00, 2023406-00, 2023409-00, 3023206-00, 3023206-01, 3023206-02, 3023405-00, 3023406-00, 3023409-00 | | |

| | | | |
|---|---|-----------------|--------|
|  | | | |
| 1 | | | |
| GEV No. | 111779 | Ref. No. | 209905 |
| description | knob switch 7-position t.max.°C ø 65mm shaft ø 6x4.6mm shaft flat upper black | | |
| For models: | 0223202-00, 1223201-00, 1223201-01, 1223202-00, 1223207-00, 1223207-01, 1320401-00, 1320401-01, 1323201-00, 1323201-01, 1323201-02, 1323207-00, 1323207-02, 1323208-00, 1323208-01, 1323208-02, 1323208-03, 1323208-04, 1420401-00, 1420401-01, 1424802-00, 1424802-01, 1424802-02, 1424808-00, 1424808-01, 1424808-02, 1424808-03, 1424809-00, 1424809-01, 1424809-02, 1424809-03, 1424809-04, 1424809-05, 1424809-06, 1424809-07, 1424809-08, 1424809-09, 1424809-10, 1424809-11, 1424809-12, 1424809-13, 1424812-00, 1424812-01, 1424812-02, 1424813-00, 1424813-01, 1424813-02, 2020401-00, 2020401-01, 2023201-00, 2023201-01, 2023201-02, 2023201-03, 2023201-04, 2023201-05, 2023201-06, 2023201-07, 2023201-08, 2023201-09, 2023201-10, 2023201-11, 2023202-00... (Other models you can see in the webshop) | | |

| | | | |
|--|---|-----------------|--------|
|  | | | |
| 1 | | | |
| GEV No. | 111868 | Ref. No. | 209930 |
| description | knob thermostat 1-10 t.max.°C ø 65mm shaft ø 6x4.6mm shaft flat upper | | |
| For models: | 1223215-00, 1223215A00, 1223216-00, 1223216A00, 1223504A00, 1223505-00, 1223505A00, 1323504-00, 1323504A00, 1323505-00, 1323505A00, 1323506-00, 1323506A00, 1323515-00, 1323515A00, 1323516-00, 1323516A00, 1323517-00, 1323517A00, 1423501-00, 1423501A00, 1423502-00, 1423502-01, 1423502A00, 1423502A01, 1423504-00, 1423504A00, 1423505-00, 1423505A00, 1423507A00, 1423508A00, 1423524A00, 1423525A00, 1424814-00, 1424814-01, 1424814-02, 1424814-03, 1424814-04, 1424814A00, 1424814A01, 1424814A03, 1424814A04, 1424815-00, 1424815-01, 1424815-02, 1424815-03, 1424815-04, 1424815A00, 1424815A01, 1424815A03... (Other models you can see in the webshop) | | |

| | | | |
|---|---|-----------------|--------|
|  | | | |
| 1 | | | |
| GEV No. | 110199 | Ref. No. | 209901 |
| description | knob thermostat t.max. 110°C ø 65mm shaft ø 6x4.6mm shaft flat upper black temperature range 30-110°C rotation 270° | | |
| For models: | 0220501-00, 0220502-00, 0220503-00, 0220802-00, 1020510-00, 1022603-00, 1120510-00, 1120510-01, 1220402-00, 1220402-01, 1220501-00, 1220501-01, 1220501-02, 1220502-00, 1220502-01, 1220503-00, 1220504-01, 1220802-00, 1220802-01, 1222601-00, 1222603-00, 1320402-00, 1320402-01, 1320501-00, 1320501A00, 1320501A01, 1320502-00, 1320502A00, 1320502A01, 1320504-01, 1320504-02, 1320802-00, 1320802A00, 1322601-00, 1322603-00, 1420402-00, 1420402-01, 1420405-00, 1420501-00, 1420501-01, 1420501-02, 1420501-03, 1420502-00, 1420502-01, 1420502-02, 1420504-00, 1420504-01, 1420504-02, 1420504-03, 1420504-04... (Other models you can see in the webshop) | | |

| | | | |
|--|---|-----------------|--------|
|  | | | |
| 1 | | | |
| GEV No. | 111938 | Ref. No. | 209075 |
| description | knob time 15min t.max. °C ø 65mm shaft ø 6x4.6mm shaft flat upper black | | |
| For models: | 0220302A03, 0220302C03, 0220302H01, 0220303A03, 0220303C02, 0220303H01, 1220303A00, 1220303A01, 1220303A02, 1220303A03, 1220303C00, 1220303C01, 1220303C02, 1220303C03, 1220303F01, 1220303F02, 1220303F03, 1220303H00, 1220303H01, 1220303H02, 1220303H03, 1220305A00, 1220305A01, 1220305A02, 1220305A03, 1220305A04, 1220305A05, 1220305C00, 1220305C01, 1220305C02, 1220305C03, 1220305C04, 1220305C05, 1220305E00, 1220305E01, 1220305F01, 1220305F02, 1220305F03, 1220305F04, 1220305F05, 1220305H00, 1220305H01, 1220305H02, 1220305H03, 1220305H04, 1220305H05, 1320303A00, 1320303A01, 1320303A02, 1320303C00... (Other models you can see in the webshop) | | |

| | | | |
|---|---|-----------------|--------|
|  | | | |
| 2 | | | |
| GEV No. | 111905 | Ref. No. | 209902 |
| description | knob thermostat t.max. 185°C ø 65mm shaft ø 6x4.6mm shaft flat upper black temperature range 100-185°C rotation 270° | | |
| For models: | 0220301-00, 0220301B00, 0220301B01, 0220301B02, 0220301D00, 0220302-00, 0220302A00, 0220302A01, 0220302A02, 0220302A03, 0220302B00, 0220302B01, 0220302B02, 0220302C00, 0220302C01, 0220302C02, 0220302C03, 0220302D00, 0220302E00, 0220302E01, 0220302H00, 0220302H01, 0220303-00, 0220303-01, 0220303A00, 0220303A01, 0220303A02, 0220303A03, 0220303B00, 0220303B01, 0220303C00, 0220303C01, 0220303C02, 0220303D00, 0220303D01, 0220303E00, 0220303E01, 0220303H00, 0220303H01, 0220304-00, 0220305-00, 0220306-00, 0720332R00, 0720332V00, 1220301-00, 1220301-01, 1220301-02, 1220301-03, 1220301-04, 1220301B00... (Other models you can see in the webshop) | | |

| | | | |
|--|---|-----------------|--------|
|  | | | |
| 1 | | | |
| GEV No. | 112801 | Ref. No. | 209918 |
| description | knob zero mark ø 65mm MKN shaft ø 6x4.6mm shaft flat upper black | | |
| For models: | 14228011-0, 14228022-0, 14228033-0, 14228044-0, 14228055-0, 2012801-00, 2012801-01, 2012801A00, 2012801A01, 2012801B00, 2012801B01, 2012801C00, 2012801C01, 2012802-00, 2012802-01, 2012802A00, 2012802A01, 2012802B00, 2012802B01, 2012802C00, 2012802C01, 2012803-00, 2012803-01, 2012803A00, 2012803A01, 2012803B00, 2012803B01, 2012803C00, 2012803C01, 2012804-00, 2012804-01, 2012804A00, 2012804A01, 2012804B00, 2012804B01, 2012804C00, 2012804C01, 2012805-00, 2012805-01, 2012805A00, 2012805A01, 2012805B00, 2012805B01, 2012805C00, 2012805C01, 2012806B00, 2012806C00, 2012807B00, 2012807C00, 2012901B00... (Other models you can see in the webshop) | | |

| | | | |
|---|---|-----------------|--------|
|  | | | |
| 1 | | | |
| GEV No. | 111888 | Ref. No. | 209903 |
| description | knob thermostat t.max. 300°C 50-300°C ø 65mm shaft ø 6x4.6mm shaft flat upper black rotation 270° | | |
| For models: | 0221101-00, 0221101-01, 0221101A00, 0221101A01, 0221102-00, 0221102-01, 0221103-00, 0221103-01, 0221104-00, 0221104-01, 0221104A00, 0221104A01, 0221105-00, 0221105-01, 0221106-00, 0221106-01, 0221107-00, 0221107A00, 0221108-00, 0221109-00, 0221109A00, 0221110-00, 0522101-00, 0522101-03, 0522101-04, 0522102-03, 0522102-04, 1121117-00, 1121117-01, 1121117A00, 1121118-00, 1121118-01, 1121119-00, 1121119A00, 1121120-00, 1121121-00, 1121121A00, 1121135A01, 1221101-00, 1221101A00, 1221101B00, 1221102-00, 1221102A00, 1221102B00, 1221103-00, 1221103-01, 1221103-02, 1221103-04, 1221103A00, 1221103A01... (Other models you can see in the webshop) | | |

| | | | |
|---|--------|-----------------|--------|
|  Image not available | | | |
| 1 | | | |
| GEV No. | 111949 | Ref. No. | 580029 |
| description | knob | | |

| | | | |
|--|--|-----------------|--------|
|  | | | |
| 1 | | | |
| GEV No. | 111885 | Ref. No. | 209224 |
| description | knob switch zero mark ø 21mm shaft ø 6mm black | | |



| | | | |
|--|--------|-----------------|--------|
|  <p>Image not available</p> | | | |
| 1 | | | |
| GEV No. | 111951 | Ref. No. | 580030 |
| description | knob | | |

| | | | |
|--|--------|-----------------|--------|
|  <p>Image not available</p> | | | |
| 1 | | | |
| GEV No. | 111952 | Ref. No. | 209007 |
| description | knob | | |

| | | | |
|--|--------|-----------------|--------|
|  <p>Image not available</p> | | | |
| 1 | | | |
| GEV No. | 111954 | Ref. No. | 209024 |
| description | knob | | |

| | | | |
|--|---|-----------------|--------|
|  | | | |
| 1 | | | |
| GEV No. | 690965 | Ref. No. | 216076 |
| description | hand wheel ø 175mm D1 ø 40mm bore ø 16mm thread M6 hole distance 7mm groove widthmm L1 42mm L2 55mm handle length 80mm with folding handle | | |
| For models: | 2013003B04, 2013003B05, 2013003B06, 2013007B04, 2013007B05, 2013007B06, 2013009B04, 2013009B05, 2013009B06, 2013017B03, 2013017B04, 2013017B05, 2021401-09, 2021401A09, 2021401B09, 2021401C09, 2021407-03, 2021407A03, 2021407B03, 2021407C03, 2021409-02, 2021409B02, 2021430-01, 2021430-02, 2021430A01, 2021430A02, 2021430B02, 2021430B03, 2021430C02, 2021430C03, 2021436-02, 2021436-03, 2021436A02, 2021436A03, 2021436B02, 2021436B03, 2021436C02, 2021436C03, 2021440-04, 2021440-05, 2021440A04, 2021440A05, 2021440B04, 2021440B05, 2021440C04, 2021440C05, 2021441-04, 2021441-05, 2021441-06, 2021441-07... (Other models you can see in the webshop) | | |
| accessories for | 690965 | | |
| |  | GEV No. | 560555 |
| | | Ref. No. | — |
| | hexagonal screw thread M6 thread L 15mm SS WS 10 Qty 1 pcs DIN 933 / ISO 4017 | | |

handles and hand wheels

hand wheels

hand wheels

| | | | |
|---|---|-----------------|--------|
|  | | | |
| 1 | | | |
| GEV No. | 690966 | Ref. No. | 216004 |
| description | hand wheel ø 175mm D1 ø 40mm bore ø 16mm thread M6 hole distance 7mm groove widthmm L1 41mm L2 55mm handle length 80mm with folding handle with fixing kit | | |
| For models: | 2013003B01, 2013003B02, 2013003B03, 2013007B01, 2013007B02, 2013007B03, 2013009B01, 2013009B02, 2013009B03, 2013017B00, 2013017B01, 2013017B02, 2021401-02, 2021401-03, 2021401-04, 2021401-05, 2021401-06, 2021401-07, 2021401-08, 2021401A01, 2021401A02, 2021401A03, 2021401A04, 2021401A06, 2021401A07, 2021401A08, 2021401B01, 2021401B02, 2021401B03, 2021401B04, 2021401B06, 2021401B07, 2021401B08, 2021401C01, 2021401C02, 2021401C03, 2021401C04, 2021401C06, 2021401C07, 2021401C08, 2021405C00, 2021407-00, 2021407-01, 2021407-02, 2021407A02, 2021407B00, 2021407B01, 2021407B02, 2021407C02, 2021409-00... (Other models you can see in the webshop) | | |

| | | | |
|---|---|-----------------|--------|
|  | | | |
| 1 | | | |
| GEV No. | 690964 | Ref. No. | 216907 |
| description | hand wheel ø 200mm D1 ø 40mm bore ø 20mm thread M6 groove widthmm L1 20mm L2 60mm handle length 90mm with folding handle | | |
| For models: | 2021403-00, 2021403-01, 2021403-02, 2021403-03, 2021403-04, 2021403-05, 2021403-06, 20214033-0, 2021403A00, 2021403A01, 2021403A02, 2021403A04, 2021403A05, 2021403A06, 2021403B00, 2021403B01, 2021403B02, 2021403B04, 2021403B05, 2021403B06, 2021403C01, 2021403C02, 2021403C04, 2021403C05, 2021403C06, 2021405-00, 2021405-01, 2021405-02, 2021405-03, 20214055-0, 2021405B00, 2021405B01, 2021405B02, 2021405B03, 2021413-00, 2021413B00, 2021415B00, 2021432C00, 2023001-00, 20230011-0, 20230011-1, 2023001A00, 2023001B00, 2023001C00, 2023003-00, 20230033-0, 20230033-1, 2023003A00, 2023003B00, 2023003C00... (Other models you can see in the webshop) | | |
| spare parts for | 690964 | | |
| |  | GEV No. | 690859 |
| | | Ref. No. | — |
| | folding handle ø 28mm total length 110mm seat ø 26mm shaft ømm thread M6 with pin L 110mm | | |

ball handles



| | | | |
|------------------------|---|-----------------|--------|
| GEV No. | 693474 | Ref. No. | 207035 |
| description | ball handle ø 40mm bore ø conical 12mm for drive into black | | |
| For models: | 0521704-00, 0521704-02, 0521704-03, 0521704-04, 0521704-05, 0521704-06, 0521704-07, 0521704A00, 0521704A01, 0521705-00, 0521705-01, 0522101-00, 0522101-01, 0522101-02, 0522101-03, 0522101-04, 0522102-00, 0522102-01, 0522102-02, 0522102-03, 0522102-04, 0722101-06, 1323208-00, 1323208-01, 1323208-02, 1323208-03, 1323208-04, 1323210-00, 1323210-01, 1323210-02, 1323210-03, 1323210-04, 1323403-00, 1323403K00, 1323506-00, 1323506-01, 1323506A00, 1323506A01, 1323517-00, 1323517A00, 1363403-00, 1363403-01, 1363403-02, 1363403-03, 1363403-04, 1363403-05, 1363415-05, 1412831-00, 1412832-00, 1412833-00... (Other models you can see in the webshop) | | |
| accessories for | 693474 | | |
| |  | GEV No. | 696529 |
| | | Ref. No. | — |
| | lever for ball handle thread M8x1.25 ø 12/14mm angled 90° SS | | |

lever handles



| | | | |
|--------------------|---|-----------------|----------|
| GEV No. | 692814 | Ref. No. | 10013388 |
| description | door handle plastic ø 48mm L 190mm suitable for MKN black | | |

door handles

door handles



| | | | |
|--------------------|---|-----------------|--------|
| GEV No. | 693473 | Ref. No. | 207179 |
| description | door handle metal dimensions ø10mm | | |
| For models: | 0522101-00, 0522101-01, 0522101-02, 0522101-03, 0522101-04, 0522102-00, 0522102-01, 0522102-02, 0522102-03, 0522102-04, 0722101-06, 1323208-00, 1323208-01, 1323208-02, 1323208-03, 1323208-04, 1323210-00, 1323210-01, 1323210-02, 1323210-03, 1323210-04, 1323403-00, 1323403K00, 1323506-00, 1323506-01, 1323506A00, 1323506A01, 1323517-00, 1323517A00, 1363403-00, 1363403-01, 1363403-02, 1363403-03, 1363403-04, 1363403-05, 1363415-05, 1422101-00, 1422101-01, 1422101-02, 1422101-03, 1422101-04, 1422101-05, 1422101-06, 1422102-00, 1422102-01, 1422102-02, 1422102-03, 1422102-04, 1422102-05, 1422104-05... (Other models you can see in the webshop) | | |

locks

electromagnetic closer



| | | | |
|--------------------|---|-----------------|--------|
| GEV No. | 692216 | Ref. No. | 203768 |
| description | electromagnetic closer 24V voltage DC L 104mm W 24mm H 34mm series 8440 | | |
| For models: | CPE63 | | |

handle latches

producer-specific

MKN





| | | | |
|------------------------|--|-----------------|--------|
| GEV No. | 691666 | Ref. No. | 207092 |
| description | catch clamp length 46mm BL 31mm for off-set 59-69mm | | |
| For models: | CGE11-L, CGE11-R, CGE12-L, CGE12-R, CGE61-L, CGE61-R, CGE62-L, CGE62-R, CGG11-L, CGG11-R, CGG12-L, CGG12-R, CGG61-L, CGG61-R, CGG62-L, CGG62-R, CSE11-L, CSE11-R, CSE11-R-DG, CSE12-L, CSE12-R, CSE12-R-DG, CSE61-L, CSE61-R, CSE61-R-DG, CSE62-L, CSE62-R, CSE62-R-DG, CSG11-L, CSG11-R, CSG11-R-DG, CSG12-L, CSG12-R, CSG12-R-DG, CSG61-L, CSG61-R, CSG61-R-DG, CSG62-L, CSG62-R, CSG62-R-DG | | |
| spare parts for | 691666 | | |
| |  | GEV No. | 514390 |
| | | Ref. No. | — |
| | spring for door handle ø 6mm L 54mm W 27.5mm | | |
| accessories for | 691666 | | |
| |  | GEV No. | 691780 |
| | | Ref. No. | 207090 |
| | door catch L 24mm H 21mm thread M8 thread L 20mm | | |
| |  | GEV No. | 694066 |
| | | Ref. No. | — |
| | door catch with spigot 2-stage L 28mm W 14mm H 15mm H1 16mm total length 51mm thread M8 thread L 23mm stainless steel | | |
| |  | GEV No. | 694067 |
| | | Ref. No. | — |
| | door catch with spigot 1-stage L 26mm total length 51mm thread M8 | | |

| | | | |
|--|--|-----------------|----------|
|  <p>1</p> | | | |
| GEV No. | 692726 | Ref. No. | 10012036 |
| description | catch for combi-steamer mounting thread M4/M8 clamp length 48mm BL 45mm ø 42mm | | |
| For models: | CGE11-L, CGE11-R, CGE12-L, CGE12-R, CGE61-L, CGE61-R, CGE62-L, CGE62-R, CGG11-L, CGG11-R, CGG12-L, CGG12-R, CGG61-L, CGG61-R, CGG62-L, CGG62-R, CSE11-L, CSE11-R, CSE11-R-DG, CSE12-L, CSE12-R, CSE12-R-DG, CSE61-L, CSE61-R, CSE61-R-DG, CSE62-L, CSE62-R, CSE62-R-DG, CSG11-L, CSG11-R, CSG11-R-DG, CSG12-L, CSG12-R, CSG12-R-DG, CSG61-L, CSG61-R, CSG61-R-DG, CSG62-L, CSG62-R, CSG62-R-DG | | |

| | | | |
|--|--|-----------------|--------|
|  <p>2</p> | | | |
| GEV No. | 694660 | Ref. No. | 207094 |
| description | catch L 103mm clamp length 60mm | | |
| For models: | CGE21-L, CGE21-R, CGE22-L, CGE22-R, CGG21-L, CGG21-R, CGG22-L, CGG22-R, CSE21-L, CSE21-R, CSE22-L, CSE22-R, CSG21-L, CSG21-R, CSG22-L, CSG22-R | | |

| | | | |
|---|---|-----------------|--------|
|  <p>1</p> | | | |
| GEV No. | 699292 | Ref. No. | 203737 |
| description | counterpart for door handle L 136mm W 34mm H 42mm hole ø 18mm | | |
| For models: | CCE60, CCE63, CPE60, CPE63 | | |

| | | | |
|--|--|-----------------|--------|
|  <p>1</p> | | | |
| GEV No. | 694662 | Ref. No. | 203667 |
| description | cover for door latch plastic grey L 185mm W 48mm mounting distance 186mm D 37mm | | |
| For models: | CGE11-L, CGE11-R, CGE12-L, CGE12-R, CGE21-L, CGE21-R, CGE22-L, CGE22-R, CGE61-L, CGE61-R, CGE62-L, CGE62-R, CGG11-L, CGG11-R, CGG12-L, CGG12-R, CGG21-L, CGG21-R, CGG22-L, CGG22-R, CGG61-L, CGG61-R, CGG62-L, CGG62-R, CSE11-L, CSE11-R, CSE12-L, CSE12-R, CSE21-L, CSE21-R, CSE22-L, CSE22-R, CSE61-L, CSE61-R, CSE62-L, CSE62-R, CSG11-L, CSG11-R, CSG12-L, CSG12-R, CSG21-L, CSG21-R, CSG22-L, CSG22-R, CSG61-L, CSG61-R, CSG62-L, CSG62-R | | |

| | | | |
|--|--|-----------------|--------|
|  <p>1</p> | | | |
| GEV No. | 696809 | Ref. No. | 207101 |
| description | door catch for combi-steamer L 42mm W 30mm H 36mm mounting thread M5 | | |
| For models: | CCE60, CCE63, CPE60, CPE63 | | |

| | | | |
|--|---|-----------------|--------|
|  <p>1</p> | | | |
| GEV No. | 692767 | Ref. No. | 207144 |
| description | door catch for combi-steamer with roller L 44mm W 11.5mm H 11.5mm M6 thread L 18mm B1 6mm rollerø 7.8mm | | |
| For models: | CPE63 | | |

| | | | |
|--|--|-----------------|--------|
|  <p>1</p> | | | |
| GEV No. | 691780 | Ref. No. | 207090 |
| description | door catch L 24mm H 21mm thread M8 thread L 20mm | | |
| For models: | CGE11-L, CGE11-R, CGE12-L, CGE12-R, CGE21-L, CGE21-R, CGE22-L, CGE22-R, CGE61-L, CGE61-R, CGE62-L, CGE62-R, CGG11-L, CGG11-R, CGG12-L, CGG12-R, CGG21-L, CGG21-R, CGG22-L, CGG22-R, CGG61-L, CGG61-R, CGG62-L, CGG62-R, CSE11-L, CSE11-R, CSE11-R-DG, CSE12-L, CSE12-R, CSE12-R-DG, CSE21-L, CSE21-R, CSE22-L, CSE22-R, CSE61-L, CSE61-R, CSE61-R-DG, CSE62-L, CSE62-R, CSE62-R-DG, CSG11-L, CSG11-R, CSG11-R-DG, CSG12-L, CSG12-R, CSG12-R-DG, CSG21-L, CSG21-R, CSG22-L, CSG22-R...(Other models you can see in the webshop) | | |

| | | | |
|--|---|-----------------|--------|
|  <p>1</p> | | | |
| GEV No. | 705011 | Ref. No. | 207103 |
| description | door catch L 57mm W 13mm mounting thread 6mm BL 6mm | | |
| For models: | CCE60, CCE63, CPE60, CPE63 | | |





| | | | |
|--|--|-----------------|--------|
|  <p>1</p> | | | |
| GEV No. | 696815 | Ref. No. | 207102 |
| description | door handle for combi-steamer L 142mm W 36mm H 55mm grey plastic | | |
| For models: | CCE60, CCE63, CPE60, CPE63 | | |

| | | | |
|--|--|-----------------|--------|
|  <p>1</p> | | | |
| GEV No. | 692766 | Ref. No. | 207143 |
| description | door handle for combi-steamer L 143mm W 37mm H 59mm grey plastic | | |
| For models: | CPE63 | | |

| | | | |
|---|--|-----------------|------------------------|
|  | | | |
| 1 | | | |
| GEV No. | 691617 | Ref. No. | 207089 |
| description | door handle grey plastic | | |
| For models: | CGE11-L, CGE11-R, CGE12-L, CGE12-R, CGE21-L, CGE21-R, CGE22-L, CGE22-R, CGE61-L, CGE61-R, CGE62-L, CGE62-R, CGG11-L, CGG11-R, CGG12-L, CGG12-R, CGG21-L, CGG21-R, CGG22-L, CGG22-R, CGG61-L, CGG61-R, CGG62-L, CGG62-R, CSE11-L, CSE11-R, CSE11-R-DG, CSE12-L, CSE12-R, CSE12-R-DG, CSE21-L, CSE21-R, CSE22-L, CSE22-R, CSE61-L, CSE61-R, CSE61-R-DG, CSE62-L, CSE62-R, CSE62-R-DG, CSG11-L, CSG11-R, CSG11-R-DG, CSG12-L, CSG12-R, CSG12-R-DG, CSG21-L, CSG21-R, CSG22-L, CSG22-R...(Other models you can see in the webshop) | | |
| accessories for | 691617 | | |
|  | GEV No. | 691666 | Ref. No. 207092 |
| | catch clamp length 46mm BL 31mm for off-set 59-69mm | | |
|  | GEV No. | 691777 | Ref. No. 202662 |
| | cover cap plastic grey L 94mm W 40mm mounting distance 75mm D 36mm | | |
|  | GEV No. | 691780 | Ref. No. 207090 |
| | door catch L 24mm H 21mm thread M8 thread L 20mm | | |
|  | GEV No. | 691782 | Ref. No. 801064 |
| | cover plate round ø 40mm thickness 1mm | | |
|  | GEV No. | 691783 | Ref. No. 801059 |
| | cover plate rectangular L 35mm W 14mm thickness 1mm | | |

| | | | |
|---|--|-----------------|--------|
|  | | | |
| 1 | | | |
| GEV No. | 691785 | Ref. No. | 207147 |
| description | catch L 97mm clamp length 54mm BL 39mm ø 51.5mm | | |
| For models: | CGE21-L, CGE21-R, CGE22-L, CGE22-R, CGG21-L, CGG21-R, CGG22-L, CGG22-R, CSE21-L, CSE21-R, CSE21-R-DG, CSE22-L, CSE22-R, CSE22-R-DG, CSG21-L, CSG21-R, CSG21-R-DG, CSG22-L, CSG22-R, CSG22-R-DG | | |

| | | | |
|---|--|-----------------|--------|
|  | | | |
| 1 | | | |
| GEV No. | 691786 | Ref. No. | 207148 |
| description | door catch L 38mm H 19mm thread M8 thread L 21mm | | |
| For models: | CGE21-L, CGE21-R, CGE22-L, CGE22-R, CGG21-L, CGG21-R, CGG22-L, CGG22-R, CSE21-L, CSE21-R, CSE21-R-DG, CSE22-L, CSE22-R, CSE22-R-DG, CSG21-L, CSG21-R, CSG21-R-DG, CSG22-L, CSG22-R, CSG22-R-DG | | |

| | | | |
|--|--|-----------------|------------------------|
|  | | | |
| 1 | | | |
| GEV No. | 691784 | Ref. No. | 207149 |
| description | door handle L 200mm W 32mm H 70mm grey plastic | | |
| For models: | CGE21-L, CGE21-R, CGE22-L, CGE22-R, CGG21-L, CGG21-R, CGG22-L, CGG22-R, CSE21-L, CSE21-R, CSE21-R-DG, CSE22-L, CSE22-R, CSE22-R-DG, CSG21-L, CSG21-R, CSG21-R-DG, CSG22-L, CSG22-R, CSG22-R-DG | | |
| accessories for | 691784 | | |
|  | GEV No. | 691777 | Ref. No. 202662 |
| | cover cap plastic grey L 94mm W 40mm mounting distance 75mm D 36mm | | |
|  | GEV No. | 691781 | Ref. No. 802694 |
| | cover plate round ø 38mm thickness 1mm | | |
|  | GEV No. | 691785 | Ref. No. 207147 |
| | catch L 97mm clamp length 54mm BL 39mm ø 51.5mm | | |
|  | GEV No. | 691786 | Ref. No. 207148 |
| | door catch L 38mm H 19mm thread M8 thread L 21mm | | |

| | | | |
|--|--|-----------------|--------|
|  | | | |
| 1 | | | |
| GEV No. | 691777 | Ref. No. | 202662 |
| description | cover cap plastic grey L 94mm W 40mm mounting distance 75mm D 36mm | | |
| For models: | CGE11-L, CGE11-R, CGE12-L, CGE12-R, CGE21-L, CGE21-R, CGE22-L, CGE22-R, CGE61-L, CGE61-R, CGE62-L, CGE62-R, CGG11-L, CGG11-R, CGG12-L, CGG12-R, CGG21-L, CGG21-R, CGG22-L, CGG22-R, CGG61-L, CGG61-R, CGG62-L, CGG62-R, CSE11-L, CSE11-R, CSE11-R-DG, CSE12-L, CSE12-R, CSE12-R-DG, CSE21-L, CSE21-R, CSE21-R-DG, CSE22-L, CSE22-R, CSE22-R-DG, CSE61-L, CSE61-R, CSE61-R-DG, CSE62-L, CSE62-R, CSE62-R-DG, CSG11-L, CSG11-R, CSG11-R-DG, CSG12-L, CSG12-R, CSG12-R-DG, CSG21-L, CSG21-R...(Other models you can see in the webshop) | | |

| | | | |
|---|--|-----------------|--------|
|  | | | |
| 1 | | | |
| GEV No. | 691783 | Ref. No. | 801059 |
| description | cover plate rectangular L 35mm W 14mm thickness 1mm | | |
| For models: | CGE11-L, CGE11-R, CGE12-L, CGE12-R, CGE61-L, CGE61-R, CGE62-L, CGE62-R, CGG11-L, CGG11-R, CGG12-L, CGG12-R, CGG61-L, CGG61-R, CGG62-L, CGG62-R, CSE11-L, CSE11-R, CSE11-R-DG, CSE12-L, CSE12-R, CSE12-R-DG, CSE61-L, CSE61-R, CSE61-R-DG, CSE62-L, CSE62-R, CSE62-R-DG, CSG11-L, CSG11-R, CSG11-R-DG, CSG12-L, CSG12-R, CSG12-R-DG, CSG61-L, CSG61-R, CSG61-R-DG, CSG62-L, CSG62-R, CSG62-R-DG | | |



| | | | |
|---|--|-----------------|--------|
|  | | | |
| 1 | | | |
| GEV No. | 691781 | Ref. No. | 802694 |
| description | cover plate round ø 38mm thickness 1mm | | |
| For models: | CGE21-L, CGE21-R, CGE22-L, CGE22-R, CGG21-L, CGG21-R, CGG22-L, CGG22-R, CSE21-L, CSE21-R, CSE21-R-DG, CSE22-L, CSE22-R, CSE22-R-DG, CSG21-L, CSG21-R, CSG21-R-DG, CSG22-L, CSG22-R, CSG22-R-DG | | |

| | | | |
|---|--|-----------------|--------|
|  | | | |
| 1 | | | |
| GEV No. | 691782 | Ref. No. | 801064 |
| description | cover plate round ø 40mm thickness 1mm | | |
| For models: | CGE11-L, CGE11-R, CGE12-L, CGE12-R, CGE21-L, CGE21-R, CGE22-L, CGE22-R, CGE61-L, CGE61-R, CGE62-L, CGE62-R, CGG11-L, CGG11-R, CGG12-L, CGG12-R, CGG21-L, CGG21-R, CGG22-L, CGG22-R, CGG61-L, CGG61-R, CGG62-L, CGG62-R, CSE11-L, CSE11-R, CSE11-R-DG, CSE12-L, CSE12-R, CSE12-R-DG, CSE21-L, CSE21-R, CSE22-L, CSE22-R, CSE61-L, CSE61-R, CSE61-R-DG, CSE62-L, CSE62-R, CSE62-R-DG, CSG11-L, CSG11-R, CSG11-R-DG, CSG12-L, CSG12-R, CSG12-R-DG, CSG21-L, CSG21-R, CSG22-L, CSG22-R...(Other models you can see in the webshop) | | |

| | | | |
|--|--|-----------------|--------|
|  | | | |
| 1 | | | |
| GEV No. | 520507 | Ref. No. | 201093 |
| description | outlet tap brass L 210mm thread 1/2" IT - 3/4" IT | | |
| For models: | 0220301-00, 0220301B00, 0220301B01, 0220301B02, 0220302-00, 0220302A00, 0220302A01, 0220302A02, 0220302A03, 0220302B00, 0220302B01, 0220302B02, 0220302C00, 0220302C01, 0220302C02, 0220302C03, 0220302F00, 0220303-00, 0220303-01, 0220303A00, 0220303A01, 0220303A02, 0220303A03, 0220303B00, 0220303B01, 0220303C00, 0220303C01, 0220303C02, 0220304-00, 0220305-00, 0220306-00 | | |

| | | | |
|--|---|-----------------|--------|
|  | | | |
| 1 | | | |
| GEV No. | 520536 | Ref. No. | 201114 |
| description | outlet tap L 175mm thread 1/2" IT - 3/4" IT shaft L 92mm total length 174mm shaft intake ø 6x6mm shaft ø 8mm | | |
| For models: | 1220301-00, 1220301-01, 1220301-02, 1220301-03, 1220301-04, 1220301B00, 1220301B01, 1220301B02, 1220301B03, 1220301B04, 1220301J00, 1220301J01, 1220301J02, 1220301J03, 1220302-00, 1220302-01, 1220302B00, 1220302B01, 1220303-00, 1220303-01, 1220303-02, 1220303-03, 1220303-04, 1220303-05, 1220303A00, 1220303A01, 1220303A02, 1220303A03, 1220303B00, 1220303B01, 1220303B02, 1220303B03, 1220303B04, 1220303B05, 1220303C00, 1220303C01, 1220303C02, 1220303C03, 1220303I00, 1220303I01, 1220303I02, 1220303J01, 1220303J02, 1220303J03, 1220303J04, 1220303K00, 1220303K01, 1220304-00, 1220304-01, 1220304A00... (Other models you can see in the webshop) | | |



fittings for catering equipment

outlet taps

producer-specific

MKN

| | | | |
|---|--|-----------------|--------|
|  | | | |
| 1 | | | |
| GEV No. | 520376 | Ref. No. | 205252 |
| description | drain pipe thread 1/2" ET connection 1/2" | | |
| For models: | 0220501-00, 0220502-00, 0220503-00, 0220802-00, 0221501-00, 0221502-00, 0260501-00 | | |

| | | | |
|---|--|-----------------|------------------------|
|  | | | |
| 1 | | | |
| GEV No. | 520378 | Ref. No. | 201092 |
| description | outlet tap brass L 100mm thread 1/2" IT - 3/4" IT | | |
| For models: | 0220501-00, 0220502-00, 0220503-00, 0220802-00, 0221501-00, 0221502-00, 0260501-00, 0520303-00, 0520303-01, 0520303-02, 1020510-00, 1022603-00, 1220501-00, 1220501-01, 1220501-02, 1220502-00, 1220502-01, 1220802-00, 1220802-01, 1221501-00, 1221501-01, 1221501-02, 1260501-00, 1320501-00, 1320502-00, 1320802-00, 1321501-00, 1321501-01, 1321501-02, 1321501-03, 1360501-00, 1360501-01, 4228801-00, 4228801-01 | | |
| accessories for | 520378 | | |
|  | GEV No. | 520376 | Ref. No. 205252 |
| | drain pipe thread 1/2" ET connection 1/2" | | |

aerators and air bleeders





| | | | |
|--|---|-----------------|--------|
|  | | | |
| 1 | | | |
| GEV No. | 540949 | Ref. No. | 201091 |
| description | aerator and air bleeder thread 1/2" ET chrome-plated with O-ring L 15mm ø 25mm | | |
| For models: | 2012801-01, 2012801A01, 2012801B01, 2012801C01, 2012802-01, 2012802A01, 2012802B01, 2012802C01, 2012803-01, 2012803A01, 2012803B01, 2012803C01, 2012804-01, 2012804A01, 2012804B01, 2012804C01, 2012805-01, 2012805A01, 2012805B01, 2012805C01, 2012827-00, 2012827-01, 2012827-02, 2012828-00, 2012828-01, 2012828-02, 2012828-03, 2012828-04, 2012828-05, 2012829-00, 2012829-01, 2012829-02, 2022801-02, 2022801-03, 2022801A02, 2022801A03, 2022801B02, 2022801B03, 2022801C02, 2022801C03, 2022802-02, 2022802-03, 2022802A02, 2022802A03, 2022802B02, 2022802B03, 2022802C02, 2022802C03, 2022803-02, 2022803-03... (Other models you can see in the webshop) | | |



1

| | | | |
|--------------------|--|-----------------|--------|
| GEV No. | 541428 | Ref. No. | 201084 |
| description | aerator and air bleeder thread 3/4" ET chrome-plated L 25mm ø 33mm | | |
| For models: | 14228011-0, 14228022-0, 14228033-0, 14228044-0, 14228055-0, 2022801-00, 2022801-01, 20228011-0, 20228011-1, 2022801A00, 2022801A01, 2022801B00, 2022801B01, 2022801C00, 2022802-00, 2022802-01, 20228022-0, 20228022-1, 2022802A00, 2022802A01, 2022802B00, 2022802B01, 2022802C00, 2022802C01, 2022803-00, 2022803-01, 20228033-0, 20228033-1, 2022803A00, 2022803A01, 2022803B00, 2022803B01, 2022803C00, 2022803C01, 2022804-00, 2022804-01, 20228044-0, 20228044-1, 2022804A00, 2022804A01, 2022804B00, 2022804B01, 2022804C00, 2022804C01, 2022805-00, 2022805-01, 20228055-0, 20228055-1, 2022805A00, 2022805A01... (Other models you can see in the webshop) | | |

spare parts for 541544

| | | | | |
|---|---|--------|-----------------|---|
|  | GEV No. | 541546 | Ref. No. | — |
| | screw chrome-plated brass thread M5 thread L 10mm | | | |
|  | GEV No. | 541548 | Ref. No. | — |
| | gasket PTFE ID ø 15mm H 7mm for thread 1 1/4" ED ø 35mm | | | |
|  | GEV No. | 541554 | Ref. No. | — |
| | gasket copper ext. ø 49 ID ø 42mm H 2mm for thread 1 1/4" | | | |
|  | GEV No. | 541557 | Ref. No. | — |
| | tap head chrome-plated thread 1 1/4" for steam tap 1" | | | |

lid hinges

type ECHTERMANN

10 series

10.71





| | | | |
|----------------|--------|-----------------|--------|
| GEV No. | 693502 | Ref. No. | 207175 |
|----------------|--------|-----------------|--------|

| | | | |
|--------------------|---|--|--|
| description | lid hinge type 6910.71 level of centre of rotation 32mm load capacity 10-20NM opening angle 80° closing angle 10° mounting distance 198mm bore ø 11mm MT lid M8mm chrome-plated brass L 270mm | | |
|--------------------|---|--|--|

| | | | |
|--------------------|--|--|--|
| For models: | 14228011-0, 2012801-00, 2012801-01, 2012801A00, 2012801A01, 2022801-00, 2022801-01, 2022801-02, 2022801-03, 20228011-0, 20228011-1, 2022801A00, 2022801A01, 2022801A02, 2022801A03, 2062801-00, 2062801-01, 2062801-02, 2062801-03, 2062801-04, 2062801-05, 2062801-06, 2062801A00, 2062801A01, 2062801A02, 2062801A03, 2062801A04, 2062801A05, 2062801A06, 20628022-0, 20628022-1, 20628022-2, 2112801-00, 2112801-01, 2112801A00, 2112801A01, 2122801-00, 2122801-01, 2122801-02, 2122801-03, 2122801A00, 2122801A01, 2122801A02, 2122801A03, 2122802A00, 3012801-00, 3012801-01, 3012801A00, 3012801A01, 3022801-00... (Other models you can see in the webshop) | | |
|--------------------|--|--|--|

spare parts for 693502

| | | | | |
|---|--|--------|-----------------|---|
|  | GEV No. | 691611 | Ref. No. | — |
| | repair kit for lid hinge load capacity 10-20NM | | | |



2

| | | | |
|--------------------|--|-----------------|--------|
| GEV No. | 541430 | Ref. No. | 201736 |
| description | air valve thread 1/2" ET chrome-plated L 16mm ø 25mm | | |
| For models: | 1422802B04, 1422802B05, 1422802B06, 1422802B07, 1422802B08, 1422804B04, 1422804B05, 1422804B06, 1422804B07, 1422804B08, 1422805B04, 1422805B05, 1422805B06, 1422805B07, 1422805B08, 1462802B00, 1462802B01, 1462802B02, 1462802B03, 1462802B04, 1462802B05, 1462804B00, 1462804B01, 1462804B02, 1462804B03, 1462804B04, 1462804B05, 1462835-00, 1462836-00, 1462837-00, 1462838-00, 1462839-00, 1462840-00, 2012802B02, 2012802B03, 2012802B04, 2012802B05, 2012802B06, 2012802B07, 2012804B02, 2012804B03, 2012804B04, 2012804B05, 2012804B06, 2012804B07, 2012805B02, 2012805B03, 2012805B04, 2012805B05, 2012805B06... (Other models you can see in the webshop) | | |

steam valves

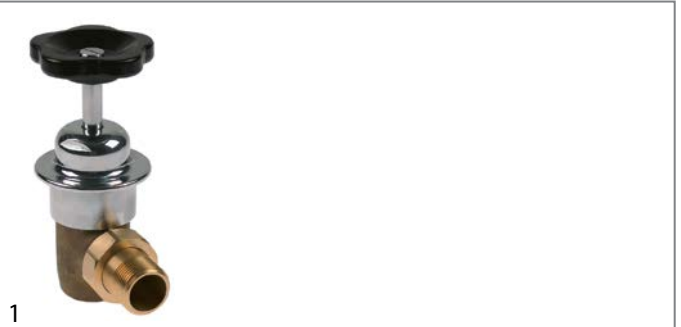

| | | | |
|----------------|--------|-----------------|--------|
| GEV No. | 541544 | Ref. No. | 201052 |
|----------------|--------|-----------------|--------|

| | | | |
|--------------------|---|--|--|
| description | steam valve angled connection 1" IT - 1" ET total length 82mm H 136mm brass | | |
|--------------------|---|--|--|



| | | | |
|--------------------|--|--|--|
| For models: | 1412831-00, 1412832-00, 1412833-00, 1412834-00, 1412908-00, 1412910-00, 2012801-00, 2012801-01, 2012801A00, 2012801A01, 2012801B00, 2012801B01, 2012801C00, 2012801C01, 2012802-00, 2012802-01, 2012802A00, 2012802A01, 2012802B00, 2012802B01, 2012802B02, 2012802B03, 2012802B04, 2012802B05, 2012802B06, 2012802B07, 2012802C00, 2012802C01, 2012803-00, 2012803-01, 2012803A00, 2012803A01, 2012803B00, 2012803B01, 2012803C00, 2012803C01, 2012804-00, 2012804-01, 2012804A00, 2012804A01, 2012804B00, 2012804B01, 2012804B02, 2012804B03, 2012804B04, 2012804B05, 2012804B06, 2012804B07, 2012804C00, 2012804C01... (Other models you can see in the webshop) | | |
|--------------------|--|--|--|

spare parts for 541544



| | | | | |
|---|---|--------|-----------------|---|
|  | GEV No. | 540229 | Ref. No. | — |
| | star handle shaft 9x9mm ø 80mm L 23mm black thermoplastic | | | |



| 10.72 | | | |
|---|---|-----------------|--------|
|  Image not available 1 | | | |
| GEV No. | 693503 | Ref. No. | 207170 |
| description | lid hinge type 6910.72 level of centre of rotation 35mm load capacity 10-20NM opening angle 80° closing angle 10° mounting distance 198mm bore ø 11mm MT lid M8mm chrome-plated brass L 270mm | | |
| For models: | 14228022-0, 14228033-0, 2012802-00, 2012802-01, 2012802A00, 2012802A01, 2012803-00, 2012803-01, 2012803A00, 2012803A01, 2022802-00, 2022802-01, 2022802-02, 2022802-03, 20228022-0, 20228022-1, 2022802A00, 2022802A01, 2022802A02, 2022802A03, 2022803-00, 2022803-01, 2022803-02, 2022803-03, 20228033-0, 20228033-1, 2022803A00, 2022803A01, 2022803A02, 2022803A03, 2062802-00, 2062802-01, 2062802-02, 2062802-03, 2062802-04, 2062802-05, 2062802-06, 2062802A00, 2062802A01, 2062802A02, 2062802A03, 2062802A04, 2062802A05, 2062802A06, 2062803-00, 2062803-01, 2062803-02, 2062803-03, 2062803-04, 2062803-05... (Other models you can see in the webshop) | | |

| 10.73 | | | |
|---|---|-----------------|-----------------|
|  Image not available 1 | | | |
| GEV No. | 693504 | Ref. No. | 207171 |
| description | lid hinge type 6910.73 level of centre of rotation 35mm load capacity 20-30NM opening angle 80° closing angle 10° mounting distance 198mm bore ø 11mm MT lid M8mm chrome-plated brass L 270mm | | |
| For models: | 14228044-0, 14228055-0, 2012804-00, 2012804-01, 2012804A00, 2012804A01, 2022804-00, 2022804-01, 2022804-02, 2022804-03, 20228044-0, 20228044-1, 2022804A00, 2022804A01, 2022804A02, 2022804A03, 2022805-00, 2022805-01, 20228055-0, 20228055-1, 2022805A00, 2022805A01, 2062804-00, 2062804-01, 2062804-02, 2062804-03, 2062804-04, 2062804-05, 2062804-06, 20628044-0, 20628044-1, 20628044-2, 2062804A00, 2062804A01, 2062804A02, 2062804A03, 2062804A04, 2062804A05, 2062804A06, 3012804-00, 3012804-01, 3012804A00, 3012804A01, 3012805-00, 3012805-01, 3012805A00, 3012805A01, 3022804-00, 3022804-01, 3022804-02... (Other models you can see in the webshop) | | |
| spare parts for | 693504 | | |
| | GEV No. | 691612 | Ref. No. |
| |  repair kit for lid hinge load capacity 20-30NM | | |

| 12 series | | | |
|---|---|--------|-----------------|
| 12.84 | | | |
|  1 | | | |
| | GEV No. | 693505 | Ref. No. |
| | | | 207160 |
| description | lid hinge type 1284 level of centre of rotation 35mm load capacity 10-20NM opening angle 80° closing angle 10° mounting distance 198mm bore ø 11mm MD lid 90mm 26.5 MT lid M8mm chrome-plated brass | | |
| For models: | 14228011-0, 14228022-0, 1422802B04, 1422802B05, 1422802B06, 1462802B00, 1462802B01, 1462802B02, 1462802B03, 1462802B04, 1462802B05, 2012801B00, 2012801B01, 2012801C00, 2012801C01, 2012802B00, 2012802B01, 2012802B02, 2012802B03, 2012802B04, 2012802C00, 2012802C01, 2021407-00, 2021407-01, 2021407-02, 2021407-03, 2021407A02, 2021407A03, 2021408-00, 2021408-01, 2021408-02, 2021408A02, 2021417-00, 2021436-00, 2021436-01, 2021436-02, 2021436-03, 2021436A01, 2021436A02, 2021436A03, 2021437-01, 2021437-02, 2021437A00, 2021437A01, 2022801B00, 2022801B01, 2022801B02, 2022801B03, 2022801C00, 2022801C01... (Other models you can see in the webshop) | | |

| | | | |
|---|---|--------|-----------------|
|  1 | | | |
| | GEV No. | 693506 | Ref. No. |
| | | | 207180 |
| description | lid hinge type 1284 level of centre of rotation 35mm load capacity 20-30NM opening angle 80° closing angle 10° mounting distance 198mm bore ø 11mm MD lid 90mm 26.5 MT lid M8mm chrome-plated brass | | |
| For models: | 1422705-00, 1422705-01, 1422705-02, 1422706-00, 1422706-01, 1422706-02, 1422707-00, 1422707-01, 1422707-02, 1422708-00, 1422708-01, 1422708-02, 1422804B04, 1422804B05, 1422804B06, 1422805B05, 1422805B06, 1462804B00, 1462804B01, 1462804B02, 1462804B03, 1462804B04, 1462804B05, 2012803B00, 2012803B01, 2012803C00, 2012803C01, 2012804B02, 2012804B03, 2012804B04, 2012805B02, 2012805B03, 2012805B04, 2012806B00, 2012806C00, 2013003B01, 2013003B02, 2013003B03, 2013003B04, 2013003B05, 2013003B06, 2013004B01, 2013004B02, 2013004B03, 2013004B04, 2013004B05, 2021401-09, 2021401A09, 2021402-08, 2021402A08... (Other models you can see in the webshop) | | |
| spare parts for | 693506 | | |
| | GEV No. | 691612 | Ref. No. |
| |  repair kit for lid hinge load capacity 20-30NM | | |

| | | | |
|--------------------|---|-----------------|--------|
| GEV No. | 693507 | Ref. No. | 207174 |
| description | lid hinge type 1284 level of centre of rotation 35mm load capacity 30-50NM opening angle 80° closing angle 10° mounting distance 198mm bore ø 11mm MD lid 90mm 26.5 MT lid M8mm chrome-plated brass | | |
| For models: | 1422701-00, 1422701-01, 1422701-02, 1422701-03, 1422702-00, 1422702-01, 1422702-02, 1422702-03, 1422703-00, 1422703-01, 1422703-02, 1422704-00, 1422704-01, 1422704-02, 14228033-0, 14228044-0, 14228055-0, 1422805B04, 1422807B00, 1422807B01, 1422807B02, 1422807B03, 1422807B04, 1422902-00, 1422902-01, 1422902-02, 1422902-03, 1422902-04, 2012804B00, 2012804B01, 2012804C00, 2012804C01, 2012805-00, 2012805-01, 2012805A00, 2012805A01, 2012805B00, 2012805B01, 2012805C00, 2012805C01, 2012807B00, 2012807B01, 2012807B02, 2012807B03, 2012807B04, 2012807C00, 2012815-00, 2012815-01, 2012901B00, 2012901C00... (Other models you can see in the webshop) | | |

| | | | |
|---|---|-----------------|-------------------|
| GEV No. | 693508 | Ref. No. | 207015 |
| description | lid hinge type 1284 level of centre of rotation 35mm load capacity 50-60NM opening angle 80° closing angle 10° mounting distance 198mm bore ø 11mm MD lid 90mm 26.5 MT lid M8mm chrome-plated brass | | |
| For models: | 2012903-01, 2012903-02, 2012903-03, 2012903-04, 2012909-00, 2012909-01, 2012909-02, 2021401B00, 2021401B01, 2021401B02, 2021401B03, 2021401B04, 2021401B06, 2021401B07, 2021401B08, 2021401B09, 2021401C00, 2021401C01, 2021401C02, 2021401C03, 2021401C04, 2021401C06, 2021401C07, 2021401C08, 2021401C09, 2021402B00, 2021402B01, 2021402B02, 2021402B03, 2021402B04, 2021402B06, 2021402B07, 2021402B08, 2021402C00, 2021402C01, 2021402C02, 2021402C03, 2021402C04, 2021402C06, 2021402C07, 2021402C08, 2021403B04, 2021403B05, 2021403B06, 2021403C04, 2021403C05, 2021403C06, 2021404B04, 2021404B05, 2021404B06... (Other models you can see in the webshop) | | |
| spare parts for | 693508 | | |
|  | GEV No. | 691614 | Ref. No. — |
| repair kit for lid hinge load capacity 50-60NM | | | |

drain taps

accessories

| | | | |
|--------------------|---|-----------------|--------|
| GEV No. | 541531 | Ref. No. | 211125 |
| description | repair kit for drain tap 1½" 4x O-ring + fitting grease | | |
| For models: | 1422802B06, 1422802B07, 1422802B08, 1422804B06, 1422804B07, 1422804B08, 1422805B06, 1422805B07, 1422805B08, 1422807B03, 1422807B04, 1422902-03, 1422902-04, 1462802B03, 1462804B03, 2012802B05, 2012802B06, 2012802B07, 2012804B05, 2012804B06, 2012804B07, 2012805B05, 2012805B06, 2012805B07, 2012807B03, 2012807B04, 2012812-00, 2012812-01, 2012812-02, 2012813-00, 2012813-01, 2012813-02, 2012813-03, 2012814-00, 2012814-01, 2012814-02, 2012814-03, 2012815-00, 2012902-02, 2012902-03, 2012903-01, 2012903-02, 2012903-03, 2012907-00, 2012907-01, 2012907-02, 2012909-01, 2013003B04, 2013003B05, 2013003B06... (Other models you can see in the webshop) | | |

| | | | |
|--------------------|---|-----------------|--------|
| GEV No. | 541532 | Ref. No. | 211126 |
| description | repair kit for drain tap 2" 4x O-ring + fitting grease | | |
| For models: | 1422701-02, 1422701-03, 1422702-02, 1422702-03, 1422703-01, 1422703-02, 1422704-01, 1422704-02, 1422705-01, 1422705-02, 1422706-01, 1422706-02, 1422707-01, 1422707-02, 1422708-01, 1422708-02, 1423901-00, 1423901-01, 1423901-02, 1423902-00, 1423902-01, 1423902-02, 1423903-00, 1423903-01, 1423903-02, 1424101-01, 1424102-01, 1424103-00, 1424104-00, 2012903-04, 2012909-02, 2013901-00, 2013901-01, 2013901-02, 2013901-03, 2013902-00, 2013902-01, 2013902-02, 2013902-03, 2013903-00, 2013903-01, 2013903-02, 2013903-03, 2022701-03, 2022701-04, 2022703-03, 2022703-04, 2022705-03, 2022705-04, 2022707-03... (Other models you can see in the webshop) | | |



steam traps

steam traps

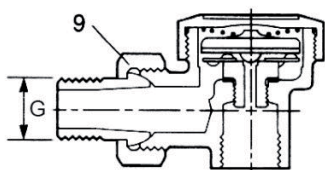

1

| | | | |
|--------------------|--|-----------------|--------|
| GEV No. | 540243 | Ref. No. | 201734 |
| description | thermostatic steam trap thread 1/2" type BPT13UA brass | | |
| For models: | 1412831-00, 1412832-00, 1412833-00, 1412833-01, 1412834-00, 1412834-01, 1412908-00, 1412910-00, 1412910-01, 1422802B04, 1422802B05, 1422802B06, 1422802B07, 1422802B08, 1422804B04, 1422804B05, 1422804B06, 1422804B07, 1422804B08, 1422805B04, 1422805B05, 1422805B06, 1422805B07, 1422805B08, 1422807B00, 1422807B01, 1422807B02, 1422807B03, 1422807B04, 1422831-00, 1422832-00, 1422833-00, 1422834-00, 1422902-00, 1422902-01, 1422902-02, 1422902-03, 1422902-04, 1422908-00, 1422910-00, 1423901-00, 1423901-01, 1423901-02, 1423902-00, 1423902-01, 1423902-02, 1423903-00, 1423903-01, 1423903-02, 1462802B00... (Other models you can see in the webshop) | | |

test taps

test taps

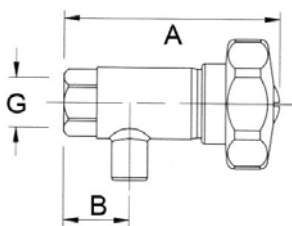

1

| | | | |
|--------------------|--|-----------------|--------|
| GEV No. | 514277 | Ref. No. | 201051 |
| description | test tap thread 3/8" IT W 70mm W1 25mm | | |
| For models: | 14228011-0, 14228022-0, 14228033-0, 14228044-0, 14228055-0, 2022801-00, 2022801-01, 20228011-0, 20228011-1, 2022801A00, 2022801A01, 2022801B00, 2022801B01, 2022801C00, 2022801C01, 2022802-00, 2022802-01, 20228022-0, 20228022-1, 2022802A00, 2022802A01, 2022802B00, 2022802B01, 2022802C00, 2022802C01, 2022803-00, 2022803-01, 20228033-0, 20228033-1, 2022803A00, 2022803A01, 2022803B00, 2022803B01, 2022803C00, 2022803C01, 2022804-00, 2022804-01, 20228044-0, 20228044-1, 2022804A00, 2022804A01, 2022804B00, 2022804B01, 2022804C00, 2022804C01, 2022805-00, 2022805-01, 20228055-0, 20228055-1, 2022805A00... (Other models you can see in the webshop) | | |

safety fittings

safety fittings



1

| | | | | |
|------------------------|---|-----------------|-----------------|--------|
| GEV No. | 514328 | Ref. No. | 201050 | |
| description | safety fitting thread 1" 0.4bar 130kg/h thread size manometer 1/4"-1/2" chrome-plated H 200mm W 180mm | | | |
| spare parts for | 514328 | | | |
| | GEV No. | 540320 | Ref. No. | — |
| | ball handle thread M5 ø 20mm with metal bush | | | |
| | GEV No. | 540322 | Ref. No. | — |
| | ball handle thread M8 ø 32mm with metal bush | | | |
| | GEV No. | 540926 | Ref. No. | — |
| | filling funnel thread 3/8" for safety fitting | | | |
| | GEV No. | 540949 | Ref. No. | 201091 |
| | aerator and air bleeder thread 1/2" ET chrome-plated with O-ring L 15mm ø 25mm | | | |
| accessories for | 514328 | | | |
| | GEV No. | 541062 | Ref. No. | 201105 |
| | manometer ø 63mm pressure range 0 up to 1bar connection marking adjustable kettle thread 1/4" | | | |

safety valves



1

| | | | |
|--------------------|--|-----------------|--------|
| GEV No. | 541436 | Ref. No. | 201044 |
| description | safety valve thread 3/4" | | |
| For models: | 14228011-0, 14228022-0, 14228033-0, 14228044-0, 14228055-0, 2012801-00, 2012801-01, 2012801A00, 2012801A01, 2012801B00, 2012801B01, 2012801C00, 2012801C01, 2012802-00, 2012802-01, 2012802A00, 2012802A01, 2012802B00, 2012802B01, 2012802C00, 2012802C01, 2012803-00, 2012803-01, 2012803A00, 2012803A01, 2012803B00, 2012803B01, 2012803C00, 2012803C01, 2012804-00, 2012804-01, 2012804A00, 2012804A01, 2012804B00, 2012804B01, 2012804C00, 2012804C01, 2012805-00, 2012805-01, 2012805A00, 2012805A01, 2012805B00, 2012805B01, 2012805C00, 2012805C01, 2012806B00, 2012806C00, 2012807B00, 2012807C00, 2012901B00... (Other models you can see in the webshop) | | |



| | | | |
|--------------------|--|-----------------|--------|
| GEV No. | 518668 | Ref. No. | 211124 |
| description | gasket set EPDM ID ø 24/38/52/63mm for safety valve | | |
| For models: | 1423901-00, 1423901-01, 1423901-02, 1423902-00, 1423902-01, 1423902-02, 1423903-00, 1423903-01, 1423903-02, 1424101-01, 1424102-01, 1424103-00, 1424104-00, 2013901-00, 2013901-01, 2013901-02, 2013901-03, 2013902-00, 2013902-01, 2013902-02, 2013902-03, 2013903-00, 2013903-01, 2013903-02, 2013903-03, 2023901-00, 2023901-01, 2023901-02, 2023901-03, 2023902-00, 2023902-01, 2023902-02, 2023903-00, 2023903-01, 2023903-02, 2024101-01, 2024102-01, 2024103-01, 2024104-01, 2024201-04, 2024202-01, 2024203-04, 2024204-01, 2024205-01, 2024206-00, 2024207-01, 2024208-00, 3023901-03, 3023902-00, 3023902-01... (Other models you can see in the webshop) | | |

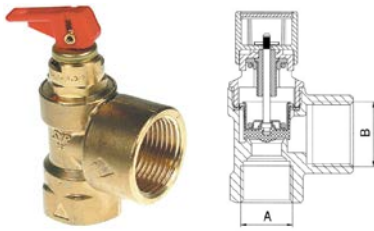

| | | | |
|--------------------|--|-----------------|--------|
| GEV No. | 541431 | Ref. No. | 201730 |
| description | safety valve T1: 3/4" T2: 1" triggering pressure 1bar | | |
| For models: | 1412831-00, 1412832-00, 1412833-00, 1412833-01, 1412834-00, 1412834-01, 1412908-00, 1412910-00, 1412910-01, 1422802B04, 1422802B05, 1422802B06, 1422802B07, 1422802B08, 1422804B04, 1422804B05, 1422804B06, 1422804B07, 1422804B08, 1422805B04, 1422805B05, 1422805B06, 1422805B07, 1422805B08, 1422807B00, 1422807B01, 1422807B02, 1422807B03, 1422807B04, 1422831-00, 1422832-00, 1422833-00, 1422834-00, 1422902-00, 1422902-01, 1422902-02, 1422902-03, 1422902-04, 1422908-00, 1422910-00, 1462802B00, 1462802B01, 1462802B02, 1462802B03, 1462802B04, 1462802B05, 1462804B00, 1462804B01, 1462804B02, 1462804B03... (Other models you can see in the webshop) | | |

baskets

fryer baskets

| | | | |
|--------------------|---|-----------------|--------|
| MKN | | | |
| GEV No. | 970735 | Ref. No. | 206008 |
| description | fryer basket W1 135mm L1 176mm H1 114mm L2 375mm H3 180mm chrome-plated steel | | |
| For models: | 0520302-00, 0520302-01, 0520302-02, 0520302A00, 0520302A01 | | |

| | | | |
|--------------------|--|-----------------|--------|
| GEV No. | 970152 | Ref. No. | 206129 |
| description | fryer basket W1 160mm L1 310mm H1 115mm chrome-plated steel | | |
| For models: | 0220301-00, 0220301B00, 0220301B01, 0220301B02, 0220301D00, 0220302-00, 0220302A00, 0220302A01, 0220302A02, 0220302A03, 0220302B00, 0220302B01, 0220302B02, 0220302C00, 0220302C01, 0220302C02, 0220302C03, 0220302D00, 0220302E00, 0220302E01, 0220302F00, 0220302H00, 0220302H01, 0220303-00, 0220303-01, 0220303A00, 0220303A01, 0220303A02, 0220303A03, 0220303B00, 0220303B01, 0220303C00, 0220303C01, 0220303C02, 0220303D00, 0220303D01, 0220303E00, 0220303E01, 0220303H00, 0220303H01, 0220304-00, 0220305-00, 0220306-00, 0260301-00, 0260301-01, 0260302-00, 0260302-01, 0720325-03, 0720325-04, 0720325B03... (Other models you can see in the webshop) | | |

| | | | |
|--------------------|---|-----------------|--------|
| GEV No. | 970293 | Ref. No. | 206000 |
| description | fryer basket W1 205mm L1 240mm H1 110mm | | |
| For models: | 1820301-00, 1820301-01, 1820301-02 | | |

| | | | |
|--------------------|--|-----------------|--------|
| GEV No. | 970464 | Ref. No. | 206130 |
| description | fryer basket W1 343mm L1 368mm H1 114mm L2 392mm H2 133mm H3 243mm chrome-plated steel gas fryer | | |
| For models: | 0260302-00, 0260302-01, 1260302-00, 1260302-01, 1460302-00, 1460302-01, 1460302-02, 2060301-00, 2060301-01, 2060301-02 | | |

equipment feet and end caps

equipment feet

with screw mounting

universal



| | | | |
|--------------------|--|-----------------|--------|
| GEV No. | 701646 | Ref. No. | 204561 |
| description | equipment foot tube ø 64mm thread M10x1.5 thread L 17mm H 100-135mm SS Qty 1 pcs | | |
| For models: | CGE11-L, CGE11-R, CGE12-L, CGE12-R, CGE61-L, CGE61-R, CGE62-L, CGE62-R, CGG11-L, CGG11-R, CGG12-L, CGG12-R, CGG61-L, CGG61-R, CGG62-L, CGG62-R, CSE11-L, CSE11-R, CSE11-R-DG, CSE12-L, CSE12-R, CSE12-R-DG, CSE61-L, CSE61-R, CSE61-R-DG, CSE62-L, CSE62-R, CSE62-R-DG, CSG11-L, CSG11-R, CSG11-R-DG, CSG12-L, CSG12-R, CSG12-R-DG, CSG61-L, CSG61-R, CSG61-R-DG, CSG62-L, CSG62-R, CSG62-R-DG | | |

| | |
|---|---|
|  | |
| GEV No. | 970414 |
| Ref. No. | 206020 |
| description | fryer basket W1 380mm L1 345mm H1 100mm H2 130mm H3 230mm chrome-plated steel electric fryer |
| For models: | 0220303-00, 0220303-01, 0220303A00, 0220303A01, 0220303A02, 0220303A03, 0220303B00, 0220303B01, 0220303C00, 0220303C01, 0220303C02, 0220303D00, 0220303D01, 0220303E00, 0220303E01, 0220303H00, 0220303H01, 0220306-00, 1220305-00, 1220305-01, 1220305-02, 1220305-03, 1220305-04, 1220305-05, 1220305-06, 1220305-07, 1220305A00, 1220305A01, 1220305A02, 1220305A03, 1220305A04, 1220305A05, 1220305B00, 1220305B01, 1220305B02, 1220305B03, 1220305B04, 1220305B05, 1220305B06, 1220305B07, 1220305C00, 1220305C01, 1220305C02, 1220305C03, 1220305C04, 1220305C05, 1220305D00, 1220305D01, 1220305D02, 1220305D03... (Other models you can see in the webshop) |

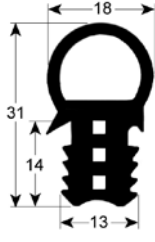
| | |
|---|--|
|  | |
| GEV No. | 902213 |
| Ref. No. | 10012490 |
| description | door seal profile 2064 W 600mm L 740mm outer plug size |
| For models: | CGE11-L, CGE11-R, CGE12-L, CGE12-R, CGG11-L, CGG11-R, CGG12-L, CGG12-R, CSE11-L, CSE11-R, CSE11-R-DG, CSE12-L, CSE12-R, CSE12-R-DG, CSG11-L, CSG11-R, CSG11-R-DG, CSG12-L, CSG12-R, CSG12-R-DG |

gaskets

gaskets for heated units

door seals

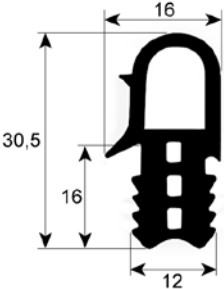
| | |
|--|---|
|  | |
| GEV No. | 901456 |
| Ref. No. | 211112 |
| description | door seal profile 2063 perimeter 1540mm Qty 1 |
| For models: | CCE60, CCE63, CPE60, CPE63 |

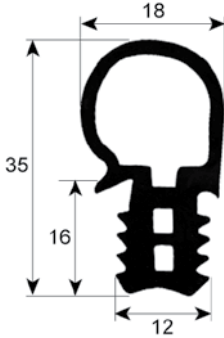
| | |
|--|--|
|  | |
| GEV No. | 900793 |
| Ref. No. | 211096 |
| description | door seal profile 2065 W 605mm L 1480mm external size Qty 1 |
| For models: | CGE21-L, CGE21-R, CGE22-L, CGE22-R, CGG21-L, CGG21-R, CGG22-L, CGG22-R, CSE21-L, CSE21-R, CSE21-R-DG, CSE22-L, CSE22-R, CSE22-R-DG, CSG21-L, CSG21-R, CSG21-R-DG, CSG22-L, CSG22-R, CSG22-R-DG |

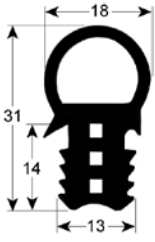
| | |
|---|--|
|  | |
| GEV No. | 902501 |
| Ref. No. | 10012489 |
| description | door seal profile 2064 W 472mm L 600mm outer plug size suitable for MKN |
| For models: | CGE61-L, CGE61-R, CGE62-L, CGE62-R, CGG61-L, CGG61-R, CGG62-L, CGG62-R, CSE61-L, CSE61-R, CSE61-R-DG, CSE62-L, CSE62-R, CSE62-R-DG, CSG61-L, CSG61-R, CSG61-R-DG, CSG62-L, CSG62-R, CSG62-R-DG |

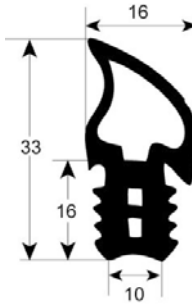
| | |
|--|--|
|  | |
| GEV No. | 900783 |
| Ref. No. | 211094 |
| description | door seal profile 2743 W 480mm L 610mm external size Qty 1 |
| For models: | CGE61-L, CGE61-R, CGE62-L, CGE62-R, CGG61-L, CGG61-R, CGG62-L, CGG62-R, CSE61-L, CSE61-R, CSE61-R-DG, CSE62-L, CSE62-R, CSE62-R-DG, CSG61-L, CSG61-R, CSG61-R-DG, CSG62-L, CSG62-R, CSG62-R-DG |

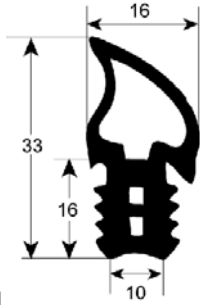

| | | | |
|--------------------|--|-----------------|--------|
| GEV No. | 900784 | Ref. No. | 211095 |
| description | door seal profile 2743 W 610mm L 750mm external size Qty 1 | | |
| For models: | CGE11-L, CGE11-R, CGE12-L, CGE12-R, CGG11-L, CGG11-R, CGG12-L, CGG12-R, CSE11-L, CSE11-R, CSE11-R-DG, CSE12-L, CSE12-R, CSE12-R-DG, CSG11-L, CSG11-R, CSG11-R-DG, CSG12-L, CSG12-R, CSG12-R-DG | | |

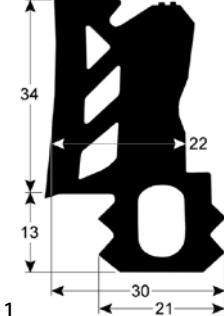

| | | | |
|--------------------|--|-----------------|--------|
| GEV No. | 902499 | Ref. No. | 211171 |
| description | tray rack trolley gasket profile 4120 L 630mm Qty 1 | | |
| For models: | CGE21-L, CGE21-R, CGE22-L, CGE22-R, CGG21-L, CGG21-R, CGG22-L, CGG22-R, CSE21-L, CSE21-R, CSE22-L, CSE22-R, CSG21-L, CSG21-R, CSG22-L, CSG22-R | | |

door seals with fixing hook



| | | | |
|--------------------|---|-----------------|--------|
| GEV No. | 900512 | Ref. No. | 211063 |
| description | door seal L 525mm W 270mm 3-sided long side open with 5 mounting clips | | |
| For models: | 0522101-04, 0522102-04, 0722101-06, 1323208-04, 1323210-03, 1323210-04, 1323403-00, 1323403K00, 1323506-00, 1323506-01, 1323506A00, 1323506A01, 1323517-00, 1323517A00, 1363403-03, 1363403-04, 1363403-05, 1363415-05, 1422101-04, 1422101-05, 1422101-06, 1422102-04, 1422102-05, 1422301-01, 2023114-00, 2023118-00, 2023119-00, 2023203-07, 2023205-07, 2023207-03, 2023207-04, 2023207-05, 2023406-00, 2023503-10, 2023503-11, 2023503-12, 2023503-13, 2023503A10, 2023503A11, 2023503A12, 2023503A13, 2063403-08, 2063403-09, 2063403-10, 2063406-08, 2063406-09, 2063406-10, 2063415-05, 2063418-05, 2063502-08... (Other models you can see in the webshop) | | |

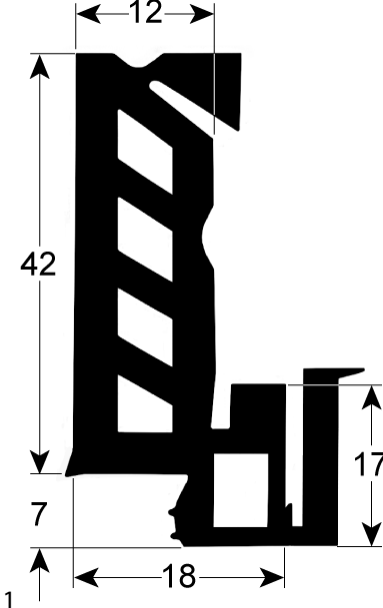

| | | | |
|--------------------|---|-----------------|--------|
| GEV No. | 902500 | Ref. No. | 211156 |
| description | tray rack trolley gasket profile 4130 L 654mm Qty 1 | | |
| For models: | CSE21-R-DG, CSE22-R-DG, CSG21-R-DG, CSG22-R-DG | | |

gaskets for tray rack trolleys



| | | | |
|--------------------|--|-----------------|--------|
| GEV No. | 901157 | Ref. No. | 211104 |
| description | tray rack trolley gasket profile 4075 L 645mm | | |
| For models: | CGE21-L, CGE21-R, CGE22-L, CGE22-R, CGG21-L, CGG21-R, CGG22-L, CGG22-R, CSE21-L, CSE21-R, CSE22-L, CSE22-R, CSG21-L, CSG21-R, CSG22-L, CSG22-R | | |

gaskets for control panels



| | | | |
|--------------------|--|-----------------|--------|
| GEV No. | 902484 | Ref. No. | 211089 |
| description | gasket for control panel W 220mm L 1420mm suitable for MKN combi-steamer with 10 mounting clips model HD20.x | | |
| For models: | CGE21-L, CGE21-R, CGE22-L, CGE22-R, CGG21-L, CGG21-R, CGG22-L, CGG22-R, CSE21-L, CSE21-R, CSE21-R-DG, CSE22-L, CSE22-R, CSE22-R-DG, CSG21-L, CSG21-R, CSG21-R-DG, CSG22-L, CSG22-R, CSG22-R-DG | | |



| | | | |
|--------------------|--|-----------------|--------|
| GEV No. | 902447 | Ref. No. | 211087 |
| description | gasket for cover L 1580mm suitable for MKN for combi-steamer with 6 mounting clips | | |
| For models: | CGE61-L, CGE61-R, CGE62-L, CGE62-R, CGG61-L, CGG61-R, CGG62-L, CGG62-R, CSE61-L, CSE61-R, CSE61-R-DG, CSE62-L, CSE62-R, CSE62-R-DG, CSG61-L, CSG61-R, CSG61-R-DG, CSG62-L, CSG62-R, CSG62-R-DG | | |



| | | | |
|--------------------|--|-----------------|--------|
| GEV No. | 902448 | Ref. No. | 211088 |
| description | gasket for cover L 2040mm suitable for MKN for combi-steamer with 6 mounting clips | | |
| For models: | CGE11-L, CGE11-R, CGE12-L, CGE12-R, CGG11-L, CGG11-R, CGG12-L, CGG12-R, CSE11-L, CSE11-R, CSE11-R-DG, CSE12-L, CSE12-R, CSE12-R-DG, CSG11-L, CSG11-R, CSG11-R-DG, CSG12-L, CSG12-R, CSG12-R-DG | | |

miscellaneous

miscellaneous

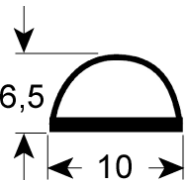

| | | | |
|--------------------|--|-----------------|--------|
| GEV No. | 902485 | Ref. No. | 211090 |
| description | lid gasket profile 10x6.5 L 1075mm combi-steamer self-adhesive mounting pos. casing cover suitable for MKN | | |
| For models: | CGE11-L, CGE11-R, CGE12-L, CGE12-R, CGE21-L, CGE21-R, CGE22-L, CGE22-R, CGE61-L, CGE61-R, CGE62-L, CGE62-R, CGG11-L, CGG11-R, CGG12-L, CGG12-R, CGG21-L, CGG21-R, CGG22-L, CGG22-R, CGG61-L, CGG61-R, CGG62-L, CGG62-R, CSE11-L, CSE11-R, CSE11-R-DG, CSE12-L, CSE12-R, CSE12-R-DG, CSE21-L, CSE21-R, CSE21-R-DG, CSE22-L, CSE22-R, CSE22-R-DG, CSE61-L, CSE61-R, CSE61-R-DG, CSE62-L, CSE62-R, CSE62-R-DG, CSG11-L, CSG11-R, CSG11-R-DG, CSG12-L, CSG12-R, CSG12-R-DG, CSG21-L, CSG21-R...(Other models you can see in the webshop) | | |

lid gaskets

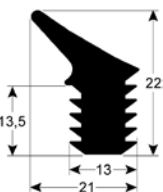

| | | | |
|--------------------|---|-----------------|----------|
| GEV No. | 902503 | Ref. No. | 10011826 |
| description | gasket for lid profile 2719 W 685mm L 1098mm outer plug size suitable for MKN Qty 1 | | |

O-rings

EPDM

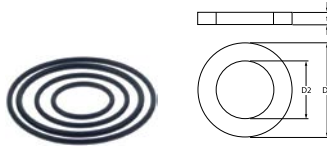

| | | | |
|--------------------|---|-----------------|--------|
| GEV No. | 518668 | Ref. No. | 211124 |
| description | gasket set EPDM ID \varnothing 24/38/52/63mm for safety valve | | |
| For models: | 1423901-00, 1423901-01, 1423901-02, 1423902-00, 1423902-01, 1423902-02, 1423903-00, 1423903-01, 1423903-02, 1424101-01, 1424102-01, 1424103-00, 1424104-00, 2013901-00, 2013901-01, 2013901-02, 2013901-03, 2013902-00, 2013902-01, 2013902-02, 2013902-03, 2013903-00, 2013903-01, 2013903-02, 2013903-03, 2023901-00, 2023901-01, 2023901-02, 2023901-03, 2023902-00, 2023902-01, 2023902-02, 2023903-00, 2023903-01, 2023903-02, 2024101-01, 2024102-01, 2024103-01, 2024104-01, 2024201-04, 2024202-01, 2024203-04, 2024204-01, 2024205-01, 2024206-00, 2024207-01, 2024208-00, 3023901-03, 3023902-00, 3023902-01... (Other models you can see in the webshop) | | |

Viton

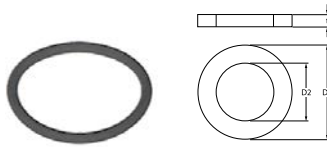

| | | | |
|--------------------|---|-----------------|--------|
| GEV No. | 104212 | Ref. No. | 211018 |
| description | O-ring Viton thickness 3mm ID \varnothing 32.5mm Qty 1 pcs | | |
| For models: | 0263401-00, 0263401-01, 1220501-00, 1220501-01, 1220501-02, 1220502-00, 1220502-01, 1220802-00, 1220802-01, 1222507-00, 1222509-00, 1263401-00, 1263402-00, 1263402-01, 1263402-02, 1263404-00, 1263404-01, 1263404-02, 1263413-02, 1263414-02, 1320501-00, 1320502-00, 1320802-00, 1322507-00, 1322509-00, 1363401-00, 1363402-00, 1363402-01, 1363402-02, 1363403-00, 1363403-01, 1363403-02, 1363403-03, 1363403-04, 1363403-05, 1363404-00, 1363404-01, 1363404-02, 1363404-03, 1363413-03, 1363415-05, 1422513B00, 1422513B01, 1422515B01, 1422515B02, 1422701-00, 1422701-01, 1422701-02, 1422701-03, 1422702-00... (Other models you can see in the webshop) | | |



| | | | |
|--------------------|--|-----------------|--------|
| GEV No. | 532733 | Ref. No. | 211086 |
| description | O-ring Viton thickness 5mm ID \varnothing 65mm Qty 1 pcs | | |
| For models: | CGE11-L, CGE11-R, CGE12-L, CGE12-R, CGE21-L, CGE21-R, CGE22-L, CGE22-R, CGE61-L, CGE61-R, CGE62-L, CGE62-R, CGG11-L, CGG11-R, CGG12-L, CGG12-R, CGG21-L, CGG21-R, CGG22-L, CGG22-R, CGG61-L, CGG61-R, CGG62-L, CGG62-R, CSE11-L, CSE11-R, CSE11-R-DG, CSE12-L, CSE12-R, CSE12-R-DG, CSE21-L, CSE21-R, CSE21-R-DG, CSE22-L, CSE22-R, CSE22-R-DG, CSE61-L, CSE61-R, CSE61-R-DG, CSE62-L, CSE62-R, CSE62-R-DG, CSG11-L, CSG11-R, CSG11-R-DG, CSG12-L, CSG12-R, CSG21-L, CSG21-R, CSG21-R-DG...(Other models you can see in the webshop) | | |

miscellaneous

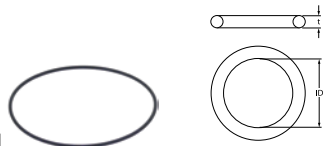

| | | | |
|--------------------|---|-----------------|----------|
| GEV No. | 519627 | Ref. No. | 10010994 |
| description | O-ring thickness 1.5mm ID ø 56mm Qty 1 pcs suitable for MKN | | |



| | | | |
|--------------------|---|-----------------|----------|
| GEV No. | 519628 | Ref. No. | 10014116 |
| description | O-ring thickness 3.5mm ID ø 45mm Qty 1 pcs suitable for MKN | | |

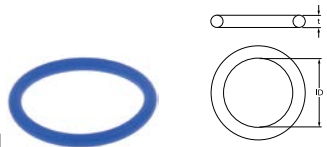

| | | | |
|--------------------|---|-----------------|--------|
| GEV No. | 532734 | Ref. No. | 211116 |
| description | O-ring thickness 5mm ID ø 45mm for outflow plug blue | | |
| For models: | 1222507-00, 1222509-00, 1322507-00, 1322509-00, 1422513B00, 1422513B01, 1422515B01, 1422515B02, 1422701-02, 1422701-03, 1422702-02, 1422702-03, 1422703-01, 1422703-02, 1422704-01, 1422704-02, 1422705-01, 1422705-02, 1422706-01, 1422706-02, 1422707-01, 1422707-02, 1422708-01, 1422708-02, 1424101-01, 1424102-01, 1424103-00, 1424104-00, 1522507-00, 1522507-01, 1522509-00, 1522509-01, 2022509-00, 2022513-00, 2022701-02, 2022701-03, 2022701-04, 2022703-01, 2022703-03, 2022703-04, 2022705-02, 2022705-03, 2022705-04, 2022707-01, 2022707-03, 2022707-04, 2024101-01, 2024102-01, 2024103-01, 2024104-01... (Other models you can see in the webshop) | | |

sealing washers

aluminium gaskets



| | | | |
|--------------------|---|-----------------|--------|
| GEV No. | 560307 | Ref. No. | 214006 |
| description | flat gasket aluminium ED ø 21mm ID ø 17mm thickness 1.5mm Qty 1 pcs | | |
| For models: | 2013003B04, 2013003B05, 2013003B06, 2013007B04, 2013007B05, 2013007B06, 2013009B04, 2013009B05, 2013009B06, 2013017B03, 2013017B04, 2013017B05, 2021401-09, 2021401A09, 2021401B09, 2021401C09, 2021407-03, 2021407A03, 2021407B03, 2021407C03, 2021409-02, 2021409B02, 2021430-01, 2021430-02, 2021430A01, 2021430A02, 2021430B02, 2021430B03, 2021430C02, 2021430C03, 2021436-02, 2021436-03, 2021436A02, 2021436A03, 2021436B02, 2021436B03, 2021436C02, 2021436C03, 2021440-04, 2021440-05, 2021440A04, 2021440A05, 2021440B04, 2021440B05, 2021440C04, 2021440C05, 2021441-04, 2021441-05, 2021441-06, 2021441-07... (Other models you can see in the webshop) | | |

fibre gaskets



| | | | |
|--------------------|---|-----------------|--------|
| GEV No. | 540071 | Ref. No. | 214001 |
| description | flat gasket FIBER ED ø 18mm ID ø 10mm thickness 2mm Qty 1 pcs | | |
| For models: | 1423901-00, 1423901-01, 1423901-02, 1423902-00, 1423902-01, 1423902-02, 1423903-00, 1423903-01, 1423903-02, 1424101-00, 1424101-01, 1424102-00, 1424102-01, 1424103-00, 1424104-00, 2013901-00, 2013901-01, 2013901-02, 2013901-03, 2013902-00, 2013902-01, 2013902-02, 2013902-03, 2013903-00, 2013903-01, 2013903-02, 2013903-03, 2020406A01, 2023901-00, 2023901-01, 2023901-02, 2023901-03, 2023902-00, 2023902-01, 2023902-02, 2023903-00, 2023903-01, 2023903-02, 2024101-00, 2024101-01, 2024102-00, 2024102-01, 2024103-00, 2024103-01, 2024104-00, 2024104-01, 2024201-00, 2024201-01, 2024201-02, 2024201-03... (Other models you can see in the webshop) | | |

graphite gaskets



| | | | |
|--------------------|--|-----------------|--------|
| GEV No. | 691609 | Ref. No. | 211143 |
| description | gasket graphite ED ø 150mm ID ø 115mm thickness 2mm Qty 1 pcs | | |
| For models: | CGG11-L, CGG11-R, CGG12-L, CGG12-R, CGG21-L, CGG21-R, CGG22-L, CGG22-R, CGG61-L, CGG61-R, CGG62-L, CGG62-R, CSG11-L, CSG11-R, CSG11-R-DG, CSG12-L, CSG12-R, CSG12-R-DG, CSG21-L, CSG21-R, CSG21-R-DG, CSG22-L, CSG22-R, CSG22-R-DG, CSG61-L, CSG61-R, CSG61-R-DG, CSG62-L, CSG62-R, CSG62-R-DG | | |

rubber gaskets



| | | | |
|--------------------|---|-----------------|--------|
| GEV No. | 512514 | Ref. No. | 211139 |
| description | flat gasket rubber ED ø 19mm ID ø 8mm thickness 2mm for combi-steamer Qty 1 pcs | | |
| For models: | CGE11-L, CGE11-R, CGE12-L, CGE12-R, CGE21-L, CGE21-R, CGE22-L, CGE22-R, CGE61-L, CGE61-R, CGE62-L, CGE62-R, CGG11-L, CGG11-R, CGG12-L, CGG12-R, CGG21-L, CGG21-R, CGG22-L, CGG22-R, CGG61-L, CGG61-R, CGG62-L, CGG62-R, CSE11-L, CSE11-R, CSE11-R-DG, CSE12-L, CSE12-R, CSE12-R-DG, CSE21-L, CSE21-R, CSE21-R-DG, CSE22-L, CSE22-R, CSE22-R-DG, CSE61-L, CSE61-R, CSE61-R-DG, CSE62-L, CSE62-R, CSE62-R-DG, CSG11-L, CSG11-R, CSG11-R-DG, CSG12-L, CSG12-R, CSG12-R-DG, CSG21-L, CSG21-R... (Other models you can see in the webshop) | | |



copper gaskets

DIN-7603-C



1

| | | | |
|--------------------|---|-----------------|--------|
| GEV No. | 528520 | Ref. No. | 211004 |
| description | gasket copper ED ø 22mm ID ø 16mm thickness 2mm | | |
| For models: | 1223212-00, 1261101-00, 1261101-01, 1261101-02, 1261102-00, 1261102-01, 1261102-02, 1361101-00, 1361101-01, 1361101-02, 1361101-03, 1361102-00, 1361102-01, 1361102-02, 1361102-03, 1461101-01, 1461101-02, 1461101-03, 1461102-01, 1461102-02, 1461102-03, 1461104-01, 1461104-02, 1461104-03, 1461105-01, 1461105-02, 1461105-03, 1461109-01, 1461109-02, 1461109A01, 1461109A02, 1462802B00, 1462804B00, 1463501-03, 1463501-04, 1463501-05, 1561110-00, 2061101-01, 2061101-02, 2061101-03, 2061101-04, 2061101-05, 2061102-01, 2061102-02, 2061102-03, 2061102-04, 2061102-05, 2061103-04, 2061107-00, 2061107-01... (Other models you can see in the webshop) | | |

PTFE gaskets



1

| | | | |
|--------------------|--|-----------------|----------|
| GEV No. | 507588 | Ref. No. | 10011097 |
| description | flat gasket PTFE ED ø 14mm ID ø 10mm thickness 1mm Qty 1 pcs suitable for | | |
| For models: | CGE11-L, CGE11-R, CGE12-L, CGE12-R, CGE21-L, CGE21-R, CGE22-L, CGE22-R, CGE61-L, CGE61-R, CGE62-L, CGE62-R, CGG11-L, CGG11-R, CGG12-L, CGG12-R, CGG21-L, CGG21-R, CGG22-L, CGG22-R, CGG61-L, CGG61-R, CGG62-L, CGG62-R, CSE11-L, CSE11-R, CSE11-R-DG, CSE12-L, CSE12-R, CSE12-R-DG, CSE61-L, CSE61-R, CSE61-R-DG, CSE62-L, CSE62-R, CSE62-R-DG, CSG11-L, CSG11-R, CSG11-R-DG, CSG12-L, CSG12-R, CSG12-R-DG, CSG21-L, CSG21-R, CSG21-R-DG, CSG22-L, CSG22-R, CSG22-R-DG, CSG61-L, CSG61-R...(Other models you can see in the webshop) | | |

sealing cords

round



1

| | | | |
|--------------------|---|-----------------|--------|
| GEV No. | 693464 | Ref. No. | 211047 |
| description | sealing cord ø 10mm Qty supplied by meter | | |
| For models: | 1424802-00, 1424802-01, 1424802-02, 1424808-01, 1424808-02, 1424808-03, 1424809-01, 1424809-02, 1424811-01, 1424811-02, 1424811-03, 1424812-01, 1424812-02, 1424813-01, 1424813-02, 2023201-01, 2023201-02, 2023201-03, 2023201A01, 2023202-01, 2023202-02, 2023202A01, 2023203-02, 2023203-03, 2023203-04, 2023203-05, 2023203-06, 2023203-07, 2023203A02, 2023203A03, 2023204-01, 2023204-02, 2023204A01, 2023205-02, 2023205-03, 2023205-04, 2023205-05, 2023205-06, 2023205-07, 2023205A02, 2023205A03, 2083201A01, 2083202A02, 2083202A03, 2123201-01, 2123201-02, 2123201-03, 2123201-04, 2123202-01, 2123202-02... (Other models you can see in the webshop) | | |



1

| | | | |
|--------------------|---|-----------------|--------|
| GEV No. | 693451 | Ref. No. | 211031 |
| description | sealing cord ø 8mm Qty supplied by meter | | |
| For models: | 1223215-00, 1223215A00, 1223216-00, 1223216A00, 1223504A00, 1223504A01, 1223505-00, 1223505-01, 1223505A00, 1223505A01, 1323504-00, 1323504-01, 1323504A00, 1323504A01, 1323505-00, 1323505-01, 1323505A00, 1323505A01, 1323506-00, 1323506-01, 1323506A00, 1323506A01, 1323515-00, 1323515A00, 1323516-00, 1323516A00, 1323517-00, 1323517A00, 1423501-00, 1423501-01, 1423501A00, 1423501A01, 1423502-00, 1423502-01, 1423502-02, 1423502A00, 1423502A01, 1423502A02, 1423504-00, 1423504-01, 1423504A00, 1423504A01, 1423505-00, 1423505-01, 1423505A00, 1423505A01, 1423507A00, 1423508A00, 1423510A00, 1423511A00... (Other models you can see in the webshop) | | |

shaft gaskets

miscellaneous



1

| | | | |
|--------------------|--|-----------------|--------|
| GEV No. | 691513 | Ref. No. | 211084 |
| description | shaft seal ID ø 16.5mm ED ø 29mm thickness 4.8mm | | |
| For models: | CCE60, CGE11-L, CGE11-R, CGE12-L, CGE12-R, CGE21-L, CGE21-R, CGE22-L, CGE22-R, CGE61-L, CGE61-R, CGE62-L, CGE62-R, CGG11-L, CGG11-R, CGG12-L, CGG12-R, CGG21-L, CGG21-R, CGG22-L, CGG22-R, CGG61-L, CGG61-R, CGG62-L, CGG62-R, CPE60, CSE11-L, CSE11-R, CSE11-R-DG, CSE12-L, CSE12-R, CSE12-R-DG, CSE21-L, CSE21-R, CSE21-R-DG, CSE22-L, CSE22-R, CSE22-R-DG, CSE61-L, CSE61-R, CSE61-R-DG, CSE62-L, CSE62-R, CSE62-R-DG, CSG11-L, CSG11-R, CSG11-R-DG, CSG12-L, CSG12-R, CSG12-R-DG...(Other models you can see in the webshop) | | |

special gaskets

for combi-steamers



1

| | | | |
|--------------------|--|-----------------|----------|
| GEV No. | 699480 | Ref. No. | 10010162 |
| description | gasket suitable for MKN combi-steamer ED ø 74mm ID ø 60mm graphite thickness 1.5mm | | |
| For models: | CGE11-L, CGE11-R, CGE12-L, CGE12-R, CGE21-L, CGE21-R, CGE22-L, CGE22-R, CGE61-L, CGE61-R, CGE62-L, CGE62-R, CGG11-L, CGG11-R, CGG12-L, CGG12-R, CGG21-L, CGG21-R, CGG22-L, CGG22-R, CGG61-L, CGG61-R, CGG62-L, CGG62-R, CSE11-L, CSE11-R, CSE11-R-DG, CSE12-L, CSE12-R, CSE12-R-DG, CSE21-L, CSE21-R, CSE21-R-DG, CSE22-L, CSE22-R, CSE22-R-DG, CSE61-L, CSE61-R, CSE61-R-DG, CSE62-L, CSE62-R, CSE62-R-DG, CSG11-L, CSG11-R, CSG11-R-DG, CSG12-L, CSG12-R, CSG12-R-DG, CSG21-L, CSG21-R...(Other models you can see in the webshop) | | |



1

| | | | |
|--------------------|--|-----------------|--------|
| GEV No. | 699465 | Ref. No. | 211129 |
| description | gasket suitable for MKN combi-steamer L 148mm W 121mm mounting pos. - thickness 3mm | | |
| For models: | CGE11-L, CGE11-R, CGE12-L, CGE12-R, CGE61-L, CGE61-R, CGE62-L, CGE62-R, CGG11-L, CGG11-R, CGG12-L, CGG12-R, CGG21-L, CGG21-R, CGG22-L, CGG22-R, CGG61-L, CGG61-R, CGG62-L, CGG62-R, CSE11-L, CSE11-R, CSE11-R-DG, CSE12-L, CSE12-R, CSE12-R-DG, CSE61-L, CSE61-R, CSE61-R-DG, CSE62-L, CSE62-R, CSE62-R-DG, CSG11-L, CSG11-R, CSG11-R-DG, CSG12-L, CSG12-R, CSG12-R-DG, CSG61-L, CSG61-R, CSG61-R-DG, CSG62-L, CSG62-R, CSG62-R-DG | | |



| | | | |
|--------------------|--|-----------------|--------|
| GEV No. | 699464 | Ref. No. | 211145 |
| description | gasket suitable for MKN combi-steamer L 43mm W 19mm mounting pos. level glass graphite thickness 1.5mm | | |
| For models: | CGG11-L, CGG11-R, CGG12-L, CGG12-R, CGG21-L, CGG21-R, CGG22-L, CGG22-R, CGG61-L, CGG61-R, CGG62-L, CGG62-R, CSG11-L, CSG11-R, CSG11-R-DG, CSG12-L, CSG12-R, CSG12-R-DG, CSG21-L, CSG21-R, CSG21-R-DG, CSG22-L, CSG22-R, CSG22-R-DG, CSG61-L, CSG61-R, CSG61-R-DG, CSG62-L, CSG62-R, CSG62-R-DG | | |



| | | | |
|--------------------|--|-----------------|----------|
| GEV No. | 699481 | Ref. No. | 10011098 |
| description | gasket suitable for MKN combi-steamer L 58mm W 22mm ID ø 13mm graphite thickness 1.5mm | | |
| For models: | CGE11-L, CGE11-R, CGE12-L, CGE12-R, CGE21-L, CGE21-R, CGE22-L, CGE22-R, CGE61-L, CGE61-R, CGE62-L, CGE62-R, CGG11-L, CGG11-R, CGG12-L, CGG12-R, CGG21-L, CGG21-R, CGG22-L, CGG22-R, CGG61-L, CGG61-R, CGG62-L, CGG62-R, CSE11-L, CSE11-R, CSE11-R-DG, CSE12-L, CSE12-R, CSE12-R-DG, CSE61-L, CSE61-R, CSE61-R-DG, CSE62-L, CSE62-R, CSE62-R-DG, CSG11-L, CSG11-R, CSG11-R-DG, CSG12-L, CSG12-R, CSG12-R-DG, CSG21-L, CSG21-R, CSG21-R-DG, CSG22-L, CSG22-R, CSG22-R-DG, CSG61-L, CSG61-R...(Other models you can see in the webshop) | | |



| | | | |
|--------------------|--|-----------------|--------|
| GEV No. | 699462 | Ref. No. | 211144 |
| description | gasket suitable for MKN combi-steamer L 64mm W 64mm mounting pos. heat exchanger ID ø 43mm graphite thickness 1.5mm | | |
| For models: | CGG11-L, CGG11-R, CGG12-L, CGG12-R, CGG21-L, CGG21-R, CGG22-L, CGG22-R, CGG61-L, CGG61-R, CGG62-L, CGG62-R, CSG11-L, CSG11-R, CSG11-R-DG, CSG12-L, CSG12-R, CSG12-R-DG, CSG21-L, CSG21-R, CSG21-R-DG, CSG22-L, CSG22-R, CSG22-R-DG, CSG61-L, CSG61-R, CSG61-R-DG, CSG62-L, CSG62-R, CSG62-R-DG | | |





| | | | |
|--------------------|--|-----------------|--------|
| GEV No. | 699463 | Ref. No. | 211097 |
| description | gasket suitable for MKN combi-steamer L 70mm W 35mm mounting pos. for injection pipe ID ø 13mm graphite thickness 1mm | | |
| For models: | CGE11-L, CGE11-R, CGE12-L, CGE12-R, CGE21-L, CGE21-R, CGE22-L, CGE22-R, CGE61-L, CGE61-R, CGE62-L, CGE62-R, CGG11-L, CGG11-R, CGG12-L, CGG12-R, CGG21-L, CGG21-R, CGG22-L, CGG22-R, CGG61-L, CGG61-R, CGG62-L, CGG62-R, CPE63, CSE11-L, CSE11-R, CSE11-R-DG, CSE12-L, CSE12-R, CSE12-R-DG, CSE21-L, CSE21-R, CSE21-R-DG, CSE22-L, CSE22-R, CSE22-R-DG, CSE61-L, CSE61-R, CSE61-R-DG, CSE62-L, CSE62-R, CSE62-R-DG, CSG11-L, CSG11-R, CSG11-R-DG, CSG12-L, CSG12-R, CSG12-R-DG, CSG21-L, CSG21-R, CSG21-R-DG, CSG22-L...(Other models you can see in the webshop) | | |

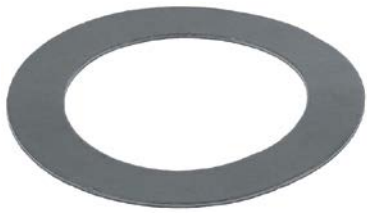

| | | | |
|--------------------|--|-----------------|--------|
| GEV No. | 692800 | Ref. No. | 211141 |
| description | gasket suitable for MKN combi-steamer L 82mm W 62mm mounting pos. burner thickness 1.5mm graphite Qty 1 pcs | | |
| For models: | CGG11-L, CGG11-R, CGG12-L, CGG12-R, CGG21-L, CGG21-R, CGG22-L, CGG22-R, CGG61-L, CGG61-R, CGG62-L, CGG62-R, CSG11-L, CSG11-R, CSG11-R-DG, CSG12-L, CSG12-R, CSG12-R-DG, CSG21-L, CSG21-R, CSG21-R-DG, CSG22-L, CSG22-R, CSG22-R-DG, CSG61-L, CSG61-R, CSG61-R-DG, CSG62-L, CSG62-R, CSG62-R-DG | | |



| | | | |
|------------------------|--|-----------------|--------|
| GEV No. | 699482 | Ref. No. | 211146 |
| description | gasket suitable for MKN combi-steamer mounting pos. for lens ED ø 105mm ID ø 71mm graphite thickness 1mm | | |
| For models: | CGE21-L, CGE21-R, CGE22-L, CGE22-R, CGG21-L, CGG21-R, CGG22-L, CGG22-R, CSE11-L, CSE11-R, CSE11-R-DG, CSE12-L, CSE12-R, CSE12-R-DG, CSE21-L, CSE21-R, CSE21-R-DG, CSE22-L, CSE22-R, CSE22-R-DG, CSE61-L, CSE61-R, CSE61-R-DG, CSE62-L, CSE62-R, CSE62-R-DG, CSG11-L, CSG11-R, CSG11-R-DG, CSG12-L, CSG12-R, CSG12-R-DG, CSG21-L, CSG21-R, CSG21-R-DG, CSG22-L, CSG22-R, CSG22-R-DG, CSG61-L, CSG61-R, CSG61-R-DG, CSG62-L, CSG62-R, CSG62-R-DG | | |
| accessories for | 699482 | | |
| |  | GEV No. | 694294 |
| | | Ref. No. | 216115 |
| | glass panel ø 90mm thickness 8mm | | |



| | | | |
|--------------------|---|-----------------|--------|
| GEV No. | 699483 | Ref. No. | 214009 |
| description | gasket suitable for MKN combi-steamer mounting pos. for temperature probe ED ø 19mm ID ø 12mm graphite thickness 1mm | | |
| For models: | CCE60, CCE63, CGE11-L, CGE11-R, CGE12-L, CGE12-R, CGE21-L, CGE21-R, CGE22-L, CGE22-R, CGE61-L, CGE61-R, CGE62-L, CGE62-R, CGG11-L, CGG11-R, CGG12-L, CGG12-R, CGG21-L, CGG21-R, CGG22-L, CGG22-R, CGG61-L, CGG61-R, CGG62-L, CGG62-R, CPE60, CPE63, CSE11-L, CSE11-R, CSE11-R-DG, CSE12-L, CSE12-R, CSE12-R-DG, CSE61-L, CSE61-R, CSE61-R-DG, CSE62-L, CSE62-R, CSE62-R-DG, CSG11-L, CSG11-R, CSG11-R-DG, CSG12-L, CSG12-R, CSG12-R-DG, CSG21-L, CSG21-R, CSG21-R-DG, CSG22-L...(Other models you can see in the webshop) | | |



| | | | |
|--------------------|--|-----------------|----------|
| GEV No. | 699479 | Ref. No. | 10010164 |
| description | gasket suitable for MKN combi-steamer mounting pos. outflow ED ø 115mm ID ø 71mm graphite thickness 1.5mm | | |
| For models: | CGE21-L, CGE21-R, CGE22-L, CGE22-R, CGG21-L, CGG21-R, CGG22-L, CGG22-R, CSG21-L, CSG21-R, CSG21-R-DG, CSG22-L, CSG22-R, CSG22-R-DG | | |



1

| | | | |
|--------------------|--|-----------------|----------|
| GEV No. | 699478 | Ref. No. | 10010161 |
| description | gasket suitable for MKN combi-steamer mounting pos. outflow ED ø 88mm ID ø 53mm graphite thickness 1.5mm | | |
| For models: | CGE11-L, CGE11-R, CGE12-L, CGE12-R, CGE61-L, CGE61-R, CGE62-L, CGE62-R, CGG11-L, CGG11-R, CGG12-L, CGG12-R, CGG61-L, CGG61-R, CGG62-L, CGG62-R, CSE11-L, CSE11-R, CSE11-R-DG, CSE12-L, CSE12-R, CSE12-R-DG, CSE61-L, CSE61-R, CSE61-R-DG, CSE62-L, CSE62-R, CSE62-R-DG, CSG11-L, CSG11-R, CSG11-R-DG, CSG12-L, CSG12-R, CSG12-R-DG, CSG61-L, CSG61-R, CSG61-R-DG, CSG62-L, CSG62-R, CSG62-R-DG | | |



1

| | | | |
|--------------------|--|-----------------|--------|
| GEV No. | 699461 | Ref. No. | 211142 |
| description | gasket suitable for MKN combi-steamer mounting pos. radial fan ED ø 82mm ID ø 52mm graphite thickness 1.5mm | | |
| For models: | 1462831-00, 1462832-00, 1462833-00, 1462834-00, 1462835-00, 1462836-00, 1462837-00, 1462838-00, 1462839-00, 1462840-00, 1462908-00, 1462910-00, 2062831-00, 2062832-00, 2062833-00, 2062834-00, 2062835-00, 2062835-01, 2062836-00, 2062836-01, 2062837-00, 2062837-01, 2062838-00, 2062838-01, 2062839-00, 2062839-01, 2062840-00, 2062840-01, 2062908-00, 2062910-00, 2162835-00, 2162835-01, 2162838-00, 2162838-01, 3062831-00, 3062832-00, 3062833-00, 3062834-00, 3062835-00, 3062836-00, 3062837-00, 3062838-00, 3062839-00, 3062840-00, 3062908-00, 3062910-00, CGG11-L, CGG11-R, CGG12-L, CGG12-R...(Other models you can see in the webshop) | | |



1

| | | | |
|--------------------|--|-----------------|--------|
| GEV No. | 699466 | Ref. No. | 211123 |
| description | gasket suitable for MKN ED ø 9mm ID ø 5mm thickness 3.7mm | | |
| For models: | CGE11-L, CGE11-R, CGE12-L, CGE12-R, CGE61-L, CGE61-R, CGE62-L, CGE62-R, CGG11-L, CGG11-R, CGG12-L, CGG12-R, CGG61-L, CGG61-R, CGG62-L, CGG62-R, CSE11-L, CSE11-R, CSE11-R-DG, CSE12-L, CSE12-R, CSE12-R-DG, CSE61-L, CSE61-R, CSE61-R-DG, CSE62-L, CSE62-R, CSE62-R-DG, CSG11-L, CSG11-R, CSG11-R-DG, CSG12-L, CSG12-R, CSG12-R-DG, CSG61-L, CSG61-R, CSG61-R-DG, CSG62-L, CSG62-R, CSG62-R-DG | | |



1

| | | | |
|--------------------|--|-----------------|--------|
| GEV No. | 699458 | Ref. No. | 211099 |
| description | gasket suitable for MKN for pipe DN70 ring - combi-steamer | | |
| For models: | CGE21-L, CGE21-R, CGE22-L, CGE22-R, CGG21-L, CGG21-R, CGG22-L, CGG22-R, CSE21-L, CSE21-R, CSE21-R-DG, CSE22-L, CSE22-R, CSE22-R-DG, CSG21-L, CSG21-R, CSG21-R-DG, CSG22-L, CSG22-R, CSG22-R-DG | | |



1

| | | | |
|--------------------|--|-----------------|--------|
| GEV No. | 699460 | Ref. No. | 211092 |
| description | gasket suitable for MKN for spray gun grommet ED ø 56mm ID ø 32.5mm foam seal thickness 13mm combi-steamer | | |
| For models: | CGE11-L, CGE11-R, CGE12-L, CGE12-R, CGE21-L, CGE21-R, CGE22-L, CGE22-R, CGE61-L, CGE61-R, CGE62-L, CGE62-R, CGG11-L, CGG11-R, CGG12-L, CGG12-R, CGG21-L, CGG21-R, CGG22-L, CGG22-R, CGG61-L, CGG61-R, CGG62-L, CGG62-R, CSE11-L, CSE11-R, CSE11-R-DG, CSE12-L, CSE12-R, CSE12-R-DG, CSE21-L, CSE21-R, CSE22-L, CSE22-R, CSE61-L, CSE61-R, CSE61-R-DG, CSE62-L, CSE62-R, CSE62-R-DG, CSG11-L, CSG11-R, CSG11-R-DG, CSG12-L, CSG12-R, CSG12-R-DG, CSG21-L, CSG21-R, CSG22-L, CSG22-R...(Other models you can see in the webshop) | | |



1

| | | | |
|--------------------|---|-----------------|--------|
| GEV No. | 699362 | Ref. No. | 211079 |
| description | gasket suitable for MKN profile no to be sold in France for combi-steamer ED ø 58mm rubber DN 50mm | | |
| For models: | 815156, 815157, 815166, 815167, 845906, 845986, 846111, 846116, CGE11-L, CGE11-R, CGE12-L, CGE12-R, CGE61-L, CGE61-R, CGE62-L, CGE62-R, CGG11-L, CGG11-R, CGG12-L, CGG12-R, CGG21-L, CGG21-R, CGG22-L, CGG22-R, CGG61-L, CGG61-R, CGG62-L, CGG62-R, CSE11-L, CSE11-R, CSE11-R-DG, CSE12-L, CSE12-R, CSE12-R-DG, CSE61-L, CSE61-R, CSE61-R-DG, CSE62-L, CSE62-R, CSE62-R-DG, CSG11-L, CSG11-R, CSG11-R-DG, CSG12-L, CSG12-R, CSG12-R-DG, CSG21-L, CSG21-R, CSG21-R-DG, CSG22-L...(Other models you can see in the webshop) | | |



1

| | | | |
|--------------------|---|-----------------|--------|
| GEV No. | 699459 | Ref. No. | 211131 |
| description | gasket suitable for MKN size 24x34x10 ring - combi-steamer | | |
| For models: | CCE60, CCE63, CGE11-L, CGE11-R, CGE12-L, CGE12-R, CGE21-L, CGE21-R, CGE22-L, CGE22-R, CGE61-L, CGE61-R, CGE62-L, CGE62-R, CGG11-L, CGG11-R, CGG12-L, CGG12-R, CGG21-L, CGG21-R, CGG22-L, CGG22-R, CGG61-L, CGG61-R, CGG62-L, CGG62-R, CPE60, CPE63, CSE11-L, CSE11-R, CSE11-R-DG, CSE12-L, CSE12-R, CSE12-R-DG, CSE21-L, CSE21-R, CSE21-R-DG, CSE22-L, CSE22-R, CSE22-R-DG, CSE61-L, CSE61-R, CSE61-R-DG, CSE62-L, CSE62-R, CSE62-R-DG, CSG11-L, CSG11-R, CSG11-R-DG, CSG12-L...(Other models you can see in the webshop) | | |



| | | | |
|--------------------|---|-----------------|--------|
| GEV No. | 699366 | Ref. No. | 211080 |
| description | gasket suitable for profile for combi-steamer ED ø 42mm ID ø 36mm rubber thickness 6.5mm | | |
| For models: | CCE60, CCE63, CGE11-L, CGE11-R, CGE12-L, CGE12-R, CGE21-L, CGE21-R, CGE22-L, CGE22-R, CGE61-L, CGE61-R, CGE62-L, CGE62-R, CGG11-L, CGG11-R, CGG12-L, CGG12-R, CGG21-L, CGG21-R, CGG22-L, CGG22-R, CGG61-L, CGG61-R, CGG62-L, CGG62-R, CPE60, CPE63, CSE11-L, CSE11-R, CSE11-R-DG, CSE12-L, CSE12-R, CSE12-R-DG, CSE21-L, CSE21-R, CSE21-R-DG, CSE22-L, CSE22-R, CSE22-R-DG, CSE61-L, CSE61-R, CSE61-R-DG, CSE62-L, CSE62-R, CSE62-R-DG, CSG11-L, CSG11-R, CSG11-R-DG, CSG12-L...(Other models you can see in the webshop) | | |



| | | | |
|--------------------|--|-----------------|--------|
| GEV No. | 699365 | Ref. No. | 211078 |
| description | gasket U-bend L 73mm W 73mm ID ø 60mm thickness 3mm | | |
| For models: | CGE11-L, CGE11-R, CGE12-L, CGE12-R, CGE21-L, CGE21-R, CGE22-L, CGE22-R, CGE61-L, CGE61-R, CGE62-L, CGE62-R, CGG11-L, CGG11-R, CGG12-L, CGG12-R, CGG21-L, CGG21-R, CGG22-L, CGG22-R, CGG61-L, CGG61-R, CGG62-L, CGG62-R, CSE11-L, CSE11-R, CSE11-R-DG, CSE12-L, CSE12-R, CSE12-R-DG, CSE21-L, CSE21-R, CSE21-R-DG, CSE22-L, CSE22-R, CSE22-R-DG, CSE61-L, CSE61-R, CSE61-R-DG, CSE62-L, CSE62-R, CSE62-R-DG, CSG11-L, CSG11-R, CSG11-R-DG, CSG12-L, CSG12-R, CSG12-R-DG, CSG21-L, CSG21-R...(Other models you can see in the webshop) | | |

miscellaneous



| | | | |
|--------------------|--|-----------------|--------|
| GEV No. | 550289 | Ref. No. | 211003 |
| description | flat gasket | | |
| For models: | 0524301-01, 0524302-01, 0524303-01, 0524304-01, 0720325-03, 0720325-04, 0720325B03, 0720325B04, 0720332P00, 0720332R00, 0720332T00, 0720332V00, 0720504-04, 0721134-01, 0721134A01, 0721172A01, 0721173A01, 0721174A01, 0721175A01, 0722101-06, 0723104-03, 0723104A03, 0723104B03, 0723105-03, 0723105A03, 0723105B03, 0723405-01, 0723405-02, 0723409-01, 0723409-02, 0723412K01, 0723413-02, 0723414-02, 1020510-00, 1022603-00, 1023101-00, 1023101-01, 1023106-00, 1023106-01, 1023111-00, 1023111-01, 1023401-00, 1023401K00, 1023410-00, 1121121-00, 1121121A00, 1220301-00, 1220301-01, 1220301-02, 1220301-03...(Other models you can see in the webshop) | | |

evaporators

for fridges

producer-specific



| | | | |
|--------------------|-----------------------------------|-----------------|--------|
| GEV No. | 750238 | Ref. No. | 935611 |
| description | evaporator L 535mm W 80mm H 205mm | | |

springs

torsion springs



| | | | |
|--------------------|--|-----------------|--------|
| GEV No. | 699291 | Ref. No. | 216156 |
| description | torsion spring ø 24mm L2 69mm wire gauge ø 3mm L1 23mm L3 69mm for door handle | | |
| For models: | CCE60, CCE63, CPE60, CPE63 | | |



| | | | |
|--------------------|--|-----------------|--------|
| GEV No. | 700514 | Ref. No. | 216079 |
| description | torsion spring ø 26.6mm wire gauge ø 6.1mm L1 420mm L3 26mm | | |
| For models: | 0522101-00, 0522101-01, 0522101-02, 0522101-03, 0522101-04, 0522102-00, 0522102-01, 0522102-02, 0522102-03, 0522102-04, 0722101-06, 1323208-00, 1323208-01, 1323208-02, 1323208-03, 1323208-04, 1323210-00, 1323210-01, 1323210-02, 1323210-03, 1323210-04, 1323403-00, 1323403K00, 1323506-00, 1323506-01, 1323506A00, 1323506A01, 1323517-00, 1323517A00, 1363403-00, 1363403-01, 1363403-02, 1363403-03, 1363403-04, 1363403-05, 1363415-05, 1422101-00, 1422101-01, 1422101-02, 1422101-03, 1422101-04, 1422101-05, 1422101-06, 1422102-00, 1422102-01, 1422102-02, 1422102-03, 1422102-04, 1422102-05, 1422104-05...(Other models you can see in the webshop) | | |

tension springs





| | | | |
|--------------------|---|-----------------|--------|
| GEV No. | 700552 | Ref. No. | 216084 |
| description | tension spring | | |
| For models: | 2013003B01, 2013003B02, 2013003B03, 2013003B04, 2013003B05, 2013003B06, 2013007B01, 2013007B02, 2013007B03, 2013007B04, 2013007B05, 2013007B06, 2013009B01, 2013009B02, 2013009B03, 2013009B04, 2013009B05, 2013009B06, 2013017B00, 2013017B01, 2013017B02, 2013017B03, 2013017B04, 2013017B05, 2021403-00, 2021403-01, 2021403-02, 2021403-03, 2021403-04, 2021403-05, 2021403-06, 2021403-0, 2021403A00, 2021403A01, 2021403A02, 2021403A04, 2021403A05, 2021403A06, 2021403B00, 2021403B01, 2021403B02, 2021403B04, 2021403B05, 2021403B06, 2021403C01, 2021403C02, 2021403C04, 2021403C05, 2021403C06, 2021405-00...(Other models you can see in the webshop) | | |



manometers

| | | | |
|--|---|-----------------|--------|
|  <p>1</p> | | | |
| GEV No. | 541427 | Ref. No. | 201106 |
| description | manometer ø 62mm pressure range 0 up to 1.6bar thread 1/4" marking 0.5 connection on the backside | | |
| For models: | 14228011-0, 14228022-0, 14228033-0, 14228044-0, 14228055-0, 2012801-00, 2012801-01, 2012801A00, 2012801A01, 2012801B00, 2012801B01, 2012801C00, 2012801C01, 2012802-00, 2012802-01, 2012802A00, 2012802A01, 2012802B00, 2012802B01, 2012802C00, 2012802C01, 2012803-00, 2012803-01, 2012803A00, 2012803A01, 2012803B00, 2012803B01, 2012803C00, 2012803C01, 2012804-00, 2012804-01, 2012804A00, 2012804A01, 2012804B00, 2012804B01, 2012804C00, 2012804C01, 2012805-00, 2012805-01, 2012805A00, 2012805A01, 2012805B00, 2012805B01, 2012805C00, 2012805C01, 2012806B00, 2012806C00, 2012807B00, 2012807C00, 2012901B00... (Other models you can see in the webshop) | | |

| | | | |
|--|---|-----------------|--------|
|  <p>1</p> | | | |
| GEV No. | 541062 | Ref. No. | 201105 |
| description | manometer ø 63mm pressure range 0 up to 1bar connection marking adjustable kettle thread 1/4" | | |
| spare parts for | 541062 | | |
| |  | GEV No. | 541130 |
| | | Ref. No. | — |
| | glass panel ø 58mm thickness 2mm | | |

| | | | |
|--|---|-----------------|--------|
|  <p>1</p> | | | |
| GEV No. | 541099 | Ref. No. | 201731 |
| description | manometer ø 63mm pressure range -1.5 up to +1.5bar thread 1/4" marking 1 kettle | | |
| For models: | 1412831-00, 1412832-00, 1412833-00, 1412833-01, 1412834-00, 1412834-01, 1412908-00, 1412910-00, 1412910-01, 1422802B04, 1422802B05, 1422802B06, 1422802B07, 1422802B08, 1422804B04, 1422804B05, 1422804B06, 1422804B07, 1422804B08, 1422805B04, 1422805B05, 1422805B06, 1422805B07, 1422805B08, 1422807B00, 1422807B01, 1422807B02, 1422807B03, 1422807B04, 1422831-00, 1422832-00, 1422833-00, 1422834-00, 1422902-00, 1422902-01, 1422902-02, 1422902-03, 1422902-04, 1422908-00, 1422910-00, 1462802B00, 1462802B01, 1462802B02, 1462802B03, 1462802B04, 1462802B05, 1462804B00, 1462804B01, 1462804B02, 1462804B03... (Other models you can see in the webshop) | | |

hose reels and spray guns

spray guns

| | | | |
|--|---|-----------------|--------|
|  <p>1</p> | | | |
| GEV No. | 542800 | Ref. No. | 201147 |
| description | spray gun for appliances 1/2" ET L 120mm with backflow preventer type MKN | | |
| For models: | CGE11-L, CGE11-R, CGE12-L, CGE12-R, CGE21-L, CGE21-R, CGE22-L, CGE22-R, CGE61-L, CGE61-R, CGE62-L, CGE62-R, CGG11-L, CGG11-R, CGG12-L, CGG12-R, CGG21-L, CGG21-R, CGG22-L, CGG22-R, CGG61-L, CGG61-R, CGG62-L, CGG62-R, CSE11-L, CSE11-R, CSE11-R-DG, CSE12-L, CSE12-R, CSE12-R-DG, CSE21-L, CSE21-R, CSE21-R-DG, CSE22-L, CSE22-R, CSE22-R-DG, CSE61-L, CSE61-R, CSE61-R-DG, CSE62-L, CSE62-R, CSE62-R-DG, CSG11-L, CSG11-R, CSG11-R-DG, CSG12-L, CSG12-R, CSG12-R-DG, CSG21-L, CSG21-R... (Other models you can see in the webshop) | | |

| | | | |
|--|--|-----------------|--------|
|  <p>1</p> | | | |
| GEV No. | 699460 | Ref. No. | 211092 |
| description | gasket suitable for MKN for spray gun grommet ED ø 56mm ID ø 32.5mm foam seal thickness 13mm combi-steamer | | |
| For models: | CGE11-L, CGE11-R, CGE12-L, CGE12-R, CGE21-L, CGE21-R, CGE22-L, CGE22-R, CGE61-L, CGE61-R, CGE62-L, CGE62-R, CGG11-L, CGG11-R, CGG12-L, CGG12-R, CGG21-L, CGG21-R, CGG22-L, CGG22-R, CGG61-L, CGG61-R, CGG62-L, CGG62-R, CSE11-L, CSE11-R, CSE11-R-DG, CSE12-L, CSE12-R, CSE12-R-DG, CSE21-L, CSE21-R, CSE22-L, CSE22-R, CSE61-L, CSE61-R, CSE61-R-DG, CSE62-L, CSE62-R, CSE62-R-DG, CSG11-L, CSG11-R, CSG11-R-DG, CSG12-L, CSG12-R, CSG12-R-DG, CSG21-L, CSG21-R, CSG22-R... (Other models you can see in the webshop) | | |

| | | | |
|--|---|-----------------|--------|
|  <p>1</p> | | | |
| GEV No. | 694988 | Ref. No. | 204428 |
| description | grommet connection bush Hans Dampf for spray gun | | |
| For models: | CGE11-L, CGE11-R, CGE12-L, CGE12-R, CGE21-L, CGE21-R, CGE22-L, CGE22-R, CGE61-L, CGE61-R, CGE62-L, CGE62-R, CGG11-L, CGG11-R, CGG12-L, CGG12-R, CGG21-L, CGG21-R, CGG22-L, CGG22-R, CGG61-L, CGG61-R, CGG62-L, CGG62-R, CSE11-L, CSE11-R, CSE11-R-DG, CSE12-L, CSE12-R, CSE12-R-DG, CSE21-L, CSE21-R, CSE21-R-DG, CSE22-L, CSE22-R, CSE22-R-DG, CSE61-L, CSE61-R, CSE61-R-DG, CSE62-L, CSE62-R, CSE62-R-DG, CSG11-L, CSG11-R, CSG11-R-DG, CSG12-L, CSG12-R, CSG12-R-DG, CSG21-L, CSG21-R... (Other models you can see in the webshop) | | |



hose reels

appliance hose reels



| | | | |
|--------------------|--|-----------------|--------|
| GEV No. | 542804 | Ref. No. | 204410 |
| description | hose reel without spray gun hose length 1.8m | | |
| For models: | CGE11-L, CGE11-R, CGE12-L, CGE12-R, CGE21-L, CGE21-R, CGE22-L, CGE22-R, CGE61-L, CGE61-R, CGE62-L, CGE62-R, CGG11-L, CGG11-R, CGG12-L, CGG12-R, CGG21-L, CGG21-R, CGG22-L, CGG22-R, CGG61-L, CGG61-R, CGG62-L, CGG62-R, CSE11-L, CSE11-R, CSE11-R-DG, CSE12-L, CSE12-R, CSE12-R-DG, CSE21-L, CSE21-R, CSE21-R-DG, CSE22-L, CSE22-R, CSE22-R-DG, CSE61-L, CSE61-R, CSE61-R-DG, CSE62-L, CSE62-R, CSE62-R-DG, CSG11-L, CSG11-R, CSG11-R-DG, CSG12-L, CSG12-R, CSG21-L, CSG21-R, CSG21-R-DG...(Other models you can see in the webshop) | | |

dosing pumps



membrane dosing pumps

self-priming

LANG

accessories



| | | | |
|---|--|-----------------|-------------------|
| GEV No. | 101286 | Ref. No. | 201571 |
| description | olive ID ø 6mm Qty 1 pcs | | |
| For models: | 0260301-00, 0260301-01, 0260302-00, 0260302-01, 1260301-00, 1260301-01, 1260302-00, 1260302-01, 1412831-00, 1412832-00, 1412833-00, 1412833-01, 1412834-00, 1412834-01, 1412908-00, 1412910-00, 1412910-01, 1422802B04, 1422802B05, 1422802B06, 1422802B07, 1422802B08, 1422804B04, 1422804B05, 1422804B06, 1422804B07, 1422804B08, 1422805B04, 1422805B05, 1422805B06, 1422805B07, 1422805B08, 1422807B00, 1422807B01, 1422807B02, 1422807B03, 1422807B04, 1422831-00, 1422832-00, 1422833-00, 1422834-00, 1422902-00, 1422902-01, 1422902-02, 1422902-03, 1422902-04, 1422908-00, 1422910-00, 1423901-00, 1423901-01...(Other models you can see in the webshop) | | |
| accessories for | 101286 | | |
|  | GEV No. | 100909 | Ref. No. — |
| | union screw thread M10x1 for pipe ø 6mm Qty 1 pcs | | |
|  | GEV No. | 101464 | Ref. No. — |
| | union nut thread M12x1 for pipe ø 6mm | | |

hoses

industrial hoses

nylon hoses



| | | | |
|--------------------|--|-----------------|--------|
| GEV No. | 530566 | Ref. No. | 050016 |
| description | nylon hose ID ø 8mm ED ø 10mm L 5m thickness 1mm operating p. 10bar burst p. 50bar t.max. 100°C transparent | | |
| For models: | CGE11-L, CGE11-R, CGE12-L, CGE12-R, CGE21-L, CGE21-R, CGE22-L, CGE22-R, CGE61-L, CGE61-R, CGE62-L, CGE62-R, CGG11-L, CGG11-R, CGG12-L, CGG12-R, CGG21-L, CGG21-R, CGG22-L, CGG22-R, CGG61-L, CGG61-R, CGG62-L, CGG62-R, CSE11-L, CSE11-R, CSE11-R-DG, CSE12-L, CSE12-R, CSE12-R-DG, CSE21-L, CSE21-R, CSE21-R-DG, CSE22-L, CSE22-R, CSE22-R-DG, CSE61-L, CSE61-R, CSE61-R-DG, CSE62-L, CSE62-R, CSE62-R-DG, CSG11-L, CSG11-R, CSG11-R-DG, CSG12-L, CSG12-R, CSG12-R-DG, CSG21-L, CSG21-R...(Other models you can see in the webshop) | | |

silicone hoses

without fabric

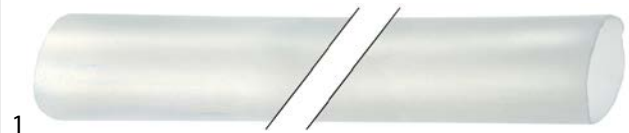

| | | | |
|--------------------|--|-----------------|--------|
| GEV No. | 530898 | Ref. No. | 050015 |
| description | silicone hose ID ø 60mm ED ø 64mm L 1m thickness 2mm | | |
| For models: | 815156, 815157, 815166, 815167, CCE60, CCE63, CGE11-L, CGE11-R, CGE12-L, CGE12-R, CGE21-L, CGE21-R, CGE22-L, CGE22-R, CGE61-L, CGE61-R, CGE62-L, CGE62-R, CGG11-L, CGG11-R, CGG12-L, CGG12-R, CGG21-L, CGG21-R, CGG22-L, CGG22-R, CGG61-L, CGG61-R, CGG62-L, CGG62-R, CPE60, CPE63, CSE11-L, CSE11-R, CSE11-R-DG, CSE12-L, CSE12-R, CSE12-R-DG, CSE21-L, CSE21-R, CSE21-R-DG, CSE22-L, CSE22-R, CSE22-R-DG, CSE61-L, CSE61-R, CSE61-R-DG, CSE62-L, CSE62-R, CSE62-R-DG...(Other models you can see in the webshop) | | |

pressure hoses (other)



| | | | |
|--------------------|--|-----------------|--------|
| GEV No. | 520107 | Ref. No. | 050003 |
| description | pressure hose | | |
| For models: | 1412831-00, 1412832-00, 1412833-00, 1412833-01, 1412834-00, 1412834-01, 1412908-00, 1412910-00, 1412910-01, 14228011-0, 14228022-0, 1422802B04, 1422802B05, 1422802B06, 1422802B07, 1422802B08, 14228033-0, 14228044-0, 1422804B04, 1422804B05, 1422804B06, 1422804B07, 1422804B08, 14228055-0, 1422805B04, 1422805B05, 1422805B06, 1422805B07, 1422805B08, 1422807B00, 1422807B01, 1422807B02, 1422807B03, 1422807B04, 1422831-00, 1422832-00, 1422833-00, 1422834-00, 1422902-00, 1422902-01, 1422902-02, 1422902-03, 1422902-04, 1422908-00, 1422910-00, 1423901-00, 1423901-01, 1423901-02, 1423902-00, 1423902-01...(Other models you can see in the webshop) | | |



formed hoses

miscellaneous



| | | | |
|--------------------|--|-----------------|------------------|
| GEV No. | 513326 | Ref. No. | 050024 204690 |
| description | formed hose ID ø 15mm ED ø 24mm U-bend | | |
| For models: | CGE11-L, CGE11-R, CGE12-L, CGE12-R, CGE61-L, CGE61-R, CGE62-L, CGE62-R, CGG11-L, CGG11-R, CGG12-L, CGG12-R, CGG61-L, CGG61-R, CGG62-L, CGG62-R, CSE11-L, CSE11-R, CSE11-R-DG, CSE12-L, CSE12-R, CSE12-R-DG, CSE61-L, CSE61-R, CSE61-R-DG, CSE62-L, CSE62-R, CSE62-R-DG, CSG11-L, CSG11-R, CSG11-R-DG, CSG12-L, CSG12-R, CSG12-R-DG, CSG61-L, CSG61-R, CSG61-R-DG, CSG62-L, CSG62-R, CSG62-R-DG | | |

miscellaneous

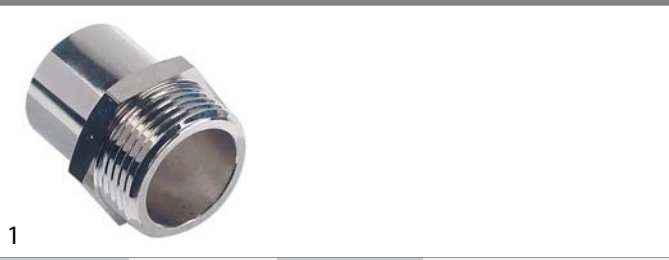

| | | | |
|--------------------|---|-----------------|--------|
| GEV No. | 520375 | Ref. No. | 201038 |
| description | screw connection thread 1" L 42mm ø 30mm | | |
| For models: | 0220301D00, 0220302D00, 0220302E00, 0220302E01, 0220303D00, 0220303D01, 0220303E00, 0220303E01, 0260301-00, 0260301-01, 0260302-00, 0260302-01, 0720504-04, 1220301D00, 1220301D01, 1220301E00, 1220301E01, 1220302D00, 1220302E00, 1220303D00, 1220303D01, 1220303D02, 1220303E00, 1220303E01, 1220303E02, 1220303F01, 1220303F02, 1220303F03, 1220303H00, 1220303H01, 1220303H02, 1220303H03, 1220304D00, 1220304E00, 1220304F00, 1220304H00, 1220305D00, 1220305D01, 1220305D02, 1220305D03, 1220305D04, 1220305E00, 1220305E01, 1220305E02, 1220305E03, 1220305E04, 1220305F01, 1220305F02, 1220305F03, 1220305F04... (Other models you can see in the webshop) | | |

fittings, hose and pipe connectors

hose connectors

without screw connection



| | | | |
|--------------------|--|-----------------|--------|
| GEV No. | 504817 | Ref. No. | 205174 |
| description | T-piece SS hose ø 10-10-10mm | | |
| For models: | CCE60, CCE63, CGE21-L, CGE21-R, CGE22-L, CGE22-R, CGG21-L, CGG21-R, CGG22-L, CGG22-R, CPE60, CPE63, CSE21-L, CSE21-R, CSE21-R-DG, CSE22-L, CSE22-R, CSE22-R-DG, CSG21-L, CSG21-R, CSG21-R-DG, CSG22-L, CSG22-R, CSG22-R-DG | | |

hose connectors

plastic



| | | | |
|--------------------|--|-----------------|--------|
| GEV No. | 506275 | Ref. No. | 205320 |
| description | hose connector plastic straight thread G 3/4" hose ø 11mm Qty 1 pcs with gasket | | |
| For models: | CCE60, CCE63, CGE11-L, CGE11-R, CGE12-L, CGE12-R, CGE21-L, CGE21-R, CGE22-L, CGE22-R, CGE61-L, CGE61-R, CGE62-L, CGE62-R, CGG11-L, CGG11-R, CGG12-L, CGG12-R, CGG21-L, CGG21-R, CGG22-L, CGG22-R, CGG61-L, CGG61-R, CGG62-L, CGG62-R, CPE60, CPE63, CSE11-L, CSE11-R, CSE11-R-DG, CSE12-L, CSE12-R, CSE12-R-DG, CSE21-L, CSE21-R, CSE21-R-DG, CSE22-L, CSE22-R, CSE22-R-DG, CSE61-L, CSE61-R, CSE61-R-DG, CSE62-L, CSE62-R, CSE62-R-DG, CSG11-L, CSG11-R, CSG11-R-DG, CSG12-L... (Other models you can see in the webshop) | | |

fittings

sleeves



| | | | |
|--------------------|---|-----------------|--------|
| GEV No. | 521282 | Ref. No. | 205296 |
| description | sleeve thread 1/4" - 1/4" SS WS 17 total length 22mm | | |
| For models: | CGE11-L, CGE11-R, CGE12-L, CGE12-R, CGE21-L, CGE21-R, CGE22-L, CGE22-R, CGE61-L, CGE61-R, CGE62-L, CGE62-R, CGG11-L, CGG11-R, CGG12-L, CGG12-R, CGG21-L, CGG21-R, CGG22-L, CGG22-R, CGG61-L, CGG61-R, CGG62-L, CGG62-R, CSE11-L, CSE11-R, CSE11-R-DG, CSE12-L, CSE12-R, CSE12-R-DG, CSE21-L, CSE21-R, CSE21-R-DG, CSE22-L, CSE22-R, CSE22-R-DG, CSE61-L, CSE61-R, CSE61-R-DG, CSE62-L, CSE62-R, CSE62-R-DG, CSG11-L, CSG11-R, CSG11-R-DG, CSG12-L, CSG12-R, CSG12-L, CSG21-R, CSG21-R-DG... (Other models you can see in the webshop) | | |

nickel-plated brass

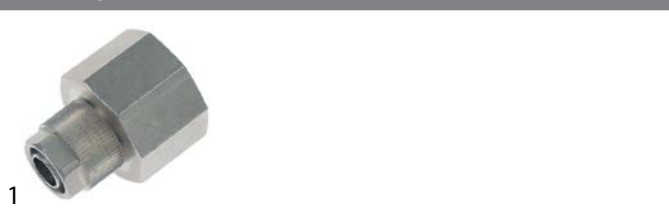

| | | | |
|--------------------|---|-----------------|--------|
| GEV No. | 362019 | Ref. No. | 205298 |
| description | screw pipe fitting straight nickel-plated brass thread 1/2" hose ø 8/10mm Qty 1 pcs | | |
| For models: | CGE11-L, CGE11-R, CGE12-L, CGE12-R, CGE21-L, CGE21-R, CGE22-L, CGE22-R, CGE61-L, CGE61-R, CGE62-L, CGE62-R, CGG11-L, CGG11-R, CGG12-L, CGG12-R, CGG21-L, CGG21-R, CGG22-L, CGG22-R, CGG61-L, CGG61-R, CGG62-L, CGG62-R, CSE11-L, CSE11-R, CSE11-R-DG, CSE12-L, CSE12-R, CSE12-R-DG, CSE21-L, CSE21-R, CSE21-R-DG, CSE22-L, CSE22-R, CSE22-R-DG, CSE61-L, CSE61-R, CSE61-R-DG, CSE62-L, CSE62-R, CSE62-R-DG, CSG11-L, CSG11-R, CSG11-R-DG, CSG12-L, CSG12-R, CSG12-R-DG, CSG21-L, CSG21-R... (Other models you can see in the webshop) | | |



| | | | |
|--------------------|--|-----------------|--------|
| | | | |
| GEV No. | 362018 | Ref. No. | 205297 |
| description | screw pipe fitting angled 90° nickel-plated brass thread 1/4" hose ø 8/10mm Qty 1 pcs | | |
| For models: | CGE11-L, CGE11-R, CGE12-L, CGE12-R, CGE21-L, CGE21-R, CGE22-L, CGE22-R, CGE61-L, CGE61-R, CGE62-L, CGE62-R, CGG11-L, CGG11-R, CGG12-L, CGG12-R, CGG21-L, CGG21-R, CGG22-L, CGG22-R, CGG61-L, CGG61-R, CGG62-L, CGG62-R, CSE11-L, CSE11-R, CSE11-R-DG, CSE12-L, CSE12-R, CSE12-R-DG, CSE21-L, CSE21-R, CSE21-R-DG, CSE22-L, CSE22-R, CSE22-R-DG, CSE61-L, CSE61-R, CSE61-R-DG, CSE62-L, CSE62-R, CSE62-R-DG, CSG11-L, CSG11-R, CSG11-R-DG, CSG12-L, CSG12-R, CSG12-R-DG, CSG21-L, CSG21-R...(Other models you can see in the webshop) | | |

| | | | |
|--------------------------|--|-----------------|--------|
| producer-specific | | | |
| MKN | | | |
| | | | |
| GEV No. | 541457 | Ref. No. | 201012 |
| description | ball valve connection 1/2" ET | | |
| For models: | 14228011-0, 14228022-0, 1422802B04, 1422802B05, 1422802B06, 1422802B07, 1422802B08, 14228033-0, 14228044-0, 1422804B04, 1422804B05, 1422804B06, 1422804B07, 1422804B08, 14228055-0, 1422805B04, 1422805B05, 1422805B06, 1422805B07, 1422805B08, 1422807B00, 1422807B01, 1422807B02, 1422807B03, 1422807B04, 1422831-00, 1422832-00, 1422833-00, 1422834-00, 1422902-00, 1422902-01, 1422902-02, 1422902-03, 1422902-04, 1422908-00, 1422910-00, 1423901-00, 1423901-01, 1423901-02, 1423902-00, 1423902-01, 1423902-02, 1423903-00, 1423903-01, 1423903-02, 1462802B00, 1462802B01, 1462802B02, 1462802B03, 1462802B04...(Other models you can see in the webshop) | | |

valves and tank inlets

ball valves

universal

ball valves with butterfly handle

| | | | |
|--------------------|--|-----------------|--------|
| | | | |
| GEV No. | 542430 | Ref. No. | 201171 |
| description | ball valve connection 3/4" IT - 3/4" IT DN20 PN 64 total length 78mm stainless steel | | |
| For models: | 0720325-03, 0720325-04, 0720325B03, 0720325B04, 0720332P00, 0720332R00, 0720332T00, 0720332V00, 1220321-00, 1220321-01, 1220321B00, 1220321B01, 1220325-00, 1220325-01, 1220325-02, 1220325B00, 1220325B01, 1220325B02, 1220327-00, 1220327-01, 1220327B01, 1220329-00, 1220329-01, 1220329B00, 1220329B01, 1220330-00, 1220330-01, 1220330B00, 1220330B01, 1320321-00, 1320321-01, 1320321-02, 1320321B00, 1320321B01, 1320321B02, 1320323-00, 1320323B00, 1320325-00, 1320325-01, 1320325-02, 1320325A00, 1320325A01, 1320325A02, 1320325B00, 1320325B01, 1320325B02, 1320325C00, 1320325C01, 1320325C02, 1320327-00...(Other models you can see in the webshop) | | |

gate valves

| | | | |
|--------------------|--|-----------------|------------------|
| | | | |
| GEV No. | 520377 | Ref. No. | 201033 201071 |
| description | gate valve connection 1" IT - 1" IT total length 51mm chrome-plated brass | | |
| For models: | 0220301D00, 0220302D00, 0220302E00, 0220302E01, 0220303D00, 0220303D01, 0220303E00, 0220303E01, 0260301-00, 0260301-01, 0260302-00, 0260302-01, 0720504-04, 1220301D00, 1220301D01, 1220301E00, 1220301E01, 1220302D00, 1220302E00, 1220303D00, 1220303D01, 1220303D02, 1220303E00, 1220303E01, 1220303E02, 1220303F01, 1220303F02, 1220303F03, 1220303H00, 1220303H01, 1220303H02, 1220303H03, 1220304D00, 1220304E00, 1220304F00, 1220304H00, 1220305D00, 1220305D01, 1220305D02, 1220305D03, 1220305D04, 1220305E00, 1220305E01, 1220305E02, 1220305E03, 1220305E04, 1220305F01, 1220305F02, 1220305F03, 1220305F04...(Other models you can see in the webshop) | | |

ball valves with lever handle

| | | | |
|--------------------|--|-----------------|--------|
| | | | |
| GEV No. | 514442 | Ref. No. | 201762 |
| description | ball valve connection 1 1/2" IT - 1 1/2" IT total length 93mm with lever handle handle length 155mm | | |
| For models: | 1220402-00, 1220402-01, 1220504-01, 1222601-00, 1222603-00, 1320402-00, 1320402-01, 1320504-01, 1320504-02, 1322601-00, 1322603-00, 1322604-00, 1420402-00, 1420402-01, 1420403-00, 1420403-01, 1420403-02, 1420403B02, 1420509-01, 1422601-00, 1422602-00, 1520402-00, 1520402-01, 1520403-00, 1520403-01, 1522603-00, 1522603-01, 2020402-00, 2020402-01, 2020403-00, 2020403-01, 2020506-01, 2022601-00, 2022601-01, 2022603-00, 2022604-00, 2120402-00, 2120402-01, 2120403-00, 2120504-01, 2122601-00, 2122601-01, 2122602-00, 2122604-00, 2220403-00, 2220403-01, 2220403-02, 2222608-02, 2420403-00, 2420403-01...(Other models you can see in the webshop) | | |



shut-off valves

universal



| | | | |
|---|---|-----------------|-------------------|
| GEV No. | 514482 | Ref. No. | 201077 |
| description | shut-off valve connection 1/2" tap head 1/2" cold/warm total length 45mm | | |
| For models: | 1320401-00, 1320401-01, 1420401-00, 1420401-01, 1420405-00, 14228011-0, 14228022-0, 14228033-0, 14228044-0, 14228055-0, 2020401-00, 2020401-01, 2022801-00, 2022801-01, 20228011-0, 20228011-1, 2022801A00, 2022801A01, 2022801B00, 2022801B01, 2022801C00, 2022801C01, 2022802-00, 2022802-01, 20228022-0, 20228022-1, 2022802A00, 2022802A01, 2022802B00, 2022802B01, 2022802C00, 2022802C01, 2022803-00, 2022803-01, 20228033-0, 20228033-1, 2022803A00, 2022803A01, 2022803B00, 2022803B01, 2022803C00, 2022803C01, 2022804-00, 2022804-01, 20228044-0, 20228044-1, 2022804A00, 2022804A01, 2022804B00, 2022804B01... (Other models you can see in the webshop) | | |
| spare parts for | 514482 | | |
|  | GEV No. | 547951 | Ref. No. — |
| | tap head connection 3/4" without handle total lengthmm | | |

| | | | |
|---|---|--------|-------------------|
| spare parts for | 541544 | | |
|  | GEV No. | 541557 | Ref. No. — |
| | tap head chrome-plated thread 1 1/4" for steam tap 1" | | |

tank inlets



| | | | |
|--------------------|--|-----------------|--------|
| GEV No. | 691607 | Ref. No. | 201006 |
| description | tank inlet connection 1/2" WS 34 L1 20mm L2 34mm with non-return valve | | |
| For models: | 1320401-00, 1320401-01, 1420401-00, 1420401-01, 1420405-00, 2020401-00, 2020401-01, 2120401-00, 2120401-01 | | |

water cycle components





supply filters



| | | | |
|--------------------|---|-----------------|--------|
| GEV No. | 692893 | Ref. No. | 201134 |
| description | screen H 14mm ø 19.5mm plastic | | |
| For models: | 1422807B03, 1422807B04, 1422831-00, 1422832-00, 1422833-00, 1422834-00, 1422902-03, 1422902-04, 1422908-00, 1422910-00, 1423901-00, 1423901-01, 1423901-02, 1423902-00, 1423902-01, 1423902-02, 1423903-00, 1423903-01, 1423903-02, 1462831-00, 1462832-00, 1462833-00, 1462834-00, 1462835-00, 1462836-00, 1462837-00, 1462838-00, 1462839-00, 1462840-00, 1462908-00, 1462910-00, 2022802B08, 2022802B09, 2022802B10, 2022802C08, 2022802C09, 2022802C10, 2022802D00, 2022802D01, 2022802D02, 2022804B08, 2022804B09, 2022804B10, 2022804C08, 2022804C09, 2022804C10, 2022804D00, 2022804D01, 2022804D02, 2022805B08... (Other models you can see in the webshop) | | |

steam valves



| | | | |
|---|---|-----------------|-------------------|
| GEV No. | 541544 | Ref. No. | 201052 |
| description | steam valve angled connection 1" IT - 1" ET total length 82mm H 136mm brass | | |
| For models: | 1412831-00, 1412832-00, 1412833-00, 1412834-00, 1412908-00, 1412910-00, 2012801-00, 2012801-01, 2012801A00, 2012801A01, 2012801B00, 2012801B01, 2012801C00, 2012801C01, 2012802-00, 2012802-01, 2012802A00, 2012802A01, 2012802B00, 2012802B01, 2012802B02, 2012802B03, 2012802B04, 2012802B05, 2012802B06, 2012802B07, 2012802C00, 2012802C01, 2012803-00, 2012803-01, 2012803A00, 2012803A01, 2012803B00, 2012803B01, 2012803C00, 2012803C01, 2012804-00, 2012804-01, 2012804A00, 2012804A01, 2012804B00, 2012804B01, 2012804B02, 2012804B03, 2012804B04, 2012804B05, 2012804B06, 2012804B07, 2012804C00, 2012804C01... (Other models you can see in the webshop) | | |
| spare parts for | 541544 | | |
|  | GEV No. | 540229 | Ref. No. — |
| | star handle shaft 9x9mm ø 80mm L 23mm black thermoplastic | | |
|  | GEV No. | 541546 | Ref. No. — |
| | screw chrome-plated brass thread M5 thread L 10mm | | |
|  | GEV No. | 541548 | Ref. No. — |
| | gasket PTFE ID ø 15mm H 7mm for thread 1 1/4" ED ø 35mm | | |
|  | GEV No. | 541554 | Ref. No. — |
| | gasket copper ext. ø 49 ID ø 42mm H 2mm for thread 1 1/4" | | |

ancillary products

clamps

hose clamps

DIN 3017 - W2



| | | | |
|--------------------|--|-----------------|--------------------------------|
| GEV No. | 520113 | Ref. No. | 208045 W1 Stahl verzinkt 1 Stk |
| description | hose clamp ø 16-27mm width 9mm Qty 10 pcs DIN 3017 | | |

DIN 3017 - W4



| | | | |
|--------------------|---|-----------------|--------|
| GEV No. | 520120 | Ref. No. | 208049 |
| description | hose clamp SS W4 ø 12-20mm width 9mm Qty 1 pcs DIN 3017 | | |
| For models: | CCE60, CCE63, CGE11-L, CGE11-R, CGE12-L, CGE12-R, CGE21-L, CGE21-R, CGE22-L, CGE22-R, CGE61-L, CGE61-R, CGE62-L, CGE62-R, CGG11-L, CGG11-R, CGG12-L, CGG12-R, CGG21-L, CGG21-R, CGG22-L, CGG22-R, CGG61-L, CGG61-R, CGG62-L, CGG62-R, CPE60, CPE63, CSE11-L, CSE11-R, CSE11-R-DG, CSE12-L, CSE12-R, CSE12-R-DG, CSE21-L, CSE21-R, CSE21-R-DG, CSE22-L, CSE22-R, CSE22-R-DG, CSE61-L, CSE61-R, CSE61-R-DG, CSE62-L, CSE62-R, CSE62-R-DG, CSG11-L, CSG11-R, CSG11-R-DG, CSG12-L...(Other models you can see in the webshop) | | |

fastening material

rivets/rivet nuts

blind rivet nuts hexagonal



| | | | |
|--------------------|--|-----------------|--------|
| GEV No. | 551382 | Ref. No. | 208039 |
| description | rivet nut thread M8 DN 11mm L 16.4mm SS Qty 1 pcs | | |
| For models: | CGE11-L, CGE11-R, CGE12-L, CGE12-R, CGE21-L, CGE21-R, CGE22-L, CGE22-R, CGE61-L, CGE61-R, CGE62-L, CGE62-R, CGG11-L, CGG11-R, CGG12-L, CGG12-R, CGG21-L, CGG21-R, CGG22-L, CGG22-R, CGG61-L, CGG61-R, CGG62-L, CGG62-R, CSE11-L, CSE11-R, CSE11-R-DG, CSE12-L, CSE12-R, CSE12-R-DG, CSE21-L, CSE21-R, CSE21-R-DG, CSE22-L, CSE22-R, CSE22-R-DG, CSE61-L, CSE61-R, CSE61-R-DG, CSE62-L, CSE62-R, CSE62-R-DG, CSG11-L, CSG11-R, CSG11-R-DG, CSG12-L, CSG12-R, CSG12-R-DG, CSG21-L, CSG21-R...(Other models you can see in the webshop) | | |

tools

hand tools

screwdrivers

nut spinners



| | | | |
|--------------------|--|-----------------|--------|
| GEV No. | 801436 | Ref. No. | 204206 |
| description | nut spinner size 6x6mm total length 213mm blade length 125mm square | | |
| For models: | 0220301-00, 0220301B00, 0220301B01, 0220301B02, 0220302-00, 0220302A00, 0220302A01, 0220302A02, 0220302A03, 0220302B00, 0220302B01, 0220302B02, 0220302C00, 0220302C01, 0220302C02, 0220302C03, 0220302F00, 0220303-00, 0220303-01, 0220303A00, 0220303A01, 0220303A02, 0220303A03, 0220303B00, 0220303B01, 0220303C00, 0220303C01, 0220303C02, 0220304-00, 0220305-00, 0220306-00, 0220501-00, 0220502-00, 0220503-00, 0220802-00, 0221501-00, 0221502-00, 0260301-00, 0260301-01, 0260302-00, 0260302-01, 0260501-00, 0520303-00, 0520303-01, 0520303-02, 1020510-00, 1022603-00, 1220301-00, 1220301-01, 1220301-02...(Other models you can see in the webshop) | | |

screws

sheet metal screws



| | | | |
|--------------------|---|-----------------|--------|
| GEV No. | 560102 | Ref. No. | 111202 |
| description | sheet metal screws ø 3.9mm L 9.5mm SS Qty 20 pcs DIN 7981/ISO 7049 head ø 7.5mm oval head | | |

countersunk screws



| | | | |
|--------------------|--|-----------------|--------|
| GEV No. | 560263 | Ref. No. | 105470 |
| description | countersunk screw thread M4 L 25mm SS DIN 963/ISO 2009 Qty 20 pcs intake slotted head ø 7.5mm | | |
| For models: | CGE21-L, CGE21-R, CGE22-L, CGE22-R, CGG11-L, CGG11-R, CGG12-L, CGG12-R, CGG21-L, CGG21-R, CGG22-L, CGG22-R, CGG61-L, CGG61-R, CGG62-L, CGG62-R, CSE21-L, CSE21-R, CSE21-R-DG, CSE22-L, CSE22-R, CSE22-R-DG, CSG11-L, CSG11-R, CSG11-R-DG, CSG12-L, CSG12-R, CSG12-R-DG, CSG21-L, CSG21-R, CSG21-R-DG, CSG22-L, CSG22-R, CSG22-R-DG, CSG61-L, CSG61-R, CSG61-R-DG, CSG62-L, CSG62-R, CSG62-R-DG | | |

| | | | |
|--------------------|--|-----------------|--------|
| GEV No. | 560425 | Ref. No. | 105466 |
| description | countersunk screw thread M4 L 13mm stainless steel DIN 965/ISO 7046 Qty 1 pcs head ø 7.5mm | | |

measuring equipment

thermometers

built-in thermometers





| | | | |
|--------------------|--|-----------------|--------|
| GEV No. | 541411 | Ref. No. | 201562 |
| description | thermometer mounting measurements 58x25.5mm 0 up to +250°C capillary pipe 2100mm probe ø 6mm probe L 200mm | | |
| For models: | 0260301-00, 0260301-01, 0260302-00, 0260302-01, 1260301-00, 1260301-01, 1260302-00, 1260302-01, 1460302-00, 1460302-01, 1460302-02, 2020303-00, 2020303-01, 2020303-02, 2020303-03, 2020303-04, 2020303A00, 2020310-00, 2020310-01, 2020310-02, 2020310-03, 2020310A00, 2020310A01, 2020310A02, 2020310A03, 2020311-00, 2020311-01, 2020311-02, 2020311-03, 2020311A00, 2020311A01, 2020311A02, 2020311A03, 2020339A00, 2020339A01, 2020340A00, 2020340A01, 2060301-00, 2060301-01, 2060301-02, 3020310-00, 3020310-01, 3020310A00, 3020310A01, 3020311-00, 3020311-01, 3020311A00, 3020311A01 | | |



| flat-headed bolts | | | |
|---|---|-----------------|--------|
|  | | | |
| GEV No. | 560635 | Ref. No. | 105008 |
| description | flat-headed bolt thread M3 thread L 6mm with plain washer | | |
| For models: | CCE60, CCE63, CGE11-L, CGE11-R, CGE12-L, CGE12-R, CGE21-L, CGE21-R, CGE22-L, CGE22-R, CGE61-L, CGE61-R, CGE62-L, CGE62-R, CGG11-L, CGG11-R, CGG12-L, CGG12-R, CGG21-L, CGG21-R, CGG22-L, CGG22-R, CGG61-L, CGG61-R, CGG62-L, CGG62-R, CPE60, CPE63, CSE11-L, CSE11-R, CSE11-R-DG, CSE12-L, CSE12-R, CSE12-R-DG, CSE21-L, CSE21-R, CSE21-R-DG, CSE22-L, CSE22-R, CSE22-R-DG, CSE61-L, CSE61-R, CSE61-R-DG, CSE62-L, CSE62-R, CSE62-R-DG, CSG11-L, CSG11-R, CSG11-R-DG, CSG12-L...(Other models you can see in the webshop) | | |

| | | | |
|---|--|-----------------|--------|
|  | | | |
| GEV No. | 560626 | Ref. No. | 105001 |
| description | flat-headed bolt thread M4 thread L 8mm head ø 8mm head thickness 3mm torx | | |
| For models: | 0021130A00, 0021130A01, 0021135A00, 0220601-00, 0521704-06, 0521704-07, 0521705-01, 0720325-03, 0720325-04, 0720325B03, 0720325B04, 0720332P00, 0720332R00, 0720332T00, 0720332V00, 0721134-01, 0721134A01, 0721172A01, 0721173A01, 0721174A01, 0721175A01, 0723104-03, 0723104A03, 0723104B03, 0723105-03, 0723105A03, 0723105B03, 0723405-01, 0723405-02, 0723409-01, 0723409-02, 0723412K01, 0723413-02, 0723414-02, 1003601-00, 1003602-00, 1020510-00, 1021130A00, 1021135A00, 1022512-00, 1022603-00, 1023101-00, 1023101-01, 1023106-00, 1023106-01, 1023111-00, 1023111-01, 1023401-00, 1023401K00, 1023410-00...(Other models you can see in the webshop) | | |

| | | | |
|---|--|-----------------|--------|
|  | | | |
| GEV No. | 511004 | Ref. No. | 105115 |
| description | flat-headed bolt thread M4 thread L 12mm SS DIN 84/ISO 1207 Qty 1 pcs intake slotted L 14.5mm | | |
| For models: | 0120101-00, 0120101-01, 0120101-02, 0120101-03, 0120101-04, 0120101C00, 0120101D00, 0120101D01, 0120101D02, 0120101D04, 0120105-00, 0120105-01, 0120105-02, 0120105-03, 0120105-04, 0120105C00, 0120105D00, 0120105D01, 0120105D02, 0120105D04, 0120201-00, 0120201-01, 0220301-00, 0220301B00, 0220301B01, 0220301B02, 0220301D00, 0220302-00, 0220302A00, 0220302A01, 0220302A02, 0220302A03, 0220302B00, 0220302B01, 0220302B02, 0220302C00, 0220302C01, 0220302C02, 0220302C03, 0220302D00, 0220302E00, 0220302E01, 0220302F00, 0220302H00, 0220302H01, 0220303-00, 0220303-01, 0220303A00, 0220303A01, 0220303A02...(Other models you can see in the webshop) | | |

| | | | |
|---|---|-----------------|--------|
|  | | | |
| GEV No. | 560454 | Ref. No. | 105121 |
| description | flat-headed bolt thread M4 thread L 22mm SS DIN 84/ISO 1207 Qty 1 pcs intake slotted head ø 7mm head thickness 2.5mm | | |
| For models: | 0220301-00, 0220301B00, 0220301B01, 0220301B02, 0220301D00, 0220302-00, 0220302A00, 0220302A01, 0220302A02, 0220302A03, 0220302B00, 0220302B01, 0220302B02, 0220302C00, 0220302C01, 0220302C02, 0220302C03, 0220302D00, 0220302E00, 0220302E01, 0220302F00, 0220303-00, 0220303-01, 0220303A00, 0220303A01, 0220303A02, 0220303A03, 0220303B00, 0220303B01, 0220303C00, 0220303C01, 0220303C02, 0220303D00, 0220303D01, 0220303E00, 0220303E01, 0220304-00, 0220305-00, 0220306-00, 0521704-0, 0521704-03, 0521704-04, 0521704-05, 0521704-06, 0521704-07, 0521704A01, 0521705-01, 1424814-01, 1424814A00, 1424815-01...(Other models you can see in the webshop) | | |

| raised countersunk head screws | | | |
|--|---|-----------------|--------|
|  | | | |
| GEV No. | 560627 | Ref. No. | 105466 |
| description | raised countersunk head screw thread M4 thread L 12mm SS DIN 966/ISO 7047 Qty 1 pcs head thickness 3mm | | |
| For models: | CCE60, CCE63, CGE11-L, CGE11-R, CGE12-L, CGE12-R, CGE21-L, CGE21-R, CGE22-L, CGE22-R, CGE61-L, CGE61-R, CGE62-L, CGE62-R, CGG11-L, CGG11-R, CGG12-L, CGG12-R, CGG21-L, CGG21-R, CGG22-L, CGG22-R, CGG61-L, CGG61-R, CGG62-L, CGG62-R, CPE60, CPE63, CSE11-L, CSE11-R, CSE11-R-DG, CSE12-L, CSE12-R, CSE12-R-DG, CSE21-L, CSE21-R, CSE21-R-DG, CSE22-L, CSE22-R, CSE22-R-DG, CSE61-L, CSE61-R, CSE61-R-DG, CSE62-L, CSE62-R, CSE62-R-DG, CSG11-L, CSG11-R, CSG11-R-DG, CSG12-L...(Other models you can see in the webshop) | | |

| | | | |
|--|--|-----------------|--------|
|  | | | |
| GEV No. | 560634 | Ref. No. | 105471 |
| description | raised countersunk head screw thread M4 thread L 40mm SS Qty 1 pcs intake slotted head ø 7.3mm | | |
| For models: | CGE11-L, CGE11-R, CGE12-L, CGE12-R, CGE21-L, CGE21-R, CGE22-L, CGE22-R, CGE61-L, CGE61-R, CGE62-L, CGE62-R, CGG11-L, CGG11-R, CGG12-L, CGG12-R, CGG21-L, CGG21-R, CGG22-L, CGG22-R, CGG61-L, CGG61-R, CGG62-L, CGG62-R, CPE60, CPE63, CSE11-L, CSE11-R, CSE11-R-DG, CSE12-L, CSE12-R, CSE12-R-DG, CSE21-L, CSE21-R, CSE21-R-DG, CSE22-L, CSE22-R, CSE22-R-DG, CSE61-L, CSE61-R, CSE61-R-DG, CSE62-L, CSE62-R, CSE62-R-DG, CSG11-L, CSG11-R, CSG11-R-DG, CSG12-L, CSG12-R, CSG12-R-DG, CSG21-L, CSG21-R...(Other models you can see in the webshop) | | |

| hexagonal screws | | | |
|---|--|-----------------|--------|
|  | | | |
| GEV No. | 560311 | Ref. No. | 101451 |
| description | hexagonal screw thread M10 thread L 20mm SS W5 17 Qty 1 pcs DIN 933 / ISO 4017 | | |
| For models: | CCE60, CGE11-L, CGE11-R, CGE12-L, CGE12-R, CGE21-L, CGE21-R, CGE22-L, CGE22-R, CGE61-L, CGE61-R, CGE62-L, CGE62-R, CGG11-L, CGG11-R, CGG12-L, CGG12-R, CGG21-L, CGG21-R, CGG22-L, CGG22-R, CGG61-L, CGG61-R, CGG62-L, CGG62-R, CPE60, CSE11-L, CSE11-R, CSE11-R-DG, CSE12-L, CSE12-R, CSE12-R-DG, CSE21-L, CSE21-R, CSE21-R-DG, CSE22-L, CSE22-R, CSE22-R-DG, CSE61-L, CSE61-R, CSE61-R-DG, CSE62-L, CSE62-R, CSE62-R-DG, CSG11-L, CSG11-R, CSG11-R-DG, CSG12-L, CSG12-R, CSG12-R-DG...(Other models you can see in the webshop) | | |

| | | | |
|---|---|-----------------|--------|
|  | | | |
| 1 | | | |
| GEV No. | 560081 | Ref. No. | 101412 |
| description | hexagonal screw thread M4 thread L 10mm SS WS 7 Qty 20 pcs DIN 933 / ISO 4017 | | |
| For models: | 0021130A00, 0021130A01, 0021135A00, 0120101-01, 0120101-02, 0120101-03, 0120101-04, 0120101D00, 0120101D01, 0120101D02, 0120101D04, 0120105-01, 0120105-02, 0120105-03, 0120105-04, 0120105D00, 0120105D01, 0120105D02, 0120105D04, 0221107-00, 0221107A00, 0221108-00, 0221109-00, 0221109A00, 0221110-00, 0263401-00, 0520302-01, 0520302-02, 0520302A00, 0520302A01, 0521702A03, 0521702A04, 0521704-00, 0521704-01, 0521704-02, 0521704-03, 0521704-04, 0521704-05, 0521704-06, 0521704-07, 0521704A00, 0521704A01, 0521705-00, 0521705-01, 0521706-00, 0522101-00, 0522101-01, 0522101-02, 0522101-03, 0522101-04... (Other models you can see in the webshop) | | |

| | | | |
|---|--|-----------------|--------|
|  | | | |
| 1 | | | |
| GEV No. | 560086 | Ref. No. | 101405 |
| description | hexagonal screw thread M6 thread L 10mm SS WS 10 Qty 20 pcs DIN 933 / ISO 4017 | | |

| | | | |
|---|--|-----------------|--------|
|  | | | |
| 1 | | | |
| GEV No. | 550682 | Ref. No. | 101435 |
| description | hexagonal screw thread M8 thread L 20mm SS WS 13 Qty 1 pcs DIN 933 / ISO 4017 | | |
| For models: | CCE60, CCE63, CGE11-L, CGE11-R, CGE12-L, CGE12-R, CGE21-L, CGE21-R, CGE22-L, CGE22-R, CGE61-L, CGE61-R, CGE62-L, CGE62-R, CGG11-L, CGG11-R, CGG12-L, CGG12-R, CGG21-L, CGG21-R, CGG22-L, CGG22-R, CGG61-L, CGG61-R, CGG62-L, CGG62-R, CPE60, CPE63, CSE11-L, CSE11-R, CSE11-R-DG, CSE12-L, CSE12-R, CSE12-R-DG, CSE21-L, CSE21-R, CSE21-R-DG, CSE22-L, CSE22-R, CSE22-R-DG, CSE61-L, CSE61-R, CSE61-R-DG, CSE62-L, CSE62-R, CSE62-R-DG, CSG11-L, CSG11-R, CSG11-R-DG, CSG12-L... (Other models you can see in the webshop) | | |

cylinder head bolts

DIN 912/ISO 4762

| | | | |
|--|---|-----------------|--------|
|  | | | |
| 1 | | | |
| GEV No. | 560305 | Ref. No. | 102008 |
| description | cylinder head bolt thread M5 thread L 16mm WS 4 intake internal hexagon DIN 912/ISO 4762 | | |
| For models: | 0720325-03, 0720325-04, 0720325B03, 0720325B04, 0720332P00, 0720332R00, 0720332T00, 0720332V00, 1220301-00, 1220301-01, 1220301-02, 1220301-03, 1220301-04, 1220301B00, 1220301B01, 1220301B02, 1220301B03, 1220301B04, 1220301D00, 1220301D01, 1220301E00, 1220301E01, 1220301J00, 1220301J01, 1220301J02, 1220301J03, 1220302-00, 1220302-01, 1220302B00, 1220302B01, 1220302D00, 1220302E00, 1220303-00, 1220303-01, 1220303-02, 1220303-03, 1220303-04, 1220303-05, 1220303A00, 1220303A01, 1220303A02, 1220303A03, 1220303B00, 1220303B01, 1220303B02, 1220303B03, 1220303B04, 1220303B05, 1220303C00, 1220303C01... (Other models you can see in the webshop) | | |

| | | | |
|---|--|-----------------|--------|
|  | | | |
| 1 | | | |
| GEV No. | 520455 | Ref. No. | 102050 |
| description | screw thread M8 thread L 20mm WS 6 SS Qty 1 pcs DIN 912/ISO 4762 | | |
| For models: | CGE11-L, CGE11-R, CGE12-L, CGE12-R, CGE61-L, CGE61-R, CGE62-L, CGE62-R, CGG11-L, CGG11-R, CGG12-L, CGG12-R, CGG61-L, CGG61-R, CGG62-L, CGG62-R, CSE11-L, CSE11-R, CSE11-R-DG, CSE12-L, CSE12-R, CSE12-R-DG, CSE61-L, CSE61-R, CSE61-R-DG, CSE62-L, CSE62-R, CSE62-R-DG, CSG11-L, CSG11-R, CSG11-R-DG, CSG12-L, CSG12-R, CSG12-R-DG, CSG61-L, CSG61-R, CSG61-R-DG, CSG62-L, CSG62-R, CSG62-R-DG | | |

| | | | |
|---|---|-----------------|--------|
|  | | | |
| 2 | | | |
| GEV No. | 560080 | Ref. No. | 101127 |
| description | hexagonal screw thread M4 thread L 8mm SS WS 7 Qty 20 pcs DIN 933 / ISO 4017 | | |
| For models: | 0263401-01, 0522101-02, 0522101-03, 0522102-02, 0522102-03, 0720325-03, 0720325-04, 0720325B03, 0720325B04, 1220301-00, 1220301-01, 1220301-02, 1220301-03, 1220301-04, 1220301B00, 1220301B01, 1220301B02, 1220301B03, 1220301B04, 1220301D00, 1220301D01, 1220301E00, 1220301E01, 1220301J00, 1220301J01, 1220301J02, 1220301J03, 1220302-00, 1220302-01, 1220302B00, 1220302B01, 1220302D00, 1220302E00, 1220303-00, 1220303-01, 1220303-02, 1220303-03, 1220303-04, 1220303-05, 1220303A00, 1220303A01, 1220303A02, 1220303A03, 1220303B00, 1220303B01, 1220303B02, 1220303B03, 1220303B04, 1220303B05, 1220303C00... (Other models you can see in the webshop) | | |

| | | | |
|---|--|-----------------|--------|
|  | | | |
| 1 | | | |
| GEV No. | 560083 | Ref. No. | 101125 |
| description | hexagonal screw thread M5 thread L 10mm SS WS 8 Qty 20 pcs DIN 933 / ISO 4017 | | |
| For models: | 0021130A00, 0021130A01, 0021135A00, 0263401-00, 0263401-01, 0521704-0, 0521704-00, 0521704-01, 0521704-02, 0521704-03, 0521704-04, 0521704-05, 0521704-06, 0521704-07, 0521704A00, 0521704A01, 0521705-00, 0521705-01, 0521706-00, 1121117-00, 1121117-01, 1121117A00, 1121118-00, 1121118-01, 1121119-00, 1121119A00, 1121120-00, 1121121-00, 1121121A00, 1121135A01, 1203603-00, 1204012-00, 1204012-01, 1204014-00, 1204014-01, 1204015-00, 1204015-01, 1204017-00, 1204017-01, 1204018-00, 1204018-01, 1204019-00, 1204019-01, 1220301-00, 1220301B00, 1220301D00, 1220301E00, 1220302-00, 1220302-01, 1220302B00... (Other models you can see in the webshop) | | |

| | | | |
|---|--|-----------------|--------|
|  | | | |
| 1 | | | |
| GEV No. | 560084 | Ref. No. | 101403 |
| description | hexagonal screw thread M5 thread L 16mm SS WS 8 Qty 20 pcs DIN 933 / ISO 4017 | | |
| For models: | CCE60, CCE63, CGG11-L, CGG11-R, CGG12-L, CGG12-R, CGG21-L, CGG21-R, CGG22-L, CGG22-R, CGG61-L, CGG61-R, CGG62-L, CGG62-R, CPE60, CPE63, CSG11-L, CSG11-R, CSG11-R-DG, CSG12-L, CSG12-R, CSG12-R-DG, CSG21-L, CSG21-R, CSG21-R-DG, CSG22-L, CSG22-R, CSG22-R-DG, CSG61-L, CSG61-R, CSG61-R-DG, CSG62-L, CSG62-R, CSG62-R-DG | | |



side bolts

| | | | |
|--|---|-----------------|--------|
|  <p>1</p> | | | |
| GEV No. | 560051 | Ref. No. | 118005 |
| description | side bolts thread M4 L 16mm SS Qty 20 pcs intake slotted head ø 10mm | | |
| For models: | 0021130A00, 0021130A01, 0021135A00, 0120101-00, 0120101-01, 0120101-02, 0120101-03, 0120101-04, 0120101C00, 0120101D00, 0120101D01, 0120101D02, 0120101D04, 0120105-00, 0120105-01, 0120105-02, 0120105-03, 0120105-04, 0120105C00, 0120105D00, 0120105D01, 0120105D02, 0120105D04, 0120202-00, 0120202-01, 0120203-00, 0120203-01, 0203601-00, 0203602-00, 0203603-00, 0204601-00, 0220301-00, 0220301B00, 0220301B01, 0220301B02, 0220301D00, 0220302-00, 0220302A00, 0220302A01, 0220302A02, 0220302A03, 0220302B00, 0220302B01, 0220302B02, 0220302C00, 0220302C01, 0220302C02, 0220302C03, 0220302D00, 0220302E00... (Other models you can see in the webshop) | | |

| | | | |
|--|---|-----------------|--------|
|  <p>1</p> | | | |
| GEV No. | 560053 | Ref. No. | 118009 |
| description | side bolts thread M5 L 16mm SS Qty 20 pcs intake slotted head ø 12.5mm | | |
| For models: | 1203603-00, 1204012-00, 1204014-00, 1204015-00, 1204017-00, 1204018-00, 1204019-00, 1303703-00, 1303703-01, 1420309A01, 1420309A02, 1420309A03, 1420309C01, 1420309C02, 1420309C03, 1420310A01, 1420310A02, 1420310A03, 1420310A04, 1420310A05, 1420310C01, 1420310C02, 1420310C03, 1420310C04, 1420310C05, 1420325A00, 1420325A01, 1420325A02, 1420325A03, 1420325C00, 1420325C01, 1420325C02, 1420325C03, 1420327A00, 1420327A01, 1420327C00, 1420327C01, 1420329A00, 1420329A01, 1420329C00, 1420329C01, 1420330A00, 1420330A01, 1420330A02, 1420330A03, 1420330C00, 1420330C01, 1420330C02, 1420330C03, 1422807B00... (Other models you can see in the webshop) | | |

grub screws

miscellaneous

| | | | |
|--|---|-----------------|--------|
|  <p>1</p> | | | |
| GEV No. | 560306 | Ref. No. | 110124 |
| description | grub screw thread M6 L 10mm DIN 915 intake internal hexagon Qty 1 pcs | | |

nuts

| | | | |
|--|---|-----------------|--------|
|  <p>1</p> | | | |
| GEV No. | 696820 | Ref. No. | 116064 |
| description | cap nuts thread M10 IT WS 17 SS Qty 1 pcs DIN/ISO 917 | | |
| For models: | 0522102-02, 0522102-03, 0522102-04, 14228011-0, 14228022-0, 14228033-0, 14228044-0, 14228055-0, 1462802B00, 1462804B00, 2012801-00, 2012801-01, 2012801A00, 2012801A01, 2012801B00, 2012801B01, 2012801C00, 2012801C01, 2012802-00, 2012802-01, 2012802A00, 2012802A01, 2012802B00, 2012802B01, 2012802C00, 2012802C01, 2012803-00, 2012803-01, 2012803A00, 2012803A01, 2012803B00, 2012803B01, 2012803C00, 2012803C01, 2012804-00, 2012804-01, 2012804A00, 2012804A01, 2012804B00, 2012804B01, 2012804C00, 2012804C01, 2012805-00, 2012805-01, 2012805A00, 2012805A01, 2012805B00, 2012805B01, 2012805C00, 2012805C01... (Other models you can see in the webshop) | | |

| | | | |
|--|--|-----------------|--------|
|  <p>1</p> | | | |
| GEV No. | 696826 | Ref. No. | 116067 |
| description | cap nuts thread M12 WS 19 SS Qty 1 pcs with bore | | |
| For models: | CCE60, CCE63, CGE11-L, CGE11-R, CGE12-L, CGE12-R, CGE21-L, CGE21-R, CGE22-L, CGE22-R, CGE61-L, CGE61-R, CGE62-L, CGE62-R, CGG11-L, CGG11-R, CGG12-L, CGG12-R, CGG21-L, CGG21-R, CGG22-L, CGG22-R, CGG61-L, CGG61-R, CGG62-L, CGG62-R, CPE60, CPE63, CSE11-L, CSE11-R, CSE11-R-DG, CSE12-L, CSE12-R, CSE12-R-DG, CSE61-L, CSE61-R, CSE61-R-DG, CSE62-L, CSE62-R, CSE62-R-DG | | |

| | | | |
|--|---|-----------------|--------|
|  <p>1</p> | | | |
| GEV No. | 696822 | Ref. No. | 116058 |
| description | cap nuts thread M6 WS 10 SS Qty 1 pcs DIN/ISO 917 | | |
| For models: | 0720332P00, 0720332R00, 0720332T00, 0720332V00, 1220301J02, 1220301J03, 1220303J03, 1220303J04, 1220303K00, 1220303K01, 1220305J03, 1220305J04, 1220305K02, 1220305K03, 1260302-00, 1260302-01, 1320401-01, 1420332P01, 1420332P02, 1420332P03, 1420332R00, 1420332R01, 1420332R02, 1420332R03, 1420332T01, 1420332T02, 1420332T03, 1420332V01, 1420332V02, 1420332V03, 1420333P01, 1420333P02, 1420333R00, 1420333R01, 1420333R02, 1420333T01, 1420333T02, 1420333V01, 1420333V02, 1420334P00, 1420334P01, 1420334P02, 1420334P03, 1420334P04, 1420334R02, 1420334R03, 1420334R04, 1420334T02, 1420334T03, 1420334T04... (Other models you can see in the webshop) | | |

hexagonal nuts

DIN 934 / ISO 4032/8673



1

| | | | |
|--------------------|---|-----------------|--------|
| GEV No. | 560223 | Ref. No. | 113081 |
| description | hexagonal nut thread M3 H 2.4mm WS 5.5 SS DIN/ISO DIN 934 / ISO 4032/8673 Qty 1 pcs | | |
| For models: | 0120201-01, 0120202-00, 0120202-01, 0120203-00, 0120203-01, 0220303A00, 0220303A01, 0220303A02, 0220303A03, 0220303C00, 0220303C01, 0220303C02, 0220306-00, 0260302-00, 0260302-01, 0521706-00, 1220303A00, 1220303A01, 1220303A02, 1220303A03, 1220303C00, 1220303C01, 1220303C02, 1220303C03, 1220303F01, 1220303F02, 1220303F03, 1220303H00, 1220303H01, 1220303H02, 1220303H03, 1220304A00, 1220304A01, 1220304A02, 1220304C00, 1220304C01, 1220304C02, 1220304F00, 1220304F01, 1220304H00, 1220304H01, 1220305A00, 1220305A01, 1220305A02, 1220305A03, 1220305A04, 1220305A05, 1220305C00, 1220305C01, 1220305C02... (Other models you can see in the webshop) | | |



1

| | | | |
|--------------------|---|-----------------|--------|
| GEV No. | 560340 | Ref. No. | 113082 |
| description | hexagonal nut thread M4 H 3.2mm WS 7 SS DIN/ISO DIN 934 / ISO 4032/8673 Qty 1 pcs | | |
| For models: | 0021130A00, 0021130A01, 0021135A00, 0120101-00, 0120101-01, 0120101-02, 0120101-03, 0120101-04, 0120101C00, 0120101D00, 0120101D01, 0120101D02, 0120101D04, 0120105-00, 0120105-01, 0120105-02, 0120105-03, 0120105-04, 0120105C00, 0120105D00, 0120105D01, 0120105D02, 0120105D04, 0120201-00, 0120201-01, 0120202-00, 0120202-01, 0120203-00, 0120203-01, 0203603-00, 0220301-00, 0220301B00, 0220301B01, 0220301B02, 0220301D00, 0220302-00, 0220302A00, 0220302A01, 0220302A02, 0220302A03, 0220302B00, 0220302B01, 0220302B02, 0220302C00, 0220302C01, 0220302C02, 0220302C03, 0220302D00, 0220302E00, 0220302E01... (Other models you can see in the webshop) | | |



1

| | | | |
|--------------------|---|-----------------|------------------|
| GEV No. | 560129 | Ref. No. | 113087 113088 |
| description | hexagonal nut thread M5 H 4mm WS 8 SS DIN/ISO DIN 934 / ISO 4032/8673 Qty 1 pcs | | |



1

| | | | |
|--------------------|---|-----------------|--------|
| GEV No. | 511212 | Ref. No. | 113091 |
| description | hexagonal nut thread M6 H 5mm WS 10 SS DIN/ISO DIN 934 / ISO 4032/8673 Qty 1 pcs | | |
| For models: | 0021130A00, 0021130A01, 0021135A00, 0203601-00, 0203602-00, 0203603-00, 0204601-00, 0220301-00, 0220301B00, 0220301B01, 0220301B02, 0220301D00, 0220302-00, 0220302A00, 0220302A01, 0220302A02, 0220302A03, 0220302B00, 0220302B01, 0220302B02, 0220302C00, 0220302C01, 0220302C02, 0220302C03, 0220302D00, 0220302E00, 0220302E01, 0220302F00, 0220302H00, 0220302H01, 0220303-00, 0220303-01, 0220303A00, 0220303A01, 0220303A02, 0220303A03, 0220303B00, 0220303B01, 0220303C00, 0220303C01, 0220303C02, 0220303D00, 0220303D01, 0220303E00, 0220303E01, 0220303H00, 0220303H01, 0220304-00, 0220305-00, 0220306-00... (Other models you can see in the webshop) | | |



1

| | | | |
|--------------------|---|-----------------|--------|
| GEV No. | 560197 | Ref. No. | 113096 |
| description | nut thread M10 H 8mm WS 17 SS DIN/ISO DIN 934 / ISO 4032/8673 Qty 1 pcs | | |
| For models: | 1220301J02, 1220301J03, 1220303J03, 1220303J04, 1220303K00, 1220303K01, 1220305J03, 1220305J04, 1220305K02, 1220305K03, 2013003B01, 2013003B02, 2013003B03, 2013003B04, 2013003B05, 2013003B06, 2013004B01, 2013004B02, 2013004B03, 2013004B04, 2013004B05, 2013007B01, 2013007B02, 2013007B03, 2013007B04, 2013007B05, 2013007B06, 2013008B01, 2013008B02, 2013008B03, 2013008B04, 2013008B05, 2013009B01, 2013009B02, 2013009B03, 2013009B04, 2013009B05, 2013009B06, 2013010B01, 2013010B02, 2013010B03, 2013010B04, 2013010B05, 2013017B00, 2013017B01, 2013017B02, 2013017B03, 2013017B04, 2013017B05, 2013018B00... (Other models you can see in the webshop) | | |



1

| | | | |
|--------------------|---|-----------------|--------|
| GEV No. | 517174 | Ref. No. | 113092 |
| description | nut thread M8 H 6.5mm WS 13 SS DIN/ISO DIN 934 / ISO 4032/8673 Qty 1 pcs | | |
| For models: | 0261301-00, 0521704-00, 0521704-01, 0521704-02, 0521704-03, 0521704-04, 0521704-05, 0521704-06, 0521704-07, 0521704A00, 0521704A01, 0521705-00, 0521705-01, 0521706-00, 1223201-00, 1223201-01, 1223207-00, 1223207-01, 1261101-01, 1261101-02, 1261102-01, 1261102-02, 1323201-00, 1323201-01, 1323201-02, 1323207-00, 1323207-02, 1323208-00, 1323208-01, 1323208-03, 1323208-04, 1361101-01, 1361101-02, 1361101-03, 1361102-01, 1361102-02, 1361102-03, 1422802B04, 1422804B04, 1422805B04, 1422807B00, 1422902-00, 1424802-00, 1424802-01, 1424802-02, 1424808-00, 1424808-01, 1424808-02, 1424808-03, 1424809-00... (Other models you can see in the webshop) | | |

DIN 985





1

| | | | |
|--------------------|--|-----------------|--------|
| GEV No. | 560227 | Ref. No. | 116041 |
| description | hexagonal nut thread M3 H 4mm WS 5.5 Qty 1 pcs self-locking | | |
| For models: | CCE60, CCE63, CGE11-L, CGE11-R, CGE12-L, CGE12-R, CGE21-L, CGE21-R, CGE22-L, CGE22-R, CGE61-L, CGE61-R, CGE62-L, CGE62-R, CGG11-L, CGG11-R, CGG12-L, CGG12-R, CGG21-L, CGG21-R, CGG22-L, CGG22-R, CGG61-L, CGG61-R, CGG62-L, CGG62-R, CPE60, CPE63, CSE11-L, CSE11-R, CSE11-R-DG, CSE12-L, CSE12-R, CSE12-R-DG, CSE21-L, CSE21-R, CSE21-R-DG, CSE22-L, CSE22-R, CSE22-R-DG, CSE61-L, CSE61-R, CSE61-R-DG, CSE62-L, CSE62-R, CSE62-R-DG, CSG11-L, CSG11-R, CSG11-R-DG, CSG12-L... (Other models you can see in the webshop) | | |





| | | | |
|---|--|-----------------|------------------|
|  | | | |
| 1 | | | |
| GEV No. | 560140 | Ref. No. | 113014 116042 |
| description | hexagonal nut thread M4 H 4.8mm SS WS 7 Qty 20 pcs DIN/ISO DIN 985 self-locking | | |
| For models: | CCE60, CCE63, CGE11-L, CGE11-R, CGE12-L, CGE12-R, CGE21-L, CGE21-R, CGE22-L, CGE22-R, CGE61-L, CGE61-R, CGE62-L, CGE62-R, CGG11-L, CGG11-R, CGG12-L, CGG12-R, CGG21-L, CGG21-R, CGG22-L, CGG22-R, CGG61-L, CGG61-R, CGG62-L, CGG62-R, CPE60, CPE63, CSE11-L, CSE11-R, CSE11-R-DG, CSE12-L, CSE12-R, CSE12-R-DG, CSE21-L, CSE21-R, CSE21-R-DG, CSE22-L, CSE22-R, CSE22-R-DG, CSE61-L, CSE61-R, CSE61-R-DG, CSE62-L, CSE62-R, CSE62-R-DG, CSG11-L, CSG11-R, CSG11-R-DG, CSG12-L, CSG12-R, CSG12-R-DG, CSG21-L, CSG21-R, CSG21-R-DG, CSG22-L, CSG22-R, CSG22-R-DG, CSG61-L, CSG61-R, CSG61-R-DG, CSG62-L, CSG62-R, CSG62-R-DG | | |

| | | | |
|---|--|-----------------|--------|
|  | | | |
| 2 | | | |
| GEV No. | 560141 | Ref. No. | 116061 |
| description | hexagonal nut thread M5 H 5.4mm SS WS 8 Qty 20 pcs DIN/ISO DIN 985 self-locking | | |
| For models: | CCE60, CCE63, CGG11-L, CGG11-R, CGG12-L, CGG12-R, CGG21-L, CGG21-R, CGG22-L, CGG22-R, CGG61-L, CGG61-R, CGG62-L, CGG62-R, CPE60, CPE63, CSG11-L, CSG11-R, CSG11-R-DG, CSG12-L, CSG12-R, CSG12-R-DG, CSG21-L, CSG21-R, CSG21-R-DG, CSG22-L, CSG22-R, CSG22-R-DG, CSG61-L, CSG61-R, CSG61-R-DG, CSG62-L, CSG62-R, CSG62-R-DG | | |

| | | | |
|--|--|-----------------|--------|
|  | | | |
| 1 | | | |
| GEV No. | 560142 | Ref. No. | 116063 |
| description | hexagonal nut thread M6 H 6mm SS WS 10 Qty 20 pcs DIN/ISO DIN 985 self-locking | | |
| For models: | CCE60, CCE63, CGE11-L, CGE11-R, CGE12-L, CGE12-R, CGE21-L, CGE21-R, CGE22-L, CGE22-R, CGE61-L, CGE61-R, CGE62-L, CGE62-R, CGG11-L, CGG11-R, CGG12-L, CGG12-R, CGG21-L, CGG21-R, CGG22-L, CGG22-R, CGG61-L, CGG61-R, CGG62-L, CGG62-R, CPE60, CPE63, CSE11-L, CSE11-R, CSE11-R-DG, CSE12-L, CSE12-R, CSE12-R-DG, CSE61-L, CSE61-R, CSE61-R-DG, CSE62-L, CSE62-R, CSE62-R-DG, CSG11-L, CSG11-R, CSG11-R-DG, CSG12-L, CSG12-R, CSG12-R-DG, CSG21-L, CSG21-R, CSG21-R-DG, CSG22-L, CSG22-R, CSG22-R-DG, CSG61-L, CSG61-R, CSG61-R-DG, CSG62-L, CSG62-R, CSG62-R-DG | | |

| | | | |
|---|--|-----------------|--------|
|  | | | |
| 1 | | | |
| GEV No. | 560143 | Ref. No. | 121124 |
| description | hexagonal nut thread M8 H 8.5mm SS WS 13 Qty 20 pcs DIN/ISO DIN 985 self-locking | | |
| For models: | 2012827-00, 2012827-01, 2012827-02, 2012828-00, 2012828-01, 2012828-02, 2012828-03, 2012828-04, 2012828-05, 2012829-00, 2012829-01, 2012829-02, 2022827-00, 2022827-01, 2022828-01, 2022828-02, 2022828-03, 2022828-04, 2022828-05, 2022828-06, 2022829-00, 2022829-01, 2061603-00, 2061603-01, 2061603-02, 3012827-00, 3012827-01, 3012827-02, 3012828-00, 3012828-01, 3012828-02, 3012828-03, 3012828-04, 3012828-05, 3012829-00, 3012829-01, 3012829-02, 3022827-00, 3022827-01, 3022828-03, 3022828-04, 3022828-05, 3022828-06, 3022828-07, 3022829-00, 3022829-01, CCE60, CCE63, CGE11-L, CGE11-R...(Other models you can see in the webshop) | | |

| | | | |
|---|--|-----------------|--------|
|  | | | |
| 1 | | | |
| DIN 439 / ISO 4035/8675 | | | |
| GEV No. | 560653 | Ref. No. | 113097 |
| description | nut thread M12 H 6mm SS WS 19 Qty 1 pcs DIN/ISO 439 | | |
| For models: | CCE60, CCE63, CGE11-L, CGE11-R, CGE12-L, CGE12-R, CGE21-L, CGE21-R, CGE22-L, CGE22-R, CGE61-L, CGE61-R, CGE62-L, CGE62-R, CGG11-L, CGG11-R, CGG12-L, CGG12-R, CGG21-L, CGG21-R, CGG22-L, CGG22-R, CGG61-L, CGG61-R, CGG62-L, CGG62-R, CPE60, CPE63, CSE11-L, CSE11-R, CSE11-R-DG, CSE12-L, CSE12-R, CSE12-R-DG, CSE61-L, CSE61-R, CSE61-R-DG, CSE62-L, CSE62-R, CSE62-R-DG, CSG11-L, CSG11-R, CSG11-R-DG, CSG12-L, CSG12-R, CSG12-R-DG, CSG21-L, CSG21-R, CSG21-R-DG, CSG22-L, CSG22-R, CSG22-R-DG, CSG61-L, CSG61-R, CSG61-R-DG, CSG62-L, CSG62-R, CSG62-R-DG | | |

| | | | |
|---|---|-----------------|--------|
|  | | | |
| 1 | | | |
| hexagonal nuts metric (without norm) | | | |
| GEV No. | 521101 | Ref. No. | 113000 |
| description | nut thread M14x1.5 H 5mm WS 19 SS Qty 1 pcs | | |
| For models: | 00217022-0, 0120101-00, 0120101-01, 0120101-02, 0120101-03, 0120101-04, 0120101C00, 0120101D00, 0120101D01, 0120101D02, 0120101D04, 0120105-00, 0120105-01, 0120105-02, 0120105-03, 0120105-04, 0120105C00, 0120105D00, 0120105D01, 0120105D02, 0120105D04, 0120201-00, 0120201-01, 0120202-00, 0120202-01, 0120203-00, 0120203-01, 0220301-00, 0220301B00, 0220301B01, 0220301B02, 0220301D00, 0220302-00, 0220302A00, 0220302A01, 0220302A02, 0220302A03, 0220302B00, 0220302B01, 0220302B02, 0220302C00, 0220302C01, 0220302C02, 0220302C03, 0220302D00, 0220302E00, 0220302E01, 0220302F00, 0220302H00, 0220302H01... (Other models you can see in the webshop) | | |

| | | | |
|---|---|-----------------|--------|
|  | | | |
| 1 | | | |
| GEV No. | 102067 | Ref. No. | 201524 |
| description | nut thread M8x1 H 3mm brass Qty 1 pcs type SEF 1 | | |
| For models: | 0260301-00, 0260302-00, 0260501-00, 0261101-00, 0261101-01, 0261102-00, 0261102-01, 0261103-00, 0261103-01, 0261301-00, 0261601-00, 0263401-00, 0263401-01, 1263401-00, 1263402-00, 1263402-01, 1263402-02, 1263404-00, 1263404-01, 1263404-02, 1263405-00, 1263405-01, 1263413-02, 1263414-02, 1363401-00, 1363402-00, 1363402-01, 1363402-02, 1363403-00, 1363403-01, 1363403-02, 1363403-03, 1363403-04, 1363403-05, 1363404-00, 1363404-01, 1363404-02, 1363404-03, 1363405-00, 1363405-01, 1363413-03, 1363415-05, 14621011-0, 1462831-00, 1462832-00, 1462833-00, 1462834-00, 1462835-00, 1462836-00, 1462837-00... (Other models you can see in the webshop) | | |

miscellaneous



1

| GEV No. | 560548 | Ref. No. | 208025 |
|-------------|--|----------|--------|
| description | nut thread M4 Qty 1 pcs | | |
| For models: | 0021130A00, 0021130A01, 0021135A00, 02211107-00, 0221107A00, 0221108-00, 0221109-00, 0221109A00, 0221110-00, 0521702-01, 0521702-02, 0521702-03, 0521702-04, 0521702A02, 0521702A03, 0521702A04, 0521702B03, 0521702B04, 0521702C04, 0521704-04, 0521704-05, 0521704-06, 0521704-07, 0522101-03, 0522101-04, 0522102-03, 0522102-04, 0721134-01, 0721134A01, 0721172A01, 0721173A01, 0721174A01, 0721175A01, 0722101-06, 0723412K01, 1003601-00, 1003602-00, 1020510-00, 1021130A00, 1021135A00, 1022512-00, 1022603-00, 1023101-00, 1023101-01, 1023106-00, 1023106-01, 1023111-00, 1023111-01, 1023401-00, 1023401K00... (Other models you can see in the webshop) | | |

washers

spring rings



1

| GEV No. | 560655 | Ref. No. | 121035 |
|-------------|---|----------|--------|
| description | lock washer ID ø 10.5mm ext. ø 18.1mm max. spring steel DIN 127A Qty 1 pcs for thread M10 | | |
| For models: | 1412831-00, 1412832-00, 1412833-00, 1412833-01, 1412834-00, 1412834-01, 1412908-00, 1412910-00, 1412910-01, 1422701-00, 1422701-01, 1422701-02, 1422701-03, 1422702-00, 1422702-01, 1422702-02, 1422702-03, 1422703-00, 1422703-01, 1422703-02, 1422704-00, 1422704-01, 1422704-02, 1422705-00, 1422705-01, 1422705-02, 1422706-00, 1422706-01, 1422706-02, 1422707-00, 1422707-01, 1422707-02, 1422708-00, 1422708-01, 1422708-02, 1422807B00, 1422807B01, 1422807B02, 1422807B03, 1422807B04, 1422831-00, 1422832-00, 1422833-00, 1422834-00, 1422902-00, 1422902-01, 1422902-02, 1422902-03, 1422902-04, 1422908-00... (Other models you can see in the webshop) | | |



1

| GEV No. | 560657 | Ref. No. | 121030 |
|-------------|---|----------|--------|
| description | lock washer ID ø 3.1mm ext. ø 6.2mm max. spring steel DIN 127A Qty 1 pcs for thread M3 | | |
| For models: | 0120201-01, 0120202-00, 0120202-01, 0120203-00, 0120203-01, 0260302-00, 0260302-01, 0520303-02, 1420309A01, 1420309A02, 1420309C01, 1420309C02, 1420310A01, 1420310A02, 1420310A03, 1420310C01, 1420310C02, 1420310C03, 1424824-00, 1424824-01, 1462802B01, 1462802B02, 1462802B03, 1462802B04, 1462802B05, 1462804B01, 1462804B02, 1462804B03, 1462804B04, 1462804B05, 1462831-00, 1462832-00, 1462833-00, 1462834-00, 1462835-00, 1462836-00, 1462837-00, 1462838-00, 1462839-00, 1462840-00, 1462908-00, 1462910-00, 1463501-03, 1463501-04, 1463501-05, 2020301A01, 2020301A02, 2020301C01, 2020301C02, 2020302A01... (Other models you can see in the webshop) | | |



1

| GEV No. | 560122 | Ref. No. | 121032 |
|-------------|--|----------|--------|
| description | lock washer ID ø 5.2mm ED ø 9mm SS DIN127 Qty 20 pcs for thread M5 | | |
| For models: | 0021130A00, 0021130A01, 0021135A00, 0221101-01, 0221101A01, 0221102-01, 0221103-01, 0221104-01, 0221104A01, 0221105-01, 0221106-01, 0261101-01, 0261102-01, 0261103-01, 0263401-00, 0263401-01, 0521704-0, 0521704-00, 0521704-01, 0521704-02, 0521704-03, 0521704-04, 0521704-05, 0521704-06, 0521704-07, 0521704A00, 0521704A01, 0521705-00, 0521705-01, 0521706-00, 0522101-00, 0522101-02, 0522101-03, 0522101-04, 0522102-00, 0522102-02, 0522102-03, 0522102-04, 0720325-03, 0720325-04, 0720325B03, 0720325B04, 0720332P00, 0720332R00, 0720332T00, 0720332V00, 0722101-06, 1023101-01, 1023106-01, 1023111-01... (Other models you can see in the webshop) | | |



1

| GEV No. | 560656 | Ref. No. | 121034 |
|-------------|--|----------|--------|
| description | lock washer ID ø 8.1mm ext. ø 14.8mm max. spring steel DIN 127A Qty 1 pcs for thread M8 | | |
| For models: | 0120101-00, 0120101-01, 0120101-02, 0120101-03, 0120101C00, 0120101D00, 0120101D01, 0120101D02, 0120105-00, 0120105-01, 0120105-02, 0120105-03, 0120105C00, 0120105D00, 0120105D01, 0120105D02, 0521704-0, 0521704-00, 0521704-01, 0521704-02, 0521704-03, 0521704-04, 0521704-05, 0521704-06, 0521704-07, 0521704A00, 0521704A01, 0521705-00, 0521705-01, 0521706-00, 1223201-00, 1223201-01, 1223207-00, 1223207-01, 1323201-00, 1323201-01, 1323201-02, 1323207-00, 1323207-02, 1323208-00, 1323208-01, 1323208-03, 1323208-04, 1422701-00, 1422702-00, 1422802B04, 1422802B05, 1422804B04, 1422804B05, 1422805B04... (Other models you can see in the webshop) | | |

washers

DIN 125A





1

| GEV No. | 560110 | Ref. No. | 120005 |
|-------------|---|----------|--------|
| description | plain washer ID ø 3.2mm ED ø 7mm thickness 0.5mm SS Qty 20 pcs DIN 125A for thread M3 | | |
| For models: | 0220302A03, 0220302C03, 0220302H01, 0220303A00, 0220303A01, 0220303A02, 0220303A03, 0220303C00, 0220303C01, 0220303C02, 0220303H01, 0220306-00, 0520303-02, 0521706-00, 1220303A00, 1220303A01, 1220303A02, 1220303A03, 1220303C00, 1220303C01, 1220303C02, 1220303C03, 1220303F01, 1220303F02, 1220303F03, 1220303H00, 1220303H01, 1220303H02, 1220303H03, 1220305A00, 1220305A01, 1220305A02, 1220305A03, 1220305A04, 1220305A05, 1220305C00, 1220305C01, 1220305C02, 1220305C03, 1220305C04, 1220305C05, 1220305F01, 1220305F02, 1220305F03, 1220305F04, 1220305F05, 1220305H00, 1220305H01, 1220305H02, 1220305H03... (Other models you can see in the webshop) | | |



| | | | |
|---|---|-----------------|--------|
|  | | | |
| 1 | | | |
| GEV No. | 560111 | Ref. No. | 120017 |
| description | plain washer ID ø 4.3mm ED ø 9mm thickness 0.8mm SS Qty 20 pcs DIN 125A for thread M4 | | |
| For models: | 0021130A00, 0021130A01, 0021135A00, 0120101-01, 0120101-02, 0120101-03, 0120101-04, 0120101D00, 0120101D01, 0120101D02, 0120101D04, 0120105-01, 0120105-02, 0120105-03, 0120105-04, 0120105D00, 0120105D01, 0120105D02, 0120105D04, 0203603-00, 0220301-00, 0220301B00, 0220301B01, 0220301B02, 0220301D00, 0220302-00, 0220302A00, 0220302A01, 0220302A02, 0220302A03, 0220302B00, 0220302B01, 0220302B02, 0220302C00, 0220302C01, 0220302C02, 0220302C03, 0220302D00, 0220302E00, 0220302E01, 0220302F00, 0220302H00, 0220302H01, 0220303-00, 0220303-01, 0220303A00, 0220303A01, 0220303A02, 0220303A03, 0220303B00... (Other models you can see in the webshop) | | |

| | | | |
|---|--|-----------------|--------|
|  | | | |
| 1 | | | |
| GEV No. | 560114 | Ref. No. | 120108 |
| description | plain washer ID ø 8.4mm ED ø 16mm thickness 1.6mm SS Qty 20 pcs DIN 125A for thread M8 | | |
| For models: | 0120101-00, 0120101-01, 0120101-02, 0120101-03, 0120101C00, 0120101D00, 0120101D01, 0120101D02, 0120105-00, 0120105-01, 0120105-02, 0120105-03, 0120105C00, 0120105D00, 0120105D01, 0120105D02, 0521704-0, 0521704-00, 0521704-01, 0521704-02, 0521704-03, 0521704-04, 0521704-05, 0521704-06, 0521704-07, 0521704A00, 0521704A01, 0521705-00, 0521705-01, 0521706-00, 1220402-00, 1220402-01, 1220504-01, 1222601-00, 1222603-00, 1223201-00, 1223201-01, 1223207-00, 1223207-01, 1261101-00, 1261101-01, 1261101-02, 1261102-00, 1261102-01, 1261102-02, 1320402-00, 1320402-01, 1320504-01, 1320504-02, 1322601-00... (Other models you can see in the webshop) | | |

| | | | |
|---|---|-----------------|--------|
|  | | | |
| 2 | | | |
| GEV No. | 560112 | Ref. No. | 120022 |
| description | plain washer ID ø 5.3mm ED ø 10mm thickness 1mm SS Qty 20 pcs DIN 125A for thread M5 | | |
| For models: | 0221101-01, 0221101A01, 0221102-01, 0221103-01, 0221104-01, 0221104A01, 0221105-01, 0221106-01, 0261101-01, 0261102-01, 0261103-01, 0521706-00, 0522101-00, 0522101-02, 0522101-03, 0522101-04, 0522102-00, 0522102-02, 0522102-03, 0522102-04, 0722101-06, 0723104-03, 0723104A03, 0723104B03, 0723105-03, 0723105A03, 0723105B03, 1203603-00, 1204001-00, 1204001-01, 1204002-00, 1204002-01, 1204003-00, 1204003-01, 1204004-00, 1204004-01, 1204005-00, 1204005-01, 1204006-00, 1204006-01, 1204007-00, 1204007-01, 1204008-00, 1204008-01, 1204009-00, 1204009-01, 1204012-01, 1204014-01, 1204015-01, 1204017-01... (Other models you can see in the webshop) | | |

| | | | |
|---|--|-----------------|--------|
| DIN 9021 | | | |
|  | | | |
| 1 | | | |
| GEV No. | 560304 | Ref. No. | 945104 |
| description | plain washer ID ø 10.5mm ED ø 25mm Qty 1 pcs for thread M9 | | |

| | | | |
|--|---|-----------------|--------|
|  | | | |
| 1 | | | |
| GEV No. | 560303 | Ref. No. | 120030 |
| description | plain washer ID ø 6.4mm ED ø 18mm Qty 1 pcs for thread M6 | | |
| For models: | 0021130A00, 0021130A01, 0021135A00, 0220301-00, 0220301B00, 0220301B01, 0220301B02, 0220301D00, 0220302-00, 0220302A00, 0220302A01, 0220302A02, 0220302A03, 0220302B00, 0220302B01, 0220302B02, 0220302C00, 0220302C01, 0220302C02, 0220302C03, 0220302D00, 0220302E00, 0220302E01, 0220302F00, 0220302H00, 0220302H01, 0220303-00, 0220303-01, 0220303A00, 0220303A01, 0220303A02, 0220303A03, 0220303B00, 0220303B01, 0220303C00, 0220303C01, 0220303C02, 0220303D00, 0220303D01, 0220303E00, 0220303E01, 0220303H00, 0220303H01, 0261101-01, 0261102-01, 0261103-01, 0263401-00, 0263401-01, 0521701-00, 0521701-01... (Other models you can see in the webshop) | | |

| | | | |
|---|---|-----------------|--------|
|  | | | |
| 1 | | | |
| GEV No. | 560333 | Ref. No. | 120027 |
| description | plain washer ID ø 6.4mm ED ø 12mm thickness 1.6mm SS Qty 1 pcs DIN 125A for thread M6 | | |
| For models: | 0021130A00, 0021130A01, 0021135A00, 0203601-00, 0203602-00, 0203603-00, 0204601-00, 0220301-00, 0220301B00, 0220301B01, 0220301B02, 0220301D00, 0220302-00, 0220302A00, 0220302A01, 0220302A02, 0220302A03, 0220302B00, 0220302B01, 0220302B02, 0220302C00, 0220302C01, 0220302C02, 0220302C03, 0220302D00, 0220302E00, 0220302E01, 0220302F00, 0220302H00, 0220302H01, 0220303-00, 0220303-01, 0220303A00, 0220303A01, 0220303A02, 0220303A03, 0220303B00, 0220303B01, 0220303C00, 0220303C01, 0220303C02, 0220303D00, 0220303D01, 0220303E00, 0220303E01, 0220303H00, 0220303H01, 1204014-01, 1204015-01, 1204017-01... (Other models you can see in the webshop) | | |

| | | | |
|---|--|-----------------|--------|
| nylon | | | |
|  | | | |
| 1 | | | |
| GEV No. | 560646 | Ref. No. | 120007 |
| description | plain washer ID ø 12.5mm ED ø 28mm thickness 3mm nylon Qty 1 pcs | | |
| For models: | CCE60, CCE63, CPE60, CPE63 | | |

| | | | |
|---|--|-----------------|--------|
|  | | | |
| 1 | | | |
| GEV No. | 560645 | Ref. No. | 120008 |
| description | plain washer ID ø 7.4mm ED ø 14mm thickness 1.6mm SS Qty 1 pcs DIN 125A | | |
| For models: | CCE60, CCE63, CGG11-L, CGG11-R, CGG12-L, CGG12-R, CGG21-L, CGG21-R, CGG22-L, CGG22-R, CGG61-L, CGG61-R, CGG62-L, CGG62-R, CPE60, CPE63, CSG11-L, CSG11-R, CSG11-R-DG, CSG12-L, CSG12-R, CSG12-R-DG, CSG21-L, CSG21-R, CSG21-R-DG, CSG22-L, CSG22-R, CSG22-R-DG, CSG61-L, CSG61-R, CSG61-R-DG, CSG62-L, CSG62-R, CSG62-R-DG | | |

tooth lock washers

DIN 6798A



| | | | |
|--------------------|---|-----------------|--------|
| GEV No. | 560125 | Ref. No. | 121023 |
| description | tooth lock washer ID ø 4.2mm ED ø 8mm SS DIN/ISO DIN 6798A Qty 20 pcs for thread M4 | | |
| For models: | 0720332P00, 0720332R00, 0720332T00, 0720332V00, 1220301-02, 1220301-03, 1220301-04, 1220301B02, 1220301B03, 1220301B04, 1220301J01, 1220301J03, 1220303-03, 1220303-04, 1220303-05, 1220303B03, 1220303B04, 1220303B05, 1220303I02, 1220303J02, 1220303J04, 1220303K01, 1220307-01, 1220326-01, 1220326B01, 1220327-00, 1220327-01, 1220327B01, 1220329-00, 1220329-01, 1220329B00, 1220329B01, 1220402-00, 1220402-01, 1320323-00, 1320323B00, 1320327-00, 1320327A01, 1320327A02, 1320327B00, 1320327C01, 1320327C02, 1320327Z00, 1320327Z01, 1320329-00, 1320329-01, 1320329A01, 1320329A02, 1320329B00, 1320329B01... (Other models you can see in the webshop) | | |

miscellaneous



| | | | |
|--------------------|---|-----------------|--------|
| GEV No. | 560654 | Ref. No. | 121210 |
| description | tooth lock washer ID ø 12.5mm ED ø 20.5mm spring steel DIN/ISO 6797 Qty 1 pcs for thread M12 | | |
| For models: | 0220501-00, 0220502-00, 0220503-00, 0220802-00, 0522101-00, 0522101-02, 0522101-03, 0522102-00, 0522102-02, 0522102-03, 1323208-00, 1323208-01, 1323208-02, 1323208-03, 1323210-00, 1323210-01, 1323210-02, 1363403-00, 1363403-01, 1363403-02, 1420501-00, 1420502-00, 1420504-00, 1420505-00, 1420801-00, 1420803-00, 1422101-00, 1422101-02, 1422101-03, 1422102-00, 1422102-02, 1422102-03, 14621011-0, 1820501-00, 18208011-0, 2020501-00, 2020501-01, 20205011-0, 2020502-00, 20205033-0, 2020504-00, 2020505-00, 2023203-00, 2023203-03, 2023203-04, 2023203-05, 2023203-06, 2023203A00, 2023203A03, 2023205-00... (Other models you can see in the webshop) | | |

fasteners

clamps

hose clamps

DIN 3017 - W2



| | | | |
|--------------------|--|-----------------|--------------------------------|
| GEV No. | 520113 | Ref. No. | 208045 W1 Stahl verzinkt 1 Stk |
| description | hose clamp ø 16-27mm width 9mm Qty 10 pcs DIN 3017 | | |

DIN 3017 - W4



| | | | |
|--------------------|--|-----------------|--------|
| GEV No. | 520120 | Ref. No. | 208049 |
| description | hose clamp SS W4 ø 12-20mm width 9mm Qty 1 pcs DIN 3017 | | |
| For models: | CCE60, CCE63, CGE11-L, CGE11-R, CGE12-L, CGE12-R, CGE21-L, CGE21-R, CGE22-L, CGE22-R, CGE61-L, CGE61-R, CGE62-L, CGE62-R, CGG11-L, CGG11-R, CGG12-L, CGG12-R, CGG21-L, CGG21-R, CGG22-L, CGG22-R, CGG61-L, CGG61-R, CGG62-L, CGG62-R, CPE60, CPE63, CSE11-L, CSE11-R, CSE11-R-DG, CSE12-L, CSE12-R, CSE12-R-DG, CSE21-L, CSE21-R, CSE21-R-DG, CSE22-L, CSE22-R, CSE22-R-DG, CSE61-L, CSE61-R, CSE61-R-DG, CSE62-L, CSE62-R, CSE62-R-DG, CSG11-L, CSG11-R, CSG11-R-DG, CSG12-L... (Other models you can see in the webshop) | | |

miscellaneous



| | | | |
|--------------------|---|-----------------|--------|
| GEV No. | 521185 | Ref. No. | 208065 |
| description | hose clamp ø 50-70mm width 12mm Qty 1 pcs | | |
| For models: | 815156, 815157, 815166, 815167, CCE60, CCE63, CGE11-L, CGE11-R, CGE12-L, CGE12-R, CGE21-L, CGE21-R, CGE22-L, CGE22-R, CGE61-L, CGE61-R, CGE62-L, CGE62-R, CGG11-L, CGG11-R, CGG12-L, CGG12-R, CGG21-L, CGG21-R, CGG22-L, CGG22-R, CGG61-L, CGG61-R, CGG62-L, CGG62-R, CPE60, CPE63, CSE11-L, CSE11-R, CSE11-R-DG, CSE12-L, CSE12-R, CSE12-R-DG, CSE21-L, CSE21-R, CSE21-R-DG, CSE22-L, CSE22-R, CSE22-R-DG, CSE61-L, CSE61-R, CSE61-R-DG, CSE62-L, CSE62-R, CSE62-R-DG... (Other models you can see in the webshop) | | |

roll pins



| | | | |
|--------------------|---|-----------------|--------|
| GEV No. | 696825 | Ref. No. | 123004 |
| description | roll pin ø 5mm L 10mm spring steel DIN 1481 | | |
| For models: | CGE11-L, CGE11-R, CGE12-L, CGE12-R, CGE21-L, CGE21-R, CGE22-L, CGE22-R, CGE61-L, CGE61-R, CGE62-L, CGE62-R, CGG11-L, CGG11-R, CGG12-L, CGG12-R, CGG21-L, CGG21-R, CGG22-L, CGG22-R, CGG61-L, CGG61-R, CGG62-L, CGG62-R, CSE11-L, CSE11-R, CSE11-R-DG, CSE12-L, CSE12-R, CSE12-R-DG, CSE21-L, CSE21-R, CSE21-R-DG, CSE22-L, CSE22-R, CSE22-R-DG, CSE61-L, CSE61-R, CSE61-R-DG, CSE62-L, CSE62-R, CSE62-R-DG, CSG11-L, CSG11-R, CSG11-R-DG, CSG12-L, CSG12-R, CSG12-R-DG, CSG21-L, CSG21-R... (Other models you can see in the webshop) | | |



| | | | |
|---|--|-----------------|--------|
|  | | | |
| 1 | | | |
| GEV No. | 696824 | Ref. No. | 123005 |
| description | roll pin ø 5mm L 16mm spring steel DIN 1481 | | |
| For models: | CGE11-L, CGE11-R, CGE12-L, CGE12-R, CGE21-L, CGE21-R, CGE22-L, CGE22-R, CGE61-L, CGE61-R, CGE62-L, CGE62-R, CGG11-L, CGG11-R, CGG12-L, CGG12-R, CGG21-L, CGG21-R, CGG22-L, CGG22-R, CGG61-L, CGG61-R, CGG62-L, CGG62-R, CSE11-L, CSE11-R, CSE11-R-DG, CSE12-L, CSE12-R, CSE12-R-DG, CSE21-L, CSE21-R, CSE21-R-DG, CSE22-L, CSE22-R, CSE22-R-DG, CSE61-L, CSE61-R, CSE61-R-DG, CSE62-L, CSE62-R, CSE62-R-DG, CSG11-L, CSG11-R, CSG11-R-DG, CSG12-L, CSG12-R, CSG12-R-DG, CSG21-L, CSG21-R...(Other models you can see in the webshop) | | |

| | | | |
|---|--|-----------------|--------|
| <p>pins</p>  | | | |
| 1 | | | |
| GEV No. | 696823 | Ref. No. | 123027 |
| description | pin ø 5mm L 10mm SS Qty 1 pcs | | |
| For models: | CGE11-L, CGE11-R, CGE12-L, CGE12-R, CGE21-L, CGE21-R, CGE22-L, CGE22-R, CGE61-L, CGE61-R, CGE62-L, CGE62-R, CGG11-L, CGG11-R, CGG12-L, CGG12-R, CGG21-L, CGG21-R, CGG22-L, CGG22-R, CGG61-L, CGG61-R, CGG62-L, CGG62-R, CSE11-L, CSE11-R, CSE11-R-DG, CSE12-L, CSE12-R, CSE12-R-DG, CSE21-L, CSE21-R, CSE21-R-DG, CSE22-L, CSE22-R, CSE22-R-DG, CSE61-L, CSE61-R, CSE61-R-DG, CSE62-L, CSE62-R, CSE62-R-DG, CSG11-L, CSG11-R, CSG11-R-DG, CSG12-L, CSG12-R, CSG12-R-DG, CSG21-L, CSG21-R...(Other models you can see in the webshop) | | |

| | | | |
|---|--|-----------------|--------|
|  | | | |
| 1 | | | |
| GEV No. | 696827 | Ref. No. | 123034 |
| description | pin ø 5mm L 20mm steel Qty 1 pcs | | |
| For models: | CGE11-L, CGE11-R, CGE12-L, CGE12-R, CGE21-L, CGE21-R, CGE22-L, CGE22-R, CGE61-L, CGE61-R, CGE62-L, CGE62-R, CGG11-L, CGG11-R, CGG12-L, CGG12-R, CGG21-L, CGG21-R, CGG22-L, CGG22-R, CGG61-L, CGG61-R, CGG62-L, CGG62-R, CSE11-L, CSE11-R, CSE11-R-DG, CSE12-L, CSE12-R, CSE12-R-DG, CSE21-L, CSE21-R, CSE21-R-DG, CSE22-L, CSE22-R, CSE22-R-DG, CSE61-L, CSE61-R, CSE61-R-DG, CSE62-L, CSE62-R, CSE62-R-DG, CSG11-L, CSG11-R, CSG11-R-DG, CSG12-L, CSG12-R, CSG12-R-DG, CSG21-L, CSG21-R...(Other models you can see in the webshop) | | |

consumables

sealants and adhesives

high temperature silicone

| | | | |
|---|---|-----------------|--------|
|  | | | |
| 1 | | | |
| GEV No. | 890060 | Ref. No. | 303046 |
| description | adhesive PACTAN 6076 310ml 250°C anthracite | | |
| description | <p>PACTAN 6076 - cartridge 310ml - anthracite</p> <p>1-component silicone-based product for specific gluing and sealing purposes that require a high temperature resistance. The material is used for bonding and sealing of parts with high temperature load e.g. inner door of oven as well as for other bonding and sealing purposes especially on ovens and ranges. The product is fast to light, resistant to ageing and ozone and reveals a very good chemical resistance.</p> <p>Temperature resistance up to 250°C</p> | | |
| For models: | 0720332P00, 0720332R00, 0720332T00, 0720332V00, 0723104-03, 0723104A03, 0723104B03, 0723105-03, 0723105A03, 0723105B03, 1023101-00, 1023101-01, 1023106-00, 1023106-01, 1023111-00, 1023111-01, 1023401-00, 1023401K00, 1023410-00, 1220301J02, 1220301J03, 1220303J03, 1220303J04, 1220303K00, 1220303K01, 1223101-00, 1223101-01, 1223101-02, 1223103-00, 1223103-01, 1223103-02, 1223106-00, 1223106-01, 1223106-02, 1223202-00, 1223202A00, 1223202A01, 1223202J00, 1223202J01, 1223203-00, 1223203-01, 1223203-02, 1223203-03, 1223204-00, 1223204-01, 1223204-02, 1223205-00, 1223205-01, 1223205-02, 1223206-00... (Other models you can see in the webshop) | | |

cleaning agents

combi-steamer detergents/descalers

Notice: Articles labelled 'DANGEROUS GOODS' are delivered by road through a forwarder for reasons of safety and are charged separately!

| | | | |
|--|---|-----------------|---------------------|
|  | | | |
| 1 | | | |
| GEV No. | 802061 | Ref. No. | 303324 40-100575 |
| description | detergent for combi-steamer MKN WaveClean detergent/rinse aid Qty 10 pcs | | |
| description | <p>MKN WaveClean - detergent - box of 10 cartridges</p> <p>Combination product for cleaning and descaling of combi steamers with WaveClean®</p> <p>Innovative 2-in-1 cartridge with cleaner and rinse aid. Easy handling with no direct contact to active agents. Cleans MKN combi steamers reliably, economically and hygienically. Start the WaveClean® cleaning program, unscrew the 2-in-1 cartridge cap and insert the cartridge into the holder when prompted to do so. After the cleaning process remove the cartridge before starting the machine. Rinse off any residue with plenty of water. For commercial use only.</p> | | |

lava rocks / ceramic briquetts

| | | | |
|---|--|-----------------|--------|
|  | | | |
| 1 | | | |
| GEV No. | 211100 | Ref. No. | 201517 |
| description | ceramic briquetts size 53x53x24 | | |
| For models: | 0261601-00, 1261601-00, 1261601-01, 1261602-00, 1261602-01, 1261602-02, 1261602-03, 1261604-03, 1361601-00, 1361601-01, 1361601-02, 1361602-00, 1361602-01, 1361602-02, 1361604-02, 1461601-00, 1461602-00, 2061602-00, 2061602-01, 2061603-00, 2061603-01, 2061603-02, 2061604-01, 3061602-00 | | |

fuses

fine fuses

| | | | |
|---|--|-----------------|--------|
|  | | | |
| 1 | | | |
| GEV No. | 358598 | Ref. No. | 202776 |
| description | fine fuse size ø5x20mm 0.63A slow-acting rated 250V Qty 10 pcs | | |
| For models: | 0720332R00, 0720332V00 | | |

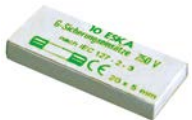
| | | | |
|--|---|-----------------|--------|
|  | | | |
| 1 | | | |
| GEV No. | 358599 | Ref. No. | 203720 |
| description | fine fuse size ø5x20mm 0.8A slow-acting rated 250V Qty 10 pcs | | |
| For models: | 0521702B03, 0521702B04, 2022828-01, 2022828-02, 2022828-03, 2022828-04, 2022828-05, 2022828-06, 3022828-03, 3022828-04, 3022828-05, 3022828-06, 3022828-07, CGE11-L, CGE11-R, CGE12-L, CGE12-R, CGE21-L, CGE21-R, CGE22-L, CGE22-R, CGE61-L, CGE61-R, CGE62-L, CGE62-R, CPE63, CSE11-L, CSE11-R, CSE12-L, CSE12-R, CSE21-L, CSE21-R, CSE22-L, CSE22-R, CSE61-L, CSE61-R, CSE62-L, CSE62-R | | |

| | | | |
|---|--|-----------------|--------|
|  | | | |
| 1 | | | |
| GEV No. | 358601 | Ref. No. | 203722 |
| description | fine fuse size ø5x20mm 1.25A slow-acting rated 250V Qty 10 pcs | | |
| For models: | CCE60, CCE63, CGE12-L, CGE12-R, CGE62-L, CGE62-R, CGG11-L, CGG11-R, CGG12-L, CGG12-R, CGG21-L, CGG21-R, CGG22-L, CGG22-R, CGG61-L, CGG61-R, CGG62-L, CGG62-R, CPE60, CPE63, CSE12-L, CSE12-R, CSE62-L, CSE62-R, CSG11-L, CSG11-R, CSG11-R-DG, CSG12-L, CSG12-R, CSG12-R-DG, CSG21-L, CSG21-R, CSG21-R-DG, CSG22-L, CSG22-R, CSG22-R-DG, CSG61-L, CSG61-R, CSG61-R-DG, CSG62-L, CSG62-R, CSG62-R-DG | | |

| | | | |
|--|--|-----------------|--------|
|  | | | |
| 1 | | | |
| GEV No. | 358608 | Ref. No. | 203996 |
| description | fine fuse size ø5x20mm 10A slow-acting rated 250V Qty 10 pcs | | |
| For models: | CGE11-L, CGE11-R, CGE12-L, CGE12-R, CGE21-L, CGE21-R, CGE22-L, CGE22-R, CGE61-L, CGE61-R, CGE62-L, CGE62-R, CGG11-L, CGG11-R, CGG12-L, CGG12-R, CGG21-L, CGG21-R, CGG22-L, CGG22-R, CGG61-L, CGG61-R, CGG62-L, CGG62-R, CPE63, CSE11-L, CSE11-R, CSE11-R-DG, CSE12-L, CSE12-R, CSE12-R-DG, CSE21-L, CSE21-R, CSE21-R-DG, CSE22-L, CSE22-R, CSE22-R-DG, CSE61-L, CSE61-R, CSE61-R-DG, CSE62-L, CSE62-R, CSE62-R-DG, CSG11-L, CSG11-R, CSG11-R-DG, CSG12-L, CSG12-R, CSG12-R-DG, CSG21-L...(Other models you can see in the webshop) | | |

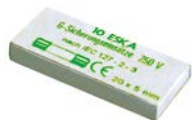
| | | | |
|--|--|-----------------|--------|
|  | | | |
| 1 | | | |
| GEV No. | 358603 | Ref. No. | 203474 |
| description | fine fuse size ø5x20mm 2A slow-acting rated 250V Qty 10 pcs | | |
| For models: | 0220302A00, 0220302A01, 0220302A02, 0220302A03, 0220302C00, 0220302C01, 0220302C02, 0220302C03, 0220303A00, 0220303A01, 0220303A02, 0220303A03, 0220303B00, 0220303B01, 0220303C00, 0220303C01, 0220303C02, 0220303E00, 0220303E01, 0220304-00, 0220305-00, 0220306-00, 0221501-00, 0221502-00, 0720332P00, 0720332R00, 0720332T00, 0720332V00, 1220307-00, 1220307-01, 1220308-00, 1220326-00, 1220326-01, 1220326B00, 1220326B01, 1220327-00, 1220327-01, 1220327B01, 1220329-00, 1220329-01, 1220329B00, 1220329B01, 1221112-00, 1320323-00, 1320323B00, 1320327-00, 1320327A00, 1320327A01, 1320327A02, 1320327B00...(Other models you can see in the webshop) | | |

| | | | |
|--|--|-----------------|--------|
|  | | | |
| 1 | | | |
| GEV No. | 358605 | Ref. No. | 203742 |
| description | fine fuse size ø5x20mm 3.15A slow-acting rated 250V Qty 10 pcs | | |

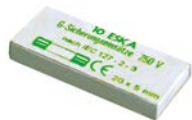
| | | | |
|--|--|-----------------|--------|
|  | | | |
| 1 | | | |
| GEV No. | 358607 | Ref. No. | 203473 |
| description | fine fuse size ø5x20mm 6.3A slow-acting rated 250V Qty 10 pcs | | |
| For models: | 1422701-01, 1422701-02, 1422701-03, 1422702-01, 1422702-02, 1422702-03, 1422802B04, 1422802B05, 1422802B06, 1422802B07, 1422802B08, 1422804B04, 1422804B05, 1422804B06, 1422804B07, 1422804B08, 1422805B04, 1422805B05, 1422805B06, 1422805B07, 1422805B08, 1422807B00, 1422807B01, 1422807B02, 1422807B03, 1422807B04, 1422902-00, 1422902-01, 1422902-02, 1422902-03, 1422902-04, 2013004B01, 2013004B02, 2013004B03, 2013004B04, 2013004B05, 2013008B01, 2013008B02, 2013008B03, 2013008B04, 2013008B05, 2013010B01, 2013010B02, 2013010B03, 2013010B04, 2013010B05, 2013018B00, 2013018B01, 2013018B02, 2013018B03...(Other models you can see in the webshop) | | |

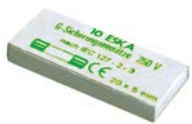

| | | | |
|---|---|-----------------|--------|
|  | | | |
| 1 | | | |
| GEV No. | 358704 | Ref. No. | 203741 |
| description | fine fuse size ø5x20mm 8A slow-acting rated 250V Qty 10 pcs | | |

| | | | |
|---|--|-----------------|--------|
| screw locks | | | |
| D0-system (NEOZED) | | | |
|  | | | |
| 1 | | | |
| GEV No. | 358045 | Ref. No. | 203739 |
| description | fuse size D02 35A rated 250/400V E18 ø 15mm L 36mm Qty 10 pcs | | |
| For models: | CGE21-L, CGE21-R, CGG11-L, CGG11-R, CGG12-L, CGG12-R, CGG61-L, CGG61-R, CSE12-L, CSE12-R, CSE12-R-DG, CSE21-L, CSE21-R, CSE21-R-DG, CSG11-L, CSG11-R, CSG11-R-DG | | |

| | | | |
|---|--------------|---|----------|
| A | | | |
| alarm devices | 48 | | |
| appliance hose reels | 142 | | |
| axial fans | 64 | | |
| B | | | |
| ball valves | 144 | | |
| bar burners | 101 | | |
| bi-metal thermostats | 29, 29 | | |
| C | | | |
| cable glands | 70, 70 | | |
| cables | 70 | | |
| cam switches | 40 | | |
| cap nuts | 149 | | |
| ceramic heaters | 25 | | |
| clamps | 37, 145, 154 | | |
| cleaning agents | 155 | | |
| combi-steamer detergents/descalers | 155 | | |
| condensators & interference suppression filters | 68 | | |
| connection cables | 70 | | |
| consumables | 155 | | |
| contactors | 48 | | |
| control equipment | 43 | | |
| control thermostats | 30 | | |
| countersunk screws | 146 | | |
| cylinder head bolts | 148 | | |
| D | | | |
| digital timers | 48 | | |
| door seals | 133 | | |
| door seals with fixing hook | 134 | | |
| dosing pumps | 142 | | |
| drain pumps | 67 | | |
| E | | | |
| electric accessories | 70 | | |
| electrodes | 63 | | |
| electromagnetic closer | 124 | | |
| electronic magnets | 73 | | |
| energy regulators | 29 | | |
| evaporators | 140 | | |
| F | | | |
| fans | 64 | | |
| fasteners | 154 | | |
| fastening material | 146 | | |
| female fastons | 71 | | |
| filters | 68 | | |
| fine fuses | 156 | | |
| fittings | 143 | | |
| flat-headed bolts | 147 | | |
| | | float switches | 40 |
| | | flow meters | 63 |
| | | forced air burners | 104 |
| | | formed hoses | 143 |
| | | fuses | 68, 156 |
| G | | | |
| | | gas ball valves | 112 |
| | | gas burners | 95 |
| | | gas control valves | 84 |
| | | gas nozzles | 105 |
| | | gas solenoid valves | 86 |
| | | gas taps | 73 |
| | | gas thermostats | 82 |
| | | gaskets for control panels | 134 |
| | | gaskets for heated units | 133 |
| | | gaskets for tray rack trolleys | 134 |
| | | gate valves | 144 |
| | | grub screws | 149 |
| H | | | |
| | | halogen lamp | 46 |
| | | hand tools | 146 |
| | | heating elements | 3 |
| | | heating elements for bain maries | 7 |
| | | heating elements for chargrills | 21 |
| | | heating elements for chip scuttles | 11 |
| | | heating elements for convection | 26 |
| | | heating elements for fryers | 11 |
| | | heating elements for frying pans | 10 |
| | | heating elements for griddles | 19 |
| | | heating elements for heating bridges | 24 |
| | | heating elements for large hobs | 20 |
| | | heating elements for ovens | 3 |
| | | heating elements for pasta cookers | 20 |
| | | heating elements for rechauds | 21 |
| | | heating elements for salamanders/toasters | 22 |
| | | heating elements for tilting bratt pan | 20 |
| | | hexagonal nuts | 150 |
| | | hexagonal screws | 147 |
| | | high temperature silicone | 155 |
| | | hob burners | 95 |
| | | hose clamps | 145, 154 |
| | | hose connectors | 143, 143 |
| | | hose reels | 142 |
| | | hoses | 142 |
| | | hot air motors | 64 |
| | | hot plates | 27 |
| I | | | |
| | | ignition boxes | 85 |
| | | ignition bridges | 94 |
| | | ignition cables | 92 |

| | | | |
|--------------------------------------|----------|--|--|
| immersion heating elements | 25 | | |
| indicator lights | 45 | | |
| indicator lights (complete) | 45 | | |
| industrial hoses | 142 | | |
| inline splice connectors | 70 | | |
| L | | | |
| lamps | 45 | | |
| lava rocks / ceramic briquetts | 112, 156 | | |
| lid gaskets | 135 | | |
| M | | | |
| magnetic switches | 42 | | |
| measuring equipment | 146 | | |
| microswitches | 39 | | |
| motors | 67 | | |
| N | | | |
| neon light bulbs | 45, 46 | | |
| nut spinners | 146 | | |
| nuts | 149 | | |
| nylon hoses | 142 | | |
| O | | | |
| operating capacitors | 68 | | |
| O-rings | 135 | | |
| oven lamps | 47 | | |
| P | | | |
| piezoelectric igniters | 92 | | |
| pilot burners | 86 | | |
| pins | 155 | | |
| plug connectors | 71 | | |
| plugs - couplings - power sockets | 70 | | |
| plunger sockets | 39 | | |
| pressure switches | 62 | | |
| probe clips | 37 | | |
| probes | 54 | | |
| protective pipes for capillary pipes | 38 | | |
| pumps | 67 | | |
| push/momentary push switches | 39 | | |
| R | | | |
| radial fans | 66 | | |
| radiation heaters | 27 | | |
| raised countersunk head screws | 147 | | |
| relays | 52 | | |
| ribbon cables | 70 | | |
| rivets/rivet nuts | 146 | | |
| rocker/momentary rocker switches | 39 | | |
| roll pins | 154 | | |
| rotary switches | 42 | | |
| round burners | 103 | | |
| S | | | |
| safety bi-metal thermostats | 29 | | |
| safety thermostats | 35 | | |
| screw locks | 157 | | |
| screwdrivers | 146 | | |
| screws | 146 | | |
| sealants and adhesives | 155 | | |
| sealing cords | 137 | | |
| sealing washers | 136 | | |
| shaft gaskets | 137 | | |
| sheet metal screws | 146 | | |
| shut-off valves | 145 | | |
| side bolts | 149 | | |
| silicone | 155 | | |
| silicone hoses | 142 | | |
| sleeves | 143 | | |
| solenoid valves | 60 | | |
| solid state relays | 51 | | |
| spray guns | 141 | | |
| spray guns with external thread | 141 | | |
| spring rings | 152 | | |
| steam valves | 145 | | |
| supply filters | 145, 145 | | |
| switches and momentary switches | 39 | | |
| T | | | |
| tank inlets | 145 | | |
| terminals | 71 | | |
| terminals and connectors | 70 | | |
| thermocouples | 92 | | |
| thermostats | 29 | | |
| time relays | 53 | | |
| timers | 48 | | |
| tools | 146 | | |
| tooth lock washers | 154 | | |
| transformers | 53 | | |
| V | | | |
| valves and tank inlets | 144 | | |
| W | | | |
| washers | 152 | | |
| water cycle components | 145 | | |