



GAS COMPONENTS



ELECTRIC COMPONENTS



WATER TECHNOLOGY



MECHANICAL COMPONENTS



TOOLS

Spare parts suitable for

MAKRO-PROFESSIO-

Find the complete and up-to-date range of products in our GEV Webshop



Manufacturer catalogue

The most important spare parts and accessories arranged clearly for every manufacturer

- ✓ Complete product range and all appliance data always up to date in the GEV Webshop
- ✓ Alphabetical Index at the end of the catalogue

GEV Webshop

www.gev-online.co.uk

www.gev-online.com



- 🔍 Add to Favourites
- 🔍 Sign In with email address and usual password
- 🔍 Easy-order – place several items in your basket at the same time
- 🔍 Quick Item search – no login needed



induction

induction coils



1

GEV No.	404010	Ref. No.	AD100087
description	induction coils ø 220mm H 10mm		
For models:	GIC3035		

heating elements

heating elements for ovens

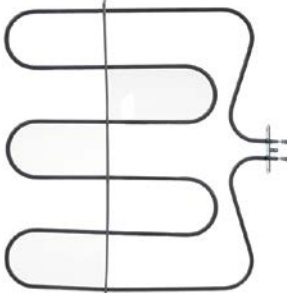

1

GEV No.	416969	Ref. No.	01203250
description	heating element 1400W 230V heating circuits 1 L 370mm W 400mm L1 45mm L2 325mm W1 184mm W2 30mm flange length 70mm flange width 22mm hole distance 46mm bridge length 420mm hole ø 5mm tube ø 6.3mm connection male faston 6.3mm windings 3 rectangular flange dry heating element		
For models:	GCO2001		
accessories for	416969		
	GEV No.	510368	Ref. No. —
	gasket L 70mm W 23.5mm hole ø 5mm hole distance 56mm FIBER thickness 2mm for heating element		

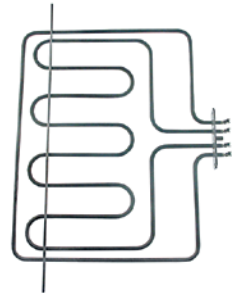

1

GEV No.	416970	Ref. No.	01203240
description	heating element 2800W 230V heating circuits 2 L 323mm W 393mm L1 30mm L2 293mm W1 166mm W2 61mm flange length 100mm flange width 22mm hole distance 76mm bridge length 485mm hole ø 5mm tube ø 6.3mm connection male faston 6.3mm rectangular flange dry heating element		
For models:	GCO2001		
accessories for	416970		
	GEV No.	528090	Ref. No. 01000160
	gasket L 100mm W 22mm thickness 1mm		

heating elements for fryers

2 hole fixing

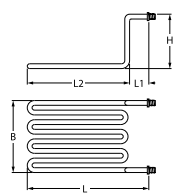
1

GEV No.	417598	Ref. No.	1.07.HDF4140403
description	heating element 2500W 230V heating circuits 1 L 290mm W 130mm H 200mm L1 40mm L2 230mm tube ø 8mm		
For models:	GDF3004, GDF3024		

1

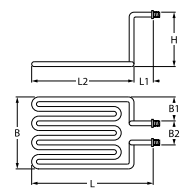
GEV No.	417599	Ref. No.	1.07.HDF8141903
description	heating element 3250W 230V heating circuits 1 thread M12x1.25 L 280mm W 190mm H 210mm L1 35mm L2 245mm W1 120mm W2 70mm tube ø 8mm connection M4		
For models:	GDF3008, GDF3028, GDF5008, GDF5028		

heating elements for griddles



1

GEV No.	419177	Ref. No.	D02169
description	heating element 1750W 230V heating circuits 1 L 255mm W 240mm H 60mm tube ø 6.3mm cable length 600mm bain marie connection distance 234mm dry heating element		
For models:	GEG2001		



heating elements for hot dog machines

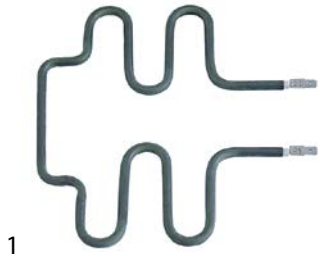

1

GEV No.	416718	Ref. No.	D02002
description	heating element 300W 230V L 170mm W 198mm tube ϕ 6.3mm L1 50mm L2 120mm W1 68mm W2 62mm connection male faston 6.3mm connection distance 56mm dry heating element heating circuits 1 hot dog machine		
For models:	GHM1001		

heating cables

miscellaneous



1

GEV No.	417745	Ref. No.	W0310067
description	heating cable 600W L 1100mm silicone connection plug GFR2700		
For models:	GFR2700		

quartz heating elements



1

GEV No.	420089	Ref. No.	D04034
description	quartz heating element 600W 115V L 365mm ϕ 11mm connection male faston 6.3mm		
For models:	GTO1001, GTO2001		
accessories for	420089		
	GEV No.	551108	Ref. No. B07025
	spring clip stainless steel for quartz heating element L 39mm W 25mm H 13.5mm bore ϕ 10mm		

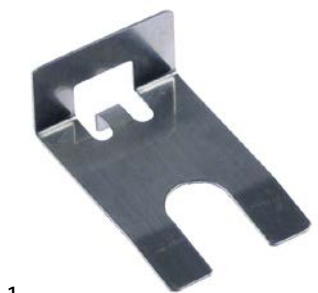



1

GEV No.	551108	Ref. No.	B07025
description	spring clip stainless steel for quartz heating element L 39mm W 25mm H 13.5mm bore ϕ 10mm		
For models:	GTO1001, GTO2001		

immersion heating elements





3 hole flange ϕ 38.5mm

1

GEV No.	416267	Ref. No.	905560
description	heating element 4500W 230V mounting ϕ 38.5mm heating circuits 3 L 358mm W 32mm H 58mm L1 36mm L2 72mm L3 250mm H1 28mm H2 30mm hole distance 57mm hole ϕ 10mm tube ϕ 6.3mm connection male faston 6.3mm immersion heater 3 hole flange		
For models:	GDW2001		
spare parts for	416267		
	GEV No.	521120	Ref. No. 907981
	O-ring EPDM thickness 5.34mm ID ϕ 37.47mm Qty 1 pcs		
accessories for	416267		
	GEV No.	532577	Ref. No. —
	O-ring EPDM thickness 5.34mm ID ϕ 40.65mm Qty 1 pcs		



1

GEV No.	416260	Ref. No.	905745
description	heating element 2500W 230V heating circuits 1 L 357mm W 34mm H 39mm H1 4mm H2 35mm thread M10x1 mounting distance 28mm tube ϕ 6.3mm connection male faston 6.3mm 2 hole fixing immersion heater connection length 25mm		
For models:	GDW2001		
accessories for	416260		
	GEV No.	510416	Ref. No. —
	flat gasket fibre ED ϕ 19mm ID ϕ 10.5mm thickness 1.5mm for thread M10 Qty 1 pcs		
	GEV No.	510893	Ref. No. —
	O-ring EPDM thickness 2.62mm ID ϕ 9.92mm Qty 1 pcs		
	GEV No.	520231	Ref. No. —
	nut thread M10x1 H 6mm WS 14 zinc-coated steel Qty 1 pcs		
	GEV No.	521129	Ref. No. —
	nut thread M10 H 6mm SS WS 17 Qty 1 pcs DIN/ISO DIN 439		



heating elements for convection



1

GEV No.	418044	Ref. No.	01203260
description	heating element 2500W 230V heating circuits 1 ID ø 180mm ED ø 192mm L 245mm H 28mm L1 45mm W1 30mm H1 3mm H2 25mm flange length 70mm flange width 22mm hole distance 56mm connection male faston 6.3mm tube ø 6.3mm convection heating element hole ø 5mm rectangular flange		
For models:	GCO2001		
accessories for	418044		
	GEV No.	Ref. No.	01000140
	gasket L 71mm W 21mm hole ø 5mm hole distance 57mm fibre thickness 1mm for heating element		



1

GEV No.	419243	Ref. No.	RES30033
description	heating element 2700W 230V heating circuits 1 ID ø 180mm ED ø 193mm L 208mm H 30mm L1 8mm W1 30mm H1 7mm H2 23mm flange length 70 no to be sold in Francemm flange width 22mm hole distance 56mm connection male faston 6.3mm tube ø 6.3mm convection heating element hole ø 5mm rectangular flange 70 x 22mm with screws		
For models:	GCO500		
spare parts for	419243		
	GEV No.	Ref. No.	—
	sheet metal screws ø 3.9mm L 9.5mm SS Qty 20 pcs DIN 7981/ISO 7049 head ø 7.5mm oval head		

foil heating elements



1

GEV No.	419256	Ref. No.	W0310080
description	foil heating element L 520mm W 220mm 61W 220V cable length 400mm connection plug GFR2700		
For models:	GFR2700		

accessories

various



1

GEV No.	551108	Ref. No.	B07025
description	spring clip stainless steel for quartz heating element L 39mm W 25mm H 13.5mm bore ø 10mm		
For models:	GTO1001, GTO2001		

sealing washers

O-rings

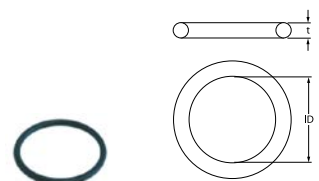

1

GEV No.	521120	Ref. No.	907981
description	O-ring EPDM thickness 5.34mm ID ø 37.47mm Qty 1 pcs		
For models:	GDW2001		

flange gaskets



1

GEV No.	528090	Ref. No.	01000160
description	gasket L 100mm W 22mm thickness 1mm		
For models:	GCO2001		



1

GEV No.	550937	Ref. No.	01000140
description	gasket L 71mm W 21mm hole ø 5mm hole distance 57mm fibre thickness 1mm for heating element		
For models:	GCO2001		

thermostats

bi-metal thermostats

safety bi-metal thermostats



1

GEV No.	390717	Ref. No.	907297
description	bi-metal safety thermostat hole distance 23.8mm switch-off temp. 110°C 1NC 1-pole 16A 250V connection F6.3 2 hole fixing mounting ø 18.3mm		
For models:	GDW2001		



bi-metal thermostats



1

GEV No.	390869	Ref. No.	253099000143
description	bi-metal thermostat hole distance 23.5mm switch-off temp. 140°C 1NC 1-pole 10A 250V connection F4.8 Qty 1 pcs		
For models:	GMW1025		



1

GEV No.	390634	Ref. No.	TER30002
description	bi-metal thermostat hole distance 23.5mm switch-off temp. 145°C 1NC 1-pole 16A 250V connection F6.3 2 hole fixing		
For models:	GCO500		



1

GEV No.	390867	Ref. No.	253099000224
description	bi-metal thermostat hole distance 23.5mm switch-off temp. 180°C 1NC 1-pole 10A 250V connection F4.8 Qty 1 pcs		
For models:	GMW1025		



1

GEV No.	390763	Ref. No.	907244
description	bi-metal thermostat hole distance 23.8mm switch-off temp. 55°C 1NC 1-pole 16A 250V connection F6.3 2 hole fixing for tank		
For models:	GDW2001		

control and safety thermostats

EGO

control thermostats

55.17_ series



1

GEV No.	371320	Ref. No.	A06032
description	thermostat t.max. 280°C temperature range 30-280°C 1-pole 1NO 16A probe ø 3mm probe L 170mm capillary pipe 860mm capillary pipe isolatedmm gland nut shaft L 14mm shaft position upper rotation 270°		
For models:	GEG2001		



1

GEV No.	391048	Ref. No.	TER30016
description	thermostat t.max. 292°C 1-pole 1NO probe ø 3mm probe L 182mm shaft ø 6x4.6mm shaft L 23mm shaft position upper° rotation 270° probe material SS with mounting accessories		
For models:	GCO500		

safety thermostats

55.32_ series



1

GEV No.	390999	Ref. No.	01202690
description	safety thermostat switch-off temp. 350°C temperature range°C 2-pole NC 20A probe ø 3mm probe L 187mm capillary pipe 690mm capillary pipe isolated 680mm gland nut shaft ømm probe SS		
For models:	GCO2001		



IMIT / TEMPOMATIC / ARTHERMO

control thermostats



GEV No.	390683	Ref. No.	TR0440
description	thermostat t.max. 86°C temperature range 0-86°C 1-pole 1CO 16A probe ø 6.5mm probe L 98mm capillary pipe 1000mm capillary pipe isolated 960mm gland nut shaft ø 6x4.6mm shaft L 20mm shaft position +135° rotation 270° probe material copper		
For models:	GDW2001		
accessories for	390683		
	GEV No.	110100	Ref. No. 903982
	knob thermostat t.max. 90°C 0-90°C ø 42mm shaft ø 6x4.6mm shaft flat -135° black		

TECASA

control thermostats

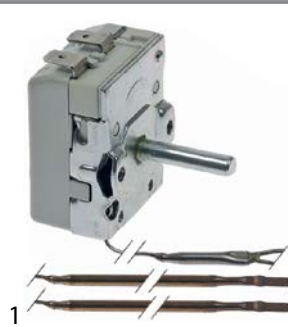

GEV No.	376091	Ref. No.	01201220
description	thermostat t.max. 328°C temperature range 57-328°C 1-pole 1NO 16A probe ø 3mm probe L 98mm capillary pipe 1540mm capillary pipe isolated 1500mm gland nut shaft ø 6x4.6mm shaft L 21mm rotation 270° outer switch probe thread disc ømm		
For models:	GCO2001		

various

control thermostats



GEV No.	390871	Ref. No.	1.1.A.A06.02
description	thermostat t.max. 95°C temperature range 0-95°C 1-pole 1NO 6A probe ø 6mm probe L 95mm capillary pipe 550mm capillary pipe isolated 490mm gland nut shaft ø 6x4mm shaft L 23mm shaft position 45° rotation 270° probe material zinc-coated steel 250V contacts male faston 4.8mm Qty 1 pcs		
For models:	GGC1078, GGC1078B		



GEV No.	390968	Ref. No.	1.06.1851713
description	thermostatcontroller t.max. 185°C temperature range°C 2-pole 1NO 16A probe ø 6mm probe L 77mm capillary pipe 1500mm capillary pipe isolated 1500mm gland nut shaft ø 6x4.6mm shaft L 25mm shaft position upper rotation 270° probe material SS		
For models:	GDF3004, GDF3008, GDF3024, GDF3028, GDF5008, GDF5028		

safety thermostats



GEV No.	390970	Ref. No.	1.06.230171301
description	safety thermostat switch-off temp. 230°C 2-pole 1NC 16A probe ø 5mm probe L 48mm capillary pipe 440mm capillary pipe isolated 150mm gland nut probe 250V model WQS-230		
For models:	GDF3004, GDF3008, GDF3024, GDF3028, GDF5008, GDF5028		

refrigeration thermostats

universal with housing



GEV No.	698867	Ref. No.	GPC1046-09
description	thermostat probe capillary pipe 650mm 1NO threaded type WPF17C-L2		
For models:	GPC1046		



switches and momentary switches

rocker/momentary rocker switches

30x22mm



GEV No.	347791	Ref. No.	1.1.A.A07.10 205426 A07034 E2301GR00001 S900.01 W0308019
description	rocker switch mounting measurements 30x22mm green 2NO 230V 20A illuminated 0-I connection male faston 6.3mm ambient temperature max. 125/55°C protection IP65 with rubber collar		
For models:	GCV1600, GDS2600, GFR2700, GHM1001, GHS1600, GHS2600, GJU1001, GPS2600, GRE2700, GSA2600, GSD2600, GSF2600		

ø20mm



GEV No.	347803	Ref. No.	DQKA0000
description	rocker switch mounting measurements 20mm red 1NO 250V 15A 0-I connection male faston 4.8mm ambient temperature max. 85°C protection IP40		
For models:	GSC1100G, GSC2336		

push/momentary push switches

30x22mm



GEV No.	345712	Ref. No.	00000700296
description	push switch mounting measurements 30x22mm red/green 2CO 250V 16A Stop / I connection male faston 6.3mm ambient temperature max. 85°C protection IP40 with indicator		
For models:	GFS1022, GFS1025, GFS1030, GFS2019, GFS2022, GFS2025, GFS2030		
accessories for	345712		
	GEV No.	301127	Ref. No.
			00000000285
	protective cover internal size 30x55mm transparent		

ø22mm



GEV No.	301127	Ref. No.	00000000285
description	protective cover internal size 30x55mm transparent		
For models:	GFS1022, GFS1025, GFS1030, GFS2019, GFS2025, GFS2030		

accessories

push buttons



GEV No.	348239	Ref. No.	905346
description	push button for dishwasher shaft 3.7x3.7mm blue ED ø 21mm ID ø 19mm		
For models:	GDW2001		

element holders



GEV No.	348240	Ref. No.	905341
description	element holder ø 23.5mm ID ø 21.5mm silver		
For models:	GDW2001		

microswitches

pin-plunger actuated



GEV No.	347799	Ref. No.	253039000003
description	microswitch with plunger 250V 15A 1CO connection male faston 4.8mm ambient temperature max. 105°C mounting distance 22mm type W-15-102C actuating force: 180g white		
For models:	GMW1025		

miscellaneous



GEV No.	347560	Ref. No.	00000000304
description	microswitch with plunger mounting distance 22mm thread M10 thread L 14mm 250V 12A 1NO connection male faston 6.3mm stroke 3.5mm ambient temperature max. 125°C type VRSR03AA1 actuating force: 135g		
For models:	GFS1025		



with push button

switches with snap-fit



1			
GEV No.	348227	Ref. No.	W0308012
description	microswitch 250V 0.5A connection male faston 2.8mm for fridge GFR2700/GRE2700		
For models:	GFR2700, GRE2700		

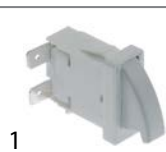

1			
GEV No.	348192	Ref. No.	I0202070
description	microswitch with push button 250VA 1NO connection male faston 6.3mm L 26x12mm ambient temperature max. 85°C actuating force: 500g		
For models:	GRE3600, GRE3600S		

position switches

METRO



1			
GEV No.	348088	Ref. No.	1.05.035011HDFMS116
description	microswitch 1NO 250V 16A L 41mm W 12mm H 44mm actuating force: 250g		
For models:	GDF3004, GDF3008, GDF3024, GDF3028, GDF5008, GDF5028		

system switches (ROLD)



1			
GEV No.	301104	Ref. No.	905312
description	momentary switch unit 1NO 250V 16A connection male faston 6.3mm		
For models:	GDW2001		

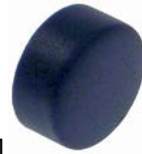

1			
GEV No.	348239	Ref. No.	905346
description	push button for dishwasher shaft 3.7x3.7mm blue ED ø 21mm ID ø 19mm		
For models:	GDW2001		



1			
GEV No.	345651	Ref. No.	905314
description	switch 2CO 250V 16A connection male faston 6.3mm		
For models:	GDW2001		



1			
GEV No.	348238	Ref. No.	905447
description	switch 2NO 250V 16A connection male faston 6.3mm type SA		
For models:	GDW2001		

cam switches

4-position

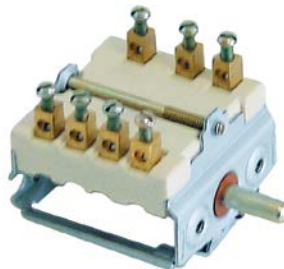

1			
GEV No.	300094	Ref. No.	A01001
description	cam switch 4 operating positions 1NO/2CO sequence 0-1-2-3 16A shaft ø 6x4.6mm shaft L 15mm connection screw 4-position ceramic		
For models:	GEG2001		



4 operating positions



GEV No.	347101	Ref. No.	A01017
description	cam switch 4 operating positions 1NO/1CO sequence 0-1-2-3 13A shaft \varnothing 6x4.6mm shaft L 23mm connection male faston 6.3mm plastic		
For models:	GTO1001, GTO2001		

10 operating positions



GEV No.	301205	Ref. No.	01200040
description	cam switch 10 operating positions 5NO/1CO sequence 0-1-2-3-4-5-6-7-8-9 16A shaft \varnothing 6x4.6mm shaft L 23mm connection male faston 6.3mm ceramic		
For models:	GCO2001		

magnetic switches

37x16mm

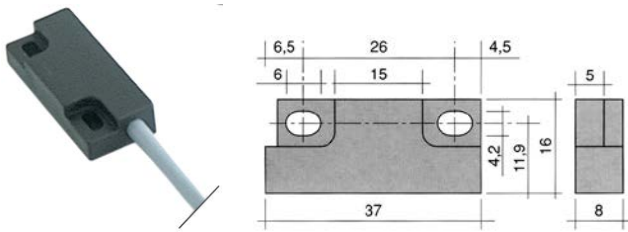

GEV No.	345341	Ref. No.	909290
description	magnetic switch L 37mm W 16mm 1NO 250V 0.04A P max. 10W connection cable length 1960mm		
For models:	GDW2001		

accessories

magnets

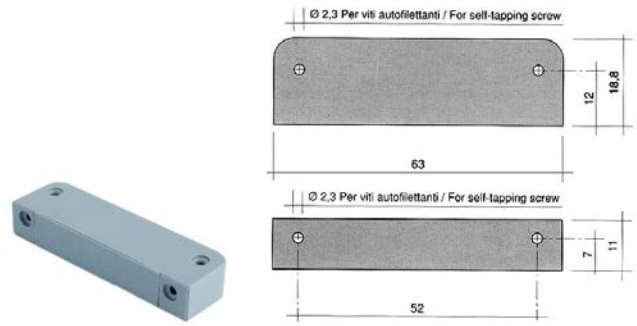

GEV No.	519049	Ref. No.	903651
description	magnet \varnothing 8mm L 63mm H 10.7mm W 18.8mm hole distance 52mm M2 hole \varnothing 2mm		
For models:	GDW2001		
accessories for	519049		
	GEV No.	560095	Ref. No. —
	sheet metal screws \varnothing 2.9mm L 9.5mm SS Qty 20 pcs DIN 7981/ISO 7049 head \varnothing 5.6mm oval head		

lamps

indicator lights

indicator lights 2-piece (lens and indicator lamp)

indicator light lenses

\varnothing 8mm (type RL-2)









GEV No.	359819	Ref. No.	00002360
description	indicator light lens green Qty 1 pcs \varnothing 8mm		
For models:	GCO2001		





GEV No.	359820	Ref. No.	00002350
description	indicator light lens yellow Qty 1 pcs \varnothing 8mm		
For models:	GCO2001		





indicator lamps for socket type RL			
			
1			
GEV No.	359818	Ref. No.	01200330 IND30009
description	indicator light 230V clear connection male faston 6.3mm		
For models:	GCO2001, GCO500		
accessories for	359818		
	GEV No.	359820	Ref. No. 00002350
indicator light lens yellow Qty 1 pcs ø 8mm			
	GEV No.	359833	Ref. No. —
indicator light lens red Qty 1 pcs ø 8mm			
	GEV No.	359948	Ref. No. —
indicator light lens clear Qty 1 pcs ø 8mm			

			
1			
GEV No.	359817	Ref. No.	01200340
description	indicator light 230V green connection male faston 6.3mm		
For models:	GCO2001		
accessories for	359817		
	GEV No.	359819	Ref. No. 00002360
indicator light lens green Qty 1 pcs ø 8mm			

indicator lights (complete)			
ø 6mm			
			
1			
GEV No.	359005	Ref. No.	903644
description	indicator light ø 6mm 230V yellow cable length 400mm		
For models:	GDW2001		

ø 9mm			
			
1			
GEV No.	360766	Ref. No.	903688
description	indicator light ø 8.5mm green 250V connection male faston 6.3mm cable length 270mm temp.-resist. 120°C		
For models:	GDW2001		

			
1			
GEV No.	360765	Ref. No.	903686
description	indicator light ø 8.5mm yellow 250V connection male faston 6.3mm cable length 260/400mm temp.-resist. 90°C		
For models:	GDW2001		

			
1			
GEV No.	360767	Ref. No.	903685
description	indicator light ø 8.5mm yellow 250V connection male faston 6.3mm cable length 260mm temp.-resist. 120°C		
For models:	GDW2001		

ø12mm			
with plug-in socket			
			
1			
GEV No.	359041	Ref. No.	A08009
description	indicator light ø 12mm green 230V connection male faston 6.3mm temp.-resist. 120°C Qty 1 pcs		
For models:	GEG2001		

			
1			
GEV No.	359042	Ref. No.	A08003
description	indicator light ø 12mm yellow 230V connection male faston 6.3mm temp.-resist. 120°C Qty 1 pcs		
For models:	GEG2001, GTO1001, GTO2001		

ø14mm			
with screw socket			
			
1			
GEV No.	360622	Ref. No.	1.03.00020013
description	indicator light ø 14mm green 220V connection male faston 4.8mm plastic		
For models:	GDF3004, GDF3008, GDF3024, GDF3028, GDF5008, GDF5028		

			
1			
GEV No.	360621	Ref. No.	1.03.00020017
description	indicator light ø 14mm yellow 220V connection male faston 4.8mm plastic		
For models:	GDF3004, GDF3008, GDF3024, GDF3028, GDF5008, GDF5028		



LED

LED bars

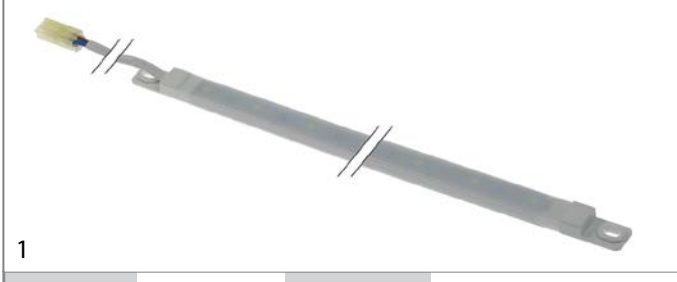

1	
GEV No. 357257	Ref. No. DQLED007
description	LED bar L 1100mm W 14.4mm H 7.5mm 24VDC white number of lamps 36 cable length 120mm
For models:	GSC2336

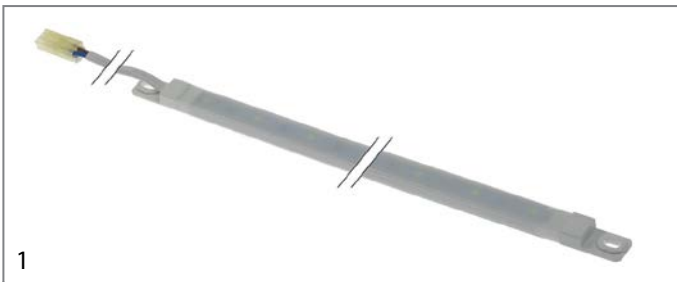

1	
GEV No. 357256	Ref. No. DQLED008
description	LED bar L 1200mm W 14.4mm H 7.5mm 24VDC white number of lamps 42 cable length 120mm
For models:	GSC1100G



1	
GEV No. 357260	Ref. No. W0304086 W0304511
description	LED bar L 130mm W 14mm H 8mm cable length 300mm GFR2700/GRE2700
For models:	GFR2700, GRE2700
accessories for	357260

	GEV No. 692879	Ref. No. W0409863
cover for lamp L 185mm W 55mm H 40mm for GFR2700/GRE2700		



1	
GEV No. 357251	Ref. No. DQLED066
description	LED bar L 400mm W 12mm H 12mm 24V blue number of lamps 30 cable length 280mm
For models:	GBC1102

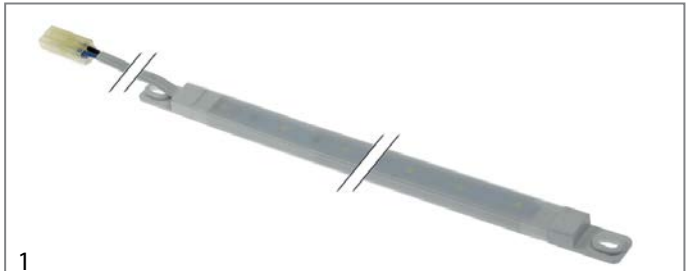

1	
GEV No. 357255	Ref. No. DQLED011
description	LED bar L 400mm W 14.4mm H 7.5mm 24VDC white number of lamps 18 cable length 380mm
For models:	GSC2336

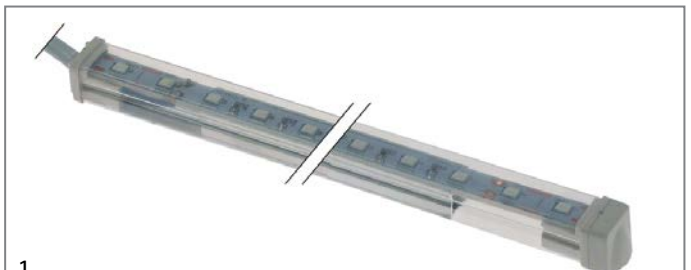

1	
GEV No. 357241	Ref. No. DQLED067
description	LED bar L 600mm W 11.5mm H 12.5mm 24V number of lamps 42 cable length 285mm voltage DC
For models:	GBC1103

1	
GEV No. 357138	Ref. No. 1.1.A.A01.03.03
description	LED bar L 698mm W 13mm H 13mm 230V number of lamps 27 cable length 800mm
For models:	GCV1600

accessories



1	
GEV No. 357152	Ref. No. 1.1.B.B25.20
description	power supply for LEDs RT-130-2-24cm Qty 1 pcs
For models:	GCV1600



fluorescent lamps

fluorescent lamps

G5

			
1			
GEV No.	357156	Ref. No.	DQDA0009
description	fluorescent lamp socket G5 L 285mm 8W ø 16mm 230VT5/865 Qty 1 pcs		
For models:	GBC1001, GBC1001S, GBC1001SS		

			
1			
GEV No.	357148	Ref. No.	DQDA0010
description	fluorescent lamp socket G5 L 547mm 14W ø 16mm 230V T5/865 Qty 1 pcs		
For models:	GBC1002, GBC1002S, GBC1002SS, GBC1003, GBC1003S, GBC1003SS		

accessories

sockets

			
1			
GEV No.	381169	Ref. No.	SLJY2010
description	lamp holder socket G13 L 26.5mm W 24.5mm Qty 1 pcs for fluorescent lamps		

			
1			
GEV No.	381447	Ref. No.	SLZA3000
description	lamp socket socket G13 L 33mm W 10mm H 28mm		
For models:	GBC1001, GBC1001S, GBC1001SS, GBC1002, GBC1002S, GBC1002SS, GBC1003, GBC1003S, GBC1003SS		

starter holders

			
1			
GEV No.	381170	Ref. No.	SLZA1000
description	starter holder L 32mm W 24mm housing ø 23mm Qty 1 pcs		
For models:	GBC1001, GBC1001S, GBC1001SS, GBC1002, GBC1002S, GBC1002SS, GBC1003, GBC1003S, GBC1003SS		

starter

			
1			
GEV No.	380464	Ref. No.	DQDF0000
description	starter 4-65W		
For models:	GBC1001, GBC1001S, GBC1001SS, GBC1002, GBC1002S, GBC1002SS, GBC1003, GBC1003S, GBC1003SS		

			
1			
GEV No.	357150	Ref. No.	1.1.A.A01.02.01
description	starter for fluorescent lamps L 69mm W 38.5mm 11W type HG-YZ11E Qty 1 pcs		
For models:	GGC1078, GGC1078B, GGC2270, GGC2270B		

ballasts

			
1			
GEV No.	403192	Ref. No.	DQZB0005
description	electrical ballast 15W 220-240V connection screw clamp for fluorescent lamps type JF-1595M Qty 1 pcs		
For models:	GBC1002, GBC1002S, GBC1002SS, GBC1003, GBC1003S, GBC1003SS		

			
1			
GEV No.	403190	Ref. No.	DQZA0027
description	electrical ballast 30W 220-240V connection screw clamp for fluorescent lamps type JF-3095W Qty 1 pcs		

			
1			
GEV No.	403191	Ref. No.	DQZB0029
description	electrical ballast 9W 220V connection screw clamp for fluorescent lamps type JF-995M Qty 1 pcs		
For models:	GBC1001, GBC1001S, GBC1001SS		



covers

			
1			
GEV No.	699314	Ref. No.	SLZV0017
description	cover L 510mm W 30mm H 30mm		
For models:	GBC1001, GBC1001S, GBC1001SS		



1			
GEV No.	694873	Ref. No.	SLSE2008
description	cover L 590mm W 280mm H 1mm		
For models:	GSC2336		

1			
GEV No.	699312	Ref. No.	SLZV0018
description	cover L 810mm W 30mm H 30mm transparent		
For models:	GBC1002, GBC1002S, GBC1002SS, GBC1102		

1				
GEV No.	694874	Ref. No.	SLZQ0037	
description	cover set mounting pos. left/right W 82mm H 280mm D 34			
For models:	GSC1100G, GSC2336			
spare parts for	694874			
	GEV No.	692393	Ref. No.	—
bezel for cover mounting pos. right/left W 82mm H 280mm D 34mm plastic Qty 1 pcs				
	GEV No.	692394	Ref. No.	—
bezel for cover mounting pos. left W 82mm H 280mm D 34mm plastic Qty 1 pcs				

1			
GEV No.	694872	Ref. No.	SLJV2040
description	cover support L 610mm W 20mm H 55mm mounting pos. lower		
For models:	GSC2336		

1			
GEV No.	694871	Ref. No.	SLJV2041
description	cover support L 610mm W 20mm H 55mm mounting pos. upper		
For models:	GSC2336		

microwave lamps



light bulbs

1			
GEV No.	357175	Ref. No.	253079000039
description	light bulb socket E14 230V 20W ø 25mm L 63mm Qty 1 pcs lens L 37mm		
For models:	GMW1025		

oven lamps

universal oven lamps



mounting diameter 35.5mm

1				
GEV No.	359718	Ref. No.	00002330	
description	oven lamp mounting ø 35.5mm 230V 15W socket E14 temp.-resist. 300°C connection male faston 6.3mm hard glas			
For models:	GCO2001			
spare parts for	359718			
	GEV No.	359701	Ref. No.	—
lamp socket socket E14 220-230V mounting ø 35.5mm connection male faston 6.3mm 15W				
	GEV No.	359740	Ref. No.	—
light bulb t.max. 300°C socket E14 15W 230V ø 22mm L 48mm lens L 20mm for oven lamp IMPORT				

1			
GEV No.	357176	Ref. No.	LAM30006
description	oven lamp mounting ø 35.5mm 230V 40W socket G9 temp.-resist. 300°C connection cable 100mm hard glas		
For models:	GCO500		

lamp accessories

fascias

1				
GEV No.	692879	Ref. No.	W0409863	
description	cover for lamp L 185mm W 55mm H 40mm for GFR2700/GRE2700			
For models:	GFR2700, GRE2700			
accessories for	692879			
	GEV No.	357260	Ref. No.	W0304086 W0304511
LED bar L 130mm W 14mm H 8mm cable length 300mm GFR2700/GRE2700				



timers

mechanical timers



1

GEV No.	350130	Ref. No.	PRG30001
description	timer M11 with bell 1-pole operation time 120min impulse mechanical 1NO at 250V 16A permanent position yes shaft \varnothing 6x4.6mm shaft L 23mm mounting distance 28mm mounting thread M4 connection male faston 6.3mm 4 hole fixing shaft flat upper		
For models:	GCO500		



1

GEV No.	350186	Ref. No.	01202980
description	timer M2 2-pole operation time 120min impulse mechanical 2CO at 250V 16A permanent position yes shaft \varnothing 6x4.6mm shaft L 23mm mounting distance 28mm		
For models:	GCO2001		
accessories for	350186		
	GEV No.	112627	Ref. No. —
	knob time 120min \varnothing 58mm shaft \varnothing 6x4.6mm shaft flat lower		



1

GEV No.	360164	Ref. No.	A02008
description	timer MT49 2-pole operation time 15min impulse mechanical 2NO at 250V 16A permanent position yes shaft 6x4.6mm shaft L 16mm mounting distance 28mm connection lateral		
For models:	GTO1001, GTO2001		

defrost timers

miscellaneous



1

GEV No.	360553	Ref. No.	1.1.A.A05.06
description	defrost timer SONXIE type DBZF-625-2G2B defrosting interval 6h defrosting time 2minmin fan delaymin 200-240V Qty 1 pcs		
For models:	GGC1078, GGC1078B		

alarm devices

buzzer boards



1

GEV No.	401062	Ref. No.	01201250
description	buzzer board 230VAC L 48mm W 45mm connection Faston 6.3mm		
For models:	GCO2001		

contactors

LOVATO

power contactors



1

GEV No.	380705	Ref. No.	907190
description	power contactor resistive load 20A 230VAC (AC3/400V) 9A/4kW main contacts 3NO auxiliary contacts 1NO connection screw connection type 11BG0910A230		
For models:	GDW2001		
accessories for	380705		
	GEV No.	380057	Ref. No. —
	auxiliary contact contacts 1NO/1NC AC1 10A for contactors BG series connection screw type BGX1011		

solid state relays

accessories

diodes

high voltage diodes



GEV No.	403261	Ref. No.	253089000101
description	hv diode type RG501 connection F6.3mm / lug M4 cable lengthmm for microwave Qty 1 pcs		
For models:	GMW1025		

relays

power relays

with bracket mounting

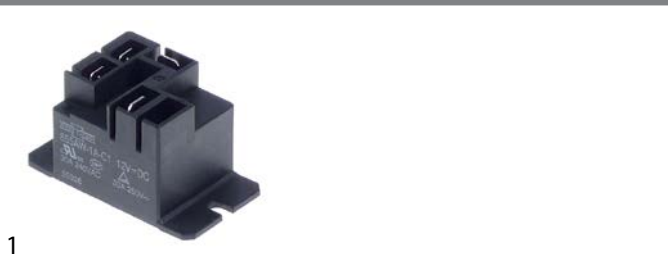

GEV No.	380867	Ref. No.	DQWBZJ02
description	relay SHANGFANG 12VDC 30A 1NO connection male faston 6.3mm screw mounting at 250V 30A manuf. no. 855AW-1A-C1		
For models:	GSC1100G, GSC2336		

magnetrons



GEV No.	403173	Ref. No.	253017000051
description	Magnetron type 2M248J(JT)		
For models:	GMW1025		

transformers

power supplies

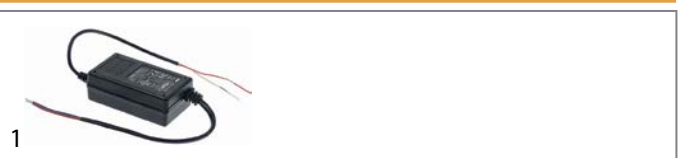

GEV No.	403903	Ref. No.	W0399114
description	power supply primary 100-240VAC secondary 24VDC H 30mm L 85mm W 45mm 50/60Hz type JKY36-SP2400600		
For models:	GFR2700		



GEV No.	403902	Ref. No.	W0399115
description	power supply primary 100-240VAC secondary 24VDC H 34mm L 114mm W 45mm 50/60Hz type JKY36-SP2401500 GRE2700		
For models:	GRE2700		

HV transformers



GEV No.	403257	Ref. No.	253029000256
description	HV transformer primary 230-240V 50Hz type GAL-1000E-1G for microwave		
For models:	GMW1025		

miscellaneous

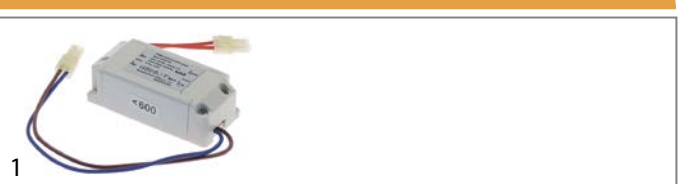

GEV No.	403660	Ref. No.	DQLED069
description	transformer primary 100-240V secondary 24VDC 20VA secondary 0.84A		
For models:	GBC1001, GBC1001S, GBC1002, GBC1002S, GBC1003, GBC1003S, GBC1102, GBC1103		



GEV No.	403867	Ref. No.	DQLED055
description	transformer primary 100-240V secondary 24VDC secondary 0.42A H 25mm L 95mm W 40mm		
For models:	GSC1100G, GSC2336		



electronic controllers

DIXELL

refrigeration controllers

built-in version



1

GEV No.	378256	Ref. No.	S900.02
description	electronic controller DIXELL XR02CX-5N0C0 mounting measurements 71x29mm built-in depth 56mm 230V voltage AC NTC relay outputs 1 CO-8A(4) NTC protection IP54 defrosting function/time control -40 up to +110°C display 2½ digit		
For models:	GHS1600, GHS2600		
spare parts for	378256		
	GEV No.	Ref. No.	—
	379161		
	temperature probe NTC 10kOhm cable thermoplastic probe -40 up to +110°C cable -40 up to +110°C probe ø6x14mm cable length 3m without screw connection 2-wire		
accessories for	378256		
	GEV No.	Ref. No.	—
	378194		
	temperature probe NTC 10kOhm cable PVC probe -20 up to +80°C cable -10 up to 100°C probe ø7x24.5mm cable length 1.5m without screw connection 2-wire		
	GEV No.	Ref. No.	—
	379057		
	temperature probe NTC 10kOhm cable PVC probe -20 up to +80°C cable -10 up to 100°C probe ø6x25mm cable length 3m 2-wire		
	GEV No.	Ref. No.	E21010150001
	379160		
	temperature probe NTC 10kOhm cable thermoplastic probe -40 up to +110°C cable -40 up to +110°C probe ø6x14mm cable length 1.5m without screw connection 2-wire		
	GEV No.	Ref. No.	—
	379161		
	temperature probe NTC 10kOhm cable thermoplastic probe -40 up to +110°C cable -40 up to +110°C probe ø6x14mm cable length 3m without screw connection 2-wire		
	GEV No.	Ref. No.	—
	379343		
	temperature probe NTC 10kOhm cable silicone probe -40 up to +110°C cable -50 up to +180°C probe ø6x40mm cable length 3m 2-wire		
	GEV No.	Ref. No.	—
	379458		
	temperature probe NTC 10kOhm cable silicone probe -40 up to +110°C cable -50 up to +180°C probe ø6x40mm cable length 1.5m without screw connection 2-wire		



1

GEV No.	378267	Ref. No.	E20A111C4D00
description	electronic controller DIXELL XR02CX-5N0C1 mounting measurements 71x29mm built-in depth 56mm 230V voltage AC NTC relay outputs 1 NO-20A(8) NTC DI protection IP54 defrosting function/time control -40 up to +110°C display 2½ digit		
For models:	GDS2600, GPS2600, GSA2600, GSD2600, GSF2600		
accessories for	378267		
	GEV No.	Ref. No.	—
	379161		
	temperature probe NTC 10kOhm cable thermoplastic probe -40 up to +110°C cable -40 up to +110°C probe ø6x14mm cable length 3m without screw connection 2-wire		
	GEV No.	Ref. No.	—
	381249		
	temperature probe NTC 10kOhm cable PVC probe -40 up to +110°C cable -10 up to 100°C connection 2-wire thread probe ø6x14mm cable length 3m		



1

GEV No.	378665	Ref. No.	W0302160
description	electronic controller DIXELL XR03CX-5R0C1 mounting measurements 71x29mm built-in depth 50mm 230V voltage AC NTC relay outputs 2 NO-20A(8) CO-8A(3) NTC DI protection IP65 defrosting function/time control -55 up to +99°C display 2 digit		
For models:	GRE2700		



1

GEV No.	378363	Ref. No.	W0302159
description	electronic controller DIXELL XR06CX-5R0C1 mounting measurements 71x29mm 230V voltage AC NTC relay outputs 3 NO-20A(8) CO-8A(3) NO-5A(2) NTC NTC DI protection IP54 -40 up to +110°C display 3½ digits		
For models:	GFR2700		
accessories for	378363		
	GEV No.	Ref. No.	—
	381249		
	temperature probe NTC 10kOhm cable PVC probe -40 up to +110°C cable -10 up to 100°C connection 2-wire thread probe ø6x14mm cable length 3m		



1

GEV No.	379843 ¹	Ref. No.	1.1.A.A06.03.31
description	electronic controller kit DIXELL XR30CX-5N2C1 mounting measurements 71x29mm 230V voltage AC NTC/PTC relay outputs 2 1x NTC probe inclusive -50 up to +150°C display 3½ digits 2 RoomTempLN NTC/PTC DEF Probe DigilN1 DigilN2 DEF Relay fan relay Temp4/Dig1 NTC/PTC/DIGI evaporator probe defr. funct. compressor relay NO-20A(8) light relay alarm relay CO-8A(3) auxiliary relay		
For models:	GCV1600		
spare parts for	379843		
	GEV No.	379160	Ref. No. E21010150001
	temperature probe NTC 10kOhm cable thermoplastic probe -40 up to +110°C cable -40 up to +110°C probe ø6x14mm cable length 1.5m without screw connection 2-wire		

¹incl. 1x NTC probe

SHANGFANG

refrigeration controllers

built-in version



1

GEV No.	379799 ¹	Ref. No.	DQWBZX02
description	electronic controller SHANGFANG type SF-104S-2 mounting measurements 71x29mm 12V voltage AC NTC relay outputs 2 12VDC 12VDC NTC front measurements 77x35mm built-in depth 40mm protection IP54 accuracy 1% built-in version alarm without accessories defr. funct. yes -45 up to +45°C display 3 digits		
For models:	GSC1100G, GSC2336		
spare parts for	379799		
	GEV No.	379054	Ref. No. —
	transformer primary 230VAC secondary 12VAC 3VA secondary 0.25A H 40mm L 45mm W 50mm connection screw 50/60Hz type 153/M		
	GEV No.	380867	Ref. No. DQWBZJ02
	relay SHANGFANG 12VDC 30A 1NO connection male faston 6.3mm screw mounting at 250V 30A manuf. no. 855AW-1A-C1		
	GEV No.	381318	Ref. No. —
	temperature probe NTC cable silicone cable colours white cable length 3m probe -40 up to +110°C cable -50 up to +180°C probe ø7x25mm coded plug		
	GEV No.	381319	Ref. No. —
	temperature probe NTC cable silicone cable colours black cable length 3m evaporator probe -40 up to +110°C cable -50 up to +180°C probe ø7x25mm coded plug		
accessories for	379799		
	GEV No.	379054	Ref. No. —
	transformer primary 230VAC secondary 12VAC 3VA secondary 0.25A H 40mm L 45mm W 50mm connection screw 50/60Hz type 153/M		
	GEV No.	380867	Ref. No. DQWBZJ02
	relay SHANGFANG 12VDC 30A 1NO connection male faston 6.3mm screw mounting at 250V 30A manuf. no. 855AW-1A-C1		

¹without relay, cable harness, probe and transformer

accessories for	379799		
	GEV No.	381318	Ref. No. —
	temperature probe NTC cable silicone cable colours white cable length 3m probe -40 up to +110°C cable -50 up to +180°C probe ø7x25mm coded plug		
	GEV No.	381319	Ref. No. —
	temperature probe NTC cable silicone cable colours black cable length 3m evaporator probe -40 up to +110°C cable -50 up to +180°C probe ø7x25mm coded plug		

built-in version 2-piece











1

GEV No.	379849 ¹	Ref. No.	DQWB005
description	electronic controller SHANGFANG type SF-101S mounting measurements 71x29mm 230V voltage AC NTC relay outputs 1 NO-30A NTC Comp front measurements 77x35mm built-in depth 40mm protection IP54 accuracy 1% built-in version alarm incl. relay, cable harness, probe and transformer defr. funct. yes -45 up to +45°C display 3 digits		
For models:	GBC1001, GBC1001S, GBC1001SS, GBC1002, GBC1002S, GBC1002SS, GBC1003, GBC1003S, GBC1003SS		
spare parts for	379849		
	GEV No.	379054	Ref. No. —
	transformer primary 230VAC secondary 12VAC 3VA secondary 0.25A H 40mm L 45mm W 50mm connection screw 50/60Hz type 153/M		
	GEV No.	380867	Ref. No. DQWBZJ02
	relay SHANGFANG 12VDC 30A 1NO connection male faston 6.3mm screw mounting at 250V 30A manuf. no. 855AW-1A-C1		
	GEV No.	381318	Ref. No. —
	temperature probe NTC cable silicone cable colours white cable length 3m probe -40 up to +110°C cable -50 up to +180°C probe ø7x25mm coded plug		
	GEV No.	381319	Ref. No. —
	temperature probe NTC cable silicone cable colours black cable length 3m evaporator probe -40 up to +110°C cable -50 up to +180°C probe ø7x25mm coded plug		
accessories for	379849		
	GEV No.	379054	Ref. No. —
	transformer primary 230VAC secondary 12VAC 3VA secondary 0.25A H 40mm L 45mm W 50mm connection screw 50/60Hz type 153/M		
	GEV No.	380867	Ref. No. DQWBZJ02
	relay SHANGFANG 12VDC 30A 1NO connection male faston 6.3mm screw mounting at 250V 30A manuf. no. 855AW-1A-C1		
	GEV No.	381318	Ref. No. —
	temperature probe NTC cable silicone cable colours white cable length 3m probe -40 up to +110°C cable -50 up to +180°C probe ø7x25mm coded plug		
	GEV No.	381319	Ref. No. —
	temperature probe NTC cable silicone cable colours black cable length 3m evaporator probe -40 up to +110°C cable -50 up to +180°C probe ø7x25mm coded plug		

¹incl. relay, cable harness, probe and transformer



 <p>71 x 29mm</p>			
1			
GEV No.	403074 ¹	Ref. No.	DQWB0002
description	electronic controller SHANGFANG type SF-104S-2 mounting measurements 71x29mm 230V voltage AC NTC relay outputs 2 NO-30A NO-30A NTC NTC front measurements 77x35mm built-in depth 38mm protection IP54 accuracy 1% built-in version alarm incl. relay, cable harness, probe and transformer defr. funct. yes -45 up to +45°C display 2½ digit		
For models:	GBC1001, GBC1001S, GBC1002, GBC1002S, GBC1003, GBC1003S, GBC1102, GBC1103, GSC1100G, GSC2336		
spare parts for	403074		
	GEV No.	379054	Ref. No. —
	transformer primary 230VAC secondary 12VAC 3VA secondary 0.25A H 40mm L 45mm W 50mm connection screw 50/60Hz type 153/M		
	GEV No.	380867	Ref. No. DQWBZJ02
	relay SHANGFANG 12VDC 30A 1NO connection male faston 6.3mm screw mounting at 250V 30A manuf. no. 855AW-1A-C1		
	GEV No.	381318	Ref. No. —
	temperature probe NTC cable silicone cable colours white cable length 3m probe -40 up to +110°C cable -50 up to +180°C probe ø7x25mm coded plug		
	GEV No.	381319	Ref. No. —
	temperature probe NTC cable silicone cable colours black cable length 3m evaporator probe -40 up to +110°C cable -50 up to +180°C probe ø7x25mm coded plug		
accessories for	403074		
	GEV No.	379054	Ref. No. —
	transformer primary 230VAC secondary 12VAC 3VA secondary 0.25A H 40mm L 45mm W 50mm connection screw 50/60Hz type 153/M		
	GEV No.	380867	Ref. No. DQWBZJ02
	relay SHANGFANG 12VDC 30A 1NO connection male faston 6.3mm screw mounting at 250V 30A manuf. no. 855AW-1A-C1		
	GEV No.	381318	Ref. No. —
	temperature probe NTC cable silicone cable colours white cable length 3m probe -40 up to +110°C cable -50 up to +180°C probe ø7x25mm coded plug		
	GEV No.	381319	Ref. No. —
	temperature probe NTC cable silicone cable colours black cable length 3m evaporator probe -40 up to +110°C cable -50 up to +180°C probe ø7x25mm coded plug		

¹incl. relay, cable harness, probe and transformer

accessories

			
1			
GEV No.	380867	Ref. No.	DQWBZJ02
description	relay SHANGFANG 12VDC 30A 1NO connection male faston 6.3mm screw mounting at 250V 30A manuf. no. 855AW-1A-C1		
For models:	GSC1100G, GSC2336		

accessories universal for electronic con-

miscellaneous

			
1			
GEV No.	692369	Ref. No.	1.1.C.C63.71
description	bracket for thermometer W 81mm H 41mm plastic Qty 1 pcs		
For models:	GCV1600		

probes

universal probes

temperature probes

			
1			
GEV No.	379160	Ref. No.	E21010150001
description	temperature probe NTC 10kOhm cable thermoplastic probe -40 up to +110°C cable -40 up to +110°C probe ø6x14mm cable length 1.5m without screw connection 2-wire		
For models:	GDS2600, GPS2600, GSA2600, GSD2600, GSF2600		

producer-specific probes

probes

			
1			
GEV No.	403899	Ref. No.	W0302305
description	probe NTC 10kOhm cable PVC probe -40 up to +110°C cable -40 up to +110°C connection coded plug thread probe ø6x14mm cable length 600m GFR2700/GRE2700		
For models:	GFR2700		

			
1			
GEV No.	403901	Ref. No.	W0302304
description	probe NTC 10kOhm cable PVC probe -40 up to +110°C cable -40 up to +110°C connection coded plug thread probe ø6x14mm cable length 800m GFR2700/GRE2700		
For models:	GFR2700, GRE2700		



1 

GEV No.	403910	Ref. No.	I0205805
description	temperature probe NTC 10kOhm cable PVC probe -40 up to +110°C connection 2-wire probe 5x20 cable length 1.475m		
For models:	GFR3600S, GRE3600, GRE3600S		

sensors



1 

GEV No.	403155	Ref. No.	AD400009
description	sensor for induction device ø 25mm H 17mm cable length 130mm		
For models:	GIC3035		

1 

GEV No.	403529	Ref. No.	263019008956
description	display PCB microwave GMW1025 L 160mm W 85mm cable length 200mm for microwave		
For models:	GMW1025		

1 

GEV No.	403154	Ref. No.	DQA020110R
description	keypad PCB induction device GIC3035 L 247mm W 53mm keypad connection 4 contact pins edition since 2012 buttons 8		
For models:	GIC3035		
accessories for	403154		
		GEV No.	403156
		Ref. No.	LAC5000003
	control panel induction device GIC3535 W 300mm H 58mm		
		GEV No.	403160
		Ref. No.	—
	control panel induction device GIC3535 W 300mm mounting pos. right H 58mm		

electronics

PCBs

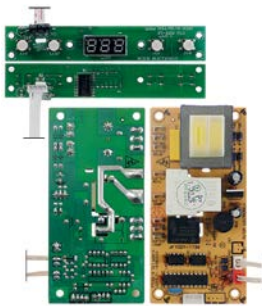
1 

GEV No.	361873	Ref. No.	1.1.A.A17.01.01 1.1.A.A17.04.06
description	control PCB refrigerated show case GGC 1270/2270 cable length 225mm 2-piece type KB3150		
For models:	GGC2270, GGC2270B		

1 

GEV No.	403188	Ref. No.	263029001088
description	line filter microwave for GMW1025 250V 50/60Hz conductor 2 PCB connection male faston 4.8mm L 80mm H 20mm W 40mm PCB Qty 1 pcs cable length 120mm type DNV-0818A-5		
For models:	GMW1025		

1 

GEV No.	403736	Ref. No.	43845000 I9R00462
description	control PCB refrigeration IARP L 222mm W 40mm		
For models:	GFR3600S, GRE3600, GRE3600S		

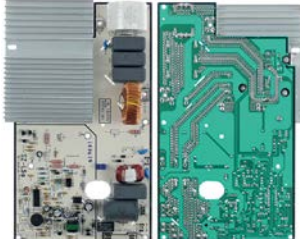
1 

GEV No.	403153	Ref. No.	DQA010095R
description	main PCB induction device GIC3035 L 267mm W 160mm connection male faston 6.3mm vertical keypad connection 4 contact pins SZ-L5		
For models:	GIC3035		
accessories for	403153		
		GEV No.	403154
		Ref. No.	DQA020110R
	keypad PCB induction device GIC3035 L 247mm W 53mm keypad connection 4 contact pins edition since 2012 buttons 8		

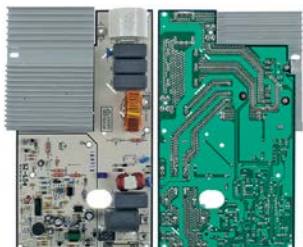

1 

GEV No.	403680	Ref. No.	DQA010198R
description	main PCB induction device GIC3035 L 267mm W 160mm connection screw keypad connection 4 contact pins SZ-L5a		
For models:	GIC3035		

1 

GEV No.	403165	Ref. No.	2852
description	PCB GSM1000 speed control		
For models:	GSM1000		
spare parts for	403165		
	GEV No.	696506	Ref. No. 2858
knob for PCB ø 26mm black Qty 1 pcs			

central units

1 

GEV No.	400788	Ref. No.	0000000297
description	control box for slicer 230V		
For models:	GFS1022, GFS1025, GFS1030, GFS2022, GFS2025		

1 

GEV No.	403682	Ref. No.	00000001752
description	control box for slicer 230V 50Hz edition since 04/2016		
For models:	GFS2019, GFS2030		

1 

GEV No.	401855	Ref. No.	00000009240
description	control box with pressure switch double for slicer 230V		
For models:	GFS1030		

keypads

front foils

1 

GEV No.	403156	Ref. No.	LAC5000003
description	control panel induction device GIC3535 W 300mm H 58mm		
For models:	GIC3035		
accessories for	403156		
	GEV No.	403154	Ref. No. DQA020110R
keypad PCB induction device GIC3035 L 247mm W 53mm keypad connection 4 contact pins edition since 2012 buttons 8			

1 

GEV No.	403764	Ref. No.	49357000
description	front foil blast freezer L 165mm W 45mm		
For models:	GFR3600S, GRE3600, GRE3600S		

membrane keypads

1 

GEV No.	403187	Ref. No.	253069002692
description	membrane keypad microwave GMW1025 2-piece buttons 15 Qty 1 pcs L 164mm W 70mm		
For models:	GMW1025		

control panel

1 

GEV No.	506281	Ref. No.	909763
description	control panel for dishwasher L 250mm W 40mm black suitable for Silanos		
For models:	GDW2001		



solenoid valves

solenoid valves (water)

TP



GEV No.	370017	Ref. No.	902390
description	solenoid valve single straight 230VAC inlet 3/4" outlet 11.5mm DN10 TP p max 10bar		

For models: GDW2001

spare parts for 370017

	GEV No.	371013	Ref. No.	—
solenoid coil TP 230VAC 50/60Hz				

accessories for 370017

	GEV No.	371220	Ref. No.	—
reducer TP flow rate 3l/min red tolerance ±15%				
	GEV No.	371221	Ref. No.	—
reducer TP flow rate 5.5l/min yellow tolerance ±15%				
	GEV No.	371222	Ref. No.	—
reducer TP flow rate 6l/min grey tolerance ±15%				
	GEV No.	371223	Ref. No.	—
reducer TP flow rate 10l/min white tolerance ±15%				
	GEV No.	371224	Ref. No.	—
reducer TP flow rate 12l/min bronze tolerance ±15%				
	GEV No.	371225	Ref. No.	—
reducer TP flow rate 16l/min light brown tolerance ±15%				
	GEV No.	371226	Ref. No.	—
reducer TP flow rate 20l/min red tolerance ±15%				
	GEV No.	371230	Ref. No.	—
reducer TP flow rate 0.25l/min red tolerance ±25%				
	GEV No.	371231	Ref. No.	—
reducer TP flow rate 0.35l/min violet tolerance ±25%				
	GEV No.	371232	Ref. No.	—
reducer TP flow rate 0.5l/min orange tolerance ±25%				
	GEV No.	371233	Ref. No.	—
reducer TP flow rate 0.8l/min white tolerance ±25%				
	GEV No.	371234	Ref. No.	—
reducer TP flow rate 1l/min light blue tolerance ±25%				
	GEV No.	371235	Ref. No.	—
reducer TP flow rate 1.2l/min brown tolerance ±25%				

accessories for 370017	GEV No.	371236	Ref. No.	—
	reducer TP flow rate 1.5l/min light brown tolerance ±25%			
	GEV No.	371237	Ref. No.	—
reducer TP flow rate 2.5l/min yellow tolerance ±25%				
	GEV No.	371238	Ref. No.	—
reducer TP flow rate 3.4l/min dark green tolerance ±25%				
	GEV No.	371239	Ref. No.	—
reducer TP flow rate 5l/min black tolerance ±25%				
	GEV No.	371240	Ref. No.	—
reducer TP flow rate 8l/min blue tolerance ±20%				

solenoid valves (refrigeration)

SANHUA

valves



GEV No.	374110	Ref. No.	W0205011	
description	solenoid valve type FDF2AT connection 6mm soldering connection L 143mm pipe connection ø 6mm 220-240V			
For models:	GFR2700			
accessories for 374110	GEV No.	696787	Ref. No.	W0208009
	T-piece copper ID ø 4.5mm ED ø 6mm refrigeration for GFR2700			

pressure switches

for warewashing

ø 58mm with male faston 6.3mm

with connection horizontal



GEV No.	541001	Ref. No.	905264
description	pressure control pressure range 35/17mbar connection 6mm ø 58mm pressure connection horizontal warewashing		
For models:	GDW2001		



compressors

ACC/ZEL

R600A

LBP monophase

Lower evaporation temperature below -20°C



1

GEV No.	605141	Ref. No.	DQYD0015 E27B6F1Z0001
description	compressor coolant R600a type HPY12AAa 220-240V 50Hz LBP 8.8kg 1/5HP cylinder capacity 12cm ³ RSIR H 200mmWWWWWWWWWW		
For models:	GBC1002, GBC1002S, GBC1002SS, GBC1003, GBC1003S, GBC1003SS, GBC1102, GDS2600, GPS2600, GSA2600, GSC2336, GSD2600, GSF2600		



1

GEV No.	605150	Ref. No.	1.1.A.A02.01
description	compressor coolant R600a type HVM10AA 220-240V 50Hz LBP 8.7kg 1/6HP cylinder capacity 10cm ³ RSIR H 180mmWWWWWWWWWW		
For models:	GCV1600		



1

GEV No.	650150	Ref. No.	VRX1560.01
description	compressor coolant R600a type HVM67AA 220-240V 50Hz LBP 7.5kg 1/8HP cylinder capacity 7cm ³ RSIR H 180mmWWWW		
For models:	GHS1600, GHS2600		



1

GEV No.	605142	Ref. No.	1.1.A.A02.04 DQYD0014
description	compressor coolant R600a type HVM86AA 220-240V 50Hz LBP fully hermetic 7.83kg 1/7HP cylinder capacity 8.6cm ³ RSIR H 174mmWWWW		
For models:	GBC1001, GBC1001S, GBC1001SS, GGC1078, GGC1078B		

EMBRACO / ASPERA

R290A

LBP monophase

Lower evaporation temperature below -20°C



1

GEV No.	605258	Ref. No.	I0210981 W0201133
description	compressor coolant R290 type EMTE2134U 220-240V 50Hz LBP 9kg 3/8HP cylinder capacity 9.5cm ³ CSIR H 187mm 250W 278W 305W 330W 366WWWWWW		
For models:	GFR2700, GFR3600S		



R600A

LBP monophase

Lower evaporation temperature below -20°C



1

GEV No.	605281	Ref. No.	W0201151
description	compressor coolant R600a type EMB40CLC 220-240V 50Hz LBP 8kg 1HP cylinder capacity 7.24cm ³ H 160mm		
For models:	GRE2700		



1

GEV No.	605257	Ref. No.	45004031
description	compressor coolant R600a type EMD46CLT 220-240V 50Hz LBP 7.5kg cylinder capacity 7.96cm ³ RSCR H 210mm 88W 118W 154W 196W 246WWWWW		
For models:	GRE3600, GRE3600S		

miscellaneous

R134A



1

GEV No.	605140	Ref. No.	DQYA0087
description	compressor KONOR type GQR90AA coolant R134a 220-240V 50Hz 10.1kg 1/4HP cylinder capacity 9.1cm ³ RSIR H 186mmWWWWWWWWW		

R600A



1

GEV No.	605143	Ref. No.	1.1.A.A02.25
description	compressor DONPER type QD167YU coolant R600a 220-240V 50Hz fully hermetic 11.9kg power input 276W cylinder capacity 16.7cm ³ RSCR H 220mm 169W 199W 236W 280W 334W 391WWWWW test method ASHRAE capacitor 6µF		
For models:	GGC2270, GGC2270B		

accessories

miscellaneous



1

GEV No.	699425	Ref. No.	1.1.C.C41.01
description	vibration damper ø 25mm H 10mm		
For models:	GGC1078, GGC1078B		

fans

axial fans

import



1

GEV No.	601131 ¹	Ref. No.	I0221151
description	axial fan L 119mm W 119mm H 25mm 230VAC 50/60Hz 19/18W bearing ball bearing connection male faston 2.8mm metal ADDA fan wheel ø 110mm temp.-resist. 70°C		
For models:	GFR3600S, GRE3600, GRE3600S		
accessories for	601131		
	GEV No.	550898	Ref. No. I0221181
	connecting cable cable length 2000mm connection F 2.8 connection distance 7.9mm for axial flow fan		

¹with ball bearings



1

GEV No.	601909 ¹	Ref. No.	45003031
description	axial fan L 119mm W 119mm H 38mm 220-240 50/60Hz 31/29W bearing ball bearing connection male faston 2.8mm		
For models:	GFR3600S, GRE3600, GRE3600S		

¹with ball bearings



1

GEV No.	601787 ¹	Ref. No.	DQFA1000 DQFD1000 DQFD1001
description	axial fan L 119mm W 119mm H 38mm 230VAC 50/60Hz 22/38.4W bearing slide bearing manuf. no. HT-A12038S220 connection plug cable length 300mm HUI TONG fan wheel ø 110mm input current 0.1/0.16A housing aluminium		
For models:	GBC1001, GBC1001S, GBC1001SS, GSC1100G, GSC2336		

¹with slide bearings



1

GEV No.	601834 ¹	Ref. No.	1.1.A.A03.01.31
description	axial fan L 119mm W 119mm H 38mm 230VAC 50/60Hz 16/15W bearing ball bearing manuf. no. RAM1238B1 connection cable length 900mm XINRUILIAN fan wheel ø 110mm temp.-resist. -10 up to +70°C input current 0.16A		
For models:	GCV1600		

¹with ball bearings



1

GEV No.	602136	Ref. No.	DQFD2003
description	axial fan L 119mm W 119mm H 38mm 230VAC 50/60Hz 22/38.4W bearing slide bearing manuf. no. HT-A12038S220 connection with cable 500mm cable length 300mm HUI TONG fan wheel ø 110mm input current 0.1/0.16A housing aluminium		
For models:	GBC1001, GBC1001S, GBC1001SS, GBC1002, GBC1002S, GBC1002SS, GBC1003, GBC1003S, GBC1003SS, GBC1102, GBC1103		



1

GEV No.	601604 ¹	Ref. No.	E17A1A010100 S900.34
description	axial fan L 119mm W 119mm H 38mm 230VAC 50/60Hz 17/15W bearing slide bearing manuf. no. AA1282HS-AT connection cable 300mm fan wheel ø 110mm temp.-resist. 70°C input current 0.1A airflow 130m ³ /h 2600rpm		
For models:	GDS2600, GHS1600, GHS2600, GPS2600, GSA2600, GSD2600, GSF2600		

¹with slide bearings

accessories

fan guards



1

GEV No.	691104	Ref. No.	I0427017 WJFZ0007
description	guard ø 115mm mounting distance 105mm for axial fan 119mm		
For models:	GBC1001, GBC1001S, GBC1001SS, GBC1002, GBC1002S, GBC1002SS, GBC1003, GBC1003S, GBC1003SS, GBC1102, GBC1103, GRE3600, GRE3600S, GSC2336		

connecting cables



1

GEV No.	550898	Ref. No.	I0221181
description	connecting cable cable length 2000mm connection F 2.8 connection distance 7.9mm for axial flow fan		
For models:	GRE3600, GRE3600S		

refrigeration fans

refrigeration motors universal

ebm-papst

miscellaneous



1

GEV No.	601783	Ref. No.	E17A1A050500
description	fan motor 10W 230V 50/60Hz L3 87mm W 67mm cable length 400mm 1300rpm ebm-papst M4Q045-CA03-51/C18 3 mounting options bearing slide bearing for refrigerated counters		
For models:	GDS2600, GPS2600, GSA2600, GSD2600, GSF2600		
spare parts for	601783		
	GEV No.	601413	Ref. No. —
	fixing plate suitable for fanwheel ED ø 32mm shaft ø 7 mounting distance 26mm		
accessories for	601783		
	GEV No.	601385	Ref. No. E181A1723401
	fan wheel sucking ø 172mm fan wheel mounting 25.4mm blade angle 34° W 42mm aluminium		

IMPORT

multi fit fan motors



1

GEV No.	601020	Ref. No.	W0301906 W0301911
description	fan motor 5W 230V 50-60Hz L1 44mm L2 48mm L3 79mm W 84mm cable length 500mm 1300rpm YZF5-13-18/26 5 mounting options bearing slide bearing		
For models:	GFR2700, GRE2700		

miscellaneous



1

GEV No.	601789	Ref. No.	1.1.A.A03.01.10
description	fan motor 10W 220-240V 50/60Hz L1 50mm L2 72mm L3 90mm W 84mm cable length 460mm 1300rpm HANGZOU SAIWEI MOTOR YZ10-20		
For models:	GGC2270, GGC2270B		
spare parts for	601789		
	GEV No.	601413	Ref. No. —
	fixing plate suitable for fanwheel ED ø 32mm shaft ø 7 mounting distance 26mm		

accessories

fan wheels

aluminium



1

GEV No.	601553	Ref. No.	W0301078
description	fan wheel sucking ø 172mm fan wheel mounting 25.4mm blade angle 28° W 35mm aluminium		
For models:	GFR2700, GRE2700		



1

GEV No.	601385	Ref. No.	E181A1723401
description	fan wheel sucking ø 172mm fan wheel mounting 25.4mm blade angle 34° W 42mm aluminium		
For models:	GDS2600, GPS2600, GSA2600, GSD2600, GSF2600		

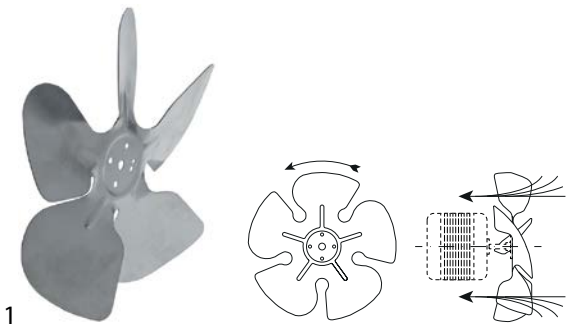
1

GEV No.	601070	Ref. No.	1.1.A.A03.03.05 W0301060
description	fan wheel sucking ø 200mm fan wheel mounting 25.4mm blade angle 28° W 38mm aluminium		
For models:	GFR2700, GGC2270, GGC2270B, GRE2700		

fan guards

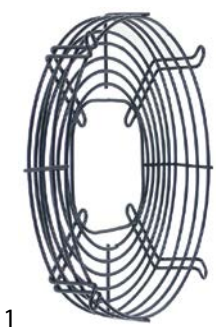

1

GEV No.	602101	Ref. No.	E192A1200300 E192A1723800
description	guard ø 210mm H 35mm mounting distance 1 230mm mounting distance 2 100mm		
For models:	GDS2600, GPS2600, GSA2600, GSD2600, GSF2600		

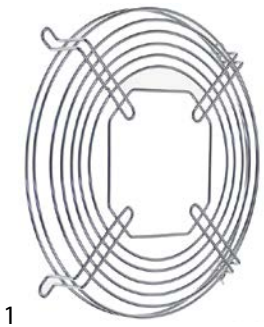

1

GEV No.	699432	Ref. No.	1.1.B.B10.36
description	guard ø 215mm mounting distance 230mm		
For models:	GGC2270, GGC2270B		

cooling motors (complete)



1

GEV No.	602174	Ref. No.	W0301913
description	fan 220-240V 7W 50/60Hz fan wheel ø 170mm connection cable 350mm 1300rpm GFR2700/GRE2700		
For models:	GFR2700, GRE2700		
accessories for	602174		
	GEV No.	699579	Ref. No. 80021501
	bracket for fan for evaporator L 130mm W 80mm hole distance 63mm for GFR2700/GRE2700		



1

GEV No.	601836	Ref. No.	DQJB2004
description	fan 220V 25/3W 50/60Hz fan wheel ø 172mm L 82mm W 82mm connection spate terminal M4 cable length 1000mm		
For models:	GBC1002, GBC1002S, GBC1002SS, GBC1003, GBC1003S, GBC1003SS, GBC1102, GBC1103		



1

GEV No.	601835	Ref. No.	DQJB2013
description	fan 220V 35/5W 50/60Hz L 82mm W 82mm connection spate terminal M4 cable length 1100mm		
spare parts for	601835		
	GEV No.	602184	Ref. No. —
	fixing plate suitable for fanwheel ED ø 33mm shaft ø 6 mounting distance 17mm		



1

GEV No.	601791	Ref. No.	1.1.A.A03.02.04
description	fan motor pair 220-240V 10W 50Hz fan wheel ø 110mm mounting distance 137mm cable length 800mm		
For models:	GGC2270, GGC2270B		

cold air circulating fans

cold air circulating fans

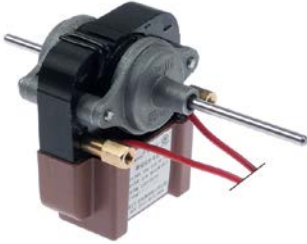

1

GEV No.	601845	Ref. No.	1.1.A.A03.01.08
description	fan motor 220-240V 50Hz IN 22W / OUT 5W shaft ø 4mm shaft L 20/48mm L 65mm W 66mm H 73mm Qty 1 pcs		
For models:	GGC1078, GGC1078B		
accessories for	601845		
	GEV No.	601846	Ref. No. 1.1.C.C17.04
	fan wheel blowing ø 150mm shaft intake ø 4mm W 33mm plastic Qty 1 pcs		

accessories

fan wheels for cold air circulating fans



1

GEV No.	601846	Ref. No.	1.1.C.C17.04
description	fan wheel blowing ø 150mm shaft intake ø 4mm W 33mm plastic Qty 1 pcs		
For models:	GGC1078, GGC1078B		

cross flow fans

EMMEVI - FERGAS

with standard coil



1

GEV No.	601018	Ref. No.	01202330
description	cross flow fan TG 180 roller ø 60mm roller length 180mm motor position right 230V/50Hz 25W universal bearing silicone connection male faston 6.3mm -10 up to +60°C 230V connections 1-2 1950U/min connections 1-4 1500U/min		
For models:	GCO2001		

accessories for cross flow fans

air ducts



1

GEV No.	701630	Ref. No.	00012330
description	air duct for cross flow fan for combi-steamer plastic grey		
For models:	GCO2001		



hot air fans

miscellaneous



1

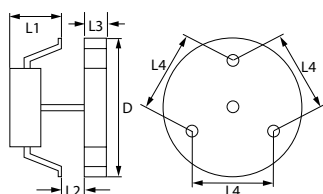

GEV No. 500902 **Ref. No.** MOT30029

description fan motor 220V 55W 50/60Hz L1 68mm FIME type L25R without fan wheel

For models: GCO500

accessories for 500902

GEV No. 550879 **Ref. No.** —



insulation ø 130mm thickness 3mm hole ø 20mm for hot air fan



1

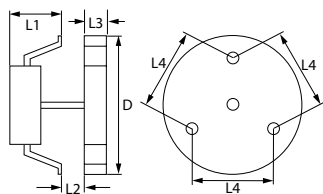

GEV No. 602100 **Ref. No.** 01203230

description hot air fan 240V 59W 50/60Hz L1 80mm L2 16mm fan wheel ø 150mm IMS type 138251

For models: GCO2001



1

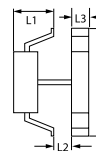

GEV No. 601838 **Ref. No.** 278009000033

description fan motor 220-240V 18W 2500rpm L1 33mm L2 12mm L3 15mm L4mm fan wheel ø 120mm shaft 2x2.5mm GALANZ type GAL6309E(30)-ZD Qty 1 pcs

For models: GMW1025



1

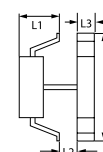

GEV No. 601827 **Ref. No.** DQB000019R

description hot air fan 18V 2750rpm L1 6mm L2mm L3 16mm L4mm fan wheel ø 85mm type YHWF-85

For models: GIC3035

accessories

fan wheels for hot air fans



1

GEV No. 601839 **Ref. No.** 223149000014

description fan wheel ø 120mm W 32mm shaft intake ø 2x2.5mm plastic blades 4 Qty 1 pcs

For models: GMW1025



1

GEV No. 601261 **Ref. No.** VEN30013

description fan wheel ø 154mm W 25mm shaft intake ø 6x5mm chrome-plated blades 7

For models: GCO500



miscellaneous



1			
GEV No.	601840	Ref. No.	22313900011
description	bracket \varnothing 130mm L 135mm W 130mm for hot air fan Qty 1 pcs		
For models:	GMW1025		

motors

for slicers

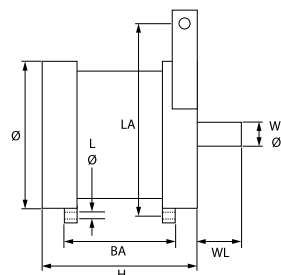

1			
GEV No.	501530	Ref. No.	0000001753
description	motor 230V 1 phase 50Hz 1380rpm shaft \varnothing 15mm shaft length 25mm 195-220 edition since 04/2016		
For models:	GFS2019		

speed controllers

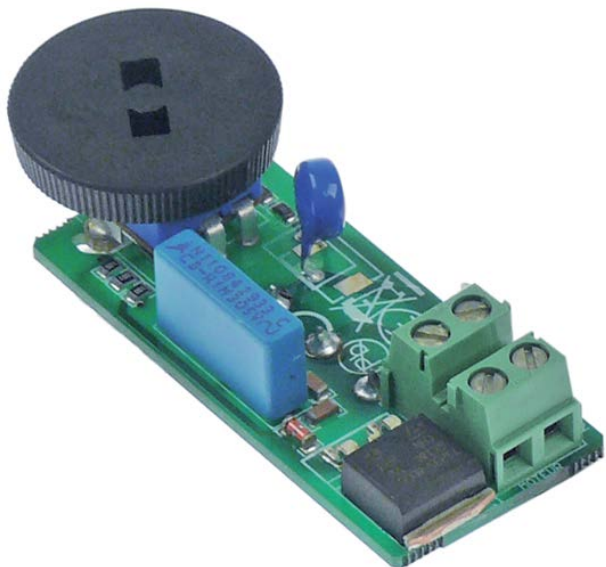

1			
GEV No.	403165	Ref. No.	2852
description	PCB GSM1000 speed control		
For models:	GSM1000		
spare parts for	403165		
	GEV No.	Ref. No.	2858
	knob for PCB \varnothing 26mm black Qty 1 pcs		

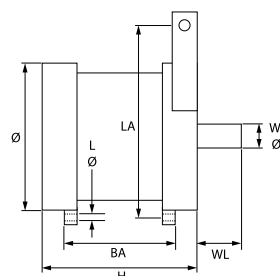

1			
GEV No.	501427	Ref. No.	00000700283
description	motor 230V 1 phase 50Hz 1380rpm shaft \varnothing 15mm shaft length 25mm \varnothing 115mm H 86mm mounting distance 44mm hole distance 145mm hole \varnothing 6mm type H35-700283		
For models:	GFS1022, GFS2022		

motors

gear motors

for microwaves



1			
GEV No.	601867	Ref. No.	27801900017
description	gear motor GALANZ type GAL-33-30-TD(B) 4W 30V voltage AC 50/60Hz 33/40rpm shaft \varnothing 6x3.5mm for microwave Qty 1 pcs		
For models:	GMW1025		

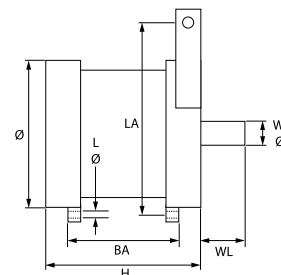

1			
GEV No.	501434	Ref. No.	0000000423
description	motor 230V 1 phase 50Hz 1380rpm shaft \varnothing 15mm shaft length 33mm \varnothing 113mm H 91mm mounting distance 49mm hole distance 150mm hole \varnothing 6mm type H40-423 ELETTRMECANICA capacitor 8 μ F		
For models:	GFS1025, GFS2025		

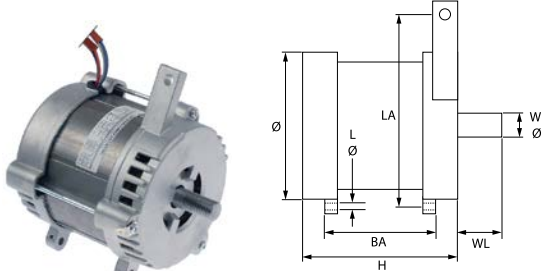



1

GEV No.	501433	Ref. No.	0000000681
description	motor 230V 1 phase 50Hz 1380rpm shaft \varnothing 15mm shaft length 35mm \varnothing 113mm H 121mm mounting distance 79mm hole distance 150mm hole \varnothing 6mm type H70-681 ELETTROMECHANICA capacitor 10 μ F		
For models:	GFS1030		

for hand blenders

motors



1

GEV No.	698378	Ref. No.	2847
description	motor for hand blender 230V 100W shaft \varnothing 6.4mm GSM1000		
For models:	GSM1000		

for citrus juicers



1

GEV No.	501426	Ref. No.	900956
description	motor for citrus juicers 180W 230-240V 50Hz shaft \varnothing 8mm shaft length 40mm type RCJ298252 0.18kW		
For models:	GJU1001		

pumps

wash and rinse pumps

LGB



1

GEV No.	500984	Ref. No.	902263
description	pump inlet \varnothing 45mm outlet \varnothing 39mm type ZF270VSX 230V 50Hz 1 phase 0.4kW L 209mm rotation direction right capacitor 10 μ F LGB		
For models:	GDW2001		

drain pumps

HANNING



1

GEV No.	501596	Ref. No.	902332
description	drain pump 40W 220-240V inlet \varnothing 30mm outlet \varnothing 24mm 50Hz type DPS35-061 HANNING		
For models:	GDW2001		

booster pumps II

accessories



1

GEV No.	365015	Ref. No.	0000000633
description	operating capacitor capacity 10 μ F 400V tolerance 5%Hz ambient temperature max. -25 to +85°C \varnothing 35.5mm L 59mm M8 plastic connection male faston 6.3mm protection		
For models:	GFS1030, GFS2030		





1

GEV No.	365012	Ref. No.	00000000149
description	operating capacitor capacity 6.3µF 450V tolerance 5% 50Hz ambient temperature max. -25 to +85°C ø 30mm L 61mm M8 plastic connection male faston 6.3mm protection		
For models:	GFS1022		

condensators & interference suppression filters

operating capacitors

plastic



1

GEV No.	365015	Ref. No.	00000000633
description	operating capacitor capacity 10µF 400V tolerance 5%Hz ambient temperature max. -25 to +85°C ø 35.5mm L 59mm M8 plastic connection male faston 6.3mm protection		
For models:	GFS1030, GFS2030		



1

GEV No.	365012	Ref. No.	00000000149
description	operating capacitor capacity 6.3µF 450V tolerance 5% 50Hz ambient temperature max. -25 to +85°C ø 30mm L 61mm M8 plastic connection male faston 6.3mm protection		
For models:	GFS1022		



1

GEV No.	365013	Ref. No.	00000000182
description	operating capacitor capacity 8µF 400V tolerance 5%Hz ambient temperature max. -25 to +85°C ø 31.5mm L 55mm M8 plastic connection male faston 6.3mm protection		
For models:	GFS1025, GFS2019, GFS2022, GFS2025		

filters

interference suppression filters



1

GEV No.	365168	Ref. No.	902107
description	interference suppression filter type FCP045000 250V 50/60Hz conductor 4 with E connection male faston 6.3mm L 56mm ø 38mm Hmm Wmm M8 plastic Qty 1 pcs		
For models:	GDW2001		

line filters

without housing



1

GEV No.	403188	Ref. No.	263029001088
description	line filter microwave for GMW1025 250V 50/60Hz conductor 2 PCB connection male faston 4.8mm L 80mm H 20mm W 40mm PCB Qty 1 pcs cable length 120mm type DNV-0818A-5		
For models:	GMW1025		

HV capacitors



1

GEV No.	365159	Ref. No.	253059000142
description	HV capacitor for microwave 1.15µF type CH85-21115 2100V 50/60Hz double connection male faston 4.8mm L 105mm H 33mm W 52mm dependent on equipment aluminium Qty 1 pcs		
For models:	GMW1025		

fuses

fine fuses



1

GEV No.	358186	Ref. No.	DZJ020003
description	fuse size ø6.3x32 15A slow-acting rated 250V Qty 1 pcs		
For models:	GIC3035		



electric accessories

cables

power supply cables

1			
GEV No.	551085	Ref. No.	0000009171 C03013
description	cable CEE7/7 type E+F 3-pole contacts P+N+E 1.5mm ² max. 16A max 230V 2m with plug H05VV-F 3G1.5		
For models:	GFS1022, GFS1025, GFS1030, GFS2019, GFS2022, GFS2025, GFS2030, GTO1001, GTO2001		

1			
GEV No.	698880	Ref. No.	E25EUB315300
description	connecting cable 3-pole contacts P+N+E 1.5mm ² max. 16A max 250V 2.9m		
For models:	GDS2600, GPS2600, GSA2600, GSD2600, GSF2600		

1			
GEV No.	699317	Ref. No.	S900.47
description	connecting cable CEE7/7 type E+F 3-pole contacts P+N+E 1.5mm ² max. 16A max 250V 2.95m H05VV-F black		
For models:	GHS1600, GHS2600		

1			
GEV No.	551203	Ref. No.	C03007 CAV30014
description	connecting cable CEE7/7 type E+F 3-pole contacts P+N+E 2.5mm ² max. 16A max 230V 2m H07 RN-F with plug		
For models:	GCO500, GEG2001		

1			
GEV No.	551232	Ref. No.	253159002607
description	power lead CEE7/7 1mm ² max 500V 1.5m Qty 1 pcs connection male faston 6.3mm black		
For models:	GMW1025		

1			
GEV No.	551217	Ref. No.	DQXA6002
description	power lead CEE7/7 type E+F 3-pole contacts P+N+E 0.75mm ² max. 16A 2.2m with strain relief 16A Qty 1 pcs white		
For models:	GBC1001, GBC1001S, GBC1001SS, GBC1002, GBC1002S, GBC1002SS, GBC1003, GBC1003S, GBC1003SS, GBC1102, GBC1103, GSC1100G, GSC2336		

1			
GEV No.	551218	Ref. No.	1.1.A.A08.02.02 1.1.A.A08.02.79 1.1.A.A08.02.87
description	power lead CEE7/7 type E+F 3-pole contacts P+N+E 0.75mm ² max. 16A max 230V 2m Qty 1 pcs grey		
For models:	GCV1600, GGC1078, GGC1078B, GGC2270, GGC2270B		

1			
GEV No.	552002	Ref. No.	I3306470
description	power lead CEE7/7 type E+F contacts P+N+E 1mm ² max. 16A max 230V 2.5m		
For models:	GRE3600, GRE3600S		

1			
GEV No.	551325	Ref. No.	XC0000071R
description	power lead P+N+E 1mm ² max 500V 1.5m Qty 1m connection screw		
For models:	GIC3035		

accessories

cable glands

threaded cable glands

screw connections

1			
GEV No.	551379	Ref. No.	PPC30004
description	cable gland thread PG13.5 cable ø 12mm mounting ø 20mm WS 24 plastic Qty 1 pcs with nut		
For models:	GCO500		



1

GEV No.	551288 ¹	Ref. No.	A10032
description	cable gland thread PG16 cable ø 14mm mounting ø 22.5mm WS 27 plastic Qty 1 pcs		
For models:	GEG2001		

¹incl. fastening nut

strain reliefs



1

GEV No.	506235	Ref. No.	1.1.C.C24.03
description	strain relief L 28mm W 12mm H 8mm hole ø 3.5mm hole distance 16mm plastic Qty 1 pcs		
For models:	GGC1078, GGC1078B		

cable harnesses



1

GEV No.	694615	Ref. No.	253169000472
description	cable harness for microwave L 800mm Qty 1 pcs		
For models:	GMW1025		

connection cables

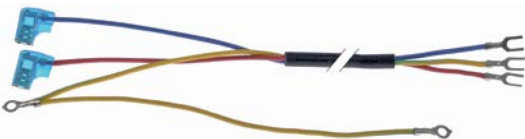

1

GEV No.	699304	Ref. No.	DQXB9019
description	connection cable L 360mm 3-pole		
For models:	GBC1001, GBC1001S, GBC1001SS, GBC1002, GBC1002S, GBC1002SS, GBC1003, GBC1003S, GBC1003SS, GBC1102, GBC1103		

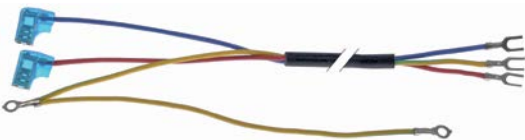

1

GEV No.	699305	Ref. No.	DQXB2003
description	connection cable L 650mm 3-pole		
For models:	GSC2336		

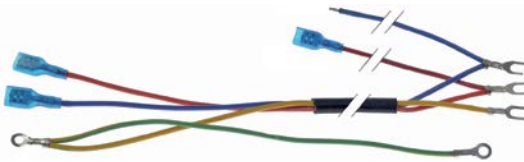

1

GEV No.	699306	Ref. No.	DQXB4003
description	connection cable L 665mm 3-pole		
For models:	GSC1100G		

terminals

connection terminals with screw/faston connections



1

GEV No.	551444	Ref. No.	01200720
description	power terminal block 3-pole max. 25A max 450V connection male faston 6.3mm temp.-resist. 150°C		
For models:	GCO2001		



1

GEV No.	550516	Ref. No.	MOR30005
description	power terminal block 3-pole max. 40A max 400V connection M6/ male faston 6.3mm temp.-resist. 150°C cross section 6mm ² mounting distance 66.5mm		
For models:	GCO500		



1

GEV No.	550411	Ref. No.	904150 A16014
description	power terminal block 6-pole max. 40A max 450V connection ø6mm ² / F6.3 temp.-resist. 150°C cross section 6mm ²		
For models:	GDW2001, GEG2001		



connection terminals with faston connections



1			
GEV No.	519372	Ref. No.	904167
description	distribution terminal block 4-pole max. 17.5A max 450V connection F6.3 temp.-resist. 110°C 450V		
For models:	GDW2001		

connection boxes



1			
GEV No.	550300	Ref. No.	A10007
description	power terminal block 3-pole contacts P+N+E		
For models:	GTO1001, GTO2001		

terminal boxes



1			
GEV No.	551214	Ref. No.	S900.48
description	terminal box 4-pole L 90mm W 52mm H 28mm with strain relief Qty 1 pcs		
For models:	GHS1600, GHS2600		



1			
GEV No.	551216	Ref. No.	SLZB3001
description	terminal box 4-pole L 90mm W 52mm H 33mm with strain relief 250V 1mm ² Qty 1 pcs		
For models:	GBC1001, GBC1001S, GBC1001SS, GBC1002, GBC1002S, GBC1002SS, GBC1003, GBC1003S, GBC1003SS, GBC1102, GBC1103, GSC2336		

equipment-specific units

for slicers

covers



1			
GEV No.	696528	Ref. No.	00000000489
description	blade covering ø 180mm for knife ø 220mm mounting thread M6 fixing dimensions 12x12mm cast aluminium edition since year of construction 2010		
For models:	GFS1022, GFS2022		

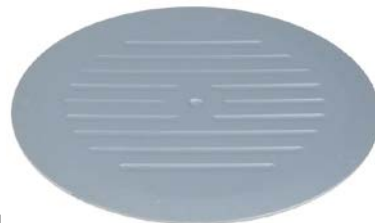

1			
GEV No.	697749	Ref. No.	00000000463 00000000490
description	blade covering ø 209mm for knife ø 250mm mounting thread M6 fixing dimensions 12x12mm aluminium		
For models:	GFS1025, GFS2025		



1			
GEV No.	697744	Ref. No.	00000000403
description	blade covering ø 248mm for knife ø 300mm mounting thread M6 fixing dimensions 12x12mm aluminium		
For models:	GFS1030, GFS2030		

locking screws

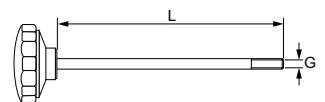

1			
GEV No.	698376	Ref. No.	00000001302 00000701302
description	locking screw thread M6 L 134mm black		
For models:	GFS1022, GFS2022		

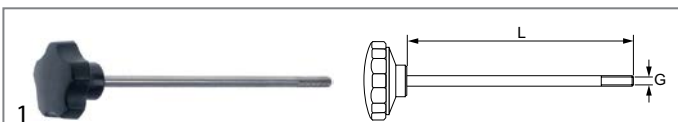

GEV No.	697439	Ref. No.	0000000777
description	locking screw thread M6 L 155mm handle ø 40mm		
For models:	GFS2025		

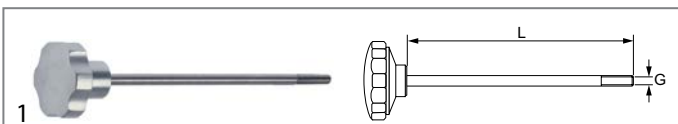

GEV No.	696602	Ref. No.	0000009958
description	locking screw thread M6 L 188mm handle ø 39mm for model 300/S-G,Dolly Verticale VS300		
For models:	GFS1030		

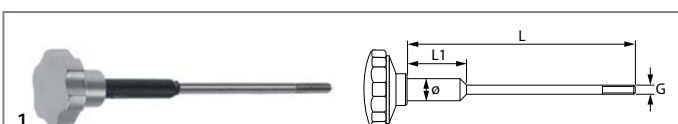

GEV No.	698629	Ref. No.	00000709956
description	locking screw thread M6 L 155mm ø 10mm L1 55mm handle ø 29mm		
For models:	GFS1025		

adjustment knobs



GEV No.	697419	Ref. No.	0000000130 00000700130
description	adjusting knob 0-15 ø 55mm shaft ø 12mm shaft L 28mm handle ø 42mm 250		
For models:	GFS1022, GFS2019, GFS2022, GFS2025, GFS2030		



GEV No.	696522	Ref. No.	0000009503
description	adjusting knob 0-22 ø 68mm shaft ø 18mm shaft L 50mm handle ø 68mm turn direction left		
For models:	GFS1030		

eccentric disc for slice thickness



GEV No.	697470	Ref. No.	0000000830
description	eccentrics for cutting thickness hole ø 12mm groove width 6mm ED ø 52mm thickness 21.5mm		
For models:	GFS2025		



GEV No.	697471	Ref. No.	0000000379
description	eccentrics for cutting thickness hole ø 12mm groove width 6mm ED ø 58mm thickness 21mm		
For models:	GFS1022, GFS1025, GFS2019, GFS2022, GFS2030		

spring washers



GEV No.	697478	Ref. No.	0000000671
description	spring washer ID ø 19mm ED ø 26mm Qty 1 pcs		
For models:	GFS1030		

guiding pieces

for sliding plates

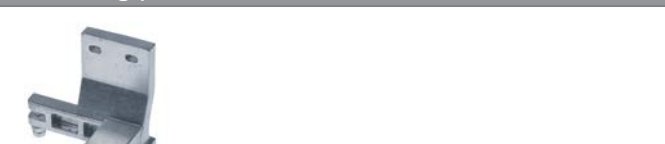



GEV No.	697483	Ref. No.	0000000117
description	guide 195		
For models:	GFS1022, GFS2019, GFS2022		



GEV No.	697448	Ref. No.	0000009177
description	guide 220-250		
For models:	GFS2025, GFS2030		



			
1			
GEV No.	696524	Ref. No.	00000000602 00000009691
description	guide L 117mm W 92mm H 51mm hole ø 18mm shaft intake ø 16mm aluminium		
For models:	GFS1030		

			
1			
GEV No.	697477	Ref. No.	00000000126
description	connection plate L 75mm W 15mm		
For models:	GFS2019, GFS2022, GFS2025, GFS2030		

for carriage			
			
1			
GEV No.	696510	Ref. No.	00000009466
description	guide 220		
For models:	GFS1022, GFS2019, GFS2022		

bushes			
			
1			
GEV No.	698626	Ref. No.	00000000119
description	bush ED ø 18mm ID ø 16mm H 15mm		
For models:	GFS1030, GFS2025, GFS2030		

			
1			
GEV No.	698627	Ref. No.	00000000611
description	bush ED ø 8mm ID ø 5mm H 10mm		
For models:	GFS1030		

spindles			
			
1			
GEV No.	697782	Ref. No.	00000000501
description	spindle for carriage ø 16mm L 390mm thread M8		
For models:	GFS1025		

housings			
bottom parts			
			
1			
GEV No.	696512	Ref. No.	00000000504
description	bottom plate 220		
For models:	GFS1022, GFS2019, GFS2022		

			
1			
GEV No.	696345	Ref. No.	00000000516
description	bottom plate L 390mm W 190mm plastic 300		
For models:	GFS1025		

			
1			
GEV No.	698393	Ref. No.	00000000701
description	bottom plate L 409mm W 174mm plastic		
For models:	GFS2025, GFS2030		

			
1			
GEV No.	698389	Ref. No.	00000000768
description	cover L 447mm W 180mm plastic		
For models:	GFS1030		

hand guard			
			
1			
GEV No.	697754	Ref. No.	00000000784
description	hand protection for knife ø 300mm H 125mm W 60mm thickness 1.2mm hole ø 6.5mm mounting distance 84mm stainless steel		
For models:	GFS1030		

			
1			
GEV No.	696511	Ref. No.	00000000197
description	wiper for knife ø 220/250mm stainless steel		
For models:	GFS1025, GFS2025		

			
1			
GEV No.	697755	Ref. No.	00000000162
description	hand protection for carriage 300 H 180mm W 152mm thickness 5mm hole ø 10mm mounting distance 110mm plastic		
For models:	GFS1030		

			
1			
GEV No.	697826	Ref. No.	00000000924
description	hand protection for slicer		
For models:	GFS1025, GFS2025		

			
1			
GEV No.	698964	Ref. No.	00000000482
description	hand protection for slicer 195-220		
For models:	GFS2019, GFS2022		

accessories



			
1			
GEV No.	697482	Ref. No.	00000000446
description	screw thread M5 ø 8mm L 15mm		
For models:	GFS1025, GFS1030, GFS2019, GFS2022, GFS2025		

			
1			
GEV No.	697481	Ref. No.	00000000623
description	Thumb screw thread M6 thread L 8mm ø 14mm H 6mm SS		
For models:	GFS1030, GFS2019, GFS2022, GFS2025		

			
1			
GEV No.	698640	Ref. No.	00000009924
description	blade pulley complete with shaft shaft ø 14 shaft length 95mm mounting thread M5 3 hole fixing		
For models:	GFS1022, GFS2022		

			
1			
GEV No.	697747	Ref. No.	00000009920
description	blade pulley with spindle D1 ø 40mm D2 ø 64.3mm D3 ø 67.5mm shaft ø 14 L 33mm shaft length 152mm mounting thread M5 mounting ø 3-hole		
For models:	GFS1025		

			
1			
GEV No.	697746	Ref. No.	00000009469
description	blade pulley with spindle D1 ø 40mm D2 ø 76mm shaft ø 16 L 40mm shaft length 157mm mounting thread M5 mounting ø 3-hole		
For models:	GFS1030		



spare parts for 697746			
	GEV No.	514030	Ref. No. —
retaining ring shaft ø 20mm thickness 1.3mm steel DIN 471			
	GEV No.	523512	Ref. No. 00000000632
deep-groove ball bearing type 6204-2RS shaft ø 20mm ED ø 47mm W 14mm with sealing discs deep-groove ball bearing DIN 625-1			
	GEV No.	692029	Ref. No. —
retaining ring bore ø 47mm thickness 1.8mm steel DIN 472			



food holders

handles

			
1			
GEV No.	698642	Ref. No.	00000001130
description	handle thread M10 ø 59mm L 100mm aluminium		
For models:	GFS1030		

			
1			
GEV No.	696515	Ref. No.	00000001242
description	handle thread M10x1.5 ø 34mm L 88mm food holder		
For models:	GFS1025		
accessories for	696515		
	GEV No.	696517	Ref. No. 00000800678
	 thread bolt for handle ø 12mm L 64mm thread M6/M10 stainless steel		

			
1			
GEV No.	697429	Ref. No.	00000000298
description	handle thread M6 ø 25mm L 126mm with hand guard D1 ø 70mm		
For models:	GFS2019, GFS2022, GFS2025, GFS2030		

food holders



			
1			
GEV No.	698644	Ref. No.	00000000608
description	food holder 300-350 L 290mm hole ø 12mm handle M10 CE		
For models:	GFS1030		
accessories for	698644		
	GEV No.	110703	Ref. No. —
	 cylindrical handle thread M10 ø 28mm L 87mm		

			
1			
GEV No.	698418	Ref. No.	00000009878
description	food holder L 240mm hole ø 12mm handle M6 with handle		
For models:	GFS1025, GFS2025, GFS2030		

accessories

			
1			
GEV No.	698630	Ref. No.	00000000827
description	spike food holder ø 3mm L 11.5mm		
For models:	GFS1025, GFS1030, GFS2019, GFS2022, GFS2025, GFS2030		

			
1			
GEV No.	697480	Ref. No.	00000000151
description	stop bolt food holder ø 7.5mm L 8mm plastic		
For models:	GFS1025, GFS1030, GFS2019, GFS2022, GFS2025, GFS2030		

			
1			
GEV No.	696517	Ref. No.	00000800678
description	thread bolt for handle ø 12mm L 64mm thread M6/M10 stainless steel		
For models:	GFS1025		
accessories for	696517		
	GEV No.	696515	Ref. No. 00000001242
	 handle thread M10x1.5 ø 34mm L 88mm food holder		

blades

standard

			
1			
GEV No.	697546	Ref. No.	00000000254
description	slicing machine blade ED ø 195mm seat ø 30mm 3-hole ID ø 155mm H 12.8mm C45 standard		
For models:	GFS2019		

			
1			
GEV No.	697436	Ref. No.	00000000855
description	slicing machine blade ED ø 220mm seat ø 40mm 3-hole ID ø 180mm H 15.5mm C45		
For models:	GFS1022, GFS2022		

			
1			
GEV No.	697365	Ref. No.	0000000142
description	slicing machine blade ED ø 250mm seat ø 40mm 3-hole ID ø 210mm H 17.5mm C45 standard		
For models:	GFS1025, GFS2025		

			
1			
GEV No.	697385	Ref. No.	00000000636
description	slicing machine blade ED ø 300mm seat ø 40mm 3-hole ID ø 250mm H 20mm C45 standard		
For models:	GFS1030, GFS2030		

sharpeners units

lids

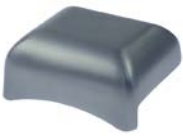
			
1			
GEV No.	696514	Ref. No.	00000000863
description	lid for sharpeners units L 116mm W 100mm mounting distance 26mm		
For models:	GFS1025, GFS2022, GFS2025		

			
1			
GEV No.	698643	Ref. No.	00000000596
description	lid for sharpeners units L 150mm W 120mm		
For models:	GFS1030, GFS2030		

holders

			
1			
GEV No.	696493	Ref. No.	00000000771
description	bracket for sharpeners units L 60mm W 31mm H 78mm hole ø 12mm mounting thread M6 with fastening angle		
For models:	GFS1030		

knobs			
			
1			
GEV No.	697441	Ref. No.	00000000854
description	locking screw thread M5 handle ø 25mm black L 30mm		
For models:	GFS2022, GFS2025		

			
1			
GEV No.	696518	Ref. No.	00000000954
description	locking screw thread M5 L 47mm handle ø 25mm silver		
For models:	GFS1025		

			
1			
GEV No.	697428	Ref. No.	00000000138
description	locking screw thread M6 handle ø 25mm black L 15mm		
For models:	GFS2019		

			
1			
GEV No.	697384	Ref. No.	00000000734
description	locking screw thread M6 handle ø 25mm black L 54mm		
For models:	GFS2030		

			
1			
GEV No.	696523	Ref. No.	000000009510
description	locking screw thread M6 L 53mm handle ø 34mm silver		
For models:	GFS1030		

			
1			
GEV No.	697445	Ref. No.	00000000677
description	mushroom cap handle thread M6 handle ø 33mm L 26mm plastic black		
For models:	GFS2030		



sharpener units



1

GEV No.	697397	Ref. No.	00000009864
description	blade sharpener 220/250/275		
For models:	GFS1022, GFS1025, GFS2022, GFS2025		



1

GEV No.	697355	Ref. No.	00000009693	
description	blade sharpener 350			
For models:	GFS1030			
spare parts for	697355			
	GEV No.	697377	Ref. No.	00000000720
	grindstone ø 51mm thickness 12mm bore ø 8mm grained coarse without bevel			
	GEV No.	697378	Ref. No.	00000000721
	grindstone ø 51mm thickness 7mm bore ø 8mm grained fine with bevel, without hub			



1

GEV No.	697420	Ref. No.	00000009168	
description	blade sharpener PARKER			
For models:	GFS2019			
spare parts for	697420			
	GEV No.	697423	Ref. No.	00000000816
	grindstone ø 40mm thickness 8mm bore ø 6mm grained fine with bevel, with hub			
	GEV No.	697424	Ref. No.	00000000871
	grindstone ø 40mm thickness 8mm bore ø 6mm grained coarse with bevel, with hub			
	GEV No.	697428	Ref. No.	00000000138
	locking screw thread M6 handle ø 25mm black L 15mm			

spindles



1

GEV No.	698633	Ref. No.	00000000778
description	spindle for sharpener units ø 12mm L 95mm thread M5		
For models:	GFS1030		

grindstones



1

GEV No.	697378	Ref. No.	00000000721
description	grindstone ø 51mm thickness 7mm bore ø 8mm grained fine with bevel, without hub		
For models:	GFS1030, GFS2030		

grindstones with hub



1

GEV No.	697424	Ref. No.	00000000871
description	grindstone ø 40mm thickness 8mm bore ø 6mm grained coarse with bevel, with hub		
For models:	GFS2019		



1

GEV No.	697423	Ref. No.	00000000816
description	grindstone ø 40mm thickness 8mm bore ø 6mm grained fine with bevel, with hub		
For models:	GFS2019		



1

GEV No.	697421	Ref. No.	00000000641
description	grindstone ø 45mm thickness 8mm bore ø 6mm grained coarse with bevel, with hub		
For models:	GFS1025, GFS2022, GFS2025		



1

GEV No.	697422	Ref. No.	00000000642
description	grindstone ø 45mm thickness 8mm bore ø 6mm grained fine with bevel, with hub		
For models:	GFS1025, GFS2022, GFS2025		

grindstones cup form



1			
GEV No.	697377	Ref. No.	00000000720
description	grindstone ø 51mm thickness 12mm bore ø 8mm grained coarse without bevel		
For models:	GFS1030, GFS2030		

carriages

handles



1			
GEV No.	697440	Ref. No.	00000000432
description	handle thread M10 handle ø 66mm H 51mm black		
For models:	GFS1022		

accessories



1			
GEV No.	696516	Ref. No.	00000000186
description	bracket for carriage L 56mm aluminium		
For models:	GFS2019, GFS2022		



1			
GEV No.	698631	Ref. No.	00000000895
description	spindle for carriage thread M6 L 170mm ø 12mm		
For models:	GFS2025		



1			
GEV No.	697827	Ref. No.	00000000678
description	spindle for slicer thread M10 L 95mm thread L 12/15mm total length 122mm ø 16mm stainless steel		
For models:	GFS1030		

miscellaneous



1			
GEV No.	697356	Ref. No.	00000000300
description	bracket thread M10x0.75 ø 30mm for microswitch ID ø 14.5mm thickness 13mm mounting thread M5		
For models:	GFS1025		



1			
GEV No.	697476	Ref. No.	00000000509
description	bush ø 14mm L 88mm ID ø 12mm		
For models:	GFS1025, GFS2019, GFS2022, GFS2025, GFS2030		



1			
GEV No.	698388	Ref. No.	00000000765
description	mounting flange ø 18mm L 128mm W 28mm		
For models:	GFS1030		



1			
GEV No.	698392	Ref. No.	00000000828
description	thread bolt thread M6 ø 6mm L 35mm for slicer		
For models:	GFS1025, GFS1030, GFS2019, GFS2022, GFS2025, GFS2030		



1			
GEV No.	698628	Ref. No.	00000000774
description	threaded shaft thread M6 L 37mm for slicer		
For models:	GFS1030		

for hand blenders

housings



1			
GEV No.	699708	Ref. No.	2840M
description	cover for handle blue GSM1000 L 80mm W 42mm		
For models:	GSM1000		



			
1			
GEV No.	696503	Ref. No.	2851
description	handle for hand blender plastic grey		
For models:	GSM1000		

			
1			
GEV No.	699134	Ref. No.	2849M
description	housing left blue GSM1000		
For models:	GSM1000		
accessories for	699134		
	GEV No.	Ref. No.	
	699133	2843M	
	housing right blue GSM1000		

			
1			
GEV No.	699133	Ref. No.	2843M
description	housing right blue GSM1000		
For models:	GSM1000		
accessories for	699133		
	GEV No.	Ref. No.	
	699134	2849M	
	housing left blue GSM1000		

			
1			
GEV No.	698386	Ref. No.	2848M
description	sticker for hand blender silver L 125mm W 25mm thickness 1mm ON-OFF		
For models:	GSM1000		

			
1			
GEV No.	698387	Ref. No.	2853M
description	sticker for lid silver L 50mm W 27mm		
For models:	GSM1000		

couplings

			
1			
GEV No.	696504	Ref. No.	2846
description	coupling for hand blender D1 ø 19mm int. ø 1 6.3mm L 29.5mm teeth 8 GSM1000		
For models:	GSM1000		

			
1			
GEV No.	696505	Ref. No.	2860
description	coupling with roll pin for hand blender D1 ø 19mm int. ø 1 8mm teeth 8 GSM1000		
For models:	GSM1000		

blender sticks

blades

blades with adaptor (complete)

			
1			
GEV No.	698262	Ref. No.	0551
description	knife ø 39mm hole ø 4mm H 12mm		
For models:	GSM1000		



1

GEV No.	698261	Ref. No.	0550
description	knife ø 39mm hole ø 4mm H 18mm		
For models:	GSM1000		



1

GEV No.	698381	Ref. No.	0552
description	mixer disc ø 36mm hole ø 4mm H 0.8mm GSM1000		
For models:	GSM1000		



1

GEV No.	698382	Ref. No.	0553
description	mixer disc ø 36mm hole ø 4mm H 3.4mm GSM1000		
For models:	GSM1000		

blender sticks



1

GEV No.	698379	Ref. No.	2845M
description	blender stick GSM1000 L 234mm flange ø 66mm		
For models:	GSM1000		

spindles



1

GEV No.	698380	Ref. No.	2844M	
description	drive shaft for hand blender with coupling D1 ø 4mm D2 ø 8mm L 214mm SS			
For models:	GSM1000			
spare parts for	698380			
	GEV No.	696505	Ref. No.	2860
	coupling with roll pin for hand blender D1 ø 19mm int. ø 1.8mm teeth 8 GSM1000			

miscellaneous



1

GEV No.	698385	Ref. No.	2841
description	bracket for grab handle L 40mm W 37mm thickness 1.5mm		
For models:	GSM1000		



1

GEV No.	696507	Ref. No.	2854
description	bracket for motor plastic black		
For models:	GSM1000		



1

GEV No.	696506	Ref. No.	2858
description	knob for PCB ø 26mm black Qty 1 pcs		
For models:	GSM1000		



1

GEV No.	532648	Ref. No.	2859
description	O-ring EPDM thickness 1.5mm ID ø 5mm Qty 1 pcs		
For models:	GSM1000		



1

GEV No.	698384	Ref. No.	45710
description	protection cap for grab handle plastic black		
For models:	GSM1000		



1

GEV No.	698383	Ref. No.	0632
description	shaft sealing ID ø 4mm ED ø 12mm for hand blender H 6.3mm		
For models:	GSM1000		



for citrus juicers

spillage trays



1			
GEV No.	696502	Ref. No.	900963
description	drain tray for citrus juicers ø 175mm hole ø 42mm H 110mm SS		
For models:	GJU1001		

gaskets



1			
GEV No.	532647	Ref. No.	900970
description	O-ring EPDM thickness 1.8mm ID ø 11.8mm Qty 1 pcs		
For models:	GJU1001		



1			
GEV No.	511953	Ref. No.	900871
description	seal kit for citrus juicers		
For models:	GJU1001		

motors



1			
GEV No.	501426	Ref. No.	900956
description	motor for citrus juicers 180W 230-240V 50Hz shaft ø 8mm shaft length 40mm type RCJ298252 0.18kW		
For models:	GJU1001		

juicer insert



1			
GEV No.	650168	Ref. No.	900901
description	filter for citrus juicers ø 155mm H 23mm plastic		
For models:	GJU1001		



1			
GEV No.	650167	Ref. No.	221266
description	juicer insert set for citrus juicers ø 57/62/79mm H 45/50/55mm plastic		
For models:	GJU1001		

spindles



1			
GEV No.	650170	Ref. No.	900895
description	spindle L 48mm square thread M8x1.25 for citrus juicers WS 12		
For models:	GJU1001		

miscellaneous



1			
GEV No.	650171	Ref. No.	900925
description	cover for spindle ø 44mm H 18mm aluminium		
For models:	GJU1001		



1			
GEV No.	650169	Ref. No.	221242
description	drip tray for citrus juicers ø 79mm H 20mm plastic black		
For models:	GJU1001		

for fridges

drain systems

drain valves



1			
GEV No.	699499	Ref. No.	W0409858
description	drain fitting connection A L 47mm hose ø 15mm for GFR2700/GRE2700 plastic		
For models:	GFR2700, GRE2700		
accessories for	699499		



GEV No.	699567	Ref. No.	W0409859
description	drain fitting connection B L 20mm for GFR2700/GRE2700 plastic		



1

GEV No.	699567	Ref. No.	W0409859
description	drain fitting connection B L 20mm for GFR2700/GRE2700 plastic		
For models:	GFR2700, GRE2700		
accessories for	699567		
	GEV No.	699499	Ref. No.
			W0409858
	drain fitting connection A L 47mm hose ø 15mm for GFR2700/GRE2700 plastic		

drain pans



1

GEV No.	530916	Ref. No.	80012001
description	drain pan L 520mm W 233mm H 30mm for GFR2700/GRE2700 hole ø 24mm		
For models:	GFR2700, GRE2700		

control parts



1

GEV No.	698848	Ref. No.	GPC1088-03
description	lamp with thermostat ø 140mm H 35mm		
For models:	GPC1088		

spare parts and accessories



1

GEV No.	699568	Ref. No.	W0604038
description	base plate for door hinge mounting pos. lower L 35mm W 25mm for GFR2700/GRE2700		
For models:	GFR2700, GRE2700		



1

GEV No.	699569	Ref. No.	W0604030
description	base plate for door hinge mounting pos. right L 74mm W 42mm for GFR2700/GRE2700		
For models:	GFR2700, GRE2700		



1

GEV No.	694967	Ref. No.	SLCX0002
description	cover L 51mm W 44mm H 12mm plastic mounting distance 30mm		
For models:	GSC2336		



1

GEV No.	692867	Ref. No.	W04102051
description	cover ø 20mm L 400mm W 43mm plastic Qty 1 pcs for GFR2700/GRE2700		
For models:	GFR2700, GRE2700		



accessories for	692867		
	GEV No.	692870	Ref. No.
			W0413062
	rubber pad L 40mm W 17mm H 30mm for GFR2700/GRE2700		

	GEV No.	696789	Ref. No.
			W0210413
	copper pipe with insulation pipe ø 6 for fridge GFR2700/GRE2700		







			
1			
GEV No.	698849	Ref. No.	GPC1046-03 GPC1088-04
description	cover cap L 96mm W 44mm H 13mm plastic		
For models:	GPC1046, GPC1088		



			
1			
GEV No.	698878	Ref. No.	WJQZ9001
description	guide counterweight for sliding door L 248mm W 20mm H 10mm		
For models:	GBC1102, GBC1103		

			
1			
GEV No.	692870	Ref. No.	W0413062
description	rubber pad L 40mm W 17mm H 30mm for GFR2700/GRE2700		
For models:	GFR2700, GRE2700		
accessories for	692870		
	GEV No.	692867	Ref. No. W04102051
	cover ø 20mm L 400mm W 43mm plastic Qty 1 pcs for GFR2700/GRE2700		
	GEV No.	696789	Ref. No. W0210413
	copper pipe with insulation pipe ø 6 for fridge GFR2700/GRE2700		



			
1			
GEV No.	699232	Ref. No.	I0535012
description	strain relief L 56mm W 14.5mm H 20mm		
For models:	GFR3600S		

housing and bezels			
covers			
			
1			
GEV No.	699586	Ref. No.	80010941 80011041
description	bracket for air baffle L 800mm W 38mm H 20mm for GFR2700/GRE2700 3 holes		
For models:	GFR2700, GRE2700		
accessories for	699586		
	GEV No.	699573	Ref. No. 80010942 80011042
	deflector rear L 1030mm W 363mm H 20mm for GFR2700/GRE2700		

			
1			
GEV No.	699576	Ref. No.	81131203
description	cover for drain pan L 598mm W 218mm H 42mm for GFR2700/GRE2700		
For models:	GFR2700, GRE2700		
accessories for	699576		
	GEV No.	696783	Ref. No. W0803011
	insulation Styropor for drain pan L 515mm W 213mm H 18mm Qty pcs for GFR2700/GRE2700		

			
1			
GEV No.	692879	Ref. No.	W0409863
description	cover for lamp L 185mm W 55mm H 40mm for GFR2700/GRE2700		
For models:	GFR2700, GRE2700		
accessories for	692879		
	GEV No.	357260	Ref. No. W0304086 W0304511
	LED bar L 130mm W 14mm H 8mm cable length 300mm GFR2700/GRE2700		

			
1			
GEV No.	998252	Ref. No.	44037000
description	cover for ventilation L 72mm W 62mm H 10mm Qty 1 pcs		
For models:	GFR3600S, GRE3600, GRE3600S		



			
1			
GEV No.	699574	Ref. No.	81131204
description	cover front for evaporator L 598mm W 295mm H 65mm for GFR2700/GRE2700		
For models:	GFR2700, GRE2700		
accessories for	699574		
	GEV No.	699577	Ref. No. 80021203
	cover left for evaporator L 255mm W 155mm H 15mm for GFR2700/GRE2700		
	GEV No.	699578	Ref. No. 80021204
	cover right for evaporator L 255mm W 155mm H 15mm for GFR2700/GRE2700		



control panel			
			
1			
GEV No.	699234	Ref. No.	44027000
description	bezel L 780mm W 67mm H 62mm mounting pos. upper		
For models:	GRE3600		



lids			
			
1			
GEV No.	698864	Ref. No.	GPC1046-05 GPC1088-06
description	cover black L 50mm W 42mm H 7mm		
For models:	GPC1046, GPC1088		

 housings			
			
1			
GEV No.	699575	Ref. No.	81131401 81131403
description	front panel front-upper for fridge L 730mm W 300mm H 62mm for GFR2700/GRE2700		
For models:	GFR2700, GRE2700		

			
1			
GEV No.	699233	Ref. No.	I9500323
description	terminal box L 98mm W 74mm H 35mm kit		
For models:	GFR3600S, GRE3600, GRE3600S		

			
1			
GEV No.	699577	Ref. No.	80021203
description	cover left for evaporator L 255mm W 155mm H 15mm for GFR2700/GRE2700		
For models:	GFR2700, GRE2700		
accessories for	699577		
	GEV No.	699574	Ref. No. 81131204
	cover front for evaporator L 598mm W 295mm H 65mm for GFR2700/GRE2700		
	GEV No.	699578	Ref. No. 80021204
	cover right for evaporator L 255mm W 155mm H 15mm for GFR2700/GRE2700		

			
1			
GEV No.	699578	Ref. No.	80021204
description	cover right for evaporator L 255mm W 155mm H 15mm for GFR2700/GRE2700		
For models:	GFR2700, GRE2700		
accessories for	699578		
	GEV No.	699574	Ref. No. 81131204
	cover front for evaporator L 598mm W 295mm H 65mm for GFR2700/GRE2700		
	GEV No.	699577	Ref. No. 80021203
	cover left for evaporator L 255mm W 155mm H 15mm for GFR2700/GRE2700		

			
1			
GEV No.	699573	Ref. No.	80010942 80011042
description	deflector rear L 1030mm W 363mm H 20mm for GFR2700/GRE2700		
For models:	GFR2700, GRE2700		
accessories for	699573		
	GEV No.	699586	Ref. No. 80010941 80011041
	bracket for air baffle L 800mm W 38mm H 20mm for GFR2700/GRE2700 3 holes		



equipment feet



GEV No.	698865	Ref. No.	GPC1088-12
description	equipment foot M8 thread L 15mm ø 29mm		
For models:	GPC1088		

handles



GEV No.	692390	Ref. No.	LCCG0005
description	handle rod for door L 380mm W 40mm aluminium Qty 1 pcs		
For models:	GSC1100G		

caps



GEV No.	692372	Ref. No.	S900.03
description	cap grey ø 16.5mm mounting ø 12.5mm H 7mm Qty 1 pcs		
For models:	GHS1600, GHS2600		

frame



GEV No.	699583	Ref. No.	W04102045
description	frame rail for door mounting pos. left/right L 1530mm W 19mm H 7.5mm plastic for GFR2700/GRE2700		
For models:	GFR2700, GRE2700		
accessories for	699583		
	GEV No.	Ref. No.	W04102044
	699584		
	frame rail for door mounting pos. upper/lower L 650mm W 19mm H 7.5mm plastic for GFR2700/GRE2700		

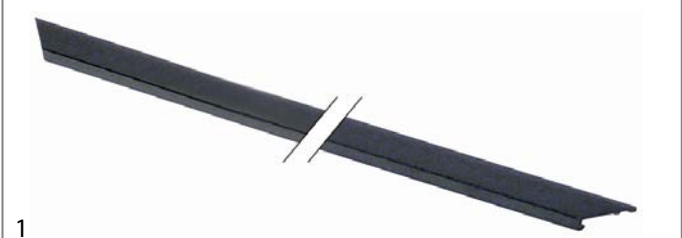

GEV No.	699584	Ref. No.	W04102044
description	frame rail for door mounting pos. upper/lower L 650mm W 19mm H 7.5mm plastic for GFR2700/GRE2700		
For models:	GFR2700, GRE2700		
accessories for	699584		
	GEV No.	Ref. No.	W04102045
	699583		
	frame rail for door mounting pos. left/right L 1530mm W 19mm H 7.5mm plastic for GFR2700/GRE2700		

miscellaneous



GEV No.	692392	Ref. No.	SLSE4005
description	cover for lighting W 1170mm H 280mm thickness 1mm plastic Qty 1 pcs		
For models:	GSC1100G		



GEV No.	692391	Ref. No.	SLZE0027
description	housing for bulb socket L 150mm W 40mm H 20mm plastic Qty 1 pcs		
For models:	GSC1100G, GSC2336		

doors



GEV No.	699571	Ref. No.	81130201
description	door right suitable for GFR2700/GRE2700 W 730mm H 1610mm thickness 45mm stainless steel		
For models:	GFR2700, GRE2700		
spare parts for	699571		
	GEV No.	Ref. No.	W0604030
	699569		
	base plate for door hinge mounting pos. right L 74mm W 42mm for GFR2700/GRE2700		
	GEV No.	Ref. No.	W0409842
	701641		
	bush upper for door hinge ID ø 11mm ED ø 13mm L 29.5mm for GFR2700/GRE2700		
	GEV No.	Ref. No.	W0409843
	701642		
	bush lower for door hinge ID ø 11mm ED ø 13mm L 26mm for GFR2700/GRE2700		

Table continues overleaf

spare parts for 699571			
GEV No.	902514	Ref. No.	W0404514
refrigeration gasket profile 9750 W 660mm L 1537mm plug size			



GEV No.	699381	Ref. No.	BLGM4010
description	glass door left W 600mm H 1330mm D 40mm		
For models:	GSC1100G		



GEV No.	699382	Ref. No.	BLGM4011
description	glass door right W 600mm H 1330mm D 40mm		
For models:	GSC1100G		

miscellaneous



GEV No.	692869	Ref. No.	81131801 W0409081
description	cover for drain pipe L 145mm W 49mm H 44mm plastic for GFR2700		
For models:	GFR2700, GRE2700		



GEV No.	698888	Ref. No.	SLZV0019
description	cover transparent for lamp L 810mm W 40mm H 30mm Qty 1 pcs		
For models:	GBC1003, GBC1003S, GBC1003SS, GBC1103		

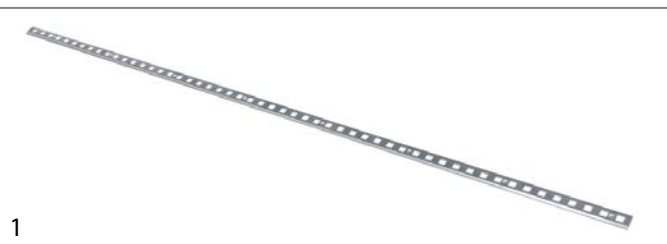

GEV No.	692426	Ref. No.	LCCJ2029
description	guide for fridge L 1145mm W 26mm H 4.5mm Qty 1 pcs		
For models:	GSC1100G, GSC2336		

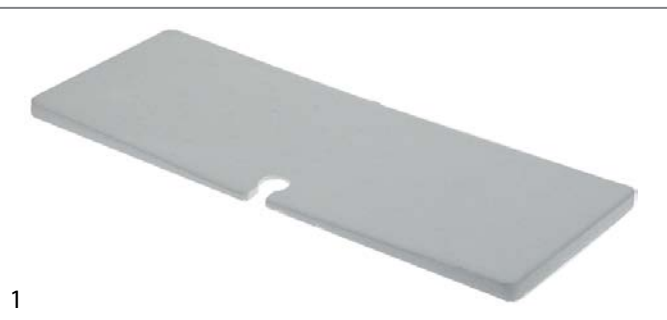

GEV No.	696783	Ref. No.	W0803011
description	insulation Styropor for drain pan L 515mm W 213mm H 18mm Qty pcs for GFR2700/GRE2700		
For models:	GFR2700, GRE2700		

accessories for	696783		
	GEV No.	699576	Ref. No.
			81131203
	cover for drain pan L 598mm W 218mm H 42mm for GFR2700/GRE2700		



			
1			
GEV No.	698877	Ref. No.	LCCCK0001
description	shelf support L 26.5mm W 8.5mm H 40mm aluminium		
For models:	GSC1100G, GSC2336		

for display coolers

control parts

			
1			
GEV No.	692700	Ref. No.	1.1.C.C12.07
description	door handle L 100mm W 32mm hole distance 68mm black Qty 1 pcs		
For models:	GGC2270B		

			
1			
GEV No.	692409	Ref. No.	1.1.C.C12.06
description	door handle L 100mm W 32mm hole distance 68mm white		
For models:	GGC2270		

			
1			
GEV No.	692402	Ref. No.	1.1.C.C12.14
description	handle grey for vitrine H 9.5mm L 85mm W 25mm mounting distance 70mm Qty 1 pcs		
For models:	GGC1078		

			
1			
GEV No.	692401	Ref. No.	1.1.C.C23.01
description	knob ø 27mm grey zero mark shaft ø 6x4.6mm shaft flat left for thermostat to clip Qty 1		
For models:	GGC1078, GGC1078B		

spare parts and accessories

			
1			
GEV No.	699422	Ref. No.	1.1.C.C63.61
description	clip for dryer L 90mm W 20mm H 52mm plastic Qty 1 pcs		
For models:	GCV1600		

housing and bezels

fascias

			
1			
GEV No.	692411	Ref. No.	1.1.C.C40.02
description	base plate for evaporator L 305mm W 241mm thickness 1.5mm plastic Qty 1 pcs		
For models:	GGC2270, GGC2270B		

			
1			
GEV No.	692405	Ref. No.	1.1.C.C22.08
description	control panel for vitrine temperature MIN/MAX W 130mm D 23mm H 145mm plastic Qty 1 pcs		
For models:	GGC1078, GGC1078B		

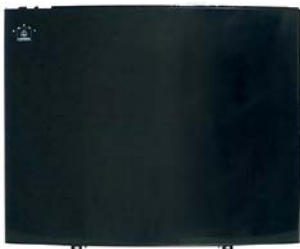
			
1			
GEV No.	699410	Ref. No.	1.1.C.C15.03.35
description	front panel mounting pos. front W 518mm D 35mm H 440mm black		
For models:	GGC2270B		



1

GEV No.	699409	Ref. No.	1.1.C.C15.03.03
description	front panel mounting pos. front W 518mm D 35mm H 440mm white		
For models:	GGC2270		



1

GEV No.	699401	Ref. No.	S24AC21A0001
description	front panel mounting pos. front W 865mm D 15mm H 248mm		
For models:	GDS2600, GPS2600, GSA2600, GSD2600, GSF2600		



1

GEV No.	698854	Ref. No.	1.1.C.C15.01.02
description	front panel mounting pos. in the front/at the back black W 427mm D 33mm H 190mm plastic Qty 1 pcs for vitrine		
For models:	GGC1078B		



1

GEV No.	692417	Ref. No.	1.1.C.C21.01
description	housing for control W 130mm D 75mm H 145mm plastic Qty 1 pcs		
For models:	GGC1078, GGC1078B		



1

GEV No.	699415	Ref. No.	1.1.C.C02.02
description	lamp cover W 310mm D 5mm H 172mm black		
For models:	GGC1078, GGC1078B, GGC2270B		



1

GEV No.	699414	Ref. No.	1.1.C.C02.01
description	lamp cover W 310mm D 5mm H 172mm white		
For models:	GGC2270		



1

GEV No.	699407	Ref. No.	S24AC20A0005
description	sheet mounting pos. upper for door W 890mm D 115mm H 10mm		
For models:	GDS2600, GPS2600, GSA2600, GSD2600, GSF2600		

lids



1

GEV No.	699403	Ref. No.	S24AC50A0003
description	top for display refrigerator W 910mm D 705mm H 125mm		
For models:	GSD2600		

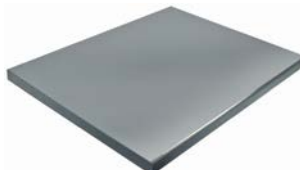

1

GEV No.	699404	Ref. No.	S24AC30A0003
description	top for display refrigerator W 910mm D 705mm H 55mm		
For models:	GDS2600, GSF2600		

housings



1

GEV No.	698851	Ref. No.	1.1.C.C15.01.06
description	back panel for vitrine W 515mm D 45mm H 410mm black		
For models:	GGC2270B		





1

GEV No.	692269	Ref. No.	1.1.C.C15.01.05
description	back panel for vitrine W 515mm D 45mm H 410mm white		
For models:	GGC2270		

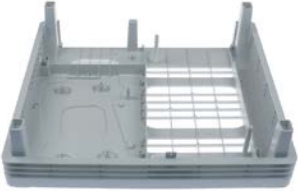

			
1			
GEV No.	692416	Ref. No.	1.1.C.C25.15
description	bottom for vitrine W 378mm H 115mm L 425mm Qty 1 pcs		
For models:	GGC1078		

			
1			
GEV No.	692419	Ref. No.	1.1.C.C01.15
description	casing cover for display refrigerator W 425mm L 380mm plastic Qty 1 pcs white		
For models:	GGC1078		
accessories for	692419		
	GEV No.	692414	Ref. No.
			—
	 lid L 313mm W 163mm for lighting Qty 1 pcs		

			
1			
GEV No.	692437	Ref. No.	1.1.C.C22.07
description	casing cover W 130mm D 70mm H 6mm plastic Qty 1 pcs		
For models:	GGC2270, GGC2270B		

			
1			
GEV No.	692420	Ref. No.	1.1.B.B05.02
description	cover for condenser W 365mm D 220mm H 130mm plate Qty 1 pcs		
For models:	GGC1078, GGC1078B		

			
1			
GEV No.	692422	Ref. No.	1.1.C.C16.02
description	cover for evaporator W 280mm D 345mm H 35mm plastic Qty 1 pcs		
For models:	GGC1078, GGC1078B		

			
1			
GEV No.	692403	Ref. No.	1.1.C.C15.01.01
description	front panel mounting pos. front for vitrine W 427mm D 33mm H 190mm plastic Qty 1 pcs white		
For models:	GGC1078		

			
1			
GEV No.	698860	Ref. No.	1.1.C.C56.84
description	guide mounting pos. front for side part W 23mm D 30mm H 635mm Qty 1 pcs		
For models:	GGC1078B		

			
1			
GEV No.	698861	Ref. No.	1.1.C.C56.85
description	guide mounting pos. rear for side part W 30mm D 30mm H 635mm Qty 1 pcs		
For models:	GGC1078B		

			
1			
GEV No.	699175	Ref. No.	P04AC21A0003
description	housing for control part W 200mm D 115mm H 95mm		
For models:	GDS2600, GPS2600, GSA2600, GSD2600, GSF2600		

			
1			
GEV No.	692415	Ref. No.	1.1.C.C18.04
description	housing for evaporator W 370mm H 175mm L 420mm Qty 1 pcs		
For models:	GGC1078, GGC1078B		



1

GEV No.	699323	Ref. No.	VRX1560.2
description	housing for switch W 114mm D 68mm H 100mm		
For models:	GHS1600, GHS2600		



1

GEV No.	692436	Ref. No.	1.1.C.C21.03
description	housing W 128mm D 65mm H 38mm plastic Qty 1 pcs		
For models:	GGC2270, GGC2270B		



1

GEV No.	692270	Ref. No.	1.1.C.C15.03.08 1.1.C.C15.03.09
description	side panel W 418mm H 410mm plastic white		
For models:	GGC2270		

ventilation grilles



1

GEV No.	698855	Ref. No.	1.1.C.C14.02
description	cover for fan W 425mm D 380mm H 36mm plastic Qty 1 pcs black		
For models:	GGC1078B		



1

GEV No.	699411	Ref. No.	1.1.C.C14.01
description	cover for fan W 425mm D 380mm H 36mm plastic Qty 1 pcs white		
For models:	GGC1078		



1

GEV No.	698853	Ref. No.	1.1.C.C26.02
description	grid mounting pos. lower for ventilation W 350mm D 12mm H 57mm plastic Qty 1 pcs black		
For models:	GGC1078B		



1

GEV No.	699417	Ref. No.	1.1.C.C26.01
description	grid mounting pos. lower for ventilation W 350mm D 12mm H 57mm plastic Qty 1 pcs white		
For models:	GGC1078		



1

GEV No.	701253	Ref. No.	1.1.C.C49.09
description	ventilation grille for air fan plastic black H 50mm L 620mm Qty 1 pcs		
For models:	GCV1600		



1

GEV No.	701254	Ref. No.	1.1.C.C49.10
description	ventilation grille for aspiration plastic black H 50mm L 260mm Qty 1 pcs		
For models:	GCV1600		

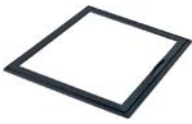

frame			
			
1			
GEV No.	699412	Ref. No.	1.1.C.C63.14
description	door frame inner W 378mm D 10mm H 385mm		
For models:	GCV1600		

			
1			
GEV No.	699413	Ref. No.	1.1.C.C63.13
description	door frame outer W 375mm D 10mm H 375mm		
For models:	GCV1600		

side parts			
			
1			
GEV No.	698862	Ref. No.	1.1.C.C38.19
description	side panel for door L 590mm thickness 17mm		
For models:	GGC1078B		

			
1			
GEV No.	698852	Ref. No.	1.1.C.C15.02.02
description	side panel mounting pos. left/right black W 316mm D 13.5mm H 190mm plastic Qty 1 pcs for vitrine		
For models:	GGC1078B		

			
1			
GEV No.	692404	Ref. No.	1.1.C.C15.02.01
description	side panel mounting pos. left/right white W 316mm D 13.5mm H 190mm plastic Qty 1 pcs for vitrine		
For models:	GGC1078		

			
1			
GEV No.	699444	Ref. No.	1.1.C.C56.06
description	side panel mounting pos. vertical W 40mm D 40mm H 1370mm black		
For models:	GGC2270B		

			
1			
GEV No.	699443	Ref. No.	1.1.C.C56.03
description	side panel mounting pos. vertical W 40mm D 40mm H 1370mm white		
For models:	GGC2270		

			
1			
GEV No.	699324	Ref. No.	VRX38.12
description	side panel W 390mm D 40mm H 222mm		
For models:	GHS1600, GHS2600		

			
1			
GEV No.	698850	Ref. No.	1.1.C.C15.03.10
description	side panel W 418mm H 410mm plastic black		
For models:	GGC2270B		

miscellaneous			
			
1			
GEV No.	699427	Ref. No.	1.1.C.C03.01
description	blank H 5mm ø 12mm		
For models:	GGC1078, GGC2270		

			
1			
GEV No.	699428	Ref. No.	1.1.C.C03.02
description	blank H 5mm ø 12mm		
For models:	GGC1078B, GGC2270B		

			
1			
GEV No.	692369	Ref. No.	1.1.C.C63.71
description	bracket for thermometer W 81mm H 41mm plastic Qty 1 pcs		
For models:	GCV1600		



GEV No.	692410	Ref. No.	1.1.C.C09.01
description	cover for lighting mounting pos. inner L 230mm W 84mm H 2.5mm plastic Qty 1 pcs		
For models:	GGC1078, GGC1078B, GGC2270, GGC2270B		



GEV No.	699315	Ref. No.	SLZE0042
description	fixing plate for evaporator L 55mm W 27mm H 6mm		
For models:	GBC1001, GBC1001S, GBC1001SS, GBC1002, GBC1002S, GBC1002SS, GBC1003, GBC1003S, GBC1003SS, GBC1102, GBC1103		



GEV No.	692370	Ref. No.	1.1.C.C63.70
description	rail for gasket L 740mm W 42mm H 19mm plastic Qty 1 pcs		
For models:	GCV1600		

glass panels

glass panels

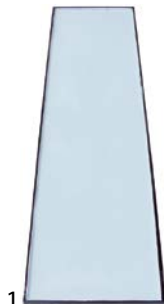

GEV No.	692293	Ref. No.	1.1.E.E2.02.44
description	glass panel L 1392mm W 376mm thickness 10mm flat mounting pos. lateral for display refrigerator		
For models:	GGC2270, GGC2270B		

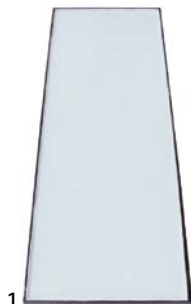

GEV No.	699328	Ref. No.	1.1.E.E2.02.45
description	glass panel L 1395mm W 464mm thickness 17.5mm mounting pos. rear refrigerated show case GGC2270		
For models:	GGC2270, GGC2270B		



GEV No.	699330	Ref. No.	1.1.E.E2.02.76
description	glass panel L 360mm W 357mm thickness 10.5mm for door GCV1600		
For models:	GCV1600		

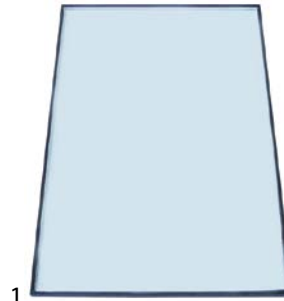

GEV No.	692291	Ref. No.	1.1.E.E2.02.64
description	glass panel L 635mm W 390mm thickness 10mm flat mounting pos. door for display refrigerator		
For models:	GGC1078, GGC1078B		



GEV No.	699326	Ref. No.	1.1.E.E2.02.74
description	glass panel L 645mm W 595mm H 16mm thickness 8mm mounting pos. left for display refrigerator GCV1600		
For models:	GCV1600		

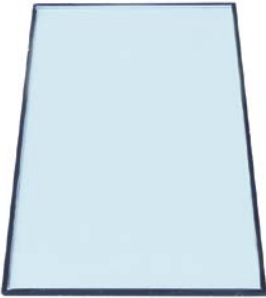

GEV No.	699327	Ref. No.	1.1.E.E2.02.75
description	glass panel L 645mm W 595mm H 16mm thickness 8mm mounting pos. right for display refrigerator GCV1600		
For models:	GCV1600		

1

GEV No.	692292	Ref. No.	1.1.E.E2.02.12
description	glass panel L 655mm W 390mm thickness 10mm flat mounting pos. rear for display refrigerator		
For models:	GGC1078, GGC1078B		

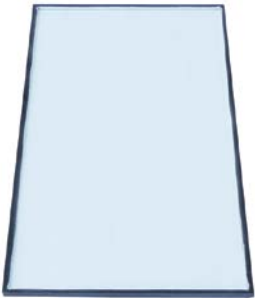

1

GEV No.	692290	Ref. No.	1.1.E.E2.02.11
description	glass panel L 660mm W 332mm thickness 10mm flat mounting pos. lateral for fridge		
For models:	GGC1078, GGC1078B		



1

GEV No.	699329	Ref. No.	1.1.E.E2.04.15.A0
description	glass panel L 773mm W 710mm thickness 12mm mounting pos. front-side for display refrigerator GCV1600		
For models:	GCV1600		

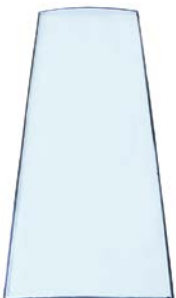

1

GEV No.	692289	Ref. No.	1.1.E.E2.02.65
description	glass panel W 460mm H 1360mm thickness 17mm curved for fridge		
For models:	GGC2270, GGC2270B		

accessories



1

GEV No.	699431	Ref. No.	1.1.B.B14.05
description	rail L 775mm		
For models:	GCV1600		

doors



1

GEV No.	699176	Ref. No.	S24AC22A0001-LEFT
description	door L 515mm W 425mm H 55mm mounting pos. left		
For models:	GPS2600, GSA2600, GSD2600, GSF2600		



1

GEV No.	699177	Ref. No.	S24AC22A0001-RIGHT
description	door L 515mm W 425mm H 55mm mounting pos. right		
For models:	GPS2600, GSA2600, GSD2600, GSF2600		



1

GEV No.	698859	Ref. No.	1.1.C.C11.02
description	door frame L 425mm W 15mm H 28mm mounting pos. upper/lower		
For models:	GGC1078B		



1

GEV No.	699405	Ref. No.	S24AC50A0004
description	shelf L 255mm W 890mm H 30mm stainless steel		
For models:	GSD2600		

door mechanics

bolts



1

GEV No.	699424	Ref. No.	1.1.B.B09.03
description	door bolt H 7mm W 7mm L 20.5mm mounting pos. upper		
For models:	GGC1078, GGC1078B		

bushes



1

GEV No.	699430	Ref. No.	1.1.C.C13.02
description	bush H 15mm ø 10mm		
For models:	GGC1078B, GGC2270, GGC2270B		

miscellaneous



1

GEV No.	694928	Ref. No.	WJXC0000
description	door magnet L 46mm W 16mm H 14.5mm		
For models:	GBC1102, GBC1103		



1

GEV No.	694929	Ref. No.	WJXC0000
description	plate for magnet L 45mm W 12mm H 1.5mm mounting distance 32mm		
For models:	GBC1102, GBC1103		

for pyroceram ranges

ceramic hobs

ceramic glass plates

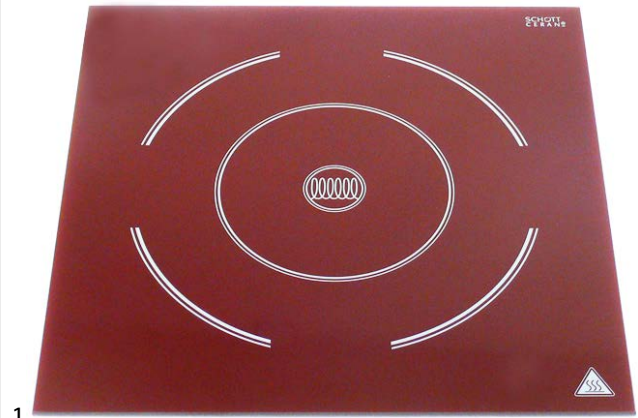

1

GEV No.	694579	Ref. No.	MBF000032R
description	ceramic plate L 300mm W 300mm thickness 4mm		
For models:	GLC3035		

for deep fryers

fasteners



1

GEV No.	692544	Ref. No.	2.02HDF4260701
description	mounting strap L 63mm W 25mm H 15mm		
For models:	GDF3024, GDF3028, GDF5028		

lids



1

GEV No.	698544	Ref. No.	3.CP0603070100
description	mushroom cap handle handle ø 50mm ø 70mm L 36mm plastic black		
For models:	GDF3004, GDF3008, GDF3024, GDF3028, GDF5008, GDF5028		



miscellaneous

 <p>1</p>			
GEV No.	694737	Ref. No.	2.02HDF8A130001
description	bezel plate L 63mm H 15mm ID ø 26mm		
For models:	GDF5008, GDF5028		

 <p>1</p>			
GEV No.	699212	Ref. No.	2.HDF8A460201
description	pipe stainless steel L 30mm W 13mm thread M5		
For models:	GDF5008, GDF5028		

for convection ovens/combi-steamers

 <p>1</p>			
GEV No.	692843	Ref. No.	00004380
description	spacer bush ID ø 7mm H 7.5mm ED ø 17.5mm for glass plate white Spacer		
For models:	GCO2001		

spare parts and accessories

 <p>1</p>			
GEV No.	693043	Ref. No.	F02005
description	guard		
For models:	GTO1001, GTO2001		

glass panels

 <p>1</p>			
GEV No.	694950	Ref. No.	VET30017
description	door glass for combi-steamer L 485mm mounting pos. inner W 415mm thickness 4mm		
For models:	GCO500		

 <p>1</p>			
GEV No.	694951	Ref. No.	VET05021
description	door glass for combi-steamer L 555mm mounting pos. outer W 425mm thickness 4mm		
For models:	GCO500		

 <p>1</p>			
GEV No.	692841	Ref. No.	21100870
description	glass panel L 447mm mounting pos. inner W 585mm		
For models:	GCO2001		
accessories for	692841		
	GEV No.	Ref. No.	21100880
	692842		
	glass panel L 450mm mounting pos. outer W 590mm		
	GEV No.	Ref. No.	00004380
	692843		
	spacer bush ID ø 7mm H 7.5mm ED ø 17.5mm for glass plate white Spacer		

 <p>1</p>			
GEV No.	692842	Ref. No.	21100880
description	glass panel L 450mm mounting pos. outer W 590mm		
For models:	GCO2001		
accessories for	692842		
	GEV No.	Ref. No.	21100870
	692841		
	glass panel L 447mm mounting pos. inner W 585mm		
	GEV No.	Ref. No.	00004380
	692843		
	spacer bush ID ø 7mm H 7.5mm ED ø 17.5mm for glass plate white Spacer		
	GEV No.	Ref. No.	00011680
	694993		
	door handle ø 18mm L 350mm stainless steel M5 black matt		

Fans - accessories

 <p>1</p>			
GEV No.	701630	Ref. No.	00012330
description	air duct for cross flow fan for combi-steamer plastic grey		
For models:	GCO2001		

for hot dog machines

lids



1

GEV No.	694450	Ref. No.	F05051
description	lid for hot dog machine ø 205mm		
For models:	GHM1001		

glass cylinders



1

GEV No.	693002	Ref. No.	F05009
description	glass cylinder ø 200mm Pyrex glass H 240mm		
For models:	GHM1001		

skewers



1

GEV No.	693018	Ref. No.	F05010
description	bun spikes for hot dog machine		
For models:	GHM1001		

water containers



1

GEV No.	693005	Ref. No.	F05022
description	water container for hot dog machine PTFE/aluminium		
For models:	GHM1001		

for induction devices

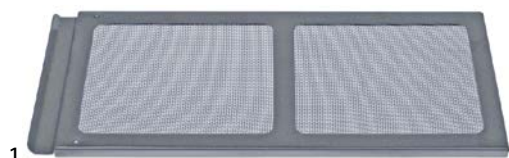

1

GEV No.	970790	Ref. No.	AB600022
description	grease filter W 323mm H 144mm thickness 8mm SS layers 2 outer grids 1 inner grids 1 for induction device		
For models:	GIC3035		

for tilting bratt pans

miscellaneous



1

GEV No.	523510	Ref. No.	00000000860
description	deep-groove ball bearing type 6202-2RS shaft ø 15mm ED ø 35mm W 11mm with sealing discs deep-groove ball bearing DIN 625-1		
For models:	GFS1025, GFS2019, GFS2022, GFS2025, GFS2030		

for microwaves

electric

line filters

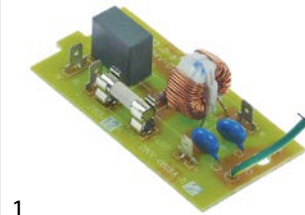

1

GEV No.	403188	Ref. No.	263029001088
description	line filter microwave for GMW1025 250V 50/60Hz conductor 2 PCB connection male faston 4.8mm L 80mm H 20mm W 40mm PCB Qty 1 pcs cable length 120mm type DNV-0818A-5		
For models:	GMW1025		

ceramic plates

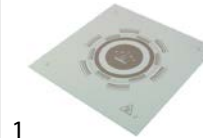

1

GEV No.	692350	Ref. No.	243999000108	
description	ceramic plate L 330mm W 335mm for microwave thickness 3.5mm GMW1025 Qty 1 pcs			
For models:	GMW1025			
accessories for	692350			
	GEV No.	901698	Ref. No.	593219000016
		gasket L 330mm W 325mm silicone for ceramic plate Qty 1 pcs		

miscellaneous



1

GEV No.	601869	Ref. No.	213149000023
description	bracket L 78mm W 20mm H 50mm for condenser Qty 1 pcs		
For models:	GMW1025		



doors

films



1

GEV No.	692451	Ref. No.	515059000119
description	film L 287mm W 159mm for door inside thickness 0.1mm transparent suitable for GALANZ plastic Qty 1 pcs		
For models:	GMW1025		

for ovens

housing and bezels



1

GEV No.	692763	Ref. No.	DEF30123
description	cover for hot air oven L 320mm W 325mm H 62mm		
For models:	GCO500		

for saladettes

housing and bezels



1

GEV No.	692692	Ref. No.	KITSR4AC2A00
description	bridge L 168/330/534mm 6 pieces		
For models:	GSA2600		



1

GEV No.	692691	Ref. No.	KITSR4AC4A00
description	bridge set 2-piece for saladette W 25mm D 184mm H 11mm		
For models:	GPS2600, GSD2600		



1

GEV No.	993263	Ref. No.	P04AC20A0006
description	cutting board L 950mm W 130mm H 20mm		
For models:	GSA2600		



1

GEV No.	692257	Ref. No.	VRX.01 VRX.02 VRX.04 VRX.05 VRX.06 VRX33-38
description	mounting set for glass plate for saladette 53-piece Qty 1 pcs 6x mounting clip 7x angle 12x flat-headed bolt 14x bush 14x screw connection		
For models:	GHS1600, GHS2600		

doors



1

GEV No.	701546	Ref. No.	S24AC22A0006
description	door bolt L 28mm mounting pos. upper thread L 8mmmm		
For models:	GPS2600, GSA2600, GSD2600, GSF2600		

for salamander grills



GEV No.	692240	Ref. No.	30045
description	drain tray for salamander grill L 350mm W 245mm		
For models:	GTO1001, GTO2001		

for dishwashers

boilers

boilers for dishwashers



GEV No.	508429	Ref. No.	900384
description	boiler 3500W 230V ø 127mm L 400mm		
For models:	GDW2001		

air traps

air traps



GEV No.	519643	Ref. No.	905262
description	air trap L 91mm W 54mm H 41mm hose ø 4x7mm plastic		
For models:	GDW2001		

air trap accessories

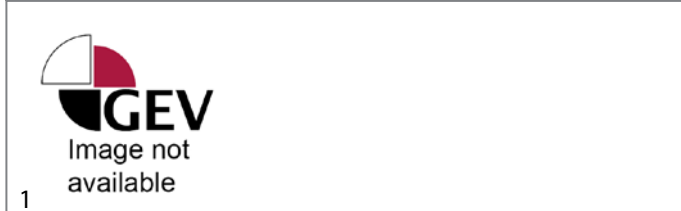

GEV No.	519162	Ref. No.	904131
description	spring		
For models:	GDW2001		

backflow preventers

backflow preventers



GEV No.	516101	Ref. No.	TR2433
description	backflow preventer dishwasher hose ø 12mm		
For models:	GDW2001		
spare parts for	516101		

GEV No.	506367	Ref. No.	—
description	flat gasket rubber ED ø 40mm ID ø 28mm thickness 1.8mm Qty 1 pcs		

door mechanics

linkage



GEV No.	519261	Ref. No.	902740
description	door pin tie bar		
For models:	GDW2001		

threaded shafts



GEV No.	519228	Ref. No.	905424
description	threaded part end stop		
For models:	GDW2001		

sliding plates



GEV No.	519208	Ref. No.	904952
description	sliding plate sliding plate		
For models:	GDW2001		

hinges

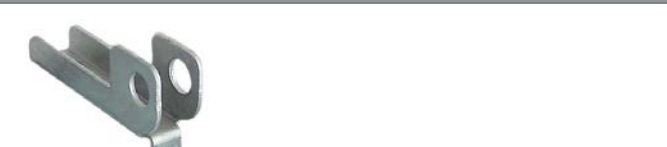

GEV No.	519035	Ref. No.	901245
description	door hinge bores 3 hinge		
For models:	GDW2001		



hinge pins



GEV No.	519204	Ref. No.	904795
description	hinge pin hinge pin		
For models:	GDW2001		

locks



GEV No.	519247	Ref. No.	906121
description	door catch door locking catch		
For models:	GDW2001		
accessories for	519247		
	GEV No.	519050	Ref. No.
			—
	nut thread M12x1.75 H 4mm WS 16 SS Qty 1 pcs for snap lock		

screw connections



GEV No.	519645	Ref. No.	902111
description	nut thread 3/8" H 14mm WS 24 plastic Qty 1 pcs		
For models:	GDW2001		

washing and rinsing systems



GEV No.	501351	Ref. No.	908154
description	flange mounting pos. upper ø 91mm H 11mm ID ø 45mm hole ø 5.5mm		
For models:	GDW2001		



GEV No.	519444	Ref. No.	905449
description	opposite support mounting pos. upper/lower for wash arm support suitable for Silanos		
For models:	GDW2001		
accessories for	519444		
	GEV No.	519445	Ref. No.
			908141
	gasket D1 ø 80mm D2 ø 50mm thickness 3mm with 4 screw holes		



GEV No.	519238	Ref. No.	906002
description	plain washer ID ø 15mm ED ø 33mm thickness 0.8mm SS Qty 1 pcs		
For models:	GDW2001		



GEV No.	501349	Ref. No.	908456
description	reducer for rinse arm shaft		
For models:	GDW2001		



GEV No.	517355	Ref. No.	908702
description	spacer piece for wash arm support ID ø 44mm ED ø 80mm thickness 18mm L 55mm plastic		
For models:	GDW2001		



GEV No.	519085	Ref. No.	902880
description	Thumb screw ø 34mm thread M6		
For models:	GDW2001		



GEV No.	519537	Ref. No.	908701
description	wash pipe ø 37mm L 720mm plastic suitable for Silanos		
For models:	GDW2001		

for toasters

spare parts and accessories



GEV No.	693043	Ref. No.	F02005
description	guard		
For models:	GTO1001, GTO2001		

miscellaneous

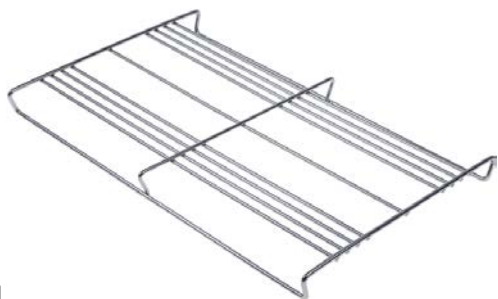

1			
GEV No.	694449	Ref. No.	F01069
description	guard L 315mm W 200mm for toaster H 24mm		
For models:	GTO1001, GTO2001		

handles and hand wheels

mushroom cap handles



1			
GEV No.	697445	Ref. No.	0000000677
description	mushroom cap handle thread M6 handle ø 33mm L 26mm plastic black		
For models:	GFS2030		

knobs

universal knobs



1			
GEV No.	112733	Ref. No.	3ZCK165BT19010101MGB
description	knob zero mark t.max.°C ø 55mm shaft ø 6x4.6mm shaft flat upper black		
For models:	GDF3004, GDF3008, GDF3024, GDF3028, GDF5008, GDF5028		



1			
GEV No.	698641	Ref. No.	00000001111
description	mushroom cap handle thread M6 handle ø 34mm L 25mm aluminium		
For models:	GFS1030		

miscellaneous



1			
GEV No.	696506	Ref. No.	2858
description	knob for PCB ø 26mm black Qty 1 pcs		
For models:	GSM1000		

handle bars

producer-specific handle rails

TECNOEKA



1			
GEV No.	694993	Ref. No.	00011680
description	door handle ø 18mm L 350mm stainless steel M5 black matt		
For models:	GCO2001		

accessories

rosettes



1			
GEV No.	111806	Ref. No.	3.ZCK165BT20010101-1
description	rosette knob ø 16mm ø 55mm		
For models:	GDF3004, GDF3008, GDF3024, GDF3028, GDF5008, GDF5028		

handle rails

handle rails



1			
GEV No.	699449	Ref. No.	SLZB0020
description	handle rail for fridge L 220mm W 36mm H 23mm grey hole distance 120mm		
For models:	GSC2336		



miscellaneous



1

GEV No.	692409	Ref. No.	1.1.C.C12.06
description	door handle L 100mm W 32mm hole distance 68mm white		
For models:	GGC2270		



1

GEV No.	698858	Ref. No.	1.1.C.C12.15
description	handle black for vitrine H 9.5mm L 85mm W 25mm mounting distance 70mm Qty 1 pcs		
For models:	GGC1078B		



1

GEV No.	692402	Ref. No.	1.1.C.C12.14
description	handle grey for vitrine H 9.5mm L 85mm W 25mm mounting distance 70mm Qty 1 pcs		
For models:	GGC1078		



1

GEV No.	691960	Ref. No.	A15015
description	handle L 100mm W 32mm hole distance 70mm for lid		
For models:	GTO1001, GTO2001		



1

GEV No.	110921	Ref. No.	A15016
description	handle L 130mm W 39mm hole distance 91mm Qty 1 pcs		
For models:	GHM1001		



1

GEV No.	692545	Ref. No.	3.HDF409010101
description	handle L 96mm W 64mm hole distance 73mm mounting pos. side panel black		
For models:	GDF3004, GDF3024		

locks

locking devices

producer-specific

WEIBO



1

GEV No.	692878	Ref. No.	W0604007
description	key cylinder rotation 90° cam length 45mm cam width 14mm for GFR2700/GRE2700 with 2 keys		
For models:	GFR2700, GRE2700		



hinges

oven hinges



1

GEV No.	701631	Ref. No.	00014600	
description	opposite support mounting distance 119mm L 135mm W 12mm			
For models:	GCO2001			
accessories for	701631			
	GEV No.	701573	Ref. No.	00014610
	oven hinge mounting distance 142mm mounting distance 2mm lug mountingmm lever lengthmm groove distance 12mm spring thickness 3.3mm mounting ear position spring length 116mm L 170mm mounting pos. left/right W 22mm			

			
1			
GEV No.	701573	Ref. No.	00014610
description	oven hinge mounting distance 142mm mounting distance 2mm lug mountingmm lever lengthmm groove distance 12mm spring thickness 3.3mm mounting ear position spring length 116mm L 170mm mounting pos. left/right W 22mm		
For models:	GCO2001		
accessories for	701573		
	GEV No.	701631	Ref. No. 00014600
	opposite support mounting distance 119mm L 135mm W 12mm		

			
1			
GEV No.	701592	Ref. No.	CER30021 STA00028
description	oven hinge set mounting distance 140mm lever length 42mm groove distance 15mm spring thickness 2.9mm L 170mm mounting pos. left/right with opposite support Qty 2 pcs		
For models:	GCO500		

door bearing

			
1			
GEV No.	692406	Ref. No.	1.1.B.B10.17
description	bolt H 16.5mm ø 10/14mm ID ø 7mm brass for door hinge Qty 1 pcs		
For models:	GGC2270, GGC2270B		

			
1			
GEV No.	701562	Ref. No.	44447000
description	bolt L 36mm W 22mm thread M6 bolt 12mm bolt ø 12mm		
For models:	GFR3600S, GRE3600, GRE3600S		

			
1			
GEV No.	692421	Ref. No.	1.1.C.C13.01
description	bush H 15mm ø 10/13mm ID ø 7mm plastic for door hinge Qty 1 pcs		
For models:	GGC1078, GGC2270, GGC2270B		

			
1			
GEV No.	701567	Ref. No.	41649000
description	bush L 11mm ø 11/15mm thickness 2mm		
For models:	GFR3600S, GRE3600, GRE3600S		

			
1			
GEV No.	701572	Ref. No.	I0534002
description	bush ø 18.5mm ID ø 12mm		
For models:	GFR3600S		

			
1			
GEV No.	701280	Ref. No.	WJMA4002
description	door hinge L 42mm W 33mm H 82mm mounting pos. bottom right/left set Qty 1 pcs		
For models:	GSC1100G		

			
1			
GEV No.	701281	Ref. No.	WJMA4005
description	door hinge L 43mm W 82mm H 71mm mounting pos. upper right/left set Qty 1 pcs		
For models:	GSC1100G		



			
1			
GEV No.	698866	Ref. No.	GPC1046-12 GPC1088-13
description	door hinge L 90mm W 40mm H 19mm mounting pos. lower bolt 13mm bolt ø 10.5mm		
For models:	GPC1046, GPC1088		





 <p>1</p>			
GEV No.	698863	Ref. No.	GPC1046-04 GPC1088-05
description	door hinge L 90mm W 40mm H 19mm mounting pos. upper bolt 13mm bolt ø 10.5mm		
For models:	GPC1046, GPC1088		

 <p>1</p>			
GEV No.	701564	Ref. No.	46996000
description	hinge L 130mm W 85mm H 38mm mounting distance 48mm mounting distance 2 33mm thread M6 ø 8mm bolt 13mm bolt ø 8mm		
For models:	GRE3600		

 <p>1</p>			
GEV No.	692690	Ref. No.	S24AC22A0003
description	hinge L 40mm W 70mm H 22mm mounting distance 2 20mm		
For models:	GPS2600, GSA2600, GSD2600, GSF2600		

 <p>1</p>			
GEV No.	699587	Ref. No.	W0604033
description	hinge L 87mm W 46mm mounting pos. upper right thickness 3.6mm bolt 46mm bolt ø 10.5mm for GFR2700/GRE2700		
For models:	GFR2700, GRE2700		
accessories for	699588		
 <p>1</p>			
GEV No.	699588	Ref. No.	W0604037
description	hinge L 88mm W 50mm mounting pos. bottom right thickness 3.6mm bolt 29mm bolt ø 11mm for GFR2700/GRE2700		
For models:	GFR2700, GRE2700		

 <p>1</p>			
GEV No.	699588	Ref. No.	W0604037
description	hinge L 88mm W 50mm mounting pos. bottom right thickness 3.6mm bolt 29mm bolt ø 11mm for GFR2700/GRE2700		
For models:	GFR2700, GRE2700		
spare parts for	699588		
 <p>1</p>			
GEV No.	699568	Ref. No.	W0604038
description	base plate for door hinge mounting pos. lower L 35mm W 25mm for GFR2700/GRE2700		

accessories for	699588		
 <p>1</p>			
GEV No.	699587	Ref. No.	W0604033
description	hinge L 87mm W 46mm mounting pos. upper right thickness 3.6mm bolt 46mm bolt ø 10.5mm for GFR2700/GRE2700		

 <p>1</p>			
GEV No.	701563	Ref. No.	43870000
description	hinge L 98mm W 48mm H 38mm mounting distance 40mm mounting distance 2 20mm thread M6		
For models:	GFR3600S, GRE3600, GRE3600S		

 <p>1</p>			
GEV No.	694866	Ref. No.	WJMA2003
description	hinge mounting pos. lower L 82mm W 53mm H 43mm mounting distance 30mm mounting distance 2 56mm thickness 4mm bolt 20mm bolt ø 7mm		
For models:	GSC2336		

 <p>1</p>			
GEV No.	694865	Ref. No.	WJMA0004
description	hinge mounting pos. upper L 50mm W 33mm H 42mm mounting distance 27mm thickness 3mm bolt 32.5mm bolt ø 9mm Qty 1kg		
For models:	GSC2336		

 <p>1</p>			
GEV No.	699419	Ref. No.	1.1.B.B09.01
description	hinge bearing L 55mm W 15mm H 14mm mounting distance 26mm mounting pos. upper		
For models:	GGC1078, GGC1078B		

 <p>1</p>			
GEV No.	701565	Ref. No.	48205000
description	hinge bearing L 72mm W 39mm H 30mm mounting distance 25mm mounting distance 2 25mm mounting pos. left		
For models:	GRE3600		

			
1			
GEV No.	701566	Ref. No.	46997000
description	hinge bearing L 72mm W 39mm H 30mm mounting distance 25mm mounting distance 2 25mm mounting pos. right		
For models:	GRE3600		

			
1			
GEV No.	699423	Ref. No.	1.1.B.B09.17
description	hinge bearing L 85mm W 17mm H 17mm mounting distance 48mm mounting pos. upper		
For models:	GGC2270, GGC2270B		

accessories

bushes

			
1			
GEV No.	701642	Ref. No.	W0409843
description	bush lower for door hinge ID ø 11mm ED ø 13mm L 26mm for GFR2700/GRE2700		
For models:	GFR2700, GRE2700		

			
1			
GEV No.	701641	Ref. No.	W0409842
description	bush upper for door hinge ID ø 11mm ED ø 13mm L 29.5mm for GFR2700/GRE2700		
For models:	GFR2700, GRE2700		

base plate

			
1			
GEV No.	699568	Ref. No.	W0604038
description	base plate for door hinge mounting pos. lower L 35mm W 25mm for GFR2700/GRE2700		
For models:	GFR2700, GRE2700		

			
1			
GEV No.	699569	Ref. No.	W0604030
description	base plate for door hinge mounting pos. right L 74mm W 42mm for GFR2700/GRE2700		
For models:	GFR2700, GRE2700		

filters

accessories

fastening material

			
1			
GEV No.	694581	Ref. No.	WJB000079R
description	frame L 317mm W 170mm H 9mm for filter		
For models:	GIC3035		

equipment feet and end caps

equipment feet

with screw mounting

			
1			
GEV No.	701640	Ref. No.	W0409018
description	equipment foot tube ø 51mm plate size 70x70mm hole distance 50mm H 11,7-18mm Qty 1 pcs for GFR2700/GRE2700 adjustable		
For models:	GFR2700, GRE2700		

with fixing plate

			
1			
GEV No.	701640	Ref. No.	W0409018
description	equipment foot tube ø 51mm plate size 70x70mm hole distance 50mm H 11,7-18mm Qty 1 pcs for GFR2700/GRE2700 adjustable		
For models:	GFR2700, GRE2700		



screw-in feet



1

GEV No.	701230	Ref. No.	900888
description	equipment feet kit thread M5 thread L 10mm ø 22mm H 12mm rubber WS Qty 4 pcs bore ø 5/10mm		
For models:	GJU1001		



1

GEV No.	700972	Ref. No.	S900.13
description	equipment foot thread M10 thread L 16mm ø 29mm H 11.5mm Qty 1 pcs for fridge		
For models:	GHS1600, GHS2600		



1

GEV No.	701593	Ref. No.	PIE30010
description	equipment foot thread M10 thread L 18.5mm ø 49mm H 35mm plastic Qty 4 pcs		
For models:	GCO500		



1

GEV No.	692235	Ref. No.	A13012
description	equipment foot thread M10 thread L 20mm ø 26mm H 6mm Qty 1 pcs		
For models:	GEG2001		



1

GEV No.	802156	Ref. No.	00002790
description	equipment foot thread M10 thread L 20mm ø 60mm H 50mm Qty 1 pcs		
For models:	GCO2001		



1

GEV No.	701112	Ref. No.	I0403014
description	equipment foot thread M10 thread L 43mm ø 29mm H 52mm plastic WS 35 Qty 1 pcs		
For models:	GRE3600, GRE3600S		



1

GEV No.	701451	Ref. No.	00000001240
description	equipment foot thread M5 thread L 13mm ø 37.5mm H 25mm conical aluminium WS Qty 1 pcs bore ø 6mm		
For models:	GFS1025		



1

GEV No.	701219	Ref. No.	AB300035
description	equipment foot thread M5 thread L 9mm ø 33mm H 34mm Qty 1 pcs		
For models:	GIC3035		



1

GEV No.	701220	Ref. No.	AB300055
description	equipment foot thread M6 thread L 20mm ø 33mm H 20mm WS 12 Qty 1 pcs		
For models:	GIC3035		



1

GEV No.	698495	Ref. No.	00000001251
description	equipment foot thread M8 thread L 9mm ø 48mm H 43mm conical aluminium WS Qty 1 pcs		
For models:	GFS1030		

bolting feet



1

GEV No.	691814	Ref. No.	A13003
description	equipment foot \varnothing 22mm H 20mm bore \varnothing 4mm Qty 1 pcs		
For models:	GHM1001, GTO1001, GTO2001		



1

GEV No.	698546	Ref. No.	3.0000161
description	equipment foot \varnothing 29mm H 16mm rubber bore \varnothing 6mm Qty 1 pcs		
For models:	GDF3004, GDF3008, GDF3024, GDF3028, GDF5008, GDF5028		



1

GEV No.	697433	Ref. No.	00000000140 00000700140
description	equipment foot \varnothing 35mm H 26mm bore \varnothing 5mm Qty 1 pcs		
For models:	GFS1022, GFS2019, GFS2022, GFS2025, GFS2030		

equipment feet with stem



1

GEV No.	701251	Ref. No.	223189000015
description	equipment foot \varnothing 20mm H 12mm mounting \varnothing 8mm mounting measurements 19mm overall height 19mm plastic Qty 1 pcs		
For models:	GMW1025		

miscellaneous

with fixing plate

 \varnothing 30mm

1

GEV No.	701277 ¹	Ref. No.	WJLA1001 WJLA1009
description	swivel castor 2 with & 2 without brake \varnothing 30mm plate fixing housing zinc-plated sheet steel plate size 61x51mm hole distance mm capacity 60kg bearing slide bearing wheel body PVC tread PVC H 44mm wheel width 23.5mm		
For models:	GBC1001, GBC1001S, GBC1001SS, GBC1002, GBC1002S, GBC1002SS, GBC1003, GBC1003S, GBC1003SS, GBC1102, GBC1103, GSC2336		

¹with swivel brake \varnothing 75mm

1

GEV No.	701282	Ref. No.	WJLA1002
description	swivel castor set 2 with & 2 without brake \varnothing 75mm plates fixing 102x83mm housing zinc-plated sheet steel hole distance 55/75mm bearing slide bearing H 112mm wheel width 31mm Qty 4 pcs		
For models:	GSC1100G		

with spigot

 \varnothing 40mm

1

GEV No.	701120	Ref. No.	1.1.B.B10.95 1.1.B.B10.96
description	castor set 2 with & 2 without brake \varnothing 40mm with thread bolt housing chrome-plated steel thread L 24mm thread \varnothing M10x1.5mm capacity 60kg bearing ball bearing wheel body nylon tread nylon H 68mm wheel width 20mm Qty 4 pcs		
For models:	GGC2270, GGC2270B		

baskets

crumb screens



1

GEV No.	970869	Ref. No.	2.HDF405069510
description	crumb screen L 220mm W 160mm H 35mm 4 litre		
For models:	GDF3004, GDF3024		



1

GEV No.	970870	Ref. No.	2.HDF812020609510
description	crumb screen L 245mm W 200mm H 35mm 8 litre		
For models:	GDF3008, GDF3028, GDF5008, GDF5028		



wire baskets for hot dog machines



GEV No.	693004	Ref. No.	F04012
description	grid basket for hot dog grill ø 180mm H 210mm		
For models:	GHM1001		

shelves and shelf rails

grates

universal

without upstand



GEV No.	970801	Ref. No.	WJGA9008
description	grate W 345mm D 400mm chrome-plated steel wire gauge frame 6mm lengthwise wires gauge 2.5mm crossing wires 4 Qty 1 pcs		
For models:	GBC1003, GBC1003S, GBC1003SS, GBC1103		

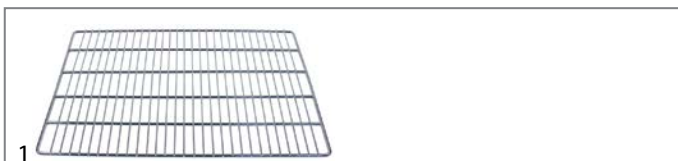

GEV No.	970800	Ref. No.	WJGA9002
description	grate W 345mm D 500mm chrome-plated steel wire gauge frame 6mm lengthwise wires gauge 2.5mm crossing wires 4 Qty 1 pcs		
For models:	GBC1001, GBC1001S, GBC1001SS		

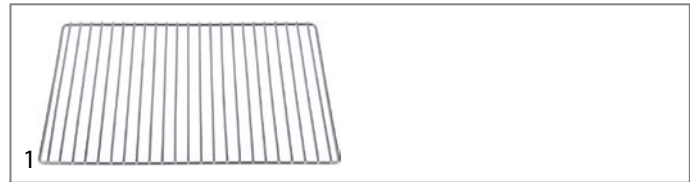

GEV No.	970747	Ref. No.	F01070
description	grate W 350mm D 240mm H 7mm SS for toaster wire gauge frame 4mm lengthwise wires gauge 3mm crossing wires ROLLER GRILL		
For models:	GTO1001, GTO2001		



GEV No.	970905	Ref. No.	GPC1046-13 GPC1088-14-half size
description	grate W 365mm D 165mm H 7mm wire gauge frame 4mm lengthwise wires gauge 3mm		
For models:	GPC1046, GPC1088		

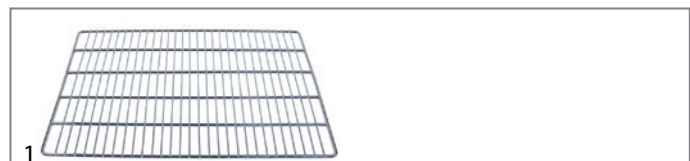

GEV No.	970906	Ref. No.	WJGA9005
description	grate W 400mm D 345mm chrome-plated steel wire gauge frame 6mm crossing wires 4		
For models:	GBC1002, GBC1002S, GBC1002SS, GBC1003, GBC1003S, GBC1102		

with upstand



GEV No.	970925	Ref. No.	S14AC29A0001
description	grate W 325mm D 570mm GN 1/1 H 55mm plastic-coated steel wire gauge frame 7.5mm lengthwise wires gauge 4mm crossing wires 3 grey		
For models:	GPS2600, GSA2600, GSD2600, GSF2600		



GEV No.	970904	Ref. No.	GPC1088-14-full size
description	grate W 350mm D 295mm H 30mm chrome-plated steel wire gauge frame 4mm lengthwise wires gauge 2mm crossing wires 1 Qty 2 pcs		
For models:	GPC1088		



GEV No.	970795	Ref. No.	1.1.B.B25.15
description	grate W 735mm D 235mm H 37mm chrome-plated steel wire gauge frame 8mm lengthwise wires gauge 3mm crossing wires 1		
For models:	GCV1600		



GEV No.	970794	Ref. No.	1.1.B.B25.16
description	grate W 735mm D 365mm H 35mm chrome-plated steel wire gauge frame 8mm lengthwise wires gauge 3mm crossing wires 1		
For models:	GCV1600		

producer-specific



GEV No.	698856	Ref. No.	1.1.B.B02.01.03
description	grate W 360mm D 305mm plastic-coated steel		
For models:	GGC1078B		
accessories for	698856		



GEV No.	692400	Ref. No.	1.1.C.C10.07
description	shelf support L 28.5mm W 14mm H 17.5mm plastic Qty 1 pcs		



GEV No.	698857	Ref. No.	1.1.C.C10.08
description	shelf support L 28.5mm W 14mm H 17.5mm plastic Qty 1 pcs		



GEV No.	970876	Ref. No.	1.1.B.B02.01.01
description	grate W 360mm D 305mm plastic-coated steel		
For models:	GGC1078		



GEV No.	692696	Ref. No.	1.1.B.B02.04.02
description	grate W 430mm D 390mm H 8mm plastic-coated steel refrigeration wire gauge frame 8mm lengthwise wires gauge 3.6mm crossing wires 5 black		
For models:	GGC2270B		



GEV No.	692339	Ref. No.	1.1.B.B02.04.01
description	grate W 430mm D 390mm H 8mm plastic-coated steel refrigeration wire gauge frame 8mm lengthwise wires gauge 3.6mm crossing wires 5 white		
For models:	GGC2270		



GEV No.	970799	Ref. No.	WJGA4078
description	grate W 540mm D 505mm H 41mm plastic-coated steel wire gauge frame 6mm lengthwise wires gauge 3mm crossing wires 3 white Qty 1 pcs		
For models:	GSC1100G		



GEV No.	970982	Ref. No.	W0402040
description	grate W 620mm D 530mm plastic-coated steel with hinge camp crossing wires 2 suitable for GRE2700		
For models:	GRE2700		



GEV No.	970980	Ref. No.	W0402366
description	grate W 630mm D 602mm plastic-coated steel crossing wires 2 suitable for GFR2700/GRE2700		
For models:	GFR2700, GRE2700		





GEV No.	970930	Ref. No.	44714000
description	grate W 650mm D 330mm H 9mm wire gauge frame 7mm lengthwise wires gauge 3mm crossing wires 1		
For models:	GRE3600, GRE3600S		



GEV No.	970981	Ref. No.	W0402369
description	grate W 650mm D 530mm plastic-coated steel crossing wires 2 suitable for GFR2700		
For models:	GFR2700		



 <p>1</p>			
GEV No.	970929	Ref. No.	44379000
description	grate W 665mm D 560mm H 30mm wire gauge frame 7mm lengthwise wires gauge 3mm crossing wires 2		
For models:	GFR3600S, GRE3600, GRE3600S		

 <p>1</p>			
GEV No.	692367	Ref. No.	1.1.B.B25.26
description	rack support L 320mm H 83mm mounting pos. bottom left SS Qty 1 pcs		
For models:	GCV1600		

accessories

 <p>1</p>			
GEV No.	691917	Ref. No.	F03006
description	grid handle L 204mm W 80mm		
For models:	GTO1001, GTO2001		

 <p>1</p>			
GEV No.	701252	Ref. No.	1.1.B.B25.35
description	rail for grid attachment L 405mm Hmm mounting pos. left/right W 19mm SS Qty 1 pcs		
For models:	GCV1600		

grid attachments

 <p>1</p>			
GEV No.	692368	Ref. No.	1.1.B.B25.27
description	rack support L 220mm H 83mm mounting pos. bottom right SS Qty 1 pcs		
For models:	GCV1600		

shelf rails and supports

producer-specific

 <p>1</p>			
GEV No.	698870	Ref. No.	LCCJ2001
description	guide L 390mm W 25mm mounting pos. left/right inner height 4mm		
For models:	GBC1001, GBC1001S, GBC1001SS, GBC1002, GBC1002S, GBC1002SS, GBC1003, GBC1003S, GBC1003SS, GBC1102, GBC1103		

 <p>1</p>			
GEV No.	692365	Ref. No.	1.1.B.B25.28
description	rack support L 220mm H 83mm mounting pos. upper left SS Qty 1 pcs		
For models:	GCV1600		

 <p>1</p>			
GEV No.	701643	Ref. No.	80037407
description	guide U-shape L 620mm W 15mm H 20mm mounting pos. left for GFR2700/GRE2700		
For models:	GFR2700, GRE2700		
accessories for	701643		
GEV No.	701644	Ref. No.	80037408
description	guide U-shape L 620mm W 15mm H 20mm mounting pos. right for GFR2700/GRE2700		

 <p>1</p>			
GEV No.	692366	Ref. No.	1.1.B.B25.29
description	rack support L 220mm H 83mm mounting pos. upper right SS Qty 1 pcs		
For models:	GCV1600		



1

GEV No.	701644	Ref. No.	80037408
description	guide U-shape L 620mm W 15mm H 20mm mounting pos. right for GFR2700/GRE2700		
For models:	GFR2700, GRE2700		
accessories for	701644		
	GEV No.	Ref. No.	80037407
	guide U-shape L 620mm W 15mm H 20mm mounting pos. left for GFR2700/GRE2700		



1

GEV No.	699231	Ref. No.	I0402137
description	guide white L 1350mm W 20mm H 5mm Qty 1		
For models:	GRE3600, GRE3600S		



1

GEV No.	696443	Ref. No.	KITGD4AC2A00
description	pair of setting bar U-shape L 548mm W 20mm inner height 13mm mounting pos. left/right		
For models:	GPS2600, GSA2600, GSD2600, GSF2600		



1

GEV No.	701550	Ref. No.	S24AC29A0002
description	rack L 244mm W 50mm H 8mm mounting pos. front		
For models:	GPS2600, GSA2600, GSD2600, GSF2600		



1

GEV No.	701548	Ref. No.	S24AC29A0004
description	rack L 245mm W 40mm H 30mm mounting pos. left		
For models:	GPS2600, GSA2600, GSD2600, GSF2600		



1

GEV No.	701549	Ref. No.	S24AC29A0005
description	rack L 245mm W 40mm H 30mm mounting pos. right		
For models:	GPS2600, GSA2600, GSD2600, GSF2600		



1

GEV No.	699585	Ref. No.	80037402
description	rack L 985mm W 57mm H 38mm mounting pos. left/right aperture 15x15mm hole distance 55mm 18 holes for GFR2700/GRE2700		
For models:	GFR2700, GRE2700		
accessories for	699585		
	GEV No.	Ref. No.	80037407
	guide U-shape L 620mm W 15mm H 20mm mounting pos. left for GFR2700/GRE2700		
	GEV No.	Ref. No.	80037408
	guide U-shape L 620mm W 15mm H 20mm mounting pos. right for GFR2700/GRE2700		



1

GEV No.	692398	Ref. No.	LCCK0002
description	shelf support L 24mm W 9mm H 29mm aluminium for fridge Qty 1 pcs		
For models:	GBC1001, GBC1001S, GBC1001SS, GBC1002, GBC1002S, GBC1002SS, GBC1003, GBC1003S, GBC1003SS, GBC1102, GBC1103		



1

GEV No.	692400	Ref. No.	1.1.C.C10.07
description	shelf support L 28.5mm W 14mm H 17.5mm plastic Qty 1 pcs		
For models:	GGC1078		

1

GEV No.	698857	Ref. No.	1.1.C.C10.08
description	shelf support L 28.5mm W 14mm H 17.5mm plastic Qty 1 pcs		
For models:	GGC1078B		



1

GEV No.	692408	Ref. No.	1.1.C.C10.09
description	shelf support L 38.5mm W 14mm H 18mm plastic Qty 1 pcs		
For models:	GGC2270		



1

GEV No.	699416	Ref. No.	1.1.C.C10.10
description	shelf support L 38.5mm W 14mm H 18mm plastic Qty 1 pcs		
For models:	GGC2270B		

gaskets

refrigeration gaskets

plug-in gaskets

profile 9750

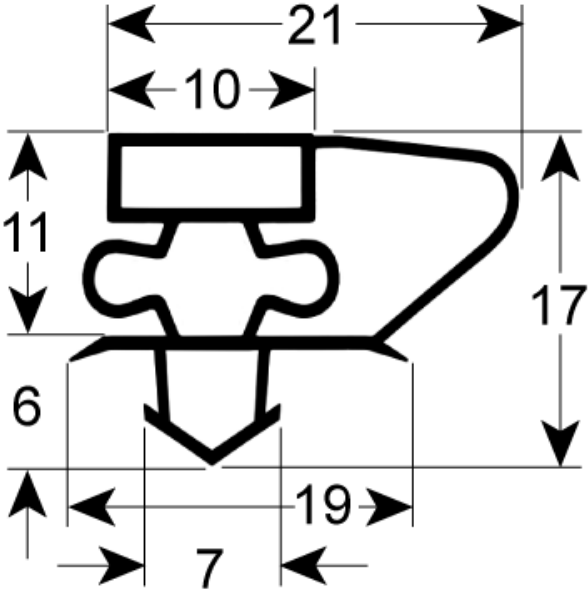

1

GEV No.	902514	Ref. No.	W0404514
description	refrigeration gasket profile 9750 W 660mm L 1537mm plug size		
For models:	GFR2700, GRE2700		

profile 9149

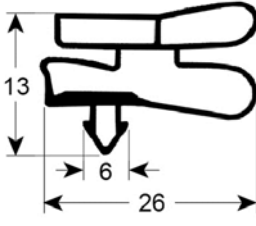

1

GEV No.	902216	Ref. No.	R04AC22A0002
description	refrigeration gasket profile 9149 W 385mm L 480mm plug size		
For models:	GPS2600, GSA2600, GSD2600, GSF2600		

profile 9058

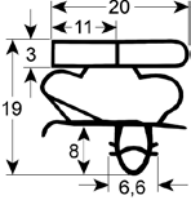

1

GEV No.	902395	Ref. No.	44404000
description	refrigeration gasket profile 9058 W 770mm L 1810mm plug size Qty 1		
For models:	GFR3600S, GRE3600, GRE3600S		

profile 9156

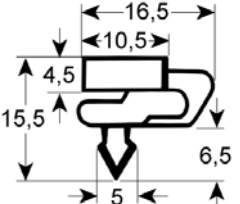

1

GEV No.	901662	Ref. No.	SLJP4007
description	door seal profile 9156 W 569mm L 1295mm plug size Qty 1 pcs		
For models:	GSC1100G		

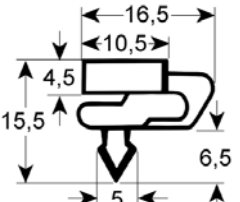

1

GEV No.	901648	Ref. No.	SLJP2010
description	refrigeration gasket profile 9156 W 595mm L 1340mm plug size Qty 1 pcs		
For models:	GSC2336		

profile 9930

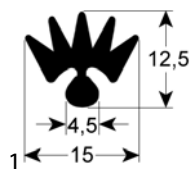

GEV No.	901645	Ref. No.	1.1.C.63.69
description	refrigeration gasket profile 9930 Wmm L 746mm plug size		
For models:	GCV1600		

screw-in gaskets

profile 9968

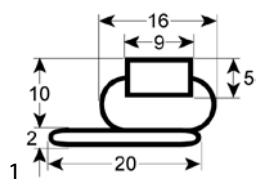

GEV No.	901649	Ref. No.	1.1.E.E1.35
description	refrigeration gasket profile 9968 W 418mm L 658mm external size with metal reinforcement Qty 1 pcs		
For models:	GGC1078B		

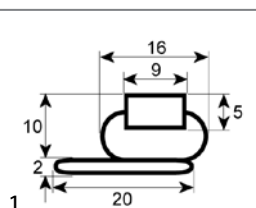

GEV No.	901650	Ref. No.	1.1.E.E1.25
description	refrigeration gasket profile 9968 W 515mm L 1390mm external size with metal reinforcement Qty 1 pcs		
For models:	GGC2270		

profile 9910

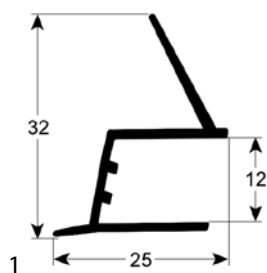

GEV No.	901651	Ref. No.	1.1.C.C63.67
description	refrigeration gasket profile 9910 Wmm L 735mm Qty 1 mounting pos. left		
For models:	GCV1600		

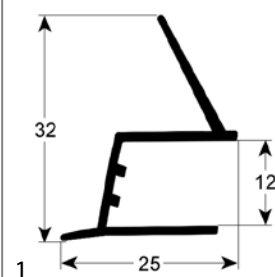

GEV No.	901646	Ref. No.	1.1.C.C63.76
description	refrigeration gasket profile 9910 Wmm L 735mm Qty 1 mounting pos. right		
For models:	GCV1600		

gaskets for heated units

door seals

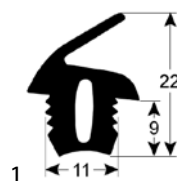

GEV No.	902446	Ref. No.	GUA30015
description	door seal profile 2718 L 5500mm		
For models:	GCO500		

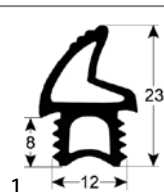

GEV No.	902497	Ref. No.	01000770
description	door seal profile 2764 L 1020mm suitable for TECNOEKA		
For models:	GCO2001		

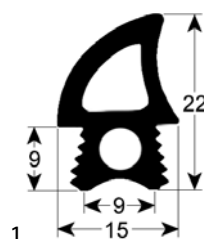

GEV No.	902419	Ref. No.	01000810
description	door seal profile 2767 L 1780mm suitable for TECNOEKA		
For models:	GCO2001		



O-rings

EPDM

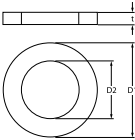
1

GEV No.	532648	Ref. No.	2859
description	O-ring EPDM thickness 1.5mm ID ø 5mm Qty 1 pcs		
For models:	GSM1000		

1

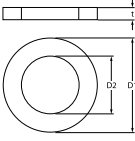
GEV No.	532647	Ref. No.	900970
description	O-ring EPDM thickness 1.8mm ID ø 11.8mm Qty 1 pcs		
For models:	GJU1001		

1

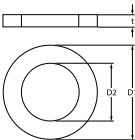
GEV No.	510955	Ref. No.	00002001
description	O-ring EPDM thickness 3mm ID ø 6mm Qty 1 pcs		
For models:	GCO2001		



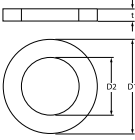

1

GEV No.	521120	Ref. No.	907981
description	O-ring EPDM thickness 5.34mm ID ø 37.47mm Qty 1 pcs		
For models:	GDW2001		

sealing washers

rubber gaskets



1

GEV No.	519114	Ref. No.	903260
description	flat gasket rubber ED ø 25mm ID ø 16.5mm thickness 2mm Qty 1 pcs		
For models:	GDW2001		

shaft gaskets

shaft gaskets



1

GEV No.	697475	Ref. No.	00000012671
description	shaft seal ID ø 20mm ED ø 30mm thickness 5mm		
For models:	GFS1025		



1

GEV No.	698383	Ref. No.	0632
description	shaft sealing ID ø 4mm ED ø 12mm for hand blender H 6.3mm		
For models:	GSM1000		

miscellaneous



1

GEV No.	511953	Ref. No.	900871
description	seal kit for citrus juicers		
For models:	GJU1001		

special gaskets

for microwaves



1

GEV No.	901698	Ref. No.	593219000016
description	gasket L 330mm W 325mm silicone for ceramic plate Qty 1 pcs		
For models:	GMW1025		

miscellaneous



1

GEV No.	698545	Ref. No.	3.0000404
description	gasket ED ø 31mm ID ø 21mm		
For models:	GDF3008, GDF3028, GDF5008, GDF5028		



1

GEV No.	698543	Ref. No.	3.0000403
description	gasket external height 4mm ED ø 25mm ID ø 16mm		
For models:	GDF3008, GDF3028, GDF5008, GDF5028		

gaskets for wash arm support



1

GEV No.	519445	Ref. No.	908141
description	gasket D1 ø 80mm D2 ø 50mm thickness 3mm with 4 screw holes		
For models:	GDW2001		

miscellaneous



1

GEV No.	750381	Ref. No.	TCGV0002
description	dryer ø 18.5mm L 115.5mm connection 2,4/5,2mm Qty 1 pcs		
For models:	GBC1001, GBC1001S, GBC1001SS, GBC1002, GBC1002S, GBC1002SS, GBC1003, GBC1003S, GBC1003SS, GBC1102, GBC1103, GSC2336		



1

GEV No.	750693	Ref. No.	1.1.A.A04.01
description	dryer ø 19mm L 120.5mm connection 2/5mm Qty 1 pcs		
For models:	GCV1600, GGC1078, GGC1078B		



1

GEV No.	750378	Ref. No.	C01AE66A0001 C04AC26A0001
description	dryer ø 19mm L 145mm connection 4,5/8mm type XH9 Qty 1 pcs		
For models:	GDS2600, GPS2600, GSA2600, GSD2600, GSF2600		



1

GEV No.	750748	Ref. No.	W0204101
description	dryer ø 19mm L 166mm connection 2,7/5,2 for GFR2700/GRE2700		
For models:	GFR2700, GRE2700		



1

GEV No.	750694	Ref. No.	1.1.A.A04.06
description	dryer ø 25mm L 144mm connection 6/8mm Qty 1 pcs		
For models:	GGC2270, GGC2270B		



1

GEV No.	750324	Ref. No.	S900.44
description	dryer size 20g ø 23mm L 117mm connection 4,8/8,3mm		
For models:	GHS1600, GHS2600		



1

GEV No.	750382	Ref. No.	TCGV0009	
description	dryer ø 18.5mm L 120mm connection 4/7mm Qty 1 pcs			
For models:	GSC1100G			
accessories for	750382			
	GEV No.	694868	Ref. No.	—
	bracket for dryer L 40mm W 30mm H 31mm Qty 1 pcs			

refrigeration cycle components

valves

Schrader valves

Schrader valves (complete)



1

GEV No.	750636	Ref. No.	S900.42
description	Schrader valve complete connection 1/4"SAE ø 6mm L 120mm		
For models:	GHS1600, GHS2600		

filter driers

accessories

holders



1

GEV No.	699297	Ref. No.	SLJAC008
description	bracket L 40mm W 30mm H 31mm ID ø 18mm ED ø 22mm for dryer		
For models:	GBC1001, GBC1001S, GBC1001SS, GBC1002, GBC1002S, GBC1002SS, GBC1003, GBC1003S, GBC1003SS, GBC1102, GBC1103, GSC1100G, GSC2336		



refrigeration pipes

copper pipes uninsulated



1			
GEV No.	694931	Ref. No.	VRX.15
description	capillary pipe ID ø 0.8mm ED ø 2mm L 2340m		
For models:	GHS1600, GHS2600		



1			
GEV No.	692407	Ref. No.	1.1.B.B06.21
description	copper pipe copper ID ø 3.8mm ED ø 4.8mm L 0.1m Qty 1 pcs		
For models:	GGC2270, GGC2270B		



1			
GEV No.	692730	Ref. No.	TCGO3004
description	copper pipe ID ø 4mm ED ø 6mm L 0.095m		
For models:	GBC1002, GBC1002S, GBC1003, GBC1003S, GBC1102, GBC1103		



1			
GEV No.	692418	Ref. No.	1.1.B.B06.26
description	refrigeration pipe copper ID ø 5mm ED ø 6mm L 1m Qty 1		
For models:	GCV1600, GGC1078, GGC1078B, GGC2270, GGC2270B		



1			
GEV No.	692872	Ref. No.	W0210284
description	refrigeration pipe ID ø 2/3mm ED ø 5mm L 0.4m refrigeration GFR2700		
For models:	GFR2700		



1			
GEV No.	692871	Ref. No.	W0210452
description	refrigeration pipe ID ø 3/7mm ED ø 6/8mm L 0.38m refrigeration GFR2700		
For models:	GFR2700		



1			
GEV No.	692874	Ref. No.	W0210412
description	refrigeration pipe ID ø 5.5mm ED ø 6.5mm L 0.3m refrigeration GFR2700		
For models:	GFR2700		



1			
GEV No.	692876	Ref. No.	W0210411
description	refrigeration pipe ID ø 5mm ED ø 6.5mm L 0.28m refrigeration GFR2700		
For models:	GFR2700		



1			
GEV No.	692875	Ref. No.	W0210416
description	refrigeration pipe ID ø 6,5/7,5mm ED ø 7,5/8,5mm L 0.38m refrigeration GRE2700		
For models:	GRE2700		



1			
GEV No.	692873	Ref. No.	W0210282
description	refrigeration pipe ID ø 6.5mm ED ø 8mm L 0.36m refrigeration GFR2700		
For models:	GFR2700		

accessories for	692873		
GEV No.	696787	Ref. No.	W0208009

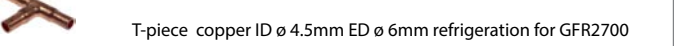

T-piece	copper ID ø 4.5mm ED ø 6mm refrigeration for GFR2700		
----------------	--	--	--

1 

GEV No.	692877	Ref. No.	W0210417
description	refrigeration pipe ID ø 6/7mm ED ø 7/8mm L 0.41m refrigeration GRE2700		
For models:	GRE2700		

copper pipes insulated

1 

GEV No.	696789	Ref. No.	W0210413	
description	copper pipe with insulation pipe ø 6 for fridge GFR2700/GRE2700			
For models:	GFR2700, GRE2700			
accessories for	696789			
	GEV No.	692867	Ref. No.	W04102051
	cover ø 20mm L 400mm W 43mm plastic Qty 1 pcs for GFR2700/GRE2700			
	GEV No.	692870	Ref. No.	W0413062
	rubber pad L 40mm W 17mm H 30mm for GFR2700/GRE2700			

1 



GEV No.	699570	Ref. No.	W0210414
description	refrigeration pipe pipe ø 8 L 1700mm GFR2700		
For models:	GFR2700		

1 

GEV No.	699572	Ref. No.	W0210418
description	refrigeration pipe pipe ø 8 L 1700mm GRE2700		
For models:	GRE2700		

connections

1 

GEV No.	696787	Ref. No.	W0208009	
description	T-piece copper ID ø 4.5mm ED ø 6mm refrigeration for GFR2700			
For models:	GFR2700			
accessories for	696787			
	GEV No.	374110	Ref. No.	W0205011
	solenoid valve type FDF2AT connection 6mm soldering connection L 143mm pipe connection ø 6mm 220-240V			
	GEV No.	692873	Ref. No.	W0210282
	refrigeration pipe ID ø 6.5mm ED ø 8mm L 0.36m refrigeration GFR2700			



heating tubes



GEV No.	701583	Ref. No.	C04AC26A0002
description	heater ED ø 6mm ID ø 3mm L 260mm copper		
For models:	GPS2600, GSA2600, GSD2600, GSF2600		

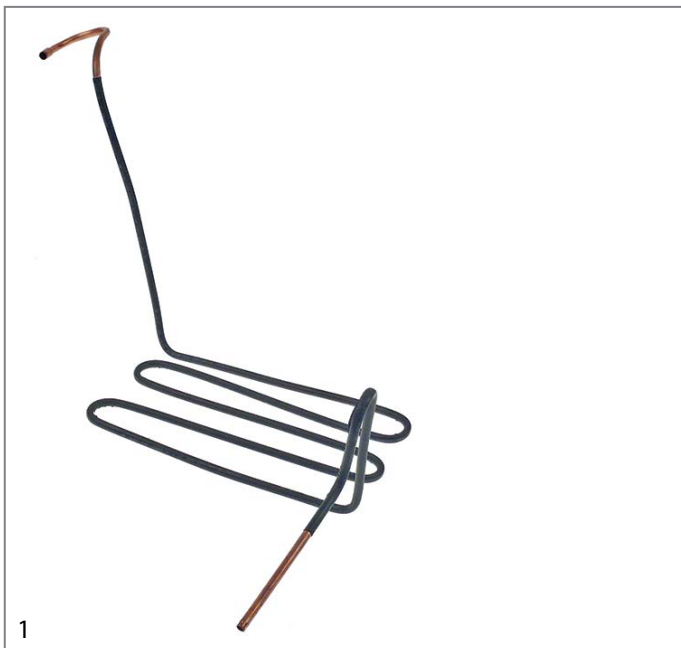

GEV No.	701495	Ref. No.	TCGD4010
description	heater ED ø 6mm ID ø 5mm Qty 1m for evaporator connection ø 6mm		
For models:	GSC1100G		

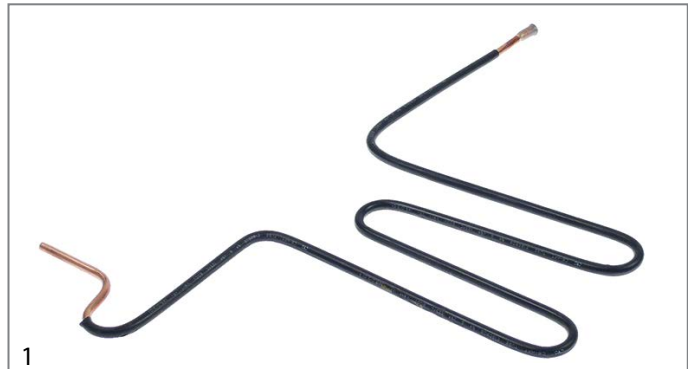

GEV No.	701582	Ref. No.	TCGD2001
description	heater pipe ED ø 5mm ID ø 3mm L 355mm H 250mm		
For models:	GBC1001, GBC1001S, GBC1001SS		

evaporators for fridges

producer-specific



GEV No.	750387	Ref. No.	TLZA9000
description	evaporator for fridge GBC1001 L 430mm W 500mm		
For models:	GBC1001, GBC1001S, GBC1001SS		

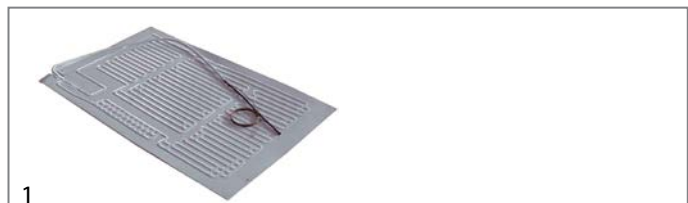

GEV No.	750376	Ref. No.	TLZD9001
description	evaporator for fridge GBC1002 L 760mm W 500mm		
For models:	GBC1002, GBC1002S, GBC1002SS, GBC1102		



GEV No.	750377	Ref. No.	TLZD9002
description	evaporator for fridge L 1000mm W 500mm		
For models:	GBC1003, GBC1003S, GBC1003SS, GBC1103		



1

GEV No.	750352	Ref. No.	1.1.A.A10.27
description	evaporator L 250mm W 50mm H 117mm		
For models:	GGC1078, GGC1078B		



1

GEV No.	750629	Ref. No.	GPC1088-02
description	evaporator L 320mm W 320mm H 5mm		
For models:	GPC1088		

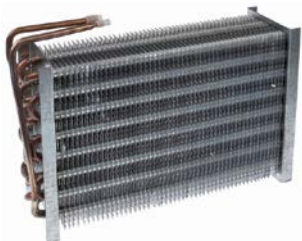

1

GEV No.	750350	Ref. No.	1.1.A.A10.40
description	evaporator L 345mm W 100mm H 215mm total length 345mm overall width 100mm overall height 240mm for fridge		
For models:	GGC2270, GGC2270B		



1

GEV No.	750744	Ref. No.	W0202112	
description	evaporator L 404mm W 175mm H 142mm GFR2700			
For models:	GFR2700			
accessories for	750744			
	GEV No.	699574	Ref. No.	81131204
	cover front for evaporator L 598mm W 295mm H 65mm for GFR2700/ GRE2700			
	GEV No.	699577	Ref. No.	80021203
	cover left for evaporator L 255mm W 155mm H 15mm for GFR2700/ GRE2700			
	GEV No.	699578	Ref. No.	80021204
	cover right for evaporator L 255mm W 155mm H 15mm for GFR2700/ GRE2700			



1

GEV No.	750371	Ref. No.	1.1.A.A10.23
description	evaporator L 545mm W 50mm H 110mm total length 600mm overall width 50mm overall height 123mm		
For models:	GCV1600		



1

GEV No.	750660	Ref. No.	TLZA4003
description	evaporator L 620mm W 225mm H 160mm		



1

GEV No.	750375	Ref. No.	TLZA4004
description	evaporator L 760mm W 140mm H 225mm		



1

GEV No.	750743	Ref. No.	W0202117	
description	evaporator W 150mm H 135mm L 300mm GRE2700			
For models:	GRE2700			
accessories for	750743			
	GEV No.	699574	Ref. No.	81131204
	cover front for evaporator L 598mm W 295mm H 65mm for GFR2700/ GRE2700			
	GEV No.	699577	Ref. No.	80021203
	cover left for evaporator L 255mm W 155mm H 15mm for GFR2700/ GRE2700			
	GEV No.	699578	Ref. No.	80021204
	cover right for evaporator L 255mm W 155mm H 15mm for GFR2700/ GRE2700			



accessories

miscellaneous



GEV No.	692868	Ref. No.	W0409079
description	cover for evaporator plastic GFR2700/GRE2700		
For models:	GFR2700, GRE2700		

condensors

filters



GEV No.	699402	Ref. No.	P04AC28A0002
description	filter for condenser L 218mm W 230mm thickness 6mm Qty 1 pcs		
For models:	GDS2600, GPS2600, GSA2600, GSD2600, GSF2600		

condensors



GEV No.	750746	Ref. No.	W0203051
description	condenser Capacitor W 250mm H 100mm L 260mm for GRE2700		
For models:	GRE2700		

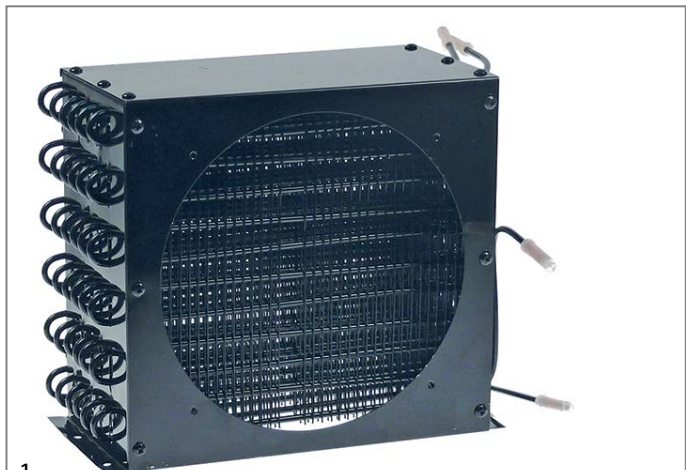

GEV No.	750742	Ref. No.	W0203052
description	condenser Capacitor W 250mm H 140mm L 260mm GFR2700		
For models:	GFR2700		



GEV No.	750319	Ref. No.	VRX.11
description	condenser for pizza table W 228mm D 77mm H 179mm		
For models:	GHS1600, GHS2600		

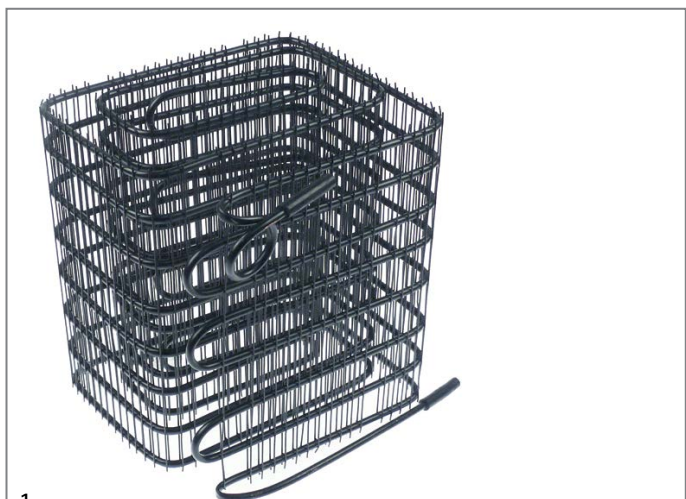

GEV No.	750373	Ref. No.	DTLA9002
description	condenser W 190mm D 160mm H 205mm Qty 1 pcs		
For models:	GBC1003, GBC1003S, GBC1003SS, GBC1103		



1

GEV No.	750372	Ref. No.	DTLA9000
description	condenser W 195mm D 80mm H 205mm Qty 1 pcs		
For models:	GBC1001, GBC1001S, GBC1001SS		



1

GEV No.	750351	Ref. No.	1.1.A.A09.09
description	condenser W 255mm D 130mm H 235mm		
For models:	GGC2270, GGC2270B		



1

GEV No.	750347	Ref. No.	C04AC28A0001
description	condenser W 220mm D 100mm H 230mm L 270mm		
For models:	GDS2600, GPS2600, GSA2600, GSD2600, GSF2600		



1

GEV No.	750370	Ref. No.	1.1.A.A09.21
description	condenser W 265mm D 93mm H 140mm Qty 1 pcs		
For models:	GCV1600		



1

GEV No.	750384	Ref. No.	1.1.A.A09.01
description	condenser W 220mm D 60mm H 280mm Qty 1 pcs		
For models:	GGC1078, GGC1078B		



1

GEV No.	750374	Ref. No.	DTLA4008
description	condenser W 555mm D 100mm H 275mm Qty 1 pcs		

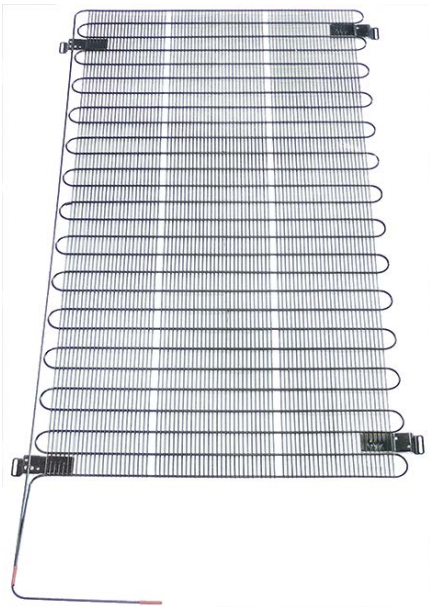
1

GEV No.	750703	Ref. No.	44918000
description	condenser W 790mm D 10mm H 1360mm		
For models:	GFR3600S		

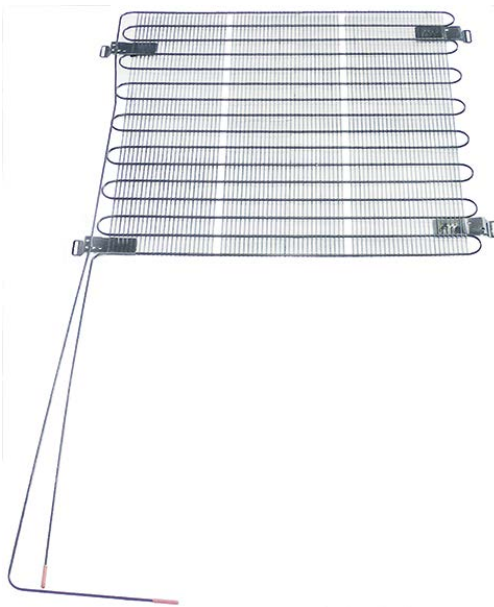

1

GEV No.	750699	Ref. No.	45034000
description	condenser W 790mm D 10mm H 750mm Qty 1 pcs		
For models:	GRE3600, GRE3600S		

evaporation and condensing trays

evaporation trays



1

GEV No.	699302	Ref. No.	SLZJ0021
description	evaporation tray L 185mm W 130mm H 75mm		
For models:	GBC1001, GBC1001S, GBC1001SS		



1

GEV No.	699299	Ref. No.	SLZJ0014
description	evaporation tray L 210mm W 105mm H 80mm		
For models:	GSC2336		



1

GEV No.	699211	Ref. No.	I0425088
description	evaporation tray L 230mm W 144mm H 45mm		
For models:	GRE3600, GRE3600S		



1

GEV No.	750745	Ref. No.	W0409071	
description	evaporation tray rear L 527mm W 238mm for fridge for GFR2700/ GRE2700			
For models:	GFR2700, GRE2700			
accessories for	750745			
	GEV No.	750747	Ref. No.	W0409078
	overflow plastic for GFR2700/GRE2700			

unheated condensing trays



1

GEV No.	750630	Ref. No.	GPC1088-08
description	condensing tray L 200mm W 135mm H 30mm plastic		
For models:	GPC1088		



GEV No.	750632	Ref. No.	SLZJ0022
description	drip tray L 187mm W 128mm H 70mm plastic		
For models:	GBC1002, GBC1002S, GBC1002SS, GBC1003, GBC1003S, GBC1003SS, GBC1102, GBC1103		

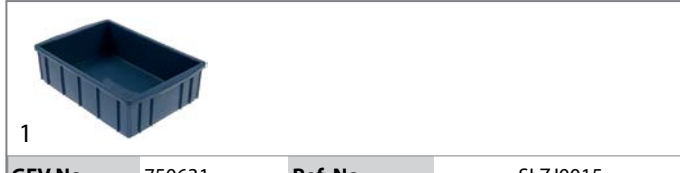

GEV No.	750631	Ref. No.	SLZJ0015
description	drip tray L 302mm W 204mm H 85mm plastic		
For models:	GSC1100G		

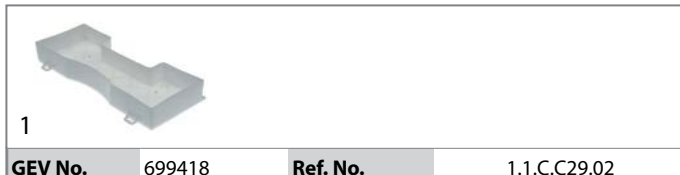

GEV No.	699418	Ref. No.	1.1.C.C29.02
description	drip tray L 400mm W 144mm H 50mm plastic		
For models:	GGC2270, GGC2270B		

miscellaneous



GEV No.	750747	Ref. No.	W0409078
description	overflow plastic for GFR2700/GRE2700		
For models:	GFR2700, GRE2700		
accessories for	750747		

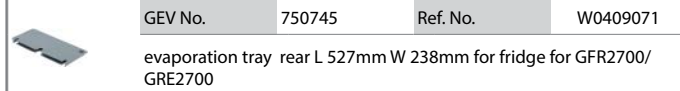

GEV No.	750745	Ref. No.	W0409071
description	evaporation tray rear L 527mm W 238mm for fridge for GFR2700/GRE2700		

transmission technology and ball bearings

ball bearings

deep-groove ball bearings 2RS



GEV No.	523501	Ref. No.	00000000637
description	deep-groove ball bearing type 608-2RS shaft ø 8mm ED ø 22mm W 7mm with sealing discs deep-groove ball bearing DIN 625-1		
For models:	GFS1030		



GEV No.	523510	Ref. No.	00000000860
description	deep-groove ball bearing type 6202-2RS shaft ø 15mm ED ø 35mm W 11mm with sealing discs deep-groove ball bearing DIN 625-1		
For models:	GFS1025, GFS2019, GFS2022, GFS2025, GFS2030		



GEV No.	523512	Ref. No.	00000000632
description	deep-groove ball bearing type 6204-2RS shaft ø 20mm ED ø 47mm W 14mm with sealing discs deep-groove ball bearing DIN 625-1		
For models:	GFS1030		



GEV No.	523504	Ref. No.	00000000862
description	deep-groove ball bearing type 626-2RS shaft ø 6mm ED ø 19mm W 6mm with sealing discs deep-groove ball bearing DIN 625-1		
For models:	GFS1025, GFS2019, GFS2022, GFS2025, GFS2030		



drive belts

poly-v belts

1

GEV No.	698215	Ref. No.	0000000635
description	poly-v belt grooves 10 W 20mm L 400mm profile TB2		
For models:	GFS1030		

1

GEV No.	698963	Ref. No.	0000000492
description	poly-v belt grooves 5 W 10mm L 310mm profile TB2		
For models:	GFS2019, GFS2022		

1

GEV No.	698217	Ref. No.	0000000861
description	poly-v belt grooves 7 W 14mm L 330mm profile TB2		
For models:	GFS1025, GFS2025		

springs

compression springs

1

GEV No.	519162	Ref. No.	904131
description	spring		
For models:	GDW2001		

1

GEV No.	692701	Ref. No.	1.1.B.B10.06
description	spring L 4mm wire gauge ϕ 1mm windings 5 D1 ϕ 9.5mm		
For models:	GGC1078, GGC1078B		

dosing pumps

membrane dosing pumps

self-priming

SEKO

1

GEV No.	362031	Ref. No.	902201
description	dosing pump type DIB E rinse aid pump rate 0-5cm ³ per stroke pressure connection ϕ 4x6mm suction connection ϕ 4x6mm suction connection SEKO supporting pressure closed		
For models:	GDW2001		

accessories

miscellaneous

1

GEV No.	513329	Ref. No.	906375
description	bracket for dosing pump L 70mm H 25mm W 40mm spring steel		
For models:	GDW2001		

hoses

drain hoses

1

GEV No.	530921	Ref. No.	907446
description	drain hose 3/4" L 1500mm A int. ϕ 29mm A ext. ϕ 34mm B int. ϕ 21mm B ext. ϕ 26mm outer hose ϕ 24mm		
For models:	GDW2001		

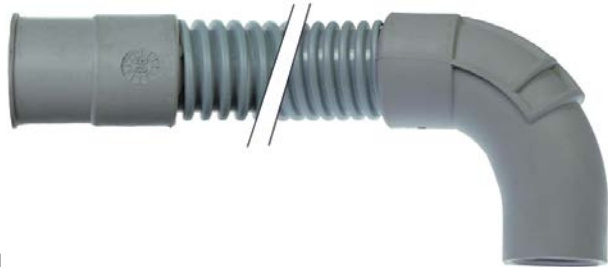

1

GEV No.	519456	Ref. No.	907439
description	drain hose L 1500mm D1 ø 21mm D2 ø 21mm		
For models:	GDW2001		

industrial hoses

PVC hoses

PVC hoses without fabric



1

GEV No.	570027	Ref. No.	902046
description	PVC hose ID ø 4mm ED ø 7mm L 100m thickness 1.5mm t.max. 60°C transparent		
For models:	GDW2001		

silicone hoses

without fabric



1

GEV No.	530410	Ref. No.	907279
description	silicone hose ID ø 4mm ED ø 7mm L 2m thickness 1.5mm t.max. 200°C transparent		
For models:	GDW2001		

formed hoses

straight



1

GEV No.	519392	Ref. No.	903756
description	formed hose L 61mm dishwasher straight hose ext. ø 50mm hose int. ø 38mm		
For models:	GDW2001		

form L



1

GEV No.	503190	Ref. No.	903694
description	formed hose L 120mm supply EPDM warewashing 45 ED ø 56mm		
For models:	GDW2001		



1

GEV No.	506280	Ref. No.	909371
description	formed hose L 190mm EPDM warewashing black		
For models:	GDW2001		



1

GEV No.	505410	Ref. No.	903672
description	formed hose L 70mm warewashing ID ø 27mm ED ø 37mm		
For models:	GDW2001		

miscellaneous



1

GEV No.	699420	Ref. No.	1.1.C.C41.13
description	formed hose ID ø 19mm ED ø 24mm L 150mm		
For models:	GGC1078, GGC1078B		

for dishwashers

miscellaneous



1

GEV No.	503190	Ref. No.	903694
description	formed hose L 120mm supply EPDM warewashing 45 ED ø 56mm		
For models:	GDW2001		



1

GEV No.	506280	Ref. No.	909371
description	formed hose L 190mm EPDM warewashing black		
For models:	GDW2001		

fittings, hose and pipe connectors

hose connectors

without screw connection



1

GEV No.	519644	Ref. No.	905434
description	T-piece plastic connection ϕ 12mm - ϕ 5mm - ϕ 12mm		
For models:	GDW2001		



1

GEV No.	519216	Ref. No.	905382
description	T-piece plastic hose ϕ 12-12-12mm 3-way		
For models:	GDW2001		

ancillary products

clamps

double wire clamps



1

GEV No.	513268	Ref. No.	902425
description	hose clamp ϕ 8-10mm wire gauge ϕ 1mm Qty 1 pcs		
For models:	GDW2001		

fastening material

screws

side bolts



1

GEV No.	560551	Ref. No.	0000000615
description	side bolts thread M10 L 15mm SS Qty 1 pcs intake slotted head ϕ 24.5mm		
For models:	GFS1030		

knurled screws



1

GEV No.	697481	Ref. No.	0000000623
description	Thumb screw thread M6 thread L 8mm ϕ 14mm H 6mm SS		
For models:	GFS1030, GFS2019, GFS2022, GFS2025		

nuts

hexagonal nuts

DIN 985



1

GEV No.	560142	Ref. No.	902040
description	hexagonal nut thread M6 H 6mm SS WS 10 Qty 20 pcs DIN/ISO DIN 985 self-locking		
For models:	GDW2001		

miscellaneous



1

GEV No.	551380	Ref. No.	DAD30010
description	cage nut thread M10 Qty 4 pcs		
For models:	GCO500		

washers

spring washers



1

GEV No.	697478	Ref. No.	00000000671
description	spring washer ID ø 19mm ED ø 26mm Qty 1 pcs		
For models:	GFS1030		

washers

miscellaneous



1

GEV No.	519238	Ref. No.	906002
description	plain washer ID ø 15mm ED ø 33mm thickness 0.8mm SS Qty 1 pcs		
For models:	GDW2001		

fasteners

mounting clips



1

GEV No.	692865	Ref. No.	00007750
description	mounting clip for bulb socket L 16mm H 19mm		
For models:	GCO2001		

clamps

double wire clamps



1

GEV No.	513268	Ref. No.	902425
description	hose clamp ø 8-10mm wire gauge ø 1mm Qty 1 pcs		
For models:	GDW2001		

roll pins



1

GEV No.	691637	Ref. No.	0744
description	roll pin ø 3mm L 20mm		
For models:	GSM1000		

A			
alarm devices	15		
axial fans	24		
B			
ballasts	13		
bi-metal thermostats	5, 6		
booster pumps II	31		
C			
cable glands	33		
cables	33		
cam switches	9		
castors and bumper angles	70		
clamps	89, 90		
cold air circulating fans	28		
compressors	23		
condensators & interference suppression filters	32		
connection cables	34		
contactors	15		
control thermostats	6, 7		
copper pipes insulated	80		
copper pipes uninsulated	79		
cross flow fans	28		
D			
defrost timers	15		
door seals	76		
dosing pumps	87		
double wire clamps	89, 90		
drain hoses	87		
drain pumps	31		
E			
electric accessories	33		
electronic controllers	17		
evaporators	81		
F			
fans	24		
fasteners	90		
fastening material	89		
filter driers	78		
filters	32		
fluorescent lamps	13, 13		
foil heating elements	5		
formed hoses	88		
fuses	32		
G			
gaskets for heated units	76		
gaskets for wash arm support	78		
		grates	71
H			
		heating cables	4
		heating elements	3
		heating elements for convection	5
		heating elements for fryers	3
		heating elements for griddles	3
		heating elements for ovens	3
		hexagonal nuts	89
		hose connectors	89
		hoses	87
		hot air fans	29
		HV capacitors	32
I			
		immersion heating elements	4
		indicator lights	10
		indicator lights (complete)	11
		induction coils	3
		industrial hoses	88
K			
		knurled screws	89
L			
		lamp accessories	14
		lamps	10
		LED	12
M			
		magnetic switches	10
		magnetrons	16
		mechanical timers	15
		microswitches	8
		microwave lamps	14
		motors	30
		mounting clips	90
N			
		nuts	89
O			
		operating capacitors	32
		O-rings	77
		oven hinges	65
		oven lamps	14
P			
		plug-in gaskets	75
		position switches	9
		power supply cables	33
		pressure switches	22

probes	19
pumps	31
push/momentary push switches	8
PVC hoses	88

Q

quartz heating elements	4
-------------------------	---

R

refrigeration cycle components	78
refrigeration fans	26
refrigeration gaskets	75
refrigeration motors universal	26
refrigeration pipes	79
refrigeration thermostats	7
relays	16
rocker/momentary rocker switches	8
roll pins	90

S

safety bi-metal thermostats	5
safety thermostats	6
Schrader valves	78
screw-in gaskets	76
screws	89
sealing washers	77
shaft gaskets	77
shelves and shelf rails	71
side bolts	89
silicone hoses	88
solenoid valves	22
solid state relays	16
speed controllers	30
spring washers	90
starter	13
strain reliefs	34
switches and momentary switches	8
system switches (ROLD)	9

T

temperature probes	19
terminal boxes	35
terminals	34
thermostats	5
threaded cable glands	33
timers	15
transformers	16

U

universal probes	19
------------------	----

W

wash and rinse pumps	31
----------------------	----

washers	90
---------	----