



GAS COMPONENTS



ELECTRIC COMPONENTS



WATER TECHNOLOGY



MECHANICAL COMPONENTS



TOOLS

Spare parts suitable for

MALAG

Find the complete and up-to-date range of products in our GEV Webshop



Manufacturer catalogue

The most important spare parts and accessories arranged clearly for every manufacturer

- ✓ Complete product range and all appliance data always up to date in the GEV Webshop
- ✓ Alphabetical Index at the end of the catalogue

GEV Webshop

www.gev-online.co.uk

www.gev-online.com



- 🔍 Add to Favourites
- 🔍 Sign In with email address and usual password
- 🔍 Easy-order – place several items in your basket at the same time
- 🔍 Quick Item search – no login needed



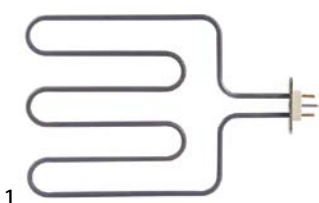

heating elements

heating elements for ovens

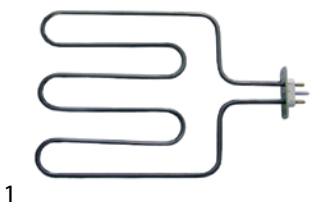

| | | | |
|--------------------|---|-----------------|--------------|
| GEV No. | 418225 | Ref. No. | 105597 (old) |
| description | heating element 1000W 230V windings 3 mounting pos. upper | | |



| | | | | |
|---|--|-----------------|-----------------|---|
| GEV No. | 415315 | Ref. No. | 105597 | |
| description | heating element 2000W 230V heating circuits 1 L 327mm W 228mm L1 85mm L2 244mm W1 98mm W2 31mm flange length 71mm flange width 23mm hole distance 56mm hole ø M4mm tube ø 6.3mm connection plug-in connection windings 3 rectangular flange grill setting oven | | | |
| accessories for | 415315 | | | |
|  | GEV No. | 550404 | Ref. No. | — |
| | power socket I-II phase 240V max. 16A countries I with screw connection for heating element | | | |
|  | GEV No. | 550405 | Ref. No. | — |
| | power socket male faston 6.3mm for heating element 2-pole + earthing | | | |

heating elements for bain maries



| | | | |
|--------------------|--|-----------------|------------------|
| GEV No. | 415323 | Ref. No. | 105619 105643 |
| description | heating element 1600W 230V heating circuits 1 L 383mm W 96mm flange length 45mm flange width 12mm hole distance 36mm tube ø 6.3mm cable length 290mm rectangular flange hole ø M5mm dry heating element L1 14mm L2 369mm W1 72mm W2 24mm | | |



| | | | |
|--------------------|---|-----------------|--------|
| GEV No. | 415322 | Ref. No. | 105627 |
| description | heating element 2600W 230V heating circuits 1 L 468mm W 130mm flange length 45mm flange width 17mm hole distance 36mm connection length 53mm tube ø 6.3mm cable length 200mm rectangular flange thread M5 dry heating element L1 13mm L2 455mm W1 105mm W2 25mm | | |

heating elements for fryers

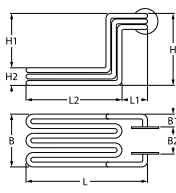
| | | | |
|--------------------|---|-----------------|--------|
| GEV No. | 418226 | Ref. No. | 144436 |
| description | heating element 6500W 220V heating circuits 3 L 370mm W 185mm H 255mm L1 90mm L2 280mm W1 39mm W2 107mm H1 343mm H2 27mm windings 9 flange ø 43mm rotation flange cable length 1450mm connection cable immersion heater mounting ø 39mm | | |
| For models: | EF224, FF5-224 | | |

heating elements for heated cabinets



| | | | |
|--------------------|--|-----------------|------------------|
| GEV No. | 415323 | Ref. No. | 105619 105643 |
| description | heating element 1600W 230V heating circuits 1 L 383mm W 96mm flange length 45mm flange width 12mm hole distance 36mm tube ø 6.3mm cable length 290mm rectangular flange hole ø M5mm dry heating element L1 14mm L2 369mm W1 72mm W2 24mm | | |

heating rods



| | | | |
|--------------------|--|-----------------|--------|
| GEV No. | 480063 | Ref. No. | 117994 |
| description | heating rod type E2 450W 220V W 22.5mm heated length 700mm | | |



| | | | |
|--------------------|--|-----------------|--------|
| GEV No. | 480064 | Ref. No. | 117995 |
| description | heating rod type E2 450W 380V W 22.5mm heated length 700mm | | |

pilot heating elements







| | | | | |
|---|--|-----------------|-----------------|---|
| GEV No. | 415653 | Ref. No. | 105708 | |
| description | heating element 600W 230V heating circuits 1 mounting ø 47.5mm L 280mm W 36mm H 16mm round flange connection male faston 6.3mm immersion heater tube ø 6.3mm thermostat sleeves ø 7mm length thermostat sleeves 220mm number of thermostat sleeves 1 pilot heating element | | | |
| spare parts for | 415653 | | | |
|  | GEV No. | 510408 | Ref. No. | — |
| | O-ring EPDM thickness 5.34mm ID ø 47mm Qty 1 pcs | | | |

Table continues overleaf









| | | | |
|---|--|--------|------------|
| accessories for | 415653 | | |
|  | GEV No. | 510562 | Ref. No. — |
| | O-ring silicone thickness 5.34mm ID ø 47mm Qty 1 pcs | | |
|  | GEV No. | 550675 | Ref. No. — |
| | O-ring Viton thickness 6mm ID ø 47mm Qty 1 pcs | | |



quartz heating elements





| | | | |
|--------------------|---|-----------------|------------------|
| 1 |  | | |
| GEV No. | 415309 | Ref. No. | 12050000 (14-01) |
| description | quartz heating element 400W 230V L 340mm ø 10mm connection plug-in connection | | |









immersion heating elements

with round flange ø47.5mm

| | | | |
|---|---|-----------------|------------|
| 1 |  | | |
| GEV No. | 415581 | Ref. No. | 105716 |
| description | heating element 3000W 230V heating circuits 3 L 268mm W 36mm H 28mm tube ø 6.3mm connection cable cable length 300mm immersion heater mounting ø 47.5mm | | |
| accessories for | 415581 | | |
|  | GEV No. | 510562 | Ref. No. — |
| | O-ring silicone thickness 5.34mm ID ø 47mm Qty 1 pcs | | |
|  | GEV No. | 520235 | Ref. No. — |
| | 3 hole flange hole distance 70.5mm perforation ø 6.5mm ID ø 53.5mm | | |
|  | GEV No. | 520236 | Ref. No. — |
| | flange for heating element ID ø 50mm ED ø 90mm hole ø 6.5mm 3 holes | | |
|  | GEV No. | 521012 | Ref. No. — |
| | gasket graphite ED ø 15mm ID ø 5mm thickness 1.2mm Qty 1 pcs | | |
|  | GEV No. | 550002 | Ref. No. — |
| | tension strap H 10mm L 21mm W 10mm hole ø 6.5mm for heating element | | |
|  | GEV No. | 550362 | Ref. No. — |
| | blind flange ø 64mm mounting ø 47.5mm | | |

| | | | |
|---|--|-----------------|------------|
| 1 |  | | |
| GEV No. | 415263 | Ref. No. | 105724 |
| description | heating element 4500W 230V heating circuits 3 mounting ø 47.5mm L 375mm W 38mm H 46mm round flange connection male faston 6.3mm immersion heater tube ø 6.3mm thermostat sleeves ø 7mm number of thermostat sleeves 1 length thermostat sleeves 240mm thermostat sleeve not clinging | | |
| accessories for | 415263 | | |
|  | GEV No. | 510408 | Ref. No. — |
| | O-ring EPDM thickness 5.34mm ID ø 47mm Qty 1 pcs | | |
|  | GEV No. | 520235 | Ref. No. — |
| | 3 hole flange hole distance 70.5mm perforation ø 6.5mm ID ø 53.5mm | | |

| | | | |
|---|---|--------|------------|
| accessories for | 415263 | | |
|  | GEV No. | 520236 | Ref. No. — |
| | flange for heating element ID ø 50mm ED ø 90mm hole ø 6.5mm 3 holes | | |
|  | GEV No. | 521012 | Ref. No. — |
| | gasket graphite ED ø 15mm ID ø 5mm thickness 1.2mm Qty 1 pcs | | |
|  | GEV No. | 550002 | Ref. No. — |
| | tension strap H 10mm L 21mm W 10mm hole ø 6.5mm for heating element | | |
|  | GEV No. | 550362 | Ref. No. — |
| | blind flange ø 64mm mounting ø 47.5mm | | |

| | | | |
|---|---|-----------------|------------|
| 1 |  | | |
| GEV No. | 415663 | Ref. No. | 105732 |
| description | heating element 6000W 230V heating circuits 3 mounting ø 47.5mm L 400mm W 40mm H 28mm round flange connection M4 immersion heater tube ø 6.3mm thermostat sleeves ø 7mm number of thermostat sleeves 2 length thermostat sleeves 150mm thermostat sleeve not clinging | | |
| spare parts for | 415663 | | |
|  | GEV No. | 510408 | Ref. No. — |
| | O-ring EPDM thickness 5.34mm ID ø 47mm Qty 1 pcs | | |
| accessories for | 415663 | | |
|  | GEV No. | 510408 | Ref. No. — |
| | O-ring EPDM thickness 5.34mm ID ø 47mm Qty 1 pcs | | |
|  | GEV No. | 510562 | Ref. No. — |
| | O-ring silicone thickness 5.34mm ID ø 47mm Qty 1 pcs | | |
|  | GEV No. | 520235 | Ref. No. — |
| | 3 hole flange hole distance 70.5mm perforation ø 6.5mm ID ø 53.5mm | | |
|  | GEV No. | 520236 | Ref. No. — |
| | flange for heating element ID ø 50mm ED ø 90mm hole ø 6.5mm 3 holes | | |
|  | GEV No. | 550002 | Ref. No. — |
| | tension strap H 10mm L 21mm W 10mm hole ø 6.5mm for heating element | | |
|  | GEV No. | 550362 | Ref. No. — |
| | blind flange ø 64mm mounting ø 47.5mm | | |

hot plates

square & rectangular

with radiused edge

| | | | |
|--------------------|---|-----------------|--------|
| 1 |  | | |
| GEV No. | 490065 | Ref. No. | 161632 |
| description | hot plate dimensions 220x220mm 2000W 230V with spill ring connection 4 screw clamps protector no square | | |



1

| | | | |
|------------------------|---|-----------------|--------|
| GEV No. | 490067 | Ref. No. | 161634 |
| description | hot plate dimensions 220x220mm 2000W 400V with spill ring connection 4 screw clamps protector no square | | |
| accessories for | 490067 | | |
| | GEV No. | Ref. No. | — |
| | sealing cord ø 10mm Qty supplied by meter | | |



1

| | | | |
|--------------------|--|-----------------|--------|
| GEV No. | 490057 ¹ | Ref. No. | 117902 |
| description | hot plate dimensions 300x300mm 3000W 400V with spill ring connection 4 screw clamps protector yes square | | |

¹incl. protector



1

| | | | |
|--------------------|--|-----------------|--------|
| GEV No. | 490066 ¹ | Ref. No. | 161624 |
| description | hot plate dimensions 220x220mm 2600W 230V with spill ring connection 4 screw clamps protector yes square | | |

¹incl. protector



1

| | | | |
|--------------------|--|-----------------|--------|
| GEV No. | 490071 ¹ | Ref. No. | 117889 |
| description | hot plate dimensions 300x300mm 4000W 230V with spill ring connection 4 screw clamps protector yes square | | |

¹incl. protector



1

| | | | |
|--------------------|--|-----------------|--------|
| GEV No. | 490068 ¹ | Ref. No. | 161635 |
| description | hot plate dimensions 220x220mm 2600W 400V with spill ring connection 4 screw clamps protector yes square | | |

¹incl. protector



1

| | | | |
|--------------------|--|-----------------|--------|
| GEV No. | 490074 ¹ | Ref. No. | 117890 |
| description | hot plate dimensions 300x300mm 4000W 400V with spill ring connection 4 screw clamps protector yes square | | |

¹incl. protector



1

| | | | |
|--------------------|--|-----------------|--------|
| GEV No. | 490056 ¹ | Ref. No. | 117897 |
| description | hot plate dimensions 300x300mm 3000W 230V with spill ring connection 4 screw clamps protector yes square | | |

¹incl. protector

round

with radiused edge

for domestic and commercial kitchens



1

| | | | |
|--------------------|--|-----------------|--------|
| GEV No. | 490016 | Ref. No. | 117854 |
| description | hot plate ø 180mm 2000W 230V connection 4 screw clamps with 8mm spill ring | | |



1

| | | | |
|------------------------|--|-----------------|----------|
| GEV No. | 490020 | Ref. No. | 117846 |
| description | hot plate ø 220mm 2600W 230V connection 4 screw clamps with 8mm spill ring | | |
| accessories for | 490020 | | |
| | GEV No. | 550796 | Ref. No. |
| | fixing plate for hot plate ø220mm | | |

with cast brim

with screw connection

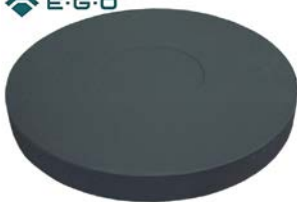

1

| | | | |
|--------------------|--|-----------------|-----------|
| GEV No. | 490106 | Ref. No. | HR4067021 |
| description | hot plate ø 400mm 5000W 400V connection 2x 3 screw clamps with cast edge screw bolt H 42mm | | |



1

| | | | |
|--------------------|--|-----------------|--------|
| GEV No. | 375546 | Ref. No. | 105740 |
| description | thermostat t.max. 110°C temperature range 30-110°C 1-pole 1NO 16A probe ø 6mm probe L 130mm capillary pipe 900mm capillary pipe isolated 900mm gland nut shaft ø 6x4.6mm shaft L 15mm shaft position upper rotation 318° | | |



1

| | | | |
|--------------------|---|-----------------|--------|
| GEV No. | 375709 | Ref. No. | 172146 |
| description | thermostat t.max. 110°C temperature range 86-110°C 1-pole 1NO 16A probe ø 6mm probe L 265mm capillary pipe 860mm capillary pipe isolated 800mm gland nut shaft ø 6x4.6mm shaft L 23mm shaft position upper rotation 270° with disc screw connection M14x1 disc ø 12.5mm | | |

55.13_series



1

| | | | |
|--------------------|--|-----------------|--------|
| GEV No. | 375710 | Ref. No. | 105767 |
| description | thermostat t.max. 132°C temperature range fixed 132°C 1-pole 1CO 16A probe ø 6mm probe L 86mm capillary pipe 1150mm capillary pipe isolated 350mm gland nut shaft Lmm shaft position° shaft position rotation° switch-off temp. 132°C probe SS | | |

thermostats

control and safety thermostats

EGO

control thermostats

55.10/19_series



1

| | | | |
|--------------------|--|-----------------|--------|
| GEV No. | 375897 | Ref. No. | 172154 |
| description | thermostat t.max. 110°C 1-pole 1NC 16A probe ø 6mm probe L 270mm capillary pipe 900mm capillary pipe isolated 750mm gland nut shaft ø 6x4.6mm shaft L 23mm shaft position upper° rotation 270° | | |



E-G-O



1

| | | | |
|---|--|-----------------|-------------------|
| GEV No. | 375012 | Ref. No. | 143702 |
| description | thermostat t.max. 358°C temperature range 50-358°C 1-pole 1NO 16A probe ø 3.1mm probe L 147mm capillary pipe 1730mm capillary pipe isolated 1100mm gland nut shaft L 23mm shaft position upper rotation 270° | | |
| accessories for | 375012 | | |
|  | GEV No. | 110247 | Ref. No. — |
| | knob thermostat t.max. 350°C ø 50mm shaft ø 6x4.6mm shaft flat upper black temperature range 100-350°C | | |

E-G-O



1

| | | | |
|--------------------|---|-----------------|--------|
| GEV No. | 375101 | Ref. No. | 105849 |
| description | thermostat t.max. 360°C temperature range 140-360°C 3-pole 3NO 16A probe ø 4mm probe L 292mm capillary pipe 990mm capillary pipe isolated 500mm gland nut shaft L 23mm shaft position upper rotation 318° | | |

55.34_ series

E-G-O



1

| | | | |
|--------------------|---|-----------------|--------|
| GEV No. | 375188 | Ref. No. | 105813 |
| description | thermostat t.max. 110°C temperature range 30-110°C 3-pole 3NO 16A probe ø 6mm probe L 131mm capillary pipe 1160mm capillary pipe isolatedmm gland nut shaft ø 6x4.6mm shaft L 23mm shaft position upper rotation 310° | | |

E-G-O



1

| | | | |
|--------------------|--|-----------------|--------|
| GEV No. | 375225 | Ref. No. | 105847 |
| description | thermostat t.max. 400°C temperature range 91-400°C 3-pole 3NO 16A probe ø 3.9mm probe L 308mm capillary pipe 920mm capillary pipe isolated 800mm gland nut shaft ø 6x4.6mm shaft L 23mm shaft position upper rotation 310° | | |

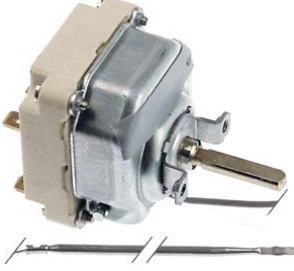

1

| | | | |
|--------------------|---|-----------------|--------|
| GEV No. | 375685 | Ref. No. | 105783 |
| description | thermostat t.max. 300°C temperature range 50-300°C 3-pole 3NO 16A probe ø 3.1mm probe L 226mm capillary pipe 1180mm capillary pipe isolated 500mm gland nut shaft ø 6x4.6mm shaft L 23mm shaft position upper rotation 318° | | |

safety thermostats

55.31_ series

E-G-O



1

| | | | |
|--------------------|---|-----------------|--------|
| GEV No. | 375686 | Ref. No. | 174963 |
| description | safety thermostat switch-off temp. 250°C 3-pole 20A probe ø 6mm probe L 219mm capillary pipe 1430mm capillary pipe isolated 1100mm gland nut probe SS | | |



switches and momentary switches

cam switches

4-position



1

| | | | |
|--------------------|---|-----------------|--------|
| GEV No. | 300103 | Ref. No. | 106062 |
| description | cam switch 4 operating positions 1NO/2CO sequence 0-1-2-3 32A shaft \varnothing 6x4.6mm shaft L 23mm connection screw ceramic | | |



7-position



1

| | | | |
|--------------------|--|-----------------|--------|
| GEV No. | 300025 | Ref. No. | 106070 |
| description | cam switch 7 operating positions 1NO/2CO sequence 0-1-2-3-4-5-6 16A shaft \varnothing 6x4.6mm shaft L 23mm connection screw 7-position ceramic | | |

accessories for 300025

| | | | | |
|---|---|--------|-----------------|---|
|  | GEV No. | 112172 | Ref. No. | — |
| | knob universal \varnothing 70mm black without adaptor/dial plate | | | |
|  | GEV No. | 112213 | Ref. No. | — |
| | knob dial plate silver switch 7-position t.max.°C ED \varnothing 63mm ID \varnothing 45.5mm | | | |
|  | GEV No. | 112311 | Ref. No. | — |
| | knob adapter shaft \varnothing 6x4.6mm L 0mm with spring | | | |



1

| | | | |
|--------------------|---|-----------------|--------|
| GEV No. | 300106 | Ref. No. | 106072 |
| description | cam switch 7 operating positions 1NO/2CO sequence 0-1-2-3-4-5-6 32A shaft \varnothing 6x4.6mm shaft L 23mm connection screw 7-position shaft flat upper | | |

operation switches



1

| | | | |
|--------------------|--|-----------------|--------|
| GEV No. | 300006 | Ref. No. | 143774 |
| description | cam switch changeover switch 16A sequence 0-1-2-3-4-5 shaft \varnothing 6x4.6mm connection male faston 6.3mm 3-pole ambient temperature max. 150°C | | |

lamps

indicator lights

indicator lights 3-piece (housing, lens and bulb)

lamps

neon light bulbs



1

| | | | |
|--------------------|---|-----------------|--------|
| GEV No. | 359602 | Ref. No. | 105473 |
| description | neon light bulb socket E14 230V clear \varnothing 14mm L 30mm | | |

screw-on/push-on fit

neon light bulbs



1

| | | | |
|--------------------|---|-----------------|--------|
| GEV No. | 359602 | Ref. No. | 105473 |
| description | neon light bulb socket E14 230V clear \varnothing 14mm L 30mm | | |



solenoid valves

solenoid valves (water)

metal

BÜRKERT

solenoid valves steam (water)

2-way

0407 series



1

| | | | |
|--------------------|---|-----------------|------------------|
| GEV No. | 370364 | Ref. No. | 161363 161373 |
| description | solenoid valve 2-ways 230VAC connection 3/8" L 55mm DN 12mm slide-on receptacle DIN 180°C BÜRKERT type series 0407 membranes PTFE p max 10bar brass | | |

pressure switches

for steam control



1

| | | | |
|--------------------|---|-----------------|--------|
| GEV No. | 541022 | Ref. No. | 161357 |
| description | pressure control steam control pressure connection vertical pressure range adjustable 0.25-4.5bar connection 1/4" pressure connection 1/4" IT | | |

gas taps

PEL

23S/V series



1

| | | | |
|---|--|-----------------|-------------------|
| GEV No. | 101630 | Ref. No. | 112623 |
| description | gas tap PEL type 23S/V gas inlet 1/2" IT bypass nozzle ø 0.35mm gas outlet 1/2" MT (tube ø 14mm) thermocouple connection M10x1 pilot connection M10x1 shaft ø 10mm shaft L 25mm shaft flat | | |
| spare parts for | 101630 | | |
|  | GEV No. | 100455 | Ref. No. — |
| | bypass nozzle type PEL23/24 bore ø 0.35mm thread M8x0.5 | | |

| | | | |
|---|---|--------|-------------------|
| spare parts for | 101630 | | |
|  | GEV No. | 101059 | Ref. No. — |
| | magnet unit T1: M10x1 T2: M22x1 L 46mm ø 18mm suitable for PEL23S M10x1 | | |
|  | GEV No. | 102767 | Ref. No. — |
| | gas tap front part shaft ø 10mm shaft L 26.5mm shaft flat suitable for PEL23S | | |
| accessories for | 101630 | | |
|  | GEV No. | 100908 | Ref. No. — |
| | union screw thread M10x1 for pipe ø 4mm Qty 1 pcs | | |
|  | GEV No. | 100909 | Ref. No. — |
| | union screw thread M10x1 for pipe ø 6mm Qty 1 pcs | | |
|  | GEV No. | 100945 | Ref. No. — |
| | roll pin ø 3.2mm L 10mm | | |
|  | GEV No. | 101218 | Ref. No. — |
| | shaft extension JUNKERS | | |
|  | GEV No. | 101219 | Ref. No. — |
| | shaft extension L 25mm JUNKERS | | |
|  | GEV No. | 101246 | Ref. No. — |
| | olive for pipe ø 4mm Qty 1 pcs | | |
|  | GEV No. | 101286 | Ref. No. — |
| | olive ID ø 6mm Qty 1 pcs | | |
|  | GEV No. | 110064 | Ref. No. — |
| | knob | | |
|  | GEV No. | 110066 | Ref. No. — |
| | knob screw | | |
|  | GEV No. | 550396 | Ref. No. — |
| | shaft extension L 25mm JUNKERS | | |

alternatives to EGA

GPEL22 series

with nozzle outlet



1

| | | | |
|---|---|-----------------|-------------------|
| GEV No. | 101662 | Ref. No. | N/A |
| description | gas tap alternatives to EGA type GPEL22D with nozzle outlet (with nozzle) gas inlet M18x1.5 (tube ø 12mm) external nozzle ø 2.1mm internal nozzle ø 1mm bypass nozzle ø 0.35mm mixing pipe connection M22x1 thermocouple connection M8x1 pilot connection M10x1 shaft ø 6.5x9mm shaft L 34/15mm shaft flat upper and bottom | | |
| spare parts for | 101662 | | |
|  | GEV No. | 100259 | Ref. No. — |
| | bypass nozzle type PEL22 bore ø 0.35mm thread M6x0.5 | | |

Table continues overleaf

| | | | | |
|---|---------|--------|----------|--------|
| spare parts for 101662 | | | | |
|  | GEV No. | 100338 | Ref. No. | — |
| gas injector thread M15x1 bore ø 2.10mm WS 17 | | | | |
|  | GEV No. | 100343 | Ref. No. | — |
| internal nozzle bore ø 1mm type EGA/PEL22 | | | | |
|  | GEV No. | 100908 | Ref. No. | — |
| union screw thread M10x1 for pipe ø 4mm Qty 1 pcs | | | | |
|  | GEV No. | 100927 | Ref. No. | — |
| torsion spring L 2.8-8.0mm for internal nozzle ø 3mm bore ømm | | | | |
|  | GEV No. | 101058 | Ref. No. | 162589 |
| magnet unit L 39mm D1 ø 15.4mm D2 ø 13.5mm suitable for PEL22/ EGA24197 standard | | | | |
|  | GEV No. | 101230 | Ref. No. | — |
| thermocouple nut T1: M8x1 T2: M18x1 aluminium | | | | |
|  | GEV No. | 101246 | Ref. No. | — |
| olive for pipe ø 4mm Qty 1 pcs | | | | |
|  | GEV No. | 101460 | Ref. No. | — |
| O-ring ø 12.37mm D1 ø 2.62mm suitable for PEL22 | | | | |
|  | GEV No. | 101527 | Ref. No. | — |
| O-ring Viton thickness 1.78mm ID ø 6.75mm Qty 1 pcs | | | | |
|  | GEV No. | 101594 | Ref. No. | — |
| adjusting screw for internal nozzle thread M10x0.75 | | | | |
|  | GEV No. | 101821 | Ref. No. | — |
| gas tap front part shaft ø 9x6.5mm shaft L 34/15mm shaft flat upper/ lower suitable for PEL22 | | | | |
| accessories for 101662 | | | | |
|  | GEV No. | 100909 | Ref. No. | — |
| union screw thread M10x1 for pipe ø 6mm Qty 1 pcs | | | | |
|  | GEV No. | 100944 | Ref. No. | — |
| union nut thread M18x1.5 for pipe ø 12mm | | | | |
|  | GEV No. | 101273 | Ref. No. | — |
| olive for pipe ø 12mm L 9.5mm brass Qty 1 pcs suitable for universal | | | | |
|  | GEV No. | 101286 | Ref. No. | — |
| olive ID ø 6mm Qty 1 pcs | | | | |
|  | GEV No. | 110217 | Ref. No. | 179922 |
| knob gas tap with ignition flame ø 64mm shaft ø 9x7mm shaft flat horizontal black | | | | |

| | | | | |
|---|--|-----------------|------------------|--------|
|  | | | | |
| 1 | | | | |
| GEV No. | 101764 | Ref. No. | 112721 112722 | |
| description | gas tap alternatives to EGA type PEL22S with nozzle outlet (with nozzle) gas inlet M18x1.5 (tube ø 12mm) external nozzle ø 1.6mm internal nozzle ø 1mm bypass nozzle ø 0.35mm mixing pipe connection M22x1 thermocouple connection M8x1 pilot connection M10x1 shaft ø 9x6.5mm shaft L 34/15mm shaft flat upper and bottom | | | |
| spare parts for 101764 | | | | |
|  | GEV No. | 100259 | Ref. No. | — |
| bypass nozzle type PEL22 bore ø 0.35mm thread M6x0.5 | | | | |
|  | GEV No. | 100337 | Ref. No. | — |
| gas injector thread M15x1 bore ø 1.60mm WS 17 | | | | |
|  | GEV No. | 100343 | Ref. No. | — |
| internal nozzle bore ø 1mm type EGA/PEL22 | | | | |
|  | GEV No. | 100908 | Ref. No. | — |
| union screw thread M10x1 for pipe ø 4mm Qty 1 pcs | | | | |
|  | GEV No. | 100927 | Ref. No. | — |
| torsion spring L 2.8-8.0mm for internal nozzle ø 3mm bore ømm | | | | |
|  | GEV No. | 101058 | Ref. No. | 162589 |
| magnet unit L 39mm D1 ø 15.4mm D2 ø 13.5mm suitable for PEL22/ EGA24197 standard | | | | |
|  | GEV No. | 101230 | Ref. No. | — |
| thermocouple nut T1: M8x1 T2: M18x1 aluminium | | | | |
|  | GEV No. | 101246 | Ref. No. | — |
| olive for pipe ø 4mm Qty 1 pcs | | | | |
|  | GEV No. | 101460 | Ref. No. | — |
| O-ring ø 12.37mm D1 ø 2.62mm suitable for PEL22 | | | | |
|  | GEV No. | 101527 | Ref. No. | — |
| O-ring Viton thickness 1.78mm ID ø 6.75mm Qty 1 pcs | | | | |
|  | GEV No. | 101594 | Ref. No. | — |
| adjusting screw for internal nozzle thread M10x0.75 | | | | |
|  | GEV No. | 101821 | Ref. No. | — |
| gas tap front part shaft ø 9x6.5mm shaft L 34/15mm shaft flat upper/ lower suitable for PEL22 | | | | |
| accessories for 101764 | | | | |
|  | GEV No. | 100944 | Ref. No. | — |
| union nut thread M18x1.5 for pipe ø 12mm | | | | |
|  | GEV No. | 101273 | Ref. No. | — |
| olive for pipe ø 12mm L 9.5mm brass Qty 1 pcs suitable for universal | | | | |
|  | GEV No. | 101286 | Ref. No. | — |
| olive ID ø 6mm Qty 1 pcs | | | | |

Table continues overleaf



| | | | | |
|---|---------|--------|----------|---|
| accessories for 101764 | | | | |
|  | GEV No. | 101909 | Ref. No. | — |
| gas tap type PEL22S | | | | |



| | | | |
|----------------|--------|-----------------|--|
| GEV No. | 101624 | Ref. No. | 112721 old version 112722 old version |
|----------------|--------|-----------------|--|

| | |
|--------------------|---|
| description | gas tap alternatives to EGA type PEL22S with nozzle outlet (without nozzle) gas inlet M18x1.5 (tube ø 12mm) external nozzle ømm internal nozzle ømm bypass nozzle ø 0.35mm mixing pipe connection M22x1 thermocouple connection M8x1 pilot connection M10x1 shaft ø 9x6.5mm shaft L 34/15mm shaft flat upper and bottom |
|--------------------|---|

| | |
|------------------------|--------|
| spare parts for | 101624 |
|------------------------|--------|

| | | | | |
|---|---------|--------|----------|---|
|  | GEV No. | 100259 | Ref. No. | — |
|---|---------|--------|----------|---|

bypass nozzle type PEL22 bore ø 0.35mm thread M6x0.5

| | | | | |
|---|---------|--------|----------|---|
|  | GEV No. | 100927 | Ref. No. | — |
|---|---------|--------|----------|---|

torsion spring L 2.8-8.0mm for internal nozzle ø 3mm bore ømm

| | | | | |
|--|---------|--------|----------|--------|
|  | GEV No. | 101058 | Ref. No. | 162589 |
|--|---------|--------|----------|--------|

magnet unit L 39mm D1 ø 15.4mm D2 ø 13.5mm suitable for PEL22/ EGA24197 standard

| | | | | |
|---|---------|--------|----------|---|
|  | GEV No. | 101230 | Ref. No. | — |
|---|---------|--------|----------|---|

thermocouple nut T1: M8x1 T2: M18x1 aluminium

| | | | | |
|---|---------|--------|----------|---|
|  | GEV No. | 101460 | Ref. No. | — |
|---|---------|--------|----------|---|

O-ring ø 12.37mm D1 ø 2.62mm suitable for PEL22

| | | | | |
|---|---------|--------|----------|---|
|  | GEV No. | 101527 | Ref. No. | — |
|---|---------|--------|----------|---|

O-ring Viton thickness 1.78mm ID ø 6.75mm Qty 1 pcs

| | | | | |
|---|---------|--------|----------|---|
|  | GEV No. | 101594 | Ref. No. | — |
|---|---------|--------|----------|---|

adjusting screw for internal nozzle thread M10x0.75

| | | | | |
|---|---------|--------|----------|---|
|  | GEV No. | 101821 | Ref. No. | — |
|---|---------|--------|----------|---|

gas tap front part shaft ø 9x6.5mm shaft L 34/15mm shaft flat upper/ lower suitable for PEL22

| | |
|------------------------|--------|
| accessories for | 101624 |
|------------------------|--------|

| | | | | |
|---|---------|--------|----------|---|
|  | GEV No. | 100908 | Ref. No. | — |
|---|---------|--------|----------|---|

union screw thread M10x1 for pipe ø 4mm Qty 1 pcs

| | | | | |
|---|---------|--------|----------|---|
|  | GEV No. | 100909 | Ref. No. | — |
|---|---------|--------|----------|---|

union screw thread M10x1 for pipe ø 6mm Qty 1 pcs

| | | | | |
|---|---------|--------|----------|---|
|  | GEV No. | 100944 | Ref. No. | — |
|---|---------|--------|----------|---|

union nut thread M18x1.5 for pipe ø 12mm

| | | | | |
|---|---------|--------|----------|---|
|  | GEV No. | 101246 | Ref. No. | — |
|---|---------|--------|----------|---|

olive for pipe ø 4mm Qty 1 pcs

| | | | | |
|---|---------|--------|----------|---|
|  | GEV No. | 101273 | Ref. No. | — |
|---|---------|--------|----------|---|

olive for pipe ø 12mm L 9.5mm brass Qty 1 pcs suitable for universal

| | | | | |
|---|---------|--------|----------|---|
|  | GEV No. | 101286 | Ref. No. | — |
|---|---------|--------|----------|---|

olive ID ø 6mm Qty 1 pcs

| | | | | |
|---|---------|--------|----------|--------|
| accessories for 101624 | | | | |
|  | GEV No. | 110217 | Ref. No. | 179922 |
| knob gas tap with ignition flame ø 64mm shaft ø 9x7mm shaft flat horizontal black | | | | |

alternatives to JUNKERS



| | | | |
|----------------|--------|-----------------|--------|
| GEV No. | 101630 | Ref. No. | 112623 |
|----------------|--------|-----------------|--------|

| | |
|--------------------|--|
| description | gas tap PEL type 23S/V gas inlet 1/2" IT bypass nozzle ø 0.35mm gas outlet 1/2" MT (tube ø 14mm) thermocouple connection M10x1 pilot connection M10x1 shaft ø 10mm shaft L 25mm shaft flat |
|--------------------|--|

| | |
|------------------------|--------|
| spare parts for | 101630 |
|------------------------|--------|

| | | | | |
|---|---------|--------|----------|---|
|  | GEV No. | 100455 | Ref. No. | — |
|---|---------|--------|----------|---|

bypass nozzle type PEL23/24 bore ø 0.35mm thread M8x0.5

| | | | | |
|---|---------|--------|----------|---|
|  | GEV No. | 101059 | Ref. No. | — |
|---|---------|--------|----------|---|

magnet unit T1: M10x1 T2: M22x1 L 46mm ø 18mm suitable for PEL23S M10x1

| | | | | |
|--|---------|--------|----------|---|
|  | GEV No. | 102767 | Ref. No. | — |
|--|---------|--------|----------|---|

gas tap front part shaft ø 10mm shaft L 26.5mm shaft flat suitable for PEL23S

| | |
|------------------------|--------|
| accessories for | 101630 |
|------------------------|--------|

| | | | | |
|---|---------|--------|----------|---|
|  | GEV No. | 100908 | Ref. No. | — |
|---|---------|--------|----------|---|

union screw thread M10x1 for pipe ø 4mm Qty 1 pcs

| | | | | |
|---|---------|--------|----------|---|
|  | GEV No. | 100909 | Ref. No. | — |
|---|---------|--------|----------|---|

union screw thread M10x1 for pipe ø 6mm Qty 1 pcs

| | | | | |
|---|---------|--------|----------|---|
|  | GEV No. | 100945 | Ref. No. | — |
|---|---------|--------|----------|---|

roll pin ø 3.2mm L 10mm

| | | | | |
|---|---------|--------|----------|---|
|  | GEV No. | 101218 | Ref. No. | — |
|---|---------|--------|----------|---|

shaft extension JUNKERS

| | | | | |
|---|---------|--------|----------|---|
|  | GEV No. | 101219 | Ref. No. | — |
|---|---------|--------|----------|---|

shaft extension L 25mm JUNKERS

| | | | | |
|---|---------|--------|----------|---|
|  | GEV No. | 101246 | Ref. No. | — |
|---|---------|--------|----------|---|

olive for pipe ø 4mm Qty 1 pcs

| | | | | |
|---|---------|--------|----------|---|
|  | GEV No. | 101286 | Ref. No. | — |
|---|---------|--------|----------|---|

olive ID ø 6mm Qty 1 pcs

| | | | | |
|---|---------|--------|----------|---|
|  | GEV No. | 110064 | Ref. No. | — |
|---|---------|--------|----------|---|

knob

| | | | | |
|---|---------|--------|----------|---|
|  | GEV No. | 110066 | Ref. No. | — |
|---|---------|--------|----------|---|

knob screw

| | | | | |
|---|---------|--------|----------|---|
|  | GEV No. | 550396 | Ref. No. | — |
|---|---------|--------|----------|---|

shaft extension L 25mm JUNKERS



ignition parts

pilot burners

JUNKERS



CB 502 series

pilot burners



1

| | | | | |
|---|--|-----------------|----------|--------|
| GEV No. | 100085 | Ref. No. | 112569 | |
| description | pilot burner JUNKERS type CB502031 natural gas nozzle no.6 gas connection 6mm with primary air | | | |
| For models: | GK8-40 | | | |
| spare parts for | 100085 | | | |
|  | GEV No. | 100227 | Ref. No. | — |
| | pilot burner nozzle natural gas gas pressure 25mbar code 6 Qty 1 pcs suitable for JUNKERS CB50203_ | | | |
|  | GEV No. | 100704 | Ref. No. | 112414 |
| | ignition electrode D1 ø 9mm connection M4 D2 ø 11mm L1 17mm L2 17mm BL1 13mm BL2 4mm BL3 22mm | | | |
|  | GEV No. | 100909 | Ref. No. | — |
| | union screw thread M10x1 for pipe ø 6mm Qty 1 pcs | | | |
|  | GEV No. | 101287 | Ref. No. | — |
| | olive for pipe ø 6mm Qty 1 pcs | | | |
|  | GEV No. | 101292 | Ref. No. | — |
| | union screw for igniter suitable for CB 502/505 Qty 1 pcs | | | |
|  | GEV No. | 101295 | Ref. No. | — |
| | clamping collet for thermocouple suitable for CB 502/505 Qty 1 pcs | | | |
| accessories for | 100085 | | | |
|  | GEV No. | 100220 | Ref. No. | — |
| | pilot burner nozzle LPG gas pressure 50mbar code 2 Qty 1 pcs suitable for JUNKERS CB503_ | | | |
|  | GEV No. | 100221 | Ref. No. | — |
| | pilot burner nozzle LPG gas pressure 30mbar code 29 Qty 1 pcs suitable for JUNKERS CB50203_ | | | |
|  | GEV No. | 100222 | Ref. No. | — |
| | pilot burner nozzle LPG gas pressure 50mbar code 5 Qty 1 pcs suitable for JUNKERS CB50203_ | | | |
|  | GEV No. | 100223 | Ref. No. | — |
| | pilot burner nozzle natural gas gas pressure 20mbar code 3 Qty 1 pcs suitable for JUNKERS CB503_ | | | |
|  | GEV No. | 100224 | Ref. No. | — |
| | pilot burner nozzle natural gas gas pressure 25mbar code 26 Qty 1 pcs suitable for JUNKERS CB503_ | | | |
|  | GEV No. | 100225 | Ref. No. | — |
| | pilot burner nozzle LPG gas pressure 30mbar code 39 Qty 1 pcs suitable for JUNKERS CB503_ | | | |
|  | GEV No. | 100226 | Ref. No. | — |
| | pilot burner nozzle LPG gas pressure 50mbar code 15 suitable for JUNKERS | | | |

| | | | | |
|---|--|--------|----------|---|
| accessories for | 100085 | | | |
|  | GEV No. | 100228 | Ref. No. | — |
| | pilot burner nozzle town gas gas pressure 8mbar code 4 Qty 1 pcs suitable for JUNKERS CB50203_ | | | |
|  | GEV No. | 101281 | Ref. No. | — |
| | olive for pipe ø 4mm L 8.7mm Qty 1 pcs suitable for CB 502/503 | | | |
|  | GEV No. | 101283 | Ref. No. | — |
| | union screw thread M10x1 for pipe ø 4mm Qty 1 pcs | | | |

CB 505 series

pilot burners



1

| | | | |
|--------------------|--------------------------------------|-----------------|--------|
| GEV No. | 100180 | Ref. No. | 172317 |
| description | pilot burner JUNKERS type 7749505104 | | |













| | | | | |
|---|---|-----------------|----------|---|
|  | 1 | | | |
| GEV No. | 100134 | Ref. No. | 172316 | |
| description | pilot burner JUNKERS type CB505101 natural gas nozzle no.45 gas connection 4mm no primary air | | | |
| spare parts for | 100134 | | | |
|  | GEV No. | 100213 | Ref. No. | — |
| | pilot burner nozzle natural gas code 45 gas pressure 20mbar L 16mm Qty 1 pcs suitable for JUNKERS CB5051_ | | | |
|  | GEV No. | 100702 | Ref. No. | — |
| | ignition electrode D1 ø 9mm D2 ø 11mm L1 13mm L2 4mm BL1 13mm BL2 4mm BL3 22mm to clip connection ø 4mm | | | |
|  | GEV No. | 100802 | Ref. No. | — |
| | gasket for pilot burner | | | |
|  | GEV No. | 101282 | Ref. No. | — |
| | olive for pipe ø 4mm L 7.4mm Qty 1 pcs | | | |
|  | GEV No. | 101283 | Ref. No. | — |
| | union screw thread M10x1 for pipe ø 4mm Qty 1 pcs | | | |
|  | GEV No. | 101292 | Ref. No. | — |
| | union screw for igniter suitable for CB 502/505 Qty 1 pcs | | | |
|  | GEV No. | 101295 | Ref. No. | — |
| | clamping collet for thermocouple suitable for CB 502/505 Qty 1 pcs | | | |
| accessories for | 100134 | | | |
|  | GEV No. | 100210 | Ref. No. | — |
| | pilot burner nozzle LPG code 46 gas pressure 30mbar L 16mm Qty 1 pcs suitable for JUNKERS CB5051_ | | | |

Table continues overleaf



| accessories for | | 100134 | |
|---|---------|--------|------------|
|  | GEV No. | 100211 | Ref. No. — |
| pilot burner nozzle natural gas code 44 gas pressure 25mbar L 16mm Qty 1 pcs suitable for JUNKERS CB5051_ | | | |
|  | GEV No. | 100212 | Ref. No. — |
| pilot burner nozzle LPG code 42 gas pressure 50mbar L 16mm Qty 1 pcs suitable for JUNKERS CB5051_ | | | |
|  | GEV No. | 100909 | Ref. No. — |
| union screw thread M10x1 for pipe ø 6mm Qty 1 pcs | | | |
|  | GEV No. | 101288 | Ref. No. — |
| olive for pipe ø 6mm L 6mm aluminium Qty 1 pcs ED ø 8.5mm | | | |

producer-specific pilot burners

MALAG

AG_ / AGE_ series



| | | | | |
|--|---------|--------|----------|---|
| 1 | GEV No. | 107473 | Ref. No. | - |
| description pilot burner natural/liquid gas complete | | | | |

electrodes

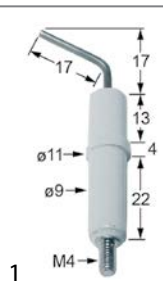

| | | | | |
|---|---------|--------|----------|--------|
| 1 | GEV No. | 100704 | Ref. No. | 112414 |
| description ignition electrode D1 ø 9mm connection M4 D2 ø 11mm L1 17mm L2 17mm BL1 13mm BL2 4mm BL3 22mm | | | | |

piezoelectric igniters

miscellaneous



| | | | | |
|---|---------|------------------|----------|--------|
| 1 | GEV No. | nla ¹ | Ref. No. | 112607 |
| description piezoelectric igniter body metal connection F6.3x0.8 2 hole fixing ø 22mm | | | | |

¹no longer available

thermocouples

threaded thermocouples

threaded thermocouples standard

with socket with thread M8x1

type Junkers with aluminised tip

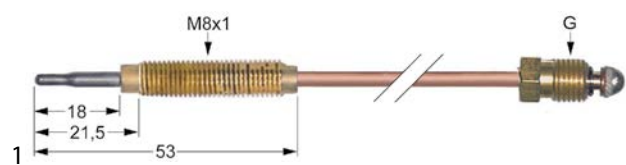

| | | | | |
|---|---------|--------|----------|--------|
| 1 | GEV No. | 102234 | Ref. No. | 112402 |
| description thermocouple M10x1 L 320mm M8x1 | | | | |
| For models: GK8-40 | | | | |

gas burners

hob burners

producer-specific hob burners

MALAG

universal





1
Image not available

| | | | | |
|-----------------------------------|---------|--------|----------|--------|
| 1 | GEV No. | 105796 | Ref. No. | 112275 |
| description burner 3.8kW complete | | | | |





| | | | |
|---|--|-----------------|------------------------|
|  | | | |
| 1 | | | |
| GEV No. | 105801 | Ref. No. | 112267 |
| description | burner 5.8kW complete | | |
| spare parts for | 105801 | | |
|  | GEV No. | 105797 | Ref. No. 112224 |
| | burner cap ø 104mm 5.8kW with central hole hole ø 39mm | | |
|  | GEV No. | 105798 | Ref. No. 177776 |
| | burner ring 5.8kW small | | |
|  | GEV No. | 105799 | Ref. No. 177806 |
| | burner ring 5.8kW large | | |
|  | GEV No. | 105801 | Ref. No. 112267 |
| | burner 5.8kW complete | | |

| | | | |
|---|---------------------------|-----------------|--------|
|  | | | |
| 1 | | | |
| GEV No. | 106653 | Ref. No. | 112232 |
| description | burner cap 3.7kW complete | | |

| | | | |
|---|--|-----------------|--------|
|  | | | |
| 1 | | | |
| GEV No. | 105797 | Ref. No. | 112224 |
| description | burner cap ø 104mm 5.8kW with central hole hole ø 39mm | | |

| | | | |
|---|-------------------|-----------------|--------|
|  | | | |
| 1 | | | |
| GEV No. | 105795 | Ref. No. | 199992 |
| description | burner head 3.7kW | | |

| | | | |
|---|-------------------|-----------------|--------------------|
|  | | | |
| 1 | | | |
| GEV No. | 105800 | Ref. No. | 199992 old version |
| description | burner head 5.8kW | | |

| | | | |
|---|-------------------------|-----------------|--------|
|  | | | |
| 1 | | | |
| GEV No. | 105794 | Ref. No. | 177792 |
| description | burner ring 3.7kW large | | |

| | | | |
|---|-------------------------|-----------------|--------|
|  | | | |
| 1 | | | |
| GEV No. | 105793 | Ref. No. | 177768 |
| description | burner ring 3.7kW small | | |

| | | | |
|---|-------------------------|-----------------|--------|
|  | | | |
| 1 | | | |
| GEV No. | 105799 | Ref. No. | 177806 |
| description | burner ring 5.8kW large | | |

| | | | |
|---|-------------------------|-----------------|--------|
|  | | | |
| 1 | | | |
| GEV No. | 105798 | Ref. No. | 177776 |
| description | burner ring 5.8kW small | | |

gas nozzles

pilot burner nozzles

pilot burner nozzles EGA

| | | | |
|---|---|-----------------|--------|
|  | | | |
| 1 | | | |
| GEV No. | 100214 | Ref. No. | 112534 |
| description | pilot burner nozzle LPG bore ø 0.16mm Qty 1 pcs | | |



| | | | |
|---|---|-----------------|--------|
|  | | | |
| 1 | | | |
| GEV No. | 100215 | Ref. No. | 162558 |
| description | pilot burner nozzle natural gas bore ø 0.28mm Qty 1 pcs | | |

auxiliary gas parts

gas lines

pilot tubes

universal

| | | | |
|--|---|-----------------|-------------------|
|  | | | |
| 1 | | | |
| GEV No. | 102110 | Ref. No. | 112488 |
| description | pilot tube copper pipe ø 4mm thickness 1mm L 3000mm | | |
| accessories for | 102110 | | |
|  | GEV No. | 100908 | Ref. No. — |
| | union screw thread M10x1 for pipe ø 4mm Qty 1 pcs | | |
|  | GEV No. | 101246 | Ref. No. — |
| | olive for pipe ø 4mm Qty 1 pcs | | |



knobs

producer-specific knobs

MALAG



1

| | | | |
|--------------------|---|-----------------|--------|
| GEV No. | 110217 | Ref. No. | 179922 |
| description | knob gas tap with ignition flame ø 64mm shaft ø 9x7mm shaft flat horizontal black | | |



1

| | | | |
|--------------------|--|-----------------|----------------|
| GEV No. | 110218 | Ref. No. | 1004243,179930 |
| description | knob gas thermostat 1-8 ø 64mm shaft ø 9x7mm shaft flat horizontal | | |



1

| | | | |
|--------------------|---|-----------------|--------|
| GEV No. | 110210 | Ref. No. | 144216 |
| description | knob switch 0-1-0-1 ø 64mm shaft ø 6x4.6mm shaft flat lower black | | |



1

| | | | |
|--------------------|--|-----------------|--------|
| GEV No. | 110211 | Ref. No. | 144452 |
| description | knob switch 4-position ø 64mm shaft ø 6x4.6mm shaft flat lower black | | |



1

| | | | |
|--------------------|--|-----------------|--------|
| GEV No. | 110212 | Ref. No. | 143871 |
| description | knob switch 7-position ø 64mm shaft ø 6x4.6mm shaft flat lower black | | |



1

| | | | |
|--------------------|---|-----------------|--------|
| GEV No. | 110213 | Ref. No. | 106100 |
| description | knob thermostat t.max. 110°C ø 64mm shaft ø 6x4.6mm shaft flat lower black temperature range 30-110°C | | |



1

| | | | |
|--------------------|--|-----------------|--------|
| GEV No. | 110215 | Ref. No. | 106128 |
| description | knob thermostat t.max. 250°C ø 64mm shaft ø 6x4.6mm shaft flat lower black temperature range 50-250°C rotation 270° thermostat | | |



1

| | | | |
|--------------------|--|-----------------|------------------|
| GEV No. | 110214 | Ref. No. | 106119 144208 |
| description | knob thermostat t.max. 300°C ø 64mm shaft ø 6x4.6mm shaft flat lower black temperature range 50-300°C thermostat | | |



1

| | | | |
|--------------------|--|-----------------|--------|
| GEV No. | 110216 | Ref. No. | 106135 |
| description | knob thermostat t.max. 370°C ø 64mm shaft ø 6x4.6mm shaft flat lower black temperature range 130-370°C | | |

hinges

oven hinges



1

| | | | |
|--------------------|---|-----------------|--------|
| GEV No. | 700898 ¹ | Ref. No. | 143928 |
| description | oven hinge mounting distance 118mm lug mounting 12mm lever length 113mm groove distance 6mm spring thickness 3.5mm mounting ear position left/right spring length 55mm L 155mm W 22mm with opposite support | | |

¹with opposite support

fittings for catering equipment

aerators and air bleeders

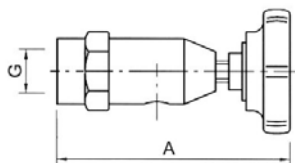

1

| | | | |
|--------------------|---|-----------------|--------|
| GEV No. | 540013 | Ref. No. | 114405 |
| description | aerator and air bleeder thread 3/8" ET WS 27 chrome-plated L 86mm | | |

spare parts for 540013

| | | | |
|--------------------|---|-----------------|---|
| GEV No. | 112777 | Ref. No. | — |
| description | star handle shaft 6x6mm ø 50mm L 18mm black plastic | | |

| | | | |
|--------------------|---|-----------------|---|
| GEV No. | 540365 | Ref. No. | — |
| description | star handle shaft 6x6mm ø 50mm L 18mm black thermoplastic | | |



1

| | | | |
|--------------------|---|-----------------|--------|
| GEV No. | 540011 | Ref. No. | 113905 |
| description | aerator and air bleeder thread 1/2" ET chrome-plated brass metal seated L 42mm ø 26mm | | |



1

| | | | |
|--------------------|--|-----------------|--------|
| GEV No. | 540010 | Ref. No. | 113891 |
| description | aerator and air bleeder thread 3/8" ET WS 22 chrome-plated metal seated L 22mm | | |

test taps

test taps

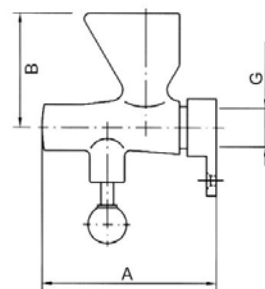

1

| | | | |
|--------------------|--------------------------------------|-----------------|--------|
| GEV No. | 540079 | Ref. No. | 114227 |
| description | funnel thread 1/2" IT W 90mm W1 60mm | | |

baskets

fryer baskets

MALAG



1

| | | | |
|--------------------|---|-----------------|--------|
| GEV No. | 970436 | Ref. No. | 113123 |
| description | fryer basket L1 320mm W1 160mm H1 165mm | | |



1

| | | | |
|--------------------|---|-----------------|--------|
| GEV No. | 970437 | Ref. No. | 113131 |
| description | fryer basket L1 380mm W1 320mm H1 180mm | | |

springs

tension springs



| | | | |
|--------------------|--|-----------------|--------|
| GEV No. | 700897 | Ref. No. | 144517 |
| description | tension spring \varnothing 18mm total length 164mm wire gauge \varnothing 2mm L1 17mm L2 130mm L3 17mm | | |

C

| | |
|---------------------|---|
| cam switches | 8 |
| control thermostats | 6 |

G

| | |
|-------------|----|
| gas burners | 13 |
| gas lines | 14 |
| gas nozzles | 14 |
| gas taps | 9 |

H

| | |
|--------------------------------------|----|
| heating elements | 3 |
| heating elements for bain maries | 3 |
| heating elements for fryers | 3 |
| heating elements for heated cabinets | 3 |
| heating elements for ovens | 3 |
| heating rods | 3 |
| hob burners | 13 |
| hot plates | 4 |

I

| | |
|----------------------------|---|
| immersion heating elements | 4 |
| indicator lights | 8 |

L

| | |
|-------|---|
| lamps | 8 |
|-------|---|

N

| | |
|------------------|------|
| neon light bulbs | 8, 8 |
|------------------|------|

O

| | |
|-------------|----|
| oven hinges | 16 |
|-------------|----|

P

| | |
|------------------------|----|
| piezoelectric igniters | 13 |
| pilot burners | 12 |
| pilot heating elements | 3 |
| pressure switches | 9 |

Q

| | |
|-------------------------|---|
| quartz heating elements | 4 |
|-------------------------|---|

S

| | |
|---------------------------------|---|
| safety thermostats | 7 |
| solenoid valves | 9 |
| switches and momentary switches | 8 |

T

| | |
|---------------|----|
| thermocouples | 13 |
| thermostats | 6 |