



GAS COMPONENTS



ELECTRIC COMPONENTS



WATER TECHNOLOGY



MECHANICAL COMPONENTS



TOOLS

Spare parts suitable for

MARENO

Find the complete and up-to-date range of products in our GEV Webshop



Manufacturer catalogue

The most important spare parts and accessories arranged clearly for every manufacturer

- ✓ Complete product range and all appliance data always up to date in the GEV Webshop
- ✓ Alphabetical Index at the end of the catalogue

GEV Webshop

www.gev-online.co.uk

www.gev-online.com



- 🔍 Add to Favourites
- 🔍 Sign In with email address and usual password
- 🔍 Easy-order – place several items in your basket at the same time
- 🔍 Quick Item search – no login needed



heating elements

heating elements for ovens



GEV No.	415088	Ref. No.	1890500 213443 MA1890500
description	heating element 1000W 220V L 557mm W 132mm flange length 175mm flange width 32mm hole distance 160mm tube ø 8.5mm connection length 33mm heating circuits 1 hole ø 6mm connection M5 dry heating element		
For models:	C9F4E, C9F6E, C9FE6GS, C9V2E, C9V4E, NXBV7FC4, NXBV7FC8, V9F4E, V9FP4E, V9V2E, V9V4E, V9VP2E, V9VP4E, XBV7FC4, XBV7FC8, XBV9FC4, XBV9FC8		

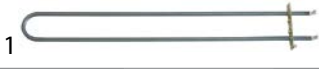

GEV No.	416808	Ref. No.	CM018102 MACM018102
description	heating element 1000W 230V L 555mm W 63mm flange length 100mm flange width 22mm hole distance 86mm tube ø 8.5mm connection length 55mm heating circuits 1 hole ø 5.5mm connection male faston 6.3mm rectangular flange dry heating element		
For models:	BF78E, BF98E, C7FE12G, C7FE8E, C7FE8EC, C7FE8G, C9FE12G, C9FE8E, C9FE8EC, C9FE8G		

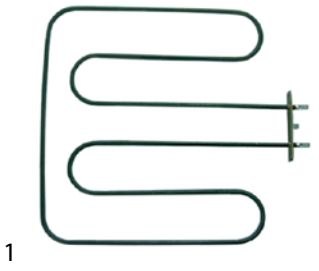

GEV No.	415968	Ref. No.	1037302400 MA1037302400
description	heating element 1200W 230V heating circuits 1 L 346mm W 342mm L1 36mm L2 310mm W1 141mm W2 60mm flange length 100mm flange width 22mm hole distance 86mm hole ø 5mm tube ø 6.5mm connection male faston 6.3mm mounting pos. lower rectangular flange dry heating element		
For models:	FOE60M, OFOE60M		

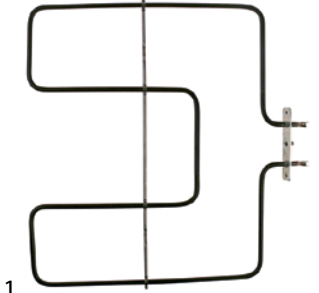

GEV No.	418696	Ref. No.	0410150 CR0410150 CR410150
description	heating element 1300W 230V heating circuits 1 L 350mm W 380mm L1 35mm L2 315mm W1 160mm W2 60mm flange length 100mm flange width 22mm hole distance 86mm bridge length 400mm hole ø 3.2mm tube ø 6mm connection male faston 6.3mm connection length 10mm windings 2		
For models:	CFE60, CFE60P, CFGE61, CFGE61D, CFGE61L, CFGE61P, CFVE60, OCFE60, OCFGE61		



GEV No.	420111	Ref. No.	CR0681390
description	heating element 1500W 230V heating circuits 1 L 555mm W 210mm L1 70mm L2 485mm W1 88mm W2 33mm flange length 70mm flange width 22mm hole distance 56mm hole ø 5mm tube ø 8.5mm connection male faston 6.3mm connection length 17mm windings 3 flange connection dry heating element for oven		
For models:	NC7FE12G36, NC7FE8E, NC7FE8EQ, NC7FE8G24, NC9FE12G44, NC9FE12G52, NC9FE8E, NC9FE8E2, NC9FE8G28, NC9FE8G36, NC9FE8G48		

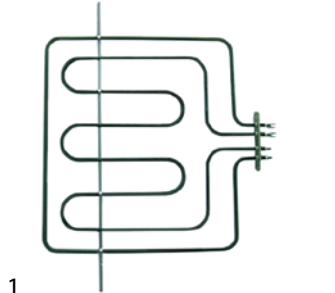

GEV No.	415967	Ref. No.	1037302300 MA1037302300
description	heating element 2600W 230/400V heating circuits 2 L 355mm W 360mm L1 40mm L2 315mm W1 140mm W2 60mm flange length 100mm flange width 22mm hole distance 76mm bridge length 485mm hole ø 5mm tube ø 6.3mm connection male faston 6.3mm mounting pos. upper rectangular flange dry heating element		
For models:	FOE60M, OFOE60M		



GEV No.	415972	Ref. No.	1890600 MA1890600
description	heating element 750W 230V L 483mm W 64mm H 21mm flange length 100mm flange width 22mm hole distance 85mm connection M5 tube ø 8.5mm heating circuits 1 rectangular flange hole ø 5mm dry heating element		
For models:	C7011EFE, C7011EFEQ, C707EFE, C707EFEQ, CFE70, EC74EVG, EC78EVG, EC7FE8E		

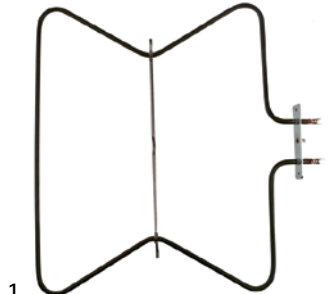

GEV No.	418695	Ref. No.	CR0410140
description	heating element 900W 230V heating circuits 1 L 350mm W 390mm L1 40mm L2 310mm W1 165mm W2 60mm flange length 100mm flange width 22mm hole distance 86mm bridge length 300mm hole ø 3.2mm tube ø 6mm connection male faston 6.3mm connection length 10mm windings 4 oven		
For models:	CFE60, CFE60P, CFGE61, CFGE61D, CFGE61L, CFGE61P, CFVE60, OCFE60, OCFGE61		

1 electric components



heating elements for bain maries



GEV No.	415091	Ref. No.	1037039513 892600 MA1037039513
description	heating element 1000W 230V heating circuits 1 L 295mm W 85mm connection length 20mm connection M3 tube ø 6.5mm 2 hole fixing thread M14x1 immersion heater/dry heating element bain marie/chip scuttle L1 145mm L2 150mm H 18mm mounting distance 79mm		
For models:	BME40DM, BME40DMB, BME40M, BME60, BME602, BME60DM, BME60DMB, BME60M, BME80M, BSE40M, BSE140M, CSP6220, CSP6230, NSP74E, NSP94E, OBSE140M, SP74E, SP94E		
spare parts for	415091		



GEV No.	510417	Ref. No.	—
description	flat gasket fibre ED ø 20mm ID ø 14mm thickness 2mm Qty 1 pcs		

accessories for	415091			
	GEV No.	520228	Ref. No.	—
description	tooth lock washer ID ø 15.3mm ED ø 24mm steel Qty 1 pcs for thread M14			



GEV No.	521133	Ref. No.	1325313 MA1325313
description	nut thread M14x1.5 H 6mm WS 19 zinc-coated steel Qty 1 pcs		



GEV No.	527169	Ref. No.	—
description	hexagonal nut thread M3 H 2.8mm WS 5.5 brass Qty 1 pcs		



GEV No.	550261	Ref. No.	—
description	nut thread M14x1 H 4mm WS 19 SS Qty 1 pcs		



GEV No.	550262	Ref. No.	—
description	flat gasket copper ED ø 20mm ID ø 14mm thickness 2mm		



GEV No.	560110	Ref. No.	—
description	plain washer ID ø 3.2mm ED ø 7mm thickness 0.5mm SS Qty 20 pcs DIN 125A for thread M3		



GEV No.	560130	Ref. No.	—
description	hexagonal nut thread M3 H 2.4mm WS 5.5 SS DIN/ISO DIN 934 / ISO 4032/8673 Qty 20 pcs		

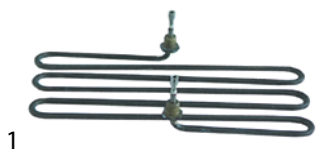

GEV No.	415092	Ref. No.	1037039613 MA1037039613
description	heating element 1300W 230V L 290mm W 130mm connection M4 tube ø 6.3mm 2 hole fixing thread M14x1.5 immersion heater L1 140mm L2 150mm H 18mm mounting distance 127mm		
For models:	BME40M, BME60, BME602, BME60M, BME80M		

accessories for	415092			
	GEV No.	510417	Ref. No.	—
description	flat gasket fibre ED ø 20mm ID ø 14mm thickness 2mm Qty 1 pcs			



GEV No.	520228	Ref. No.	—
description	tooth lock washer ID ø 15.3mm ED ø 24mm steel Qty 1 pcs for thread M14		



GEV No.	520230	Ref. No.	—
description	nut thread M14x1.5 H 5mm WS 19 zinc-coated steel Qty 1 pcs		

accessories for	415092			
	GEV No.	521101	Ref. No.	—
description	nut thread M14x1.5 H 5mm WS 19 SS Qty 1 pcs			
	GEV No.	521103	Ref. No.	—
description	nut thread M4 H 3mm WS 7 brass Qty 20 pcs			
	GEV No.	521104	Ref. No.	—
description	washer ID ø 4.3mm ED ø 8mm thickness 0.5mm brass Qty 20 pcs for thread M4			
	GEV No.	550262	Ref. No.	—
description	flat gasket copper ED ø 20mm ID ø 14mm thickness 2mm			
	GEV No.	560111	Ref. No.	—
description	plain washer ID ø 4.3mm ED ø 9mm thickness 0.8mm SS Qty 20 pcs DIN 125A for thread M4			
	GEV No.	560131	Ref. No.	—
description	hexagonal nut thread M4 H 3.2mm WS 7 SS DIN/ISO DIN 934 / ISO 4032/8673 Qty 20 pcs			



GEV No.	415979	Ref. No.	1634100 MA1634100
description	heating element 1500W 230V heating circuits 1 L 497mm W 90mm flange length 124mm flange width 30mm hole distance 108mm connection length 33mm connection M5 tube ø 10mm rectangular flange hole ø 4mm dry heating element bain marie suitable for 700 series		
For models:	BM74E, BM77E		

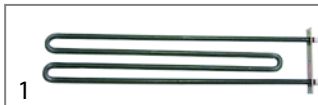

GEV No.	415992	Ref. No.	1634200 MA1634200
description	heating element 1800W 230V heating circuits 1 L 495mm W 90mm flange length 124mm flange width 30mm hole distance 108mm connection length 33mm connection M5 tube ø 10mm rectangular flange hole ø 4mm dry heating element bain marie		
For models:	B74E, B78E, B94E, B98E, B9SB2E, B9SB4E, B9V2E, B9V4E, NB74E, NB78E, NB94E, NB98E		



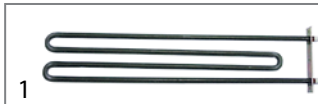

GEV No.	415081	Ref. No.	627510 MA627510
description	heating element 1800W 240V heating circuits 1 L 500mm W 34mm connection M5 tube ø 8.5mm expansion flange bain marie flange 40x16mm		



GEV No.	415083	Ref. No.	1368400 1634300 MA1634300
description	heating element 2100W 220V heating circuits 1 L 500mm W 90mm flange length 124mm flange width 30mm hole distance 108mm connection length 33mm connection M5 tube ø 10mm rectangular flange hole ø 5mm bain marie suitable for 900 series		
For models:	B9SB2E, B9SB4E, B9V2E, B9V4E, B9VP2E, B9VP4E, BM74E, BM77E		



			
GEV No.	415082	Ref. No.	33610
description	heating element 2200W 230V L 410mm W 34mm connection M5 tube ø 8.5mm expansion flange immersion heater flange 40x16mm		



			
GEV No.	418694	Ref. No.	CR0502320
description	heating element 750W 230V heating circuits 1 L 410mm W 63mm flange length 100mm flange width 22mm hole distance 86mm connection length 27mm connection male faston 6.3mm tube ø 8.5mm rectangular flange hole ø 5.5mm dry heating element		

heating elements for frying pans

			
GEV No.	416698	Ref. No.	1037317700 MA1037317700
description	heating element 1350W 230V L 460mm W 95mm connection M4 tube ø 6.3mm dry heating element multi purpose roasting pan H 40mm connection distance 89mm		
For models:	NVB74E, NVB74E2, NVB76E, NVB76E2, NVB96E, OVBE40, OVBE60, VB12C9E, VB74E, VB76E, VB96E, VBE40, VBE402, VBE40D, VBE40DB, VBE60, VBE602, VBE60D, VBE60DDB		

heating elements for chip scuttles

			
GEV No.	415091	Ref. No.	1037039513 892600 MA1037039513
description	heating element 1000W 230V heating circuits 1 L 295mm W 85mm connection length 20mm connection M3 tube ø 6.5mm 2 hole fixing thread M14x1 immersion heater/dry heating element bain marie/ chip scuttle L1 145mm L2 150mm H 18mm mounting distance 79mm		
For models:	BME40DM, BME40DMB, BME40M, BME60, BME602, BME60DM, BME60DMB, BME60M, BME80M, BSE40M, BSEI40M, CSP6220, CSP6230, NSP74E, NSP94E, OBSEI40M, SP74E, SP94E		
spare parts for	415091		
	GEV No.	510417	Ref. No. —
	flat gasket fibre ED ø 20mm ID ø 14mm thickness 2mm Qty 1 pcs		
accessories for	415091		
	GEV No.	520228	Ref. No. —
	tooth lock washer ID ø 15.3mm ED ø 24mm steel Qty 1 pcs for thread M14		
	GEV No.	521133	Ref. No. 1325313 MA1325313
	nut thread M14x1.5 H 6mm WS 19 zinc-coated steel Qty 1 pcs		
	GEV No.	527169	Ref. No. —
	hexagonal nut thread M3 H 2.8mm WS 5.5 brass Qty 1 pcs		
	GEV No.	550261	Ref. No. —
	nut thread M14x1 H 4mm WS 19 SS Qty 1 pcs		
	GEV No.	550262	Ref. No. —
	flat gasket copper ED ø 20mm ID ø 14mm thickness 2mm		



accessories for	415091		
	GEV No.	560110	Ref. No. —
	plain washer ID ø 3.2mm ED ø 7mm thickness 0.5mm SS Qty 20 pcs DIN 125A for thread M3		
	GEV No.	560130	Ref. No. —
	hexagonal nut thread M3 H 2.4mm WS 5.5 SS DIN/ISO DIN 934 / ISO 4032/8673 Qty 20 pcs		

heating elements for fryers

side connection

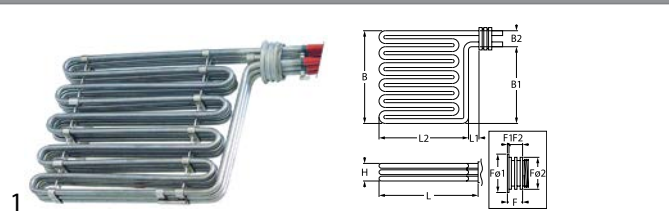
with thread



GEV No.	416813	Ref. No.	CM032101 CM032101R MACM032101 MACM032101R
description	heating element 10500W 230/400V heating circuits 3 mounting pos. right L 320mm W 240mm H 32mm flange length 21mm flange length 1 2mm flange length 2 19mm flange ø1 63mm flange ø2 57.5mm sensor screw connection 2x M10x1 thermostat sleeve upper/lower L1 20mm L2 300mm W1 204mm W2 33mm thread M54x1.5 windings 5 tube ø 8.5mm cable length 460mm rotation flange fryer fryer connection length 90mm 2		
For models:	EF74E12, F12C4E12, F74E10, F74E12, F76E10, F78E12, F94E10, F94E12, F94E18, F94E18K, F96E10, F98E12, F98E18, F98E18K, F9S4E12, F9S4E18, F9S4E18K, F9S8E12, F9S8E18, F9S8E18K		
accessories for	416813		
	GEV No.	550449	Ref. No. —
	special wrench for ring nut		
	GEV No.	550496	Ref. No. CM099200 MACM099200
	O-ring Viton thickness 3.53mm ID ø 50.39mm Qty 1 pcs		
	GEV No.	550662	Ref. No. CM021600 MACM021600
	ring nut thread M54x1.5 H 7mm		

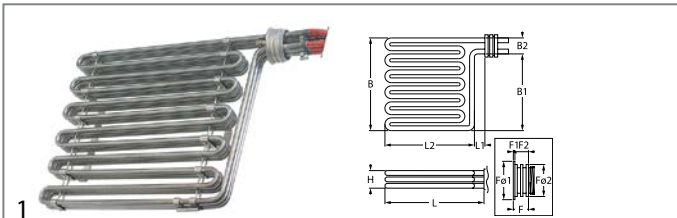

GEV No.	416814	Ref. No.	CM032401 CM032401R MACM032401 MACM032401R
description	heating element 16500W 230/400V heating circuits 3 mounting pos. right L 400mm W 315mm H 36mm flange length 23mm flange length 1 2mm flange length 2 21mm flange ø1 63mm flange ø2 57.5mm sensor screw connection 2x M10x1 thermostat sleeve eccentric L1 15mm L2 378mm W1 282mm W2 33mm thread M54x1.5 windings 6 for o-ring ø 50.39mm tube ø 8.5mm cable length 280mm connection cable rotation flange immersion heater fryer connection length 75mm 2		
For models:	F74E10, F74E12, F76E10, F78E12, F94E10, F94E12, F94E18, F94E18K, F96E10, F98E12, F98E18, F98E18K, F954E12, F954E18, F954E18K, F958E12, F958E18, F958E18K		

accessories for	416814			
	GEV No.	106605	Ref. No.	CM012401 MACM012401
	union screw thread M10x1 probe ø max. 4.5mm			
	GEV No.	528687	Ref. No.	CM097900 MACM097900
	O-ring Viton thickness 1.78mm ID ø 3.69mm Qty 1 pcs			
	GEV No.	550496	Ref. No.	CM099200 MACM099200
	O-ring Viton thickness 3.53mm ID ø 50.39mm Qty 1 pcs			
	GEV No.	550662	Ref. No.	CM021600 MACM021600
	ring nut thread M54x1.5 H 7mm			

off-center connection
with thread

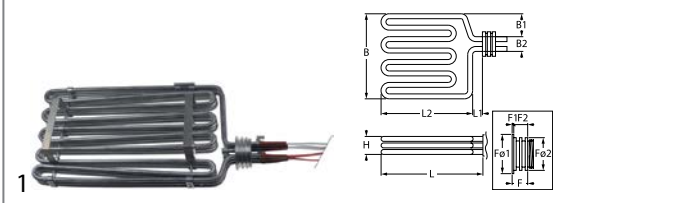

GEV No.	420113	Ref. No.	CR0583860 CR0583860R
description	heating element 12000W 230V heating circuits 3 L 385mm W 205mm H 32mm flange length 21mm flange length 1 2mm flange length 2 19mm flange ø1 63mm flange ø2 54mm sensor screw connection 2x M10x1 thermostat sleeve upper/lower L1 20mm L2 365mm W1 45mm W2 32mm thread M54x1.5 tube ø 8.5mm cable length 300mm rotation flange immersion heater with probe intake ø 4mm for fryer		
For models:	NF74E15, NF78E15, NF94E15, NF98E15		

accessories for	420113			
	GEV No.	532681	Ref. No.	CR0582140
	O-ring Viton thickness 3.53mm ID ø 66.27mm Qty 1 pcs			
	GEV No.	550496	Ref. No.	CM099200 MACM099200
	O-ring Viton thickness 3.53mm ID ø 50.39mm Qty 1 pcs			
	GEV No.	550662	Ref. No.	CM021600 MACM021600
	ring nut thread M54x1.5 H 7mm			

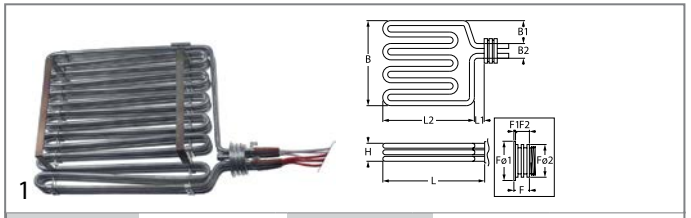

GEV No.	420112	Ref. No.	CR0583740 CR0583740R
description	heating element 18000W 400V heating circuits 3 L 387mm W 305mm H 34mm flange length 21mm flange length 1 2.5mm flange length 2 18.5mm flange ø1 63mm flange ø2 54mm sensor screw connection 2x M10x1 thermostat sleeve upper/lower L1 25mm L2 362mm W1 45mm W2 32mm thread M54x1.5 tube ø 8.5mm cable length 350mm rotation flange immersion heater with probe intake ø 4mm for fryer		
For models:	NF94E22, NF94E222, NF94E222K, NF94E22K, NF98E22, NF98E222, NF98E222K, NF98E22K		

accessories for	420112			
	GEV No.	550496	Ref. No.	CM099200 MACM099200
	O-ring Viton thickness 3.53mm ID ø 50.39mm Qty 1 pcs			

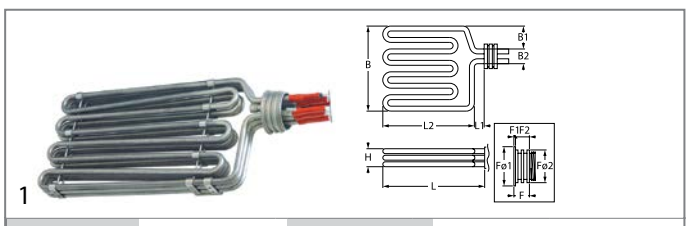

GEV No.	416812	Ref. No.	1037316601 1037316601R MA1037316601 MA1037316601R
description	heating element 9000W 230/400V heating circuits 3 mounting pos. right L 360mm W 170mm H 35mm flange length 21mm flange length 1 2mm flange length 2 19mm flange ø1 63mm flange ø2 57.5mm thermostat sleeves ø 6.5mm sensor screw connection 2x M10x1 thermostat sleeve upper/lower L1 25mm L2 335mm W1 40mm W2 33mm thread M54x1.5 tube ø 8.7mm cable length 250mm rotation flange immersion heater with probe intake ø 4mm fryer code 3000 2		
For models:	EF74E10VG, F74E10, F74E6, F76E10, F94E10, F94E6, F96E10, FQE41R, FQE41RL, FQE41RL2, FQE61R, FQE61RL, NF74E10, NF76E10, NF94E10, NF96E10		

accessories for	416812			
	GEV No.	550496	Ref. No.	CM099200 MACM099200
	O-ring Viton thickness 3.53mm ID ø 50.39mm Qty 1 pcs			
	GEV No.	550662	Ref. No.	CM021600 MACM021600
	ring nut thread M54x1.5 H 7mm			





GEV No.	415090	Ref. No.	1037039900 1037039915 892900 MA1037039915
description	heating element 5500W 230/400V heating circuits 3 L 325mm W 200mm H 210mm L1 15mm L2 310mm W1 67mm W2 66mm H1 183mm H2 25mm windings 12 flange length 115mm flange width 30mm hole distance 95mm hole ø 7mm connection M4 rectangular flange fryer heaters		
For models:	FQE40, FQE40D, FQE40DSP, FQE60, FQE60D, FQE60DSP		
accessories for	415090		
	GEV No.	521103	Ref. No. —
	nut thread M4 H 3mm WS 7 brass Qty 20 pcs		
	GEV No.	521104	Ref. No. —
	washer ID ø 4.3mm ED ø 8mm thickness 0.5mm brass Qty 20 pcs for thread M4		
	GEV No.	560111	Ref. No. —
	plain washer ID ø 4.3mm ED ø 9mm thickness 0.8mm SS Qty 20 pcs DIN 125A for thread M4		
	GEV No.	560131	Ref. No. —
	hexagonal nut thread M4 H 3.2mm WS 7 SS DIN/ISO DIN 934 / ISO 4032/8673 Qty 20 pcs		

GEV No.	415963	Ref. No.	1037301600 1037301615 MA1037301615
description	heating element 7500W 230/400V heating circuits 3 L 330mm W 194mm H 212mm L1 20mm L2 310mm W1 63mm W2 68mm H1 177mm H2 35mm windings 12 flange length 115mm flange width 30mm hole distance 95mm hole ø 6.5mm connection clamp tube ø 8.5mm rectangular flange fryer		
For models:	FQE40, FQE40D, FQE40DSP, FQE60, FQE60D, FQE60DSP, FR74E10, FR77E10, FR92E10, FR94E10, FR9P2E10, FR9P4E10		

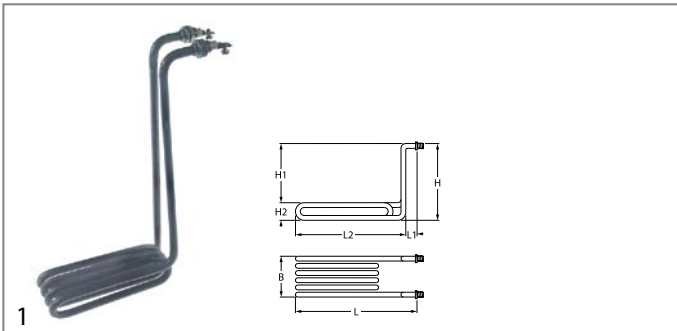

<p>2 hole fixing</p>			
GEV No.	415962	Ref. No.	1037314944
description	heating element 2000W 230V heating circuits 1 L 318mm W 58mm H 200mm W1 8mm W2 40mm H1 155mm H2 45mm mounting distance 33mm thread M12x1 tube ø 8.5mm connection length 30mm connection male faston 6.3mm 2 hole fixing immersion heater		
For models:	FQE41, FQE41L, FQE41L2, FQE61, FQE61L, FQE61L2, FR74E10, FR74E10L, FR74E10L2, FR77E10, FR77E10L, FR77E10L2, FR92E10, FR92E10L, FR92E10L2, FR94E10, FR94E10L, FR94E10L2		
accessories for	415962		
	GEV No.	361182	Ref. No. —
	nut thread 1/4" H 5mm nickel-plated brass WS 17 Qty 1 pcs		
	GEV No.	510417	Ref. No. —
	flat gasket fibre ED ø 20mm ID ø 14mm thickness 2mm Qty 1 pcs		
	GEV No.	520228	Ref. No. —
	tooth lock washer ID ø 15.3mm ED ø 24mm steel Qty 1 pcs for thread M14		
	GEV No.	550262	Ref. No. —
	flat gasket copper ED ø 20mm ID ø 14mm thickness 2mm		

GEV No.	415961	Ref. No.	1037313044
description	heating element 3000W 230V heating circuits 1 L 325mm W 54mm H 206mm W1 9mm W2 37mm H1 167mm H2 42mm mounting distance 25mm thread M12x1 tube ø 8.5mm connection male faston 6.3mm 2 hole fixing immersion heater		
For models:	FQE41, FQE41L, FQE41L2, FQE61, FQE61L, FQE61L2, FR74E10, FR74E10L, FR74E10L2, FR77E10, FR77E10L, FR77E10L2, FR92E10, FR92E10L, FR92E10L2, FR94E10, FR94E10L, FR94E10L2		
accessories for	415961		
	GEV No.	520229	Ref. No. —
	nut thread M12x1 H 4mm WS 16 zinc-coated steel Qty 1 pcs		
	GEV No.	521110	Ref. No. —
	flat gasket fibre ED ø 20mm ID ø 13mm thickness 2mm Qty 1 pcs		
	GEV No.	521131	Ref. No. —
	nut thread M12x1 H 3.5mm WS 17 SS Qty 1 pcs		
	GEV No.	528110	Ref. No. —
	O-ring EPDM thickness 2.62mm ID ø 12.37mm Qty 1 pcs		



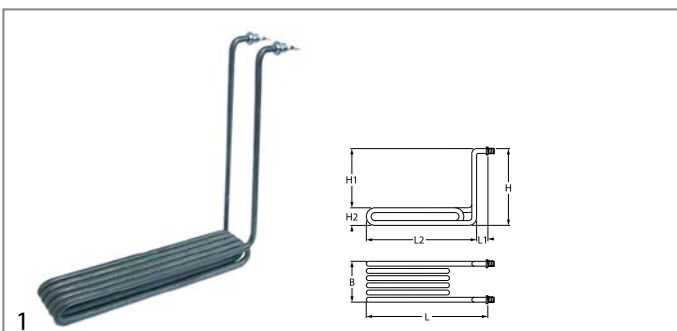





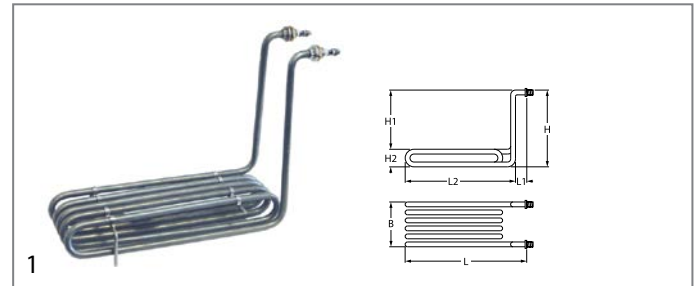

GEV No.	415976	Ref. No.	1750000 MA1750000
description	heating element 2300W 230V heating circuits 1 L 210mm W 66mm H 315mm L1 40mm L2 170mm H1 270mm H2 45mm thread M14x1.5 tube ø 10mm 2 hole fixing connection M5 windings 4 suitable for 700 series		
For models:	FR74E, FR77E		
accessories for	415976		
	GEV No.	560112	Ref. No. 15830499 MA15830499
	plain washer ID ø 5.3mm ED ø 10mm thickness 1mm SS Qty 20 pcs DIN 125A for thread M5		
	GEV No.	560132	Ref. No. —
	hexagonal nut thread M5 H 4mm WS 8 SS DIN/ISO DIN 934 / ISO 4032/8673 Qty 20 pcs		



GEV No.	415986	Ref. No.	1464000 1466200 MA1464000 MA1466200
description	heating element 5000W 220V heating circuits 1 L 346mm W 58mm H 330mm L1 26mm L2 320mm H1 288mm H2 42mm thread M14x1.25 tube ø 10mm 2 hole fixing connection M5 fryer windings 5 suitable for 900 series		
For models:	FR92E13, FR92E132, FR92E13T, FR92E13T2, FR92E22, FR92E22T, FR94E13, FR94E132, FR94E13T, FR94E13T2, FR94E22, FR94E22T		
accessories for	415986		
	GEV No.	560112	Ref. No. 15830499 MA15830499
	plain washer ID ø 5.3mm ED ø 10mm thickness 1mm SS Qty 20 pcs DIN 125A for thread M5		
	GEV No.	560132	Ref. No. —
	hexagonal nut thread M5 H 4mm WS 8 SS DIN/ISO DIN 934 / ISO 4032/8673 Qty 20 pcs		



GEV No.	416576	Ref. No.	1037305600 MA1037305600
description	heating element 2500W 220V heating circuits 1 L 285mm W 98mm H 214mm L1 20mm L2 265mm H1 174mm H2 40mm thread M12x1 tube ø 8.5mm 2 hole fixing connection M4 connection length 77mm fryer heaters windings 5		
For models:	FQE4		
accessories for	416576		
	GEV No.	520229	Ref. No. —
	nut thread M12x1 H 4mm WS 16 zinc-coated steel Qty 1 pcs		
	GEV No.	521103	Ref. No. —
	nut thread M4 H 3mm WS 7 brass Qty 20 pcs		
	GEV No.	521104	Ref. No. —
	washer ID ø 4.3mm ED ø 8mm thickness 0.5mm brass Qty 20 pcs for thread M4		
	GEV No.	521110	Ref. No. —
	flat gasket fibre ED ø 20mm ID ø 13mm thickness 2mm Qty 1 pcs		
	GEV No.	521131	Ref. No. —
	nut thread M12x1 H 3.5mm WS 17 SS Qty 1 pcs		
	GEV No.	528110	Ref. No. —
	O-ring EPDM thickness 2.62mm ID ø 12.37mm Qty 1 pcs		
	GEV No.	560111	Ref. No. —
	plain washer ID ø 4.3mm ED ø 9mm thickness 0.8mm SS Qty 20 pcs DIN 125A for thread M4		
	GEV No.	560131	Ref. No. —
	hexagonal nut thread M4 H 3.2mm WS 7 SS DIN/ISO DIN 934 / ISO 4032/8673 Qty 20 pcs		

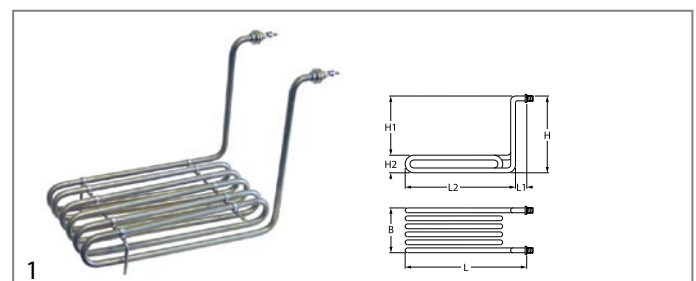



GEV No.	416577	Ref. No.	1037305700 MA1037305700
description	heating element 3500W 230V heating circuits 1 L 288mm W 146mm H 210mm L1 23mm L2 265mm H1 165mm H2 45mm thread 1/4" mounting distance 138mm tube ø 8.5mm 2 hole fixing connection M4 fryer heaters windings 6		
For models:	FQE6, FQE6+6		
accessories for	416577		
	GEV No.	361182	Ref. No. —
	nut thread 1/4" H 5mm nickel-plated brass WS 17 Qty 1 pcs		

Table continues overleaf



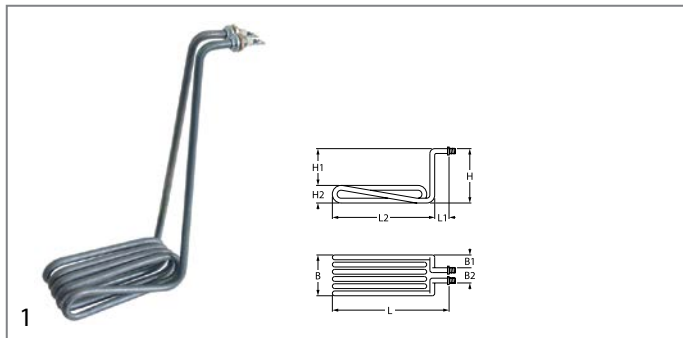

accessories for 416577	
	GEV No. 510417 Ref. No. — flat gasket fibre ED ø 20mm ID ø 14mm thickness 2mm Qty 1 pcs
	GEV No. 520228 Ref. No. — tooth lock washer ID ø 15.3mm ED ø 24mm steel Qty 1 pcs for thread M14
	GEV No. 521103 Ref. No. — nut thread M4 H 3mm WS 7 brass Qty 20 pcs
	GEV No. 521104 Ref. No. — washer ID ø 4.3mm ED ø 8mm thickness 0.5mm brass Qty 20 pcs for thread M4
	GEV No. 550262 Ref. No. — flat gasket copper ED ø 20mm ID ø 14mm thickness 2mm
	GEV No. 560111 Ref. No. — plain washer ID ø 4.3mm ED ø 9mm thickness 0.8mm SS Qty 20 pcs DIN 125A for thread M4
	GEV No. 560131 Ref. No. — hexagonal nut thread M4 H 3.2mm WS 7 SS DIN/ISO DIN 934 / ISO 4032/8673 Qty 20 pcs



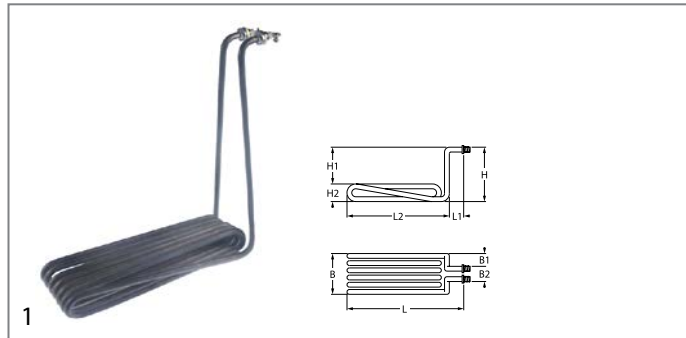



GEV No.	415969	Ref. No.	1982700 MA1982700
description	heating element 2400W 230V heating circuits 1 L 212mm W 74mm H 310mm L1 42mm L2 170mm W1 12mm W2 50mm H1 263mm H2 47mm tube ø 10mm connection M5 thread M14x1.25 2 hole fixing windings 5 mounting distance 54mm fryer connection length 22mm suitable for 700 series		
For models:	FR74E, FR74E2, FR77E, FR77E2		
accessories for 415969			
	GEV No. 560112 Ref. No. 15830499 MA15830499	plain washer ID ø 5.3mm ED ø 10mm thickness 1mm SS Qty 20 pcs DIN 125A for thread M5	
	GEV No. 560132 Ref. No. —	hexagonal nut thread M5 H 4mm WS 8 SS DIN/ISO DIN 934 / ISO 4032/8673 Qty 20 pcs	

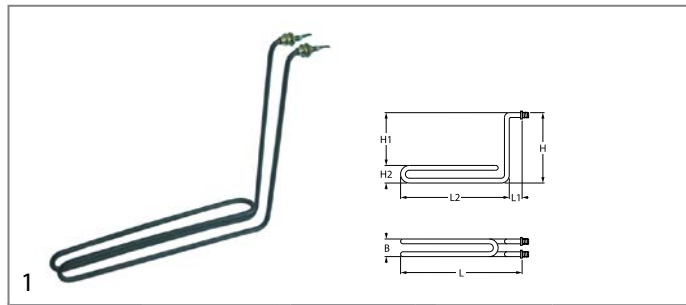

GEV No.	415990	Ref. No.	1982900 MA1982900
description	heating element 5800W 230V heating circuits 1 L 343mm W 110mm H 328mm L1 28mm L2 315mm W1 28mm W2 55mm H1 283mm H2 45mm tube ø 10mm connection M5 thread M14x1.25 2 hole fixing windings 7 mounting distance 96mm fryer connection length 35mm suitable for 900 series		
For models:	FR92E13, FR92E132, FR92E13T, FR92E13T2, FR92E22, FR92E22T, FR94E13, FR94E132, FR94E13T, FR94E13T2, FR94E22, FR94E22T		
accessories for 415990			
	GEV No. 560112 Ref. No. 15830499 MA15830499	plain washer ID ø 5.3mm ED ø 10mm thickness 1mm SS Qty 20 pcs DIN 125A for thread M5	
	GEV No. 560132 Ref. No. —	hexagonal nut thread M5 H 4mm WS 8 SS DIN/ISO DIN 934 / ISO 4032/8673 Qty 20 pcs	



GEV No.	415089	Ref. No.	132522
description	heating element 1850W 240V heating circuits 1 L 355mm W 38mm H 287mm L1 21mm L2 334mm H1 240mm H2 47mm thread 1/4" mounting distance 25mm tube ø 8.5mm 2 hole fixing connection male faston 6.3mm connection length 32mm fryer heaters windings 2		
accessories for 415089			
	GEV No. 361182 Ref. No. —	nut thread 1/4" H 5mm nickel-plated brass WS 17 Qty 1 pcs	
	GEV No. 510417 Ref. No. —	flat gasket fibre ED ø 20mm ID ø 14mm thickness 2mm Qty 1 pcs	
	GEV No. 520228 Ref. No. —	tooth lock washer ID ø 15.3mm ED ø 24mm steel Qty 1 pcs for thread M14	
	GEV No. 550262 Ref. No. —	flat gasket copper ED ø 20mm ID ø 14mm thickness 2mm	

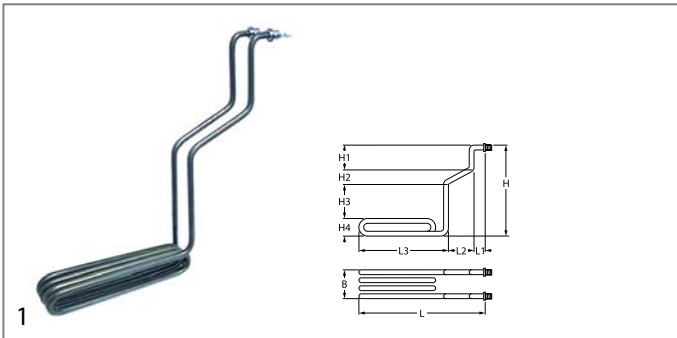

GEV No.	415985	Ref. No.	1463900 1466100 MA1463900 MA1466100
description	heating element 3000W 220V L 350mm W 55mm H 330mm 2 hole fixing connection M5 heating circuits 1 fryer heaters L1 32mm L2 100mm L3 218mm H1 95mm H2 70mm H3 125mm H4 40mm tube ø 10mm thread M14x1.5 mounting distance 45mm connection length 10mm windings 3		
For models:	FR92E13, FR92E132, FR92E13T, FR92E13T2, FR92E22, FR92E22T, FR94E13, FR94E132, FR94E13T, FR94E13T2, FR94E22, FR94E22T		

accessories for	415985		
	GEV No.	510417	Ref. No. —
	flat gasket fibre ED ø 20mm ID ø 14mm thickness 2mm Qty 1 pcs		
	GEV No.	520228	Ref. No. —
	tooth lock washer ID ø 15.3mm ED ø 24mm steel Qty 1 pcs for thread M14		
	GEV No.	520230	Ref. No. —
	nut thread M14x1.5 H 5mm WS 19 zinc-coated steel Qty 1 pcs		
	GEV No.	521101	Ref. No. —
	nut thread M14x1.5 H 5mm WS 19 SS Qty 1 pcs		
	GEV No.	550262	Ref. No. —
	flat gasket copper ED ø 20mm ID ø 14mm thickness 2mm		
	GEV No.	560112	Ref. No. 15830499 MA15830499
	plain washer ID ø 5.3mm ED ø 10mm thickness 1mm SS Qty 20 pcs DIN 125A for thread M5		
	GEV No.	560132	Ref. No. —
	hexagonal nut thread M5 H 4mm WS 8 SS DIN/ISO DIN 934 / ISO 4032/8673 Qty 20 pcs		

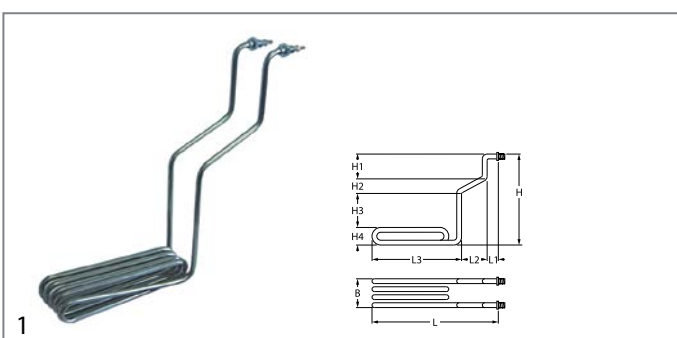

GEV No.	415989	Ref. No.	1982800 MA1982800
description	heating element 3000W 230V L 345mm W 65mm H 325mm 2 hole fixing connection grip connection heating circuits 1 immersion heater L1 30mm L2 95mm L3 220mm H1 96mm H2 55mm H3 130mm H4 44mm tube ø 10mm thread M14x1.25 mounting distance 58mm connection length 35mm windings 5 suitable for 900 series		
For models:	FR92E13, FR92E132, FR92E13T, FR92E13T2, FR92E22, FR92E22T, FR94E13, FR94E132, FR94E13T, FR94E13T2, FR94E22, FR94E22T		



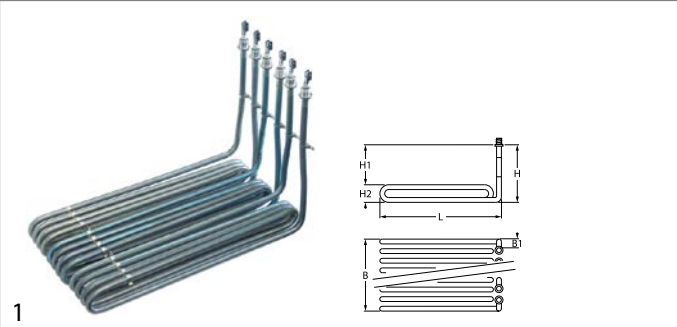

6 hole fixing

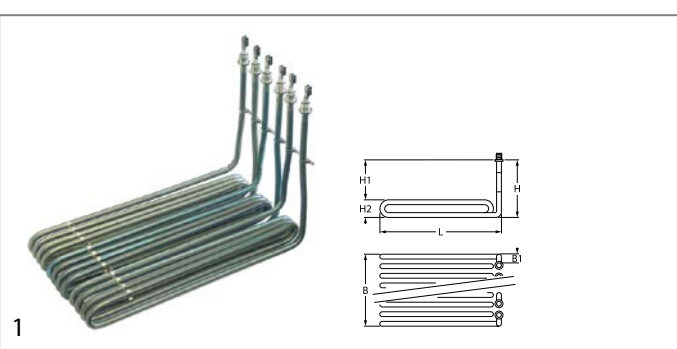

GEV No.	416810	Ref. No.	1037317100 MA1037317100
description	heating element 6000W 230/400V heating circuits 3 L 320mm W 175mm H 205mm W1 5mm H1 165mm H2 40mm thread M12x1 tube ø 8.5mm connection male faston 6.3mm immersion heater 6 hole fixing		
For models:	FQE41, FQE41L, FQE41L2, FQE61, FQE61L, FQE61L2, FR74E10, FR74E10L, FR74E10L2, FR77E10, FR77E10L, FR77E10L2, OFQE41, OFQE61		



GEV No.	416811	Ref. No.	1037317200 MA1037317200
description	heating element 9000W 230V heating circuits 3 L 320mm W 175mm H 205mm W1 5mm H1 165mm H2 40mm thread M12x1 tube ø 8.5mm connection male faston 6.3mm immersion heater 6 hole fixing		
For models:	FQE41, FQE41L, FQE41L2, FQE61, FQE61L, FQE61L2, FR74E10, FR74E10L, FR74E10L2, FR77E10, FR77E10L, FR77E10L2, OFQE41, OFQE61		

spare parts for	416811		
	GEV No.	521110	Ref. No. —
	flat gasket fibre ED ø 20mm ID ø 13mm thickness 2mm Qty 1 pcs		
accessories for	416811		
	GEV No.	520229	Ref. No. —
	nut thread M12x1 H 4mm WS 16 zinc-coated steel Qty 1 pcs		
	GEV No.	521131	Ref. No. —
	nut thread M12x1 H 3.5mm WS 17 SS Qty 1 pcs		
	GEV No.	528110	Ref. No. —
	O-ring EPDM thickness 2.62mm ID ø 12.37mm Qty 1 pcs		



heating elements for griddles







GEV No.	415087	Ref. No.	892800
description	heating element 1300W 220V heating circuits 1 L 428mm W 80mm H 66mm tube ø 6.3mm W1 13mm W2 43mm connection M4 dry heating element		



GEV No.	415982	Ref. No.	1941800 MA1941800
description	heating element 1300W 230V heating circuits 1 L 405mm W 85mm H 100mm tube ø 6.3mm W1 16mm W2 53mm connection clamp connection distance 40mm for grill		
For models:	FT74E, FT74E2, FT74ER, FT74ER2, FT77E, FT77E2, FT77EC, FT77EC2, FT77ECRL, FT77ECRL2, FT77ERL, FT77ERL2		



GEV No.	415076	Ref. No.	1037300700 1037300713 MA1037300713
description	heating element 1300W 230V heating circuits 1 L 490mm W 78mm H 70mm tube ø 6.3mm W1 17mm W2 44mm connection M4 connection length 20mm dry heating element		
For models:	BIE40, BIE40B, BIE60, BIE60B, EFT74ELVG, EFT74ERVG, EFT78ELVG, EFT78EMVG, FTE100B, FTE100BR, FTE100C, FTE100CRL, FTE40B, FTE40BR, FTE40C, FTE40D, FTE40DC, FTE60B, FTE60BR, FTE60BRR, FTE60C, FTE60D, FTE60DC, FTE60DCRL, FTE60DR, OFTE100CRL, OFTE40B, OFTE40BR, OFTE40C, OFTE60B, OFTE60BR, OFTE60BRR, OFTE60C		

accessories for	415076		
	GEV No.	521103	Ref. No. —
	nut thread M4 H 3mm WS 7 brass Qty 20 pcs		
	GEV No.	521104	Ref. No. —
	washer ID ø 4.3mm ED ø 8mm thickness 0.5mm brass Qty 20 pcs for thread M4		
	GEV No.	560111	Ref. No. —
	plain washer ID ø 4.3mm ED ø 9mm thickness 0.8mm SS Qty 20 pcs DIN 125A for thread M4		
	GEV No.	560131	Ref. No. —
	hexagonal nut thread M4 H 3.2mm WS 7 SS DIN/ISO DIN 934 / ISO 4032/8673 Qty 20 pcs		



GEV No.	415085	Ref. No.	167622
description	heating element 1400W 240V heating circuits 1 L 583mm W 50mm H 36mm tube ø 10mm connection M5 griddle dry heating element		



GEV No.	416175	Ref. No.	CM164800 MACM164800
description	heating element 1600W 230V heating circuits 1 L 417mm W 87mm H 90mm tube ø 8.5mm L1 32mm L2 385mm connection M5 griddle connection distance 79mm dry heating element		
For models:	FT129ELC, FT129EM, FT12C9EL, FT12C9ELC, FT12C9EM, FT12C9EMC, FT74EL, FT74ELC, FT74ER, FT76EL, FT76ELC, FT76EM, FT76EMC, FT78EL, FT78ELC, FT78EM, FT78EMC, FT94EL, FT94ELC, FT94ER, FT96EL, FT96ELC, FT96EM, FT96EMC, FT98EL, FT98ELC, FT98EM, FT98EMC, PM129E		







GEV No.	415975	Ref. No.	1730000 MA1730000
description	heating element 1800W 240V heating circuits 1 L 488mm W 84mm H 63mm tube ø 8.5mm W2 47mm connection M5 connection distance 35mm suitable for 700 series for grill		
For models:	FT74E, FT74ER, FT74ERL, FT77E, FT77EC, FT77ERL		





GEV No.	415958	Ref. No.	1941900 MA1941900
description	heating element 1900W 230V heating circuits 1 L 585mm W 90mm H 80mm tube ø 6.3mm L1 585mm W2 50mm connection grip connection length 20mm connection distance 70mm suitable for 900 series for grill		
For models:	F9V2E, F9V2E2, F9V2ER, F9V2ER2, F9V4E, F9V4E2, F9V4EC, F9V4EC2, F9V4ECRL, F9V4ECRL2, F9V4ER, F9V4ER2, F9V4ERL, F9V4ERL2		





GEV No.	415086	Ref. No.	1029200 MA1029200
description	heating element 2000W 220V heating circuits 1 L 600mm W 80mm H 70mm tube ø 6.3mm W1 10mm W2 58mm connection M4 griddle connection distance 45mm dry heating element		
For models:	F9V2E, F9V2ER, F9V4E, F9V4EC, F9V4ECR, F9V4ER, F9V4ERL		
accessories for	415086		
	GEV No.	521103	Ref. No. —
	nut thread M4 H 3mm WS 7 brass Qty 20 pcs		
	GEV No.	521104	Ref. No. —
	washer ID ø 4.3mm ED ø 8mm thickness 0.5mm brass Qty 20 pcs for thread M4		
	GEV No.	560111	Ref. No. —
	plain washer ID ø 4.3mm ED ø 9mm thickness 0.8mm SS Qty 20 pcs DIN 125A for thread M4		
	GEV No.	560131	Ref. No. —
	hexagonal nut thread M4 H 3.2mm WS 7 SS DIN/ISO DIN 934 / ISO 4032/8673 Qty 20 pcs		





			
GEV No.	420105	Ref. No.	CR0731580
description	heating element 2000W 230V heating circuits 1 L 480mm W 90mm H 42mm tube ø 8.5mm IRCA L1 50mm L2 430mm W1 49mm W2 20mm flange connection connection M5 hole distance 89mm flange length 100mm flange width 35mm hole ø 6mm windings 2 dry heating element		
For models:	NG74E, NG74E2, NG78E, NG78E2		

			
GEV No.	416180	Ref. No.	CM165100 MACM165100
description	heating element 2200W 230V heating circuits 1 L 420mm W 130mm H 92mm tube ø 8.5mm L1 24mm L2 396mm connection M5 connection distance 122mm dry heating element		
For models:	FT74EL, FT74ELC, FT74ER, FT76EL, FT76ELC, FT76EM, FT76EMC, FT78EL, FT78ELC, FT78EM, FT78EMC, FT94EL, FT94ELC, FT94ER, FT96EL, FT96ELC, FT96EM, FT96EMC, FT98EL, FT98ELC, FT98EM, FT98EMC		

			
GEV No.	416694	Ref. No.	CM164900 MACM164900
description	heating element 2200W 230V heating circuits 1 L 570mm W 110mm H 90mm tube ø 8.5mm L1 20mm L2 550mm connection M5 griddle connection distance 102mm suitable for 900 series dry heating element		
For models:	FT74EL, FT74ELC, FT74ER, FT76EL, FT76ELC, FT76EM, FT76EMC, FT78EL, FT78ELC, FT78EM, FT78EMC, FT94EL, FT94ELC, FT94ER, FT96EL, FT96ELC, FT96EM, FT96EMC, FT98EL, FT98ELC, FT98EM, FT98EMC		

			
GEV No.	420109	Ref. No.	CR0582840
description	heating element 2500W 230V heating circuits 1 L 635mm W 90mm H 80mm L1 30mm connection M5 connection distance 81.5mm tube ø 8.5mm connection length 18mm dry heating element for griddle		
For models:	NFT94EL, NFT94ELC, NFT94ELO, NFT94ER, NFT96EL, NFT96ELC, NFT96EM, NFT96EMC, NFT98EL, NFT98ELC, NFT98ELO, NFT98EM, NFT98EMC		

			
GEV No.	420415	Ref. No.	CR0937830
description	heating element 2600W 230V heating circuits 1 L 480mm W 90mm H 42mm tube ø 8.5mm L1 50mm L2 430mm W1 49mm W2 20mm flange connection connection M5 hole distance 89mm flange length 100mm flange width 35mm hole ø 6mm windings 2 dry heating element		

			
GEV No.	416695	Ref. No.	CM165200 MACM165200
description	heating element 3300W 230V heating circuits 1 L 570mm W 130mm H 90mm tube ø 8.5mm L1 20mm L2 550mm griddle dry heating element		
For models:	FT74EL, FT74ELC, FT74ER, FT76EL, FT76ELC, FT76EM, FT76EMC, FT78EL, FT78ELC, FT78EM, FT78EMC, FT94EL, FT94ELC, FT94ER, FT96EL, FT96ELC, FT96EM, FT96EMC, FT98EL, FT98ELC, FT98EM, FT98EMC		

heating elements for refrigeration

heating elements for defrosting

			
GEV No.	416325	Ref. No.	24769.35 MA2476935
description	heating element 105W 230V L 410mm W 295mm H 6.5mm L1 93mm L2 317mm W1 257mm W2 38mm cable length 2500mm tube ø 6.3mm immersion heater defrosting		
For models:	AF140B, AF140C, AF140F, AF140I, AF140MB, AF140MC, AF140MF, AF140MI, AF140MN, AF140MP, AF140N, AF140P, AF14F, AF14G, AF14N, AF70B, AF70C, AF70F, AF70I, AF70MB, AF70MC, AF70MF, AF70MI, AF70MN, AF70MP, AF70N, AF70P, AF72B, AF72C, AF72F, AF72I, AF72N, AF72P, AF7C, AF7F, AF7G, EF140DF, EF140DN, EF140DP, EF140MB, EF140MC, EF140MF, EF140MI, EF140MN, EF140MP, EF70DF, EF70DN, EF70DP, EF70MB, EF70MC...(Other models you can see in the webshop)		



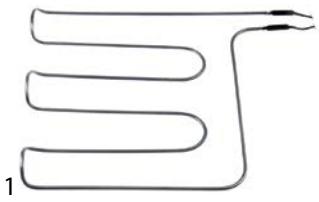

			
GEV No.	416326	Ref. No.	24752.00 24752.15 MA2475215
description	heating element 365W 230V L 435mm W 133mm H 50mm cable length 1200mm tube ø 6.5mm connection length 55mm defrosting		
For models:	AF140B, AF140C, AF140F, AF140I, AF140MB, AF140MC, AF140MF, AF140MI, AF140MN, AF140MP, AF140N, AF140P, AF14F, AF14G, AF14N, AF70B, AF70C, AF70F, AF70I, AF70MB, AF70MC, AF70MF, AF70MI, AF70MN, AF70MP, AF70N, AF70P, AF72B, AF72C, AF72F, AF72I, AF72N, AF72P, AF7C, AF7F, AF7G, EF140DF, EF140DN, EF140DP, EF140MB, EF140MC, EF140MF, EF140MI, EF140MN, EF140MP, EF143MNI, EF70DF, EF70DN, EF70DP, EF70MB...(Other models you can see in the webshop)		





GEV No.	418744	Ref. No.	2315200
description	heating element 450W 220V L 400mm W 400mm L1 70mm L2 330mm W1 50mm W2 350mm defrosting		
For models:	AFC14, AFC14V, AFC7, AFC7V, AFPC214, AFPC214P, AFPC214V, AFR1143P, AFR14, AFR14V, AFR214P, AFR214PV, AFR7, AFR7P, AFR7PV, AFR7V, AFRC214, AFRC214V		

heating elements for tilting bratt pan







GEV No.	415076	Ref. No.	1037300700 1037300713 MA1037300713
description	heating element 1300W 230V heating circuits 1 L 490mm W 78mm H 70mm tube ø 6.3mm W1 17mm W2 44mm connection M4 connection length 20mm dry heating element		
For models:	BIE40, BIE40B, BIE60, BIE60B, EFT74ELVG, EFT74ERVG, EFT78ELVG, EFT78EMVG, FTE100B, FTE100BR, FTE100C, FTE100CRL, FTE40B, FTE40BR, FTE40C, FTE40D, FTE40DC, FTE60B, FTE60BR, FTE60BRR, FTE60C, FTE60D, FTE60DC, FTE60DCRL, FTE60DR, OFTE100CRL, OFTE40B, OFTE40BR, OFTE40C, OFTE60B, OFTE60BR, OFTE60BRR, OFTE60C		
accessories for	415076		
	GEV No.	521103	Ref. No. —
	nut thread M4 H 3mm WS 7 brass Qty 20 pcs		
	GEV No.	521104	Ref. No. —
	washer ID ø 4.3mm ED ø 8mm thickness 0.5mm brass Qty 20 pcs for thread M4		
	GEV No.	560111	Ref. No. —
	plain washer ID ø 4.3mm ED ø 9mm thickness 0.8mm SS Qty 20 pcs DIN 125A for thread M4		
	GEV No.	560131	Ref. No. —
	hexagonal nut thread M4 H 3.2mm WS 7 SS DIN/ISO DIN 934 / ISO 4032/8673 Qty 20 pcs		



GEV No.	415973	Ref. No.	1685100 1686900 MA1686900
description	heating element 2700W 240V heating circuits 1 L 360mm W 141mm H 85mm L1 55mm connection M4 connection distance 133mm tube ø 10mm connection length 25mm tilting bratt pan L2 305mm suitable for 700 series		
For models:	BR707E, BR707EI, BR78EF, BR78EI, BR912EFM, BR912EIM, BR98EF, BR98EFM, BR98EI, BR98EIM, BR9S8EF, BR9S8EI		



GEV No.	415084	Ref. No.	1475600 1878700 MA1878700
description	heating element 3900W 240V L 520mm W 170mm H 94mm connection M4 tilting bratt pan heating circuits 1 tube ø 10mm L1 58mm L2 200mm connection length 25mm connection distance 160mm		
For models:	BR78EF, BR78EI, BR912EFM, BR912EIM, BR94E, BR94EI, BR98EF, BR98EFM, BR98EI, BR98EIM, BR9M4E, BR9M4EI, BR9M4GI, BR9M6E, BR9M6EI, BR9S8EF, BR9S8EI, BR9SB4E, BR9SB4EI		
accessories for	415084		
	GEV No.	521103	Ref. No. —
	nut thread M4 H 3mm WS 7 brass Qty 20 pcs		
	GEV No.	521104	Ref. No. —
	washer ID ø 4.3mm ED ø 8mm thickness 0.5mm brass Qty 20 pcs for thread M4		
	GEV No.	560111	Ref. No. —
	plain washer ID ø 4.3mm ED ø 9mm thickness 0.8mm SS Qty 20 pcs DIN 125A for thread M4		
	GEV No.	560131	Ref. No. —
	hexagonal nut thread M4 H 3.2mm WS 7 SS DIN/ISO DIN 934 / ISO 4032/8673 Qty 20 pcs		

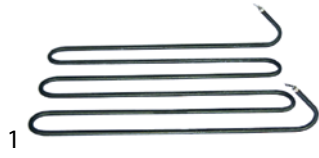

GEV No.	415987	Ref. No.	1493800 1878800 MA1878800
description	heating element 5850W 230V L 530mm W 295mm H 90mm connection male faston for grill heating circuits 1 tube ø 10mm L1 80mm connection distance 275mm		
For models:	BR78EF, BR78EI, BR912EFM, BR912EIM, BR94E, BR94EI, BR96E, BR96EI, BR98EF, BR98EFM, BR98EI, BR98EIM, BR9M4E, BR9M4EI, BR9M4GI, BR9M6E, BR9M6EI, BR9S8EF, BR9S8EI, BR9SB4E, BR9SB4EI		



GEV No.	420104	Ref. No.	CR0683221
description	heating element for tilting bratt pan 5000W 230V L 555mm W 180mm H 30mm connection M5 dry heating element heating circuits 1 tube ø 8.5mm L1 25mm L2 530mm W1 45mm W2 90mm flange connection flange length 170mm flange width 30mm hole ø 6.3mm windings 3		
For models:	NBR912EFM, NBR912EIM, NBR98EF, NBR98EFM, NBR98EI, NBR98EIM		

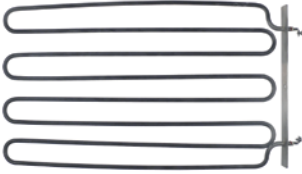

GEV No.	420106	Ref. No.	CR0684240
description	heating element for tilting bratt pan 6350W 230V L 550mm W 320mm H 24mm connection M5 dry heating element heating circuits 1 tube ø 8.5mm L1 45mm L2 505mm W1 48mm W2 225mm flange connection flange length 305mm flange width 30mm hole ø 6mm windings 4		
For models:	NBR912EFM, NBR912EIM, NBR98EF, NBR98EFM, NBR98EI, NBR98EIM		



GEV No.	415077	Ref. No.	1037301700 1037301713 MA1037301713
description	heating element stock pot 1300W 230V L 280mm W 150mm H 40mm connection male faston 6.3mm tilting bratt pan heating circuits 1 tube ø 8.5mm bracket mounting hole distance 142mm hole ø 5mm lug length 25mm lug width 15mm		
For models:	BRE40, BRE40D, BRE40DB, BRE40DG, BRE40DGB, BRE40G, OBRE40		

heating elements for pasta cookers













GEV No.	415020	Ref. No.	110331
description	heating element 4500W 230V mounting ø 57.5mm heating circuits 3 L 355mm W 35mm H 47mm number of thermostat sleeves 1 thermostat sleeves ø 7mm length thermostat sleeves 295mm thermostat sleeve upper tube ø 8.5mm hole distance 70mm hole ø 10mm connection length 25mm connection male faston 6.3mm 3 hole flange immersion heater		





GEV No.	420096	Ref. No.	CR0731030 CR0731030R
description	heating element 5600W 230V heating circuits 3 L 255mm W 210mm H 32mm rotation flange thread M54x1.5 tube ø 8.4mm L1 60mm L2 195mm W1 180mm W2 30mm cable length 1200mm windings 2 flange length 1 2mm flange length 2 20mm flange length 21mm flange ø1 63mm flange ø2 54mm for pasta cooker immersion heater		
For models:	NPC74E, NPC78E		



GEV No.	415977	Ref. No.	1870000 1870000R MA1870000 MA1870000R	
description	heating element 5670W 230V heating circuits 3 L 292mm W 225mm H 26mm rotation flange tube ø 6.3mm thermostat sleeves ø 9mm length thermostat sleeves 185mm L1 42mm L2 250mm W1 197mm W2 28mm cable length 460mm number of thermostat sleeves 1 connection length 50mm flange length 1 9mm flange length 2 15.5mm flange length 24.5mm flange ø1 43.8mm flange ø2 39.7mm thermostat sleeve centred, adjacent pasta cooker sensor screw connection M10x1			
For models:	CP704E, EPC74E, PC12C4E, PC12C9E, PC74E, PC76E, PC78E, PC94E, PC96E, PC98E, PC9S4E, PC9S6E, PC9S8E			
accessories for	415977			
	GEV No.	514016	Ref. No.	1036500400 1814500 MA1814500
	flat gasket PTFE ED ø 45mm ID ø 40mm thickness 4mm Qty 1 pcs equiv. no. 1036500400/1814500 suitable for MARENO			
	GEV No.	514017	Ref. No.	0105246 1036500200 1814400 MA1814400 R0105246 SIR0105246
	O-ring silicone thickness 3.53mm ID ø 32.93mm Qty 1 pcs			
	GEV No.	514018	Ref. No.	1033703500 1814600 MA1814600
	bush			
	GEV No.	514020	Ref. No.	1036500100 1815000 1815014 MA1815014
	bush			
	GEV No.	514021	Ref. No.	1036500300 1814700 MA1814700
	O-ring silicone thickness 3.53mm ID ø 49.21mm Qty 1 pcs			
	GEV No.	514022	Ref. No.	1032300100 14044599 MA14044599
	nut thread 1½" H 12mm SS WS 59 Qty 1 pcs			
	GEV No.	540435	Ref. No.	1869600 MA1869600
	threaded rod thread M10 hollow			
	GEV No.	540436	Ref. No.	1033514900 MA1033514900
	hexagonal nut thread M10x1.25 H 4mm WS 13 brass Qty 1 pcs			
	GEV No.	540438	Ref. No.	1868700 MA1868700
	long nut thread M10 L 25mm WS 13 brass Qty 1 pcs			
	GEV No.	540439	Ref. No.	1869500 MA1869500
	distance washer			



			
GEV No.	415991	Ref. No.	1814213 1869900 1869900R MA1869900 MA1869900R
description	heating element 8499W 230V heating circuits 3 L 405mm W 225mm H 25mm rotation flange tube ø 6.3mm thermostat sleeves ø 9mm length thermostat sleeves 223mm L1 40mm L2 365mm W1 196mm W2 29mm cable length 1250mm number of thermostat sleeves 1 connection length 48mm flange length 1 9mm flange length 2 15.5mm flange length 24.5mm flange ø1 43.8mm flange ø2 39.7mm suitable for 900 series thermostat sleeve centred, adjacent pasta cooker sensor screw connection M10x1		
For models:	CP92E, CP92E2, CP94E, CP94E2, CP95B2E, CP95B2E2, CP95B4E, CP95-B4E2, DE92142, DE94242, PC12C9E, PC74E, PC76E, PC78E, PC94E, PC96E, PC98E, PC954E, PC956E, PC958E		
accessories for	415991		
	GEV No.	514016	Ref. No. 1036500400 1814500 MA1814500
	flat gasket PTFE ED ø 45mm ID ø 40mm thickness 4mm Qty 1 pcs equiv. no. 1036500400/1814500 suitable for MARENO		
	GEV No.	514017	Ref. No. 0105246 1036500200 1814400 MA1814400 R0105246 SIR0105246
	O-ring silicone thickness 3.53mm ID ø 32.93mm Qty 1 pcs		
	GEV No.	514018	Ref. No. 1033703500 1814600 MA1814600
	bush		
	GEV No.	514019	Ref. No. 1033202200 1033709000 MA1033202200
	threaded rod thread M8 L 45mm brass		
	GEV No.	514020	Ref. No. 1036500100 1815000 1815014 MA1815014
	bush		
	GEV No.	514021	Ref. No. 1036500300 1814700 MA1814700
	O-ring silicone thickness 3.53mm ID ø 49.21mm Qty 1 pcs		
	GEV No.	514022	Ref. No. 1032300100 14044599 MA14044599
	nut thread 1½" H 12mm SS WS 59 Qty 1 pcs		
	GEV No.	540435	Ref. No. 1869600 MA1869600
	threaded rod thread M10 hollow		
	GEV No.	540436	Ref. No. 1033514900 MA1033514900
	hexagonal nut thread M10x1.25 H 4mm WS 13 brass Qty 1 pcs		
	GEV No.	540438	Ref. No. 1868700 MA1868700
	long nut thread M10 L 25mm WS 13 brass Qty 1 pcs		
	GEV No.	540439	Ref. No. 1869500 MA1869500
	distance washer		

			
GEV No.	420098	Ref. No.	CR0582040 CR0582040R
description	heating element 8500W 230V heating circuits 3 L 378mm W 210mm H 32mm rotation flange thread M54x1.5 tube ø 8.4mm L1 68mm L2 310mm W1 178mm W2 32mm cable length 1250mm windings 3 flange length 1 2mm flange length 2 19mm flange length 21mm flange ø1 63mm flange ø2 54mm for pasta cooker immersion heater		
For models:	NPC94E, NPC98E		
accessories for	420098		
	GEV No.	514419	Ref. No. —
	bracket for heating element L 68mm W 20mm H 28mm		
	GEV No.	550496	Ref. No. CM099200 MACM099200
	O-ring Viton thickness 3.53mm ID ø 50.39mm Qty 1 pcs		





			
GEV No.	415971	Ref. No.	1037305810 1870100 1870100R MA1870100 MA1870100R
description	heating element 9000W 230/415V heating circuits 3 L 245mm W 320mm H 25mm rotation flange tube ø 6.3mm thermostat sleeves ø 7mm length thermostat sleeves 210mm L1 55mm L2 190mm W1 28mm W2 292mm cable length 600mm number of thermostat sleeves 1 connection length 35mm flange length 1 9mm flange length 2 15.5mm flange length 24.5mm flange ø1 43.8mm flange ø2 39.7mm mounting pos. left suitable for 600 series thermostat sleeve centred, adjacent pasta cooker sensor screw connection M10x1		
For models:	CPE60, CPE602, CPE60DB, OCP66, OCP660, PC12C4E, PC12C9E, PC74E, PC76E, PC78E, PC94E, PC96E, PC98E, PC954E, PC956E, PC958E		
accessories for	415971		
	GEV No.	514016	Ref. No. 1036500400 1814500 MA1814500
	flat gasket PTFE ED ø 45mm ID ø 40mm thickness 4mm Qty 1 pcs equiv. no. 1036500400/1814500 suitable for MARENO		
	GEV No.	514017	Ref. No. 0105246 1036500200 1814400 MA1814400 R0105246 SIR0105246
	O-ring silicone thickness 3.53mm ID ø 32.93mm Qty 1 pcs		
	GEV No.	514018	Ref. No. 1033703500 1814600 MA1814600
	bush		
	GEV No.	514019	Ref. No. 1033202200 1033709000 MA1033202200
	threaded rod thread M8 L 45mm brass		



Table continues overleaf



accessories for		415971	
	GEV No.	514020	Ref. No. 1036500100 1815000 1815014 MA1815014
bush			
	GEV No.	514021	Ref. No. 1036500300 1814700 MA1814700
O-ring silicone thickness 3.53mm ID ø 49.21mm Qty 1 pcs			
	GEV No.	514022	Ref. No. 1032300100 14044599 MA14044599
nut thread 1½" H 12mm SS WS 59 Qty 1 pcs			
	GEV No.	540435	Ref. No. 1869600 MA1869600
threaded rod thread M10 hollow			
	GEV No.	540436	Ref. No. 1033514900 MA1033514900
hexagonal nut thread M10x1.25 H 4mm WS 13 brass Qty 1 pcs			
	GEV No.	540438	Ref. No. 1868700 MA1868700
long nut thread M10 L 25mm WS 13 brass Qty 1 pcs			
	GEV No.	540439	Ref. No. 1869500 MA1869500
distance washer			



GEV No.	420097	Ref. No.	CR0688330
description	heating element 9000W 230V heating circuits 3 L 250mm W 325mm H 32mm rotation flange thread M54x1.5 tube ø 8.3mm L1 200mm L2 50mm W1 293mm W2 32mm cable length 1200mm windings 2 flange length 1 2mm flange length 2 19mm flange length 21mm flange ø1 63mm flange ø2 54mm for pasta cooker immersion heater		
For models:	NPC76E, NPC96E		

accessories for		420097	
	GEV No.	504230	Ref. No. 15119299 MA15119299
grub screw thread M5 L 8mm A2-A2L DIN 914/ISO 4027 WS 2.5 Qty 1 pcs			
	GEV No.	550496	Ref. No. CM099200 MACM099200
O-ring Viton thickness 3.53mm ID ø 50.39mm Qty 1 pcs			
	GEV No.	550662	Ref. No. CM021600 MACM021600
ring nut thread M54x1.5 H 7mm			



GEV No.	415094	Ref. No.	1037305800
description	heating element 9000W 230V heating circuits 3 rotation flange pasta cooker immersion heater		
accessories for	415094		
	GEV No.	514016	Ref. No. 1036500400 1814500 MA1814500
flat gasket PTFE ED ø 45mm ID ø 40mm thickness 4mm Qty 1 pcs equiv. no. 1036500400/1814500 suitable for MARENO			

accessories for		415094	
	GEV No.	514017	Ref. No. 0105246 1036500200 1814400 MA1814400 R0105246 SIR0105246
O-ring silicone thickness 3.53mm ID ø 32.93mm Qty 1 pcs			
	GEV No.	514018	Ref. No. 1033703500 1814600 MA1814600
bush			
	GEV No.	514019	Ref. No. 1033202200 1033709000 MA1033202200
threaded rod thread M8 L 45mm brass			
	GEV No.	514020	Ref. No. 1036500100 1815000 1815014 MA1815014
bush			
	GEV No.	514021	Ref. No. 1036500300 1814700 MA1814700
O-ring silicone thickness 3.53mm ID ø 49.21mm Qty 1 pcs			
	GEV No.	514022	Ref. No. 1032300100 14044599 MA14044599
nut thread 1½" H 12mm SS WS 59 Qty 1 pcs			
	GEV No.	540435	Ref. No. 1869600 MA1869600
threaded rod thread M10 hollow			
	GEV No.	540436	Ref. No. 1033514900 MA1033514900
hexagonal nut thread M10x1.25 H 4mm WS 13 brass Qty 1 pcs			
	GEV No.	540438	Ref. No. 1868700 MA1868700
long nut thread M10 L 25mm WS 13 brass Qty 1 pcs			
	GEV No.	540439	Ref. No. 1869500 MA1869500
distance washer			

heating elements for pizza ovens

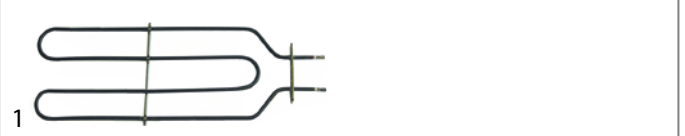

GEV No.	416573	Ref. No.	1037316400 MA1037316400
description	heating element 1000W 230V L 428mm W 162mm flange length 100mm flange width 22mm connection length 20mm connection male faston 6.3mm L3 360mm W1 50mm W2 50mm tube ø 6.3mm heating circuits 1 rectangular flange dry heating element		
For models:	SPE60M		









GEV No.	415164	Ref. No.	59741 MA59741
description	heating element 900W 240V L 295mm W 88mm flange length 34mm flange width 24mm connection length 26mm connection M5 L3 200mm W1 30mm W2 28mm tube ø 6.3mm heating circuits 1 rectangular flange hole ø 5mm dry heating element bain marie		
For models:	SBA, SBAC, SVAC, SVAC12, SVAC16, SVAC20, SVCG, SVCG08, SVCG12, SVCG16, SVCG20		

heating elements for charrills







GEV No.	420467	Ref. No.	CR0681360 CR0842340
description	heating element 3300W 230V L 620mm W 95mm H 40mm W1 20mm W2 48mm L1 15mm L2 30mm L3 575mm flange length 100mm flange width 35mm hole distance 88mm connection M5 heating circuits 1 tube ø 8.5mm connection length 45mm hole ø 6.5mm rectangular flange dry heating element		
For models:	NG912E, NG912E2, NG94E, NG94E2, NG98E, NG98E2		



GEV No.	415095	Ref. No.	1037300000 MA1037300000
description	heating element 1500W 220V L 465mm W 75mm H 55mm 2 hole fixing thread 1/4" mounting distance 70mm connection M4 L1 25mm L2 440mm tube ø 6.3mm dry heating element heating circuits 1		
accessories for	415095		
	GEV No.	521103	Ref. No. —
	nut thread M4 H 3mm WS 7 brass Qty 20 pcs		
	GEV No.	521104	Ref. No. —
	washer ID ø 4.3mm ED ø 8mm thickness 0.5mm brass Qty 20 pcs for thread M4		
	GEV No.	560111	Ref. No. —
	plain washer ID ø 4.3mm ED ø 9mm thickness 0.8mm SS Qty 20 pcs DIN 125A for thread M4		
	GEV No.	560131	Ref. No. —
	hexagonal nut thread M4 H 3.2mm WS 7 SS DIN/ISO DIN 934 / ISO 4032/8673 Qty 20 pcs		



GEV No.	415965	Ref. No.	1037311315 MA1037311315
description	heating element 1800W 230V L 486mm W 83mm H 30mm 2 hole fixing mounting distance 72mm connection M4 L1 38mm L2 448mm heating circuits 1 tube ø 6.3mm dry heating element thread M12x1 for sausage warmer		
For models:	CWE42, CWE422, CWE62, CWE622, OCWE42, OCWE422, OCWE62, OCWE622		
accessories for	415965		
	GEV No.	520229	Ref. No. —
	nut thread M12x1 H 4mm WS 16 zinc-coated steel Qty 1 pcs		

accessories for	415965		
	GEV No.	521110	Ref. No. —
	flat gasket fibre ED ø 20mm ID ø 13mm thickness 2mm Qty 1 pcs		
	GEV No.	521131	Ref. No. —
	nut thread M12x1 H 3.5mm WS 17 SS Qty 1 pcs		
	GEV No.	528110	Ref. No. —
	O-ring EPDM thickness 2.62mm ID ø 12.37mm Qty 1 pcs		

heating elements for salamanders/toast-



GEV No.	416572	Ref. No.	1037316500 MA1037316500
description	heating element 1000W 230V heating circuits 1 L 425mm W 62mm flange length 100mm flange width 22mm hole distance 86mm connection male faston 6.3mm tube ø 6.3mm rectangular flange hole ø 5mm dry heating element		
For models:	TSE60M		







GEV No.	415140	Ref. No.	1037041200 1037316100 MA1037041200 MA1037316100
description	heating element 2000W 230V heating circuits 1 L 435mm W 170mm L1 20mm L2 60mm L3 355mm W1 52mm W2 61mm flange length 100mm flange width 22mm hole distance 86mm tube ø 6.3mm connection length 54mm for salamander grill connection male faston 6.3mm rectangular flange hole ø 5mm H 6.3mm		
For models:	SME62M, SME63M, SME70M		



GEV No.	415141	Ref. No.	1037042200 1037316200 MA1037316200
description	heating element 2900W 230V heating circuits 1 L 425mm W 165mm L1 25mm L2 50mm L3 350mm W1 52mm W2 60mm flange length 100mm flange width 22mm hole distance 88mm tube ø 8.5mm connection length 17mm dry heating element rectangular flange hole ø 5mm H 8.5mm		
For models:	SME62M, SME63M, SME70M		

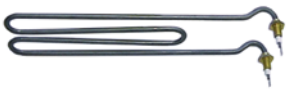

			
GEV No.	415142	Ref. No.	1037042300 1037316300 MA1037316300
description	heating element 3500W 230V heating circuits 1 L 525mm W 167mm L1 15mm L2 50mm L3 460mm W1 63mm W2 50mm flange length 100mm flange width 22mm hole distance 31mm tube ø 9mm connection length 54mm dry heating element connection male faston 6.3mm rectangular flange hole ø 10mm H 9mm		
For models:	SME62M, SME63M, SME70M		

			
GEV No.	415938	Ref. No.	1037303813
description	heating element 1800W 230V heating circuits 1 L 330mm W 82mm H 25mm thread M10x1 mounting distance 72mm tube ø 6.3mm 2 hole fixing connection length 20mm immersion heater		
For models:	DLS30, DLS303, DLS30P, DLS30P3, DLS31, DLS313, DLS31P3, MLS30, MLS303, MLS30P, MLS30P3, MLS31, MLS313, MLS31P3, MLS35, MLS353, MPLS30P		
accessories for	415938		
	GEV No.	510416	Ref. No. —
	flat gasket fibre ED ø 19mm ID ø 10.5mm thickness 1.5mm for thread M10 Qty 1 pcs		
	GEV No.	510893	Ref. No. 200810
	O-ring EPDM thickness 2.62mm ID ø 9.92mm Qty 1 pcs		
	GEV No.	520231	Ref. No. —
	nut thread M10x1 H 6mm WS 14 zinc-coated steel Qty 1 pcs		
	GEV No.	521129	Ref. No. —
	nut thread M10 H 6mm SS WS 17 Qty 1 pcs DIN/ISO DIN 439		

heating elements for heating bridges

			
GEV No.	416665	Ref. No.	1037041600 1037041613 MA1037041613
description	heating element 1000W 230V heating circuits 1 L 427mm W 60mm hole distance 87mm connection length 30mm connection M4 tube ø 6.3mm rectangular flange hole ø 5mm dry heating element flange length 100mm flange width 22mm		
For models:	RIE40M, RIEP40M, TSE60M		

heating elements for heated cabinets

			
GEV No.	416575	Ref. No.	1215400 MA1215400
description	heating element 770W 240V heating circuits 1 L 462mm W 33mm flange length 70mm flange width 22mm hole distance 56mm connection length 32mm connection M5 tube ø 8.5mm rectangular flange hole ø 5mm for heated trolley		
For models:	TP13E, TP17E, TP213E, TP217E, TP21E, TP221E		

heating cables

connection on both sides (metal braided)

			
GEV No.	416323	Ref. No.	5576.12
description	heating cable 42.7W 230V L1 (unheated) 1530mm L2 (heated) 2960mm door frame heating ø 4mm L 6020mm connection cable		

			
GEV No.	416324	Ref. No.	5576.22 5577.12 MA557622 MA557712
description	heating cable 43W 230V L1 (unheated) 2x1500mm L2 (heated) 3000mm door frame heating ø 4mm L 6000mm connection cable		
For models:	AF140B, AF140C, AF140F, AF140I, AF140MB, AF140MC, AF140MF, AF140MI, AF140MN, AF140MP, AF140N, AF140P, AF70B, AF70C, AF70F, AF70I, AF70MB, AF70MC, AF70MF, AF70MI, AF70MN, AF70MP, AF70N, AF70P, EF140DF, EF140DN, EF140DP, EF140MB, EF140MC, EF140MF, EF140MI, EF140MN, EF140MP, EF143DNF, EF143MNI, EF70DF, EF70DN, EF70DP, EF70MB, EF70MC, EF70MF, EF70MI, EF70MN, EF70MP, EF72DNF, EF72MNF, F140DF, F140DI, F140DN, F140DP...(Other models you can see in the webshop)		

			
GEV No.	416321	Ref. No.	2524612 4653500 MA2524612 MA4653500
description	heating cable 49W 230V L1 (unheated) 830mm L2 (heated) 7600mm door frame heating ø 4mm L 9230mm connection cable		
For models:	IR13C, IR13CC, IR13CV, IR13M, IR13MC, IR13MV, IR13V, IR17C, IR17CC, IR17CV, IR17M, IR17MC, IR17MV, IR17V, TR13C2P, TR13I4C, TR13I4CC, TR13I4CV, TR13N2C1P, TR13N2C1PC, TR13N2C1PV, TR13N2P, TR13N2PC, TR13N2PV, TR13N4C, TR13N4CC, TR13N4CV, TR17C3P, TR17I6C, TR17I6CC, TR17I6CV, TR17N2C2P, TR17N2C2PC, TR17N2C2PV, TR17N2P, TR17N3P, TR17N3PC, TR17N3PV, TR17N4C1P, TR17N4C1PC, TR17N4C1PV, TR17N6C, TR17N6CC, TR17N6CV, TR21N2C3P, TR21N2C3PC, TR21N2C3PV, TR21N4C2P, TR21N4C2PC...(Other models you can see in the webshop)		

heating cartridges

			
GEV No.	420223	Ref. No.	4646700 MA4646700
description	heating cartridge 240W 230V ø 12mm L 240mm thread 3/8" cable length 3000mm connection cable flange with thread immersion heater		
For models:	FB110F, FB110N, FB110P, FB140F, FB140FN, FB140N, FB140NN, FB140P, FB140PF, FB140PN, FB140PP, FB143NI, FB55F, FB55N, FB55P, FB70F, FB70N, FB70P, FB72F, FB72N, FB72NF, FB72P, FS140F, FS140FI, FS140FN, FS140I, FS140N, FS140NG, FS140NI, FS140NN, FS140P, FS140PN, FS140PP, FS143F, FS143FI, FS143N, FS143NF, FS143NI, FS143NN, FS143NP, FS143P, FS70F, FS70FG, FS70I, FS70N, FS70NG, FS70P, FS72F, FS72FI, FS72IN...(Other models you can see in the webshop)		





ceramic heaters

245x60mm

1





GEV No.	415104	Ref. No.	1037039600 1037317601 MA1037317601
description	ceramic emitter 1000W 230V cable beaded cord L 245mm W 60mm H 35mm		
For models:	BSEI40M, NSP74E, NSP94E, OBSEI40M, SP74E, SP94E		
spare parts for	415104		
	GEV No.	415109	Ref. No. —
	spring clip		
accessories for	415104		
	GEV No.	415110	Ref. No. —
	reflector L 245mm W 95mm H 31mm thickness 0.75mm hole ø 15x40mm		

immersion heating elements

3 hole flange ø47.5mm

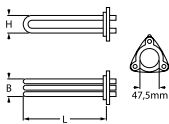
1





GEV No.	415935	Ref. No.	1037305400
description	heating element 4500W 230V mounting ø 47.5mm heating circuits 3 L 320mm W 34mm H 30mm number of thermostat sleeves 1 thermostat sleeves ø 7mm length thermostat sleeves 300mm thermostat sleeve eccentric, clinging tube ø 6.3mm hole distance 63mm hole ø 10mm connection male faston 6.3mm 3 hole flange immersion heater		
For models:	DLS30, DLS303, DLS30P, DLS30P3, DLS31, DLS313, DLS31P3, MLC65, MLC653, MLS30, MLS303, MLS30P, MLS30P3, MLS31, MLS313, MLS31P3, MPLS30P		
spare parts for	415935		
	GEV No.	510408	Ref. No. 200820 BN0118462630
	O-ring EPDM thickness 5.34mm ID ø 47mm Qty 1 pcs		
accessories for	415935		
	GEV No.	510562	Ref. No. —
	O-ring silicone thickness 5.34mm ID ø 47mm Qty 1 pcs		

3 hole flange ø57.5mm

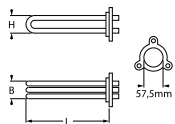
1

GEV No.	420101	Ref. No.	0589130R CR0589130 CR0589130R
description	heating element 10500W 400V heating circuits 3 L 580mm W 36mm H 42mm tube ø 8.4mm number of thermostat sleeves 0 cable length 700mm immersion heater 3 hole flange hole distance 73mm mounting ø 57.5mm hole ø 10mm		
For models:	NPI98E10, NPI98E15		
accessories for	420101		
	GEV No.	521146	Ref. No. CM046200 MACM046200
	O-ring Viton thickness 5.34mm ID ø 56.52mm Qty 1 pcs		

1

GEV No.	416818	Ref. No.	CM183900 MACM183900
description	heating element 3400W 230V heating circuits 3 L 437mm W 45mm H 40mm tube ø 10mm connection cable cable length 1270mm connection length 10mm kettle 3 hole flange hole distance 72mm mounting ø 57.5mm hole ø 8/10mm suitable for 700 series		
For models:	PI76E5, PI96E5		

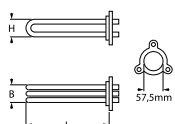
1

GEV No.	416819	Ref. No.	CM182300 MACM182300
description	heating element 7600W 230V heating circuits 3 L 590mm W 48mm H 65mm tube ø 8.5mm cable length 1170mm connection length 26mm immersion heater 3 hole flange hole distance 72mm mounting ø 57.5mm hole ø 8x10mm		
For models:	PI98E10, PI98E15, PI9S8E10		

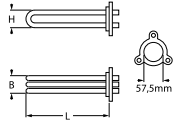
1

GEV No.	415060	Ref. No.	110363
description	heating element 3000W 230V mounting ø 57.5mm heating circuits 1 L 330mm W 45mm H 29mm number of thermostat sleeves 1 thermostat sleeves ø 7mm length thermostat sleeves 295mm thermostat sleeve not clinging tube ø 6.25mm hole distance 73mm hole ø 8mm connection male faston 6.3mm 3 hole flange immersion heater		

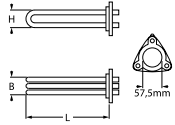

GEV No.	415934	Ref. No.	1037312600
description	heating element 3500W 230V mounting \varnothing 57.5mm heating circuits 3 L 192mm W 38mm H 50mm number of thermostat sleeves 1 thermostat sleeves \varnothing 7.5mm length thermostat sleeves 180mm thermostat sleeve eccentric, clinging tube \varnothing 8.5mm hole distance 72mm hole \varnothing 8mm connection male faston 6.3mm 3 hole flange immersion heater		
For models:	MLC50, MLC503, MLC65, MLC653		

GEV No.	415020	Ref. No.	110331
description	heating element 4500W 230V mounting \varnothing 57.5mm heating circuits 3 L 355mm W 35mm H 47mm number of thermostat sleeves 1 thermostat sleeves \varnothing 7mm length thermostat sleeves 295mm thermostat sleeve upper tube \varnothing 8.5mm hole distance 70mm hole \varnothing 10mm connection length 25mm connection male faston 6.3mm 3 hole flange immersion heater		

GEV No.	415021	Ref. No.	1037305500 110349 MA1037305500	
description	heating element 6000W 230V mounting \varnothing 57.5mm heating circuits 3 L 343mm W 37mm H 50mm number of thermostat sleeves 1 thermostat sleeves \varnothing 7mm length thermostat sleeves 294mm thermostat sleeve not clinging tube \varnothing 8.5mm hole distance 72mm hole \varnothing 8mm connection M5 3 hole flange			
For models:	DLS30, DLS303, DLS30P, DLS30P3, DLS31, DLS313, DLS31P3, MLC50, MLC503, MLS30, MLS303, MLS30P, MLS30P3, MLS31, MLS313, MLS31P3, MLS35, MLS353, MPLS30P			
spare parts for	415021			
	GEV No.	510409	Ref. No.	1036504200 LA70045010 LAR70045010 R70045010
	O-ring EPDM thickness 5.34mm ID \varnothing 56.52mm Qty 1 pcs			
accessories for	415021			
	GEV No.	550002	Ref. No.	—
	tension strap H 10mm L 21mm W 10mm hole \varnothing 6.5mm for heating element			

GEV No.	415937	Ref. No.	1037312700	
description	heating element 9000W 230V mounting \varnothing 57.5mm heating circuits 3 L 340mm W 37mm H 52mm number of thermostat sleeves 1 thermostat sleeves \varnothing 7mm length thermostat sleeves 300mm thermostat sleeve clinging tube \varnothing 8.5mm hole distance 72mm hole \varnothing 8mm connection M5 3 hole flange immersion heater			
For models:	MLC65, MLC653			
spare parts for	415937			
	GEV No.	510409	Ref. No.	1036504200 LA70045010 LAR70045010 R70045010
	O-ring EPDM thickness 5.34mm ID \varnothing 56.52mm Qty 1 pcs			

with expansion flange 70 x 18mm

GEV No.	415016	Ref. No.	110227
description	heating element 3000W 230V heating circuits 3 flange 70x18mm L 398mm W 60mm H 24mm connection male faston 6.3mm immersion heater expansion flange tube \varnothing 6.3mm		

with round flange \varnothing 47.5mm



GEV No.	416272	Ref. No.	110262	
description	heating element 2400W 230V heating circuits 1 mounting \varnothing 47.5mm L 220mm W 35mm H 37mm round flange connection male faston 6.3mm immersion heater tube \varnothing 6.5mm thermostat sleeves \varnothing 7mm number of thermostat sleeves 1 length thermostat sleeves 195mm			
spare parts for	416272			
	GEV No.	510408	Ref. No.	200820 BN0118462630
	O-ring EPDM thickness 5.34mm ID \varnothing 47mm Qty 1 pcs			
accessories for	416272			
	GEV No.	510408	Ref. No.	200820 BN0118462630
	O-ring EPDM thickness 5.34mm ID \varnothing 47mm Qty 1 pcs			
	GEV No.	510562	Ref. No.	—
	O-ring silicone thickness 5.34mm ID \varnothing 47mm Qty 1 pcs			
	GEV No.	520235	Ref. No.	—
	3 hole flange hole distance 70.5mm perforation \varnothing 6.5mm ID \varnothing 53.5mm			
	GEV No.	520236	Ref. No.	—
	flange for heating element ID \varnothing 50mm ED \varnothing 90mm hole \varnothing 6.5mm 3 holes			
	GEV No.	550002	Ref. No.	—
	tension strap H 10mm L 21mm W 10mm hole \varnothing 6.5mm for heating element			



Table continues overleaf







accessories for 416272	
	GEV No. 550362 Ref. No. — blind flange ø 64mm mounting ø 47.5mm



with round flange ø57.5mm

	
1	
GEV No. 415849	Ref. No. R65020420 R65020421
description	heating element 1500W 230V heating circuits 3 mounting ø 57.5mm L 530mm W 45mm H 30mm round flange connection M4 immersion heater tube ø 8.5mm connection length 15mm thermostat sleeves ø 7mm number of thermostat sleeves 1 length thermostat sleeves 272mm thermostat sleeve eccentric, clinging
For models:	ME102D, ME102M, ME102P, ME102T, ME201D, ME201M, ME201P, ME201T, ME202D, ME202M, ME202P, ME202T, ME220M, ME220P, ME220X, MEC40M, MEMT20D, MEMT20P, MEMT21D, MEMT21P, MEMT40D, MEMT40P
accessories for 415849	
	GEV No. 550002 Ref. No. — tension strap H 10mm L 21mm W 10mm hole ø 6.5mm for heating element

	
1	
GEV No. 415848	Ref. No. R65020350
description	heating element 7500W 230V heating circuits 3 mounting ø 57.5mm L 365mm W 36mm H 50mm round flange connection M4 immersion heater tube ø 8.5mm thermostat sleeves ø 7.5mm number of thermostat sleeves 1 length thermostat sleeves 270mm thermostat sleeve eccentric, clinging
For models:	EM010M+SC, EM106H, EM106M, EM106M+SC, EM106P, EM110H, EM110M, EM110M+SC, EM110P, EM210H, EM210M, EM210M+SC, EM210P, ME061D, ME061P, ME061T, ME101D, ME101M, ME101P, ME101T, ME106M, ME106P, ME106X, ME110M, ME110P, ME110X, ME120M, ME120P, ME120X, ME210M, ME210P, ME210X, MEC24H, MEMT06D, MEMT06P, MEMT10D, MEMT10P
spare parts for 415848	
	GEV No. 510409 Ref. No. 1036504200 LA70045010 LAR70045010 R70045010 O-ring EPDM thickness 5.34mm ID ø 56.52mm Qty 1 pcs
accessories for 415848	
	GEV No. 550002 Ref. No. — tension strap H 10mm L 21mm W 10mm hole ø 6.5mm for heating element

	
1	
GEV No. 415957	Ref. No. 5152300 MA5152300
description	heating element 9000W 400V heating circuits 3 mounting ø 57.5mm L 402mm W 33mm H 43mm round flange cable length 1270mm immersion heater tube ø 8.5mm thermostat sleeves ø 7mm number of thermostat sleeves 1 length thermostat sleeves 270mm thermostat sleeve clinging
For models:	CSM102E, CSM102EP, CSM10E, CSM10EP, CSM201E, CSM201EP, CSM202E, CSM202EP, CSM6E, CSM6EP
accessories for 415957	
	GEV No. 550002 Ref. No. — tension strap H 10mm L 21mm W 10mm hole ø 6.5mm for heating element

miscellaneous			
			
1			
GEV No. 415994	Ref. No. 1677000 1878100 MA1878100		
description	heating element 3400W 230V heating circuits 3 L 430mm W 38mm H 46mm tube ø 10mm hole distance 58mm hole ø 10mm cable length 1300mm 4 hole flange kettle		
For models:	P915E, PI707E		
accessories for 415994			
	GEV No. 505092	Ref. No. 2604100 BN0119472130 MA2604100	O-ring EPDM thickness 5.34mm ID ø 43.82mm Qty 1 pcs

			
1			
GEV No. 415984	Ref. No. 1414300 1878200 MA1878200		
description	heating element 6000W 240-415V heating circuits 3 L 584mm W 70mm H 65mm tube ø 8.5mm hole distance 96mm hole ø 6.5mm cable length 1300mm connection length 38mm 8 hole flange immersion heater flange width 116mm flange length 116mm		
For models:	P9D10E, P9D15E, P9DA10E, P9DA15E, P9I10E, P9I15E, P9IA10E, P9IA15E		
accessories for 415984			
	GEV No. 521116	Ref. No. 1422200 MA1422200	O-ring Viton thickness 3.53mm ID ø 78.97mm Qty 1 pcs

			
1			
GEV No. 416815	Ref. No. 1878300 MA1878300		
description	heating element 7500W 230V heating circuits 3 L 580mm W 66mm H 64mm tube ø 8.5mm cable length 1290mm immersion heater hole distance 37mm flange length 110mm flange width 110mm hole ø 6mm		
For models:	P9I10E, P9I15E, P9IA10E		



			
1			
GEV No. 420074	Ref. No. CR0682160 CR0682160R		
description	heating element 260W 230V heating circuits 1 L 242mm W 18mm H 6.25mm tube ø 6.25mm thermostat sleeves ø 5mm length thermostat sleeves 230mm number of thermostat sleeves 1 thermostat sleeve centred, adjacent connection male faston 6.3mm connection length 35mm immersion heater flange with thread WS 32 thread 1"		
For models:	NPI76E5, NPI76G5, NPI78E8, NPI78G8, NPI96E5, NPI96G5, NPI98E10, NPI98E15, NPI98G10, NPI98G14, NPI98G14A		
spare parts for 420074			
	GEV No. 503158	Ref. No. —	flat gasket FIBER ED ø 44mm ID ø 33mm thickness 2mm Qty 1 pcs





Table continues overleaf



accessories for	420074		
	GEV No.	507532	Ref. No. —
	nut thread 1" H 10mm WS 40 brass Qty 1 pcs		



GEV No.	416816	Ref. No.	1414400 1879000 MA1879000
description	heating element 2000W 230V heating circuits 1 L 270mm W 242mm H 44mm tube ø 8.5mm connection M5 connection length 38mm kettle 2 hole fixing kettle W2 43mm thread 1/4" mounting distance 43mm		
For models:	P9D10E, P9D15E, P9DA10E, P9DA15E, P9DSB10E, P9I10E, P9IA10E, PDASB10E		

accessories for	416816		
	GEV No.	361182	Ref. No. —
	nut thread 1/4" H 5mm nickel-plated brass WS 17 Qty 1 pcs		
	GEV No.	510417	Ref. No. —
	flat gasket fibre ED ø 20mm ID ø 14mm thickness 2mm Qty 1 pcs		
	GEV No.	520228	Ref. No. —
	tooth lock washer ID ø 15.3mm ED ø 24mm steel Qty 1 pcs for thread M14		
	GEV No.	550262	Ref. No. —
	flat gasket copper ED ø 20mm ID ø 14mm thickness 2mm		

2 connections

straight



GEV No.	416817	Ref. No.	CM096300 CM096301 CR0682150 MACM096301
description	heating element 4000W 230V heating circuits 1 L 619mm W 150mm Hmm tube ø 8.5mm cable length 790mm connection length 18mm kettle suitable for 900 series		
For models:	NPD98E10, NPD98E15, PD98E10, PD98E15, PD9S8E10		

heating elements for convection



GEV No.	415828	Ref. No.	R65011310
description	heating element 15000W 230V heating circuits 3 ID ø 388mm ED ø 408mm L 428mm H 132mm L1 20mm W1 105mm H1 114mm H2 18mm flange length 140mm flange width 25mm hole distance 126mm connection M4 connection length 65mm tube ø 8.5mm convection heating element hole ø 6.3mm rectangular flange		
For models:	EC110M, EC210M, EM010M+SC, EM110H, EM110M, EM110M+SC, EM110P, EM210H, EM210M, EM210M+SC, EM210P, EV110H, EV110M, EV110M+SC, EV110P, EV210H, EV210M, EV210M+SC, EV210P, MACE10M, ME101D, ME101M, ME101P, ME101T, ME102D, ME102M, ME102P, ME102T, ME110M, ME110P, ME110X, ME120M, ME120P, ME120X, ME201D, ME201M, ME201P, ME201T, ME202D, ME202M, ME202P, ME202T, ME210M, ME210P, ME210X, ME220M, ME220P, ME220X, MEC24H, MEC40M...(Other models you can see in the webshop)		



GEV No.	418197	Ref. No.	R65011250
description	heating element 15000W 230V heating circuits 3 ID ø 512mm ED ø 530mm L 545mm H 130mm L1 15mm W1 105mm H1 25mm H2 105mm flange length 142mm flange width 25mm hole distance 126mm connection M4 connection length 68mm tube ø 8.5mm convection heating element hole ø 6mm rectangular flange		
For models:	EC210M, EM210H, EM210M, EM210M+SC, EM210P, EV210H, EV210M, EV210M+SC, EV210P, ME102D, ME102M, ME102P, ME102T, ME202D, ME202M, ME202P, ME202T, MEC24H, MEC40M, MEMENT20D, MEMENT20P, MEMENT40D, MEMENT40P, MEVT20D, MEVT20P, MEVT40D, MEVT40P		

1

GEV No.	415966	Ref. No.	1037300200 1037300400 4330700 MA1037300200 MA4330700
description	heating element 2500W 230V heating circuits 1 ID ø 176mm ED ø 188mm L 210mm H 28mm L1 22mm W1 30mm H1 3mm H2 25mm flange length 70mm flange width 22mm hole distance 56mm connection male faston 6.3mm tube ø 6.3mm convection heating element hole ø 5mm rectangular flange		
For models:	CFE60, CFE60P, CFGE60, CFGE61, CFGE61D, CFGE61L, CFGE61P, CFVE60, FOE60M, OFOE60M, SNA12, SNA16, SNA20, SNAC12, SNAC16, SNAC20, SNG08, SNG12, SNG16, SNG20, SVAC16, SVAC20, SVCG08, SVCG12, SVCG16, SVCG20, SVCG8		
accessories for	415966		
	GEV No.	510368	Ref. No. —
	gasket L 70mm W 23.5mm hole ø 5mm hole distance 56mm FIBER thickness 2mm for heating element		



1

GEV No.	415845	Ref. No.	R65010320
description	heating element 3150W 230V heating circuits 3 ID ø 201mm ED ø 215mm L 272mm H 35mm L1 57mm W1 60mm H1 8mm H2 27mm flange length 95mm flange width 22mm hole distance 77mm connection male faston 6.3mm connection length 20mm tube ø 6.5mm convection heating element hole ø 6mm rectangular flange		
For models:	CVE004H, CVE004M, MACE04M, MVE042P, VE004M, VE004X		



1

GEV No.	415855	Ref. No.	R65010450
description	heating element 3900W 230V heating circuits 3 ID ø 176mm ED ø 244mm L 282mm H 43mm L1 38mm W1 61mm H1 13mm H2 30mm flange length 92mm flange width 22mm hole distance 78mm connection male faston 6.3mm connection length 60mm tube ø 6.3mm convection heating element hole ø 6.3mm rectangular flange		
For models:	CVE104H, CVE104M, VE104M, VE104X		



1

GEV No.	415251	Ref. No.	65010200 7800400 LA65010200 LAR65010200 MA7800400
description	heating element 2500W 230V heating circuits 1 ID ø 178mm ED ø 190mm L 242mm H 35mm L1 46mm W1 31mm H1 10mm H2 25mm flange length 70mm flange width 22mm hole distance 56mm connection male faston 6.3mm horizontal tube ø 6.3mm convection heating element hole ø 5mm rectangular flange		
For models:	AC, AR712PA, AR712PP, AR712PS, AR713PA, AR713PP, AR713PS, AR714PA, AR714PP, AR714PS, AR715PA, AR715PP, AR715PS, AR716PA, AR716PP, AR716PS, AR717PA, AR717PP, AR717PS, AR718PA, AR718PP, AR718PS, AR719PA, AR719PP, AR719PS, AR720PA, AR720PP, AR720PS, AU04, AU05, AU08, AU10, AU20, EAR612PA, EAR612PP, EAR612PS, EAR613PA, EAR613PP, EAR613PS, EAR614PA, EAR614PP, EAR614PS, EAR615PA, EAR615PP, EAR615PS, EAR616PA, EAR616PP, EAR616PS, EAR617PA, EAR617PP..(Other models you can see in the webshop)		
spare parts for	415251		
	GEV No.	510368	Ref. No. —
	gasket L 70mm W 23.5mm hole ø 5mm hole distance 56mm FIBER thickness 2mm for heating element		



1

GEV No.	418196	Ref. No.	R65011530
description	heating element 6000W 230V heating circuits 3 ID ø 215mm ED ø 228mm L 266mm H 78mm L1 38mm W1 102mm H1 10mm H2 68mm flange length 142mm flange width 25mm hole distance 57mm connection M4 connection length 66mm tube ø 6.3mm convection heating element hole ø 6mm rectangular flange		
For models:	MACE05M, MVE051P		



1

GEV No.	415871	Ref. No.	R65011520
description	heating element 6000W 230V heating circuits 3 ID ø 217mm ED ø 230mm L 267mm H 75mm L1 38mm W1 103mm H1 65mm H2 10mm flange length 140mm flange width 23mm hole distance 67mm connection M4 connection length 25mm tube ø 6.5mm convection heating element hole ø 5mm rectangular flange		
For models:	CVE105H, CVE105M, MVE042P, VE105M, VE105X		





1

GEV No.	415993	Ref. No.	R65010680
description	heating element 7200W 230V heating circuits 3 ID ϕ 215mm ED ϕ 230mm L 270mm H 78mm L1 30mm W1 102mm H1 10mm H2 68mm flange length 140mm flange width 22mm hole distance 63mm connection M4 connection length 65mm tube ϕ 6.3mm convection heating element hole ϕ 5mm rectangular flange		
For models:	FE105M, FE105X, PE040M, PE040X		



1

GEV No.	415829	Ref. No.	R65011540
description	heating element 7500W 230V heating circuits 3 ID ϕ 248mm ED ϕ 260mm L 287mm H 88mm L1 20mm W1 105mm H1 23mm H2 65mm flange length 142mm flange width 25mm hole distance 64mm connection M4 connection length 78mm convection heating element hole ϕ 5mm rectangular flange		
For models:	EC106M, EM106H, EM106M, EM106M+SC, EM106P, EV006M, EV106H, EV106M, EV106M+SC, EV106P, MACE07M, ME061D, ME061P, ME061T, ME106M, ME106P, ME106X, MEMT06D, MEMT06P, MEVT06D, MEVT06P, VE106M, VE106P, VE106X		
accessories for	415829		
		GEV No.	531270
		Ref. No.	—
	gasket L 141mm W 22mm D1 ϕ 10mm D2 ϕ 9mm 9 holes graphite thickness 1mm suitable for UNOX		



1

GEV No.	415827	Ref. No.	R65011210
description	heating element 9000W 230V heating circuits 3 ID ϕ 508mm ED ϕ 526mm L 550mm H 122mm L1 24mm W1 105mm H1 26mm H2 96mm flange length 140mm flange width 25mm hole distance 126mm connection M4 connection length 68mm tube ϕ 9mm convection heating element hole ϕ 6.3mm rectangular flange		
For models:	ME210M, ME210P, ME210X, ME220M, ME220P, ME220X, VE210M, VE210P, VE210X, VE220M, VE220P, VE220X		



1

GEV No.	415737	Ref. No.	R65010180
description	heating element 2500W 230V heating circuits 1 L 655mm W 120mm L1 30mm L2 625mm W2 90mm flange length 70mm flange width 22mm hole distance 56mm connection length 100mm connection M4 tube ϕ 6.3mm hole ϕ 5.5mm W1 30mm rectangular flange convection heating element windings 2		
For models:	FE110M, FE110X, PE080M, PE080X		



1

GEV No.	415998	Ref. No.	5152100 MA5152100
description	heating element 3000W 400V heating circuits 1 L 513mm W 120mm L1 33mm L2 480mm W2 100mm flange length 50mm flange width 26mm connection M4 tube ϕ 8.5mm hole ϕ 6mm W1 20mm compression flange convection heating element		
For models:	CON10E, CON10EP, CON201E, CON201EP, CSM102E, CSM102EP, CSM10E, CSM10EP, CSM201E, CSM201EP		



1

GEV No.	415736	Ref. No.	R65010390
description	heating element 3500W 230V heating circuits 1 L 655mm W 125mm L1 30mm L2 625mm W2 88mm flange length 70mm flange width 22mm hole distance 56mm connection length 97mm connection M4 tube ϕ 6.25mm hole ϕ 5mm W1 30mm rectangular flange convection heating element windings 2 mounting distance 58mm		
For models:	FE210M		

radiation heaters





1

GEV No.	416963	Ref. No.	1037308900 1037308913 CR0419950 MA1037308913
description	radiation heater octagonal 2400W 230V L 230mm W 230mm heating circuits 1 with heating coil energy regulation with temperature signalization connections 2+2 connection type cable AD		
For models:	CFVE60, CT78EC, CT7FE8EC, PCVE40, PCVE40D, PCVE40DB, PCVE60, PCVE60D, PCVE60DB, V74EC, V76EC		



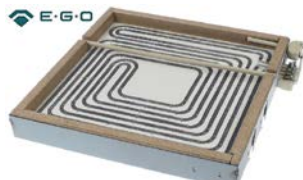

 <p>1</p>			
GEV No.	490200	Ref. No.	CR0509610
description	radiation heater octagonal 3400W 230V L 300mm W 300mm heating circuits 2 H 30mm with heating coil energy regulation with temperature signalization connections 2+2 connection type cable cable length 800mm AD		
For models:	CT98EC, CT9FE8EC		

 <p>1</p>			
GEV No.	490195	Ref. No.	CR0688660
description	radiation heater L 300mm W 300mm 4000W 400V heating circuits 2 H 40mm connection type screw without pan detection EGO		
For models:	NCT98E, NCT98E2, NCT9FE8E, NCT9FE8E2, NV94E, NV98E, NV9FE8E		

 <p>1</p>				
GEV No.	490079	Ref. No.	CR0509620	
description	radiation heater octagonal 3400W 230V L 300mm W 300mm heating circuits 2 H 30mm with heating coil energy regulation with temperature signalization connections 4+2 connection type cable AD			
For models:	V94E, V98E			
spare parts for	490079			
 <p>Image not available</p>	GEV No.	390931	Ref. No.	—
	safety thermostat for radiation heater			

 <p>1</p>			
GEV No.	418029	Ref. No.	1037311013 MA1037311013
description	radiation heater rectangular 1500W 230V L 450mm W 190mm heating circuits 1 connections 2 IRCA		
For models:	FTVE100, FTVE40, FTVE40D, FTVE60, FTVE60D		

 <p>1</p>			
GEV No.	490153	Ref. No.	CM189500 MACM189500
description	radiation heater octagonal 3400W 230V L 300mm W 300mm heating circuits 2 H 30mm with heating coil energy regulation with temperature signalization connections 4+2 connection type cable cable length 900mm AD		
For models:	CT98EC, CT9FE8EC, V94E, V98E		

 <p>1</p>			
GEV No.	418030	Ref. No.	1037311213 MA1037311213
description	radiation heater rectangular 2500W 230V L 450mm W 295mm heating circuits 1 connections 2 IRCA		
For models:	FTVE100, FTVE40, FTVE40D, FTVE60, FTVE60D		

<p>square</p>  <p>1</p>			
GEV No.	490202	Ref. No.	CR0735680
description	radiation heater L 300mm W 300mm 4000W 400V H 40mm connection type screw with pan detection		

<p>1-circuit</p>  <p>1</p>			
GEV No.	490116	Ref. No.	1037309600 1037309613 MA1037309613
description	radiation heater ø 165mm 1200W 230V heating circuits 1 H 33mm 7-position control with temperature signalization with ribbon heater connections 2+2 connection type male faston 6.3mm CERAMASPEED		
For models:	CFVE60, PCVE40, PCVE40D, PCVE40DB, PCVE60, PCVE60D, PCVE60DB, V74EC, V76EC		



GEV No.	490113	Ref. No.	1037309000 1037309013
description	radiation heater ø 200mm 1800W 230V heating circuits 1 energy regulation with temperature signalization with ribbon heater connections 2+2 connection type male faston 6.3mm CERAMASPEED		
For models:	CFVE60, PCVE40, PCVE40D, PCVE40DB, PCVE60, PCVE60D, PCVE60DB, V74EC, V76EC		



GEV No.	490150	Ref. No.	CR0791310
description	radiation heater ø 250mm 2500W 230V heating circuits 1 energy regulation with temperature signalization with heating coil connections 2+2 connection type male faston 6.3mm EGO		
For models:	NCT78E, NCT7FE8E, NV74EC, NV78EC, NV7FE8E		

2-circuit



GEV No.	490139	Ref. No.	CR0511560
description	radiation heater ø 250mm 2500W 230V heating circuits 2 energy regulation with temperature signalization partial power 1000W with ribbon heater connections 3+2 connection type male faston 6.3mm EGO		
For models:	CFVE60, PCVE40, PCVE40D, PCVE40DB, PCVE60, PCVE60D, PCVE60DB, V74EC, V76EC		

foil heating elements



GEV No.	420439	Ref. No.	4330600 MA4330600
description	foil heating element L 460mm W 270mm 700W 220V t.max. 150°C thickness 1.5mm		
For models:	SNA12, SNA16, SNA20, SNAC12, SNAC16, SNAC20, SNG08, SNG12, SNG16, SNG20, SVAC16, SVAC20, SVCG08, SVCG12, SVCG16, SVCG20, SVCG8		



GEV No.	417701	Ref. No.	BN1666273
description	heater mat L 430mm W 120mm 30W 230V cable length 1200mm connection male faston 6.3mm		

accessories

hexagonal nuts



GEV No.	540436	Ref. No.	1033514900 MA1033514900
description	hexagonal nut thread M10x1.25 H 4mm WS 13 brass Qty 1 pcs		
For models:	C74GS, C78GS, C79G, C7FE12GS, C7FE8GS, C7FG12GS, C7FG8GS, C7FG9G, CFGE61, CFGE61D, CFGE61L, CFGE61P, CP704E, CP92E, CP92E2, CP94E, CP94E2, CP9SB2E, CP9SB2E2, CP9SB4E, CP9SB4E2, CPE40, CPE402, CPE60, CPE602, CPE60DB, DE92142, DE94242, EC74GVG, EC78GVG, EC7FG8G, EPC74E, OCFGE61, OCPE6, OCPE60, OPCG41, OPCG61, PC12C4E, PC12C9E, PC74E, PC76E, PC78E, PC94E, PC96E, PC98E, PC9S4E, PC9S6E, PC9S8E, PCG41, PCG41L...(Other models you can see in the webshop)		





GEV No.	514022	Ref. No.	1032300100 14044599 MA14044599
description	nut thread 1½" H 12mm SS WS 59 Qty 1 pcs		
For models:	CP704E, CP92E, CP92E2, CP94E, CP94E2, CP9SB2E, CP9SB2E2, CP9SB4E, CP9SB4E2, CPE40, CPE402, CPE60, CPE602, CPE60DB, DE92142, DE94242, EPC74E, OCPE6, OCPE60, PC12C4E, PC12C9E, PC74E, PC76E, PC78E, PC94E, PC96E, PC98E, PC9S4E, PC9S6E, PC9S8E		



GEV No.	521133	Ref. No.	1325313 MA1325313
description	nut thread M14x1.5 H 6mm WS 19 zinc-coated steel Qty 1 pcs		
For models:	B9SB2G, B9SB4G, B9V2G, B9V4G, B9VP4G, BM74G, BM77G, C124G, C129G, C12C2G9, C12C9G, C12FG9G, C7011G, C7011GFE, C7011GFG, C704G, C707G, C707GFE, C707GFG, C712G, C74G, C78G, C7FE12G, C7FE8G, C7FG12G, C7FG8G, C7FGM12G, C912G, C912GS, C94G, C94GP, C94GS, C98G, C98GP, C98GS, C9F4E, C9F4GS, C9F6E, C9F6GS, C9F8GS, C9FE12G, C9FE12GS, C9FE4GS, C9FE6GS, C9FE8G, C9FE8GS, C9FEP4GS, C9FEP6GS, C9FEP8GS, C9FG12G...(Other models you can see in the webshop)		



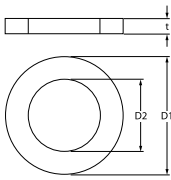

washers			
 <p>1</p>			
GEV No.	560112	Ref. No.	15830499 MA15830499
description	plain washer ID \varnothing 5.3mm ED \varnothing 10mm thickness 1mm SS Qty 20 pcs DIN 125A for thread M5		
For models:	BR707E, BR707EI, BR707G, BR707GI, BR94E, BR94EI, BR94G, BR94GI, BR96E, BR96EI, BR96G, BR96GI, BR9M4E, BR9M4EI, BR9M4G, BR9M4GI, BR9M6E, BR9M6EI, BR9M6G, BR9M6GI, BR9SB4E, BR9SB4EI, BR9SB4G, BR9SB4GI, EPC74E, EPC74G, PC12C4E, PC12C4G, PC12C9E, PC12C9G, PC74E, PC74G, PC76E, PC76G, PC78E, PC78G, PC94E, PC94G, PC96E, PC96G, PC98E, PC98G, PD707G, PI707E, PI707G, SER15, SER15A, SER18, SER18A, SER21		

PTFE gaskets			
  <p>1</p>			
GEV No.	514016	Ref. No.	1036500400 1814500 MA1814500
description	flat gasket PTFE ED \varnothing 45mm ID \varnothing 40mm thickness 4mm Qty 1 pcs equiv. no. 1036500400/1814500 suitable for MARENO		
For models:	CP704E, CP92E, CP92E2, CP94E, CP94E2, CP9SB2E, CP9SB2E2, CP9SB4E, CP9SB4E2, CPE40, CPE402, CPE60, CPE602, CPE60DB, DE92142, DE94242, EPC74E, OCPE6, OCPE60, PC12C4E, PC12C9E, PC74E, PC76E, PC78E, PC94E, PC96E, PC98E, PC9S4E, PC9S6E, PC9S8E		

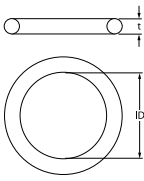
ring nuts			
 <p>1</p>			
GEV No.	550662	Ref. No.	CM021600 MACM021600
description	ring nut thread M54x1.5 H 7mm		
For models:	EF74E10VG, EF74E12, F12C4E12, F74E10, F74E12, F74E6, F76E10, F78E12, F94E10, F94E12, F94E18, F94E18K, F94E6, F96E10, F98E12, F98E18, F98E18K, F9S4E18K, F9S8E18K, FQE41R, FQE41RL, FQE41RL2, FQE61R, FQE61RL, NF74E10, NF74E15, NF76E10, NF78E15, NF94E10, NF94E15, NF94E22, NF94E222, NF94E22K, NF94E22K, NF96E10, NF98E15, NF98E22, NF98E222, NF98E222K, NF98E22K, NPC74E, NPC76E, NPC78E, NPC94E, NPC96E, NPC98E		
accessories for	550662		
	GEV No.	Ref. No.	—
	 <p>special wrench for ring nut</p>		

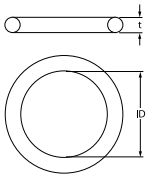
O-rings			
  <p>1</p>			
GEV No.	510893	Ref. No.	200810
description	O-ring EPDM thickness 2.62mm ID \varnothing 9.92mm Qty 1 pcs		

  <p>1</p>			
GEV No.	510901	Ref. No.	200843
description	O-ring EPDM thickness 2mm ID \varnothing 13mm Qty 1 pcs		

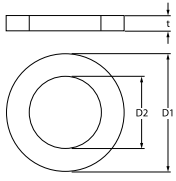
sealing washers			
fibre gaskets			
  <p>1</p>			
GEV No.	510404	Ref. No.	CR0682770
description	flat gasket fibre ED \varnothing 44mm ID \varnothing 34mm thickness 2mm Qty 1 pcs		
For models:	NPI76E5, NPI76G5, NPI78E8, NPI78G8, NPI96E5, NPI96G5, NPI98E10, NPI98E15, NPI98G10, NPI98G14, NPI98G14A		

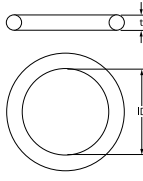
  <p>1</p>			
GEV No.	505092	Ref. No.	2604100 BN0119472130 MA2604100
description	O-ring EPDM thickness 5.34mm ID \varnothing 43.82mm Qty 1 pcs		
For models:	CS102E, CS102EP, CS10E, CS10EP, CS6E, CS6EP, FV4E, FV4E1, P915E, PI707E, PI76E5, PI96E5, PI98E10, PI98E15, PI9S8E10		

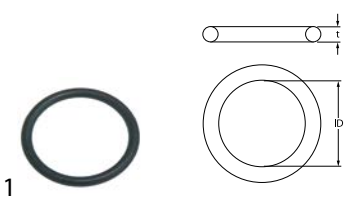

GEV No.	510408	Ref. No.	200820 BN0118462630
description	O-ring EPDM thickness 5.34mm ID ø 47mm Qty 1 pcs		

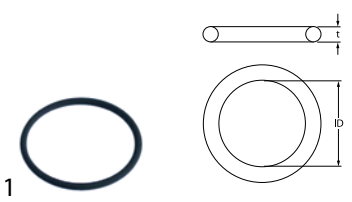

GEV No.	550496	Ref. No.	CM099200 MACM099200
description	O-ring Viton thickness 3.53mm ID ø 50.39mm Qty 1 pcs		
For models:	EF74E10VG, EF74E12, F12C4E12, F74E10, F74E12, F74E6, F76E10, F78E12, F94E10, F94E12, F94E18, F94E18K, F94E6, F96E10, F98E12, F98E18, F98E18K, F9S4E12, F9S4E18, F9S4E18K, F9S8E12, F9S8E18, F9S8E18K, FQE41R, FQE41RL, FQE41RL2, FQE61R, FQE61RL, NF74E10, NF74E15, NF76E10, NF78E15, NF94E10, NF94E15, NF94E22, NF94E222, NF94E222K, NF94E22K, NF96E10, NF98E15, NF98E22, NF98E222, NF98E222K, NF98E22K, NPC74E, NPC76E, NPC78E, NPC94E, NPC96E, NPC98E		

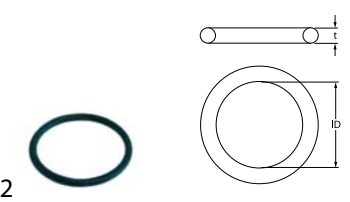

GEV No.	510409	Ref. No.	1036504200 LA70045010 LAR70045010
description	O-ring EPDM thickness 5.34mm ID ø 56.52mm Qty 1 pcs		
For models:	DLS30, DLS303, DLS30P, DLS30P3, DLS31, DLS313, DLS31P3, ME101M, ME101P, ME101T, ME102D, ME102M, ME102P, ME102T, ME201D, ME201M, ME201P, ME201T, ME202D, ME202M, ME202P, ME202T, MEMT06D, MEMT06P, MEMT10D, MEMT10P, MEMT20D, MEMT20P, MEMT21D, MEMT21P, MEMT40D, MEMT40P, MLC50, MLC503, MLC65, MLC653, MLS30, MLS303, MLS30P, MLS30P3, MLS31, MLS313, MLS31P3, MLS35, MLS353, MPLS30P		

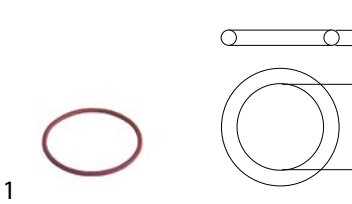

GEV No.	521116	Ref. No.	1422200 MA1422200
description	O-ring Viton thickness 3.53mm ID ø 78.97mm Qty 1 pcs		
For models:	P9D10E, P9D15E, P9DA10E, P9DA15E, P9I10E, P9I15E, P9IA10E, P9IA15E		

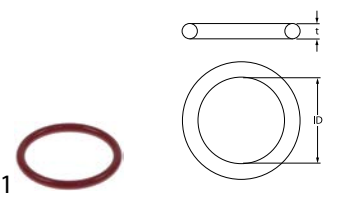

GEV No.	514017	Ref. No.	0105246 1036500200 1814400 MA1814400 R0105246 SIR0105246
description	O-ring silicone thickness 3.53mm ID ø 32.93mm Qty 1 pcs		
For models:	CP704E, CP92E, CP92E2, CP94E, CP94E2, CP9S82E, CP9S82E2, CP9S84E, CP9S84E2, CPE40, CPE402, CPE60, CPE602, CPE60DB, DE92142, DE94242, EPC74E, OCPE6, OCPE60, PC12C4E, PC12C9E, PC74E, PC76E, PC78E, PC94E, PC96E, PC98E, PC9S4E, PC9S6E, PC9S8E		

capillary tube clips



GEV No.	550970	Ref. No.	1033709500 MA1033709500
description	capillary tube clip for pipe ø 8.5mm		
For models:	FQE41, FQE41L, FQE41L2, FQE61, FQE61L, FQE61L2, FR74E10, FR74E10L, FR74E10L2, FR77E10, FR77E10L, FR77E10L2, FR92E10, FR92E10L, FR92E10L2, FR94E10, FR94E10L, FR94E10L2, OFQE41, OFQE61		

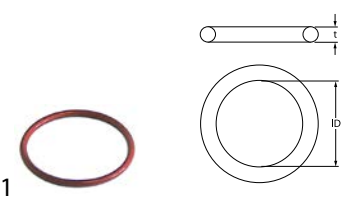

GEV No.	514021	Ref. No.	1036500300 1814700 MA1814700
description	O-ring silicone thickness 3.53mm ID ø 49.21mm Qty 1 pcs		
For models:	CP704E, CP92E, CP92E2, CP94E, CP94E2, CP9S82E, CP9S82E2, CP9S84E, CP9S84E2, CPE40, CPE402, CPE60, CPE602, CPE60DB, EPC74E, OCPE6, OCPE60, PC12C4E, PC12C9E, PC74E, PC76E, PC78E, PC94E, PC96E, PC98E, PC9S4E, PC9S6E, PC9S8E		

spring clips



GEV No.	550419	Ref. No.	1567200 MA1567200
description	probe clip for pipe ø 8.5mm for probe ø 6mm Qty 1 pcs		
For models:	FR74E, FR74E2, FR77E, FR77E2, FR92E13, FR92E132, FR92E13T, FR92E13T2, FR92E22, FR92E22T, FR94E13, FR94E132, FR94E13T, FR94E13T2, FR94E22, FR94E22T		





			
1			
GEV No.	550417	Ref. No.	1033515200 MA1033515200
description	probe clip for pipe ø 2x8.5mm for probe ø 6mm for heating elements spacing 15-19mm Qty 1 pcs		
For models:	FQE41, FQE41L, FQE41L2, FQE61, FQE61L, FQE61L2, FR74E10, FR74E10L, FR74E10L2, FR77E10, FR77E10L, FR77E10L2, FR92E10, FR92E10L, FR92E10L2, FR94E10, FR94E10L, FR94E10L2, OFQE41, OFQE61		

			
1			
GEV No.	691354	Ref. No.	1041304334 MA1041304334
description	lever for tilting element		
For models:	FQE41, FQE41L, FQE41L2, FQE61, FQE61L, FQE61L2, FR74E10, FR74E10L, FR74E10L2, FR77E10, FR77E10L, FR77E10L2, OFQE41, OFQE61		

protection caps

			
1			
GEV No.	510490	Ref. No.	161102
description	protection cap for heating element ø 62mm H 54mm mounting distance 70mm		

			
1			
GEV No.	514018	Ref. No.	1033703500 1814600 MA1814600
description	bush		
For models:	CP704E, CP92E, CP92E2, CP94E, CP94E2, CP9SB2E, CP9SB2E2, CP9SB4E, CP9SB4E2, CPE40, CPE402, CPE60, CPE602, CPE60DB, DE92142, DE94242, EPC74E, OCPE6, OCPE60, PC12C4E, PC12C9E, PC74E, PC76E, PC78E, PC94E, PC96E, PC98E, PC9S4E, PC9S6E, PC9S8E		

			
1			
GEV No.	514020	Ref. No.	1036500100 1815000 1815014 MA1815014
description	bush		
For models:	CP704E, CP92E, CP92E2, CP94E, CP94E2, CP9SB2E, CP9SB2E2, CP9SB4E, CP9SB4E2, CPE40, CPE402, CPE60, CPE602, CPE60DB, DE92142, DE94242, EPC74E, OCPE6, OCPE60, PC12C4E, PC12C9E, PC74E, PC76E, PC78E, PC94E, PC96E, PC98E, PC9S4E, PC9S6E, PC9S8E		

			
1			
GEV No.	691335	Ref. No.	1033715314 MA1033715314
description	lever for tilting element		
For models:	FQE41, FQE41L, FQE41L2, FQE61, FQE61L, FQE61L2, FR74E10, FR74E10L, FR74E10L2, FR77E10, FR77E10L, FR77E10L2, OFQE41, OFQE61		

hot plates

square & rectangular

with radiused edge

			
1			
GEV No.	490066 ¹	Ref. No.	1712913 CR1078117R MA1712913
description	hot plate dimensions 220x220mm 2600W 230V with spill ring connection 4 screw clamps protector yes square		
For models:	C7011EFE, C7011EFEQ, C707EFE, C707EFEQ, C74EC, C78EC, C78EQC, C7FE8E, C7FE8EC, C7FE8EQ, C94E, C94EC, C98E, C98EC, C9FE8E, C9FE8EC, NC74E2, NC74EQC, NC78E2, NC78EQC, NC7FE8E2, NC7FE8EQ		

¹incl. protector

			
1			
GEV No.	490056 ¹	Ref. No.	1340800 1937100 MA1340800 MA1937100
description	hot plate dimensions 300x300mm 3000W 230V with spill ring connection 4 screw clamps protector yes square		
For models:	C9F4E, C9F6E, C9V2E, C9V4E		

¹incl. protector



1

GEV No.	490073	Ref. No.	1937200 MA1937200
description	hot plate dimensions 300x300mm 3000W 400V with spill ring connection 4 screw clamps protector no square		
For models:	C9F4E, C9F6E, C9V2E, C9V4E		



1

GEV No.	490071 ¹	Ref. No.	1340900 1937300 MA1937300 MA1937300R
description	hot plate dimensions 300x300mm 4000W 230V with spill ring connection 4 screw clamps protector yes square		
For models:	C74EC, C78EC, C78EQC, C7FE8E, C7FE8EC, C7FE8EQ, C7FG12G, C7FG8G, C94E, C94EC, C98E, C98EC, C9F4E, C9F6E, C9FE8E, C9FE8EC, C9V2E, C9V4E, NC94E, NC94E2, NC98E, NC98E2, NC9FE8E, NC9FE8E2		

¹incl. protector



1

GEV No.	490074 ¹	Ref. No.	1937400 MA1937400
description	hot plate dimensions 300x300mm 4000W 400V with spill ring connection 4 screw clamps protector yes square		
For models:	C74EC, C78EC, C78EQC, C7FE8E, C7FE8EC, C7FE8EQ, C7FG12G, C7FG8G, C94E, C94EC, C98E, C98EC, C9F4E, C9F6E, C9FE8E, C9FE8EC, C9V2E, C9V4E, NC94E, NC94E2, NC98E, NC98E2, NC9FE8E, NC9FE8E2		

¹incl. protector

tiltable

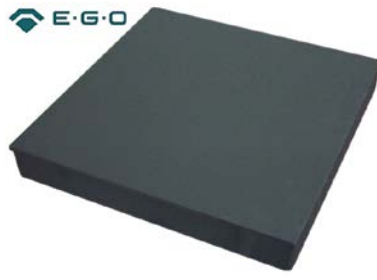

1

GEV No.	490088	Ref. No.	279111
description	hot plate dimensions 300x300mm 2500W 400V with cast edge tilt boiling plate connection 4 screw clamps H 43mm square		

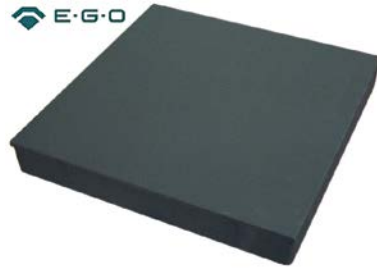

1

GEV No.	490089	Ref. No.	783700 MA783700
description	hot plate dimensions 300x300mm 4000W 230V with cast edge tilt boiling plate connection 4 screw clamps H 43mm square		

round

with radiused edge

for domestic and commercial kitchens



1

GEV No.	490014	Ref. No.	1037040900 1037044000 1641600
description	hot plate ø 180mm 1500W 230V connection 4 screw clamps with 8mm spill ring		





1



GEV No.	490129	Ref. No.	1839813 MA1839813
description	hot plate ø 180mm 1500W 230V connection 4 screw clamps with 8mm spill ring		
For models:	C7011E, C7011EFE, C7011GFE, C704E, C707E, C707EFE, C707GFE, CFE60, CFE60P, CFE70, EC74EVG, EC78EVG, EC7FE8E, OCPE60, OPCE40, OPCE60, PCE40, PCE40D, PCE40DB, PCE60, PCE60D, PCE60DB		



			
GEV No.	490016	Ref. No.	CM059900 MACM059900
description	hot plate ø 180mm 2000W 230V connection 4 screw clamps with 8mm spill ring		
For models:	C74EC, C78EC, C78EQC, C7FE8E, C7FE8EC, C7FE8EQ, C7FG12G, C7FG8G, C94E, C94EC, C98E, C98EC, C9FE8E, C9FE8EC		

			
GEV No.	490018	Ref. No.	1037043900 1037079100 1641500
description	hot plate ø 220mm 2000W 230V connection 4 screw clamps with 8mm spill ring		

			
GEV No.	490130	Ref. No.	1647013 MA1647013
description	hot plate ø 220mm 2000W 230V connection 4 screw clamps with 8mm spill ring		
For models:	C7011E, C7011EFE, C7011GFE, C704E, C707E, C707EFE, C707GFE, CFE60, CFE60P, OCFE60, PCE100, PCE40, PCE40M, PCE60		

			
GEV No.	490020	Ref. No.	1832313 MA1832313
description	hot plate ø 220mm 2600W 230V connection 4 screw clamps with 8mm spill ring		
For models:	C7011E, C7011EFE, C7011GFE, C704E, C707E, C707EFE, C707GFE, C74EC, C78EC, C78EQC, C7FE8E, C7FE8EC, C7FE8EQ, C7FG12G, C7FG8G, C94E, C94EC, C98E, C98EC, C9FE8E, C9FE8EC, CFE60, CFE60P, CFE70, EC74EVG, EC78EVG, EC7FE8E, NC74E2, NC74EC, NC78E2, NC78EC, NC7FE8E, NC7FE8E2, OCFE60, OPCE40, OPCE60, PCE40, PCE40D, PCE40DB, PCE60, PCE60D, PCE60DB		
accessories for	490020		
	GEV No.	550796	Ref. No. —
	 fixing plate for hot plate ø220mm		

with cast brim			
with screw connection			
			
GEV No.	490106	Ref. No.	779111
description	hot plate ø 400mm 5000W 400V connection 2x 3 screw clamps with cast edge screw bolt H 42mm		
For models:	FP1E		

energy regulators

EGO

1-circuit			
			
GEV No.	380015	Ref. No.	1037035310 1037110113 426710 MA1037110113
description	energy regulator 230V 13A single-circuit turn direction right shaft ø 6x4.6mm shaft L 23mm mounting thread M4 power release 6-100% no. 50.57021.010		
For models:	CFVE60, CON102E, CON102EP, CON102G, CON102GP, CON10E, CON10EP, CON10G, CON10GP, CON201E, CON201EP, CON201G, CON201GP, CON202E, CON202EP, CON202G, CON202GP, CON6E, CON6EP, CON6G, CON6GP, CP704E, CP92E, CP92E2, CP94E, CP94E2, CP95B2E, CP95B2E2, CP95B4E, CP95B4E2, CPE60, CRE6220, CRE6230, CRE6320, CRE6330, CS102E, CS102EP, CS102G, CS102GP, CS10E, CS10EP, CS10G, CS6E, CS6EP, CS6G, CWE42, CWE62, FC10E, FC10G, FC20E...(Other models you can see in the webshop)		

2-circuit			
			
GEV No.	380024	Ref. No.	1037108713 MA1037108713
description	energy regulator 240V 13A turn direction right shaft ø 6x4.6mm shaft L 36mm mounting thread M4 no. 50.67079.601 with operation switch 1-pole		
For models:	CFVE60, PCVE40, PCVE40D, PCVE40DB, PCVE60, PCVE60D, PCVE60DB, V74EC, V76EC, V94E, V98E		



1

GEV No.	380027	Ref. No.	CM189600 CM293900 MACM189600 MACM293900
description	energy regulator EGO 230V 13A dual circuit turn direction right shaft ø 6x4.6mm shaft L 23mm mounting thread M4 power release 6-70% no. 50.55021.100		
For models:	CFVE60, CP704E, CP92E, CP92E2, CP94E, CP94E2, CPE60, CPE602, CPE60DB, DE92142, DE94242, EPC74E, ERA10, ERA12, ERA14, ERA16, ERA18, ERA20, ERA210, ERA212, ERA214, ERA216, ERA218, ERA220, FTVE100, FTVE40, FTVE40D, FTVE60, FTVE60D, NPC74E, NPC74G, NPC76E, NPC76G, NPC78E, NPC78G, NPC94E, NPC94G, NPC96E, NPC96G, NPC98E, NPC98G, NPD76G5, NPD78G8, NPD96G5, NPD98E10, NPD98E15, NPD98G10, NPD98G15, NPD98G15A, NPI76E5...(Other models you can see in the webshop)		

control and safety thermostats

EGO

control thermostats

55.10/19_ series



1

GEV No.	390265	Ref. No.	4644600 MA4644600
description	thermostat t.max. 100°C temperature range fixed 100°C 1-pole 1NO 16A probe ø 6mm probe L 130mm capillary pipe 3000mm capillary pipe isolatedmm gland nut		
For models:	F140DF, F140DI, F140DN, F140DP, F14DFG, F14DNG, F70DF, F70DI, F70DN, F70DP, F7DFG, F7DNG		

thermostats

bi-metal thermostats

bi-metal thermostats



1

GEV No.	390293	Ref. No.	2430400 2578300 MA2578300
description	bi-metal thermostat 1NO 1-pole probe L 21mm probe ø 21mm		



1

GEV No.	390025	Ref. No.	120524
description	bi-metal thermostat hole distance 40mm switch-off temp. 55/42°C NC/NO 2-pole 16A 250V connection F6.3 2 hole fixing		
accessories for	390025		
	GEV No.	512154	Ref. No.
			200494
	gasket for thermostat ID ø 20mm equiv. no. 200494/H200494 hole distance 41mm suitable for COMENDA, HOONVED		



1

GEV No.	390232	Ref. No.	1037304000
description	bi-metal thermostat switch-off temp. 55°C 1-pole		
For models:	DLS30, DLS303, DLS30P, DLS30P3, DLS31, DLS313, DLS31P3, MLC50, MLC503, MLC65, MLC653, MLS30, MLS303, MLS30P, MLS30P3, MLS31, MLS313, MLS31P3, MLS35, MLS353, MPLS30P		



1

GEV No.	375548	Ref. No.	CR0682740
description	thermostat t.max. 142°C temperature range fixed 142°C 1-pole 1CO 16A probe ø 4mm probe L 157mm capillary pipe 870mm capillary pipe isolated 870mm gland nut shaft ø 6x4.6mm shaft Lmm shaft position		
For models:	NPD78G8, NPI76E5, NPI76G5, NPI78E8, NPI78G8, NPI96E5, NPI96G5, NPI98E10, NPI98E15, NPI98G10, NPI98G14, NPI98G14A		



GEV No.	375198	Ref. No.	1568600 1873500 1981900 MA1568600 MA1873500 MA1981900
description	thermostat t.max. 190°C temperature range 100-190°C 1-pole 1NO 16A probe ø 6mm probe L 130mm capillary pipe 3000mm capillary pipe isolated 2650mm gland nut M9x1 shaft L 23mm shaft position upper rotation 270° probe material SS		
For models:	F74E10, F74E12, F76E10, F78E12, F94E10, F94E12, F94E18, F94E18K, F96E10, F98E12, F98E18, F98E18K, F954E12, F954E18, F954E18K, F958E12, F958E18, F958E18K, FQE40, FQE40D, FQE40DSP, FQE41, FQE41L, FQE41L2, FQE60, FQE60D, FQE60DSP, FQE61, FQE61L, FQE61L2, FR74E, FR74E10, FR74E10L, FR74E10L2, FR74E2, FR77E, FR77E10, FR77E10L, FR77E10L2, FR77E2, FR92E10, FR92E10L, FR92E10L2, FR92E13, FR92E132, FR92E22, FR94E10, FR94E10L, FR94E10L2, FR94E13...(Other models you can see in the webshop)		



GEV No.	375201	Ref. No.	2992900 MA2992900
description	thermostat t.max. 270°C temperature range 50-270°C 1-pole 1CO 16A probe ø 3mm probe L 219mm capillary pipe 3000mm capillary pipe isolated 2500mm gland nut M10x1 shaft L 23mm shaft position upper rotation 270° probe material SS		
For models:	CON102E, CON102EP, CON102G, CON102GP, CON10E, CON10EP, CON10G, CON10GP, CON201E, CON201EP, CON201G, CON201GP, CON202E, CON202EP, CON202G, CON202GP, CON6E, CON6EP, CON6G, CON6GP, CSM102E, CSM102EP, CSM102G, CSM102GP, CSM10E, CSM10EP, CSM10G, CSM10GP, CSM201, CSM201E, CSM201EP, CSM201G, CSM201GP, CSM202, CSM202E, CSM202EP, CSM202G, CSM202GP, CSM6E, CSM6EP, CSM6G, CSM6GP		



GEV No.	390046	Ref. No.	1037035800 1450200 1450900 1450914 MA1037035800 MA1450200
description	thermostat t.max. 190°C temperature range 104-190°C 1-pole 1NO 16A probe ø 6mm probe L 133mm capillary pipe 870mm capillary pipe isolatedmm gland nut M9x1 shaft ø 6x4.6mm shaft L 23mm shaft position lower rotation 270° probe material SS		
For models:	FQE4, FQE6, FQE6+6, FR74E, FR74E10, FR77E, FR77E10, FR92E10, FR92E13, FR92E22, FR92G22, FR94E10, FR94E13, FR94E22, FR94G22, FR94G23, FR9P2E10, FR9P4E10, P9D10E, P9D15E, P9DA10E, P9DA15E, P9I10E, P9I10G, P9I15E, P9I5E, P9IA10E, P9IA10G, P9IA15E		



GEV No.	375216	Ref. No.	LA65070210 LAR65070210
description	thermostat t.max. 280°C temperature range 50-280°C 1-pole 1NO 16A probe ø 3mm probe L 228mm capillary pipe 1300mm capillary pipe isolated 1150mm gland nut shaft L 23mm shaft position upper rotation 318°		
For models:	CVE004M, CVE104M, CVE105M, CVG105M, EC106M, EC110M, EC210M, EM010M+SC, EM106M, EM106M+SC, EM110M, EM110M+SC, EM210M, EM210M+SC, EV006M, EV106M, EV106M+SC, EV110M, EV110M+SC, EV210M, EV210M+SC, FE105M, FE105X, FE110M, FE110X, FE210M, FG105M, FG105X, FG110M, FG110X, FG210M, FG210X, GC106M, GC110M, GC210M, GM106M, GM106M+SC, GM110M, GM110M+SC, GM210M, GM210M+SC, GV106M, GV106M+SC, GV110M, GV110M+SC, GV210M, GV210M+SC, ME106M, ME106X, ME110M...(Other models you can see in the webshop)		



GEV No.	375322	Ref. No.	1037103500 MA1037103500
description	thermostat t.max. 295°C temperature range fixed 295°C 1-pole 1NO 15A probe ø 3mm probe L 219mm capillary pipe 900mm capillary pipe isolatedmm gland nut		
For models:	SPE60M, SPW60M		



GEV No.	375184	Ref. No.	1037102300 MA1037102300
description	thermostat t.max. 298°C temperature range 55-294°C 1-pole 1NO 16A probe ø 3.1mm probe L 226mm capillary pipe 870mm capillary pipe isolated 350mm gland nut shaft L 23mm shaft position upper probe material SS		
For models:	BR707E, BR707EI, BR78EF, BR78EI, BR912EFM, BR912EIM, BR912GFM, BR912GIM, BR94E, BR94EI, BR94G, BR94GI, BR98EF, BR98EFM, BR98EI, BR98EIM, BR98GF, BR98GFM, BR98GI, BR98GIM, BR9M4E, BR9M4EI, BR9M4G, BR9M4GI, BR9M6E, BR9M6EI, BR9M6G, BR9M6GI, BR9S8EF, BR9S8EI, BR9S8GF, BR9S8GI, BR9SB4E, BR9SB4EI, BR9SB4G, BR9SB4GI, CFE60, CFE60P, CFGE60, CFGE61, CFGE61D, CFGE61L, CFGE61P, CFVE60, FOE60M, MS10AG, MS10IG, MS70AG, MS70IG, MS70IGS... (Other models you can see in the webshop)		

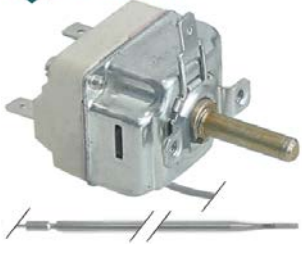

GEV No.	375667	Ref. No.	R65070360
description	thermostat t.max. 300°C temperature range 68-300°C 1-pole 1NO 16A probe ø 3.1mm probe L 226mm capillary pipe 980mm capillary pipe isolated 980mm gland nut shaft ø 6x4.6mm shaft L 23mm shaft position upper rotation 318°		
For models:	MACE04M, MACE05M, MACE07M, MACE10M, MACE20M, MACG05M, MACG07M, MACG10M, MACG20M, ME061M, ME101M, ME102M, ME201M, ME202M, MG061M, MG101M, MG102M, MG201M, MG202M		

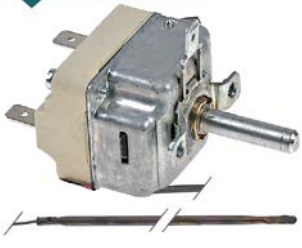

GEV No.	375884	Ref. No.	CM293800 CM293801 MACM293801
description	thermostat t.max. 400°C temperature range 65-400°C 1-pole 1NO probe ø 3.9mm probe L 163mm capillary pipe 870mm capillary pipe isolated 600mm gland nut shaft ø 6x4.6mm shaft L 23mm shaft position upper rotation 270°		
For models:	CT78EC, CT7FE8EC, CT98EC, CT9FE8EC		
accessories for	375884		
	GEV No.	112172	Ref. No. —
	knob universal ø 70mm black without adaptor/dial plate		
	GEV No.	112311	Ref. No. —
	knob adapter shaft ø 6x4.6mm L 0mm with spring		

accessories for	375884		
	GEV No.	112405	Ref. No. —
	knob dial plate silver thermostat t.max. 350°C 100-350°C rotation 270° ED ø 63mm ID ø 45.5mm		



GEV No.	375945	Ref. No.	CR0734520
description	thermostat t.max. 470°C temperature range 90-470°C 1-pole 1NO 16A probe ø 3.9mm probe L 163mm capillary pipe 870mm capillary pipe isolated 600mm shaft ø 4.5x6mm shaft L 23mm shaft position upper rotation 270°		
For models:	NCT78E, NCT7FE8E, NCT98E, NCT98E2, NCT9FE8E, NCT9FE8E2		



GEV No.	375219	Ref. No.	R65070100
description	thermostat t.max. 55°C temperature range fixed 55°C 1-pole 1NO 16A probe ø 6mm probe L 130mm capillary pipe 900mm capillary pipe isolated 850mm gland nut shaft Lmm shaft position probe material SS		
For models:	EM010M+SC, EM106M, EM106M+SC, EM110M, EM110M+SC, EM210M, EM210M+SC, GM106M, GM106M+SC, GM110M, GM110M+SC, GM210M, GM210M+SC, ME061M, ME101M, ME102D, ME102M, ME106M, ME106X, ME110M, ME110X, ME120M, ME120X, ME201M, ME202M, ME210M, ME210X, ME220M, ME220X, MEC40M, MG061M, MG101M, MG102M, MG106M, MG106X, MG110M, MG110X, MG120M, MG120X, MG201M, MG202M, MG210M, MG210X, MG220M, MG220X, MGC20X		
accessories for	375219		
	GEV No.	550148	Ref. No. —
	gland duct ET M12x0.75 IT M9x1 probe ø max. 6.5mm WS 17 silicone		



GEV No.	375215	Ref. No.	R65070165
description	thermostat t.max. 65°C temperature range fixed 65°C 1-pole 1CO 16A probe ø 6mm probe L 130mm capillary pipe 900mm capillary pipe isolated 900mm gland nut shaft Lmm shaft position		
For models:	CVE004M, CVE104M, CVE105M, CVG105M, EM010M+SC, EM106M, EM106M+SC, EM110M, EM110M+SC, EM210M, EM210M+SC, EV006M, EV106M, EV106M+SC, EV110M, EV110M+SC, EV210M, EV210M+SC, GM106M, GM106M+SC, GM110M, GM110M+SC, GM210M, GM210M+SC, GV106M, GV106M+SC, GV110M, GV110M+SC, GV210M, GV210M+SC, ME061M, ME101M, ME102D, ME102M, ME106M, ME106X, ME110M, ME110X, ME120M, ME120X, ME201M, ME202M, ME210M, ME210X, ME220M, ME220X, MEC40M, MG061M, MG101M, MG102M...(Other models you can see in the webshop)		



GEV No.	390040	Ref. No.	7800300 MA7800300
description	thermostat t.max. 90°C temperature range 30-90°C 1-pole 1CO 16A probe ø 6mm probe L 130mm capillary pipe 2040mm capillary pipe isolated 1940mm gland nut shaft ø 6x4.6mm shaft L 23mm shaft position upper rotation 270° probe material SS		
For models:	AR712PA, AR712PP, AR712PS, AR713PA, AR713PP, AR713PS, AR714PA, AR714PP, AR714PS, AR715PA, AR715PP, AR715PS, AR716PA, AR716PP, AR716PS, AR717PA, AR717PP, AR717PS, AR718PA, AR718PP, AR718PS, AR719PA, AR719PP, AR719PS, AR720PA, AR720PP, AR720PS, EAR612PA, EAR612PP, EAR612PS, EAR613PA, EAR613PP, EAR613PS, EAR614PA, EAR614PP, EAR614PS, EAR615PA, EAR615PP, EAR615PS, EAR616PA, EAR616PP, EAR616PS, EAR617PA, EAR617PP, EAR617PS, EAR618PA, EAR618PP, EAR618PS, EAR619PA, EAR619PP...(Other models you can see in the webshop)		



GEV No.	375217	Ref. No.	R65070240
description	thermostat t.max. 70°C temperature range fixed 70°C 1-pole 1CO 16A probe ø 6mm probe L 130mm capillary pipe 900mm capillary pipe isolated 900mm gland nut shaft Lmm shaft position probe material SS		
For models:	CVE004M, CVE104M, CVE105M, CVG105M, EM010M+SC, EM106M, EM106M+SC, EM110M, EM110M+SC, EM210M, EM210M+SC, EV006M, EV106M, EV106M+SC, EV110M, EV110M+SC, EV210M, EV210M+SC, GM106M, GM106M+SC, GM110M, GM110M+SC, GM210M, GM210M+SC, GV106M, GV106M+SC, GV110M, GV110M+SC, GV210M, GV210M+SC, ME061M, ME101M, ME102D, ME102M, ME106M, ME106X, ME110M, ME110X, ME120M, ME120X, ME201M, ME202M, ME210M, ME210X, ME220M, ME220X, MEC40M, MG061M, MG101M, MG102M...(Other models you can see in the webshop)		

55.13_series



GEV No.	375505	Ref. No.	643800 MA643800
description	thermostat t.max. 320°C temperature range 50-320°C 1-pole 1NO 16A probe ø 3mm probe L 160mm capillary pipe 870mm capillary pipe isolatedmm gland nut shaft ø 6x4.6mm shaft L 23mm shaft position upper rotation 270°		
For models:	BR94E, BR94EI, BR94G, BR94GI, BR96G, BR96GI, BR9M4E, BR9M4EI, BR9M4G, BR9M4GI, BR9M6E, BR9M6EI, BR9M6G, BR9M6GI, BR9SB4E, BR9SB4EI		



GEV No.	375211	Ref. No.	1037314600
description	thermostat t.max. 85°C temperature range 30-85°C 1-pole 1CO 16A probe ø 6mm probe L 130mm capillary pipe 900mm capillary pipe isolated 900mm gland nut shaft L 23mm shaft position upper rotation 270° probe material SS		
For models:	MLC50, MLC503, MLC65, MLC653, MLS35, MLS353		



55.14_series



GEV No.	375874	Ref. No.	1037117700 MA1037117700
description	thermostat t.max. 90°C temperature range 30-90°C 1-pole 1NO 16A probe ø 6mm probe L 74mm capillary pipe 900mm capillary pipe isolated 800mm gland nut M10x1 shaft ø 6x4.6mm shaft L 23mm shaft position 180° shaft position rotation 270°		
For models:	BME40DM, BME40DMB, BME40M, BME60DM, BME60DMB, BME60M, BME80M, BSEI40M, CSP6220, CSP6230, NSP74E, NSP94E, OBSEI40M, SP74E, SP94E		

55.34_series



GEV No.	375188	Ref. No.	CR0500540
description	thermostat t.max. 110°C temperature range 30-110°C 3-pole 3NO 16A probe ø 6mm probe L 131mm capillary pipe 1160mm capillary pipe isolatedmm gland nut shaft ø 6x4.6mm shaft L 23mm shaft position upper rotation 310°		



GEV No.	375385	Ref. No.	8219601 BN8219601
description	thermostat t.max. 180°C temperature range 100-180°C 3-pole 3NO 16A probe ø 6mm probe L 131mm capillary pipe 2000mm capillary pipe isolated 1800mm gland nut shaft ø 6x4.6mm shaft L 23mm shaft position upper rotation 270°		



GEV No.	375410	Ref. No.	1037101400 1616000 MA1037101400
description	thermostat t.max. 180°C temperature range 95-180°C 3-pole 3NO 16A probe ø 6mm probe L 133mm capillary pipe 1780mm capillary pipe isolated 1400mm gland nut M10x1 shaft ø 6x4.6mm shaft L 23mm shaft position upper rotation 270°		
For models:	PI707E		



GEV No.	390135	Ref. No.	426011
description	thermostat t.max. 220°C temperature range 90-220°C 3-pole capillary pipe isolatedmm gland nut		

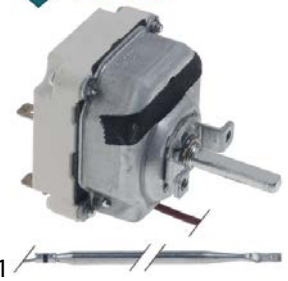

GEV No.	375559	Ref. No.	CR0686120
description	thermostat t.max. 230°C temperature range 95-230°C 3-pole 3NO 16A probe ø 4mm probe L 128mm capillary pipe 1250mm capillary pipe isolated 1000mm gland nut shaft ø 6x4.6mm shaft L 23mm shaft position upper rotation 270°		
For models:	NG74E, NG74E2, NG78E, NG78E2, NG912E, NG912E2, NG94E, NG94E2, NG98E, NG98E2		



GEV No.	375183	Ref. No.	1037100600 MA1037100600
description	thermostat t.max. 298°C temperature range 50-298°C 3-pole 3NO 16A probe ø 3mm probe L 219mm capillary pipe 900mm capillary pipe isolatedmm gland nut shaft ø 6x4.6mm shaft L 23mm shaft position upper rotation 318°		
For models:	FTE100B, FTE100BR, FTE100CRL, FTE40B, FTE40C, FTE60B, FTE60BR, FTE60C		



GEV No.	375412	Ref. No.	1037035200 1732000 BN6A044600 MA1037035200 MA1732000 No More Available
description	thermostat t.max. 320°C temperature range 50-320°C 3-pole 3NO 16A probe ø 3.1mm probe L 226mm capillary pipe 1480mm capillary pipe isolated 1400mm gland nut shaft ø 6x4.6mm shaft L 23mm shaft position upper rotation 318°		
For models:	BIE40, BIE60, BRE40, BRE40G, FT74E, FT74ER, FT74ERL, FT77E, FT77EC, FT77ERL, FTE100B, FTE100BR, FTE100CRL, FTE40B, FTE40C, FTE60B, FTE60BR, FTE60C		



GEV No.	375192	Ref. No.	1309100 1309115 MA1309115
description	thermostat t.max. 300°C temperature range 50-300°C 3-pole 3NO 16A probe ø 3mm probe L 219mm capillary pipe 900mm capillary pipe isolatedmm gland nut shaft ø 6x4.6mm shaft L 23mm shaft position upper rotation 270°		
For models:	BF78E, BF98E, BIE40, BIE40B, BIE60, BIE60B, BR707E, BR707EI, BR94E, BR94EI, BR96E, BR96EI, BR9M4E, BR9M4EI, BR9M6E, BR9M6EI, BRE40, BRE40D, BRE40DB, BRE40DG, BRE40DGB, BRE40G, C12FEP9G, C7011EFE, C7011EFEQ, C707EFE, C707EFEQ, C7FE12G, C7FE8E, C7FE8EC, C7FE8G, C9F4E, C9F6E, C9FE12G, C9FE6GS, C9FE8E, C9FE8EC, C9FE8G, C9V2E, C9V4E, CFE70, CWE42, CWE422, CWE62, CWE622, EC74EVG, EC78EVG, EC7FE8E, EFT74ELVG, EFT74ERVG... (Other models you can see in the webshop)		



GEV No.	375944	Ref. No.	CR0582770
description	thermostat t.max. 350°C temperature range 100-350°C 3-pole 3NOA probe ø 3mm probe L 147mm capillary pipe 900mm capillary pipe isolatedmm gland nut shaft ø 6x4.6mm shaft L 26mm shaft position upper rotation 270° probe material SS		
For models:	NFT74EL, NFT74ELC, NFT74ELCO, NFT74ELO, NFT74ER, NFT74ERC, NFT76EL, NFT76ELC, NFT76EM, NFT76EMC, NFT76ER, NFT78EL, NFT78ELC, NFT78ELCO, NFT78ELO, NFT78EM, NFT78EMC, NFT78ER, NFT78ERC, NFT94EL, NFT94ELC, NFT94ELO, NFT94ER, NFT96EL, NFT96ELC, NFT96EM, NFT96EMC, NFT98EL, NFT98ELC, NFT98ELO, NFT98EM, NFT98EMC		



GEV No.	390020	Ref. No.	425900
description	thermostat t.max. 300°C temperature range 50-300°C 3-pole capillary pipe isolatedmm gland nut		



GEV No.	375092	Ref. No.	1037035000
description	thermostat t.max. 90°C temperature range 30-90°C 3-pole capillary pipe isolatedmm gland nut		
For models:	BME40M, BME60, BME60M, BME80M, BSE40M		

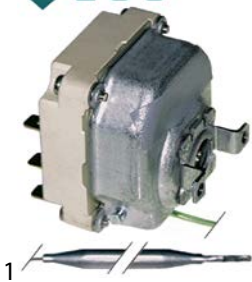

GEV No.	375210	Ref. No.	1037304900
description	thermostat t.max. 90°C temperature range 38-90°C 3-pole 3CO 16A probe ø 6mm probe L 215mm capillary pipe 900mm capillary pipe isolated 900mm gland nut shaft Lmm rotation 270°		
For models:	DLS30, DLS303, DLS30P, DLS30P3, DLS31, DLS313, DLS31P3, MLS30, MLS303, MLS30P, MLS30P3, MLS31, MLS313, MLS31P3, MPLS30P		

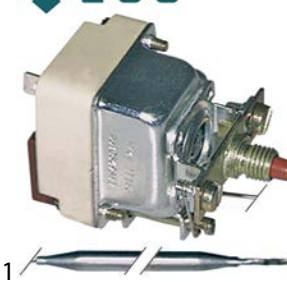

GEV No.	375197	Ref. No.	1568700 MA1568700
description	safety thermostat switch-off temp. 220°C 1-pole 16A probe ø 6mm probe L 142mm capillary pipe 2970mm capillary pipe isolated 2600mm gland nut probe SS		
For models:	FR92E13, FR92E132, FR92E13T, FR92E13T2, FR92E22, FR92E22T, FR94E13, FR94E132, FR94E13T, FR94E13T2, FR94E22, FR94E22T		



GEV No.	375411	Ref. No.	1037035015 1230200 MA1037035015 MA1230200
description	thermostat t.max. 93°C temperature range 30-93°C 3-pole 3NO 16A probe ø 6mm probe L 129mm capillary pipe 1480mm capillary pipe isolated 1100mm gland nut M10x1 shaft ø 6x4.6mm shaft L 23mm shaft position upper rotation 270°		
For models:	B124E, B74E, B78E, B94E, B98E, BM74E, BM77E, BME40DM, BME40DMB, BME40M, BME60, BME602, BME60DM, BME60DMB, BME60M, BME80M, BSE40M, NB74E, NB78E, NB94E, NB98E, SNA12, SNA16, SNA20, SNAC12, SNAC16, SNAC20, SNG08, SNG12, SNG16, SNG20, SVAC16, SVAC20, SVCG08, SVCG12, SVCG16, SVCG20, SVCG8, TP13E, TP17E, TP213E, TP217E, TP21E, TP221E		

55.31_ series



GEV No.	390066	Ref. No.	893100 MA893100
description	safety thermostat switch-off temp. 220°C 3-pole 20A probe ø 14mm probe L 105mm capillary pipe 820mm capillary pipe isolated 660mm gland nut probe with half round bulb		

safety thermostats

55.10/19_ series

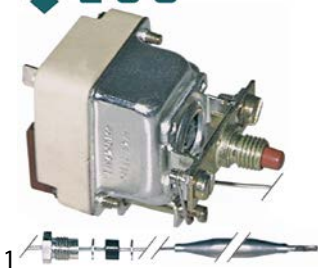

GEV No.	390061	Ref. No.	732913 BN6A049401 MA732913
description	safety thermostat switch-off temp. 220°C 1-pole 0.5A probe ø 6mm probe L 140mm capillary pipe 900mm capillary pipe isolatedmm gland nut probe M9x1		
For models:	FR74E, FR74E10, FR74G, FR77E, FR77E10, FR77G, FR92E10, FR92E13, FR92E22, FR92G22, FR94E10, FR94E13, FR94E22, FR94G23, FR9P2E10, FR9P4E10, P9D10E, P9D15E, P9DA10E, P9DA15E, P9I10E, P9I10G, P9I15E, P9I5E, P9IA10E, P9IA10G, P9IA15E, P1707G		



GEV No.	375104	Ref. No.	1037035900 MA1037035900
description	safety thermostat switch-off temp. 230°C 3-pole 20A probe ø 6mm probe L 167mm capillary pipe 830mm capillary pipe isolated 600mm gland nut M10x1 probe		



GEV No.	390168	Ref. No.	1878000 733100
description	safety thermostat switch-off temp. 230°C 3-pole 3NC 20A probe ø 6mm probe L 239mm capillary pipe 830mm capillary pipe isolated-mm gland nut M9x1 probe SS		
For models:	PI707E		



GEV No.	375394	Ref. No.	2613300 MA2613300
description	safety thermostat switch-off temp. 135°C 3-pole 1CO/2NC 20A probe ø 6mm probe L 73mm capillary pipe 1490mm capillary pipe isolated 1350mm gland nut M9x1 probe SS		
For models:	CS4E, CS4EP, FV4E, FV4E1		

55.32_ series



GEV No.	375947	Ref. No.	CR0585120
description	safety thermostat switch-off temp. 120°C 3-pole 20A probe ø 6mm probe L 94mm capillary pipe 900mm capillary pipe isolated 850mm gland nut starting temperature 111°C probe		
For models:	NB74E, NB78E, NB94E, NB98E		



GEV No.	375208	Ref. No.	2865100 MA2865100
description	safety thermostat switch-off temp. 139°C 3-pole 2x20/1x0.5A probe ø 6mm probe L 77mm capillary pipe 890mm capillary pipe isolated-mm gland nut M9x1 probe SS		
For models:	CS102E, CS102EP, CS102G, CS102GP, CS10E, CS10EP, CS10G, CS6E, CS6EP, CS6G, CSM102E, CSM102EP, CSM102G, CSM102GP, CSM10E, CSM10EP, CSM10G, CSM10GP, CSM201E, CSM201EP, CSM201G, CSM201GP, CSM202E, CSM202EP, CSM202G, CSM202GP, CSM6E, CSM6EP, CSM6G, CSM6GP		



GEV No.	375199	Ref. No.	1878900 MA1878900
description	safety thermostat switch-off temp. 132°C 3-pole 2x20/1x0.5A probe ø 6mm probe L 77mm capillary pipe 890mm capillary pipe isolated-mm gland nut M10x1 probe SS		
For models:	AR712PA, AR712PP, AR712PS, AR713PA, AR713PP, AR713PS, AR714PA, AR714PP, AR714PS, AR715PA, AR715PP, AR715PS, AR716PA, AR716PP, AR716PS, AR717PA, AR717PP, AR717PS, AR718PA, AR718PP, AR718PS, AR719PA, AR719PP, AR719PS, AR720PA, AR720PP, AR720PS, CP704E, CP92E, CP92E2, CP94E, CP94E2, CP95B2E, CP95B2E2, CP95B4E, CP95B4E2, CPE60, CPE602, CPE60DB, DE92142, DE94242, EAR612PA, EAR612PP, EAR612PS, EAR613PA, EAR613PP, EAR613PS, EAR614PA, EAR614PP, EAR614PS...(Other models you can see in the webshop)		



GEV No.	375668	Ref. No.	R65070020
description	safety thermostat switch-off temp. 140°C 3-pole 20A probe ø 6mm probe L 88mm capillary pipe 890mm capillary pipe isolated 800mm gland nut		
For models:	AC, AU04, AU05, AU08, AU10, AU20		



GEV No.	375209	Ref. No.	1037305000
description	safety thermostat switch-off temp. 140°C 3-pole 20A probe ø 6mm probe L 89mm capillary pipe 900mm capillary pipe isolated 900mm gland nut probe SS		
For models:	DLS30, DLS303, DLS30P, DLS30P3, DLS31, DLS313, DLS31P3, MLC50, MLC503, MLC65, MLC653, MLS30, MLS303, MLS30P, MLS30P3, MLS31, MLS313, MLS31P3, MLS35, MLS353, MPLS30P		



GEV No.	375189	Ref. No.	1982000 MA1982000
description	safety thermostat switch-off temp. 230°C 3-pole 20A probe ø 6mm probe L 89mm capillary pipe 3000mm capillary pipe isolated 2650mm gland nut M9x1 probe SS		
For models:	FR74E, FR74E10, FR74E10L, FR74E10L2, FR74E2, FR77E, FR77E10, FR77E10L, FR77E10L2, FR77E2, FR92E10, FR92E10L, FR92E10L2, FR92E13, FR92E132, FR92E13T, FR92E13T2, FR92E22, FR92E22T, FR94E10, FR94E10L, FR94E10L2, FR94E13, FR94E132, FR94E13T, FR94E13T2, FR94E22, FR94E22T		



GEV No.	390159	Ref. No.	R65070080 R65070081
description	safety thermostat switch-off temp. 150°C 1-pole 20A probe ø 6mm probe L 89mm capillary pipe 900mm capillary pipe isolated 800mm gland nut probe		
For models:	EM010M+SC, EM106H, EM106M, EM106M+SC, EM106P, EM110H, EM110M, EM110M+SC, EM110P, EM210H, EM210M, EM210M+SC, EM210P, GM106H, GM106M, GM106M+SC, GM106P, GM110H, GM110M, GM110M+SC, GM110P, GM210H, GM210M, GM210M+SC, GM210P, GMT06D, GMT20D, ME061D, ME061M, ME061P, ME061T, ME101D, ME101M, ME101P, ME101T, ME102D, ME102M, ME102P, ME102T, ME106M, ME106P, ME106X, ME110M, ME110P, ME110X, ME120M, ME120P, ME120X, ME201D, ME201M...(Other models you can see in the webshop)		



GEV No.	375445	Ref. No.	097700 CM097701 MACM097701
description	safety thermostat switch-off temp. 230°C 3-pole 2x20/1x0.5A probe ø 4mm probe L 120mm capillary pipe 900mm capillary pipe isolated 700mm gland nut probe		
For models:	EF74E10VG, EF74E12, EF74G15, EF74G8VA, EF74G8VG, F12C4E12, F12C4G15, F74E10, F74E12, F74E6, F74G10, F74G15, F74G6, F76E10, F76G10, F78E12, F78G15, F94E10, F94E12, F94E18, F94E18K, F94E6, F94G10, F94G15, F94G22, F94G22K, F94G6, F96E10, F96G10, F98E12, F98E18, F98E18K, F98G15, F98G22, F98G22K, FQE41R, FQE41RL, FQE61R, FQE61RL, FQG41, FQG61, NF74E10, NF74E15, NF74G10, NF74G15, NF74G15T, NF74G8, NF76E10, NF76G10, NF76G8...(Other models you can see in the webshop)		



GEV No.	375358	Ref. No.	1871100 MA1871100
description	safety thermostat switch-off temp. 230°C 2-pole 1x20/1x0.5A probe ø 6mm probe L 74mm capillary pipe 880mm capillary pipe isolated-mm gland nut M9x1 probe SS automatic		
For models:	CP9A15GD, FQG40, FQG60, FR74G, FR77G, FR92G13, FR92G22, FR92G22T, FR94G13, FR94G22, FR94G22T, MM10IG, P9110E, P9110G, P9115E, P915G, P91A10E, P91A10G, P1707G		



GEV No.	375873	Ref. No.	1878600 MA1878600
description	safety thermostat switch-off temp. 236°C 3-pole 20A probe ø 6mm probe L 77mm capillary pipe 1190mm capillary pipe isolated 990mm gland nut starting temperature 218°C probe		
For models:	FQE40, FQE40D, FQE40DSP, FQE41, FQE41L, FQE41L2, FQE60, FQE60D, FQE60DSP, FQE61, FQE61L, FQE61L2, OFQE41, OFQE61, P915E, PI707E		
accessories for	375873		
	GEV No.	550148	Ref. No.
	gland duct ET M12x0.75 IT M9x1 probe ø max. 6.5mm WS 17 silicone		

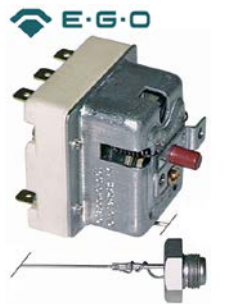

GEV No.	375220	Ref. No.	R65070050
description	safety thermostat switch-off temp. 330°C 3-pole 20A probe ø 11mm probe L 18.5mm capillary pipe 900mm capillary pipe isolated 900mm gland nut probe screw-in probe probe thread M14x1		
For models:	CVE004H, CVE004M, CVE104H, CVE104M, VE004M, VE004X, VE104M, VE104X		



GEV No.	375357	Ref. No.	1942900 MA1942900
description	safety thermostat switch-off temp. 325°C 1-pole 0.5A probe ø 3mm probe L 188mm capillary pipe 900mm capillary pipe isolatedmm gland nut probe		
For models:	FTG40B, FTG40BLC, FTG40BR, FTG60B, FTG60BLC, FTG60BR, FTG60BRR, FTG80B, FTG80BLC, FTG80BR		



GEV No.	375291	Ref. No.	R65070060
description	safety thermostat switch-off temp. 344°C 1-pole 20A probe ø 6mm probe L 79mm capillary pipe 900mm capillary pipe isolated 900mm gland nut probe		
For models:	FE105M, FE105X, FE110M, FE110X, FE210M, FG105M, FG105X, FG110M, FG110X, FG210M, FG210X, PE040M, PE040X, PE080M, PE080X, PG040M, PG040X, PG080M, PG080X		



GEV No.	375206	Ref. No.	2864714 MA2864714
description	safety thermostat switch-off temp. 325°C 3-pole 20A probe ø 3.1mm probe L 188mm capillary pipe 900mm capillary pipe isolated 700mm gland nut M10x1 probe SS		
For models:	CON102E, CON102EP, CON102G, CON102GP, CON10E, CON10EP, CON10G, CON10GP, CON201E, CON201EP, CON201G, CON201GP, CON202E, CON202EP, CON202G, CON202GP, CON6E, CON6EP, CON6G, CON6GP, CS102E, CS102EP, CS102G, CS102GP, CS10E, CS10G, CS4E, CS4EP, CS6E, CS6G, CSM102E, CSM102EP, CSM102G, CSM102GP, CSM10E, CSM10EP, CSM10G, CSM10GP, CSM201E, CSM201EP, CSM201G, CSM201GP, CSM202E, CSM202EP, CSM202G, CSM202GP, CSM6E, CSM6EP, CSM6G, CSM6GP...(Other models you can see in the webshop)		



GEV No.	375455	Ref. No.	R65070070
description	safety thermostat switch-off temp. 350°C 1-pole 16A probe ø 11mm probe L 16mm capillary pipe 900mm capillary pipe isolated 900mm gland nut probe screw-in probe probe thread M14x1		
For models:	CVE105H, CVE105M, CVG105H, CVG105M, EC106M, EC110M, EC210M, EM010M+SC, EM106H, EM106M, EM106M+SC, EM106P, EM110H, EM110M, EM110M+SC, EM110P, EM210H, EM210M, EM210M+SC, EM210P, EV006M, EV106H, EV106M, EV106M+SC, EV106P, EV110H, EV110M, EV110M+SC, EV110P, EV210H, EV210M, EV210M+SC, EV210P, GC106M, GC110M, GC210M, GM106H, GM106M, GM106M+SC, GM106P, GM110H, GM110M, GM110M+SC, GM110P, GM210H, GM210M, GM210M+SC, GM210P, GV106H, GV106M...(Other models you can see in the webshop)		



GEV No.	375163	Ref. No.	1475513
description	safety thermostat switch-off temp. 350°C 3-pole 0.5A probe ø 6mm probe L 79mm capillary pipe 3000mm capillary pipe isolated 2800mm gland nut probe SS		
For models:	F9V4EC, F9V4ECR, FT74E, FT74ER, FT74ERL, FT77E, FT77EC		



GEV No.	375684	Ref. No.	R65070350
description	safety thermostat switch-off temp. 360°C 1-pole 20A probe ø 11mm probe L 16mm capillary pipe 900mm capillary pipe isolated 900mm gland nut probe screw-in probe probe thread M14x1		
For models:	GMT06D, GMT20D, GVT06D, GVT20D, MACE04M, MACE05M, MACE07M, MACE10M, MACE20M, MACG05M, MACG07M, MACG10M, MACG20M, ME061D, ME061M, ME061P, ME061T, ME101D, ME101M, ME101P, ME101T, ME102D, ME102M, ME102P, ME102T, ME201D, ME201M, ME201P, ME201T, ME202D, ME202M, ME202P, ME202T, MEMT06D, MEMT06P, MEMT10D, MEMT10P, MEMT20D, MEMT20P, MEMT21D, MEMT21P, MEMT40D, MEMT40P, MEVT06D, MEVT06P, MEVT10D, MEVT10P, MEVT20D, MEVT20P, MEVT21D...(Other models you can see in the webshop)		



GEV No.	375187	Ref. No.	1878500 MA1878500
description	safety thermostat switch-off temp. 360°C 3-pole 3NC 2x20/1x0.5A probe ø 6mm probe L 79mm capillary pipe 890mm capillary pipe isolatedmm gland nut probe SS		
For models:	BF78E, BF98E, BIE40, BIE40B, BIE60, BIE60B, BR707E, BR707EI, BR78EF, BR78EI, BR912EFM, BR912EIM, BR912GFM, BR912GIM, BR94E, BR94EI, BR94G, BR94GI, BR98EF, BR98EFM, BR98EI, BR98EIM, BR98GF, BR98GFM, BR98GI, BR98GIM, BR9M4E, BR9M4EI, BR9M4G, BR9M4GI, BR9M6E, BR9M6EI, BR9M6G, BR9M6GI, BR9S8EF, BR9S8EI, BR9S8GF, BR9S8GI, BR9SB4E, BR9SB4EI, BR9SB4G, BR9SB4GI, C12FEP9G, C7011EFE, C7011EFEQ, C707EFE, C707EFEQ, C7FE12G, C7FE8E, C7FE8EC...(Other models you can see in the webshop)		

56._ series



GEV No.	390854	Ref. No.	CR1074320
description	safety thermostat switch-off temp. 245°C 1-pole 1NC 16A probe ø 3.1mm probe L 155mm capillary pipe 1130mm capillary pipe isolatedmm gland nut M9x1 probe		

control thermostats with operation switch

55.10/19_ series

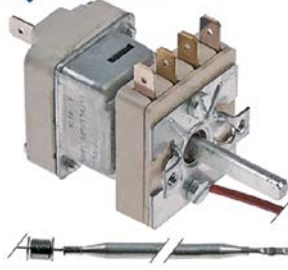

GEV No.	375875	Ref. No.	1037317300 MA1037317300
description	thermostat t.max. 180°C temperature range 53-180°C 1-pole 1NO 16A probe ø 6mm probe L 133mm capillary pipe 1170mm capillary pipe isolated 1000mm gland nut shaft ø 6x4.6mm shaft L 23mm rotation 270° outer switch 2NO		
For models:	FQE40, FQE40D, FQE40DSP, FQE41, FQE41L, FQE41L2, FQE60, FQE60D, FQE60DSP, FQE61, FQE61L, FQE61L2, OFQE41, OFQE61		

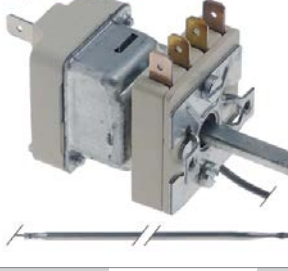

GEV No.	375180	Ref. No.	CR0589660
description	thermostat t.max. 185°C temperature range 99-185°C 1-pole 1NO 0.5A probe ø 4mm probe L 235mm capillary pipe 870mm capillary pipe isolated 700mm gland nut shaft ø 6x4.6mm shaft L 23mm shaft position rotation 270° outer switch 2NO		
For models:	EF74E10VG, NF74E10, NF74E15, NF76E10, NF78E15, NF94E10, NF94E15, NF94E22, NF94E222, NF96E10, NF98E15, NF98E22, NF98E222		

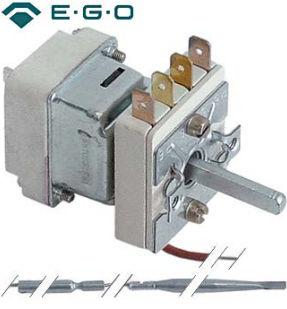

GEV No.	375331	Ref. No.	CM097800 MACM097800
description	thermostat t.max. 189°C temperature range 62-189°C 1-pole 1NO 0.5A probe ø 4mm probe L 116mm capillary pipe 900mm capillary pipe isolated 700mm gland nut shaft ø 6x4.6mm shaft L 23mm shaft position upper rotation 270° outer switch 2NO		
For models:	EF74E12, F12C4E12, F74E10, F74E12, F74E6, F76E10, F78E12, F94E10, F94E12, F94E18, F94E18K, F94E6, F94G22, F96E10, F98E12, F98E18, F98E18K, F98G22, F9S4E12, F9S4E18, F9S4E18K, F9S4G22, F9S8E12, F9S8E18, F9S8E18K, F9S8G22, FQE41R, FQE41RL, FQE41RL2, FQE61R, FQE61RL, PI76E5, PI96E5, PI98E10, PI98E15, PI98G10, PI98G14, PI98G14A, PI9S8E10		



GEV No.	375946	Ref. No.	CR0581280
description	thermostat t.max. 350°C temperature range 100-350°C 1-pole 1NO 16A probe ø 3mm probe L 145mm capillary pipe 900mm capillary pipe isolated 800mm gland nut shaft ø 4.5x6mm shaft L 25mm shaft position upper rotation 275° outer switch 2NC		
For models:	NBR78EF, NBR78EI, NBR912EFM, NBR912EIM, NBR912GFM, NBR912GIM, NBR98EF, NBR98EFM, NBR98EI, NBR98EIM, NBR98GF, NBR98GFM, NBR98GI, NBR98GIM		

55.34_ series



GEV No.	375140	Ref. No.	21351299 CR0688650
description	thermostat t.max. 650°C temperature range 50°C/50-600°C/70-650°C 3-pole 3NO 16A probe ø 4mm probe L 228mm capillary pipe 1200mm capillary pipe isolated 1200mm gland nut shaft ø 6x4.6mm shaft L 23mm shaft position left rotation 318° outer switch 2NO		
For models:	NV94E, NV98E, NV9FE8E, V9F4E, V9V2E, V9V4E		



IMIT / TEMPOMATIC / AR THERMO

control thermostats



GEV No.	390014	Ref. No.	120525
description	thermostat t.max. 85°C temperature range 40-78 / 47-85°C 2-pole 2CO 16A probe ø 6.5mm probe L 95mm capillary pipe 1500mm capillary pipe isolated 1450mm gland nut shaft ø 6x4.6mm shaft L 15mm shaft position right rotation 270°		



GEV No.	390006	Ref. No.	120501
description	thermostat t.max. 86°C temperature range 0-86°C 1-pole 1CO 16A probe ø 6.5mm probe L 95mm capillary pipe 1500mm capillary pipe isolatedmm gland nut shaft ø 6x4.6mm shaft L 19mm rotation 270°		
accessories for	390006		
	GEV No.	110100	Ref. No. 450315
	knob thermostat t.max. 90°C 0-90°C ø 42mm shaft ø 6x4.6mm shaft flat -135° black		
	GEV No.	110105	Ref. No. —
	rosette knob ø 42mm ø 56mm zero mark		



GEV No.	390022	Ref. No.	120522
description	thermostat t.max. 90°C temperature range 30-90°C 1-pole 1CO 16A probe ø 9.5mm probe L 50mm capillary pipe 1000mm capillary pipe isolated 1000mm gland nut shaft L 19mm rotation 270°		

safety thermostats



GEV No.	390773	Ref. No.	120519
description	safety thermostat switch-off temp. 135°C temperature range 95-135°C 1-pole 1CO 16A probe ø 5mm probe L 130mm capillary pipe 1000mm capillary pipe isolated 900mm gland nut probe		

RANCO

safety thermostats

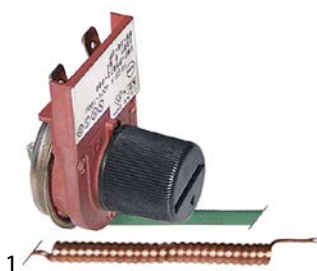

GEV No.	390024	Ref. No.	120523
description	safety thermostat t.max. 110°C temperature range°C 1-pole 1NC 16A probe ø 6mm probe L 50mm capillary pipe 1540mm capillary pipe isolated 160mm gland nut shaft ømm shaft Lmm shaft position rotation° probe material copper with coiled probe switch-off temp. 110°C		

refrigeration thermostats

RANCO

K22 series



GEV No.	390261	Ref. No.	24759.12 995352 FR6639240 FR995352 MA2475912
description	thermostat RANCO type K22L2557 probe ømm probe Lmm capillary pipe 2550mm temperature range -5 up to +13°C		
For models:	AF140MB, AF140MC, AF140MF, AF140MI, AF140MN, AF140MP, AF70MB, AF70MC, AF70MF, AF70MI, AF70MN, AF70MP, EF140DF, EF140DN, EF140DP, EF140MB, EF140MC, EF140MF, EF140MI, EF140MN, EF140MP, EF143DNF, EF143MNI, EF70DF, EF70DN, EF70DP, EF70MB, EF70MC, EF70MF, EF70MI, EF70MN, EF70MP, EF72DNF, EF72MNF, F140DF, F140DI, F140DN, F140DP, F14DFG, F14DNG, F70DF, F70DI, F70DN, F70DP, F7DFG, F7DNG, HF140DPF, IR13C, IR13CC, IR13CV... (Other models you can see in the webshop)		

K50 series



GEV No.	390255	Ref. No.	2523400 MA2523400
description	thermostat RANCO type K50P1115/012 capillary pipe 2000mm temperature range +1.5 up to +11°C		



GEV No.	390292	Ref. No.	2523500 MA2523500
description	thermostat RANCO type K50P1118 probe ømm probe Lmm capillary pipe 1250mm temperature range -3 up to +2.5°C		



GEV No.	390547	Ref. No.	MA2478500
description	thermostat RANCO type K50H2005 probe ø 10mm probe L 48mm capillary pipe 1500mm temperature range°C		

K55 series



GEV No.	390262	Ref. No.	24756.12 MA2475612
description	thermostat RANCO type K55L5085 capillary pipe 2500mm temperature range -0.5 up to +4°C		
For models:	AF140MB, AF140MC, AF140MF, AF140MI, AF140MN, AF140MP, AF70MB, AF70MC, AF70MF, AF70MI, AF70MN, AF70MP, EF140MB, EF140MC, EF140MF, EF140MI, EF140MN, EF140MP, EF143MNI, EF70MB, EF70MC, EF70MF, EF70MI, EF70MN, EF70MP, EF72MNF, SF100MB, SF100MC, SF100MF, SF100MI, SF100MN, SF100MP, SF110MF, SF110MI, SF110MN, SF110MP, SF50MB, SF50MC, SF50MF, SF50MI, SF50MN, SF50MP, SF55MF, SF55MI, SF55MN, SF55MP, SPAR, SPAR15, SPAR16, SPAR18... (Other models you can see in the webshop)		



RANCO



1

GEV No.	390263	Ref. No.	24757.12 MA2475712
description	thermostat RANCO type K55L5086 temperature range -10 up to -2°C		
For models:	AF140MB, AF140MC, AF140MF, AF140MI, AF140MN, AF140MP, AF70MB, AF70MC, AF70MF, AF70MI, AF70MN, AF70MP, EF140MB, EF140MC, EF140MF, EF140MI, EF140MN, EF140MP, EF143MNI, EF70MB, EF70MC, EF70MF, EF70MI, EF70MN, EF70MP, EF72MNF, SF100MB, SF100MC, SF100MF, SF100MI, SF100MN, SF100MP, SF110MF, SF110MI, SF110MN, SF110MP, SF50MB, SF50MC, SF50MF, SF50MI, SF50MN, SF50MP, SF55MF, SF55MI, SF55MN, SF55MP, SPAR, SPAR15, SPAR16, SPAR18...(Other models you can see in the webshop)		

accessories

probe clips

spring clips

for thermostat



1

GEV No.	550419	Ref. No.	1567200 MA1567200
description	probe clip for pipe ø 8.5mm for probe ø 6mm Qty 1 pcs		
For models:	FR74E, FR74E2, FR77E, FR77E2, FR92E13, FR92E132, FR92E13T, FR92E13T2, FR92E22, FR92E22T, FR94E13, FR94E132, FR94E13T, FR94E13T2, FR94E22, FR94E22T		

for safety thermostat



1

GEV No.	550417	Ref. No.	1033515200 MA1033515200
description	probe clip for pipe ø 2x8.5mm for probe ø 6mm for heating elements spacing 15-19mm Qty 1 pcs		
For models:	FQE41, FQE41L, FQE41L2, FQE61, FQE61L, FQE61L2, FR74E10, FR74E10L, FR74E10L2, FR77E10, FR77E10L, FR77E10L2, FR92E10, FR92E10L, FR92E10L2, FR94E10, FR94E10L, FR94E10L2, OFQE41, OFQE61		



1

GEV No.	551080	Ref. No.	1033515800 MA1033515800
description	probe clip for pipe ø 8.5mm for probe ø 4mm Qty 1 pcs		
For models:	EF74E10VG, EF74E12, F74E10, F74E6, F76E10, F94E10, F94E18K, F94E6, F96E10, F98E18K, F9S4E18K, F9S8E18K, FQE41R, FQE41RL, FQE41RL2, FQE61R, FQE61RL, NF74E10, NF74E15, NF76E10, NF78E15, NF94E10, NF94E15, NF94E22, NF94E222, NF94E222K, NF94E22K, NF96E10, NF98E15, NF98E22, NF98E222, NF98E222K, NF98E22K		

capillary tube clips



1

GEV No.	550970	Ref. No.	1033709500 MA1033709500
description	capillary tube clip for pipe ø 8.5mm		
For models:	FQE41, FQE41L, FQE41L2, FQE61, FQE61L, FQE61L2, FR74E10, FR74E10L, FR74E10L2, FR77E10, FR77E10L, FR77E10L2, FR92E10, FR92E10L, FR92E10L2, FR94E10, FR94E10L, FR94E10L2, OFQE41, OFQE61		

gland nut accessories

ducts



1

GEV No.	100820	Ref. No.	1395714 MA1395714
description	gland duct ET M14x1.5 IT M10x0.75 probe ø max. 6.5mm WS 22		
For models:	FR74G, FR77G, FR92G13, FR94G13		

locking screws





1

GEV No.	106605	Ref. No.	CM012401 MACM012401
description	union screw thread M10x1 probe ø max. 4.5mm		
For models:	EF74E10VG, EF74E12, EF74G15, EF74G8VA, EF74G8VG, F12C4E12, F12C4G15, F74E10, F74E12, F74E6, F74G10, F74G15, F74G6, F76E10, F76G10, F78E12, F78G15, F94E10, F94E12, F94E18, F94E18K, F94E6, F94G10, F94G15, F94G22, F94G22K, F94G6, F96E10, F96G10, F98E12, F98E18, F98E18K, F98G15, F98G22, F98G22K, F9S4E12, F9S4E18, F9S4E18K, F9S4G15, F9S4G22, F9S4G22K, F9S8E12, F9S8E18, F9S8E18K, F9S8G15, F9S8G22, F9S8G22K, FQE41R, FQE41RL, FQE41RL2...(Other models you can see in the webshop)		

plunger sockets







1



GEV No.	510935	Ref. No.	450515
description	thermowell thread 1/2" L 107mm SS single ø 8mm		
accessories for	510935		
	GEV No.	Ref. No.	—
	361184		
	nut thread 1/2" H 6mm nickel-plated brass WS 24 Qty 1 pcs		
	GEV No.	Ref. No.	—
	521122		
	flat gasket fibre ED ø 31mm ID ø 21.5mm thickness 2mm for thread 1/2" Qty 1 pcs		

1 electric components



			
1			
GEV No.	510987	Ref. No.	450519
description	thermowell thread 1/2" L 44mm SS single ø 10mm		
accessories for	510987		
	GEV No.	361184	Ref. No. —
	nut thread 1/2" H 6mm nickel-plated brass WS 24 Qty 1 pcs		
	GEV No.	521122	Ref. No. —
	flat gasket fibre ED ø 31mm ID ø 21.5mm thickness 2mm for thread 1/2" Qty 1 pcs		

connecting bows			
			
1			
GEV No.	550060	Ref. No.	1037003300 1037033300 1988500 1998500 921200 MA1988500 MA921200
description	connecting bow long for thermostat Qty 1 pcs		
For models:	AR712PA, AR712PP, AR712PS, AR713PA, AR713PP, AR713PS, AR714PA, AR714PP, AR714PS, AR715PA, AR715PP, AR715PS, AR716PA, AR716PP, AR716PS, AR717PA, AR717PP, AR717PS, AR718PA, AR718PP, AR718PS, AR719PA, AR719PP, AR719PS, AR720PA, AR720PP, AR720PS, B9SB2E, B9SB2G, B9SB4E, B9SB4G, B9V2E, B9V2G, B9V4E, B9V4G, BIE40, BIE40B, BIE60, BIE60B, BM74E, BM77E, BME40DM, BME40DMB, BME40M, BME60, BME602, BME60DM, BME60DMB, BME60M, BME80M...(Other models you can see in the webshop)		

25.5x25mm			
			
1			
GEV No.	345278 ¹	Ref. No.	2770400 2770500 MA2770400 MA2770500
description	rocker switch mounting measurements 25.5x25mm green 2NO 250V 16A illuminated 0-1 connection male faston 6.3mm protection IP40		
For models:	BR120, BR160, FC5E, FC5G, TAR134C2I, TAR176C2I		
accessories for	345278		
	GEV No.	301323	Ref. No. —
	protective cover external size 35x35mm H 11mm transparent suitable for rocker switch mounting measurements 25.5x25mm L 35mm W 35mm		

¹illuminated

27.8x25mm			
			
1			
GEV No.	345843 ¹	Ref. No.	130471
description	momentary rocker switch mounting measurements 27.8x25mm green 2CO 24V 16A illuminated outflow connection male faston 6.3mm ambient temperature max. 85°C protection IP40		

¹illuminated

			
1			
GEV No.	345123	Ref. No.	130447
description	rocker switch mounting measurements 27.8x25mm black 2CO 250V 16A auto/manual connection male faston 6.3mm ambient temperature max. 85°C protection IP40		

			
1			
GEV No.	510281	Ref. No.	160733
description	blank black mounting measurements 27.8x25mm		



30x22mm			
			
1			
GEV No.	347791	Ref. No.	4640500 MA4640500
description	rocker switch mounting measurements 30x22mm green 2NO 230V 20A illuminated 0-1 connection male faston 6.3mm ambient temperature max. 125/55°C protection IP65 with rubber collar		
For models:	B124E, CRE6220, CRE6230, CRE6320, CRE6330, CSP6220, CSP6230, EF140DF, EF140DN, EF140DP, EF140MB, EF140MC, EF140MF, EF140MI, EF140MN, EF140MP, EF143DNF, EF143MNI, EF70DF, EF70DN, EF70DP, EF70MB, EF70MC, EF70MF, EF70MI, EF70MN, EF70MP, EF72DNF, EF72MNF, F140DF, F140DI, F140DN, F140DP, F14DFG, F14DNG, F70DF, F70DI, F70DN, F70DP, F7DFG, F7DNG, HF140DPF, IR13C, IR13CC, IR13CV, IR13M, IR13MC, IR13MV, IR13V, IR17C...(Other models you can see in the webshop)		



switches and momentary switches



rocker/momentary rocker switches



19x13mm			
			
1			
GEV No.	345314	Ref. No.	1037102500 MA1037102500
description	momentary rocker switch mounting measurements 19x13mm black 1NO 250V 10A 0-1 connection male faston 4.8mm ambient temperature max. 85°C protection IP40		







			
GEV No.	301003	Ref. No.	0109015 211101.99
description	rocker switch mounting measurements 30x22mm green 2NO 250V 16A illuminated 0-1 connection male faston 6.3mm ambient temperature max. 125/55°C protection IP65		
For models:	AF140MB, AF140MC, AF140MF, AF140MI, AF140MN, AF140MP, AF70MB, AF70MC, AF70MF, AF70MI, AF70MN, AF70MP, AFC14, AFC14V, AFC7, AFC7V, AFPC214, AFPC214P, AFPC214V, AFR1143P, AFR14, AFR14V, AFR214P, AFR214PV, AFR7, AFR7P, AFR7PV, AFR7V, AFRC214, AFRC214V, AFRV14, AFRV144A, AFRV14V, AFRV7, AFRV74A, AFRV7V, C9F6E, C9FE6GS, EF140MB, EF140MC, EF140MF, EF140MI, EF140MN, EF140MP, EF143MNI, EF70MB, EF70MC, EF70MF, EF70MI, EF70MN... (Other models you can see in the webshop)		
accessories for	301003		
		GEV No.	301036 Ref. No. —
	protective cover internal size 30x22mm for rocker switch mounting measurementsmm		

			
GEV No.	345983	Ref. No.	40563-00 MA4056300
description	momentary rocker switch mounting measurements 30x22mm green 2NO 250V 16A illuminated 0-1 connection male faston 6.3mm ambient temperature max. 85°C protection IP65 with cover cap		
For models:	CRE6220, CRE6230, CRE6320, CRE6330, SBA, SBAC, SVAC, SVAC12, SVAC16, SVAC20, SVCG, SVCG08, SVCG12, SVCG16, SVCG20		
accessories for	345983		
		GEV No.	301036 Ref. No. —
	protective cover internal size 30x22mm for rocker switch mounting measurementsmm		

			
GEV No.	301017	Ref. No.	211102.99 MA21110299
description	rocker switch mounting measurements 30x22mm green 2CO 250V 16A illuminated connection male faston 6.3mm ambient temperature max. 125/55°C protection IP40		
For models:	AF140MB, AF140MC, AF140MF, AF140MI, AF140MN, AF140MP, AF70MB, AF70MC, AF70MF, AF70MI, AF70MN, AF70MP, SER15, SER15A, SER18, SER18A, SER21		
accessories for	301017		
		GEV No.	301036 Ref. No. —
	protective cover internal size 30x22mm for rocker switch mounting measurementsmm		

			
GEV No.	345982	Ref. No.	4640400 MA4640400
description	rocker switch mounting measurements 30x22mm green 2CO 250V 16A illuminated connection male faston 6.3mm ambient temperature max. 125/55°C protection IP65 with cover cap		
For models:	F140DF, F140DI, F140DN, F140DP, F14DFG, F14DNG, F70DF, F70DI, F70DN, F70DP, F7DFG, F7DNG, IR13C, IR13CC, IR13CV, IR13M, IR13MC, IR13MV, IR13V, IR17C, IR17CC, IR17CV, IR17M, IR17MC, IR17MV, IR17V, NF140DF, NF140DFN, NF140DN, NF140DNI, NF140DNN, NF140DP, NF140DPN, NF140DPP, NF143DNF, NF143DNI, NF143DNP, NF14DNG, NF70DF, NF70DI, NF70DN, NF70DP, NF72DNF, NF72DNI, NF72DNN, NF7DFG, NF7DNG, SPAR16, SPAR20, SPRG12...(Other models you can see in the webshop)		
accessories for	345982		
		GEV No.	301036 Ref. No. —
	protective cover internal size 30x22mm for rocker switch mounting measurementsmm		

blank			
			
GEV No.	347706	Ref. No.	R65260510
description	momentary rocker switch mounting measurements 30x22mm black 2CO 250V 16A connection male faston 6.3mm ambient temperature max. 100/55°C protection IP65 with cover cap		
For models:	EC106M, EC110M, EC210M, EM010M+SC, EM106M, EM106M+SC, EM110M, EM110M+SC, EM210M, EM210M+SC, EV006M, EV106M, EV106M+SC, EV110M, EV110M+SC, EV210M, EV210M+SC, FE105M, FE105X, FE110M, FE110X, FE210M, FG105M, FG105X, FG110M, FG110X, FG210M, FG210X, GC106M, GC110M, GC210M, GM106M, GM106M+SC, GM110M, GM110M+SC, GM210M, GM210M+SC, GV106M, GV106M+SC, GV110M, GV110M+SC, GV210M, GV210M+SC, PE040M, PE040X, PE080M, PE080X, PG040M, PG040X, PG080M... (Other models you can see in the webshop)		
accessories for	347706		
		GEV No.	301036 Ref. No. —
	protective cover internal size 30x22mm for rocker switch mounting measurementsmm		

labelled			
			
GEV No.	301200	Ref. No.	R65260050
description	rocker switch mounting measurements 30x22mm black 2NO 230V 16A 0-1 connection male faston 6.3mm ambient temperature max. 85°C protection IP65 with cover cap		
For models:	AC, AU04, AU05, AU08, AU10, AU20, EC106M, EC110M, EC210M, EM106M, EM110M, EM210M, EV006M, EV106M, EV110M, EV210M, FE105X, FG105X, FG110X, FG210X, GC106M, GC110M, GC210M, GM106M, GM110M, GM210M, GV106M, GV110M, GV210M, PE040X, PG040X, PG080X		
accessories for	301200		
		GEV No.	301036 Ref. No. —
	protective cover internal size 30x22mm for rocker switch mounting measurementsmm		



with symbol



1

GEV No.	301228	Ref. No.	R65260210
description	rocker switch mounting measurements 30x22mm black 2CO 250V 16A I-II connection male faston 6.3mm ambient temperature max. 125/55°C protection IP65 with cover cap		
For models:	FE105X, FG105X, FG110X, FG210X, PE040X, PG040X, PG080X		
accessories for	301228		
	GEV No.	301036	Ref. No. —
	protective cover internal size 30x22mm for rocker switch mounting measurementsmm		

push/momentary push switches

28.5x28.5mm



1

GEV No.	345846	Ref. No.	130459
description	momentary push switch mounting measurements 28.5x28.5mm grey 2CO 250V 16A START connection male faston 6.3mm ambient temperature max. 150°C protection IP40		



1

GEV No.	345845	Ref. No.	130460
description	push switch mounting measurements 28.5x28.5mm green/red 2CO 250V 16A ON-OFF connection male faston 6.3mm ambient temperature max. 150°C protection IP40		

ø16mm



1

GEV No.	301172	Ref. No.	R65260610
description	momentary push switch mounting ø 16mm black 1NO 250V 16A connection male faston 6.3mm protection IP40 ambient temperature max. 150°C		
For models:	MACE04M, MACE05M, MACE07M, MACE10M, MACE20M, MACG05M, MACG07M, MACG10M, MACG20M, ME061M, ME101M, ME102M, ME201M, ME202M, MG061M, MG101M, MG102M, MG201M, MG202M		



1

GEV No.	346287 ¹	Ref. No.	R65260480
description	momentary push switch mounting ø 16mm red 1NO 250V 3A illuminated connection male faston 2.8mm ambient temperature max. 125/55°C protection IP65 with cover cap		
For models:	GC106M, GC110M, GC210M, GM106H, GM106M, GM106M+SC, GM106P, GM110H, GM110M, GM110M+SC, GM110P, GM210H, GM210M, GM210M+SC, GM210P, GV106H, GV106M, GV106M+SC, GV106P, GV110H, GV110M, GV110M+SC, GV110P, GV210H, GV210M, GV210M+SC, GV210P		

¹illuminated

1

GEV No.	301227	Ref. No.	R65260120 R65260600
description	push switch mounting ø 16mm black 1NO 250V 16A connection male faston 6.3mm protection IP40 ambient temperature max. 150°C		
For models:	MACE04M, MACE05M, MACE07M, MACE10M, MACE20M, MACG05M, MACG07M, MACG10M, MACG20M, ME061M, ME101M, ME102M, ME201M, ME202M, MEC40M, MG061M, MG101M, MG102M, MG201M, MG202M		

ø25mm



1

GEV No.	345038	Ref. No.	CR0410290
description	momentary push switch mounting ø 25mm black 2NO 250V 16A connection male faston 6.3mm ambient temperature max. 85°C protection IP40		
For models:	CFG70, CFG70M, NBR912EFM, NBR912EIM, NBR912GFM, NBR912GIM, NBR98EF, NBR98EFM, NBR98EI, NBR98EIM, NBR98GF, NBR98GFM, NBR98GI, NBR98GIM		



1

GEV No.	345039	Ref. No.	1037115000 CR0410310 MACR0410310
description	protective cover round ED ø 33mm external size 23mm internal size 21mm H 12mm clear mounting ø 25mm		
For models:	CFG70, CFG70M, EF140DF, EF140DN, EF140DP, EF143DNF, EF70DF, EF70DN, EF70DP, EF72DNF, F140DF, F140DI, F140DN, F140DP, F14D-FG, F14DNG, F70DF, F70DI, F70DN, F70DP, F7DFG, F7DNG, FB110F, FB110N, FB110P, FB140F, FB140FN, FB140N, FB140NN, FB140P, FB140PF, FB140PN, FB140PP, FB143NI, FB55F, FB55N, FB55P, FB70F, FB70N, FB70P, FB72F, FB72N, FB72NF, FB72P, FR92G22T, FR94G22T, FS140F, FS140FI, FS140FN, FS140I...(Other models you can see in the webshop)		
accessories for	345039		
	GEV No.	345001	Ref. No. —
	momentary push switch mounting ø 25mm yellow 1NO/indicator light 250V 16A cover connection male faston 6.3mm ambient temperature max. 85°C protection IP65		



microswitches

lever actuated



GEV No.	345254	Ref. No.	1037111300 1037304200 MA1037111300 MA1037304200
description	microswitch with lever 250V 16A 1CO connection male faston 6.3mm ambient temperature max. 120°C mounting distance 22mm actuating force: 60g lever length 58mm		
For models:	BR78EF, BR78EI, BR78GF, BR78GI, BR912EFM, BR912EIM, BR912GFM, BR912GIM, BR98EF, BR98EFM, BR98EI, BR98EIM, BR98GF, BR98GFM, BR98GI, BR98GIM, BR9S8EF, BR9S8EI, BR9S8GF, BR9S8GI, DLS30, DLS303, DLS30P, DLS30P3, DLS31, DLS313, DLS31P3, EF140DF, EF140DN, EF140DP, EF140MB, EF140MC, EF140MF, EF140MI, EF140MN, EF140MP, EF143DNF, EF143MNI, EF70DF, EF70DN, EF70DP, EF70MB, EF70MC, EF70MF, EF70MI, EF70MN, EF70MP, EF72DNF, EF72MNF, EF74E10VG...(Other models you can see in the webshop)		

pin-plunger actuated



GEV No.	345326	Ref. No.	1037312900 MA1037312900
description	microswitch with plunger 250V 16A 1NO connection male faston 6.3mm ambient temperature max. 85°C mounting distance 22mm type XP52Z11 actuating force: 350g red stroke 15mm		
For models:	FQE40, FQE40D, FQE40DSP, FQE41, FQE41L, FQE41L2, FQE60, FQE60D, FQE60DSP, FQE61, FQE61L, FQE61L2, FR74E10, FR74E10L, FR74E10L2, FR77E10, FR77E10L, FR77E10L2, FR92E10, FR92E10L, FR92E10L2, FR94E10, FR94E10L, FR94E10L2, OFQE41, OFQE61		

M10



GEV No.	345032	Ref. No.	1267300 MA1267300 R65260540
description	microswitch with plunger thread M10x1 thread L 12mm 250V 16A 1CO connection male faston 6.3mm stroke 7mm mounting distance 22mm L 28mm ambient temperature max. 125°C type SP9603 actuating force: 180g		
For models:	BR94G, BR94GI, BR9M4G, BR9M4GI, EC106M, EC110M, EC210M, EM010M+SC, EM106H, EM106M, EM106M+SC, EM106P, EM110H, EM110M, EM110M+SC, EM110P, EM210H, EM210M, EM210M+SC, EM210P, EV006M, EV106H, EV106M, EV106M+SC, EV106P, EV110H, EV110M, EV110M+SC, EV110P, EV210H, EV210M, EV210M+SC, EV210P, FC10E, FC10G, FC20E, FC20G, FC5E, FC5G, FC7E, FC7G, FE105M, FE105X, FE110M, FE110X, FE210M, FG105M, FG105X, FG110M, FG110X...(Other models you can see in the webshop)		

M12



GEV No.	345350	Ref. No.	R65260530
description	microswitch with plunger mounting distance 22mm thread M12x0.75 thread L 16mm 250V 16A 1CO connection male faston 6.3mm stroke 4mm ambient temperature max. 125°C type EF83161.3 actuating force: 66g		
For models:	CVE004H, CVE004M, CVE104H, CVE104M, CVE105H, CVE105M, CVG105H, CVG105M, VE004M, VE004X, VE104M, VE104X, VE105M, VE105X, VG105M, VG105X		
accessories for	345350		
		GEV No.	345351
		Ref. No.	—
	nut thread M12x0.75 H 1.6mm WS 14 chrome-plated brass Qty 1 pcs		

position switches

PIZZATO

FD series



GEV No.	345075	Ref. No.	120343
description	position switch cast aluminum 1NO/1NC 400V 3A L 141mm W 40mm H 35mm protection IP67 actuating force: 300g screw connection PG13.5 mounting distance 30x60mm type FD503		

FR series



GEV No.	345144	Ref. No.	1871500 MA1871500
description	position switch plastic 1NC/1NO 400V 3A L 92mm W 31mm H 31mm protection IP67 actuating force: 360g screw connection PG13.5 mounting distance 22mm screw		
For models:	BR707E, BR707EI, BR94E, BR94EI, BR94G, BR94GI, BR9M4E, BR9M4EI, BR9M4G, BR9M4GI, BR9M6E, BR9M6EI, BR9M6G, BR9M6GI, BR9SB4E, BR9SB4EI, BR9SB4G, BR9SB4GI, MS10AG, MS10IG, MS70AG, MS70IG, MS70IGS		



GEV No.	345181	Ref. No.	1037307700 MA1037307700
description	position switch plastic 1NC/1NO 400V 3A L 92mm W 31mm H 31mm protection IP67 actuating force: 450g screw connection PG13.5 mounting distance 22mm screw		
For models:	MLC50, MLC503, MLC65, MLC653		



system switches (ROLD)

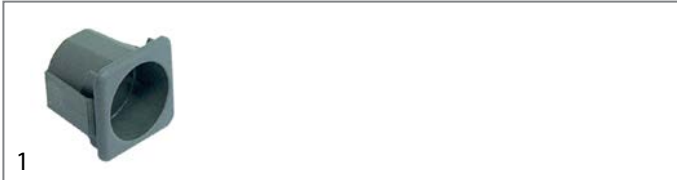

1	GEV No.	345131	Ref. No.	190140
description element holder mounting measurements 28.5x28.5mm grey single element holder				



1	GEV No.	345130	Ref. No.	130449
description momentary switch unit 1NO 250V 16A connection male faston 6.3mm				



1	GEV No.	345133	Ref. No.	450321
description push button ø 23mm grey				



1	GEV No.	345851	Ref. No.	450331
description push button ø 23mm grey START				

cam switches

on/off



1	GEV No.	300021	Ref. No.	1230100 MA1230100
description cam switch 4 operating positions 4NO sequence 0-1-0-1 16A shaft ø 6x4.6mm shaft L 23mm connection screw ceramic				
For models: B124E, B74E, B78E, B94E, B98E, B9VP2E, B9VP4E, BR94E, BR94EI, BR96E, BR96EI, BR9M4E, BR9M4EI, BR9M4GI, BR9M6E, BR9M6EI, BR9SB4E, BR9SB4EI, BSEI40M, FTE100B, FTE100BR, FTE100C, FTE100CRL, FTE40B, FTE40BR, FTE40C, FTE40D, FTE40DC, FTE60B, FTE60BR, FTE60BRR, FTE60C, FTE60D, FTE60DC, FTE60DCRL, FTE60DR, NB74E, NB78E, NB94E, NB98E, NF94E222K, NF94E22K, NF94G23K, NF98E222K, NF98E22K, NF98G23K, NSP74E, NSP94E, OBSEI40M, OFTE100CRL...(Other models you can see in the webshop)				

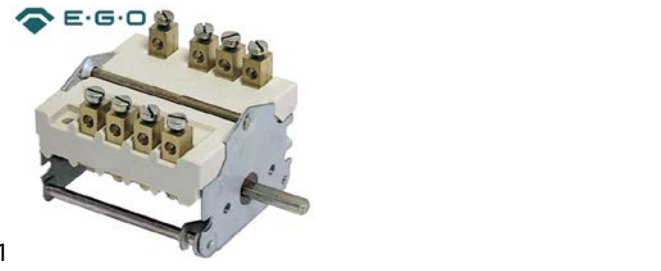

1	GEV No.	300102	Ref. No.	1475900 MA1475900
description cam switch 4 operating positions 4NO sequence 0-1-0-1 32A shaft ø 6x4.6mm shaft L 23mm connection screw ceramic				
For models: BR707E, BR707EI, BR94E, BR94EI, BR9M4E, BR9M4EI, FT74E, FT74ER, FT74ERL, FT77E, FT77EC				



1	GEV No.	300083	Ref. No.	1037307900 1037307900 (NML)
description cam switch ON-OFF				
For models: MLC50, MLC503, MLC65, MLC653				

4-position



1	GEV No.	300103	Ref. No.	501400 MA501400
description cam switch 4 operating positions 1NO/2CO sequence 0-1-2-3 32A shaft ø 6x4.6mm shaft L 23mm connection screw ceramic				
For models: C9F4E, C9F6E, C9V2E, C9V4E				



1	GEV No.	300104	Ref. No.	1037100500 790700 MA790700
description cam switch 4 operating positions 3NO/1CO sequence 0-1-2-3 32A shaft ø 6x4.6mm shaft L 23mm connection screw ceramic				
For models: CP704E, CP92E, CP94E, CP9SB2E, CP9SB4E, CPE40, CPE402, CPE60, CPE602, FP1E				



7-position



1

GEV No.	300025	Ref. No.	1037033100 1616100 MA1616100
description	cam switch 7 operating positions 1NO/2CO sequence 0-1-2-3-4-5-6 16A shaft ø 6x4.6mm shaft L 23mm connection screw 7-position ceramic		
For models:	C7011E, C7011EFE, C7011FEQ, C7011GFE, C704E, C707E, C707EFE, C707EFEQ, C707GFE, C74EC, C78EC, C78EQC, C7FE8E, C7FE8EC, C7FE8EQ, C7FG12G, C7FG8G, C94E, C94EC, C98E, C98EC, C9F4E, C9F6E, C9FE8E, C9FE8EC, C9V2E, C9V4E, CFE60, CFE60P, CFE70, EC74EVG, EC78EVG, EC7FE8E, NC74E2, NC74EC, NC74EQC, NC78E2, NC78EC, NC78EQC, NC7FE8E, NC7FE8E2, NC7FE8EQ, NC94E, NC94E2, NC98E, NC98E2, NC9FE8E, NC9FE8E2, OCPE60, OPCE40...(Other models you can see in the webshop)		
accessories for	300025		
	GEV No.	112172	Ref. No. —
	knob universal ø 70mm black without adaptor/dial plate		
	GEV No.	112213	Ref. No. —
	knob dial plate silver switch 7-position t.max.°C ED ø 63mm ID ø 45.5mm		
	GEV No.	112311	Ref. No. —
	knob adapter shaft ø 6x4.6mm L 0mm with spring		



1

GEV No.	300106	Ref. No.	1937800 21131099 MA1937800
description	cam switch 7 operating positions 1NO/2CO sequence 0-1-2-3-4-5-6 32A shaft ø 6x4.6mm shaft L 23mm connection screw 7-position shaft flat upper		
For models:	C74EC, C78EC, C78EQC, C7FE8E, C7FE8EC, C7FE8EQ, C94E, C94EC, C98E, C98EC, C9FE8E, C9FE8EC, NC94E, NC94E2, NC98E, NC98E2, NC9FE8E, NC9FE8E2		

2 operating positions

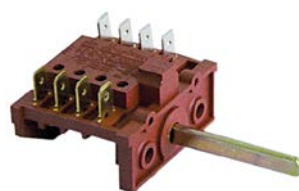

1

GEV No.	300085	Ref. No.	1037303100
description	cam switch 2 operating positions programme sequence 0-1 shaft ø 6x4.6mm connection male faston 6.3mm 4-pole		
For models:	DLS30, DLS303, DLS30P, DLS30P3, DLS31, DLS313, DLS31P3, MLS30, MLS303, MLS30P, MLS30P3, MLS31, MLS313, MLS31P3, MLS35, MLS353, MPLS30P		

3 operating positions



1

GEV No.	300086	Ref. No.	1037303200
description	cam switch 3 operating positions programme sequence 1-0-2 shaft ø 6x4.6mm connection male faston 10-pole		
For models:	DLS30, DLS303, DLS30P, DLS30P3, DLS31, DLS313, DLS31P3, MLS30, MLS303, MLS30P, MLS30P3, MLS31, MLS313, MLS31P3, MPLS30P		

4 operating positions

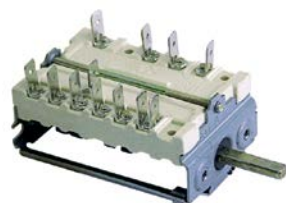

1

GEV No.	300010	Ref. No.	R65080010
description	cam switch 4 operating positions 2NO/2CO sequence 0-1-2-3 16A shaft ø 6x4.6mm shaft L 23mm connection male faston 6.3mm ceramic		
For models:	EC106M, EC110M, EC210M, FE105M, FE105X, FE110M, FE110X, FE210M, FG105M, FG105X, FG110M, FG110X, FG210M, FG210X, GC106M, GC110M, GC210M, MACE04M, MACE05M, MACE07M, MACE10M, MACE20M, MACG05M, MACG07M, MACG10M, MACG20M, PE040M, PE040X, PE080M, PE080X, PG040M, PG040X, PG080M, PG080X		



1

GEV No.	300081	Ref. No.	1309000 MA1309000
description	cam switch 4 operating positions 3NO/2CO sequence 0-1-2-3 16A shaft ø 6x4.6mm shaft L 23mm connection screw		
For models:	BF78E, BF98E, C12FEP9G, C7011EFE, C7011EFEQ, C707EFE, C707EFEQ, C7FE12G, C7FE8E, C7FE8EC, C7FE8G, C9F4E, C9F6E, C9FE12G, C9FE6G5, C9FE8E, C9FE8EC, C9FE8G, C9V2E, C9V4E, CFE70, EC74EVG, EC78EVG, EC7FE8E, NC7FE12G36, NC7FE8E, NC7FE8EQ, NC7FE8G24, NC9FE12G44, NC9FE12G52, NC9FE8E, NC9FE8E2, NC9FE8G28, NC9FE8G36, NC9FE8G48, V9F4E, V9FP4E, V9V2E, V9V4E, V9VP2E, V9VP4E		



2

GEV No.	300239	Ref. No.	CR0581810
description	operation switch 4 operating positions 4NO sequence 0-1-2-3 16A shaft ø 6x4.6mm shaft L 23mm connection male faston 6.3mm plastic		
For models:	NPC74E, NPC74G, NPC76E, NPC76G, NPC78E, NPC78G, NPC94E, NPC94G, NPC96E, NPC96G, NPC98E, NPC98G, NPD76G5, NPD78G8, NPD96G5, NPD98E10, NPD98E15, NPD98G10, NPD98G15, NPD98G15A, NPI76E5, NPI76G5, NPI78E8, NPI78G8, NPI96E5, NPI96G5, NPI98E10, NPI98E15, NPI98G10, NPI98G14, NPI98G14A		

5 operating positions

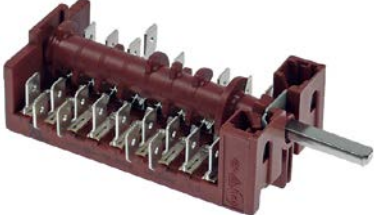

1

GEV No.	347191	Ref. No.	R65080020
description	cam switch 5 operating positions 9NO sequence 1-0-2-3-4 16A shaft ø 6x4.6mm shaft L 23mm connection male faston 6.3mm plastic		
For models:	CVE004M, CVE104M, CVE105M, CVG105M, EM010M+SC, EM106M, EM106M+SC, EM110M, EM110M+SC, EM210M, EM210M+SC, EV006M, EV106M, EV106M+SC, EV110M, EV110M+SC, EV210M, EV210M+SC, GM106M, GM106M+SC, GM110M, GM110M+SC, GM210M, GM210M+SC, GV106M, GV106M+SC, GV110M, GV110M+SC, GV210M, GV210M+SC, ME061M, ME101M, ME102M, ME106M, ME106X, ME110M, ME110X, ME120M, ME120X, ME201M, ME202M, ME210M, ME210X, ME220M, ME220X, MEC40M, MG061M, MG101M, MG102M, MG106M...(Other models you can see in the webshop)		

10 operating positions



1

GEV No.	345666	Ref. No.	1037103800 MA1037103800
description	cam switch 10 operating positions 6NO/1CO sequence 0-1-2-3-4-5-6-7-8-9 8A shaft ø 6x4.6mm shaft L 23mm connection male faston 6.3mm plastic		
For models:	FOE60M, OFOE60M		

with potentiometer



1

GEV No.	300252	Ref. No.	CR0737320
description	potentiometer 2 operating positions 2NO sequence 0-1 16A shaft ø 6x4.6mm shaft L 23mm connection coded plug cable length 1420mm 10kOhm 12V with cable and indicator light		
For models:	NI74E, NI78E, NI94E, NI98E, NIW74TE, NIW74TE2, NIW94TE, NIW94TE2		

operation switches



1

GEV No.	300080	Ref. No.	1037033200 218111 65085010 710300 LAR65085010 MA218111 MA710300
description	cam switch 2 operating positions 4NO 16A sequence 0-1 shaft ø 6x4.6mm shaft L 23mm connection screw operation switch ceramic ambient temperature max. 150°C		
For models:	B9SB2E, B9SB2G, B9SB4E, B9SB4G, B9V2E, B9V2G, B9V4E, B9V4G, BIE40, BIE40B, BIE60, BIE60B, BM74E, BM77E, BME40DM, BME40DMB, BME40M, BME60, BME602, BME60DM, BME60DMB, BME60M, BME80M, BR912GFM, BR912GIM, BR94G, BR94GI, BR96G, BR96GI, BR98GF, BR98GFM, BR98GI, BR98GIM, BR9M4G, BR9M4GI, BR9M6G, BR9M6GI, BR9S8GF, BR9S8GI, BR9SB4G, BR9SB4GI, BRE40, BRE40D, BRE40DB, BRE40DG, BRE40DGB, BRE40G, BSE40M, C7011EFE, C7011EFEQ...(Other models you can see in the webshop)		
accessories for	300080		
		GEV No.	551456
		Ref. No.	—
	gasket for switch ED ø 14mm ID ø 2.5mm thickness 3.5mm white		

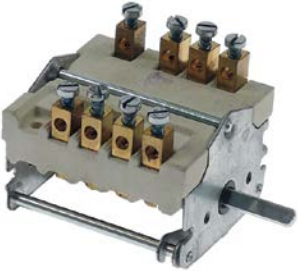

			
1			
GEV No.	300180	Ref. No.	CR0686110
description	cam switch 2 operating positions operation switch 32A sequence 0-1 shaft ø 6x4.6mm shaft L 23mm connection screw ceramic		
For models:	NFT74EL, NFT74ELC, NFT74ELCO, NFT74ELO, NFT74ER, NFT74ERC, NFT76EL, NFT76ELC, NFT76EM, NFT76EMC, NFT76ER, NFT78EL, NFT78ELC, NFT78ELCO, NFT78ELO, NFT78EM, NFT78EMC, NFT78ER, NFT78ERC, NFT94EL, NFT94ELC, NFT94ELO, NFT94ER, NFT96EL, NFT96ELC, NFT96EM, NFT96EMC, NFT98EL, NFT98ELC, NFT98ELO, NFT98EM, NFT98EMC, NG912E, NG912E2, NG94E, NG94E2, NG98E, NG98E2		

			
1			
GEV No.	300200	Ref. No.	1037313200 65260030 LAR65260030 MA1037313200
description	operation switch 2 operating positions 2NO 16A sequence 0-1 shaft ø 6x4.6mm shaft L 23mm connection male faston 6.3mm operation switch ceramic		
For models:	AR712PA, AR712PP, AR712PS, AR713PA, AR713PP, AR713PS, AR714PA, AR714PP, AR714PS, AR715PA, AR715PP, AR715PS, AR716PA, AR716PP, AR716PS, AR717PA, AR717PP, AR717PS, AR718PA, AR718PP, AR718PS, AR719PA, AR719PP, AR719PS, AR720PA, AR720PP, AR720PS, BME40DM, BME40DMB, BME40M, BME60DM, BME60DMB, BME60M, BME80M, BR707E, BR707EI, BR78EF, BR78EI, BR912EFM, BR912EIM, BR912GFM, BR912GIM, BR94E, BR94EI, BR98EF, BR98EFM, BR98EI, BR98EIM, BR98GF, BR98GFM...(Other models you can see in the webshop)		

			
1			
GEV No.	300091	Ref. No.	1037035700 MA1037035700
description	operation switch EGO 2 operating positions 2NO 16A sequence 0-1 shaft ø 6x4.6mm shaft L 23mm connection screw ceramic		
For models:	FQE4, FQE6, FQE6+6		

rotary switches

BREMAS

A1200 series

			
1			
GEV No.	345019	Ref. No.	120712
description	rotary switch sets of contacts 2 2 0-1 type CA0120002 380V 12A shaft ø 5x5mm shaft L 23mm shaft square connection screw		

A1600 series

			
1			
GEV No.	345840	Ref. No.	120737
description	rotary switch 3 0-1-2 sets of contacts 4 type CS0168308 400V 16A shaft ø 5x5mm shaft L 23mm shaft square connection screw		

			
1			
GEV No.	345842	Ref. No.	120716
description	rotary switch 5 0-1-2-3-4 sets of contacts 6 type CS0168359 400V 16A shaft ø 5x5mm shaft L 23mm shaft square connection screw		

			
1			
GEV No.	345024	Ref. No.	120729
description	rotary switch 6 0-1-2-3-4-5 sets of contacts 8 type CS0168339 400V 16A shaft ø 5x5mm shaft L 25mm shaft square connection screw		

TECNOMATIC

			
1			
GEV No.	300365	Ref. No.	1037308000 MA1037308000
description	rotary switch 4 0-1-2-3 sets of contacts 4 type HD12X274R000 600V 12A shaft ø 5x5mm shaft L 22mm shaft square connection male faston 6.3mm		
For models:	MLC50, MLC503, MLC65, MLC653		



touch sensitive light switches



1

GEV No.	346388	Ref. No.	R65260750
description	touch sensitive light switch 1NOVA for combi-steamer L 47mm W 20mm H 30mm		
For models:	GMT06D, GMT20D, GVT06D, GVT20D, MACE07M, MACE10M, MACE20M, MACG07M, MACG10M, MACG20M, ME061D, ME061M, ME061P, ME061T, ME101D, ME101M, ME101P, ME101T, ME102D, ME102M, ME102P, ME102T, ME201D, ME201M, ME201P, ME201T, ME202D, ME202M, ME202P, ME202T, MEMT06D, MEMT06P, MEMT10D, MEMT10P, MEMT10T, MEMT20D, MEMT20P, MEMT20T, MEMT21D, MEMT21P, MEMT40D, MEMT40P, MEVT06D, MEVT06P, MEVT10D, MEVT10P, MEVT20D, MEVT20P, MEVT21D, MEVT21P, MEVT40D, MEVT40P...(Other models you can see in the webshop)		

magnetic switches

36x13mm



1

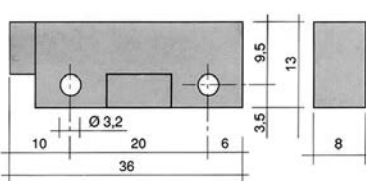

GEV No.	345335	Ref. No.	5169100 MA5169100
description	magnetic switch L 36mm W 13mm 1NO 250V 0.04A P max. 10W connection cable cable length 960mm		
For models:	CON102E, CON102EP, CON102G, CON102GP, CON10E, CON10EP, CON10G, CON10GP, CON201E, CON201EP, CON201G, CON201GP, CON202E, CON202EP, CON202G, CON202GP, CON6E, CON6EP, CON6G, CON6GP, CSM102E, CSM102EP, CSM102G, CSM102GP, CSM10E, CSM10EP, CSM10G, CSM10GP, CSM201E, CSM201EP, CSM201G, CSM201GP, CSM202E, CSM202EP, CSM202G, CSM202GP, CSM6E, CSM6EP, CSM6G, CSM6GP		
accessories for	345335		
	GEV No.	519049	Ref. No. —
	magnet ømm L 63mm H 10.7mm W 18.8mm hole distance 52mm M2 hole ø 2mm		

37x16mm



1

GEV No.	347790	Ref. No.	R65265100
description	magnetic switch L 37mm W 16mm 1NO 250V connection cable cable length 1960mm 10W with magnet nominal 0.04A		
For models:	GMT06D, GMT20D, GVT06D, GVT20D, ME061D, ME061M, ME061P, ME061T, ME101D, ME101M, ME101P, ME101T, ME102D, ME102M, ME102P, ME102T, ME106M, ME106P, ME106X, ME110M, ME110P, ME110X, ME120M, ME120P, ME120X, ME201D, ME201M, ME201P, ME201T, ME202D, ME202M, ME202P, ME202T, ME210M, ME210P, ME210X, ME220M, ME220P, ME220X, MEC24H, MEC40M, MEMT06D, MEMT06P, MEMT10D, MEMT10P, MEMT20D, MEMT20P, MEMT21D, MEMT21P, MEMT40D...(Other models you can see in the webshop)		

65x20mm



1

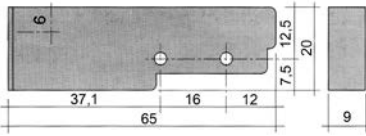



GEV No.	345122 ¹	Ref. No.	120333
description	magnetic switch L 65mm W 20mm 1NO 24V 8A P max. 192W connection male faston 6.3mm cable length 344mm		

¹with coded connector

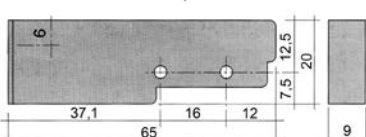

1



GEV No.	345116	Ref. No.	120348 BN161801
description	magnetic switch L 65mm W 20mm 1NO 250V 0.4A P max. 100W connection cable cable length 3000mm		
accessories for	345116		
	GEV No.	345399	Ref. No. —
	magnet ø 3.3mm L 40mm H 8mm W 13mm hole distance 30mm M3		

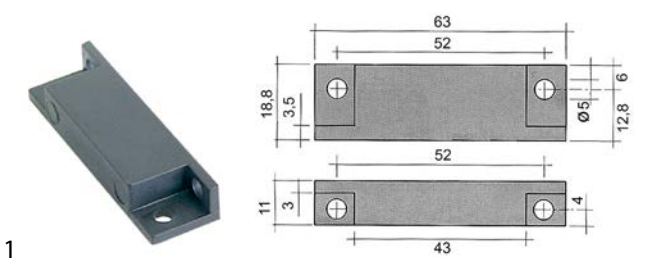

miscellaneous			
			
GEV No.	401961	Ref. No.	R66110300
description	magnetic switch door contact		
For models:	GMT20D, GVT06D, GVT20D, MACE07M, MACE10M, MACE20M, MACG07M, MACG10M, MACG20M, ME061M, ME061P, ME061T, ME101M, ME101P, ME101T, ME102M, ME102P, ME102T, ME201M, ME201P, ME201T, ME202D, ME202M, ME202P, ME202T, MEMT06D, MEMT06P, MEMT10D, MEMT10P, MEMT20D, MEMT20P, MEMT21D, MEMT21P, MEMT40D, MEMT40P, MEVT06D, MEVT06P, MEVT10D, MEVT10P, MEVT20D, MEVT20P, MEVT21D, MEVT21P, MEVT40D, MEVT40P, MG061M, MG061P, MG061T, MG101M, MG101P...(Other models you can see in the webshop)		

accessories			
magnets			
			
GEV No.	345336	Ref. No.	5169200 BN3108890 MA5169200
description	magnet ø 4.8mm L 63mm H 11mm W 18.8mm hole distance 51mm M4		
For models:	CON102E, CON102EP, CON102G, CON102GP, CON10E, CON10EP, CON10G, CON10GP, CON201E, CON201EP, CON201G, CON201GP, CON202E, CON202EP, CON202G, CON202GP, CON6E, CON6EP, CON6G, CON6GP, CSM102E, CSM102EP, CSM102G, CSM102GP, CSM10E, CSM10EP, CSM10G, CSM10GP, CSM201, CSM201E, CSM201EP, CSM201G, CSM201GP, CSM202, CSM202E, CSM202EP, CSM202G, CSM202GP, CSM6E, CSM6EP, CSM6G, CSM6GP		

3SB series ø22mm new			
rotary switches			
			
GEV No.	346629	Ref. No.	2998200 CR0413380
description	rotary selector mounting measurements ø22mm black momentary sequence 1-0-2		
For models:	BR78EF, BR78EI, BR78GF, BR78GI, BR912EFM, BR912EIM, BR912GFM, BR912GIM, BR98EF, BR98EFM, BR98EI, BR98EIM, BR98GF, BR98GFM, BR98GI, BR98GIM, BR9S8EF, BR9S8EI, BR9S8GF, BR9S8GI, CP9A15GD, F94E18K, F94G22K, F98E18K, F98G22K, NBR912EFM, NBR912EIM, NBR912GFM, NBR912GIM, NBR98EF, NBR98EFM, NBR98EI, NBR98EIM, NBR98GF, NBR98GFM, NBR98GI, NBR98GIM		
accessories for	346629		
	GEV No.	346602	Ref. No. —
contact block SIEMENS 3SB3400-0D 2NO max 400V 10A black			
	GEV No.	346603	Ref. No. —
contact block SIEMENS 3SB3400-0E 2NC max 400V 10A black			
	GEV No.	346630	Ref. No. —
contact block SIEMENS 3SB3400-0B 1NO max 400V 10A black			
	GEV No.	346631	Ref. No. —
contact block SIEMENS 3SB3400-0C 1NC max 400V 10A black			
	GEV No.	346632	Ref. No. —
contact block SIEMENS 3SB3400-0D 1NC/1NO max 400V 10A black			

control equipment

SIEMENS

3SB series ø22mm old			
rotary switches			
			
GEV No.	345526	Ref. No.	2860600 MA2860600 SI0102505 SIR0102505
description	rotary selector mounting measurements ø22mm sequence 0-1 latching black		
For models:	CON102E, CON102EP, CON102G, CON102GP, CON10E, CON10EP, CON10G, CON10GP, CON201E, CON201EP, CON201G, CON201GP, CON202E, CON202EP, CON202G, CON202GP, CON6E, CON6EP, CON6G, CON6GP, CS102E, CS102EP, CS102G, CS102GP, CS10E, CS10EP, CS10G, CS4E, CS4EP, CS6E, CS6EP, CS6G, CSM102E, CSM102EP, CSM102G, CSM102GP, CSM10E, CSM10EP, CSM10G, CSM10GP, CSM201, CSM201E, CSM201EP, CSM201G, CSM201GP, CSM202, CSM202E, CSM202EP, CSM202G, CSM202GP...(Other models you can see in the webshop)		

encoders and potentiometers

			
GEV No.	401338	Ref. No.	R65301450
description	encoder		
For models:	GMT06D, GMT20D, GVT06D, GVT20D, ME061D, ME061P, ME061T, ME101D, ME101P, ME101T, ME102D, ME102P, ME102T, ME201D, ME201P, ME201T, ME202D, ME202P, ME202T, MEMT06D, MEMT06P, MEMT10D, MEMT10P, MEMT20D, MEMT20P, MEMT21D, MEMT21P, MEMT40D, MEMT40P, MEVT06D, MEVT06P, MEVT10D, MEVT10P, MEVT20D, MEVT20P, MEVT21D, MEVT21P, MEVT40D, MEVT40P, MG061D, MG061P, MG061T, MG101D, MG101P, MG101T, MG102D, MG102P, MG102T, MG201D, MG201P...(Other models you can see in the webshop)		



			
1			
GEV No.	300252	Ref. No.	CR0737320
description	potentiometer 2 operating positions 2NO sequence 0-1 16A shaft \varnothing 6x4.6mm shaft L 23mm connection coded plug cable length 1420mm 10kOhm 12V with cable and indicator light		
For models:	NI74E, NI78E, NI94E, NI98E, NIW74TE, NIW74TE2, NIW94TE, NIW94TE2		

lamps

indicator lights

indicator lights 2-piece (lens and indicator lamp)

indicator light lenses

\varnothing 6mm (type SQ-20)

			
1			
GEV No.	359806	Ref. No.	130707
description	indicator light lens clear Qty 1 pcs \varnothing 6mm		

			
1			
GEV No.	359803	Ref. No.	130704
description	indicator light lens green Qty 1 pcs \varnothing 6mm		

			
1			
GEV No.	359805	Ref. No.	130706
description	indicator light lens red Qty 1 pcs \varnothing 6mm		

\varnothing 12mm (type SDY-3)

			
1			
GEV No.	359262	Ref. No.	130711 BN6A001438
description	indicator light housings mounting measurements \varnothing 12mm green round Qty 1 pcs		

			
1			
GEV No.	359261	Ref. No.	130710
description	indicator light housings mounting measurements \varnothing 12mm red round Qty 1 pcs		

indicator lamps for socket type SRZ / SDK / SDY / SFK

			
1			
GEV No.	359129	Ref. No.	130170
description	indicator lamp 24V clear connection male faston 6.3mm		

			
1			
GEV No.	359132	Ref. No.	1037303400
description	indicator lamp green 250V connection male faston 6.3mm protection IP54 ambient temperature max. 85°C		
For models:	DLS30, DLS303, DLS30P, DLS30P3, DLS31, DLS313, DLS31P3, MLC50, MLC503, MLC65, MLC653, MLS30, MLS303, MLS30P, MLS30P3, MLS31, MLS313, MLS31P3, MLS35, MLS353, MPLS30P		

indicator lights (complete)

\varnothing 6mm

			
1			
GEV No.	359004	Ref. No.	2998600 MA2998600
description	indicator light \varnothing 6mm 230V green cable length 400mm temp.-resist. 106°C		
For models:	CON102E, CON102EP, CON102G, CON102GP, CON10E, CON10EP, CON10G, CON10GP, CON201E, CON201EP, CON201G, CON201GP, CON202E, CON202EP, CON202G, CON202GP, CON6E, CON6EP, CON6G, CON6GP		

			
1			
GEV No.	359005	Ref. No.	2998700 MA2998700
description	indicator light \varnothing 6mm 230V yellow cable length 400mm		
For models:	CON102E, CON102EP, CON102G, CON102GP, CON10E, CON10EP, CON10G, CON10GP, CON201E, CON201EP, CON201G, CON201GP, CON202E, CON202EP, CON202G, CON202GP, CON6E, CON6EP, CON6G, CON6GP		

			
1			
GEV No.	359284	Ref. No.	2959600 MA2959600
description	indicator light \varnothing 6mm 24V green cable length 150mm		
For models:	CON201E, CON201EP, CON201G, CON201GP, CON202E, CON202EP, CON202G, CON202GP, CS4E, CS4EP, CSM102E, CSM102EP, CSM102G, CSM102GP, CSM10E, CSM10EP, CSM10G, CSM10GP, CSM201, CSM201E, CSM201EP, CSM201G, CSM201GP, CSM202, CSM202E, CSM202EP, CSM202G, CSM202GP, CSM6E, CSM6EP, CSM6G, CSM6GP		





			
1			
GEV No.	359285	Ref. No.	2959700 MA2959700
description	indicator light ø 6mm 24V yellow cable length 150mm		
For models:	CON201E, CON201EP, CON201G, CON201GP, CON202E, CON202EP, CON202G, CON202GP, CS4E, CS4EP, CSM102E, CSM102EP, CSM102G, CSM102GP, CSM10E, CSM10EP, CSM10G, CSM10GP, CSM201, CSM201E, CSM201EP, CSM201G, CSM201GP, CSM202, CSM202E, CSM202EP, CSM202G, CSM202GP, CSM6E, CSM6EP, CSM6G, CSM6GP		

			
1			
GEV No.	359031	Ref. No.	130157
description	indicator light ø 6mm 230V green		

ø10mm			
with screw socket			
			
1			
GEV No.	359378	Ref. No.	1037300810 MA1037300810
description	indicator light ø 10mm 230V green connection male faston 6.3mm socket screw base		
For models:	B9SB2E, B9SB4E, B9V2E, B9V4E, BIE40, BIE40B, BIE60, BIE60B, BM74E, BM77E, BME40DM, BME40DMB, BME40M, BME60, BME602, BME60DM, BME60DMB, BME60M, BME80M, BRE40, BRE40D, BRE40DB, BRE40DG, BRE40DGB, BRE40G, BSE40M, BSEI40M, CB3, CB5, CD24, CFE60, CFE60P, CFE70, CFGE60, CFGE61, CFGE61D, CFGE61L, CFGE61P, CFVE60, CPE40, CPE402, CPE60, CPE602, CWE42, CWE422, CWE62, CWE622, F9V2E, F9V2E2, F9V2ER...(Other models you can see in the webshop)		

			
1			
GEV No.	359379	Ref. No.	CR0587500
description	indicator light ø 10mm 230V yellow connection male faston 6.3mm socket screw base		
For models:	EF74E10VG, EF74E12, NB74E, NB78E, NBR78EF, NBR78EI, NBR912EFM, NBR912EIM, NBR912GFM, NBR912GIM, NBR98EF, NBR98EFM, NBR98EI, NBR98EIM, NBR98GF, NBR98GFM, NBR98GI, NBR98GIM, NC74E2, NC74EC, NC74EQC, NC78E2, NC78EC, NC78EQC, NC7FE8E, NC7FE8E2, NC7FE8EQ, NC94E, NC94E2, NC98E, NC98E2, NC9FE8E, NC9FE8E2, NCT78E, NCT7FE8E, NCT98E, NCT98E2, NCT9FE8E, NCT9FE8E2, NF74E10, NF74E15, NF76E10, NF78E15, NF94E10, NF94E15, NF94E22, NF94E222, NF96E10, NF98E15, NF98E22...(Other models you can see in the webshop)		

with plug-in socket			
			
1			
GEV No.	359140	Ref. No.	1037300900 1037300910 MA1037300910
description	indicator light ø 10mm yellow 230V connection male faston 6.3mm Qty 1 pcs		
For models:	AR712PA, AR712PP, AR712PS, AR713PA, AR713PP, AR713PS, AR714PA, AR714PP, AR714PS, AR715PA, AR715PP, AR715PS, AR716PA, AR716PP, AR716PS, AR717PA, AR717PP, AR717PS, AR718PA, AR718PP, AR718PS, AR719PA, AR719PP, AR719PS, AR720PA, AR720PP, AR720PS, B124E, B74E, B78E, B94E, B98E, B9SB2E, B9SB4E, B9V2E, B9V4E, BF78E, BF98E, BIE40, BIE40B, BIE60, BIE60B, BM74E, BM77E, BME40DM, BME40DMB, BME40M, BME60, BME602, BME60DM...(Other models you can see in the webshop)		

ø12mm			
with screw socket			
			
1			
GEV No.	359027	Ref. No.	R65270230
description	indicator light ø 12mm 250V green connection male faston 6.3mm		
For models:	CVE004M, CVE104M, CVE105M, CVG105M, EC106M, EC110M, EC210M, EM010M+SC, EM106M, EM106M+SC, EM110M, EM110M+SC, EM210M, EM210M+SC, EV006M, EV106M, EV106M+SC, EV110M, EV110M+SC, EV210M, EV210M+SC, FE105M, FE105X, FE110M, FE110X, FE210M, FG105M, FG105X, FG110M, FG110X, FG210M, FG210X, GC106M, GC110M, GC210M, GM106M, GM106M+SC, GM110M, GM110M+SC, GM210M, GM210M+SC, GV106M, GV106M+SC, GV110M, GV110M+SC, GV210M, GV210M+SC, ME106M, ME106X, ME110M...(Other models you can see in the webshop)		

			
1			
GEV No.	359290	Ref. No.	R65270220
description	indicator light ø 12mm 400V yellow connection male faston 6.3mm		
For models:	AC, AU04, AU05, AU08, AU10, AU20, CVE004M, CVE104M, CVE105M, CVG105M, EC106M, EC110M, EC210M, EM010M+SC, EM106M, EM106M+SC, EM110M, EM110M+SC, EM210M, EM210M+SC, EV006M, EV106M, EV106M+SC, EV110M, EV110M+SC, EV210M, EV210M+SC, FE105M, FE105X, FE110M, FE110X, FE210M, FG105M, FG105X, FG110M, FG110X, FG210M, FG210X, GC106M, GC110M, GC210M, GM106M, GM106M+SC, GM110M, GM110M+SC, GM210M, GM210M+SC, GV106M, GV106M+SC, GV110M...(Other models you can see in the webshop)		



ø13mm

with plug-in socket



1

GEV No.	359142	Ref. No.	1819800 21016199 MA1819800 MA21016199
description	indicator light ø 13mm green 230V connection male faston 6.3mm temp.-resist. 120°C Qty 1 pcs		
For models:	B9SB2E, B9SB4E, B9V2E, B9V4E, B9VP2E, B9VP4E, BM74E, BM77E, BR707E, BR707EI, C7011E, C7011EFE, C7011EFEQ, C704E, C707E, C707EFE, C707EFEQ, C9F4E, C9F6E, C9V2E, C9V4E, F9V2E, F9V2ER, F9V4E, F9V4EC, F9V4ECR, F9V4ER, F9V4ERL, FC10E, FC10G, FC20E, FC20G, FC5E, FC5G, FC7E, FC7G, FR74E, FR74E10, FR77E, FR77E10, FR92E10, FR92E13, FR92E132, FR92E22, FR94E10, FR94E13, FR94E132, FR94E22, FR9P2E10, FR9P4E10...(Other models you can see in the webshop)		



2

GEV No.	359143	Ref. No.	1819900 21016299 MA1819900 MA21016299
description	indicator light ø 13mm yellow 230V connection male faston 6.3mm temp.-resist. 120°C Qty 1 pcs		
For models:	B9SB2E, B9SB4E, B9V2E, B9V4E, B9VP2E, B9VP4E, BM74E, BM77E, BR707E, BR707EI, C7011EFE, C7011EFEQ, C707EFE, C707EFEQ, C9F4E, C9F6E, C9V2E, C9V4E, CP704E, CP92E, CP94E, CP95B2E, CP95B4E, F9V2E, F9V2ER, F9V4E, F9V4EC, F9V4ECR, F9V4ER, F9V4ERL, FC10E, FC10G, FC20E, FC20G, FC5E, FC5G, FC7E, FC7G, FP1E, FR74E, FR74E10, FR77E, FR77E10, FR92E10, FR92E13, FR92E132, FR92E22, FR94E10, FR94E13, FR94E132...(Other models you can see in the webshop)		

ø16mm

with plug-in socket



1

GEV No.	359788	Ref. No.	R65270160
description	indicator light ø 16mm 230V green connection male faston 6.3mm		
For models:	MACE04M, MACE05M, MACE07M, MACE10M, MACE20M, MACG05M, MACG07M, MACG10M, MACG20M, ME061M, ME101M, ME102M, ME201M, ME202M, MG061M, MG101M, MG102M, MG201M, MG202M		



1

GEV No.	359789	Ref. No.	R65270150
description	indicator light ø 16mm 230V yellow connection male faston 6.3mm		
For models:	MACE04M, MACE05M, MACE07M, MACE10M, MACE20M, MACG05M, MACG07M, MACG10M, MACG20M, ME061M, ME101M, ME102M, ME201M, ME202M, MG061M, MG101M, MG102M, MG201M, MG202M		

14x11mm



1

GEV No.	359270	Ref. No.	1037036300 MA1037036300
description	indicator light mounting measurements 14x11mm 230V green connection male faston 6.3mm		
For models:	RIE40M, RIEP40M		

26.5x25.6mm



1

GEV No.	345853	Ref. No.	130168
description	indicator light mounting measurements 27.8x25mm green 230V connection male faston 6.3mm		



1

GEV No.	345854	Ref. No.	130169
description	indicator light mounting measurements 27.8x25mm green 230V connection male faston 6.3mm		



1

GEV No.	345855	Ref. No.	130152
description	indicator light mounting measurements 27.8x25mm green 230V connection male faston 6.3mm temp.-resist. 125°C		



1

GEV No.	359012	Ref. No.	130136
description	indicator light mounting measurements 27.8x25mm yellow 230V connection male faston 6.3mm		

30x11mm			
 <p>1</p>			
GEV No.	359160	Ref. No.	1230300
description	indicator light mounting measurements 30x11mm 230V green connection male faston 6.3mm rectangular temp.-resist. 125°C		
For models:	B9SB2E, B9SB2G, B9SB4E, B9SB4G, B9V2E, B9V2G, B9V4E, B9V4G, F9V2E, F9V2ER, F9V4E, F9V4EC, F9V4ECR, F9V4ER, F9V4ERL, FR92E13, FR92E22, FR92G22, FR94E13, FR94E22, FR94G23, P9D10E, P9D15E, P9DA10E, P9DA15E, P9I10E, P9I10G, P9IA10E, P9IA10G, TP13E, TP17E, TP213E, TP217E, TP21E, TP221E		

 <p>2</p>			
GEV No.	359159	Ref. No.	912800
description	indicator light mounting measurements 30x11mm 230V yellow connection male faston 6.3mm temp.-resist. 125°C		
For models:	B9SB2E, B9SB2G, B9SB4E, B9SB4G, B9V2E, B9V2G, B9V4E, B9V4G, C9F4E, C9F6E, C9V2E, C9V4E, CB3, CB5, CD24, CP92E, CP94E, F9V2E, F9V2ER, F9V4E, F9V4EC, F9V4ECR, F9V4ER, F9V4ERL, FR92E13, FR92E22, FR92G22, FR94E13, FR94E22, FR94G23, P9D10E, P9D15E, P9DA10E, P9DA15E, P9I10E, P9I10G, P9IA10E, P9IA10G, TP13E, TP17E, TP213E, TP217E, TP21E, TP221E		

30x22mm			
 <p>1</p>			
GEV No.	359164	Ref. No.	1314400
description	indicator light mounting measurements 30x22mm 230V green/white connection male faston 6.3mm temp.-resist. 125°C		
For models:	BR94E, BR94EI, BR94G, BR94GI, BR96E, BR96EI, BR96G, BR96GI, BR9M4E, BR9M4EI, BR9M4G, BR9M4GI, BR9M6E, BR9M6EI, BR9M6G, BR9M6GI, C9F6E, C9F6G6S		

screw-on/push-on fit

light bulbs

for ovens

 <p>1</p>			
GEV No.	359612	Ref. No.	2861900 MA2861900
description	light bulb t.max. 300°C socket E14 25W 230V ø 25mm L 56mm lens L 30mm for oven lamp type Philips		
For models:	CON102E, CON102EP, CON102G, CON102GP, CON201E, CON201EP, CON201G, CON201GP, CON202E, CON202EP, CON202G, CON202GP, CS102E, CS102EP, CS102G, CS102GP, CS10E, CS10EP, CS10G, CS6E, CS6EP, CS6G, CSM102E, CSM102EP, CSM102G, CSM102GP, CSM10E, CSM10EP, CSM10G, CSM10GP, CSM201E, CSM201EP, CSM201G, CSM201GP, CSM202E, CSM202EP, CSM202G, CSM202GP, CSM6E, CSM6EP, CSM6G, CSM6GP		

halogen lamp

for socket E14 / E27

 <p>1</p>			
GEV No.	359728	Ref. No.	4625800 MA4625800
description	halogen lamp socket E14 230V 40W ø 25mm lens L 54mm L 80mm temp.-resist. 300°C Qty 1		
For models:	F140DF, F140DI, F140DN, F140DP, F143, F70DF, F70DI, F70DN, F70DP, F72, F7DFG, F7DNG, FB110F, FB110N, FB110P, FB140F, FB140FN, FB140N, FB140NN, FB140P, FB140PF, FB140PN, FB140PP, FB143NI, FB55F, FB55N, FB55P, FB70F, FB70N, FB70P, FB72F, FB72N, FB72NF, FB72P, FS140F, FS140FI, FS140FN, FS140I, FS140N, FS140NG, FS140NI, FS140NN, FS140P, FS140PN, FS140PP, FS143F, FS143FI, FS143N, FS143NF, FS143NI...(Other models you can see in the webshop)		



for socket G4 / G6.35 / G9

 <p>1 500°C</p>			
GEV No.	359599	Ref. No.	R65270020
description	halogen lamp socket G4 12V 20W temp.-resist. 500°C		
For models:	EC106M, EC110M, EC210M, EM010M+SC, EM106H, EM106M, EM106M+SC, EM106P, EM110H, EM110M, EM110M+SC, EM110P, EM210H, EM210M, EM210M+SC, EM210P, EV006M, EV106H, EV106M, EV106M+SC, EV106P, EV110H, EV110M, EV110M+SC, EV110P, EV210H, EV210M, EV210M+SC, EV210P, FE105X, FG105X, FG110X, FG210X, GC106M, GC110M, GC210M, GM106H, GM106M, GM106M+SC, GM106P, GM110H, GM110M, GM110M+SC, GM110P, GM210H, GM210M, GM210M+SC, GM210P, GMT06D, GMT20D...(Other models you can see in the webshop)		

oven lamps

universal oven lamps

mounting diameter 35.5mm

 <p>1</p>			
GEV No.	359718	Ref. No.	1037300100 1037317000 MA1037300100 MA1037317000
description	oven lamp mounting ø 35.5mm 230V 15W socket E14 temp.-resist. 300°C connection male faston 6.3mm hard glas		
For models:	CFE60, CFE60P, CFGE60, CFGE61, CFGE61D, CFGE61L, CFGE61P, CFVE60, FOE60M, OCFE60, OCFGE61, OFOE60M		
spare parts for	359718		
			
GEV No.	359701	Ref. No.	—
description	lamp socket socket E14 220-230V mounting ø 35.5mm connection male faston 6.3mm 15W		
			
GEV No.	359740	Ref. No.	—
description	light bulb t.max. 300°C socket E14 15W 230V ø 22mm L 48mm lens L 20mm for oven lamp IMPORT		

55x70mm



GEV No.	359375	Ref. No.	R65270510
description	lamp socket complete without lamp socket E14 mounting measurements 55x70mm		
For models:	MACE04M, MACE05M, MACG05M, MVE042P, MVE051P, MVG051P		

55x100mm



GEV No.	101372	Ref. No.	2862100 MA2862100
description	oven lamp complete L 100mm W 55mm 230V 25W socket E14 rectangular temp.-resist. 300°C connection male faston 6.3mm		
For models:	CON102E, CON102EP, CON102G, CON102GP, CON201E, CON201EP, CON201G, CON201GP, CON202E, CON202EP, CON202G, CON202GP, CS102E, CS102EP, CS102G, CS102GP, CS10E, CS10EP, CS10G, CS6E, CS6EP, CS6G, CSM102E, CSM102EP, CSM102G, CSM102GP, CSM10E, CSM10EP, CSM10G, CSM10GP, CSM201E, CSM201EP, CSM201G, CSM201GP, CSM202E, CSM202EP, CSM202G, CSM202GP, CSM6E, CSM6EP, CSM6G, CSM6GP		

spare parts for 101372

	GEV No.	359612	Ref. No.	2861900 MA2861900
	description	light bulb t.max. 300°C socket E14 25W 230V ø 25mm L 56mm lens L 30mm for oven lamp type Philips		

	GEV No.	359698	Ref. No.	—
	description	lamp socket L 100mm W 55mm socket E14 connection male faston 6.3mm		

	GEV No.	359714	Ref. No.	—
	description	gasket for bulb socket		

	GEV No.	359715	Ref. No.	—
	description	lamp glass L 110mm W 65mm thickness 5mm		

	GEV No.	359716	Ref. No.	—
	description	frame for bulb socket		

lamps

light bulbs



GEV No.	359612	Ref. No.	2861900 MA2861900
description	light bulb t.max. 300°C socket E14 25W 230V ø 25mm L 56mm lens L 30mm for oven lamp type Philips		
For models:	CON102E, CON102EP, CON102G, CON102GP, CON201E, CON201EP, CON201G, CON201GP, CON202E, CON202EP, CON202G, CON202GP, CS102E, CS102EP, CS102G, CS102GP, CS10E, CS10EP, CS10G, CS6E, CS6EP, CS6G, CSM102E, CSM102EP, CSM102G, CSM102GP, CSM10E, CSM10EP, CSM10G, CSM10GP, CSM201E, CSM201EP, CSM201G, CSM201GP, CSM202E, CSM202EP, CSM202G, CSM202GP, CSM6E, CSM6EP, CSM6G, CSM6GP		

halogen lamps

for socket E14 / E27



GEV No.	359728	Ref. No.	4625800 MA4625800
description	halogen lamp socket E14 230V 40W ø 25mm lens L 54mm L 80mm temp.-resist. 300°C Qty 1		
For models:	F140DF, F140DI, F140DN, F140DP, F143, F70DF, F70DI, F70DN, F70DP, F72, F7DFG, F7DNG, FB110F, FB110N, FB110P, FB140F, FB140FN, FB140N, FB140NN, FB140P, FB140PF, FB140PN, FB140PP, FB143NI, FB55F, FB55N, FB55P, FB70F, FB70N, FB70P, FB72F, FB72N, FB72NF, FB72P, FS140F, FS140FI, FS140FN, FS140I, FS140N, FS140NG, FS140NI, FS140NN, FS140P, FS140PN, FS140PP, FS143F, FS143FI, FS143N, FS143NF, FS143NI...(Other models you can see in the webshop)		

for socket G4 / G6.35 / G9



GEV No.	359599	Ref. No.	R65270020
description	halogen lamp socket G4 12V 20W temp.-resist. 500°C		
For models:	EC106M, EC110M, EC210M, EM010M+SC, EM106H, EM106M, EM106M+SC, EM106P, EM110H, EM110M, EM110M+SC, EM110P, EM210H, EM210M, EM210M+SC, EM210P, EV006M, EV106H, EV106M, EV106M+SC, EV106P, EV110H, EV110M, EV110M+SC, EV110P, EV210H, EV210M, EV210M+SC, EV210P, FE105X, FG105X, FG110X, FG210X, GC106M, GC110M, GC210M, GM106H, GM106M, GM106M+SC, GM106P, GM110H, GM110M, GM110M+SC, GM110P, GM210H, GM210M, GM210M+SC, GM210P, GMT06D, GMT20D...(Other models you can see in the webshop)		



residual heat indicators



1

GEV No.	359326	Ref. No.	1037309400 MA1037309400
description	residual heat indicator 4-fold		
For models:	CFVE60, PCVE40, PCVE40D, PCVE40DB, PCVE60, PCVE60D, PCVE60DB, V74EC, V76EC, V94E, V98E		



1

GEV No.	359327	Ref. No.	1037309310 MA1037309310
description	residual heat indicator single		
For models:	PCVE40, PCVE40D, PCVE40DB, PCVE60, PCVE60D, PCVE60DB		

timers

programme timers



1

GEV No.	403577	Ref. No.	R65095000
description	gear motor CDC 4901F1 engines 1 chambers 1 operation time 20s 230V 50Hz shaft ø 6x4.6mm shaft L 24mm		
For models:	ME061P, ME061T, ME101P, ME101T, ME102P, ME102T, ME106P, ME110P, ME120P, ME201P, ME201T, ME202P, ME202T, ME210P, ME220P, MEC24H, MEMT06P, MEMT10P, MEMT20P, MEMT21P, MEMT40P, MEVT06P, MEVT10P, MEVT20P, MEVT21P, MEVT40P, MG061P, MG061T, MG101P, MG101T, MG102P, MG102T, MG106P, MG110P, MG120P, MG201P, MG201T, MG202P, MG202T, MG210P, MG220P, MGC24H, MGC40H, MGMT06P, MGMT10P, MGMT20P, MGMT21P, MGMT40P, MGVT06P, MGVT10P...(Other models you can see in the webshop)		





1

GEV No.	360752	Ref. No.	R65090190
description	timer CDC 4902F1 engines 1 chambers 2 operation time 8min 230V shaft ømm shaft Lmm		
For models:	CVE004M, CVE104M, CVE105M, CVG105M, EC106M, EC110M, EC210M, EM010M+SC, EM106M, EM106M+SC, EM110M, EM110M+SC, EM210M, EM210M+SC, EV006M, EV106M, EV106M+SC, EV110M, EV110M+SC, EV210M, EV210M+SC, FE105M, FE105X, FE110M, FE110X, FE210M, FG105M, FG105X, FG110M, FG110X, FG210M, FG210X, GC106M, GC110M, GC210M, GM106M, GM106M+SC, GM110M, GM110M+SC, GM210M, GM210M+SC, GV106M, GV106M+SC, GV110M, GV110M+SC, GV210M, GV210M+SC, MACE04M, MACE05M, MACE07M...(Other models you can see in the webshop)		





1

GEV No.	360047	Ref. No.	120268
description	timer CDC 4905DV engines 2 chambers 5 operation time 4s / 150s 230V shaft ømm shaft Lmm manif. no. 4905DV / 360047 motor type M48L ATS		
spare parts for	360047		
	GEV No.	360083	Ref. No. —
	motor CDC pinion ø 4.9mm teeth 10 230V turn direction left motor ø 47mm H 19.3mm motor type M48L ATS for timer		





1

GEV No.	360080	Ref. No.	120277
description	timer CEM HH3M16 engines 1 chambers 3 operation time 20min 230V manif. no. HH3M16 / 120277 motor type UDS11NE1RH		
spare parts for	360080		
	GEV No.	360112	Ref. No. —
	motor SAIA pinion ø 4mm teeth 12 230V turn direction right motor ø 48mm motor type UDS11NE1RHZ for timer		



1

GEV No.	360043	Ref. No.	120262
description	timer CEM HH4M16 engines 1 chambers 4 operation time 120s 230V shaft ømm shaft Lmm manu. no. HH4M16 / 120262 motor type UDS11NE1RH		
spare parts for	360043		
	GEV No.	360112	Ref. No. —
	motor SAIA pinion ø 4mm teeth 12 230V turn direction right motor ø 48mm motor type UDS11NE1RHZ for timer		



1

GEV No.	360044	Ref. No.	120263
description	timer CEM HH4M16 engines 1 chambers 4 operation time 150s 230V shaft ømm shaft Lmm manu. no. HH4M16 / 120263 motor type UDS11NE1RH		
spare parts for	360044		
	GEV No.	360112	Ref. No. —
	motor SAIA pinion ø 4mm teeth 12 230V turn direction right motor ø 48mm motor type UDS11NE1RHZ for timer		



1

GEV No.	360332	Ref. No.	2971200 MA2971200
description	timer FIBER P25 engines 1 chambers 3 operation time 60s 230V shaft ømm shaft Lmm manu. no. P255J01H191 motor type M51BJ0R6400		
For models:	CON102E, CON102EP, CON102G, CON102GP, CON10E, CON10EP, CON10G, CON10GP, CON6E, CON6EP, CON6G, CON6GP, CS102E, CS102EP, CS102G, CS102GP		
spare parts for	360332		
	GEV No.	360673	Ref. No. —
	motor kit pinion ø 6.8mm teeth 15 230V voltage AC 50/60Hz turn direction clockwise motor ø 48mm H 18.5mm motor type UDS-40NE1RNZ165 cable length 150mm with holder		



1

GEV No.	350034	Ref. No.	5151700 MA5151700
description	timer FIBER P25 engines 1 chambers 1 operation time 60s 24V shaft ømm shaft Lmm manu. no. P255201H191 motor type M51B20R6400 voltage AC		
For models:	CON201E, CON201EP, CON201G, CON201GP, CON202E, CON202EP, CON202G, CON202GP, CSM102E, CSM102EP, CSM102G, CSM102GP, CSM10E, CSM10EP, CSM10G, CSM10GP, CSM201E, CSM201EP, CSM201G, CSM201GP, CSM202E, CSM202EP, CSM202G, CSM202GP, CSM6E, CSM6EP, CSM6G, CSM6GP		
spare parts for	350034		
	GEV No.	360675	Ref. No. —
	motor kit pinion ø 6.8mm teeth 15 24V voltage AC 50/60Hz turn direction clockwise motor ø 48mm H 18.5mm motor type UDS-40NE1RNZ165 cable length 150mm with holder		



1

GEV No.	360331	Ref. No.	2971100 MA2971100
description	timer FIBER P25 engines 1 chambers 3 operation time 60min 230V shaft ø 6x4.6mm shaft L 20mm manu. no. P255J03W190 motor type M51BJ0L6400 impulse electric		
For models:	CON102E, CON102EP, CON102G, CON102GP, CON10E, CON10EP, CON10G, CON10GP, CON201E, CON201EP, CON201G, CON201GP, CON202E, CON202EP, CON202G, CON202GP, CON6E, CON6EP, CON6G, CON6GP, CP9A15GD, CS102E, CS102EP, CS102G, CS102GP		
spare parts for	360331		
	GEV No.	360674	Ref. No. —
	motor kit pinion ø 6.8mm teeth 15 230V voltage AC 50/60Hz turn direction counterclockwise motor ø 48mm H 18.5mm motor type UDS40NE1RNZ165 cable length 150mm with holder		







1

GEV No.	350033	Ref. No.	5151600 MA5151600
description	timer FIBER P25 engines 1 chambers 3 operation time 60min 24V shaft ø 6x4.6mm shaft L 20mm manuf. no. P255203W190 motor type M51B20L6400 impulse electric		
For models:	CP9A15GD, CSM102E, CSM102EP, CSM102G, CSM102GP, CSM10E, CSM10EP, CSM10G, CSM10GP, CSM201, CSM201E, CSM201EP, CSM201G, CSM201GP, CSM202, CSM202E, CSM202EP, CSM202G, CSM202GP, CSM6E, CSM6EP, CSM6G, CSM6GP		





1

GEV No.	360287	Ref. No.	121218
description	timer FIBER P25 engines 2 chambers 6 operation time 6s / 3min 230V shaft ømm shaft Lmm manuf. no. P255J06JBG6 motor type M51B-J0R6400 / M51BJ0L6400		
spare parts for	360287		
	GEV No.	360673	Ref. No. —
	motor kit pinion ø 6.8mm teeth 15 230V voltage AC 50/60Hz turn direction clockwise motor ø 48mm H 18.5mm motor type UDS-40NE1RNZ165 cable length 150mm with holder		
	GEV No.	360674	Ref. No. —
	motor kit pinion ø 6.8mm teeth 15 230V voltage AC 50/60Hz turn direction counterclockwise motor ø 48mm H 18.5mm motor type UDS40NE1RNZ165 cable length 150mm with holder		



2

GEV No.	360120	Ref. No.	1037303000
description	timer FIBER P25 engines 1 chambers 5 operation time 180s 230V shaft ø 6x4.6mm shaft L 40mm manuf. no. P255J05H542 motor type M51BJ0R6400 for devices with electric dosing pump edition until year of construction 2000		
For models:	DLS30, DLS303, DLS30P3, DLS31, DLS313, DLS31P3, MLS30, MLS303, MLS30P, MLS30P3, MLS31, MLS313, MLS31P3, MLS35, MLS353, MPLS30P		
spare parts for	360120		
	GEV No.	360673	Ref. No. —
	motor kit pinion ø 6.8mm teeth 15 230V voltage AC 50/60Hz turn direction clockwise motor ø 48mm H 18.5mm motor type UDS-40NE1RNZ165 cable length 150mm with holder		





1

GEV No.	360398	Ref. No.	1037318000
description	timer FIBER P25 engines 2 chambers 7 operation time 12s / 2min 230V shaft ømm shaft Lmm manuf. no. P255J07JGJ7 motor type M51BJ0R6400 / M51BJ0L6400		
For models:	MLC65, MLC653		





1

GEV No.	360050	Ref. No.	120275
description	timer FIBER P25 engines 2 chambers 6 operation time 6s / 3min 230V 50/60Hz shaft ømm shaft Lmm manuf. no. P255J06JB61 motor type M51BJ0R6400 / M51BJ0L6400		
spare parts for	360050		
	GEV No.	360673	Ref. No. —
	motor kit pinion ø 6.8mm teeth 15 230V voltage AC 50/60Hz turn direction clockwise motor ø 48mm H 18.5mm motor type UDS-40NE1RNZ165 cable length 150mm with holder		
	GEV No.	360674	Ref. No. —
	motor kit pinion ø 6.8mm teeth 15 230V voltage AC 50/60Hz turn direction counterclockwise motor ø 48mm H 18.5mm motor type UDS40NE1RNZ165 cable length 150mm with holder		





1

GEV No.	360122	Ref. No.	1037307600
description	timer FIBER P25 engines 2 chambers 8 operation time 12s / 2min 230V shaft ømm shaft Lmm manuf. no. P255J08JG75 motor type M51BJ0R6400 / M51BJ0L6400		
For models:	MLC65, MLC653		
spare parts for	360122		
	GEV No.	360673	Ref. No. —
	motor kit pinion ø 6.8mm teeth 15 230V voltage AC 50/60Hz turn direction clockwise motor ø 48mm H 18.5mm motor type UDS-40NE1RNZ165 cable length 150mm with holder		
	GEV No.	360674	Ref. No. —
	motor kit pinion ø 6.8mm teeth 15 230V voltage AC 50/60Hz turn direction counterclockwise motor ø 48mm H 18.5mm motor type UDS40NE1RNZ165 cable length 150mm with holder		



1

GEV No.	360121	Ref. No.	1037307500
description	timer FIBER P25 engines 2 chambers 8 operation time 40s / 120s 230V shaft ømm shaft Lmm manif. no. P255J08JH76 motor type M51BJ0R6400 / M51BJ0L6400		
For models:	MLC50, MLC503		
spare parts for	360121		
	GEV No.	360673	Ref. No. —
	motor kit pinion ø 6.8mm teeth 15 230V voltage AC 50/60Hz turn direction clockwise motor ø 48mm H 18.5mm motor type UDS-40NE1RNZ165 cable length 150mm with holder		
	GEV No.	360674	Ref. No. —
	motor kit pinion ø 6.8mm teeth 15 230V voltage AC 50/60Hz turn direction counterclockwise motor ø 48mm H 18.5mm motor type UDS40NE1RNZ165 cable length 150mm with holder		



1

GEV No.	360041	Ref. No.	120290
description	timer FIBER P26 engines 1 chambers 3 operation time 120s 230V shaft ømm shaft Lmm manif. no. P265J03H322 motor type M61B40R6400 / M61B40L6400		

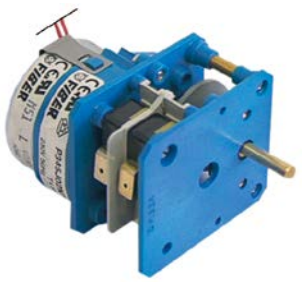

1

GEV No.	350038	Ref. No.	R65090020
description	timer FIBER P34 engines 1 chambers 2 operation time 144min 230V shaft ø 6x4.6mm shaft L 20mm manif. no. P345J02N765 motor type M51BJ0L6400 impulse electric		
For models:	EC106M, EC110M, EC210M, FE105M, FE105X, FE110M, FE110X, FE210M, FG105M, FG105X, FG110M, FG110X, FG210M, FG210X, GC106M, GC110M, GC210M, MACE04M, MACE05M, MACE07M, MACE10M, MACE20M, MACG05M, MACG07M, MACG10M, MACG20M, PE040M, PE040X, PE080M, PE080X, PG040M, PG040X, PG080M, PG080X		
spare parts for	350038		
	GEV No.	360674	Ref. No. —
	motor kit pinion ø 6.8mm teeth 15 230V voltage AC 50/60Hz turn direction counterclockwise motor ø 48mm H 18.5mm motor type UDS40NE1RNZ165 cable length 150mm with holder		

digital timers

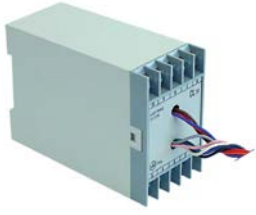

1

GEV No.	400946	Ref. No.	120254
description	timer electronic		

mechanical timers



1

GEV No.	350003	Ref. No.	2709900 2812300 MA2709900
description	timer M2 with bell 2-pole operation time 120min impulse mechanical 2NO at 250V 16A permanent position no shaft ø 6x4.6mm shaft 6x4.6mm shaft L 23mm mounting distance 28mm connection lateral		
For models:	FC10E, FC10G, FC20E, FC20G, FC5E, FC5G, FC7E, FC7G		
accessories for	350003		
	GEV No.	110366	Ref. No. —
	knob switch zero mark t.max. °C ø 44mm shaft ø 6x4.6mm shaft flat upper black		
	GEV No.	111199	Ref. No. —
	dial plate graduation 120min permanent position no rotation 0-330° ø 60mm timers knob ø 45mm		



1

GEV No.	350049	Ref. No.	1037103400 MA1037103400
description	timer M2 with bell 2-pole operation time 30min impulse mechanical 2NO at 250V 16A permanent position yes shaft ø 6x4.6mm shaft 6x4.6mm shaft L 23mm mounting distance 28mm connection lateral		
For models:	SPE60M, SPW60M		
accessories for	350049		
	GEV No.	110366	Ref. No. —
	knob switch zero mark t.max. °C ø 44mm shaft ø 6x4.6mm shaft flat upper black		
	GEV No.	111205	Ref. No. —
	dial plate graduation 30min permanent position yes rotation 30-300° ø 60mm		



audible timers

 <p>1</p>			
GEV No.	350036	Ref. No.	1031006400 2600200 MA1031006400
description	audible timer operation time 60min ø 55mm shaft ø 6x4.6mm shaft L 22mm mounting distance 28mm		
For models:	CFE60, CFE60P, CFGE60, CFGE61, CFGE61D, CFGE61L, CFGE61P, CFVE60, FOE60M, FV4E, FV4E1, OCFE60, OCFGE61, OFOE60M		

alarm devices

alarm units

 <p>1</p>			
GEV No.	350081	Ref. No.	R65330020
description	alarm device 9-15VDC H 14.5mm wall-mounted version 75dB protection IPx0		
For models:	EM106H, EM106P, EM110H, EM110P, EM210H, EM210P, EV106H, EV106P, EV110H, EV110P, EV210H, EV210P, GM106H, GM106P, GM110H, GM110P, GM210H, GM210P, GV106H, GV106P, GV110H, GV110P, GV210H, GV210P		

buzzer boards

 <p>1</p>			
GEV No.	350078	Ref. No.	2864400 MA2864400
description	buzzer board		
For models:	CON102E, CON102EP, CON102G, CON102GP, CON10E, CON10EP, CON10G, CON10GP, CON6E, CON6EP, CON6G, CON6GP, CP9A15GD, CS102E, CS102EP, CS102G, CS102GP, CS10E, CS10EP, CS10G, CS6E, CS6EP, CS6G		

 <p>1</p>			
GEV No.	350079	Ref. No.	5152000 MA5152000
description	buzzer board		
For models:	CON201E, CON201EP, CON201G, CON201GP, CON202E, CON202EP, CON202G, CON202GP, CSM102E, CSM102EP, CSM102G, CSM102GP, CSM10E, CSM10EP, CSM10G, CSM10GP, CSM201E, CSM201EP, CSM201G, CSM201GP, CSM202E, CSM202EP, CSM202G, CSM202GP, CSM6E, CSM6EP, CSM6G, CSM6GP		

 <p>1</p>			
GEV No.	400143	Ref. No.	R65300670
description	buzzer board		
For models:	ME106P, ME110P, ME120P, ME210P, ME220P, MG106P, MG110P, MG120P, MG210P, MG220P, VE106P, VE120P, VE210P, VE220P, VG106P, VG110P, VG120P, VG210P, VG220P		

buzzers

 <p>1</p>			
GEV No.	350055	Ref. No.	R65330040
description	buzzer 12VDC connection cable 200mm PCB buzzer 20dB		
For models:	CVE004H, CVE104H, CVE105H, CVG105H, ME106P, ME110P, ME120P, ME210P, ME220P, MEC24H, MG106P, MG110P, MG120P, MG210P, MG220P, MGC24H, MGC40H, VE106P, VE120P, VE210P, VE220P, VG106P, VG110P, VG120P, VG210P, VG220P		

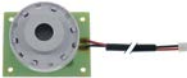
 <p>1</p>			
GEV No.	350086	Ref. No.	R65301440 RA919008
description	buzzer 12VDC connection cable 200mm PCB buzzer 20dB		
For models:	DP018T, DP112T, DPC20T, DPC40T, DX018T, DX110T, DX112T, DXC20T, DXC40T, GMT06D, GMT20D, GVT06D, GVT20D, MDP112T, MDPC20T, MDPC40T, MDX112T, MDXC20T, MDXC40T, ME061D, ME061P, ME061T, ME101D, ME101P, ME101T, ME102D, ME102P, ME102T, ME201D, ME201P, ME201T, ME202D, ME202P, ME202T, MEMT06D, MEMT06P, MEMT10D, MEMT10P, MEMT20D, MEMT20P, MEMT21D, MEMT21P, MEMT40D, MEMT40P, MEVT06D, MEVT06P, MEVT10D, MEVT10P, MEVT20D, MEVT20P...(Other models you can see in the webshop)		

 <p>1</p>			
GEV No.	350050	Ref. No.	R65330010
description	buzzer 230VAC connection male faston 6.3mm screw mounting thread M4 60dB		
For models:	CVE004M, CVE104M, CVE105M, CVG105M, EC106M, EC110M, EC210M, EM010M+SC, EM106M, EM106M+SC, EM110M, EM110M+SC, EM210M, EM210M+SC, EV006M, EV106M, EV106M+SC, EV110M, EV110M+SC, EV210M, EV210M+SC, FE105M, FE105X, FE110M, FE110X, FE210M, FG105M, FG105X, FG110M, FG110X, FG210M, FG210X, GC106M, GC110M, GC210M, GM106M, GM106M+SC, GM110M, GM110M+SC, GM210M, GM210M+SC, GV106M, GV106M+SC, GV110M, GV110M+SC, GV210M, GV210M+SC, MACE04M, MACE05M, MACE07M...(Other models you can see in the webshop)		



contactors

GENERAL ELECTRIC (AEG)

power contactors

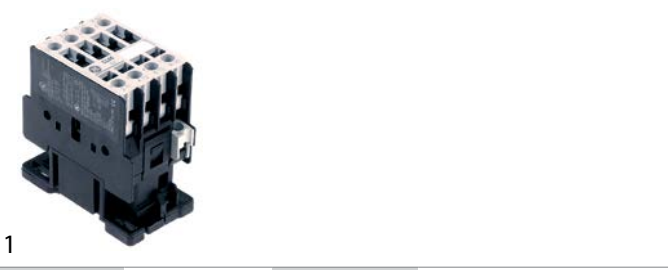

GEV No.	380248	Ref. No.	120429
description	power contactor resistive load 25A 24VAC (AC3/400V) 9A/4kW main contacts 3NO auxiliary contacts 1NO connection screw connection type AEG LS4K 10A type GE CL00A 310		

LOVATO

power contactors



GEV No.	380083	Ref. No.	120444
description	power contactor resistive load 25A 230VAC (AC3/400V) 9A/4.2kW main contacts 3NO auxiliary contacts 1NC connection screw connection type BF0901A230		

MOELLER/EATON

power contactors



GEV No.	380550	Ref. No.	R65140550
description	power contactor resistive load 20A 230VAC (AC3/400V) 9A/4kW main contacts 3NO auxiliary contacts 1NC connection screw connection type DILM9 01		
For models:	GMT06D, GVT06D, MACE04M, MACE05M, MACE07M, MACE10M, MACE20M, MACG07M, MACG10M, MACG20M, MEMT06D, MEMT06P, MEMT10D, MEMT10P, MEVT06D, MEVT06P, MEVT10D, MEVT10P, MGMT06D, MGMT06P, MGMT10D, MGMT10P, MGVT06D, MGVT06P, MGVT10D, MGVT10P, MVE042P, MVE051P		

accessories for	380550			
	GEV No.	380555	Ref. No.	—
	auxiliary contact contacts 2NO/2NC AC15 16A for contactors DILEM connection screw type DILA-XHI22			
	GEV No.	380556	Ref. No.	—
	auxiliary contact contacts 4NO AC15 16A for contactors DILM 7-32 connection screw type DILA-XHI40			

accessories for	380550			
	GEV No.	380557	Ref. No.	—
	auxiliary contact contacts 4NC AC15 16A for contactors DILM 7-32 connection screw type DILA-XHI04			
	GEV No.	380558	Ref. No.	—
	auxiliary contact contacts 3NO/1NC AC15 16A for contactors DILM 7-32 connection screw type DILA-XHI31			
	GEV No.	380559	Ref. No.	—
	auxiliary contact contacts 1NO/3NC AC15 16A for contactors DILM 7-32 connection screw type DILA-XHI13			
	GEV No.	380568	Ref. No.	—
	RC circuit suitable for DILM 9-12 rated 110-240V			



GEV No.	381005	Ref. No.	R65140560
description	power contactor resistive load 35A 230VAC (AC3/400V) 17A/7.5kW main contacts 3NO auxiliary contacts 1NC connection screw connection type DILM 17-01		
For models:	MACE10M, MACE20M, MEMT10D, MEMT10P, MEVT10D, MEVT10P		

overload switches



GEV No.	381006	Ref. No.	R65160420
description	overload switch connection screw setting range 1-1.6A type ZB12		
For models:	MACE10M, MACE20M, MEMT10D, MEVT10D		

auxiliary contacts

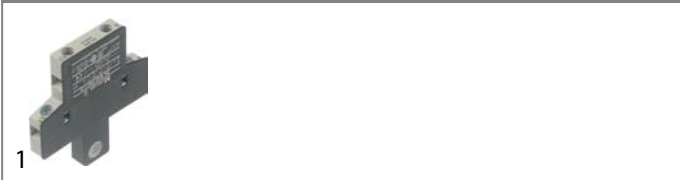

GEV No.	380565	Ref. No.	R65140600
description	auxiliary contact contacts 1NO/1NC AC15 10A for contactors DIL 17-32 connection screw type DILM 32-CHI11-S		
For models:	MEMT10D, MEMT10P, MEVT10D, MEVT10P		



SIEMENS

power contactors



1

GEV No.	380645	Ref. No.	R65140240
description	power contactor 230VAC with auxiliary contacts		
For models:	EC110M, EC210M, EM010M+SC, EM110H, EM110M, EM110M+SC, EM110P, EM210H, EM210M, EM210M+SC, EM210P, EV110H, EV110M, EV110M+SC, EV110P, EV210H, EV210M, EV210M+SC, EV210P, FE110M, FE110X, ME110M, ME110P, ME110X, ME120M, ME120P, ME120X, ME210M, ME210P, ME210X, ME220M, ME220P, ME220X, MEC24H, MEC40M, PE080M, PE080X, VE110M, VE110X, VE120M, VE120P, VE120X, VE210M, VE210P, VE210X, VE220M, VE220P, VE220X		



1

GEV No.	381387	Ref. No.	CM187301 MACM187301
description	power contactor resistive load 22A 230VAC (AC3/400V) 4kW main contacts 3NO auxiliary contacts 1NO connection screw connection type 3RT2016-1AP01		



1

GEV No.	380652	Ref. No.	R65140380
description	power contactor resistive load 22A 230VAC (AC3/400V) 9A/4kW main contacts 3NO auxiliary contacts 1NC connection screw connection type 3RT10-16-1AP02		
For models:	GMT20D, GVT20D, ME061D, ME061M, ME061P, ME061T, ME101D, ME101M, ME101P, ME101T, ME102D, ME102M, ME102P, ME102T, ME201D, ME201M, ME201P, ME201T, ME202D, ME202M, ME202P, ME202T, MEMT20D, MEMT20P, MEMT21D, MEMT21P, MEMT40D, MEMT40P, MEVT20D, MEVT20P, MEVT21D, MEVT21P, MEVT40D, MEVT40P, MG061D, MG061M, MG061P, MG061T, MG101D, MG101M, MG101P, MG101T, MG102D, MG102M, MG102P, MG102T, MG201D, MG201M, MG201P, MG201T...(Other models you can see in the webshop)		



1

GEV No.	380389	Ref. No.	1037104800 21450299 21453199 CM187300 MACM187300
description	power contactor resistive load 22A 230VAC (AC3/400V) 9A/4kW main contacts 3NO auxiliary contacts 1NO connection screw connection type 3RT10-16-1AP01		
For models:	AF140MB, AF140MC, AF140MF, AF140MI, AF140MN, AF140MP, AF70MB, AF70MC, AF70MF, AF70MI, AF70MN, AF70MP, BR707E, BR707EI, BR78EF, BR78EI, BR912EFM, BR912EIM, BR94E, BR94EI, BR98EF, BR98EFM, BR98EI, BR98EIM, BR9M4E, BR9M4EI, BR9M6E, BR9M6EI, BR9S8EF, BR9S8EI, BR9SB4E, BR9SB4EI, CON102E, CON102EP, CON102G, CON102GP, CON10E, CON10EP, CON10G, CON10GP, CON6E, CON6EP, CON6G, CON6GP, CP704E, CP92E, CP92E2, CP94E, CP94E2, CP9SB2E...		



1

GEV No.	380390	Ref. No.	21407999 21452399 21453599 CM187400 CM187401 MACM187400 MACM187401
description	power contactor resistive load 40A 230VAC (AC3/400V) 12A/5.5kW main contacts 3NO auxiliary contacts connection screw connection type 3RT10-24-1AL20 50/60Hz		
For models:	BR78EF, BR78EI, BR912EFM, BR912EIM, BR94E, BR94EI, BR98EF, BR98EFM, BR98EI, BR98EIM, BR9M4E, BR9M4EI, BR9M6E, BR9M6EI, BR9S8EF, BR9S8EI, BR9SB4E, BR9SB4EI, CON102E, CON102EP, CON10E, CON10EP, CON201E, CON201EP, CS10E, CS10EP, F74E12, F78E12, F94E12, F94E18, F94E18K, F98E12, F98E18, F98E18K, F9S4E12, F9S4E18, F9S4E18K, F9S8E12, F9S8E18, F9S8E18K, FC7E, FR92E13, FR92E132, FR92E13T, FR92E13T2, FR92E22, FR92E22T, FR94E13, FR94E132, FR94E13T...(Other models you can see in the webshop)		



1

GEV No.	380646	Ref. No.	R65140400
description	power contactor resistive load 40A 230VAC (AC3/400V) 17A/7.5kW main contacts 3NO auxiliary contacts connection screw connection type 3RT10-25-1AL20		
For models:	ME101D, ME101M, ME101P, ME101T, ME102D, ME102M, ME102P, ME102T, ME201D, ME201M, ME201P, ME201T, ME202D, ME202M, ME202P, ME202T, MEMENT20D, MEMENT20P, MEMENT21D, MEMENT21P, MEMENT40D, MEMENT40P, MEVT20D, MEVT20P, MEVT21D, MEVT21P, MEVT40D, MEVT40P		



1

GEV No.	380530	Ref. No.	187500 CM187500 MACM187500
description	power contactor resistive load 60A 230VAC (AC3/400V) 40A/18.5kW main contacts 3NO connection screw connection type 3RT10-35-1AL20		

auxiliary contacts



1

GEV No.	380653	Ref. No.	R65140420
description	auxiliary contact contacts 1NO/1NC AC15 3A for contactors 3RT101 connection screw connection type 3RH1911-1FA11		
For models:	ME061D, ME061M, ME061P, ME061T, ME101D, ME101M, ME101P, ME101T		



1

GEV No.	380647	Ref. No.	R65140430
description	auxiliary contact contacts 1NO/1NC AC15 3A for contactors 3RT102 3 RT103 connection screw connection type 3RH1921-1EA11 resistive load 10A AC-12 10A		
For models:	ME101D, ME101M, ME101P, ME101T, ME102D, ME102M, ME102P, ME102T, ME201D, ME201M, ME201P, ME201T, ME202D, ME202M, ME202P, ME202T, MEMENT20D, MEMENT20P, MEMENT21D, MEMENT21P, MEMENT40D, MEMENT40P, MEVT20P, MEVT21D, MEVT21P, MEVT40D, MEVT40P		

overload switches



1

GEV No.	380655	Ref. No.	R65160150
description	overload switch setting range 0.25-0.4A		
For models:	CVE004H, CVE004M, CVE104H, CVE104M, VE004M, VE004X, VE104M, VE104X		



1

GEV No.	380656	Ref. No.	R65160100 R65160110
description	overload switch setting range 0.63-1A		
For models:	CVE105H, CVE105M, CVG105H, CVG105M, EM110H, EM110P, EM210H, EM210P, EV110H, EV110P, EV210H, EV210P, ME106M, ME106P, ME106X, ME110P, ME110X, ME120P, ME120X, ME210P, ME210X, ME220P, ME220X, MEC24H, MG106M, MG106P, MG106X, VE105M, VE105X, VE106M, VE106P, VE106X, VE110X, VE120P, VE120X, VE210P, VE210X, VE220P, VE220X, VG105M, VG105X, VG106M, VG106P, VG106X		



1

GEV No.	380659	Ref. No.	R65160570
description	overload switch setting range 0.7-1A connection screw type 3RU1116-0JB0 (AC3/400V) 0.25kW		
For models:	ME101P, ME101T, ME102P, ME102T, ME201P, ME201T, ME202P, ME202T, MEMENT20P, MEMENT21P, MEMENT40P, MEVT20P, MEVT21P, MEVT40P		



1

GEV No.	380661	Ref. No.	R65160620
description	overload switch setting range 1.4-2.0A connection screw type 3RU1116-1BB0 (AC3/400V) 0.75kW		
For models:	ME101D, ME101M, ME101P, ME101T, ME201D, ME201M, ME201P, ME201T, MEMENT21D, MEMENT21P, MEVT21D, MEVT21P, MG101P, MG101T, MG201P, MG201T, MG202P, MG202T, MGMT21P, MGMT40P, MGVT21P, MGVT40P		



			
1			
GEV No.	380657	Ref. No.	R65160120
description	overload switch setting range 1.8-2.5A		
For models:	EC110M, EC210M, EM010M+SC, EM110H, EM110M, EM110M+SC, EM110P, EM210H, EM210M, EM210M+SC, EM210P, EV110H, EV110M, EV110M+SC, EV110P, EV210H, EV210M, EV210M+SC, EV210P, FE110M, FE110X, FE210M, FG110X, FG210X, GM110H, GM110P, GM210H, GM210P, GV110H, GV110P, GV210H, GV210P, ME110M, ME110P, ME110X, ME120M, ME120P, ME120X, ME210M, ME210P, ME210X, ME220M, ME220P, ME220X, MEC24H, MEC40M, MG110P, MG110X, MG120P, MG120X...(Other models you can see in the webshop)		

spare parts for 381158			
	GEV No.	381071	Ref. No. —
overload switch setting range 3.5-5A			

power contactors

			
1			
GEV No.	380654	Ref. No.	R65140150 R65140170
description	power contactor 230V with auxiliary contacts		
For models:	CVE004H, CVE004M, CVE104H, CVE104M, CVE105H, CVE105M, CVG105H, CVG105M, EC106M, EC110M, EC210M, EM010M+SC, EM106H, EM106M, EM106M+SC, EM106P, EM110H, EM110M, EM110M+SC, EM110P, EM210H, EM210M, EM210M+SC, EM210P, EV006M, EV106H, EV106M, EV106M+SC, EV106P, EV110H, EV110M, EV110M+SC, EV110P, EV210H, EV210M, EV210M+SC, EV210P, FE105M, FE105X, FE110M, FE110X, FE210M, FG105M, FG105X, FG110M, FG110X, FG210M, FG210X, GC106M, GC110M...(Other models you can see in the webshop)		

motor protection circuit breakers

			
1			
GEV No.	382000	Ref. No.	R65160590
description	motor protection circuit breaker type 3RU1116-1EBO setting range 2.8-4A (AC3/400V) 1.5kW		
For models:	GMT20D, GVT20D, MG101D, MG101M, MG101P, MG101T, MG201D, MG201M, MG201P, MG201T, MG202D, MG202M, MG202P, MG202T, MGMT21D, MGMT21P, MGMT40D, MGMT40P, MGVT21D, MGVT21P, MGVT40D, MGVT40P		

relays

power relays



with DIN rail mounting

upper

			
1			
GEV No.	380330	Ref. No.	1037312400
description	power relays Italiana Relè 230VAC 16A 2CO connection male faston 6.3mm DIN rail manuf. no. A2S-230AC-AD		
For models:	MLC50, MLC503, MLC65, MLC653		

miscellaneous



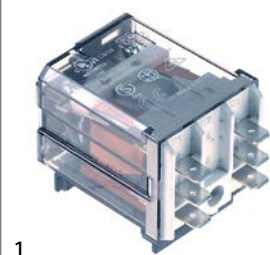

kits

			
1			
GEV No.	381158	Ref. No.	R65160130
description	overload switch kit		
For models:	FG110M, FG110X, FG210M, FG210X, GC110M, GC210M, GM110H, GM110M, GM110M+SC, GM110P, GM210H, GM210M, GM210M+SC, GM210P, GV110H, GV110M, GV110M+SC, GV110P, GV210H, GV210M, GV210M+SC, GV210P, MG110M, MG110P, MG110X, MG120M, MG120P, MG120X, MG210M, MG210P, MG210X, MG220M, MG220P, MG220X, MGC20X, MGC24H, MGC40H, PG080M, PG080X, VG110M, VG110P, VG110X, VG120M, VG120P, VG120X, VG210M, VG210P, VG210X, VG220M, VG220P...(Other models you can see in the webshop)		
spare parts for	381158		
	GEV No.	380652	Ref. No. R65140380
power contactor resistive load 22A 230VAC (AC3/400V) 9A/4kW main contacts 3NO auxiliary contacts 1NC connection screw connection type 3RT10-16-1AP02			
	GEV No.	380660	Ref. No. —
base			

lateral



1

GEV No.	380336	Ref. No.	R65170100
description	power relays FINDER 230VAC 16A 2NO connection male faston 6.3mm DIN rail manuf. no. 62.82.8.230.0308		
For models:	CVE004H, CVE104H, MVE042P, MVE051P, MVG051P		
accessories for	380336		
	GEV No.	380703	Ref. No. —
	adapter for flange mounting suitable for Finder relay 62 series.		
	GEV No.	380811	Ref. No. —
	adapter with bracket mounting suitable for Finder relay 62 series.		
	GEV No.	380954	Ref. No. —
	adapter hole distance 54mm bracket mounting suitable for Finder relay 62 series. L 41mm W 39mm H 49mm		
	GEV No.	381003	Ref. No. —
	adapter for DIN rail mounting suitable for Finder relay 62 series.		
	GEV No.	381039	Ref. No. —
	adapter for DIN rail mounting suitable for Finder relay 62 series.		



1

GEV No.	380379	Ref. No.	890029 SIRA890029 SIRRA890029
description	power relays SCHRACK 230VAC 25A 2CO connection male faston 6.3mm DIN rail manuf. no. RM809730		

with flange mounting



1

GEV No.	380310	Ref. No.	23685.00
description	power relays FINDER 230VAC 16A 2CO connection male faston 6.3mm screw mounting at 250VA manuf. no. 62.82.8.230.0000+062.10		
For models:	AF140B, AF140C, AF140F, AF140I, AF140MB, AF140MC, AF140MF, AF140MI, AF140MN, AF140MP, AF140N, AF140P, AF14F, AF14G, AF14N, AF70B, AF70C, AF70F, AF70I, AF70MB, AF70MC, AF70MF, AF70MI, AF70MN, AF70MP, AF70N, AF70P, AF72B, AF72C, AF72F, AF72I, AF72N, AF72P, AF7C, AF7F, AF7G, AFC14, AFC14V, AFC7, AFC7V, AFCP214, AFCP214P, AFCP214V, AFR1143P, AFR14, AFR14V, AFR214P, AFR214PV, AFR7, AFR7P...(Other models you can see in the webshop)		



1

GEV No.	380131	Ref. No.	120459
description	power relays Italiana Relè 230VAC 16A 3CO connection male faston 6.3mm screw mounting manuf. no. B2-3-230AC		

with bracket mounting

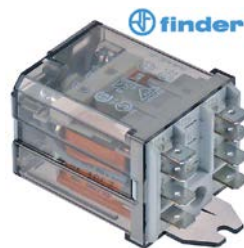

1

GEV No.	380139	Ref. No.	CR0413170
description	power relays FINDER 230VAC 16A 2CO connection F6.3 bracket mounting dimensions 68x38.2x35.8mm manuf. no. 62.82.8.230.0000		
For models:	FB110F, FB110N, FB110P, FB140F, FB140FN, FB140N, FB140NN, FB140P, FB140PF, FB140PN, FB140PP, FB143NI, FB55F, FB55N, FB55P, FB70F, FB70N, FB70P, FB72F, FB72N, FB72NF, FB72P, SPAR16, SPAR20, SPRG12, SPRG16, SPRG20, SVAR16, SVAR20, SVRG12, SVRG16, SVRG20		



with male contacts

bullet connectors, 8 contacts

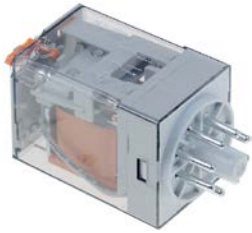

1

GEV No.	380951	Ref. No.	0683840 CR0683840
description	power relays FINDER 230VAC 10A 2CO connection plug-in connection round 8-pole manuf. no. 60.12.4.101.0040 90.26/ZVE8 250V		
For models:	NPI76E5, NPI76G5, NPI78E8, NPI78G8, NPI96E5, NPI96G5, NPI98E10, NPI98E15, NPI98G10, NPI98G14, NPI98G14A		



1

GEV No.	380134	Ref. No.	2863600 MA2863600
description	power relays Italiana Relè 230VAC 10A 2CO connection plug-in connection round 8-pole manuf. no. C42-230VAC 90.26/ZVE8 250V		
For models:	CS10E, CS10EP, CS10G, CS6E, CS6EP, CS6G, HF140DPF, NF140DF, NF140DFN, NF140DN, NF140DNI, NF140DNN, NF140DP, NF140DPN, NF140DPP, NF143DNF, NF143DNI, NF143DNP, NF14DNG, NF70DF, NF70DI, NF70DN, NF70DP, NF72DNF, NF72DNI, NF72DNN, NF7DFG, NF7DNG, SPAR16, SPAR20, SPRG12, SPRG16, SPRG20, SVAR16, SVAR20, SVRG12, SVRG16, SVRG20		

accessories for	380134			
	GEV No.	380137	Ref. No.	—
		relay socket 8-pole connection plug-in connection round 8-pole dimensions 65x28x40mm 380V voltage AC 10A Italiana Relè manuf. no. ZVE8		
	GEV No.	380638	Ref. No.	2609500 MA2609500
		relay socket 8-pole dimensions 51x41x23mm 250V 10A FINDER manuf. no. 90.26		

female contact 2.0mm



1

GEV No.	380382	Ref. No.	2998400 MA2998400
description	power relays 16A 1CO plug-in connection 250V connection 2mm		
For models:	CON102E, CON102EP, CON102G, CON102GP, CON10E, CON10EP, CON10G, CON10GP, CON6E, CON6EP, CON6G, CON6GP		

accessories for	380382			
	GEV No.	380341	Ref. No.	2998500
		relay socket 4-pole contacts 12 300V voltage AC 6A Italiana Relè manuf. no. ZMD4		

accessories for	380382			
	GEV No.	380378	Ref. No.	—
		relay socket 2-pole 55/85 dimensions 70.5x30x27mm 250V voltage AC 10A FINDER manuf. no. 94.72		
	GEV No.	380384	Ref. No.	—
		relay socket 2-pole contacts male faston 2.8mm 250V voltage AC 10A W 23mm for		
	GEV No.	380399	Ref. No.	—
		relay socket 4-pole dimensions 76.2x27x86.1mm 250V voltage AC 1A FINDER manuf. no. 94.94.3		

plug-in/print relays



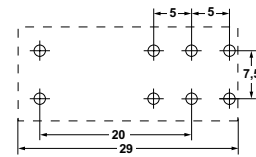

1





GEV No.	380333	Ref. No.	R65170050	
description	print relay 230VAC 2CO at 250V 8A connection pins raster size 5mm FINDER manuf. no. 40.52.8.230.0000 95.65/95.75			
For models:	ME061M, ME101M, ME102D, ME102M, ME106M, ME106X, ME110M, ME110X, ME120M, ME120X, ME201M, ME202M, ME210M, ME210X, ME220M, ME220X, MEC40M, MEMT06P, MEMT10P, MEMT20P, MEMT21P, MEMT40P, MG061M, MG101M, MG102M, MG106M, MG106X, MG110M, MG110X, MG120M, MG120X, MG201M, MG202M, MG210M, MG210X, MG220M, MG220X, MGC20X, MGMT06P, MGMT10P, MGMT20P, MGMT21P, MGMT40P, VE106M, VE106X, VE110M, VE110X, VE120M, VE120X, VE210M...(Other models you can see in the webshop)			
accessories for	380333			
	GEV No.	380340	Ref. No.	5151400 MA5151400
		relay socket dimensions 62x36x15mm 250V voltage AC 10A Italiana Relè manuf. no. ZMEM/5		
	GEV No.	380505	Ref. No.	—
		relay socket 2CO 40.52 dimensions 81.9x15.5x75mm 250V voltage AC 10A FINDER manuf. no. 95.95.3		
	GEV No.	381181	Ref. No.	—
		relay socket 2-pole 40.51/40.52/40.61 connection screw clamp dimensions 15.8x78.6mm 250V voltage AC 10A FINDER manuf. no. 95.75		

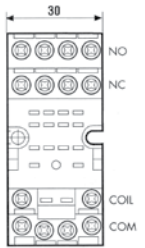

1			
GEV No.	380331	Ref. No.	51513.00 MA5151300
description	print relay 24VAC 1CO at 250V 10A connection pins raster size 5mm		
For models:	CON201E, CON201EP, CON201G, CON201GP, CON202E, CON202EP, CON202G, CON202GP, CP9A15GD, CSM102E, CSM102EP, CSM102G, CSM102GP, CSM10E, CSM10EP, CSM10G, CSM10GP, CSM201E, CSM201EP, CSM201G, CSM201GP, CSM202E, CSM202EP, CSM202G, CSM202GP, CSM6E, CSM6EP, CSM6G, CSM6GP		
accessories for	380331		
	GEV No.	380340	Ref. No. 5151400 MA5151400
	relay socket dimensions 62x36x15mm 250V voltage AC 10A Italiana Relè manuf. no. ZMEM/5		
	GEV No.	380505	Ref. No. —
	relay socket 2CO 40.52 dimensions 81.9x15.5x75mm 250V voltage AC 10A FINDER manuf. no. 95.95.3		
	GEV No.	381181	Ref. No. —
	relay socket 2-pole 40.51/40.52/40.61 connection screw clamp dimensions 15.8x78.6mm 250V voltage AC 10A FINDER manuf. no. 95.75		

relay sockets



1			
GEV No.	380341	Ref. No.	2998500
description	relay socket 4-pole contacts 12 300V voltage AC 6A Italiana Relè manuf. no. ZMD4		
For models:	CON102E, CON102EP, CON102G, CON102GP, CON10E, CON10EP, CON10G, CON10GP, CON6E, CON6EP, CON6G, CON6GP, CP9A15GD		
accessories for	380341		
	GEV No.	380804	Ref. No. —
	support bracket		



1			
GEV No.	380638	Ref. No.	2609500 MA2609500
description	relay socket 8-pole dimensions 51x41x23mm 250V 10A FINDER manuf. no. 90.26		
For models:	CS10E, CS10EP, CS10G, CS6E, CS6EP, CS6G, FV4E, FV4E1, HF140DPF, NF140DF, NF140DFN, NF140DN, NF140DNI, NF140DNN, NF140DP, NF140DPN, NF140DPP, NF143DNF, NF143DNI, NF143DNP, NF14DNG, NF70DF, NF70DI, NF70DN, NF70DP, NF72DNF, NF72DNI, NF72DNN, NF7DFG, NF7DNG, NPI76E5, NPI76G5, NPI78E8, NPI78G8, NPI96E5, NPI96G5, NPI98E10, NPI98E15, NPI98G10, NPI98G14, NPI98G14A, SPAR16, SPAR20, SPRG12, SPRG16, SPRG20, SVAR16, SVAR20, SVRG12, SVRG16...(Other models you can see in the webshop)		



1			
GEV No.	380340	Ref. No.	5151400 MA5151400
description	relay socket dimensions 62x36x15mm 250V voltage AC 10A Italiana Relè manuf. no. ZMEM/5		
For models:	CON201E, CON201EP, CON201G, CON201GP, CON202E, CON202EP, CON202G, CON202GP, CP9A15GD, CSM102E, CSM102EP, CSM102G, CSM102GP, CSM10E, CSM10EP, CSM10G, CSM10GP, CSM201E, CSM201EP, CSM201G, CSM201GP, CSM202E, CSM202EP, CSM202G, CSM202GP, CSM6E, CSM6EP, CSM6G, CSM6GP		

level relays

GICAR



1			
GEV No.	401224	Ref. No.	R65120010
description	level relay 230V connection F6.3 type RL30/3ES/F/G		
For models:	EM010M+SC, EM106M, EM106M+SC, EM110M, EM110M+SC, EM210M, EM210M+SC, GM106M, GM106M+SC, GM110M, GM110M+SC, GM210M, GM210M+SC, ME061M, ME101M, ME102D, ME102M, ME106M, ME106X, ME110M, ME110X, ME120M, ME120X, ME201M, ME202M, ME210M, ME210X, ME220M, ME220X, MEC40M, MG061M, MG101M, MG102M, MG106M, MG106X, MG110M, MG110X, MG120M, MG120X, MG201M, MG202M, MG210M, MG210X, MG220M, MG220X, MGC20X		



time relays

time relays



1

GEV No.	381421	Ref. No.	R65090450
description	time relay CROUZET EMAR7 88 829 117 time range 0.1s-20h 240VAC 5A NO connection grip connection		
For models:	CVG105H, CVG105M, MACG05M, MACG07M, MACG10M, MACG20M, ME061M, ME101M, ME102D, ME102M, ME201M, ME202M, MEC40M, MG061M, MG101M, MG102M, MG106M, MG106P, MG106X, MG110M, MG110P, MG110X, MG120M, MG120P, MG120X, MG201M, MG202M, MG210M, MG210P, MG210X, MG220M, MG220P, MG220X, MGC20X, MGC24H, MGC40H, VG105M, VG105X, VG106M, VG106P, VG106X, VG110M, VG110P, VG110X, VG120M, VG120P, VG120X, VG210M, VG210P, VG210X...(Other models you can see in the webshop)		



1

GEV No.	380489	Ref. No.	R65090480
description	time relay CROUZET MUR1-88826105 time range 0.1s-100h 24-240VAC/24VDC 8A mounting measurements DIN railmm 1CO connection grip connection		
For models:	EM010M+SC, EM106M, EM106M+SC, EM110M, EM110M+SC, EM210M, EM210M+SC, GM106M, GM106M+SC, GM110M, GM110M+SC, GM210M, GM210M+SC, MVE042P		

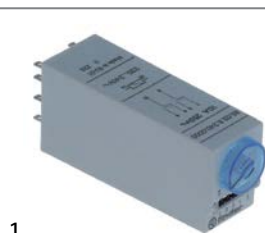

1

GEV No.	380329	Ref. No.	R65090460
description	time relay FIBER 85.02.8.240 time range 0.05s - 100h 230-240VAC 10A mounting measurements 20.6x27.7mm 2CO connection 2.0		
For models:	ME106M, ME106X, ME110M, ME110X, ME120M, ME120X, ME210M, ME210X, ME220M, ME220X, MG106M, MG106X, MG110M, MG110X, MG120M, MG120X, MG210M, MG210X, MG220M, MG220X		
accessories for	380329		
	GEV No.	380378	Ref. No. —
	GEV No.	380803	Ref. No. —

transformers

open transformers

with clamp terminal



1

GEV No.	400947	Ref. No.	120608
description	transformer primary 220/230-240-380/400-415V secondary 12-24V 150VA secondary 4.17A 50/60Hz		



1

GEV No.	401152	Ref. No.	5153000 MA5153000
description	transformer primary 230/400V secondary 12V 100VA		
For models:	CP9A15GD, CSM102G, CSM102GP, CSM10G, CSM10GP, CSM6E, CSM6EP, CSM6G, CSM6GP		



1

GEV No.	401153	Ref. No.	5153100 MA5153100
description	transformer primary 230/400V secondary 12V 160VA		
For models:	CON201E, CON201EP, CON201G, CON201GP, CON202E, CON202EP, CON202G, CON202GP, CSM102E, CSM102EP, CSM10E, CSM10EP, CSM201E, CSM201EP, CSM201G, CSM201GP, CSM202E, CSM202EP, CSM202G, CSM202GP		



toroidal core transformers



1

GEV No.	401151	Ref. No.	5159300 MA5159300
description	transformer primary 230V secondary 12V 20VA		
For models:	CON102E, CON102EP, CON102G, CON102GP, CON10E, CON10EP, CON10G, CON10GP, CON201E, CON201EP, CON201G, CON201GP, CON202E, CON202EP, CON202G, CON202GP, CON6E, CON6EP, CON6G, CON6GP, CP9A15GD, CSM102E, CSM102EP, CSM102G, CSM102GP, CSM10E, CSM10EP, CSM10G, CSM10GP, CSM201E, CSM201EP, CSM201G, CSM201GP, CSM202E, CSM202EP, CSM202G, CSM202GP, CSM6E, CSM6EP, CSM6G, CSM6GP		

encapsulated transformers

with screw connection



1

GEV No.	402950	Ref. No.	CR0684780
description	transformer primary 230V secondary 24V 100VA connection screw 50/60Hz type 192		
For models:	NBR912EFM, NBR912EIM, NBR912GFM, NBR912GIM, NBR98EF, NBR98EFM, NBR98EI, NBR98EIM, NBR98GF, NBR98GFM, NBR98GI, NBR98GIM		



1

GEV No.	400127	Ref. No.	R65180430
description	transformer primary 230VAC secondary 12VAC 40VA secondary 3.2A H 63mm L 75mm W 78mm connection 2-wire connection systems 50/60Hz moulded		
For models:	EC110M, EC210M, EM010M+SC, EM110H, EM110M, EM110M+SC, EM110P, EM210H, EM210M, EM210M+SC, EM210P, EV110H, EV110M, EV110M+SC, EV110P, EV210H, EV210M, EV210M+SC, EV210P, FG110X, FG210X, GC110M, GC210M, GM110H, GM110M, GM110M+SC, GM110P, GM210H, GM210M+SC, GM210P, GMT20D, GV110H, GV110M, GV110M+SC, GV110P, GV210H, GV210M+SC, GV210P, GVT20D, ME101D, ME101M, ME101P, ME101T, ME102D, ME102M, ME102P, ME102T, ME110P, ME110X, ME120P...(Other models you can see in the webshop)		

PMA



1

GEV No.	401340	Ref. No.	R65180770
description	transformer primary 220/240V secondary 24V 50VA secondary 2.1A connection screw 50/60Hz		
For models:	GMT06D, GMT20D, GVT06D, GVT20D, MACG05M, MACG07M, MACG10M, MACG20M, MG061D, MG061M, MG061P, MG061T, MG101D, MG101M, MG101P, MG101T, MG102D, MG102M, MG102P, MG102T, MG201D, MG201M, MG201P, MG201T, MG202D, MG202M, MG202P, MG202T, MGMT06D, MGMT06P, MGMT10D, MGMT10P, MGMT20D, MGMT20P, MGMT21D, MGMT21P, MGMT40D, MGMT40P, MGVT06D, MGVT06P, MGVT10D, MGVT10P, MGVT20D, MGVT20P, MGVT21D, MGVT21P, MGVT40D, MGVT40P, MVG051P		



1

GEV No.	400125	Ref. No.	R65180410
description	transformer primary 220-240V secondary 12V 16VA secondary 12V/0.3A/1AA connection screw 50Hz		
For models:	EM106P, EM110P, EM210P, EV106P, EV110P, EV210P, GM106P, GM110P, GM210P, GV106P, GV110P, GV210P, ME106P, ME110P, ME120P, ME210P, ME220P, MG106P, MG110P, MG120P, MG210P, MG220P, VE106P, VE120P, VE210P, VE220P, VG106P, VG110P, VG120P, VG210P, VG220P		



1

GEV No.	400126	Ref. No.	R65180420
description	transformer primary 230VAC secondary 12VAC 20VA secondary 2.1A connection screw 50Hz		
For models:	EC106M, EM106H, EM106M, EM106M+SC, EM106P, EV006M, EV106H, EV106M, EV106M+SC, EV106P, FE105X, FG105X, GC106M, GM106H, GM106M, GM106M+SC, GM106P, GMT06D, GMT20D, GV106H, GV106M, GV106M+SC, GV106P, GVT06D, GVT20D, MACE07M, MACE10M, MACE20M, MACG07M, MACG10M, MACG20M, ME061D, ME061M, ME061P, ME061T, ME101P, ME101T, ME102P, ME102T, ME106P, ME106X, ME201P, ME201T, ME202P, ME202T, MEMT06D, MEMT06P, MEMT10D, MEMT10P, MEMT20D...(Other models you can see in the webshop)		

1

GEV No.	379054	Ref. No.	24706.00 MA2470600
description	transformer primary 230VAC secondary 12VAC 3VA secondary 0.25A H 40mm L 45mm W 50mm connection screw 50/60Hz type 153/M		
For models:	SER15, SER15A, SER18, SER18A, SER21		

electronic controllers

ELIWELL





universal controllers

built-in version



71 x 29mm

1

GEV No.	379563	Ref. No.	2959300 MA2959300	
description	electronic controller ELIWELL type ICPlus902 mounting measurements 71x29mm 230V voltage AC NTC/PTC relay outputs 1 relay CO-8A(4) defr. funct. no -55 up to +150°C display 3½ digits Templ1 yes 8A			
For models:	CON102E, CON102EP, CON102G, CON102GP, CON10E, CON10EP, CON10G, CON10GP, CON201E, CON201EP, CON201G, CON201GP, CON202E, CON202EP, CON202G, CON202GP, CON6E, CON6EP, CON6G, CON6GP, CP9A15GD, CS4E, CS4EP, CSM102E, CSM102EP, CSM102G, CSM102GP, CSM10E, CSM10EP, CSM10G, CSM10GP, CSM201, CSM201E, CSM201EP, CSM201G, CSM201GP, CSM202, CSM202E, CSM202EP, CSM202G, CSM202GP, CSM6E, CSM6EP, CSM6G, CSM6GP			
accessories for	379563			
	GEV No.	379053	Ref. No.	—
	description	temperature probe PTC 1kOhm cable PVC probe -50 up to +150°C cable -10 up to 100°C probe ø6x30mm cable length 3m without screw connection 2-wire		
	GEV No.	379064	Ref. No.	23745.00 MA2374500
	description	temperature probe PTC 1kOhm cable silicone probe -50 up to +150°C cable -50 up to +180°C probe ø6x40mm cable length 3m without screw connection 2-wire		
	GEV No.	379161	Ref. No.	—
	description	temperature probe NTC 10kOhm cable thermoplastic probe -40 up to +110°C cable -40 up to +110°C probe ø6x14mm cable length 3m without screw connection 2-wire		
	GEV No.	379782	Ref. No.	—
	description	temperature probe PTC 1kOhm cable thermoplastic probe -50 up to +150°C cable -40 up to +110°C probe ø6x14mm cable length 3m 2-wire resistor 1kOhm		

EVCO - EVERY CONTROL

refrigeration controllers

built-in version



1

GEV No.	379850	Ref. No.	1681118 BN1681118
description	electronic controller EVERY CONTROL type EVC20S35N7ALX40 mounting measurements 165x45mm 230V voltage AC NTC relay outputs 4 NO-16A(5) NO-8A(4) CO-8A(4) NO-8A(4) NTC NTC DI DI for fridge front measurementsmm built-in depth 56mm protection IP00 yes yes yes -40 up to +99°C display 4 digits		

SHANGFANG

accessories



1

GEV No.	379054	Ref. No.	24706.00 MA2470600
description	transformer primary 230VAC secondary 12VAC 3VA secondary 0.25A H 40mm L 45mm W 50mm connection screw 50/60Hz type 153/M		
For models:	SER15, SER15A, SER18, SER18A, SER21		

probes

universal probes

temperature probes



1

GEV No.	379343	Ref. No.	4671600 46716000 MA4671600
description	temperature probe NTC 10kOhm cable silicone probe -40 up to +110°C cable -50 up to +180°C probe ø6x40mm cable length 3m 2-wire		
For models:	FB110F, FB110N, FB110P, FB140F, FB140FN, FB140N, FB140NN, FB140P, FB140PF, FB140PN, FB140PP, FB143NI, FB55F, FB55N, FB55P, FB70F, FB70N, FB70P, FB72F, FB72N, FB72NF, FB72P, FS140F, FS140FI, FS140FN, FS140I, FS140N, FS140NG, FS140NI, FS140NN, FS140P, FS140PN, FS140PP, FS143F, FS143FI, FS143N, FS143NF, FS143NI, FS143NN, FS143NP, FS143P, FS70F, FS70FG, FS70I, FS70N, FS70NG, FS70P, FS72F, FS72FI, FS72IN...(Other models you can see in the webshop)		



electric components

GEV No.	379130 ¹	Ref. No.	R65325000
description	temperature probe Pt100 cable Vetrotex probe -200 up to +600°C cable -50 up to +350°C probe ø6x100mm cable length 1.4m without screw connection 3-wire resistance at 0°C 100Ohm		
For models:	CVE004H, CVE104H, CVE105H, CVG105H, EM106H, EM106P, EM110H, EM110P, EM210H, EM210P, EV106H, EV106P, EV110H, EV110P, EV210H, EV210P, GM106H, GM106P, GM110H, GM110P, GM210H, GM210P, GMT06D, GMT20D, GV106H, GV106P, GV110H, GV110P, GV210H, GV210P, GVT06D, GVT20D, ME061D, ME061P, ME061T, ME101D, ME101P, ME101T, ME102T, ME106P, ME110P, ME120P, ME201D, ME201P, ME201T, ME202D, ME202P, ME202T, ME210P... (Other models you can see in the webshop)		

¹3-wire

GEV No.	379050 ¹	Ref. No.	R65325010
description	temperature probe Pt100 cable Vetrotex probe -200 up to +600°C cable -50 up to +350°C probe ø6x100mm cable length 2.7m without screw connection 3-wire		
For models:	ME201D, ME202D, ME220P, MEC24H, MEMT21D, MEMT21P, MEMT40D, MEVT21D, MEVT21P, MEVT40D, MEVT40P, MG201D, MG202D, MG220P, MGC24H, MGC40H, MGMT21D, MGMT21P, MGMT40D, MGMT21D, MGMT21P, MGMT40D, MGMT40P		

¹3-wire

GEV No.	379064	Ref. No.	23745.00 MA2374500
description	temperature probe PTC 1kOhm cable silicone probe -50 up to +150°C cable -50 up to +180°C probe ø6x40mm cable length 3m without screw connection 2-wire		
For models:	BR120, BR160, EF140DF, EF140DN, EF140DP, EF143DNF, EF70DF, EF70DN, EF70DP, EF72DNF, F140DF, F140DI, F140DN, F140DP, F14DFG, F14DNG, F70DF, F70DI, F70DN, F70DP, F7DFG, F7DNG, IR13C, IR13CC, IR13CV, IR13M, IR13MC, IR13MV, IR13V, IR17C, IR17CV, IR17M, IR17MC, IR17MV, IR17V, NF140DF, NF140DN, NF140DNI, NF140DNN, NF140DP, NF140DPN, NF140DPP, NF143DNF, NF143DNI, NF143DNP, NF14DNG, NF70DF, NF70DI... (Other models you can see in the webshop)		

producer-specific probes

probes

GEV No.	379387	Ref. No.	1957600
description	temperature probe Pt100 cable PTFE probe -100 up to 450°C cable -40 up to +250°C connection 2-wire thread probe ø4x350mm cable length 0.85m		
For models:	FR92G22T, FR94G22T		

GEV No.	379143	Ref. No.	R65325020
description	temperature probe Pt100 cable Vetrotex probe -200 up to +600°C cable -50 up to +350°C connection 2-wire thread probe ø3-6x90mm cable length 5m		
For models:	ME220P, MG220P, MGC40H, VE220P, VG220P		
spare parts for	379143		
	GEV No.	100909	Ref. No. —
	union screw thread M10x1 for pipe ø 6mm Qty 1 pcs		
	GEV No.	101286	Ref. No. —
	olive ID ø 6mm Qty 1 pcs		

GEV No.	379711	Ref. No.	RA932001
description	temperature probe PTC 1kOhm cable silicone probe -50 up to +150°C cable -50 up to +180°C connection coded plug thread probe ø6x40mm cable length 3.5m		
For models:	10-teglie-GN-MISTI-FR-STD, 10-teglie-GN-MISTI-FR-TOP, 10-teglie-GN-MISTI-IT-STD, 10-teglie-GN-MISTI-IT-TOP, 10-teglie-GN-MISTI-TX-STD, 10-teglie-GN-positivi-FR-STD, 10-teglie-GN-positivi-FR-TOP, 10-teglie-GN-positivi-IT, 10-teglie-GN-positivi-IT-STD, 10-teglie-GN-positivi-IT-TOP, 10-teglie-GN-positivi-TX-STD, 12-teglie-PA-MISTI-FR-STD, 12-teglie-PA-MISTI-FR-TOP, 12-teglie-PA-MISTI-IT-STD, 12-teglie-PA-MISTI-IT-TOP, 12-teglie-PA-positivi-FR-STD, 12-teglie-PA-positivi-FR-TOP, 12-teglie-PA-positivi-IT-STD, 12-teglie-PA-positivi-IT-TOP, 14-teglie-GN-MISTI-FR-dep-STD, 14-teglie-GN-MISTI-FR-dep-TOP, 14-teglie-GN-MISTI-FR-STD, 14-teglie-GN-MISTI-FR-TOP, 14-teglie-GN-MISTI-IT-dep-STD, 14-teglie-GN-MISTI-IT-dep-TOP, 14-teglie-GN-MISTI-IT-STD, 14-teglie-GN-MISTI-IT-TOP, 14-teglie-GN-positivi-FR, 14-teglie-GN-positivi-FR-dep-STD, 14-teglie-GN-positivi-FR-dep-TOP, 14-teglie-GN-positivi-FR-STD, 14-teglie-GN-positivi-FR-TOP, 14-teglie-GN-positivi-IT-dep-STD, 14-teglie-GN-positivi-IT-dep-TOP, 14-teglie-GN-positivi-IT-STD, 14-teglie-GN-positivi-IT-TOP, 14-teglie-GN-positivi-TX-STD, 15-teglie-PA-MISTI-FR-dep, 17-teglie-PA-MISTI-FR-dep-TOP, 17-teglie-PA-MISTI-FR-STD, 17-teglie-PA-MISTI-FR-TOP, 17-teglie-PA-MISTI-IT-dep, 17-teglie-PA-MISTI-IT-dep-TOP, 17-teglie-PA-MISTI-IT-STD, 17-teglie-PA-MISTI-IT-TOP, 17-teglie-PA-positivi-FR-dep-STD, 17-teglie-PA-positivi-FR-dep-TOP... (Other models you can see in the webshop)		

GEV No.	379388	Ref. No.	CM295900 MACM295900
description	temperature probe thermocouple J (Fe-CuNi) cable TP probe -50 up to +750°C cable -40 up to +110°C connection 2-wire thread probe ø4x250mm cable length 0.7m		
For models:	F94E18K, F94G22K, F98E18K, F98G22K, NF94E222K, NF94E22K, NF94G23K, NF98E222K, NF98E22K, NF98G23K		

core probes

GEV No.	379134	Ref. No.	R65320900
description	core temperature probe Pt100 cable PTFE probe -40 up to +250°C cable -40 up to +250°C connection plug probe ø4x100mm thread cable length 1m handle ø 15mm handle length 83mm		
For models:	CVE004H, CVE104H, CVE105H, CVG105H, EM010M+SC, EM106H, EM106M+SC, EM106P, EM110H, EM110M+SC, EM110P, EM210H, EM210M+SC, EM210P, EV106H, EV106M+SC, EV106P, EV110H, EV110M+SC, EV110P, EV210H, EV210M+SC, EV210P, GM106H, GM106M+SC, GM106P, GM110H, GM110M+SC, GM110P, GM210H, GM210M+SC, GM210P, GV106H, GV106M+SC, GV106P, GV110H, GV110M+SC, GV110P, GV210H, GV210M+SC, GV210P, ME061M, ME101M, ME102M, ME106P, ME106X, ME110P, ME110X, ME120P, ME120X... (Other models you can see in the webshop)		

GEV No.	379132	Ref. No.	2912400 LAR65320180
description	core temperature probe Pt100 cable SS corrugated hose probe -40 up to +250°C cable -40 up to +250°C connection 2-wire probe ø4x100mm thread 1/8" cable length 2.5m handle ø 9mm handle length 85mm		
For models:	CS10E, CS10EP, CS10G, CS6E, CS6EP, CS6G		

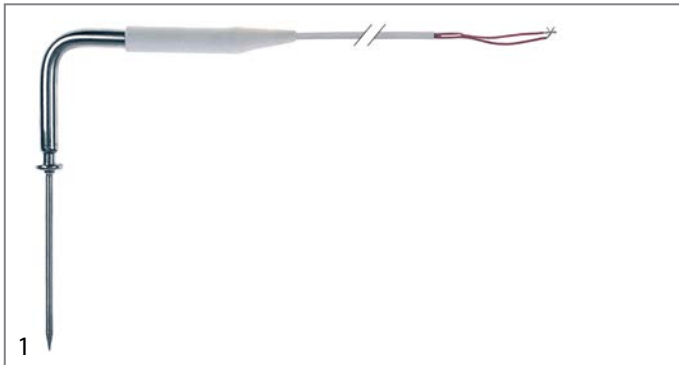

1			
GEV No.	379544	Ref. No.	RA 930013 SIRA930013 SIRRA930013
description	core temperature probe Pt1000 cable silicone probe -40 up to +120°C cable -50 up to +180°C connection 2-wire probe ø4x100mm thread cable length 3.6m handle ø 16mm handle length 120mm		
For models:	10-teglie-GN-MISTI-FR-STD, 10-teglie-GN-MISTI-IT-STD, 10-teglie-GN-MISTI-TX-STD, 10-teglie-GN-positivi-FR-STD, 10-teglie-GN-positivi-IT, 10-teglie-GN-positivi-IT-STD, 10-teglie-GN-positivi-TX-STD, 12-teglie-PA-MISTI-FR-STD, 12-teglie-PA-MISTI-IT-STD, 12-teglie-PA-positivi-FR-STD, 12-teglie-PA-positivi-IT-STD, 14-teglie-GN-MISTI-FR-dep-STD, 14-teglie-GN-MISTI-IT-STD, 14-teglie-GN-MISTI-TX-STD, 14-teglie-GN-positivi-FR-dep-STD, 14-teglie-GN-positivi-FR-STD, 14-teglie-GN-positivi-IT-dep-STD, 14-teglie-GN-positivi-IT-STD, 14-teglie-GN-positivi-TX-STD, 15-teglie-PA-MISTI-FR-STD, 15-teglie-PA-MISTI-TX-STD, 17-teglie-PA-MISTI-FR-dep, 17-teglie-PA-MISTI-FR-STD, 17-teglie-PA-MISTI-IT-dep, 17-teglie-PA-MISTI-IT-STD, 17-teglie-PA-positivi-FR-dep-STD, 17-teglie-PA-positivi-FR-STD, 17-teglie-PA-positivi-IT-dep-STD, 17-teglie-PA-positivi-IT-STD, 20-teglie-GN-misti-FR-STD, 20-teglie-GN-positivi-FR-STD, 20-teglie-GN-positivi-IT-STD, 21-teglie-PA-MISTI-TX-STD		

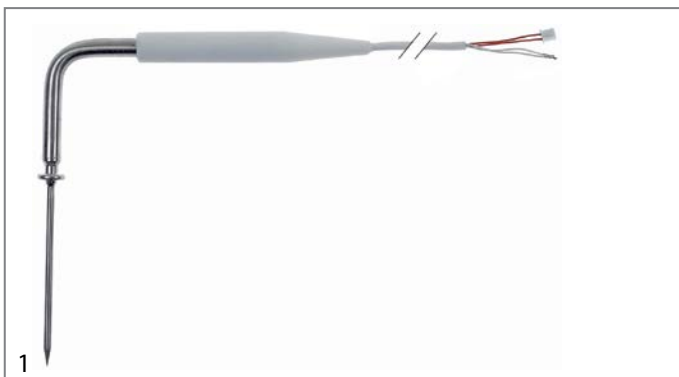

1			
GEV No.	379757	Ref. No.	RA 930014 SIRA930014 SIRRA930014
description	core temperature probe Pt1000 cable silicone probe -40 up to +120°C cable -50 up to +180°C connection 2-wire probe ø4x100mm thread cable length 3.6m handle ø 16mm handle length 125mm		
For models:	10-teglie-GN-MISTI-FR-TOP, 10-teglie-GN-MISTI-IT-TOP, 10-teglie-GN-positivi-FR-TOP, 10-teglie-GN-positivi-IT-TOP, 12-teglie-PA-MISTI-FR-TOP, 12-teglie-PA-MISTI-IT-TOP, 12-teglie-PA-positivi-FR-TOP, 12-teglie-PA-positivi-IT-TOP, 14-teglie-GN-MISTI-FR-dep-TOP, 14-teglie-GN-MISTI-IT-TOP, 14-teglie-GN-MISTI-IT-dep-TOP, 14-teglie-GN-positivi-FR-TOP, 14-teglie-GN-positivi-IT-dep-TOP, 14-teglie-GN-positivi-IT-TOP, 17-teglie-PA-MISTI-FR-dep-TOP, 17-teglie-PA-MISTI-FR-TOP, 17-teglie-PA-MISTI-IT-dep-TOP, 17-teglie-PA-MISTI-IT-TOP, 17-teglie-PA-positivi-FR-dep-TOP, 17-teglie-PA-positivi-FR-TOP, 17-teglie-PA-positivi-IT-dep-TOP, 17-teglie-PA-positivi-IT-TOP, 20-teglie-GN-positivi-FR-TOP, 20-teglie-GN-positivi-IT-TOP		

1			
GEV No.	379510	Ref. No.	R65321100
description	core temperature probe thermocouple K (NiCr-Ni) cable PTFE probe -40 up to +250°C cable -40 up to +250°C connection 6-pin connector probe ø3.5x90mm thread cable length 1.1m handle ømm handle length 90mm		
For models:	ME061T, ME101T, ME102T, ME201T, ME202T, MG061T, MG101T, MG102T, MG201T, MG202T		

1			
GEV No.	379773 ¹	Ref. No.	R65321120
description	core temperature probe thermocouple K (NiCr-Ni) cable PTFE probe -40 up to +250°C cable -40 up to +250°C connection plug probe ø3.5x90mm thread cable length 1.1m handle ømm handle length 90mm		
For models:	GMT06D, GMT20D, GVT06D, GVT20D, ME061D, ME061P, ME101D, ME101P, ME102D, ME102P, ME201D, ME201P, ME202D, ME202P, MEMT06D, MEMT06P, MEMENT10D, MEMENT10P, MEMENT20D, MEMENT20P, MEMENT21D, MEMENT21P, MEMENT40D, MEMENT40P, MEVT06D, MEVT06P, MEVT10D, MEVT10P, MEVT20D, MEVT20P, MEVT21D, MEVT21P, MEVT40D, MEVT40P, MG061D, MG061P, MG101D, MG101P, MG102D, MG102P, MG201D, MG201P, MG202D, MG202P, MGMT06D, MGMT06P, MGMT10D, MGMT10P, MGMT20D, MGMT20P...(Other models you can see in the webshop)		

¹ multipoint probe

accessories

plugs/bushes

1			
GEV No.	378016	Ref. No.	R65320920
description	female connector 4-pole		
For models:	CVE004H, CVE104H, CVE105H, CVG105H, EM010M+SC, EM106H, EM106M+SC, EM106P, EM110H, EM110M+SC, EM110P, EM210H, EM210M+SC, EM210P, EV106H, EV106M+SC, EV106P, EV110H, EV110M+SC, EV110P, EV210H, EV210M+SC, EV210P, GM106H, GM106M+SC, GM106P, GM110H, GM110M+SC, GM110P, GM210H, GM210M+SC, GM210P, GMT06D, GMT20D, GV106H, GV106M+SC, GV106P, GV110H, GV110M+SC, GV110P, GV210H, GV210M+SC, GV210P, GVT06D, GVT20D, ME061D, ME061M, ME061P, ME101D, ME101M...(Other models you can see in the webshop)		

1			
GEV No.	378017	Ref. No.	R65321020
description	lid for plug contact		
For models:	CVE004H, CVE104H, CVE105H, CVG105H, EM010M+SC, EM106H, EM106M+SC, EM106P, EM110H, EM110M+SC, EM110P, EM210H, EM210M+SC, EM210P, EV106H, EV106M+SC, EV106P, EV110H, EV110M+SC, EV110P, EV210H, EV210M+SC, EV210P, GM106H, GM106M+SC, GM106P, GM110H, GM110M+SC, GM110P, GM210H, GM210M+SC, GM210P, GMT06D, GMT20D, GV106H, GV106M+SC, GV106P, GV110H, GV110M+SC, GV110P, GV210H, GV210M+SC, GV210P, GVT06D, GVT20D, ME061D, ME061M, ME061P, ME061T, ME101D...(Other models you can see in the webshop)		

miscellaneous



GEV No.	379856	Ref. No.	R86020420
description	bag for core temperature probe		
For models:	CVE004H, CVE104H, CVE105H, CVG105H, EM010M+SC, EM106H, EM106M+SC, EM106P, EM110H, EM110M+SC, EM110P, EM210H, EM210M+SC, EM210P, EV106H, EV106M+SC, EV106P, EV110H, EV110M+SC, EV110P, EV210H, EV210M+SC, EV210P, GM106H, GM106M+SC, GM106P, GM110H, GM110M+SC, GM110P, GM210H, GM210M+SC, GM210P, GMT06D, GMT20D, GV106H, GV106M+SC, GV106P, GV110H, GV110M+SC, GV110P, GV210H, GV210M+SC, GV210P, GVT06D, GVT20D, ME061D, ME061M, ME101D, ME101M, ME102D...(Other models you can see in the webshop)		





GEV No.	400149	Ref. No.	R65300580
description	keypad PCB		
For models:	VE004X, VE104X, VE105X, VG105X		

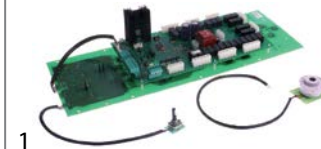

GEV No.	401332	Ref. No.	R65300540
description	keypad PCB		
For models:	EM010M+SC, EM106M+SC, EM110M+SC, EM210M+SC, EV106M+SC, EV110M+SC, EV210M+SC, GM106M+SC, GM110M+SC, GM210M+SC, GV106M+SC, GV110M+SC, GV210M+SC, ME061M, ME101M, ME102M, ME201M, ME202M, MG061M, MG101M, MG102M, MG201M, MG202M, MGC20X		



GEV No.	401591	Ref. No.	R65301410 R65301420 R65301460	
description	keypad PCB combi-steamer ME061T complete			
For models:	ME061T, ME101T, ME102T, ME201T, ME202T, MG061T, MG101T, MG102T, MG201T, MG202T			
spare parts for	401591			
	GEV No.	350086	Ref. No.	R65301440 RA919008
	buzzer 12VDC connection cable 200mm PCB buzzer 20dB			
	GEV No.	401338	Ref. No.	R65301450
	encoder			

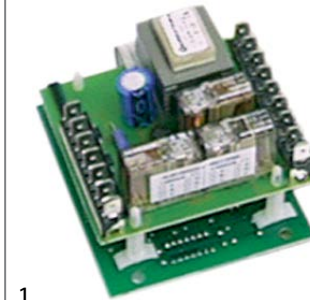

GEV No.	400140	Ref. No.	R65300500
description	keypad PCB combi-steamer ME106M with keypad		
For models:	ME106M, ME110M, ME120M, ME210M, MG106M, MG110M, MG120M, MG210M, MG220M, VE106M, VE110M, VE120M, VE210M, VE220M, VG106M, VG110M, VG120M, VG210M, VG220M		

electronics

PCBs

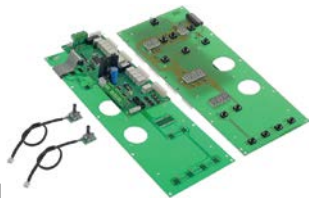



GEV No.	403472	Ref. No.	R65301400
description	control PCB combi-steamer VE 061/1011 L 410mm W 150mm suitable for LAINOX		
For models:	MEVT06P, MEVT10P, MEVT20P, MEVT21P, MEVT40P, MGVT06P, MGVT10P, MGVT20P, MGVT21P, MGVT40P		





GEV No.	402427	Ref. No.	R65301370 R65301390
description	control PCB L 410mm W 150mm for LAINOX buttons 13		
For models:	ME061P, ME101P, ME102P, ME201P, ME202P, MEMT06P, MEMT10P, MEMT20P, MEMT21P, MEMT40P, MEVT06P, MEVT10P, MEVT20P, MEVT21P, MEVT40P, MG061P, MG101P, MG102P, MG201P, MG202P, MGMT06P, MGMT10P, MGMT20P, MGMT21P, MGMT40P, MGVT06P, MGVT10P, MGVT20P, MGVT21P, MGVT40P		





 <p>1</p>			
GEV No.	401661	Ref. No.	R65301800 R65301810 R65301820
description	keypad PCB combi-steamer MVE04 kit		
For models:	MVE042P, MVE051P, MVG051P		

 <p>1</p>			
GEV No.	400687	Ref. No.	CM295800 MACM295800
description	keypad PCB fryer EFE....K		
For models:	F94E18K, F94G22K, F98E18K, F98G22K, NF94E222K, NF94E22K, NF94G23K, NF98E222K, NF98E22K, NF98G23K		

 <p>1</p>			
GEV No.	400142	Ref. No.	R65300570
description	keypad PCB L 100mm W 95mm buttons 8		
For models:	ME106X, ME110X, ME120X, ME210X, ME220M, ME220X, MG106X, MG110X, MG120X, MG210X, MG220X, VE106X, VE110X, VE120X, VE210X, VE220X, VG106X, VG110X, VG120X, VG210X, VG220X		

 <p>1</p>			
GEV No.	401352	Ref. No.	R65301330
description	keypad PCB temperature		
For models:	GMT06D, GMT20D, ME061D, ME101D, ME102D, ME201D, MG061D, MG101D, MG102D, MG201D, MG202D		

 <p>1</p>			
GEV No.	400150	Ref. No.	R65300830
description	main PCB		
For models:	CVE004H, CVE104H, CVE105H, CVG105H		

 <p>1</p>			
GEV No.	400148	Ref. No.	R65300550
description	PCB		
For models:	VE004X, VE104X, VE105X, VG105X		

 <p>1</p>			
GEV No.	401333	Ref. No.	R65300490
description	PCB		
For models:	EM010M+SC, EM106M+SC, EM110M+SC, EM210M+SC, EV106M+SC, EV110M+SC, EV210M+SC, GM106M+SC, GM110M+SC, GM210M+SC, GV106M+SC, GV110M+SC, GV210M+SC, ME061M, ME101M, ME102M, ME201M, ME202M, MG061M, MG101M, MG102M, MG201M, MG202M, MGC20X		



1

GEV No.	401341	Ref. No.	R63130020
description	PCB		
For models:	GMT06D, GMT20D, GVT06D, GVT20D, MACG05M, MACG07M, MACG10M, MACG20M, MG061D, MG061M, MG061P, MG061T, MG101D, MG101M, MG101P, MG101T, MG102D, MG102M, MG102P, MG102T, MG201D, MG201M, MG201P, MG201T, MG202D, MG202M, MG202P, MG202T, MGMT06D, MGMT06P, MGMT10D, MGMT10P, MGMT20D, MGMT20P, MGMT21D, MGMT21P, MGMT40D, MGMT40P, MGVT06D, MGVT06P, MGVT10D, MGVT10P, MGVT20D, MGVT20P, MGVT21D, MGVT21P, MGVT40D, MGVT40P, MVG051P		



2

GEV No.	400141	Ref. No.	R65300520
description	PCB blast chiller suitable for LAINOX		
For models:	ME106X, ME110X, ME120X, ME210X, ME220X, MG106X, MG110X, MG120X, MG210X, MG220X, VE106X, VE110X, VE120X, VE210X, VE220X, VG106X, VG110X, VG120X, VG210X, VG220X		



1

GEV No.	402825	Ref. No.	R65301480
description	PCB combi-steamer GEMT L 130mm W 86mm new edition level control steam generator EVCO		
For models:	GMT06D, GMT20D, ME061D, ME061P, ME101D, ME101P, ME102D, ME102P, ME201D, ME201P, ME202D, ME202P, MEMT06D, MEMT06P, MEMT10D, MEMT10P, MEMT20D, MEMT20P, MEMT21D, MEMT21P, MEMT40D, MEMT40P, MG061D, MG061P, MG101D, MG101P, MG102D, MG102P, MG201D, MG201P, MG202D, MG202P, MGMT06D, MGMT06P, MGMT10D, MGMT10P, MGMT20D, MGMT20P, MGMT21D, MGMT21P, MGMT40D, MGMT40P		



1

GEV No.	400152	Ref. No.	R65300850
description	PCB core temperature		
For models:	CVE004H, CVE104H, CVE105H, CVG105H		



1

GEV No.	401767	Ref. No.	RA910059 SIRRA910059
description	power PCB		



1

GEV No.	402972	Ref. No.	011AD1600001 0509630R BN011AD1600001 CR0509630R
description	relay PCB L 69mm W 59mm		
For models:	V94E, V98E		

keypads

front foils



1

GEV No.	401304	Ref. No.	R67010450
description	front foil		
For models:	CVE004M, CVE104M, VE004M, VE104M		



1

GEV No.	401308	Ref. No.	R67010530
description	front foil		
For models:	VE106M, VE110M, VE120M, VE210M, VE220M, VG106M, VG110M, VG120M, VG210M, VG220M		

1			
GEV No.	401313	Ref. No.	R67012950
description	front foil		
For models:	ME061M, ME101M, ME102M, ME201M, ME202M, MG061M, MG101M, MG102M, MG201M, MG202M		

1			
GEV No.	511409	Ref. No.	461073
description	front foil		

1			
GEV No.	511411	Ref. No.	461074
description	front foil		

1			
GEV No.	511412	Ref. No.	461101
description	front foil		

1			
GEV No.	511414	Ref. No.	461138
description	front foil		

1			
GEV No.	511416	Ref. No.	461075
description	front foil		

1			
GEV No.	401305	Ref. No.	R67010460
description	front foil suitable for LAINOX L 399mm W 74mm		
For models:	VE004X, VE104X		

1			
GEV No.	401306	Ref. No.	R67010490
description	front foil suitable for LAINOX L 493mm W 75mm		
For models:	CVE105M, CVG105M, VE105M, VG105M		

1			
GEV No.	401307	Ref. No.	R67010500
description	keypad foil		
For models:	VE105X, VG105X		

1			
GEV No.	401309	Ref. No.	R67010550
description	keypad foil		
For models:	VE106X, VE110X, VE120X, VE210X, VE220X, VG106X, VG110X, VG120X, VG210X, VG220X		

1			
GEV No.	401311	Ref. No.	R67010630
description	keypad foil		
For models:	ME106X, ME110X, ME120X, ME210X, ME220X, MG106X, MG110X, MG120X, MG210X, MG220X		

1			
GEV No.	401312	Ref. No.	R67012960
description	keypad foil		
For models:	ME061M, ME101M, ME102M, ME201M, ME202M, MG061M, MG101M, MG102M, MG201M, MG202M		

1			
GEV No.	401324	Ref. No.	R67010660
description	keypad foil		
For models:	MEC24H, MGC24H, MGC40H		

1			
GEV No.	401326	Ref. No.	R67010920
description	keypad foil		
For models:	ME106P, ME110P, ME120P, ME210P, ME220P, MG106P, MG110P, MG120P, MG210P, MG220P		



solenoid valves

solenoid valves (water)

			
GEV No.	401327	Ref. No.	R67010950
description	keypad foil		
For models:	VE106P, VE120P, VE210P, VE220P, VG106P, VG110P, VG120P, VG210P, VG220P		

			
GEV No.	401329	Ref. No.	R67010870
description	keypad foil		
For models:	CVE004H, CVE104H		

			
GEV No.	401330	Ref. No.	R67012910
description	keypad foil		
For models:	MG101P		

			
GEV No.	401349	Ref. No.	R67013461
description	keypad foil		
For models:	MVE042P, MVE051P, MVG051P		



			
GEV No.	400688	Ref. No.	CM247301 MACM247301
description	keypad foil fryer F94/F98		
For models:	F94E18K, F94G22K, F98E18K, F98G22K		

			
GEV No.	504294	Ref. No.	CR0588380
description	keypad foil suitable for 900 series L 92mm W 54mm buttons 4		
For models:	NF94E222K, NF94E22K, NF94G23K, NF98E222K, NF98E22K, NF98G23K		

ELBI straight



GEV No.	373021	Ref. No.	R65110040 R65115000
description	solenoid valve double straight 230VAC inlet 3/4" outlet 11.5mm output 1x 4.7l/min DN10 ELBI		
For models:	CVE105H, CVE105M, CVG105H, CVG105M, EM010M+SC, EM106H, EM106M, EM106M+SC, EM106P, EM110H, EM110M, EM110M+SC, EM110P, EM210H, EM210M, EM210M+SC, EM210P, GM106H, GM106M, GM106M+SC, GM106P, GM110H, GM110M, GM110M+SC, GM110P, GM210H, GM210M, GM210M+SC, GM210P, ME106M, ME106P, ME106X, ME110M, ME110P, ME110X, ME120M, ME120P, ME120X, ME210M, ME210P, ME210X, ME220M, ME220P, ME220X, MEC24H, MEC40M, MG106M, MG106P, MG106X, MG110M...(Other models you can see in the webshop)		

spare parts for 373021			
	GEV No.	370467	Ref. No. —
solenoid valve filter suitable for ELBI			
	GEV No.	371263	Ref. No. —
reducer ELBI type EATON (INVENSYS) flow rate 4.7l/min pressure range 0 up to 10bar tolerance ±15/25% grey			



GEV No.	373017	Ref. No.	R65110010
description	solenoid valve single straight 230VAC inlet 3/4" outlet 11.5mm DN10 ELBI		
For models:	EM010M+SC, EM106M, EM106M+SC, EM110M, EM110M+SC, EM210M, EM210M+SC, EV006M, EV106H, EV106M, EV106M+SC, EV106P, EV110H, EV110M, EV110M+SC, EV110P, EV210H, EV210M, EV210M+SC, EV210P, FE105M, FE105X, FE110M, FE110X, FE210M, FG105M, FG105X, FG110M, FG110X, FG210M, FG210X, GM106M, GM106M+SC, GM110M, GM110M+SC, GM210M, GM210M+SC, GV106H, GV106M, GV106M+SC, GV106P, GV110H, GV110M, GV110M+SC, GV110P, GV210H, GV210M, GV210M+SC, GV210P, ME106M...(Other models you can see in the webshop)		



spare parts for 373017			
	GEV No.	370467	Ref. No. —
solenoid valve filter suitable for ELBI			



angled



GEV No.	370833	Ref. No.	CR0682320 CR0682320R
description	solenoid valve single angled 230VAC inlet 3/4" outlet 11.5mm input 18.5-20l/min DN10 ELBI		
For models:	NBR912EFM, NBR912EIM, NBR912GFM, NBR912GIM, NBR98EF, NBR98EFM, NBR98EI, NBR98EIM, NBR98GF, NBR98GFM, NBR98GI, NBR98GIM, NPD76G5, NPD78G8, NPD96G5, NPD98E10, NPD98E15, NPD98G10, NPD98G15, NPD98G15A, NPI76E5, NPI76G5, NPI78E8, NPI78G8, NPI96E5, NPI96G5, NPI98E10, NPI98E15, NPI98G10, NPI98G14, NPI98G14A		

GEV No.	370360	Ref. No.	R65115040
description	solenoid valve single straight 230VAC inlet 3/4" outlet 11.5mm output 0.25l/min t.max. 90°C ELBI plastic flow regulating valve outlet white flow regulating valve inlet clear		
For models:	EC110M, EC210M, EV110M, EV110M+SC, EV210M, EV210M+SC, GC110M, GC210M, GV110M, GV110M+SC, GV210M, GV210M+SC, VE106M, VE106P, VE106X, VE110M, VE110X, VE210M, VE210P, VE210X, VG106M, VG106P, VG106X, VG110M, VG110P, VG110X, VG210M, VG210P, VG210X		



GEV No.	370359	Ref. No.	R65115050
description	solenoid valve double straight 230VAC inlet 3/4" outlet 11.5mm input 5.5l/min t.max. 90°C ELBI plastic flow regulating valve inlet yellow output A 5.5l/min output B 2l/min output A brown output B white		
For models:	CVE004H, CVE004M, CVE104H, CVE104M, VE004M, VE004X, VE104M, VE104X		



GEV No.	370361	Ref. No.	R65115060
description	solenoid valve double straight 230VAC inlet 3/4" outlet 11.5mm plastic output A 0.25l/min		
For models:	VE120M, VE120P, VE120X, VE220M, VE220P, VE220X, VG120M, VG120P, VG120X, VG220M, VG220P, VG220X		

spare parts and accessories

reducers

outlet side



GEV No.	371060	Ref. No.	R65110520
description	reducer ELBI flow rate 0.25l/min pressure range 0 up to 10bar tolerance ±15/25% green		
For models:	MGVT10D, MGVT10P		

RPE

JOHN GUEST



GEV No.	374032 ¹	Ref. No.	R65110230
description	solenoid valve double straight 230VAC inlet 3/4" outlet 10mm DN10 plastic output A w/t membrane (constantly open)		
For models:	GVT06D, GVT20D, ME061P, ME061T, ME101P, ME101T, ME102P, ME102T, ME201P, ME201T, ME202P, ME202T, MEMT40P, MEVT06D, MEVT06P, MEVT10D, MEVT10P, MEVT20D, MEVT20P, MG061P, MG061T, MG101P, MG101T, MG102P, MG102T, MG201P, MG201T, MG202P, MG202T, MGMT06P, MGMT40P, MGVT06D, MGVT06P, MGVT10D, MGVT10P, MGVT20D, MGVT20P, MGVT40P, MVE042P, MVE051P, MVG051P		

¹cylindrical outlet





GEV No.	370768 ¹	Ref. No.	R65110200
description	solenoid valve single straight 230VAC inlet 3/4" outlet 10mm input/ min output/ min DN10 t.max. 90°C duty cycle 100% RPE		
For models:	GMT06D, GMT20D, GVT06D, GVT20D, MACE04M, MACE05M, MACE07M, MACE10M, MACE20M, MACG05M, MACG07M, MACG10M, MACG20M, ME061D, ME061M, ME101D, ME101M, ME102D, ME102M, ME201D, ME201M, ME202D, ME202M, MEMT06D, MEMT06P, MEMT10D, MEMT10P, MEMT20D, MEMT20P, MEMT21D, MEMT21P, MEMT40D, MEVT06D, MEVT06P, MEVT10D, MEVT10P, MEVT20D, MEVT20P, MEVT21D, MEVT21P, MEVT40D, MEVT40P, MG061D, MG061M, MG101D, MG101M, MG102D, MG102M, MG201D, MG201M...(Other models you can see in the webshop)		

¹cylindrical outlet

reducers			
outlet side			
			
1			
GEV No.	371269	Ref. No.	R65110420 R65110500
description	reducer flow rate 0.07-0.14l/min brown		
For models:	CVE004H, CVE004M, CVE104H, CVE104M, EV106H, EV106P, EV110H, GMT06D, GV106H, GV106P, MACE04M, MACE05M, MACE07M, MACG05M, ME202D, ME202M, ME202P, MEMT06D, MEMT06P, MEMT40D, MEMT40P, MEVT06D, MEVT06P, MEVT40D, MEVT40P, MG202D, MG202M, MG202P, MG202T, MGMT06D, MGMT06P, MGMT40D, MGMT40P, MGVT40D, MGVT40P, MVE042P, MVE051P, MVG051P, VE004M, VE004X, VE104M, VE104X		

solenoid valves with reducers			
2-fold			
			
1			
GEV No.	374031	Ref. No.	R65110210
description	solenoid valve double straight 230VAC inlet 3/4 outlet JG 10 input 10-12l/min t.max. 90°C RPE plastic flow regulating valve inlet white + outlet reducer red		
For models:	GMT06D, GMT20D, ME061D, ME061M, ME061P, ME061T, ME101D, ME101M, ME101P, ME101T, ME102D, ME102M, ME102P, ME102T, ME201D, ME201M, ME201P, ME201T, ME202D, ME202M, ME202P, ME202T, MEMT06D, MEMT06P, MEMT10D, MEMT10P, MEMT20D, MEMT20P, MEMT21D, MEMT21P, MEMT40D, MEMT40P, MG061D, MG061M, MG061P, MG061T, MG101D, MG101M, MG101P, MG101T, MG102D, MG102M, MG102P, MG102T, MG201D, MG201M, MG201P, MG201T, MG202D, MG202M...(Other models you can see in the webshop)		

			
1			
GEV No.	374000	Ref. No.	CR0586050 CR0586050R CR1220370R
description	solenoid valve double straight 230VAC inlet 3/4" outlet 11.5mm input 10-12l/min DN10 t.max. 90°C RPE flow regulating valve inlet white output A 0.32-0.42l/min flow regulating valve outlet A dark green		
For models:	NPC74E, NPC74G, NPC76E, NPC76G, NPC78E, NPC78G, NPC94E, NPC94G, NPC96E, NPC96G, NPC98E, NPC98G		
accessories for	374000		
	GEV No.	371256	Ref. No. —
reducer RPE flow rate 10-12l/min pressure range 0.5-10bar white			

3-fold			
			
1			
GEV No.	374033	Ref. No.	R65110240
description	solenoid valve triple straight 230VAC inlet 3/4" outlet 10mm input 10-12l/min t.max. 90°C RPE plastic flow regulating valve inlet white output B w/t membrane (constantly open)		
For models:	ME061T, ME101T, ME102T, ME201T, MEMT40P, MEVT21D, MEVT21P, MEVT40D, MEVT40P, MG102T, MG201T, MG202T, MGMT40P, MGVT21D, MGVT21P, MGVT40D		

























TP			
			
1			
GEV No.	370017	Ref. No.	2709000 MA2709000
description	solenoid valve single straight 230VAC inlet 3/4" outlet 11.5mm DN10 TP p max 10bar		
For models:	B124E, CON102E, CON102EP, CON102G, CON102GP, CON10E, CON10EP, CON10G, CON10GP, CON6E, CON6EP, CON6G, CON6GP, CRE6220, CRE6230, CRE6320, CRE6330, CS102E, CS102EP, FC10E, FC10G, FC20E, FC20G, FC5E, FC5G, FC7E, FC7G, SBA, SBAC, SNA12, SNA16, SNA20, SNAC12, SNAC16, SNAC20, SNG08, SNG12, SNG16, SNG20, SVAC, SVAC12, SVAC16, SVAC20, SVCG, SVCG08, SVCG12, SVCG16, SVCG20, SVCG8		
spare parts for	370017		
	GEV No.	371013	Ref. No. —
solenoid coil TP 230VAC 50/60Hz			
accessories for	370017		
	GEV No.	371220	Ref. No. —
reducer TP flow rate 3l/min red tolerance ±15%			
	GEV No.	371221	Ref. No. —
reducer TP flow rate 5.5l/min yellow tolerance ±15%			
	GEV No.	371222	Ref. No. —
reducer TP flow rate 6l/min grey tolerance ±15%			
	GEV No.	371223	Ref. No. —
reducer TP flow rate 10l/min white tolerance ±15%			
	GEV No.	371224	Ref. No. —
reducer TP flow rate 12l/min bronze tolerance ±15%			
	GEV No.	371225	Ref. No. —
reducer TP flow rate 16l/min light brown tolerance ±15%			
	GEV No.	371226	Ref. No. —
reducer TP flow rate 20l/min red tolerance ±15%			
	GEV No.	371230	Ref. No. —
reducer TP flow rate 0.25l/min red tolerance ±25%			

Table continues overleaf

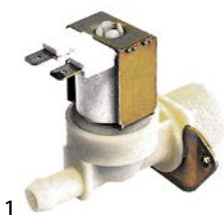

accessories for		370017		
GEV No.		371231	Ref. No.	—
	reducer TP flow rate 0.35l/min violet tolerance ±25%			
	reducer TP flow rate 0.5l/min orange tolerance ±25%			
	reducer TP flow rate 0.8l/min white tolerance ±25%			
	reducer TP flow rate 1l/min light blue tolerance ±25%			
	reducer TP flow rate 1.2l/min brown tolerance ±25%			
	reducer TP flow rate 1.5l/min light brown tolerance ±25%			
	reducer TP flow rate 2.5l/min yellow tolerance ±25%			
	reducer TP flow rate 3.4l/min dark green tolerance ±25%			
	reducer TP flow rate 5l/min black tolerance ±25%			
	reducer TP flow rate 8l/min blue tolerance ±20%			

 <p>1</p>				
GEV No.	370029	Ref. No.	2956900	
description	solenoid valve single straight 24VAC inlet 3/4" outlet 11.5mm DN10 TP flow regulating valve inlet white			
For models:	CON201E, CON201EP, CON201G, CON201GP, CON202E, CON202EP, CON202G, CON202GP, CS4E, CS4EP, CSM102E, CSM102EP, CSM102G, CSM102GP, CSM10E, CSM10EP, CSM10G, CSM10GP, CSM201E, CSM201EP, CSM201G, CSM201GP, CSM202E, CSM202EP, CSM202G, CSM202GP, CSM6E, CSM6EP, CSM6G, CSM6GP			
spare parts for	370029			
	GEV No.	371035	Ref. No.	—
solenoid coil 24VAC				
accessories for	370029			
	GEV No.	371220	Ref. No.	—
reducer TP flow rate 3l/min red tolerance ±15%				
	GEV No.	371221	Ref. No.	—
reducer TP flow rate 5.5l/min yellow tolerance ±15%				
	GEV No.	371222	Ref. No.	—
reducer TP flow rate 6l/min grey tolerance ±15%				

accessories for		370029		
GEV No.		371223	Ref. No.	—
	reducer TP flow rate 10l/min white tolerance ±15%			
	reducer TP flow rate 12l/min bronze tolerance ±15%			
	reducer TP flow rate 16l/min light brown tolerance ±15%			
	reducer TP flow rate 20l/min red tolerance ±15%			
	reducer TP flow rate 0.25l/min red tolerance ±25%			
	reducer TP flow rate 0.35l/min violet tolerance ±25%			
	reducer TP flow rate 0.5l/min orange tolerance ±25%			
	reducer TP flow rate 0.8l/min white tolerance ±25%			
	reducer TP flow rate 1l/min light blue tolerance ±25%			
	reducer TP flow rate 1.2l/min brown tolerance ±25%			
	reducer TP flow rate 1.5l/min light brown tolerance ±25%			
	reducer TP flow rate 2.5l/min yellow tolerance ±25%			
	reducer TP flow rate 3.4l/min dark green tolerance ±25%			
	reducer TP flow rate 5l/min black tolerance ±25%			
	reducer TP flow rate 8l/min blue tolerance ±20%			

			
1			
GEV No.	370019	Ref. No.	120142
description	solenoid valve double angled 230VAC inlet 3/4" outlet 11.5mm DN10 TP plastic		
spare parts for	370019		
	GEV No.	371013	Ref. No.
	solenoid coil TP 230VAC 50/60Hz		
accessories for	370019		
	GEV No.	371220	Ref. No.
	reducer TP flow rate 3l/min red tolerance ±15%		
	GEV No.	371221	Ref. No.
	reducer TP flow rate 5.5l/min yellow tolerance ±15%		
	GEV No.	371222	Ref. No.
	reducer TP flow rate 6l/min grey tolerance ±15%		
	GEV No.	371223	Ref. No.
	reducer TP flow rate 10l/min white tolerance ±15%		
	GEV No.	371224	Ref. No.
	reducer TP flow rate 12l/min bronze tolerance ±15%		
	GEV No.	371225	Ref. No.
	reducer TP flow rate 16l/min light brown tolerance ±15%		
	GEV No.	371226	Ref. No.
	reducer TP flow rate 20l/min red tolerance ±15%		
	GEV No.	371230	Ref. No.
	reducer TP flow rate 0.25l/min red tolerance ±25%		
	GEV No.	371231	Ref. No.
	reducer TP flow rate 0.35l/min violet tolerance ±25%		
	GEV No.	371232	Ref. No.
	reducer TP flow rate 0.5l/min orange tolerance ±25%		
	GEV No.	371233	Ref. No.
	reducer TP flow rate 0.8l/min white tolerance ±25%		
	GEV No.	371234	Ref. No.
	reducer TP flow rate 1l/min light blue tolerance ±25%		
	GEV No.	371235	Ref. No.
	reducer TP flow rate 1.2l/min brown tolerance ±25%		
	GEV No.	371236	Ref. No.
	reducer TP flow rate 1.5l/min light brown tolerance ±25%		
	GEV No.	371237	Ref. No.
	reducer TP flow rate 2.5l/min yellow tolerance ±25%		

accessories for	370019		
	GEV No.	371238	Ref. No.
	reducer TP flow rate 3.4l/min dark green tolerance ±25%		
	GEV No.	371239	Ref. No.
	reducer TP flow rate 5l/min black tolerance ±25%		
	GEV No.	371240	Ref. No.
	reducer TP flow rate 8l/min blue tolerance ±20%		

















			
1			
GEV No.	370109	Ref. No.	5151500 MA5151500
description	solenoid valve double angled 24VAC inlet 3/4" outlet 11.5mm DN10 t.max. 90°C TP plastic flow regulating valve inlet white		
For models:	CSM201E, CSM201EP, CSM201G, CSM201GP, CSM202E, CSM202EP, CSM202G, CSM202GP		
spare parts for	370109		
	GEV No.	371035	Ref. No.
	solenoid coil 24VAC		
accessories for	370109		
	GEV No.	371220	Ref. No.
	reducer TP flow rate 3l/min red tolerance ±15%		
	GEV No.	371221	Ref. No.
	reducer TP flow rate 5.5l/min yellow tolerance ±15%		
	GEV No.	371222	Ref. No.
	reducer TP flow rate 6l/min grey tolerance ±15%		
	GEV No.	371223	Ref. No.
	reducer TP flow rate 10l/min white tolerance ±15%		
	GEV No.	371224	Ref. No.
	reducer TP flow rate 12l/min bronze tolerance ±15%		
	GEV No.	371225	Ref. No.
	reducer TP flow rate 16l/min light brown tolerance ±15%		
	GEV No.	371226	Ref. No.
	reducer TP flow rate 20l/min red tolerance ±15%		
	GEV No.	371230	Ref. No.
	reducer TP flow rate 0.25l/min red tolerance ±25%		
	GEV No.	371231	Ref. No.
	reducer TP flow rate 0.35l/min violet tolerance ±25%		
	GEV No.	371232	Ref. No.
	reducer TP flow rate 0.5l/min orange tolerance ±25%		





Table continues overleaf



accessories for		370109		
	GEV No.	371233	Ref. No.	—
reducer TP flow rate 0.8l/min white tolerance ±25%				
	GEV No.	371234	Ref. No.	—
reducer TP flow rate 1l/min light blue tolerance ±25%				
	GEV No.	371235	Ref. No.	—
reducer TP flow rate 1.2l/min brown tolerance ±25%				
	GEV No.	371236	Ref. No.	—
reducer TP flow rate 1.5l/min light brown tolerance ±25%				
	GEV No.	371237	Ref. No.	—
reducer TP flow rate 2.5l/min yellow tolerance ±25%				
	GEV No.	371238	Ref. No.	—
reducer TP flow rate 3.4l/min dark green tolerance ±25%				
	GEV No.	371239	Ref. No.	—
reducer TP flow rate 5l/min black tolerance ±25%				
	GEV No.	371240	Ref. No.	—
reducer TP flow rate 8l/min blue tolerance ±20%				



accessories for		370015		
	GEV No.	371220	Ref. No.	—
reducer TP flow rate 3l/min red tolerance ±15%				
	GEV No.	371221	Ref. No.	—
reducer TP flow rate 5.5l/min yellow tolerance ±15%				
	GEV No.	371222	Ref. No.	—
reducer TP flow rate 6l/min grey tolerance ±15%				
	GEV No.	371223	Ref. No.	—
reducer TP flow rate 10l/min white tolerance ±15%				
	GEV No.	371224	Ref. No.	—
reducer TP flow rate 12l/min bronze tolerance ±15%				
	GEV No.	371225	Ref. No.	—
reducer TP flow rate 16l/min light brown tolerance ±15%				
	GEV No.	371226	Ref. No.	—
reducer TP flow rate 20l/min red tolerance ±15%				

accessories for		370015		
	GEV No.	371230	Ref. No.	—
reducer TP flow rate 0.25l/min red tolerance ±25%				
	GEV No.	371231	Ref. No.	—
reducer TP flow rate 0.35l/min violet tolerance ±25%				
	GEV No.	371232	Ref. No.	—
reducer TP flow rate 0.5l/min orange tolerance ±25%				
	GEV No.	371233	Ref. No.	—
reducer TP flow rate 0.8l/min white tolerance ±25%				
	GEV No.	371234	Ref. No.	—
reducer TP flow rate 1l/min light blue tolerance ±25%				
	GEV No.	371235	Ref. No.	—
reducer TP flow rate 1.2l/min brown tolerance ±25%				
	GEV No.	371236	Ref. No.	—
reducer TP flow rate 1.5l/min light brown tolerance ±25%				
	GEV No.	371237	Ref. No.	—
reducer TP flow rate 2.5l/min yellow tolerance ±25%				
	GEV No.	371238	Ref. No.	—
reducer TP flow rate 3.4l/min dark green tolerance ±25%				
	GEV No.	371239	Ref. No.	—
reducer TP flow rate 5l/min black tolerance ±25%				
	GEV No.	371240	Ref. No.	—
reducer TP flow rate 8l/min blue tolerance ±20%				

solenoid valves with reducers

	Image not available		
1			
GEV No.	370011	Ref. No.	120144
description	solenoid valve double angled 230VAC inlet 3/4" outlet 11.5mm		

spare parts and accessories

reducers

outlet side

	1		
GEV No.	691081	Ref. No.	R65110410
description	reducer flow rate 0.25l/min green tolerance ±25%		
For models:	CVE105H, CVE105M, CVG105H, CVG105M, EV110P, EV210H, EV210P, GV110H, GV110P, GV210H, GV210P, VE105M, VE105X, VG105M, VG105X		



various



GEV No.	374057	Ref. No.	R65115120
description	solenoid valve single straight 230VAC inlet 3/4" outlet 11.5mm output 0.12l/min ELBI		
For models:	EC106M, EV006M, EV106M, EV106M+SC, GC106M, GV106M, GV-106M+SC		



GEV No.	370363	Ref. No.	R65110260
description	solenoid valve single straight cable length 600mm suitable for LAINOX		
For models:	ME061T, ME101T, ME102T, ME201T, MEMT06P, MEMT10P, MEMT20P, MEMT21P, MEMT40P, MG102T, MG201T, MG202T, MGMT06P, MGMT10P, MGMT20P, MGMT21P, MGMT40P		



metal

SIRAI

2-way

L180-B series



GEV No.	370329	Ref. No.	120131
description	solenoid valve 2-ways 24VAC inlet 1/2" outlet 1/2" connection 1/2" L 66mm DN 13.5mm slide-on receptacle compact -10 up to +90°C SIRAI type series L180-B coil type Z610A membranes NBR (water) p max 12bar p min 0.35bar		
spare parts for	370329		
	GEV No.	371070	Ref. No. 630948
	solenoid coil 24VAC 10VA SIRAI coil type Z610A seat ø 10mm		
	GEV No.	371171	Ref. No. —
	membrane series L180-B membrane type NBR (water)		
accessories for	370329		
	GEV No.	371091	Ref. No. —
	power socket plug type DIN 43650B cable lengthmm small		

solenoid valves steam (water)

2-way

L153-D series



GEV No.	370326	Ref. No.	21504199
description	solenoid valve 2-ways 230VAC connection 1" L 105mm DN 22mm slide-on receptacle DIN -10 up to 140°C SIRAI type series L153-D coil type Z914A membranes EPDM (steam/water) p max 8bar p min 0.1bar		
spare parts for	370326		
	GEV No.	371161	Ref. No. —
	solenoid coil 230VAC 27VA SIRAI coil type Z923A seat ø 16mm 50Hz		



GEV No.	370327	Ref. No.	120166
description	solenoid valve 2-ways 24VAC connection 1" L 105mm DN 22mm -10 up to 140°C SIRAI coil type Z923A membranes EPDM (steam/water) p max 8bar p min 0.1bar		

spare parts and accessories

solenoid coils

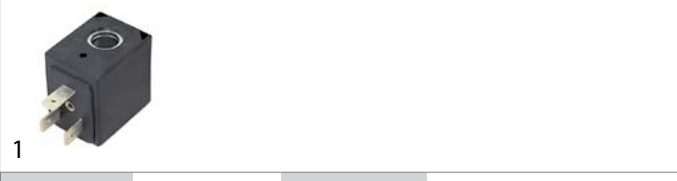

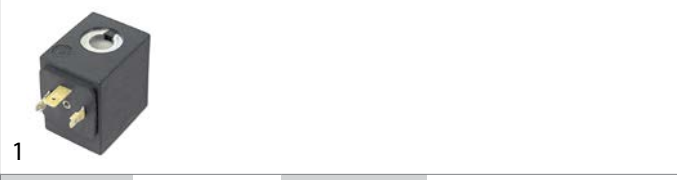

GEV No.	371070	Ref. No.	630948
description	solenoid coil 24VAC 10VA SIRAI coil type Z610A seat ø 10mm		
accessories for	371070		
	GEV No.	371091	Ref. No. —
	power socket plug type DIN 43650B cable lengthmm small		



GEV No.	371068	Ref. No.	630972
description	solenoid coil 24VAC 14VA SIRAI coil type Z534A seat ø 12mm		



			
1			
GEV No.	371162	Ref. No.	630976
description	solenoid coil 24VAC 27VA SIRAI seat ø 16mm		

membranes			
			
1			
GEV No.	371169	Ref. No.	630629
description	membrane connection 1" series L153-D membrane type EPDM		

			
1			
GEV No.	371168	Ref. No.	630628
description	membrane connection 3/4" series L153-D membrane type EPDM		

ball valves electric



			
1			
GEV No.	403042	Ref. No.	R65110560
description	ball valve inlet 3/4" IT outlet 3/4" IT 230V L 68mm closed off-current mode of operation electric connection cable 400mm		
For models:	GMT06D, GMT20D, ME061D, ME061P, ME061T, ME101D, ME101M, ME101P, ME101T, ME102D, ME102M, ME102P, ME102T, ME201D, ME201M, ME201P, ME201T, ME202D, ME202M, ME202P, ME202T, MEMENT06D, MEMENT06P, MEMENT10D, MEMENT10P, MEMENT20D, MEMENT20P, MEMENT21D, MEMENT21P, MEMENT40D, MEMENT40P, MG061D, MG061M, MG061P, MG061T, MG101D, MG101M, MG101P, MG101T, MG102D, MG102M, MG102P, MG102T, MG201D, MG201M, MG201P, MG201T, MG202D, MG202M, MG202P...(Other models you can see in the webshop)		

pressure switches

for warewashing

ø 58mm with male faston 6.3mm

with connection horizontal

			
1			
GEV No.	541830	Ref. No.	CR0585951
description	pressure control pressure range 260/230mbar connection 6mm ø 58mm pressure connection ø 6mm		
For models:	NPC74E, NPC74G, NPC76E, NPC76G, NPC78E, NPC78G, NPC94E, NPC94G, NPC96E, NPC96G, NPC98E, NPC98G		
accessories for	541830		
		GEV No.	541831 Ref. No. CR0731840
	bracket metal for pressure switch mounting distance 38.5mm		

			
1			
GEV No.	541047	Ref. No.	1037308700
description	pressure control pressure range 340/200mbar connection 6mm ø 58mm pressure connection horizontal warewashing		
For models:	MLC50, MLC503, MLC65, MLC653		

			
1			
GEV No.	541046	Ref. No.	1037302800
description	pressure control pressure range 45/20mbar connection 6mm ø 58mm pressure connection horizontal warewashing		
For models:	DLS30, DLS303, DLS30P, DLS30P3, DLS31, DLS313, DLS31P3, MLS30, MLS303, MLS30P, MLS30P3, MLS31, MLS313, MLS31P3, MLS35, MLS353, MPLS30P		

			
1			
GEV No.	541039	Ref. No.	130621
description	pressure control pressure range 45/25mbar connection 6mm ø 58mm pressure connection horizontal warewashing		



			
1			
GEV No.	541010	Ref. No.	130605
description	pressure control pressure range 50/30mbar connection 6mm ø 58mm pressure connection horizontal warewashing		

			
1			
GEV No.	541003	Ref. No.	1662600
description	pressure control pressure range 55/35mbar connection 6mm ø 58mm pressure connection horizontal warewashing pressure connection ø 6mm		

			
1			
GEV No.	541012	Ref. No.	130604
description	pressure control pressure range 68/40mbar connection 6mm ø 58mm pressure connection horizontal warewashing pressure connection ø 6mm		

miscellaneous

			
1			
GEV No.	541038	Ref. No.	1037302900
description	pressure control double		
For models:	DLS30, DLS303, DLS30P, DLS30P3, DLS31, DLS313, DLS31P3, MLS30, MLS303, MLS30P, MLS30P3, MLS31, MLS313, MLS31P3, MPLS30P		

accessories

			
1			
GEV No.	541831	Ref. No.	CR0731840
description	bracket metal for pressure switch mounting distance 38.5mm		
For models:	NPC94E, NPC94G, NPC98E, NPC98G		

for gas equipment

			
1			
GEV No.	541051	Ref. No.	5151000 MA5151000
description	pressure control ø 45mm pressure range adjustable 10-50mbar pressure connection vertical gas technology connection 1/4" pressure connection ø 1/4"mm		
For models:	CON102G, CON102GP, CON10G, CON10GP, CON201G, CON201GP, CON202G, CON202GP, CON6G, CON6GP, CP9A15GD, CSM102G, CSM102GP, CSM10G, CSM10GP, CSM201G, CSM201GP, CSM202G, CSM202GP, CSM6G, CSM6GP		

			
1			
GEV No.	541073	Ref. No.	R63070010
description	pressure control ø 45mm pressure range adjustable 5-20mbar pressure connection vertical gas technology connection 1/4" pressure connection ø 1/4"mm		
For models:	CVG105H, CVG105M, GC106M, GC110M, GC210M, GM106H, GM106M, GM106M+SC, GM106P, GM110H, GM110M, GM110M+SC, GM110P, GM210H, GM210M, GM210M+SC, GM210P, GMT06D, GMT20D, GV106H, GV106M, GV106M+SC, GV106P, GV110H, GV110M, GV110M+SC, GV110P, GV210H, GV210M, GV210M+SC, GV210P, GVT06D, GVT20D, MACG05M, MACG07M, MACG10M, MACG20M, MG061D, MG061M, MG061P, MG061T, MG101D, MG101M, MG101P, MG101T, MG102D, MG102M, MG102P, MG102T, MG106M...(Other models you can see in the webshop)		

for steam control

			
1			
GEV No.	541795	Ref. No.	CR0587800
description	pressure control ø 45mm pressure connection vertical steam control pressure range -1 up to +1bar connection male faston 6.3mm BECK pressure connection 3/8"		
For models:	NPI76E5, NPI76G5, NPI78E8, NPI78G8, NPI96E5, NPI96G5, NPI98E10, NPI98E15, NPI98G10, NPI98G14, NPI98G14A		



			
1			
GEV No.	541074	Ref. No.	R63070050
description	pressure control ø 45mm triggering pressure 0.5bar reset pressure 0.35bar pressure connection vertical steam control pressure range 0.35/0.51bar connection 1/8" pressure connection 1/8"		
For models:	EV106H, EV106P, EV110H, EV110P, EV210H, EV210P, GV106H, GV106P, GV110H, GV110P, GV210H, GV210P, GVT06D, GVT20D, MEVT06D, MEVT06P, MEVT10D, MEVT10P, MEVT20D, MEVT20P, MEVT21D, MEVT21P, MEVT40D, MEVT40P, MGVT06D, MGVT06P, MGVT10D, MGVT10P, MGVT20D, MGVT20P, MGVT21D, MGVT21P, MGVT40D, MGVT40P, MVE042P, MVE051P, MVG051P, VE106P, VE120P, VE210P, VE220P, VG106P, VG110P, VG120P, VG210P, VG220P		

electrodes

			
1			
GEV No.	401154	Ref. No.	2911600
description	level electrode 1/4" total length 126mm probe L 100mm insulated probe length 26mm connection male faston 6.3mm stainless steel ø 2.5mm		
For models:	CS6G, CSM6G, CSM6GP		

			
1			
GEV No.	401162	Ref. No.	2916100
description	level electrode 1/4" total length 129mm probe L 103mm insulated probe length 26mm connection male faston 6.3mm stainless steel ø 2.5mm		
For models:	CS4E, CS4EP, CS6E, CS6EP, CSM6E, CSM6EP		

			
1			
GEV No.	401155	Ref. No.	2911700
description	level electrode 1/4" total length 133mm probe L 106mm insulated probe length 26mm connection male faston 6.3mm stainless steel ø 2.5mm		
For models:	CS6G, CSM6G, CSM6GP		

			
1			
GEV No.	401163	Ref. No.	2916200
description	level electrode 1/4" total length 136mm probe L 110mm insulated probe length 27mm connection male faston 6.3mm stainless steel ø 2.5mm		
For models:	CS4E, CS4EP, CS6E, CS6EP, CSM6E, CSM6EP		

			
1			
GEV No.	401164	Ref. No.	2899600
description	level electrode 1/4" total length 147mm probe L 120mm insulated probe length 26mm connection male faston 6.3mm stainless steel ø 2.5mm		
For models:	CS10E, CS10EP, CSM10E, CSM10EP		

			
1			
GEV No.	401157	Ref. No.	2908300
description	level electrode 1/4" total length 150mm probe L 122mm insulated probe length 26mm connection male faston 6.3mm stainless steel ø 2.5mm		
For models:	CS102E, CS102EP, CS10G, CSM102E, CSM102EP, CSM10G, CSM10GP, CSM201E, CSM201EP, CSM201G, CSM201GP, CSM202E, CSM202EP		

			
1			
GEV No.	401156	Ref. No.	2911800
description	level electrode 1/4" total length 150mm probe L 124mm insulated probe length 26mm connection male faston 6.3mm stainless steel ø 2.5mm		
For models:	CS6G, CSM10E, CSM10EP, CSM6E, CSM6EP, CSM6G, CSM6GP		

			
1			
GEV No.	401158	Ref. No.	2908200
description	level electrode 1/4" total length 162mm probe L 134mm insulated probe length 26mm connection male faston 6.3mm stainless steel ø 2.5mm		
For models:	CS102E, CS102EP, CS10G, CSM102E, CSM102EP, CSM10G, CSM10GP, CSM201E, CSM201EP, CSM201G, CSM201GP, CSM202E, CSM202EP		

			
1			
GEV No.	401165	Ref. No.	2899800
description	level electrode 1/4" total length 165mm probe L 138mm insulated probe length 26mm connection male faston 6.3mm stainless steel ø 2.5mm		
For models:	CS10E, CS10EP, CSM10E, CSM10EP		

			
1			
GEV No.	401160	Ref. No.	2908100
description	level electrode 1/4" total length 186mm probe L 158mm insulated probe length 26mm connection male faston 6.3mm stainless steel ø 2.5mm		
For models:	CS102E, CS102EP, CS102G, CS102GP, CS10G, CSM102G, CSM102GP, CSM201E, CSM201EP, CSM201G, CSM201GP, CSM202E, CSM202EP, CSM202G, CSM202GP		



compressors

ACC/ZEL

R404a/R507

LBP monophase

Lower evaporation temperature below -20°C



GEV No.	605073	Ref. No.	25017199 MA25017199
description	compressor coolant R404a/R507 type MP14FB 220-240V 50Hz LBP fully hermetic 13.9kg 1/2HP cylinder capacity 14cm ³ CSIR H 203.6mm 439W 584W 746W 926W 1124WWWWW test method ASHRAE		
For models:	EF143MNI, EF70MF, EF70MN, EF70MP, EF72MNF, FB140FN, FB140NN, FB140PF, FB140PN, FB140PP, FB143NI, FB55F, FB55N, FB55P, FB70F, FB70N, FB70P, FB72F, FB72N, FB72NF, FB72P, FS140FI, FS140FN, FS140I, FS140NI, FS140NN, FS140PN, FS140PP, FS143FI, FS143NF, FS143NI, FS143NN, FS143NP, FS70F, FS70FG, FS70I, FS70N, FS70NG, FS70P, FS72F, FS72IF, FS72IN, FS72N, FS72NF, FS72NN, FS72P, HF140D-FN, HF140DNN, HF140DPF, HF140DPN...(Other models you can see in the webshop)		

CUBIGEL

R404a/R507

LBP monophase

Lower evaporation temperature below -20°C



GEV No.	605138	Ref. No.	25016899
description	compressor coolant R404a/R507 type MP12FB 220-240V 50Hz LBP 12kg 3/8HP cylinder capacity 12cm ³ CSIR H 215mm 381W 510W 657W 819W 999WWWWW test method ASHRAE		
For models:	EF143MNI, EF70MF, EF70MN, EF70MP, EF72MNF, FB140FN, FB140NN, FB140PF, FB140PN, FB140PP, FB143NI, FB55F, FB55N, FB55P, FB70F, FB70N, FB70P, FB72F, FB72N, FB72NF, FB72P, FS140FI, FS140FN, FS140I, FS140NI, FS140NN, FS140PN, FS140PP, FS143FI, FS143NF, FS143NI, FS143NN, FS143NP, FS70F, FS70FG, FS70I, FS70N, FS70NG, FS70P, FS72F, FS72IF, FS72IN, FS72N, FS72NF, FS72NN, FS72P, HF140D-FN, HF140DNN, HF140DPF, HF140DPN...(Other models you can see in the webshop)		

			
1			
GEV No.	401159	Ref. No.	2987000
description	level electrode 1/4" total length 187mm probe L 160mm insulated probe length 26mm connection male faston 6.3mm stainless steel ø 2.5mm		
For models:	CS102G, CS102GP, CSM102E, CSM102EP, CSM102G, CSM102GP, CSM10G, CSM10GP, CSM201E, CSM201EP, CSM201G, CSM201GP, CSM202G, CSM202GP		

			
1			
GEV No.	401161	Ref. No.	2927500 MA2927500
description	level electrode 1/4" total length 210mm probe L 184mm insulated probe length 26mm connection male faston 6.3mm stainless steel ø 2.5mm		
For models:	CS102G, CS102GP, CSM102G, CSM102GP, CSM201E, CSM201EP, CSM201G, CSM201GP, CSM202G, CSM202GP		

			
1			
GEV No.	400130	Ref. No.	R65320010
description	level electrode M14x1.25 total length 220mm probe L 194mm insulated probe length 26mm connection male faston 6.3mm ø 2.5mm		
For models:	EM010M+SC, EM106H, EM106M, EM106M+SC, EM106P, EM110H, EM110M, EM110M+SC, EM110P, EM210H, EM210M, EM210M+SC, EM210P, GM106H, GM106M, GM106M+SC, GM106P, GM110H, GM110M, GM110M+SC, GM110P, GM210H, GM210M, GM210M+SC, GM210P, GMT06D, GMT20D, ME061D, ME061P, ME061T, ME101D, ME101M, ME101P, ME101T, ME102D, ME102M, ME102P, ME102T, ME106M, ME106P, ME106X, ME110M, ME110P, ME110X, ME120M, ME120P, ME120X, ME201D, ME201M, ME201P...(Other models you can see in the webshop)		



L'UNITE HERMETIQUE / TECUMSEH

R404A
HMBP monophase

High/Medium evaporation temperature above -20/-15 °C



GEV No.	605027	Ref. No.	RA070029
description	compressor coolant R404A type CAJ4517Z 220-240V 50Hz HMBP fully hermetic 24kg 1.2HP cylinder capacity 25.95cm ³ CSR H 282mm WW 1588W 1987W 2451W 2971W 3536W 4132W test method EN 12900 4742W		



GEV No.	601038 ¹	Ref. No.	CM250700 MACM250700
description	axial fan L 80mm W 80mm H 38mm 230VAC 50/60Hz 12W bearing ball bearing manuf. no. 8556N metal connection cable 300mm ebm-papst fan wheel ø 75mm temp.-resist. 90°C airflow 50m ³ /h		
For models:	F94E18K, F94G22K, F98E18K, F98G22K, F9S4E18K, F9S4G22K, F9S8E18K, F9S8G22K		
accessories for	601038		
	GEV No.	691102	Ref. No. —
	guard ø 75mm mounting distance 71mm for axial fan 80mm		



¹with ball bearings

fans

axial fans

ebm-papst





GEV No.	601030 ¹	Ref. No.	R65060050
description	axial fan L 119mm W 119mm H 38mm 230VAC 50Hz 18W bearing ball bearing manuf. no. 4656Z metal connection male faston 2.8mm ebm-papst fan wheel ø 110mm temp.-resist. 75°C		
For models:	EC106M, EC110M, EC210M, EM010M+SC, EM106H, EM106M, EM106M+SC, EM106P, EM110H, EM110M, EM110M+SC, EM110P, EM210H, EM210M, EM210M+SC, EM210P, EV006M, EV106H, EV106M, EV106M+SC, EV106P, EV110H, EV110M, EV110M+SC, EV110P, EV210H, EV210M, EV210M+SC, EV210P, GC106M, GC110M, GC210M, GM106H, GM106M, GM106M+SC, GM106P, GM110H, GM110M, GM110M+SC, GM110P, GM210H, GM210M, GM210M+SC, GM210P, GMT06D, GMT20D, GV106H, GV106M, GV106M+SC, GV106P..(Other models you can see in the webshop)		
accessories for	601030		
	GEV No.	550898	Ref. No. —
	connecting cable cable length 2000mm connection F 2.8 connection distance 7.9mm for axial flow fan		
	GEV No.	692497	Ref. No. —
	guard ø 105mm mounting distance 150mm for axial fan ebm-papst-mm		

¹with ball bearings

import



GEV No.	601080 ¹	Ref. No.	CM303000 MACM303000
description	axial fan L 119mm W 119mm H 38mm 230VAC 50/60Hz 23/20W bearing ball bearing connection male faston 2.8mm metal ADDA fan wheel ø 110mm temp.-resist. 70°C		
For models:	CT78EC, CT7FE8EC, CT98EC, CT9FE8EC, NCT78E, NCT7FE8E, NCT98E, NCT98E2, NCT9FE8E, NCT9FE8E2, NF94G23K, NF98G23K		
accessories for	601080		
	GEV No.	550898	Ref. No. —
	connecting cable cable length 2000mm connection F 2.8 connection distance 7.9mm for axial flow fan		
	GEV No.	692519	Ref. No. —
	guard L 120mm W 120mm plastic		

¹with ball bearings

refrigeration fans

refrigeration motors universal

ELCO

N series - multi fit



1			
GEV No.	601528	Ref. No.	12214099 25314099 MA25314099
description	fan motor ELCO 16W 230V 50/60Hz bearing slide bearing L1 48mm L2 64mm L3 91.5mm W 83mm connection cable 500mm 1300/1550rpm 5 mounting options VNT16-25/029		
For models:	SER15, SER15A, SER18, SER18A, SER21		
spare parts for	601528		
	GEV No.	601413	Ref. No. —
	fixing plate suitable for fanwheel ED ø 32mm shaft ø 7 mounting distance 26mm		

IMPORT

multi fit fan motors



1			
GEV No.	601022	Ref. No.	253071.99
description	fan motor 10W 230V 50-60Hz L1 44mm L2 54mm L3 85mm W 84mm cable length 500mm 1300rpm YZF10-20-18/26 5 mounting options bearing slide bearing		



1			
GEV No.	601081 ¹	Ref. No.	R65060010
description	axial fan L 80mm W 80mm H 38mm 230VAC 50/60Hz 14/13.5W bearing ball bearing connection male faston 2.8mm metal ADDA fan wheel ø 75mm temp.-resist. 70°C		
For models:	CVE105H, CVE105M, CVG105H, CVG105M, ME106M, ME106P, ME106X, ME110M, ME110P, ME110X, ME120M, ME120P, ME120X, ME210M, ME210P, ME210X, ME220M, ME220P, ME220X, MG106M, MG106P, MG106X, MG110M, MG110P, MG110X, MG120M, MG120P, MG120X, MG210M, MG210P, MG210X, MG220M, MG220P, MG220X, MVE042P, MVE051P, MVG051P, VE105M, VE105X, VE106M, VE106P, VE106X, VE110M, VE110X, VE120M, VE120P, VE120X, VE210M, VE210P, VE210X...(Other models you can see in the webshop)		
accessories for	601081		
	GEV No.	691102	Ref. No. —
	guard ø 75mm mounting distance 71mm for axial fan 80mm		

¹with ball bearings

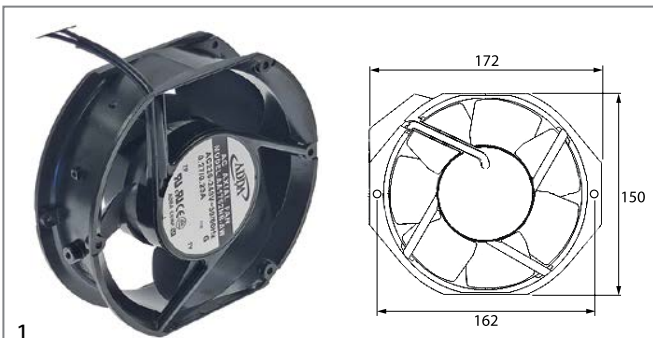

1			
GEV No.	602151	Ref. No.	R65060060
description	axial fan L 172mm W 150mm H 51mm 220-240V 50-60Hz manuf. no. AA1752HB-AW connection cable cable length 3000mm ADDA suitable for combi-steamer fan wheel ø 140mm 0.27/0.23A		
For models:	ME101M, ME101P, ME101T, ME201D, ME201M, ME201P, ME201T, ME202D, ME202M, ME202P, ME202T, MEMT40D, MEMT40P, MEVT40D, MEVT40P, MG101M, MG101P, MG101T, MG201D, MG201M, MG201P, MG201T, MG202D, MG202M, MG202P, MG202T, MGMT40D, MG-MT40P, MGVT40D, MGVT40P		

			
1			
GEV No.	601023	Ref. No.	25314399 253154.99 MA25303099 MA25314399
description	fan motor 16W 230V 50-60Hz L1 45mm L2 61mm L3 92mm W 84mm cable length 500mm 1300rpm YZF16-25-18/26 5 mounting options bearing slide bearing		
For models:	AF140B, AF140C, AF140F, AF140I, AF140MB, AF140MC, AF140MF, AF140MI, AF140MN, AF140MP, AF140N, AF140P, AF14F, AF14G, AF14N, AF70B, AF70C, AF70F, AF70I, AF70MB, AF70MC, AF70MF, AF70MI, AF70MN, AF70MP, AF70N, AF70P, AF72B, AF72C, AF72F, AF72I, AF72N, AF72P, AF7C, AF7F, AF7G, EF140DF, EF140DN, EF140DP, EF140MB, EF140MC, EF140MF, EF140MI, EF140MN, EF140MP, EF143MNI, EF70DF, EF70DN, EF70DP, EF70MB...(Other models you can see in the webshop)		

			
2			
GEV No.	601020	Ref. No.	23766.00 253151.99 MA2376600 MA25315199
description	fan motor 5W 230V 50-60Hz L1 44mm L2 48mm L3 79mm W 84mm cable length 500mm 1300rpm YZF5-13-18/26 5 mounting options bearing slide bearing		
For models:	BR120, BR160, SER15, SER15A, SER18, SER18A, SER21		

accessories			
fan wheels			
aluminium			
			
1			
GEV No.	601172	Ref. No.	25315699 MA25315699
description	fan wheel sucking ø 230mm fan wheel mounting 25.4mm blade angle 34° W 50mm aluminium		
For models:	AF140B, AF140C, AF140F, AF140I, AF140MB, AF140MC, AF140MF, AF140MI, AF140MN, AF140MP, AF140N, AF140P, AF14F, AF14G, AF14N, AF70B, AF70C, AF70F, AF70I, AF70MB, AF70MC, AF70MF, AF70MI, AF70MN, AF70MP, AF70N, AF70P, AF72B, AF72C, AF72F, AF72I, AF72N, AF72P, AF7C, AF7F, AF7G, EF140DF, EF140DN, EF140DP, EF140MB, EF140MC, EF140MF, EF140MI, EF140MN, EF140MP, EF143MNI, EF70DF, EF70DN, EF70DP, EF70MB...(Other models you can see in the webshop)		

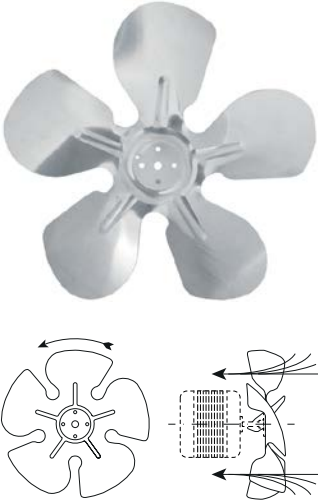
			
1			
GEV No.	601387	Ref. No.	25315599 MA25315599
description	fan wheel sucking ø 254mm fan wheel mounting 25.4mm blade angle 34° W 50mm aluminium		
For models:	AF140B, AF140C, AF140F, AF140I, AF140MB, AF140MC, AF140MF, AF140MI, AF140MN, AF140MP, AF140N, AF140P, AF14F, AF14G, AF14N, AF70B, AF70C, AF70F, AF70I, AF70MB, AF70MC, AF70MF, AF70MI, AF70MN, AF70MP, AF70N, AF70P, AF72B, AF72C, AF72F, AF72I, AF72N, AF72P, AF7C, AF7F, AF7G, EF140DF, EF140DN, EF140DP, EF140MB, EF140MC, EF140MF, EF140MI, EF140MN, EF140MP, EF143MNI, EF70DF, EF70DN, EF70DP, EF70MB...(Other models you can see in the webshop)		



cold air circulating fans (complete)

ebm-papst

A2E series

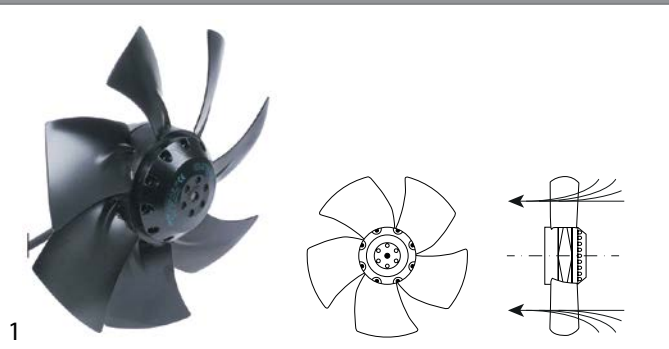

GEV No.	601750	Ref. No.	RA880002
----------------	--------	-----------------	----------

description
fan A2E250-AL06-09 fan wheel ø 250mm blades 7 230V 50/60Hz 120/160W 2500rpm cable length 200mm ebm-papst sucking suitable capacitor 3µF

For models:
14-teglie-GN-MISTI-FR-dep-STD, 14-teglie-GN-MISTI-FR-dep-TOP, 14-teglie-GN-MISTI-FR-STD, 14-teglie-GN-MISTI-FR-TOP, 14-teglie-GN-MISTI-IT-dep-STD, 14-teglie-GN-MISTI-IT-dep-TOP, 14-teglie-GN-MISTI-IT-STD, 14-teglie-GN-MISTI-IT-TOP, 14-teglie-GN-MISTI-TX-STD, 14-teglie-GN-positivi-FR, 14-teglie-GN-positivi-FR-dep-STD, 14-teglie-GN-positivi-FR-dep-TOP, 14-teglie-GN-positivi-FR-STD, 14-teglie-GN-positivi-FR-TOP, 14-teglie-GN-positivi-IT-dep-STD, 14-teglie-GN-positivi-IT-dep-TOP, 14-teglie-GN-positivi-IT-STD, 14-teglie-GN-positivi-IT-TOP, 14-teglie-GN-positivi-TX-STD, 15-teglie-PA-MISTI-FR-STD, 17-teglie-PA-MISTI-FR-dep, 17-teglie-PA-MISTI-FR-dep-TOP, 17-teglie-PA-MISTI-FR-STD, 17-teglie-PA-MISTI-FR-TOP, 17-teglie-PA-MISTI-IT-dep, 17-teglie-PA-MISTI-IT-dep-TOP, 17-teglie-PA-MISTI-IT-STD, 17-teglie-PA-MISTI-IT-TOP, 17-teglie-PA-positivi-FR-dep-STD, 17-teglie-PA-positivi-FR-dep-TOP, 17-teglie-PA-positivi-FR-STD, 17-teglie-PA-positivi-FR-TOP, 17-teglie-PA-positivi-IT-dep-STD, 17-teglie-PA-positivi-IT-dep-TOP, 17-teglie-PA-positivi-IT-STD, 17-teglie-PA-positivi-IT-TOP, 20-teglie-GN-misti-FR-STD, 20-teglie-GN-misti-FR-TOP, 20-teglie-GN-misti-IT-STD, 20-teglie-GN-misti-IT-TOP, 20-teglie-GN-positivi-FR-STD, 20-teglie-GN-positivi-FR-TOP, 20-teglie-GN-positivi-IT-STD, 20-teglie-GN-positivi-IT-TOP, 21-teglie-PA-MISTI-TX-STD, 3-teglie-GN-positivi-FR-STD, 3-teglie-GN-positivi-FR-TOP, 3-teglie-GN-positivi-FR-dep-STD, 5-teglie-GN-positivi-FR-STD, 5-teglie-GN-positivi-FR-TOP...(Other models you can see in the webshop)

accessories for 601750

GEV No.	365137	Ref. No.	—
----------------	--------	-----------------	---

 capacitor capacity 3µF 450V tolerance 5% 50/60Hz ambient temperature max. -25 to +85°C ø 25mm L 56mm M8 plastic connection cable 250mm 416.17.77GF protection

A4E series

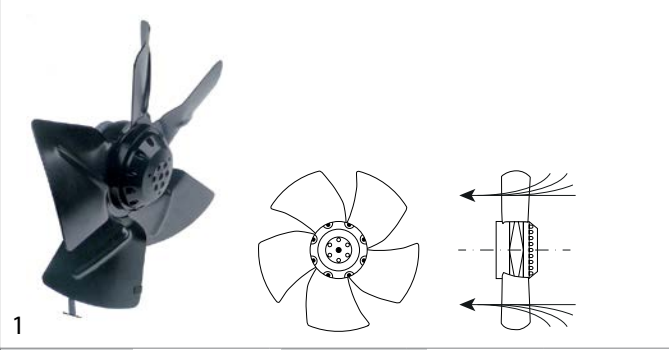

GEV No.	601623	Ref. No.	RA880046
----------------	--------	-----------------	----------

description
fan A4E315-AC08-19 fan wheel ø 315mm blades 5 230V 50Hz 95W 1370rpm cable length 450mm ebm-papst sucking suitable capacitor 3µF

For models:
10-teglie-GN-MISTI-FR-STD, 10-teglie-GN-MISTI-FR-TOP, 10-teglie-GN-MISTI-IT-STD, 10-teglie-GN-MISTI-IT-TOP, 10-teglie-GN-MISTI-TX-STD, 10-teglie-GN-positivi-FR-STD, 10-teglie-GN-positivi-FR-TOP, 10-teglie-GN-positivi-IT, 10-teglie-GN-positivi-IT-STD, 10-teglie-GN-positivi-IT-TOP, 10-teglie-GN-positivi-TX-STD, 12-teglie-PA-MISTI-FR-STD, 12-teglie-PA-MISTI-IT-STD, 12-teglie-PA-MISTI-IT-TOP, 12-teglie-PA-positivi-FR-STD, 12-teglie-PA-positivi-FR-TOP, 12-teglie-PA-positivi-IT-STD, 12-teglie-PA-positivi-IT-TOP, 15-teglie-PA-MISTI-TX-STD, 3-teglie-GN-misti-FR-STD, 3-teglie-GN-misti-FR-TOP, 3-teglie-GN-misti-IT-STD, 5-teglie-dep-GN-misti-FR-STD, 5-teglie-dep-GN-misti-IT-STD, 5-teglie-GN-misti-FR-STD, 5-teglie-GN-misti-IT-STD, 5-teglie-GN-misti-IT-TOP, 5-teglie-GN-misti-TX-STD, 5-teglie-PA-misti-FR-STD, 6-teglie-PA-misti-FR-dep, 6-teglie-PA-misti-FR-STD, 6-teglie-PA-misti-FR-TOP, 6-teglie-PA-misti-IT-dep, 6-teglie-PA-misti-IT-STD, 6-teglie-PA-misti-IT-TOP, 6-teglie-PA-misti-TX-STD

accessories for 601623

GEV No.	365137	Ref. No.	—
----------------	--------	-----------------	---

 capacitor capacity 3µF 450V tolerance 5% 50/60Hz ambient temperature max. -25 to +85°C ø 25mm L 56mm M8 plastic connection cable 250mm 416.17.77GF protection

cross flow fans

ebm-papst



GEV No.	602167	Ref. No.	2590900 MA2590900
----------------	--------	-----------------	----------------------

description
cross flow fan ebm-papst QLK45/1200A39-2513L roller ø 45mm roller length 120mm laminated core thickness 13mm motor position right 230VAC refrigeration bearing rubber connection male faston 6.3mm airflow 80m³/h 0 up to +60°C

For models:
IR13C, IR13CC, IR13CV, IR13M, IR13MC, IR13MV, IR13V, IR17C, IR17CC, IR17CV, IR17M, IR17MC, IR17MV, IR17V, SIPR12, SIPR16, SIPR20, SIVR12, SIVR16, SIVR20, SPAR16, SPAR20, SPRG12, SPRG16, SPRG20, SVAR16, SVAR20, SVRG12, SVRG16, SVRG20, TR13C2P, TR13I4C, TR13I4CC, TR13I4CV, TR13N2C1P, TR13N2C1PC, TR13N2C1PV, TR13N2P, TR13N2PC, TR13N2PV, TR13N4C, TR13N4CC, TR13N4CV, TR17C3P, TR17I6C, TR17I6CC, TR17I6CV, TR17N2C2P, TR17N2C2PC, TR17N2C2PV...(Other models you can see in the webshop)



EMMEVI - FERGAS

with standard coil



1

GEV No.	601718	Ref. No.	2522700 MA2522700
description	cross flow fan TG 60/3-420/30 roller ø 60mm roller length 420mm laminated core thickness 30mm motor position right 230V/50Hz 32W universal bearing silicone connection male faston 6.3mm -10 up to +60°C 230V protection F housing aluminium fixing dimensions 40x442.5mm		
For models:	TAR134C2I, TAR176C2I		

double fans



1

GEV No.	601455	Ref. No.	1215500 1215512
description	cross flow fan roller ø 60mm roller length 2x180mm laminated core thickness 35mm motor position centre 230V/50Hz 30W universal bearing silicone connection F 6.3 airflow 280m³/h -30 up to +100°C total length 470mm		
For models:	TP13E, TP17E, TP213E, TP217E, TP21E, TP221E		

COPREL

with standard coil



1

GEV No.	601025	Ref. No.	25320500
description	cross flow fan COPREL TFR(FN) roller ø 60mm roller length 180mm laminated core thickness 15mm motor position right 230V/50Hz 19W refrigeration bearing rubber connection male faston 6.3mm coil type airflow 120m³/h -10 up to +60°C		

hot air motors



1

GEV No.	550857	Ref. No.	R58003870
description	counterflange for fan motor ED ø 50mm int. ø 1 25mm int. ø 2 16mm thickness 6mm brass		
For models:	CVE105H, CVE105M, CVG105H, CVG105M, EC106M, EM106H, EM106M, EM106M+SC, EM106P, EV006M, EV106H, EV106M, EV106M+SC, EV106P, FE105M, FE105X, FG105M, FG105X, GC106M, GM106H, GM106M, GM106M+SC, GM106P, GMT06D, GV106H, GV106M, GV106M+SC, GV106P, GVT06D, MACE07M, MACG07M, ME061D, ME061M, ME061P, ME061T, ME106M, ME106P, ME106X, MEMT06D, MEMT06P, MEVT06D, MEVT06P, MG061D, MG061M, MG061P, MG061T, MG106M, MG106P, MG106X, MGMT06D...(Other models you can see in the webshop)		



1

GEV No.	601452	Ref. No.	25320599 MA25320599
description	cross flow fan TFL 180 roller ø 60mm roller length 180mm laminated core thickness 20mm motor position left 230V/50Hz 19W universal bearing silicone connection male faston 6.3mm airflow 100m³/h -30 up to +100°C 230V 50Hz		



1

GEV No.	550859	Ref. No.	R58003850
description	counterflange for fan motor ED ø 60mm int. ø 1 34mm int. ø 2 25mm thickness 6mm brass		
For models:	EC110M, EC210M, EM010M+SC, EM110H, EM110M, EM110M+SC, EM110P, EM210H, EM210M, EM210M+SC, EM210P, EV110H, EV110M, EV110M+SC, EV110P, EV210H, EV210M, EV210M+SC, EV210P, FE110M, FE110X, FE210M, FG110M, FG110X, FG210M, FG210X, GC110M, GC210M, GM110H, GM110M, GM110M+SC, GM110P, GM210H, GM210M, GM210M+SC, GM210P, GMT20D, GV110H, GV110M, GV110M+SC, GV110P, GV210H, GV210M, GV210M+SC, GV210P, GVT20D, MACE10M, MACE20M, MACG10M, MACG20M...(Other models you can see in the webshop)		

GEV No.	500656	Ref. No.	R65040520
description	fan motor 200-240/415V 3 phase 50/60Hz 0.15/0.55kW 900/1400rpm speeds 2 L1 150mm L2 50mm L3 48mm D1 ø 24mm D2 ø 20mm M12L IT 2.3/1.3-1.2/0.7A at 50Hz 200-240/415V at 60Hz 200-240/480V at 50Hz 900/1400rpm at 60Hz 1100/1700rpm type 3042D4050		
For models:	ME101P, ME101T, ME201P, ME201T		
spare parts for	500656		
	GEV No.	511172	Ref. No. R70020050
shaft sealing ID ø 24mm ED ø 29mm thickness 3mm			

GEV No.	500135	Ref. No.	R65040031
description	fan motor 200-240V 1 phase 50Hz 0.185/0.55kW 900/1400rpm speeds 2 L1 195mm L2 45mm L3 47mm D1 ø 24mm D2 ø 20mm M12L IT 3.6/2A suitable capacitor 16µF-450V/12.5µF-450V at 50Hz 900/1400rpm type 1063D2250		
For models:	FG110X, FG210X, GM110H, GM110P, GM210H, GM210P, GV110H, GV110P, GV210H, GV210P, MG102P, MG102T, MG110P, MG110X, MG120P, MG120X, MG210P, MG210X, MG220P, MG220X, MGC24H, MGC40H, MGMT10P, MGMT20P, MGMT21P, MGMT10P, MGMT20P, MGMT21P, PG080X, VG110P, VG110X, VG120P, VG120X, VG210P, VG210X, VG220P, VG220X		

GEV No.	500671	Ref. No.	R65040071
description	fan motor 200-240V 1 phase 50/60Hz 0.11kW 2760/3320rpm speeds 1 L1 130mm L2 55mm L3 30mm D1 ø 15mm D2 ø 12mm M10L ET at 50Hz 2760rpm at 60Hz 3320rpm		
For models:	CVE105H, CVE105M, CVG105H, CVG105M, VE105M, VE105X, VG105M, VG105X		

GEV No.	601046	Ref. No.	R65040061
description	fan motor 220/380V 3 phase 50/60Hz 0.75kW 1350/1650rpm speeds 1 L1 185mm L2 42mm L3 47mm D1 ø 24mm D2 ø 20mm M12L IT 1.9/3.3A Cos(φ) 0.83 at 50Hz 200-240/346-415V at 60Hz 200-277/346-480V at 50Hz 1350rpm at 60Hz 1650rpm type ST80/4 no. 661512		
For models:	EC110M, EC210M, EM010M+SC, EM110M, EM110M+SC, EM210M, EM210M+SC, EV110M, EV110M+SC, EV210M, EV210M+SC, FE110M, FE210M, ME102D, ME102M, ME110M, ME120M, ME202D, ME202M, ME210M, ME220M, MEC40M, MEMENT10D, MEMENT20D, MEMENT21D, MEMENT40D, MEVT10D, MEVT20D, MEVT21D, MEVT40D, PE080M, VE110M, VE120M, VE210M, VE220M		

GEV No.	500134	Ref. No.	R65040021
description	fan motor 200-240V 1 phase 50/60Hz 0.25HP 1400/1700rpm speeds 1 L1 115mm L2 77mm L3 30mm D1 ø 15mm D2 ø 12mm M10L ET 1A suitable capacitor 5µF/400V at 50Hz 1400rpm at 60Hz 1700rpm type 1060.1950		
For models:	ME106M, MG106M, VE106M, VG106M		
accessories for	500134		
	GEV No.	380659	Ref. No. R65160570
overload switch setting range 0.7-1A connection screw type 3RU1116-0JB0 (AC3/400V) 0.25kW			

GEV No.	500662	Ref. No.	R65041000
description	fan motor 220-240V 1 phase 50/60Hz 0.12kW 2800/3200rpm speeds 1 L1 85mm L2 7mm L3 47mm L4 12mm D1 ø 8/6mm D2 ø 12mm M5R ET 1.6A power input 0.25W suitable capacitor 5µF/400V		
For models:	MACE04M, MACE05M, MACG05M, MVE042P, MVE051P, MVG051P		



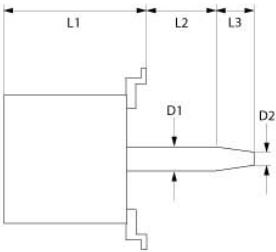

1

GEV No.	501587	Ref. No.	R65040051
description	fan motor 220-240V 1 phase 50/60Hz 0.55kW 1400/1700rpm L1 190mm L2 45mm L3 47mm D1 ø 24mm D2 ø 20mm M12L IT 3.6A type 1063A2250		
For models:	EM110H, EM110P, EM210H, EM210P, EV110H, EV110P, EV210H, EV210P, ME102P, ME102T, ME110P, ME110X, ME120P, ME120X, ME202P, ME202T, ME210P, ME210X, ME220P, ME220X, MEC24H, MEMENT10P, MEMENT20P, MEMENT21P, MEMENT40P, MEVT10P, MEVT20P, MEVT21P, MEVT40P, VE110X, VE120P, VE120X, VE210P, VE210X, VE220P, VE220X		

1

GEV No.	500136	Ref. No.	R65040041
description	fan motor 220-240V 1 phase 50/60Hz 0.55kW 1400rpm speeds 1 L1 190mm L2 47mm L3 47mm D1 ø 24mm D2 ø 20mm M12L IT 3.6A suitable capacitor 16µF/450V Cos(φ) 0.9 at 50Hz 1400rpm at 60Hz 1700rpm type 1063/4M		
For models:	FG110M, FG210M, GC110M, GC210M, GM110M, GM110M+SC, GM210M, GM210M+SC, GMT20D, GV110M, GV110M+SC, GV210M, GV210M+SC, GVT20D, MG102D, MG102M, MG110M, MG120M, MG210M, MG220M, MGC20X, MGMT10D, MGMT20D, MGMT21D, MGVT10D, MGVT20D, MGVT21D, PG080M, VG110M, VG120M, VG210M, VG220M		
accessories for	500136		
	GEV No.	511172	Ref. No. R70020050
shaft sealing ID ø 24mm ED ø 29mm thickness 3mm			

1

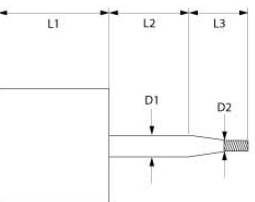
GEV No.	500661	Ref. No.	R65040431
description	fan motor 220-240V 1 phase 50Hz 0.03/0.2kW 0.05/0.25HP 1400/2700rpm speeds 2 L1 123mm L2 77mm L3 30mm D1 ø 15mm D2 ø 12mm M10L ET 1.6/0.6A suitable capacitor 10µF/450 V at 50Hz 1400/2700rpm type 1057D1901		
For models:	ME061P, ME061T, MEMENT06P, MEVT06P, MG061P, MGMT06P, MGVT06P		



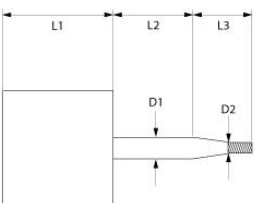

1

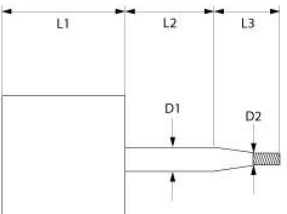
GEV No.	500133	Ref. No.	R65040011
description	fan motor 220-240V 1 phase 50Hz 0.1/0.25HP 900/1400rpm speeds 2 L1 123mm L2 77mm L3 30mm D1 ø 15mm D2 ø 12mm M10L ET 1/0.6A suitable capacitor 5µF/450V at 50Hz 900/1400rpm at 60Hz 1100/1700rpm type 1061.1950		
For models:	ME106P, ME106X, MG106P, MG106X, VE106P, VE106X, VG106P, VG106X		

1

GEV No.	601043	Ref. No.	R65040260
description	fan motor 220-240V 1 phase 50Hz 0.37/0.07kW 0.1/0.5HP 1400/2700rpm speeds 2 L1 123mm L2 107mm L3 15mm D1 ø 15mm D2 ø 12mm M10L ET 2/0.7A suitable capacitor 20µF/250V at 50Hz 1400/2700rpm type 1057		
For models:	FE105M, FE105X, FG105M, FG105X, PE040M, PE040X, PG040M, PG040X		
accessories for	601043		
	GEV No.	365019	Ref. No. —
operating capacitor capacity 20µF 400V tolerance 5% 50/60Hz ambient temperature max. -25 to +85°C ø 39.5mm L 70mm M8 plastic connection male faston 6.3mm 16.10.25. protection			

1

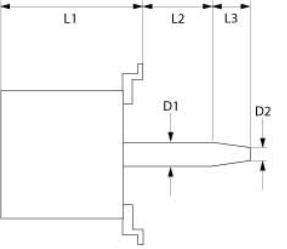

GEV No.	500658	Ref. No.	R65040530
description	fan motor 230/400V 3 phase 50/60Hz 0.55kW 1400/1700rpm speeds 1 L1 145mm L2 47mm L3 47mm D1 ø 24mm D2 ø 20mm M12L IT 2.6-2.3/1.5-1.3A (at 50-60Hz)A Cos(φ) 0.73 at 50Hz 200-240/415V at 60Hz 200-240/480V at 50Hz 1400rpm at 60Hz 1700rpm		
For models:	MACE10M, MACE20M, ME101D, ME101M, ME201D, ME201M		
spare parts for	500658		
	GEV No.	511172	Ref. No. R70020050
shaft sealing ID ø 24mm ED ø 29mm thickness 3mm			

Table continues overleaf



accessories for 500658			
	GEV No.	560449	Ref. No. R58004000
hexagonal screw thread M12x1.5 L thread L 22mm bore ϕ 6.3mm WS 19 total length 30mm			
	GEV No.	601244	Ref. No. R75400440
fan wheel D1 ϕ 350mm H1 114mm blades 12 D2 ϕ 19.5mm D3 ϕ 23mm H2 45mm			

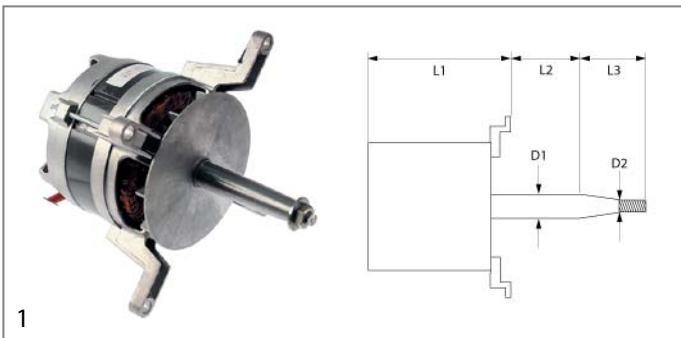

GEV No.	500659	Ref. No.	R65040550
description	fan motor 230V 1 phase 50/60Hz 0.55kW 1400/1700rpm speeds 1 L1 150mm L2 52mm L3 45mm D1 ϕ 24mm D2 ϕ 20mm M12L IT 3A suitable capacitor 20 μ F/450V Cos(f) 0.9 at 50Hz 1400rpm at 60Hz 1700rpm type 3042A2350		
For models:	GMT20D, GVT20D, MACG10M, MACG20M, MG101D, MG101M, MG201D, MG201M, MG202D, MG202M, MGMT40D, MGVT40D		

spare parts for 500659			
	GEV No.	511172	Ref. No. R70020050
shaft sealing ID ϕ 24mm ED ϕ 29mm thickness 3mm			

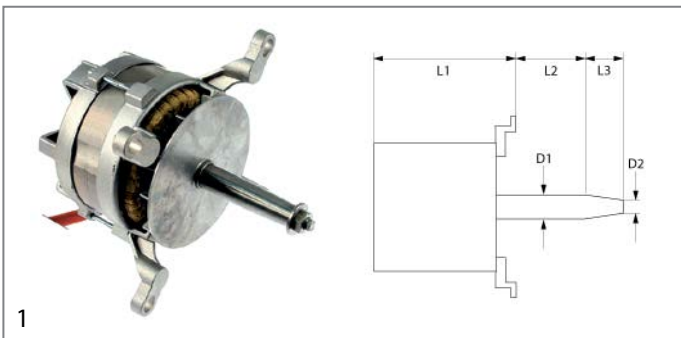

GEV No.	500657	Ref. No.	R65040540
description	fan motor 230V 1 phase 50Hz 0.15/0.55kW 900/1400rpm speeds 2 L1 150mm L2 45mm L3 47mm D1 ϕ 24mm D2 ϕ 20mm M12L IT 1.3/3.0A suitable capacitor 20/10 μ F Cos(f) 0.98 at 50Hz 900/1400rpm at 60Hz 1100/1700rpm 4P/6P type LM/FB 100L no. 472986		
For models:	MG101P, MG101T, MG201P, MG201T, MG202P, MG202T, MGMT40P, MGVT40P		

spare parts for 500657			
	GEV No.	511172	Ref. No. R70020050
shaft sealing ID ϕ 24mm ED ϕ 29mm thickness 3mm			

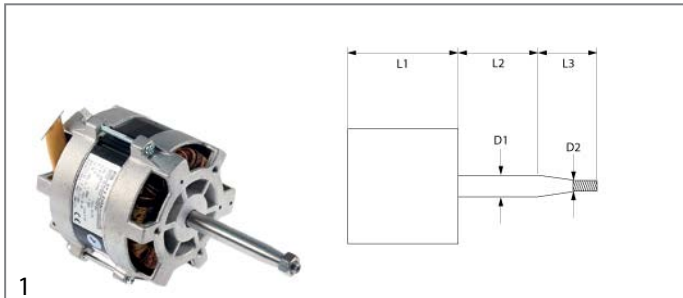

GEV No.	500663	Ref. No.	R65040421
description	fan motor 230V 1 phase 50Hz 0.18kW 0.25HP 2800rpm speeds 1 L1 123mm L2 77mm L3 30mm D1 ϕ 15mm D2 ϕ 12mm M10L ET 1.6A suitable capacitor 10 μ F/400V Cos(f) 0.95 at 50Hz 2800rpm type 1057C2401		
For models:	GMT06D, GVT06D, MACE07M, MACG07M, ME061D, ME061M, MEMT06D, MEVT06D, MG061D, MG061M, MGMT06D, MGVT06D		

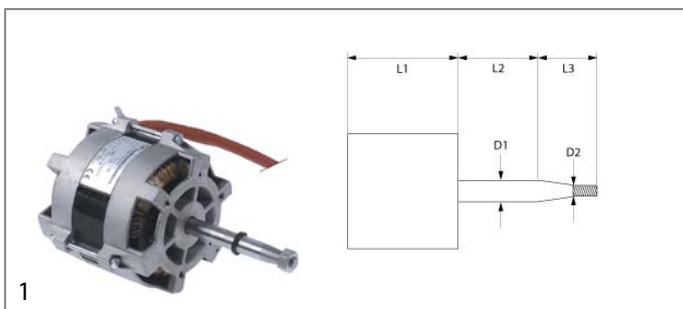

GEV No.	500680	Ref. No.	R65040420
description	fan motor 230V 1 phase 50Hz 0.37kW 2800rpm speeds 1 L1 121mm L2 77mm L3 31mm D1 ϕ 16mm D2 ϕ 11mm 2.5A Cos(f) 0.95 at 50Hz 230V at 50Hz 2800rpm type 1057.2155		
For models:	EC106M, EM106M, EM106M+SC, EV006M, EV106M, EV106M+SC, GC106M, GM106M, GM106M+SC, GV106M, GV106M+SC		

accessories for 500680			
	GEV No.	601060	Ref. No. R75400130
fan wheel D1 ϕ 180mm H1 60mm blades 16 D2 ϕ 11mm D3 ϕ 16mm H2 30mm			



GEV No.	601067	Ref. No.	R75400040
description	fan wheel D1 ϕ 150mm H1 38mm blades 36 D2 ϕ 6mm D3 ϕ 6mm H2 14mm		
For models:	CVE004H, CVE004M, CVE104H, CVE104M, VE004M, VE004X, VE104M, VE104X		



1

GEV No.	601353	Ref. No.	R75400510
description	fan wheel D1 ø 150mm H1 50mm blades 36 D2 ø 8mm D3 ø 6/8mm H2 26mm		
For models:	MACE04M, MVE042P		



1

GEV No.	601068	Ref. No.	R75400080
description	fan wheel D1 ø 160mm H1 70mm blades 16 D2 ø 12mm D3 ø 16mm H2 29mm		
For models:	CVE105H, CVE105M, CVG105H, CVG105M, VE105M, VE105X, VG105M, VG105X		



1

GEV No.	601060	Ref. No.	R75400130
description	fan wheel D1 ø 180mm H1 60mm blades 16 D2 ø 11mm D3 ø 16mm H2 30mm		
For models:	FE105M, FE105X, FG105M, FG105X, PE040M, PE040X, PG040M, PG040X		



1

GEV No.	601246	Ref. No.	R75400410
description	fan wheel D1 ø 180mm H1 77mm blades 12 D2 ø 8mm D3 ø 6mm H2 25.5mm		
For models:	MACE05M, MACG05M, MVE051P, MVG051P		



1

GEV No.	601243	Ref. No.	R75400400
description	fan wheel D1 ø 220mm H1 78mm blades 12 D2 ø 11mm D3 ø 16mm H2 29mm		
For models:	EC106M, EM106H, EM106M, EM106M+SC, EM106P, EV006M, EV106H, EV106M, EV106M+SC, EV106P, GC106M, GM106H, GM106M, GM106M+SC, GM106P, GMT06D, GV106H, GV106M, GV106M+SC, GV106P, GVT06D, MACE07M, MACG07M, ME061D, ME061M, ME061P, ME061T, MEMT06D, MEMT06P, MEVT06D, MEVT06P, MG061D, MG061M, MG061P, MG061T, MGMT06D, MGMT06P, MGVT06D, MGVT06P		



1

GEV No.	601064	Ref. No.	R75400230
description	fan wheel D1 ø 220mm H1 78mm blades 20 D2 ø 11.5mm D3 ø 16.5mm H2 30mm		
For models:	ME106M, ME106P, ME106X, MG106M, MG106P, MG106X, VE106M, VE106P, VE106X, VG106M, VG106P, VG106X		



1

GEV No.	601065	Ref. No.	R75400290
description	fan wheel D1 ø 300mm H1 120mm blades 20 D2 ø 19.5mm D3 ø 23mm H2 46mm		
For models:	EC110M, EM010M+SC, EM110H, EM110M, EM110M+SC, EM110P, EV110H, EV110M, EV110M+SC, EV110P, GC110M, GM110H, GM110M, GM110M+SC, GM110P, GV110H, GV110M, GV110M+SC, GV110P, ME110M, ME110P, ME110X, ME120M, ME120P, ME120X, MG110M, MG110P, MG110X, MG120M, MG120P, MG120X, MGC20X, VE110M, VE110X, VE120M, VE120P, VE120X, VG110M, VG110P, VG110X, VG120M, VG120P, VG120X		



1

GEV No.	514037	Ref. No.	2919900 MA2919900
description	fan wheel D1 ø 330mm H1 110mm blades 12 D2 ø 12mm D3 ø 24mm H2 47mm		
For models:	CON10E, CON10EP, CON10G, CON10GP, CS10E, CS10EP, CS10G, CSM10E, CSM10EP, CSM10G, CSM10GP		



1

GEV No.	514038	Ref. No.	2939414 MA2939414
description	fan wheel D1 ø 350mm H1 150mm blades 16 D2 ø 12mm D3 ø 23mm H2 48mm		
For models:	CON102E, CON102EP, CON102G, CON102GP, CON201E, CON201EP, CON201G, CON201GP, CS102E, CS102EP, CS102G, CS102GP, CSM102E, CSM102EP, CSM102G, CSM102GP, CSM201E, CSM201EP, CSM201G, CSM201GP		



1

GEV No.	601244	Ref. No.	R75400440
description	fan wheel D1 ø 350mm H1 114mm blades 12 D2 ø 19.5mm D3 ø 23mm H2 45mm		
For models:	GMT20D, GVT20D, MACE10M, MACE20M, MACG10M, MACG20M, ME101D, ME101M, ME101P, ME101T, ME102D, ME102M, ME102P, ME102T, ME201D, ME201M, ME201P, ME201T, ME202D, ME202M, ME202P, ME202T, MEMT10D, MEMT10P, MEMT20D, MEMT20P, MEMT21D, MEMT21P, MEMT40D, MEMT40P, MEVT10D, MEVT10P, MEVT20D, MEVT20P, MEVT21D, MEVT21P, MEVT40D, MEVT40P, MG101D, MG101M, MG101P, MG101T, MG102D, MG102M, MG102P, MG102T, MG201D, MG201M, MG201P, MG201T...(Other models you can see in the webshop)		



1

GEV No.	514039	Ref. No.	5103414
description	fan wheel D1 ø 350mm H1 190mm blades 16 D2 ø 12mm D3 ø 23.5mm H2 47mm		
For models:	CON202E, CON202EP, CON202G, CON202GP, CSM202E, CSM202EP, CSM202G, CSM202GP		



1

GEV No.	601066	Ref. No.	R75400380
description	fan wheel D1 ø 350mm H1 120mm blades 24 D2 ø 19.5mm D3 ø 23.5mm H2 45mm		
For models:	EC210M, EM210H, EM210M, EM210M+SC, EM210P, EV210H, EV210M, EV210M+SC, EV210P, GC210M, GM210H, GM210M, GM210M+SC, GM210P, GV210H, GV210M, GV210M+SC, GV210P, ME210M, ME210P, ME210X, ME220M, ME220P, ME220X, MEC24H, MEC40M, MG210M, MG210P, MG210X, MG220M, MG220P, MG220X, MGC24H, MGC40H, VE210M, VE210P, VE210X, VE220M, VE220P, VE220X, VG210M, VG210P, VG210X, VG220M, VG220P, VG220X		



1

GEV No.	550855	Ref. No.	R58005510
description	flange for fan motor ED ø 35mm int. ø 1 22mm int. ø 2 8mm thickness 8mm brass		
For models:	CVE004H, CVE004M, CVE104H, CVE104M, VE004M, VE004X, VE104M, VE104X		



1

GEV No.	550856	Ref. No.	R58003860
description	flange for fan motor ED ø 50mm int. ø 1 19.5mm int. ø 2 16mm thickness 3mm brass		
For models:	CVE105H, CVE105M, CVG105H, CVG105M, EC106M, EM106H, EM106M, EM106M+SC, EM106P, EV006M, EV106H, EV106M, EV106M+SC, EV106P, FE105M, FE105X, FG105M, FG105X, GC106M, GM106H, GM106M, GM106M+SC, GM106P, GMT06D, GV106H, GV106M, GV106M+SC, GV106P, GVT06D, MACE07M, MACG07M, ME061D, ME061M, ME061P, ME061T, ME106M, ME106P, ME106X, MEMT06D, MEMT06P, MEVT06D, MEVT06P, MG061D, MG061M, MG061P, MG061T, MG106M, MG106P, MG106X, MGMT06D...(Other models you can see in the webshop)		

			
1			
GEV No.	550858	Ref. No.	R58003840
description	flange for fan motor ED ø 60mm int. ø 1 28.5mm int. ø 2 25mm thickness 4mm brass		
For models:	EC110M, EC210M, EM010M+SC, EM110H, EM110M, EM110M+SC, EM110P, EM210H, EM210M, EM210M+SC, EM210P, EV110H, EV110M, EV110M+SC, EV110P, EV210H, EV210M, EV210M+SC, EV210P, FE110M, FE110X, FE210M, FG110M, FG110X, FG210M, FG210X, GC110M, GC210M, GM110H, GM110M, GM110M+SC, GM110P, GM210H, GM210M, GM210M+SC, GM210P, GMT20D, GV110H, GV110M, GV110M+SC, GV110P, GV210H, GV210M, GV210M+SC, GV210P, GVT20D, MACE10M, MACE20M, MACG10M, MACG20M...(Other models you can see in the webshop)		

			
1			
GEV No.	550860	Ref. No.	R58005500
description	flange for gasket ED ø 35mm int. ø 1 22mm int. ø 2 9mm thickness 8mm brass		
For models:	MACE04M, MACE05M, MACG05M, MVE042P, MVE051P, MVG051P		

			
1			
GEV No.	560449	Ref. No.	R58004000
description	hexagonal screw thread M12x1.5 L thread L 22mm bore ø 6.3mm WS 19 total length 30mm		
For models:	EC110M, EC210M, EM010M+SC, EM110H, EM110M, EM110M+SC, EM110P, EM210H, EM210M, EM210M+SC, EM210P, EV110H, EV110M, EV110M+SC, EV110P, EV210H, EV210M, EV210M+SC, EV210P, FE110M, FE110X, FE210M, FG110M, FG110X, FG210M, FG210X, GC110M, GC210M, GM110H, GM110M, GM110M+SC, GM110P, GM210H, GM210M, GM210M+SC, GM210P, GMT20D, GV110H, GV110M, GV110M+SC, GV110P, GV210H, GV210M, GV210M+SC, GV210P, GVT20D, MACE10M, MACE20M, MACG10M, MACG20M...(Other models you can see in the webshop)		

			
1			
GEV No.	500639	Ref. No.	R65040101
description	motor kit 220/240V 1 phase 50/60Hz 0.25kW type K48210		
For models:	CVE004H, CVE004M, CVE104H, CVE104M, VE004M, VE004X, VE104M, VE104X		
spare parts for	500639		
		GEV No.	511170
		Ref. No.	R70020010
	shaft seal ID ø 7mm ED ø 22mm thickness 7mm		
		GEV No.	550855
		Ref. No.	R58005510
	flange for fan motor ED ø 35mm int. ø 1 22mm int. ø 2 8mm thickness 8mm brass		
		GEV No.	601067
		Ref. No.	R75400040
	fan wheel D1 ø 150mm H1 38mm blades 36 D2 ø 6mm D3 ø 6mm H2 14mm		
		GEV No.	601856
		Ref. No.	—
	fan motor 230V 1 phase 50Hz 0.075kW 2650rpm speeds 1 L1 85mm L2 30mm L3 23mm L4 12mm D1 ø 8x6mm D2 ø 8mm 0.6A suitable capacitor 5µF/400V		

			
1			
GEV No.	550861	Ref. No.	R70020020
description	shaft seal for fan motor ID ø 7.5mm ED ø 22mm thickness 7mm		
For models:	MACE04M, MACE05M, MACG05M, MVE042P, MVE051P, MVG051P		

			
1			
GEV No.	511171	Ref. No.	LA70020040 LAR70020040
description	shaft seal ID ø 14.5mm ED ø 20mm thickness 3mm		
For models:	CVE105H, CVE105M, CVG105H, CVG105M, EC106M, EM106H, EM106M, EM106M+SC, EM106P, EV006M, EV106H, EV106M, EV106M+SC, EV106P, FE105M, FE105X, FG105M, FG105X, GC106M, GM106H, GM106M, GM106M+SC, GM106P, GMT06D, GV106H, GV106M, GV106M+SC, GV106P, GVT06D, MACE07M, MACG07M, ME061D, ME061M, ME061P, ME061T, ME106M, ME106P, ME106X, MEMT06D, MEMT06P, MEVT06D, MEVT06P, MG061D, MG061M, MG061P, MG061T, MG106M, MG106P, MG106X, MGMT06D...(Other models you can see in the webshop)		

			
1			
GEV No.	511170	Ref. No.	R70020010
description	shaft seal ID ø 7mm ED ø 22mm thickness 7mm		
For models:	CVE004H, CVE004M, CVE104H, CVE104M, VE004M, VE004X, VE104M, VE104X		

			
1			
GEV No.	511172	Ref. No.	R70020050
description	shaft sealing ID ø 24mm ED ø 29mm thickness 3mm		
For models:	EC110M, EC210M, EM010M+SC, EM110H, EM110M, EM110M+SC, EM110P, EM210H, EM210M, EM210M+SC, EM210P, EV110H, EV110M, EV110M+SC, EV110P, EV210H, EV210M, EV210M+SC, EV210P, FE110M, FE110X, FE210M, FG110M, FG110X, FG210M, FG210X, GC110M, GC210M, GM110H, GM110M, GM110M+SC, GM110P, GM210H, GM210M, GM210M+SC, GM210P, GMT20D, GV110H, GV110M, GV110M+SC, GV110P, GV210H, GV210M, GV210M+SC, GV210P, GVT20D, MACE10M, MACE20M, MACG10M, MACG20M...(Other models you can see in the webshop)		



hot air fans

miscellaneous



1

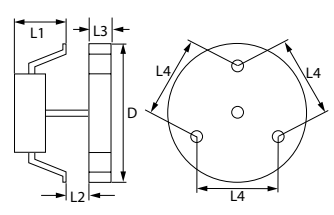

GEV No.	601054	Ref. No.	1037117200 7800200 MA1037117200 MA7800200
description	hot air fan 220-240V 32W 50/60Hz L1 60mm L2 10mm L3 25mm L4 87mm fan wheel ø 150mm FIME type C20X0E01/46		
For models:	CFE60, CFE60P, CFGE61, CFGE61D, CFGE61L, CFGE61P, CFVE60, OCFE60, OCFGE61, TP12, TP126, TP126E, TP12E, TP13, TP136, TP136E, TP13E, TP14, TP146, TP146E, TP14E, TP15, TP156, TP156E, TP15E, TP16, TP166, TP166E, TP16E, TP17, TP176, TP176E, TP17E, TP18, TP186, TP186E, TP18E, TP19, TP196, TP196E, TP19E, TP20, TP206, TP206E, TP20E, TP21, TP212, TP2126, TP2126E, TP212E...(Other models you can see in the webshop)		
spare parts for	601054		
	GEV No.	601441	Ref. No. —
	fan wheel ø 150mm W 25mm shaft intake ø 6x5mm stainless steel blades 7		
accessories for	601054		
	GEV No.	550879	Ref. No. —
	insulation ø 130mm thickness 3mm hole ø 20mm for hot air fan		

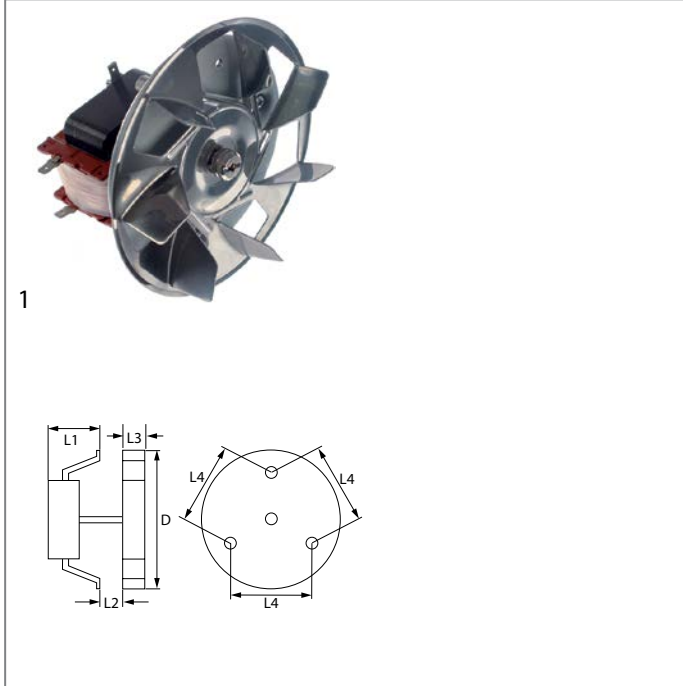

1

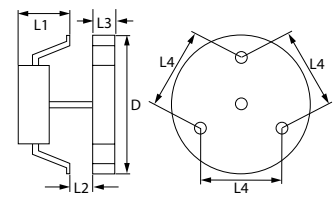

GEV No.	601696	Ref. No.	4330800 MA4330800
description	hot air fan 230V 40W 50/60Hz L1 70mm L2 11mm L3 29mm L4 87mm fan wheel ø 155mm with ball bearing		
For models:	AR712PA, AR712PP, AR712PS, AR713PA, AR713PP, AR713PS, AR714PA, AR714PP, AR714PS, AR715PA, AR715PP, AR715PS, AR716PA, AR716PP, AR716PS, AR717PA, AR717PP, AR717PS, AR718PA, AR718PP, AR718PS, AR719PA, AR719PP, AR719PS, AR720PA, AR720PP, AR720PS, EAR612PA, EAR612PP, EAR612PS, EAR613PA, EAR613PP, EAR613PS, EAR614PA, EAR614PP, EAR614PS, EAR615PA, EAR615PP, EAR615PS, EAR616PA, EAR616PP, EAR616PS, EAR617PA, EAR617PP, EAR617PS, EAR618PA, EAR618PP, EAR618PS, EAR619PA, EAR619PP...(Other models you can see in the webshop)		
spare parts for	601696		
	GEV No.	550879	Ref. No. —
	insulation ø 130mm thickness 3mm hole ø 20mm for hot air fan		

accessories

fan wheels for hot air fans



1

GEV No.	601630	Ref. No.	1034400200 MA1034400200
description	fan wheel ø 150mm W 25mm shaft intake ø 6x5mm chrome-plated blades 7		
For models:	CFE60, CFE60P, CFGE61, CFGE61D, CFGE61L, CFGE61P, CFVE60, OCFE60, OCFGE61		



miscellaneous



1

GEV No.	551434	Ref. No.	R58004010
description	plain washer ø 30mm thickness 3mm hole ø 12.5mm for fan wheel combi-steamer		
For models:	EC110M, EC210M, EM010M+SC, EM110H, EM110M, EM110M+SC, EM110P, EM210H, EM210M, EM210M+SC, EM210P, EV110H, EV110M, EV110M+SC, EV110P, EV210H, EV210M, EV210M+SC, EV210P, FE110M, FE110X, FE210M, FG110M, FG110X, FG210M, FG210X, GC110M, GC210M, GM110H, GM110M, GM110M+SC, GM110P, GM210H, GM210M, GM210M+SC, GM210P, GMT20D, GV110H, GV110M, GV110M+SC, GV110P, GV210H, GV210M, GV210M+SC, GV210P, GVT20D, MACE10M, MACE20M, MACG10M, MACG20M...(Other models you can see in the webshop)		

radial fans

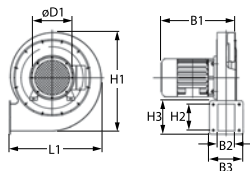

1

GEV No.	601245	Ref. No.	R63130010
description	radial fan 24V voltage DC 50Hz 45W H1 170mm L1 170mm D1 ø 50mm W1 90mm W2 44mm H2 57mm W3 83mm H3 83mm		
For models:	GMT06D, GMT20D, GVT06D, GVT20D, MACG05M, MACG07M, MACG10M, MACG20M, MG061D, MG061M, MG061P, MG061T, MG101D, MG101M, MG101P, MG101T, MG102D, MG102M, MG102P, MG102T, MG201D, MG201M, MG201P, MG201T, MG202D, MG202M, MG202P, MG202T, MGMT06D, MGMT06P, MGMT10D, MGMT10P, MGMT20D, MGMT20P, MGMT21D, MGMT21P, MGMT40D, MGMT40P, MGVT06D, MGVT06P, MGVT10D, MGVT10P, MGVT20D, MGVT20P, MGVT21D, MGVT21P, MGVT40D, MGVT40P, MVG051P		
accessories for	601245		
		GEV No.	104309 Ref. No. R63140020
	gasket L 106mm W 100mm H 3mm 4 holes		

motors

gear motors

for tilting bratt pans



1

GEV No.	600000	Ref. No.	CM056300 MACM056300
description	gear motor NERI type M63B4 120W 230V voltage DC 50Hz 1360rpm shaft ø 14mm L 308mm W 140mm H 170mm for tilting bratt pan		
For models:	BR78EF, BR78EI, BR78GF, BR78GI, BR912EFM, BR912EIM, BR912GFM, BR912GIM, BR98EF, BR98EFM, BR98EI, BR98EIM, BR98GF, BR98GFM, BR98GI, BR98GIM, BR9S8EF, BR9S8EI, BR9S8GF, BR9S8GI		

pumps

wash and rinse pumps

FIR

pumps



1

GEV No.	500019	Ref. No.	100702
description	pump inlet ø 28mm outlet ø 26mm type B229.1405 230V 50Hz 1 phase 0.22kW 0.3HP L 200mm rotation direction right capacitor 5µF FIR		
spare parts for	500019		
		GEV No.	365017 Ref. No. —
	operating capacitor capacity 5µF 450V tolerance 5% 50/60Hz ambient temperature max. -25 to +85°C ø 28mm L 54mm M8 plastic connection male faston 6.3mm 16.10.08 protection		
		GEV No.	510510 Ref. No. 630125
	pump cover pump type 2212/2228/2229/2211		
		GEV No.	510532 Ref. No. —
	impellor ø 72mm H 22mm shaft ø 11mm shaft length 32mm blades 3		
		GEV No.	510695 Ref. No. 630514
	mechanical shaft seal height counter ring 5.5mm ID ø 11mm		
		GEV No.	521703 Ref. No. —
	pump cover gasket EPDM thickness 2.5mm ID ø 75mm Qty 1 pcs		







1

GEV No.	500127	Ref. No.	100740
description	pump inlet \varnothing 37mm outlet \varnothing 41mm type 4247.1900 230V 50Hz 1 phase 0.44kW 0.6HP L 200mm rotation direction right capacitor 10 μ F FIR		
spare parts for	500127		
	GEV No.	365015	Ref. No. 631206 LA65190180 LAR65190180 R65190180
	operating capacitor capacity 10 μ F 400V tolerance 5%Hz ambient temperature max. -25 to +85°C \varnothing 35.5mm L 59mm M8 plastic connection male faston 6.3mm protection		
	GEV No.	510608	Ref. No. 631683
	impellor \varnothing 93mm H 32mm shaft intake \varnothing 9/8mm blades 6 inner height 11mm		
	GEV No.	510692	Ref. No. —
	mechanical shaft seal for shaft \varnothing 11mm slide ring ext. \varnothing 24mm slide ring H 13mm counter ring mounting \varnothing 26mm height counter ring 8mm counter ring int. \varnothing 14mm		
	GEV No.	521505	Ref. No. 630129
	pump cover FIR inlet \varnothing 37mm outlet \varnothing 40mm turn direction right \varnothing 160mm ID \varnothing 125mm inner height 25mm		
	GEV No.	521702	Ref. No. 630419
	pump cover gasket thickness 3.5x4.5mm Qty 1 pcs		



1

GEV No.	500038	Ref. No.	1037304600
description	pump inlet \varnothing 45mm outlet \varnothing 40mm type 3911.1425 230V 50Hz 1 phase 0.55kW 0.75HP L 205mm rotation direction right capacitor 10 μ F FIR		
For models:	DLS30, DLS303, DLS30P, DLS30P3, DLS31, DLS313, DLS31P3, MLS30, MLS303, MLS30P, MLS30P3, MLS31, MLS313, MLS31P3, MLS35, MLS353, MPLS30P		
spare parts for	500038		
	GEV No.	365015	Ref. No. 631206 LA65190180 LAR65190180 R65190180
	operating capacitor capacity 10 μ F 400V tolerance 5%Hz ambient temperature max. -25 to +85°C \varnothing 35.5mm L 59mm M8 plastic connection male faston 6.3mm protection		
	GEV No.	510508	Ref. No. —
	pump cover FIR inlet \varnothing 45mm outlet \varnothing 40mm pump type PU 0.5/3911 turn direction right \varnothing 160mm ID \varnothing 125mm inner height 25mm		
	GEV No.	510610	Ref. No. —
	impellor \varnothing 95.5mm H 23mm shaft intake \varnothing 9/8mm rotation direction right seat \varnothing 16mm blades 6		
	GEV No.	510692	Ref. No. —
	mechanical shaft seal for shaft \varnothing 11mm slide ring ext. \varnothing 24mm slide ring H 13mm counter ring mounting \varnothing 26mm height counter ring 8mm counter ring int. \varnothing 14mm		
	GEV No.	521702	Ref. No. 630419
	pump cover gasket thickness 3.5x4.5mm Qty 1 pcs		
accessories for	500038		
	GEV No.	551286	Ref. No. —
	adapter L 120mm 4-pole for Meiko pump suitable for 500038 plug type dependent on equipment		

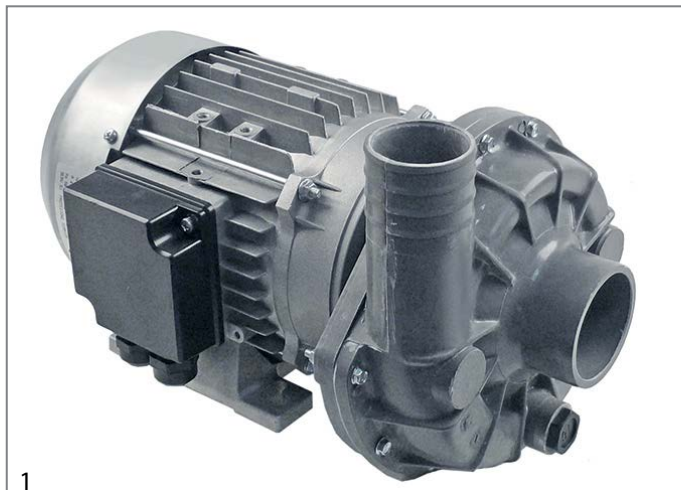



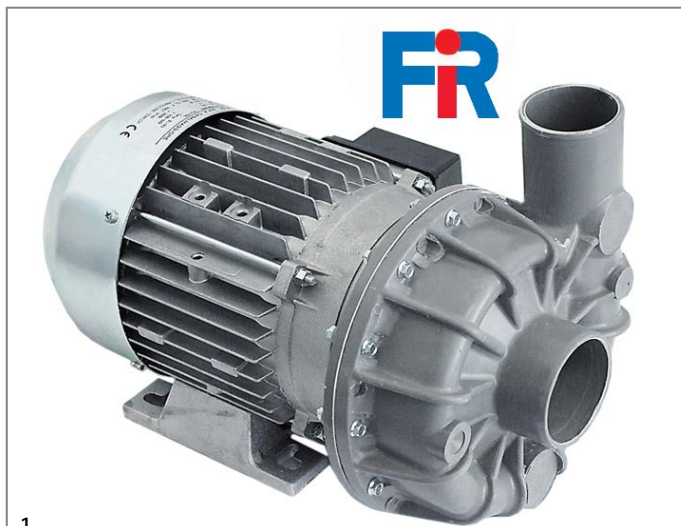

1

GEV No.	500023	Ref. No.	1037307400
description	pump inlet ø 63mm outlet ø 47mm type 1225.2725 230/400V 50Hz 3 phase 1.1kW 1.5HP L 335mm rotation direction right FIR		
For models:	MLC50, MLC503, MLC65, MLC653		
spare parts for	500023		
	GEV No.	510602	Ref. No. —
	impellor ø 110mm H 34mm rotation direction right thread M8L shaft ø 28mm seat ø 12.2mm blades 6		
	GEV No.	510693	Ref. No. 630501
	mechanical shaft seal for shaft ø 12mm slide ringext. ø 24mm slide ring H 15.5mm slide ring int. ø 11mm counter ring mounting ø 24mm height counter ring 8mm counter ring int. ø 13.5mm		
	GEV No.	521513	Ref. No. —
	pump cover FIR inlet ø 63mm outlet ø 47mm turn direction right ID ø 150mm inner high 32mm		
	GEV No.	524416	Ref. No. —
	pump cover gasket thickness 4x4mm Qty 1 pcs		



1

GEV No.	500111	Ref. No.	100663
description	pump inlet ø 63mm outlet ø 53mm type 1241.2500 230/400V 50Hz 3 phase 1.1kW 1.5HP L 330mm rotation direction left FIR		
spare parts for	500111		
	GEV No.	510531	Ref. No. 630114
	pump cover FIR inlet ø 63mm outlet ø 53mm auxiliary pressure connection M16x1.5mm supporting pressure open turn direction left ø 185mm ID ø 150mm inner high 37mm		
	GEV No.	510612	Ref. No. 631653
	impellor ø 110mm H 34mm M8R		

spare parts for	500111		
	GEV No.	510693	Ref. No. 630501
	mechanical shaft seal for shaft ø 12mm slide ringext. ø 24mm slide ring H 15.5mm slide ring int. ø 11mm counter ring mounting ø 24mm height counter ring 8mm counter ring int. ø 13.5mm		
	GEV No.	524416	Ref. No. —
	pump cover gasket thickness 4x4mm Qty 1 pcs		



1

GEV No.	501467	Ref. No.	100717
description	pump inlet ø 63mm outlet ø 53mm type 2241.2501 230/400V 50Hz 3 phase 0.89kW 1.5HP L 305mm rotation direction left FIR		

LGB



1





GEV No.	500513	Ref. No.	100727
description	pump inlet ø 45mm outlet ø 40mm type FM4023SX 230V 50Hz 1 phase 0.75kW 1HP L 300mm rotation direction right capacitor 16µF LGB		
spare parts for	500513		
	GEV No.	365021	Ref. No. 631202 LAR65190030 R65190030
	operating capacitor capacity 16µF 425V tolerance 5% 50/60Hz ambient temperature max. -25 to +85°C ø 35mm L 73mm single M8 plastic connection male faston 6.3mm 416.10.99 protection		
	GEV No.	510703	Ref. No. —
	mechanical shaft seal for shaft ø 13mm slide ring H 13mm height counter ring 5.5mm ED ø 26mm		

Table continues overleaf



spare parts for 500513			
	GEV No.	521246	Ref. No. 631674
	impellor ø 103mm H 26mm thread M8L shaft ø 20mm shaft length 7mm seat ø 8.2mm blades 6		
	GEV No.	521542	Ref. No. —
	pump cover LGB inlet ø 45mm outlet ø 40mm auxiliary pressure connection 13mm supporting pressure open ø 150mm ID ø 120mm inner height 25mm		
	GEV No.	521714	Ref. No. 630420
	pump cover gasket thickness 4x4mm Qty 1 pcs		

miscellaneous



1	GEV No.	500016	Ref. No.	100399
	description	pump type AL15 1 phase IBMEI		

drain pumps

ASKOLL



1	GEV No.	500210	Ref. No.	1037304700 MA1037304700
	description	drain pump 230V 40W		
	For models:	DLS30, DLS303, DLS30P, DLS30P3, DLS31, DLS313, DLS31P3, MLS30, MLS303, MLS30P, MLS30P3, MLS31, MLS313, MLS31P3, MLS35, MLS353, MPLS30P		

GRE



1	GEV No.	500961	Ref. No.	100342
	description	drain pump inlet ø 30mm outlet ø 23mm 100W 230V 50Hz GRE		
	accessories for	500961		
	GEV No.	524719	Ref. No.	—
	formed hose hose ext. ø 40mm hose int. ø 30mm L 65mm warewashing black Qty 1			

miscellaneous



1	GEV No.	500201	Ref. No.	R65110300
	description	drain pump inlet ø 24mm outlet ø 22mm 230V 100W		
	For models:	GMT06D		

booster pumps II

accessories



1	GEV No.	365015	Ref. No.	631206 LA65190180 LAR65190180
	description	operating capacitor capacity 10µF 400V tolerance 5%Hz ambient temperature max. -25 to +85°C ø 35.5mm L 59mm M8 plastic connection male faston 6.3mm protection		
	For models:	EC106M, EM106H, EM106M, EM106M+SC, EM106P, EV006M, EV106H, EV106M, EV106M+SC, EV106P, GC106M, GM106H, GM106M, GM106M+SC, GM106P, GMT06D, GV106H, GV106M, GV106M+SC, GV106P, GVT06D, MACE04M, MACE05M, MACE07M, MACE10M, MACE20M, MACG05M, MACG07M, MACG10M, MACG20M, ME061D, ME061M, ME061P, ME061T, MEMT06D, MEMT06P, MEVT06D, MEVT06P, MG061D, MG061M, MG061P, MG061T, MG101D, MG101M, MG101P, MG101T, MG201D, MG201M, MG201P, MG201T...(Other models you can see in the webshop)		



vibration pumps

<p>1</p>			
GEV No.	500568	Ref. No.	R65110600
description	vibration pump 230V 32W 50Hz inlet \varnothing 7 outlet \varnothing 1/8" IT CEME type E512/A32		
For models:	ME061T, ME101T, ME102T, ME201T, MEMT06P, MEMT10P, MEMT20P, MEMENT21P, MEMENT40P, MG102T, MG201T, MG202T, MGMT06P, MGMT10P, MGMT20P, MGMT21P, MGMT40P		
spare parts for	500568		
	GEV No.	390698	Ref. No. —
1	thermal fuse switch-off temp. 110°C suitable for ULKA pump		
	GEV No.	520153	Ref. No. —
1	bracket rubber dimensions 53x34x28mm		

accessories

pump cover gaskets

<p>1</p>			
GEV No.	510399	Ref. No.	630413
description	pump cover gasket		
<p>1</p>			
GEV No.	510550	Ref. No.	630416
description	pump cover gasket pump type 2212/1290/2211/2228/2229/2213 EPDM thickness 2.62mm ID \varnothing 82.22mm Qty 1 pcs		

condensators & interference suppression filters

operating capacitors

plastic

<p>1</p>			
GEV No.	365015	Ref. No.	631206 LAR65190180 LAR65190180
description	operating capacitor capacity 10 μ F 400V tolerance 5%Hz ambient temperature max. -25 to +85°C \varnothing 35.5mm L 59mm M8 plastic connection male faston 6.3mm protection		
For models:	EC106M, EM106H, EM106M, EM106M+SC, EM106P, EV006M, EV106H, EV106M, EV106M+SC, EV106P, GC106M, GM106H, GM106M, GM106M+SC, GM106P, GMT06D, GV106H, GV106M, GV106M+SC, GV106P, GVT06D, MACE04M, MACE05M, MACE07M, MACE10M, MACE20M, MACG05M, MACG07M, MACG10M, MACG20M, ME061D, ME061M, ME061P, ME061T, MEMT06D, MEMT06P, MEVT06D, MEVT06P, MG061D, MG061M, MG061P, MG061T, MG101D, MG101M, MG101P, MG101T, MG201D, MG201M, MG201P, MG201T...(Other models you can see in the webshop)		

<p>1</p> <p>Image not available</p>			
GEV No.	365034	Ref. No.	R65190090
description	operating capacitor capacity 12 μ F with plastic sheathing		
For models:	GM110H, GM110P, GM210H, GM210P, GV110H, GV110P, GV210H, GV210P, MG102P, MG102T, MG110P, MG110X, MG120P, MG120X, MG210P, MG210X, MG220P, MG220X, MGC24H, MGC40H, MGMT20P, MGVT20P, VG110P, VG110X, VG120P, VG120X, VG210P, VG210X, VG220P, VG220X		

<p>1</p>			
GEV No.	365021	Ref. No.	631202 LAR65190030
description	operating capacitor capacity 16 μ F 425V tolerance 5% 50/60Hz ambient temperature max. -25 to +85°C \varnothing 35mm L 73mm single M8 plastic connection male faston 6.3mm 416.10.99 protection		
For models:	GC110M, GC210M, GM110H, GM110M, GM110M+SC, GM110P, GM210H, GM210M, GM210M+SC, GM210P, GMT20D, GV110H, GV110M, GV110M+SC, GV110P, GV210H, GV210M, GV210M+SC, GV210P, GVT20D, MG102D, MG102M, MG102P, MG102T, MG110M, MG110P, MG110X, MG120M, MG120P, MG120X, MG210M, MG210P, MG210X, MG220M, MG220P, MG220X, MGC20X, MGC24H, MGC40H, MGMT20D, MGMT20P, MGVT20D, MGVT20P, VG110M, VG110P, VG110X, VG120M, VG120P, VG120X, VG210M...(Other models you can see in the webshop)		



1

GEV No.	365033	Ref. No.	R65190080
description	operating capacitor capacity 5µF with plastic sheathing		
For models:	CVE004H, CVE004M, CVE104H, CVE104M, CVE105H, CVE105M, CVG105H, CVG105M, ME106M, ME106P, ME106X, MG106M, MG106P, MG106X, VE004M, VE004X, VE104M, VE104X, VE105M, VE105X, VE106M, VE106P, VE106X, VG105M, VG105X, VG106M, VG106P, VG106X		

ferrite rings



1

GEV No.	691295	Ref. No.	R65280450
description	ferrite ring ID ø 17mm ED ø 28mm H 20mm for protection		
For models:	EM106H, EM106P, EM110H, EM110P, EM210H, EM210P, EV106H, EV106P, EV110H, EV110P, EV210H, EV210P, GM106H, GM106P, GM110H, GM110P, GM210H, GM210P, GMT06D, GMT20D, GV106H, GV106P, GV110H, GV110P, GV210H, GV210P, GVT06D, GVT20D, ME061D, ME061P, ME061T, ME101D, ME101P, ME101T, ME102P, ME102T, ME201D, ME201P, ME201T, ME202D, ME202P, ME202T, MEC24H, MEMT06D, MEMT06P, MEMT10D, MEMT10P, MEMT20D, MEMT20P, MEMT21D...(Other models you can see in the webshop)		

filters

interference suppression filters



1

GEV No.	365046	Ref. No.	631209
description	interference suppression filter type 10S7E-G1474253105-Q 115/250V 50/60Hz conductor 2 with E connection male faston 6.3mm L 40mm ø 40mm Hmm Wmm M8 plastic Qty 1 pcs		



1

GEV No.	365045	Ref. No.	1037116500 MA1037116500
description	interference suppression filter type FC701Y2F 250V 50-60Hz conductor 2 with E connection cable 200mm L 40mm ø 30mm Hmm Wmm plastic Qty 1 pcs		
For models:	CPE60, CPE602, CPE60DB, FQE40, FQE40D, FQE40DSP, FQE41, FQE41L, FQE41L2, FQE60, FQE60D, FQE60DSP, FQE61, FQE61L, FQE61L2, FTVE100, FTVE40, FTVE40D, FTVE60, FTVE60D, OCPE6, OCPE60, OFQE41, OFQE61, PCVE40, PCVE40D, PCVE40DB, PCVE60, PCVE60D, PCVE60DB, SME62M, SME63M, SME70M, TSE60M, V74EC, V76EC, V94E, V98E		



1

GEV No.	365044	Ref. No.	1984000 MA1984000 R65280200
description	interference suppression filter type FC701Y2F 250V 50-60Hz conductor 2 with E connection cable 200mm L 42mm ø 23mm Hmm Wmm plastic Qty 1 pcs		
For models:	CP704E, CP92E, CP92E2, CP94E, CP94E2, CP95B2E, CP95B2E2, CP95B4E, CP95B4E2, DE92142, DE94242, EC106M, EC110M, EC210M, EM010M+SC, EM106H, EM106M, EM106M+SC, EM106P, EM110H, EM110M, EM110M+SC, EM110P, EM210H, EM210M, EM210M+SC, EM210P, EV006M, EV106H, EV106M, EV106M+SC, EV106P, EV110H, EV110M, EV110M+SC, EV110P, EV210H, EV210M, EV210M+SC, EV210P, FR74E, FR74E10, FR74E10L, FR74E10L2, FR74E2, FR77E, FR77E10, FR77E10L, FR77E10L2, FR77E2...(Other models you can see in the webshop)		

RC circuits



1

GEV No.	365155	Ref. No.	R65280130
description	RC circuit 250/630V connection male faston 6.3mm cable length 65mm capacity 47nF 100Ohm		
For models:	EC106M, EC110M, EC210M, EM010M+SC, EM106M, EM106M+SC, EM110M, EM110M+SC, EM210M, EM210M+SC, EV006M, EV106M, EV106M+SC, EV110M, EV110M+SC, EV210M, EV210M+SC, GC106M, GC110M, GC210M, GM106M, GM106M+SC, GM110M, GM110M+SC, GM210M, GM210M+SC, GV106M, GV106M+SC, GV110M, GV110M+SC, GV210M, GV210M+SC, MACE04M, MACE05M, MACE07M, MACE10M, MACE20M, MACG05M, MACG07M, MACG10M, MACG20M, ME061M, ME101M, ME102D, ME102M, ME201M, ME202M, MEC40M, MG061M, MG101M...(Other models you can see in the webshop)		

fuses

fine fuses



1

GEV No.	358532	Ref. No.	R65200200
description	fine fuse size ø5x20mm 2A fast-acting rated 250V Qty 10 pcs		
For models:	CVE004H, CVE004M, CVE104H, CVE104M, CVE105H, CVE105M, CVG105H, CVG105M, EC106M, EC110M, EC210M, EM010M+SC, EM106H, EM106M, EM106M+SC, EM106P, EM110H, EM110M, EM110M+SC, EM110P, EM210H, EM210M, EM210M+SC, EM210P, EV006M, EV106H, EV106M, EV106M+SC, EV106P, EV110H, EV110M, EV110M+SC, EV110P, EV210H, EV210M, EV210M+SC, EV210P, FE105M, FE105X, FE110M, FE110X, FE210M, FG105M, FG105X, FG110M, FG110X, FG210M, FG210X, GC106M, GC110M...(Other models you can see in the webshop)		



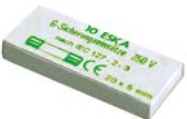

			
1			
GEV No.	358593	Ref. No.	R65200086
description	fine fuse size ϕ 5x20mm 0.125A slow-acting rated 250V Qty 10 pcs		
For models:	CVE004H, CVE104H, CVE105H, CVG105H, EM010M+SC, EM106H, EM106M+SC, EM106P, EM110M+SC, EM110P, EM210M+SC, EM210P, EV106H, EV106M+SC, EV106P, EV110M+SC, EV110P, EV210M+SC, EV210P, GM106H, GM106M+SC, GM106P, GM110M+SC, GM110P, GM210M+SC, GM210P, GV106H, GV106M+SC, GV106P, GV110M+SC, GV110P, GV210M+SC, GV210P, ME061P, ME061T, ME101P, ME101T, ME102P, ME102T, ME106M, ME106P, ME106X, ME110M, ME110P, ME110X, ME120M, ME120P, ME120X, ME201P, ME201T...(Other models you can see in the webshop)		

			
1			
GEV No.	358592	Ref. No.	R65200140
description	fine fuse size ϕ 5x20mm 0.1A slow-acting rated 250V Qty 10 pcs		
For models:	GMT20D, MG061M, MG101D, MG101M, MG102D, MG102M, MG201D, MG201M, MGMT20D		

			
1			
GEV No.	358595	Ref. No.	R65200320
description	fine fuse size ϕ 5x20mm 0.2A slow-acting rated 250V Qty 10 pcs		
For models:	EC106M, EM106H, EM106M, EM106M+SC, EM106P, EM110H, EM110P, EM210H, EM210P, EV006M, EV106H, EV106M, EV106M+SC, EV106P, EV110H, EV110P, EV210H, EV210P, FG105X, GC106M, GM106H, GM106M, GM106M+SC, GM106P, GM110H, GM210H, GV106H, GV106M, GV106M+SC, GV106P, GV110H, GV210H, MACE10M, MACE20M, ME061P, ME061T, ME101D, ME101M, ME102D, ME102M, ME106P, ME106X, ME110P, ME120P, ME201D, ME201M, ME210P, ME220P, MEC24H, MEMT10D...(Other models you can see in the webshop)		

			
1			
GEV No.	358703	Ref. No.	R65200350
description	fine fuse size ϕ 5x20mm 0.4A slow-acting rated 250V Qty 10 pcs		
For models:	EC110M, EC210M, EM010M+SC, EM110H, EM110M, EM110M+SC, EM110P, EM210H, EM210M, EM210M+SC, EM210P, EV110H, EV110M, EV110M+SC, EV110P, EV210H, EV210M, EV210M+SC, EV210P, FE105X, FG110X, FG210X, GC110M, GC210M, GM110H, GM110M, GM110M+SC, GM110P, GM210H, GM210M, GM210M+SC, GM210P, GV110H, GV110M, GV110M+SC, GV110P, GV210H, GV210M, GV210M+SC, GV210P, ME110P, ME110X, ME120P, ME120X, ME210P, ME210X, ME220P, ME220X, MEC24H, MEC40M...(Other models you can see in the webshop)		

			
1			
GEV No.	358033	Ref. No.	130259
description	fine fuse size ϕ 10x38mm 1A slow-acting rated 500V type aM Qty 1 pcs		

			
1			
GEV No.	358034	Ref. No.	130260
description	fine fuse size ϕ 10x38mm 2A slow-acting rated 500V type aM Qty 1 pcs		

			
1			
GEV No.	358035	Ref. No.	130230
description	fine fuse size ϕ 10x38mm 4A slow-acting rated 500V type aM Qty 1 pcs		

			
1			
GEV No.	358196	Ref. No.	130246
description	fine fuse size ϕ 10x38mm 12A rated 500V type Gg fast-acting Qty 1 pcs		

			
1			
GEV No.	358028	Ref. No.	130248
description	fine fuse size ϕ 10x38mm 20A rated 500V type Gg fast-acting Qty 1 pcs		

			
1			
GEV No.	358024	Ref. No.	130245
description	fine fuse size ϕ 10x38mm 8A rated 500V type gl fast-acting Qty 1 pcs		

fine fuse holders



GEV No.	358512	Ref. No.	208021-99 208021-99 n.m.liefe LA65210020 LAR65210020
description	fuse holder		
For models:	CS102E, CS102EP, CS102G, CS102GP, CVE004H, CVE004M, CVE104H, CVE104M, CVE105H, CVE105M, CVG105H, CVG105M, EC106M, EC110M, EC210M, EM010M+SC, EM106H, EM106M, EM106M+SC, EM106P, EM110H, EM110M, EM110M+SC, EM110P, EM210H, EM210M, EM210M+SC, EM210P, EV006M, EV106H, EV106M, EV106M+SC, EV106P, EV110H, EV110M, EV110M+SC, EV110P, EV210H, EV210M, EV210M+SC, EV210P, FE105M, FE105X, FE110M, FE110X, FE210M, FG105M, FG105X, FG110M, FG110X...(Other models you can see in the webshop)		



GEV No.	358075	Ref. No.	150710
description	fuse holder for for fuse ø10x38mm suitable fuse ø10x38mm 1-pole 32A rated 690V for DIN rail 35mm cross section 10mm ² suitable for for fuse ø10x38mm		

overload switches



GEV No.	358514	Ref. No.	R65160300
description	overload switch drop-away current 0.8A		
For models:	EM106H, EM106P, EV106H, EV106P, GM106H, GM106P, GV106H, GV106P, ME061P, ME061T, MEMT06P, MEVT06P, MG061P, MG061T, MGMT06P, MGVT06P		



GEV No.	358515	Ref. No.	R65160310
description	overload switch drop-away current 2.5A		
For models:	EC106M, EM106H, EM106M, EM106M+SC, EM106P, EV006M, EV106H, EV106M, EV106M+SC, EV106P, GC106M, GM106H, GM106M, GM106M+SC, GM106P, GV106H, GV106M, GV106M+SC, GV106P, MG061T		



GEV No.	358520	Ref. No.	R65160220
description	overload switch drop-away current 2.5A connection male faston 6.3mm		
For models:	FE105M, FE105X, FG105M, FG105X, PE040M, PE040X, PG040M, PG040X		



GEV No.	358516	Ref. No.	R65160320
description	overload switch drop-away current 2A		
For models:	GMT06D, GVT06D, MACE07M, MACG07M, ME061D, ME061M, ME061P, ME061T, MEMT06D, MEMT06P, MEVT06D, MEVT06P, MG061D, MG061M, MG061P, MGMT06D, MGMT06P, MGVT06D, MGVT06P		

electric accessories

cables

accessories
cable glands
threaded cable glands
screw connections



GEV No.	550971	Ref. No.	1037115100 MA1037115100
description	cable gland thread PG16 cable ø 14mm mounting ø 22.5mm Qty 1 pcs plastic WS 27		
For models:	AR712PA, AR712PP, AR712PS, AR713PA, AR713PP, AR713PS, AR714PA, AR714PP, AR714PS, AR715PA, AR715PP, AR715PS, AR716PA, AR716PP, AR716PS, AR717PA, AR717PP, AR717PS, AR718PA, AR718PP, AR718PS, AR719PA, AR719PP, AR719PS, AR720PA, AR720PP, AR720PS, B124E, B9SB2E, B9SB4E, B9V2E, B9V4E, BIE40, BIE40B, BIE60, BIE60B, BME40DM, BME40DMB, BME40M, BME60, BME60D, BME60DM, BME60DMB, BME60M, BME80M, BRE40, BRE40D, BRE40DB, BRE40DG, BRE40DGB...(Other models you can see in the webshop)		





GEV No.	550973	Ref. No.	1037112400 MA1037112400
description	cable gland thread PG21 cable ø 17mm mounting ø 28mm Qty 1 pcs plastic WS 34		
For models:	CP92E, CP92E2, CP94E, CP94E2, CP95B2E, CP95B2E2, CP95B4E, CP95B4E2, EC74EVG, EC78EVG, EC7FE8E, EF74E12, F12C4E12, F74E10, F74E6, F76E10, F94E10, F94E6, F96E10, FQE40, FQE40D, FQE40DSP, FQE41, FQE41L, FQE41L2, FQE41R, FQE41RL, FQE41RL2, FQE60, FQE60D, FQE60DSP, FQE61, FQE61L, FQE61L2, FQE61R, FQE61RL, NBR78EF, NBR78EI, NBR912EFM, NBR912EIM, NBR98EF, NBR98EFM, NBR98EI, NBR98EIM, NF74E10, NF76E10, NF94E10, NF96E10, NPC74E, NPC74G...(Other models you can see in the webshop)		



fastening nuts			
 <p>1</p>			
GEV No.	550972	Ref. No.	1037115200 MA1037115200
description	nut thread PG16 WS 30 plastic Qty 1 pcs thickness 6mm mounting ømm cable ømm		
For models:	AR712PA, AR712PP, AR712PS, AR713PA, AR713PP, AR713PS, AR714PA, AR714PP, AR714PS, AR715PA, AR715PP, AR715PS, AR716PA, AR716PP, AR716PS, AR717PA, AR717PP, AR717PS, AR718PA, AR718PP, AR718PS, AR719PA, AR719PP, AR719PS, AR720PA, AR720PP, AR720PS, B124E, B9SB2E, B9SB4E, B9V2E, B9V4E, BIE40, BIE40B, BIE60, BIE60B, BME40DM, BME40DMB, BME40M, BME60, BME602, BME60DM, BME60DMB, BME60M, BME80M, BRE40, BRE40D, BRE40DB, BRE40DG, BRE40DGB...(Other models you can see in the webshop)		

 <p>1</p>			
GEV No.	550974	Ref. No.	1037114500 MA1037114500
description	nut thread PG21 WS 34 plastic Qty 1 pcs thickness 7.5mm mounting ømm cable ømm		
For models:	CP92E, CP92E2, CP94E, CP94E2, CP9SB2E, CP9SB2E2, CP9SB4E, CP9SB4E2, EC74EVG, EC78EVG, EC7FE8E, EF74E12, F12C4E12, F74E10, F74E6, F76E10, F94E10, F94E6, F96E10, FQE40, FQE40D, FQE40DSP, FQE41, FQE41L, FQE41L2, FQE41R, FQE41RL, FQE41RL2, FQE60, FQE60D, FQE60DSP, FQE61, FQE61L, FQE61L2, FQE61R, FQE61RL, NBR78EF, NBR78EI, NBR912EFM, NBR912EIM, NBR98EF, NBR98EFM, NBR98EI, NBR98EIM, NF74E10, NF76E10, NF94E10, NF96E10, NPC74E, NPC74G...(Other models you can see in the webshop)		

ribbon cables			
group 1			
 <p>1</p>			
GEV No.	403107	Ref. No.	R65301470
description	ribbon cable 16-pole L 85mm plug type 2 row coded		
For models:	ME061P, ME101P, ME102P, ME201P, ME202P, MEMT06P, MEMT10P, MEMT20P, MEMT21P, MGMT40P, MEVT06P, MEVT10P, MEVT20P, MEVT21P, MEVT40P, MG061P, MG101P, MG102P, MG201P, MG202P, MGMT06P, MGMT10P, MGMT20P, MGMT21P, MGMT40P, MGVT06P, MGVT10P, MGVT20P, MGVT21P, MGVT40P		

miscellaneous			
 <p>1</p>			
GEV No.	401960	Ref. No.	R66110320
description	kable set		
For models:	GMT20D, GVT20D, MACE07M, MACE10M, MACE20M, MACG07M, MACG10M, MACG20M, ME101D, ME101M, ME101P, ME101T, ME102D, ME102M, ME102P, ME102T, ME201D, ME201M, ME201P, ME201T, ME202D, ME202M, ME202P, ME202T, MEMT10D, MEMT10P, MEMT20D, MEMT20P, MEVT10D, MEVT10P, MEVT20D, MEVT20P, MG101D, MG101M, MG101P, MG101T, MG102D, MG102M, MG102P, MG102T, MG201D, MG201M, MG201P, MG201T, MG202D, MG202M, MG202P, MG202T, MGMT10D, MGMT10P...(Other models you can see in the webshop)		

terminals and connectors			
not insulated			
female bullets			
 <p>1</p>			
GEV No.	100023	Ref. No.	MA20418099
description	female bullet size 2.3mm 0.5-1.5mm ² CuZn t.max. 125°C Qty 20 pcs		

terminals			
porcelain clamps			
 <p>1</p>			
GEV No.	550115	Ref. No.	1037117600 MA1037117600
description	porcelain terminal block 2-pole 10mm ² max. 30A max 450V L 37mm W 37mm H 23mm mounting distancemm Qty 1 pcs		
For models:	CT78EC, CT7FE8EC, CT98EC, CT9FE8EC, ERA10, ERA12, ERA14, ERA16, ERA18, ERA20, ERA210, ERA212, ERA214, ERA216, ERA218, ERA220, NSP74E, NSP94E, SP74E, SP94E		

 <p>1</p>			
GEV No.	550414	Ref. No.	112800
description	porcelain terminal block 4-pole 10mm ² hole distance 29mm max. 30A max 450V t.max. 200°C L 60mm W 28mm H 20mm mounting distance 29mm Qty 1 pcs		
For models:	B9SB2E, B9SB4E, B9V2E, B9V4E, BR707E, BR707EI, BR94E, BR94EI, BR96E, BR96EI, BR9M4E, BR9M4EI, BR9M4GI, BR9M6E, BR9M6EI, BR9SB4E, BR9SB4EI, C7011E, C7011EFE, C7011EFEQ, C704E, C707E, C707EFE, C707EFEQ, C9F4E, C9F6E, C9FE6GS, C9V2E, C9V4E, CP92E, CP94E, CP9SB2E, CP9SB4E, F9V2E, F9V2ER, F9V4E, F9V4EC, F9V4ECR, F9V4ER, F9V4ERL, FC10E, FC10G, FC20E, FC20G, FC5E, FC7E, FC7G, FP1E, FR92E13, FR92E22...(Other models you can see in the webshop)		

connection terminals with screw/faston connections



1

GEV No.	550278	Ref. No.	1037117300 MA1037117300
description	power terminal block 3-pole max. 40A max 400V connection $\phi 6\text{mm}^2$ / F6.3 temp.-resist. 150°C cross section 6mm ²		
For models:	AR712PA, AR712PP, AR712PS, AR713PA, AR713PP, AR713PS, AR714PA, AR714PP, AR714PS, AR715PA, AR715PP, AR715PS, AR716PA, AR716PP, AR716PS, AR717PA, AR717PP, AR717PS, AR718PA, AR718PP, AR718PS, AR719PA, AR719PP, AR719PS, AR720PA, AR720PP, AR720PS, B124E, BME40DM, BME40DMB, BME40M, BME60DM, BME60DMB, BME60M, BME80M, BSEI40M, EAR612PA, EAR612PP, EAR612PS, EAR613PA, EAR613PP, EAR613PS, EAR614PA, EAR614PP, EAR614PS, EAR615PA, EAR615PP, EAR615PS, EAR616PA, EAR616PP...(Other models you can see in the webshop)		



2

GEV No.	550411	Ref. No.	1037104000 1616200 MA1037104000
description	power terminal block 6-pole max. 40A max 450V connection $\phi 6\text{mm}^2$ / F6.3 temp.-resist. 150°C cross section 6mm ²		
For models:	BIE40B, BIE60B, BM74E, BM77E, BME40M, BME60, BME602, BME60M, BME80M, BRE40, BRE40D, BRE40DB, BRE40DG, BRE40DGB, BRE40G, BSE40M, CFE60, CFE60P, CFGE60, CFGE61, CFGE61D, CFGE61L, CFGE61P, CFVE60, CPE60, CPE602, CPE60DB, CRE6220, CRE6230, CRE6320, CRE6330, CSP6220, CSP6230, CWE42, CWE422, CWE62, CWE622, DLS30, DLS303, DLS30P, DLS30P3, DLS31, DLS313, DLS31P3, FQE40, FQE40D, FQE40DSP, FQE41, FQE41L, FQE41L2...(Other models you can see in the webshop)		



1

GEV No.	550977 ¹	Ref. No.	CR0588170
description	power terminal block 6-pole max. 40A max 450V connection $\phi 6\text{mm}^2$ / F6.3 temp.-resist. 150°C cross section 6mm ² with ground lug		
For models:	EC74EVG, EC78EVG, EC7FE8E, EFT74ELVG, EFT74ERVG, EFT78ELVG, EFT78EMVG, EPC74E, NBR78EF, NBR78EI, NC74E2, NC74EC, NC74EQC, NC78E2, NC78EC, NC78EQC, NC7FE8E, NC7FE8E2, NC7FE8EQ, NC94E, NC94E2, NC98E, NC98E2, NC9FE8E, NC9FE8E2, NCT78E, NCT7FE8E, NFT74EL, NFT74ELC, NFT74ELCO, NFT74ELO, NFT74ER, NFT74ERC, NFT76EL, NFT76ELC, NFT76EM, NFT76EMC, NFT76ER, NFT78EL, NFT78ELC, NFT78ELCO, NFT78ELO, NFT78EM, NFT78EMC, NFT78ER, NFT78ERC, NFT94EL, NFT94ELC, NFT94ELO, NFT94ER...(Other models you can see in the webshop)		

terminal boards



1

GEV No.	550413	Ref. No.	1229800 MA1229800
description	terminal board 3-pole thread M5 L 55mm W 36mm		
For models:	B9SB2E, B9SB2G, B9SB4E, B9SB4G, B9V2E, B9V2G, B9V4E, B9V4G, BR707E, BR707EI, C7011EFE, C7011EFEQ, C707EFE, C707EFEQ, C9F4E, C9F6E, C9FE6GS, C9V2E, C9V4E, CP704E, CP92E, CP94E, CP95B2E, CP95B4E, CPE60, F9V2E, F9V2ER, F9V4E, F9V4EC, F9V4ECR, F9V4ER, F9V4ERL, FC5E, FR74E, FR77E, P9D10E, P9D15E, P9DA10E, P9DA15E, P9DSB10E, P9I10E, P9IA10E, PDASB10E, PI707E, SBA, SBAC, SVAC, SVAC12, SVAC16, SVAC20...(Other models you can see in the webshop)		

rail-mounted terminals

rail-mounted terminal blocks



1

GEV No.	550421 ¹	Ref. No.	R65220090
description	rail-mounted terminal block 5-pole contacts 3P+N+E cross section 1.0-10mm ²		
For models:	CVE004H, CVE004M, CVE104H, CVE104M, CVE105H, CVE105M, CVG105H, CVG105M, EC106M, EM106H, EM106M, EM106M+SC, EM106P, EV006M, EV106H, EV106M, EV106M+SC, EV106P, FE105M, FE105X, FE110M, FE110X, FG110M, FG110X, FG210M, FG210X, MACE04M, MACE05M, MACE07M, MACG05M, ME061D, ME061M, ME061P, ME061T, ME106M, ME106P, ME106X, MEMT06D, MEMT06P, MEVT06D, MEVT06P, MG106M, MG106P, MG106X, MG110M, MG110P, MG110X, MG120M, MG120P, MG120X...(Other models you can see in the webshop)		

¹with fused terminal block





1

GEV No.	550420	Ref. No.	R65220080
description	rail-mounted terminal block 5-pole contacts 3P+N+E cross section 1.5-16mm ²		
For models:	EC110M, EM010M+SC, EM110H, EM110M, EM110M+SC, EM110P, EV110H, EV110M, EV110M+SC, EV110P, FE210M, MACE10M, ME101D, ME101M, ME101P, ME101T, ME110M, ME110P, ME110X, MEMT10D, MEMT10P, MEVT10D, MEVT10P, VE110M, VE110X, VE210P		

¹with ground lug







			
1			
GEV No.	550422	Ref. No.	R65220130
description	rail-mounted terminal block 9-pole		
For models:	EC210M, EM210H, EM210M, EM210M+SC, EM210P, EV210H, EV210M, EV210M+SC, EV210P, ME102D, ME102M, ME102P, ME102T, ME120M, ME120P, ME120X, ME201D, ME201M, ME201P, ME201T, ME202D, ME202M, ME202P, ME202T, ME210M, ME210P, ME210X, ME220M, ME220P, ME220X, MEC24H, MEC40M, MEMT20D, MEMT20P, MEMT21D, MEMT21P, MEMT40D, MEMT40P, MEVT20D, MEVT20P, MEVT21D, MEVT21P, MEVT40D, MEVT40P, MG202P, MG202T, MG-MT40P, MGVT40P, VE120M, VE120P...(Other models you can see in the webshop)		

various			
			
1			
GEV No.	693955	Ref. No.	1878400 MA1878400
description	terminal grounding cable		
For models:	AR712PA, AR712PP, AR712PS, AR713PA, AR713PP, AR713PS, AR-714PA, AR714PP, AR714PS, AR715PA, AR715PP, AR715PS, AR716PA, AR716PP, AR716PS, AR717PA, AR717PP, AR717PS, AR718PA, AR718PP, AR718PS, AR719PA, AR719PP, AR719PS, AR720PA, AR720PP, AR720PS, BIE40B, BIE60B, BME40DM, BME40DMB, BME40M, BME60, BME60Z, BME60DM, BME60DMB, BME60M, BME80M, BRE40, BRE40D, BRE40DB, BRE40DG, BRE40DGB, BRE40G, BSE40M, BSEI40M, CRE6220, CRE6230, CRE6320, CRE6330...(Other models you can see in the webshop)		

gas taps

PEL

20S series			
			
1			
GEV No.	101094	Ref. No.	1341700 SIR0100730
description	gas tap PEL type 20S gas inlet M16x1.5 (tube ø 10mm) bypass nozzle ø 0.35mm gas outlet M16x1.5 (tube ø 10/8mm) thermocouple connection M8x1 pilot connection shaft ø 8x6.5mm shaft L 22/15mm shaft flat lower		
For models:	C9F6G, C9F6GS, T9F6GS		
spare parts for	101094		
	GEV No.	100408	Ref. No. —
	bypass nozzle type PEL20/21 bore ø 0.35mm thread M5x0.5		
	GEV No.	101060	Ref. No. 24030199 MA24030199 SI0100752 SIR0100752
	magnet unit standard L 39mm D1 ø 15.4mm D2 ø 11mm suitable for PEL20-21/JUNKERS/EGA		
	GEV No.	101205	Ref. No. —
	gas tap front part shaft ø 8x6.5mm shaft L 22/15mm shaft flat upper/lower suitable for PEL20		

spare parts for	101094		
	GEV No.	101230	Ref. No. 24030299 MA24030299
	thermocouple nut T1: M8x1 T2: M18x1 aluminium		
accessories for	101094		
	GEV No.	101278	Ref. No. 867-20 MA86720
	olive for pipe ø 10mm Qty 1 pcs		
	GEV No.	101300	Ref. No. 1326500 MA1326500
	union nut thread M16x1.5 tube ø 10mm		
	GEV No.	101450	Ref. No. —
	olive for pipe ø 8mm L 12.7mm Qty 1 pcs ED ø 10mm		
	GEV No.	101451	Ref. No. —
	union nut thread M16x1.5 tube ø 8mm		
	GEV No.	110081	Ref. No. —
	knob ø 70mm shaft ø 8x6.5mm shaft flat universal		
	GEV No.	110083	Ref. No. —
	knob dial plate gas tap without ignition flame silver		









21S series			
			
1			
GEV No.	101095	Ref. No.	1700200 1700500 MA1700200
description	gas tap PEL type 21S gas inlet M16x1.5 (tube ø 10mm) bypass nozzle ø 0.35mm gas outlet M16x1.5 (tube ø 10/8mm) thermocouple connection M8x1 pilot connection M10x1 shaft ø 8x6.5mm shaft L 22/15mm shaft flat lower		
For models:	C7011G, C7011GFE, C7011GFG, C704G, C707G, C707GFE, C707GFG, FT74G, FT74GR, FT77G, FT77GRL, GB707G		
spare parts for	101095		
	GEV No.	100408	Ref. No. —
	bypass nozzle type PEL20/21 bore ø 0.35mm thread M5x0.5		
	GEV No.	101060	Ref. No. 24030199 MA24030199 SI0100752 SIR0100752
	magnet unit standard L 39mm D1 ø 15.4mm D2 ø 11mm suitable for PEL20-21/JUNKERS/EGA		
	GEV No.	101206	Ref. No. —
	gas tap front part shaft ø 8x6.5mm shaft L 22/15mm shaft flat upper/lower suitable for PEL21		
	GEV No.	101230	Ref. No. 24030299 MA24030299
	thermocouple nut T1: M8x1 T2: M18x1 aluminium		
accessories for	101095		
	GEV No.	100908	Ref. No. 0100777 673500 MA673500 R0100777 SIR0100777
	union screw thread M10x1 for pipe ø 4mm Qty 1 pcs		

Table continues overleaf

accessories for		101095	
	GEV No.	100909	Ref. No. —
union screw thread M10x1 for pipe ø 6mm Qty 1 pcs			
	GEV No.	101246	Ref. No. 673600 MA673600
olive for pipe ø 4mm Qty 1 pcs			
	GEV No.	101278	Ref. No. 867-20 MA86720
olive for pipe ø 10mm Qty 1 pcs			
	GEV No.	101286	Ref. No. —
olive ID ø 6mm Qty 1 pcs			
	GEV No.	101300	Ref. No. 1326500 MA1326500
union nut thread M16x1.5 tube ø 10mm			
	GEV No.	101450	Ref. No. —
olive for pipe ø 8mm L 12.7mm Qty 1 pcs ED ø 10mm			
	GEV No.	101451	Ref. No. —
union nut thread M16x1.5 tube ø 8mm			
	GEV No.	110081	Ref. No. —
knob ø 70mm shaft ø 8x6.5mm shaft flat universal			
	GEV No.	112206	Ref. No. —
knob dial plate silver gas tap PEL21/22/23 t.max.°C ED ø 63mm ID ø 45.5mm			



1

GEV No.	101397	Ref. No.	1888700 1888800 1888900 1916900 CM226800 MA1888700
description	gas tap PEL type 21S gas inlet M16x1.5 (tube ø 10mm) bypass nozzle ø 0.35mm gas outlet M16x1.5 (tube ø 10/8mm) thermocouple connection M9x1 pilot connection M10x1 shaft ø 8x6.5mm shaft L 22/15mm shaft flat lower		
For models:	BR78GF, BR78GI, C7011G, C7011GFE, C7011GFG, C704G, C707G, C707GFE, C707GFG, C712G, C74G, C74GS, C78G, C78GS, C79G, C7FE12G, C7FE12GS, C7FE8G, C7FE8GS, C7FG12G, C7FG12GS, C7FG8G, C7FG8GS, C7FG9G, C7FGM12G, C912G, C912GS, C94G, C94GP, C94GS, C98G, C98GP, C98GS, C9F4GS, C9F6GS, C9F8GS, C9FE12G, C9FE12GS, C9FE4GS, C9FE6GS, C9FE8G, C9FE8GS, C9FEP4GS, C9FEP6GS, C9FEP8GS, C9FG12G, C9FG12GS, C9FG16G, C9FG8G, C9FG8GP...(Other models you can see in the webshop)		
spare parts for		101397	
	GEV No.	100408	Ref. No. —
bypass nozzle type PEL20/21 bore ø 0.35mm thread M5x0.5			
	GEV No.	101060	Ref. No. 24030199 MA24030199 SI0100752 SIR0100752
magnet unit standard L 39mm D1 ø 15.4mm D2 ø 11mm suitable for PEL20-21/JUNKERS/EGA			
	GEV No.	101206	Ref. No. —
gas tap front part shaft ø 8x6.5mm shaft L 22/15mm shaft flat upper/lower suitable for PEL21			

spare parts for		101397	
	GEV No.	101231	Ref. No. —
thermocouple nut T1: M9x1 T2: M18x1			
accessories for		101397	
	GEV No.	100908	Ref. No. 0100777 673500 MA673500 R0100777 SIR0100777
union screw thread M10x1 for pipe ø 4mm Qty 1 pcs			
	GEV No.	100909	Ref. No. —
union screw thread M10x1 for pipe ø 6mm Qty 1 pcs			
	GEV No.	101246	Ref. No. 673600 MA673600
olive for pipe ø 4mm Qty 1 pcs			
	GEV No.	101278	Ref. No. 867-20 MA86720
olive for pipe ø 10mm Qty 1 pcs			
	GEV No.	101286	Ref. No. —
olive ID ø 6mm Qty 1 pcs			
	GEV No.	101300	Ref. No. 1326500 MA1326500
union nut thread M16x1.5 tube ø 10mm			
	GEV No.	101450	Ref. No. —
olive for pipe ø 8mm L 12.7mm Qty 1 pcs ED ø 10mm			
	GEV No.	101451	Ref. No. —
union nut thread M16x1.5 tube ø 8mm			
	GEV No.	110081	Ref. No. —
knob ø 70mm shaft ø 8x6.5mm shaft flat universal			
	GEV No.	112206	Ref. No. —
knob dial plate silver gas tap PEL21/22/23 t.max.°C ED ø 63mm ID ø 45.5mm			



1

















GEV No.	101693	Ref. No.	1031500200 MA1031500200
description	gas tap PEL type 21S gas inlet M16x1.5 (tube ø 10mm) bypass nozzle ø 0.7mm gas outlet M16x1.5 (tube ø 10/8mm) thermocouple connection M8x1 pilot connection M10x1 shaft ø 6x4.6mm shaft L 35/28mm shaft flat right		
For models:	BIG40, BIG60, CFG101, CFG70, CFG70M, CFGE61, CFGE61D, CFGE61L, CFGE61P, OCFG101, OCFG70, OCFG61, OPG41, OPG61, PCG41, PCG41L, PCG61, PCG61L		
spare parts for		101693	
	GEV No.	100552	Ref. No. 0102067 1884200 MA1884200 R0102067 SIR0102067
bypass nozzle type PEL20/21 bore ø 0.7mm thread M5x0.5			
	GEV No.	101060	Ref. No. 24030199 MA24030199 SI0100752 SIR0100752
magnet unit standard L 39mm D1 ø 15.4mm D2 ø 11mm suitable for PEL20-21/JUNKERS/EGA			

Table continues overleaf



spare parts for 101693				
	GEV No.	101230	Ref. No.	24030299 MA24030299
thermocouple nut T1: M8x1 T2: M18x1 aluminium				
	GEV No.	101877	Ref. No.	—
gas tap front part shaft ø 6x4.6mm type PEL21				
accessories for 101693				
	GEV No.	100908	Ref. No.	0100777 673500 MA673500 R0100777 SIR0100777
union screw thread M10x1 for pipe ø 4mm Qty 1 pcs				
	GEV No.	100909	Ref. No.	—
union screw thread M10x1 for pipe ø 6mm Qty 1 pcs				
	GEV No.	101246	Ref. No.	673600 MA673600
olive for pipe ø 4mm Qty 1 pcs				
	GEV No.	101278	Ref. No.	867-20 MA86720
olive for pipe ø 10mm Qty 1 pcs				
	GEV No.	101286	Ref. No.	—
olive ID ø 6mm Qty 1 pcs				
	GEV No.	101300	Ref. No.	1326500 MA1326500
union nut thread M16x1.5 tube ø 10mm				
	GEV No.	101450	Ref. No.	—
olive for pipe ø 8mm L 12.7mm Qty 1 pcs ED ø 10mm				
	GEV No.	101451	Ref. No.	—
union nut thread M16x1.5 tube ø 8mm				

 <p>1</p>				
GEV No.	101913	Ref. No.	1031501300 MA1031501300	
description	gas tap PEL type 215 gas inlet M16x1.5 (tube ø 10mm) bypass nozzle ø 0.9mm gas outlet M16x1.5 (tube ø 10/8mm) thermocouple connection M8x1 pilot connection M10x1 shaft ø 6x4.6mm shaft L 35/28mm shaft flat right			
For models:	CFG101, CFG70, CFG70M, CFGE61, CFGE61D, CFGE61L, CFGE61P, OCFG101, OCFG70, OCFGE61, OPCG41, OPCG61, OPLG40, OPLG80, PCG41, PCG41L, PCG42, PCG61, PCG61L, PCG82, PLG40, PLG80			
spare parts for 101913				
	GEV No.	100528	Ref. No.	1033720200 1889000 MA1033720200 MA1889000
bypass nozzle type PEL20/21 bore ø 0.9mm thread M5x0.5				
	GEV No.	101060	Ref. No.	24030199 MA24030199 SIO100752 SIR0100752
magnet unit standard L 39mm D1 ø 15.4mm D2 ø 11mm suitable for PEL20-21/JUNKERS/EGA				
	GEV No.	101230	Ref. No.	24030299 MA24030299
thermocouple nut T1: M8x1 T2: M18x1 aluminium				













spare parts for 101913				
	GEV No.	101877	Ref. No.	—
gas tap front part shaft ø 6x4.6mm type PEL21				
accessories for 101913				
	GEV No.	100908	Ref. No.	0100777 673500 MA673500 R0100777 SIR0100777
union screw thread M10x1 for pipe ø 4mm Qty 1 pcs				
	GEV No.	100909	Ref. No.	—
union screw thread M10x1 for pipe ø 6mm Qty 1 pcs				
	GEV No.	101246	Ref. No.	673600 MA673600
olive for pipe ø 4mm Qty 1 pcs				
	GEV No.	101278	Ref. No.	867-20 MA86720
olive for pipe ø 10mm Qty 1 pcs				
	GEV No.	101286	Ref. No.	—
olive ID ø 6mm Qty 1 pcs				
	GEV No.	101300	Ref. No.	1326500 MA1326500
union nut thread M16x1.5 tube ø 10mm				
	GEV No.	101450	Ref. No.	—
olive for pipe ø 8mm L 12.7mm Qty 1 pcs ED ø 10mm				
	GEV No.	101451	Ref. No.	—
union nut thread M16x1.5 tube ø 8mm				
	GEV No.	110078	Ref. No.	—
knob without symbol ø 70mm shaft ø 6x4.6mm shaft flat universal				
	GEV No.	112206	Ref. No.	—
knob dial plate silver gas tap PEL21/22/23 t.max.°C ED ø 63mm ID ø 45.5mm				

 <p>1</p>				
GEV No.	101824	Ref. No.	CR0580450	
description	gas tap PEL type 215 gas inlet pipe flange ø 21mm bypass nozzle ø 0.9mm gas outlet M16x1.5 (tube ø 10/8mm) thermocouple connection M9x1 pilot connection M10x1 shaft ø 8x6.5mm shaft L 22/15mm shaft flat upper pipe input ø 9mm			
For models:	NC712G36, NC74G12, NC78G24, NC7FE12G36, NC7FE8G24, NC7FG12G44, NC7FG8G32, NC7FGM12G, NC912G44, NC94G16, NC94G20, NC98G28, NC98G40, NC9FE12G44, NC9FE8G28, NC9FG12G52, NC9FG16G72, NC9FG8G32, NC9FG8G36, NC9FG8G48, NC9FGM12G, NFT74GL, NFT74GR, NFT76GL, NFT76GM, NFT76GR, NFT78GL, NFT78GM, NFT78GR, NFT94GL, NFT94GR, NFT96GL, NFT96GM, NFT96GL, NFT98GL, NFT98GM, NFT98GR, NS78GS, NS7FG12GS, NS7FG8GS, NT7FG12G, NT9FG12G			



22N/O series



GEV No.	101443	Ref. No.	1337600 673800 MA1337600
description	gas tap PEL type 22N/O gas inlet M20x1.5 (tube ø 12mm) bypass nozzle ø 0.35mm gas outlet M20x1.5 (tube ø 12/10mm) thermocouple connection pilot connection M10x1 shaft ø 10x8mm shaft L 25/17mm shaft flat lower		
For models:	C9F4G, C9F6G, C9F8G, C9SB4GS, C9V2G, C9V4G, C9V6G, C9V8G		
spare parts for	101443		
	GEV No.	100259	Ref. No. —
bypass nozzle type PEL22 bore ø 0.35mm thread M6x0.5			
	GEV No.	101201	Ref. No. —
gas tap front part shaft ø 10x8mm shaft L 25/17mm shaft flat upper/lower suitable for PEL22			
	GEV No.	101240	Ref. No. —
gas connection thread M20x1.5 tube ø 12/10mm for PEL gas taps with gasket and screws horizontal			
	GEV No.	101460	Ref. No. —
O-ring ø 12.37mm D1 ø 2.62mm suitable for PEL22			
	GEV No.	101461	Ref. No. —
screw kit suitable for PEL22 Qty 4 pcs			
accessories for	101443		
	GEV No.	100908	Ref. No. 0100777 673500 MA673500 R0100777 SIR0100777
union screw thread M10x1 for pipe ø 4mm Qty 1 pcs			
	GEV No.	100909	Ref. No. —
union screw thread M10x1 for pipe ø 6mm Qty 1 pcs			
	GEV No.	101246	Ref. No. 673600 MA673600
olive for pipe ø 4mm Qty 1 pcs			
	GEV No.	101248	Ref. No. 673300 MA673300
olive for pipe ø 12mm Qty 1 pcs suitable for PEL			
	GEV No.	101249	Ref. No. 673400 MA673400
olive for pipe ø 10mm Qty 1 pcs			
	GEV No.	101250	Ref. No. 673200 MA673200
union nut thread M20x1.5 for pipe ø 10mm			
	GEV No.	101251	Ref. No. 673100 MA673100
union nut thread M20x1.5 for pipe ø 12mm			
	GEV No.	101286	Ref. No. —
olive ID ø 6mm Qty 1 pcs			

22S/O series











GEV No.	101089	Ref. No.	1093600 1093700 1337200 MA1093600
description	gas tap PEL type 22S/O gas inlet M20x1.5 (tube ø 12mm) bypass nozzle ø 0.35mm gas outlet M20x1.5 (tube ø 12/10mm) thermocouple connection M8x1 pilot connection M10x1 shaft ø 10x8mm shaft L 25/17mm shaft flat upper		
For models:	704S, 706S, C9F4GS, C9F6GS, C9F8GS, C9SB4GS, C9V2GS, C9V4GS, C9V6GS, C9V8GS, CP707G, CP92G, CP94G, F9SB2G, F9SB2GR, F9SB4G, F9SB4GR, F9SB4GRL, F9V2G, F9V2GR, F9V4G, F9V4GR, F9V4GRL, P9D2G, PD707G, T7011GFG, T707G, T707GFG, TPF706S		
spare parts for	101089		
	GEV No.	100259	Ref. No. —
bypass nozzle type PEL22 bore ø 0.35mm thread M6x0.5			
	GEV No.	101058	Ref. No. —
magnet unit L 39mm D1 ø 15.4mm D2 ø 13.5mm suitable for PEL22/EGA24197 standard			
	GEV No.	101201	Ref. No. —
gas tap front part shaft ø 10x8mm shaft L 25/17mm shaft flat upper/lower suitable for PEL22			
	GEV No.	101230	Ref. No. 24030299 MA24030299
thermocouple nut T1: M8x1 T2: M18x1 aluminium			
	GEV No.	101240	Ref. No. —
gas connection thread M20x1.5 tube ø 12/10mm for PEL gas taps with gasket and screws horizontal			
	GEV No.	101460	Ref. No. —
O-ring ø 12.37mm D1 ø 2.62mm suitable for PEL22			
	GEV No.	101461	Ref. No. —
screw kit suitable for PEL22 Qty 4 pcs			
accessories for	101089		
	GEV No.	100908	Ref. No. 0100777 673500 MA673500 R0100777 SIR0100777
union screw thread M10x1 for pipe ø 4mm Qty 1 pcs			
	GEV No.	100909	Ref. No. —
union screw thread M10x1 for pipe ø 6mm Qty 1 pcs			
	GEV No.	101241	Ref. No. —
gas connection thread M20x1.5 tube ø 12/10mm for PEL gas taps vertical			
	GEV No.	101246	Ref. No. 673600 MA673600
olive for pipe ø 4mm Qty 1 pcs			
	GEV No.	101248	Ref. No. 673300 MA673300
olive for pipe ø 12mm Qty 1 pcs suitable for PEL			

Table continues overleaf



accessories for 101089				
	GEV No.	101249	Ref. No.	673400 MA673400
olive for pipe ø 10mm Qty 1 pcs				
	GEV No.	101250	Ref. No.	673200 MA673200
union nut thread M20x1.5 for pipe ø 10mm				
	GEV No.	101251	Ref. No.	673100 MA673100
union nut thread M20x1.5 for pipe ø 12mm				
	GEV No.	101286	Ref. No.	—
olive ID ø 6mm Qty 1 pcs				
	GEV No.	110080	Ref. No.	—
knob ø 70mm shaft ø 10x8mm shaft flat universal				
	GEV No.	112206	Ref. No.	—
knob dial plate silver gas tap PEL21/22/23 t.max.°C ED ø 63mm ID ø 45.5mm				

 <p>1</p>				
GEV No.	101086	Ref. No.	1888600 1926800 MA1888600 MA1926800	
description	gas tap PEL type 22S/O gas inlet M20x1.5 (tube ø 12mm) bypass nozzle ø 0.35mm gas outlet M20x1.5 (tube ø 12/10mm) thermocouple connection M9x1 pilot connection M10x1 shaft ø 10x8mm shaft L 25/17mm shaft flat lower			
For models:	C124G, C129G, C12C2G9, C12C9G, C12FG9G, C712G, C74G, C78G, C7FE12G, C7FE8G, C7FG12G, C7FG8G, C7FGM12G, C912G, C912GS, C94G, C94GP, C94GS, C98G, C98GP, C98GS, C9FE12G, C9FE12GS, C9FE8G, C9FE8GS, C9FG12G, C9FG12GS, C9FG16G, C9FG8G, C9FG8GP, C9FG8GS, C9FGM12G, CP704G, CP92G, CP94G, CP9SB2G, CP9SB4G, ET78VG, ET7FG8G, FB1GS, FP1GS, NG74G, NG78G, NG94G, NG98G, NT78G, NT7FG12G, NT7FG8G, NT98G, NT9FG12G... (Other models you can see in the webshop)			
spare parts for 101086				
	GEV No.	100259	Ref. No.	—
bypass nozzle type PEL22 bore ø 0.35mm thread M6x0.5				
	GEV No.	101058	Ref. No.	—
magnet unit L 39mm D1 ø 15.4mm D2 ø 13.5mm suitable for PEL22/ EGA24197 standard				
	GEV No.	101201	Ref. No.	—
gas tap front part shaft ø 10x8mm shaft L 25/17mm shaft flat upper/lower suitable for PEL22				
	GEV No.	101231	Ref. No.	—
thermocouple nut T1: M9x1 T2: M18x1				
	GEV No.	101240	Ref. No.	—
gas connection thread M20x1.5 tube ø 12/10mm for PEL gas taps with gasket and screws horizontal				
	GEV No.	101460	Ref. No.	—
O-ring ø 12.37mm D1 ø 2.62mm suitable for PEL22				
	GEV No.	101461	Ref. No.	—
screw kit suitable for PEL22 Qty 4 pcs				

accessories for 101086				
	GEV No.	100908	Ref. No.	0100777 673500 MA673500 R0100777 SIR0100777
union screw thread M10x1 for pipe ø 4mm Qty 1 pcs				
	GEV No.	100909	Ref. No.	—
union screw thread M10x1 for pipe ø 6mm Qty 1 pcs				
	GEV No.	101241	Ref. No.	—
gas connection thread M20x1.5 tube ø 12/10mm for PEL gas taps vertical				
	GEV No.	101246	Ref. No.	673600 MA673600
olive for pipe ø 4mm Qty 1 pcs				
	GEV No.	101248	Ref. No.	673300 MA673300
olive for pipe ø 12mm Qty 1 pcs suitable for PEL				
	GEV No.	101249	Ref. No.	673400 MA673400
olive for pipe ø 10mm Qty 1 pcs				
	GEV No.	101250	Ref. No.	673200 MA673200
union nut thread M20x1.5 for pipe ø 10mm				
	GEV No.	101251	Ref. No.	673100 MA673100
union nut thread M20x1.5 for pipe ø 12mm				
	GEV No.	101286	Ref. No.	—
olive ID ø 6mm Qty 1 pcs				
	GEV No.	110080	Ref. No.	—
knob ø 70mm shaft ø 10x8mm shaft flat universal				
	GEV No.	112206	Ref. No.	—
knob dial plate silver gas tap PEL21/22/23 t.max.°C ED ø 63mm ID ø 45.5mm				

22S/V series



 <p>1</p>				
GEV No.	101457	Ref. No.	1031027900 932500 MA1031027900 MA932500	
description	gas tap alternatives to JUNKERS type CH110 gas inlet M20x1.5 (tube ø 12mm) bypass nozzle ø 0.35mm gas outlet M20x1.5 (tube ø 12/10mm) thermocouple connection M8x1 pilot connection M10x1 shaft ø 10mm shaft L 25mm shaft flat with pipe outlet			
For models:	704S, 706S, TPF706S			
spare parts for 101457				
	GEV No.	100259	Ref. No.	—
bypass nozzle type PEL22 bore ø 0.35mm thread M6x0.5				

Table continues overleaf

spare parts for		101457	
	GEV No.	100908	Ref. No.
			0100777 673500 MA673500 R0100777 SIR0100777
union screw thread M10x1 for pipe ø 4mm Qty 1 pcs			
	GEV No.	101058	Ref. No.
			—
magnet unit L 39mm D1 ø 15.4mm D2 ø 13.5mm suitable for PEL22/ EGA24197 standard			
	GEV No.	101200	Ref. No.
			—
gas tap front part shaft ø 10mm shaft L 25mm shaft flat suitable for 22S/O			
	GEV No.	101230	Ref. No.
			24030299 MA24030299
thermocouple nut T1: M8x1 T2: M18x1 aluminium			
	GEV No.	101241	Ref. No.
			—
gas connection thread M20x1.5 tube ø 12/10mm for PEL gas taps vertical			
	GEV No.	101246	Ref. No.
			673600 MA673600
olive for pipe ø 4mm Qty 1 pcs			
	GEV No.	101460	Ref. No.
			—
O-ring ø 12.37mm D1 ø 2.62mm suitable for PEL22			
	GEV No.	101461	Ref. No.
			—
screw kit suitable for PEL22 Qty 4 pcs			
accessories for		101457	
	GEV No.	100945	Ref. No.
			—
roll pin ø 3.2mm L 10mm			
	GEV No.	101218	Ref. No.
			—
shaft extension JUNKERS			
	GEV No.	101219	Ref. No.
			—
shaft extension L 25mm JUNKERS			
	GEV No.	101231	Ref. No.
			—
thermocouple nut T1: M9x1 T2: M18x1			
	GEV No.	101248	Ref. No.
			673300 MA673300
olive for pipe ø 12mm Qty 1 pcs suitable for PEL			
	GEV No.	101249	Ref. No.
			673400 MA673400
olive for pipe ø 10mm Qty 1 pcs			
	GEV No.	101250	Ref. No.
			673200 MA673200
union nut thread M20x1.5 for pipe ø 10mm			
	GEV No.	101251	Ref. No.
			673100 MA673100
union nut thread M20x1.5 for pipe ø 12mm			
	GEV No.	101290	Ref. No.
			—
thermocouple nut T1: M10x1 T2: M18x1 suitable for PEL20/21			
	GEV No.	110064	Ref. No.
			932600 MA932600
knob			
	GEV No.	110066	Ref. No.
			932700 MA932700
knob screw			

accessories for		101457	
	GEV No.	550396	Ref. No.
			—
shaft extension L 25mm JUNKERS			

 Image not available 1			
GEV No.	101909	Ref. No.	1031503700
description	gas tap type PEL22S		
For models:	BRG40, BRG40G		
spare parts for		101909	
	GEV No.	100628	Ref. No.
			—
bypass nozzle type PEL23/24 bore ø 1.05mm thread M8x0.5			
	GEV No.	100908	Ref. No.
			0100777 673500 MA673500 R0100777 SIR0100777
union screw thread M10x1 for pipe ø 4mm Qty 1 pcs			
	GEV No.	101058	Ref. No.
			—
magnet unit L 39mm D1 ø 15.4mm D2 ø 13.5mm suitable for PEL22/ EGA24197 standard			
	GEV No.	101200	Ref. No.
			—
gas tap front part shaft ø 10mm shaft L 25mm shaft flat suitable for 22S/O			
	GEV No.	101230	Ref. No.
			24030299 MA24030299
thermocouple nut T1: M8x1 T2: M18x1 aluminium			
	GEV No.	101241	Ref. No.
			—
gas connection thread M20x1.5 tube ø 12/10mm for PEL gas taps vertical			
	GEV No.	101246	Ref. No.
			673600 MA673600
olive for pipe ø 4mm Qty 1 pcs			
	GEV No.	101460	Ref. No.
			—
O-ring ø 12.37mm D1 ø 2.62mm suitable for PEL22			
	GEV No.	101461	Ref. No.
			—
screw kit suitable for PEL22 Qty 4 pcs			
accessories for		101909	
	GEV No.	101248	Ref. No.
			673300 MA673300
olive for pipe ø 12mm Qty 1 pcs suitable for PEL			
	GEV No.	101249	Ref. No.
			673400 MA673400
olive for pipe ø 10mm Qty 1 pcs			
	GEV No.	101250	Ref. No.
			673200 MA673200
union nut thread M20x1.5 for pipe ø 10mm			
	GEV No.	101251	Ref. No.
			673100 MA673100
union nut thread M20x1.5 for pipe ø 12mm			



23S/V series

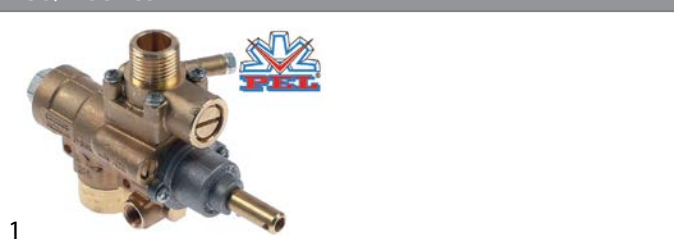

GEV No.	101630	Ref. No.	745700 MA745700
description	gas tap PEL type 23S/V gas inlet 1/2" IT bypass nozzle ø 0.35mm gas outlet 1/2" MT (tube ø 14mm) thermocouple connection M10x1 pilot connection M10x1 shaft ø 10mm shaft L 25mm shaft flat		
spare parts for	101630		
	GEV No.	100455	Ref. No. —
	bypass nozzle type PEL23/24 bore ø 0.35mm thread M8x0.5		
	GEV No.	101059	Ref. No. —
	magnet unit T1: M10x1 T2: M22x1 L 46mm ø 18mm suitable for PEL23S M10x1		
	GEV No.	102767	Ref. No. —
	gas tap front part shaft ø 10mm shaft L 26.5mm shaft flat suitable for PEL23S		
accessories for	101630		
	GEV No.	100908	Ref. No. 0100777 673500 MA673500 R0100777 SIR0100777
	union screw thread M10x1 for pipe ø 4mm Qty 1 pcs		
	GEV No.	100909	Ref. No. —
	union screw thread M10x1 for pipe ø 6mm Qty 1 pcs		
	GEV No.	100945	Ref. No. —
	roll pin ø 3.2mm L 10mm		
	GEV No.	101218	Ref. No. —
	shaft extension JUNKERS		
	GEV No.	101219	Ref. No. —
	shaft extension L 25mm JUNKERS		
	GEV No.	101246	Ref. No. 673600 MA673600
	olive for pipe ø 4mm Qty 1 pcs		
	GEV No.	101286	Ref. No. —
	olive ID ø 6mm Qty 1 pcs		
	GEV No.	110064	Ref. No. 932600 MA932600
	knob		
	GEV No.	110066	Ref. No. 932700 MA932700
	knob screw		
	GEV No.	550396	Ref. No. —
	shaft extension L 25mm JUNKERS		















GEV No.	101093	Ref. No.	1345300 19546-00 MA1345300 MA1954600
description	gas tap PEL type 23S/V gas inlet M28x1.5 (tube ø 20mm) bypass nozzle ø 0.35mm thermocouple connection M10x1 pilot connection M10x1 shaft ø 10x8mm shaft L 25/17mm shaft flat lower		
For models:	MM10DG, MM10DGS, MM15DG, P9D10G, P9D15G, P9DA10G, P9DA15G, P9DASB10G, P9DSB10G, PD98G10, PD98G15, PD98G15A, PD9S8G10, PDASB10G, PI98G10, PI98G14, PI98G14A, T9F4G, T9F6GS, T9S84G, T9V4G, T9V6GS		
spare parts for	101093		
	GEV No.	100455	Ref. No. —
	bypass nozzle type PEL23/24 bore ø 0.35mm thread M8x0.5		
	GEV No.	101059	Ref. No. —
	magnet unit T1: M10x1 T2: M22x1 L 46mm ø 18mm suitable for PEL23S M10x1		
	GEV No.	101204	Ref. No. —
	gas tap front part shaft ø 10x8mm shaft L 25/17mm shaft flat upper/lower suitable for PEL23S		
	GEV No.	101245	Ref. No. —
	gas connection thread M24x1.5 tube ø 12/16mm vertical for PEL gas taps		
	GEV No.	101463	Ref. No. —
	screw suitable for PEL23S Qty 4 pcs		
	GEV No.	528455	Ref. No. —
	O-ring Viton thickness 2.62mm ID ø 18.72mm Qty 1 pcs		
accessories for	101093		
	GEV No.	100908	Ref. No. 0100777 673500 MA673500 R0100777 SIR0100777
	union screw thread M10x1 for pipe ø 4mm Qty 1 pcs		
	GEV No.	100909	Ref. No. —
	union screw thread M10x1 for pipe ø 6mm Qty 1 pcs		
	GEV No.	101246	Ref. No. 673600 MA673600
	olive for pipe ø 4mm Qty 1 pcs		
	GEV No.	101252	Ref. No. —
	union nut thread M24x1.5 for pipe ø 12mm		
	GEV No.	101253	Ref. No. 1421000 MA1421000
	union nut thread M24x1.5 PEL for pipe ø 16mm		
	GEV No.	101254	Ref. No. 1346900 MA1346900
	union nut thread M28x1.5 tube ø 20mm		
	GEV No.	101255	Ref. No. —
	olive for pipe ø 12mm Qty 1 pcs		

Table continues overleaf

accessories for		101093	
	GEV No.	101256	Ref. No. 1127400 MA1127400
olive for pipe ø 16mm Qty 1 pcs			
	GEV No.	101257	Ref. No. 1347000 MA1347000
olive for pipe ø 20mm Qty 1 pcs			
	GEV No.	101286	Ref. No. —
olive ID ø 6mm Qty 1 pcs			
	GEV No.	110080	Ref. No. —
knob ø 70mm shaft ø 10x8mm shaft flat universal			
	GEV No.	112206	Ref. No. —
knob dial plate silver gas tap PEL21/22/23 t.max.°C ED ø 63mm ID ø 45.5mm			

alternatives to JUNKERS

1			
GEV No.	101457	Ref. No.	1031027900 932500 MA1031027900 MA932500
description	gas tap alternatives to JUNKERS type CH110 gas inlet M20x1.5 (tube ø 12mm) bypass nozzle ø 0.35mm gas outlet M20x1.5 (tube ø 12/10mm) thermocouple connection M8x1 pilot connection M10x1 shaft ø 10mm shaft L 25mm shaft flat with pipe outlet		
For models:	704S, 706S, TPF706S		
spare parts for	101457		
	GEV No.	100259	Ref. No. —
bypass nozzle type PEL22 bore ø 0.35mm thread M6x0.5			
	GEV No.	100908	Ref. No. 0100777 673500 MA673500 R0100777 SIR0100777
union screw thread M10x1 for pipe ø 4mm Qty 1 pcs			
	GEV No.	101058	Ref. No. —
magnet unit L 39mm D1 ø 15.4mm D2 ø 13.5mm suitable for PEL22/ EGA24197 standard			
	GEV No.	101200	Ref. No. —
gas tap front part shaft ø 10mm shaft L 25mm shaft flat suitable for 22S/O			
	GEV No.	101230	Ref. No. 24030299 MA24030299
thermocouple nut T1: M8x1 T2: M18x1 aluminium			
	GEV No.	101241	Ref. No. —
gas connection thread M20x1.5 tube ø 12/10mm for PEL gas taps vertical			
	GEV No.	101246	Ref. No. 673600 MA673600
olive for pipe ø 4mm Qty 1 pcs			
	GEV No.	101460	Ref. No. —
O-ring ø 12.37mm D1 ø 2.62mm suitable for PEL22			

spare parts for	101457		
	GEV No.	101461	Ref. No. —
screw kit suitable for PEL22 Qty 4 pcs			
accessories for	101457		
	GEV No.	100945	Ref. No. —
roll pin ø 3.2mm L 10mm			
	GEV No.	101218	Ref. No. —
shaft extension JUNKERS			
	GEV No.	101219	Ref. No. —
shaft extension L 25mm JUNKERS			
	GEV No.	101231	Ref. No. —
thermocouple nut T1: M9x1 T2: M18x1			
	GEV No.	101248	Ref. No. 673300 MA673300
olive for pipe ø 12mm Qty 1 pcs suitable for PEL			
	GEV No.	101249	Ref. No. 673400 MA673400
olive for pipe ø 10mm Qty 1 pcs			
	GEV No.	101250	Ref. No. 673200 MA673200
union nut thread M20x1.5 for pipe ø 10mm			
	GEV No.	101251	Ref. No. 673100 MA673100
union nut thread M20x1.5 for pipe ø 12mm			
	GEV No.	101290	Ref. No. —
thermocouple nut T1: M10x1 T2: M18x1 suitable for PEL20/21			
	GEV No.	110064	Ref. No. 932600 MA932600
knob			
	GEV No.	110066	Ref. No. 932700 MA932700
knob screw			
	GEV No.	550396	Ref. No. —
shaft extension L 25mm JUNKERS			

1			
GEV No.	101630	Ref. No.	745700 MA745700
description	gas tap PEL type 23S/V gas inlet 1/2" IT bypass nozzle ø 0.35mm gas outlet 1/2" MT (tube ø 14mm) thermocouple connection M10x1 pilot connection M10x1 shaft ø 10mm shaft L 25mm shaft flat		
spare parts for	101630		
	GEV No.	100455	Ref. No. —
bypass nozzle type PEL23/24 bore ø 0.35mm thread M8x0.5			
	GEV No.	101059	Ref. No. —
magnet unit T1: M10x1 T2: M22x1 L 46mm ø 18mm suitable for PEL23S M10x1			

Table continues overleaf



spare parts for 101630	
	GEV No. 102767 Ref. No. — gas tap front part shaft ø 10mm shaft L 26.5mm shaft flat suitable for PEL23S
accessories for 101630	
	GEV No. 100908 Ref. No. 0100777 673500 MA673500 R0100777 SIR0100777 union screw thread M10x1 for pipe ø 4mm Qty 1 pcs
	GEV No. 100909 Ref. No. — union screw thread M10x1 for pipe ø 6mm Qty 1 pcs
	GEV No. 100945 Ref. No. — roll pin ø 3.2mm L 10mm
	GEV No. 101218 Ref. No. — shaft extension JUNKERS
	GEV No. 101219 Ref. No. — shaft extension L 25mm JUNKERS
	GEV No. 101246 Ref. No. 673600 MA673600 olive for pipe ø 4mm Qty 1 pcs
	GEV No. 101286 Ref. No. — olive ID ø 6mm Qty 1 pcs
	GEV No. 110064 Ref. No. 932600 MA932600 knob
	GEV No. 110066 Ref. No. 932700 MA932700 knob screw
	GEV No. 550396 Ref. No. — shaft extension L 25mm JUNKERS

spare parts for 101909	
	GEV No. 101200 Ref. No. — gas tap front part shaft ø 10mm shaft L 25mm shaft flat suitable for 22S/O
	GEV No. 101230 Ref. No. 24030299 MA24030299 thermocouple nut T1: M8x1 T2: M18x1 aluminium
	GEV No. 101241 Ref. No. — gas connection thread M20x1.5 tube ø 12/10mm for PEL gas taps vertical
	GEV No. 101246 Ref. No. 673600 MA673600 olive for pipe ø 4mm Qty 1 pcs
	GEV No. 101460 Ref. No. — O-ring ø 12.37mm D1 ø 2.62mm suitable for PEL22
	GEV No. 101461 Ref. No. — screw kit suitable for PEL22 Qty 4 pcs
accessories for 101909	
	GEV No. 101248 Ref. No. 673300 MA673300 olive for pipe ø 12mm Qty 1 pcs suitable for PEL
	GEV No. 101249 Ref. No. 673400 MA673400 olive for pipe ø 10mm Qty 1 pcs
	GEV No. 101250 Ref. No. 673200 MA673200 union nut thread M20x1.5 for pipe ø 10mm
	GEV No. 101251 Ref. No. 673100 MA673100 union nut thread M20x1.5 for pipe ø 12mm

 Image not available 1			
GEV No.	101909	Ref. No.	1031503700
description	gas tap type PEL22S		
For models:	BRG40, BRG40G		
spare parts for 101909			
	GEV No. 100628	Ref. No.	—
bypass nozzle type PEL23/24 bore ø 1.05mm thread M8x0.5			
	GEV No. 100908	Ref. No.	0100777 673500 MA673500 R0100777 SIR0100777
union screw thread M10x1 for pipe ø 4mm Qty 1 pcs			
	GEV No. 101058	Ref. No.	—
magnet unit L 39mm D1 ø 15.4mm D2 ø 13.5mm suitable for PEL22/ EGA24197 standard			





SKG			
 1			
GEV No.	101154	Ref. No.	1031028200 1031028300 MA1031028300
description	gas tap SKG without ignition flame connection		
spare parts for 101154			
	GEV No. 101060	Ref. No.	24030199 MA24030199 S10100752 SIR0100752
magnet unit standard L 39mm D1 ø 15.4mm D2 ø 11mm suitable for PEL20-21/JUNKERS/EGA			
accessories for 101154			
	GEV No. 101060	Ref. No.	24030199 MA24030199 S10100752 SIR0100752
magnet unit standard L 39mm D1 ø 15.4mm D2 ø 11mm suitable for PEL20-21/JUNKERS/EGA			
	GEV No. 101351	Ref. No.	—
mounting strap for gas tap			

Table continues overleaf

accessories for 101154			
	GEV No.	101376	Ref. No. —
gasket ID ø 8mm ED ø 12mm H 3/5mm			

gas thermostats

SIT





630 Eurosit series

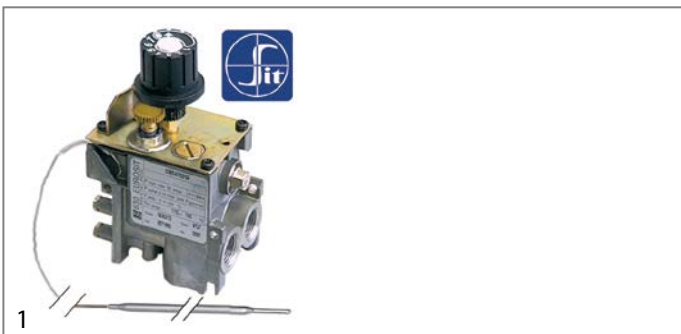

GEV No.	107688	Ref. No.	CR0585671
description	gas thermostat 100-340°C gas inlet 3/8" gas outlet 3/8" thermocouple connection M9x1 pilot connection M10x1 probe ø 4mm probe L 72mm capillary pipe 1050mm		



GEV No.	101188	Ref. No.	CM097000 MACM097000
description	gas thermostat type 630 Eurosit series t.max. 190°C 110-190°C gas inlet 3/8" gas outlet 3/8" thermocouple connection M9x1 pilot connection M10x1 probe ø 4mm probe L 202mm capillary pipe 1050mm SIT		
For models:	F12C4G15, F74G10, F74G15, F74G6, F76G10, F78G15, F94G10, F94G15, F94G6, F96G10, F98G15, F954G15, F958G15, PI76G5, PI96G5		



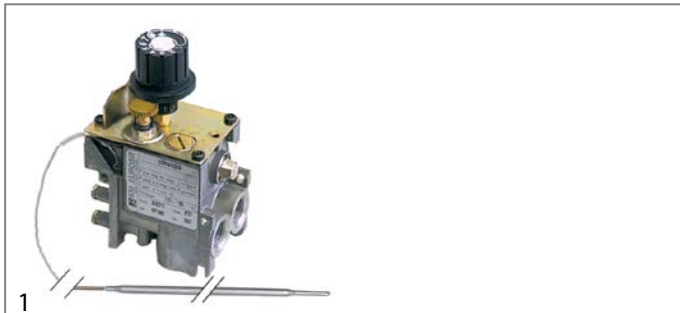

accessories for 101188			
	GEV No.	100904	Ref. No. 1388000 1394700 MA1394700
locking screw M10x1 for pipe ø 4mm Qty 1 pcs			
	GEV No.	100905	Ref. No. 1394800 MA1394800
locking screw M10x1 for pipe ø 6mm Qty 1 pcs			
	GEV No.	101273	Ref. No. 0100842 417810 MA417810 R0100842 SIR0100842
olive for pipe ø 12mm L 9.5mm brass Qty 1 pcs suitable for universal			
	GEV No.	101276	Ref. No. 459300 MA459300
union screw thread 3/8" tube ø 12mm Qty 1 pcs			
	GEV No.	101333	Ref. No. 1888200 MA1888200
plug thread 3/8" with O-ring			

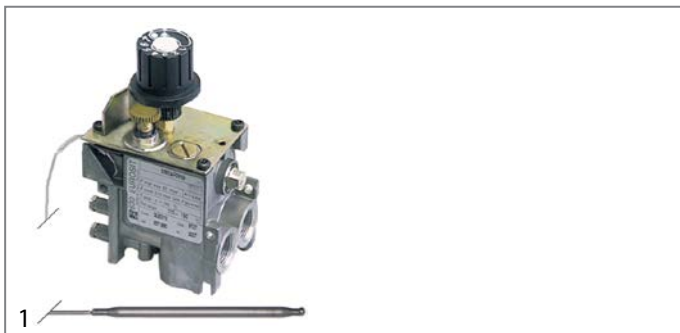











GEV No.	103076	Ref. No.	CR0508680
description	gas thermostat type 630 Eurosit series t.max. 190°C 110-190°C gas inlet 3/8" gas outlet 3/8" thermocouple connection M9x1 pilot connection M10x1 probe ø 4mm probe L 202mm capillary pipe 1050mm SIT		
For models:	EF74G15, EF74G8VA, EF74G8VG, FQG41, FQG61, NF74G10, NF74G15, NF74G15T, NF74G8, NF76G10, NF76G8, NF78G15, NF78G15T, NF94G15, NF94G23, NF96G10, NF98G15, NF98G23, OFQG41, OFQG61		









GEV No.	101409	Ref. No.	1031504800 MA1031504800
description	gas thermostat type 630 Eurosit series t.max. 280°C 40-280°C gas inlet 3/8" gas outlet 3/8" thermocouple connection M9x1 pilot connection M10x1 probe ø 4mm probe L 72mm capillary pipe 1050mm SIT		

spare parts for 101409			
	GEV No.	101333	Ref. No. 1888200 MA1888200
plug thread 3/8" with O-ring			
accessories for 101409			
	GEV No.	100904	Ref. No. 1388000 1394700 MA1394700
locking screw M10x1 for pipe ø 4mm Qty 1 pcs			
	GEV No.	100905	Ref. No. 1394800 MA1394800
locking screw M10x1 for pipe ø 6mm Qty 1 pcs			
	GEV No.	101273	Ref. No. 0100842 417810 MA417810 R0100842 SIR0100842
olive for pipe ø 12mm L 9.5mm brass Qty 1 pcs suitable for universal			
	GEV No.	101276	Ref. No. 459300 MA459300
union screw thread 3/8" tube ø 12mm Qty 1 pcs			



				
GEV No.	101125	Ref. No.	1887600 MA1887600	
description	gas thermostat type 630 Eurosit series t.max. 340°C 100-340°C gas inlet 3/8" gas outlet 3/8" thermocouple connection M9x1 pilot connection M10x1 probe ø 4mm probe L 72mm capillary pipe 1050mm SIT			
For models:	BF78G, BF912G, BF912GH, BF98G, BR707G, BR707GI, BR78GF, BR78GI, C12FGP9G, C7FG12G, C7FG8G, C7FGM12G, C9F4E, C9F4GS, C9F6E, C9F6GS, C9F8GS, C9FG12G, C9FG16G, C9FG8G, C9FG8GP, C9FG-M12G, C9FP, C9FP4GS, C9FP6GS, C9FP8GS, FT129GLC, FT129GM, FT12C9GL, FT12C9GM, FT12C9GTL, FT12C9GTMC, FT12G7L70, FT12G7LC70, FT12G7R70, FT12G7RC70, FT12G7RL70, FT12G7RLC70, FT14G8L90, FT14G8LC90, FT14G8R2L90, FT14G8R2LC90, FT14G8R90, FT14G8RC90, FT6G4L70, FT6G4LC70, FT6G4R70, FT6G4RC70, FT74GL, FT74GLC...(Other models you can see in the webshop)			
accessories for	101125			
	GEV No.	100825	Ref. No.	—
	gas tap spindle shaft ø 8x6.5mm shaft L 22/14mm suitable for EUROSIT			
	GEV No.	100904	Ref. No.	1388000 1394700 MA1394700
	locking screw M10x1 for pipe ø 4mm Qty 1 pcs			
	GEV No.	100905	Ref. No.	1394800 MA1394800
	locking screw M10x1 for pipe ø 6mm Qty 1 pcs			
	GEV No.	100949	Ref. No.	—
	gasket suitable for 630 Eurosit series			
	GEV No.	101273	Ref. No.	0100842 417810 MA417810 R0100842 SIR0100842
	olive for pipe ø 12mm L 9.5mm brass Qty 1 pcs suitable for universal			
	GEV No.	101276	Ref. No.	459300 MA459300
	union screw thread 3/8" tube ø 12mm Qty 1 pcs			
	GEV No.	101333	Ref. No.	1888200 MA1888200
	plug thread 3/8" with O-ring			
	GEV No.	101390	Ref. No.	1905525 MA1905525
	gas tap spindle shaft ø 6x4.6mm shaft L 32/15mm gas tap with ignition flame suitable for ZANUSSI, MARENO for gas thermostat EUROSIT			
	GEV No.	101392	Ref. No.	1868600 MA1868600
	adapter suitable for 630 Eurosit series			
	GEV No.	110357	Ref. No.	—
	gas tap spindle shaft ø 8x6.5mm shaft L 36/12mm suitable for 630 Eurosit series			
	GEV No.	110358	Ref. No.	—
	adapter shaft ø 10x8mm shaft L 29/18mm suitable for 630 Eurosit series			

				
GEV No.	101700	Ref. No.	CR0585670	
description	gas thermostat type 630 Eurosit series t.max. 340°C 100-340°C gas inlet 3/8" gas outlet 3/8" thermocouple connection M9x1 pilot connection M10x1 probe ø 4mm probe L 72mm capillary pipe 1050mm SIT			
For models:	NBR78GF, NBR78GI, NC7FG12G44, NC7FG8G32, NC7FG8G36, NC7FG8G48, NC9FG12G52, NC9FG16G72, NC9FG8G32, NC9FG8G36, NC9FG8G48, NFT74GTLC, NFT74GTLCO, NFT74GTLO, NFT74GTRC, NFT76GLC, NFT76GMC, NFT76GRC, NFT76GTLC, NFT76GTMC, NFT78GTL, NFT78GTLC, NFT78GTLCO, NFT78GTLO, NFT78GTM, NFT78GTMC, NFT78GTR, NFT78GTRC, NFT94GTLC, NFT94GTLO, NFT94GTRC, NFT96GLC, NFT96GMC, NFT98GTL, NFT98GTLC, NFT98GTLO, NFT98GTM, NFT98GTMC, NFT98GTR, NT78G, NT7FG12G, NT7FG8G, NT98G, NT9FG12G, NT9FG8G			
accessories for	101700			
	GEV No.	100904	Ref. No.	1388000 1394700 MA1394700
	locking screw M10x1 for pipe ø 4mm Qty 1 pcs			
	GEV No.	100905	Ref. No.	1394800 MA1394800
	locking screw M10x1 for pipe ø 6mm Qty 1 pcs			
	GEV No.	101273	Ref. No.	0100842 417810 MA417810 R0100842 SIR0100842
	olive for pipe ø 12mm L 9.5mm brass Qty 1 pcs suitable for universal			
	GEV No.	101276	Ref. No.	459300 MA459300
	union screw thread 3/8" tube ø 12mm Qty 1 pcs			
	GEV No.	101333	Ref. No.	1888200 MA1888200
	plug thread 3/8" with O-ring			



710 Minisit series



GEV No.	101437	Ref. No.	1393300 1451000 1451024 1677300 1677314 MA1393300
description	gas thermostat SIT type MINISIT 710 t.max. 190°C 110-190°C gas inlet 1/2" gas outlet 3/8" thermocouple connection M9x1 pilot connection M10x1 probe ø 6mm probe L 102mm capillary pipe 1050mm probe type type A3 pressure controller yes pressure regulator 3-18mbar gland nut		
For models:	FQG40, FQG60, FR74G, FR77G, FR92G13, FR94G13, MM10IG, P9I10G, P9I5G, P9IA10G, PI707G		
spare parts for	101437		
	GEV No.	101053	Ref. No. 24021499 MA24021499
magnet unit T1: M9x1 T2: M24x1 L 45mm ø 17mm suitable for Minisit			
accessories for	101437		
	GEV No.	100809	Ref. No. 1394000 BN6A011606 MA1394000
O-ring EPDM thickness 2mm ID ø 21mm Qty 1 pcs			
	GEV No.	100820	Ref. No. 1395714 MA1395714
gland duct ET M14x1.5 IT M10x0.75 probe ø max. 6.5mm WS 22			
	GEV No.	100904	Ref. No. 1388000 1394700 MA1394700
locking screw M10x1 for pipe ø 4mm Qty 1 pcs			
	GEV No.	100905	Ref. No. 1394800 MA1394800
locking screw M10x1 for pipe ø 6mm Qty 1 pcs			
	GEV No.	101054	Ref. No. —
magnet unit T1: M10x1 T2: M24x1 L 45mm ø 17mm suitable for Minisit			
	GEV No.	101136	Ref. No. 1393700 24020299 MA1393700
piezoelectric igniter suitable for Minisit with cover cap ømm connection F6.3x0.8			
	GEV No.	101137	Ref. No. 1393600 MA1393600
cover cap without piezoelectric igniter			
	GEV No.	101267	Ref. No. —
reducer IT 3/8" ET 1/2" L 21mm			
	GEV No.	101268	Ref. No. 1393800 MA1393800
gas connection thread 3/8" angled with O-ring MINISIT 710			
	GEV No.	101269	Ref. No. 1393900 MA1393900
gas connection thread 1/2" angled with O-ring MINISIT 710			



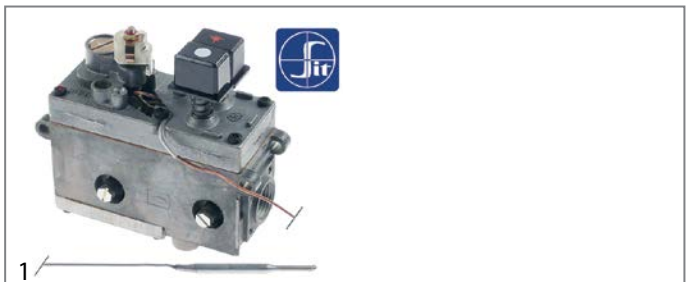











accessories for	101437		
	GEV No.	101270	Ref. No. —
screw connection IT 3/8" ET 3/8" L 28mm			
	GEV No.	101272	Ref. No. —
screw connection IT 1/2" ET 3/8" L 57mm			
	GEV No.	101273	Ref. No. 0100842 417810 MA417810 R0100842 SIR0100842
olive for pipe ø 12mm L 9.5mm brass Qty 1 pcs suitable for universal			
	GEV No.	101274	Ref. No. —
olive for pipe ø 16mm Qty 1 pcs			
	GEV No.	101275	Ref. No. —
union screw thread 1/2" for pipe ø 16mm Qty 1 pcs			
	GEV No.	101276	Ref. No. 459300 MA459300
union screw thread 3/8" tube ø 12mm Qty 1 pcs			
	GEV No.	110068	Ref. No. 1393500 1693500 24020399 MA1393500
knob suitable for Minisit ø 37mm			



GEV No.	101132	Ref. No.	1393100 410622 671111 MA1393100
description	gas thermostat SIT type MINISIT 710 t.max. 340°C 100-340°C gas inlet 1/2" gas outlet 3/8" thermocouple connection M9x1 pilot connection M10x1 probe ø 5mm probe L 68mm capillary pipe 1050mm probe type type B1 pressure controller no pressure regulator or mbar gland nut ignition gas no		
For models:	C9F4G, C9F4GS, C9F6G, C9F6GS, C9F8G, C9F8GS, T9F4G, T9F6GS		
spare parts for	101132		
	GEV No.	101053	Ref. No. 24021499 MA24021499
magnet unit T1: M9x1 T2: M24x1 L 45mm ø 17mm suitable for Minisit			
	GEV No.	102102	Ref. No. 24021699 BN6A011709 MA24021699
probe 100-340°C probe ø 5mm probe L 68mm capillary pipe 1750mm t.max. 340°C oven/grill probe type type B1 suitable for MINISIT 710			
accessories for	101132		
	GEV No.	100809	Ref. No. 1394000 BN6A011606 MA1394000
O-ring EPDM thickness 2mm ID ø 21mm Qty 1 pcs			
	GEV No.	100904	Ref. No. 1388000 1394700 MA1394700
locking screw M10x1 for pipe ø 4mm Qty 1 pcs			







Table continues overleaf









accessories for 101132	
	GEV No. 100905 Ref. No. 1394800 MA1394800
locking screw M10x1 for pipe ø 6mm Qty 1 pcs	
	GEV No. 101054 Ref. No. —
magnet unit T1: M10x1 T2: M24x1 L 45mm ø 17mm suitable for Minisit	
	GEV No. 101136 Ref. No. 1393700 24020299 MA1393700
piezoelectric igniter suitable for Minisit with cover cap ømm connection F6.3x0.8	
	GEV No. 101137 Ref. No. 1393600 MA1393600
cover cap without piezoelectric igniter	
	GEV No. 101267 Ref. No. —
reducer IT 3/8" ET 1/2" L 21mm	
	GEV No. 101268 Ref. No. 1393800 MA1393800
gas connection thread 3/8" angled with O-ring MINISIT 710	
	GEV No. 101269 Ref. No. 1393900 MA1393900
gas connection thread 1/2" angled with O-ring MINISIT 710	
	GEV No. 101270 Ref. No. —
screw connection IT 3/8" ET 3/8" L 28mm	
	GEV No. 101272 Ref. No. —
screw connection IT 1/2" ET 3/8" L 57mm	
	GEV No. 101273 Ref. No. 0100842 417810 MA417810 R0100842 SIR0100842
olive for pipe ø 12mm L 9.5mm brass Qty 1 pcs suitable for universal	
	GEV No. 101274 Ref. No. —
olive for pipe ø 16mm Qty 1 pcs	
	GEV No. 101275 Ref. No. —
union screw thread 1/2" for pipe ø 16mm Qty 1 pcs	
	GEV No. 101276 Ref. No. 459300 MA459300
union screw thread 3/8" tube ø 12mm Qty 1 pcs	
	GEV No. 110068 Ref. No. 1393500 1693500 24020399 MA1393500
knob suitable for Minisit ø 37mm	

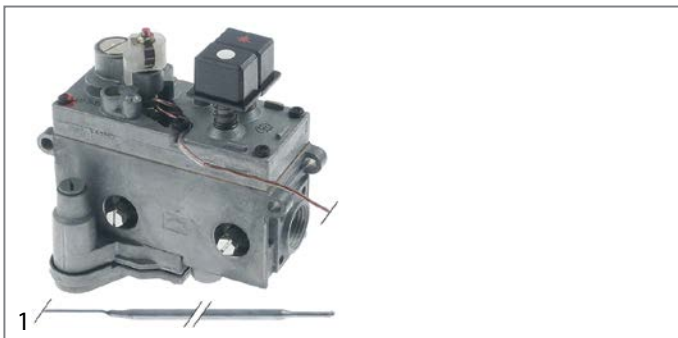











	
GEV No. 101438	Ref. No. 139300 1393400 1685500 MA1393400 SIR0100855
description	gas thermostat SIT type MINISIT 710 t.max. 340°C 100-340°C gas inlet 1/2" gas outlet 3/8" thermocouple connection M9x1 pilot connection M10x1 probe ø 5mm probe L 68mm capillary pipe 1050mm probe type B1 pressure controller yes pressure regulator 3-18mbar gland nut
For models:	BR707G
spare parts for 101438	
	GEV No. 101053 Ref. No. 24021499 MA24021499
magnet unit T1: M9x1 T2: M24x1 L 45mm ø 17mm suitable for Minisit	
	GEV No. 102102 Ref. No. 24021699 BN6A011709 MA24021699
probe 100-340°C probe ø 5mm probe L 68mm capillary pipe 1750mm t.max. 340°C oven/grill probe type type B1 suitable for MINISIT 710	
accessories for 101438	
	GEV No. 100809 Ref. No. 1394000 BN6A011606 MA1394000
O-ring EPDM thickness 2mm ID ø 21mm Qty 1 pcs	
	GEV No. 100904 Ref. No. 1388000 1394700 MA1394700
locking screw M10x1 for pipe ø 4mm Qty 1 pcs	
	GEV No. 100905 Ref. No. 1394800 MA1394800
locking screw M10x1 for pipe ø 6mm Qty 1 pcs	
	GEV No. 101054 Ref. No. —
magnet unit T1: M10x1 T2: M24x1 L 45mm ø 17mm suitable for Minisit	
	GEV No. 101136 Ref. No. 1393700 24020299 MA1393700
piezoelectric igniter suitable for Minisit with cover cap ømm connection F6.3x0.8	
	GEV No. 101137 Ref. No. 1393600 MA1393600
cover cap without piezoelectric igniter	
	GEV No. 101267 Ref. No. —
reducer IT 3/8" ET 1/2" L 21mm	
	GEV No. 101268 Ref. No. 1393800 MA1393800
gas connection thread 3/8" angled with O-ring MINISIT 710	
	GEV No. 101269 Ref. No. 1393900 MA1393900
gas connection thread 1/2" angled with O-ring MINISIT 710	

Table continues overleaf















accessories for		101438	
	GEV No.	101270	Ref. No. —
screw connection IT 3/8" ET 3/8" L 28mm			
	GEV No.	101272	Ref. No. —
screw connection IT 1/2" ET 3/8" L 57mm			
	GEV No.	101273	Ref. No. 0100842 417810 MA417810 R0100842 SIR0100842
olive for pipe ϕ 12mm L 9.5mm brass Qty 1 pcs suitable for universal			
	GEV No.	101274	Ref. No. —
olive for pipe ϕ 16mm Qty 1 pcs			
	GEV No.	101275	Ref. No. —
union screw thread 1/2" for pipe ϕ 16mm Qty 1 pcs			
	GEV No.	101276	Ref. No. 459300 MA459300
union screw thread 3/8" tube ϕ 12mm Qty 1 pcs			
	GEV No.	110068	Ref. No. 1393500 1693500 24020399 MA1393500
knob suitable for Minisit ϕ 37mm			







GEV No.	101088	Ref. No.	1031501100 MA1031501100
description	gas thermostat with pressure controller SIT type MINISIT 710 t.max. 100°C 30-100°C gas inlet 1/2" gas outlet 3/8" thermocouple connection M9x1 pilot connection M10x1 probe ϕ 5mm probe L 125mm capillary pipe 1050mm probe type type A1 pressure controller yes pressure regulator 3-18mbar gland nut		
For models:	BMG40, BMG60		
spare parts for	101088		
	GEV No.	101053	Ref. No. 24021499 MA24021499
magnet unit T1: M9x1 T2: M24x1 L 45mm ϕ 17mm suitable for Minisit			
	GEV No.	102100	Ref. No. —
probe 30-100°C probe ϕ 5mm probe L 122mm capillary pipe 1050mm t.max. 100°C bain marie probe type type A1 suitable for MINISIT 710			
accessories for	101088		
	GEV No.	100809	Ref. No. 1394000 BN6A011606 MA1394000
O-ring EPDM thickness 2mm ID ϕ 21mm Qty 1 pcs			
	GEV No.	100820	Ref. No. 1395714 MA1395714
gland duct ET M14x1.5 IT M10x0.75 probe ϕ max. 6.5mm WS 22			
	GEV No.	100904	Ref. No. 1388000 1394700 MA1394700
locking screw M10x1 for pipe ϕ 4mm Qty 1 pcs			

accessories for		101088	
	GEV No.	100905	Ref. No. 1394800 MA1394800
locking screw M10x1 for pipe ϕ 6mm Qty 1 pcs			
	GEV No.	101054	Ref. No. —
magnet unit T1: M10x1 T2: M24x1 L 45mm ϕ 17mm suitable for Minisit			
	GEV No.	101136	Ref. No. 1393700 24020299 MA1393700
piezoelectric igniter suitable for Minisit with cover cap ϕ 6mm connection F6.3x0.8			
	GEV No.	101137	Ref. No. 1393600 MA1393600
cover cap without piezoelectric igniter			
	GEV No.	101267	Ref. No. —
reducer IT 3/8" ET 1/2" L 21mm			
	GEV No.	101268	Ref. No. 1393800 MA1393800
gas connection thread 3/8" angled with O-ring MINISIT 710			
	GEV No.	101269	Ref. No. 1393900 MA1393900
gas connection thread 1/2" angled with O-ring MINISIT 710			
	GEV No.	101270	Ref. No. —
screw connection IT 3/8" ET 3/8" L 28mm			
	GEV No.	101272	Ref. No. —
screw connection IT 1/2" ET 3/8" L 57mm			
	GEV No.	101273	Ref. No. 0100842 417810 MA417810 R0100842 SIR0100842
olive for pipe ϕ 12mm L 9.5mm brass Qty 1 pcs suitable for universal			
	GEV No.	101274	Ref. No. —
olive for pipe ϕ 16mm Qty 1 pcs			
	GEV No.	101275	Ref. No. —
union screw thread 1/2" for pipe ϕ 16mm Qty 1 pcs			
	GEV No.	101276	Ref. No. 459300 MA459300
union screw thread 3/8" tube ϕ 12mm Qty 1 pcs			
	GEV No.	110680	Ref. No. —
knob graduated Min/Max ϕ 82mm shaft ϕ 6x4.6mm shaft flat upper black			



			
GEV No.	101130	Ref. No.	1120813
description	gas thermostat without cap, button and angle SIT type MINISIT 710 t.max. 100°C 30-100°C gas inlet 1/2" gas outlet 3/8" thermocouple connection M9x1 pilot connection M10x1 probe ø 5mm probe L 122mm capillary pipe 1050mm probe type type A1 pressure controller no pressure regulator mbar gland nut		
spare parts for	101130		
	GEV No.	101053	Ref. No. 24021499 MA24021499
	magnet unit T1: M9x1 T2: M24x1 L 45mm ø 17mm suitable for Minisit		
	GEV No.	102100	Ref. No. —
	probe 30-100°C probe ø 5mm probe L 122mm capillary pipe 1050mm t.max. 100°C bain marie probe type type A1 suitable for MINISIT 710		
accessories for	101130		
	GEV No.	100809	Ref. No. 1394000 BN6A011606 MA1394000
	O-ring EPDM thickness 2mm ID ø 21mm Qty 1 pcs		
	GEV No.	100820	Ref. No. 1395714 MA1395714
	gland duct ET M14x1.5 IT M10x0.75 probe ø max. 6.5mm WS 22		
	GEV No.	100904	Ref. No. 1388000 1394700 MA1394700
	locking screw M10x1 for pipe ø 4mm Qty 1 pcs		
	GEV No.	100905	Ref. No. 1394800 MA1394800
	locking screw M10x1 for pipe ø 6mm Qty 1 pcs		
	GEV No.	101054	Ref. No. —
	magnet unit T1: M10x1 T2: M24x1 L 45mm ø 17mm suitable for Minisit		
	GEV No.	101136	Ref. No. 1393700 24020299 MA1393700
	piezoelectric igniter suitable for Minisit with cover cap ømm connection F6.3x0.8		
	GEV No.	101137	Ref. No. 1393600 MA1393600
	cover cap without piezoelectric igniter		
	GEV No.	101267	Ref. No. —
	reducer IT 3/8" ET 1/2" L 21mm		
	GEV No.	101268	Ref. No. 1393800 MA1393800
	gas connection thread 3/8" angled with O-ring MINISIT 710		
	GEV No.	101269	Ref. No. 1393900 MA1393900
	gas connection thread 1/2" angled with O-ring MINISIT 710		
	GEV No.	101270	Ref. No. —
	screw connection IT 3/8" ET 3/8" L 28mm		
	GEV No.	101272	Ref. No. —
	screw connection IT 1/2" ET 3/8" L 57mm		

accessories for	101130		
	GEV No.	101273	Ref. No. 0100842 417810 MA417810 R0100842 SIR0100842
	olive for pipe ø 12mm L 9.5mm brass Qty 1 pcs suitable for universal		
	GEV No.	101274	Ref. No. —
	olive for pipe ø 16mm Qty 1 pcs		
	GEV No.	101275	Ref. No. —
	union screw thread 1/2" for pipe ø 16mm Qty 1 pcs		
	GEV No.	101276	Ref. No. 459300 MA459300
	union screw thread 3/8" tube ø 12mm Qty 1 pcs		
	GEV No.	110068	Ref. No. 1393500 1693500 24020399 MA1393500
	knob suitable for Minisit ø 37mm		







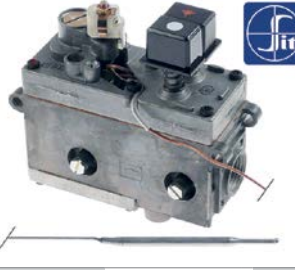

			
GEV No.	101131	Ref. No.	1031500300 1743300 1743324 SIR0108030
description	gas thermostat without cap, button and angle SIT type MINISIT 710 t.max. 190°C 50-190°C gas inlet 1/2" gas outlet 3/8" thermocouple connection M9x1 pilot connection M10x1 probe ø 5mm probe L 98mm capillary pipe 1200mm probe type type A2 pressure controller no pressure regulator mbar gland nut		
For models:	FR74G, FR77G		
spare parts for	101131		
	GEV No.	101053	Ref. No. 24021499 MA24021499
	magnet unit T1: M9x1 T2: M24x1 L 45mm ø 17mm suitable for Minisit		
	GEV No.	102103	Ref. No. 24021799 BN6A015201 MA24021799
	probe 60-200°C probe ø 5mm probe L 98mm capillary pipe 1050mm t.max. 200°C fryer probe type type A2 suitable for MINISIT 710		
accessories for	101131		
	GEV No.	100809	Ref. No. 1394000 BN6A011606 MA1394000
	O-ring EPDM thickness 2mm ID ø 21mm Qty 1 pcs		
	GEV No.	100820	Ref. No. 1395714 MA1395714
	gland duct ET M14x1.5 IT M10x0.75 probe ø max. 6.5mm WS 22		
	GEV No.	100904	Ref. No. 1388000 1394700 MA1394700
	locking screw M10x1 for pipe ø 4mm Qty 1 pcs		
	GEV No.	100905	Ref. No. 1394800 MA1394800
	locking screw M10x1 for pipe ø 6mm Qty 1 pcs		

Table continues overleaf

accessories for		101131	
	GEV No.	101054	Ref. No. —
magnet unit T1: M10x1 T2: M24x1 L 45mm ø 17mm suitable for Minisit			
	GEV No.	101136	Ref. No. 1393700 24020299 MA1393700
piezoelectric igniter suitable for Minisit with cover cap ømm connection F6.3x0.8			
	GEV No.	101137	Ref. No. 1393600 MA1393600
cover cap without piezoelectric igniter			
	GEV No.	101267	Ref. No. —
reducer IT 3/8" ET 1/2" L 21mm			
	GEV No.	101268	Ref. No. 1393800 MA1393800
gas connection thread 3/8" angled with O-ring MINISIT 710			
	GEV No.	101269	Ref. No. 1393900 MA1393900
gas connection thread 1/2" angled with O-ring MINISIT 710			
	GEV No.	101270	Ref. No. —
screw connection IT 3/8" ET 3/8" L 28mm			
	GEV No.	101272	Ref. No. —
screw connection IT 1/2" ET 3/8" L 57mm			
	GEV No.	101273	Ref. No. 0100842 417810 MA417810 R0100842 SIR0100842
olive for pipe ø 12mm L 9.5mm brass Qty 1 pcs suitable for universal			
	GEV No.	101274	Ref. No. —
olive for pipe ø 16mm Qty 1 pcs			
	GEV No.	101275	Ref. No. —
union screw thread 1/2" for pipe ø 16mm Qty 1 pcs			
	GEV No.	101276	Ref. No. 459300 MA459300
union screw thread 3/8" tube ø 12mm Qty 1 pcs			
	GEV No.	110068	Ref. No. 1393500 1693500 24020399 MA1393500
knob suitable for Minisit ø 37mm			

accessories

probes

	1		
GEV No.	102102	Ref. No.	24021699 BN6A011709 MA24021699
description probe 100-340°C probe ø 5mm probe L 68mm capillary pipe 1750mm t.max. 340°C oven/grill probe type type B1 suitable for MINISIT 710			
For models: BR707G, C9F4G, C9F4GS, C9F6G, C9F6GS, C9F8G, C9F8GS, T9F4G, T9F6GS			

	1		
GEV No.	102103	Ref. No.	24021799 BN6A015201 MA24021799
description probe 60-200°C probe ø 5mm probe L 98mm capillary pipe 1050mm t.max. 200°C fryer probe type type A2 suitable for MINISIT 710			

PEL

25ST series















	1		
GEV No.	101441	Ref. No.	CM140500 MACM140500
description gas thermostat PEL type 25ST 30-90°C gas inlet M16x1.5 (tube ø 10mm) bypass nozzle ø 0.35mm gas outlet M16x1.5 (tube ø 10/8mm) thermocouple connection M9x1 pilot connection M10x1 capillary pipe 1200mm probe ø 6mm probe L 160mm shaft ø 8x6.5mm shaft L 21/15mm shaft flat upper			
For models: B74G, B78G, B94G, B98G, NB74G, NB78G, NB94G, NB98G			
accessories for 101441			
	GEV No.	100259	Ref. No. —
bypass nozzle type PEL22 bore ø 0.35mm thread M6x0.5			
	GEV No.	101060	Ref. No. 24030199 MA24030199 SIR0100752 SIR0100752
magnet unit standard L 39mm D1 ø 15.4mm D2 ø 11mm suitable for PEL20-21/JUNKERS/EGA			
	GEV No.	106200	Ref. No. —
nut thread M9x1 suitable for PEL 24/25S			
accessories for 101441			
	GEV No.	100908	Ref. No. 0100777 673500 MA673500 R0100777 SIR0100777
union screw thread M10x1 for pipe ø 4mm Qty 1 pcs			
	GEV No.	100909	Ref. No. —
union screw thread M10x1 for pipe ø 6mm Qty 1 pcs			
	GEV No.	101246	Ref. No. 673600 MA673600
olive for pipe ø 4mm Qty 1 pcs			
	GEV No.	101278	Ref. No. 867-20 MA86720
olive for pipe ø 10mm Qty 1 pcs			
	GEV No.	101286	Ref. No. —
olive ID ø 6mm Qty 1 pcs			
	GEV No.	101300	Ref. No. 1326500 MA1326500
union nut thread M16x1.5 tube ø 10mm			
	GEV No.	101450	Ref. No. —
olive for pipe ø 8mm L 12.7mm Qty 1 pcs ED ø 10mm			



Table continues overleaf









accessories for	101441		
	GEV No.	101451	Ref. No. —
union nut thread M16x1.5 tube ø 8mm			

1			
GEV No.	107470	Ref. No.	CR0933740
description	gas thermostat PEL type 25ST 90-250°C gas inlet M16x1.5 (tube ø 10mm) bypass nozzle ø 1mm gas outlet M16x1.5 (tube ø 10/8mm) thermocouple connection M8x1 pilot connection M10x1 capillary pipe 1200mm probe ø 6mm probe L 120mm shaft ø 8x6.5mm shaft L 26/15mm shaft flat upper		



1			
GEV No.	101906	Ref. No.	1031504000 MA1031504000
description	gas thermostat PEL type 25ST up to 250°C gas inlet M16x1.5 (tube ø 10mm) bypass nozzle ø 1mm gas outlet M16x1.5 (tube ø 10/8mm) thermocouple connection M8x1 pilot connection M10x1 capillary pipe 1200mm probe ø 6mm probe L 120mm shaft ø 6x4.6mm shaft L 36/25mm shaft flat lower		
For models:	FTG40B, FTG40BLC, FTG40BR, FTG60B, FTG60BLC, FTG60BR, FTG-60BRR, FTG80B, FTG80BLC, FTG80BR		

spare parts for	101906		
	GEV No.	100407	Ref. No. —
bypass nozzle type PEL22 bore ø 1mm thread M6x0.5			
	GEV No.	101060	Ref. No. 24030199 MA24030199 SI0100752 SIR0100752
magnet unit standard L 39mm D1 ø 15.4mm D2 ø 11mm suitable for PEL20-21/JUNKERS/EGA			
	GEV No.	106199	Ref. No. —
nut thread M8x1			

accessories for	101906		
	GEV No.	100908	Ref. No. 0100777 673500 MA673500 R0100777 SIR0100777
union screw thread M10x1 for pipe ø 4mm Qty 1 pcs			
	GEV No.	100909	Ref. No. —
union screw thread M10x1 for pipe ø 6mm Qty 1 pcs			
	GEV No.	101246	Ref. No. 673600 MA673600
olive for pipe ø 4mm Qty 1 pcs			
	GEV No.	101278	Ref. No. 867-20 MA86720
olive for pipe ø 10mm Qty 1 pcs			
	GEV No.	101286	Ref. No. —
olive ID ø 6mm Qty 1 pcs			
	GEV No.	101300	Ref. No. 1326500 MA1326500
union nut thread M16x1.5 tube ø 10mm			
	GEV No.	101450	Ref. No. —
olive for pipe ø 8mm L 12.7mm Qty 1 pcs ED ø 10mm			



accessories for	101906		
	GEV No.	101451	Ref. No. —
union nut thread M16x1.5 tube ø 8mm			
	GEV No.	110078	Ref. No. —
knob without symbol ø 70mm shaft ø 6x4.6mm shaft flat universal			
	GEV No.	110079	Ref. No. —
knob dial plate gas thermostat 1-8 silver			

1			
GEV No.	101907	Ref. No.	1031503900 MA1031503900
description	gas thermostat PEL type 25ST up to 280°C gas inlet M16x1.5 (tube ø 10mm) bypass nozzle ø 1mm gas outlet M16x1.5 (tube ø 10/8mm) thermocouple connection M8x1 pilot connection M10x1 capillary pipe 1200mm probe ø 6mm probe L 120mm shaft ø 6x4.6mm shaft L 36/20mm shaft flat lower		
For models:	FTG40B, FTG40BLC, FTG40BR, FTG60B, FTG60BLC, FTG60BR, FTG-60BRR, FTG80B, FTG80BLC, FTG80BR		

spare parts for	101907		
	GEV No.	100407	Ref. No. —
bypass nozzle type PEL22 bore ø 1mm thread M6x0.5			
	GEV No.	101060	Ref. No. 24030199 MA24030199 SI0100752 SIR0100752
magnet unit standard L 39mm D1 ø 15.4mm D2 ø 11mm suitable for PEL20-21/JUNKERS/EGA			
	GEV No.	106199	Ref. No. —
nut thread M8x1			

accessories for	101907		
	GEV No.	100908	Ref. No. 0100777 673500 MA673500 R0100777 SIR0100777
union screw thread M10x1 for pipe ø 4mm Qty 1 pcs			
	GEV No.	100909	Ref. No. —
union screw thread M10x1 for pipe ø 6mm Qty 1 pcs			
	GEV No.	101246	Ref. No. 673600 MA673600
olive for pipe ø 4mm Qty 1 pcs			
	GEV No.	101278	Ref. No. 867-20 MA86720
olive for pipe ø 10mm Qty 1 pcs			
	GEV No.	101286	Ref. No. —
olive ID ø 6mm Qty 1 pcs			
	GEV No.	101300	Ref. No. 1326500 MA1326500
union nut thread M16x1.5 tube ø 10mm			
	GEV No.	101450	Ref. No. —
olive for pipe ø 8mm L 12.7mm Qty 1 pcs ED ø 10mm			
	GEV No.	101451	Ref. No. —
union nut thread M16x1.5 tube ø 8mm			

Table continues overleaf

accessories for 101907				
	GEV No.	110078	Ref. No.	—
knob without symbol ø 70mm shaft ø 6x4.6mm shaft flat universal				
	GEV No.	110079	Ref. No.	—
knob dial plate gas thermostat 1-8 silver				









GEV No.	107515	Ref. No.	CR0933730
description	gas thermostat PEL type 25ST up to 280°C gas inlet M16x1.5 (tube ø 10mm) bypass nozzle ø 1mm gas outlet M16x1.5 (tube ø 10/8mm) thermocouple connection M8x1 pilot connection M10x1 capillary pipe 1200mm probe ø 6mm probe L 120mm shaft ø 8x6.5mm shaft L 26/15mm shaft flat upper		



SABAF



GEV No.	101173	Ref. No.	103150000 1661300 1699400 MA1699400
description	gas thermostat SABAF type SABAF t.max. 300°C gas inlet M13x1 ET (tube ø 8mm) bypass nozzle ø 0.8mm gas outlet 3/8" ET (tube ø 10mm) gas outlet 2 thermocouple connection M8x1 pilot connection capillary pipe 850mm probe ø 4mm probe L 140mm shaft ø 6x4.6mm shaft L 37/15mm shaft flat lower		
For models:	C7011GFG, C707GFE, C707GFG, CFG101, CFG101D, CFG101L, CFG101P, CFG120, CFG70, CFG70D, CFG70L, CFG70M, CFG70P, EC74G-VG, EC78GVG, EC7FG8G, OCFG101, OCFG120, OCFG70, T7011GFG, T707GFG		

spare parts for 101173				
	GEV No.	101060	Ref. No.	24030199 MA24030199 SI0100752 SIR0100752
magnet unit standard L 39mm D1 ø 15.4mm D2 ø 11mm suitable for PEL20-21/JUNKERS/EGA				

accessories for 101173				
	GEV No.	101277	Ref. No.	—
olive ID ø 8mm Qty 1 pcs				
	GEV No.	101278	Ref. No.	867-20 MA86720
olive for pipe ø 10mm Qty 1 pcs				
	GEV No.	101474	Ref. No.	—
air mixing tube for pilot burner				
	GEV No.	101476	Ref. No.	1665300 MA1665300
union nut thread M13x1 for pipe ø 8mm				
	GEV No.	101478	Ref. No.	1665200 MA1665200
union nut thread 3/8" for pipe ø 10mm				

accessories for 101173				
	GEV No.	110361	Ref. No.	1036702900 1036703300 1841100 MA1036702900 MA1036703300
knob without symbol ø 65mm shaft ø 6x4.6mm shaft flat lower black				
	GEV No.	110603	Ref. No.	1930400 MA1930400
knob dial plate gas thermostat t.max. 300°C 90-300°C				



gas valves and ignition boxes

gas control valves

HONEYWELL



GEV No.	106004	Ref. No.	R63020150
description	gas valve type VK4105C 220-240V 50/60Hz gas inlet flange 32x32mm gas outlet flange 32x32mm thermocouple connection pilot connection pressure range 15-60mbar max 60mbar operator type pressure controller type V5306E 1234 1 suitable for HONEYWELL flange 32x32mm		
For models:	GC106M, GC110M, GC210M, GV106M, GV106M+SC, GV110M, GV-110M+SC, GV210M, GV210M+SC		

accessories for 106004				
	GEV No.	102845	Ref. No.	—
gas connection angled 1/2" flange 32x32mm hole distance 24x24mm Tandem				
	GEV No.	102846	Ref. No.	—
gas connection straight 1/2" flange 32x32mm hole distance 24x24mm suitable for Tandem				



GEV No.	102320	Ref. No.	R63020160
description	gas valve type VK4105Q 220-240V 50/60Hz gas inlet flange 32x32mm gas outlet flange 32x32mm thermocouple connection pilot connection pressure range 15-60mbar max 60mbar operator type HONEYWELL coil type 220/240V (V4336A 2212 1) flange 32x32mm		
For models:	GM106H, GM106M, GM106M+SC, GM106P, GM110H, GM110M, GM110M+SC, GM110P, GM210H, GM210M, GM210M+SC, GM210P, GV106H, GV106P, GV110H, GV110P, GV210H, GV210P		



accessories for 102320				
	GEV No.	102845	Ref. No.	—
gas connection angled 1/2" flange 32x32mm hole distance 24x24mm Tandem				



Table continues overleaf



accessories for	102320		
	GEV No.	102846	Ref. No. —
	gas connection straight 1/2" flange 32x32mm hole distance 24x24mm suitable for Tandem		





GEV No.	106012	Ref. No.	R63020170
description	gas valve type VK4115V 220-240V 50/60Hz gas inlet flange 32x32mm gas outlet flange 32x32mm thermocouple connection pilot connection pressure range 15-60mbar max 60mbar operator type HONEYWELL flange 32x32mm		
For models:	GMT06D, GMT20D, GVT06D, GVT20D, MACG05M, MACG07M, MACG10M, MACG20M, MG061D, MG061M, MG061P, MG061T, MG101D, MG101M, MG101P, MG101T, MG102D, MG102M, MG102P, MG102T, MG201D, MG201M, MG201P, MG201T, MG202D, MG202M, MG202P, MG202T, MGMT06D, MGMT06P, MGMT10D, MGMT10P, MGMT20D, MGMT20P, MGMT21D, MGMT21P, MGMT40D, MGMT40P, MGVT06D, MGVT06P, MGVT10D, MGVT10P, MGVT20D, MGVT20P, MGVT21D, MGVT21P, MGVT40D, MGVT40P, MVG051P		

accessories for	106012		
	GEV No.	102845	Ref. No. —
	gas connection angled 1/2" flange 32x32mm hole distance 24x24mm Tandem		
	GEV No.	102846	Ref. No. —
	gas connection straight 1/2" flange 32x32mm hole distance 24x24mm suitable for Tandem		



GEV No.	101395	Ref. No.	R63020010
description	gas valve type VR4605P 230V 50Hz gas inlet 1/2" gas outlet 1/2" thermocouple connection pilot connection pressure range 8-50mbar operator type 230V (V404A 1071) pressure controller type 220/240V (V404A 1071 4) HONEYWELL coil type 220/240V (V4336A 2220) flange 45x45mm		
For models:	CVG105H, CVG105M, MG106M, MG106P, MG106X, MG110M, MG110P, MG110X, MG120M, MG120P, MG120X, MG210M, MG210P, MG210X, MG220M, MG220P, MG220X, MGC20X, MGC24H, MGC40H, VG105M, VG105X, VG106M, VG106P, VG106X, VG110M, VG110P, VG110X, VG120M, VG120P, VG120X, VG210M, VG210P, VG210X, VG220M, VG220P, VG220X		



accessories for	101395		
	GEV No.	101320	Ref. No. —
	cover suitable for gas valves HONEYWELL		
	GEV No.	102845	Ref. No. —
	gas connection angled 1/2" flange 32x32mm hole distance 24x24mm Tandem		

accessories for	101395		
	GEV No.	102846	Ref. No. —
	gas connection straight 1/2" flange 32x32mm hole distance 24x24mm suitable for Tandem		

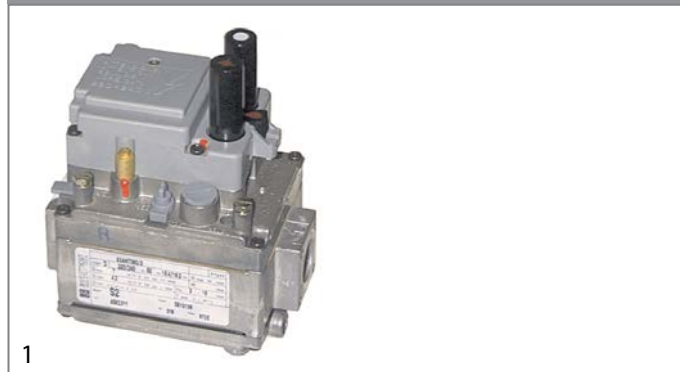
SIT
ELETTROSIT



GEV No.	101126	Ref. No.	R63025020
description	gas valve SIT type ELETROSIT 230V gas inlet 1/2" gas outlet 1/2" thermocouple connection M9x1 pilot connection M10x1 bottom equiv. no. 0.810.136		
For models:	FG105M, FG105X, PG040M, PG040X		

spare parts for	101126		
	GEV No.	101312	Ref. No. 1454900 CR0507660 MA1454900
	microswitch		
	GEV No.	101352	Ref. No. —
	solenoid coil 230V 50Hz suitable for ELETROSIT		

accessories for	101126		
	GEV No.	100006	Ref. No. —
	piezoelectric igniter suitable for ELETROSIT body plastic blowing connection ø2.4mm ø 14mm		
	GEV No.	100904	Ref. No. 1388000 1394700 MA1394700
	locking screw M10x1 for pipe ø 4mm Qty 1 pcs		
	GEV No.	100905	Ref. No. 1394800 MA1394800
	locking screw M10x1 for pipe ø 6mm Qty 1 pcs		
	GEV No.	101301	Ref. No. —
	gas connection thread 1/2" straight ELETROSIT screw with O-ring		
	GEV No.	101303	Ref. No. 1451300
	gas connection straight thread 3/4" ELETROSIT		
	GEV No.	101309	Ref. No. —
	extension		



GEV No.	101127	Ref. No.	1450100 LAR63025030
description	gas valve SIT type ELETTROSIT 230V gas inlet 3/4" gas outlet 3/4" thermocouple connection M9x1 pilot connection M10x1 lateral equiv. no. 0.810.175		
For models:	BR94G, BR94GI, BR96G, BR96GI, BR9M4G, BR9M4GI, BR9M6G, BR9M6GI, FC10G, FC20G, FC5G, FC7G, FG110M, FG110X, FG210M, FG210X, FR92G22, FR94G23, P9110G, P91A10G, PG080M, PG080X		
spare parts for	101127		
	GEV No.	101312	Ref. No. 1454900 CR0507660 MA1454900
	microswitch		
	GEV No.	101352	Ref. No. —
	solenoid coil 230V 50Hz suitable for ELETTROSIT		
accessories for	101127		
	GEV No.	100006	Ref. No. —
	piezoelectric igniter suitable for ELETTROSIT body plastic blowing connection ø2.4mm ø 14mm		
	GEV No.	100904	Ref. No. 1388000 1394700 MA1394700
	locking screw M10x1 for pipe ø 4mm Qty 1 pcs		
	GEV No.	100905	Ref. No. 1394800 MA1394800
	locking screw M10x1 for pipe ø 6mm Qty 1 pcs		
	GEV No.	101301	Ref. No. —
	gas connection thread 1/2" straight ELETTROSIT screw with O-ring		
	GEV No.	101303	Ref. No. 1451300
	gas connection straight thread 3/4" ELETTROSIT		
	GEV No.	101309	Ref. No. —
	extension		





MINISIT











GEV No.	101106	Ref. No.	1060500
description	gas valve gas inlet 3/8" gas outlet 3/8" operable temperature range manual thermocouple connection M9x1 pilot connection M10x1 Minisit SIT		
spare parts for	101106		
	GEV No.	100809	Ref. No. 1394000 BN6A011606 MA1394000
	O-ring EPDM thickness 2mm ID ø 21mm Qty 1 pcs		
	GEV No.	101053	Ref. No. 24021499 MA24021499
	magnet unit T1: M9x1 T2: M24x1 L 45mm ø 17mm suitable for Minisit		
	GEV No.	101054	Ref. No. —
	magnet unit T1: M10x1 T2: M24x1 L 45mm ø 17mm suitable for Minisit		
	GEV No.	101136	Ref. No. 1393700 24020299 MA1393700
	piezoelectric igniter suitable for Minisit with cover cap ømm connection F6.3x0.8		
	GEV No.	101137	Ref. No. 1393600 MA1393600
	cover cap without piezoelectric igniter		
	GEV No.	110068	Ref. No. 1393500 1693500 24020399 MA1393500
	knob suitable for Minisit ø 37mm		
accessories for	101106		
	GEV No.	100904	Ref. No. 1388000 1394700 MA1394700
	locking screw M10x1 for pipe ø 4mm Qty 1 pcs		
	GEV No.	100905	Ref. No. 1394800 MA1394800
	locking screw M10x1 for pipe ø 6mm Qty 1 pcs		
	GEV No.	101267	Ref. No. —
	reducer IT 3/8" ET 1/2" L 21mm		
	GEV No.	101268	Ref. No. 1393800 MA1393800
	gas connection thread 3/8" angled with O-ring MINISIT 710		
	GEV No.	101269	Ref. No. 1393900 MA1393900
	gas connection thread 1/2" angled with O-ring MINISIT 710		
	GEV No.	101270	Ref. No. —
	screw connection IT 3/8" ET 3/8" L 28mm		

Table continues overleaf



accessories for 101106					
	GEV No.	101272	Ref. No.	—	
screw connection IT 1/2" ET 3/8" L 57mm					
	GEV No.	101273	Ref. No.	0100842 417810 MA417810 R0100842 SIR0100842	
olive for pipe ø 12mm L 9.5mm brass Qty 1 pcs suitable for universal					
	GEV No.	101274	Ref. No.	—	
olive for pipe ø 16mm Qty 1 pcs					
	GEV No.	101275	Ref. No.	—	
union screw thread 1/2" for pipe ø 16mm Qty 1 pcs					
	GEV No.	101276	Ref. No.	459300 MA459300	
union screw thread 3/8" tube ø 12mm Qty 1 pcs					

accessories for 101187					
	GEV No.	101308	Ref. No.	—	
gas connection angled flange 45x45mm hole distance 36x36mm 3/4" ELETTROSIT/V4400/4600/4605 screw with O-ring suitable for SIT/HONEYWELL					
	GEV No.	102116	Ref. No.	1870712 MA1870712	
thermopile ROBERTSHAW L 900mm probe ø 9mm probe L 57mm 250-750mV screw connection 7/16"					

NOVASIT					
					
1					
GEV No.	101187	Ref. No.	1870800 826920090 BN826920090 MA1870800		
description	gas valve SIT series Novasit 820 0.17VHz gas inlet 1/2" gas outlet 1/2" thermocouple connection M9x1 pilot connection M10x1 ignition pressurebar pressure range 5-50mbar pressure regulator connection blind equiv. no. 0.820.301 supply Operator millivolt				
For models:	F94G22, F98G22, F9S4G22, F9S8G22, FR92G22, FR94G22, MM10IG, P9110G, P91A10G				
spare parts for	101187				
	GEV No.	101065	Ref. No.	—	
magnet unit with cable L 44mm D1 ø 30mm D2 ø 20mm suitable for NOVASIT					
accessories for	101187				
	GEV No.	100110	Ref. No.	1949700 MA1949700	
pilot burner SIT type 190 series 3 flames nozzle ømm gas connectionmm					
	GEV No.	101305	Ref. No.	2865700 MA2865700 R63080010	
gas connection straight 1/2" flange 45x45mm ELETTROSIT/V4400/4600/4605 suitable for SIT/HONEYWELL hole distance 36x36mm					
	GEV No.	101306	Ref. No.	2865800 MA2865800 R63080020	
gas connection angled flange 45x45mm hole distance 36x36mm 1/2" ELETTROSIT/V4400/4600/4605 screw with O-ring suitable for SIT/HONEYWELL					
	GEV No.	101307	Ref. No.	—	
gas connection straight flange 45x45mm hole distance 36x36mm 3/4" ELETTROSIT/V4400/4600/4605 screw with O-ring suitable for SIT/HONEYWELL					























					
1					
GEV No.	101162	Ref. No.	2863300 MA2863300		
description	gas valve SIT series Novasit 820 230V 50Hz gas inlet 1/2" gas outlet 1/2" thermocouple connection M9x1 pilot connection M10x1 ignition pressure 3-5mbar pressure range 3-30mbar pressure regulator connection blind equiv. no. 0.820.010				
For models:	BR912GFM, BR912GIM, BR94G, BR94GI, BR98GF, BR98GFM, BR98GI, BR98GIM, BR9M4G, BR9M4GI, BR9M6G, BR9M6GI, BR9S8GF, BR9S8GI, BR9SB4G, BR9SB4GI, CS10, CS102G, CS102GP, CS6, MS10AG, MS10IG, MS70AG, MS70IG, MS70IGS				
spare parts for	101162				
	GEV No.	101065	Ref. No.	—	
magnet unit with cable L 44mm D1 ø 30mm D2 ø 20mm suitable for NOVASIT					
	GEV No.	101313	Ref. No.	—	
solenoid coil 230V 50Hz					
accessories for	101162				
	GEV No.	100006	Ref. No.	—	
piezoelectric igniter suitable for ELETTROSIT body plastic blowing connection ø2.4mm ø 14mm					
	GEV No.	101305	Ref. No.	2865700 MA2865700 R63080010	
gas connection straight 1/2" flange 45x45mm ELETTROSIT/V4400/4600/4605 suitable for SIT/HONEYWELL hole distance 36x36mm					
	GEV No.	101306	Ref. No.	2865800 MA2865800 R63080020	
gas connection angled flange 45x45mm hole distance 36x36mm 1/2" ELETTROSIT/V4400/4600/4605 screw with O-ring suitable for SIT/HONEYWELL					
	GEV No.	101307	Ref. No.	—	
gas connection straight flange 45x45mm hole distance 36x36mm 3/4" ELETTROSIT/V4400/4600/4605 screw with O-ring suitable for SIT/HONEYWELL					
	GEV No.	101308	Ref. No.	—	
gas connection angled flange 45x45mm hole distance 36x36mm 3/4" ELETTROSIT/V4400/4600/4605 screw with O-ring suitable for SIT/HONEYWELL					
	GEV No.	101312	Ref. No.	1454900 CR0507660 MA1454900	
microswitch					

Table continues overleaf

accessories for 101162				
	GEV No.	101314	Ref. No.	—
solenoid coil 24V 50Hz				
	GEV No.	101317	Ref. No.	1880600 MA1880600
plug with cable L 1000mm suitable for NOVASIT				
	GEV No.	101318	Ref. No.	—
cover cap for solenoid coil suitable for NOVASIT				



1	GEV No.	101908	Ref. No.	1871200 MA1871200
description	gas valve SIT series Novasit 820 230V 50Hz gas inlet 1/2" gas outlet 1/2" thermocouple connection M9x1 pilot connection M10x1 ignition pressurebar pressure regulator connection blind equiv. no. 0.820.018 output pilot burner M10x1 input pressure max. 60bar setting range 3-30bar			
For models:	BR912GFM, BR912GIM, BR98GF, BR98GFM, BR98GI, BR98GIM, F94G22K, F98G22K, F954G22K, F958G22K, FR92G22T, FR94G22T, NBR912GFM, NBR912GIM, NBR98GF, NBR98GFM, NBR98GI, NBR98GIM, NF94G23K, NF98G23K, NPC74G, NPC76G, NPC78G, NPC94G, NPC96G, NPC98G, NPD76G5, NPD78G8, NPD96G5, NPD98G10, NPD98G15, NPD98G15A, NPI76G5, NPI78G8, NPI96G5, NPI98G10, NPI98G14, NPI98G14A			
spare parts for	101908			
	GEV No.	101065	Ref. No.	—
magnet unit with cable L 44mm D1 ø 30mm D2 ø 20mm suitable for NOVASIT				
	GEV No.	101313	Ref. No.	—
solenoid coil 230V 50Hz				
accessories for 101908				
	GEV No.	100006	Ref. No.	—
piezoelectric igniter suitable for ELETTRISIT body plastic blowing connection ø2.4mm ø 14mm				
	GEV No.	101305	Ref. No.	2865700 MA2865700 R63080010
gas connection straight 1/2" flange 45x45mm ELETTRISIT/V4400/4600/4605 suitable for SIT/HONEYWELL hole distance 36x36mm				
	GEV No.	101306	Ref. No.	2865800 MA2865800 R63080020
gas connection angled flange 45x45mm hole distance 36x36mm 1/2" ELETTRISIT/V4400/4600/4605 screw with O-ring suitable for SIT/HONEYWELL				
	GEV No.	101307	Ref. No.	—
gas connection straight flange 45x45mm hole distance 36x36mm 3/4" ELETTRISIT/V4400/4600/4605 screw with O-ring suitable for SIT/HONEYWELL				
	GEV No.	101308	Ref. No.	—
gas connection angled flange 45x45mm hole distance 36x36mm 3/4" ELETTRISIT/V4400/4600/4605 screw with O-ring suitable for SIT/HONEYWELL				

accessories for 101908				
	GEV No.	101312	Ref. No.	1454900 CR0507660 MA1454900
microswitch				
	GEV No.	101314	Ref. No.	—
solenoid coil 24V 50Hz				
	GEV No.	101317	Ref. No.	1880600 MA1880600
plug with cable L 1000mm suitable for NOVASIT				
	GEV No.	101318	Ref. No.	—
cover cap for solenoid coil suitable for NOVASIT				

















1	GEV No.	101967	Ref. No.	5118500 MA5118500
description	gas valve SIT series Novasit 822 230V 50Hz gas inlet 1/2" gas outlet 1/2" thermocouple connection pilot connection M10x1 ignition pressure 3-5mbar pressure range 3-30mbar pressure regulator connection perforated equiv. no. 0.822.110			
For models:	CON102G, CON102GP, CON201G, CON201GP, CON202G, CON202GP, CP9A1 5GD, CSM102G, CSM102GP, CSM201G, CSM201GP, CSM202G, CSM202GP			
spare parts for	101967			
	GEV No.	101313	Ref. No.	—
solenoid coil 230V 50Hz				
	GEV No.	101542	Ref. No.	—
solenoid coil 50Hz NOVA 822/826/827 suitable for NOVASIT 230V				
accessories for 101967				
	GEV No.	100904	Ref. No.	1388000 1394700 MA1394700
locking screw M10x1 for pipe ø 4mm Qty 1 pcs				
	GEV No.	100905	Ref. No.	1394800 MA1394800
locking screw M10x1 for pipe ø 6mm Qty 1 pcs				
	GEV No.	101305	Ref. No.	2865700 MA2865700 R63080010
gas connection straight 1/2" flange 45x45mm ELETTRISIT/V4400/4600/4605 suitable for SIT/HONEYWELL hole distance 36x36mm				
	GEV No.	101306	Ref. No.	2865800 MA2865800 R63080020
gas connection angled flange 45x45mm hole distance 36x36mm 1/2" ELETTRISIT/V4400/4600/4605 screw with O-ring suitable for SIT/HONEYWELL				
	GEV No.	101307	Ref. No.	—
gas connection straight flange 45x45mm hole distance 36x36mm 3/4" ELETTRISIT/V4400/4600/4605 screw with O-ring suitable for SIT/HONEYWELL				

Table continues overleaf





accessories for 101967			
	GEV No.	101308	Ref. No. —
gas connection angled flange 45x45mm hole distance 36x36mm 3/4" ELETROSIT/V4400/4600/4605 screw with O-ring suitable for SIT/HONEYWELL			
	GEV No.	101503	Ref. No. —
O-ring EPDM thickness 2mm ID ø 32mm Qty 1 pcs			
	GEV No.	101924	Ref. No. —
plug with cable L 1090mm suitable for NOVA 822/826/827			

accessories			
	1		
GEV No.	101306	Ref. No.	2865800 MA2865800 R63080020
description	gas connection angled flange 45x45mm hole distance 36x36mm 1/2" ELETROSIT/V4400/4600/4605 screw with O-ring suitable for SIT/HONEYWELL		
For models:	BR912GFM, BR912GIM, BR94G, BR94GI, BR98GF, BR98GFM, BR98GI, BR98GIM, BR9M4G, BR9M4GI, BR9M6G, BR9M6GI, BR9S8GF, BR9S8GI, BR9SB4G, BR9SB4GI, CON10G, CON10GP, CON201G, CON201GP, CON202G, CON202GP, CON6G, CON6GP, CS10, CS102G, CS102GP, CS6, CSM10G, CSM10GP, CSM201G, CSM201GP, CSM202G, CSM202GP, CSM6G, CSM6GP, CVG105H, CVG105M, MG106M, MG106P, MG106X, MG110M, MG110P, MG110X, MG120M, MG120P, MG120X, MG210M, MG210P, MG210X...(Other models you can see in the webshop)		
spare parts for 101306			
	GEV No.	517104	Ref. No. —
O-ring EPDM thickness 2.62mm ID ø 31.42mm Qty 1 pcs			

	1		
GEV No.	101305	Ref. No.	2865700 MA2865700 R63080010
description	gas connection straight 1/2" flange 45x45mm ELETROSIT/V4400/4600/4605 suitable for SIT/HONEYWELL hole distance 36x36mm		
For models:	BR94G, BR94GI, BR9M4G, BR9M4GI, BR9M6G, BR9M6GI, BR9SB4G, BR9SB4GI, CON10G, CON10GP, CON201G, CON201GP, CON202G, CON202GP, CON6G, CON6GP, CS10, CS102G, CS102GP, CS6, CSM10G, CSM10GP, CSM201G, CSM201GP, CSM202G, CSM202GP, CSM6G, CSM6GP, MG106M, MG106P, MG106X, MG110M, MG110P, MG110X, MG210M, MG210P, MG210X, MS10AG, MS10IG, MS70AG, MS70IG, MS70IGS, VG106M, VG106P, VG106X, VG110M, VG110P, VG110X, VG210M, VG210P...(Other models you can see in the webshop)		
spare parts for 101305			
	GEV No.	101503	Ref. No. —
O-ring EPDM thickness 2mm ID ø 32mm Qty 1 pcs			

	1		
GEV No.	101817	Ref. No.	CM091301 CM091302 MACM091302
description	knob adapter L 30mm shaft ø 10x8mm shaft L 30/20mm size 10x8mm suitable for MARENO		
For models:	BR912GFM, BR912GIM, BR98GF, BR98GFM, BR98GI, BR98GIM, BR9S8GF, BR9S8GI		

	1		
GEV No.	101391	Ref. No.	1923500 MA1923500
description	knob adapter shaft ø 6x4.6mm shaft L 31/15mm suitable for NOVA-SIT		
For models:	BR94G, BR94GI, BR9M4G, BR9M4GI, BR9M6G, BR9M6GI, BR9SB4G, BR9SB4GI, MM10IG, MS10AG, MS10IG, MS70AG, MS70IG, MS70IGS, P9110G, P91A10G		

	1		
GEV No.	100905	Ref. No.	1394800 MA1394800
description	locking screw M10x1 for pipe ø 6mm Qty 1 pcs		
For models:	BR707G, CS10, CS102G, CS102GP, CS6, CSM201E, CSM201EP, CSM201G, CSM201GP, CSM202E, CSM202EP, CSM202G, CSM202GP, FR74G, FR77G		

	1		
GEV No.	101312	Ref. No.	1454900 CR0507660 MA1454900
description	microswitch		
For models:	BR912GFM, BR912GIM, BR98GF, BR98GFM, BR98GI, BR98GIM, CS10, CS102G, CS102GP, CS6, FR92G22, FR94G23, NBR912GFM, NBR912GIM, NBR98GF, NBR98GFM, NBR98GI, NBR98GIM, NF94G23K, NF98G23K, NPC74G, NPC78G, NPC94G, NPC98G, NPD76G5, NPD78G8, NPD96G5, NPD98G10, NPD98G15, NPD98G15A, NPI76G5, NPI78G8, NPI96G5, NPI98G10, NPI98G14, NPI98G14A		



	1		
GEV No.	100110	Ref. No.	1949700 MA1949700
description	pilot burner SIT type 190 series 3 flames nozzle ømm gas connecti-onmm		
For models:	MM10IG, P9110G, P91A10G		
accessories for 100110			
	GEV No.	100202	Ref. No. —
pilot burner nozzle natural gas code 41 Qty 1 pcs nozzle ø 0.41mm			

Table continues overleaf



accessories for		100110	
	GEV No.	100203	Ref. No. —
pilot burner nozzle LPG code 25 Qty 1 pcs nozzle ø 0.25mm			
	GEV No.	100701	Ref. No. 1888300 1949900 MA1888300 MA1949900
ignition electrode connection M4 Qty 1 pcs			
	GEV No.	100906	Ref. No. 1888400 MA1888400
screw connection thread M10x1 for ignition electrode brass Qty 1 pcs WS 10			
	GEV No.	100907	Ref. No. 1891700 24010899 MA1891700 MA24010899
screw connection thread M10x1 Qty 1 pcs type SEF 1 ømm for thermocouple			
	GEV No.	100908	Ref. No. 0100777 673500 MA673500 R0100777 SIR0100777
union screw thread M10x1 for pipe ø 4mm Qty 1 pcs			
	GEV No.	100909	Ref. No. —
union screw thread M10x1 for pipe ø 6mm Qty 1 pcs			
	GEV No.	101282	Ref. No. 469000 MA469000
olive for pipe ø 4mm L 7.4mm Qty 1 pcs			
	GEV No.	101287	Ref. No. —
olive for pipe ø 6mm Qty 1 pcs			
	GEV No.	102110	Ref. No. 1413100 1413200 1682300 1876500
pilot tube copper pipe ø 4mm thickness 1mm L 3000mm			
	GEV No.	102111	Ref. No. 1690200
pilot tube copper pipe ø 6mm thickness 1mm L 3000mm			
	GEV No.	107650	Ref. No. 0100802 CR0410100 R0100802 SIR0100802
pilot burner nozzle SIT LPG code 30 Qty 1 pcs			



GEV No.	101317	Ref. No.	1880600 MA1880600
description	plug with cable L 1000mm suitable for NOVASIT		
For models:	BR912GFM, BR912GIM, BR94G, BR94GI, BR98GF, BR98GFM, BR98GI, BR98GIM, BR9M4G, BR9M4GI, BR9M6G, BR9M6GI, BR9S8GF, BR9S8GI, BR9S84G, BR9S84GI, CON201G, CON201GI, CON202G, CON202GI, CSM201G, CSM201GI, CSM202G, CSM202GI, F94G22K, F98G22K, F95-4G22K, F958G22K, FR92G22T, FR94G22T, MS10AG, MS10GI, MS70AG, MS70GI, MS70IGS, NBR912GFM, NBR912GIM, NBR98GF, NBR98GFM, NBR98GI, NBR98GIM, NF94G23K, NF98G23K, NPC74G, NPC78G, NPC94G, NPC98G, NPD76G5, NPD78G8, NPD96G5...(Other models you can see in the webshop)		

TANDEM



GEV No.	101189	Ref. No.	2942600 MA2942600
description	gas valve 230V 50Hz gas inlet 1/2" gas outlet 1/2" pilot connection M10x1 level slow ignition ignition times pressure range 3-50mbar power supply for modulator equiv. no. 0.830.040 suitable for Tandem		
For models:	CON10G, CON10GP, CON6G, CON6GP, CSM10G, CSM10GP, CSM6G, CSM6GP, P198G10, P198G14, P198G14A		
spare parts for	101189		
	GEV No.	101379	Ref. No. —
solenoid coil 230V 50Hz suitable for Tandem			
accessories for	101189		
	GEV No.	100904	Ref. No. 1388000 1394700 MA1394700
locking screw M10x1 for pipe ø 4mm Qty 1 pcs			
	GEV No.	100905	Ref. No. 1394800 MA1394800
locking screw M10x1 for pipe ø 6mm Qty 1 pcs			
	GEV No.	101274	Ref. No. —
olive for pipe ø 16mm Qty 1 pcs			
	GEV No.	101275	Ref. No. —
union screw thread 1/2" for pipe ø 16mm Qty 1 pcs			
	GEV No.	101925	Ref. No. —
plug with O-ring thread M10x1 for pilot burner suitable for NOVASIT			
	GEV No.	102845	Ref. No. —
gas connection angled 1/2" flange 32x32mm hole distance 24x24mm Tandem			
	GEV No.	102846	Ref. No. —
gas connection straight 1/2" flange 32x32mm hole distance 24x24mm suitable for Tandem			
	GEV No.	102847	Ref. No. —
O-ring			



ignition boxes

HONEYWELL

Honeywell



GEV No.	102367	Ref. No.	LAR63060120
description	ignition box HONEYWELL type S4565A 2092 1 electrodes 3 waiting times safety time 10s 220-240V 4VA 50/60Hz		
For models:	GMT06D, GMT20D, GVT06D, GVT20D, MACG05M, MACG07M, MACG10M, MACG20M, MG061D, MG061M, MG061P, MG061T, MG101D, MG101M, MG101P, MG101T, MG102D, MG102M, MG102P, MG102T, MG201D, MG201M, MG201P, MG201T, MG202D, MG202M, MG202P, MG202T, MGMT06D, MGMT06P, MGMT10D, MGMT10P, MGMT20D, MGMT20P, MGMT21D, MGMT21P, MGMT40D, MGMT40P, MGVT06D, MGVT06P, MGVT10D, MGVT10P, MGVT20D, MGVT20P, MGVT21D, MGVT21P, MGVT40D, MGVT40P, MVG051P		

Honeywell



GEV No.	102318	Ref. No.	R63060100
description	ignition box HONEYWELL type S4565AF 1007V01 electrodes 2 waiting times safety time 10s 220-240V 4VA 50/60Hz		
For models:	GC106M, GC110M, GC210M, GM106H, GM106M, GM106M+SC, GM106P, GM110H, GM110M, GM110M+SC, GM110P, GM210H, GM210M, GM210M+SC, GM210P, GV106H, GV106M, GV106M+SC, GV106P, GV110H, GV110M, GV110M+SC, GV110P, GV210H, GV210M, GV210M+SC, GV210P		

SIT



GEV No.	102303	Ref. No.	5153200 MA5153200
description	ignition box SIT type 501EFD electrodes 2 waiting time 1.5s safety time 5s 250V 10VA 50-60Hz		
For models:	CON102G, CON102GP, CON10G, CON10GP, CON201G, CON201GP, CON202G, CON202GP, CON6G, CON6GP, CP9A15GD, CSM102G, CSM102GP, CSM10G, CSM10GP, CSM201G, CSM201GP, CSM202G, CSM202GP, CSM6G, CSM6GP		

safety valves

SIT

400 series



GEV No.	101470	Ref. No.	1491900 MA1491900	
description	safety valve front fixing M12x1 pressure range 50mbar gas inlet 1/8" IT gas outlet 1/8" - M6x0.75 thermocouple connection M8x1 equiv. no. 0.400.088 suitable for SIT			
For models:	BR96G, BR96GI, BR9M6G, BR9M6GI, MS10AG, MS10IG			
spare parts for	101470			
	GEV No.	101052	Ref. No.	—
	magnet unit L 43.5mm D1 ø 15.3mm D2 ø 10.5mm suitable for SIT M1			
accessories for	101470			
	GEV No.	101299	Ref. No.	—
	nut thread M12x1			
	GEV No.	101499	Ref. No.	—
	protection cap for safety valve thread M12x0.75 ID ø 18mm L 24mm aluminium			

ignition parts

pilot burners

SIT



100 series

















GEV No.	107103	Ref. No.	24022099 BN6A013100	
description	pilot burner SIT 1 flame nozzle ø 0.2mm gas connection 6mm			
spare parts for	107103			
	GEV No.	100245	Ref. No.	1415100 3020054 MA1415100
	pilot burner nozzle LPG code 20 bore ø 0.2mm Qty 1 pcs thread M8x0.75			
	GEV No.	100885	Ref. No.	1324900 MA1324900
	air mixing sleeve for pilot burner Qty 1 pcs			
	GEV No.	100916	Ref. No.	—
	compression spring for pilot burner Qty 1 pcs			
	GEV No.	100917	Ref. No.	—
	gasket for pilot burner Qty 1 pcs aluminium			













Table continues overleaf





spare parts for		107103	
	GEV No.	100918	Ref. No. —
screw for pilot burner			
	GEV No.	107160	Ref. No. —
pilot burner cap SIT 1 flame Hmm Lmm Qty 1 pcs			
	GEV No.	107166	Ref. No. —
pilot burner head SIT 1 flame Hmm Lmm Qty 1 pcs			
	GEV No.	107701	Ref. No. —
pilot burner bottom part SIT 100 series nozzle ø 0.2mm			
accessories for		107103	
	GEV No.	100246	Ref. No. 1422600 MA1422600
pilot burner nozzle natural gas bore ø 0.35mm Qty 1 pcs thread M8x0.75			
	GEV No.	100904	Ref. No. 1388000 1394700 MA1394700
locking screw M10x1 for pipe ø 4mm Qty 1 pcs			
	GEV No.	100905	Ref. No. 1394800 MA1394800
locking screw M10x1 for pipe ø 6mm Qty 1 pcs			
	GEV No.	102110	Ref. No. 1413100 1413200 1682300 1876500
pilot tube copper pipe ø 4mm thickness 1mm L 3000mm			
	GEV No.	102111	Ref. No. 1690200
pilot tube copper pipe ø 6mm thickness 1mm L 3000mm			
	GEV No.	107171	Ref. No. 1031502100 1842300 MA1031502100 MA1842300
pilot burner nozzle SIT natural/liquid gas bore ø 0.25mm Qty 1 pcs			
	GEV No.	107700	Ref. No. —
pilot burner bottom part SIT 100 series nozzle ø 0.25mm			
	GEV No.	107702	Ref. No. 1031501800 1314800 MA1314800
pilot burner bottom part SIT 100 series nozzle ø 0.35mm			

 <p>1</p>			
GEV No.	106902	Ref. No.	94400
description	pilot burner SIT type 100 series 2 flames nozzle ø 0.2mm gas connection 6mm		
spare parts for		106902	
	GEV No.	100245	Ref. No. 1415100 3020054 MA1415100
pilot burner nozzle LPG code 20 bore ø 0.2mm Qty 1 pcs thread M8x0.75			
	GEV No.	100842	Ref. No. —
pilot burner cap 2 flames Qty 1 pcs			

spare parts for		106902	
	GEV No.	100885	Ref. No. 1324900 MA1324900
air mixing sleeve for pilot burner Qty 1 pcs			
	GEV No.	100916	Ref. No. —
compression spring for pilot burner Qty 1 pcs			
	GEV No.	100917	Ref. No. —
gasket for pilot burner Qty 1 pcs aluminium			
	GEV No.	100918	Ref. No. —
screw for pilot burner			
	GEV No.	107161	Ref. No. —
pilot burner cap SIT 2 flames Hmm Lmm Qty 1 pcs			
	GEV No.	107701	Ref. No. —
pilot burner bottom part SIT 100 series nozzle ø 0.2mm			
accessories for		106902	
	GEV No.	100246	Ref. No. 1422600 MA1422600
pilot burner nozzle natural gas bore ø 0.35mm Qty 1 pcs thread M8x0.75			
	GEV No.	100904	Ref. No. 1388000 1394700 MA1394700
locking screw M10x1 for pipe ø 4mm Qty 1 pcs			
	GEV No.	100905	Ref. No. 1394800 MA1394800
locking screw M10x1 for pipe ø 6mm Qty 1 pcs			
	GEV No.	102110	Ref. No. 1413100 1413200 1682300 1876500
pilot tube copper pipe ø 4mm thickness 1mm L 3000mm			
	GEV No.	102111	Ref. No. 1690200
pilot tube copper pipe ø 6mm thickness 1mm L 3000mm			
	GEV No.	107171	Ref. No. 1031502100 1842300 MA1031502100 MA1842300
pilot burner nozzle SIT natural/liquid gas bore ø 0.25mm Qty 1 pcs			
	GEV No.	107700	Ref. No. —
pilot burner bottom part SIT 100 series nozzle ø 0.25mm			
	GEV No.	107702	Ref. No. 1031501800 1314800 MA1314800
pilot burner bottom part SIT 100 series nozzle ø 0.35mm			



 <p>1</p>			
GEV No.	106906	Ref. No.	1040511 1314500 431500 6A013200 BN6A013200 LAR63050020 MA1040511 MA431500
description	pilot burner SIT type 100 series 3 flames nozzle ø 0.2mm gas connection 6mm		
For models:	B9SB2G, B9SB4G, B9V2G, B9V4G, F9SB2G, F9SB2GR, F9SB4G, F9SB4GR, F9SB4GRL, F9V2G, F9V2GR, F9V4G, F9V4GR, F9V4GRL, FG105M, FG105X, FG110M, FG110X, FG210M, FG210X, P9110G, P91A10G, PG040M, PG040X, PG080M, PG080X, T7011GFG, T707G, T707GFG, T9F4G, T9F6GS, T9SB4G, T9V4G, T9V6GS		
spare parts for	106906		
	GEV No.	100245	Ref. No. 1415100 3020054 MA1415100
	pilot burner nozzle LPG code 20 bore ø 0.2mm Qty 1 pcs thread M8x0.75		
	GEV No.	100855	Ref. No. —
	pilot burner bracket triple		
	GEV No.	100885	Ref. No. 1324900 MA1324900
	air mixing sleeve for pilot burner Qty 1 pcs		
	GEV No.	100916	Ref. No. —
	compression spring for pilot burner Qty 1 pcs		
	GEV No.	100917	Ref. No. —
	gasket for pilot burner Qty 1 pcs aluminium		
	GEV No.	100918	Ref. No. —
	screw for pilot burner		
	GEV No.	107162	Ref. No. —
	pilot burner cap SIT 3 flames Hmm Lmm Qty 1 pcs		
	GEV No.	107701	Ref. No. —
	pilot burner bottom part SIT 100 series nozzle ø 0.2mm		
accessories for	106906		
	GEV No.	100245	Ref. No. 1415100 3020054 MA1415100
	pilot burner nozzle LPG code 20 bore ø 0.2mm Qty 1 pcs thread M8x0.75		
	GEV No.	100246	Ref. No. 1422600 MA1422600
	pilot burner nozzle natural gas bore ø 0.35mm Qty 1 pcs thread M8x0.75		
	GEV No.	100904	Ref. No. 1388000 1394700 MA1394700
	locking screw M10x1 for pipe ø 4mm Qty 1 pcs		
	GEV No.	100905	Ref. No. 1394800 MA1394800
	locking screw M10x1 for pipe ø 6mm Qty 1 pcs		

accessories for	106906		
	GEV No.	102110	Ref. No. 1413100 1413200 1682300 1876500
	pilot tube copper pipe ø 4mm thickness 1mm L 3000mm		
	GEV No.	102111	Ref. No. 1690200
	pilot tube copper pipe ø 6mm thickness 1mm L 3000mm		
	GEV No.	107171	Ref. No. 1031502100 1842300 MA1031502100 MA1842300
	pilot burner nozzle SIT natural/liquid gas bore ø 0.25mm Qty 1 pcs		
	GEV No.	107700	Ref. No. —
	pilot burner bottom part SIT 100 series nozzle ø 0.25mm		
	GEV No.	107702	Ref. No. 1031501800 1314800 MA1314800
	pilot burner bottom part SIT 100 series nozzle ø 0.35mm		





























 <p>1</p>			
GEV No.	106907	Ref. No.	1315100 CR0588730
description	pilot burner SIT type 100 series 3 flames nozzle ø 0.35mm gas connection 6mm		
For models:	C9F4G, C9F4GS, C9F6G, C9F6GS, C9F8G, C9F8GS, NG74G, NG78G, NG94G, NG98G, P9D10G, P9D15G, P9DA10G, P9DA15G, T9F4G, T9F6GS		
spare parts for	106907		
	GEV No.	100246	Ref. No. 1422600 MA1422600
	pilot burner nozzle natural gas bore ø 0.35mm Qty 1 pcs thread M8x0.75		
	GEV No.	100855	Ref. No. —
	pilot burner bracket triple		
	GEV No.	100885	Ref. No. 1324900 MA1324900
	air mixing sleeve for pilot burner Qty 1 pcs		
	GEV No.	100916	Ref. No. —
	compression spring for pilot burner Qty 1 pcs		
	GEV No.	100917	Ref. No. —
	gasket for pilot burner Qty 1 pcs aluminium		
	GEV No.	100918	Ref. No. —
	screw for pilot burner		
	GEV No.	107162	Ref. No. —
	pilot burner cap SIT 3 flames Hmm Lmm Qty 1 pcs		
	GEV No.	107702	Ref. No. 1031501800 1314800 MA1314800
	pilot burner bottom part SIT 100 series nozzle ø 0.35mm		

Table continues overleaf

accessories for		106907	
	GEV No.	100245	Ref. No. 1415100 3020054 MA1415100
pilot burner nozzle LPG code 20 bore ø 0.2mm Qty 1 pcs thread M8x0.75			
	GEV No.	100904	Ref. No. 1388000 1394700 MA1394700
locking screw M10x1 for pipe ø 4mm Qty 1 pcs			
	GEV No.	100905	Ref. No. 1394800 MA1394800
locking screw M10x1 for pipe ø 6mm Qty 1 pcs			
	GEV No.	102110	Ref. No. 1413100 1413200 1682300 1876500
pilot tube copper pipe ø 4mm thickness 1mm L 3000mm			
	GEV No.	102111	Ref. No. 1690200
pilot tube copper pipe ø 6mm thickness 1mm L 3000mm			
	GEV No.	107171	Ref. No. 1031502100 1842300 MA1031502100 MA1842300
pilot burner nozzle SIT natural/liquid gas bore ø 0.25mm Qty 1 pcs			
	GEV No.	107700	Ref. No. —
pilot burner bottom part SIT 100 series nozzle ø 0.25mm			
	GEV No.	107701	Ref. No. —
pilot burner bottom part SIT 100 series nozzle ø 0.2mm			

accessories			
pilot burner caps			
			
1			
GEV No.	100837	Ref. No.	1576000 MA1576000
description	pilot burner cap 3 flames H 24mm L 48mm Qty 1 pcs		
For models:	EF74G15, F12C4G15, F74G10, F74G15, F76G10, F78G15, F94G10, F94G15, F94G22, F94G22K, F96G10, F98G15, F98G22, F98G22K, F9S4G15, F9S4G22, F9S4G22K, F9S8G15, F9S8G22, F9S8G22K, FR74G, FR77G, FR92G13, FR92G22, FR92G22T, FR94G13, FR94G22, FR94G22T, NF74G15T, NF78G15T		

pilot burner bottom parts			
			
1			
GEV No.	107702	Ref. No.	1031501800 1314800 MA1314800
description	pilot burner bottom part SIT 100 series nozzle ø 0.35mm		
For models:	C7011G, C7011GFE, C7011GFG, C704G, C707G, C707GFE, C707GFG, C9F4G, C9F4GS, C9F6G, C9F6GS, C9F8G, C9F8GS, C9SB4GS, C9V2G, C9V2GS, C9V4G, C9V4GS, C9V6G, C9V6GS, C9V8G, C9V8GS		
spare parts for	107702		
	GEV No.	100246	Ref. No. 1422600 MA1422600
pilot burner nozzle natural gas bore ø 0.35mm Qty 1 pcs thread M8x0.75			
	GEV No.	100916	Ref. No. —
compression spring for pilot burner Qty 1 pcs			
	GEV No.	100917	Ref. No. —
gasket for pilot burner Qty 1 pcs aluminium			
accessories for 107702			
	GEV No.	100245	Ref. No. 1415100 3020054 MA1415100
pilot burner nozzle LPG code 20 bore ø 0.2mm Qty 1 pcs thread M8x0.75			
	GEV No.	100904	Ref. No. 1388000 1394700 MA1394700
locking screw M10x1 for pipe ø 4mm Qty 1 pcs			
	GEV No.	100905	Ref. No. 1394800 MA1394800
locking screw M10x1 for pipe ø 6mm Qty 1 pcs			
	GEV No.	102110	Ref. No. 1413100 1413200 1682300 1876500
pilot tube copper pipe ø 4mm thickness 1mm L 3000mm			
	GEV No.	102111	Ref. No. 1690200
pilot tube copper pipe ø 6mm thickness 1mm L 3000mm			
	GEV No.	102742	Ref. No. —
pilot burner nozzle LPG code 25 bore ø 0.25mm Qty 1 pcs			





			
1			
GEV No.	100880	Ref. No.	1874100 MA1874100
description	pilot burner bottom part SIT 100 series nozzle ϕ 0.4mm		
For models:	EF74G15, F12C4G15, F74G10, F74G15, F76G10, F78G15, F94G10, F94G15, F94G22, F94G22K, F96G10, F98G15, F98G22, F98G22K, F954G15, F954G22, F954G22K, F958G15, F958G22, F958G22K, FR74G, FR77G, FR92G13, FR92G22, FR92G22T, FR94G13, FR94G22, FR94G22T, NF74G15T, NF78G15T		

			
1			
GEV No.	100246	Ref. No.	1422600 MA1422600
description	pilot burner nozzle natural gas bore ϕ 0.35mm Qty 1 pcs thread M8x0.75		
For models:	B95B2G, B95B4G, B9V2G, B9V4G, C7011G, C7011GFE, C7011GFG, C704G, C707G, C707GFE, C707GFG, C9F4G, C9F4GS, C9F6G, C9F6GS, C9F8G, C9F8GS, C95B4GS, C9V2G, C9V2GS, C9V4G, C9V4GS, C9V6G, C9V6GS, C9V8G, C9V8GS, F95B2G, F95B2GR, F95B4G, F95B4GR, F95B4GRL, F9V2G, F9V2GR, F9V4G, F9V4GR, F9V4GRL, P9D10G, P9D15G, P9DA10G, P9DA15G, P9I10G, P9IA10G, T7011GFG, T707G, T707GFG, T9F4G, T9F6GS, T95B4G, T9V4G, T9V6GS		

pilot burner brackets

universal

			
1			
GEV No.	100894	Ref. No.	1031502300
description	opposite support for pilot burner suitable for 100 series		

			
1			
GEV No.	102972	Ref. No.	1996200 CR0684580 MA1996200
description	pilot burner nozzle natural gas code 40 bore ϕ 0.4mm Qty 1 pcs		
For models:	EF74G15, F12C4G15, F74G10, F74G15, F76G10, F78G15, F94G10, F94G15, F94G22, F94G22K, F96G10, F98G15, F98G22, F98G22K, F954G15, F954G22, F954G22K, F958G15, F958G22, F958G22K, NF74G15T, NF78G15T, NG74G, NG78G, NG94G, NG98G		

			
1			
GEV No.	100893	Ref. No.	1031502200
description	pilot burner bracket suitable for 100 series 2-piece		

ignition electrodes

			
1			
GEV No.	100706	Ref. No.	1031502500 224211 636700 MA224211 MA636700
description	ignition electrode connection M4 Qty 1 pcs		
For models:	702BMG, 706, 706S, B95B2G, B95B4G, B9V2G, B9V4G, BIG40, BIG60, BMG40, BMG60, BR707G, BR94G, BR94GI, BR96G, BR96GI, BR9M4G, BR9M4GI, BR9M6G, BR9M6GI, BRG40, BRG40G, C7011GFE, C7011GFG, C707GFE, C707GFG, C9F4G, C9F4GS, C9F6G, C9F6GS, C9F8G, C9F8GS, C9F101, C9F101D, C9F101L, C9F101P, C9F120, C9F70, C9F70D, C9F70L, C9F70M, C9F70P, CP707G, CP92G, CP94G, CS10, CS102G, CS102GP, CS6, EC74GVG...(Other models you can see in the webshop)		

producer-specific

			
1			
GEV No.	100890	Ref. No.	1314915 1706100 MA1314915
description	pilot burner bracket suitable for 100 series		
For models:	C7011G, C7011GFE, C7011GFG, C704G, C707G, C707GFE, C707GFG, C9F4G, C9F4GS, C9F6G, C9F6GS, C9F8G, C9F8GS, C95B4GS, C9V2G, C9V2GS, C9V4G, C9V4GS, C9V6G, C9V6GS, C9V8G, C9V8GS		

pilot burner nozzles

			
1			
GEV No.	100245	Ref. No.	1415100 3020054 MA1415100
description	pilot burner nozzle LPG code 20 bore ϕ 0.2mm Qty 1 pcs thread M8x0.75		
For models:	B95B2G, B95B4G, B9V2G, B9V4G, C7011G, C7011GFE, C7011GFG, C704G, C707G, C707GFE, C707GFG, C9F4G, C9F4GS, C9F6G, C9F6GS, C9F8G, C9F8GS, C95B4GS, C9V2G, C9V2GS, C9V4G, C9V4GS, C9V6G, C9V6GS, C9V8G, C9V8GS, EF74G15, F12C4G15, F74G10, F74G15, F76G10, F78G15, F94G10, F94G15, F94G22, F94G22K, F96G10, F98G15, F98G22, F98G22K, F954G15, F954G22, F954G22K, F958G15, F958G22, F958G22K, F95B2G, F95B2GR, F95B4G, F95B4GR...(Other models you can see in the webshop)		

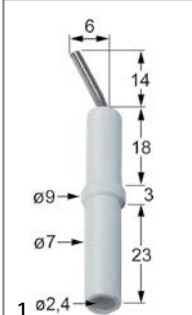

GEV No.	100707	Ref. No.	R63050010
description	ignition electrode D1 ø 7mm D2 ø 9mm connection ø2.4mm L1 14mm L2 6mm BL1 18mm BL2 3mm BL3 23mm to clip Qty 1 pcs		
For models:	FG105M, FG105X, FG110M, FG110X, FG210M, FG210X, PG040M, PG040X, PG080M, PG080X		

miscellaneous















GEV No.	100885	Ref. No.	1324900 MA1324900
description	air mixing sleeve for pilot burner Qty 1 pcs		
For models:	C7011G, C7011GFE, C7011GFG, C704G, C707G, C707GFE, C707GFG, C9F4G, C9F4GS, C9F6G, C9F6GS, C9F8G, C9F8GS, C9SB4GS, C9V2G, C9V2GS, C9V4G, C9V4GS, C9V6G, C9V6GS, C9V8G, C9V8GS		

140 - 145 -150 series







GEV No.	106943 ¹	Ref. No.	1887700 MA1887700
description	pilot burner SIT type 140 series 1 flame nozzle 0mm gas connectionmm		
For models:	B9SB2G, B9SB4G, B9V2G, B9V4G, B9VP4G, BM74G, BM77G, BR707G, BR707GI, BR94G, BR94GI, BR9M4G, BR9M4GI, BR9M6G, BR9M6GI, BR9SB4G, BR9SB4GI, C124G, C129G, C12C2G9, C12C9G, C12FG9G, C7011G, C7011GFE, C7011GFG, C704G, C707G, C707GFE, C707GFG, C712G, C74G, C78G, C7FE12G, C7FE8G, C7FG12G, C7FG8G, C7FG-M12G, C912G, C912GS, C94G, C94GP, C94GS, C98G, C98GP, C98GS, C9F4E, C9F4GS, C9F6E, C9F6GS, C9F8GS...(Other models you can see in the webshop)		
spare parts for	106943		
	GEV No.	100907	Ref. No.
			1891700 24010899 MA1891700 MA24010899
	screw connection thread M10x1 Qty 1 pcs type SEF 1 ømm for thermocouple		



GEV No.	107114 ¹	Ref. No.	CM029000 MACM029000
description	pilot burner SIT type 140 series 2 flames nozzle ømm gas connectionmm		
For models:	B74G, B78G, B94G, B98G, BR78GF, BR78GI, BR912GFM, BR912GIM, BR98GF, BR98GFM, BR98GI, BR98GIM, BR9S8GF, BR9S8GI, C7FG9G, EFT74GLVG, EFT74GRVG, EFT78GLVG, EFT78GMVG, ET78GVG, ET-7FG8G, FT129GLC, FT129GM, FT12C9GL, FT12C9GM, FT12C9GTL, FT12C9GTMC, FT74GL, FT74GLC, FT74GR, FT74GRC, FT76GL, FT76GLC, FT76GM, FT76GMC, FT76GR, FT78GL, FT78GLC, FT78GLT, FT78GM, FT78GMC, FT78GMT, FT78GR, FT78GRT, FT94G, FT94GL, FT94GLC, FT-94GR, FT94GRC, FT96GL...(Other models you can see in the webshop)		
spare parts for	107114		
	GEV No.	100907	Ref. No.
			1891700 24010899 MA1891700 MA24010899
	screw connection thread M10x1 Qty 1 pcs type SEF 1 ømm for thermocouple		
accessories for	107114		
	GEV No.	100204	Ref. No.
			1888000 MA1888000
	pilot burner nozzle SIT LPG code 14 bore ø 0.18/0.20mm Qty 1 pcs suitable for 140 series		
	GEV No.	100205	Ref. No.
			1033722000 BN822140380 MA1033722000
	pilot burner nozzle SIT LPG code 19 bore ø 0.23/0.26mm Qty 1 pcs suitable for SIT 150 series		
	GEV No.	100206	Ref. No.
			—
	pilot burner nozzle SIT natural gas code 36 bore ø 0.60/0.55mm Qty 1 pcs suitable for SIT 150 series		
	GEV No.	100207	Ref. No.
			1887800 MA1887800
	pilot burner nozzle SIT natural gas code 27 bore ø 0.40/0.38mm suitable for SIT 140 series		
	GEV No.	100216	Ref. No.
			—
	pilot burner nozzle SIT natural gas code 38 bore ø 0.45mm Qty 1 pcs suitable for SIT 150 series		
	GEV No.	100701	Ref. No.
			1888300 1949900 MA1888300 MA1949900
	ignition electrode connection M4 Qty 1 pcs		
	GEV No.	100801	Ref. No.
			—
	gasket for pilot burner Qty 1 pcs		
	GEV No.	100897	Ref. No.
			1881000 1888100 MA1888100
	olive for pipe ø 4mm Qty 1 pcs for pilot burner		
	GEV No.	100898	Ref. No.
			—
	olive for pipe ø 6mm Qty 1 pcs for pilot burner		
	GEV No.	100906	Ref. No.
			1888400 MA1888400
	screw connection thread M10x1 for ignition electrode brass Qty 1 pcs WS 10		

¹incl. thermocouple fitting
Table continues overleaf



accessories for 107114				
	GEV No.	100908	Ref. No.	0100777 673500 MA673500 R0100777 SIR0100777
union screw thread M10x1 for pipe ø 4mm Qty 1 pcs				
	GEV No.	100909	Ref. No.	—
union screw thread M10x1 for pipe ø 6mm Qty 1 pcs				
	GEV No.	102110	Ref. No.	1413100 1413200 1682300 1876500
pilot tube copper pipe ø 4mm thickness 1mm L 3000mm				
	GEV No.	102111	Ref. No.	1690200
pilot tube copper pipe ø 6mm thickness 1mm L 3000mm				







160 series









GEV No.	100109	Ref. No.	CM040800 MACM040800
----------------	--------	-----------------	------------------------

description	pilot burner SIT type 160 series 1 flame nozzle ømm gas connecti-onmm		
For models:	BF78G, BF912G, BF912GH, BF98G, C12FGP9G, C7FG12G, C7FG8G, C7FGM12G, C9FG12G, C9FG16G, C9FG8G, C9FG8GP, C9FGM12G, EF74G8VA, EF74G8VG, EPC74G, FQG41, FQG61, NC7FG12G44, NC7FG8G32, NC7FG8G36, NC7FG8G48, NC7FGM12G, NC9FG12G52, NC9FG16G72, NC9FG8G32, NC9FG8G36, NC9FG8G48, NF74G10, NF74G15, NF74G8, NF76G10, NF76G8, NF78G15, NF94G15, NF94G23, NF94G23K, NF96G10, NF98G15, NF98G23, NF98G23K, NPC74G, NPC78G, NPC94G, NPC98G, NPD76G5, NPD78G8, NPD96G5, NPD98G10, NPD98G15...(Other models you can see in the webshop)		

spare parts for 100109				
	GEV No.	100907	Ref. No.	1891700 24010899 MA1891700 MA24010899
screw connection thread M10x1 Qty 1 pcs type SEF 1 ømm for thermocouple				

accessories for 100109				
	GEV No.	100202	Ref. No.	—
pilot burner nozzle natural gas code 41 Qty 1 pcs nozzle ø 0.41mm				
	GEV No.	100203	Ref. No.	—
pilot burner nozzle LPG code 25 Qty 1 pcs nozzle ø 0.25mm				
	GEV No.	100701	Ref. No.	1888300 1949900 MA1888300 MA1949900
ignition electrode connection M4 Qty 1 pcs				
	GEV No.	100801	Ref. No.	—
gasket for pilot burner Qty 1 pcs				
	GEV No.	100869	Ref. No.	—
pilot burner nozzle natural gas code 51 Qty 1 pcs suitable for 160 series nozzle ø 0.51mm				
	GEV No.	100906	Ref. No.	1888400 MA1888400
screw connection thread M10x1 for ignition electrode brass Qty 1 pcs WS 10				

accessories for 100109				
	GEV No.	100908	Ref. No.	0100777 673500 MA673500 R0100777 SIR0100777
union screw thread M10x1 for pipe ø 4mm Qty 1 pcs				
	GEV No.	100909	Ref. No.	—
union screw thread M10x1 for pipe ø 6mm Qty 1 pcs				
	GEV No.	101282	Ref. No.	469000 MA469000
olive for pipe ø 4mm L 7.4mm Qty 1 pcs				
	GEV No.	101287	Ref. No.	—
olive for pipe ø 6mm Qty 1 pcs				
	GEV No.	102110	Ref. No.	1413100 1413200 1682300 1876500
pilot tube copper pipe ø 4mm thickness 1mm L 3000mm				
	GEV No.	102111	Ref. No.	1690200
pilot tube copper pipe ø 6mm thickness 1mm L 3000mm				
	GEV No.	107650	Ref. No.	0100802 CR0410100 R0100802 SIR0100802
pilot burner nozzle SIT LPG code 30 Qty 1 pcs				

190 series



GEV No.	100110	Ref. No.	1949700 MA1949700
----------------	--------	-----------------	----------------------

description	pilot burner SIT type 190 series 3 flames nozzle ømm gas connecti-onmm		
For models:	MM10IG, P9110G, P91A10G		













accessories for 100110				
	GEV No.	100202	Ref. No.	—
pilot burner nozzle natural gas code 41 Qty 1 pcs nozzle ø 0.41mm				
	GEV No.	100203	Ref. No.	—
pilot burner nozzle LPG code 25 Qty 1 pcs nozzle ø 0.25mm				
	GEV No.	100701	Ref. No.	1888300 1949900 MA1888300 MA1949900
ignition electrode connection M4 Qty 1 pcs				
	GEV No.	100906	Ref. No.	1888400 MA1888400
screw connection thread M10x1 for ignition electrode brass Qty 1 pcs WS 10				
	GEV No.	100907	Ref. No.	1891700 24010899 MA1891700 MA24010899
screw connection thread M10x1 Qty 1 pcs type SEF 1 ømm for thermocouple				

Table continues overleaf

accessories for		100110	
	GEV No.	100908	Ref. No.
			0100777 673500 MA673500 R0100777 SIR0100777
union screw thread M10x1 for pipe ø 4mm Qty 1 pcs			
	GEV No.	100909	Ref. No.
			—
union screw thread M10x1 for pipe ø 6mm Qty 1 pcs			
	GEV No.	101282	Ref. No.
			469000 MA469000
olive for pipe ø 4mm L 7.4mm Qty 1 pcs			
	GEV No.	101287	Ref. No.
			—
olive for pipe ø 6mm Qty 1 pcs			
	GEV No.	102110	Ref. No.
			1413100 1413200 1682300 1876500
pilot tube copper pipe ø 4mm thickness 1mm L 3000mm			
	GEV No.	102111	Ref. No.
			1690200
pilot tube copper pipe ø 6mm thickness 1mm L 3000mm			
	GEV No.	107650	Ref. No.
			0100802 CR0410100 R0100802 SIR0100802
pilot burner nozzle SIT LPG code 30 Qty 1 pcs			



JUNKERS

CB 505 series

pilot burners



1

GEV No.	100073	Ref. No.	1031027800 411111 509900 578800 MA509900
description	pilot burner JUNKERS type CB505018 3 flames natural gas nozzle no.9 gas connection 6mm with primary air		
For models:	704, 704S, 706, 706AS, 706S, BIG40, BIG60, BMG40, BMG60, BR707G, BR94G, BR94GI, BR96G, BR96GI, BR9M4G, BR9M4GI, BR9M6G, BR9M6GI, BRG40, BRG40G, CP707G, CP92G, CP94G, CS10, CS102G, CS102GP, CS6, FC10G, FC20G, FCSG, FC7G, FQG40, FQG60, FR15G, FR15G2, FR2G, FR2G15, FR4G, FR4G15, FR74G, FR77G, FR92G22, FR94G23, FT74G, FT74GR, FT77G, FT77GRL, FTG40B, FTG40BLC, FTG-40BR...(Other models you can see in the webshop)		
spare parts for	100073		
	GEV No.	100231	Ref. No.
			—
pilot burner nozzle natural gas gas pressure 25mbar code 4 Qty 1 pcs suitable for JUNKERS CB5050_			
	GEV No.	100703	Ref. No.
			1031025700 638700
ignition electrode D1 ø 9mm connection M4 D2 ø 11mm L1 8mm BL1 13mm BL2 4mm BL3 22mm to clip			
	GEV No.	100907	Ref. No.
			1891700 24010899 MA1891700 MA24010899
screw connection thread M10x1 Qty 1 pcs type SEF 1 ømm for thermocouple			

spare parts for		100073	
	GEV No.	101282	Ref. No.
			469000 MA469000
olive for pipe ø 4mm L 7.4mm Qty 1 pcs			
	GEV No.	101283	Ref. No.
			468800 MA468800
union screw thread M10x1 for pipe ø 4mm Qty 1 pcs			
	GEV No.	101292	Ref. No.
			636600 MA636600
union screw for igniter suitable for CB 502/505 Qty 1 pcs			
accessories for		100073	
	GEV No.	100217	Ref. No.
			—
pilot burner nozzle LPG gas pressure 30mbar code 3 Qty 1 pcs suitable for JUNKERS CB5050_			
	GEV No.	100230	Ref. No.
			932900 MA932900
pilot burner nozzle LPG gas pressure 50mbar code 2 Qty 1 pcs suitable for JUNKERS CB5050_			
	GEV No.	100232	Ref. No.
			—
pilot burner nozzle natural gas gas pressure 25mbar code 9 Qty 1 pcs suitable for JUNKERS CB5050_			
	GEV No.	100233	Ref. No.
			—
pilot burner nozzle LPG gas pressure 50mbar code 8 Qty 1 pcs suitable for JUNKERS CB5050_			
	GEV No.	100234	Ref. No.
			—
pilot burner nozzle natural gas gas pressure 20mbar code 14 Qty 1 pcs suitable for JUNKERS CB5050_			
	GEV No.	100909	Ref. No.
			—
union screw thread M10x1 for pipe ø 6mm Qty 1 pcs			
	GEV No.	101288	Ref. No.
			—
olive for pipe ø 6mm L 6mm aluminium Qty 1 pcs ED ø 8.5mm			

producer-specific pilot burners

MARENO

700 series



1







GEV No.	100089	Ref. No.	432600
description	pilot burner		
accessories for	100089		
	GEV No.	100217	Ref. No.
			—
pilot burner nozzle LPG gas pressure 30mbar code 3 Qty 1 pcs suitable for JUNKERS CB5050_			
	GEV No.	100230	Ref. No.
			932900 MA932900
pilot burner nozzle LPG gas pressure 50mbar code 2 Qty 1 pcs suitable for JUNKERS CB5050_			
	GEV No.	100231	Ref. No.
			—
pilot burner nozzle natural gas gas pressure 25mbar code 4 Qty 1 pcs suitable for JUNKERS CB5050_			
	GEV No.	100232	Ref. No.
			—
pilot burner nozzle natural gas gas pressure 25mbar code 9 Qty 1 pcs suitable for JUNKERS CB5050_			

Table continues overleaf



accessories for 100089	
	GEV No. 100233 Ref. No. — pilot burner nozzle LPG gas pressure 50mbar code 8 Qty 1 pcs suitable for JUNKERS CB5050_
	GEV No. 100234 Ref. No. — pilot burner nozzle natural gas gas pressure 20mbar code 14 Qty 1 pcs suitable for JUNKERS CB5050_
	GEV No. 100909 Ref. No. — union screw thread M10x1 for pipe ø 6mm Qty 1 pcs
	GEV No. 101282 Ref. No. 469000 MA469000 olive for pipe ø 4mm L 7.4mm Qty 1 pcs
	GEV No. 101283 Ref. No. 468800 MA468800 union screw thread M10x1 for pipe ø 4mm Qty 1 pcs
	GEV No. 101288 Ref. No. — olive for pipe ø 6mm L 6mm aluminium Qty 1 pcs ED ø 8.5mm

	
1	
GEV No. 102979	Ref. No. 1032501300 MA1032501300
description	pilot burner suitable for MARENO
For models:	C74GS, C78GS, C79G, C7FE12GS, C7FE8GS, C7FG12GS, C7FG8GS, C7FG9G, CFG101, CFG70, CFG70M, CFGE61, CFGE61D, CFGE61L, CFGE61P, EC74GVG, EC78GVG, EC7FG8G, OCFG101, OCFG70, OCFG61, OPCG41, OPCG61, PCG41, PCG41L, PCG61, PCG61L
accessories for 102979	
	GEV No. 101860 Ref. No. — nut thread M10x1 H 4mm WS 14 chrome-plated brass Qty 1 pcs
	GEV No. 102980 Ref. No. 1033717300 1033717300R MA1033717300 pilot burner mushroom cap with mounting thread

Snack 600 / Protagonista 70 / Easy series

	
1	
GEV No. 100082	Ref. No. N/A
description	pilot burner
accessories for 100082	
	GEV No. 100202 Ref. No. — pilot burner nozzle natural gas code 41 Qty 1 pcs nozzle ø 0.41mm
	GEV No. 100203 Ref. No. — pilot burner nozzle LPG code 25 Qty 1 pcs nozzle ø 0.25mm
	GEV No. 100834 Ref. No. — pilot burner cap
	GEV No. 100908 Ref. No. 0100777 673500 MA673500 R0100777 SIR0100777 union screw thread M10x1 for pipe ø 4mm Qty 1 pcs
	GEV No. 100909 Ref. No. — union screw thread M10x1 for pipe ø 6mm Qty 1 pcs
	GEV No. 101282 Ref. No. 469000 MA469000 olive for pipe ø 4mm L 7.4mm Qty 1 pcs
	GEV No. 101287 Ref. No. — olive for pipe ø 6mm Qty 1 pcs
	GEV No. 101860 Ref. No. — nut thread M10x1 H 4mm WS 14 chrome-plated brass Qty 1 pcs
	GEV No. 107650 Ref. No. 0100802 CR0410100 R0100802 SIR0100802 pilot burner nozzle SIT LPG code 30 Qty 1 pcs

NP70 / NP90 series







	
1	
GEV No. 103074	Ref. No. CR0586451
description	venturi for burner cap ø 102mm with pilot burner suitable for 900 series
For models:	NC912G44, NC94G16, NC94G20, NC98G28, NC98G40, NC9FE12G44, NC9FE8G28, NC9FG12G52, NC9FG16G72, NC9FG8G32, NC9FG8G36, NC9FG8G48, NC9FGM12G, NT9FG12G
	
1	
GEV No. 107422	Ref. No. CR0586441
description	venturi for burner cap ø 64mm with pilot burner suitable for 900 series
For models:	NC712G36, NC74G12, NC78G24, NC7FE12G36, NC7FE8G24, NC7FG12G44, NC7FG8G32, NC7FGM12G, NC912G44, NC94G16, NC94G20, NC98G28, NC98G40, NC9FE12G44, NC9FE8G28, NC9FG12G52, NC9FG16G72, NC9FG8G32, NC9FG8G36, NC9FG8G48, NC9FGM12G, NS78GS, NS7FG12GS, NT7FG12G, NT9FG12G
accessories for 107422	
	GEV No. 103071 Ref. No. CR0580010 burner cap ø 64mm H 26mm suitable for 900 series
	GEV No. 103072 Ref. No. CR0580030 burner head for burner cap ø 64mm H 37mm suitable for 900 series
	GEV No. 103075 Ref. No. CR0581700 nozzle holder ø 34mm H 150mm suitable for 900 series

Table continues overleaf

accessories for 107422					
	<table border="1"> <tr> <td>GEV No.</td> <td>103083</td> <td>Ref. No.</td> <td>8204760 R8204760 S18204760 SIR8204760</td> </tr> </table>	GEV No.	103083	Ref. No.	8204760 R8204760 S18204760 SIR8204760
GEV No.	103083	Ref. No.	8204760 R8204760 S18204760 SIR8204760		
gasket L 77mm W 69mm thickness 2mm graphite for Venturi suitable for 900 series					

accessories universal

covers

			
1			
GEV No.	107883	Ref. No.	CM060801 MACM060801
description	cover for pilot burner for gas range suitable for LAINOX		
For models:	C124G, C129G, C12C2G9, C12C9G, C12FG9G, C712G, C74G, C78G, C7FE12G, C7FE8G, C7FG12G, C7FG8G, C7FGM12G, C912G, C912GS, C94G, C94GP, C94GS, C98G, C98GP, C98GS, C9FE12G, C9FE12GS, C9FE8G, C9FE8GS, C9FG12G, C9FG12GS, C9FG16G, C9FG8G, C9FG8GP, C9FG8GS, C9FGM12G		

electrodes

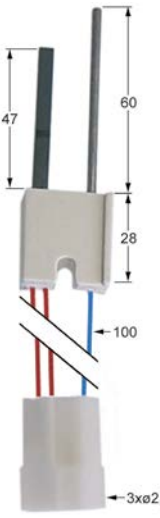
			
1			
GEV No.	100730	Ref. No.	R63050040
description	glow plug cable length 100mm connection \varnothing 2.4mm L1 47mm L2 60mm		
For models:	CVG105H, CVG105M, MG106M, MG106P, MG106X, MG110M, MG110X, MG120M, MG120P, MG120X, MG210M, MG210P, MG210X, MG220M, MG220P, MG220X, MGC20X, MGC24H, MGC40H, VG105M, VG105X, VG106M, VG106P, VG106X, VG110M, VG110P, VG110X, VG120M, VG120P, VG120X, VG210M, VG210P, VG210X, VG220M, VG220P, VG220X		

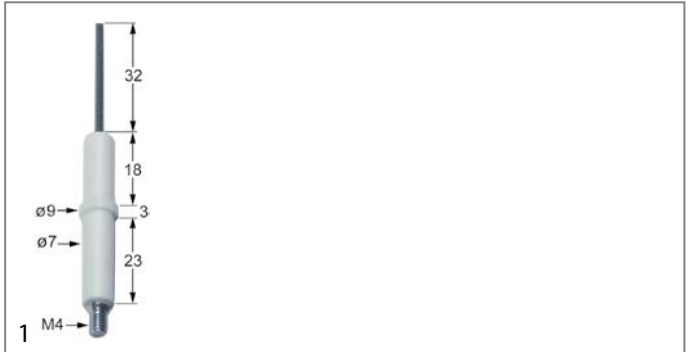

GEV No.	100701	Ref. No.	1888300 1949900 MA1888300 MA1949900
description	ignition electrode connection M4 Qty 1 pcs		
For models:	B74G, B78G, B94G, B98G, B9SB2G, B9SB4G, B9V2G, B9V4G, B9VP4G, BF78G, BF912G, BF912GH, BF98G, BM74G, BM77G, BR707G, BR707GI, BR78GF, BR78GI, BR912GFM, BR912GIM, BR94G, BR94GI, BR98GF, BR98GFM, BR98GI, BR98GIM, BR9M4G, BR9M4GI, BR9M6G, BR9M6GI, BR9S8GF, BR9S8GI, BR9SB4G, BR9SB4GI, C124G, C129G, C12C2G9, C12C9G, C12FG9G, C12FGP9G, C7011G, C7011GFE, C7011GFG, C704G, C707G, C707GFE, C707GFG, C712G, C74G...(Other models you can see in the webshop)		
accessories for	100701		
	GEV No.	100906	Ref. No. 1888400 MA1888400
	screw connection thread M10x1 for ignition electrode brass Qty 1 pcs WS 10		

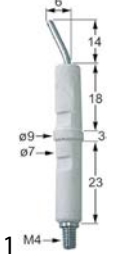
			
1			
GEV No.	100706	Ref. No.	1031502500 224211 636700 MA224211 MA636700
description	ignition electrode connection M4 Qty 1 pcs		
For models:	702BMG, 706, 706S, B9SB2G, B9SB4G, B9V2G, B9V4G, BIG40, BIG60, BMG40, BMG60, BR707G, BR94G, BR94GI, BR96G, BR96GI, BR9M4G, BR9M4GI, BR9M6G, BR9M6GI, BRG40, BRG40G, C7011GFE, C7011GFG, C707GFE, C707GFG, C9F4G, C9F4GS, C9F6G, C9F6GS, C9F8G, C9F8GS, CFG101, CFG101D, CFG101L, CFG101P, CFG120, CFG70, CFG70D, CFG70L, CFG70M, CFG70P, CP707G, CP92G, CP94G, CS10, CS102G, CS102GP, CS6, EC74GVG...(Other models you can see in the webshop)		



GEV No.	102314	Ref. No.	CR0687080
description	ignition electrode D1 ø 7mm D2 ø 9mm connection M4 L1 2mm BL1 28mm BL2 3mm BL3 23mm to clip		
For models:	NC712G36, NC74G12, NC78G24, NC7FE12G36, NC7FE8G24, NC7FG12G44, NC7FG8G32, NC7FGM12G, NC912G44, NC94G16, NC94G20, NC98G28, NC98G40, NC9FE12G44, NC9FE8G28, NC9FG12G52, NC9FG16G72, NC9FG8G32, NC9FG8G36, NC9FG8G48, NC9FGM12G, NS78GS, NS7FG12GS, NT7FG12G, NT9FG12G		

GEV No.	100707	Ref. No.	R63050010
description	ignition electrode D1 ø 7mm D2 ø 9mm connection ø2.4mm L1 14mm L2 6mm BL1 18mm BL2 3mm BL3 23mm to clip Qty 1 pcs		
For models:	FG105M, FG105X, FG110M, FG110X, FG210M, FG210X, PG040M, PG040X, PG080M, PG080X		

GEV No.	100703	Ref. No.	1031025700 638700
description	ignition electrode D1 ø 9mm connection M4 D2 ø 11mm L1 8mm BL1 13mm BL2 4mm BL3 22mm to clip		

GEV No.	104687	Ref. No.	R63050080 R63050090
description	ignition electrode flange length 17mm flange width 24mm D1 ø 9.5mm D2 ø 9.5mm L1 49mm BL1 64mm BL2 52mm connection male faston 2.8mm fixing dimensions 4.5mm flange		
For models:	MG102M, MG102P, MG102T, MG201M, MG201P		

GEV No.	104695	Ref. No.	R63050310
description	ignition electrode flange length 23mm flange width 15mm D1 ø 7mm D2 ø 7mm L1 13mm L2 19mm L3 13mm BL1 31mm BL2 24mm connection M4 fixing dimensions 4x5mm flange		
For models:	GC106M, GM106H, GM106M, GM106M+SC, GM106P, GV106H, GV106M, GV106M+SC, GV106P		

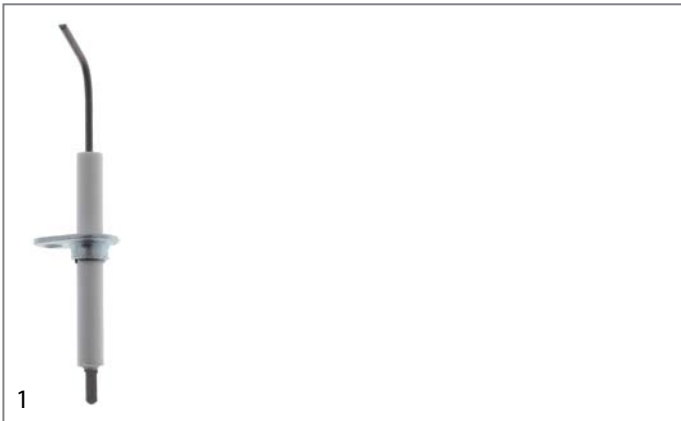

GEV No.	104686	Ref. No.	R63050340
description	ignition electrode flange length 23mm flange width 15mm D1 ø 7mm D2 ø 7mm L1 20mm L2 15mm BL1 22mm BL2 4mm BL3 28mm connection male faston 2.8mm		
For models:	GC110M, GC210M, GM110H, GM110M, GM110M+SC, GM110P, GM210H, GM210M, GM210M+SC, GM210P, GV110H, GV110M, GV110M+SC, GV110P, GV210H, GV210M, GV210M+SC, GV210P		

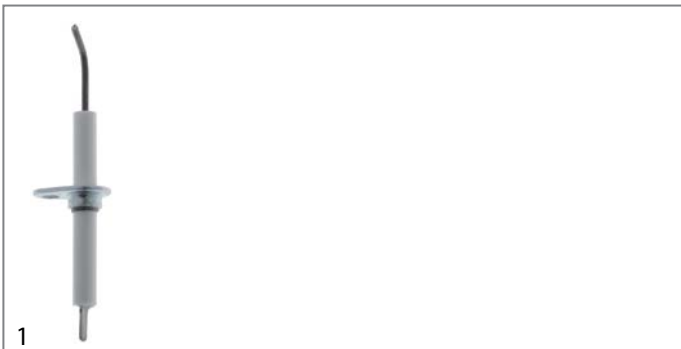

GEV No.	104685	Ref. No.	R63050300
description	ignition electrode flange length 23mm flange width 15mm D1 ø 7mm L1 15mm L2 12mm BL1 22mm BL2 31mm connection male faston 2.8mm fixing dimensions ø4mm with flange		
For models:	GC106M, GM106H, GM106M, GM106M+SC, GM106P, GV106H, GV106M, GV106M+SC, GV106P		

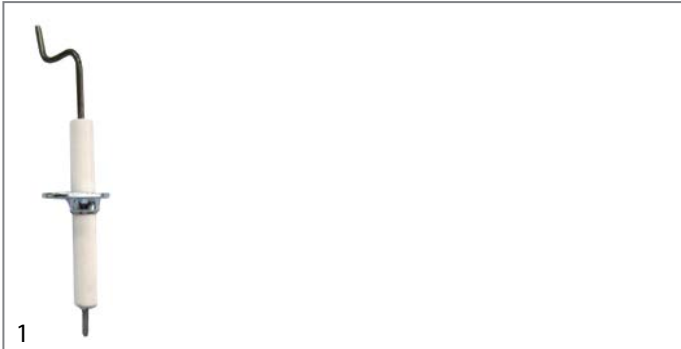

GEV No.	104451	Ref. No.	R63050350
description	ignition electrode flange length 23mm flange width 15mm D1 ø 7mm L1 25mm L2 14mm L4 15mm BL1 22mm BL2 34mm		
For models:	GC110M, GC210M, GM110H, GM110M, GM110M+SC, GM110P, GM210H, GM210M, GM210M+SC, GM210P, GV110H, GV110M, GV110M+SC, GV110P, GV210H, GV210M, GV210M+SC, GV210P		

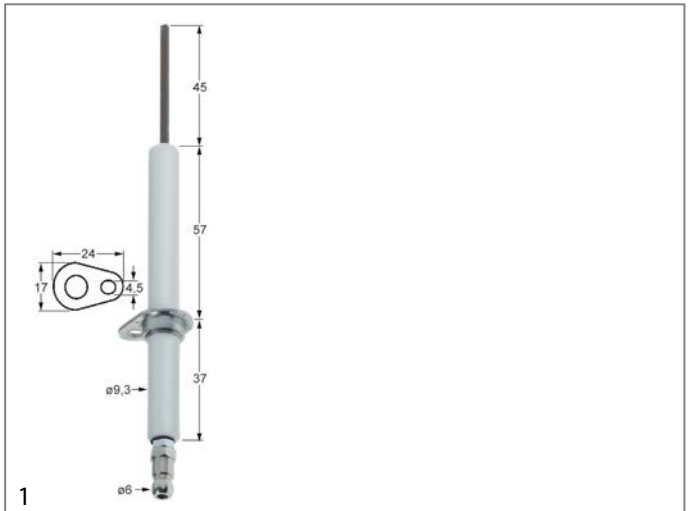

GEV No.	106756	Ref. No.	LAR63050130
description	ignition electrode flange length 24mm flange width 17mm D1 ø 9.3mm L1 45mm BL1 57mm BL2 37mm connection ø6 fixing dimensions ø4.5mm A1/B13/C2		

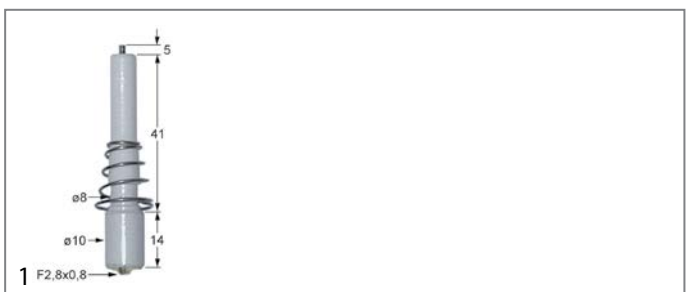

GEV No.	100729	Ref. No.	1031025600 MA1031025600
description	ignition electrode L1 5mm D1 ø 8mm D2 ø 10mm BL1 41mm BL2 14mm connection F 2.8x0.8mm to clip with spring		

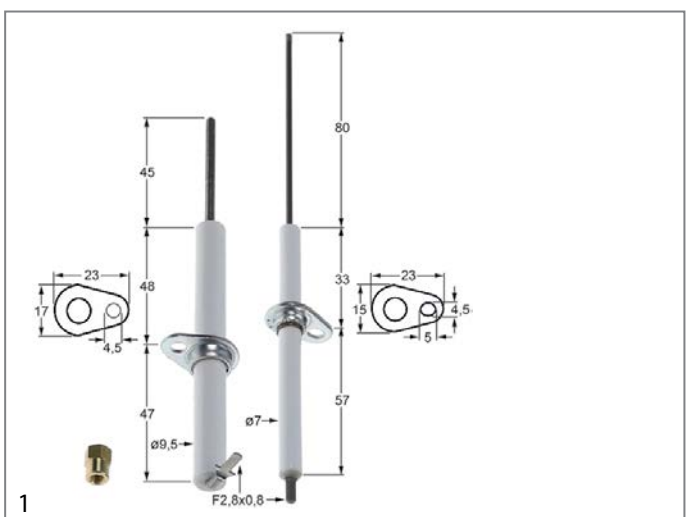

GEV No.	106525	Ref. No.	R63050070
description	ignition electrode set Qty 2 flange length 23mm flange width 15/17mm D1 ø 7/9.5mm L1 80/45mm BL1 33/48mm BL2 57/47mm connection F2.8x0.8 fixing dimensions ø4.5mm		
For models:	MACG05M, MACG07M, MG061D, MG061M, MG061P, MG061T, MG101M, MG101P, MG101T, MG201T, MVG051P		

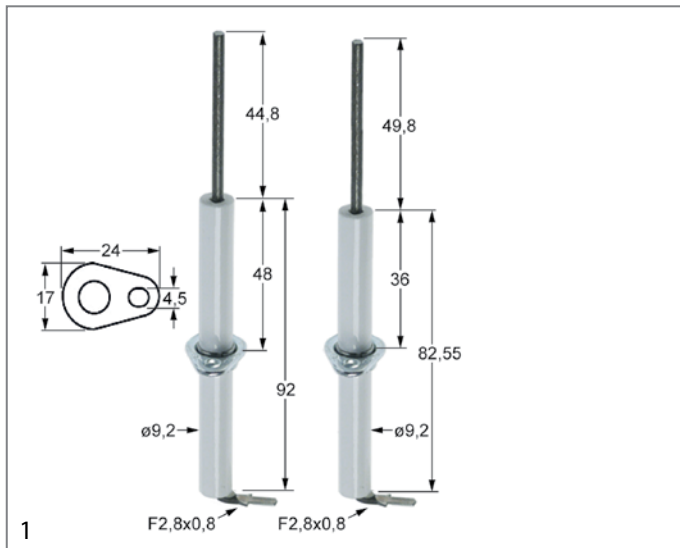

GEV No.	106647	Ref. No.	R63050100
description	ignition electrode set flange length 24mm flange width 17mm D1 ø 9.5mm L1 45mm BL1 48mm BL2 48mm connection male faston 2.8mm with screw connection 1x ignition 1x flame monitoring		
For models:	GMT06D, GMT20D, GVT06D, GVT20D, MACG10M, MACG20M, MG101D, MG101M, MG101P, MG102D, MG102M, MG102P, MG102T, MG201D, MG201M, MG201P, MG201T, MG202D, MG202M, MG202P, MG202T, MGMT06D, MGMT06P, MGMT10D, MGMT10P, MGMT20D, MGMT20P, MGMT21D, MGMT21P, MGMT40D, MGMT40P, MGVT06D, MGVT06P, MGVT10D, MGVT10P, MGVT20D, MGVT20P, MGVT21D, MGVT21P, MGVT40D, MGVT40P		



GEV No.	100906	Ref. No.	1888400 MA1888400
description	screw connection thread M10x1 for ignition electrode brass Qty 1 pcs WS 10		
For models:	B74G, B78G, B94G, B98G, B9SB2G, B9SB4G, B9V2G, B9V4G, B9VP4G, BF78G, BF912G, BF912GH, BF98G, BM74G, BM77G, BR707G, BR707GI, BR78GF, BR78GI, BR912GFM, BR912GIM, BR94G, BR94GI, BR98GF, BR98GFM, BR98GI, BR98GIM, BR9M4G, BR9M4GI, BR9M6G, BR9M6GI, BR9S8GF, BR9S8GI, BR9SB4G, BR9SB4GI, C124G, C129G, C12C2G9, C12C9G, C12FG9G, C12FGP9G, C7011G, C7011GF, C7011GFG, C704G, C707G, C707GFE, C707GFG, C712G, C74G...(Other models you can see in the webshop)		

ignition cables

terminals and connectors



GEV No.	100023	Ref. No.	MA20418099
description	female bullet size 2.3mm 0.5-1.5mm ² CuZn t.max. 125°C Qty 20 pcs		

pre-assembled cables



GEV No.	100026	Ref. No.	548300 BN2532997
description	ignition cable cable length 1000mm connection ø4mm / F6.3mm		



GEV No.	102157	Ref. No.	1152900
description	ignition cable cable length 1200mm connection F2.8mm / lug M4		
For models:	P9D10G, P9D15G, P9DA10G, P9DA15G, P9I10G, P9IA10G		



GEV No.	100179	Ref. No.	R66600400
description	ignition cable cable length 1200mm connection F2.8mm / ø2.4mm		
For models:	FG105M, FG105X, PG040M, PG040X		



GEV No.	100195	Ref. No.	1950312 1950324 MA1950324
description	ignition cable cable length 1200mm connection ø2.4mm / lug M4		
For models:	BF78G, BF912G, BF912GH, BF98G, C124G, C129G, C12C2G9, C12C9G, C12FG9G, C7011G, C7011GFE, C7011GFG, C704G, C707G, C707GFE, C707GFG, C712G, C74G, C78G, C7FE12G, C7FE8G, C7FG12G, C7FG8G, C7FG9G, C7FGM12G, C912G, C912GS, C94G, C94GP, C94GS, C98G, C98GP, C98GS, C9F4GS, C9F6GS, C9F8GS, C9FE12G, C9FE12GS, C9FE4GS, C9FE6GS, C9FE8G, C9FE8GS, C9FEP4GS, C9FEP6GS, C9FEP8GS, C9FG12G, C9FG12GS, C9FG16G, C9FG8G, C9FG8GP.. (Other models you can see in the webshop)		



GEV No.	102163	Ref. No.	R66600410
description	ignition cable cable length 1500mm connection F2.8mm / ø2.4mm		
For models:	FG110M, FG110X, FG210M, FG210X, PG080M, PG080X		



GEV No.	102189	Ref. No.	CR0508710
description	ignition cable cable length 300mm connection ø2.4mm / lug M4		
For models:	FQG41, FQG61, OFQG41, OFQG61		



GEV No.	107851	Ref. No.	R66110370
description	ignition cable cable length 300mm set 2-piece		
For models:	MACG05M, MACG07M, MACG10M, MACG20M, MG061D, MG061M, MG061P, MG061T, MG101D, MG101M, MG101P, MG101T, MG201D, MG201M, MG201P, MG201T, MVG051P		



GEV No.	100196	Ref. No.	1047024200 MA1047024200
description	ignition cable cable length 400mm connection F2.8mm / ø2.4mm		



GEV No.	100036	Ref. No.	1047102900 MA1047102900
description	ignition cable cable length 500mm connection F2.8mm / F2.8mm		



GEV No.	100197	Ref. No.	1047024300 BN8220191 MA1047024300
description	ignition cable cable length 600mm connection F2.8mm / ø2.4mm		



GEV No.	100186	Ref. No.	1047024400 1936300 MA1047024400 MA1936300
description	ignition cable cable length 600mm connection ø2.4mm / lug M4		
For models:	B74G, B78G, B94G, B98G, B9SB2G, B9SB4G, B9V2G, B9V4G, BIG40, BIG60, BM74G, BM77G, BMG40, BMG60, BR707G, BR707GI, BR912G-FM, BR912GIM, BR98GF, BR98GFM, BR98GI, BR98GIM, BRG40, BRG40G, CP704G, EF74G15, EF74G8VA, EF74G8VG, EFT74GLVG, EFT74GRVG, EFT78GLVG, EFT78GMVG, EPC74G, F12C4G15, F74G10, F74G15, F74G6, F76G10, F78G15, F94G10, F94G15, F94G22, F94G22K, F94G6, F96G10, F98G15, F98G22, F98G22K, F954G15, F954G22...(Other models you can see in the webshop)		



GEV No.	100199	Ref. No.	1088300 1088600 1088900 1152700 1152800 MA1152800
description	ignition cable cable length 600mm connection ø4mm / F2.8mm		
For models:	B9SB2G, B9V2G, BR94G, BR94GI, BR96G, BR96GI, BR9M4G, BR9M4GI, BR9M6G, BR9M6GI, CP92G, CP94G, F9SB2G, F9SB2GR, F9SB4G, F9SB-4GR, F9SB4GRL, F9V2G, F9V2GR, F9V4G, F9V4GR, F9V4GRL, FR74G, FR77G, FR92G22, FR94G23, FT74G, FT74GR, FT77G, FT77GRL, GB707G, P9D2G, T7011GFG, T707G, T707GFG		



GEV No.	100025	Ref. No.	1394600 671300 671400 671500 672400 MA1394600
description	ignition cable cable length 600mm connection ø4mm / F6.3mm		
For models:	FR92G13, FR94G13		



GEV No.	100037	Ref. No.	1047103000
description	ignition cable cable length 900mm connection F2.8mm / F2.8mm		



GEV No.	100019	Ref. No.	1047024600 1936400 1950300 BN4185326050610 CR0688770 MA1936400
description	ignition cable cable length 900mm connection ø2.4mm / ø4mm		
For models:	B9SB2G, B9SB4G, B9V2G, B9V4G, B9VP4G, BF78G, BF912G, BF912GH, BF98G, BR78GF, BR78GI, BR912GFM, BR912GIM, BR98GF, BR98GFM, BR98GI, BR98GIM, BR9S8GF, BR9S8GI, C12FGP9G, C7FG12G, C7FG8G, C9F4E, C9F4GS, C9F6E, C9F6GS, C9F8GS, C9FE4GS, C9FE6GS, C9FE8GS, C9FG12G, C9FG16G, C9FG8G, C9FG8GP, C9FGM12G, C9FP, C9FP4GS, C9FP6GS, C9FP8GS, C9V2GS, C9V4GS, C9V6GS, C9V8GS, CP92G, CP94G, CP9SB2G, CP9SB4G, ET78GVG, ET7FG8G, FT129GLC...(Other models you can see in the webshop)		



GEV No.	102155	Ref. No.	1152600 SI9303074 SIR9303074
description	ignition cable cable length 900mm connection ø4mm / F2.8mm		
For models:	B9SB4G, B9V4G, C9F4G, C9F4GS, C9F6G, C9F6GS, C9F8G, C9F8GS, T9F4G, T9F6GS, T9SB4G, T9V4G, T9V6GS		

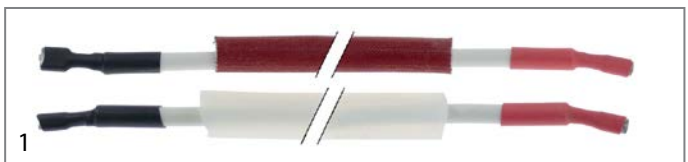

GEV No.	107853	Ref. No.	R66605900
description	ignition cable for combi-steamer set 2-piece L 800mm		
For models:	GC106M, GC110M, GC210M, GM106H, GM106M, GM106M+SC, GM106P, GM110H, GM110M, GM110M+SC, GM110P, GM210H, GM210M, GM210M+SC, GM210P, GV106H, GV106M, GV106M+SC, GV106P, GV110H, GV110M, GV110M+SC, GV110P, GV210H, GV210M, GV210M+SC, GV210P		

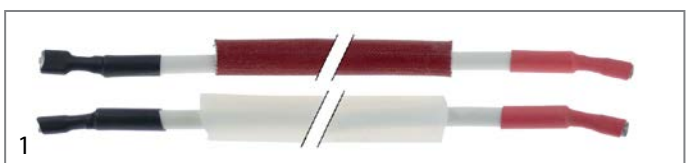

GEV No.	107855	Ref. No.	R66110380
description	ignition cable set 2-piece L 700mm		
For models:	MG102M, MG102P, MG102T		



piezoelectric igniters

mounting diameter 18mm





1

GEV No.	100003	Ref. No.	1936100 986000 MA1936100 MA986000
description	piezoelectric igniter body metal blowing mounting ø 18mm connection F2.8x0.8		
For models:	702BMG, 706, 706S, B74G, B78G, B94G, B98G, B9SB2G, B9SB4G, B9V2G, B9V4G, B9VP4G, BF78G, BF912G, BF912GH, BF98G, BIG40, BIG60, BM74G, BM77G, BMG40, BMG60, BR707G, BR707GI, BR78GF, BR78GI, BR912GFM, BR912GIM, BR98GF, BR98GFM, BR98GI, BR98GIM, BR9S8GF, BR9S8GI, BRG40, BRG40G, C124G, C129G, C12C2G9, C12C9G, C12FG9G, C12FGP9G, C7011G, C7011GF, C7011GFG, C704G, C707G, C707GFE, C707GFG, C712G...(Other models you can see in the webshop)		



1

GEV No.	100009	Ref. No.	1906100 BN6A041105 MA1906100
description	piezoelectric igniter body plastic blowing mounting ø 18mm connection ø2.4mm front measurements 26mm M18x1.5		
accessories for	100009		
	GEV No.	101339	Ref. No. —
	cover cap for piezoelectric igniter		
	GEV No.	106869	Ref. No. CM136000 MACM136000
	cover cap for piezoelectric igniter ID ø 22mm ED ø 35mm H 25mm		
	GEV No.	107931	Ref. No. —
	cover cap for piezoelectric igniter ID ø 21mm ED ø 36mm		

mounting diameter 22mm



1

GEV No.	100013	Ref. No.	1031500600
description	piezoelectric igniter body plastic blowing mounting ø 22mm connection ø2.4mm cable lengthmm		
accessories for	100013		
	GEV No.	100023	Ref. No. MA20418099
	female bullet size 2.3mm 0.5-1.5mm ² CuZn t.max. 125°C Qty 20 pcs		

miscellaneous



1

GEV No.	nla ¹	Ref. No.	224311
description	piezoelectric igniter body metal connection F6.3x0.8 2 hole fixing ø 22mm		
For models:	702BMG, 706, 706S, TPF706, TPF706S		

¹no longer available



1

GEV No.	nla ¹	Ref. No.	1393700 24020299 MA1393700
description	piezoelectric igniter suitable for Minisit with cover cap ømm connection F6.3x0.8		
For models:	FR92G13, FR94G13		
spare parts for	101136		
	GEV No.	100001	Ref. No. —
	piezoelectric igniter suitable for Minisit connection F6.3x0.8 ømm		

¹no longer available

accessories



1

GEV No.	106869	Ref. No.	CM136000 MACM136000
description	cover cap for piezoelectric igniter ID ø 22mm ED ø 35mm H 25mm		
For models:	EPC74G, F12C4G15, NB74G, NB78G, NB94G, NB98G, NBR78GF, NBR78GI, NC712G36, NC74G12, NC78G24, NC7FE12G36, NC7FE8G24, NC7FG12G44, NC7FG8G32, NC7FG8G36, NC7FG8G48, NC7FGM12G, NC912G44, NC94G16, NC94G20, NC98G28, NC98G40, NC9FE12G44, NC9FE8G28, NC9FG12G52, NC9FG16G72, NC9FG8G32, NC9FG8G36, NC9FG8G48, NC9FGM12G, NF74G10, NF74G15, NF74G15T, NF74G8, NF76G10, NF76G8, NF78G15, NF78G15T, NF94G15, NF94G23, NF96G10, NF98G15, NF98G23, NFT74GL, NFT74GR, NFT74GTLC, NFT74GTLCO, NFT74GTLO, NFT74GTRC...(Other models you can see in the webshop)		



1

GEV No.	106868	Ref. No.	CM136100 MACM136100
description	disc for piezoelectric igniter ID ø 18mm ED ø 32mm H 4mm		
For models:	NB74G, NB78G, NBR78GF, NBR78GI, NF74G15T, NF78G15T, NF96G10, NG74G, NG78G, NG94G, NG98G, NGL74G, NGL78G, PC12C9G		

ignition units

			
1			
GEV No.	102485	Ref. No.	1450300 2971400 BN6A050100 MA2971400 R65180290
description	ignition unit outputs 2 220-240VAC 0.6VA 50-60Hz		
For models:	BR912GFM, BR912GIM, BR94G, BR94GI, BR98GF, BR98GFM, BR98GI, BR98GIM, BR9M4G, BR9M4GI, BR9M6G, BR9M6GI, BR9S5B4G, BR9S5B4GI, CS10, CS102G, CS102GP, CS6, FC10G, FC20G, FC5G, FC7G, FG105M, FG105X, FG110M, FG110X, FG210M, FG210X, FR92G22, FR94G23, MS10AG, MS10IG, MS70AG, MS70IG, MS70IGS, NBR912GFM, NBR912GIM, NBR98GF, NBR98GFM, NBR98GI, NBR98GIM, NF94G23K, NF98G23K, NPC74G, NPC76G, NPC78G, NPC94G, NPC96G, NPC98G, NPD76G5...(Other models you can see in the webshop)		

			
1			
GEV No.	102388	Ref. No.	1037301400 MA1037301400
description	ignition unit outputs 4 230VAC dimensions 111x23x34mm mounting distance 100mm inlet F6.3x0.8 outlet F2.8x0.8 type WAC-T4 0.6VA 50/60Hz		

ignition switches

			
1			
GEV No.	345038	Ref. No.	CR0410290
description	momentary push switch mounting ø 25mm black 2NO 250V 16A connection male faston 6.3mm ambient temperature max. 85°C protection IP40		
For models:	CFG70, CFG70M, NBR912EFM, NBR912EIM, NBR912GFM, NBR912GIM, NBR98EF, NBR98EFM, NBR98EI, NBR98EIM, NBR98GF, NBR98GFM, NBR98GI, NBR98GIM		

thermocouples

plug-in thermocouples

plug-in thermocouples standard

with barrel socket ø6mm

type Junkers with aluminised tip

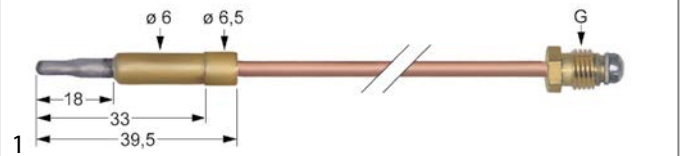

GEV No.	102225	Ref. No.	933300
description	thermocouple M10x1 L 320mm plug connection ø6.0mm		

with barrel socket ø6(6.5)mm

thermocouples SIT

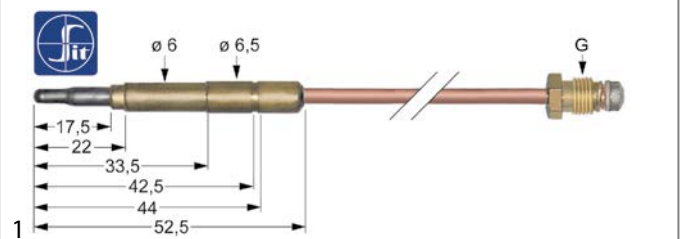

GEV No.	107618	Ref. No.	641600 MA641600
description	thermocouple SIT M10x1 L 750mm plug connection ø6.0(6.5)mm		

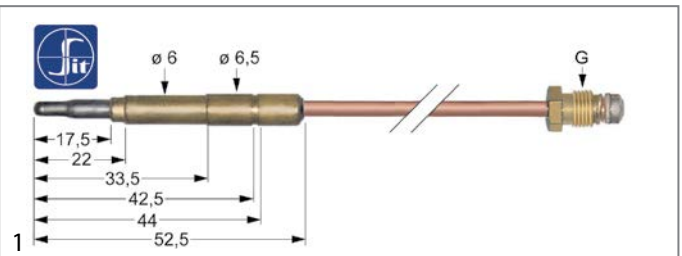

GEV No.	107601	Ref. No.	1033027500 1033027800 1206400 MA1033027800 MA1206400
description	thermocouple SIT M8x1 L 600mm plug connection ø6.0(6.5)mm		

For models:	BIG40, BIG60, BRG40, BRG40G, CFG101, CFG101D, CFG101L, CFG101P, CFG120, CFG70, CFG70D, CFG70L, CFG70M, CFG70P, CFGE61, CFGE61D, CFGE61L, CFGE61P, FTG40B, FTG40BLC, FTG40BR, FTG60B, FTG60BLC, FTG60BR, FTG60BRR, FTG80B, FTG80BLC, FTG80BR, OCFG101, OCFG120, OCFG70, OCFG61, OPCG41, OPCG61, PCG41, PCG41D, PCG41L, PCG41P, PCG61, PCG61D, PCG61L, PCG61P, PCGD41, PCGD41D, PCGD41L, PCGD41P, PCGD61, PCGD61D, PCGD61L, PCGD61P		
--------------------	---	--	--

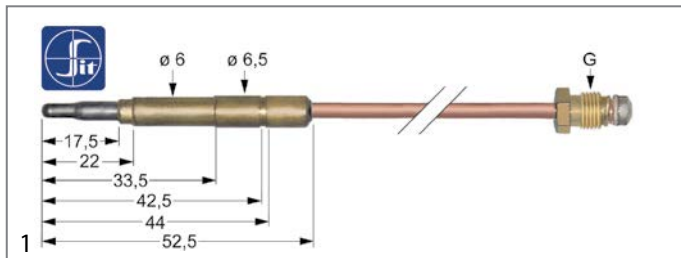

GEV No.	107602	Ref. No.	1206500 MA1206500
description	thermocouple SIT M8x1 L 850mm plug connection ø6.0(6.5)mm		
For models:	BR96G, BR96GI, BR9M6G, BR9M6GI, GB707G		

accessories for 107602

	GEV No.	100920	Ref. No.	—
	thermocouple fitting thread M8x1 / M9x1 Qty 1 pcs			
	GEV No.	100922	Ref. No.	—
	thermocouple fitting thread M10x1 / ASA 11/32 Qty 1 pcs			

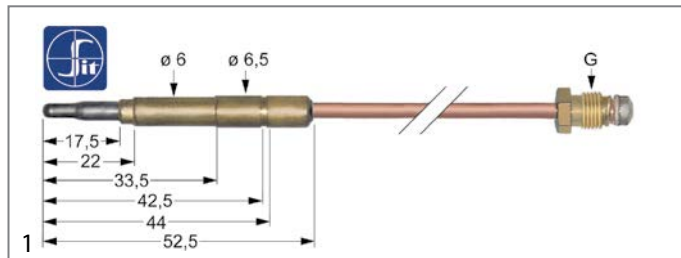

GEV No.	107606	Ref. No.	1031500400 MA1031500400
description	thermocouple SIT M9x1 L 320mm plug connection ø6.0(6.5)mm		
For models:	FQG40, FQG60		

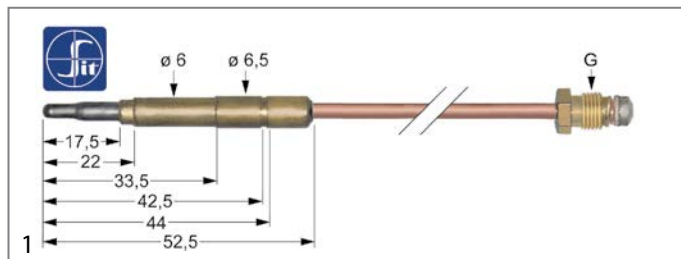

GEV No.	107608	Ref. No.	1031504300 641900 6A011912 BN6A011912 MA1031504300 MA641900
description	thermocouple SIT M9x1 L 500mm plug connection ø6.0(6.5)mm		
For models:	C124G, C129G, C12C2G9, C12C9G, C12FG9G, EFT74GLVG, EFT74GR-VG, EFT78GLVG, EFT78GMVG, FT74G, FT74GR, FT77G, FT77GRL		

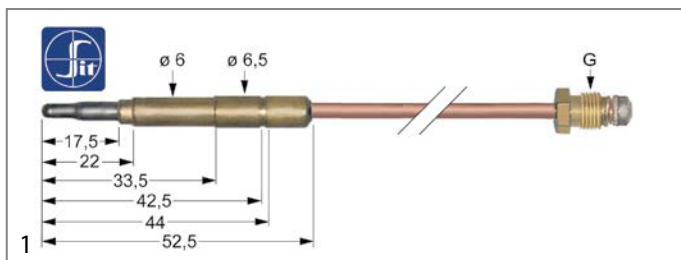

GEV No.	107613	Ref. No.	263800 MA263800
description	thermocouple SIT M9x1 L 1200mm plug connection ø6.0(6.5)mm		
For models:	704, 704S, 706, 706AS, 706S, B9SB2G, B9SB4G, B9V2G, B9V4G, B9VP4G, C7FG9G, CS10, CS6, MM10DG, MM10DGS, MM15DG, NC7FG12G44, NC7FG8G32, NC7FG8G36, NC7FG8G48, NC9FG12G52, NC9FG16G72, NC9FG8G32, NC9FG8G36, NC9FG8G48, NT7FG12G, NT7FG8G, NT9FG12G, NT9FG8G, P9D10G, P9D15G, P9DA10G, P9DA15G, P9DASB10G, P9DSB10G, PDASB10G, TPF706, TPF706S		

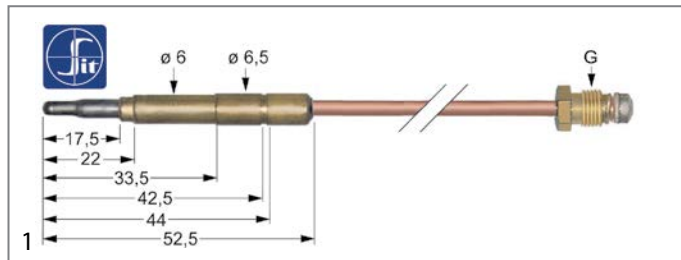

GEV No.	107609	Ref. No.	1031501500 1033027600 90520 MA1031501500 MA1033027600 MA90520
description	thermocouple SIT M9x1 L 600mm plug connection ø6.0(6.5)mm		
For models:	B9SB2G, B9V2G, BMG40, BMG60, BR707G, C9F4G, C9F4GS, C9F6G, C9F6GS, C9F8G, C9F8GS, CP92G, CP94G, F9SB2G, F9SB2GR, F9SB4G, F9SB4GR, F9SB4GRL, F9V2G, F9V2GR, F9V4G, F9V4GR, F9V4GRL, FR15G, FR15G2, FR2G, FR2G15, FR4G, FR4G15, P9D2G, PD707G, T7011GFG, T707G, T707GFG, T9F4G, T9F6GS, T9SB4G, T9V4G, T9V6GS		

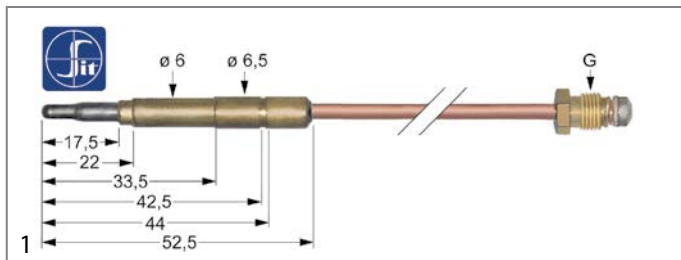

GEV No.	107614	Ref. No.	2639-00 R63040030 SI0100818 SIR0100818
description	thermocouple SIT M9x1 L 1500mm plug connection ø6.0(6.5)mm		
For models:	CS102G, CS102GP, FG110M, FG110X, FG210M, FG210X, PG080M, PG080X		

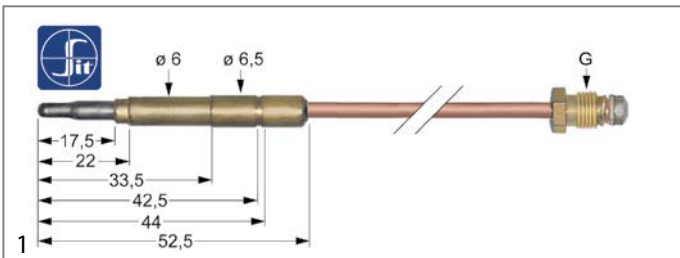

GEV No.	107611	Ref. No.	1031501600 1916000 2716500 CM029100 MA1031501600 MA1916000 MA2716500 MACM029100 R63040020
----------------	--------	-----------------	---

description thermocouple SIT M9x1 L 850mm plug connection $\varnothing 6.0(6.5)$ mm

For models: B74G, B78G, B94G, B98G, B9SB2G, B9SB4G, B9V2G, B9V4G, BF78G, BF912G, BF912GH, BF98G, BM74G, BM77G, BMG40, BMG60, BR707G, BR707GI, BR78GF, BR78GI, BR94G, BR94GI, BR9M4G, BR9M4GI, BR9M6G, BR9M6GI, C12FGP9G, C7011G, C7011GFE, C7011GFG, C704G, C707G, C707GFE, C707GFG, C712G, C74G, C74GS, C78G, C78GS, C79G, C7FE12G, C7FE12GS, C7FE8G, C7FE8GS, C7FG12G, C7FG12GS, C7FG8G, C7FG8GS, C7FG9G, C7FGM12G...(Other models you can see in the webshop)

plug-in thermocouples with interruption

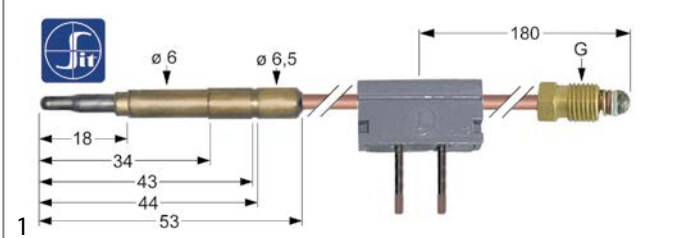

GEV No.	107864	Ref. No.	MA1955400
----------------	--------	-----------------	-----------

description thermocouple SIT with interrupter M9x1 L 600mm plug connection $\varnothing 6.0(6.5)$ mm soldering connection

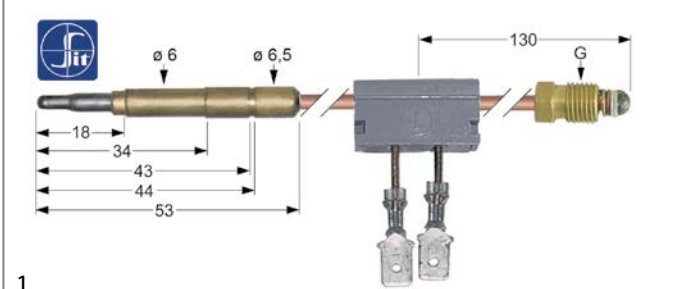

GEV No.	107177	Ref. No.	41826920050 BN41826920050
----------------	--------	-----------------	------------------------------

description thermocouple SIT with interrupter M9x1 L 600mm plug connection $\varnothing 6.0$ mm F 6.3mm

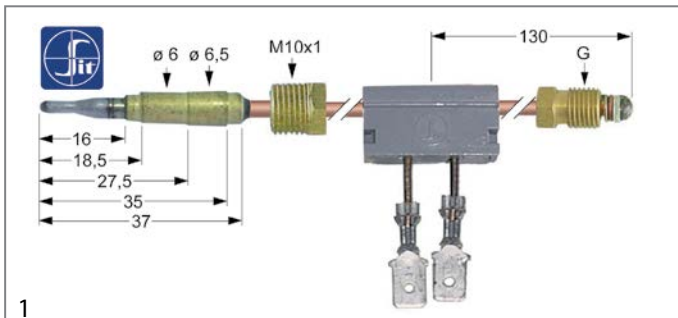

GEV No.	102238	Ref. No.	1949800 MA1949800
description	thermocouple with interrupter M9x1 L 600mm M10x1 F 6.3mm		
For models:	MM10IG, P9I10G, P9IA10G		

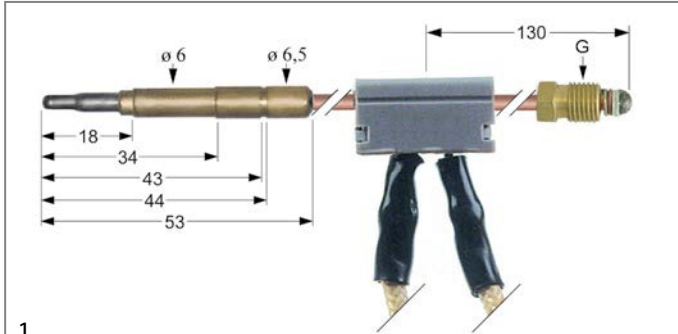

GEV No.	102247	Ref. No.	1950100 1955500 838323 CR0508700 MA1950100 MA1955500 MA838323
----------------	--------	-----------------	---

description thermocouple with interrupter M9x1 L 600mm plug connection $\varnothing 6.0$ mm cable 700mm

For models: BR912GFM, BR912GIM, BR94G, BR94GI, BR98GF, BR98GFM, BR98GI, BR98GIM, BR9M4G, BR9M4GI, BR9M6G, BR9M6GI, BR9SB4G, BR9SB4GI, EF74G15, EF74G8VA, EF74G8VG, F12C4G15, F74G10, F74G15, F74G6, F76G10, F78G15, F94G10, F94G15, F94G22, F94G22K, F94G6, F96G10, F98G15, F98G22, F98G22K, F954G15, F954G22, F954G22K, F958G15, F958G22, F958G22K, FQG41, FQG61, FR74G, FR77G, FR92G13, FR92G22, FR92G22T, FR94G13, FR94G22, FR94G22T, FR94G23, FT129GLC...(Other models you can see in the webshop)



threaded thermocouples
threaded thermocouples standard
with socket with thread M8x1

SIT

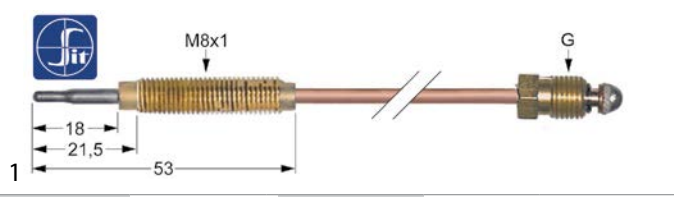

GEV No.	107633	Ref. No.	1665000 MA1665000
description	thermocouple SIT M8x1 L 1200mm M8x1		
For models:	C7011GFG, C707GFE, C707GFG, CFG101, CFG101D, CFG101L, CFG101P, CFG120, CFG70, CFG70D, CFG70L, CFG70M, CFG70P, EC74G-VG, EC78GVG, EC7FG8G, OCFG101, OCFG120, OCFG70, T7011GFG, T707GFG		
accessories for	107633		
	GEV No.	102067	Ref. No. 6A012300 939300 BN6A012300 MA939300
nut thread M8x1 H 3mm brass Qty 1 pcs type SEF 1			

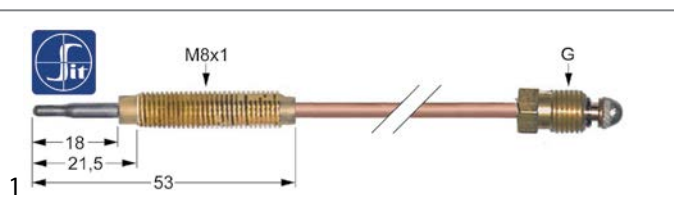

GEV No.	107627	Ref. No.	641500 MA641500
description	thermocouple SIT M8x1 L 220mm M8x1		
For models:	702BMG, 706, 706S, C9F6G, C9F6GS, T9F6GS, TPF706, TPF706S		

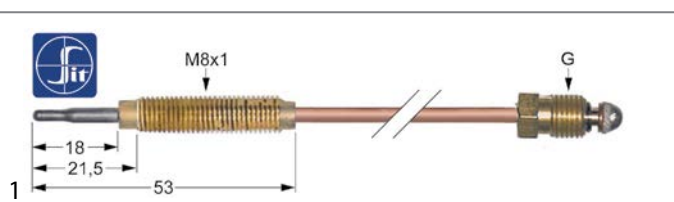

GEV No.	107628	Ref. No.	1033027100 641400 MA1033027100 MA641400
description	thermocouple SIT M8x1 L 320mm M8x1		
For models:	704S, 706S, C7011G, C7011GFE, C7011GFG, C704G, C707G, C707GFE, C707GFG, C9F4GS, C9F6GS, C9F8GS, C9S84GS, C9V2GS, C9V4GS, C9V6GS, C9V8GS, TPF706S		
accessories for	107628		
	GEV No.	102067	Ref. No. 6A012300 939300 BN6A012300 MA939300
nut thread M8x1 H 3mm brass Qty 1 pcs type SEF 1			

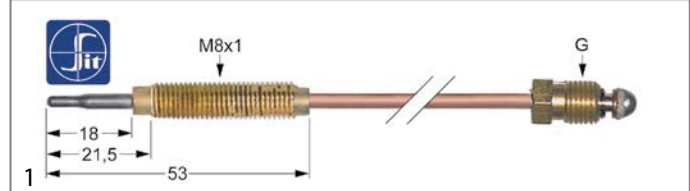

GEV No.	107630	Ref. No.	641300 MA1033027200 MA641300
description	thermocouple SIT M8x1 L 600mm M8x1		
For models:	704S, 706S, C7011G, C7011GFE, C7011GFG, C704G, C707G, C707GFE, C707GFG, C9F4GS, C9F6GS, C9F8GS, C9S84GS, C9V2GS, C9V4GS, C9V6GS, C9V8GS, TPF706S		
accessories for	107630		
	GEV No.	102067	Ref. No. 6A012300 939300 BN6A012300 MA939300
nut thread M8x1 H 3mm brass Qty 1 pcs type SEF 1			

thermopiles

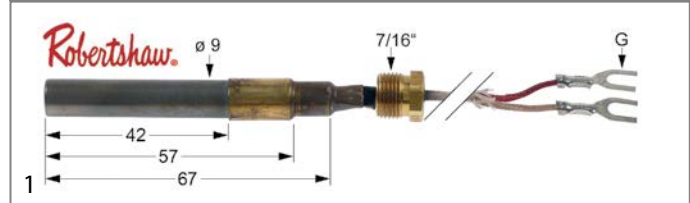

GEV No.	102116	Ref. No.	1870712 MA1870712
description	thermopile ROBERTSHAW L 900mm probe ø 9mm probe L 57mm 250-750mV screw connection 7/16"		
For models:	F94G22, F98G22, F9S4G22, F9S8G22, FR92G22, FR94G22, MM10IG, P9110G, P91A10G		

extensions



GEV No.	102011	Ref. No.	933400
description	thermocouple extension thread M10x1 L 400mm		
For models:	C9F4G, C9F4GS, C9F6G, C9F6GS, C9F8G, C9F8GS, CS10, CS102G, CS102GP, CS6, P9110G, P91A10G, T9F4G, T9F6GS, T9S84G, T9V4G, T9V6GS		

accessories

nuts



GEV No.	102067	Ref. No.	6A012300 939300 BN6A012300 MA939300
description	nut thread M8x1 H 3mm brass Qty 1 pcs type SEF 1		
For models:	702BMG, 704S, 706, 706S, C7011G, C7011GFE, C7011GFG, C704G, C707G, C707GFE, C707GFG, C9F4GS, C9F6G, C9F6GS, C9F8GS, C9S84GS, C9V2GS, C9V4GS, C9V6GS, C9V8GS, CFG101, CFG101D, CFG101L, CFG101P, CFG120, CFG70, CFG70D, CFG70L, CFG70M, CFG70P, EC74G-VG, EC78GVG, EC7FG8G, OCFG101, OCFG120, OCFG70, T7011GFG, T707GFG, T9F6GS, TPF706, TPF706S		



screws

			
1			
GEV No.	101262	Ref. No.	1162800
description	thermocouple fitting thread M10x1 Qty 1 pcs		
For models:	C9F4G, C9F4GS, C9F6G, C9F6GS, C9F8G, C9F8GS, MM10DG, MM10D-GS, MM15DG, P9D10G, P9D15G, P9DA10G, P9DA15G, P9DASB10G, P9DSB10G, PDASB10G, T9F4G, T9F6GS, T9SB4G, T9V4G, T9V6GS		

			
1			
GEV No.	101260	Ref. No.	1359100 MA1359100
description	thermocouple fitting thread M8x1 Qty 1 pcs		
For models:	BR96G, BR96GI, BR9M6G, BR9M6GI, C7FG9G, CP707G, CP92G, CP94G, F9SB2G, F9SB2GR, F9SB4G, F9SB4GR, F9SB4GRL, F9V2G, F9V2GR, F9V4G, F9V4GR, F9V4GRL, FT74G, FT74GR, FT77G, FT77GRL, FTG40B, FTG60B, FTG60BLC, FTG60BR, FTG80B, FTG80BR, GB707G, OPLG40, OPLG80, P9D2G, PCG42, PCG82, PD707G, PLG40, PLG80, T7011GFG, T707G, T707GFG		

interrupters

			
1			
GEV No.	101265	Ref. No.	1031500500 1533400 MA1533400 R63040210
description	interrupter thread M9x1		
For models:	FG105M, FG105X, FG110M, FG110X, FG210M, FG210X, FQG40, FQG60, PG040M, PG040X, PG080M, PG080X		





gas burners

hob burners

universal hob burners

GEV

			
1			
GEV No.	106379	Ref. No.	N/A
description	air mixing tube for burner cap ø 80mm L 23mm D1 ø 20mm D2 ø 15.6mm D3 ø 14mm		

				
1				
GEV No.	103068	Ref. No.	1032000800 MA1032000800	
description	burner cap ø 100mm			
accessories for	103068			
	GEV No.	103067	Ref. No.	1032009600 MA1032009600 SIR0100247
burner ring for burner cap ø 100mm				
	GEV No.	104102	Ref. No.	1032009400 MA1032009400
burner head for burner cap ø 100mm ext. ø 130				
	GEV No.	104103	Ref. No.	1032009200 MA1032009200
burner holder suitable for burner ø100mm with nozzle holder				

				
1				
GEV No.	103066	Ref. No.	1032000700 MA1032000700 SIR0100250	
description	burner cap ø 80mm			
accessories for	103066			
	GEV No.	103065	Ref. No.	1032009500 MA1032009500
burner ring for burner cap ø 80mm				
	GEV No.	104100	Ref. No.	1032009300 MA1032009300
burner head for burner cap ø 80mm				
	GEV No.	104101	Ref. No.	1032009100 MA1032009100 SIR0100260
burner holder for burner cap ø 80mm with nozzle holder with mixing sleeve				

			
1			
GEV No.	104102	Ref. No.	1032009400 MA1032009400
description	burner head for burner cap ø 100mm ext. ø 130		









				
1				
GEV No.	104100	Ref. No.	1032009300 MA1032009300	
description	burner head for burner cap ø 80mm			
accessories for	104100			
	GEV No.	103065	Ref. No.	1032009500 MA1032009500
burner ring for burner cap ø 80mm				
	GEV No.	103066	Ref. No.	1032000700 MA1032000700 SIR0100250
burner cap ø 80mm				





Table continues overleaf







accessories for	104100		
	GEV No.	104103	Ref. No. 1032009200 MA1032009200
burner holder suitable for burner ø100mm with nozzle holder			

	1		
GEV No.	104101	Ref. No.	1032009100 MA1032009100 SIR0100260
description	burner holder for burner cap ø 80mm with nozzle holder with mixing sleeve		
accessories for	104101		
	GEV No.	103065	Ref. No. 1032009500 MA1032009500
burner ring for burner cap ø 80mm			
	GEV No.	103066	Ref. No. 1032000700 MA1032000700 SIR0100250
burner cap ø 80mm			
	GEV No.	104100	Ref. No. 1032009300 MA1032009300
burner head for burner cap ø 80mm			

	1		
GEV No.	104103	Ref. No.	1032009200 MA1032009200
description	burner holder suitable for burner ø100mm with nozzle holder		
accessories for	104103		
	GEV No.	103067	Ref. No. 1032009600 MA1032009600 SIR0100247
burner ring for burner cap ø 100mm			
	GEV No.	103068	Ref. No. 1032000800 MA1032000800
burner cap ø 100mm			
	GEV No.	104102	Ref. No. 1032009400 MA1032009400
burner head for burner cap ø 100mm ext. ø 130			

	1		
GEV No.	103067	Ref. No.	1032009600 MA1032009600 SIR0100247
description	burner ring for burner cap ø 100mm		
accessories for	103067		
	GEV No.	103068	Ref. No. 1032000800 MA1032000800
burner cap ø 100mm			
	GEV No.	104102	Ref. No. 1032009400 MA1032009400
burner head for burner cap ø 100mm ext. ø 130			
	GEV No.	104103	Ref. No. 1032009200 MA1032009200
burner holder suitable for burner ø100mm with nozzle holder			





	1		
GEV No.	103065	Ref. No.	1032009500 MA1032009500
description	burner ring for burner cap ø 80mm		
accessories for	103065		
	GEV No.	103066	Ref. No. 1032000700 MA1032000700 SIR0100250
burner cap ø 80mm			
	GEV No.	104100	Ref. No. 1032009300 MA1032009300
burner head for burner cap ø 80mm			
	GEV No.	104101	Ref. No. 1032009100 MA1032009100 SIR0100260
burner holder for burner cap ø 80mm with nozzle holder with mixing sleeve			

producer-specific hob burners

MARENO

600 (1) series

	1		
GEV No.	106379	Ref. No.	N/A
description	air mixing tube for burner cap ø 80mm L 23mm D1 ø 20mm D2 ø 15.6mm D3 ø 14mm		

	1		
GEV No.	103068	Ref. No.	1032000800 MA1032000800
description	burner cap ø 100mm		
accessories for	103068		
	GEV No.	103067	Ref. No. 1032009600 MA1032009600 SIR0100247
burner ring for burner cap ø 100mm			
	GEV No.	104102	Ref. No. 1032009400 MA1032009400
burner head for burner cap ø 100mm ext. ø 130			
	GEV No.	104103	Ref. No. 1032009200 MA1032009200
burner holder suitable for burner ø100mm with nozzle holder			









	1		
GEV No.	103066	Ref. No.	1032000700 MA1032000700 SIR0100250
description	burner cap ø 80mm		
accessories for	103066		
	GEV No.	103065	Ref. No. 1032009500 MA1032009500
burner ring for burner cap ø 80mm			





Table continues overleaf





accessories for	103066			
	GEV No.	104100	Ref. No.	1032009300 MA1032009300
	burner head for burner cap ø 80mm			
	GEV No.	104101	Ref. No.	1032009100 MA1032009100 SIR0100260
	burner holder for burner cap ø 80mm with nozzle holder with mixing sleeve			





	1			
GEV No.	104102	Ref. No.	1032009400 MA1032009400	
description	burner head for burner cap ø 100mm ext. ø 130			

	1			
GEV No.	104100	Ref. No.	1032009300 MA1032009300	
description	burner head for burner cap ø 80mm			
accessories for	104100			
	GEV No.	103065	Ref. No.	1032009500 MA1032009500
	burner ring for burner cap ø 80mm			
	GEV No.	103066	Ref. No.	1032000700 MA1032000700 SIR0100250
	burner cap ø 80mm			
	GEV No.	104103	Ref. No.	1032009200 MA1032009200
	burner holder suitable for burner ø100mm with nozzle holder			

	1			
GEV No.	104101	Ref. No.	1032009100 MA1032009100 SIR0100260	
description	burner holder for burner cap ø 80mm with nozzle holder with mixing sleeve			
accessories for	104101			
	GEV No.	103065	Ref. No.	1032009500 MA1032009500
	burner ring for burner cap ø 80mm			
	GEV No.	103066	Ref. No.	1032000700 MA1032000700 SIR0100250
	burner cap ø 80mm			
	GEV No.	104100	Ref. No.	1032009300 MA1032009300
	burner head for burner cap ø 80mm			

	1			
GEV No.	104103	Ref. No.	1032009200 MA1032009200	
description	burner holder suitable for burner ø100mm with nozzle holder			
accessories for	104103			
	GEV No.	103067	Ref. No.	1032009600 MA1032009600 SIR0100247
	burner ring for burner cap ø 100mm			
	GEV No.	103068	Ref. No.	1032000800 MA1032000800
	burner cap ø 100mm			
	GEV No.	104102	Ref. No.	1032009400 MA1032009400
	burner head for burner cap ø 100mm ext. ø 130			

	1			
GEV No.	103067	Ref. No.	1032009600 MA1032009600 SIR0100247	
description	burner ring for burner cap ø 100mm			
accessories for	103067			
	GEV No.	103068	Ref. No.	1032000800 MA1032000800
	burner cap ø 100mm			
	GEV No.	104102	Ref. No.	1032009400 MA1032009400
	burner head for burner cap ø 100mm ext. ø 130			
	GEV No.	104103	Ref. No.	1032009200 MA1032009200
	burner holder suitable for burner ø100mm with nozzle holder			

	1			
GEV No.	103065	Ref. No.	1032009500 MA1032009500	
description	burner ring for burner cap ø 80mm			
accessories for	103065			
	GEV No.	103066	Ref. No.	1032000700 MA1032000700 SIR0100250
	burner cap ø 80mm			
	GEV No.	104100	Ref. No.	1032009300 MA1032009300
	burner head for burner cap ø 80mm			
	GEV No.	104101	Ref. No.	1032009100 MA1032009100 SIR0100260
	burner holder for burner cap ø 80mm with nozzle holder with mixing sleeve			



600 (2) series				
				
1				
GEV No.	107203	Ref. No.	0937560 1032501400 1032501413 1032501422 CM264200 CR0937560 MA1032501422	
description	burner cap ø 85mm 3.5kW			
For models:	C74GS, C78GS, C7FE12GS, C7FE8GS, C7FG12GS, C7FG8GS, CFG101, CFG70, CFG70M, CFGE61, CFGE61D, CFGE61L, CFGE61P, EC74GVG, EC78GVG, EC7FG8G, OCFG101, OCFG70, OCFGE61, OPG41, OPG61, PCG41, PCG41L, PCG61, PCG61L			
accessories for	107203			
				
GEV No.	103140	Ref. No.	1032101400 1032101422 CR0795730 MA1032101400	
description	burner head seat ø 75mm for burner cap ø 85mm 3.5kW			

				
1				
GEV No.	103144	Ref. No.	1032501600	
description	burner cap ø 95mm 5.5kW			

				
1				
GEV No.	103145	Ref. No.	1032501500 1032501522 MA1032501522	
description	burner cap ø 95mm 7kW with central hole			
accessories for	103145			
				
GEV No.	103147	Ref. No.	1032101300 MA1032101300	
description	burner lower part for burner cap ø 95mm 5.5/7kW			
				
GEV No.	103149	Ref. No.	1036607900 MA1036607900	
description	gasket L 55mm W 62mm for burner 5.5/7kW			
				
GEV No.	105230	Ref. No.	1033717200 MA1033717200	
description	nozzle holder			
				
GEV No.	107143	Ref. No.	CM297300 MACM297300	
description	burner head for burner cap ø 95mm 5.5kW			





				
1				
GEV No.	105259	Ref. No.	1032501613 CM264300 MACM264300	
description	burner cap ø 95mm with central hole			
For models:	CFG101, CFG70, CFGE61D, CFGE61L, CFGE61P, PCG41, PCG41L, PCG61, PCG61L			
accessories for	105259			
				
GEV No.	103141	Ref. No.	1032101500	
description	burner head ø 95mm suitable for burner 5.5kW			
				
GEV No.	103147	Ref. No.	1032101300 MA1032101300	
description	burner lower part for burner cap ø 95mm 5.5/7kW			
				
GEV No.	103149	Ref. No.	1036607900 MA1036607900	
description	gasket L 55mm W 62mm for burner 5.5/7kW			
				
GEV No.	105230	Ref. No.	1033717200 MA1033717200	
description	nozzle holder			
				
GEV No.	105262	Ref. No.	CM264100 MACM264100	
description	burner head for burner cap ø 95mm 5.5kW			

				
1				
GEV No.	107143	Ref. No.	CM297300 MACM297300	
description	burner head for burner cap ø 95mm 5.5kW			
For models:	C79G, C7FG9G, EC74GVG, EC78GVG, EC7FG8G, OPG41, OPG61, PCG41, PCG41L, PCG61, PCG61L			

				
1				
GEV No.	103142	Ref. No.	1032101600 MA1032101600	
description	burner head for burner cap ø 95mm 5.5kW with central hole			
accessories for	103142			
				
GEV No.	103145	Ref. No.	1032501500 1032501522 MA1032501522	
description	burner cap ø 95mm 7kW with central hole			
				
GEV No.	103147	Ref. No.	1032101300 MA1032101300	
description	burner lower part for burner cap ø 95mm 5.5/7kW			
				
GEV No.	103149	Ref. No.	1036607900 MA1036607900	
description	gasket L 55mm W 62mm for burner 5.5/7kW			
				
GEV No.	105230	Ref. No.	1033717200 MA1033717200	
description	nozzle holder			

				
GEV No.	103141	Ref. No.	1032101500 CM297300+CR0937570 MA1032101500 MACM297300+CR0937570	
description	burner head ø 95mm suitable for burner 5.5kW			
For models:	CFG101, CFG70, CFGE61, CFGE61D, CFGE61L, CFGE61P, OCFG101, OCFG70, OCFG61, OPG41, OPG61, PCG41, PCG41L, PCG61, PCG61L			
accessories for	103141			
	GEV No.	103147	Ref. No.	1032101300 MA1032101300
burner lower part for burner cap ø 95mm 5.5/7kW				
	GEV No.	103149	Ref. No.	1036607900 MA1036607900
gasket L 55mm W 62mm for burner 5.5/7kW				
	GEV No.	105230	Ref. No.	1033717200 MA1033717200
nozzle holder				
	GEV No.	105259	Ref. No.	1032501613 CM264300 MACM264300
burner cap ø 95mm with central hole				

				
GEV No.	103140	Ref. No.	1032101400 1032101422 CR0795730 MA1032101400	
description	burner head seat ø 75mm for burner cap ø 85mm 3.5kW			
For models:	CFG101, CFG70, CFGE61, CFGE61D, CFGE61L, CFGE61P, EC74GVG, EC78GVG, EC7FG8G, OCFG101, OCFG70, OCFG61, OPG41, OPG61, PCG41, PCG41L, PCG61, PCG61L			
accessories for	103140			
	GEV No.	103146	Ref. No.	1032101200 MA1032101200
burner lower part for burner cap ø 85mm 3.5kW				
	GEV No.	103148	Ref. No.	1036607800 MA1036607800
gasket L 47mm W 53mm suitable for burner 3.5kW				
	GEV No.	105230	Ref. No.	1033717200 MA1033717200
nozzle holder				
	GEV No.	107203	Ref. No.	0937560 1032501400 1032501413 1032501422 CM264200 CR0937560 MA1032501422
burner cap ø 85mm 3.5kW				

				
GEV No.	103146	Ref. No.	1032101200 MA1032101200	
description	burner lower part for burner cap ø 85mm 3.5kW			
For models:	C74GS, C78GS, C7FE12GS, C7FE8GS, C7FG12GS, C7FG8GS, CFG101, CFG70, CFG70M, CFGE61, CFGE61D, CFGE61L, CFGE61P, EC74GVG, EC78GVG, EC7FG8G, OCFG101, OCFG70, OCFG61, OPG41, OPG61, PCG41, PCG41L, PCG61, PCG61L			
accessories for	103146			
	GEV No.	103140	Ref. No.	1032101400 1032101422 CR0795730 MA1032101400
burner head seat ø 75mm for burner cap ø 85mm 3.5kW				
	GEV No.	103148	Ref. No.	1036607800 MA1036607800
gasket L 47mm W 53mm suitable for burner 3.5kW				
	GEV No.	105230	Ref. No.	1033717200 MA1033717200
nozzle holder				
	GEV No.	107203	Ref. No.	0937560 1032501400 1032501413 1032501422 CM264200 CR0937560 MA1032501422
burner cap ø 85mm 3.5kW				

				
GEV No.	103147	Ref. No.	1032101300 MA1032101300	
description	burner lower part for burner cap ø 95mm 5.5/7kW			
For models:	C74GS, C78GS, C79G, C7FE12GS, C7FE8GS, C7FG12GS, C7FG8GS, C7FG9G, CFG101, CFG70, CFG70M, CFGE61, CFGE61D, CFGE61L, CFGE61P, EC74GVG, EC78GVG, EC7FG8G, OCFG101, OCFG70, OCFG61, OPG41, OPG61, PCG41, PCG41L, PCG61, PCG61L			
accessories for	103147			
	GEV No.	103141	Ref. No.	1032101500
burner head ø 95mm suitable for burner 5.5kW				
	GEV No.	103147	Ref. No.	1032101300 MA1032101300
burner lower part for burner cap ø 95mm 5.5/7kW				
	GEV No.	103149	Ref. No.	1036607900 MA1036607900
gasket L 55mm W 62mm for burner 5.5/7kW				
	GEV No.	105230	Ref. No.	1033717200 MA1033717200
nozzle holder				
	GEV No.	105259	Ref. No.	1032501613 CM264300 MACM264300
burner cap ø 95mm with central hole				



			
GEV No.	103148	Ref. No.	1036607800 MA1036607800
description	gasket L 47mm W 53mm suitable for burner 3.5kW		
For models:	C74GS, C78GS, C7FE12GS, C7FE8GS, C7FG12GS, C7FG8GS, CFG101, CFG70, CFG70M, CFGE61, CFGE61D, CFGE61L, CFGE61P, EC74GVG, EC78GVG, EC7FG8G, OCFG101, OCFG70, OCFGE61, OPCG41, OPCG61, PCG41, PCG41L, PCG61, PCG61L		
accessories for	103148		
	GEV No.	103140	Ref. No. 1032101400 1032101422 CR0795730 MA1032101400
burner head seat ø 75mm for burner cap ø 85mm 3.5kW			
	GEV No.	103146	Ref. No. 1032101200 MA1032101200
burner lower part for burner cap ø 85mm 3.5kW			
	GEV No.	105230	Ref. No. 1033717200 MA1033717200
nozzle holder			
	GEV No.	107203	Ref. No. 0937560 1032501400 1032501413 1032501422 CM264200 CR0937560 MA1032501422
burner cap ø 85mm 3.5kW			

			
GEV No.	103149	Ref. No.	1036607900 MA1036607900
description	gasket L 55mm W 62mm for burner 5.5/7kW		
For models:	C74GS, C78GS, C79G, C7FE12GS, C7FE8GS, C7FG12GS, C7FG8GS, C7FG9G, CFG101, CFG70, CFG70M, CFGE61, CFGE61D, CFGE61L, CFGE61P, EC74GVG, EC78GVG, EC7FG8G, OCFG101, OCFG70, OCFGE61, OPCG41, OPCG61, PCG41, PCG41L, PCG61, PCG61L		
accessories for	103149		
	GEV No.	103141	Ref. No. 1032101500
burner head ø 95mm suitable for burner 5.5kW			
	GEV No.	103145	Ref. No. 1032501500 1032501522 MA1032501522
burner cap ø 95mm 7kW with central hole			
	GEV No.	103147	Ref. No. 1032101300 MA1032101300
burner lower part for burner cap ø 95mm 5.5/7kW			
	GEV No.	105230	Ref. No. 1033717200 MA1033717200
nozzle holder			
	GEV No.	105259	Ref. No. 1032501613 CM264300 MACM264300
burner cap ø 95mm with central hole			
	GEV No.	107143	Ref. No. CM297300 MACM297300
burner head for burner cap ø 95mm 5.5kW			

			
GEV No.	105230	Ref. No.	1033717200 MA1033717200
description	nozzle holder		
For models:	C74GS, C78GS, C79G, C7FE12GS, C7FE8GS, C7FG12GS, C7FG8GS, C7FG9G, CFG70, CFG70M, CFGE61, CFGE61D, CFGE61L, CFGE61P, EC74GVG, EC78GVG, EC7FG8G, OCFGE61, OPCG41, OPCG61, PCG41, PCG41L, PCG61, PCG61L		
accessories for	105230		
	GEV No.	103140	Ref. No. 1032101400 1032101422 CR0795730 MA1032101400
burner head seat ø 75mm for burner cap ø 85mm 3.5kW			
	GEV No.	103141	Ref. No. 1032101500
burner head ø 95mm suitable for burner 5.5kW			
	GEV No.	103146	Ref. No. 1032101200 MA1032101200
burner lower part for burner cap ø 85mm 3.5kW			
	GEV No.	103147	Ref. No. 1032101300 MA1032101300
burner lower part for burner cap ø 95mm 5.5/7kW			
	GEV No.	107143	Ref. No. CM297300 MACM297300
burner head for burner cap ø 95mm 5.5kW			

700, 900, 1000 (1) series



















			
GEV No.	105051	Ref. No.	1314700 MA1314700
description	air mixing sleeve L 45mm ED ø 45mm ID ø 42mm aluminium		
For models:	C124G, C129G, C12C2G9, C12C9G, C12FG9G, C7011G, C7011GFE, C7011GF, C704G, C707G, C707GFE, C707GF, C712G, C74G, C78G, C7FE12G, C7FE8G, C7FG12G, C7FG8G, C7FGM12G, C912G, C912GS, C94G, C94GP, C94GS, C98G, C98GP, C98GS, C9F4G, C9F4GS, C9F6G, C9F6GS, C9F8G, C9F8GS, C9FE12G, C9FE12GS, C9FE4GS, C9FE6GS, C9FE8G, C9FE8GS, C9FEP4GS, C9FEP6GS, C9FEP8GS, C9FG12G, C9FG12GS, C9FG16G, C9FG8G, C9FG8GP, C9FG8GS, C9FGM12G... (Other models you can see in the webshop)		
accessories for	105051		
	GEV No.	103150	Ref. No. 1315812 1892500 MA1892500
burner lower part for burner cap ø 110/120mm			
	GEV No.	104030	Ref. No. 1315412 1315422 MA1315422
burner head for burner cap ø 80mm			
	GEV No.	104031	Ref. No. 1315512 1315522 MA1315522
burner head for burner cap ø 110mm			
	GEV No.	104032	Ref. No. 1315912 1315922 MA1315922
burner head for burner cap ø 120mm			
	GEV No.	104033	Ref. No. 1315200
burner lower part for burner cap ø 80mm 1. generation			

Table continues overleaf

accessories for 105051				
	GEV No.	104034	Ref. No.	1315300 1315312 MA1315300
burner lower part for burner cap ø 110mm				
	GEV No.	105052	Ref. No.	1306400 1306600 1306615 MA1306615
nozzle holder ID ø 10mm nozzle mounting M10x1				
	GEV No.	105265	Ref. No.	CM006001 MACM006001
burner head for burner cap ø 80mm				
	GEV No.	105266	Ref. No.	CM042900 MACM042900
burner lower part for burner cap ø 80mm				
	GEV No.	105269	Ref. No.	CM005901 MACM005901
burner head ø 158mm for burner cap ø 110mm				
	GEV No.	105272	Ref. No.	CM043000 MACM043000
burner lower part for burner cap ø 110mm				
	GEV No.	105274	Ref. No.	CM006502 MACM006502
burner head for burner cap ø 120mm				
	GEV No.	105275	Ref. No.	CM043100 MACM043100
burner lower part for burner cap ø 120mm				

				
1				
GEV No.	103021	Ref. No.	1315700 1315712 MA1315712	
description burner cap ø 110mm				
For models: C7011G, C7011GFE, C7011GFG, C704G, C707G, C707GFE, C707GFG, C9F4G, C9F4GS, C9F6G, C9F6GS, C9F8G, C9F8GS, C9FE4GS, C9FE6GS, C9FE8GS, C9FEP4GS, C9FEP6GS, C9FEP8GS, C9FP4GS, C9FP6GS, C9FP8GS, C9SB4GS, C9V2G, C9V2GS, C9V4G, C9V4GS, C9V6G, C9V6GS, C9V8G, C9V8GS, C9VP2GS, C9VP4GS, C9VP6GS, C9VP8GS, FB1GS, FB2GS, FB3GS, T7011GFG, T9F6GS, T9V6GS				
accessories for 103021				
	GEV No.	103150	Ref. No.	1315812 1892500 MA1892500
burner lower part for burner cap ø 110/120mm				
	GEV No.	103151	Ref. No.	1893300 MA1893300
reducer suitable for burner head ø 110mm				
	GEV No.	104031	Ref. No.	1315512 1315522 MA1315522
burner head for burner cap ø 110mm				
	GEV No.	104034	Ref. No.	1315300 1315312 MA1315300
burner lower part for burner cap ø 110mm				
	GEV No.	105051	Ref. No.	1314700 MA1314700
air mixing sleeve L 45mm ED ø 45mm ID ø 42mm aluminium				

accessories for 103021				
	GEV No.	105052	Ref. No.	1306400 1306600 1306615 MA1306615
nozzle holder ID ø 10mm nozzle mounting M10x1				

				
1				
GEV No.	103022	Ref. No.	1316000 1316012 MA1316012	
description burner cap ø 120mm with central hole				
For models: C7011G, C7011GFE, C7011GFG, C704G, C707G, C707GFE, C707GFG, C9F4G, C9F4GS, C9F6G, C9F6GS, C9F8G, C9F8GS, C9FE4GS, C9FE6GS, C9FE8GS, C9FEP4GS, C9FEP6GS, C9FEP8GS, C9FP4GS, C9FP6GS, C9FP8GS, C9SB4GS, C9V2G, C9V2GS, C9V4G, C9V4GS, C9V6G, C9V6GS, C9V8G, C9V8GS, C9VP2GS, C9VP4GS, C9VP6GS, C9VP8GS, CFG120, OCFG120, PCG42, PCG82, T7011GFG, T9F6GS, T9V6GS				
accessories for 103022				
	GEV No.	103150	Ref. No.	1315812 1892500 MA1892500
burner lower part for burner cap ø 110/120mm				
	GEV No.	104032	Ref. No.	1315912 1315922 MA1315922
burner head for burner cap ø 120mm				
	GEV No.	104035	Ref. No.	1315800 MA1315800
burner lower part for burner cap ø 120mm				
	GEV No.	105051	Ref. No.	1314700 MA1314700
air mixing sleeve L 45mm ED ø 45mm ID ø 42mm aluminium				
	GEV No.	105052	Ref. No.	1306400 1306600 1306615 MA1306615
nozzle holder ID ø 10mm nozzle mounting M10x1				





				
1				
GEV No.	103020	Ref. No.	1315600 1315612 MA1315612	
description burner cap ø 80mm				
For models: C7011G, C7011GFE, C7011GFG, C704G, C707G, C707GFE, C707GFG, C9F4G, C9F4GS, C9F6G, C9F6GS, C9F8G, C9F8GS, C9FE4GS, C9FE6GS, C9FE8GS, C9FEP4GS, C9FEP6GS, C9FEP8GS, C9FP4GS, C9FP6GS, C9FP8GS, C9SB4GS, C9V2G, C9V2GS, C9V4G, C9V4GS, C9V6G, C9V6GS, C9V8G, C9V8GS, C9VP2GS, C9VP4GS, C9VP6GS, C9VP8GS, FB1GS, FB2GS, FB3GS, OCFG120, PCG42, PCG82, T7011GFG, T9F6GS, T9V6GS				
accessories for 103020				
	GEV No.	104030	Ref. No.	1315412 1315422 MA1315422
burner head for burner cap ø 80mm				
	GEV No.	104033	Ref. No.	1315200
burner lower part for burner cap ø 80mm 1. generation				

Table continues overleaf











accessories for 103020				
	GEV No.	105051	Ref. No.	1314700 MA1314700
air mixing sleeve L 45mm ED ø 45mm ID ø 42mm aluminium				
	GEV No.	105052	Ref. No.	1306400 1306600 1306615 MA1306615
nozzle holder ID ø 10mm nozzle mounting M10x1				



				
1				
GEV No.	104031	Ref. No.	1315512 1315522 MA1315522	
description	burner head for burner cap ø 110mm			
For models:	C7011G, C7011GFE, C7011GFG, C704G, C707G, C707GFE, C707GFG, C9F4G, C9F4GS, C9F6G, C9F6GS, C9F8G, C9F8GS, C9FE4GS, C9FE6GS, C9FE8GS, C9FEP4GS, C9FEP6GS, C9FEP8GS, C9FP4GS, C9FP6GS, C9FP8GS, C9SB4GS, C9V2G, C9V2GS, C9V4G, C9V4GS, C9V6G, C9V6GS, C9V8G, C9V8GS, C9VP2GS, C9VP4GS, C9VP6GS, C9VP8GS, FB1GS, FB2GS, FB3GS, T7011GFG, T9F6GS, T9V6GS			
accessories for 104031				
	GEV No.	103021	Ref. No.	1315700 1315712 MA1315712
burner cap ø 110mm				
	GEV No.	103150	Ref. No.	1315812 1892500 MA1892500
burner lower part for burner cap ø 110/120mm				
	GEV No.	103151	Ref. No.	1893300 MA1893300
reducer suitable for burner head ø 110mm				
	GEV No.	104034	Ref. No.	1315300 1315312 MA1315300
burner lower part for burner cap ø 110mm				
	GEV No.	105051	Ref. No.	1314700 MA1314700
air mixing sleeve L 45mm ED ø 45mm ID ø 42mm aluminium				
	GEV No.	105052	Ref. No.	1306400 1306600 1306615 MA1306615
nozzle holder ID ø 10mm nozzle mounting M10x1				



				
1				
GEV No.	104032	Ref. No.	1315912 1315922 MA1315922	
description	burner head for burner cap ø 120mm			
For models:	C7011G, C7011GFE, C7011GFG, C704G, C707G, C707GFE, C707GFG, C9F4G, C9F4GS, C9F6G, C9F6GS, C9F8G, C9F8GS, C9FE4GS, C9FE6GS, C9FE8GS, C9FEP4GS, C9FEP6GS, C9FEP8GS, C9FP4GS, C9FP6GS, C9FP8GS, C9SB4GS, C9V2G, C9V2GS, C9V4G, C9V4GS, C9V6G, C9V6GS, C9V8G, C9V8GS, C9VP2GS, C9VP4GS, C9VP6GS, C9VP8GS, CFG120, OCFG120, PCG42, PCG82, T7011GFG, T9F6GS, T9V6GS			
accessories for 104032				
	GEV No.	103022	Ref. No.	1316000 1316012 MA1316012
burner cap ø 120mm with central hole				
	GEV No.	103150	Ref. No.	1315812 1892500 MA1892500
burner lower part for burner cap ø 110/120mm				
	GEV No.	105051	Ref. No.	1314700 MA1314700
air mixing sleeve L 45mm ED ø 45mm ID ø 42mm aluminium				
	GEV No.	105052	Ref. No.	1306400 1306600 1306615 MA1306615
nozzle holder ID ø 10mm nozzle mounting M10x1				

				
1				
GEV No.	104030	Ref. No.	1315412 1315422 MA1315422	
description	burner head for burner cap ø 80mm			
For models:	C7011G, C7011GFE, C7011GFG, C704G, C707G, C707GFE, C707GFG, C9F4G, C9F4GS, C9F6G, C9F6GS, C9F8G, C9F8GS, C9FE4GS, C9FE6GS, C9FE8GS, C9FEP4GS, C9FEP6GS, C9FEP8GS, C9FP4GS, C9FP6GS, C9FP8GS, C9SB4GS, C9V2G, C9V2GS, C9V4G, C9V4GS, C9V6G, C9V6GS, C9V8G, C9V8GS, C9VP2GS, C9VP4GS, C9VP6GS, C9VP8GS, CFG120, FB1GS, FB2GS, FB3GS, OCFG120, PCG42, PCG82, T7011GFG, T9F6GS, T9V6GS			
accessories for 104030				
	GEV No.	103020	Ref. No.	1315600 1315612 MA1315612
burner cap ø 80mm				
	GEV No.	104033	Ref. No.	1315200
burner lower part for burner cap ø 80mm 1. generation				
	GEV No.	105051	Ref. No.	1314700 MA1314700
air mixing sleeve L 45mm ED ø 45mm ID ø 42mm aluminium				
	GEV No.	105052	Ref. No.	1306400 1306600 1306615 MA1306615
nozzle holder ID ø 10mm nozzle mounting M10x1				



			
GEV No.	103150	Ref. No.	1315812 1892500 MA1892500
description	burner lower part for burner cap ø 110/120mm		
For models:	C7011G, C7011GFE, C7011GFG, C704G, C707G, C707GFE, C707GFG, C9F4GS, C9F6GS, C9F8GS, C9FE4GS, C9FE6GS, C9FE8GS, C9FEP4GS, C9FEP6GS, C9FEP8GS, C9FP4GS, C9FP6GS, C9FP8GS, C9V2GS, C9V4GS, C9V6GS, C9V8GS, C9VP2GS, C9VP4GS, C9VP6GS, C9VP8GS, CFG120, FB1GS, FB2GS, FB3GS, OCFG120, PCG42, PCG82, T7011GFG, T9F6GS, T9V6GS		
accessories for	103150		
	GEV No.	103021	Ref. No.
			1315700 1315712 MA1315712
burner cap ø 110mm			
	GEV No.	103022	Ref. No.
			1316000 1316012 MA1316012
burner cap ø 120mm with central hole			
	GEV No.	103151	Ref. No.
			1893300 MA1893300
reducer suitable for burner head ø110mm			
	GEV No.	104031	Ref. No.
			1315512 1315522 MA1315522
burner head for burner cap ø 110mm			
	GEV No.	104032	Ref. No.
			1315912 1315922 MA1315922
burner head for burner cap ø 120mm			
	GEV No.	105051	Ref. No.
			1314700 MA1314700
air mixing sleeve L 45mm ED ø 45mm ID ø 42mm aluminium			
	GEV No.	105052	Ref. No.
			1306400 1306600 1306615 MA1306615
nozzle holder ID ø 10mm nozzle mounting M10x1			

			
GEV No.	104034	Ref. No.	1315300 1315312 MA1315300
description	burner lower part for burner cap ø 110mm		
For models:	C7011G, C7011GFE, C7011GFG, C704G, C707G, C707GFE, C707GFG, C9F4G, C9F4GS, C9F6G, C9F6GS, C9F8G, C9F8GS, C9SB4GS, C9V2G, C9V2GS, C9V4G, C9V4GS, C9V6G, C9V6GS, C9V8G, C9V8GS		
accessories for	104034		
	GEV No.	103021	Ref. No.
			1315700 1315712 MA1315712
burner cap ø 110mm			

accessories for	104034		
	GEV No.	104031	Ref. No.
			1315512 1315522 MA1315522
burner head for burner cap ø 110mm			
	GEV No.	105051	Ref. No.
			1314700 MA1314700
air mixing sleeve L 45mm ED ø 45mm ID ø 42mm aluminium			
	GEV No.	105052	Ref. No.
			1306400 1306600 1306615 MA1306615
nozzle holder ID ø 10mm nozzle mounting M10x1			

			
GEV No.	104035	Ref. No.	1315800 MA1315800
description	burner lower part for burner cap ø 120mm		
For models:	C9F4G, C9F4GS, C9F6G, C9F6GS, C9F8G, C9F8GS, C9SB4GS, C9V2G, C9V2GS, C9V4G, C9V4GS, C9V6G, C9V6GS, C9V8G, C9V8GS		

			
GEV No.	104033	Ref. No.	1315200
description	burner lower part for burner cap ø 80mm 1. generation		
For models:	C7011G, C7011GFE, C7011GFG, C704G, C707G, C707GFE, C707GFG, C9F4G, C9F4GS, C9F6G, C9F6GS, C9F8G, C9F8GS, C9SB4GS, C9V2G, C9V2GS, C9V4G, C9V4GS, C9V6G, C9V6GS, C9V8G, C9V8GS		











			
GEV No.	105052	Ref. No.	1306400 1306600 1306615 MA1306615
description	nozzle holder ID ø 10mm nozzle mounting M10x1		
For models:	B9SB2G, B9SB4G, B9V2G, B9V4G, C7011G, C7011GFE, C7011GFG, C704G, C707G, C707GFE, C707GFG, C9F4E, C9F4G, C9F4GS, C9F6E, C9F6G, C9F6GS, C9F8G, C9F8GS, C9FP, C9FP4GS, C9FP6GS, C9FP8GS, C9SB4GS, C9V2G, C9V2GS, C9V4G, C9V4GS, C9V6G, C9V6GS, C9V8G, C9V8GS, CFG101, CFG101D, CFG101L, CFG101P, CFG120, CFG70, CFG70D, CFG70L, CFG70M, CFG70P, EC74GVG, EC78GVG, EC7FG8G, FB1GS, FB2GS, FB3GS, FP1GS, FT74G...(Other models you can see in the webshop)		
accessories for	105052		
	GEV No.	100469	Ref. No.
			521611 MA521611
gas injector thread M10x1 WS 12 bore ø 1.15mm			
	GEV No.	100478	Ref. No.
			522811 MA522811
gas injector thread M10x1 WS 12 bore ø 1.75mm			

Table continues overleaf



accessories for 105052				
	GEV No.	103150	Ref. No.	1315812 1892500 MA1892500
burner lower part for burner cap ø 110/120mm				
	GEV No.	104030	Ref. No.	1315412 1315422 MA1315422
burner head for burner cap ø 80mm				
	GEV No.	104031	Ref. No.	1315512 1315522 MA1315522
burner head for burner cap ø 110mm				
	GEV No.	104032	Ref. No.	1315912 1315922 MA1315922
burner head for burner cap ø 120mm				
	GEV No.	104033	Ref. No.	1315200
burner lower part for burner cap ø 80mm 1. generation				
	GEV No.	104034	Ref. No.	1315300 1315312 MA1315300
burner lower part for burner cap ø 110mm				
	GEV No.	105051	Ref. No.	1314700 MA1314700
air mixing sleeve L 45mm ED ø 45mm ID ø 42mm aluminium				

				
1	GEV No.	103151	Ref. No.	1893300 MA1893300
description reducer suitable for burner head ø110mm				
For models: C7011G, C7011GFE, C7011GFG, C704G, C707G, C707GFE, C707GFG, C9F4GS, C9F6GS, C9F8GS, C9FE4GS, C9FE6GS, C9FE8GS, C9FEP4GS, C9FEP6GS, C9FEP8GS, C9FP4GS, C9FP6GS, C9FP8GS, C9V2GS, C9V4GS, C9V6GS, C9V8GS, C9VP2GS, C9VP4GS, C9VP6GS, C9VP8GS, FB1GS, FB2GS, FB3GS, T7011GFG, T9F6GS, T9V6GS				
accessories for 103151				
	GEV No.	103021	Ref. No.	1315700 1315712 MA1315712
burner cap ø 110mm				
	GEV No.	103150	Ref. No.	1315812 1892500 MA1892500
burner lower part for burner cap ø 110/120mm				
	GEV No.	104031	Ref. No.	1315512 1315522 MA1315522
burner head for burner cap ø 110mm				
	GEV No.	105051	Ref. No.	1314700 MA1314700
air mixing sleeve L 45mm ED ø 45mm ID ø 42mm aluminium				
	GEV No.	105052	Ref. No.	1306400 1306600 1306615 MA1306615
nozzle holder ID ø 10mm nozzle mounting M10x1				

solid tops				
				
1	GEV No.	105042	Ref. No.	1315000 1316400 MA1316400
description burner cap ø 175mm with central hole				
For models: NT78G, NT7FG12G, NT7FG8G, NT98G, NT9FG12G, NT9FG8G, T129G, T7011GFG, T707G, T707GFG, T78G, T7FG12G, T7FG8G, T98G, T9F4G, T9F6GS, T9FE4G, T9FG12G, T9FG8G, T9FP4G, T9SB4G, T9V4G, T9V6GS, T9VP4G				
accessories for 105042				
	GEV No.	105041	Ref. No.	1316300 MA1316300
burner head ø 175mm for solid top suitable for 1000, BS series				
	GEV No.	105484	Ref. No.	CM0005004 CM005004 MACM005004
burner head ø 175mm for solid top suitable for Protagonista series				

				
1	GEV No.	105041	Ref. No.	1316300 MA1316300
description burner head ø 175mm for solid top suitable for 1000, BS series				
For models: T7011GFG, T707G, T707GFG, T9F4G, T9F6GS, T9FE4G, T9FP4G, T9SB4G, T9V4G, T9V6GS, T9VP4G				
accessories for 105041				
	GEV No.	105042	Ref. No.	1315000 1316400 MA1316400
burner cap ø 175mm with central hole				

				
1	GEV No.	105484	Ref. No.	CM0005004 CM005004 MACM005004
description burner head ø 175mm for solid top suitable for Protagonista series				
For models: NT98G, NT9FG12G, NT9FG8G, T129G, T78G, T7FG12G, T7FG8G, T98G, T9FG12G, T9FG8G				
accessories for 105484				
	GEV No.	105042	Ref. No.	1315000 1316400 MA1316400
burner cap ø 175mm with central hole				



700, 900, 1000 (2) series



GEV No.	105336	Ref. No.	1044229212 MA1044229212
description	air mixing sleeve		
For models:	C74GS, C78GS, C79G, C7FE12GS, C7FE8GS, C7FG12GS, C7FG8GS, C7FG9G, CFG101, CFG70, CFG70M, CFGE61, CFGE61D, CFGE61L, CFGE61P, OCFG101, OCFG70, OCFGE61, OPCG41, OPCG61, PCG41, PCG41L, PCG61, PCG61L		

accessories for 105336

	GEV No.	103140	Ref. No.	1032101400 1032101422 CR0795730 MA1032101400
burner head seat ø 75mm for burner cap ø 85mm 3.5kW				

	GEV No.	103141	Ref. No.	1032101500
burner head ø 95mm suitable for burner 5.5kW				

	GEV No.	103146	Ref. No.	1032101200 MA1032101200
burner lower part for burner cap ø 85mm 3.5kW				

	GEV No.	103147	Ref. No.	1032101300 MA1032101300
burner lower part for burner cap ø 95mm 5.5/7kW				

	GEV No.	105262	Ref. No.	CM264100 MACM264100
burner head for burner cap ø 95mm 5.5kW				

	GEV No.	107143	Ref. No.	CM297300 MACM297300
burner head for burner cap ø 95mm 5.5kW				



GEV No.	107203	Ref. No.	0937560 1032501400 1032501413 1032501422 CM264200 CR0937560 MA1032501422
description	burner cap ø 85mm 3.5kW		
For models:	C74GS, C78GS, C7FE12GS, C7FE8GS, C7FG12GS, C7FG8GS, CFG101, CFG70, CFG70M, CFGE61, CFGE61D, CFGE61L, CFGE61P, EC74GVG, EC78GVG, EC7FG8G, OCFG101, OCFG70, OCFGE61, OPCG41, OPCG61, PCG41, PCG41L, PCG61, PCG61L		

accessories for 107203

	GEV No.	103140	Ref. No.	1032101400 1032101422 CR0795730 MA1032101400
burner head seat ø 75mm for burner cap ø 85mm 3.5kW				



GEV No.	107169	Ref. No.	1032501622 CR0937570 MA1032501622
description	burner cap ø 95mm 5.5kW with central hole		
For models:	C74GS, C78GS, C79G, C7FE12GS, C7FE8GS, C7FG12GS, C7FG8GS, C7FG9G, CFG101, CFG70, CFG70M, CFGE61, CFGE61D, CFGE61L, CFGE61P, EC74GVG, EC78GVG, EC7FG8G, OCFG101, OCFG70, OCFGE61, OPCG41, OPCG61, PCG41, PCG41L, PCG61, PCG61L		



GEV No.	105259	Ref. No.	1032501613 CM264300 MACM264300
description	burner cap ø 95mm with central hole		
For models:	CFG101, CFG70, CFGE61D, CFGE61L, CFGE61P, PCG41, PCG41L, PCG61, PCG61L		

accessories for 105259

	GEV No.	103141	Ref. No.	1032101500
burner head ø 95mm suitable for burner 5.5kW				

	GEV No.	103147	Ref. No.	1032101300 MA1032101300
burner lower part for burner cap ø 95mm 5.5/7kW				

	GEV No.	103149	Ref. No.	1036607900 MA1036607900
gasket L 55mm W 62mm for burner 5.5/7kW				

	GEV No.	105230	Ref. No.	1033717200 MA1033717200
nozzle holder				

	GEV No.	105262	Ref. No.	CM264100 MACM264100
burner head for burner cap ø 95mm 5.5kW				



GEV No.	105249	Ref. No.	CM264000 MACM264000
description	burner head for burner cap ø 85mm 3.5kW		
For models:	C74GS, C78GS, C7FE12GS, C7FE8GS, C7FG12GS, C7FG8GS		



			
GEV No.	105262	Ref. No.	CM264100 MACM264100
description	burner head for burner cap ø 95mm 5.5kW		
For models:	C74GS, C78GS, C7FE12GS, C7FE8GS, C7FG12GS, C7FG8GS		
accessories for	105262		
			
GEV No.	103147	Ref. No.	1032101300 MA1032101300
description	burner lower part for burner cap ø 95mm 5.5/7kW		
			
GEV No.	103149	Ref. No.	1036607900 MA1036607900
description	gasket L 55mm W 62mm for burner 5.5/7kW		
			
GEV No.	105230	Ref. No.	1033717200 MA1033717200
description	nozzle holder		
			
GEV No.	105259	Ref. No.	1032501613 CM264300 MACM264300
description	burner cap ø 95mm with central hole		
			
GEV No.	105336	Ref. No.	1044229212 MA1044229212
description	air mixing sleeve		

			
GEV No.	103146	Ref. No.	1032101200 MA1032101200
description	burner lower part for burner cap ø 85mm 3.5kW		
For models:	C74GS, C78GS, C7FE12GS, C7FE8GS, C7FG12GS, C7FG8GS, CFG101, CFG70, CFG70M, CFGE61, CFGE61D, CFGE61L, CFGE61P, EC74GVG, EC78GVG, EC7FG8G, OCFG101, OCFG70, OCFGE61, OPCG41, OPCG61, PCG41, PCG41L, PCG61, PCG61L		
accessories for	103146		
			
GEV No.	103140	Ref. No.	1032101400 1032101422 CR0795730 MA1032101400
description	burner head seat ø 75mm for burner cap ø 85mm 3.5kW		
			
GEV No.	103148	Ref. No.	1036607800 MA1036607800
description	gasket L 47mm W 53mm suitable for burner 3.5kW		
			
GEV No.	105230	Ref. No.	1033717200 MA1033717200
description	nozzle holder		
			
GEV No.	107203	Ref. No.	0937560 1032501400 1032501413 1032501422 CM264200 CR0937560 MA1032501422
description	burner cap ø 85mm 3.5kW		

			
GEV No.	103147	Ref. No.	1032101300 MA1032101300
description	burner lower part for burner cap ø 95mm 5.5/7kW		
For models:	C74GS, C78GS, C79G, C7FE12GS, C7FE8GS, C7FG12GS, C7FG8GS, C7FG9G, CFG101, CFG70, CFG70M, CFGE61, CFGE61D, CFGE61L, CFGE61P, EC74GVG, EC78GVG, EC7FG8G, OCFG101, OCFG70, OCFGE61, OPCG41, OPCG61, PCG41, PCG41L, PCG61, PCG61L		
accessories for	103147		
			
GEV No.	103141	Ref. No.	1032101500
description	burner head ø 95mm suitable for burner 5.5kW		
			
GEV No.	103147	Ref. No.	1032101300 MA1032101300
description	burner lower part for burner cap ø 95mm 5.5/7kW		
			
GEV No.	103149	Ref. No.	1036607900 MA1036607900
description	gasket L 55mm W 62mm for burner 5.5/7kW		
			
GEV No.	105230	Ref. No.	1033717200 MA1033717200
description	nozzle holder		
			
GEV No.	105259	Ref. No.	1032501613 CM264300 MACM264300
description	burner cap ø 95mm with central hole		

			
GEV No.	104127	Ref. No.	1315212 MA1315212
description	burner lower part ø 80mm without bores for pilot burner type 2. generation		
For models:	C7011G, C7011GFE, C7011GFG, C704G, C707G, C707GFE, C707GFG, C9F4GS, C9F6GS, C9F8GS, C9FE4GS, C9FE6GS, C9FE8GS, C9FEP4GS, C9FEP6GS, C9FEP8GS, C9FP4GS, C9FP6GS, C9FP8GS, C9V2GS, C9V4GS, C9V6GS, C9V8GS, C9VP2GS, C9VP4GS, C9VP6GS, C9VP8GS, CFG120, FB1GS, FB2GS, FB3GS, OCFG120, PCG42, PCG82, T7011GFG, T9F6GS, T9V6GS		









			
GEV No.	103148	Ref. No.	1036607800 MA1036607800
description	gasket L 47mm W 53mm suitable for burner 3.5kW		
For models:	C74GS, C78GS, C7FE12GS, C7FE8GS, C7FG12GS, C7FG8GS, CFG101, CFG70, CFG70M, CFGE61, CFGE61D, CFGE61L, CFGE61P, EC74GVG, EC78GVG, EC7FG8G, OCFG101, OCFG70, OCFGE61, OPCG41, OPCG61, PCG41, PCG41L, PCG61, PCG61L		
accessories for	103148		
			
GEV No.	103140	Ref. No.	1032101400 1032101422 CR0795730 MA1032101400
description	burner head seat ø 75mm for burner cap ø 85mm 3.5kW		

Table continues overleaf

accessories for 103148				
	GEV No.	103146	Ref. No.	1032101200 MA1032101200
burner lower part for burner cap ø 85mm 3.5kW				
	GEV No.	105230	Ref. No.	1033717200 MA1033717200
nozzle holder				
	GEV No.	107203	Ref. No.	0937560 1032501400 1032501413 1032501422 CM264200 CR0937560 MA1032501422
burner cap ø 85mm 3.5kW				

				
GEV No.	103149	Ref. No.	1036607900 MA1036607900	
description	gasket L 55mm W 62mm for burner 5.5/7kW			
For models:	C74GS, C78GS, C79G, C7FE12GS, C7FE8GS, C7FG12GS, C7FG8GS, C7FG9G, CFG101, CFG70, CFG70M, CFGE61, CFGE61D, CFGE61L, CFGE61P, EC74GVG, EC78GVG, EC7FG8G, OCFG101, OCFG70, OCFG61, OPCG41, OPG61, PCG41, PCG41L, PCG61, PCG61L			
accessories for 103149				
	GEV No.	103141	Ref. No.	1032101500
burner head ø 95mm suitable for burner 5.5kW				
	GEV No.	103145	Ref. No.	1032501500 1032501522 MA1032501522
burner cap ø 95mm 7kW with central hole				
	GEV No.	103147	Ref. No.	1032101300 MA1032101300
burner lower part for burner cap ø 95mm 5.5/7kW				
	GEV No.	105230	Ref. No.	1033717200 MA1033717200
nozzle holder				
	GEV No.	105259	Ref. No.	1032501613 CM264300 MACM264300
burner cap ø 95mm with central hole				
	GEV No.	107143	Ref. No.	CM297300 MACM297300
burner head for burner cap ø 95mm 5.5kW				

				
GEV No.	105230	Ref. No.	1033717200 MA1033717200	
description	nozzle holder			
For models:	C74GS, C78GS, C79G, C7FE12GS, C7FE8GS, C7FG12GS, C7FG8GS, C7FG9G, CFG70, CFG70M, CFGE61, CFGE61D, CFGE61L, CFGE61P, EC74GVG, EC78GVG, EC7FG8G, OCFG61, OPG61, PCG41, PCG41L, PCG61, PCG61L			
accessories for 105230				
	GEV No.	103140	Ref. No.	1032101400 1032101422 CR0795730 MA1032101400
burner head seat ø 75mm for burner cap ø 85mm 3.5kW				
	GEV No.	103141	Ref. No.	1032101500
burner head ø 95mm suitable for burner 5.5kW				

accessories for 105230				
	GEV No.	103146	Ref. No.	1032101200 MA1032101200
burner lower part for burner cap ø 85mm 3.5kW				
	GEV No.	103147	Ref. No.	1032101300 MA1032101300
burner lower part for burner cap ø 95mm 5.5/7kW				
	GEV No.	107143	Ref. No.	CM297300 MACM297300
burner head for burner cap ø 95mm 5.5kW				

700, 900, 1000 (3) series















				
GEV No.	105051	Ref. No.	1314700 MA1314700	
description	air mixing sleeve L 45mm ED ø 45mm ID ø 42mm aluminium			
For models:	C124G, C129G, C12C2G9, C12C9G, C12FG9G, C7011G, C7011GFE, C7011GFG, C704G, C707G, C707GFE, C707GFG, C712G, C74G, C78G, C7FE12G, C7FE8G, C7FG12G, C7FG8G, C7FGM12G, C912G, C912GS, C94G, C94GP, C94GS, C98G, C98GP, C98GS, C9F4G, C9F4GS, C9F6G, C9F6GS, C9F8G, C9F8GS, C9FE12G, C9FE12GS, C9FE4GS, C9FE6GS, C9FE8G, C9FE8GS, C9FEP4GS, C9FEP6GS, C9FEP8GS, C9FG12G, C9FG12GS, C9FG16G, C9FG8G, C9FG8GP, C9FG8GS, C9FGM12G... (Other models you can see in the webshop)			
accessories for 105051				
	GEV No.	103150	Ref. No.	1315812 1892500 MA1892500
burner lower part for burner cap ø 110/120mm				
	GEV No.	104030	Ref. No.	1315412 1315422 MA1315422
burner head for burner cap ø 80mm				
	GEV No.	104031	Ref. No.	1315512 1315522 MA1315522
burner head for burner cap ø 110mm				
	GEV No.	104032	Ref. No.	1315912 1315922 MA1315922
burner head for burner cap ø 120mm				
	GEV No.	104033	Ref. No.	1315200
burner lower part for burner cap ø 80mm 1. generation				
	GEV No.	104034	Ref. No.	1315300 1315312 MA1315300
burner lower part for burner cap ø 110mm				
	GEV No.	105052	Ref. No.	1306400 1306600 1306615 MA1306615
nozzle holder ID ø 10mm nozzle mounting M10x1				
	GEV No.	105265	Ref. No.	CM006001 MACM006001
burner head for burner cap ø 80mm				
	GEV No.	105266	Ref. No.	CM042900 MACM042900
burner lower part for burner cap ø 80mm				
	GEV No.	105269	Ref. No.	CM005901 MACM005901
burner head ø 158mm for burner cap ø 110mm				

Table continues overleaf



accessories for 105051				
	GEV No.	105272	Ref. No.	CM043000 MACM043000
burner lower part for burner cap ø 110mm				
	GEV No.	105274	Ref. No.	CM006502 MACM006502
burner head for burner cap ø 120mm				
	GEV No.	105275	Ref. No.	CM043100 MACM043100
burner lower part for burner cap ø 120mm				

				
1				
GEV No.	105268	Ref. No.	CM027100 MACM027100	
description	burner cap ø 110mm			
For models:	C124G, C129G, C12FG9G, C712G, C74G, C78G, C7FE12G, C7FE8G, C7FG12G, C7FG8G, C7FGM12G, C912G, C912GS, C94G, C94GP, C94GS, C98G, C98GP, C98GS, C9FE12G, C9FE12GS, C9FE8G, C9FE8GS, C9FG12G, C9FG12GS, C9FG16G, C9FG8G, C9FG8GP, C9FG8GS, C9FGM12G			
accessories for 105268				
	GEV No.	105051	Ref. No.	1314700 MA1314700
air mixing sleeve L 45mm ED ø 45mm ID ø 42mm aluminium				
	GEV No.	105267	Ref. No.	1781800 MA1781800
nozzle holder nozzle M10x1 M14x1 screw pipe fitting M16x1.5 tube ø 10mm				
	GEV No.	105269	Ref. No.	CM005901 MACM005901
burner head ø 158mm for burner cap ø 110mm				
	GEV No.	105272	Ref. No.	CM043000 MACM043000
burner lower part for burner cap ø 110mm				

				
1				
GEV No.	105273	Ref. No.	CM027200 MACM027200	
description	burner cap ø 120mm with central hole			
For models:	C124G, C129G, C12C2G9, C12C9G, C12FG9G, C712G, C74G, C78G, C7FE12G, C7FE8G, C7FG12G, C7FG8G, C7FGM12G, C912G, C912GS, C94G, C94GP, C94GS, C98G, C98GP, C98GS, C9FE12G, C9FE12GS, C9FE8G, C9FE8GS, C9FG12G, C9FG12GS, C9FG16G, C9FG8G, C9FG8GP, C9FG8GS, C9FGM12G			
accessories for 105273				
	GEV No.	105051	Ref. No.	1314700 MA1314700
air mixing sleeve L 45mm ED ø 45mm ID ø 42mm aluminium				
	GEV No.	105267	Ref. No.	1781800 MA1781800
nozzle holder nozzle M10x1 M14x1 screw pipe fitting M16x1.5 tube ø 10mm				
	GEV No.	105274	Ref. No.	CM006502 MACM006502
burner head for burner cap ø 120mm				

accessories for 105273				
	GEV No.	105275	Ref. No.	CM043100 MACM043100
burner lower part for burner cap ø 120mm				

				
1				
GEV No.	105263	Ref. No.	CM027600 MACM027600	
description	burner cap ø 80mm			
For models:	C712G, C74G, C78G, C7FE12G, C7FE8G, C7FG12G, C7FG8G, C7FGM12G, C912G, C912GS, C94G, C94GP, C94GS, C98G, C98GP, C98GS, C9FE12G, C9FE12GS, C9FE8G, C9FE8GS, C9FG12G, C9FG12GS, C9FG16G, C9FG8G, C9FG8GP, C9FG8GS, C9FGM12G			
accessories for 105263				
	GEV No.	105051	Ref. No.	1314700 MA1314700
air mixing sleeve L 45mm ED ø 45mm ID ø 42mm aluminium				
	GEV No.	105265	Ref. No.	CM006001 MACM006001
burner head for burner cap ø 80mm				
	GEV No.	105266	Ref. No.	CM042900 MACM042900
burner lower part for burner cap ø 80mm				
	GEV No.	105267	Ref. No.	1781800 MA1781800
nozzle holder nozzle M10x1 M14x1 screw pipe fitting M16x1.5 tube ø 10mm				

				
1				
GEV No.	105274	Ref. No.	CM006502 MACM006502	
description	burner head for burner cap ø 120mm			
For models:	C124G, C129G, C12C2G9, C12C9G, C12FG9G, C712G, C74G, C78G, C7FE12G, C7FE8G, C7FG12G, C7FG8G, C7FGM12G, C912G, C912GS, C94G, C94GP, C94GS, C98G, C98GP, C98GS, C9FE12G, C9FE12GS, C9FE8G, C9FE8GS, C9FG12G, C9FG12GS, C9FG16G, C9FG8G, C9FG8GP, C9FG8GS, C9FGM12G			
accessories for 105274				
	GEV No.	105051	Ref. No.	1314700 MA1314700
air mixing sleeve L 45mm ED ø 45mm ID ø 42mm aluminium				
	GEV No.	105267	Ref. No.	1781800 MA1781800
nozzle holder nozzle M10x1 M14x1 screw pipe fitting M16x1.5 tube ø 10mm				
	GEV No.	105273	Ref. No.	CM027200 MACM027200
burner cap ø 120mm with central hole				
	GEV No.	105275	Ref. No.	CM043100 MACM043100
burner lower part for burner cap ø 120mm				



1

GEV No.	105265	Ref. No.	CM006001 MACM006001
description	burner head for burner cap ø 80mm		
For models:	C712G, C74G, C78G, C7FE12G, C7FE8G, C7FG12G, C7FG8G, C7FG-M12G, C912G, C912GS, C94G, C94GP, C94GS, C98G, C98GP, C98GS, C9FE12G, C9FE12GS, C9FE8G, C9FE8GS, C9FG12G, C9FG12GS, C9FG16G, C9FG8G, C9FG8GP, C9FG8GS, C9FGM12G		
accessories for	105265		
	GEV No.	105051	Ref. No. 1314700 MA1314700
air mixing sleeve L 45mm ED ø 45mm ID ø 42mm aluminium			
	GEV No.	105263	Ref. No. CM027600 MACM027600
burner cap ø 80mm			
	GEV No.	105266	Ref. No. CM042900 MACM042900
burner lower part for burner cap ø 80mm			
	GEV No.	105267	Ref. No. 1781800 MA1781800
nozzle holder nozzle M10x1 M14x1 screw pipe fitting M16x1.5 tube ø 10mm			



1

GEV No.	105269	Ref. No.	CM005901 MACM005901
description	burner head ø 158mm for burner cap ø 110mm		
For models:	C124G, C129G, C12FG9G, C712G, C74G, C78G, C7FE12G, C7FE8G, C7FG12G, C7FG8G, C7FGM12G, C912G, C912GS, C94G, C94GP, C94GS, C98G, C98GP, C98GS, C9FE12G, C9FE12GS, C9FE8G, C9FE8GS, C9FG12G, C9FG12GS, C9FG16G, C9FG8G, C9FG8GP, C9FG8GS, C9FGM12G		
accessories for	105269		
	GEV No.	105051	Ref. No. 1314700 MA1314700
air mixing sleeve L 45mm ED ø 45mm ID ø 42mm aluminium			
	GEV No.	105267	Ref. No. 1781800 MA1781800
nozzle holder nozzle M10x1 M14x1 screw pipe fitting M16x1.5 tube ø 10mm			
	GEV No.	105268	Ref. No. CM027100 MACM027100
burner cap ø 110mm			
	GEV No.	105272	Ref. No. CM043000 MACM043000
burner lower part for burner cap ø 110mm			



1

GEV No.	105272	Ref. No.	CM043000 MACM043000
description	burner lower part for burner cap ø 110mm		
For models:	C124G, C129G, C12FG9G, C712G, C74G, C78G, C7FE12G, C7FE8G, C7FG12G, C7FG8G, C7FGM12G, C912G, C912GS, C94G, C94GP, C94GS, C98G, C98GP, C98GS, C9FE12G, C9FE12GS, C9FE8G, C9FE8GS, C9FG12G, C9FG12GS, C9FG16G, C9FG8G, C9FG8GP, C9FG8GS, C9FGM12G		
accessories for	105272		
	GEV No.	105051	Ref. No. 1314700 MA1314700
air mixing sleeve L 45mm ED ø 45mm ID ø 42mm aluminium			
	GEV No.	105267	Ref. No. 1781800 MA1781800
nozzle holder nozzle M10x1 M14x1 screw pipe fitting M16x1.5 tube ø 10mm			
	GEV No.	105268	Ref. No. CM027100 MACM027100
burner cap ø 110mm			
	GEV No.	105269	Ref. No. CM005901 MACM005901
burner head ø 158mm for burner cap ø 110mm			











1

GEV No.	105275	Ref. No.	CM043100 MACM043100
description	burner lower part for burner cap ø 120mm		
For models:	C124G, C129G, C12C2G9, C12C9G, C12FG9G, C712G, C74G, C78G, C7FE12G, C7FE8G, C7FG12G, C7FG8G, C7FGM12G, C912G, C912GS, C94G, C94GP, C94GS, C98G, C98GP, C98GS, C9FE12G, C9FE12GS, C9FE8G, C9FE8GS, C9FG12G, C9FG12GS, C9FG16G, C9FG8G, C9FG8GP, C9FG8GS, C9FGM12G		
accessories for	105275		
	GEV No.	105051	Ref. No. 1314700 MA1314700
air mixing sleeve L 45mm ED ø 45mm ID ø 42mm aluminium			
	GEV No.	105267	Ref. No. 1781800 MA1781800
nozzle holder nozzle M10x1 M14x1 screw pipe fitting M16x1.5 tube ø 10mm			
	GEV No.	105273	Ref. No. CM027200 MACM027200
burner cap ø 120mm with central hole			
	GEV No.	105274	Ref. No. CM006502 MACM006502
burner head for burner cap ø 120mm			





 <p>1</p>			
GEV No.	105266	Ref. No.	CM042900 MACM042900
description	burner lower part for burner cap ø 80mm		
For models:	C712G, C74G, C78G, C7FE12G, C7FE8G, C7FG12G, C7FG8G, C7FG-M12G, C912G, C912GS, C94G, C94GP, C94GS, C98G, C98GP, C98GS, C9FE12G, C9FE12GS, C9FE8G, C9FE8GS, C9FG12G, C9FG12GS, C9FG16G, C9FG8G, C9FG8GP, C9FG8GS, C9FGM12G		
accessories for	105266		
	GEV No.	105051	Ref. No. 1314700 MA1314700
air mixing sleeve L 45mm ED ø 45mm ID ø 42mm aluminium			
	GEV No.	105263	Ref. No. CM027600 MACM027600
burner cap ø 80mm			
	GEV No.	105265	Ref. No. CM006001 MACM006001
burner head for burner cap ø 80mm			
	GEV No.	105267	Ref. No. 1781800 MA1781800
nozzle holder nozzle M10x1 M14x1 screw pipe fitting M16x1.5 tube ø 10mm			

 <p>1</p>			
GEV No.	105267	Ref. No.	1781800 MA1781800
description	nozzle holder nozzle M10x1 M14x1 screw pipe fitting M16x1.5 tube ø 10mm		
For models:	C124G, C129G, C12C2G9, C12C9G, C12FG9G, C7011G, C7011GFE, C7011GFG, C704G, C707G, C707GFE, C707GFG, C712G, C74G, C78G, C7FE12G, C7FE8G, C7FG12G, C7FG8G, C7FGM12G, C912G, C912GS, C94G, C94GP, C94GS, C98G, C98GP, C98GS, C9F4GS, C9F6GS, C9F8GS, C9FE12G, C9FE12GS, C9FE4GS, C9FE6GS, C9FE8G, C9FE8GS, C9FEP4GS, C9FEP6GS, C9FEP8GS, C9FG12G, C9FG12GS, C9FG16G, C9FG8G, C9FG8GP, C9FG8GS, C9FGM12G, C9FP4GS, C9FP6GS, C9FP8GS...(Other models you can see in the webshop)		
accessories for	105267		
	GEV No.	105051	Ref. No. 1314700 MA1314700
air mixing sleeve L 45mm ED ø 45mm ID ø 42mm aluminium			
	GEV No.	105265	Ref. No. CM006001 MACM006001
burner head for burner cap ø 80mm			
	GEV No.	105266	Ref. No. CM042900 MACM042900
burner lower part for burner cap ø 80mm			
	GEV No.	105269	Ref. No. CM005901 MACM005901
burner head ø 158mm for burner cap ø 110mm			
	GEV No.	105272	Ref. No. CM043000 MACM043000
burner lower part for burner cap ø 110mm			
	GEV No.	105274	Ref. No. CM006502 MACM006502
burner head for burner cap ø 120mm			
	GEV No.	105275	Ref. No. CM043100 MACM043100
burner lower part for burner cap ø 120mm			

stockpot stoves/boiling pan			
 <p>1</p>			
GEV No.	105276	Ref. No.	1104400 1205900 MA1205900
description	burner cap ø 225mm with central hole		
For models:	FB1GS, FP1GS, MM10IG, P9D5G, P9I10G, P9I5G, P9IA10G, PD707G, PI707G		

 <p>1</p>			
GEV No.	105277	Ref. No.	1104300 MA1104300
description	burner head for burner cap ø 225mm for stockpot stoves		
For models:	FB1GS, FP1GS, MM10IG, P9D5G, P9I10G, P9I5G, P9IA10G, PD707G, PI707G		

 <p>1</p>			
GEV No.	105278	Ref. No.	1104600 1104612 MA1104612
description	gasket for burner head		
For models:	FB1GS, FP1GS, MM10IG, P9D5G, P9I10G, P9I5G, P9IA10G, PD707G, PI707G		

pan supports			
 <p>1</p>			
GEV No.	210019	Ref. No.	CM018402 MACM018402
description	pan support W 290mm L 345mm gas range suitable for 700 series		
For models:	C712G, C74G, C78G, C7FE12G, C7FE8G, C7FG12G, C7FG8G, C7FG-M12G, C912G, C912GS, C94G, C94GP, C94GS, C98G, C98GP, C98GS, C9FE12G, C9FE12GS, C9FE8G, C9FE8GS, C9FG12G, C9FG12GS, C9FG16G, C9FG8G, C9FG8GP, C9FG8GS, C9FGM12G		



1

GEV No.	210151	Ref. No.	1032101100 1032101101 MA1032101100 MA1032101101
description	pan support W 295mm L 545mm gas range		
For models:	CFGE61, CFGE61D, CFGE61L, CFGE61P, OCFGE61, OPG41, OPG61, PCG41, PCG41L, PCG61, PCG61L		



1

GEV No.	210150	Ref. No.	1032101000 1032101001 MA1032101000 MA1032101001
description	pan support W 340mm L 545mm		
For models:	CFG101, CFG70, CFG70M, EC74GVG, EC78GVG, EC7FG8G, OCFG101, OCFG70, OPG41, OPG61, PCG41, PCG41L, PCG61, PCG61L		



1

GEV No.	210000	Ref. No.	CM018501 MACM018501
description	pan support W 345mm L 345mm gas range suitable for 900 series suitable for MARENO		
For models:	C124G, C129G, C12C2G9, C12C9G, C12FG9G, C712G, C74G, C78G, C7FE12G, C7FE8G, C7FG12G, C7FG8G, C7FGM12G, C912G, C912GS, C94G, C94GP, C94GS, C98G, C98GP, C98GS, C9FE12G, C9FE12GS, C9FE8G, C9FE8GS, C9FG12G, C9FG12GS, C9FG16G, C9FG8G, C9FG8GP, C9FG8GS, C9FGM12G		



1

GEV No.	210103	Ref. No.	1316622 MA1316622
description	pan support W 350mm L 400mm mounting pos. rear for 900		
For models:	C9F4GS, C9F6GS, C9F8GS, C9FE4GS, C9FE6GS, C9FE8GS, C9FEP4GS, C9FEP6GS, C9FEP8GS, C9FP4GS, C9FP6GS, C9FP8GS, C9V2GS, C9V4GS, C9V6GS, C9V8GS, C9VP2GS, C9VP4GS, C9VP6GS, C9VP8GS, PCG42, PCG82, T9F6GS, T9V6GS		



1

GEV No.	210104	Ref. No.	13165-00 1316522 MA1316522
description	pan support W 400mm L 430mm for 900		
For models:	C9F4GS, C9F6GS, C9F8GS, C9FE4GS, C9FE6GS, C9FE8GS, C9FEP4GS, C9FEP6GS, C9FEP8GS, C9FP4GS, C9FP6GS, C9FP8GS, C9SB4GS, C9V2GS, C9V4GS, C9V6GS, C9V8GS, C9VP2GS, C9VP4GS, C9VP6GS, C9VP8GS, CFG120, FB1GS, FB2GS, FB3GS, OCFG120, T9F6GS, T9V6GS		

reducers for pan supports



1

GEV No.	210001	Ref. No.	86400 MA86400
description	reducer for pan support L 265mm W 265mm SS suitable for universal		
For models:	704S, 706S, C7011G, C7011GFE, C7011GFG, C704G, C707G, C707G-FE, C707GFG, C9F4GS, C9F6GS, C9F8GS, C9FEP4GS, C9FEP6GS, C9FEP8GS, C9FP4GS, C9FP6GS, C9FP8GS, C9SB4GS, C9V2GS, C9V4GS, C9V6GS, C9V8GS, C9VP4GS, C9VP6GS, C9VP8GS, TPF706S		

solid tops



1

GEV No.	104755	Ref. No.	13162-00 CM052300 MA1316200 MACM052300
description	cast plate round ø 300mm suitable for MARENO T9FP-4G		
For models:	ET78GVG, ET7FG8G, NT78G, NT7FG12G, NT7FG8G, NT98G, NT-9FG12G, NT9FG8G, T129G, T78G, T7FG12G, T7FG8G, T98G, T9F4G, T9F6GS, T9FE4G, T9FG12G, T9FG8G, T9FP4G, T9SB4G, T9V4G, T9V6GS, T9VP4G		



accessories

reducers for pan supports

			
1			
GEV No.	210001	Ref. No.	86400 MA86400
description	reducer for pan support L 265mm W 265mm SS suitable for universal		
For models:	704S, 706S, C7011G, C7011GFE, C7011GFG, C704G, C707G, C707GFE, C707GFG, C9F4GS, C9F6GS, C9F8GS, C9FEP4GS, C9FEP6GS, C9FEP8GS, C9FP4GS, C9FP6GS, C9FP8GS, C9SB4GS, C9V2GS, C9V4GS, C9V6GS, C9V8GS, C9VP4GS, C9VP6GS, C9VP8GS, TPF706S		

pan supports

			
1			
GEV No.	210019	Ref. No.	CM018402 MACM018402
description	pan support W 290mm L 345mm gas range suitable for 700 series		
For models:	C712G, C74G, C78G, C7FE12G, C7FE8G, C7FG12G, C7FG8G, C7FGM12G, C912G, C912GS, C94G, C94GP, C94GS, C98G, C98GP, C98GS, C9FE12G, C9FE12GS, C9FE8G, C9FE8GS, C9FG12G, C9FG12GS, C9FG16G, C9FG8G, C9FG8GP, C9FG8GS, C9FGM12G		

			
1			
GEV No.	210151	Ref. No.	1032101100 1032101101 MA1032101100 MA1032101101
description	pan support W 295mm L 545mm gas range		
For models:	CFGE61, CFGE61D, CFGE61L, CFGE61P, OCFGE61, OPCG41, OPCG61, PCG41, PCG41L, PCG61, PCG61L		

			
1			
GEV No.	210150	Ref. No.	1032101000 1032101001 MA1032101000 MA1032101001
description	pan support W 340mm L 545mm		
For models:	CFG101, CFG70, CFG70M, EC74GVG, EC78GVG, EC7FG8G, OCFG101, OCFG70, OPCG41, OPCG61, PCG41, PCG41L, PCG61, PCG61L		

			
1			
GEV No.	210000	Ref. No.	CM018501 MACM018501
description	pan support W 345mm L 345mm gas range suitable for 900 series suitable for MARENO		
For models:	C124G, C129G, C12C2G9, C12C9G, C12FG9G, C712G, C74G, C78G, C7FE12G, C7FE8G, C7FG12G, C7FG8G, C7FGM12G, C912G, C912GS, C94G, C94GP, C94GS, C98G, C98GP, C98GS, C9FE12G, C9FE12GS, C9FE8G, C9FE8GS, C9FG12G, C9FG12GS, C9FG16G, C9FG8G, C9FG8GP, C9FG8GS, C9FGM12G		

			
1			
GEV No.	210103	Ref. No.	1316622 MA1316622
description	pan support W 350mm L 400mm mounting pos. rear for 900		
For models:	C9F4GS, C9F6GS, C9F8GS, C9FE4GS, C9FE6GS, C9FE8GS, C9FEP4GS, C9FEP6GS, C9FEP8GS, C9FP4GS, C9FP6GS, C9FP8GS, C9V2GS, C9V4GS, C9V6GS, C9V8GS, C9VP2GS, C9VP4GS, C9VP6GS, C9VP8GS, PCG42, PCG82, T9F6GS, T9V6GS		

			
1			
GEV No.	210104	Ref. No.	13165-00 1316522 MA1316522
description	pan support W 400mm L 430mm for 900		
For models:	C9F4GS, C9F6GS, C9F8GS, C9FE4GS, C9FE6GS, C9FE8GS, C9FEP4GS, C9FEP6GS, C9FEP8GS, C9FP4GS, C9FP6GS, C9FP8GS, C9SB4GS, C9V2GS, C9V4GS, C9V6GS, C9V8GS, C9VP2GS, C9VP4GS, C9VP6GS, C9VP8GS, CFG120, FB1GS, FB2GS, FB3GS, OCFG120, T9F6GS, T9V6GS		

air mixers

			
1			
GEV No.	106804	Ref. No.	CR0508690
description	air mixer		
For models:	FQG41, FQG61, NF74G8, NF76G8, OFQG41, OFQG61		

			
1			
GEV No.	106805	Ref. No.	CR0508400
description	air mixer		
For models:	EF74G8VA, EF74G8VG, FQG41, FQG61, NF74G8, NF76G8, OFQG41, OFQG61		

			
1			
GEV No.	106066	Ref. No.	CM136600 MACM136600
description	air mixing tube dimensions 18x42mm ED ø 24mm		
For models:	EFT74GLVG, EFT74GRVG, EFT78GLVG, EFT78GMVG, FT12C9GL, FT12C9GM, FT12C9GLT, FT12C9GTMC, FT74GL, FT74GLC, FT74GR, FT74GRC, FT76GL, FT76GLC, FT76GM, FT76GMC, FT76GR, FT76GRL, FT78GLC, FT78GLT, FT78GM, FT78GMC, FT78GMT, FT78GR, FT78GRT, FT94G, FT94GL, FT94GLC, FT94GR, FT94GRC, FT96GL, FT96GLC, FT96GM, FT96GMC, FT96GR, FT98GL, FT98GLC, FT98GLT, FT98GM, FT98GMC, FT98GMT, FT98GR, FT98GRT		

bar burners

			
1			
GEV No.	108098	Ref. No.	R63016520
description	bar burner 1-row L 440mm ø 50mm flange width 57mm flange length 57mm MG110, VG110		
For models:	GC110M, GM110H, GM110M, GM110M+SC, GM110P, GV110H, GV110M, GV110M+SC, GV110P		

			
1			
GEV No.	105831	Ref. No.	R63016050
description	bar burner 2 row L 425mm Wmm ø 40mm Hmm flange width 43mm flange length 43mm combi-steamer MG106, VG106		
For models:	MG106M, MG106P, MG106X, VG106M, VG106P, VG106X		

			
1			
GEV No.	104156	Ref. No.	1031501400 1828100 1828112 MA1828112
description	bar burner 2 row L 445mm W 200mm ømm H 50mm chargrill stainless steel		
For models:	GB704G, GB707G, GB92G, GB94G, OPLG40, OPLG80, PLG40, PLG80		

			
1			
GEV No.	105260	Ref. No.	1031504600 MA1031504600
description	bar burner 2 row L 450mm W 300mm ømm H 50mm 8.5kW griddle		

			
1			
GEV No.	105827	Ref. No.	R63016060
description	bar burner 2 row L 485mm W 160mm ø 40mm H 90mm combi-steamer MG106		
For models:	MG106M, MG106P, MG106X		

			
1			
GEV No.	105490	Ref. No.	CM081302 MACM081302
description	bar burner 2 row L 485mm W 190mm ømm H 55mm griddle		
For models:	FT12C9GL, FT12C9GM, FT12C9GLT, FT12C9GTMC, FT74GL, FT74GLC, FT74GR, FT74GRC, FT76GL, FT76GLC, FT76GM, FT76GMC, FT76GR, FT76GRL, FT78GLC, FT78GLT, FT78GM, FT78GMC, FT78GMT, FT78GR, FT78GRT, FT94G, FT94GL, FT94GLC, FT94GR, FT94GRC, FT96GL, FT96GLC, FT96GM, FT96GMC, FT96GR, FT98GL, FT98GLC, FT98GLT, FT98GM, FT98GMC, FT98GMT, FT98GR, FT98GRT		

			
1			
GEV No.	105494	Ref. No.	CM203100 MACM203100
description	bar burner 2 row L 525mm W 200mm ømm H 65mm chargrill		
For models:	GL12C4G, GL12C9G, GL74G, GL78G, NGL74G, NGL78G		

			
1			
GEV No.	105845	Ref. No.	R63015280
description	bar burner 2 row L 550mm W 165mm ø 50mm H 85mm combi-steamer MG21		
For models:	FG110M, FG110X, PG080M, PG080X		



			
GEV No.	105834	Ref. No.	R63016090
description	bar burner 2 row L 575mm W 240mm ø 50mm H 110mm combi-steamer MG210, VG210		
For models:	MG210M, MG210P, MG210X, VG210M, VG210P, VG210X		

			
GEV No.	105491	Ref. No.	CM033503 MACM033503
description	bar burner 2 row L 665mm W 190mm ømm H 55mm griddle chrome-plated		
For models:	FT74GL, FT74GLC, FT74GR, FT74GRC, FT76GL, FT76GLC, FT76GM, FT76GMC, FT76GR, FT78GL, FT78GLC, FT78GLT, FT78GM, FT78GMC, FT78GMT, FT78GR, FT78GRT, FT94G, FT94GL, FT94GLC, FT94GR, FT94GRC, FT96GL, FT96GLC, FT96GM, FT96GMC, FT96GR, FT98GL, FT98GLC, FT98GLT, FT98GM, FT98GMC, FT98GMT, FT98GR, FT98GRT		

			
GEV No.	105495	Ref. No.	CM201900 MACM201900
description	bar burner 2 row L 695mm W 200mm ømm H 65mm chargrill stainless steel		
For models:	GL94G, GL98G		

			
GEV No.	105492	Ref. No.	CM081402 MACM081402
description	bar burner 3 row L 484mm W 340mm ømm H 55mm griddle		
For models:	FT74GL, FT74GLC, FT74GR, FT74GRC, FT76GL, FT76GLC, FT76GM, FT76GMC, FT76GR, FT78GL, FT78GLC, FT78GLT, FT78GM, FT78GMC, FT78GMT, FT78GR, FT78GRT, FT94G, FT94GL, FT94GLC, FT94GR, FT94GRC, FT96GL, FT96GLC, FT96GM, FT96GMC, FT96GR, FT98GL, FT98GLC, FT98GLT, FT98GM, FT98GMC, FT98GMT, FT98GR, FT98GRT		

			
GEV No.	105493	Ref. No.	CM079801 MACM079801
description	bar burner 3 row L 650mm W 340mm ømm H 55mm griddle		
For models:	FT129GLC, FT129GM, FT74GL, FT74GLC, FT74GR, FT74GRC, FT76GL, FT76GLC, FT76GM, FT76GMC, FT76GR, FT78GL, FT78GLC, FT78GLT, FT78GM, FT78GMC, FT78GMT, FT78GR, FT78GRT, FT94G, FT94GL, FT94GLC, FT94GR, FT94GRC, FT96GL, FT96GLC, FT96GM, FT96GMC, FT96GR, FT98GL, FT98GLC, FT98GLT, FT98GM, FT98GMC, FT98GMT, FT98GR, FT98GRT, PM129G		

			
GEV No.	105519	Ref. No.	CM069900 CM069901 MACM069901
description	bar burner 6 row L 350mm W 618mm ømm H 60mm tilting bratt pan		
For models:	BR78GF, BR78GI		

			
GEV No.	105520	Ref. No.	CM070003 CM070003R MACM070003 MACM070003R
description	bar burner 6 row L 520mm W 620mm ømm H 60mm tilting bratt pan		
For models:	BR78EF, BR78EI, BR912EFM, BR912EIM, BR912GFM, BR912GIM, BR98EF, BR98EFM, BR98EI, BR98EIM, BR98GF, BR98GFM, BR98GI, BR98GIM, BR9S8EF, BR9S8EI, BR9S8GF, BR9S8GI		

			
GEV No.	105521	Ref. No.	CM070100 CM070103 MACM070103
description	bar burner 8 row L 520mm W 1010mm ømm H 60mm tilting bratt pan		
For models:	BR912GFM, BR912GIM, BR98GF, BR98GFM, BR98GI, BR98GIM, BR9S8GF, BR9S8GI		

			
GEV No.	105486	Ref. No.	1664300 MA1664300
description	bar burner angled L 440mm W 200mm ømm Hmm oven		
For models:	C7011GFG, C707GFE, C707GFG, CFG101, CFG101D, CFG101L, CFG101P, CFG120, CFG70, CFG70D, CFG70L, CFG70M, CFG70P, EC74G-VG, EC78GVG, EC7FG8G, OCFG101, OCFG120, OCFG70, T7011GFG, T707GFG		

			
GEV No.	105513	Ref. No.	1845614
description	bar burner angled L 505mm W 145mm ømm Hmm bain marie		
For models:	BM74G, BM77G		

			
GEV No.	105487	Ref. No.	1305012 1305024 MA1305024
description	bar burner angled L 610mm W 380mm ømm Hmm oven		
For models:	C9F4E, C9F4G, C9F4GS, C9F6E, C9F6G, C9F6GS, C9F8G, C9F8GS, C9FP, C9FP4GS, C9FP6GS, C9FP8GS, T9F4G, T9F6G, T9F6GS, T9FP, T9FP4G		

 Image not available			
GEV No.	105828	Ref. No.	R63016080
description	bar burner combi-steamer MG110		
For models:	MG110M, MG110P, MG110X		

 Image not available			
GEV No.	105829	Ref. No.	R63016100
description	bar burner combi-steamer MG120/210		
For models:	MG120M, MG120P, MG120X, MG210M, MG210P, MG210X, MGC20X, MGC24H		

 Image not available			
GEV No.	105830	Ref. No.	R63016130
description	bar burner combi-steamer MG220		
For models:	MG220M, MG220P, MG220X, MGC40H		

 Image not available			
GEV No.	105846	Ref. No.	R63015270
description	bar burner combi-steamer PG04		
For models:	FG105M, FG105X, PG040M, PG040X		

 Image not available			
GEV No.	105832	Ref. No.	R63016070
description	bar burner convection oven MG110, VG190		
For models:	MG110M, MG110P, MG110X, VG110M, VG110P, VG110X		

 Image not available			
GEV No.	105833	Ref. No.	R63016110
description	bar burner convection oven MG120, VG120		
For models:	MG120M, MG120P, MG120X, MGC20X, VG120M, VG120P, VG120X		

 Image not available			
GEV No.	105835	Ref. No.	R63016120
description	bar burner convection oven MG220, VG220		
For models:	MG220M, MG220P, MG220X, MGC24H, MGC40H, VG220M, VG220P, VG220X		

 Image not available			
GEV No.	105847	Ref. No.	R63015260
description	bar burner convection oven PG12		
For models:	FG210M, FG210X		

			
GEV No.	105515	Ref. No.	CM140600 MACM140600
description	bar burner ø 40mm Wmm Hmm L 250mm flange ø 61mm bain marie		
For models:	B74G, B78G, B94G, B98G, NB74G, NB78G, NB94G, NB98G		



			
1			
GEV No.	104154	Ref. No.	1685400 MA1685400
description	bar burner ø 40mm Wmm Hmm L 345mm 3.5kW griddle		
For models:	BR707G, BR707GI, FT12G7L70, FT12G7LC70, FT12G7R70, FT-12G7RC70, FT12G7RL70, FT12G7RLC70, FT6G4L70, FT6G4LC70, FT6G4R70, FT6G4RC70		

			
1			
GEV No.	104243	Ref. No.	1833100 MA1833100
description	bar burner ø 50mm Wmm Hmm L 260mm flange width 52mm flange ø 75mm with bolt M5x12 pasta cooker		
For models:	CP704G		

			
1			
GEV No.	104240	Ref. No.	1031501000 MA1031501000
description	bar burner ø 40mm Wmm Hmm L 400mm flange ø 61mm 1-row chargrill with bolt M5x12		
For models:	BIG40, BIG60, FTG40B, FTG40BLC, FTG40BR, FTG60B, FTG60BLC, FTG60BR, FTG60BRR, FTG80B, FTG80BLC, FTG80BR		

			
1			
GEV No.	105498	Ref. No.	CM088200 MACM088200
description	bar burner ø 50mm Wmm Hmm L 308mm flange width 71mm flange ø 75mm pasta cooker		
For models:	EPC74G, NPC74G, NPC78G, NPD76G5, NPD78G8, NPD96G5, NPI76G5, NPI78G8, NPI96G5, PC12C4G, PC74G, PC76G, PC78G, PC94G, PC96G, PC98G, PC9S4G, PC9S6G, PC9S8G, PD76G5, PD96G5, PI76G5, PI96G5		

			
1			
GEV No.	104153	Ref. No.	1475100 MA1475100
description	bar burner ø 40mm Wmm Hmm L 480mm with retainer for nozzle rod tilting bratt pan		
For models:	BR94G, BR94GI, BR96G, BR96GI, BR9M4G, BR9M4GI, BR9M6G, BR9M-6GI, BR9SB4G, BR9SB4GI, FT14G8L90, FT14G8LC90, FT14G8R2L90, FT14G8R2LC90, FT14G8R90, FT14G8RC90, FT7G4L90, FT7G4LC90, FT7G4R90, FT7G4RC90, MS10AG, MS10IG, MS70AG, MS70IG, MS70IGS		

			
1			
GEV No.	104244	Ref. No.	2708500 2708514 MA2708514
description	bar burner ø 50mm Wmm Hmm L 410mm flange width 52mm flange ø 75mm kettle		
For models:	CP92G, CP94G, CP9SB2G, CP9SB4G, FC10G, FC20G, FC5G, FC7G, MM10DG, MM10DGS, MM10IG, MM15DG, P9D10G, P9D15G, P9D2G, P9DA10G, P9DA15G, P9DASB10G, P9DSB10G, P9I10G, P9IA10G, P9IASB10G		

			
1			
GEV No.	105516	Ref. No.	CM140700 MACM140700
description	bar burner ø 40mm Wmm Hmm L 600mm flange ø 61mm bain marie		
For models:	B74G, B78G, B94G, B98G, NB74G, NB78G, NB94G, NB98G		

			
1			
GEV No.	105730	Ref. No.	2862914 MA2862914
description	bar burner ø 50mm Wmm Hmm L 460mm flange width 52mm flange ø 75mm with bolt M5x12 combi-steamer for convection oven with 10 grids 1/1		
For models:	CON6G, CON6GP, CSM6G, CSM6GP		



			
GEV No.	105523	Ref. No.	CM088100 MACM088100
description	bar burner ø 50mm Wmm Hmm L 475mm flange ø 75mm		
For models:	NPC76G, NPC94G, NPC96G, NPC98G, NPD98G10, NPD98G15, NPD-98G15A, NPI98G10, NPI98G14, NPI98G14A, PC12C9G, PC74G, PC76G, PC78G, PC94G, PC96G, PC98G, PC9S4G, PC9S6G, PC9S8G, PD98G10, PD98G15, PD98G15A, PD9S8G10, PI98G10, PI98G14, PI98G14A		

			
GEV No.	105488	Ref. No.	CM021402 MACM021402
description	bar burner ø 50mm Wmm Hmm L 590mm flange width 71mm flange ø 75mm 8.5kW oven		
For models:	BF78G, BF912G, BF912GH, BF98G, C7FG12G, C7FG8G, C7FGM12G, C9FG12G, C9FG16G, C9FG8G, C9FG8GP, C9FGM12G, NC7FGM12G, T7FG12G, T7FG8G, T9FG12G, T9FG8G		

			
GEV No.	105735	Ref. No.	5163800 MA5163800
description	bar burner ø 50mm Wmm Hmm L 480mm flange width 52mm flange ø 75mm with bolt M5x12 combi-steamer for boiler 10 grids 1/1		
For models:	CSM10G, CSM10GP		

			
GEV No.	104150	Ref. No.	1031002300 MA1031002300
description	bar burner ømm W 28mm H 42mm L 340mm flange width 40mm flange length 54mm with bolt M5x25 4.65kW tilting bratt pan		
For models:	BMG40, BMG60, BRG40, BRG40G		

			
GEV No.	105734	Ref. No.	2862614 MA2862614
description	bar burner ø 50mm Wmm Hmm L 480mm flange width 52mm flange ø 75mm with bolt M5x12 combi-steamer for boiler 6 grids 1/1		
For models:	CP9A15GD, CSM6G, CSM6GP		

			
GEV No.	105255	Ref. No.	1031504500 MA1031504500 SIR0109046
description	bar burner ømm W 41mm H 34mm L 490mm flange width 70mm 5.5kW griddle		
For models:	EFT74GLVG, EFT74GRVG, EFT78GLVG, EFT78GMVG		

			
GEV No.	103077	Ref. No.	CR0684490
description	bar burner ø 50mm Wmm Hmm L 490mm flange width 52mm flange length 75mm fryer		
For models:	NF74G10, NF74G15, NF76G10, NF78G15, NF94G15, NF96G10, NF98G15		

			
GEV No.	210257	Ref. No.	1041301200 MA1041301200
description	chargrill grid L 500mm W 330mm		
For models:	GB704G, GB707G, GB92G, GB94G, OPLG40, OPLG80, PLG40, PLG80		

			
GEV No.	210258	Ref. No.	1041301900 MA1041301900
description	chargrill grid L 500mm W 370mm		
For models:	GB704G, GB707G, GB92G, GB94G, GL12C4G, GL12C9G, GL74G, GL78G, NGL74G, NGL78G, OPLG40, OPLG80, PLG40, PLG80		





			
1			
GEV No.	211029	Ref. No.	1829522 MA1829522
description	lava rock grid L 464mm W 310mm		
For models:	GB704G, GB707G, GB92G, GB94G, OPLG40, OPLG80, PLG40, PLG80		

			
1			
GEV No.	211030	Ref. No.	CM207900 MACM207900
description	lava rock grid L 465mm W 325mm		
For models:	GL12C4G, GL12C9G, GL74G, GL78G, NGL74G, NGL78G		

			
1			
GEV No.	211031	Ref. No.	CM209400 MACM209400
description	lava rock grid L 630mm W 325mm stainless steel		
For models:	GL94G, GL98G		

chargrill grids

			
1			
GEV No.	210257	Ref. No.	1041301200 MA1041301200
description	chargrill grid L 500mm W 330mm		
For models:	GB704G, GB707G, GB92G, GB94G, OPLG40, OPLG80, PLG40, PLG80		

			
1			
GEV No.	210258	Ref. No.	1041301900 MA1041301900
description	chargrill grid L 500mm W 370mm		
For models:	GB704G, GB707G, GB92G, GB94G, GL12C4G, GL12C9G, GL74G, GL78G, NGL74G, NGL78G, OPLG40, OPLG80, PLG40, PLG80		

lava rock grids

			
1			
GEV No.	211029	Ref. No.	1829522 MA1829522
description	lava rock grid L 464mm W 310mm		
For models:	GB704G, GB707G, GB92G, GB94G, OPLG40, OPLG80, PLG40, PLG80		

			
1			
GEV No.	211030	Ref. No.	CM207900 MACM207900
description	lava rock grid L 465mm W 325mm		
For models:	GL12C4G, GL12C9G, GL74G, GL78G, NGL74G, NGL78G		

			
1			
GEV No.	211031	Ref. No.	CM209400 MACM209400
description	lava rock grid L 630mm W 325mm stainless steel		
For models:	GL94G, GL98G		

tube burners

			
1			
GEV No.	105517	Ref. No.	1450000 MA1450000
description	tubular burner L 295mm W 59mm H 55mm for fryer oval		
For models:	FR74G, FR77G, FR92G13, FR92G22, FR92G22T, FR94G13, FR94G22, FR94G22T, FR94G23		

			
1			
GEV No.	105518	Ref. No.	CM011401 MACM011401
description	tubular burner L 310mm W 49mm H 73mm for fryer oval		
For models:	EF74G15, F12C4G15, F74G10, F74G15, F74G6, F76G10, F78G15, F94G10, F94G15, F94G22, F94G22K, F94G6, F96G10, F98G15, F98G22, F98G22K, F954G15, F954G22, F954G22K, F958G15, F958G22, F958G22K, NF74G15T, NF78G15T		



1

GEV No.	104241	Ref. No.	1032001200 1032001212 MA1032001212
description	tubular burner ø 67mm L 165mm H 44mm mounting pos. left round for fryer		
For models:	FQG40, FQG60		



1

GEV No.	104242	Ref. No.	1032001300
description	tubular burner ø 67mm L 165mm H 44mm mounting pos. right round for fryer		
For models:	FQG40, FQG60		

solid top burners



1

GEV No.	105485	Ref. No.	CM002900 MACM002900
description	solid top burner ø 65mm H 102mm L 284mm		
For models:	ET78G8G, ET7FG8G, NS78GS, NS7FG8GS, NT78G, NT7FG12G, NT7FG8G, S78GD, S78GS, S7FG8GD, S7FG8GS, T78G, T7FG12G, T7FG8G, T98G, T9FG12G, T9FG8G		

forced air burners



1

GEV No.	104309	Ref. No.	R63140020
description	gasket L 106mm W 100mm H 3mm 4 holes		
For models:	GMT20D, GVT20D, MACG10M, MACG20M, MG101D, MG101M, MG101P, MG101T, MG102D, MG102M, MG102P, MG102T, MG201D, MG201M, MG201P, MG201T, MG202D, MG202M, MG202P, MG202T, MGMT10D, MGMT10P, MGMT20D, MGMT20P, MGMT21D, MGMT21P, MGMT40D, MGMT40P, MGVT10D, MGVT10P, MGVT20D, MGVT20P, MGVT21D, MGVT21P, MGVT40D, MGVT40P		



1

GEV No.	104314	Ref. No.	R63140060
description	gasket L 108mm W 103mm H 3mm 6 holes		
For models:	GMT20D, GVT20D, MACG10M, MACG20M		



1

GEV No.	108149	Ref. No.	R63120020 R63120030 R63120040
description	venturi for combi-steamer LAINOX		
For models:	GMT06D, GMT20D, GVT06D, GVT20D, MACG05M, MACG07M, MACG20M, MG061D, MG061M, MG061P, MG061T, MG102D, MG102M, MG102P, MG102T, MG201D, MG201M, MG201P, MG201T, MG202D, MG202M, MG202P, MG202T, MGMT06D, MGMT06P, MGMT20D, MGMT20P, MGMT21D, MGMT21P, MGMT40D, MGMT40P, MGVT06D, MGVT06P, MGVT20D, MGVT20P, MGVT21D, MGVT21P, MGVT40D, MGVT40P, MVG051P		

accessories

gaskets



1

GEV No.	510254	Ref. No.	R63140000
description	gasket L 77mm W 70mm H 3mm hole ø 7mm hole distance 55x60mm graphite for gas burner		
For models:	GMT06D, GVT06D, MACG05M, MACG07M, MG061D, MG061M, MG061P, MG061T, MGMT06D, MGMT06P, MGVT06D, MGVT06P, MVG051P		

nozzle holders



1







GEV No.	105230	Ref. No.	1033717200 MA1033717200
description	nozzle holder		
For models:	C74GS, C78GS, C79G, C7FE12GS, C7FE8GS, C7FG12GS, C7FG8GS, C7FG9G, CFG70, CFG70M, CFGE61, CFGE61D, CFGE61L, CFGE61P, EC74G8G, EC78G8G, EC7FG8G, OCFGE61, OPCG41, OPCG61, PCG41, PCG41L, PCG61, PCG61L		
accessories for	105230		
	GEV No.	103140	Ref. No.
			1032101400 1032101422 CRO795730 MA1032101400
	burner head seat ø 75mm for burner cap ø 85mm 3.5kW		









Table continues overleaf



accessories for 105230				
	GEV No.	103141	Ref. No.	1032101500
burner head ø 95mm suitable for burner 5.5kW				
	GEV No.	103146	Ref. No.	1032101200 MA1032101200
burner lower part for burner cap ø 85mm 3.5kW				
	GEV No.	103147	Ref. No.	1032101300 MA1032101300
burner lower part for burner cap ø 95mm 5.5/7kW				
	GEV No.	107143	Ref. No.	CM297300 MACM297300
burner head for burner cap ø 95mm 5.5kW				

				
1				
GEV No.	105052	Ref. No.	1306400 1306600 1306615 MA1306615	
description	nozzle holder ID ø 10mm nozzle mounting M10x1			
For models:	B9SB2G, B9SB4G, B9V2G, B9V4G, C7011G, C7011GFE, C7011GFG, C704G, C707G, C707GFE, C707GFG, C9F4E, C9F4G, C9F4GS, C9F6E, C9F6G, C9F6GS, C9F8G, C9F8GS, C9FP, C9FP4GS, C9FP6GS, C9FP8GS, C9SB4GS, C9V2G, C9V2GS, C9V4G, C9V4GS, C9V6G, C9V6GS, C9V8G, C9V8GS, CFG101, CFG101D, CFG101L, CFG101P, CFG120, CFG70, CFG70D, CFG70L, CFG70M, CFG70P, EC74GVG, EC78GVG, EC7FG8G, FB1GS, FB2GS, FB3GS, FP1GS, FT74G...(Other models you can see in the webshop)			
accessories for 105052				
	GEV No.	100469	Ref. No.	521611 MA521611
gas injector thread M10x1 WS 12 bore ø 1.15mm				
	GEV No.	100478	Ref. No.	522811 MA522811
gas injector thread M10x1 WS 12 bore ø 1.75mm				
	GEV No.	103150	Ref. No.	1315812 1892500 MA1892500
burner lower part for burner cap ø 110/120mm				
	GEV No.	104030	Ref. No.	1315412 1315422 MA1315422
burner head for burner cap ø 80mm				
	GEV No.	104031	Ref. No.	1315512 1315522 MA1315522
burner head for burner cap ø 110mm				
	GEV No.	104032	Ref. No.	1315912 1315922 MA1315922
burner head for burner cap ø 120mm				
	GEV No.	104033	Ref. No.	1315200
burner lower part for burner cap ø 80mm 1. generation				
	GEV No.	104034	Ref. No.	1315300 1315312 MA1315300
burner lower part for burner cap ø 110mm				

accessories for 105052				
	GEV No.	105051	Ref. No.	1314700 MA1314700
air mixing sleeve L 45mm ED ø 45mm ID ø 42mm aluminium				

				
1				
GEV No.	105267	Ref. No.	1781800 MA1781800	
description	nozzle holder nozzle M10x1 M14x1 screw pipe fitting M16x1.5 tube ø 10mm			
For models:	C124G, C129G, C12C2G9, C12C9G, C12FG9G, C7011G, C7011GFE, C7011GFG, C704G, C707G, C707GFE, C707GFG, C712G, C74G, C78G, C7FE12G, C7FE8G, C7FG12G, C7FG8G, C7FGM12G, C912G, C912GS, C94G, C94GP, C94GS, C98G, C98GP, C98GS, C9F4GS, C9F6GS, C9F8GS, C9FE12G, C9FE12GS, C9FE4GS, C9FE6GS, C9FE8G, C9FE8GS, C9FEP4GS, C9FEP6GS, C9FEP8GS, C9FG12G, C9FG12GS, C9FG16G, C9FG8G, C9FG8GP, C9FG8GS, C9FGM12G, C9FP4GS, C9FP6GS, C9FP8GS...(Other models you can see in the webshop)			
accessories for 105267				
	GEV No.	105051	Ref. No.	1314700 MA1314700
air mixing sleeve L 45mm ED ø 45mm ID ø 42mm aluminium				
	GEV No.	105265	Ref. No.	CM006001 MACM006001
burner head for burner cap ø 80mm				
	GEV No.	105266	Ref. No.	CM042900 MACM042900
burner lower part for burner cap ø 80mm				
	GEV No.	105269	Ref. No.	CM005901 MACM005901
burner head ø 158mm for burner cap ø 110mm				
	GEV No.	105272	Ref. No.	CM043000 MACM043000
burner lower part for burner cap ø 110mm				
	GEV No.	105274	Ref. No.	CM006502 MACM006502
burner head for burner cap ø 120mm				
	GEV No.	105275	Ref. No.	CM043100 MACM043100
burner lower part for burner cap ø 120mm				

				
1				
GEV No.	106599	Ref. No.	CR0508630	
description	nozzle holder nozzle M10x1 M14x1 screw pipe fitting M16x1.5 tube ø 10mm			
For models:	EF74G8VA, EF74G8VG, FQG41, FQG61, NF74G10, NF74G15, NF74G8, NF76G10, NF76G8, NF78G15, NF94G15, NF94G23, NF94G23K, NF96G10, NF98G15, NF98G23, NF98G23K, NPD76G5, NPD78G8, NPD96G5, NPI76G5, NPI78G8, NPI96G5, OFQG41, OFQG61			



			
1			
GEV No.	106600	Ref. No.	CM021700 MACM021700
description	nozzle holder nozzle M10x1 M14x1 screw pipe fitting M16x1.5 tube ø 10mm		
For models:	B74G, B78G, B94G, B98G, BF78G, BF912G, BF912GH, BF98G, BMG40, BMG60, BR78GF, BR78GI, BRG40, BRG40G, C12FGP9G, C7FG12G, C7FG8G, C7FG9G, C7FGM12G, C9FG12G, C9FG16G, C9FG8G, C9FG8GP, C9FGM12G, EPC74G, F74G6, F94G6, FQG40, FQG60, FT-129GLC, FT129GM, FT12C9GL, FT12C9GM, FT12C9GTL, FT12C9GTM, FT74GL, FT74GLC, FT74GR, FT74GRC, FT76GL, FT76GLC, FT76GM, FT76GMC, FT76GR, FT78GL, FT78GLC, FT78GLT, FT78GM, FT78GMC, FT78GMT...(Other models you can see in the webshop)		

			
1			
GEV No.	106601	Ref. No.	1031504900 MA1031504900
description	nozzle holder nozzle M10x1 M14x1 screw pipe fitting M16x1.5 tube ø 10mm		
For models:	EFT74GLVG, EFT74GRVG, EFT78GLVG, EFT78GMVG		

miscellaneous

			
1			
GEV No.	107689	Ref. No.	1207400 MA1207400
description	flame spreader		
For models:	FB1GS, FP1GS, MM10IG, NT98G, NT9FG12G, NT9FG8G, P910G, P915G, P91A10G, PD707G, PI707G, T129G, T7011GFG, T707G, T707GFG, T78G, T7FG12G, T7FG8G, T98G, T9F4G, T9F6GS, T9FE4G, T9FG12G, T9FG8G, T9FP4G, T9SB4G, T9V4G, T9V6GS, T9VP4G		

			
1			
GEV No.	109078	Ref. No.	1033600 MA1033600
description	level glass for burner		
For models:	B9SB2G, B9SB4G, B9V2G, B9V4G, B9VP4G, BRG40, BRG40G, CP704G, CP92G, CP94G, CP9SB2G, CP9SB4G, EF74G8VA, EF74G8VG, ET78GVG, ET7FG8G, FC10G, FC20G, FC5G, FC7G, FQG41, FQG61, FT12G7L70, FT12G7LC70, FT12G7R70, FT12G7RC70, FT12G7RL70, FT12G7RLC70, FT14G8L90, FT14G8LC90, FT14G8R2L90, FT14G8R2LC90, FT14G8R90, FT14G8RC90, FT6G4L70, FT6G4LC70, FT6G4R70, FT6G4RC70, FT7G4L90, FT7G4LC90, FT7G4R90, FT7G4RC90, NF74G10, NF74G15, NF74G8, NF76G10, NF76G8, NF78G15, NF94G15, NF94G23...(Other models you can see in the webshop)		

			
1			
GEV No.	103151	Ref. No.	1893300 MA1893300
description	reducer suitable for burner head ø110mm		
For models:	C7011G, C7011GFE, C7011GFG, C704G, C707G, C707GFE, C707GFG, C9F4GS, C9F6GS, C9F8GS, C9FE4GS, C9FE6GS, C9FE8GS, C9FEP4GS, C9FEP6GS, C9FEP8GS, C9FP4GS, C9FP6GS, C9FP8GS, C9V2GS, C9V4GS, C9V6GS, C9V8GS, C9VP2GS, C9VP4GS, C9VP6GS, C9VP8GS, FB1GS, FB2GS, FB3GS, T7011GFG, T9F6GS, T9V6GS		
accessories for	103151		
			
GEV No.	103021	Ref. No.	1315700 1315712 MA1315712
description	burner cap ø 110mm		
			
GEV No.	103150	Ref. No.	1315812 1892500 MA1892500
description	burner lower part for burner cap ø 110/120mm		
			
GEV No.	104031	Ref. No.	1315512 1315522 MA1315522
description	burner head for burner cap ø 110mm		
			
GEV No.	105051	Ref. No.	1314700 MA1314700
description	air mixing sleeve L 45mm ED ø 45mm ID ø 42mm aluminium		
			
GEV No.	105052	Ref. No.	1306400 1306600 1306615 MA1306615
description	nozzle holder ID ø 10mm nozzle mounting M10x1		

gas nozzles

main nozzles

gas nozzles M6x0.75

			
1			
GEV No.	106591	Ref. No.	1033718900 MA1033718900
description	gas injector thread M6x0.75 WS 7 bore ø 1.15mm		
For models:	C74GS, C78GS, C7FE12GS, C7FE8GS, C7FG12GS, C7FG8GS, C7FG9G, CFG101, CFG70, CFG70M, CFGE61, CFGE61D, CFGE61L, CFGE61P, EC74GVG, EC78GVG, EC7FG8G, OCFG101, OCFG70, OCFG61, OPCG41, OPCG61, PCG41, PCG41L, PCG61, PCG61L		

			
1			
GEV No.	106483	Ref. No.	1033718300 MA1033718300
description	gas injector thread M6x0.75 WS 7 bore ø 1.35mm		
For models:	C74GS, C78GS, C7FE12GS, C7FE8GS, C7FG12GS, C7FG8GS, CFG101, CFG70, CFG70M, CFGE61, CFGE61D, CFGE61L, CFGE61P, EC74GVG, EC78GVG, EC7FG8G, OCFG101, OCFG70, OCFG61, OPCG41, OPCG61, PCG41, PCG41L, PCG61, PCG61L		





			
1			
GEV No.	106590	Ref. No.	1033718500 MA1033718500
description	gas injector thread M6x0.75 WS 7 bore ø 0.8mm		
For models:	C74GS, C78GS, C7FE12GS, C7FE8GS, C7FG12GS, C7FG8GS, CFG101, CFG70, CFG70M, CFGE61, CFGE61D, CFGE61L, CFGE61P, EC74GVG, EC78GVG, EC7FG8G, OCFG101, OCFG70, OCFG61, OPG41, OPG61, PCG41, PCG41L, PCG61, PCG61L		

			
1			
GEV No.	106589	Ref. No.	1033719000 MA1033719000
description	gas injector thread M6x0.75 WS 7 bore ø 1.9mm		
For models:	C74GS, C78GS, C79G, C7FE12GS, C7FE8GS, C7FG12GS, C7FG8GS, C7FG9G, CFG101, CFG70, CFG70M, CFGE61, CFGE61D, CFGE61L, CFGE61P, EC74GVG, EC78GVG, EC7FG8G, OCFG101, OCFG70, OCFG61, OPG41, OPG61, PCG41, PCG41L, PCG61, PCG61L		

			
1			
GEV No.	106588	Ref. No.	1033718600 MA1033718600
description	gas injector thread M6x0.75 WS 7 bore ø 0.9mm		
For models:	C74GS, C78GS, C79G, C7FE12GS, C7FE8GS, C7FG12GS, C7FG8GS, C7FG9G, CFG101, CFG70, CFG70M, CFGE61, CFGE61D, CFGE61L, CFGE61P, EC74GVG, EC78GVG, EC7FG8G, OCFG101, OCFG70, OCFG61, OPG41, OPG61, PCG41, PCG41L, PCG61, PCG61L		

gas nozzles M10x1			
			
1			
GEV No.	106595	Ref. No.	CR0508730
description	gas injector thread M10x1 bore ø 0.83mm L 30mm WS 12		
For models:	EF74G8VA, EF74G8VG, FQG41, FQG61, NF74G8, NF76G8, OFQG41, OFQG61		

			
1			
GEV No.	106592	Ref. No.	1033719100 MA1033719100
description	gas injector thread M6x0.75 WS 7 bore ø 1mm		
For models:	C74GS, C78GS, C7FE12GS, C7FE8GS, C7FG12GS, C7FG8GS, C7FG9G, CFG101, CFG70, CFG70M, CFGE61, CFGE61D, CFGE61L, CFGE61P, EC74GVG, EC78GVG, EC7FG8G, OCFG101, OCFG70, OCFG61, OPG41, OPG61, PCG41, PCG41L, PCG61, PCG61L		

			
1			
GEV No.	100150	Ref. No.	1491100 MA1491100
description	gas injector thread M10x1 bore ø 0.95mm L 30mm WS 12		
For models:	BR94G, BR94GI, BR96G, BR96GI, BR9M4G, BR9M4GI, BR9M6G, BR9M6GI, EF74G8VA, EF74G8VG, FQG41, FQG61, FT14G8L90, FT14G8LC90, FT14G8R2L90, FT14G8R2LC90, FT14G8R90, FT14G8RC90, FT7G4L90, FT7G4LC90, FT7G4R90, FT7G4RC90, NF74G8, NF76G8, OFQG41, OFQG61		

			
1			
GEV No.	106593	Ref. No.	1033718400 MA1033718400
description	gas injector thread M6x0.75 WS 7 bore ø 1.5mm		
For models:	C74GS, C78GS, C79G, C7FE12GS, C7FE8GS, C7FG12GS, C7FG8GS, C7FG9G, CFG101, CFG70, CFG70M, CFGE61, CFGE61D, CFGE61L, CFGE61P, EC74GVG, EC78GVG, EC7FG8G, OCFG101, OCFG70, OCFG61, OPG41, OPG61, PCG41, PCG41L, PCG61, PCG61L		

			
1			
GEV No.	100670	Ref. No.	1695400 MA1695400
description	gas injector thread M10x1 bore ø 0.9mm L 30mm WS 12		
For models:	BIG40, BIG60, BR707G, BR707GI, BR94G, BR94GI, BR9M4G, BR9M4GI, BR9M6G, BR9M6GI, BR9SB4G, BR9SB4GI, EF74G8VA, EF74G8VG, FQG41, FQG61, FT12G7L70, FT12G7LC70, FT12G7R70, FT12G7RC70, FT12G7RL70, FT12G7RLC70, FT6G4L70, FT6G4LC70, FT6G4R70, FT6G4RC70, FT74G, FT74GR, FT77G, FT77GRL, FTG40B, FTG40BLC, FTG40BR, FTG60B, FTG60BLC, FTG60BR, FTG60BRR, FTG80B, FTG80BLC, FTG80BR, MS10AG, MS10IG, MS70AG, MS70IG, MS70IGS, NF74G8, NF76G8, OFQG41, OFQG61		

			
1			
GEV No.	106594	Ref. No.	1033718700 MA1033718700
description	gas injector thread M6x0.75 WS 7 bore ø 1.75mm		
For models:	C74GS, C78GS, C79G, C7FE12GS, C7FE8GS, C7FG12GS, C7FG8GS, C7FG9G, CFG101, CFG70, CFG70M, CFGE61, CFGE61D, CFGE61L, CFGE61P, EC74GVG, EC78GVG, EC7FG8G, OCFG101, OCFG70, OCFG61, OPG41, OPG61, PCG41, PCG41L, PCG61, PCG61L		

			
1			
GEV No.	100671	Ref. No.	1513000 MA1513000
description	gas injector thread M10x1 bore ø 1.25mm L 30mm WS 12		
For models:	B74G, B78G, B94G, B98G, BF78G, BF912G, BF912GH, BF98G, C7FG12G, C7FG8G, C9FG12G, C9FG16G, C9FG8G, C9FG8GP, C9FGM12G, CP704G, CP92G, CP94G, CS10, CS6, CSM10G, CSM10GP, CSM6G, CSM6GP, FQG40, FQG60, FT12C9GL, FT12C9GM, FT12C9GTLC, FT12C9GTMC, FT74GL, FT74GLC, FT74GR, FT74GRC, FT76GL, FT76GLC, FT76GM, FT76GMC, FT76GR, FT78GL, FT78GLC, FT78GLT, FT78GM, FT78GMC, FT78GMT, FT78GR, FT78GRT, FT94G, FT94GL, FT94GLC... (Other models you can see in the webshop)		



GEV No.	101974	Ref. No.	2715400 MA2715400
description	gas injector thread M10x1 bore ø 1.35mm L 30mm WS 12		
For models:	BMG40, BMG60, CP92G, CP94G, CP95B2G, CP95B4G, EF74G8VA, EF74G8VG, FQG40, FQG41, FQG60, FQG61, FT12G7L70, FT12G7LC70, FT12G7R70, FT12G7RC70, FT12G7RL70, FT12G7RLC70, FT6G4L70, FT6G4LC70, FT6G4R70, FT6G4RC70, FT74GL, FT74GLC, FT74GR, FT74GRC, FT76GL, FT76GLC, FT76GM, FT76GMC, FT76GR, FT78GL, FT78GLC, FT78GLT, FT78GM, FT78GMC, FT78GMT, FT78GR, FT78GRT, FT94G, FT94GL, FT94GLC, FT94GR, FT94GRC, FT96GL, FT96GLC, FT96GM, FT96GMC, FT96GR, FT98GL...(Other models you can see in the webshop)		



GEV No.	100816	Ref. No.	2715300 MA2715300
description	gas injector thread M10x1 bore ø 1.5mm WS 12		
For models:	B74G, B78G, B94G, B98G, BIG40, BIG60, BMG40, BMG60, ET78GVG, ET78G8G, FC10G, FC5G, FQG41, FQG61, FT12G7L70, FT12G7LC70, FT12G7R70, FT12G7RC70, FT12G7RL70, FT12G7RLC70, FT6G4L70, FT6G4LC70, FT6G4R70, FT6G4RC70, FT74G, FT74GL, FT74GLC, FT74GR, FT74GRC, FT76GL, FT76GLC, FT76GM, FT76GMC, FT76GR, FT77G, FT77GRL, FT78GL, FT78GLC, FT78GLT, FT78GM, FT78GMC, FT78GMT, FT94GL, FT94GLC, FT94GR, FT94GRC, FT96GL, FT96GLC, FT96GM, FT96GMC...(Other models you can see in the webshop)		



GEV No.	100156	Ref. No.	1421700 MA1421700
description	gas injector thread M10x1 bore ø 1.3mm L 30mm WS 12		
For models:	B74G, B78G, B94G, B98G, C7FG9G, CS10, CS6, ET78GVG, ET78G8G, FT74GL, FT74GLC, FT74GR, FT74GRC, FT76GL, FT76GLC, FT76GM, FT76GMC, FT76GR, FT78GL, FT78GLC, FT78GLT, FT78GM, FT78GMC, FT78GMT, FT94GL, FT94GLC, FT94GR, FT94GRC, FT96GL, FT96GLC, FT96GM, FT96GMC, FT96GR, FT98GL, FT98GLC, FT98GLT, FT98GM, FT98GMC, FT98GMT, FT98GR, FT98GRT, GL12C4G, GL12C9G, GL74G, GL78G, GL94G, GL98G, MM10DG, MM10DG5, MM10IG...(Other models you can see in the webshop)		



GEV No.	100151	Ref. No.	1631300 MA1631300
description	gas injector thread M10x1 bore ø 1.65mm L 30mm WS 12		
For models:	BR78GF, BR78GI, FT129GLC, FT129GM, FT74GL, FT74GLC, FT74GR, FT74GRC, FT76GL, FT76GLC, FT76GM, FT76GMC, FT76GR, FT78GL, FT78GLC, FT78GLT, FT78GM, FT78GMC, FT78GMT, FT94GL, FT94GLC, FT94GR, FT94GRC, FT96GL, FT96GLC, FT96GM, FT96GMC, FT96GR, FT98GL, FT98GLC, FT98GLT, FT98GM, FT98GMC, FT98GMT, FT98GR, FT98GRT, NBR78GF, NBR78GI, NF94G23, NF98G23, NPC74G, NPC76G, NPC78G, NPC94G, NPC96G, NPC98G, PC12C9G, PC74G, PC76G, PC78G...(Other models you can see in the webshop)		



GEV No.	100155	Ref. No.	2902500 MA2902500
description	gas injector thread M10x1 bore ø 1.45mm L 30mm WS 12		
For models:	BF78G, BF912G, BF912GH, BF98G, BMG40, BMG60, C7FG12G, C7FG8G, C7FG9G, C9FG12G, C9FG16G, C9FG8G, C9FG8GP, C9FGM12G, CON10G, CON10GP, CS10, CS6, CSM10G, CSM10GP, EF74G8VA, EF74G8VG, EPC74G, FQG41, FQG61, FT129GLC, FT129GM, FT14G8L90, FT14G8LC90, FT14G8R2L90, FT14G8R2LC90, FT14G8R90, FT14G8RC90, FT74GL, FT74GLC, FT74GR, FT74GRC, FT76GL, FT76GLC, FT76GM, FT76GMC, FT76GR, FT78GL, FT78GLC, FT78GLT, FT78GM, FT78GMC, FT78GMT, FT7G4L90, FT7G4LC90...(Other models you can see in the webshop)		



GEV No.	100153	Ref. No.	1631200 MA1631200
description	gas injector thread M10x1 bore ø 1.6mm L 30mm WS 12		
For models:	BF78G, BF912G, BF912GH, BF98G, BMG40, BMG60, BRG40, BRG40G, C7FG12G, C7FG8G, C7FGM12G, C9FG12G, C9FG16G, C9FG8G, C9FG8GP, C9FGM12G, CS10, CS6, EF74G8VA, EF74G8VG, FQG41, FQG61, FT14G8L90, FT14G8LC90, FT14G8R2L90, FT14G8R2LC90, FT14G8R90, FT14G8RC90, FT7G4L90, FT7G4LC90, FT7G4R90, FT7G4RC90, NC7FGM12G, NF74G10, NF74G8, NF76G10, NF76G8, NF94G23K, NF96G10, NF98G23K, NPD76G5, NPD96G5, NPI76G5, NPI96G5, OFQG41, OFQG61, PC12C4G, PC74G, PC76G, PC78G...(Other models you can see in the webshop)		





GEV No.	100675	Ref. No.	1630700 MA1630700
description	gas injector thread M10x1 bore ø 1.4mm L 30mm WS 12		
For models:	BF78G, BF912G, BF912GH, BF98G, BIG40, BIG60, BR707G, BR707GI, C7FG12G, C7FG8G, C7FGM12G, C9FG12G, C9FG16G, C9FG8G, C9FG8GP, C9FGM12G, CON6G, CON6GP, CP92G, CP94G, CS10, CS6, CSM10G, CSM10GP, CSM6G, CSM6GP, ET78GVG, ET78G8G, PC12C4G, PC74G, PC76G, PC78G, PC94G, PC96G, PC98G, PC954G, PC956G, PC958G, PD76G5, PD96G5, PD98G10, PD98G15, PD98G15A, PD958G10, PI76G5, PI96G5, PI98G10, PI98G14, PI98G14A, T7FG12G...(Other models you can see in the webshop)		





GEV No.	106403	Ref. No.	707200 MA707200
description	gas injector thread M10x1 bore ø 1.9mm L 30mm WS 12		
For models:	B74G, B78G, B94G, B98G, BR78GF, BR78GI, CON202G, CON202GP, CP704G, CP707G, CSM202G, CSM202GP, FT12C9GL, FT12C9GM, FT12C9GTLC, FT12C9GTMTC, FT74GL, FT74GLC, FT74GR, FT74GRC, FT76GL, FT76GLC, FT76GM, FT76GMC, FT76GR, FT78GL, FT78GLC, FT78GLT, FT78GM, FT78GMC, FT78GMT, FT78GR, FT78GRT, FT94G, FT94GL, FT94GLC, FT94GR, FT94GRC, FT96GL, FT96GLC, FT96GM, FT96GMC, FT96GR, FT98GL, FT98GLC, FT98GLT, FT98GM, FT98GMC, FT98GMT, FT98GR...(Other models you can see in the webshop)		





			
1			
GEV No.	106401	Ref. No.	795800 MA795800
description	gas injector thread M10x1 bore ø 2.2mm L 30mm WS 12		
For models:	BMG40, BMG60, CS10, CS6, CSM10G, CSM10GP, FT74GL, FT74GLC, FT74GR, FT74GRC, FT76GL, FT76GLC, FT76GM, FT76GMC, FT76GR, FT78GL, FT78GLC, FT78GLT, FT78GM, FT78GMC, FT78GMT, FT78GR, FT78GRT, FT94G, FT94GL, FT94GLC, FT94GR, FT94GRC, FT96GL, FT96GLC, FT96GM, FT96GMC, FT96GR, FT98GL, FT98GLC, FT98GLT, FT98GM, FT98GMC, FT98GMT, FT98GR, FT98GRT, GL12C4G, GL12C9G, GL74G, GL78G, MM10DG, MM10DGS, MM10IG, MM15DG, NF74G15... (Other models you can see in the webshop)		

			
2			
GEV No.	100157	Ref. No.	MA795900
description	gas injector thread M10x1 bore ø 2.4mm L 30mm WS 12		

			
1			
GEV No.	106408	Ref. No.	1695300 MA1695300
description	gas injector thread M10x1 bore ø 3mm L 30mm WS 12		
For models:	BR707G, BR78GF, BR78GI, CP92G, CP94G, FT74G, FT74GR, FT77G, FT77GRL, NBR78GF, NBR78GI, P9D2G, PD98G10, PD98G15, PD98G15A, PD9S8G10		

			
1			
GEV No.	100464	Ref. No.	520811
description	gas injector thread M10x1 WS 12 bore ø 0.75mm		
For models:	B9SB2G, B9SB4G, B9V2G, B9V4G, BM74G, BM77G, BMG40, BMG60, FQG40, FQG60		

			
1			
GEV No.	100444	Ref. No.	520911 MA520911
description	gas injector thread M10x1 WS 12 bore ø 0.8mm		
For models:	702BMG, 706, 706S, BMG40, BMG60, C7011G, C7011GFE, C7011GFG, C704G, C707G, C707GFE, C707GFG, C712G, C74G, C78G, C7FE12G, C7FE8G, C7FG12G, C7FG8G, C7FGM12G, C912G, C912GS, C94G, C94GP, C94GS, C98G, C98GP, C98GS, C9F4G, C9F4GS, C9F6G, C9F6GS, C9F8G, C9F8GS, C9FE12G, C9FE12GS, C9FE4GS, C9FE6GS, C9FE8G, C9FE8GS, C9FEP4GS, C9FEP6GS, C9FEP8GS, C9FG12G, C9FG12GS, C9FG16G, C9FG8G, C9FG8GP, C9FG8GS, C9FGM12G...(Other models you can see in the webshop)		

			
1			
GEV No.	100466	Ref. No.	521211 MA521211
description	gas injector thread M10x1 WS 12 bore ø 0.95mm		
For models:	704S, 706S, BMG40, BMG60, C7011G, C7011GFE, C7011GFG, C704G, C707G, C707GFE, C707GFG, C712G, C74G, C78G, C7FE12G, C7FE8G, C7FG12G, C7FG8G, C7FGM12G, C912G, C912GS, C94G, C94GP, C94GS, C98G, C98GP, C98GS, C9F4G, C9F4GS, C9F6G, C9F6GS, C9F8G, C9F8GS, C9FE12G, C9FE12GS, C9FE4GS, C9FE6GS, C9FE8G, C9FE8GS, C9FEP4GS, C9FEP6GS, C9FEP8GS, C9FG12G, C9FG12GS, C9FG16G, C9FG8G, C9FG8GP, C9FG8GS, C9FGM12G, C9FP4GS...(Other models you can see in the webshop)		

			
1			
GEV No.	100442	Ref. No.	521411 MA521411
description	gas injector thread M10x1 WS 12 bore ø 1.05mm		
For models:	704, 704S, 706, 706AS, 706S, BRG40, BRG40G, C7011G, C7011GFE, C7011GFG, C704G, C707G, C707GFE, C707GFG, C9F4G, C9F4GS, C9F6G, C9F6GS, C9F8G, C9F8GS, C9SB4GS, C9V2G, C9V2GS, C9V4G, C9V4GS, C9V6G, C9V6GS, C9V8G, C9V8GS, F74G6, F94G6, FR74G, FR77G, FR92G13, FR92G22, FR92G22T, FR94G13, FR94G22, FR94G22T, FR94G23, NC712G36, NC74G12, NC78G24, NC7FE12G36, NC7FE8G24, NC7FG12G44, NC7FG8G32, NC7FGM12G, NC912G44, NC94G16...(Other models you can see in the webshop)		

			
1			
GEV No.	100469	Ref. No.	521611 MA521611
description	gas injector thread M10x1 WS 12 bore ø 1.15mm		
For models:	B9SB2G, B9SB4G, B9V2G, B9V4G, B9VP4G, C7011G, C7011GFE, C7011GFG, C704G, C707G, C707GFE, C707GFG, C9F4E, C9F4G, C9F4GS, C9F6E, C9F6G, C9F6GS, C9F8G, C9F8GS, C9FP, C9FP4GS, C9FP6GS, C9FP8GS, C9SB4GS, C9V2G, C9V2GS, C9V4G, C9V4GS, C9V6G, C9V6GS, C9V8G, C9V8GS, CFG101, CFG101D, CFG101L, CFG101P, CFG120, CFG70, CFG70D, CFG70L, CFG70M, CFG70P, EC74GVG, EC78GVG, EC7FG8G, EFT74GLVG, EFT74GRVG, EFT78GLVG, EFT78GMVG...(Other models you can see in the webshop)		

			
1			
GEV No.	100468	Ref. No.	521511 MA521511
description	gas injector thread M10x1 WS 12 bore ø 1.1mm		
For models:	C124G, C129G, C12FG9G, C7011G, C7011GFE, C7011GFG, C704G, C707G, C707GFE, C707GFG, C712G, C74G, C78G, C7FE12G, C7FE8G, C7FG12G, C7FG8G, C7FGM12G, C912G, C912GS, C94G, C94GP, C94GS, C98G, C98GP, C98GS, C9F4GS, C9F6GS, C9F8GS, C9FE12G, C9FE12GS, C9FE4GS, C9FE6GS, C9FE8G, C9FE8GS, C9FEP4GS, C9FEP6GS, C9FEP8GS, C9FG12G, C9FG12GS, C9FG16G, C9FG8G, C9FG8GP, C9FG8GS, C9FGM12G, C9FP4GS, C9FP6GS, C9FP8GS, C9V2GS, C9V4GS...(Other models you can see in the webshop)		



1

GEV No.	106754	Ref. No.	521811 MA521811
description	gas injector thread M10x1 WS 12 bore ø 1.25mm		
For models:	C124G, C129G, C12C2G9, C12C9G, C12FG9G, C712G, C74G, C78G, C7FE12G, C7FE8G, C7FG12G, C7FG8G, C7FGM12G, C912G, C912GS, C94G, C94GP, C94GS, C98G, C98GP, C98GS, C9FE12G, C9FE12GS, C9FE8G, C9FE8GS, C9FG12G, C9FG12GS, C9FG16G, C9FG8G, C9FG8GP, C9FG8GS, C9FGM12G		



1

GEV No.	102721	Ref. No.	521911 MA521911
description	gas injector thread M10x1 WS 12 bore ø 1.3mm		
For models:	B9SB2G, B9SB4G, B9V2G, B9V4G, B9VP4G, BM74G, BM77G, C7011G, C7011GFE, C7011GFG, C704G, C707G, C707GFE, C707GFG, C712G, C74G, C78G, C7FE12G, C7FE8G, C7FG12G, C7FG8G, C7FGM12G, C912G, C912GS, C94G, C94GP, C94GS, C98G, C98GP, C98GS, C9F4E, C9F4G, C9F4GS, C9F6E, C9F6G, C9F6GS, C9F8G, C9F8GS, C9FE12G, C9FE12GS, C9FE4GS, C9FE6GS, C9FE8G, C9FE8GS, C9FEP4GS, C9FEP6GS, C9FEP8GS, C9FG12G, C9FG12GS, C9FG16G...(Other models you can see in the webshop)		



1

GEV No.	100472	Ref. No.	0100931 522111 MA522111 R0100931 SIR0100931
description	gas injector thread M10x1 WS 12 bore ø 1.4mm		
For models:	702BMG, 706, 706S, B9SB2G, B9SB4G, B9V2G, B9V4G, BM74G, BM77G, C7011G, C7011GFE, C7011GFG, C704G, C707G, C707GFE, C707GFG, C712G, C74G, C78G, C7FE12G, C7FE8G, C7FG12G, C7FG8G, C7FGM12G, C912G, C912GS, C94G, C94GP, C94GS, C98G, C98GP, C98GS, C9F4GS, C9F6G, C9F6GS, C9F8GS, C9FE12G, C9FE12GS, C9FE4GS, C9FE6GS, C9FE8G, C9FE8GS, C9FEP4GS, C9FEP6GS, C9FEP8GS, C9FG12G, C9FG12GS, C9FG16G, C9FG8G, C9FG8GP...(Other models you can see in the webshop)		



1

GEV No.	100478	Ref. No.	522811 MA522811
description	gas injector thread M10x1 WS 12 bore ø 1.75mm		
For models:	C7011G, C7011GFE, C7011GFG, C704G, C707G, C707GFE, C707GFG, C9F4GS, C9F6GS, C9F8GS, C9FE4GS, C9FE6GS, C9FE8GS, C9FEP4GS, C9FEP6GS, C9FEP8GS, C9FP4GS, C9FP6GS, C9FP8GS, C9V2GS, C9V4GS, C9V6GS, C9V8GS, C9VP2GS, C9VP4GS, C9VP6GS, C9VP8GS, CFG101, CFG101D, CFG101L, CFG101P, CFG120, CFG70, CFG70D, CFG70L, CFG70M, CFG70P, EC74GVG, EC78GVG, EC7FG8G, F12C4G15, F74G10, F74G15, F76G10, F78G15, F94G10, F94G15, F94G22, F94G22K, F96G10...(Other models you can see in the webshop)		



1

GEV No.	100482	Ref. No.	523211 CR0586770
description	gas injector thread M10x1 WS 12 bore ø 1.95mm		
For models:	BR912GFM, BR912GIM, BR98GF, BR98GFM, BR98GI, BR98GIM, BR9S8GF, BR9S8GI, C7011G, C7011GFE, C7011GFG, C704G, C707G, C707GFE, C707GFG, C9F4G, C9F4GS, C9F6G, C9F6GS, C9F8G, C9F8GS, C9FE4GS, C9FE6GS, C9FE8GS, C9FEP4GS, C9FEP6GS, C9FEP8GS, C9FP4GS, C9FP6GS, C9FP8GS, C9SB4GS, C9V2G, C9V2GS, C9V4G, C9V4GS, C9V6G, C9V6GS, C9V8G, C9V8GS, C9VP2GS, C9VP4GS, C9VP6GS, C9VP8GS, CFG101, CFG101D, CFG101L, CFG101P, CFG120, CFG70, CFG70D...(Other models you can see in the webshop)		



1

GEV No.	100484	Ref. No.	523411 MA523411
description	gas injector thread M10x1 WS 12 bore ø 2.05mm		
For models:	F12C4G15, F74G15, F74G6, F78G15, F94G15, F94G6, F98G15, F9S4G15, F9S8G15, GB704G, GB707G, GB92G, GB94G, NF74G15T, NF78G15T, NG74G, NG78G, OPLG40, OPLG80, PLG40, PLG80		



1

GEV No.	100486	Ref. No.	523811 MA523811
description	gas injector thread M10x1 WS 12 bore ø 2.25mm		
For models:	B9SB2G, B9SB4G, B9V2G, B9V4G, B9VP4G, C7011G, C7011GFE, C7011GFG, C704G, C707G, C707GFE, C707GFG, C9F4E, C9F4GS, C9F6E, C9F6GS, C9F8GS, C9FE4GS, C9FE6GS, C9FE8GS, C9FEP4GS, C9FEP6GS, C9FEP8GS, C9FP, C9FP4GS, C9FP6GS, C9FP8GS, C9V2GS, C9V4GS, C9V6GS, C9V8GS, C9VP2GS, C9VP4GS, C9VP6GS, C9VP8GS, CFG120, FB1GS, FP1GS, GB707G, NBR912GFM, NBR912GIM, NBR98GF, NBR98GFM, NBR98GI, NBR98GIM, OCFG120, PCG42, PCG82, T7011GFG, T9F4G...(Other models you can see in the webshop)		





1

GEV No.	100485	Ref. No.	523711 MA523711
description	gas injector thread M10x1 WS 12 bore ø 2.2mm		
For models:	BR912GFM, BR912GIM, BR98GF, BR98GFM, BR98GI, BR98GIM, BR9S8GF, BR9S8GI, GB704G, GB707G, GB92G, GB94G, NFT74GL, NFT74GR, NFT76GL, NFT76GM, NFT76GR, NFT78GL, NFT78GM, NFT78GR, NFT94GL, NFT94GR, NFT96GL, NFT96GM, NFT98GL, NFT98GM, NFT98GR, NG74G, NG78G, OPLG40, OPLG80, PLG40, PLG80, T7011GFG, T707G, T707GFG		



			
1			
GEV No.	100487	Ref. No.	524111 MA524111
description	gas injector thread M10x1 WS 12 bore ø 2.4mm		
For models:	C124G, C129G, C12FG9G, C712G, C74G, C78G, C7FE12G, C7FE8G, C7FG12G, C7FG8G, C7FGM12G, C912G, C912GS, C94G, C94GP, C94GS, C98G, C98GP, C98GS, C9FE12G, C9FE12GS, C9FE8G, C9FE8GS, C9FG12G, C9FG12GS, C9FG16G, C9FG8G, C9FG8GP, C9FG8GS, C9FGM12G, MM10IG, NC712G36, NC74G12, NC78G24, NC7FE12G36, NC7FE8G24, NC7FG12G44, NC7FG8G32, NC7FGM12G, NC912G44, NC94G16, NC94G20, NC98G28, NC98G40, NC9FE12G44, NC9FE8G28, NC9FG12G52, NC9FG16G72, NC9FG8G32, NC9FG8G36...(Other models you can see in the webshop)		

			
1			
GEV No.	100491	Ref. No.	525211
description	gas injector thread M10x1 WS 12 bore ø 3mm		
For models:	C7011G, C7011GFE, C7011GFG, C704G, C707G, C707GFE, C707GFG, C9F4G, C9F4GS, C9F6G, C9F6GS, C9F8G, C9F8GS, C9SB4GS, C9V2G, C9V2GS, C9V4G, C9V4GS, C9V6G, C9V6GS, C9V8G, C9V8GS, PD707G, PI707G, T9F4G, T9F6GS, T9SB4G, T9V4G, T9V6GS		

			
1			
GEV No.	103234	Ref. No.	1630800 MA1630800
description	nozzle thread M10x1 WS 12 bore ø 1.5mm		
For models:	BR707G, BR707GI, BR94G, BR94GI, BR9M4G, BR9M4GI, BR9M6G, BR9M6GI, BR9SB4G, BR9SB4GI, C12FGP9G, EPC74G, FC20G, MS10AG, MS10IG, MS70AG, MS70IG, MS70IGS, NC7FGM12G, NF94G23, NF98G23, NPC74G, NPC78G, NPD98G10, NPD98G15, NPD98G15A, NPI98G10, NPI98G14, NPI98G14A, PD98G10, PD98G15, PD98G15A, PD9S8G10, T12FGP9G		

pilot burner nozzles

pilot burner nozzles JUNKERS

CB 5050_ series

			
1			
GEV No.	100230	Ref. No.	932900 MA932900
description	pilot burner nozzle LPG gas pressure 50mbar code 2 Qty 1 pcs suitable for JUNKERS CB5050_		
For models:	704, 704S, 706, 706AS, 706S, BIG40, BIG60, BMG40, BMG60, BR707G, BR94G, BR94GI, BR96G, BR96GI, BR9M4G, BR9M4GI, BR9M6G, BR9M6GI, BRG40, BRG40G, CP707G, CP92G, CP94G, CS10, CS102G, CS102GP, CS6, FQG40, FQG60, FR15G, FR15G2, FR2G, FR2G15, FR4G, FR4G15, FR74G, FR77G, FR92G22, FR94G23, FT74G, FT74GR, FT77G, FT77GRL, FTG40B, FTG40BLC, FTG40BR, FTG60B, FTG60BLC, FTG60BR, FTG60BRR...(Other models you can see in the webshop)		

pilot burner nozzles SIT

100 series

			
1			
GEV No.	100245	Ref. No.	1415100 3020054 MA1415100
description	pilot burner nozzle LPG code 20 bore ø 0.2mm Qty 1 pcs thread M8x0.75		
For models:	B9SB2G, B9SB4G, B9V2G, B9V4G, C7011G, C7011GFE, C7011GFG, C704G, C707G, C707GFE, C707GFG, C9F4G, C9F4GS, C9F6G, C9F6GS, C9F8G, C9F8GS, C9SB4GS, C9V2G, C9V2GS, C9V4G, C9V4GS, C9V6G, C9V6GS, C9V8G, C9V8GS, EF74G15, F12C4G15, F74G10, F74G15, F76G10, F78G15, F94G10, F94G15, F94G22, F94G22K, F96G10, F98G15, F98G22, F98G22K, F9S4G15, F9S4G22, F9S4G22K, F9S8G15, F9S8G22, F9S8G22K, F9SB2G, F9SB2GR, F9SB4G, F9SB4GR...(Other models you can see in the webshop)		

			
1			
GEV No.	100246	Ref. No.	1422600 MA1422600
description	pilot burner nozzle natural gas bore ø 0.35mm Qty 1 pcs thread M8x0.75		
For models:	B9SB2G, B9SB4G, B9V2G, B9V4G, C7011G, C7011GFE, C7011GFG, C704G, C707G, C707GFE, C707GFG, C9F4G, C9F4GS, C9F6G, C9F6GS, C9F8G, C9F8GS, C9SB4GS, C9V2G, C9V2GS, C9V4G, C9V4GS, C9V6G, C9V6GS, C9V8G, C9V8GS, F9SB2G, F9SB2GR, F9SB4G, F9SB4GR, F9SB4GRL, F9V2G, F9V2GR, F9V4G, F9V4GR, F9V4GRL, P9D10G, P9D15G, P9DA10G, P9DA15G, P9I10G, P9IA10G, T7011GFG, T707G, T707GFG, T9F4G, T9F6GS, T9SB4G, T9V4G, T9V6GS		

			
1			
GEV No.	102972	Ref. No.	1996200 CR0684580 MA1996200
description	pilot burner nozzle natural gas code 40 bore ø 0.4mm Qty 1 pcs		
For models:	EF74G15, F12C4G15, F74G10, F74G15, F76G10, F78G15, F94G10, F94G15, F94G22, F94G22K, F96G10, F98G15, F98G22, F98G22K, F9S4G15, F9S4G22, F9S4G22K, F9S8G15, F9S8G22, F9S8G22K, NF74G15T, NF78G15T, NG74G, NG78G, NG94G, NG98G		

			
1			
GEV No.	107171	Ref. No.	1031502100 1842300 MA1031502100 MA1842300
description	pilot burner nozzle SIT natural/liquid gas bore ø 0.25mm Qty 1 pcs		
For models:	EF74G15, F12C4G15, F74G10, F74G15, F76G10, F78G15, F94G10, F94G15, F94G22, F94G22K, F96G10, F98G15, F98G22, F98G22K, F9S4G15, F9S4G22, F9S4G22K, F9S8G15, F9S8G22, F9S8G22K, FR74G, FR77G, FR92G13, FR92G22, FR92G22T, FR94G13, FR94G22, FR94G22T, NF74G15T, NF78G15T, NG74G, NG78G, NG94G, NG98G		



140/150 series



GEV No.	100204	Ref. No.	1888000 MA1888000
description	pilot burner nozzle SIT LPG code 14 bore ø 0.18/0.20mm Qty 1 pcs suitable for 140 series		
For models:	B9SB2G, B9SB4G, B9V2G, B9V4G, B9VP4G, BM74G, BM77G, BR707G, BR707GI, BR78GF, BR78GI, BR912GFM, BR912GIM, BR94G, BR94GI, BR98GF, BR98GFM, BR98GI, BR98GIM, BR9M4G, BR9M4GI, BR9M6G, BR9M6GI, BR9S8GF, BR9S8GI, BR9S84G, BR9S84GI, C124G, C129G, C12C2G9, C12C9G, C12FG9G, C7011G, C7011GFE, C7011GFG, C704G, C707G, C707GFE, C707GFG, C712G, C74G, C78G, C7FE12G, C7FE8G, C7FG12G, C7FG8G, C7FG9G, C7FGM12G, C912G, C912GS...(Other models you can see in the webshop)		



GEV No.	100205	Ref. No.	1033722000 BN822140380 MA1033722000
description	pilot burner nozzle SIT LPG code 19 bore ø 0.23/0.26mm Qty 1 pcs suitable for SIT 150 series		
For models:	EFT74GLVG, EFT74GRVG, EFT78GLVG, EFT78GMVG		



GEV No.	100207	Ref. No.	1887800 MA1887800
description	pilot burner nozzle SIT natural gas code 27 bore ø 0.40/0.38mm suitable for SIT 140 series		
For models:	B74G, B78G, B94G, B98G, B9SB2G, B9SB4G, B9V2G, B9V4G, B9VP4G, BM74G, BM77G, BR707G, BR707GI, BR78GF, BR78GI, BR912GFM, BR912GIM, BR94G, BR94GI, BR98GF, BR98GFM, BR98GI, BR98GIM, BR9M4G, BR9M4GI, BR9M6G, BR9M6GI, BR9S8GF, BR9S8GI, BR9S84G, BR9S84GI, C124G, C129G, C12C2G9, C12C9G, C12FG9G, C7011G, C7011GFE, C7011GFG, C704G, C707G, C707GFE, C707GFG, C712G, C74G, C78G, C7FE12G, C7FE8G, C7FG12G, C7FG8G...(Other models you can see in the webshop)		



GEV No.	103288	Ref. No.	1887900 MA1887900
description	pilot burner nozzle SIT natural gas code 50 bore ø 0.50mm suitable for 140 series		
For models:	B74G, B78G, B94G, B98G, C124G, C129G, C12C2G9, C12C9G, C12FG9G, C7011G, C7011GFE, C7011GFG, C704G, C707G, C707GFE, C707GFG, C712G, C74G, C78G, C7FE12G, C7FE8G, C7FG12G, C7FG8G, C7FGM12G, C912G, C912GS, C94G, C94GP, C94GS, C98G, C98GP, C98GS, C9F4E, C9F4GS, C9F6E, C9F6GS, C9F8GS, C9FE12G, C9FE12GS, C9FE4GS, C9FE6GS, C9FE8G, C9FE8GS, C9FG12G, C9FG12GS, C9FG16G, C9FG8G, C9FG8GP, C9FG8GS, C9FGM12G...(Other models you can see in the webshop)		

160 series



GEV No.	107649	Ref. No.	1033719600 MA1033719600
description	pilot burner nozzle SIT LPG code 20 Qty 1 pcs		
For models:	BF78G, BF912G, BF912GH, BF98G, C74GS, C78GS, C79G, C7FE12GS, C7FE8GS, C7FG12G, C7FG12GS, C7FG8G, C7FG8GS, C7FG9G, C7FGM12G, C9FG12G, C9FG16G, C9FG8G, C9FG8GP, C9FGM12G, CFG101, CFG70, CFG70M, CFGE61, CFGE61D, CFGE61L, CFGE61P, EC74GVG, EC78GVG, EC7FG8G, EF74G8VA, EF74G8VB, FQG41, FQG61, FT12C9GL, FT12C9GM, FT12C9GTLC, FT12C9GTMC, FT74GL, FT74GR, FT76GL, FT76GLC, FT76GM, FT76GMC, FT78GL, FT78GLC, FT78GLT, FT78GM, FT78GMC, FT78GMT...(Other models you can see in the webshop)		



GEV No.	107172	Ref. No.	1874700 MA1874700
description	pilot burner nozzle SIT LPG code 25 Qty 1 pcs		
For models:	BF78G, BF912G, BF912GH, BF98G, C12FGP9G, C7FG12G, C7FG8G, C7FG9G, C7FGM12G, C9FG12G, C9FG16G, C9FG8G, C9FG8GP, C9FGM12G, EF74G8VA, EF74G8VB, EPC74G, FQG41, FQG61, MM10IG, NC7FG12G44, NC7FG8G32, NC7FG8G36, NC7FG8G48, NC7FGM12G, NC9FG12G52, NC9FG16G72, NC9FG8G32, NC9FG8G36, NC9FG8G48, NF74G10, NF74G15, NF74G8, NF76G10, NF76G8, NF78G15, NF94G15, NF94G23, NF94G23K, NF96G10, NF98G15, NF98G23, NF98G23K, NPC74G, NPC78G, NPC94G, NPC98G, NPD76G5, NPD78G8, NPD96G5...(Other models you can see in the webshop)		



GEV No.	107650	Ref. No.	0100802 CR0410100 R0100802 SIR0100802
description	pilot burner nozzle SIT LPG code 30 Qty 1 pcs		
For models:	C12FGP9G, EF74G8VA, EF74G8VB, EPC74G, NC712G36, NC74G12, NC78G24, NC7FE12G36, NC7FE8G24, NC7FG12G44, NC7FG8G32, NC7FGM12G, NC912G44, NC94G16, NC94G20, NC98G28, NC98G40, NC9FE12G44, NC9FE8G28, NC9FG12G52, NC9FG16G72, NC9FG8G32, NC9FG8G36, NC9FG8G48, NC9FGM12G, NF74G10, NF74G15, NF74G8, NF76G10, NF76G8, NF78G15, NF94G15, NF94G23, NF94G23K, NF96G10, NF98G15, NF98G23, NPC74G, NPC78G, NPC94G, NPC98G, NPD98G10, NPD98G15, NPD98G15A, NPI98G10, NPI98G14, NPI98G14A, NS78GS, NS7FG12GS...(Other models you can see in the webshop)		





			
1			
GEV No.	107174	Ref. No.	1033719700 MA1033719700
description	pilot burner nozzle SIT natural gas code 41 Qty 1 pcs		
For models:	BF78G, BF912G, BF912GH, BF98G, C12FGP9G, C74GS, C78GS, C79G, C7FE12GS, C7FE8GS, C7FG12G, C7FG12GS, C7FG8G, C7FG8GS, C7FG9G, C7FGM12G, C9FG12G, C9FG16G, C9FG8G, C9FG8GP, C9FGM12G, C9FG101, C9FG70, C9FG70M, C9FE61, C9FE61D, C9FE61L, C9FE61P, EC74GVG, EC78GVG, EC7FG8G, EF74G8VA, EF74G8VG, EPC74G, FQG41, FQG61, NC7FG12G44, NC7FG8G32, NC7FG8G36, NC7FG8G48, NC7FGM12G, NC9FG12G52, NC9FG16G72, NC9FG8G32, NC9FG8G36, NC9FG8G48, NF74G10, NF74G15, NF74G8, NF76G10... (Other models you can see in the webshop)		

			
1			
GEV No.	107175	Ref. No.	1874400 MA1874400
description	pilot burner nozzle SIT natural gas code 51 Qty 1 pcs suitable for 160 series		
For models:	MM10IG, P9I10G, P9IA10G		

bypass nozzles

bypass nozzles PEL20/21

			
1			
GEV No.	100550	Ref. No.	1033720000 MA1033720000
description	bypass nozzle type PEL20/21 bore ø 0.55mm thread M5x0.5		
For models:	C7011G, C7011GFE, C7011GFG, C704G, C707G, C707GFE, C707GFG, C712G, C74G, C74GS, C78G, C78GS, C79G, C7FE12G, C7FE12GS, C7FE8G, C7FE8GS, C7FG12G, C7FG12GS, C7FG8G, C7FG8GS, C7FG9G, C7FGM12G, C912G, C912GS, C94G, C94GP, C94GS, C98G, C98GP, C98GS, C9F4GS, C9F6GS, C9F8GS, C9FE12G, C9FE12GS, C9FE4GS, C9FE6GS, C9FE8G, C9FE8GS, C9FEP4GS, C9FEP6GS, C9FEP8GS, C9FG12G, C9FG12GS, C9FG16G, C9FG8G, C9FG8GP, C9FG8GS, C9FGM12G... (Other models you can see in the webshop)		

			
1			
GEV No.	100548	Ref. No.	CR0586840
description	bypass nozzle type PEL20/21 bore ø 0.65mm thread M5x0.5		
For models:	NC712G36, NC74G12, NC78G24, NC7FE12G36, NC7FE8G24, NC94G20, NC98G28, NC98G40, NC9FE12G44, NC9FE8G28, NC9FG12G52, NC9FG16G72, NC9FG8G32, NC9FG8G36, NC9FG8G48, NC9FGM12G, NS78GS, NS7FG12GS, NT7FG12G, NT9FG12G		

			
1			
GEV No.	100552	Ref. No.	0102067 1884200 MA1884200 R0102067 SIR0102067
description	bypass nozzle type PEL20/21 bore ø 0.7mm thread M5x0.5		
For models:	C7011G, C7011GFE, C7011GFG, C704G, C707G, C707GFE, C707GFG, C712G, C74G, C74GS, C78G, C78GS, C7FE12G, C7FE12GS, C7FE8G, C7FE8GS, C7FG12G, C7FG12GS, C7FG8G, C7FG8GS, C7FGM12G, C912G, C912GS, C94G, C94GP, C94GS, C98G, C98GP, C98GS, C9F4GS, C9F6GS, C9F8GS, C9FE12G, C9FE12GS, C9FE4GS, C9FE6GS, C9FE8G, C9FE8GS, C9FEP4GS, C9FEP6GS, C9FEP8GS, C9FG12G, C9FG12GS, C9FG16G, C9FG8G, C9FG8GP, C9FG8GS, C9FGM12G, C9FP4GS, C9FP6GS... (Other models you can see in the webshop)		

			
1			
GEV No.	100528	Ref. No.	1033720200 1889000 MA1033720200 MA1889000
description	bypass nozzle type PEL20/21 bore ø 0.9mm thread M5x0.5		
For models:	C7011G, C7011GFE, C7011GFG, C704G, C707G, C707GFE, C707GFG, C712G, C74G, C74GS, C78G, C78GS, C79G, C7FE12G, C7FE12GS, C7FE8G, C7FE8GS, C7FG12G, C7FG12GS, C7FG8G, C7FG8GS, C7FG9G, C7FGM12G, C912G, C912GS, C94G, C94GP, C94GS, C98G, C98GP, C98GS, C9F4GS, C9F6GS, C9F8GS, C9FE12G, C9FE12GS, C9FE4GS, C9FE6GS, C9FE8G, C9FE8GS, C9FEP4GS, C9FEP6GS, C9FEP8GS, C9FG12G, C9FG12GS, C9FG16G, C9FG8G, C9FG8GP, C9FG8GS, C9FGM12G... (Other models you can see in the webshop)		

			
1			
GEV No.	100534	Ref. No.	1883400 MA1883400
description	bypass nozzle type PEL20/21 bore ø 1.4mm thread M5x0.5		
For models:	FT74GL, FT74GLC, FT74GR, FT74GRC, FT76GL, FT76GLC, FT76GM, FT76GMC, FT76GR, FT78GL, FT78GLC, FT78GLT, FT78GM, FT78GMC, FT78GMT, FT78GR, FT78GRT, FT94G, FT94GL, FT94GLC, FT94GR, FT94GRC, FT96GL, FT96GLC, FT96GM, FT96GMC, FT96GR, FT98GL, FT98GLC, FT98GLT, FT98GM, FT98GMC, FT98GMT, FT98GR, FT98GRT, GB704G, GB707G, GB92G, GB94G, NS78GS, NS7FG8GS, OPLG40, OPLG80, PLG40, PLG80, S78GD, S78GS, S7FG8GD, S7FG8GS		

			
1			
GEV No.	100529	Ref. No.	1889100 MA1889100
description	bypass nozzle type PEL20/21 bore ø 1mm thread M5x0.5		
For models:	BIG40, BIG60, C7011G, C7011GFE, C7011GFG, C704G, C707G, C707GFE, C707GFG, C712G, C74G, C74GS, C78G, C7FE12G, C7FE8G, C7FG12G, C7FG8G, C7FGM12G, C912G, C912GS, C94G, C94GP, C94GS, C98G, C98GP, C98GS, C9F4GS, C9F6GS, C9F8GS, C9FE12G, C9FE12GS, C9FE4GS, C9FE6GS, C9FE8G, C9FE8GS, C9FEP4GS, C9FEP6GS, C9FEP8GS, C9FG12G, C9FG12GS, C9FG16G, C9FG8G, C9FG8GP, C9FG8GS, C9FGM12G, C9FP4GS, C9FP6GS, C9FP8GS, C9V2GS, C9V4GS, C9V6GS... (Other models you can see in the webshop)		



			
1			
GEV No.	106871	Ref. No.	CR0586570
description	bypass nozzle type PEL20/21 bore ø 2.2mm thread M5x0.5		
For models:	NFT74GL, NFT74GR, NFT76GL, NFT76GM, NFT76GR, NFT78GL, NFT78GM, NFT78GR, NFT94GL, NFT94GR, NFT96GL, NFT96GM, NFT98GL, NFT98GM, NFT98GR		

bypass nozzles PEL22

			
1			
GEV No.	100429	Ref. No.	1033720600 MA1033720600
description	bypass nozzle type PEL22 bore ø 0.7mm thread M6x0.5		
For models:	BRG40, BRG40G		

			
1			
GEV No.	100435	Ref. No.	1884100 MA1884100
description	bypass nozzle type PEL22 bore ø 1.05mm thread M6x0.5		
For models:	B74G, B78G, B94G, B98G, BRG40, BRG40G, C124G, C129G, C12FG9G, CP704G, CP92G, CP94G, CP95B2G, CP95B4G, ET78GVG, ET7FG8G, FB1GS, FP1GS, NB74G, NB78G, NB94G, NB98G, NG74G, NG78G, NG94G, NG98G, NT78G, NT7FG12G, NT7FG8G, PC12C4G, PC12C9G, PC74G, PC76G, PC78G, PC94G, PC96G, PC98G, PC9S4G, PC9S6G, PC9S8G, PD76G5, PD96G5, T129G, T7011GFG, T707G, T707GFG, T78G, T7FG12G, T7FG8G, T98G...(Other models you can see in the webshop)		

bypass nozzles PEL23/24

			
1			
GEV No.	103235	Ref. No.	1954900 MA1954900
description	bypass nozzle type PEL23/24 bore ø 1.4mm thread M8x0.5		
For models:	MM10DG, MM10DGS, MM15DG, P9D10G, P9D15G, P9DA10G, P9DA15G, P9DASB10G, P9DSB10G, PD98G10, PD98G15, PD98G15A, PD9S8G10, PDASB10G, PI98G10, PI98G14, PI98G14A		

			
1			
GEV No.	100265	Ref. No.	1883800 MA1883800
description	bypass nozzle type PEL23/24 bore ø 1.8mm thread M8x0.5		
For models:	CP704G, CP92G, CP94G, ET78GVG, ET7FG8G, FP1GS, NG74G, NG78G, NG94G, NG98G, NT78G, NT7FG12G, NT7FG8G, NT98G, NT9FG12G, NT9FG8G, P9D5G, PC12C4G, PC12C9G, PC74G, PC76G, PC78G, PC94G, PC96G, PC98G, PC9S4G, PC9S6G, PC9S8G, PD707G, PD76G5, PD96G5, T129G, T7011GFG, T707G, T707GFG, T78G, T7FG12G, T7FG8G, T98G, T9F4G, T9F6G5, T9FE4G, T9FG12G, T9FG8G, T9FP4G, T9SB4G, T9V4G, T9V6G5, T9VP4G		

bypass nozzles SABAF



			
1			
GEV No.	106586	Ref. No.	1885000 MA1885000
description	bypass nozzle bore ø 0.5mm thread M4x0.5 SABAF		
For models:	C7011GFG, C707GFG, CFG101, CFG101D, CFG101L, CFG101P, CFG120, CFG70, CFG70D, CFG70L, CFG70M, CFG70P, EC74GVG, EC78GVG, EC7FG8G, OCFG101, OCFG120, OCFG70, T7011GFG, T707GFG		

			
1			
GEV No.	106587	Ref. No.	1885600 MA1885600
description	bypass nozzle bore ø 0.8mm thread M4x0.5 SABAF		
For models:	C7011GFG, C707GFG, CFG101, CFG101D, CFG101L, CFG101P, CFG120, CFG70, CFG70D, CFG70L, CFG70M, CFG70P, EC74GVG, EC78GVG, EC7FG8G, OCFG101, OCFG120, OCFG70, T7011GFG, T707GFG		

auxiliary gas parts

screw connections

olives

			
1			
GEV No.	101249	Ref. No.	673400 MA673400
description	olive for pipe ø 10mm Qty 1 pcs		
For models:	704S, 706S, BM74G, BM77G, BRG40, BRG40G, C124G, C129G, C12C2G9, C12C9G, C12FG9G, C7011G, C7011GFE, C7011GFG, C704G, C707G, C707GFE, C707GFG, C712G, C74G, C78G, C7FE12G, C7FE8G, C7FG12G, C7FG8G, C7FGM12G, C912G, C912GS, C94G, C94GP, C94GS, C98G, C98GP, C98GS, C9F4G, C9F4GS, C9F6G, C9F6GS, C9F8G, C9F8GS, C9FE12G, C9FE12GS, C9FE8G, C9FE8GS, C9FG12G, C9FG12GS, C9FG16G, C9FG8G, C9FG8GP, C9FG8GS...(Other models you can see in the webshop)		
accessories for	101249		
	GEV No.	101250	Ref. No.
			673200 MA673200
	union nut thread M20x1.5 for pipe ø 10mm		









			
1			
GEV No.	101278	Ref. No.	867-20 MA86720
description	olive for pipe ø 10mm Qty 1 pcs		
For models:	704S, 706S, B74G, B78G, B94G, B98G, B9SB2G, B9SB4G, B9V2G, B9V4G, BF78G, BF912G, BF912GH, BF98G, BIG40, BIG60, BMG40, BMG60, BR707G, BR707GI, BR78GF, BR78GI, BRG40, BRG40G, C124G, C129G, C12C2G9, C12C9G, C12FG9G, C12FGP9G, C7011G, C7011GFE, C7011GFG, C704G, C707G, C707GFE, C707GFG, C712G, C74G, C74GS, C78G, C78GS, C79G, C7FE12G, C7FE12GS, C7FE8G, C7FE8GS, C7FG12G, C7FG12GS, C7FG8G...(Other models you can see in the webshop)		
accessories for	101278		
	GEV No.	100943	Ref. No.
			—
	union nut thread M17x1 tube ø 10mm		



Table continues overleaf





accessories for 101278				
	GEV No.	101300	Ref. No.	1326500 MA1326500
union nut thread M16x1.5 tube ø 10mm				
	GEV No.	101478	Ref. No.	1665200 MA1665200
union nut thread 3/8" for pipe ø 10mm				



				
GEV No.	101273	Ref. No.	0100842 417810 MA417810 R0100842 SIR0100842	
description olive for pipe ø 12mm L 9.5mm brass Qty 1 pcs suitable for universal				
For models: 704, 704S, 706, 706AS, 706S, B9SB2G, B9SB4G, B9V2G, B9V4G, B9VP4G, BF78G, BF912G, BF912GH, BF98G, BM74G, BM77G, BR707G, BR707GI, BR78GF, BR78GI, BRG40, BRG40G, C12FGP9G, C7FG12G, C7FG8G, C7FGM12G, C9F4G, C9F4GS, C9F6G, C9F6GS, C9F8G, C9F8GS, C9FG12G, C9FG16G, C9FG8G, C9FG8GP, C9FGM12G, C9FP4GS, C9FP6GS, C9FP8GS, C9SB4GS, C9V2G, C9V2GS, C9V4G, C9V4GS, C9V6G, C9V6GS, C9V8G, C9V8GS, CP92G...(Other models you can see in the webshop)				
accessories for 101273				
	GEV No.	100944	Ref. No.	—
union nut thread M18x1.5 for pipe ø 12mm				
	GEV No.	101276	Ref. No.	459300 MA459300
union screw thread 3/8" tube ø 12mm Qty 1 pcs				

				
GEV No.	101248	Ref. No.	673300 MA673300	
description olive for pipe ø 12mm Qty 1 pcs suitable for PEL				
For models: 704S, 706S, C124G, C129G, C12C2G9, C12C9G, C12FG9G, C712G, C74G, C78G, C7FE12G, C7FE8G, C7FG12G, C7FG8G, C7FGM12G, C912G, C912GS, C94G, C94GP, C94GS, C98G, C98GP, C98GS, C9F4G, C9F4GS, C9F6G, C9F6GS, C9F8G, C9F8GS, C9FE12G, C9FE12GS, C9FE8G, C9FE8GS, C9FG12G, C9FG12GS, C9FG16G, C9FG8G, C9FG8GP, C9FG8GS, C9FGM12G, C9SB4GS, C9V2G, C9V2GS, C9V4G, C9V4GS, C9V6G, C9V6GS, C9V8G, C9V8GS, CP704G...(Other models you can see in the webshop)				
accessories for 101248				
	GEV No.	101251	Ref. No.	673100 MA673100
union nut thread M20x1.5 for pipe ø 12mm				



				
GEV No.	101256	Ref. No.	1127400 MA1127400	
description olive for pipe ø 16mm Qty 1 pcs				
For models: BR707G, BR912GFM, BR912GIM, BR94G, BR94GI, BR98GF, BR98GFM, BR98GI, BR98GIM, BR9M4G, BR9M4GI, BR9M6G, BR9M6GI, BR9S8GF, BR9S8GI, BR9SB4G, BR9SB4GI, C9FEP4GS, C9FEP6GS, C9FEP8GS, C9FP4GS, C9FP6GS, C9FP8GS, C9VP4GS, C9VP6GS, C9VP8GS, CON10G, CON10GP, CON201G, CON201GP, CON202G, CON202GP, CON6G, CON6GP, CP707G, CP92E, CP92G, CP94E, CP94G, CS10, CS102G, CS102GP, CS6, CSM10G, CSM10GP, CSM201G, CSM201GP, CSM202G, CSM202GP, CSM6G...(Other models you can see in the webshop)				
accessories for 101256				
	GEV No.	101253	Ref. No.	1421000 MA1421000
union nut thread M24x1.5 PEL for pipe ø 16mm				



				
GEV No.	106598	Ref. No.	866200 MA866200	
description olive for pipe ø 18mm Qty 1 pcs ED ø 21mm				
For models: B9SB2E, B9SB2G, B9SB4E, B9SB4G, B9V2E, B9V2G, B9V4E, B9V4G, B9VP2E, B9VP4E, B9VP4G, BF78G, BF912G, BF912GH, BF98G, BM74E, BM74G, BM77E, BM77G, BME40DM, BME40DMB, BME40M, BME60, BME60D, BME60DM, BME60DMB, BME60M, BME80M, BMG40, BMG60, BV712, BV74, BV76, BV78, BV912, BV94, BV96, BV98, C12FGP9G, C7FG12G, C7FG8G, C7FGM12G, C9FG12G, C9FG16G, C9FG8G, C9FG8GP, C9FGM12G, CPE40, CPE402, CPE60...(Other models you can see in the webshop)				

				
GEV No.	101257	Ref. No.	1347000 MA1347000	
description olive for pipe ø 20mm Qty 1 pcs				
For models: MM10DG, MM10DGS, MM15DG, P9D10G, P9D15G, P9DA10G, P9DA15G, P9DASB10G, P9DSB10G, PD98G10, PD98G15, PD98G15A, PD9S8G10, PDASB10G, PI98G10, PI98G14, PI98G14A, T9F4G, T9F6GS, T9SB4G, T9V4G, T9V6GS				
accessories for 101257				
	GEV No.	101254	Ref. No.	1346900 MA1346900
union nut thread M28x1.5 tube ø 20mm				

				
GEV No.	101254	Ref. No.	1346900 MA1346900	
description olive for pipe ø 20mm Qty 1 pcs				
For models: MM10DG, MM10DGS, MM15DG, P9D10G, P9D15G, P9DA10G, P9DA15G, P9DASB10G, P9DSB10G, PD98G10, PD98G15, PD98G15A, PD9S8G10, PDASB10G, PI98G10, PI98G14, PI98G14A, T9F4G, T9F6GS, T9SB4G, T9V4G, T9V6GS				
accessories for 101257				
	GEV No.	101254	Ref. No.	1346900 MA1346900
union nut thread M28x1.5 tube ø 20mm				



			
1			
GEV No.	101282	Ref. No.	469000 MA469000
description	olive for pipe ø 4mm L 7.4mm Qty 1 pcs		
For models:	704S, 706S, BIG40, BIG60, BMG40, BMG60, BRG40, BRG40G, CP707G, CP92G, CP94G, FQG40, FQG60, FT74G, FT74GR, FT77G, FT77GRL, FTG40B, FTG40BLC, FTG40BR, FTG60B, FTG60BLC, FTG60BR, FTG-60BRR, FTG80B, FTG80BLC, FTG80BR, GB707G, P9D2G, PD707G, PI707G, TPF706S		
accessories for	101282		
	GEV No.	100908	Ref. No. 0100777 673500 MA673500 R0100777 SIR0100777
union screw thread M10x1 for pipe ø 4mm Qty 1 pcs			
	GEV No.	101283	Ref. No. 468800 MA468800
union screw thread M10x1 for pipe ø 4mm Qty 1 pcs			

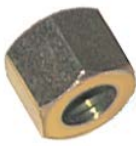

			
1			
GEV No.	101246	Ref. No.	673600 MA673600
description	olive for pipe ø 4mm Qty 1 pcs		
For models:	704S, 706S, B74G, B78G, B94G, B98G, B9SB2G, B9SB4G, B9V2G, B9V4G, BF78G, BF912G, BF912GH, BF98G, BIG40, BIG60, BR78GF, BR78GI, BR912GFM, BR912GIM, BR94G, BR94GI, BR98GF, BR98GFM, BR98GI, BR98GIM, BR9M4G, BR9M4GI, BR9M6G, BR9M6GI, BR9S8GF, BR9S8GI, BR9SB4G, BR9SB4GI, BRG40, BRG40G, C124G, C129G, C12C2G9, C12C9G, C12FG9G, C12FGP9G, C7011G, C7011GFE, C7011GFG, C704G, C707G, C707GFE, C707GFG, C712G...(Other models you can see in the webshop)		
accessories for	101246		
	GEV No.	100908	Ref. No. 0100777 673500 MA673500 R0100777 SIR0100777
union screw thread M10x1 for pipe ø 4mm Qty 1 pcs			

			
1			
GEV No.	100897	Ref. No.	1881000 1888100 MA1888100
description	olive for pipe ø 4mm Qty 1 pcs for pilot burner		
For models:	B9SB2G, B9SB4G, B9V2G, B9V4G, B9VP4G, BM74G, BM77G, BR707G, BR707GI, BR78GF, BR78GI, BR94G, BR94GI, BR9M4G, BR9M4GI, BR9M6G, BR9M6GI, BR9SB4G, BR9SB4GI, C124G, C129G, C12C2G9, C12C9G, C12FG9G, C7011G, C7011GFE, C7011GFG, C704G, C707G, C707GFE, C707GFG, C712G, C74G, C74GS, C78G, C78GS, C79G, C7FE12G, C7FE12GS, C7FE8G, C7FE8GS, C7FG12G, C7FG12GS, C7FG8G, C7FG8GS, C7FG9G, C7FGM12G, C912G, C912GS, C94G...(Other models you can see in the webshop)		

union nuts			
			
1			
GEV No.	101478	Ref. No.	1665200 MA1665200
description	union nut thread 3/8" for pipe ø 10mm		
For models:	C7011GFG, C707GFG, CFG101, CFG101D, CFG101L, CFG101P, CFG120, CFG70, CFG70D, CFG70L, CFG70P, EC74GVG, EC78GVG, EC7FG8G, OCFG101, OCFG120, OCFG70, T7011GFG, T707GFG		

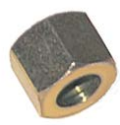
			
1			
GEV No.	101476	Ref. No.	1665300 MA1665300
description	union nut thread M13x1 for pipe ø 8mm		
For models:	C7011GFG, C707GFG, CFG101, CFG101D, CFG101L, CFG101P, CFG120, CFG70, CFG70M, EC74GVG, EC78GVG, EC7FG8G, OCFG101, OCFG120, OCFG70, T7011GFG, T707GFG		

			
1			
GEV No.	520223	Ref. No.	86643 MA86643
description	union nut thread M16x1 WS 19 L 15mm for pipe ø 10mm		
For models:	704S, 706S, B9SB2G, B9SB4G, B9V2G, B9V4G, BR707G, BR707GI, C7011GFG, C707GFG, C9F4G, C9F4GS, C9F6G, C9F6GS, C9F8G, C9F8GS, C9FP4GS, C9FP6GS, C9FP8GS, C9SB4GS, C9V2G, C9V2GS, C9V4G, C9V4GS, C9V6G, C9V6GS, C9V8G, C9V8GS, CFG101, CFG101D, CFG101L, CFG101P, CFG120, CFG70, CFG70D, CFG70L, CFG70M, CFG70P, EC74GVG, EC78GVG, EC7FG8G, EF74G15, F12C4G15, F74G10, F74G15, F74G6, F76G10, F78G15, F94G10, F94G15...(Other models you can see in the webshop)		

			
1			
GEV No.	101300	Ref. No.	1326500 MA1326500
description	union nut thread M16x1.5 tube ø 10mm		
For models:	B74G, B78G, B94G, B98G, BF78G, BF912G, BF912GH, BF98G, BIG40, BIG60, BMG40, BMG60, BR78GF, BR78GI, BRG40, BRG40G, C124G, C129G, C12C2G9, C12C9G, C12FG9G, C12FGP9G, C7011G, C7011GFE, C7011GFG, C704G, C707G, C707GFE, C707GFG, C712G, C74G, C74GS, C78G, C78GS, C79G, C7FE12G, C7FE12GS, C7FE8G, C7FE8GS, C7FG12G, C7FG12GS, C7FG8G, C7FG8GS, C7FG9G, C7FGM12G, C912G, C912GS, C94G, C94GP, C94GS...(Other models you can see in the webshop)		
accessories for	101300		
	GEV No.	101278	Ref. No. 867-20 MA86720
olive for pipe ø 10mm Qty 1 pcs			





1

GEV No.	101250	Ref. No.	673200 MA673200
description	union nut thread M20x1.5 for pipe ø 10mm		
For models:	704S, 706S, BRG40, BRG40G, C124G, C129G, C12C2G9, C12C9G, C12FG9G, C712G, C74G, C78G, C7FE12G, C7FE8G, C7FG12G, C7FG8G, C7FGM12G, C912G, C912GS, C94G, C94GP, C94GS, C98G, C98GP, C98GS, C9F4G, C9F4GS, C9F6G, C9F6GS, C9F8G, C9F8GS, C9FE12G, C9FE12GS, C9FE8G, C9FE8GS, C9FG12G, C9FG12GS, C9FG16G, C9FG8G, C9FG8GP, C9FG8GS, C9FGM12G, C9SB4GS, C9V2G, C9V2GS, C9V4G, C9V4GS, C9V6G, C9V6GS, C9V8G...(Other models you can see in the webshop)		
accessories for	101250		
	GEV No.	101249	Ref. No. 673400 MA673400
olive for pipe ø 10mm Qty 1 pcs			



1

GEV No.	101251	Ref. No.	673100 MA673100
description	union nut thread M20x1.5 for pipe ø 12mm		
For models:	704S, 706S, BRG40, BRG40G, C124G, C129G, C12C2G9, C12C9G, C12FG9G, C712G, C74G, C78G, C7FE12G, C7FE8G, C7FG12G, C7FG8G, C7FGM12G, C912G, C912GS, C94G, C94GP, C94GS, C98G, C98GP, C98GS, C9F4G, C9F4GS, C9F6G, C9F6GS, C9F8G, C9F8GS, C9FE12G, C9FE12GS, C9FE8G, C9FE8GS, C9FG12G, C9FG12GS, C9FG16G, C9FG8G, C9FG8GP, C9FG8GS, C9FGM12G, C9SB4GS, C9V2G, C9V2GS, C9V4G, C9V4GS, C9V6G, C9V6GS, C9V8G...(Other models you can see in the webshop)		
accessories for	101251		
	GEV No.	101248	Ref. No. 673300 MA673300
olive for pipe ø 12mm Qty 1 pcs suitable for PEL			

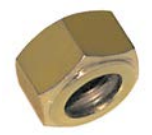

1

GEV No.	101253	Ref. No.	1421000 MA1421000
description	union nut thread M24x1.5 PEL for pipe ø 16mm		
For models:	BR912GFM, BR912GIM, BR94G, BR94GI, BR98GF, BR98GFM, BR98GI, BR98GIM, BR9M4G, BR9M4GI, BR9M6G, BR9M6GI, BR9S8GF, BR9S8GI, BR9SB4G, BR9SB4GI, C9FEP4GS, C9FEP6GS, C9FEP8GS, C9FP4GS, C9FP6GS, C9FP8GS, C9VP4GS, C9VP6GS, C9VP8GS, CON10G, CON10GP, CON201G, CON201GP, CON202G, CON202GP, CON6G, CON6GP, CP707G, CP92E, CP92G, CP94E, CP94G, CS10, CS102G, CS102GP, CS6, CSM10G, CSM10GP, CSM201G, CSM201GP, CSM202G, CSM202GP, CSM6G, CSM6GP...(Other models you can see in the webshop)		
accessories for	101253		
	GEV No.	101256	Ref. No. 1127400 MA1127400
olive for pipe ø 16mm Qty 1 pcs			

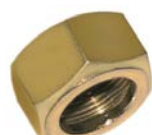

1

GEV No.	101254	Ref. No.	1346900 MA1346900
description	union nut thread M28x1.5 tube ø 20mm		
For models:	MM10DG, MM10DGS, MM15DG, P9D10G, P9D15G, P9DA10G, P9DA15G, P9DASB10G, P9DSB10G, PD98G10, PD98G15, PD98G15A, PD9S8G10, PDASB10G, PI98G10, PI98G14, PI98G14A, T9F4G, T9F6GS, T9SB4G, T9V4G, T9V6GS		
accessories for	101254		
	GEV No.	101257	Ref. No. 1347000 MA1347000
olive for pipe ø 20mm Qty 1 pcs			

union screws



1

GEV No.	100904	Ref. No.	1388000 1394700 MA1394700
description	locking screw M10x1 for pipe ø 4mm Qty 1 pcs		
For models:	B9SB2G, B9SB4G, B9V2G, B9V4G, B9VP4G, BF78G, BF912G, BF912GH, BF98G, BM74G, BM77G, BMG40, BMG60, BR707G, BR707GI, BR78GF, BR78GI, C12FGP9G, C7FG12G, C7FG8G, C7FGM12G, C9F4G, C9F4GS, C9F6G, C9F6GS, C9F8G, C9F8GS, C9FG12G, C9FG16G, C9FG8G, C9FG8GP, C9FGM12G, C9FP4GS, C9FP6GS, C9FP8GS, EF74G15, EF74G8VA, EF74G8VG, F12C4G15, F74G10, F74G15, F74G6, F76G10, F78G15, F94G10, F94G15, F94G22, F94G22K, F94G6, F96G10...(Other models you can see in the webshop)		







1



GEV No.	100905	Ref. No.	1394800 MA1394800
description	locking screw M10x1 for pipe ø 6mm Qty 1 pcs		
For models:	BR707G, CS10, CS102G, CS102GP, CS6, CSM201E, CSM201EP, CSM201G, CSM201GP, CSM202E, CSM202EP, CSM202G, CSM202GP, FR74G, FR77G		

			
1			
GEV No.	100906	Ref. No.	1888400 MA1888400
description	screw connection thread M10x1 for ignition electrode brass Qty 1 pcs WS 10		
For models:	B74G, B78G, B94G, B98G, B9SB2G, B9SB4G, B9V2G, B9V4G, B9VP4G, BF78G, BF912G, BF912GH, BF98G, BM74G, BM77G, BR707G, BR707GI, BR78GF, BR78GI, BR912GFM, BR912GIM, BR94G, BR94GI, BR98GF, BR98GFM, BR98GI, BR98GIM, BR9M4G, BR9M4GI, BR9M6G, BR9M6GI, BR9S8GF, BR9S8GI, BR9S84G, BR9S84GI, C124G, C129G, C12C2G9, C12C9G, C12FG9G, C12FGP9G, C7011G, C7011GFE, C7011GFG, C704G, C707G, C707GFE, C707GFG, C712G, C74G...(Other models you can see in the webshop)		

			
2			
GEV No.	100907	Ref. No.	1891700 24010899 MA1891700 MA24010899
description	screw connection thread M10x1 Qty 1 pcs type SEF 1 ømm for thermocouple		
For models:	B9SB2G, B9SB4G, B9V2G, B9V4G, B9VP4G, BF78G, BF912G, BF912GH, BF98G, BIG40, BIG60, BM74G, BM77G, BR707G, BR707GI, BR912GFM, BR912GIM, BR94G, BR94GI, BR96G, BR96GI, BR98GF, BR98GFM, BR98GI, BR98GIM, BR9M4G, BR9M4GI, BR9M6G, BR9M6GI, BR9S84G, BR9S84GI, C124G, C129G, C12C2G9, C12C9G, C12FG9G, C12FGP9G, C7011G, C7011GFE, C7011GFG, C704G, C707G, C707GFE, C707GFG, C712G, C74G, C78G, C7FE12G, C7FE8G, C7FG12G...(Other models you can see in the webshop)		

			
1			
GEV No.	106597	Ref. No.	866000 MA866000
description	union screw thread 3/4" for pipe ø 18mm L 20mm Qty 1 pcs WS 27		
For models:	B9SB2E, B9SB2G, B9SB4E, B9SB4G, B9V2E, B9V2G, B9V4E, B9V4G, B9VP2E, B9VP4E, B9VP4G, BF78G, BF912G, BF912GH, BF98G, BM74E, BM74G, BM77E, BM77G, BME40DM, BME40DMB, BME40M, BME60DM, BME60DMB, BME60M, BME80M, BV712, BV74, BV76, BV78, BV912, BV94, BV96, BV98, C12FGP9G, C7FG12G, C7FG8G, C7FGM12G, C9FG12G, C9FG16G, C9FG8G, C9FG8GP, C9FGM12G, CPE60, CPE602, CPE60DB, EF74E10VG, EF74G8VA, EF74G8VG, F74E10...(Other models you can see in the webshop)		

			
1			
GEV No.	100908	Ref. No.	0100777 673500 MA673500 R0100777 SIRO100777
description	union screw thread M10x1 for pipe ø 4mm Qty 1 pcs		
For models:	704S, 706S, B74G, B78G, B94G, B98G, B9SB2G, B9SB4G, B9V2G, B9V4G, B9VP4G, BF78G, BF912G, BF912GH, BF98G, BIG40, BIG60, BM74G, BM77G, BR707G, BR707GI, BR912GFM, BR912GIM, BR94G, BR94GI, BR98GF, BR98GFM, BR98GI, BR98GIM, BR9M4G, BR9M4GI, BR9M6G, BR9M6GI, BR9S8GF, BR9S8GI, BR9S84G, BR9S84GI, BRG40, BRG40G, C124G, C129G, C12C2G9, C12C9G, C12FG9G, C12FGP9G, C7011G, C7011GFE, C7011GFG, C704G, C707G...(Other models you can see in the webshop)		
accessories for	100908		
		GEV No.	100897
		Ref. No.	1881000 1888100 MA1888100
	olive for pipe ø 4mm Qty 1 pcs for pilot burner		
		GEV No.	101246
		Ref. No.	673600 MA673600
	olive for pipe ø 4mm Qty 1 pcs		
		GEV No.	101280
		Ref. No.	—
	olive for pipe ø 4mm Qty 1 pcs		
		GEV No.	101282
		Ref. No.	469000 MA469000
	olive for pipe ø 4mm L 7.4mm Qty 1 pcs		

			
1			
GEV No.	101283	Ref. No.	468800 MA468800
description	union screw thread M10x1 for pipe ø 4mm Qty 1 pcs		
For models:	704S, 706S, BIG40, BIG60, BMG40, BMG60, BRG40, BRG40G, CP707G, CP92G, CP94G, FQG40, FQG60, FT74G, FT74GR, FT77G, FT77GRL, FTG40B, FTG40BLC, FTG40BR, FTG60B, FTG60BLC, FTG60BR, FTG60BRR, FTG80B, FTG80BLC, FTG80BR, GB707G, P9D2G, PD707G, PI707G, TPF706S		
accessories for	101283		
		GEV No.	101282
		Ref. No.	469000 MA469000
	olive for pipe ø 4mm L 7.4mm Qty 1 pcs		



			
1			
GEV No.	103237	Ref. No.	459500 MA459500
description	union screw thread M14x1.5 for pipe ø 10mm Qty 1 pcs		
For models:	BMG40, BMG60, FQG40, FQG60, FT129GLC, FT129GM, FT14G8L90, FT14G8LC90, FT14G8R2L90, FT14G8R2LC90, FT14G8R90, FT14G8RC90, FT74GL, FT74GLC, FT74GR, FT74GRC, FT76GL, FT76GLC, FT76GM, FT76GMC, FT76GR, FT78GL, FT78GLC, FT78GLT, FT78GM, FT78GMC, FT78GMT, FT7G4L90, FT7G4LC90, FT7G4R90, FT7G4RC90, FT94GL, FT94GLC, FT94GR, FT94GRC, FT96GL, FT96GLC, FT96GM, FT96GMC, FT96GR, FT98GL, FT98GLC, FT98GLT, FT98GM, FT98GMC, FT98GMT, FT98GR, FT98GRT, NC712G36, NC74G12...(Other models you can see in the webshop)		

			
1			
GEV No.	102111	Ref. No.	1690200
description	pilot tube copper pipe ø 6mm thickness 1mm L 3000mm		
For models:	BR707G		

gas lines

pilot tubes

producer-specific

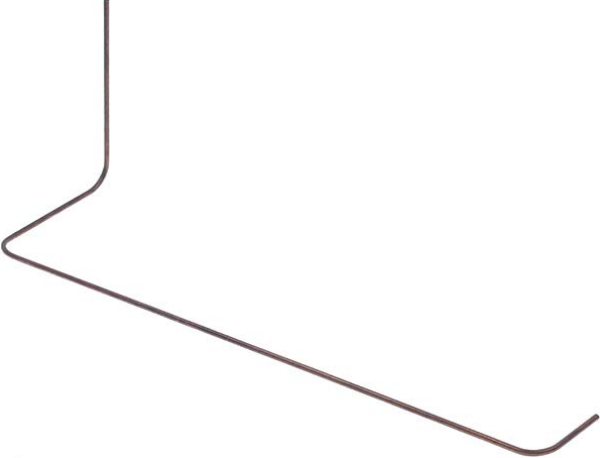

			
1			
GEV No.	107884	Ref. No.	CR0730240
description	pilot tube tube ø 4mm L 430mm W 115mm H 140mm copper		
For models:	NC712G36, NC74G12, NC78G24, NC7FE12G36, NC7FE8G24, NC7FG12G44, NC7FG8G32, NC7FGM12G, NS78GS, NS7FG12GS, NT7FG12G		

pressure switches

			
1			
GEV No.	541051	Ref. No.	5151000 MA5151000
description	pressure control ø 45mm pressure range adjustable 10-50mbar pressure connection vertical gas technology connection 1/4" pressure connection ø 1/4"mm		
For models:	CON102G, CON102GP, CON10G, CON10GP, CON201G, CON201GP, CON202G, CON202GP, CON6G, CON6GP, CP9A15GD, CSM102G, CSM102GP, CSM10G, CSM10GP, CSM201G, CSM201GP, CSM202G, CSM202GP, CSM6G, CSM6GP		

			
1			
GEV No.	541073	Ref. No.	R63070010
description	pressure control ø 45mm pressure range adjustable 5-20mbar pressure connection vertical gas technology connection 1/4" pressure connection ø 1/4"mm		
For models:	CVG105H, CVG105M, GC106M, GC110M, GC210M, GM106H, GM106M, GM106M+SC, GM106P, GM110H, GM110M, GM110M+SC, GM110P, GM210H, GM210M, GM210M+SC, GM210P, GMT06D, GMT20D, GV106H, GV106M, GV106M+SC, GV106P, GV110H, GV110M, GV110M+SC, GV110P, GV210H, GV210M, GV210M+SC, GV210P, GVT06D, GVT20D, MACG05M, MACG07M, MACG10M, MACG20M, MG061D, MG061M, MG061P, MG061T, MG101D, MG101M, MG101P, MG101T, MG102D, MG102M, MG102P, MG102T, MG106M...(Other models you can see in the webshop)		

universal

			
1			
GEV No.	102110	Ref. No.	1413100 1413200 1682300 1876500
description	pilot tube copper pipe ø 4mm thickness 1mm L 3000mm		
For models:	MM10IG, P9D10G, P9D15G, P9DA10G, P9DA15G, P9I10G, P9I5G, P9IA10G, PD707G		
accessories for	102110		
	GEV No.	100908	Ref. No. 0100777 673500 MA673500 R0100777 SIR0100777
union screw thread M10x1 for pipe ø 4mm Qty 1 pcs			
	GEV No.	101246	Ref. No. 673600 MA673600
olive for pipe ø 4mm Qty 1 pcs			

equipment-specific units

for vegetable slicers

miscellaneous

			
1			
GEV No.	110703	Ref. No.	1829200 MA1829200
description	cylindrical handle thread M10 ø 28mm L 87mm		
For models:	CRE6220, CRE6230, CRE6320, CRE6330, GB704G, GB707G, GB92G, GB94G, GL12C4G, GL12C9G, GL74G, GL78G, GL94G, GL98G, NGL74G, NGL78G, OPLG40, OPLG80, PLG40, PLG80, SME62M, SME63M, SME70M, SPE60M, SPW60M, TSE60M		

for cheese graters

miscellaneous



1

GEV No.	110703	Ref. No.	1829200 MA1829200
description	cylindrical handle thread M10 ø 28mm L 87mm		
For models:	CRE6220, CRE6230, CRE6320, CRE6330, GB704G, GB707G, GB92G, GB94G, GL12C4G, GL12C9G, GL74G, GL78G, GL94G, GL98G, NGL74G, NGL78G, OPLG40, OPLG80, PLG40, PLG80, SME62M, SME63M, SME70M, SPE60M, SPW60M, TSE60M		

for dough mixers

spindles

for mixer bowls



1

GEV No.	696629	Ref. No.	CM219100 MACM219100
description	spindle ø 19mm L 410mm		
For models:	BR78EF, BR78EI, BR78G, BR78GF, BR78GI, BR912EFM, BR912EIM, BR912GFM, BR912GIM, BR98EF, BR98EFM, BR98EI, BR98EIM, BR98GF, BR98GFM, BR98GI, BR98GIM, BR958EF, BR958EI, BR958GF, BR958GI		

for refrigerated counters

filters



1

GEV No.	694068	Ref. No.	1817200 1817201R 1817300 MA1817200 MA1817201R MA1817300
description	container filter type series 700/900		
For models:	CP704E, CP704G, CP707G, CP92E, CP92E2, CP92G, CP94E, CP94E2, CP94G, CP95B2E, CP95B2E2, CP95B2G, CP95B4E, CP95B4E2, CP95B4G, DE92142, DE94242, EPC74E, EPC74G, FQE6, FQE6+6, NPC76E, NPC76G, NPC96E, NPC96G, PC12C4E, PC12C4G, PC12C9E, PC12C9G, PC74E, PC74G, PC76E, PC76G, PC78E, PC78G, PC94E, PC94G, PC96E, PC96G, PC98E, PC98G, PC954E, PC954G, PC956E, PC956G, PC958E, PC958G, SPAR16, SPAR20, SPRG12...(Other models you can see in the webshop)		

for display coolers

doors



1

GEV No.	697877	Ref. No.	4121900 MA4121900
description	door L 643mm W 237mm H 6mm		
For models:	SER15, SER15A, SER18, SER18A, SER21		

for ice-cube maker

hoses

formed hoses

straight

silicone hoses



1

GEV No.	530063	Ref. No.	MA1036100700
description	silicone hose ID ø 18mm ED ø 25mm L 1m t.max. 200°C transparent		

for espresso machines

brewing units

filter holder gaskets

O-rings



1

GEV No.	510409	Ref. No.	1036504200 LA70045010 LAR70045010
description	O-ring EPDM thickness 5.34mm ID ø 56.52mm Qty 1 pcs		
For models:	DLS30, DLS303, DLS30P, DLS30P3, DLS31, DLS313, DLS31P3, ME101M, ME101P, ME101T, ME102D, ME102M, ME102P, ME102T, ME201D, ME201M, ME201P, ME201T, ME202D, ME202M, ME202P, ME202T, MEMT06D, MEMT06P, MEMT10D, MEMT10P, MEMT20D, MEMT20P, MEMT21D, MEMT21P, MEMT40D, MEMT40P, MLC50, MLC503, MLC65, MLC653, MLS30, MLS303, MLS30P, MLS30P3, MLS31, MLS313, MLS31P3, MLS35, MLS353, MPLS30P		

steam/water taps

steam/water pipes

accessories

gaskets



1

GEV No.	510893	Ref. No.	200810
description	O-ring EPDM thickness 2.62mm ID ø 9.92mm Qty 1 pcs		

pipes

union nuts

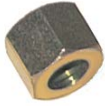

1

GEV No.	101478	Ref. No.	1665200 MA1665200
description	union nut thread 3/8" for pipe ø 10mm		
For models:	C7011GFG, C707GFG, CFG101, CFG101D, CFG101L, CFG101P, CFG120, CFG70, CFG70D, CFG70L, CFG70P, EC74GVG, EC78GVG, EC7FG8G, OCFG101, OCFG120, OCFG70, T7011GFG, T707GFG		

for coffee grinders



1

GEV No.	345019	Ref. No.	120712
description	rotary switch sets of contacts 2 2 0-1 type CA0120002 380V 12A shaft ø 5x5mm shaft L 23mm shaft square connection screw		

for pyroceram ranges

ceramic hobs

ceramic hobs (complete)



1

GEV No.	692140	Ref. No.	1041711623 1041711623R MA1041711623R
description	ceramic hob L 600mm W 400mm H 40mm		
For models:	PCVE40, PCVE40D, PCVE40DB, PCVE60, PCVE60D, PCVE60DB		

ceramic glass plates



1

GEV No.	693117	Ref. No.	1041711723 1041711723R MA1041711723R
description	ceramic plate with frame L 510mm W 548mm		
For models:	CFVE60, PCVE40, PCVE40D, PCVE40DB, PCVE60, PCVE60D, PCVE60DB		

for deep fryers

lids



1

GEV No.	691353	Ref. No.	1041306013R MA1041306013R
description	lid L 440mm W 245mm for fryer		

filters



1

GEV No.	694068	Ref. No.	1817200 1817201R 1817300 MA1817200 MA1817201R MA1817300
description	container filter type series 700/900		
For models:	CP704E, CP704G, CP707G, CP92E, CP92E2, CP92G, CP94E, CP94E2, CP94G, CP95B2E, CP95B2E2, CP95B2G, CP95B4E, CP95B4E2, CP95B4G, DE92142, DE94242, EPC74E, EPC74G, FQE6, FQE6+6, NPC76E, NPC76G, NPC96E, NPC96G, PC12C4E, PC12C4G, PC12C9E, PC12C9G, PC74E, PC74G, PC76E, PC76G, PC78E, PC78G, PC94E, PC94G, PC96E, PC96G, PC98E, PC98G, PC954E, PC954G, PC956E, PC956G, PC958E, PC958G, SPAR16, SPAR20, SPRG12...(Other models you can see in the webshop)		

for griddles

housing and bezels



1

GEV No.	691349	Ref. No.	1044314900 MA1044314900
description	spraying protection L 520mm W 390mm H 75mm		
For models:	BIE40B, BIE60B, FTE100B, FTE100BR, FTE100C, FTE100CRL, FTE40B, FTE40BR, FTE40C, FTE40D, FTE40DC, FTE60B, FTE60BR, FTE60BRR, FTE60C, FTE60D, FTE60DC, FTE60DCRL, FTE60DR, FTG40B, FTG60B, FTG60BLC, FTG60BR, FTG80B, FTG80BR, FTVE100, FTVE40, FTVE40D, FTVE60, FTVE60D, OFTE100CRL, OFTE40B, OFTE40BR, OFTE40C, OFTE60B, OFTE60BR, OFTE60BRR, OFTE60C		

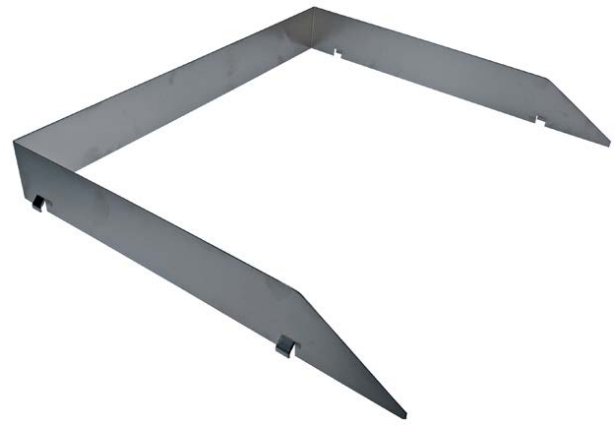

1

GEV No.	691350	Ref. No.	1044315000 MA1044315000
description	spraying protection L 520mm W 590mm H 75mm		
For models:	BIE40B, BIE60B, FTE100B, FTE100BR, FTE100C, FTE100CRL, FTE40B, FTE40BR, FTE40C, FTE40D, FTE40DC, FTE60B, FTE60BR, FTE60BRR, FTE60C, FTE60D, FTE60DC, FTE60DCRL, FTE60DR, FTG40B, FTG60B, FTG60BLC, FTG60BR, FTG80B, FTG80BR, FTVE100, FTVE40, FTVE40D, FTVE60, FTVE60D, OFTE100CRL, OFTE40B, OFTE40BR, OFTE40C, OFTE60B, OFTE60BR, OFTE60BRR, OFTE60C		



1

GEV No.	691351	Ref. No.	1044320700 MA1044320700
description	spraying protection L 520mm W 790mm H 75mm		
For models:	FTG40B, FTG60B, FTG60BLC, FTG60BR, FTG80B, FTG80BR		



drain stoppers



GEV No.	691331	Ref. No.	97313000 MA97313000
description	outflow plug for grease drain flange 30x70mm H 100mm		
For models:	BIE40B, BIE60B, EFT74ELVG, EFT74ERVG, EFT74GLVG, EFT74GRVG, EFT78ELVG, EFT78EMVG, EFT78GLVG, EFT78GMVG, FT74GL, FT74GLC, FT74GR, FT74GRC, FT76GL, FT76GLC, FT76GM, FT76GMC, FT76GR, FT78GL, FT78GLC, FT78GLT, FT78GM, FT78GMC, FT78GMT, FT78GR, FT78GRT, FT94G, FT94GL, FT94GLC, FT94GR, FT94GRC, FT96GL, FT96GLC, FT96GM, FT96GMC, FT96GR, FT98GL, FT98GLC, FT98GLT, FT98GM, FT98GMC, FT98GMT, FT98GR, FT98GRT, FTE100B, FTE100BR, FTE100C, FTE100CRL, FTE40B...(Other models you can see in the webshop)		



GEV No.	691330	Ref. No.	1033705600 MA1033705600
description	outflow plug for grease drain ϕ 32mm L 50mm ID ϕ 17.8mm ED ϕ 25.5mm		
For models:	BIE40B, BIE60B, FTE100B, FTE100BR, FTE100C, FTE100CRL, FTE40B, FTE40BR, FTE40C, FTE40D, FTE40DC, FTE60B, FTE60BR, FTE60BRR, FTE60C, FTE60D, FTE60DC, FTE60DCRL, FTE60DR, FTG40B, FTG40BLC, FTG40BR, FTG60B, FTG60BLC, FTG60BR, FTG60BRR, FTG80B, FTG80BLC, FTG80BR, OFTE100CRL, OFTE40B, OFTE40BR, OFTE40C, OFTE60B, OFTE60BR, OFTE60BRR, OFTE60C		

for convection ovens/combi-steamers

drain units

drip rails



GEV No.	691961	Ref. No.	R69180000
description	drain unit L 90mm edition since 2009		
For models:	GMT20D, GVT06D, GVT20D		



GEV No.	694606	Ref. No.	R11200520
description	drip rail L 90mm edition from 2000 until 2009		
For models:	ME061M, ME061P, ME061T, ME101M, ME101P, ME101T, ME102M, ME102P, ME102T, MG061M, MG061P, MG061T, MG101M, MG101P, MG101T, MG102M, MG102P, MG102T		



GEV No.	699451	Ref. No.	R70080010
description	bush for steam generator ID ϕ 60mm ED ϕ 76mm L 70mm ceramic suitable for combi-steamer		
For models:	GMT20D, MG101D, MG101M, MG101P, MG101T, MG102D, MG102M, MG102P, MG102T, MG201D, MG201M, MG201P, MG201T, MG202D, MG202M, MG202P, MG202T, MGMT10D, MGMT10P, MGMT20D, MGMT20P, MGMT21D, MGMT21P, MGMT40D, MGMT40P		

injection nozzles



GEV No.	691278	Ref. No.	R58006130 R58006140
description	injection nozzle bore ϕ 1mm for combi-steamer		
For models:	GMT06D, GMT20D, GVT06D, GVT20D, ME061P, ME061T, ME101D, ME101M, ME101P, ME101T, ME102D, ME102M, ME102P, ME102T, ME201D, ME201M, ME201P, ME201T, ME202D, ME202M, ME202P, ME202T, MEMT06D, MEMT06P, MEMT10D, MEMT10P, MEMT20D, MEMT20P, MEMT21D, MEMT21P, MEMT40D, MEMT40P, MEVT06D, MEVT06P, MEVT10D, MEVT10P, MEVT20D, MEVT20P, MEVT21D, MEVT21P, MEVT40D, MEVT40P, MG061D, MG061M, MG061P, MG061T, MG101D, MG101M, MG101P, MG101T...(Other models you can see in the webshop)		



GEV No.	692326	Ref. No.	R58006080
description	injection nozzle bore ϕ 2mm L 33mm WS 14 brass for combi-steamer T1: M10x1 T2: M10x1		
For models:	EM210H, EM210M, EM210M+SC, EM210P, EV210H, EV210M, EV210M+SC, EV210P, GM210H, GM210M, GM210M+SC, GM210P, GV210H, GV210M, GV210M+SC, GV210P, ME120M, ME120P, ME120X, ME210M, ME210P, ME210X, ME220M, ME220P, ME220X, MEC24H, MEC40M, MG120M, MG120P, MG120X, MG210M, MG210P, MG210X, MG220M, MG220P, MG220X, MGC20X, MGC24H, MGC40H, VE120M, VE120P, VE120X, VE210M, VE210P, VE210X, VE220M, VE220P, VE220X, VG120M, VG120P...(Other models you can see in the webshop)		

injection pipes



1

GEV No.	696767	Ref. No.	R10206480
description	extension U-shape for injection pipe ED ø 8/12mm ID ø 6/8mm		
For models:	EC110M, EC210M, EM010M+SC, EM110H, EM110M, EM110M+SC, EM110P, EM210H, EM210M, EM210M+SC, EM210P, EV110H, EV110M, EV110M+SC, EV110P, EV210H, EV210M, EV210M+SC, EV210P, GC110M, GC210M, GM110H, GM110M, GM110M+SC, GM110P, GM210H, GM210M, GM210M+SC, GM210P, GV110H, GV110M, GV110M+SC, GV110P, GV210H, GV210M, GV210M+SC, GV210P, MEC24H, MEC40M, MGC20X, MGC24H, MGC40H, VE110M, VE110X, VE120M, VE120P, VE120X, VE210M, VE210P, VE210X...(Other models you can see in the webshop)		



1

GEV No.	692819	Ref. No.	R11201980
description	injection pipe for combi-steamer ED ø 8mm ID ø 5.5mm L 170mm W 115mm		
For models:	GVT20D, MGVT10D, MGVT10P, MGVT20D, MGVT20P, MGVT40D, MGVT40P		



1

GEV No.	692821	Ref. No.	R18200540
description	injection pipe for combi-steamer H 75mm ED ø 8mm ID ø 6mm L 105mm		
For models:	MACE04M, MACE05M, MACG05M, MVE042P, MVE051P, MVG051P		



1

GEV No.	692832	Ref. No.	R11201990
description	injection pipe for combi-steamer U-shape ED ø 8mm ID ø 6mm		
For models:	GMT20D, MACG10M, MACG20M, MG101M, MG101P, MG101T, MG102D, MG102M, MG102P, MG102T, MGMT20D, MGMT20P		



1

GEV No.	694318	Ref. No.	R10206540
description	injection pipe L1 66mm L2 49mm tube ø 8mm mounting distance 36mm		
For models:	EC106M, EC110M, EC210M, EM010M+SC, EM106H, EM106M, EM106M+SC, EM106P, EM110H, EM110M, EM110M+SC, EM110P, EM210H, EM210M, EM210M+SC, EM210P, EV006M, EV106H, EV106M, EV106M+SC, EV106P, EV110H, EV110M, EV110M+SC, EV110P, EV210H, EV210M, EV210M+SC, EV210P, GC106M, GC110M, GC210M, GM106H, GM106M, GM106M+SC, GM106P, GM110H, GM110M, GM110M+SC, GM110P, GM210H, GM210M, GM210M+SC, GM210P, GV106H, GV106M, GV106M+SC, GV106P, GV110H, GV110M...(Other models you can see in the webshop)		



1

GEV No.	692820	Ref. No.	R11200650
description	injection pipe with holder for combi-steamer ED ø 8mm ID ø 6mm L 150mm H 75mm		
For models:	GMT06D, GVT06D, MACE07M, MACG07M, ME061D, ME061M, ME061P, ME061T, MEMENT06D, MEMENT06P, MEVTO6D, MEVTO6P, MG061D, MG061M, MG061P, MG061T, MGMT06D, MGMT06P, MGVT06D, MGVT06P		

filters



1

GEV No.	691269	Ref. No.	R18200260
description	drain filter ø 43mm		
For models:	MACE04M, MVE042P		





1

GEV No.	691270	Ref. No.	R02200280 R10201700
description	drain filter ø 76mm		
For models:	EC106M, EC110M, EC210M, EM010M+SC, EM106H, EM106M, EM106M+SC, EM106P, EM110H, EM110M, EM110M+SC, EM110P, EM210H, EM210M, EM210M+SC, EM210P, EV006M, EV106H, EV106M, EV106M+SC, EV106P, EV110H, EV110M, EV110M+SC, EV110P, EV210H, EV210M, EV210M+SC, EV210P, FE105M, FE105X, FE110M, FE110X, FG105M, FG105X, FG110M, FG110X, GC106M, GC110M, GC210M, GM106H, GM106M, GM106M+SC, GM106P, GM110H, GM110M, GM110M+SC, GM110P, GM210H, GM210M...(Other models you can see in the webshop)		

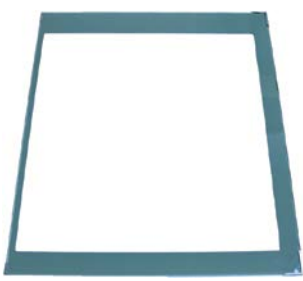

			
1			
GEV No.	691271	Ref. No.	R10201710 R10201720
description	drain filter ø 87mm		
For models:	GMT06D, GMT20D, GVT06D, MACE10M, MACE20M, MACG10M, MACG20M, ME102D, ME102M, ME102P, ME102T, ME120M, ME120P, ME120X, ME201D, ME201M, ME201P, ME201T, ME202D, ME202M, ME202P, ME202T, ME220M, ME220P, ME220X, MEC24H, MEC40M, MEMT06D, MEMT06P, MEMT10D, MEMT10P, MEMT20D, MEMT20P, MEMT21D, MEMT21P, MEMT40D, MEMT40P, MEVT06D, MEVT06P, MEVT10D, MEVT10P, MEVT20D, MEVT20P, MEVT21D, MEVT21P, MEVT40D, MEVT40P, MG120M, MG120P, MG120X...(Other models you can see in the webshop)		

<h3>glass panels</h3>			
			
1			
GEV No.	696396	Ref. No.	R11100140
description	glass panel L 860mm W 730mm thickness 6mm mounting pos. inner for combi-steamer		
For models:	GMT20D, GVT20D, ME101D, ME101M, ME101P, ME101T, ME102D, ME102M, ME102P, ME102T, MEMT20D, MEMT20P, MEVT20D, MEVT20P, MG101D, MG101M, MG101P, MG101T, MG102D, MG102M, MG102P, MG102T, MGMT20D, MGMT20P, MGV20D, MGV20P		

<h3>cleaning system</h3>			
<h4>nozzles</h4>			
			
1			
GEV No.	550864	Ref. No.	R62210042
description	nozzle flow rate 0.56l/min for combi-steamer		
For models:	ME061T, ME101T, ME102T, ME201T, MEMT06P, MEMT10P, MEMT20P, MEMT21P, MEMT40P, MG102T, MG201T, MG202T, MGMT06P, MGMT10P, MGMT20P, MGMT21P, MGMT40P		

			
1			
GEV No.	550865	Ref. No.	R62210032
description	nozzle flow rate 1.3l/min for combi-steamer		
For models:	ME061T, ME101T, ME102T, ME201T, MEMT06P, MEMT10P, MEMT20P, MEMT21P, MEMT40P, MG102T, MG201T, MG202T, MGMT06P, MGMT10P, MGMT20P, MGMT21P, MGMT40P		

<h3>coupling bushings</h3>			
			
1			
GEV No.	550863	Ref. No.	R58004980
description	bush for wash arm		
For models:	ME061T, ME101T, ME102T, ME201T, MEMT06P, MEMT10P, MEMT20P, MEMT21P, MEMT40P, MG102T, MG201T, MG202T, MGMT06P, MGMT10P, MGMT20P, MGMT21P, MGMT40P		

<h3>pipes</h3>			
			
1			
GEV No.	520970	Ref. No.	R62180022
description	drain pipe flexible L 135mm ID ø 18mm ED ø 27.5mm connection 3/4" ET - 3/4" IT SS for combi-steamer		
For models:	GMT06D, ME201D, ME201M, ME201P, ME201T, MEMT21D, MEMT21P, MG061D, MG061M, MG061P, MG061T, MG101D, MG101M, MG101P, MG101T, MG120M, MG120P, MG120X, MG201D, MG201M, MG201P, MG201T, MG202D, MG202M, MG202P, MG202T, MGC20X, MGMT06D, MGMT06P, MGMT10D, MGMT10P, MGMT21D, MGMT21P, MGMT40D, MGMT40P		

<h3>hoses</h3>			
			
1			
GEV No.	520534	Ref. No.	R70060040
description	hose ID ø 50mm ED ø 58mm L 50mm silicone Qty 1 for combi-steamer thickness 4mm		
For models:	FE105M, FE105X, FE110M, FE110X, FG105M, FG105X, FG110M, FG110X, GMT20D, ME061P, ME061T, ME101M, ME101P, ME101T, ME102M, ME102P, ME102T, ME106M, ME106P, ME106X, ME110M, ME110P, ME110X, ME120M, ME120P, ME120X, ME201D, ME201M, ME201P, ME201T, ME202D, ME202M, ME202P, ME202T, ME210M, ME210P, ME210X, ME220M, ME220P, ME220X, MEC24H, MEC40M, MEMT21D, MEMT21P, MEMT40D, MEMT40P, MEVT21D, MEVT21P, MEVT40D, MEVT40P...(Other models you can see in the webshop)		



1

GEV No.	530901	Ref. No.	R70060050
description	hose ID ø 54mm ED ø 60mm L 50mm for combi-steamer		
For models:	FE210M, FG210M, FG210X, ME102P, ME102T, ME202D, ME202M, ME202P, ME202T, MEMT40D, MEMT40P, MEVT40D, MEVT40P, MG102P, MG102T, MG202D, MG202M, MG202P, MG202T, MGMT40D, MGMT40P, MGVT40D, MGVT40P		

service kits

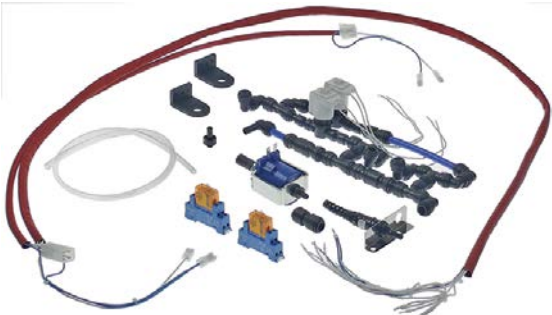

1

GEV No.	512503	Ref. No.	R62300028
description	backflow preventer kit		
For models:	ME061T, ME101T, ME102T, ME201T, MEMT06P, MEMT10P, MEMT20P, MG102T, MG201T, MGMT06P, MGMT10P, MGMT20P		



1

GEV No.	699468	Ref. No.	R58003100
description	mounting set for air baffle 4-piece		
For models:	GMT06D, GMT20D, GVT06D, GVT20D, ME061D, ME061M, ME061P, ME061T, ME101D, ME101M, ME101P, ME101T, ME102D, ME102M, ME102P, ME106M, ME106P, ME106X, ME110M, ME110P, ME110X, ME120M, ME120P, ME120X, ME201D, ME201M, ME201P, ME201T, ME202D, ME202M, ME202P, ME202T, ME210M, ME210P, ME210X, ME220M, ME220P, ME220X, MEC24H, MEC40M, MEMT06D, MEMT06P, MEMT10D, MEMT10P, MEMT20D, MEMT20P, MEMT21D, MEMT21P, MEMT40D, MEMT40P...(Other models you can see in the webshop)		

doors



1

GEV No.	692325	Ref. No.	R71010010
description	glass panel W 514mm H 314mm thickness 4mm for hot air oven Qty 1 pcs		
For models:	FE105M, FE105X, FG105M, FG105X, PE040M, PE040X, PG040M, PG040X		



1

GEV No.	691298	Ref. No.	R18100000
description	oven door complete		
For models:	MACE04M, MVE042P		



1

GEV No.	692836	Ref. No.	R11401360
description	protective plate lower for glass plate combi-steamer H 8mm W 8mm		
For models:	GMT06D, GMT20D, GVT06D, GVT20D, ME061D, ME061M, ME061P, ME061T, ME101D, ME101M, ME101P, ME101T, ME102D, ME102M, ME102P, ME102T, MEMT06D, MEMT06P, MEMT10D, MEMT10P, MEMT20D, MEMT20P, MEVT06D, MEVT06P, MEVT10D, MEVT10P, MEVT20D, MEVT20P, MG061D, MG061M, MG061P, MG061T, MG101D, MG101M, MG101P, MG101T, MG102D, MG102M, MG102P, MG102T, MGMT06D, MGMT06P, MGMT10D, MGMT10P, MGMT20D, MGMT20P, MGVT06D, MGVT06P, MGVT10D, MGVT10P...(Other models you can see in the webshop)		



 <p>1</p>			
GEV No.	692837	Ref. No.	R11401340
description	protective plate upper for glass plate combi-steamer H 8mm W 8mm		
For models:	GMT06D, GMT20D, GVT06D, GVT20D, MACE07M, MACE10M, MACE20M, MACG07M, MACG10M, MACG20M, ME061D, ME061M, ME061P, ME061T, ME101D, ME101M, ME101P, ME101T, ME102D, ME102M, ME102P, ME102T, MEMT06D, MEMT06P, MEMT10D, MEMT10P, MEMT20D, MEMT20P, MEVT06D, MEVT06P, MEVT10D, MEVT10P, MEVT20D, MEVT20P, MG061D, MG061M, MG061P, MG061T, MG101D, MG101M, MG101P, MG101T, MG102D, MG102M, MG102P, MG102T, MGMT06D, MGMT06P, MGMT10D, MGMT10P...(Other models you can see in the webshop)		

door mechanics

holders



 <p>1</p>			
GEV No.	691272	Ref. No.	R18203910
description	bracket for glass plate mounting pos. lower		
For models:	MACE07M, MACE10M, MACE20M, MACG07M, MACG10M, MACG20M		

 <p>1</p>			
GEV No.	691273	Ref. No.	R18203920
description	bracket for glass plate mounting pos. upper		
For models:	MACE07M, MACE10M, MACE20M, MACG07M, MACG10M, MACG20M		

accessories

 <p>1</p>			
GEV No.	692834	Ref. No.	R10207680
description	fixing plate for door W 30mm L 50mm		
For models:	ME120M, ME120P, ME120X, ME201D, ME201M, ME201P, ME201T, ME202D, ME202M, ME202P, ME202T, ME220M, ME220P, ME220X, MEC24H, MEC40M, MEMT21D, MEMT21P, MEMT40D, MEMT40P, MEVT21D, MEVT21P, MEVT40D, MEVT40P, MG120M, MG120P, MG120X, MG201D, MG201M, MG201P, MG201T, MG202D, MG202M, MG202P, MG202T, MG220M, MG220P, MG220X, MGC20X, MGC24H, MGC40H, MGMT21D, MGMT21P, MGMT40D, MGMT40P, MGVT21D, MGVT21P, MGVT40D, MGVT40P, VE120M...(Other models you can see in the webshop)		

vibration pumps

 <p>1</p>				
GEV No.	500568	Ref. No.	R65110600	
description	vibration pump 230V 32W 50Hz inlet ø 7 outlet ø 1/8" IT CEME type E512/A32			
For models:	ME061T, ME101T, ME102T, ME201T, MEMT06P, MEMT10P, MEMT20P, MEMT21P, MEMT40P, MG102T, MG201T, MG202T, MGMT06P, MGMT10P, MGMT20P, MGMT21P, MGMT40P			
spare parts for	500568			
	GEV No.	390698	Ref. No.	—
	thermal fuse switch-off temp. 110°C suitable for ULKA pump			
	GEV No.	520153	Ref. No.	—
	bracket rubber dimensions 53x34x28mm			

heat exchangers

 <p>1</p>			
GEV No.	520509	Ref. No.	R58004170
description	reducing washer gas burner brass ID ø 3mm ED ø 16mm thickness 2.2mm code 3		
For models:	MACG05M, MVG051P		

miscellaneous

 <p>1</p>			
GEV No.	696428	Ref. No.	R11201970
description	extension U-shape for injection pipe D1 ø 8mm D2 ø 10mm L 212mm WS 12 stainless steel		
For models:	MACE10M, MACE20M, ME101D, ME101M, ME101P, ME101T, ME102D, ME102M, ME102P, ME201D, ME201M, ME201P, ME201T, ME202D, ME202M, ME202P, ME202T, MEMT10D, MEMT10P, MEMT20D, MEMT20P, MEMT21D, MEMT21P, MEMT40D, MEMT40P, MEVT10D, MEVT10P, MEVT20D, MEVT20P, MEVT21D, MEVT21P, MEVT40D, MEVT40P, MG101D, MG201D, MG201M, MG201P, MG201T, MG202D, MG202M, MG202P, MG202T, MGMT10D, MGMT10P, MGMT21D, MGMT21P, MGMT40D, MGMT40P, MGVT21D, MGVT21P		

			
1			
GEV No.	696394	Ref. No.	R10206470
description	extension U-shape for injection pipe D1 ø 8mm D2 ø 12mm L 113mm W 72mm		
For models:	EC106M, EM106H, EM106M, EM106M+SC, EM106P, EV006M, EV106H, EV106M, EV106M+SC, EV106P, GC106M, GM106H, GM106M, GM106M+SC, GM106P, GV106H, GV106M, GV106M+SC, GV106P, VE106M, VE106P, VE106X, VG106M, VG106P, VG106X		

			
1			
GEV No.	691290	Ref. No.	R10100140
description	extractor stubs complete		
For models:	ME061P, ME061T, ME101P, ME101T, ME106M, ME106P, ME106X, ME110M, ME110P, ME110X, ME120M, ME120P, ME120X, ME210M, ME210P, ME210X, ME220M, ME220P, ME220X, MEC24H, MEMT06P, MEMT10P, MEVT06P, MEVT10P, MG061P, MG061T, MG101P, MG101T, MG106M, MG106P, MG106X, MG110M, MG110P, MG110X, MG120M, MG120P, MG120X, MG210M, MG210P, MG210X, MG220M, MG220P, MG220X, MGC24H, MGC40H, MGMT06P, MGMT10P, MGVT06P, MGVT10P, VE106M...(Other models you can see in the webshop)		

			
1			
GEV No.	691282	Ref. No.	R58005350
description	gasket for door handle D1 ø 30mm D2 ø 18mm mounting pos. upper H 1.4mm		
For models:	CVE004H, CVE004M, CVE104H, CVE104M, CVE105H, CVE105M, CVG105H, CVG105M, EC106M, EC110M, EC210M, EM010M+SC, EM106H, EM106M, EM106M+SC, EM106P, EM110H, EM110M, EM110M+SC, EM110P, EM210H, EM210M, EM210M+SC, EM210P, EV006M, EV106H, EV106M, EV106M+SC, EV106P, EV110H, EV110M, EV110M+SC, EV110P, EV210H, EV210M, EV210M+SC, EV210P, FE105M, FE105X, FE110M, FE110X, FE210M, FG105M, FG105X, FG110M, FG110X, FG210M, FG210X, GC106M, GC110M...(Other models you can see in the webshop)		

			
1			
GEV No.	691291	Ref. No.	R70060020
description	gasket for extractor stubs D1 ø 30mm D2 ø 35mm W 9mm		
For models:	ME061P, ME061T, ME101P, ME101T, ME106M, ME106P, ME106X, ME110M, ME110P, ME110X, ME120M, ME120P, ME120X, ME210M, ME210P, ME210X, ME220M, ME220P, ME220X, MEC24H, MEMT06P, MEMT10P, MEVT06P, MEVT10P, MG061P, MG061T, MG101P, MG101T, MG106M, MG106P, MG106X, MG110M, MG110P, MG110X, MG120M, MG120P, MG120X, MG210M, MG210P, MG210X, MG220M, MG220P, MG220X, MGC24H, MGC40H, MGMT06P, MGMT10P, MGVT06P, MGVT10P, VE106M...(Other models you can see in the webshop)		

			
1			
GEV No.	690099	Ref. No.	R58002150
description	hinge pin mounting pos. upper for door		
For models:	EC106M, EC110M, EC210M, EM010M+SC, EM106H, EM106M, EM106M+SC, EM106P, EM110H, EM110M, EM110M+SC, EM110P, EM210H, EM210M, EM210M+SC, EM210P, EV006M, EV106H, EV106M, EV106M+SC, EV106P, EV110H, EV110M, EV110M+SC, EV110P, EV210H, EV210M, EV210M+SC, EV210P, GC106M, GC110M, GC210M, GM106H, GM106M, GM106M+SC, GM106P, GM110H, GM110M, GM110M+SC, GM110P, GM210H, GM210M, GM210M+SC, GM210P, GMT06D, GMT20D, GV106H, GV106M, GV106M+SC, GV106P...(Other models you can see in the webshop)		

			
1			
GEV No.	506229	Ref. No.	R11200380
description	injection pipe for combi-steamer L 205mm ø 10mm		
For models:	GMT06D, GMT20D, GVT06D, GVT20D, MACE07M, MACE10M, MACE20M, MACG07M, MACG10M, MACG20M, ME061D, ME061M, ME061P, ME061T, ME101D, ME101M, ME101P, ME101T, ME102D, ME102M, ME102P, ME201D, ME201M, ME201P, ME201T, ME202D, ME202M, ME202P, ME202T, MEMT06D, MEMT06P, MEMT10D, MEMT10P, MEMT20D, MEMT20P, MEMT21D, MEMT21P, MEMT40D, MEMT40P, MEVT06D, MEVT06P, MEVT10D, MEVT10P, MEVT20D, MEVT20P, MEVT21D, MEVT21P, MEVT40D, MEVT40P, MG061D...(Other models you can see in the webshop)		

			
1			
GEV No.	691289	Ref. No.	R58004830
description	nut thread M18x1 H 5mm WS 22 brass Qty 1 pcs for door handle		
For models:	CVE004H, CVE004M, CVE104H, CVE104M, CVE105H, CVE105M, CVG105H, CVG105M, EC106M, EC110M, EC210M, EM010M+SC, EM106H, EM106M, EM106M+SC, EM106P, EM110H, EM110M, EM110M+SC, EM110P, EM210H, EM210M, EM210M+SC, EM210P, EV006M, EV106H, EV106M, EV106M+SC, EV106P, EV110H, EV110M, EV110M+SC, EV110P, EV210H, EV210M, EV210M+SC, EV210P, FE105M, FE105X, FE110M, FE110X, FE210M, FG105M, FG105X, FG110M, FG110X, FG210M, FG210X, GC106M, GC110M...(Other models you can see in the webshop)		



			
GEV No.	691296	Ref. No.	R61400052
description	plain washer ID ø 10.5mm ED ø 21mm thickness 2mm SS Qty 1 pcs for fan wheel		
For models:	CVE105H, CVE105M, CVG105H, CVG105M, EC106M, EM106H, EM106M, EM106M+SC, EM106P, EV006M, EV106H, EV106M, EV106M+SC, EV106P, FE105M, FE105X, FG105M, FG105X, GC106M, GM106H, GM106M, GM106M+SC, GM106P, GMT06D, GV106H, GV106M, GV106M+SC, GV106P, GVT06D, MACE07M, MACG07M, ME061D, ME061M, ME061P, ME061T, ME106M, ME106P, ME106X, MEMT06D, MEMT06P, MEVT06D, MEVT06P, MG061D, MG061M, MG061P, MG061T, MG106M, MG106P, MG106X, MGMT06D...(Other models you can see in the webshop)		

			
GEV No.	691292	Ref. No.	R10401710
description	plain washer ID ø 12mm ED ø 17.5mm thickness 1mm SS Qty 1 pcs		
For models:	GMT06D, GMT20D, GVT06D, GVT20D, MACE07M, MACE10M, MACE20M, MACG07M, MACG10M, MACG20M, ME061D, ME061M, ME061P, ME061T, ME101D, ME101M, ME101P, ME101T, ME102D, ME102M, ME102P, ME102T, ME106M, ME106P, ME106X, ME110M, ME110P, ME110X, ME210M, ME210P, ME210X, MEMT06D, MEMT06P, MEMT10D, MEMT10P, MEMT20D, MEMT20P, MEVT06D, MEVT06P, MEVT10D, MEVT10P, MEVT20D, MEVT20P, MG061D, MG061M, MG061P, MG061T, MG101D, MG101M, MG101P...(Other models you can see in the webshop)		

			
GEV No.	691283	Ref. No.	R58003240
description	pressure bolt for door handle D1 ø 8mm D2 ø 11mm L 73mm thread M6 bolt 16mm bolt ø 5mm		
For models:	CVE105H, CVE105M, CVG105H, CVG105M, FE105M, FE105X, FE110M, FE110X, FE210M, FG105M, FG105X, FG110M, FG110X, FG210M, FG210X, MACE04M, MACE05M, MACE07M, MACE10M, MACE20M, MACG05M, MACG07M, MACG10M, MACG20M, ME106M, ME106P, ME106X, ME110M, ME110P, ME110X, ME210M, ME210P, ME210X, MG106M, MG106P, MG106X, MG110M, MG110P, MG110X, MG210M, MG210P, MG210X, MVE042P, MVE051P, MVG051P, PE040M, PE040X, PE080M, PE080X, PG040M...(Other models you can see in the webshop)		

			
GEV No.	691297	Ref. No.	R62030118
description	reducer thread 1/4 / 1/8		
For models:	GVT06D, GVT20D, MEVT06D, MEVT06P, MEVT10D, MEVT10P, MEVT20D, MEVT20P, MEVT21D, MEVT21P, MEVT40D, MEVT40P, MGVT06D, MGVT06P, MGVT10D, MGVT10P, MGVT20D, MGVT20P, MGVT21D, MGVT21P, MGVT40D, MVE042P, MVE051P, MVG051P		

			
GEV No.	694319	Ref. No.	R58003390
description	screw connection for pressure switch L 50mm WS 30 brass thread 1/4"		
For models:	CVE004H, CVE004M, CVE104H, CVE104M, CVE105H, CVE105M, CVG105H, CVG105M, EV106H, EV106P, EV110H, EV110P, EV210H, EV210P, GV106H, GV106P, GV110H, GV110P, GV210H, GV210P, MG202D, MG202M, MG202P, MGMT40D, MGMT40P, MGVT40D, MGVT40P, VE004M, VE004X, VE104M, VE104X, VE105M, VE105X, VE106P, VE120P, VE210P, VE220P, VG105M, VG105X, VG106P, VG110P, VG120P, VG210P, VG220P		

			
GEV No.	691280	Ref. No.	R58005340
description	sealing disc for door handle mounting pos. lower ED ø 25mm ID ø 5.5mm H 5mm		
For models:	CVE004H, CVE004M, CVE104H, CVE104M, CVE105H, CVE105M, CVG105H, CVG105M, EC106M, EC110M, EC210M, EM010M+SC, EM106H, EM106M, EM106M+SC, EM106P, EM110H, EM110M, EM110M+SC, EM110P, EM210H, EM210M, EM210M+SC, EM210P, EV006M, EV106H, EV106M, EV106M+SC, EV106P, EV110H, EV110M, EV110M+SC, EV110P, EV210H, EV210M, EV210M+SC, EV210P, FE105M, FE105X, FE110M, FE110X, FE210M, FG105M, FG105X, FG110M, FG110X, FG210M, FG210X, GC106M, GC110M...(Other models you can see in the webshop)		

			
GEV No.	691281	Ref. No.	R58004270
description	spacer piece for door handle L 34mm ID ø 6mm ED ø 8mm		
For models:	CVE004H, CVE004M, CVE104H, CVE104M, CVE105H, CVE105M, CVG105H, CVG105M, FE105M, FE105X, FE110M, FE110X, FE210M, FG105M, FG105X, FG110M, FG110X, FG210M, FG210X, MACE04M, MACE05M, MACE07M, MACE10M, MACE20M, MACG05M, MACG07M, MACG10M, MACG20M, ME106M, ME106P, ME106X, ME110M, ME110P, ME110X, ME210M, ME210P, ME210X, MG106M, MG106P, MG106X, MG110M, MG110P, MG110X, MG210M, MG210P, MG210X, MVE042P, MVE051P, MVG051P, PE040M...(Other models you can see in the webshop)		

			
GEV No.	692300	Ref. No.	R70050100
description	stopper with screw connection for glass plate D1 ø 15mm L 8mm thread M4		
For models:	GMT06D, GMT20D, GVT06D, GVT20D, MACE07M, MACE10M, MACE20M, MACG07M, MACG10M, MACG20M, ME061D, ME061M, ME061P, ME061T, ME101D, ME101M, ME101P, ME101T, ME102D, ME102M, ME102P, ME102T, ME201D, ME201M, ME201P, ME201T, ME202D, ME202M, ME202P, ME202T, MEMT06D, MEMT06P, MEMT10D, MEMT10P, MEMT20D, MEMT20P, MEMT21D, MEMT21P, MEMT40D, MEMT40P, MEVT06D, MEVT06P, MEVT10D, MEVT10P, MEVT20D, MEVT20P, MEVT21D, MEVT21P, MEVT40D, MEVT40P...(Other models you can see in the webshop)		

for tilting bratt pans

spare parts and accessories



1

GEV No.	514223	Ref. No.	291110 MA291110
description	bearing screw kettle type series 700/900 tilting bratt pan		
For models:	BR707E, BR707EI, BR707G, BR707GI, BR94E, BR94EI, BR94G, BR94GI, BR96E, BR96EI, BR96G, BR96GI, BR9M4E, BR9M4EI, BR9M4G, BR9M4GI, BR9M6E, BR9M6EI, BR9M6G, BR9M6GI, BR9SB4E, BR9SB4EI, BR9SB4G, BR9SB4GI, P9D10E, P9D10G, P9D15E, P9D15G, P9D5G, P9DA10E, P9DA10G, P9DA15E, P9DA15G, P9DSB10E, P9DSB10G, P9I10E, P9I10G, P9I15E, P9I5G, P9IA10E, P9IA10G, P9IA15E, PD707G, PDASB10E, PDASB10G, PI707E, PI707G		



1

GEV No.	514225	Ref. No.	290900 MA290900
description	bush ID ø 18mm ext. ø 37		
For models:	BR707E, BR707EI, BR707G, BR707GI, BR94E, BR94EI, BR94G, BR94GI, BR96E, BR96EI, BR96G, BR96GI, BR9M4E, BR9M4EI, BR9M4G, BR9M4GI, BR9M6E, BR9M6EI, BR9M6G, BR9M6GI, BR9SB4E, BR9SB4EI, BR9SB4G, BR9SB4GI, P9D10E, P9D10G, P9D15E, P9D15G, P9D5G, P9DA10E, P9DA10G, P9DA15E, P9DA15G, P9DSB10E, P9DSB10G, P9I10E, P9I10G, P9I15E, P9I5G, P9IA10E, P9IA10G, P9IA15E, PD707G, PDASB10E, PDASB10G, PI707E, PI707G		



1

GEV No.	514232	Ref. No.	CM051403 MACM051403
description	bush left tilting bratt pan type series 700 kettle series 900		
For models:	BR78EF, BR78EI, BR78G, BR78GF, BR78GI, BR912EFM, BR912EIM, BR912GFM, BR912GIM, BR98EF, BR98EFM, BR98EI, BR98EIM, BR98GF, BR98GFM, BR98GI, BR98GIM, BR9S8EF, BR9S8EI, BR9S8GF, BR9S8GI, NPD76G5, NPD96G5, NPI76E5, NPI76G5, NPI96E5, NPI96G5, PD76G5, PD96G5, PD98E10, PD98E15, PD98G10, PD98G15, PD98G15A, PD9S8E10, PD9S8G10, PI76E5, PI76G5, PI96E5, PI96G5, PI98E10, PI98E15, PI98G10, PI98G14, PI98G14A, PI9S8E10		



1

GEV No.	514229	Ref. No.	192100 CM051301 CM192101 MACM192101
description	bush right tilting bratt pan type series 700 kettle series 900		
For models:	BR78EF, BR78EI, BR78G, BR78GF, BR78GI, BR912EFM, BR912EIM, BR912GFM, BR912GIM, BR98EF, BR98EFM, BR98EI, BR98EIM, BR98GF, BR98GFM, BR98GI, BR98GIM, BR9S8EF, BR9S8EI, BR9S8GF, BR9S8GI, NPD76G5, NPD78G8, NPD96G5, NPI76E5, NPI76G5, NPI78E8, NPI78G8, NPI96E5, NPI96G5, PD76G5, PD96G5, PD98E10, PD98E15, PD98G10, PD98G15, PD98G15A, PD9S8E10, PD9S8G10, PI76E5, PI76G5, PI96E5, PI96G5, PI98E10, PI98E15, PI98G10, PI98G14, PI98G14A, PI9S8E10		

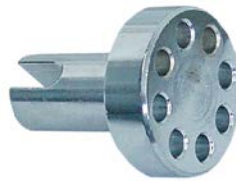

1

GEV No.	514227	Ref. No.	CM051604 MACM051604
description	hinge bolt kettle type series 700/900 tilting bratt pan		
For models:	BR78EF, BR78EI, BR78G, BR78GF, BR78GI, BR912EFM, BR912EIM, BR912GFM, BR912GIM, BR98EF, BR98EFM, BR98EI, BR98EIM, BR98GF, BR98GFM, BR98GI, BR98GIM, BR9S8EF, BR9S8EI, BR9S8GF, BR9S8GI, NPD76G5, NPD78G8, NPD96G5, NPI76E5, NPI76G5, NPI78E8, NPI78G8, NPI96E5, NPI96G5, PD76G5, PD98E10, PD98E15, PD98G10, PD98G15, PD98G15A, PD9S8E10, PD9S8G10, PI76E5, PI76G5, PI98E10, PI98E15, PI98G10, PI98G14, PI98G14A, PI9S8E10		





1

GEV No.	692579	Ref. No.	CM219200 MACM219200
description	spacer bush thickness 1mm ID ø 16mm H 18mm ext. ø 18		
For models:	BR78EF, BR78EI, BR78G, BR78GF, BR78GI, BR912EFM, BR912EIM, BR912GFM, BR912GIM, BR98EF, BR98EFM, BR98EI, BR98EIM, BR98GF, BR98GFM, BR98GI, BR98GIM, BR9S8EF, BR9S8EI, BR9S8GF, BR9S8GI		





spindles

			
1			
GEV No.	514023	Ref. No.	1685800 MA1685800
description	spindle nut thread M20x2.5 left-hand thread W 39mm bolt ø 20mm D 40mm H 40mm		
For models:	BR707E, BR707EI, BR707G, BR707GI, BR94E, BR94EI, BR94G, BR94GI, BR96E, BR96EI, BR9M4E, BR9M4EI, BR9M4G, BR9M4GI, BR9M6E, BR9M6EI, BR9M6G, BR9M6GI, BR9S84E, BR9S84EI, BR9S84G, BR9S84GI		

			
1			
GEV No.	514024	Ref. No.	1688000 MA1688000
description	spindle nut thread M20x2.5 right-hand thread W 39mm bolt ø 20mm D 40mm H 40mm		
For models:	BR707E, BR707EI, BR707G, BR707GI, BR94E, BR94EI, BR94G, BR94GI, BR96E, BR96EI, BR9M4E, BR9M4EI, BR9M4G, BR9M4GI, BR9M6E, BR9M6EI, BR9M6G, BR9M6GI, BR9S84E, BR9S84EI, BR9S84G, BR9S84GI		

			
1			
GEV No.	514237	Ref. No.	CM184300 MACM184300
description	thread block thread TR20x4 right-hand thread W 39mm bolt ø 20mm D 40mm H 40mm		
For models:	BR78EF, BR78EI, BR78GF, BR78GI, BR912EFM, BR912EIM, BR912GFM, BR912GIM, BR98EF, BR98EFM, BR98EI, BR98EIM, BR98GF, BR98GFM, BR98GI, BR98GIM, BR9S8EF, BR9S8EI, BR9S8GF, BR9S8GI, NBR78EF, NBR78EI, NBR78GF, NBR78GI, NBR912EFM, NBR912EIM, NBR912GFM, NBR912GIM, NBR98EF, NBR98EFM, NBR98EI, NBR98EIM, NBR98GF, NBR98GFM, NBR98GI, NBR98GIM, XCABR7E, XCABR7G		

			
1			
GEV No.	692503	Ref. No.	19622-00 1962200R MA1962200R
description	threaded rod L 49.5mm complete		
For models:	BR94E, BR94EI, BR94G, BR94GI, BR9M4E, BR9M4EI, BR9M4G, BR9M4GI, BR9M6E, BR9M6EI, BR9M6G, BR9M6GI, BR9S84E, BR9S84EI, BR9S84G, BR9S84GI		



			
1			
GEV No.	514239	Ref. No.	CM199200 CM199201 MACM199201
description	threaded rod thread TR20x4 total length 915mm tilting bratt pan		
For models:	BR78EF, BR78EI, BR78GF, BR78GI, BR912EFM, BR912EIM, BR912GFM, BR912GIM, BR98EF, BR98EFM, BR98EI, BR98EIM, BR98GF, BR98GFM, BR98GI, BR98GIM, BR9S8EF, BR9S8EI, BR9S8GF, BR9S8GI		

			
1			
GEV No.	514238	Ref. No.	CM199100 CM199101 MACM199100 MACM199101
description	threaded rod total length 740mm tilting bratt pan		
For models:	BR78EF, BR78EI, BR78GF, BR78GI, BR912EFM, BR912EIM, BR912GFM, BR912GIM, BR98EF, BR98EFM, BR98EI, BR98EIM, BR98GF, BR98GFM, BR98GI, BR98GIM, BR9S8EF, BR9S8EI, BR9S8GF, BR9S8GI		

miscellaneous

			
1			
GEV No.	514190	Ref. No.	CM219000 MACM219000
description	pipe L 622mm ø 40mm for tilting bratt pan chrome-plated		
For models:	BR78EF, BR78EI, BR78G, BR78GF, BR78GI, BR912EFM, BR912EIM, BR912GFM, BR912GIM, BR98EF, BR98EFM, BR98EI, BR98EIM, BR98GF, BR98GFM, BR98GI, BR98GIM, BR9S8EF, BR9S8EI, BR9S8GF, BR9S8GI		

			
1			
GEV No.	691352	Ref. No.	1041724100 MA1041724100
description	stockpot L 650mm W 350mm H 95mm		
For models:	BRE40, BRE40D, BRE40DB, BRE40DG, BRE40DGB, BRE40G, BRG40, BRG40G, OBRE40		

				
1				
GEV No.	514235	Ref. No.	1687600 1687632 MA1687632	
description	tilting mechanism complete			
For models:	BR707E, BR707EI, BR707G, BR707GI			
spare parts for	514235			
	GEV No.	514023	Ref. No.	1685800 MA1685800
	spindle nut thread M20x2.5 left-hand thread W 39mm bolt ø 20mm D 40mm H 40mm			
	GEV No.	514024	Ref. No.	1688000 MA1688000
	spindle nut thread M20x2.5 right-hand thread W 39mm bolt ø 20mm D 40mm H 40mm			

			
GEV No.	514236	Ref. No.	1478432 MA1478432
description	tilting mechanism complete		
For models:	BR94E, BR94EI, BR94G, BR94GI, BR9M4E, BR9M4EI, BR9M4G, BR9M4GI, BR9M6E, BR9M6EI, BR9M6G, BR9M6GI, BR9SB4E, BR9SB4EI, BR9SB4G, BR9SB4GI		

for boiling pans

spare parts and accessories

			
GEV No.	514223	Ref. No.	291110 MA291110
description	bearing screw kettle type series 700/900 tilting bratt pan		
For models:	BR707E, BR707EI, BR707G, BR707GI, BR94E, BR94EI, BR94G, BR94GI, BR96E, BR96EI, BR96G, BR96GI, BR9M4E, BR9M4EI, BR9M4G, BR9M4GI, BR9M6E, BR9M6EI, BR9M6G, BR9M6GI, BR9SB4E, BR9SB4EI, BR9SB4G, BR9SB4GI, P9D10E, P9D10G, P9D15E, P9D15G, P9D5G, P9DA10E, P9DA10G, P9DA15E, P9DA15G, P9DSB10E, P9DSB10G, P9I10E, P9I10G, P9I15E, P9I5G, P9IA10E, P9IA10G, P9IA15E, PD707G, PDASB10E, PDASB10G, PI707E, PI707G		

			
GEV No.	514225	Ref. No.	290900 MA290900
description	bush ID ø 18mm ext. ø 37		
For models:	BR707E, BR707EI, BR707G, BR707GI, BR94E, BR94EI, BR94G, BR94GI, BR96E, BR96EI, BR96G, BR96GI, BR9M4E, BR9M4EI, BR9M4G, BR9M4GI, BR9M6E, BR9M6EI, BR9M6G, BR9M6GI, BR9SB4E, BR9SB4EI, BR9SB4G, BR9SB4GI, P9D10E, P9D10G, P9D15E, P9D15G, P9D5G, P9DA10E, P9DA10G, P9DA15E, P9DA15G, P9DSB10E, P9DSB10G, P9I10E, P9I10G, P9I15E, P9I5G, P9IA10E, P9IA10G, P9IA15E, PD707G, PDASB10E, PDASB10G, PI707E, PI707G		

			
GEV No.	514232	Ref. No.	CM051403 MACM051403
description	bush left tilting bratt pan type series 700 kettle series 900		
For models:	BR78EF, BR78EI, BR78G, BR78GF, BR78GI, BR912EFM, BR912EIM, BR912GFM, BR912GIM, BR98EF, BR98EFM, BR98EI, BR98EIM, BR98GF, BR98GFM, BR98GI, BR98GIM, BR9S8EF, BR9S8EI, BR9S8GF, BR9S8GI, NPD76G5, NPD96G5, NPI76E5, NPI76G5, NPI96E5, NPI96G5, PD76G5, PD96G5, PD98E10, PD98E15, PD98G10, PD98G15, PD98G15A, PD9S8E10, PD9S8G10, PI76E5, PI76G5, PI96E5, PI96G5, PI98E10, PI98E15, PI98G10, PI98G14, PI98G14A, PI9S8E10		

			
GEV No.	514229	Ref. No.	192100 CM051301 CM192101 MACM192101
description	bush right tilting bratt pan type series 700 kettle series 900		
For models:	BR78EF, BR78EI, BR78G, BR78GF, BR78GI, BR912EFM, BR912EIM, BR912GFM, BR912GIM, BR98EF, BR98EFM, BR98EI, BR98EIM, BR98GF, BR98GFM, BR98GI, BR98GIM, BR9S8EF, BR9S8EI, BR9S8GF, BR9S8GI, NPD76G5, NPD78G8, NPD96G5, NPI76E5, NPI76G5, NPI78E8, NPI78G8, NPI96E5, NPI96G5, PD76G5, PD96G5, PD98E10, PD98E15, PD98G10, PD98G15, PD98G15A, PD9S8E10, PD9S8G10, PI76E5, PI76G5, PI96E5, PI96G5, PI98E10, PI98E15, PI98G10, PI98G14, PI98G14A, PI9S8E10		

			
GEV No.	514227	Ref. No.	CM051604 MACM051604
description	hinge bolt kettle type series 700/900 tilting bratt pan		
For models:	BR78EF, BR78EI, BR78G, BR78GF, BR78GI, BR912EFM, BR912EIM, BR912GFM, BR912GIM, BR98EF, BR98EFM, BR98EI, BR98EIM, BR98GF, BR98GFM, BR98GI, BR98GIM, BR9S8EF, BR9S8EI, BR9S8GF, BR9S8GI, NPD76G5, NPD78G8, NPD96G5, NPI76E5, NPI76G5, NPI78E8, NPI78G8, NPI96E5, NPI96G5, PD76G5, PD98E10, PD98E15, PD98G10, PD98G15, PD98G15A, PD9S8E10, PD9S8G10, PI76E5, PI76G5, PI98E10, PI98E15, PI98G10, PI98G14, PI98G14A, PI9S8E10		

for sliding doors

door guides



1

GEV No.	690705	Ref. No.	119390.0 MA1193900
description	guide bar		
For models:	IR13C, IR13CC, IR13CV, IR13M, IR13MC, IR13MV, IR13V, IR17C, IR17CC, IR17CV, IR17M, IR17MC, IR17MV, IR17V, TR13C2P, TR13I4C, TR13I4CC, TR13I4CV, TR13N2C1P, TR13N2C1PC, TR13N2C1PV, TR13N2P, TR13N2PC, TR13N2PV, TR13N4C, TR13N4CC, TR13N4CV, TR17C3P, TR17I6C, TR17I6CC, TR17I6CV, TR17N2C2P, TR17N2C2PC, TR17N2C2PV, TR17N2P, TR17N3P, TR17N3PC, TR17N3PV, TR17N4C1P, TR17N4C1PC, TR17N4C1PV, TR17N6C, TR17N6CC, TR17N6CV, TR21N2C3P, TR21N2C3PC, TR21N2C3PV, TR21N2P, TR21N4C2P, TR21N4C2PC... (Other models you can see in the webshop)		



1

GEV No.	690706	Ref. No.	25351.00
description	guide bar left		
For models:	IR13C, IR13CC, IR13CV, IR13M, IR13MC, IR13MV, IR13V, IR17C, IR17CC, IR17CV, IR17M, IR17MC, IR17MV, IR17V, TR13C2P, TR13I4C, TR13I4CC, TR13I4CV, TR13N2C1P, TR13N2C1PC, TR13N2C1PV, TR13N2P, TR13N2PC, TR13N2PV, TR13N4C, TR13N4CC, TR13N4CV, TR17C3P, TR17I6C, TR17I6CC, TR17I6CV, TR17N2C2P, TR17N2C2PC, TR17N2C2PV, TR17N2P, TR17N3P, TR17N3PC, TR17N3PV, TR17N4C1P, TR17N4C1PC, TR17N4C1PV, TR17N6C, TR17N6CC, TR17N6CV, TR21N2C3P, TR21N2C3PC, TR21N2C3PV, TR21N2P, TR21N4C2P, TR21N4C2PC... (Other models you can see in the webshop)		

for dishwashers

drain and intake components

MARENO

drain /intake bodies



1

GEV No.	511916	Ref. No.	1036600400
description	intake body		
For models:	DLS30, DLS303, DLS30P, DLS30P3, DLS31, DLS313, DLS31P3, MLS30, MLS303, MLS30P, MLS30P3, MLS31, MLS313, MLS31P3, MLS35, MLS353, MPLS30P		



1

GEV No.	506224	Ref. No.	1032100700
description	nut thread 1½" plastic		
For models:	MLC50, MLC503, MLC65, MLC653		

filters



1

GEV No.	511917	Ref. No.	1036601300	
description	intake filter			
For models:	DLS30, DLS303, DLS30P, DLS30P3, DLS31, DLS313, DLS31P3, MLS30, MLS303, MLS30P, MLS30P3, MLS31, MLS313, MLS31P3, MLS35, MLS353, MPLS30P			
spare parts for	511917			
	GEV No.	511916	Ref. No.	1036600400
	intake body			

overflow pipes



1

GEV No.	532062	Ref. No.	1036502300
description	O-ring EPDM thickness 2.62mm ID ø 29.82mm Qty 10 pcs		
For models:	DLS30, DLS303, DLS30P, DLS30P3, DLS31, DLS313, DLS31P3, MLC50, MLC503, MLC65, MLC653, MLS30, MLS303, MLS30P, MLS30P3, MLS31, MLS313, MLS31P3, MLS35, MLS353, MPLS30P		



1

GEV No.	514221	Ref. No.	CM142100 MACM142100
description	overflow pipe ø 20mm L 150mm		
For models:	B124E, B74E, B74G, B78E, B78G, B94E, B94G, B98E, B98G, NB74E, NB74G, NB78E, NB78G, NB94E, NB94G, NB98E, NB98G		



1

GEV No.	519454	Ref. No.	1036600700
description	overflow pipe \varnothing 31mm L 238mm ID \varnothing 27mm ED \varnothing 31mm thickness 3mm		
For models:	DLS30, DLS303, DLS30P, DLS30P3, DLS31, DLS313, DLS31P3, MLS30, MLS303, MLS30P, MLS30P3, MLS31, MLS313, MLS31P3, MLS35, MLS353, MPLS30P		

containers

accessories



1

GEV No.	510654	Ref. No.	200454
description	gasket H 6mm D1 \varnothing 82mm D2 \varnothing 68mm		

boilers

boilers for dishwashers



1

GEV No.	511000	Ref. No.	330307
description	boiler \varnothing 160mm L 500mm capacity 10l flange 3 hole flange inlet \varnothing 12		

softener cartridges

softening columns



1

GEV No.	530000	Ref. No.	640209
description	softener 4-fold L 380mm W 180mm		

housing and bezels

fastening angles



1

GEV No.	510937	Ref. No.	330725
description	mounting angle for solenoid valve		

hood mechanics for dishwashers

bolts



1

GEV No.	510988	Ref. No.	340493
description	bolt for hood joint		

bushes



1

GEV No.	510867	Ref. No.	190632
description	bush hood mechanics		



1

GEV No.	510848	Ref. No.	290821
description	spacer bush for switch hood mechanics		

springs



1

GEV No.	511968	Ref. No.	10.337.114.00
description	spring for hood mechanics L 383mm wire gauge \varnothing 5.5mm \varnothing 43mm		
For models:	MLC50, MLC503, MLC65, MLC653		



guide bars			
1			
GEV No.	511005	Ref. No.	180604
description	guide bar L 575mm hood mechanics C33, C34, LC380, LC400		

1			
GEV No.	510948	Ref. No.	180624
description	guide bar L 575mm hood mechanics C95, C155, C165, C166		

1			
GEV No.	510827	Ref. No.	180606
description	guide bar mounting pos. left hood mechanics for door		

1			
GEV No.	510826	Ref. No.	180605
description	guide bar mounting pos. right hood mechanics for door		

hood handle supports			
1			
GEV No.	510350	Ref. No.	190608
description	guide for hood handle		

1			
GEV No.	510856	Ref. No.	190110
description	handle holder hood mechanics		

1			
GEV No.	510868	Ref. No.	191013
description	handle holder hood mechanics		

1			
GEV No.	510869	Ref. No.	191014
description	handle holder hood mechanics		

miscellaneous			
1			
GEV No.	510864	Ref. No.	190607
description	bush for spring holder hood mechanics		

1			
GEV No.	510810	Ref. No.	320627
description	fixing plate for guide		

1			
GEV No.	510889	Ref. No.	200497
description	gasket for door guides hood mechanics		



1			
GEV No.	510882	Ref. No.	200451
description	gasket for opposite support L 100mm hood mechanics rubber H 3mm black W 30mm		

1			
GEV No.	511397	Ref. No.	330917
description	opposite support hood mechanics		





1			
GEV No.	511393	Ref. No.	190149
description	strengthening for handle holder hood mechanics		

air traps				
1				
GEV No.	510347	Ref. No.	161303	
description	air trap			
spare parts for	510347			
	GEV No.	510877	Ref. No.	200415
	description flat gasket rubber ED ø 18mm ID ø 10mm thickness 3mm Qty 1 pcs			

Table continues overleaf

spare parts for	510347		
	GEV No.	560197	Ref. No. 260407
	nut thread M10 H 8mm WS 17 SS DIN/ISO DIN 934 / ISO 4032/8673 Qty 1 pcs		
accessories for	510347		
	GEV No.	510877	Ref. No. 200415
	flat gasket rubber ED ø 18mm ID ø 10mm thickness 3mm Qty 1 pcs		
	GEV No.	560197	Ref. No. 260407
	nut thread M10 H 8mm WS 17 SS DIN/ISO DIN 934 / ISO 4032/8673 Qty 1 pcs		

	1		
GEV No.	511199	Ref. No.	161308
description	air trap		
accessories for	511199		
	GEV No.	511283	Ref. No. 200927
	flat gasket rubber ED ø 30mm ID ø 20mm thickness 2mm Qty 1 pcs		
	GEV No.	511284	Ref. No. 270121
	nut		
	GEV No.	511286	Ref. No. 450143
	hose clamp ø 38mm wire gauge ø 3.2mm Qty 1 pcs		
	GEV No.	511289	Ref. No. 161312
	hose ED ø 9.5mm ID ø 5mm L 420mm equiv. no. 161312		

	1		
GEV No.	510342	Ref. No.	161301
description	air trap ø 49mm H 155mm		
spare parts for	510342		
	GEV No.	510877	Ref. No. 200415
	flat gasket rubber ED ø 18mm ID ø 10mm thickness 3mm Qty 1 pcs		
	GEV No.	560197	Ref. No. 260407
	nut thread M10 H 8mm WS 17 SS DIN/ISO DIN 934 / ISO 4032/8673 Qty 1 pcs		
accessories for	510342		
	GEV No.	510877	Ref. No. 200415
	flat gasket rubber ED ø 18mm ID ø 10mm thickness 3mm Qty 1 pcs		
	GEV No.	560197	Ref. No. 260407
	nut thread M10 H 8mm WS 17 SS DIN/ISO DIN 934 / ISO 4032/8673 Qty 1 pcs		

	1		
GEV No.	511454	Ref. No.	1036600900
description	air trap W 45mm H 95mm		
For models:	DLS30, DLS303, DLS30P, DLS30P3, DLS31, DLS313, DLS31P3, MLC50, MLC503, MLC65, MLC653, MLS30, MLS303, MLS30P, MLS30P3, MLS31, MLS313, MLS31P3, MLS35, MLS353, MPLS30P		

air trap accessories

	1		
GEV No.	510486	Ref. No.	161306
description	air ducting ø 1/2"mm		

	1		
GEV No.	510354	Ref. No.	160727
description	end cap ø 1/2"mm		

	1		
GEV No.	510877	Ref. No.	200415
description	flat gasket rubber ED ø 18mm ID ø 10mm thickness 3mm Qty 1 pcs		

	1		
GEV No.	511283	Ref. No.	200927
description	flat gasket rubber ED ø 30mm ID ø 20mm thickness 2mm Qty 1 pcs		

	1		
GEV No.	511289	Ref. No.	161312
description	hose ED ø 9.5mm ID ø 5mm L 420mm equiv. no. 161312		





			
1			
GEV No.	511286	Ref. No.	450143
description	hose clamp ø 38mm wire gauge ø 3.2mm Qty 1 pcs		

			
1			
GEV No.	511284	Ref. No.	270121
description	nut		

<p>pipes</p> 			
1			
GEV No.	510808	Ref. No.	160115
description	pipe L 1000mm ø 9.5mm		

<p>backflow preventers</p> 			
<p>backflow preventers</p>			
1			
GEV No.	510993	Ref. No.	620243
description	backflow preventer		

<p>non-return valves</p> 			
1			
GEV No.	520886	Ref. No.	R65110640
description	non-return valve plastic total length 67mm		
For models:	ME061T, ME101T, ME102T, ME201T, MEMT06P, MEMT10P, MEMT20P, MEMT21P, MEMT40P, MG102T, MG201T, MG202T, MGMT06P, MGMT10P, MGMT20P, MGMT21P, MGMT40P		

<p>accessories</p> 			
1			
GEV No.	511277	Ref. No.	190330
description	T-piece thread 1/2" ø 18mm		

<p>miscellaneous</p> 			
1			
GEV No.	510349	Ref. No.	160755
description	plug D1 ø 87mm mounting ø 72mm ID ø 60mm		
accessories for	510349		
	GEV No.	Ref. No.	
	510947	200489	
	 flat gasket rubber ED ø 85mm ID ø 73mm thickness 2mm Qty 1 pcs equiv. no. 200489 suitable for COMENDA		

<p>door mechanics</p> <p>linkage</p> 			
1			
GEV No.	511154	Ref. No.	330231
description	door pin tie bar		

<p>threaded shafts</p> 			
1			
GEV No.	511156	Ref. No.	342010
description	threaded part threaded part		

<p>sliding plates</p> 			
1			
GEV No.	510492	Ref. No.	160905
description	sliding plate for tie bar		

hinges

			
1			
GEV No.	511368	Ref. No.	441107
description	door hinge hinge mounting pos. left		

			
1			
GEV No.	511367	Ref. No.	441108
description	door hinge hinge mounting pos. right		

hinge pins

			
1			
GEV No.	511369	Ref. No.	341921
description	hinge pin hinge pin		



door bumpers

			
1			
GEV No.	510957	Ref. No.	190619
description	door bumper end stop		

locks

			
1			
GEV No.	510628	Ref. No.	103650180
description	catch hook plastic for door latch		

			
1			
GEV No.	510008	Ref. No.	180506
description	door catch for dishwasher		

			
1			
GEV No.	510627	Ref. No.	1036501710
description	housing plastic for door latch		
For models:	DLS30, DLS303, DLS30P, DLS30P3, DLS31, DLS313, DLS31P3, MLS30, MLS303, MLS30P, MLS30P3, MLS31, MLS313, MLS31P3, MLS35, MLS353, MPLS30P		
accessories for	510627		
	GEV No.	510628	Ref. No.
			103650180
	GEV No.	510629	Ref. No.
			1033706100

			
1			
GEV No.	510629	Ref. No.	1033706100
description	spring for door latch		
For models:	DLS30, DLS303, DLS30P, DLS30P3, DLS31, DLS313, DLS31P3, MLS30, MLS303, MLS30P, MLS30P3, MLS31, MLS313, MLS31P3, MLS35, MLS353, MPLS30P		

miscellaneous

			
1			
GEV No.	510938	Ref. No.	331764
description	fixing plate for door seal fixing plate		

screw connections

			
1			
GEV No.	510809	Ref. No.	160709
description	screw connection thread 1"		





washing and rinsing systems



			
1			
GEV No.	511240	Ref. No.	191076
description	bush for wash arm		

			
1			
GEV No.	510946	Ref. No.	200434
description	gasket		

			
1			
GEV No.	510956	Ref. No.	200435
description	gasket for wash pipe ø 40mm		

			
1			
GEV No.	510238	Ref. No.	1033706200
description	knurled nut ø 27mm H 13.4mm wash arm support		
For models:	DLS30, DLS303, DLS30P, DLS30P3, DLS31, DLS313, DLS31P3, MLC50, MLC503, MLS30, MLS303, MLS30P, MLS30P3, MLS31, MLS313, MLS31P3, MLS35, MLS353, MPLS30P		

			
1			
GEV No.	510374	Ref. No.	270118
description	nut thread M15x1.25 H 6.5mm WS 27 SS Qty 1 pcs		

				
1				
GEV No.	510481	Ref. No.	190315	
description	rinse arm support			
accessories for	510481			
	GEV No.	511180	Ref. No.	200457
	flat gasket rubber ED ø 24mm ID ø 16mm thickness 3mm Qty 1 pcs			
	GEV No.	511182	Ref. No.	—
	nut thread 3/8" H 8mm brass WS 24 Qty 1 pcs			

			
1			
GEV No.	511255	Ref. No.	280529
description	rinse arm support mounting pos. upper H 31mm thread 3/8" L 51mm WS 26 hose ø 12mm		

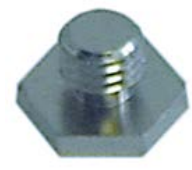
			
1			
GEV No.	511185	Ref. No.	261005
description	screw for wash arm support mounting pos. upper		

			
1			
GEV No.	519469	Ref. No.	1036600500
description	screw connection for wash arm support mounting pos. lower		
For models:	DLS30, DLS303, DLS30P, DLS30P3, DLS31, DLS313, DLS31P3, MLS30, MLS303, MLS30P, MLS30P3, MLS31, MLS313, MLS31P3, MLS35, MLS353, MPLS30P		

			
1			
GEV No.	510338	Ref. No.	170701
description	union nut dosing pump thread 1/2" ø 32mm H 15mm for dosing pump		

			
1			
GEV No.	510485	Ref. No.	180123
description	union nut for rinse arm thread 5/8"		

washing and rinsing systems (sorted by producer)

MARENO

wash arms

rotary

complete



GEV No.	510271	Ref. No.	420511
----------------	--------	-----------------	--------

description wash arm L 510mm mounting pos. upper/lower nozzles 16 mounting ø 20/57mm

spare parts for 510271

	GEV No.	510300	Ref. No.	160719
--	----------------	--------	-----------------	--------

end cap for wash arm

	GEV No.	510302	Ref. No.	200824
---	----------------	--------	-----------------	--------

O-ring EPDM ID ø 12.42mm thickness 1.78mm Qty 1 pcs

	GEV No.	510305	Ref. No.	180213
---	----------------	--------	-----------------	--------

opposite support for wash jet

	GEV No.	510346	Ref. No.	280409
---	----------------	--------	-----------------	--------

knurled nut thread M17x1 ø 35mm H 6mm SS

	GEV No.	510352	Ref. No.	—
---	----------------	--------	-----------------	---

nozzle mounting pos. right type C34

	GEV No.	510353	Ref. No.	—
---	----------------	--------	-----------------	---

nozzle mounting pos. left type C34

	GEV No.	510865	Ref. No.	—
---	----------------	--------	-----------------	---

bush for wash arm

rinse arms

rotary

complete



1

GEV No.	510266	Ref. No.	430316
----------------	--------	-----------------	--------

description rinse arm L 490mm mounting pos. upper/lower nozzles 6 mounting ø 12mm

spare parts for 510266

	GEV No.	510307	Ref. No.	261009
---	----------------	--------	-----------------	--------

Thumb screw thread M6 H 3mm thread L 8mm ø 28mm SS

	GEV No.	510369	Ref. No.	380314
--	----------------	--------	-----------------	--------

nozzle for rinse arm

	GEV No.	510813	Ref. No.	190641
---	----------------	--------	-----------------	--------

bush for rinse arm

	GEV No.	511242	Ref. No.	450218
---	----------------	--------	-----------------	--------

connector holder L 30mm H 16mm W 22mm

	GEV No.	530293	Ref. No.	200809
---	----------------	--------	-----------------	--------

O-ring EPDM thickness 1.78mm ID ø 8.73mm Qty 1 pcs







1

GEV No.	510283	Ref. No.	430319
----------------	--------	-----------------	--------

description rinse arm L 540mm mounting pos. upper nozzles 6 mounting ø 16mm



1

GEV No.	511250	Ref. No.	430323
description	rinse arm L 595mm mounting pos. upper/lower nozzles 6 mounting ø 16mm		
spare parts for	511250		
	GEV No.	510230	Ref. No. —
	connector holder L 31mm W 25mm H 16mm		
	GEV No.	510307	Ref. No. 261009
	Thumb screw thread M6 H 3mm thread L 8mm ø 28mm SS		
	GEV No.	511245	Ref. No. 190642
	bushing		
	GEV No.	511246	Ref. No. 380333
	nozzle for rinse arm		
	GEV No.	530293	Ref. No. 200809
	O-ring EPDM thickness 1.78mm ID ø 8.73mm Qty 1 pcs		

for toasters

pliers

pliers



1

GEV No.	690010	Ref. No.	10.310.098-00 MA1031009800
description	plier for toaster H 180mm total length 100mm		
For models:	TSE60M		

knobs

producer-specific knobs

MARENO



1

GEV No.	110021	Ref. No.	1621500
description	knob		



1

GEV No.	110022	Ref. No.	1621700
description	knob		
For models:	BR707E, FT74E, FT74ER, FT77E, FT77ERL		



1

GEV No.	110424	Ref. No.	1036703014
description	knob		
For models:	CWE42, CWE422, CWE62, CWE622, OCWE42, OCWE422, OCWE62, OCWE622		















1















GEV No.	110438	Ref. No.	18414-13
description	knob		
For models:	C7011EFE, C7011EFEQ, C707EFE, C707EFEQ		

















1

GEV No.	110412	Ref. No.	1036700900+1218500 1036701113+1218500 MA1036700900+MA1218500
description	knob 30-90°C		

			
GEV No.	110364	Ref. No.	1623600 1840900 1841700 862800 MA1840900
description	knob without symbol ø 65mm shaft ø 10x8mm shaft flat upper black		
For models:	704S, 706S, CP704G, CP707G, FB1GS, FP1GS, PD707G, T7011GFG, T707G, T707GFG, TPF706S		
accessories for	110364		
	GEV No.	110601	Ref. No. 1039110800 1039111800 1842000 862300 MA1842000 MA862300
knob dial plate gas tap with ignition flame t.max.°C°C			
	GEV No.	110606	Ref. No. 1039107300 MA1039107300
knob dial plate switch 7-position t.max.°C°C			
	GEV No.	110607	Ref. No. 1986600 MA1986600
knob dial plate energy regulator Min/Max t.max.°C°C			
	GEV No.	110608	Ref. No. 1039115600 MA1039115600
knob dial plate energy regulator 1-12 t.max.°C°C			
	GEV No.	110609	Ref. No. 1039115700 MA1039115700
knob dial plate energy regulator 2-circuit t.max.°C°C			
	GEV No.	110610	Ref. No. 1218500 MA1218500
knob dial plate thermostat t.max. 90°C 30-90°C			
	GEV No.	110612	Ref. No. 1840600 MA1840600
knob dial plate thermostat t.max. 180°C 100-180°C			
	GEV No.	110614	Ref. No. 1840400 MA1840400
knob dial plate thermostat t.max. 300°C 50-300°C			
	GEV No.	110616	Ref. No. 1840513 MA1840513
knob dial plate oven BH/TH/BH+TH t.max.°C°C			
	GEV No.	110948	Ref. No. 1039121600 MA1039121600
knob dial plate gas thermostat 1-7 t.max.°C°C			
	GEV No.	111531	Ref. No. 862500 MA862500
knob dial plate thermostat t.max. 90°C 30-90°C			

			
GEV No.	110361	Ref. No.	1036702900 1036703300 1841100 MA1036702900 MA1036703300
description	knob without symbol ø 65mm shaft ø 6x4.6mm shaft flat lower black		
For models:	BIG40, BIG60, BRG40, BRG40G, C7011GFG, C707GFE, C707GFG, CFG101, CFG70, CFG70M, FTG40B, FTG40BLC, FTG40BR, FTG60B, FTG60BLC, FTG60BR, FTG60BRR, FTG80B, FTG80BLC, FTG80BR, OCFG101, OCFG70, OPLG40, OPLG80, PLG40, PLG80, T7011GFG, T707GFG		
accessories for	110361		
	GEV No.	110437	Ref. No. 1804800 MA1804800
knob dial plate gas thermostat t.max. 325°C 145-325°C			
	GEV No.	110601	Ref. No. 1039110800 1039111800 1842000 862300 MA1842000 MA862300
knob dial plate gas tap with ignition flame t.max.°C°C			
	GEV No.	110603	Ref. No. 1930400 MA1930400
knob dial plate energy regulator Min/Max t.max.°C°C			
	GEV No.	110606	Ref. No. 1039107300 MA1039107300
knob dial plate gas thermostat t.max. 300°C 90-300°C			
	GEV No.	110607	Ref. No. 1986600 MA1986600
knob dial plate switch 7-position t.max.°C°C			
	GEV No.	110608	Ref. No. 1039115600 MA1039115600
knob dial plate energy regulator 1-12 t.max.°C°C			
	GEV No.	110609	Ref. No. 1039115700 MA1039115700
knob dial plate energy regulator 2-circuit t.max.°C°C			
	GEV No.	110610	Ref. No. 1218500 MA1218500
knob dial plate thermostat t.max. 90°C 30-90°C			
	GEV No.	110612	Ref. No. 1840600 MA1840600
knob dial plate thermostat t.max. 180°C 100-180°C			
	GEV No.	110614	Ref. No. 1840400 MA1840400
knob dial plate thermostat t.max. 300°C 50-300°C			
	GEV No.	110616	Ref. No. 1840513 MA1840513
knob dial plate oven BH/TH/BH+TH t.max.°C°C			
	GEV No.	110948	Ref. No. 1039121600 MA1039121600
knob dial plate gas thermostat 1-7 t.max.°C°C			
	GEV No.	111531	Ref. No. 862500 MA862500
knob dial plate thermostat t.max. 90°C 30-90°C			



				
1				
GEV No.	110362	Ref. No.	1036700900 1036701314 1036706400 1036708100 CM188200 MA1036700900 MACM188200	
description	knob without symbol ø 65mm shaft ø 6x4.6mm shaft flat right black			
For models:	BIE40, BIE40B, BIE60, BIE60B, BME40DM, BME40DMB, BME40M, BME60DM, BME60DMB, BME60M, BME80M, BRE40, BRE40D, BRE40DB, BRE40DG, BRE40DGB, BRE40G, BSEI40M, CFE60, CFE60P, CFE70, CFG101, CFG120, CFG70, CFG70M, CFGE61, CFGE61D, CFGE61L, CFGE61P, CFVE60, CRE6220, CRE6230, CRE6320, CRE6330, FQE41, FQE41L, FQE41L2, FQE61, FQE61L, FQE61L2, FTE100B, FTE100BR, FTE100C, FTE100CRL, FTE40B, FTE40BR, FTE40C, FTE40D, FTE40DC, FTE60B...(Other models you can see in the webshop)			
accessories for	110362			
	GEV No.	110437	Ref. No.	1804800 MA1804800
knob dial plate gas thermostat t.max. 325°C 145-325°C				
	GEV No.	110601	Ref. No.	1039110800 1039111800 1842000 862300 MA1842000 MA862300
knob dial plate gas tap with ignition flame t.max.°C°C				
	GEV No.	110603	Ref. No.	1930400 MA1930400
knob dial plate gas thermostat t.max. 300°C 90-300°C				
	GEV No.	110606	Ref. No.	1039107300 MA1039107300
knob dial plate switch 7-position t.max.°C°C				
	GEV No.	110607	Ref. No.	1986600 MA1986600
knob dial plate energy regulator Min/Max t.max.°C°C				
	GEV No.	110608	Ref. No.	1039115600 MA1039115600
knob dial plate energy regulator 1-12 t.max.°C°C				
	GEV No.	110609	Ref. No.	1039115700 MA1039115700
knob dial plate energy regulator 2-circuit t.max.°C°C				
	GEV No.	110610	Ref. No.	1218500 MA1218500
knob dial plate thermostat t.max. 90°C 30-90°C				
	GEV No.	110612	Ref. No.	1840600 MA1840600
knob dial plate thermostat t.max. 180°C 100-180°C				
	GEV No.	110614	Ref. No.	1840400 MA1840400
knob dial plate thermostat t.max. 300°C 50-300°C				
	GEV No.	110616	Ref. No.	1840513 MA1840513
knob dial plate oven BH/TH/BH+TH t.max.°C°C				
	GEV No.	110948	Ref. No.	1039121600 MA1039121600
knob dial plate gas thermostat 1-7 t.max.°C°C				
	GEV No.	111531	Ref. No.	862500 MA862500
knob dial plate thermostat t.max. 90°C 30-90°C				













				
1				
GEV No.	110360	Ref. No.	1036708200 1229100 1622100 1623100 1804000 1840700 1841300 1841600 1930300 862900 862914 863200 MA1840700 MA862900	
description	knob without symbol ø 65mm shaft ø 6x4.6mm shaft flat upper black			
For models:	BM74E, BM77E, BR707E, BR707EI, BR707G, BR707GI, C7011E, C7011EFE, C7011EFEQ, C704E, C707E, C707EFE, C707EFEQ, CP704E, CPE60, CPE60DB, CWE42, CWE422, CWE62, CWE622, FP1E, FQE40, FQE40D, FQE40DSP, FQE41, FQE41L, FQE41L2, FQE41R, FQE41RL, FQE41RL2, FQE60, FQE60D, FQE60DSP, FQE61, FQE61L, FQE61L2, FQE61R, FQE61RL, FR74E, FR74E10, FR74E10L, FR74E10L2, FR74E2, FR77E, FR77E10, FR77E10L, FR77E10L2, FR77E2, FR92E13, FR92E132...(Other models you can see in the webshop)			
accessories for	110360			
	GEV No.	110437	Ref. No.	1804800 MA1804800
knob dial plate gas thermostat t.max. 325°C 145-325°C				
	GEV No.	110601	Ref. No.	1039110800 1039111800 1842000 862300 MA1842000 MA862300
knob dial plate gas tap with ignition flame t.max.°C°C				
	GEV No.	110603	Ref. No.	1930400 MA1930400
knob dial plate gas thermostat t.max. 300°C 90-300°C				
	GEV No.	110606	Ref. No.	1039107300 MA1039107300
knob dial plate switch 7-position t.max.°C°C				
	GEV No.	110607	Ref. No.	1986600 MA1986600
knob dial plate energy regulator Min/Max t.max.°C°C				
	GEV No.	110608	Ref. No.	1039115600 MA1039115600
knob dial plate energy regulator 1-12 t.max.°C°C				
	GEV No.	110609	Ref. No.	1039115700 MA1039115700
knob dial plate energy regulator 2-circuit t.max.°C°C				
	GEV No.	110610	Ref. No.	1218500 MA1218500
knob dial plate thermostat t.max. 90°C 30-90°C				
	GEV No.	110612	Ref. No.	1840600 MA1840600
knob dial plate thermostat t.max. 180°C 100-180°C				
	GEV No.	110614	Ref. No.	1840400 MA1840400
knob dial plate thermostat t.max. 300°C 50-300°C				

Table continues overleaf

accessories for 110360	
	GEV No. 110616 Ref. No. 1840513 MA1840513
knob dial plate oven BH/TH/BH+TH t.max. °C°C	
	GEV No. 111531 Ref. No. 862500 MA862500
knob dial plate thermostat t.max. 90°C 30-90°C	





GEV No.	110363	Ref. No.	1623300 1840800 1841000 MA1840800 MA1841000
----------------	--------	-----------------	---

description knob without symbol ø 65mm shaft ø 8x7mm shaft flat upper black

For models: C7011G, C7011GFE, C7011GFG, C704G, C707G, C707GFE, C707GFG, FB1GS, FB2GS, FB3GS, FT74G, FT74GR, FT77G, FT77GRL, GB704G, GB707G, T7011GFG

accessories for 110363

	GEV No. 110437 Ref. No. 1804800 MA1804800
knob dial plate gas thermostat t.max. 325°C 145-325°C	

	GEV No. 110601 Ref. No. 1039110800 1039111800 1842000 862300 MA1842000 MA862300
knob dial plate gas tap with ignition flame t.max. °C°C	

description knob dial plate gas tap with ignition flame t.max. °C°C

	GEV No. 110603 Ref. No. 1930400 MA1930400
knob dial plate gas thermostat t.max. 300°C 90-300°C	

description knob dial plate gas thermostat t.max. 300°C 90-300°C

	GEV No. 110606 Ref. No. 1039107300 MA1039107300
knob dial plate switch 7-position t.max. °C°C	

description knob dial plate switch 7-position t.max. °C°C

	GEV No. 110607 Ref. No. 1986600 MA1986600
knob dial plate energy regulator Min/Max t.max. °C°C	

description knob dial plate energy regulator Min/Max t.max. °C°C

	GEV No. 110608 Ref. No. 1039115600 MA1039115600
knob dial plate energy regulator 1-12 t.max. °C°C	

description knob dial plate energy regulator 1-12 t.max. °C°C

	GEV No. 110609 Ref. No. 1039115700 MA1039115700
knob dial plate energy regulator 2-circuit t.max. °C°C	

description knob dial plate energy regulator 2-circuit t.max. °C°C

	GEV No. 110610 Ref. No. 1218500 MA1218500
knob dial plate thermostat t.max. 90°C 30-90°C	

description knob dial plate thermostat t.max. 90°C 30-90°C

	GEV No. 110612 Ref. No. 1840600 MA1840600
knob dial plate thermostat t.max. 180°C 100-180°C	

description knob dial plate thermostat t.max. 180°C 100-180°C

	GEV No. 110614 Ref. No. 1840400 MA1840400
knob dial plate thermostat t.max. 300°C 50-300°C	

description knob dial plate thermostat t.max. 300°C 50-300°C

	GEV No. 110616 Ref. No. 1840513 MA1840513
knob dial plate oven BH/TH/BH+TH t.max. °C°C	

description knob dial plate oven BH/TH/BH+TH t.max. °C°C

	GEV No. 110948 Ref. No. 1039121600 MA1039121600
knob dial plate gas thermostat 1-7 t.max. °C°C	

description knob dial plate gas thermostat 1-7 t.max. °C°C

	GEV No. 110948 Ref. No. 1039121600 MA1039121600
knob dial plate gas thermostat 1-7 t.max. °C°C	

description knob dial plate gas thermostat 1-7 t.max. °C°C

accessories for 110363	
	GEV No. 111531 Ref. No. 862500 MA862500
knob dial plate thermostat t.max. 90°C 30-90°C	



GEV No.	110608	Ref. No.	1039115600 MA1039115600
----------------	--------	-----------------	----------------------------

description knob dial plate energy regulator 1-12 t.max. °C°C

For models: CFVE60, FTVE100, FTVE40, FTVE40D, FTVE60, FTVE60D, PCVE40, PCVE40D, PCVE40DB, PCVE60, PCVE60D, PCVE60DB



GEV No.	110609	Ref. No.	1039115700 MA1039115700
----------------	--------	-----------------	----------------------------

description knob dial plate energy regulator 2-circuit t.max. °C°C

For models: CFVE60, PCVE40, PCVE40D, PCVE40DB, PCVE60, PCVE60D, PCVE60DB

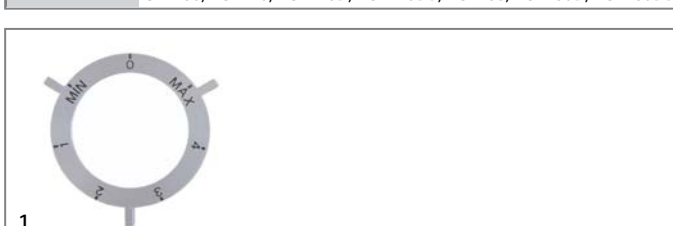

GEV No.	110607	Ref. No.	1986600 MA1986600
----------------	--------	-----------------	----------------------

description knob dial plate energy regulator Min/Max t.max. °C°C

For models: CP704E, CPE60, CPE602, CPE60DB, OCPE6, OCPE60

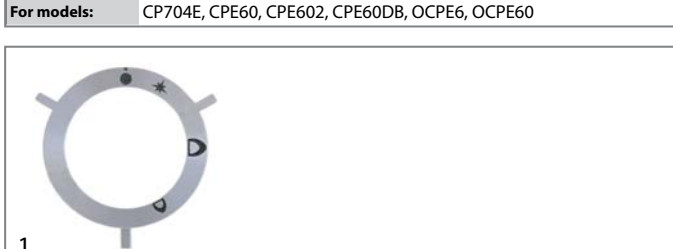

GEV No.	110601	Ref. No.	1039110800 1039111800 1842000 862300 MA1842000 MA862300
----------------	--------	-----------------	--

description knob dial plate gas tap with ignition flame t.max. °C°C

For models: BIG40, BIG60, BRG40, BRG40G, C7011G, C7011GFE, C7011GFG, C704G, C707G, C707GFE, C707GFG, CFG101, CFG120, CFG70, CFG70M, CFGE61, CFGE61D, CFGE61L, CFGE61P, CP704G, FP1GS, GB704G, GB707G, OCFG101, OCFG120, OCFG70, OCFG61, OPG41, OPG61, OPLG40, OPLG80, PCG41, PCG41L, PCG42, PCG61, PCG61L, PCG82, PD707G, PLG40, PLG80, T7011GFG, T707G, T707GFG



1

GEV No.	110948	Ref. No.	1039121600 MA1039121600
description	knob dial plate gas thermostat 1-7 t.max.°C°C		
For models:	FTG40B, FTG40BLC, FTG40BR, FTG60B, FTG60BLC, FTG60BR, FTG60BRR, FTG80B, FTG80BLC, FTG80BR		



1

GEV No.	110606	Ref. No.	1039107300 MA1039107300
description	knob dial plate switch 7-position t.max.°C°C		
For models:	C7011E, C7011EFE, C7011EFEQ, C704E, C707E, C707EFE, C707EFEQ, CFE60, CFE60P, CFE70, OCFE60, OPCE40, OPCE60, PCE40, PCE40D, PCE40DB, PCE60, PCE60D, PCE60DB		



1

GEV No.	112482	Ref. No.	1840200 MA1840200
description	knob dial plate gas thermostat t.max. 300°C 140-300°C		
For models:	C7011GFG, C707GFG, CFG101, CFG120, CFG70, CFG70M, OCFG101, OCFG120, OCFG70, T7011GFG, T707GFG		

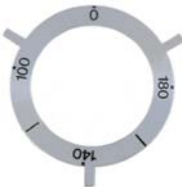

1

GEV No.	110612	Ref. No.	1840600 MA1840600
description	knob dial plate thermostat t.max. 180°C 100-180°C		
For models:	FR74E, FR74E10, FR74E10L, FR74E10L2, FR74E2, FR77E, FR77E10, FR77E10L, FR77E10L2, FR77E2, PI707E		



1

GEV No.	110603	Ref. No.	1930400 MA1930400
description	knob dial plate gas thermostat t.max. 300°C 90-300°C		
For models:	FT12G7L70, FT12G7LC70, FT12G7R70, FT12G7RC70, FT12G7RL70, FT12G7RLC70, FT6G4L70, FT6G4LC70, FT6G4R70, FT6G4RC70		

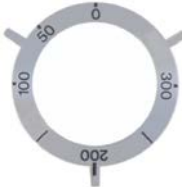

1

GEV No.	110614	Ref. No.	1840400 MA1840400
description	knob dial plate thermostat t.max. 300°C 50-300°C		
For models:	BIE40B, BIE60B, BR707E, BRE40, BRE40D, BRE40DB, BRE40DG, BRE40DGB, BRE40G, C7011E, C7011EFE, C7011EFEQ, C707E, C707EFE, C707EFEQ, CFE70, CWE42, CWE422, CWE62, CWE622, FT74E, FT74E2, FT74ER, FT74ER2, FT77E, FT77E2, FT77EC, FT77EC2, FT77ECRL, FT77ECRL2, FT77ERL, FT77ERL2, FTE100B, FTE100BR, FTE100C, FTE100CRL, FTE40B, FTE40BR, FTE40C, FTE40D, FTE40DC, FTE60B, FTE60BR, FTE60BRR, FTE60C, FTE60D, FTE60DC, FTE60DCRL, FTE60DR, OBRE40...(Other models you can see in the webshop)		



1

GEV No.	110437	Ref. No.	1804800 MA1804800
description	knob dial plate gas thermostat t.max. 325°C 145-325°C		
For models:	BR707G, BR707GI		



1

GEV No.	110615	Ref. No.	1039107500 MA1039107500
description	knob dial plate thermostat t.max. 300°C 50-300°C		



1

GEV No.	110616	Ref. No.	1840513 MA1840513
description	knob dial plate oven BH/TH/BH+TH t.max.°C°C		
For models:	C7011EFE, C7011EFEQ, C707EFE, C707EFEQ, CFE70		



1

GEV No.	110610	Ref. No.	1218500 MA1218500
description	knob dial plate thermostat t.max. 90°C 30-90°C		
For models:	BM74E, BM77E, BME40DM, BME40DMB, BME40M, BME60DM, BME60DMB, BME60M, BME80M, BSEI40M, CRE6220, CRE6230, CRE6320, CRE6330, OBSEI40M, TP, TP2, TPA		



1

GEV No.	111531	Ref. No.	862500 MA862500
description	knob dial plate thermostat t.max. 90°C 30-90°C		



1

GEV No.	110007	Ref. No.	1322400
description	knob		
For models:	C9F4G, C9F4GS, C9F6G, C9F6GS, C9F8G, C9F8GS, C9SB4GS, C9V2G, C9V2GS, C9V4G, C9V4GS, C9V6G, C9V6GS, C9V8G, C9V8GS, CP92G, CP94G, CP9SB2G, CP9SB4G, F9SB2G, F9SB2GR, F9SB4G, F9SB4GR, F9SB4GRL, F9V2G, F9V2GR, F9V4G, F9V4GR, F9V4GRL, P9D10G, P9D15G, P9D2G, P9D5G, P9DA10G, P9DA15G, P9DSB10G, PDASB10G, T9F4G, T9F6GS, T9FE4G, T9FP4G, T9SB4G, T9V4G, T9V6GS, T9VP4G		



1

GEV No.	110008	Ref. No.	1323800
description	knob		
For models:	B9VP2E, B9VP4E, BR94E, BR94EI, BR96E, BR96EI, BR9M4E, BR9M4EI, BR9M4GI, BR9M6E, BR9M6EI, BR9SB4E, BR9SB4EI, TP13E, TP17E, TP213E, TP217E, TP21E, TP221E		



1

GEV No.	110010	Ref. No.	1322600
description	knob		
For models:	BR94G, BR94GI, BR96G, BR96GI, BR9M4G, BR9M4GI, BR9M6G, BR9M6GI		



1

GEV No.	110012	Ref. No.	1323100
description	knob		
For models:	B9SB2E, B9SB2G, B9SB4E, B9SB4G, B9V2E, B9V2G, B9V4E, B9V4G, B9VP2E, B9VP4E, TP13E, TP17E, TP213E, TP217E, TP21E, TP221E		



1

GEV No.	110014	Ref. No.	2712100
description	knob		
For models:	FC10E, FC10G, FC20E, FC20G, FC5E, FC5G, FC7E, FC7G, V9F4E, V9FP4E, V9V2E, V9V4E, V9VP2E, V9VP4E		



1

GEV No.	110009	Ref. No.	1322800
description	knob ø 72mm		
For models:	C9F4E, C9F6E, C9V2E, C9V4E, CP92E, CP94E, CP9SB2E, CP9SB4E		









1

GEV No.	110388	Ref. No.	1022200 1022400 1322200 MA1322200
description	knob without symbol ø 72mm shaft ø 10x8mm shaft flat universal MARENO		
For models:	CP92G, CP94G, MM10DG, MM10DGS, MM15DG, P9D10G, P9D15G, P9DA10G, P9DA15G, P9DASB10G, P9DSB10G, T9F4G, T9F6GS, T9FE4G, T9SB4G, T9V4G, T9V6GS		
accessories for	110388		

	GEV No.	110620	Ref. No.	1322300 1893500 MA1322300
	GEV No.	110997	Ref. No.	1323500 MA1323513





 <p>1</p>			
GEV No.	110386	Ref. No.	1323000 1323400 1323600 1508100 1875000 1875200 1889700 1923200 1966700 MA1508100
description	knob without symbol ø 72mm shaft ø 6x4.6mm shaft flat universal MARENO		
For models:	B9SB2E, B9SB4E, B9V2E, B9V4E, BR94E, BR94EI, BR94G, BR94GI, BR96E, BR96EI, BR9M4E, BR9M4EI, BR9M4G, BR9M4GI, BR9M6E, BR9M6EI, BR9M6G, BR9M6GI, BR9SB4E, BR9SB4EI, BR9SB4G, BR9SB4GI, C9F4E, C9F4GS, C9F6E, C9F6GS, C9F8GS, C9FE6GS, C9FP, C9FP4GS, C9FP6GS, C9FP8GS, C9V2E, C9V4E, CB3, CB5, CD24, CP92E, CP92EI, CP94E, CP94E2, CP9SB2E, CP9SB2E2, CP9SB4E, CP9SB4E2, F9V2E, F9V2E2, F9V2ER, F9V2ER2, F9V4E...(Other models you can see in the webshop)		
accessories for	110386		
	GEV No.	110624	Ref. No. 1323700 MA1323700
	knob dial plate ON-OFF t.max.°C°C		
	GEV No.	110629	Ref. No. 1322900 MA1322900
	knob dial plate gas thermostat t.max. 180°C 100-180°C		
	GEV No.	110631	Ref. No. 1323300 MA1323300
	knob dial plate thermostat t.max. 300°C 50-300°C		
	GEV No.	110635	Ref. No. 1322500 MA1322500
	knob dial plate gas thermostat t.max. 300°C 50-300°C		
	GEV No.	112621	Ref. No. —
	knob time 120min t.max.°C°C ø 48mm shaft ø 6x4.6mm shaft flat upper black		

 <p>1</p>			
GEV No.	110387	Ref. No.	1893400 MA1893400
description	knob without symbol ø 72mm shaft ø 8x6.5mm shaft flat universal MARENO		
For models:	C9F4GS, C9F6GS, C9F8GS, C9FE4GS, C9FE6GS, C9FE8GS, C9V2GS, C9V4GS, C9V6GS, C9V8GS, MM10IG, P9I10G, P9IA10G, T9F6GS, T9V6GS		

 <p>1</p>			
GEV No.	110620	Ref. No.	1322300 1893500 MA1322300
description	knob dial plate gas tap with ignition flame t.max.°C°C		
For models:	C9F4GS, C9F6GS, C9F8GS, C9FE4GS, C9FE6GS, C9FE8GS, C9FEP4GS, C9FEP6GS, C9FEP8GS, C9FP4GS, C9FP6GS, C9FP8GS, C9V2GS, C9V4GS, C9V6GS, C9V8GS, C9VP2GS, C9VP4GS, C9VP6GS, C9VP8GS, CP92G, CP94G, GB92G, GB94G, MM10DG, MM10DGS, MM15DG, P9D10G, P9D15G, P9DA10G, P9DA15G, P9DASB10G, P9DSB10G, T9F4G, T9F6GS, T9FE4G, T9SB4G, T9V4G, T9V6GS		

 <p>1</p>			
GEV No.	110621	Ref. No.	1875100 MA1875100
description	knob dial plate gas tap without low flame t.max.°C°C		
For models:	BR94G, BR94GI, BR9M4G, BR9M4GI, BR9M6G, BR9M6GI, BR9SB4G, BR9SB4GI, MM10IG, MS10AG, MS10IG, MS70AG, MS70IG, MS70IGS, P9I10G, P9IA10G		

 <p>1</p>			
GEV No.	110629	Ref. No.	1322900 MA1322900
description	knob dial plate gas thermostat t.max. 180°C 100-180°C		
accessories for	110629		
	GEV No.	110386	Ref. No. 1323000 1323400 1323600 1508100 1875000 1875200 1889700 1923200 1966700 MA1508100
	knob without symbol ø 72mm shaft ø 6x4.6mm shaft flat universal MARENO		





1

GEV No.	110635	Ref. No.	1322500 MA1322500
description	knob dial plate gas thermostat t.max. 300°C 50-300°C		
accessories for	110635		
	GEV No.	110386	Ref. No. 1323000 1323400 1323600 1508100 1875000 1875200 1889700 1923200 1966700 MA1508100
knob without symbol ø 72mm shaft ø 6x4.6mm shaft flat universal MARENO			



1

GEV No.	110624	Ref. No.	1323700 MA1323700
description	knob dial plate ON-OFF t.max.°C°C		
accessories for	110624		
	GEV No.	110386	Ref. No. 1323000 1323400 1323600 1508100 1875000 1875200 1889700 1923200 1966700 MA1508100
knob without symbol ø 72mm shaft ø 6x4.6mm shaft flat universal MARENO			



1

GEV No.	110622	Ref. No.	1923300 MA1923300
description	knob dial plate gas thermostat t.max. 300°C 90-300°C		
For models:	FT14G8L90, FT14G8LC90, FT14G8R2L90, FT14G8R2LC90, FT14G8R90, FT14G8RC90, FT7G4L90, FT7G4LC90, FT7G4R90, FT7G4RC90		



1

GEV No.	110997	Ref. No.	1323500 MA1323513
description	knob dial plate oven BH/TH/BH+TH t.max.°C°C		



1

GEV No.	110623	Ref. No.	1889800 MA1889800
description	knob dial plate gas thermostat t.max. 330°C 120-330°C		
For models:	C9F4GS, C9F6GS, C9F8GS, C9FP4GS, C9FP6GS, C9FP8GS, T9F4G, T9F6G, T9FP4G		



1

GEV No.	110627	Ref. No.	1966800 MA1966800
description	knob dial plate switch 7-position Min/Max t.max.°C°C		
For models:	CP92E, CP92E2, CP94E, CP94E2, P9D10E, P9D15E, P9DA10E, P9DA15E, P9DSB10E, V9F4E, V9V2E, V9V4E		



1

GEV No.	110632	Ref. No.	1875300 MA1875300
description	knob dial plate graduated t.max.°C°C rotation 270°		
For models:	MM10IG, P9I10G, P9IA10G		



1

GEV No.	110630	Ref. No.	1953900 MA1953900
description	knob dial plate thermostat t.max. 190°C 100-190°C		
For models:	FR92G22, FR94G22, P9I10E, P9I15E, P9IA10E		

1

GEV No.	110631	Ref. No.	1323300 MA1323300
description	knob dial plate thermostat t.max. 300°C 50-300°C		
For models:	BR94G, BR94GI, BR9M4G, BR9M4GI, BR9M6G, BR9M6GI, BR9SB4G, BR9SB4GI, MS10AG, MS10IG, MS70AG, MS70IG, MS70IGS, V9F4E, V9V2E, V9V4E		
accessories for	110631		
			1323000 1323400 1323600 1508100 1875000 1875200 1889700 1923200 1966700 MA1508100
	GEV No.	110386	Ref. No.
			1323000 1323400 1323600 1508100 1875000 1875200 1889700 1923200 1966700 MA1508100

knob without symbol ø 72mm shaft ø 6x4.6mm shaft flat universal MARENO



1

GEV No.	110628	Ref. No.	1323200 MA1323200
description	knob dial plate thermostat t.max. 90°C 30-90°C		
For models:	B9SB2E, B9SB4E, B9V2E, B9V4E, CB3, CB5, CD24, P9D10E, P9D15E, P9DA10E, P9DA15E, P9I10E, P9IA10E		
accessories for	110628		
			1323000 1323400 1323600 1508100 1875000 1875200 1889700 1923200 1966700 MA1508100
	GEV No.	110386	Ref. No.
			1323000 1323400 1323600 1508100 1875000 1875200 1889700 1923200 1966700 MA1508100

knob without symbol ø 72mm shaft ø 6x4.6mm shaft flat universal MARENO



1

GEV No.	112519	Ref. No.	CR0502150
description	knob universal ø 67mm shaft ø 6x4.6mm shaft flat horizontal		
For models:	CFG101, CFG120, CFG70, CPE60, CPE602, CPE60DB, CWE42, CWE422, CWE62, CWE622, FQE41, FQE41L, FQE41L2, FQE61, FQE61L, FQE61L2, FTG40B, FTG40BLC, FTG40BR, FTG60B, FTG60BLC, FTG60BR, FTG60BRR, FTG80B, FTG80BLC, FTG80BR, OCFG101, OCFG120, OCFG70, OCPE6, OCPE60, OCWE42, OCWE422, OCWE62, OCWE622, OFQE41, OFQE61, OPLG40, OPLG80, PLG40, PLG80		



1

GEV No.	112518	Ref. No.	CR0502140
description	knob universal ø 67mm shaft ø 6x4.6mm shaft flat vertical		
For models:	BIE40B, BIE60B, BRE40, BRE40D, BRE40DB, BRE40DG, BRE40DGB, BRE40G, BSEI40M, CFE60, CFE60P, CFG101, CFG120, CFG70, CFGE61, CFGE61D, CFGE61L, CFGE61P, FTE100B, FTE100BR, FTE100C, FTE100CRL, FTE40B, FTE40BR, FTE40C, FTE40D, FTE40DC, FTE60B, FTE60BR, FTE60BRR, FTE60C, FTE60D, FTE60DC, FTE60DCRL, FTE60DR, OBSEI40M, OCFE60, OCFG101, OCFG120, OCFG70, OCFG61, OFTE100CRL, OFTE40B, OFTE40BR, OFTE40C, OFTE60B, OFTE60BR, OFTE60BRR, OFTE60C, OPCE40...(Other models you can see in the webshop)		



1

GEV No.	110608	Ref. No.	1039115600 MA1039115600
description	knob dial plate energy regulator 1-12 t.max.°C		
For models:	CFVE60, FTVE100, FTVE40, FTVE40D, FTVE60, FTVE60D, PCVE40, PCVE40D, PCVE40DB, PCVE60, PCVE60D, PCVE60DB		



1

GEV No.	110609	Ref. No.	1039115700 MA1039115700
description	knob dial plate energy regulator 2-circuit t.max.°C		
For models:	CFVE60, PCVE40, PCVE40D, PCVE40DB, PCVE60, PCVE60D, PCVE60DB		



1

GEV No.	110607	Ref. No.	1986600 MA1986600
description	knob dial plate energy regulator Min/Max t.max.°C		
For models:	CP704E, CPE60, CPE602, CPE60DB, OCPE6, OCPE60		



1

GEV No.	110601	Ref. No.	1039110800 1039111800 1842000 862300 MA1842000 MA862300
description	knob dial plate gas tap with ignition flame t.max.°C°C		
For models:	BIG40, BIG60, BRG40, BRG40G, C7011G, C7011GFE, C7011GFG, C704G, C707G, C707GFE, C707GFG, CFG101, CFG120, CFG70, CFG70M, CFGE61, CFGE61D, CFGE61L, CFGE61P, CP704G, FP1GS, GB704G, GB707G, OCFG101, OCFG120, OCFG70, OCFG61, OPG41, OPG61, OPLG40, OPLG80, PCG41, PCG41L, PCG42, PCG61, PCG61L, PCG82, PD707G, PLG40, PLG80, T7011GFG, T707G, T707GFG		



1

GEV No.	110948	Ref. No.	1039121600 MA1039121600
description	knob dial plate gas thermostat 1-7 t.max.°C°C		
For models:	FTG40B, FTG40BLC, FTG40BR, FTG60B, FTG60BLC, FTG60BR, FTG60BRR, FTG80B, FTG80BLC, FTG80BR		



1

GEV No.	112482	Ref. No.	1840200 MA1840200
description	knob dial plate gas thermostat t.max. 300°C 140-300°C		
For models:	C7011GFG, C707GFG, CFG101, CFG120, CFG70, CFG70M, OCFG101, OCFG120, OCFG70, T7011GFG, T707GFG		



1

GEV No.	110603	Ref. No.	1930400 MA1930400
description	knob dial plate gas thermostat t.max. 300°C 90-300°C		
For models:	FT12G7L70, FT12G7LC70, FT12G7R70, FT12G7RC70, FT12G7RL70, FT12G7RLC70, FT6G4L70, FT6G4LC70, FT6G4R70, FT6G4RC70		



1

GEV No.	110437	Ref. No.	1804800 MA1804800
description	knob dial plate gas thermostat t.max. 325°C 145-325°C		
For models:	BR707G, BR707GI		



1

GEV No.	110616	Ref. No.	1840513 MA1840513
description	knob dial plate oven BH/TH/BH+TH t.max.°C°C		
For models:	C7011EFE, C7011EFEQ, C707EFE, C707EFEQ, CFE70		

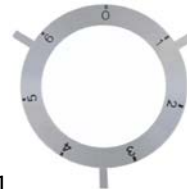

1

GEV No.	110606	Ref. No.	1039107300 MA1039107300
description	knob dial plate switch 7-position t.max.°C°C		
For models:	C7011E, C7011EFE, C7011EFEQ, C704E, C707E, C707EFE, C707EFEQ, CFE60, CFE60P, CFE70, OCFE60, OPCE40, OPCE60, PCE40, PCE40D, PCE40DB, PCE60, PCE60D, PCE60DB		

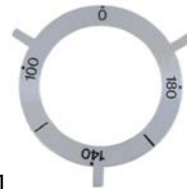



1

GEV No.	110612	Ref. No.	1840600 MA1840600
description	knob dial plate thermostat t.max. 180°C 100-180°C		
For models:	FR74E, FR74E10, FR74E10L, FR74E10L2, FR74E2, FR77E, FR77E10, FR77E10L, FR77E10L2, FR77E2, PI707E		





			
1			
GEV No.	110614	Ref. No.	1840400 MA1840400
description	knob dial plate thermostat t.max. 300°C 50-300°C		
For models:	BIE40B, BIE60B, BR707E, BRE40, BRE40D, BRE40DB, BRE40DG, BRE40DGB, BRE40G, C7011E, C7011EFE, C7011EFEQ, C707E, C707EFE, C707EFEQ, CFE70, CWE42, CWE422, CWE62, CWE622, FT74E, FT74E2, FT74ER, FT74ER2, FT77E, FT77E2, FT77EC, FT77EC2, FT77ECRL, FT77ECRL2, FT77ERL, FT77ERL2, FTE100B, FTE100BR, FTE100C, FTE100CRL, FTE40B, FTE40BR, FTE40C, FTE40D, FTE40DC, FTE60B, FTE60BR, FTE60BRR, FTE60C, FTE60D, FTE60DC, FTE60DCRL, FTE60DR, OBRE40...(Other models you can see in the webshop)		

			
2			
GEV No.	110615	Ref. No.	1039107500 MA1039107500
description	knob dial plate thermostat t.max. 300°C 50-300°C		

			
1			
GEV No.	110610	Ref. No.	1218500 MA1218500
description	knob dial plate thermostat t.max. 90°C 30-90°C		
For models:	BM74E, BM77E, BME40DM, BME40DMB, BME40M, BME60DM, BME60DMB, BME60M, BME80M, BSEI40M, CRE6220, CRE6230, CRE6320, CRE6330, OBSEI40M, TP, TP2, TPA		

			
1			
GEV No.	111531	Ref. No.	862500 MA862500
description	knob dial plate thermostat t.max. 90°C 30-90°C		

			
1			
GEV No.	110995	Ref. No.	CM062500 MACM062500
description	knob energy regulator 1-6 t.max.°C°C ø 67mm shaft ø 6x4.6mm shaft flat upper black		
For models:	I74E, I78E, I94E, I98E, IW74E, IW94E, PC12C4E, PC12C9E, PC74E, PC76E, PC78E, PC94E, PC96E, PC98E, PC9S4E, PC9S6E, PC9S8E, PD98E10, PD98E15, PD9S8E10, SPAC12, SPAC16, SPAC20, SPCG08, SPCG12, SPCG16, SPCG20, SPCG8, V74EC, V76EC, V94E, V98E		

			
1			
GEV No.	110993	Ref. No.	CM061600 MACM061600
description	knob gas tap with ignition flame t.max.°C°C ø 67mm shaft ø 10x8mm shaft flat upper black		
For models:	C124G, C129G, C12C2G9, C12C9G, C12FG9G, C712G, C74G, C78G, C7FE12G, C7FE8G, C7FG12G, C7FG8G, C7FGM12G, C912G, C912GS, C94G, C94GP, C94GS, C98G, C98GP, C98GS, C9FE12G, C9FE12GS, C9FE8G, C9FE8GS, C9FG12G, C9FG12GS, C9FG16G, C9FG8G, C9FG8GP, C9FG8GS, C9FGM12G, PC12C4G, PC12C9G, PC74G, PC76G, PC78G, PC94G, PC96G, PC98G, PC9S4G, PC9S6G, PC9S8G, PD76G5, PD96G5, PD98G10, PD98G15, PD98G15A, PD9S8G10, PI98G10...(Other models you can see in the webshop)		

			
1			
GEV No.	110894	Ref. No.	CM061700 MACM061700
description	knob gas tap with ignition flame t.max.°C°C ø 67mm shaft ø 8x6.5mm shaft flat upper black		
For models:	C712G, C74G, C74GS, C78G, C78GS, C79G, C7FE12G, C7FE12GS, C7FE8G, C7FE8GS, C7FG12G, C7FG12GS, C7FG8G, C7FG8GS, C7FG9G, C7FGM12G, C912G, C912GS, C94G, C94GP, C94GS, C98G, C98GP, C98GS, C9FE12G, C9FE12GS, C9FE8G, C9FE8GS, C9FG12G, C9FG12GS, C9FG16G, C9FG8G, C9FG8GP, C9FG8GS, C9FGM12G, FT12C9GL, FT12C9GM, FT12C9GTL, FT12C9GTMC, FT74GL, FT74GLC, FT74GR, FT74GRC, FT76GL, FT76GLC, FT76GM, FT76GMC, FT76GR, FT78GL, FT78GLC...(Other models you can see in the webshop)		

			
1			
GEV No.	110440	Ref. No.	CM061501 MACM061501
description	knob gas tap without ignition flame t.max.°C°C ø 67mm shaft ø 10x8mm shaft flat upper black		
For models:	BR912GFM, BR912GIM, BR98GF, BR98GFM, BR98GI, BR98GIM		

			
1			
GEV No.	110460	Ref. No.	CM062401 MACM062401
description	knob gas thermostat t.max. 300°C 90-300°C ø 67mm shaft ø 10x8mm shaft flat upper black		
For models:	BR78EF, BR78EI, BR78GF, BR78GI, BR912EFM, BR912EIM, BR98EF, BR98EFM, BR98EI, BR98EIM, BR9S8EF, BR9S8EI, FT129GLC, FT129GM, FT12C9GL, FT12C9GM, FT12C9GTLC, FT12C9GTMC, FT74EL, FT74ER, FT74GL, FT74GLC, FT74GR, FT74GRC, FT76EL, FT76ELC, FT76EM, FT76EMC, FT76GL, FT76GLC, FT76GM, FT76GMC, FT76GR, FT78EL, FT78ELC, FT78EM, FT78EMC, FT78GL, FT78GLC, FT78GLT, FT78GM, FT78GMC, FT78GMT, FT78GR, FT78GRT, FT94EL, FT94ELC, FT94ER, FT94G, FT94GL...(Other models you can see in the webshop)		

			
1			
GEV No.	110999	Ref. No.	CM059700 MACM059700
description	knob oven BH/TH/BH+TH t.max.°C°C ø 67mm shaft ø 6x4.6mm shaft flat upper black		
For models:	BF78E, BF98E, C12FEP9G, C7FE12G, C7FE8E, C7FE8EC, C7FE8G, C9FE12G, C9FE8E, C9FE8EC, C9FE8G		

			
1			
GEV No.	111503	Ref. No.	CM140000 MACM140000
description	knob switch 0-1-0-1 t.max.°C°C ø 67mm shaft ø 6x4.6mm shaft flat upper black		
For models:	B124E, B74E, B78E, B94E, B98E, SP74E, SP94E		

			
1			
GEV No.	110994	Ref. No.	CM062100 MACM062100
description	knob switch 7-position t.max.°C°C ø 67mm shaft ø 6x4.6mm shaft flat upper black		
For models:	C74EC, C78EC, C78EQC, C7FE8E, C7FE8EC, C7FE8EQ, C7FG12G, C7FG8G, C94E, C94EC, C98E, C98EC, C9FE8E, C9FE8EC		

			
1			
GEV No.	110415	Ref. No.	CM062301 MACM062301
description	knob thermostat t.max. 190°C ø 67mm shaft ø 10x8mm shaft flat upper black temperature range 100-190°C		
For models:	F12C4G15, F74G10, F74G15, F74G6, F76G10, F78G15, F94G10, F94G15, F94G6, F96G10, F98G15, F9S4G15, F9S8G15, PI76G5, PI96G5		

			
1			
GEV No.	110998	Ref. No.	CM059800 MACM059800
description	knob thermostat t.max. 300°C ø 67mm shaft ø 6x4.6mm shaft flat upper black temperature range 50-300°C rotation 270°		
For models:	BF78E, BF98E, BR78EF, BR78EI, BR912EFM, BR912EIM, BR912GFM, BR912GIM, BR98EF, BR98EFM, BR98EI, BR98EIM, BR98GF, BR98GFM, BR98GI, BR98GIM, BR9S8EF, BR9S8EI, BR9S8GF, BR9S8GI, C12FEP9G, C7FE12G, C7FE8E, C7FE8EC, C7FE8G, C9FE12G, C9FE8E, C9FE8EC, C9FE8G, FT129ELC, FT129EM, FT12C9EL, FT12C9ELC, FT12C9EM, FT12C9EMC, FT74EL, FT74ELC, FT74ER, FT76EL, FT76ELC, FT76EM, FT76EMC, FT78EL, FT78ELC, FT78EM, FT78EMC, FT94EL, FT94ELC, FT94ER, FT96EL...(Other models you can see in the webshop)		

			
1			
GEV No.	110996	Ref. No.	CM058001 MACM058001
description	knob thermostat t.max. 330°C ø 67mm shaft ø 10x8mm shaft flat upper black temperature range 100-330°C		
For models:	BF78G, BF912G, BF912GH, BF98G, BR78GF, BR78GI, C12FGP9G, C7FG12G, C7FG8G, C7FGM12G, C9FG12G, C9FG16G, C9FG8G, C9FG8GP, C9FGM12G, T12FGP9G, T7FG12G, T7FG8G, T9FG12G, T9FG8G		

			
1			
GEV No.	110410	Ref. No.	CM062200 MACM062200
description	knob thermostat t.max. 60°C ø 67mm shaft ø 6x4.6mm shaft flat upper black temperature range 60-190°C rotation 270°		
For models:	F12C4E12, F74E10, F74E6, F76E10, F94E10, F94E6, F94G22, F96E10, F98G22, F9S4G22, F9S8G22, PI76E5, PI96E5, PI98E10, PI98E15, PI98G10, PI98G14, PI98G14A, PI9S8E10		



			
1			
GEV No.	111504	Ref. No.	CM140100 MACM140100
description	knob thermostat t.max. 90°C 30-90°C ø 66mm shaft ø 4x6.4mm shaft flat upper		
For models:	B124E, B74E, B78E, B94E, B98E, SNA12, SNA16, SNA20, SNAC12, SNAC16, SNAC20, SNG08, SNG12, SNG16, SNG20, SP74E, SP94E, SPAC12, SPAC16, SPAC20, SPCG08, SPCG12, SPCG16, SPCG20, SPCG8, SVAC16, SVAC20, SVCG08, SVCG12, SVCG16, SVCG20, SVCG8, TP126E, TP12E, TP136E, TP13E, TP146E, TP14E, TP156E, TP15E, TP166E, TP16E, TP176E, TP17E, TP186E, TP18E, TP196E, TP19E, TP206E, TP20E...(Other models you can see in the webshop)		

			
1			
GEV No.	110463	Ref. No.	1036700700 MA1036700700
description	knob switch zero mark ø 50mm shaft ø 6x4.6mm shaft flat lower green		
For models:	CPE40, CPE402, CPE60, CPE602, CPE60DB, CWE42, CWE422, CWE62, CWE622, FQE41, FQE41L, FQE41L2, FQE41R, FQE41RL, FQE41RL2, FQE61, FQE61L, FQE61L2, FQE61R, FQE61RL, OCPE60, OCWE42, OCWE422, OCWE62, OCWE622		

			
1			
GEV No.	514061	Ref. No.	CM143100 MACM143100
description	knob water cold t.max.°C ø 67mm shaft ø 10x8mm shaft flat variable		
For models:	BR78EF, BR78E, BR78GF, BR78GI, BR912EFM, BR912EIM, BR912GFM, BR912GIM, BR98EF, BR98EFM, BR98EI, BR98EIM, BR98GF, BR98GFM, BR98GI, BR98GIM, BR9S8EF, BR9S8EI, BR9S8GF, BR9S8GI, PC12C4E, PC12C4G, PC12C9E, PC12C9G, PC74E, PC74G, PC76E, PC76G, PC78E, PC78G, PC94E, PC94G, PC96E, PC96G, PC98E, PC98G, PC9S4E, PC9S4G, PC9S6E, PC9S6G, PC9S8E, PC9S8G, PD96G5, PD98E10, PD98E15, PD98G10, PD98G15, PD98G15A, PD9S8E10, PD9S8G10...(Other models you can see in the webshop)		

			
1			
GEV No.	110408	Ref. No.	1036702200 MA1036702200
description	knob switch zero mark ø 50mm shaft ø 6x4.6mm shaft flat right black		
For models:	BIE40, BIE40B, BIE60, BIE60B, BME40DM, BME40DMB, BME40M, BME60, BME602, BME60DM, BME60DMB, BME60M, BME80M, BRE40, BRE40D, BRE40DB, BRE40DG, BRE40DGB, BRE40G, BSE40M, BSEI40M, CFE60, CFE60P, CFE70, CFG101, CFG70, CFGE60, CFGE61, CFGE61D, CFGE61L, CFGE61P, CFVE60, CPE40, CPE402, CPE60, CPE602, CRE6220, CRE6230, CRE6320, CRE6330, CWE42, CWE62, FQE60M, FQE40, FQE40D, FQE40DSP, FQE41, FQE41L, FQE41L2, FQE60...(Other models you can see in the webshop)		

			
1			
GEV No.	514245	Ref. No.	CM143200 MACM143200
description	knob water hot t.max.°C ø 67mm shaft ø 10x8mm shaft flat variable		
For models:	PD96G5, PD98E10, PD98E15, PD98G10, PD98G15, PD98G15A, PD9S8E10, PD9S8G10, PI96E5, PI96G5, PI98E10, PI98E15, PI98G10, PI98G14, PI98G14A, PI9S8E10		

			
1			
GEV No.	110405	Ref. No.	1036700500 MA1036700500
description	knob switch zero mark ø 50mm shaft ø 6x4.6mm shaft flat right green		
For models:	BIE40, BIE40B, BIE60, BIE60B, BME40DM, BME40DMB, BME40M, BME60, BME602, BME60DM, BME60DMB, BME60M, BME80M, BRE40, BRE40D, BRE40DB, BRE40DG, BRE40DGB, BRE40G, BSE40M, BSEI40M, CFE60, CFE60P, CFE70, CFG101, CFG70, CFGE60, CFGE61, CFGE61D, CFGE61L, CFGE61P, CFVE60, CRE6220, CRE6230, CRE6320, CRE6330, FQE40, FQE40D, FQE40DSP, FQE41, FQE41L, FQE41L2, FQE60, FQE60D, FQE60DSP, FQE61, FQE61L, FQE61L2, FTE100B, FTE100BR...(Other models you can see in the webshop)		

			
1			
GEV No.	110450	Ref. No.	1036702300 MA1036702300
description	knob switch zero mark ø 50mm shaft ø 6x4.6mm shaft flat lower black		
For models:	BIG40, BIG60, BRG40, BRG40G, CFG101, CFG70, CFGE61, CFGE61D, CFGE61L, CFGE61P, FTG40B, FTG40BLC, FTG40BR, FTG60B, FTG60BLC, FTG60BR, FTG60BRR, FTG80B, FTG80BLC, FTG80BR, OCFG101, OCFG70, OCFG61, OPG41, OPG61, OPLG40, OPLG80, PCG41, PCG41L, PCG42, PCG61, PCG61L, PCG82, PLG40, PLG80		





1

GEV No.	111500	Ref. No.	1036702600 2795000 MA1036702600 MA2795000
description	knob switch zero mark ø 50mm shaft ø 6x4.6mm shaft flat upper black		
For models:	CPE60, CPE602, CPE60DB, CS102E, CS102EP, CS102G, CS102GP, CS10E, CS10EP, CS10G, CS6E, CS6EP, CS6G, CWE42, CWE422, CWE62, CWE622, FQE41R, FQE41RL, FQE41RL2, FQE61R, FQE61RL, FV4E, FV4E1, OCPE60, OCWE42, OCWE422, OCWE62, OCWE622, SBA, SBAC, SPE60M, SVAC12, SVAC16, SVAC20, SVCG08, SVCG12, SVCG16, SVCG20, TSE60M		



1

GEV No.	110064	Ref. No.	932600 MA932600
description	knob		
For models:	704S, 706S, TPF706S		
accessories for	110064		
	GEV No.	Ref. No.	932700 MA932700
	knob screw		



1

GEV No.	110416	Ref. No.	1036706500
description	knob		
For models:	CFVE60, PCVE40, PCVE40D, PCVE40DB, PCVE60, PCVE60D, PCVE60DB		



1

GEV No.	110417	Ref. No.	1036704700
description	knob		
For models:	FTE100B, FTE100BR, FTE100CRL, FTE40B, FTE40C, FTE60B, FTE60BR, FTE60C		



1

GEV No.	110418	Ref. No.	1036703000
description	knob		
For models:	CWE42, CWE62		



1

GEV No.	110419	Ref. No.	1036703100
description	knob		
For models:	CPE40, CPE402, CPE60, CPE602		



1

GEV No.	110420	Ref. No.	1036708400
description	knob		
For models:	CFG101, CFG70, CFGE61, CFGE61D, CFGE61L, CFGE61P, OCFG101, OCFG70, OCFG61, OPCG41, OPCG61, PCG41, PCG41L, PCG42, PCG61, PCG61L, PCG82		



1

GEV No.	110425	Ref. No.	1036701300 MA1036701300
description	knob		
For models:	BIE40, BIE60, BRE40, BRE40G, FTE100B, FTE100BR, FTE100CRL, FTE40B, FTE40C, FTE60B, FTE60BR, FTE60C		



1

GEV No.	110433	Ref. No.	18186-00
description	knob		

Image not available

1

GEV No.	110436	Ref. No.	18412-00
description	knob		
For models:	C7011E, C7011EFE, C704E, C707E, C707EFE		

Image not available

1

GEV No.	110411	Ref. No.	1036704600 MA1036704600
description	knob ø 70mm black gas thermostat shaft ø 8x6.5mm shaft flat upper		
For models:	FTG40B, FTG60B, FTG60BLC, FTG60BR, FTG80B, FTG80BR		

Image not available

2

GEV No.	110441	Ref. No.	19305-00
description	knob		
For models:	FT12G7L70, FT12G7LC70, FT12G7R70, FT12G7RC70, FT12G7RL70, FT14G8L90, FT14G8LC90, FT14G8R2L90, FT14G8R90, FT14G8RC90, FT6G4L70, FT6G4LC70, FT6G4R70, FT6G4RC70, FT7G4L90, FT7G4LC90, FT7G4R90, FT7G4RC90		



1

GEV No.	111501	Ref. No.	1036700400 MA1036700400
description	knob switch zero mark ø 40mm green shaft special		
For models:	BMG40, BMG60, FQG40, FQG60		

Image not available

1

GEV No.	110459	Ref. No.	27115-00
description	knob		
For models:	FC10E, FC10G, FC20E, FC20G, FC7E, FC7G, P9D10E, P9D15E, P9DA10E, P9DA15E, P9DSB10E, P9I10E, P9IA10E, PDASB10E		



1

GEV No.	110407	Ref. No.	1036702400 MA1036702400
description	knob switch zero mark ø 40mm shaft ø 14mm shaft flat special green		
For models:	BMG40, BMG60, FQG40, FQG60		

Image not available

1

GEV No.	110414	Ref. No.	1036701200 MA1036701200
description	knob 7-position		
For models:	CFE60, CFE60P, CFE70, OCFE60, OPCE40, OPCE60, PCE100, PCE40, PCE40D, PCE40DB, PCE40M, PCE60, PCE60D, PCE60DB		



1

GEV No.	110093	Ref. No.	450323
description	knob switch zero mark t.max.°C ø 42mm shaft ø 5x5mm shaft flat black		



1

GEV No.	110895	Ref. No.	1031019000 MA1031019000
description	knob graduated ø 50mm shaft ø 6x4.6mm shaft flat upper black		
For models:	RIE40M, RIEP40M		





1

GEV No.	110896	Ref. No.	1031019800 MA1031019800
description	knob thermostat t.max. 180°C ø 45mm shaft ø 6x4.6mm shaft flat right black temperature range 90-180°C rotation 270°		
For models:	FQE4, FQE6, FQE6+6		

			
1			
GEV No.	110422	Ref. No.	1031019900 MA1031019900
description	knob thermostat t.max. 300°C ø 45mm shaft ø 6x4.6mm shaft flat right black temperature range 50-300°C rotation 270°		
For models:	CFE60, CFE60P, CFGE60, CFGE61, CFGE61D, CFGE61L, CFGE61P, CFVE60, OCFE60, OCFGE61		

			
1			
GEV No.	110421	Ref. No.	1031020000 MA1031020000
description	knob time 60min ø 45mm shaft ø 6x4.6mm shaft flat right black		
For models:	CFE60, CFE60P, CFGE60, CFGE61, CFGE61D, CFGE61L, CFGE61P, CFVE60, OCFE60, OCFGE61		

			
1			
GEV No.	112810	Ref. No.	CR0581710
description	knob zero mark t.max.°C ø 82.5mm shaft ø 6x4.6mm		
For models:	NB74E, NB78E, NB94E, NB98E, NBR78EF, NBR78EI, NBR912EFM, NBR912EIM, NBR912GFM, NBR912GIM, NBR98EF, NBR98EFM, NBR98EI, NBR98EIM, NBR98GF, NBR98GFM, NBR98GI, NBR98GIM, NC74E2, NC74EC, NC74EQC, NC78E2, NC78EC, NC78EQC, NC7FE12G36, NC7FE8E, NC7FE8EQ, NC7FE8G24, NC94E, NC94E2, NC98E, NC98E2, NC9FE12G44, NC9FE12G52, NC9FE8E, NC9FE8E2, NC9FE8G28, NC9FE8G36, NC9FE8G48, NCT78E, NCT7FE8E, NCT98E, NCT98E2, NCT9FE8E, NCT9FE8E2, NF74E10, NF74E15, NF76E10, NF78E15...(Other models you can see in the webshop)		
accessories for	112810		
	GEV No.	550132	Ref. No. —
knob spring ø 6x4.6mm Qty 10 pcs			

			
1			
GEV No.	111810	Ref. No.	CR0580660
description	knob zero mark t.max.°C ø 82.5mm shaft ø 8x6.5mm shaft flat upper chrome		
For models:	NB74G, NB78G, NB94G, NB98G, NC712G36, NC74G12, NC78G24, NC7FE12G36, NC7FE8G24, NC7FG12G44, NC7FG8G32, NC7FGM12G, NC912G44, NC94G16, NC94G20, NC98G28, NC98G40, NC9FE12G44, NC9FE8G28, NC9FG12G52, NC9FG16G72, NC9FG8G32, NC9FG8G36, NC9FG8G48, NC9FGM12G, NFT74GL, NFT74GR, NFT76GL, NFT76GM, NFT76GR, NFT78GL, NFT78GM, NFT78GR, NFT94GL, NFT94GR, NFT96GL, NFT96GM, NFT98GL, NFT98GM, NFT98GR, NGL74G, NGL78G, NS78GS, NS7FG12GS, NT7FG12G, NT9FG12G		



steam/water taps

steam/water taps

			
1			
GEV No.	111370	Ref. No.	1693600
description	knob zero mark ø 31mm shaft ø 8x5.5mm shaft flat right black		

accessories

fascias

			
1			
GEV No.	111811	Ref. No.	CR0580460
description	bezel ø 72.5mm		
For models:	NB74E, NB74G, NB78E, NB78G, NB94E, NB94G, NB98E, NB98G, NBR78EF, NBR78EI, NBR78GF, NBR78GI, NBR912EFM, NBR912EIM, NBR912GFM, NBR912GIM, NBR98EF, NBR98EFM, NBR98EI, NBR98EIM, NBR98GF, NBR98GFM, NBR98GI, NBR98GIM, NC712G36, NC74E2, NC74EC, NC74EQC, NC74G12, NC78E2, NC78EC, NC78EQC, NC78G24, NC7FE12G36, NC7FE8E, NC7FE8E2, NC7FE8EQ, NC7FE8G24, NC7FG12G44, NC7FG8G32, NC7FG8G36, NC7FG8G48, NC7FGM12G, NC912G44, NC94E, NC94E2, NC94G16, NC94G20, NC98E, NC98E2... (Other models you can see in the webshop)		
accessories for	111811		
	GEV No.	560056	Ref. No. —
clamping washer nominal-ø 4mm ED ø 10mm spring steel			

knob screws

			
1			
GEV No.	110066	Ref. No.	932700 MA932700
description	knob screw		
For models:	704S, 706S, TPF706S		

rosettes

			
1			
GEV No.	110310	Ref. No.	191040
description	rosette knob up to ø 45mm		



handles and hand wheels

hand wheels

hand wheels



1

GEV No.	514026	Ref. No.	1685600 1685691 MA1685691
description	hand wheel \varnothing 160mm D1 \varnothing 40mm bore \varnothing 16mm thread M8 hole distance 9mm groove widthmm L1 22mm L2 50mm handle length 75mm with folding handle		
For models:	BR707E, BR707EI, BR707G, BR707GI		
accessories for	514026		
	GEV No.	Ref. No.	—
	grub screw thread M8 L 10mm WS 4 Qty 1 pcs		



1

GEV No.	690086	Ref. No.	1475200 1475291 MA1475291
description	hand wheel \varnothing 200mm D1 \varnothing 48mm bore \varnothing 20mm thread M8 hole distance 9mm groove widthmm L1 30mm L2 60mm handle length 82mm with folding handle		
For models:	BR78EF, BR78EI, BR78GF, BR78GI, BR912EFM, BR912EIM, BR912GFM, BR912GIM, BR94E, BR94EI, BR94G, BR94GI, BR96E, BR96EI, BR96G, BR96GI, BR98EF, BR98EFM, BR98EI, BR98EIM, BR98GF, BR98GFM, BR98GI, BR98GIM, BR9M4E, BR9M4EI, BR9M4G, BR9M4GI, BR9M6E, BR9M6EI, BR9M6G, BR9M6GI, BR9S8EF, BR9S8EI, BR9S8GF, BR9S8GI, BR9SB4E, BR9SB4EI, BR9SB4G, BR9SB4GI, NBR78EF, NBR78EI, NBR78GF, NBR78GI, NBR912EFM, NBR912EIM, NBR912GFM, NBR912GIM, NBR98EF, NBR98EFM...(Other models you can see in the webshop)		
spare parts for	690086		
	GEV No.	Ref. No.	—
	folding handle \varnothing 26mm total length 85mm seat \varnothing 20mm shaft \varnothing mm thread M6 with pin L 85mm		
accessories for	690086		
	GEV No.	Ref. No.	15131099
	grub screw thread M8 L 16mm DIN 914/ISO 4027 intake internal hexagon WS 4 Qty 1 pcs		

spare parts and accessories



1

GEV No.	514241	Ref. No.	CM184800 MACM184800
description	spindle for hand wheel		
For models:	BR78EF, BR78EI, BR78GF, BR78GI, BR912EFM, BR912EIM, BR912GFM, BR912GIM, BR98EF, BR98EFM, BR98EI, BR98EIM, BR98GF, BR98GFM, BR98GI, BR98GIM, BR9S8EF, BR9S8EI, BR9S8GF, BR9S8GI		

cylindrical handles

fixed



1

GEV No.	110703	Ref. No.	1829200 MA1829200
description	cylindrical handle thread M10 \varnothing 28mm L 87mm		
For models:	CRE6220, CRE6230, CRE6320, CRE6330, GB704G, GB707G, GB92G, GB94G, GL12C4G, GL12C9G, GL74G, GL78G, GL94G, GL98G, NGL74G, NGL78G, OPLG40, OPLG80, PLG40, PLG80, SME62M, SME63M, SME70M, SPE60M, SPW60M, TSE60M		

cone handles



1

GEV No.	514033	Ref. No.	498500 MA498500
description	cone handle plastic black		
For models:	B9SB2E, B9SB2G, B9SB4E, B9SB4G, B9V2E, B9V2G, B9V4E, B9V4G, B9VP2E, B9VP4E, B9VP4G, CS10, CS6, F9V2E, F9V2ER, F9V4E, F9V4EC, F9V4ECR, F9V4ER, F9V4ERL, FC10E, FC20E, FC5E, FC7E, FT74E, FT74ER, FT74G, FT74GR, FT77E, FT77ERL, FT77G, FT77GRL, GB707G, T9F4G, T9F6GS, T9SB4G, T9V4G, T9V6GS		

star handles



1

GEV No.	514051	Ref. No.	32000599 MA32000599
description	star handle shaft 7x7mm \varnothing 60mm L 23mm black thermoplastic		
For models:	CP704E, CP704G, CP92E, CP92E2, CP92G, CP94E, CP94E2, CP94G, CP9SB2E, CP9SB2E2, CP9SB2G, CP9SB4E, CP9SB4E2, CP9SB4G		

handle bars

handle bars



1			
GEV No.	690715	Ref. No.	46191.00 MA4619100
description	handle rod		
For models:	EF140DF, EF140DN, EF140DP, EF140MB, EF140MC, EF140MF, EF140MI, EF140MN, EF140MP, EF70DF, EF70DN, EF70DP, EF70MB, EF70MC, EF70MI, EF70MN, EF70MP, HF140D, HF140DF, HF140DN, HF140DP, HF143DNI, HF70DF, HF70DN, HF70DP, NF140D, NF140DF, NF140DN, NF140DP, NF143DNF, NF143DNI, NF143DNP, NF14DNG, NF70DF, NF70DI, NF70DN, NF70DP, NF72DF, NF72DNI, NF72DN, NF72DNF, NF72DNN, NF72DP, NF7DFG, NF7DNG, SF100DF, SF100DN, SF100DP, SF100MB, SF100MC...(Other models you can see in the webshop)		

consoles



1			
GEV No.	690716	Ref. No.	4621300 MA4621300
description	console		
For models:	EF140DF, EF140DN, EF140DP, EF140MB, EF140MC, EF140MF, EF140MI, EF140MN, EF140MP, EF143DNF, EF143MNI, EF70DF, EF70DN, EF70DP, EF70MB, EF70MC, EF70MF, EF70MI, EF70MN, EF70MP, EF72DNF, EF72MNF, F140DF, F140DI, F140DN, F140DP, F143, F14DFG, F14DNG, F70DF, F70DI, F70DN, F70DP, F72, F7DFG, F7DNG, HF140D, HF140DF, HF140DN, HF140DP, HF143DNI, HF70DF, HF70DN, HF70DP, NF140D, NF140DF, NF140DFN, NF140DN, NF140DNI, NF140DNN...(Other models you can see in the webshop)		



1			
GEV No.	693135	Ref. No.	1300213 MA1300213
description	console for handle rod H 60mm Qty 1 pcs		
For models:	C9F4E, C9F6E, C9V2E, C9V4E, FR92E10, FR92E10L, FR92E10L2, FR92E13, FR92E132, FR92E13T, FR92E13T2, FR92E22, FR92E22T, FR92G13, FR92G22, FR92G22T, FR94E10, FR94E10L, FR94E10L2, FR94E13, FR94E132, FR94E13T, FR94E13T2, FR94E22, FR94E22T, FR94G13, FR94G22, FR94G22T, FR9P2E10, FR9P4E10, V9F4E, V9FP4E, V9V2E, V9V4E, V9VP2E, V9VP4E		

bracket handles



1			
GEV No.	696630	Ref. No.	CR0580340 CR0580340R
description	handle L 305mm H 40mm mounting distance 270mm chrome		
For models:	NBV712, NBV712P, NBV72, NBV74, NBV76, NBV78, NBV78P, NC7FE12G36, NC7FE8E, NC7FE8EQ, NC7FE8G24, NC7FG12G44, NC7FG8G32, NC7FG8G36, NC7FG8G48, NC9FE12G44, NC9FE12G52, NC9FE8E, NC9FE8E2, NC9FE8G28, NC9FE8G36, NC9FE8G48, NC9FG12G52, NC9FG16G72, NC9FG8G32, NC9FG8G36, NC9FG8G48, NG74E, NG74E2, NG74G, NG78E, NG78E2, NG78G, NG912E, NG912E2, NG94E, NG94E2, NG94G, NG98E, NG98E2, NG98G, NT7FG12G, NT7FG8G, NT9FG12G, NT9FG8G, NXBVAE, NXBVCA, NXBVC4, NXBVC6, NXBVP4, NXBVP6...(Other models you can see in the webshop)		



1			
GEV No.	691327	Ref. No.	CM073100 MACM073100
description	pull handle L 119mm H 37mm mounting distance 105mm handle M6		
For models:	EF74E10VG, EF74E12, EF74G15, EF74G8VA, EF74G8VG, F12C4E12, F12C4G15, F74E10, F74E12, F74E6, F74G10, F74G15, F74G6, F76E10, F76G10, F78E12, F78G15, F94E10, F94E12, F94E18, F94E18K, F94E6, F94G10, F94G15, F94G22, F94G22K, F94G6, F96E10, F96G10, F98E12, F98E18, F98E18K, F98G15, F98G22, F98G22K, F954E12, F954E18, F954E18K, F954G15, F954G22, F954G22K, F958E12, F958E18, F958E18K, F958G15, F958G22, F958G22K, FQE4, FQE41, FQE41L...(Other models you can see in the webshop)		



1			
GEV No.	691328	Ref. No.	1031110900 MA1031110900
description	pull handle L 248mm H 56mm mounting distance 235mm handle M6		
For models:	CFG120, OCFG120		



1			
GEV No.	691336	Ref. No.	1031111000 MA1031111000
description	pull handle L 544mm H 55mm mounting distance 530mm handle M6		
For models:	CFE60, CFE60P, CFE70, CFG101, CFG120, CFG70, CFGE60, CFGE61, CFGE61D, CFGE61L, CFGE61P, CFVE60, OCFE60, OCFG101, OCFG120, OCFG70, OCFGE61		



			
1			
GEV No.	697878	Ref. No.	4124500 MA4124500
description	pull handle L 72mm H 28mm ø 8mm W 64mm		
For models:	SER15, SER15A, SER18, SER18A, SER21, SER21A, SKTE15, SKTE18, SKTE21		

			
1			
GEV No.	514011	Ref. No.	1031400100 MA1031400100
description	lever right equiv. no. 1031400100		
For models:	EF74E10VG, EF74G8VA, EF74G8VG, FQE41, FQE41L, FQE41L2, FQE61, FQE61L, FQE61L2, FQG40, FQG41, FQG60, FQG61, OFQE41, OFQE61, OFQG41, OFQG61		

levers

without handle

			
1			
GEV No.	514007	Ref. No.	1044109600 MA1044109600
description	lever		
For models:	BM74E, BM74G, BM77E, BM77G, BME40DM, BME40DMB, BME40M, BME60, BME602, BME60DM, BME60DMB, BME60M, BME80M, BMG40, BMG60, FQE41, FQE41L, FQE41L2, FQE61, FQE61L, FQE61L2		

lever handles

			
1			
GEV No.	514015	Ref. No.	1036702000 1851700 MA1036702000 MA1851700
description	lever handle plastic black		
For models:	BM74E, BM74G, BM77E, BM77G, BME40DM, BME40DMB, BME40M, BME60, BME602, BME60DM, BME60DMB, BME60M, BME80M, BMG40, BMG60, CPE40, CPE402, CPE60, CPE602, CPE60DB, CRE6220, CRE6230, CRE6320, CRE6330, EF74E10VG, EF74G8VA, EF74G8VG, FQE40, FQE40D, FQE40DSP, FQE41, FQE41L, FQE41L2, FQE41R, FQE41RL, FQE41RL2, FQE60, FQE60D, FQE60DSP, FQE61, FQE61L, FQE61L2, FQE61R, FQE61RL, FQG40, FQG41, FQG60, FQG61, OCPE6, OCPE60... (Other models you can see in the webshop)		

			
1			
GEV No.	514032	Ref. No.	1041622 MA1041622
description	lever		
For models:	B9SB2E, B9SB2G, B9SB4E, B9SB4G, B9V2E, B9V2G, B9V4E, B9V4G, B9VP2E, B9VP4E, B9VP4G		

			
1			
GEV No.	514008	Ref. No.	1036700000 MA1036700000
description	lever handle plastic green		
For models:	BME40M, BME60, BME602, BME60M, BME80M, BMG40, BMG60, CPE40, CPE402, CPE60, CPE602, CPE60DB, CRE6220, CRE6230, CRE6320, CRE6330, FQE40, FQE40D, FQE40DSP, FQE41, FQE41L, FQE41L2, FQE41R, FQE41RL, FQE41RL2, FQE60, FQE60D, FQE60DSP, FQE61, FQE61L, FQE61L2, FQE61R, FQE61RL, FQG40, FQG60, OCPE6, OCPE60, OFQE41, OFQE61, PL40, PL60		

			
1			
GEV No.	514013	Ref. No.	1031400400 MA1031400400
description	lever equiv. no. 1031400400		
For models:	CPE40, CPE402, CPE60, CPE602, CPE60DB, OCPE6, OCPE60		

accessories

miscellaneous



1			
GEV No.	690717	Ref. No.	46214.00 MA4621400
description	spacer for door handle		
For models:	EF140DF, EF140DN, EF140DP, EF140MB, EF140MC, EF140MF, EF140MI, EF140MN, EF140MP, EF143DNF, EF143MNI, EF70DF, EF70DN, EF70DP, EF70MB, EF70MC, EF70MF, EF70MI, EF70MN, EF70MP, EF72DNF, EF72MNF, F140DF, F140DI, F140DN, F140DP, F143, F14DFG, F14DNG, F70DF, F70DI, F70DN, F70DP, F72, F7DFG, F7DNG, HF140D, HF140DF, HF140DN, HF140DP, HF143DNI, HF70DF, HF70DN, HF70DP, NF140D, NF140DF, NF140DFN, NF140DN, NF140DNI, NF140DNN...(Other models you can see in the webshop)		

edgemount latches

push button latches

RAHRBACH

6186 PRESTO series

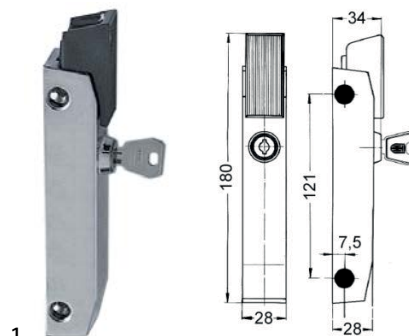

1			
GEV No.	690023	Ref. No.	720300 MA720300
description	push button latch L 180mm mounting distance 121mm lockable refrigeration units 6186 H 34mm W 28mm type PRESTO		
For models:	SPAR, SPAR15, SPAR16, SPAR18, SPAR20, SPRG, SPRG12, SPRG16, SPRG20, SVAR, SVAR15, SVAR16, SVAR18, SVAR20, SVRG, SVRG12, SVRG15, SVRG16, SVRG18, SVRG20		
spare parts for	690023		
	GEV No.	700046	Ref. No. —
	handle H 26.5mm L 55mm W 23.5mm plastic with spring spring length 14mm mounting thread M4 spring thickness 0.5mm		
accessories for	690023		
	GEV No.	690108	Ref. No. —
	base plate H 5mm L 47.5mm W 21mm for swinging strike hole distance 31mm type PRESTO no. 6186		
	GEV No.	690109	Ref. No. —
	base plate H 1mm L 47.5mm W 21mm plastic hole distance 31mm type PRESTO no. 6186		
	GEV No.	700050	Ref. No. —
	door catch H 5mm L 47mm W 21mm hole distance 31mm with spigot refrigeration units type PRESTO no. 6186		
	GEV No.	700051	Ref. No. —
	door catch H 5mm L 48mm W 21mm adjustable hole distance 31mm with spigot type PRESTO no. 6186		

locks

locking devices

producer-specific

MARENO



1			
GEV No.	690462	Ref. No.	23153.00 BN1483003 MA2315300
description	key cylinder ø 23mm thread M19x1 mounting measurements 16.5x19mm hub 38-45mm shaft ø 11mm thread L 12mm		
For models:	AF140B, AF140C, AF140F, AF140I, AF140MB, AF140MC, AF140MF, AF140MI, AF140MN, AF140MP, AF140N, AF140P, AF70B, AF70C, AF70F, AF70I, AF70MB, AF70MC, AF70MF, AF70MI, AF70MN, AF70MP, AF70N, AF70P, AFR1143P, AFR1143PE, EF140DF, EF140DN, EF140DP, EF140MB, EF140MC, EF140MF, EF140MI, EF140MN, EF140MP, EF143DNF, EF143MNI, EF70DF, EF70DN, EF70DP, EF70MB, EF70MC, EF70MF, EF70MI, EF70MN, EF70MP, EF72DNF, EF72MNF, F140DF, F140DI...(Other models you can see in the webshop)		
spare parts for	690462		
	GEV No.	691589	Ref. No. —
	spare keys for key cylinder 690462 key number 9233		

handle latches

CAFF/FERMOD

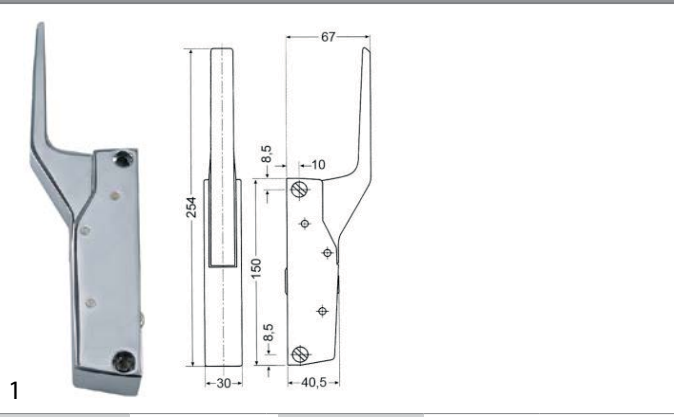

GEV No.	700060	Ref. No.	2872000 MA2872000
description	handle latch L 150mm mounting distance 133mm non lockable heated units G 791		
For models:	CON102E, CON102EP, CON102G, CON102GP, CON10E, CON10EP, CON10G, CON10GP, CON6E, CON6EP, CON6G, CON6GP, CS102E, CS102EP, CS102G, CS102GP, CSM102E, CSM102EP, CSM102G, CSM102GP, CSM10E, CSM10EP, CSM10G, CSM10GP, CSM6E, CSM6EP, CSM6G, CSM6GP		
accessories for	700060		
	GEV No.	700061	Ref. No. 5129900 MA5129900
	door catch L 58mm W 20mm H 35mm mounting distance 42mm chrome-plated brass for headed units		
	GEV No.	700062	Ref. No. —
	handle protection heated units		

door catches

	GEV No.	694577	Ref. No. 32051099 MA32051099
	description	door catch H 10mm L 48mm W 21mm mounting distance 31mm thread M5 with spigot	
	For models:	SPAR, SPAR15, SPAR16, SPAR18, SPAR20, SPRG, SPRG12, SPRG16, SPRG20, SVAR, SVAR15, SVAR16, SVAR18, SVAR20, SVRG, SVRG12, SVRG15, SVRG16, SVRG18, SVRG20	

	GEV No.	700061	Ref. No. 5129900 MA5129900
	description	door catch L 58mm W 20mm H 35mm mounting distance 42mm chrome-plated brass for headed units	
	For models:	CON102E, CON102EP, CON102G, CON102GP, CON10E, CON10EP, CON10G, CON10GP, CON6E, CON6EP, CON6G, CON6GP, CSM102E, CSM102EP, CSM102G, CSM102GP, CSM10E, CSM10EP, CSM10G, CSM10GP, CSM6E, CSM6EP, CSM6G, CSM6GP	
	accessories for	700061	
	GEV No.	690414	Ref. No. —
	handle latch L 150mm mounting distance 133mm non lockable refrigeration units G 791		

snap locks

universal			
	GEV No.	690596	Ref. No. 2844800 LA69050010 LAR69050010
	description	snap lock L 60mm W 15mm H 36mm mounting distance 48/28mm spring thickness 1.5mm complete with door catch zamak	
	For models:	CS4E, CS4EP, FC10E, FC20GP, FC5E, FC7E	

producer-specific

MARENO			
	GEV No.	694586	Ref. No. SIRRZ960029 SIRZ960029
	description	snap lock repair set	

espagnolette locks

universal			
	GEV No.	690041	Ref. No. 5145100 MA5145100
	description	cam L 148mm mounting distance 32mm	
	For models:	CSM201, CSM202	



			
1			
GEV No.	690040	Ref. No.	5156000 MA5156000
description	door catch with roller H 42mm L 40mm W 40mm zinc die cast mounting distance 26mm type 0751 series		
For models:	CSM201, CSM202		



producer-specific
MARENO

			
1			
GEV No.	690041	Ref. No.	5145100 MA5145100
description	cam L 148mm mounting distance 32mm		
For models:	CSM201, CSM202		

			
1			
GEV No.	690040	Ref. No.	5156000 MA5156000
description	door catch with roller H 42mm L 40mm W 40mm zinc die cast mounting distance 26mm type 0751 series		
For models:	CSM201, CSM202		

			
1			
GEV No.	nla	Ref. No.	5156100 MA5156100
description	door handle black plastic		
For models:	CSM201, CSM202		

				
1				
GEV No.	690042	Ref. No.	5154800 MA5154800	
description	latch gear opening to the right shaft intake ø 8x8mm L 170mm W 40mm H 40mm			
For models:	CSM201, CSM202			
accessories for	690042			
	GEV No.	690040	Ref. No.	5156000 MA5156000
door catch with roller H 42mm L 40mm W 40mm zinc die cast mounting distance 26mm type 0751 series				

accessories for	690042			
	GEV No.	690041	Ref. No.	5145100 MA5145100
cam L 148mm mounting distance 32mm				
	GEV No.	691050	Ref. No.	—
bar ø 10mm for door latch L 113.5mm				

miscellaneous

			
1			
GEV No.	691286	Ref. No.	R58001780
description	catch for glass plate		
For models:	GMT06D, GMT20D, GVT06D, GVT20D, MACE07M, MACE10M, MACE20M, MACG07M, MACG10M, MACG20M, ME061D, ME061M, ME061P, ME061T, ME101D, ME101M, ME101P, ME101T, ME102D, ME102M, ME102P, ME102T, ME201D, ME201M, ME201P, ME201T, ME202D, ME202M, ME202P, ME202T, MEMT06D, MEMT06P, MEMT10D, MEMT10P, MEMT20D, MEMT20P, MEMT21D, MEMT21P, MEMT40D, MEMT40P, MEVT06D, MEVT06P, MEVT10D, MEVT10P, MEVT20D, MEVT20P, MEVT21D, MEVT21P, MEVT40D, MEVT40P...(Other models you can see in the webshop)		

hinges

spring assisted hinges

universal

CAFF/FERMOD

group 2

GEV No.	690494	Ref. No.	4837000 MA4837000
description	spring assisted hinge series 175 mounting pos. left/right torx L 75mm W 25.6mm H 100mm A 4mm B 11mm mounting measurements 22x22mm intake torx refrigeration units mounting distance 25mm		
For models:	FB110F, FB110N, FB110P, FB140F, FB140FN, FB140N, FB140NN, FB140P, FB140PF, FB140PN, FB140PP, FB143NI, FB55F, FB55N, FB55P, FB70F, FB70N, FB70P, FB72F, FB72N, FB72NF, FB72P, FS140F, FS140FI, FS140FN, FS140I, FS140N, FS140NG, FS140NI, FS140NN, FS140P, FS140PN, FS140PP, FS143F, FS143FI, FS143N, FS143NF, FS143NI, FS143NN, FS143NP, FS143P, FS70F, FS70FG, FS70I, FS70N, FS70NG, FS70P, FS72F, FS72FI, FS72IN...(Other models you can see in the webshop)		

INTERKLIMAT

hinges

GEV No.	690714	Ref. No.	1412050 2476700 BN1412050 MA2476700
description	spring assisted hinge series 28XC mounting pos. left/right L 75mm W 25mm H 103mm A 8mm B 11mm intake 7.5x7.5 refrigeration units mounting distance 25mm		
For models:	AF140B, AF140C, AF140F, AF140I, AF140MB, AF140MC, AF140MF, AF140MI, AF140MN, AF140MP, AF140N, AF140P, AF70B, AF70C, AF70F, AF70I, AF70MB, AF70MC, AF70MF, AF70MI, AF70MN, AF70MP, AF70N, AF70P, EF140DF, EF140DN, EF140DP, EF140MB, EF140MC, EF140MF, EF140MI, EF140MN, EF140MP, EF143DNF, EF143MNI, EF70DF, EF70DN, EF70DP, EF70MB, EF70MC, EF70MF, EF70MI, EF70MN, EF70MP, EF72DNF, EF72MNF, F140DF, F140DI, F140DN, F140DP...(Other models you can see in the webshop)		

accessories

GEV No.	690747	Ref. No.	4621214 MA4621214
description	bush for hinge ID ϕ 7.5mm L 25.5mm W 25.5mm white mounting measurements 22x22mm H 4.5mm		
For models:	EF140DF, EF140DN, EF140DP, EF140MB, EF140MC, EF140MF, EF140MI, EF140MN, EF140MP, EF143DNF, EF143MNI, EF70DF, EF70DN, EF70DP, EF70MB, EF70MC, EF70MF, EF70MI, EF70MN, EF70MP, EF72DNF, EF72MNF, F140DF, F140DI, F140DN, F140DP, F143, F70DF, F70DI, F70DN, F70DP, F72, F7DFG, F7DNG, FB110F, FB110N, FB110P, FB140F, FB140FN, FB140N, FB140NN, FB140P, FB140PF, FB140PN, FB140PP, FB143NI, FB55F, FB55N, FB55P, FB70F...(Other models you can see in the webshop)		

producer-specific

ELECTROLUX/ZANUSSI



GEV No.	690747	Ref. No.	4621214 MA4621214
description	bush for hinge ID ϕ 7.5mm L 25.5mm W 25.5mm white mounting measurements 22x22mm H 4.5mm		
For models:	EF140DF, EF140DN, EF140DP, EF140MB, EF140MC, EF140MF, EF140MI, EF140MN, EF140MP, EF143DNF, EF143MNI, EF70DF, EF70DN, EF70DP, EF70MB, EF70MC, EF70MF, EF70MI, EF70MN, EF70MP, EF72DNF, EF72MNF, F140DF, F140DI, F140DN, F140DP, F143, F70DF, F70DI, F70DN, F70DP, F72, F7DFG, F7DNG, FB110F, FB110N, FB110P, FB140F, FB140FN, FB140N, FB140NN, FB140P, FB140PF, FB140PN, FB140PP, FB143NI, FB55F, FB55N, FB55P, FB70F...(Other models you can see in the webshop)		

SAGI



GEV No.	690747	Ref. No.	4621214 MA4621214
description	bush for hinge ID ϕ 7.5mm L 25.5mm W 25.5mm white mounting measurements 22x22mm H 4.5mm		
For models:	EF140DF, EF140DN, EF140DP, EF140MB, EF140MC, EF140MF, EF140MI, EF140MN, EF140MP, EF143DNF, EF143MNI, EF70DF, EF70DN, EF70DP, EF70MB, EF70MC, EF70MF, EF70MI, EF70MN, EF70MP, EF72DNF, EF72MNF, F140DF, F140DI, F140DN, F140DP, F143, F70DF, F70DI, F70DN, F70DP, F72, F7DFG, F7DNG, FB110F, FB110N, FB110P, FB140F, FB140FN, FB140N, FB140NN, FB140P, FB140PF, FB140PN, FB140PP, FB143NI, FB55F, FB55N, FB55P, FB70F...(Other models you can see in the webshop)		

oven hinges

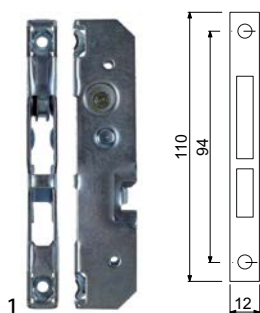

GEV No.	700003	Ref. No.	1031106000 1034400800 MA1031106000 MA1034400800
description	opposite support L 110mm W 12mm mounting distance 94mm		
For models:	CFE60, CFE60P, CFGE60, CFGE61, CFGE61D, CFGE61L, CFGE61P, CFVE60, FOE60M, OCFE60, OCFGE61, OFOE60M		

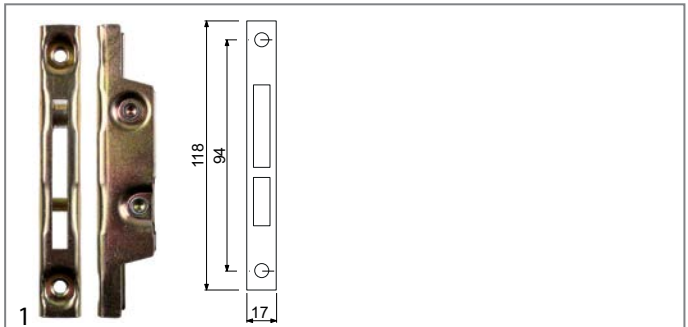

GEV No.	700001	Ref. No.	1304500 MA1304500
description	opposite support L 118mm W 17mm mounting distance 94mm		
For models:	BF78E, BF78G, BF912G, BF912GH, BF98E, BF98G, C12FEP9G, C12FGP9G, C7011EFE, C7011EFEQ, C7011GFE, C7011GFG, C707EFE, C707EFEQ, C707GFE, C707GFG, C7FE12G, C7FE8E, C7FE8EC, C7FE8G, C7FG12G, C7FG8G, C7FGM12G, C9F4E, C9F4GS, C9F6E, C9F6GS, C9F8GS, C9FE12G, C9FE6GS, C9FE8E, C9FE8EC, C9FE8G, C9FG12G, C9FG16G, C9FG8G, C9FG8GP, C9FGM12G, C9FP4GS, C9FP6GS, C9FP8GS, C9V2E, C9V4E, CFE70, CFG101, CFG101D, CFG101L, CFG101P, CFG120, CFG70...(Other models you can see in the webshop)		

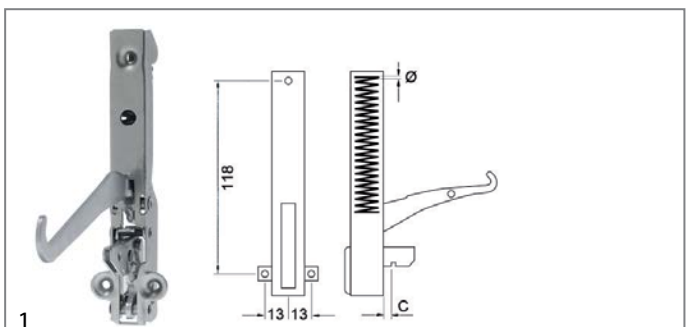

GEV No.	690030	Ref. No.	1034400400 CR1075440 MA1034400400
description	oven hinge mounting distance 118mm lug mounting 13mm lever length 117mm groove distance 10mm spring thickness 3.5mm mounting ear position left/right spring length 60mm L 155mm W 21mm		
For models:	CFE60, CFE60P, CFGE61, CFGE61D, CFGE61L, CFGE61P, CFVE60, OCFE60, OCFGE61		
accessories for	690030		
GEV No.	700003	Ref. No.	1031106000 1034400800 MA1031106000 MA1034400800
description	opposite support L 110mm W 12mm mounting distance 94mm		

GEV No.	700013	Ref. No.	1031102000 MA1031102000
description	oven hinge mounting distance 118mm lug mounting 13mm lever length 119mm groove distance 13mm spring thickness 3.5mm mounting ear position left spring length 60mm L 154mm		
For models:	CFE60, CFE60P, CFGE60, CFGE61, CFGE61D, CFGE61L, CFGE61P, CFVE60		
accessories for	700013		
	GEV No.	700003	Ref. No.
			1031106000 1034400800 MA1031106000 MA1034400800
opposite support L 110mm W 12mm mounting distance 94mm			

GEV No.	700015	Ref. No.	1031105800 MA1031105800
description	oven hinge mounting distance 118mm mounting distance 2mm lug mounting 13mm lever length 116mm groove distance 11mm spring thickness 3.5mm mounting ear position right spring length 61mm L 153mm W 20mm		
For models:	FOE60M, OFOE60M		
accessories for	700015		
	GEV No.	700003	Ref. No.
			1031106000 1034400800 MA1031106000 MA1034400800
opposite support L 110mm W 12mm mounting distance 94mm			

GEV No.	700016	Ref. No.	1031105900 MA1031105900
description	oven hinge mounting distance 118mm mounting distance 2mm lug mounting 13mm lever length 116mm groove distance 11mm spring thickness 3.5mm mounting ear position left spring length 61mm L 153mm W 20mm		
For models:	FOE60M, OFOE60M		
accessories for	700016		
	GEV No.	700003	Ref. No.
			1031106000 1034400800 MA1031106000 MA1034400800
opposite support L 110mm W 12mm mounting distance 94mm			

GEV No.	700014	Ref. No.	1031105500 MA1031105500
description	oven hinge mounting distance 118mm mounting distance 2mm lug mounting 13mm lever length 119mm groove distance 13mm spring thickness 3.5mm mounting ear position right spring length 60mm L 154mm		
For models:	CFE60, CFE60P, CFGE60, CFGE61, CFGE61D, CFGE61L, CFGE61P, CFVE60		
accessories for	700014		
	GEV No.	700003	Ref. No.
			1031106000 1034400800 MA1031106000 MA1034400800
opposite support L 110mm W 12mm mounting distance 94mm			

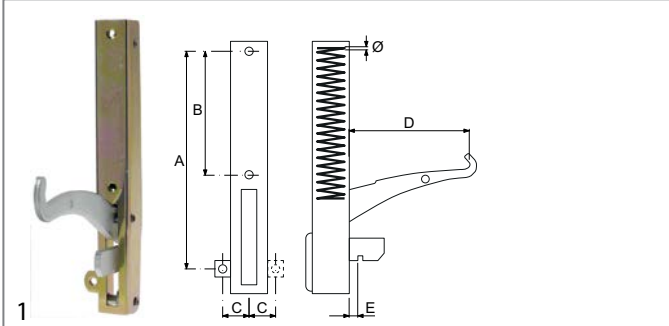

GEV No.	700005	Ref. No.	1304700 MA1304700
description	oven hinge mounting distance 173mm mounting distance 2 105mm lug mounting 14mm lever length 118mm groove distance 7mm spring thickness 3.5mm mounting ear position left spring length 112mm W 25mm		
For models:	BF78G, BF912G, BF912GH, BF98G, C7011EFE, C7011EFEQ, C7011GFE, C7011GFG, C707EFE, C707EFEQ, C707GFE, C707GFG, C7FG12G, C7FG8G, C9F4E, C9F4GS, C9F6E, C9F6GS, C9F8GS, C9FE6GS, C9FG12G, C9FG16G, C9FG8G, C9FG8GP, C9FGM12G, C9FP4GS, C9FP6GS, C9FP8GS, C9V2E, C9V4E, CFE70, CFG101, CFG101D, CFG101L, CFG101P, CFG120, CFG70, CFG70D, CFG70L, CFG70M, CFG70P, EC74EVG, EC74GVG, EC78EVG, EC78GVG, EC7FE8E, EC7FG8G, OCFG101, OCFG120, OCFG70...(Other models you can see in the webshop)		
accessories for	700005		
	GEV No.	700001	Ref. No. 1304500 MA1304500
opposite support L 118mm W 17mm mounting distance 94mm			

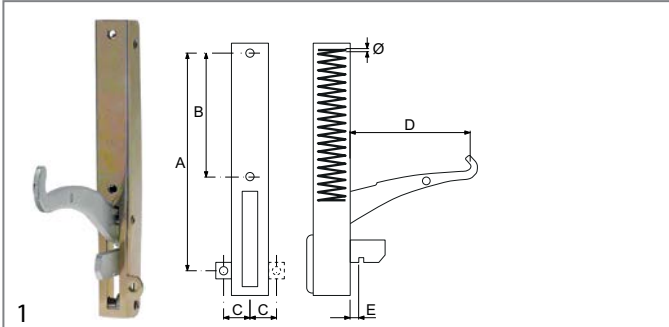

GEV No.	700004	Ref. No.	1304600 MA1304600
description	oven hinge mounting distance 173mm mounting distance 2 105mm lug mounting 14mm lever length 119mm groove distance 7mm spring thickness 3.5mm mounting ear position right spring length 112mm L 206mm W 25mm		
For models:	BF78G, BF912G, BF912GH, BF98G, C7011EFE, C7011EFEQ, C7011GFE, C7011GFG, C707EFE, C707EFEQ, C707GFE, C707GFG, C7FG12G, C7FG8G, C9F4E, C9F4GS, C9F6E, C9F6GS, C9F8GS, C9FE6GS, C9FG12G, C9FG16G, C9FG8G, C9FG8GP, C9FGM12G, C9FP4GS, C9FP6GS, C9FP8GS, C9V2E, C9V4E, CFE70, CFG101, CFG101D, CFG101L, CFG101P, CFG120, CFG70, CFG70D, CFG70L, CFG70M, CFG70P, EC74EVG, EC74GVG, EC78EVG, EC78GVG, EC7FE8E, EC7FG8G, OCFG101, OCFG120, OCFG70...(Other models you can see in the webshop)		
accessories for	700004		
	GEV No.	700001	Ref. No. 1304500 MA1304500
opposite support L 118mm W 17mm mounting distance 94mm			

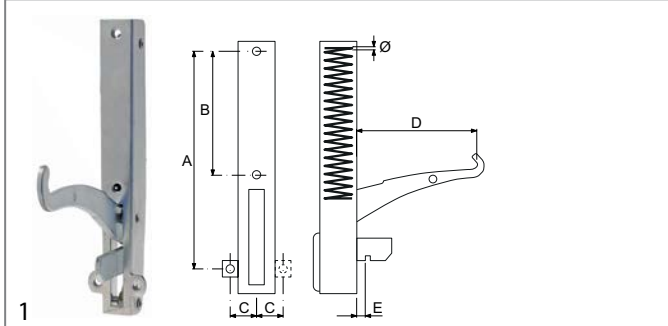

GEV No.	700164	Ref. No.	CM041300 MACM041300
description	oven hinge mounting distance 173mm mounting distance 2mm lug mounting 14mm lever length 118mm groove distance 7mm spring thickness 3.5mm mounting ear position left/right spring length 113mm L 207mm		
For models:	BF78E, BF78G, BF912G, BF912GH, BF98E, BF98G, C12FEP9G, C12FGP9G, C7FE12G, C7FE8E, C7FE8EC, C7FE8G, C7FG12G, C7FG8G, C9FE12G, C9FE8E, C9FE8EC, C9FE8G, C9FG12G, C9FG16G, C9FG8G, C9FG8GP, C9FGM12G, NC7FE12G36, NC7FE8E, NC7FE8EQ, NC7FE8G24, NC7FG12G44, NC7FG8G32, NC7FG8G36, NC7FG8G48, NC9FE12G44, NC9FE12G52, NC9FE8E, NC9FE8E2, NC9FE8G28, NC9FE8G36, NC9FE8G48, NC9FG12G52, NC9FG16G72, NC9FG8G32, NC9FG8G36, NC9FG8G48, NT7FG12G, NT7FG8G, NT9FG12G, NT9FG8G, T12FGP9G, T7FG12G, T7FG8G...(Other models you can see in the webshop)		
accessories for	700164		
	GEV No.	700001	Ref. No. 1304500 MA1304500
opposite support L 118mm W 17mm mounting distance 94mm			

door bearing





GEV No.	690758	Ref. No.	46375.14 4637524 MA4637524
description	bolt		
For models:	EF140DF, EF140DN, EF140DP, EF140MB, EF140MC, EF140MF, EF140MI, EF140MN, EF140MP, EF70DF, EF70DN, EF70DP, EF70MB, EF70MC, EF70MF, EF70MI, EF70MN, EF70MP, F140DF, F140DI, F140DN, F140DP, F143, F70DF, F70DI, F70DN, F70DP, F7DFG, F7DNG, FB110F, FB110N, FB110P, FB140F, FB140FN, FB140N, FB140NN, FB140P, FB140PF, FB140PN, FB140PP, FB143NI, FB55F, FB55N, FB55P, FB70F, FB70N, FB70P, FS140F, FS140FI, FS140FN...(Other models you can see in the webshop)		





GEV No.	514029	Ref. No.	1488800 MA1488800
description	bolt for pivot bearing		
For models:	BR707E, BR707EI, BR707G, BR707GI, BR78EF, BR78EI, BR78GF, BR78GI, BR912EFM, BR912EIM, BR912GFM, BR912GIM, BR94E, BR94EI, BR94G, BR94GI, BR96E, BR96EI, BR96G, BR96GI, BR98EF, BR98EFM, BR98EI, BR98EIM, BR98GF, BR98GFM, BR98GI, BR98GIM, BR9M4E, BR9M4EI, BR9M4G, BR9M4GI, BR9M6E, BR9M6EI, BR9M6G, BR9M6GI, BR9S8EF, BR9S8EI, BR9S8GF, BR9S8GI, BR9S84E, BR9S84EI, BR9S84G, BR9S84GI		

			
1			
GEV No.	690708	Ref. No.	25163.00 25165.00 25944.00 MA2594400
description	bush mounting pos. upper/lower for door hinge		
For models:	AA710PA, AA710PS, AP708PA, AP708PS, AP709PA, AP709PS, BC2704, BC3704, BC4704, BCB704, BCP704, BPB704, BPB708, BRP704, BTR704, EAA710PA, EAA710PS, EAP608PA, EAP608PS, EAP609PA, EAP609PS, EAP708PA, EAP708PS, EAP709PA, EAP709PS, EPA607AA, EPA608PS, EPA609PS, EPP607AA, EPP607SC, EPP608PS, EPP609PS, IR13C, IR13CC, IR13CV, IR13M, IR13MC, IR13MV, IR13V, IR17C, IR17CC, IR17CV, IR17M, IR17MC, IR17MV, IR17V, PA607AA, PA608PS, PA609PS, PP607AA... (Other models you can see in the webshop)		

			
1			
GEV No.	691288	Ref. No.	R58002520
description	door bolt		
For models:	GMT06D, GMT20D, GVT06D, GVT20D, MACE07M, MACE10M, MACE20M, MACG07M, MACG10M, MACG20M, ME061D, ME101D, ME102D, MEMT06D, MEMT06P, MEMT10D, MEMT10P, MEMT20D, MEMT20P, MEVT06D, MEVT06P, MEVT10D, MEVT10P, MEVT20D, MEVT20P, MG061D, MG101D, MG102D, MGMT06D, MGMT06P, MGMT10D, MGMT10P, MGMT20D, MGMT20P, MGVT06D, MGVT06P, MGVT10D, MGVT10P, MGVT20D, MGVT20P		

			
1			
GEV No.	692831	Ref. No.	R58002670
description	door bolt mounting pos. bottom left thread M12 bolt 15mm bolt ø 10mm		
For models:	GMT20D, GVT06D, GVT20D		

			
1			
GEV No.	692439	Ref. No.	46222.40 MA4622240
description	door hinge bolt ø 7mm flange length 24mm flange width 49mm		
For models:	FB143NI, FB72F, FB72N, FB72NF, FB72P, FS143F, FS143FI, FS143N, FS143NF, FS143NI, FS143NN, FS143NP, FS143P, FS72F, FS72IF, FS72IN, FS72N, FS72NF, FS72NN, FS72P		

			
1			
GEV No.	701437	Ref. No.	1412262 BN1412262
description	door hinge L 45mm W 35mm mounting pos. upper bolt 14.5mm bolt ø 6mm refrigerator		

			
1			
GEV No.	690098	Ref. No.	R10201330
description	door hinge mounting pos. lower with holder		
For models:	ME120M, ME120P, ME120X, ME220M, ME220P, ME220X, MEC24H, MEC40M, MG120M, MG120P, MG120X, MG220M, MG220P, MG220X, MGC20X, MGC24H, MGC40H, VE120M, VE120P, VE120X, VE220M, VE220P, VE220X, VG120M, VG120P, VG120X, VG220M, VG220P, VG220X		

			
1			
GEV No.	690097	Ref. No.	R10201290
description	door hinge mounting pos. upper		
For models:	ME106M, ME106P, ME106X, ME110M, ME110P, ME110X, ME120M, ME120P, ME120X, ME210M, ME210P, ME210X, MG106M, MG106P, MG106X, MG110M, MG110P, MG110X, MG120M, MG120P, MG120X, MG210M, MG210P, MG210X, MGC20X, VE106M, VE106P, VE106X, VE110M, VE110X, VE120M, VE120P, VE120X, VE210M, VE210P, VE210X, VG106M, VG106P, VG106X, VG110M, VG110P, VG110X, VG120M, VG120P, VG120X, VG210M, VG210P, VG210X		

			
1			
GEV No.	691287	Ref. No.	R18404500
description	hinge		
For models:	MACE07M, MACE10M, MACE20M, MACG07M, MACG10M, MACG20M		



1

GEV No.	691284	Ref. No.	R58001760
description	hinge for glass plate		
For models:	GMT06D, GMT20D, GVT06D, GVT20D, MACE07M, MACE10M, MACE20M, MACG07M, MACG10M, MACG20M, ME061D, ME061M, ME061P, ME061T, ME101D, ME101M, ME101P, ME101T, ME102D, ME102M, ME102P, ME102T, ME201D, ME201M, ME201P, ME201T, ME202D, ME202M, ME202P, ME202T, MEMT06D, MEMT06P, MEMT10D, MEMT10P, MEMT20D, MEMT20P, MEMT21D, MEMT21P, MEMT40D, MEMT40P, MEVT06D, MEVT06P, MEVT10D, MEVT10P, MEVT20D, MEVT20P, MEVT21D, MEVT21P, MEVT40D, MEVT40P...(Other models you can see in the webshop)		



1

GEV No.	699245	Ref. No.	32213056 RA051004 RRA051004 SIRRA051004
description	hinge L 58.5mm W 35mm H 109mm mounting pos. lower bolt 94mm bolt ø 8mm with accessories		



1

GEV No.	691277	Ref. No.	R18201270
description	hinge mounting pos. bottom left		
For models:	MACE04M, MACE05M, MACG05M, MVE042P, MVE051P, MVG051P		



1

GEV No.	514224	Ref. No.	1489000 MA1489000
description	hinge bearing mounting ø 18mm without bolt tilting bratt pan		
For models:	BR707E, BR707EI, BR707G, BR707GI, BR94E, BR94EI, BR94G, BR94GI, BR96E, BR96EI, BR96G, BR96GI, BR9M4E, BR9M4EI, BR9M4G, BR9M4GI, BR9M6E, BR9M6EI, BR9M6G, BR9M6GI, BR9SB4E, BR9SB4EI, BR9SB4G, BR9SB4GI, P9D10E, P9D10G, P9D15E, P9D15G, P9D5G, P9DA10E, P9DA10G, P9DA15E, P9DA15G, P9DSB10E, P9DSB10G, P9I10E, P9I10G, P9I15E, P9I5G, P9IA10E, P9IA10G, P9IA15E, PD707G, PDASB10E, PDASB10G, PI707E, PI707G		



1

GEV No.	691347	Ref. No.	1044230423 MA1044230423
description	hinge bearing mounting pos. bottom right without bolt		
For models:	CFG120, OCFG120		



1

GEV No.	690759	Ref. No.	46222.24 MA4622224
description	hinge bearing mounting pos. centre with bolt		
For models:	EF143DNF, EF143MNI, EF72DNF, EF72MNF, F143, F72, HF143DNI, NF143DNF, NF143DNI, NF143DNP, NF72DF, NF72DIN, NF72DN, NF72DNF, NF72DNI, NF72DNN, NF72DP		



1

GEV No.	514230	Ref. No.	CM051903 MACM051903
description	hinge bearing mounting pos. left series 900 without bolt tilting bratt pan kettle type series 700		
For models:	BR78EF, BR78EI, BR78G, BR78GF, BR78GI, BR912EFM, BR912EIM, BR912GFM, BR912GIM, BR98EF, BR98EFM, BR98EI, BR98EIM, BR98GF, BR98GFM, BR98GI, BR98GIM, BR9S8EF, BR9S8EI, BR9S8GF, BR9S8GI, NPD76G5, NPD78G8, NPD96G5, NPI76E5, NPI76G5, NPI78E8, NPI78G8, NPI96E5, NPI96G5, PD76G5, PD96G5, PD98E10, PD98E15, PD98G10, PD98G15, PD98G15A, PD9S8E10, PD9S8G10, PI76E5, PI76G5, PI96E5, PI96G5, PI98E10, PI98E15, PI98G10, PI98G14, PI98G14A, PI9S8E10		





1

GEV No.	690587	Ref. No.	R11200550 R11200551
description	hinge bearing mounting pos. lower with bolt		
For models:	ME061M, ME061P, ME061T, ME101M, ME101P, ME101T, ME102M, ME102P, ME102T, MG061M, MG061P, MG061T, MG101M, MG101P, MG101T, MG102M, MG102P, MG102T		



			
GEV No.	690096	Ref. No.	R10201190
description	hinge bearing mounting pos. lower without bolt		
For models:	ME106M, ME106P, ME106X, ME110M, ME110P, ME110X, ME210M, ME210P, ME210X, MG106M, MG106P, MG106X, MG110M, MG110P, MG110X, MG210M, MG210P, MG210X, VE106M, VE106P, VE106X, VE110M, VE110X, VE210M, VE210P, VE210X, VG106M, VG106P, VG106X, VG110M, VG110P, VG110X, VG210M, VG210P, VG210X		



			
GEV No.	514228	Ref. No.	CM192400 CM192401 MACM192401
description	hinge bearing mounting pos. right series 900 without bolt tilting bratt pan kettle type series 700		
For models:	BR78EF, BR78EI, BR78G, BR78GF, BR78GI, BR912EFM, BR912EIM, BR912GFM, BR912GIM, BR98EF, BR98EFM, BR98EI, BR98EIM, BR98GF, BR98GFM, BR98GI, BR98GIM, BR9S8EF, BR9S8EI, BR9S8GF, BR9S8GI, NPD76G5, NPD78G8, NPD96G5, NPI76E5, NPI76G5, NPI78E8, NPI78G8, NPI96E5, NPI96G5, PD76G5, PD96G5, PD98E10, PD98E15, PD98G10, PD98G15, PD98G15A, PD9S8E10, PD9S8G10, PI76E5, PI76G5, PI96E5, PI96G5, PI98E10, PI98E15, PI98G10, PI98G14, PI98G14A, PI9S8E10		

			
GEV No.	690712	Ref. No.	25158.00 25159.00 25160.12 MA2516012
description	hinge bearing mounting pos. right/left without bolt		
For models:	IR13C, IR13CC, IR13CV, IR13M, IR13MC, IR13MV, IR13V, IR17C, IR17CC, IR17CV, IR17M, IR17MC, IR17MV, IR17V, TR13C2P, TR13I4C, TR13I4CC, TR13I4CV, TR13N2C1P, TR13N2C1PC, TR13N2C1PV, TR13N2P, TR13N2PC, TR13N2PV, TR13N4C, TR13N4CC, TR13N4CV, TR17C3P, TR17I6C, TR17I6CC, TR17I6CV, TR17N2C2P, TR17N2C2PC, TR17N2C2PV, TR17N2P, TR17N3P, TR17N3PC, TR17N3PV, TR17N4C1P, TR17N4C1PC, TR17N4C1PV, TR17N6C, TR17N6CC, TR17N6CV, TR21N2C3P, TR21N2C3PC, TR21N2C3PV, TR21N2P, TR21N4C2P, TR21N4C2PC...(Other models you can see in the webshop)		

			
GEV No.	691276	Ref. No.	R18201260
description	hinge bearing mounting pos. upper left		
For models:	MACE04M, MACE05M, MACG05M, MVE042P, MVE051P, MVG051P		

			
GEV No.	690586	Ref. No.	R11200560
description	hinge bearing mounting pos. upper left without bolt		
For models:	GMT06D, GMT20D, GVT06D, GVT20D, MACE07M, MACE10M, MACE20M, MACG07M, MACG10M, MACG20M, ME061D, ME061M, ME061P, ME061T, ME101D, ME101M, ME101P, ME101T, ME102D, ME102M, ME102P, ME102T, ME201D, ME201M, ME201P, ME201T, ME202D, ME202M, ME202P, ME202T, MEMT06D, MEMT06P, MEMT10D, MEMT10P, MEMT20D, MEMT20P, MEMT21D, MEMT21P, MEMT40D, MEMT40P, MEVT06D, MEVT06P, MEVT10D, MEVT10P, MEVT20D, MEVT20P, MEVT21D, MEVT21P, MEVT40D, MEVT40P...(Other models you can see in the webshop)		

			
GEV No.	691346	Ref. No.	1044237100 MA1044237100
description	hinge bearing mounting pos. upper right without bolt		
For models:	CFG120, OCFG120		

			
GEV No.	514028	Ref. No.	1488600 MA1488600
description	hinge bearing without bolt		
For models:	BR707E, BR707EI, BR707G, BR707GI, BR94E, BR94EI, BR94G, BR94GI, BR96E, BR96EI, BR96G, BR96GI, BR9M4E, BR9M4EI, BR9M4G, BR9M4GI, BR9M6E, BR9M6EI, BR9M6G, BR9M6GI, BR9SB4E, BR9SB4EI, BR9SB4G, BR9SB4GI		
accessories for	514028		
		GEV No.	514029
		Ref. No.	1488800 MA1488800
	bolt for pivot bearing		

			
GEV No.	514524	Ref. No.	R11207240
description	hinge bearing without bolt for combi-steamer mounting pos. bottom left		
For models:	GMT20D, GVT06D, GVT20D		

1 			
GEV No.	691285	Ref. No.	R58001770
description	hinge bolt		
For models:	GMT06D, GMT20D, GVT06D, GVT20D, MACE07M, MACE10M, MACE20M, MACG07M, MACG10M, MACG20M, ME061D, ME061M, ME061P, ME061T, ME101D, ME101M, ME101P, ME101T, ME102D, ME102M, ME102P, ME102T, ME201D, ME201M, ME201P, ME201T, ME202D, ME202M, ME202P, ME202T, MEMT06D, MEMT06P, MEMT10D, MEMT10P, MEMT20D, MEMT20P, MEMT21D, MEMT21P, MEMT40D, MEMT40P, MEVT06D, MEVT06P, MEVT10D, MEVT10P, MEVT20D, MEVT20P, MEVT21D, MEVT21P, MEVT40D, MEVT40P...(Other models you can see in the webshop)		

1 			
GEV No.	690099	Ref. No.	R58002150
description	hinge pin mounting pos. upper for door		
For models:	EC106M, EC110M, EC210M, EM010M+SC, EM106H, EM106M, EM106M+SC, EM106P, EM110H, EM110M, EM110M+SC, EM110P, EM210H, EM210M, EM210M+SC, EM210P, EV006M, EV106H, EV106M, EV106M+SC, EV106P, EV110H, EV110M, EV110M+SC, EV110P, EV210H, EV210M, EV210M+SC, EV210P, GC106M, GC110M, GC210M, GM106H, GM106M, GM106M+SC, GM106P, GM110H, GM110M, GM110M+SC, GM110P, GM210H, GM210M, GM210M+SC, GM210P, GMT06D, GMT20D, GV106H, GV106M, GV106M+SC, GV106P...(Other models you can see in the webshop)		

1 			
GEV No.	692657	Ref. No.	BN1412270
description	mounting bracket L 45mm W 40mm mounting distance 22mm		

accessories

miscellaneous

1 			
GEV No.	690595	Ref. No.	R58002550
description	bush for door hinge		
For models:	ME120M, ME120P, ME120X, ME201D, ME201M, ME201P, ME201T, ME202D, ME202M, ME202P, ME202T, ME220M, ME220P, ME220X, MEC24H, MEC40M, MEMT21D, MEMT21P, MEMT40D, MEMT40P, MEVT21D, MEVT21P, MEVT40D, MEVT40P, MG120M, MG120P, MG120X, MG201D, MG201M, MG201P, MG201T, MG202D, MG202M, MG202P, MG202T, MG220M, MG220P, MG220X, MGC20X, MGC24H, MGC40H, MGMT21D, MGMT21P, MGMT40D, MGMT40P, MGVT21D, MGVT21P, MGVT40D, MGVT40P, VE120M...(Other models you can see in the webshop)		

1 			
GEV No.	694495	Ref. No.	CM219300 MACM219300
description	distance washer for lid hinge for tilting bratt pan ID ø 18.2mm ED ø 20mm L 20mm stainless steel		
For models:	BR78EF, BR78EI, BR78G, BR78GF, BR78GI, BR912EFM, BR912EIM, BR912GFM, BR912GIM, BR98EF, BR98EFM, BR98EI, BR98EIM, BR98GF, BR98GFM, BR98GI, BR98GIM, BR98SEF, BR98SEI, BR98SGF, BR98SGI		

1 			
GEV No.	514231	Ref. No.	CM051503 MACM051503
description	hinge pin tilting bratt pan kettle type series 700/900		
For models:	BR78EF, BR78EI, BR78G, BR78GF, BR78GI, BR912EFM, BR912EIM, BR912GFM, BR912GIM, BR98EF, BR98EFM, BR98EI, BR98EIM, BR98GF, BR98GFM, BR98GI, BR98GIM, BR98SEF, BR98SEI, BR98SGF, BR98SGI, NPD76G5, NPD78G8, NPD96G5, NPI76E5, NPI76G5, NPI78E8, NPI78G8, NPI96E5, NPI96G5, PD76G5, PD96G5, PD98E10, PD98E15, PD98G10, PD98G15, PD98G15A, PD98E10, PD98G10, PI76E5, PI76G5, PI96E5, PI96G5, PI98E10, PI98E15, PI98G10, PI98G14, PI98G14A, PI98E10		

1 			
GEV No.	690592	Ref. No.	R58002540
description	pin for hinge		
For models:	ME120M, ME120P, ME120X, ME201D, ME201M, ME201P, ME201T, ME202D, ME202M, ME202P, ME202T, ME220M, ME220P, ME220X, MEC24H, MEC40M, MEMT21D, MEMT21P, MEMT40D, MEMT40P, MEVT21D, MEVT21P, MEVT40D, MEVT40P, MG120M, MG120P, MG120X, MG201D, MG201M, MG201P, MG201T, MG202D, MG202M, MG202P, MG202T, MG220M, MG220P, MG220X, MGC20X, MGC24H, MGC40H, MGMT21D, MGMT21P, MGMT40D, MGMT40P, MGVT21D, MGVT21P, MGVT40D, MGVT40P, VE120M...(Other models you can see in the webshop)		

1 			
GEV No.	690593	Ref. No.	R58002570
description	plain washer ID ø 15mm ED ø 30mm thickness 3mm Qty 1 pcs for door hinge		
For models:	ME120M, ME120P, ME120X, ME201D, ME201M, ME201P, ME201T, ME202D, ME202M, ME202P, ME202T, ME220M, ME220P, ME220X, MEC24H, MEC40M, MEMT21D, MEMT21P, MEMT40D, MEMT40P, MEVT21D, MEVT21P, MEVT40D, MEVT40P, MG120M, MG120P, MG120X, MG201D, MG201M, MG201P, MG201T, MG202D, MG202M, MG202P, MG202T, MG220M, MG220P, MG220X, MGC20X, MGC24H, MGC40H, MGMT21D, MGMT21P, MGMT40D, MGMT40P, MGVT21D, MGVT21P, MGVT40D, MGVT40P, VE120M...(Other models you can see in the webshop)		



			
1			
GEV No.	690594	Ref. No.	R58002560
description	pressure screw for door hinge		
For models:	ME120M, ME120P, ME120X, ME201D, ME201M, ME201P, ME201T, ME202D, ME202M, ME202P, ME202T, ME220M, ME220P, ME220X, MEC24H, MEC40M, MEMT21D, MEMT21P, MEMT40D, MEMT40P, MEVT21D, MEVT21P, MEVT40D, MEVT40P, MG120M, MG120P, MG120X, MG201D, MG201M, MG201P, MG201T, MG202D, MG202M, MG202P, MG202T, MG220M, MG220P, MG220X, MGC20X, MGC24H, MGC40H, MGMT21D, MGMT21P, MGMT40D, MGMT40P, MGVT21D, MGVT21P, MGVT40D, MGVT40P, VE120M...(Other models you can see in the webshop)		

			
1			
GEV No.	694496	Ref. No.	CM052201 MACM052201
description	screw for spring compressor for tilting bratt pan ED ø 8mm L 20mm thread M6		
For models:	BR78EF, BR78EI, BR78G, BR78GF, BR78GI, BR912EFM, BR912EIM, BR912GFM, BR912GIM, BR98EF, BR98EFM, BR98EI, BR98EIM, BR98GF, BR98GFM, BR98GI, BR98GIM, BR9S8EF, BR9S8EI, BR9S8GF, BR9S8GI, NPD76G5, NPD78G8, NPD96G5, NPI76E5, NPI76G5, NPI78E8, NPI78G8, NPI96E5, NPI96G5, PD76G5, PD98E10, PD98E15, PD98G10, PD98G15, PD9S8E10, PD9S8G10, PI76E5, PI76G5, PI98E10, PI98E15, PI98G10, PI98G14, PI9S8E10		

			
1			
GEV No.	694494	Ref. No.	CM051804 MACM051804
description	spacer for lid hinge for tilting bratt pan ID ø 7mm		
For models:	BR78EF, BR78EI, BR78G, BR78GF, BR78GI, BR912EFM, BR912EIM, BR912GFM, BR912GIM, BR98EF, BR98EFM, BR98EI, BR98EIM, BR98GF, BR98GFM, BR98GI, BR98GIM, BR9S8EF, BR9S8EI, BR9S8GF, BR9S8GI		

pullouts

drawer slides

producer-specific

			
1			
GEV No.	691339	Ref. No.	1031006100 MA1031006100
description	drawer slide L 525mm pull-out lengthmm W 57mm H 15mm mounting pos. right		
For models:	CS40, CS60, EN124, EN12C4, EN72, EN74, EN76, EN78, EN92, EN94, EN96, EN98, M100, M120, M140, M160, M180, M40, M60, M80, NEN72, NEN74, NEN74C, NEN76, NEN76C, NEN78, NEN78C, NEN92, NEN94, NEN94C, NEN96, NEN96C, NEN98, NEN98C, NXBVC4, NXBVC6, NXKPA, NXPZM, OPL40, P40D, P40S, P60D, P60S, PL40, PL6, PL60, PL704C, PL707C, XR		
accessories for	691339		
	GEV No.	692500	Ref. No. 1031006200 MA1031006200
	 drawer slide L 525mm W 57mm H 15mm mounting pos. left		

rollers

rollers

			
1			
GEV No.	690709	Ref. No.	1194001 MA1194001
description	roller rollerø 28mm B1 6mm overall width 13mm A 28mm B 6mm C 10mm D 6mm E 13mm plastic		
For models:	AC705PA, AC705PS, AC709PA, AC709PS, AC714PA, AC714PS, AC716PA, AC716PS, AC717PA, AC717PS, AC718PA, AC718PS, AC719PA, AC719PS, AC720PA, AC720PS, AC721PA, AC721PS, AP-708PA, AP708PS, AP709PA, AP709PS, AP710BPS, AP710PA, AP710PS, AP711BPS, AP711PA, AP711PS, AP712BPS, AP712PA, AP712PP, AP712PS, AP713BPS, AP713PA, AP713PP, AP713PS, AP714BPS, AP-714PA, AP714PP, AP714PS, AP715BPS, AP715PA, AP715PP, AP715PS, AP716BPS, AP716PA, AP716PP, AP716PS, AP717BPS, AP717PA...(Other models you can see in the webshop)		

accessories

			
1			
GEV No.	560133	Ref. No.	260404
description	hexagonal nut thread M6 H 5mm WS 10 SS DIN/ISO DIN 934 / ISO 4032/8673 Qty 20 pcs		

			
1			
GEV No.	690703	Ref. No.	11870.00 MA1187000
description	rubber pad		
For models:	BR120, BR160, IR13C, IR13CC, IR13CV, IR13M, IR13MC, IR13MV, IR13V, IR17C, IR17CC, IR17CV, IR17M, IR17MC, IR17MV, IR17V, TP13, TP13E, TP17, TP17E, TP21, TP21E, TPC17, TPC21, TR13C2P, TR13I4C, TR13I4CC, TR13I4CV, TR13N2C1P, TR13N2C1PC, TR13N2C1PV, TR13N2P, TR13N2PC, TR13N2PV, TR13N4C, TR13N4CC, TR13N4CV, TR17C3P, TR17I6C, TR17I6CC, TR17I6CV, TR17N2C2P, TR17N2C2PC, TR17N2C2PV, TR17N2P, TR17N3P, TR17N3PC, TR17N3PV, TR17N4C1P, TR17N4C1PC...(Other models you can see in the webshop)		

fittings for catering equipment

outlet taps

producer-specific

MARENO



1

GEV No.	514325	Ref. No.	1950700 MA1950700
description	ball valve connection 1" IT - 1" IT DN25 total length 83mm with lever handle		
For models:	EF74E12, EF74G15, F12C4E12, F12C4G15, F74E10, F74E12, F74G15, F76E10, F78E12, F78G15, F94E10, F94E12, F94E18, F94E18K, F94G15, F94G22, F94G22K, F96E10, F98E12, F98E18, F98E18K, F98G15, F98G22, F98G22K, F9S4E12, F9S4E18, F9S4E18K, F9S4G15, F9S4G22, F9S4G22K, F9S8E12, F9S8E18, F9S8E18K, F9S8G15, F9S8G22, F9S8G22K, FR74E, FR74E2, FR74G, FR77E, FR77E2, FR77G, FR92E13, FR92E132, FR92E22, FR92G13, FR92G22, FR92G22T, FR94E13, FR94E132...(Other models you can see in the webshop)		



1

GEV No.	540658	Ref. No.	1450500 MA1450500
description	ball valve connection 3/4" IT - 3/4" IT DN20 total length 69mm		
For models:	CP704E, CP704G, CP92E, CP92E2, CP92G, CP94E, CP94E2, CP94G, CP95B2E, CP95B2E2, CP95B2G, CP95B4E, CP95B4E2, CP95B4G, CPE40, CPE402, CPE60, CPE602, CPE60DB, F74E10, F74E6, F76E10, F94E10, F94E6, F96E10, FR74E, FR74E10, FR74E10L, FR74E10L2, FR74G, FR77E, FR77E10, FR77E10L, FR77E10L2, FR77G, FR92E10, FR92E10L, FR92E10L2, FR92E13, FR92E22, FR92G22, FR94E10, FR94E10L, FR94E10L2, FR94E13, FR94E22, FR94G23, FR9P2E10, FR9P4E10, NF74E10...(Other models you can see in the webshop)		



1

GEV No.	514099	Ref. No.	1515900 MA1515900
description	centring piece L 20mm for extension thread ID ø 10mm D1 ø 18mm D2 ø 20mm		
For models:	CP92E, CP92E2, CP92G, CP94E, CP94E2, CP94G, CP95B2E, CP95B2E2, CP95B2G, CP95B4E, CP95B4E2, CP95B4G, EPC74E, EPC74G, NPC74E, NPC74G, NPC76E, NPC76G, NPC78E, NPC78G, NPC94E, NPC94G, NPC98E, NPC98G, PC12C4E, PC12C4G, PC12C9E, PC12C9G, PC74E, PC74G, PC76E, PC76G, PC78E, PC78G, PC94E, PC94G, PC96E, PC96G, PC98E, PC98G, PC9S4E, PC9S4G, PC9S6E, PC9S6G, PC9S8E, PC9S8G		



1

GEV No.	514033	Ref. No.	498500 MA498500
description	cone handle plastic black		
For models:	B9SB2E, B9SB2G, B9SB4E, B9SB4G, B9V2E, B9V2G, B9V4E, B9V4G, B9VP2E, B9VP4E, B9VP4G, CS10, CS6, F9V2E, F9V2ER, F9V4E, F9V4EC, F9V4ECR, F9V4ER, F9V4ERL, FC10E, FC20E, FC5E, FC7E, FT74E, FT74ER, FT74G, FT74GR, FT77E, FT77ERL, FT77G, FT77GRL, GB707G, T9F4G, T9F6GS, T9SB4G, T9V4G, T9V6GS		



1

GEV No.	514006	Ref. No.	1033061900 866100
description	drain pipe L 200mm thread ø 22mm		
For models:	B9SB2E, B9SB2G, B9SB4E, B9SB4G, B9V2E, B9V2G, B9V4E, B9V4G		



1

GEV No.	514219	Ref. No.	1577500 MA1577500
description	drain pipe thread 1" ET connection 1" total length 230mm shaft intake ø 24mm		
For models:	FR74E, FR74E2, FR74G, FR77E, FR77E2, FR77G, FR92E13, FR92E132, FR92E13T, FR92E13T2, FR92E22, FR92E22T, FR92G13, FR92G22, FR92G22T, FR94E13, FR94E132, FR94E13T, FR94E13T2, FR94E22, FR94E22T, FR94G13, FR94G22, FR94G22T		



1

GEV No.	514220	Ref. No.	CM012000 MACM012000
description	drain pipe thread 1/2" ET		
For models:	EF74E12, EF74G15, F12C4E12, F12C4G15, F74E10, F74E12, F74G15, F76E10, F78E12, F78G15, F94E10, F94E12, F94E18, F94E18K, F94G15, F94G22, F94G22K, F96E10, F98E12, F98E18, F98E18K, F98G15, F98G22, F98G22K, F9S4E12, F9S4E18, F9S4E18K, F9S4G15, F9S4G22, F9S4G22K, F9S8E12, F9S8E18, F9S8E18K, F9S8G15, F9S8G22, F9S8G22K		





1

GEV No.	691356	Ref. No.	1033720900 MA1033720900
description	extension for lever outlet tap		



			
1			
GEV No.	514007	Ref. No.	1044109600 MA1044109600
description	lever		
For models:	BM74E, BM74G, BM77E, BM77G, BME40DM, BME40DMB, BME40M, BME60, BME602, BME60DM, BME60DMB, BME60M, BME80M, BMG40, BMG60, FQE41, FQE41L, FQE41L2, FQE61, FQE61L, FQE61L2		









			
1			
GEV No.	514032	Ref. No.	1041622 MA1041622
description	lever		
For models:	B9SB2E, B9SB2G, B9SB4E, B9SB4G, B9V2E, B9V2G, B9V4E, B9V4G, B9VP2E, B9VP4E, B9VP4G		

			
1			
GEV No.	691333	Ref. No.	1044235200 MA1044235200
description	lever for outlet tap left thread		
For models:	CRE6220, CRE6230, CRE6320, CRE6330		

			
1			
GEV No.	691334	Ref. No.	1044235100 MA1044235100
description	lever for outlet tap right thread		

			
1			
GEV No.	514015	Ref. No.	1036702000 1851700 MA1036702000 MA1851700
description	lever handle plastic black		
For models:	BM74E, BM74G, BM77E, BM77G, BME40DM, BME40DMB, BME40M, BME60, BME602, BME60DM, BME60DMB, BME60M, BME80M, BMG40, BMG60, CPE40, CPE402, CPE60, CPE602, CPE60DB, CRE6220, CRE6230, CRE6320, CRE6330, EF74E10VG, EF74G8VA, EF74G8VG, FQE40, FQE40D, FQE40DSP, FQE41, FQE41L, FQE41L2, FQE41R, FQE41RL, FQE41RL2, FQE60, FQE60D, FQE60DSP, FQE61, FQE61L, FQE61L2, FQE61R, FQE61RL, FQG40, FQG41, FQG60, FQG61, OCPE6, OCPE60... (Other models you can see in the webshop)		

			
1			
GEV No.	106598	Ref. No.	866200 MA866200
description	olive for pipe ø 18mm Qty 1 pcs ED ø 21mm		
For models:	B9SB2E, B9SB2G, B9SB4E, B9SB4G, B9V2E, B9V2G, B9V4E, B9V4G, B9VP2E, B9VP4E, B9VP4G, BF78G, BF912G, BF912GH, BF98G, BM74E, BM74G, BM77E, BM77G, BME40DM, BME40DMB, BME40M, BME60, BME602, BME60DM, BME60DMB, BME60M, BME80M, BMG40, BMG60, BV712, BV74, BV76, BV78, BV912, BV94, BV96, BV98, C12FGP9G, C7FG12G, C7FG8G, C7FGM12G, C9FG12G, C9FG16G, C9FG8G, C9FG8GP, C9FGM12G, CPE40, CPE402, CPE60...(Other models you can see in the webshop)		

			
1			
GEV No.	540776	Ref. No.	BN41826900950
description	outlet tap L 83mm without handle thread 3/4" IT shaft L 9mm shaft ø 10x7.3mm handle M6		
spare parts for	540776		
	GEV No.	532453	Ref. No. —
	O-ring EPDM thickness 2.62mm ID ø 21.89mm Qty 1 pcs		
accessories for	540776		
	GEV No.	110734	Ref. No. —
	lever for outlet tap		
	GEV No.	514006	Ref. No. 1033061900 866100
	drain pipe L 200mm thread ø 22mm		
	GEV No.	514217	Ref. No. —
	handle for outlet tap		
	GEV No.	540651	Ref. No. 0109013 1033300300 MA1033300300 R0109013 SIR0109013
	drain pipe total length 210mm shaft ø 22mm		
	GEV No.	540734	Ref. No. —
	drain pipe thread		
	GEV No.	693082	Ref. No. —
	lever handle thread		



GEV No.	514005	Ref. No.	1031024110 MA1031024110
description	outlet tap without handle thread 3/4" IT shaft L 12mm		
For models:	BME40DM, BME40DMB, BME40M, BME60, BME602, BME60DM, BME60DMB, BME60M, BME80M, BMG40, BMG60, CRE6220, CRE6230, CRE6320, CRE6330, EF74E10VG, EF74G8VA, EF74G8VG, FQE40, FQE40D, FQE40DSP, FQE41, FQE41L, FQE41L2, FQE41R, FQE41RL, FQE41RL2, FQE60, FQE60D, FQE60DSP, FQE61, FQE61L, FQE61L2, FQE61R, FQE61RL, FQG40, FQG41, FQG60, FQG61, OFQE41, OFQE61, OFQG41, OFQG61		

accessories for 514005

	GEV No.	106597	Ref. No.	866000 MA866000
union screw thread 3/4" for pipe ø 18mm L 20mm Qty 1 pcs WS 27				

	GEV No.	106598	Ref. No.	866200 MA866200
olive for pipe ø 18mm Qty 1 pcs ED ø 21mm				

	GEV No.	514011	Ref. No.	1031400100 MA1031400100
lever right equiv. no. 1031400100				

	GEV No.	514015	Ref. No.	1036702000 1851700 MA1036702000 MA1851700
lever handle plastic black				

	GEV No.	540651	Ref. No.	0109013 1033300300 MA1033300300 R0109013 SIR0109013
drain pipe total length 210mm shaft ø 22mm				

	GEV No.	691334	Ref. No.	1044235100 MA1044235100
lever for outlet tap right thread				

	GEV No.	691356	Ref. No.	1033720900 MA1033720900
extension for lever outlet tap				



GEV No.	514051	Ref. No.	32000599 MA32000599
description	star handle shaft 7x7mm ø 60mm L 23mm black thermoplastic		
For models:	CP704E, CP704G, CP92E, CP92E2, CP92G, CP94E, CP94E2, CP94G, CP95B2E, CP95B2E2, CP95B2G, CP95B4E, CP95B4E2, CP95B4G		

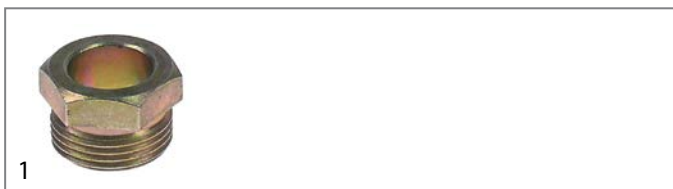

GEV No.	106597	Ref. No.	866000 MA866000
description	union screw thread 3/4" for pipe ø 18mm L 20mm Qty 1 pcs WS 27		
For models:	B9SB2E, B9SB2G, B9SB4E, B9SB4G, B9V2E, B9V2G, B9V4E, B9V4G, B9VP2E, B9VP4E, B9VP4G, BF78G, BF912G, BF912GH, BF98G, BM74E, BM74G, BM77E, BM77G, BME40DM, BME40DMB, BME40M, BME60DM, BME60DMB, BME60M, BME80M, BV712, BV74, BV76, BV78, BV912, BV94, BV96, BV98, C12FGP9G, C7FG12G, C7FG8G, C7FGM12G, C9FG12G, C9FG16G, C9FG8G, C9FG8GP, C9FGM12G, CPE60, CPE602, CPE60DB, EF74E10VG, EF74G8VA, EF74G8VG, F74E10...(Other models you can see in the webshop)		

aerators and air bleeders

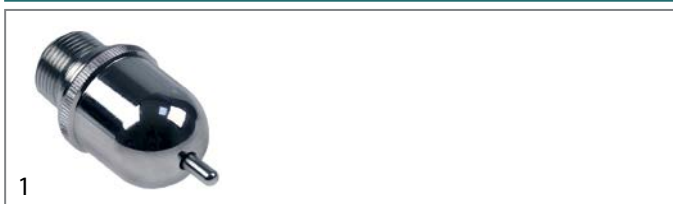

GEV No.	540827	Ref. No.	14206399 BN6A021600
description	aerator and air bleeder thread 3/4" ET chrome-plated L 45mm ø 36mm		
For models:	PV, PVA		



GEV No.	540825	Ref. No.	0587810 CR0587810
description	aerator and air bleeder thread 3/8" ET WS 24 chrome-plated L 37mm		
For models:	NPD76G5, NPD78G8, NPD96G5, NPD98E10, NPD98E15, NPD98G10, NPD98G15, NPD98G15A, NPI76E5, NPI76G5, NPI78E8, NPI78G8, NPI96E5, NPI96G5, NPI98E10, NPI98E15, NPI98G10, NPI98G14, NPI98G14A		

lid hinges

miscellaneous

spare parts



GEV No.	691659	Ref. No.	CM192301 MACM192301
description	extension for lid hinge ø 18mm L 209mm since 2003		
For models:	BR78EF, BR78EI, BR78G, BR78GF, BR78GI, BR912EFM, BR912EIM, BR912GFM, BR912GIM, BR98EF, BR98EFM, BR98EI, BR98EIM, BR98GF, BR98GFM, BR98GI, BR98GIM, BR98SEF, BR98SEI, BR98SGF, BR98SGI		





1

GEV No.	691660	Ref. No.	CM051702 MACM051702
description	pipe for lid hinge ø 40mm L 420mm		
For models:	BR78EF, BR78EI, BR78G, BR78GF, BR78GI, BR912EFM, BR912EIM, BR912GFM, BR912GIM, BR98EF, BR98EFM, BR98EI, BR98EIM, BR98GF, BR98GFM, BR98GI, BR98GIM, BR9S8EF, BR9S8EI, BR9S8GF, BR9S8GI		

drain taps

stainless steel

gaskets



1

GEV No.	510974	Ref. No.	200852
description	O-ring EPDM thickness 2.62mm ID ø 58.42mm Qty 1 pcs		

brass

drain taps



1

GEV No.	540132	Ref. No.	1677200	
description	drain tap 1 1/2" IT conical seal kettle A 90mm B 137mm B1 70mm chrome-plated brass			
For models:	P9D2G, PD707G, PI707E, PI707G			
spare parts for	540132			
	GEV No.	540213	Ref. No.	—
	handle ID ø 5mm L 117mm			
	GEV No.	540461	Ref. No.	—
	shim for drain tap			
	GEV No.	540464	Ref. No.	—
	nut for drain tap thread 1 1/2"			
accessories for	540132			
	GEV No.	510404	Ref. No.	CR0682770
	flat gasket fibre ED ø 44mm ID ø 34mm thickness 2mm Qty 1 pcs			



1

GEV No.	540131	Ref. No.	1677800 MA1677800	
description	drain tap 1 1/4" IT chrome-plated brass			
For models:	P9D10E, P9D10G, P9D15E, P9D15G, P9D5G, P9DA10E, P9DA10G, P9DA15E, P9DA15G, P9DSB10E, P9DSB10G, P9I10E, P9I10G, P9I15E, P9I5G, P9IA10E, P9IA10G, P9IA15E, PD707G, PD76G5, PD96G5, PDASB10E, PDASB10G, PI707E, PI707G, PI76E5, PI76G5, PI96E5, PI96G5			
spare parts for	540131			
	GEV No.	540213	Ref. No.	—
	handle ID ø 5mm L 117mm			
	GEV No.	540461	Ref. No.	—
	shim for drain tap			
	GEV No.	540464	Ref. No.	—
	nut for drain tap thread 1 1/2"			



1

GEV No.	540275	Ref. No.	679400 BN6A021000 CM128900 MACM128900	
description	drain tap 2" IT with union nut A 90mm B 151mm B1 80mm chrome-plated brass			
For models:	NPD98E10, NPD98E15, NPD98G10, NPD98G15, NPD98G15A, NPI98E10, NPI98E15, NPI98G10, NPI98G14, NPI98G14A, P9D10E, P9D10G, P9D15E, P9D15G, P9DA10E, P9DA10G, P9DA15E, P9DA15G, P9I10E, P9I10G, P9IA10E, P9IA10G, PD98E10, PD98E15, PD98G10, PD98G15, PD98G15A, PD9S8E10, PD9S8G10, PI98E10, PI98E15, PI98G10, PI98G14, PI98G14A, PI9S8E10, PV, PVA			
spare parts for	540275			
	GEV No.	540214	Ref. No.	—
	handle ID ø 6mm L 145mm			
accessories for	540275			
	GEV No.	529484	Ref. No.	—
	flat gasket fibre ED ø 58mm ID ø 50mm thickness 2mm Qty 1 pcs			
	GEV No.	542448	Ref. No.	—
	gasket silicone 60x49x2 for drain tap 2"			

accessories



GEV No.	540119	Ref. No.	1420925 MA1420925
description	O-ring EPDM thickness 2.5mm ID ø 59mm Qty 1 pcs		
For models:	NPD98E10, NPD98E15, NPD98G10, NPD98G15, NPD98G15A, NPI98E10, NPI98E15, NPI98G10, NPI98G14, NPI98G14A, P9D10E, P9D10G, P9D15E, P9D15G, P9D5G, P9DA10E, P9DA10G, P9DA15E, P9DA15G, P9DSB10E, P9DSB10G, P9I10E, P9I10G, P9I15E, P9I5G, P9IA10E, P9IA10G, P9IA15E, PD98E10, PD98E15, PD98G10, PD98G15, PD98G15A, PD98E10, PD98G10, PDASB10E, PDASB10G, PI98E10, PI98E15, PI98G10, PI98G14, PI98G14A, PI98E10		



GEV No.	505517	Ref. No.	77121600 MA77121600
description	O-ring EPDM thickness 5.34mm ID ø 53.34mm Qty 1 pcs		
For models:	PD98E10, PD98E15, PD98G10, PD98G15, PD98G15A, PD98E10, PD98G10, PI98E10, PI98E15, PI98G10, PI98G14, PI98G14A, PI98E10		



GEV No.	699248	Ref. No.	77121900 MA77121900
description	O-ring set silicone 2" for drain tap Qty 3 pcs		
For models:	NPD98E10, NPD98E15, NPD98G10, NPD98G15, NPD98G15A, NPI98E10, NPI98E15, NPI98G10, NPI98G14, NPI98G14A, PD98E10, PD98E15, PD98G10, PD98G15, PD98E10, PD98G10, PI98E10, PI98E15, PI98G10, PI98G14, PI98E10		

safety fittings

accessories



GEV No.	540836	Ref. No.	14206599 BN6A021700
description	funnel thread 1/2" with shut-off valve		

safety valves



GEV No.	540721	Ref. No.	14206200 14206299 BN6A021510 MA14206299	
description	safety valve triggering pressure 0.5bar M88 thread 1 1/4"			
For models:	PV, PVA			
accessories for	540721			
	GEV No.	541501	Ref. No.	—
	reducer for safety fitting IT 1 1/4" ET 3/4"			

filters

device filters



GEV No.	692816	Ref. No.	140408 935320 BN140408 FR935320
description	filter L 290mm W 290mm H 5mm for fridge		

equipment feet and end caps

equipment feet



with fixing plate



GEV No.	700724	Ref. No.	49621 6086100 6086113 MA6086113
description	equipment foot tube ø 58mm plate size 70x70mm hole distance 56x56mm H 130-210mm SS size 2 1/4" Qty 1 pcs		
For models:	AA710PA, AA710PS, AC705PA, AC705PS, AC709PA, AC709PS, AC714PA, AC714PS, AC716PA, AC716PS, AC717PA, AC717PS, AC718PA, AC718PS, AC719PA, AC719PS, AC720PA, AC720PS, AC721PA, AC721PS, AFR1143P, AFR1143PE, AP708PA, AP708PS, AP709PA, AP709PS, AP710BPS, AP710PA, AP710PS, AP711BPS, AP711PA, AP711PS, AP712BPS, AP712PA, AP712PP, AP712PS, AP713BPS, AP713PA, AP713PP, AP713PS, AP714BPS, AP714PA, AP714PP, AP714PS, AP715BPS, AP715PA, AP715PP, AP715PS, AP716BPS, AP716PA...(Other models you can see in the webshop)		



screw-in feet

			
1			
GEV No.	510939	Ref. No.	440201
description	equipment foot thread M10 thread L 40mm H 14mm ø 60mm		
accessories for	510939		
	GEV No.	524547	Ref. No. —
	plug pipe type 40x40 thickness 1.5mm thread M10 plastic Qty 1 pcs for equipment foot		

			
1			
GEV No.	510904	Ref. No.	210203
description	equipment foot thread M10 thread L 40mm ø 60mm H 30mm Qty 1 pcs		

bolting feet

			
1			
GEV No.	514009	Ref. No.	1036021600 1036021613 MA1036021613
description	equipment foot L 50mm W 29mm H 25mm bore ø 10mm mounting distance 40mm Qty 1 pcs		
For models:	BIE40, BIE40B, BIE60, BIE60B, BIG40, BIG60, BME40DM, BME40DMB, BME40M, BME60, BME60, BME602, BME60DM, BME60DMB, BME60M, BME80M, BMG40, BMG60, BRE40, BRE40D, BRE40DB, BRE40DG, BRE40DGB, BRE40G, BRG40, BRG40G, BSE40M, BSEI40M, CPE60, CPE602, CPE60DB, CRE6220, CRE6230, CRE6320, CRE6330, CSP6220, CSP6230, CWE42, CWE422, CWE62, CWE622, FQE40, FQE40D, FQE40DSP, FQE41, FQE41L, FQE41L2, FQE60, FQE60D, FQE60DSP, FQE61...(Other models you can see in the webshop)		

equipment feet with stem

			
1			
GEV No.	514010	Ref. No.	1036016200 MA1036016200
description	equipment foot ø 20mm H 4mm mounting ø 10mm overall height 12mm rubber Qty 1 pcs		
For models:	BIE40, BIE60, BIG40, BIG60, BME40M, BME60, BME602, BME60M, BME80M, BMG40, BMG60, BRE40, BRE40G, BRG40, BRG40G, BSE40M, CPE60, CSP6220, CSP6230, CWE42, CWE62, FQE41, FQE41L, FQE41L2, FQE61, FQE61L, FQE61L2, FQG40, FQG60, FTE100B, FTE100BR, FTE100CRL, FTE40B, FTE40C, FTE60B, FTE60BR, FTE60C, FTG40B, FTG60B, FTG60BLC, FTG60BR, FTG80B, FTG80BR, FTVE100, FTVE40, FTVE60, LA60, PCE40, PCE60, PCVE40...(Other models you can see in the webshop)		

miscellaneous

			
1			
GEV No.	511153	Ref. No.	160509
description	bracket for equipment foot		

DERBY RUOTE

with bolt hole

chrome-plated steel

			
1			
GEV No.	700201 ¹	Ref. No.	30700699
description	swivel castor with swivel brake ø 100mm bolt hole bolt hole ø 12mm housing chrome-plated sheet steel capacity 80kg bearing ball bearing wheel body polypropylene tread TPE tyres H 132mm wheel width 30mm Qty 1 pcs		
For models:	CB3, CB5, CD24		

¹with swivel brake

spare parts and accessories

miscellaneous

			
1			
GEV No.	560193	Ref. No.	15812699 MA15812699
description	tooth lock washer ID ø 10.4mm ED ø 18mm zinc-coated steel DIN/ISO DIN 6798A Qty 1 pcs for thread M10		
For models:	CPE60, CPE602, CPE60DB, OCPE6, OCPE60		

TENTE

with fixing plate

stainless steel

			
1			
GEV No.	701624	Ref. No.	R69090100
description	swivel castor with swivel brake ø 125mm plate fixing housing stainless steel plate size 105x85mm hole distance 78x60mm capacity 200kg bearing slide bearing wheel body polyamide tread polyurethane H 155mm wheel width 32mm		
For models:	ME201D, ME201M, ME201P, ME201T, ME202D, ME202M, ME202T, MEMT21D, MEMT21P, MEMT40D, MEMT40P, MEVT21D, MEVT21P, MEVT40D, MEVT40P, MG201D, MG201M, MG201P, MG201T, MG202D, MG202M, MG202P, MG202T, MGMT21D, MGMT21P, MGMT40D, MGMT40P, MGVT21D, MGVT21P, MGVT40D, MGVT40P		

			
1			
GEV No.	701622	Ref. No.	R69090090
description	swivel castor without brake ø 125mm plate fixing housing stainless steel plate size 105x85mm hole distance 78x60mm capacity 200kg bearing slide bearing wheel body polyamide tread polyurethane H 155mm wheel width 32mm		
For models:	ME201D, ME201M, ME201P, ME201T, ME202D, ME202M, ME202P, ME202T, MEMT21D, MEMT21P, MEMT40D, MEMT40P, MEVT21D, MEVT21P, MEVT40D, MEVT40P, MG201D, MG201M, MG201P, MG201T, MG202D, MG202M, MG202P, MG202T, MGMT21D, MGMT21P, MGMT40D, MGMT40P, MGVT21D, MGVT21P, MGVT40D, MGVT40P		

			
1			
GEV No.	970334	Ref. No.	1031108200 MA1031108200
description	fryer basket L1 260mm W1 135mm H1 100mm chrome-plated steel		
For models:	FQE4		

			
1			
GEV No.	970156	Ref. No.	1031004810 MA1031004810
description	fryer basket L1 280mm W1 200mm H1 105mm chrome-plated steel		
For models:	FQE40, FQE40D, FQE40DSP, FQE60, FQE60D, FQE60DSP, FQG40, FQG60, FR74E10, FR77E10, FR92E10, FR94E10, FR9P2E10, FR9P4E10		

			
1			
GEV No.	970353	Ref. No.	CM030400 MACM030400
description	fryer basket L1 290mm W1 255mm H1 120mm chrome-plated steel		
For models:	EF74E12, EF74G15, F12C4E12, F12C4G15, F74E10, F74E12, F74G15, F76E10, F78E12, F78G15, F94E10, F94E12, F94E18, F94E18K, F94G15, F96E10, F98E12, F98E18, F98E18K, F98G15, F9S4E12, F9S4E18, F9S4E18K, F9S4G15, F9S8E12, F9S8E18, F9S8E18K, F9S8G15, NF74G15T, NF78G15T		

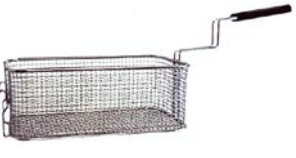
			
1			
GEV No.	970198	Ref. No.	1031110200 1031110222 MA1031110222
description	fryer basket L1 300mm W1 175mm H1 110mm chrome-plated steel		
For models:	EF74E10VG, F74E10, F76E10, F94E10, F96E10, FQE41, FQE41L, FQE41L2, FQE41R, FQE41RL, FQE41RL2, FQE61, FQE61L, FQE61L2, FQE61R, FQE61RL, FR74E10, FR74E10L, FR74E10L2, FR77E10, FR77E10L, FR77E10L2, FR92E10, FR92E10L, FR92E10L2, FR94E10, FR94E10L, FR94E10L2, NF74E10, NF76E10, NF94E10, NF96E10, OFQE41, OFQE61		

baskets

fryer baskets

MARENO

			
1			
GEV No.	970335	Ref. No.	1031108700 MA1031108700
description	fryer basket L1 230mm W1 200mm H1 115mm chrome-plated steel		
For models:	FQE6, FQE6+6		

			
1			
GEV No.	970170	Ref. No.	1464712 9323400 MA1464712
description	fryer basket L1 250mm W1 256mm H1 150mm L2 540mm H2 160mm H3 270mm chrome-plated steel		
For models:	FR74E, FR74E2, FR74G, FR77E, FR77E2, FR77G, FR92E13, FR92E132, FR92E13T, FR92E13T2, FR92E22, FR92E22T, FR92G13, FR94E13, FR94E132, FR94E13T, FR94E13T2, FR94E22, FR94E22T, FR94G13		



			
1			
GEV No.	970613	Ref. No.	CR0508550
description	fryer basket L1 350mm W1 200mm H1 110mm L2 560mm H2 180mm H3 210mm		
For models:	EF74G8VA, EF74G8VG, FQG41, FQG61, NF74G8, NF76G8, OFQG41, OFQG61		

			
1			
GEV No.	970352	Ref. No.	CM030200 MACM030200
description	fryer basket L1 360mm W1 160mm H1 120mm chrome-plated steel		
For models:	F74E10, F74E12, F76E10, F78E12, F94E10, F94E12, F94E18, F94E18K, F94G22, F94G22K, F96E10, F98E12, F98E18, F98E18K, F98G22, F98G22K, F954E12, F954E18, F954E18K, F954G22, F954G22K, F958E12, F958E18, F958E18K, F958G22, F958G22K		

			
1			
GEV No.	970171	Ref. No.	1464600 9323300 MA1464600
description	fryer basket L1 360mm W1 160mm H1 150mm L2 650mm H2 160mm H3 270mm chrome-plated steel		
For models:	FR92E13, FR92E132, FR92E13T, FR92E13T2, FR92E22, FR92E22T, FR92G22, FR94E13, FR94E132, FR94E13T, FR94E13T2, FR94E22, FR94E22T, FR94G22, FR94G23		

			
1			
GEV No.	970351	Ref. No.	9733900 CM070300 MACM070300
description	pasta basket L1 240mm W1 280mm H1 180mm H3 375mm stainless steel		

			
1			
GEV No.	970196	Ref. No.	1031100000 MA1031100000
description	pasta basket L1 280mm W1 100mm H1 115mm L2 490mm H3 207mm stainless steel		
For models:	CPE40, CPE402, CPE60, CPE602, CPE60DB, OCPE6, OCPE60		

			
1			
GEV No.	970347	Ref. No.	97337000 MA069502 MA97337000
description	pasta basket L1 280mm W1 160mm H1 180mm H3 345mm stainless steel		

pasta baskets

MARENO

			
1			
GEV No.	970566	Ref. No.	9330100 CM182900 MACM182900
description	pasta basket L1 160mm W1 96mm H1 180mm stainless steel		

			
1			
GEV No.	970348	Ref. No.	9733800 CM070800 MACM070800
description	pasta basket L1 280mm W1 310mm H1 180mm H3 380mm stainless steel		

crumb screens



1			
GEV No.	970764	Ref. No.	CM030600 MACM030600
description	crumb screen L 334mm W 272mm H 5.5mm for fryer		
For models:	EF74E12, EF74G15, F12C4E12, F12C4G15, F74E10, F74E12, F74G15, F76E10, F78E12, F78G15, F94E10, F94E12, F94E18, F94E18K, F94G15, F96E10, F98E12, F98E18, F98E18K, F98G15, F9S4E12, F9S4E18, F9S4E18K, F9S4G15, F9S8E12, F9S8E18, F9S8E18K, F9S8G15, NF-74G15T, NF78G15T		



1			
GEV No.	970614	Ref. No.	CR0508560
description	crumb screen L 400mm W 220mm suitable for fryer		
For models:	EF74G8VA, EF74G8VG, FQG41, FQG61, NF74E15, NF74G10, NF74G15, NF74G8, NF76G10, NF76G8, NF78E15, NF78G15, NF94E15, NF94G15, NF96G10, NF98E15, NF98G15, OFQG41, OFQG61		



1			
GEV No.	970832	Ref. No.	CR1073750
description	crumb screen L 375mm W 195mm H 145mm chrome-plated steel		

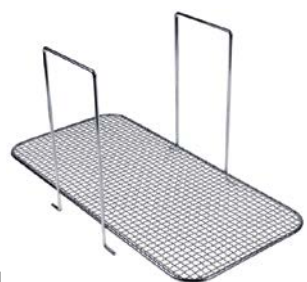

1			
GEV No.	970615	Ref. No.	1031112600 1041718424 MA1031112600
description	crumb screen L 388mm W 186mm suitable for fryer		
For models:	FQE41, FQE41L, FQE41L2, FQE61, FQE61L, FQE61L2, FR74E10, FR74E10L, FR74E10L2, FR77E10, FR77E10L, FR77E10L2, FR92E10, FR92E10L, FR92E10L2, FR94E10, FR94E10L, FR94E10L2, OFQE41, OFQE61		

shelves and shelf rails

chargrill grids



1			
GEV No.	210152	Ref. No.	1032100000 MA1032100000
description	chargrill grid L 480mm W 100mm suitable for chargrill		
For models:	CWE42, CWE422, CWE62, CWE622, OCWE42, OCWE422, OCWE62, OCWE622		

grates





universal





without upstand







1			
GEV No.	970125	Ref. No.	2522400 9019000 FR6351760 FR990028 MA2522400
description	grate W 325mm D 530mm GN 1/1 plastic-coated steel crossing wires 1 white suitable for refrigerator		
For models:	IR13C, IR17C, TR13N2C1P, TR13N2P, TR13N4C, TR17N2C2P, TR17N3P, TR17N4C1P, TR17N6C, TR21N2C3P, TR21N4C2P, TR21N4P		
accessories for	970125		
	GEV No.	690330	Ref. No. —
	rack L 1000mm W 22mm H 4mm aperture 3x8mm hole distance 12.5mm stainless steel		
	GEV No.	694700	Ref. No. —
	shelf support L 31/28mm W 22mm H 18mm SS Qty 12 pcs		
	GEV No.	694701	Ref. No. —
	shelf support L 31/28mm W 22mm H 17mm SS with hook Qty 12 pcs		

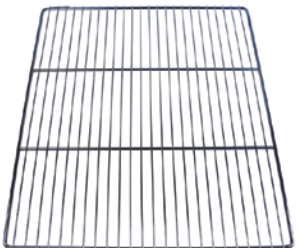

			
GEV No.	970133	Ref. No.	4624600 4657100 MA4657100
description	grate W 530mm D 600mm plastic-coated steel wire gauge frame 9mm lengthwise wires gauge 5mm crossing wires 2 white suitable for refrigerator		
For models:	EF140MF, EF140MN, EF140MP, EF70MF, EF70MN, EF70MP, FB110F, FB110N, FB110P, FB140F, FB140FN, FB140N, FB140NN, FB140P, FB140PF, FB140PN, FB140PP, FB55F, FB55N, FB55P, FB70F, FB70N, FB70P, FS140F, FS140FI, FS140FN, FS140I, FS140N, FS140NG, FS140NI, FS140NN, FS140P, FS140PN, FS140PP, FS70F, FS70FG, FS70I, FS70N, FS70NG, FS70P, HF140D, HF140DF, HF140DN, HF140DP, HF70DF, HF70DN, HF70DP, NF140D, NF140DF, NF140DN...(Other models you can see in the webshop)		
accessories for	970133		
	GEV No.	690330	Ref. No. —
	rack L 1000mm W 22mm H 4mm aperture 3x8mm hole distance 12.5mm stainless steel		
	GEV No.	694700	Ref. No. —
	shelf support L 31/28mm W 22mm H 18mm SS Qty 12 pcs		
	GEV No.	694701	Ref. No. —
	shelf support L 31/28mm W 22mm H 17mm SS with hook Qty 12 pcs		

			
GEV No.	970527	Ref. No.	2306800 MA2306800
description	grate W 530mm D 650mm GN 2/1 chrome-plated steel with hinge camp crossing wires 2 suitable for refrigerator		
For models:	AF140B, AF140C, AF140F, AF140I, AF140MB, AF140MC, AF140MF, AF140MI, AF140MN, AF140MP, AF140N, AF140P, AF70B, AF70C, AF70F, AF70I, AF70MB, AF70MC, AF70MF, AF70MI, AF70MN, AF70MP, AF70N, AF70P, AFR1143P, AFR1143PE, BF78G, BF912G, BF912GH, BF98G, C7FG12G, C7FG8G, C9F4GS, C9F6E, C9F6GS, C9F8GS, C9FE6GS, C9FG12G, C9FG16G, C9FG8G, C9FG8GP, C9FGM12G, EF140DF, EF140DN, EF140DP, EF140MB, EF140MC, EF140MF, EF140MI, EF140MN... (Other models you can see in the webshop)		
accessories for	970527		
	GEV No.	690330	Ref. No. —
	rack L 1000mm W 22mm H 4mm aperture 3x8mm hole distance 12.5mm stainless steel		
	GEV No.	694700	Ref. No. —
	shelf support L 31/28mm W 22mm H 18mm SS Qty 12 pcs		
	GEV No.	694701	Ref. No. —
	shelf support L 31/28mm W 22mm H 17mm SS with hook Qty 12 pcs		

			
GEV No.	970121	Ref. No.	4657000 MA4657000
description	grate W 650mm D 530mm GN 2/1 chrome-plated steel crossing wires 2		
For models:	EF140MF, EF140MN, EF140MP, EF143MNI, EF70MF, EF70MN, EF70MP, EF72MNF, FB110F, FB110N, FB110P, FB140F, FB140FN, FB140N, FB140NN, FB140P, FB140PF, FB140PN, FB140PP, FB143NI, FB55F, FB55N, FB55P, FB70F, FB70N, FB70P, FB72F, FB72N, FB72NF, FB72P, FS140F, FS140FI, FS140FN, FS140I, FS140N, FS140NG, FS140NI, FS140NN, FS140P, FS140PN, FS140PP, FS143F, FS143FI, FS143N, FS143NF, FS143NI, FS143NN, FS143NP, FS143P, FS70F...(Other models you can see in the webshop)		
accessories for	970121		
	GEV No.	690330	Ref. No. —
	rack L 1000mm W 22mm H 4mm aperture 3x8mm hole distance 12.5mm stainless steel		
	GEV No.	694700	Ref. No. —
	shelf support L 31/28mm W 22mm H 18mm SS Qty 12 pcs		
	GEV No.	694701	Ref. No. —
	shelf support L 31/28mm W 22mm H 17mm SS with hook Qty 12 pcs		

shelf rails and supports

producer-specific

			
GEV No.	690737	Ref. No.	46249.12 MA4624912
description	guide U-shape L 500mm W 14mm mounting pos. left/right inner height 20mm		
For models:	F140DF, F140DI, F140DN, F140DP, F143, F70DF, F70DI, F70DN, F70DP, F72, F7DFG, F7DNG		

			
GEV No.	690736	Ref. No.	46248.00 MA4624800
description	shelf support L 38mm W 20mm H 25mm		
For models:	EF140DF, EF140DN, EF140DP, EF140MB, EF140MC, EF140MF, EF140MI, EF140MN, EF140MP, EF143MNI, EF70DF, EF70DN, EF70DP, EF70MB, EF70MC, EF70MF, EF70MI, EF70MN, EF70MP, EF72MNF, HF140D, HF140DF, HF140DN, HF140DP, HF143DNI, HF70DF, HF70DN, HF70DP, NF140D, NF140DF, NF140DN, NF140DP, NF143DNF, NF143DNI, NF143DNP, NF14DNG, NF70DF, NF70DI, NF70DN, NF70DP, NF72DF, NF72DIN, NF72DN, NF72DNF, NF72DNI, NF72DNN, NF72DP, NF7DFG, NF7DNG, SF100DF...(Other models you can see in the webshop)		

gaskets

refrigeration gaskets

plug-in gaskets

profile 9048

We offer custom-made gaskets for this profile

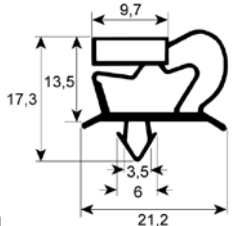
			
GEV No.	901172	Ref. No.	14414300254 BN14414300254
description	refrigeration gasket profile 9048 W 383mm L 254mm plug size		

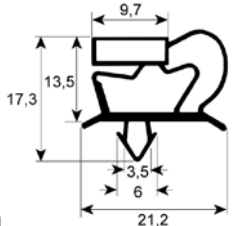
			
GEV No.	901173	Ref. No.	14414300569 926058 BN14414300569 FR926058
description	refrigeration gasket profile 9048 W 569mm L 254mm plug size		

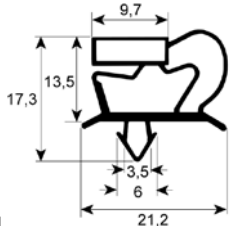
			
GEV No.	901230	Ref. No.	SIRA190067 SIRRA190067
description	refrigeration gasket profile 9048 W 390mm L 685mm plug size for blast chiller		

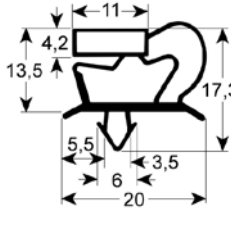
			
GEV No.	902212	Ref. No.	BN14415396616
description	refrigeration gasket profile 9048 W 396mm L 628mm plug size		

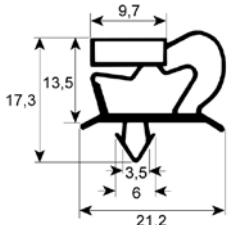
			
GEV No.	901228	Ref. No.	N/A SIRA190071 SIRRA190071
description	refrigeration gasket profile 9048 W 685mm L 1105mm plug size for blast chiller		

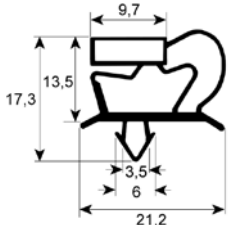
			
GEV No.	901229	Ref. No.	N/A SIRRA190070
description	refrigeration gasket profile 9048 W 690mm L 825mm plug size		

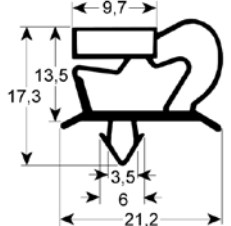
			
GEV No.	902258	Ref. No.	N/A
description	refrigeration gasket profile 9048 Wmm L 2500mm		

profile 9773

We offer custom-made gaskets for this profile

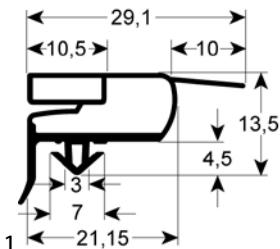

GEV No.	901231	Ref. No.	LAR70043000 N/A
description	refrigeration gasket profile 9773 W 385mm L 660mm external size W1 372mm L1 647mm plug size suitable for HIBER/LAINOX for blast chiller		

profile 9195

We offer custom-made gaskets for this profile

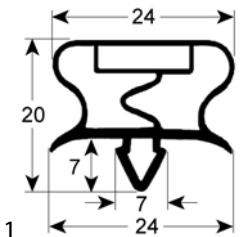

GEV No.	902435	Ref. No.	FR4501492
description	refrigeration gasket profile 9195 W 400mm L 690mm		

profile 9783

We offer custom-made gaskets for this profile

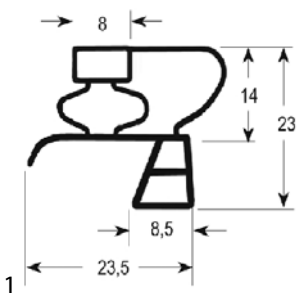

GEV No.	900024	Ref. No.	25006.00 MA2500600
description	refrigeration gasket profile 9783 W 190mm L 357mm plug size drawer refrigeration size 1/3		

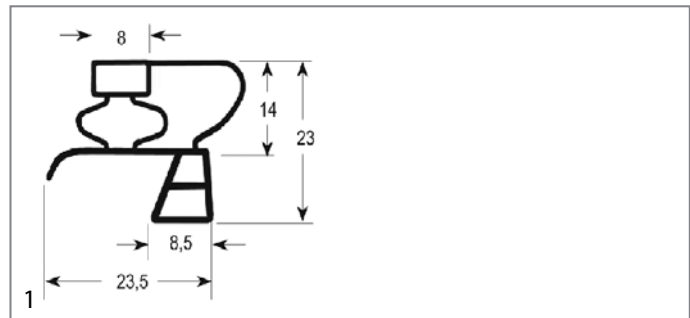

GEV No.	900025	Ref. No.	23007.12 25007.00 2500712 MA2500712
description	refrigeration gasket profile 9783 W 260mm L 355mm plug size drawer refrigeration size 1/2		
For models:	IR13C, IR13CC, IR13CV, IR13M, IR13MC, IR13MV, IR13V, IR17C, IR17CC, IR17CV, IR17M, IR17MC, IR17MV, IR17V, TR13C2P, TR13I4C, TR13I4CC, TR13I4CV, TR13N2C1P, TR13N2C1PC, TR13N2C1PV, TR13N2P, TR13N2PC, TR13N2PV, TR13N4C, TR13N4CC, TR13N4CV, TR17C3P, TR17I6C, TR17I6CC, TR17I6CV, TR17N2C2P, TR17N2C2PC, TR17N2C2PV, TR17N2P, TR17N3P, TR17N3PC, TR17N3PV, TR17N4C1P, TR17N4C1PC, TR17N4C1PV, TR17N6C, TR17N6CC, TR17N6CV, TR21N2C3P, TR21N2C3PC, TR21N2C3PV, TR21N2P, TR21N4C2P, TR21N4C2PC... (Other models you can see in the webshop)		

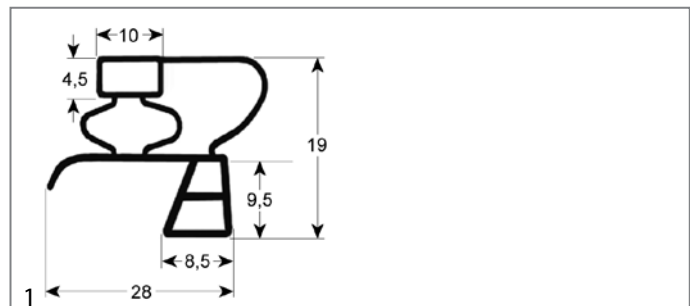

GEV No.	900026	Ref. No.	25009.00 2500912 MA2500912
description	refrigeration gasket profile 9783 W 355mm L 585mm plug size drawer refrigeration size 1/1		
For models:	IR13C, IR13CC, IR13CV, IR13M, IR13MC, IR13MV, IR13V, IR17C, IR17CC, IR17CV, IR17M, IR17MC, IR17MV, IR17V, TR13C2P, TR13I4C, TR13I4CC, TR13I4CV, TR13N2C1P, TR13N2C1PC, TR13N2C1PV, TR13N2P, TR13N2PC, TR13N2PV, TR13N4C, TR13N4CC, TR13N4CV, TR17C3P, TR17I6C, TR17I6CC, TR17I6CV, TR17N2C2P, TR17N2C2PC, TR17N2C2PV, TR17N2P, TR17N3P, TR17N3PC, TR17N3PV, TR17N4C1P, TR17N4C1PC, TR17N4C1PV, TR17N6C, TR17N6CC, TR17N6CV, TR21N2C3P, TR21N2C3PC, TR21N2C3PV, TR21N2P, TR21N4C2P, TR21N4C2PC... (Other models you can see in the webshop)		

GEV No.	900084	Ref. No.	23045.00 23045.14 MA2304514
description	refrigeration gasket profile 9783 W 625mm L 720mm plug size 1/2 door refrigeration		
For models:	AFC14, AFC14V, AFC7, AFC7V, AFPC214, AFPC214P, AFPC214V, AFR1143P, AFR1143PE, AFR14, AFR14V, AFR214P, AFR214PV, AFR7, AFR7P, AFR7PV, AFR7V, AFRC214, AFRC214V, AFRV14, AFRV144A, AFRV14V, AFRV7, AFRV74A, AFRV7V, EF143DNF, EF143MNI, EF72DNF, EF72MNF, F143, F72, FB143NI, FB72F, FB72N, FB72NF, FB72P, FS143F, FS143FI, FS143N, FS143NF, FS143NI, FS143NN, FS143NP, FS143P, FS72F, FS72IF, FS72IN, FS72N, FS72NF, FS72NN...(Other models you can see in the webshop)		

GEV No.	900049	Ref. No.	2304400 2304414 2304414 unverpackt MA2304414
description	refrigeration gasket profile 9783 W 635mm L 1530mm plug size door refrigeration		
For models:	AF70B, AF70C, AF70F, AF70I, AF70MB, AF70MC, AF70MF, AF70MI, AF70MN, AF70MP, AF70N, AF70P, AFR1143P, AFR1143PE, EF140DF, EF140DN, EF140DP, EF140MB, EF140MC, EF140MF, EF140MI, EF140MN, EF140MP, EF143DNF, EF143MNI, EF70DF, EF70DN, EF70DP, EF70MB, EF70MC, EF70MF, EF70MI, EF70MN, EF70MP, EF72DNF, EF72MNF, F140DF, F140DI, F140DN, F140DP, F143, F14DFG, F14DNG, F70DF, F70DI, F70DN, F70DP, F72, F7DFG, F7DNG...(Other models you can see in the webshop)		

GEV No.	902306	Ref. No.	N/A
description	refrigeration gasket profile 9783 Wmm L 2500mm		

screw-in gaskets

profile 9031

We offer custom-made gaskets for this profile

GEV No.	900010	Ref. No.	336500
description	refrigeration gasket profile 9031 W 195mm L 385mm external size drawer refrigeration size 1/3		

GEV No.	900010	Ref. No.	336500
description	refrigeration gasket profile 9031 W 195mm L 385mm external size drawer refrigeration size 1/3		

GEV No.	900209	Ref. No.	336400
description	refrigeration gasket profile 9031 W 458mm L 605mm external size		

GEV No.	900209	Ref. No.	336400
description	refrigeration gasket profile 9031 W 458mm L 605mm external size		

profile 9140

We offer custom-made gaskets for this profile

GEV No.	902264	Ref. No.	N/A
description	refrigeration gasket profile 9140 Wmm L 2500mm		

GEV No.	902264	Ref. No.	N/A
description	refrigeration gasket profile 9140 Wmm L 2500mm		

profile 9106

We offer custom-made gaskets for this profile

GEV No.	902262	Ref. No.	N/A
description	refrigeration gasket profile 9106 Wmm L 2500mm		

GEV No.	902262	Ref. No.	N/A
description	refrigeration gasket profile 9106 Wmm L 2500mm		



profile 9164			
GEV No.	901607	Ref. No.	143510 MA143510
description	refrigeration gasket profile 9164 W 462mm L 612mm external size Qty 1		
For models:	SPAR, SPAR15, SPAR16, SPAR18, SPAR20, SPRG, SPRG12, SPRG16, SPRG20, SVAR, SVAR15, SVAR16, SVAR18, SVAR20, SVRG, SVRG12, SVRG15, SVRG16, SVRG18, SVRG20		

gaskets for heated units

window seals			
GEV No.	900787	Ref. No.	R70044650
description	window gasket profile 1515 L 2200mm suitable for LAINOX		
For models:	MACE07M, MACG07M		

GEV No.	900129	Ref. No.	R70040840
description	window gasket profile 1530 L 1015mm Qty 1		
For models:	ME110M, ME110P, ME110X, ME210M, ME210P, ME210X, MG110M, MG110P, MG110X, MG210M, MG210P, MG210X, VE110M, VE110P, VE110X, VG110M, VG110P, VG110X, VG210M, VG210P, VG210X		

GEV No.	900501	Ref. No.	R70044260
description	window gasket profile 1530 L 1200mm Qty 1		
For models:	MACE10M, MACE20M, MACG10M, MACG20M, ME101D, ME101M, ME101P, ME101T, ME102M, ME102P, ME102T, MG101D, MG101M, MG101P, MG101T, MG102M, MG102P, MG102T		

GEV No.	900130	Ref. No.	R70040850
description	window gasket profile 1530 L 1750mm Qty 1		
For models:	ME120M, ME120P, ME120X, ME220M, ME220P, ME220X, MEC40M, MG120M, MG120P, MG120X, MG220M, MG220P, MG220X, MGC20X, MGC40H, VE120M, VE120P, VE120X, VE220M, VE220P, VE220X, VG120M, VG120P, VG120X, VG220M, VG220P, VG220X		

GEV No.	900503	Ref. No.	R70044280
description	window gasket profile 1530 L 1800mm Qty 1		
For models:	ME201D, ME201M, ME201P, ME201T, MG201D, MG201M, MG201P, MG201T		

GEV No.	900504	Ref. No.	R70044290
description	window gasket profile 1530 L 1950mm Qty 1		
For models:	ME202D, ME202M, ME202P, ME202T, MEMT21D, MEMT21P, MEMT40D, MEMT40P, MEVT21D, MEVT21P, MEVT40D, MEVT40P, MG202D, MG202M, MG202P, MG202T, MGMT21D, MGMT21P, MGMT40D, MGMT40P, MGVT21D, MGVT21P, MGVT40D, MGVT40P		

GEV No.	900483	Ref. No.	R70044150
description	window gasket profile 1530 L 2400mm Qty 1		
For models:	GMT20D, GVT20D, MACE10M, MACE20M, MACG10M, MACG20M, ME061D, ME061M, ME061P, ME061T, ME101D, ME101M, ME101P, ME101T, ME102D, ME102M, ME102P, ME102T, MEMT20D, MEMT20P, MEVT20D, MEVT20P, MG061D, MG061M, MG061P, MG061T, MG101D, MG101M, MG101P, MG101T, MG102D, MG102M, MG102P, MG102T, MGMT20D, MGMT20P, MGVT20D, MGVT20P		

GEV No.	900484	Ref. No.	R70044160
description	window gasket profile 1530 L 3720mm Qty 1		
For models:	ME201D, ME201M, ME201P, ME201T, ME202D, ME202M, ME202P, ME202T, MEMT40D, MEMT40P, MEVT40D, MEVT40P, MG201D, MG201M, MG201P, MG201T, MG202D, MG202M, MG202P, MG202T, MGMT40D, MGMT40P, MGVT40D, MGVT40P		

GEV No.	900637	Ref. No.	R70040640
description	window gasket profile 1530 Qty supplied by meter		
For models:	FE110M, FE110X, FE210M, FG110M, FG110X, FG210M, FG210X, MEMT10D, MEMT10P, MEVT10D, MEVT10P, MGMT10D, MGMT10P, MGVT10D, MGVT10P, PE080M, PE080X, PG080M, PG080X		

GEV No.	900117	Ref. No.	R70040810
description	window gasket profile 1530 L 505mm Qty 1		
For models:	CVE004H, CVE004M, CVE104H, CVE104M, VE004M, VE004X, VE104M, VE104X		

GEV No.	900120	Ref. No.	R70040050
description	window gasket profile 1620 L 1175mm Qty 1		
For models:	CVE004H, CVE004M, CVE104H, CVE104M, VE004M, VE004X, VE104M, VE104X		

GEV No.	900118	Ref. No.	R70040820
description	window gasket profile 1530 L 595mm Qty 1		
For models:	CVE105H, CVE105M, CVG105H, CVG105M, VE105M, VE105X, VG105M, VG105X		

GEV No.	900119	Ref. No.	R70040010
description	window gasket profile 1620 L 1500mm Qty 1		
For models:	CVE105H, CVE105M, CVG105H, CVG105M, VE105M, VE105X, VG105M, VG105X		

GEV No.	900128	Ref. No.	R70040830
description	window gasket profile 1530 L 750mm Qty 1		
For models:	ME106M, ME106P, ME106X, MG106M, MG106P, MG106X, VE106M, VE106P, VE106X, VG106M, VG106P, VG106X		

GEV No.	900121	Ref. No.	R70040080
description	window gasket profile 1620 L 1690mm Qty 1		
For models:	ME106M, ME106P, ME106X, MG106M, MG106P, MG106X, VE106M, VE106P, VE106X, VG106M, VG106P, VG106X		

GEV No.	900500	Ref. No.	R70044250
description	window gasket profile 1530 L 900mm Qty 1		
For models:	MACE07M, MACG07M, ME061D, ME061M, ME061P, ME061T, MG061D, MG061M, MG061P, MG061T, MVE042P, MVE051P, MVG051P		

GEV No.	900122	Ref. No.	R70040200
description	window gasket profile 1620 L 2125mm Qty 1		
For models:	ME110M, ME110P, ME110X, ME120M, ME120P, ME120X, ME210M, ME210P, ME210X, ME220M, ME220P, ME220X, MEC24H, MEC40M, MG110M, MG110P, MG110X, MG120M, MG120P, MG120X, MG210M, MG210P, MG210X, MG220M, MG220P, MG220X, MGC20X, MGC24H, MGC40H, VE110M, VE110X, VE120M, VE120P, VE120X, VE210M, VE210P, VE210X, VE220M, VE220P, VE220X, VG110M, VG110P, VG110X, VG120M, VG120P, VG120X, VG210M, VG210P, VG210X, VG220M, VG220P, VG220X... (Other models you can see in the webshop)		

GEV No.	900437	Ref. No.	2838000 MA2838000
description	window gasket profile 1640 L 10000mm Qty 1		
For models:	CSM201, CSM202, SER15, SER15A, SER18, SER18A, SER21		

GEV No.	900436	Ref. No.	2891700
description	window gasket profile 1640 L 2170mm Qty 1		
For models:	CON102E, CON102EP, CON102G, CON102GP, CON10E, CON10EP, CON10G, CON10GP, CS102E, CS102EP, CS102G, CS102GP, CSM102E, CSM102EP, CSM102G, CSM102GP, CSM10E, CSM10EP, CSM10G, CSM10GP		

GEV No.	900435	Ref. No.	2885800
description	window gasket profile 1640 L 2350mm Qty 1		
For models:	CON6E, CON6EP, CON6G, CON6GP, CSM6E, CSM6EP, CSM6G, CSM6GP		

GEV No.	900539	Ref. No.	N/A
description	window gasket profile 1640 Qty supplied by meter		

GEV No.	902460	Ref. No.	LAR70042680
description	window gasket profile 1887 L 3200mm Qty 1 suitable for LAINOX		
For models:	EC210M, EM210H, EM210M, EM210M+SC, EM210P, EV210H, EV210M, EV210M+SC, EV210P, GC210M, GM210H, GM210M, GM210M+SC, GM210P, GV210H, GV210M, GV210M+SC, GV210P		

GEV No.	902459	Ref. No.	R70042770 R70042780
description	window gasket profile 1887/1515 L 2200mm suitable for LAINOX set 2-piece		
For models:	EC110M, EC210M, EM010M+SC, EM110H, EM110M, EM110M+SC, EM110P, EM210H, EM210M, EM210M+SC, EM210P, EV110H, EV110M, EV110M+SC, EV110P, EV210H, EV210M, EV210M+SC, EV210P, GC110M, GC210M, GM110H, GM110M, GM110M+SC, GM110P, GM210H, GM210M, GM210M+SC, GM210P, GV110H, GV110M, GV110M+SC, GV110P, GV210H, GV210M, GV210M+SC, GV210P		

door seals

GEV No.	902461	Ref. No.	R70042860
description	door seal profile 2010 L 1900mm Qty 1 suitable for LAINOX		
For models:	EC106M, EM106H, EM106M, EM106M+SC, EM106P, EV006M, EV106H, EV106M, EV106M+SC, EV106P, GC106M, GM106H, GM106M, GM106M+SC, GM106P, GV106H, GV106M, GV106M+SC, GV106P		

GEV No.	901147	Ref. No.	R70042880
description	door seal profile 2010 L 3000mm Qty 1		
For models:	EC210M, EM210H, EM210M, EM210M+SC, EM210P, EV210H, EV210M, EV210M+SC, EV210P, GC210M, GM210H, GM210M, GM210M+SC, GM210P, GV210H, GV210M, GV210M+SC, GV210P		

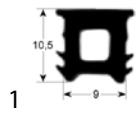

GEV No.	900142	Ref. No.	R70043280 R70043290
description	door seal profile 2010 Qty supplied by meter		
For models:	MEC24H, MGC20X, MGC24H		

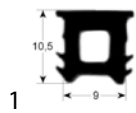

GEV No.	900131	Ref. No.	R70040980
description	door seal profile 2010 W 520mm L 610mm external size Qty 1		
For models:	ME106M, ME106P, ME106X, MG106M, MG106P, MG106X, VE106M, VE106P, VE106X, VG106M, VG106P, VG106X		

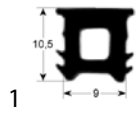

GEV No.	900132	Ref. No.	R70040990
description	door seal profile 2010 W 625mm L 750mm external size Qty 1		
For models:	ME110M, ME110P, ME110X, MG110M, MG110P, MG110X, VE110M, VE110P, VE110X, VG110M, VG110P, VG110X		

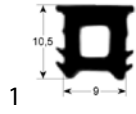

GEV No.	900134	Ref. No.	R70041010
description	door seal profile 2010 W 680mm L 1425mm external size Qty 1		
For models:	ME120M, ME120P, ME120X, MG120M, MG120P, MG120X, VE120M, VE120P, VE120X, VG120M, VG120P, VG120X		

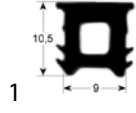

GEV No.	900135	Ref. No.	R70041020
description	door seal profile 2010 W 700mm L 1410mm external size Qty 1		
For models:	ME220M, ME220P, ME220X, MG220M, MG220P, MG220X, VE220M, VE220P, VE220X, VG220M, VG220P, VG220X		

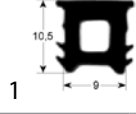

GEV No.	900133	Ref. No.	R70041000
description	door seal profile 2010 W 740mm L 765mm external size Qty 1		
For models:	ME210M, ME210P, ME210X, MG210M, MG210P, MG210X, VE210M, VE210P, VE210X, VG210M, VG210P, VG210X		

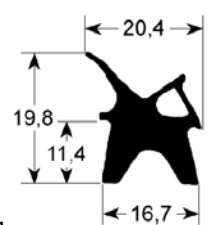

GEV No.	900115	Ref. No.	R70041990
description	door seal profile 2410 W 320mm L 420mm external size Qty 1		
For models:	CVE004H, CVE004M, CVE104H, CVE104M, VE004M, VE004X, VE104M, VE104X		

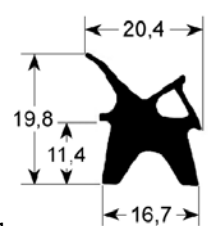

GEV No.	900116	Ref. No.	R70042000
description	door seal profile 2410 W 380mm L 608mm external size Qty 1		
For models:	CVE105H, CVE105M, CVG105H, CVG105M, VE105M, VE105X, VG105M, VG105X		

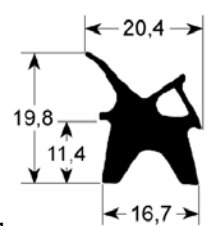

GEV No.	900157	Ref. No.	R70041540
description	door seal profile 2410 W 380mm L 632mm external size Qty 1		
For models:	FE105M, FE105X, FG105M, FG105X, PE040M, PE040X, PG040M, PG040X		

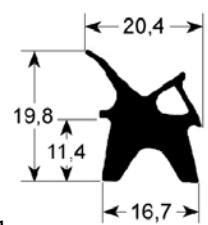

GEV No.	900817	Ref. No.	R70042560
description	door seal profile 2410 W 465mm L 495mm external size Qty 1		
For models:	EC106M, EM106H, EM106M, EM106M+SC, EM106P, EV006M, EV106H, EV106M, EV106M+SC, EV106P, GC106M, GM106H, GM106M, GM106M+SC, GM106P, GV106H, GV106M, GV106M+SC, GV106P		



GEV No.	900818	Ref. No.	R70042570
description	door seal profile 2410 W 465mm L 765mm external size Qty 1		
For models:	EC110M, EM010M+SC, EM110H, EM110M, EM110M+SC, EM110P, EV110H, EV110M, EV110M+SC, EV110P, GC110M, GM110H, GM110M, GM110M+SC, GM110P, GV110H, GV110M, GV110M+SC, GV110P		

GEV No.	900486	Ref. No.	R70041550
description	door seal profile 2410 W 666mm L 701mm external size Qty 1		
For models:	FE110M, FE110X, FG110M, FG110X, PE080M, PE080X, PG080M, PG080X		

GEV No.	900123	Ref. No.	R70042010
description	door seal profile 2410 W 500mm L 627mm external size Qty 1		
For models:	ME106M, ME106P, ME106X, MG106M, MG106P, MG106X, VE106M, VE106P, VE106X, VG106M, VG106P, VG106X		

GEV No.	900762	Ref. No.	R70041350
description	door seal profile 2410 W 701mm L 705mm external size Qty 1		
For models:	FE210M, FG210M, FG210X		

GEV No.	900124	Ref. No.	R70042020
description	door seal profile 2410 W 627mm L 738mm external size Qty 1		
For models:	ME110M, ME110P, ME110X, MG110M, MG110P, MG110X, VE110M, VE110X, VG110M, VG110P, VG110X		

GEV No.	900568	Ref. No.	R70042150
description	door seal profile 2410 W 710mm L 1310mm external size Qty 1		
For models:	MGC20X		

GEV No.	900820	Ref. No.	LAR70042580
description	door seal profile 2410 W 645mm L 765mm external size Qty 1		
For models:	EC210M, EM210H, EM210M, EM210M+SC, EM210P, EV210H, EV210M, EV210M+SC, EV210P, GC210M, GM210H, GM210M, GM210M+SC, GM210P, GV210H, GV210M, GV210M+SC, GV210P		

GEV No.	900126	Ref. No.	R70042040
description	door seal profile 2410 W 710mm L 1430mm external size Qty 1		
For models:	ME120M, ME120P, ME120X, MG120M, MG120P, MG120X, VE120M, VE120P, VE120X, VG120M, VG120P, VG120X		

GEV No.	900813	Ref. No.	R70042160
description	door seal profile 2410 W 735mm L 1310mm external size Qty 1		
For models:	MEC40M, MGC40H		

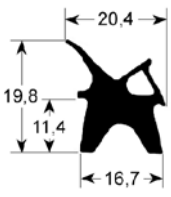

1

GEV No.	900127	Ref. No.	R70042050
description	door seal profile 2410 W 735mm L 1430mm external size Qty 1		
For models:	ME220M, ME220P, ME220X, MG220M, MG220P, MG220X, VE220M, VE220P, VE220X, VG220M, VG220P, VG220X		

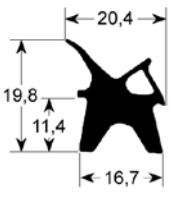

1

GEV No.	900815	Ref. No.	R70041940
description	door seal profile 2410 W 735mm L 830mm external size Qty 1		
For models:	MEC24H, MGC24H		

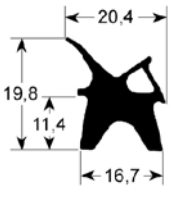

1

GEV No.	900125	Ref. No.	R70042030
description	door seal profile 2410 W 738mm L 777mm external size Qty 1		
For models:	ME210M, ME210P, ME210X, MG210M, MG210P, MG210X, VE210M, VE210P, VE210X, VG210M, VG210P, VG210X		

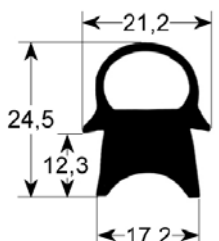

1

GEV No.	900768	Ref. No.	2784500 MA2784500
description	door seal profile 2440 W 340mm L 405mm external size Qty 1		

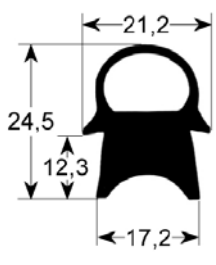

1

GEV No.	900722	Ref. No.	2725600 MA2725600
description	door seal profile 2440 W 415mm L 580mm external size Qty 1		
For models:	FC10G, FC5E, FC5G, FC7G		

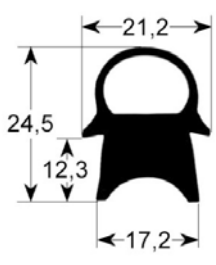

1

GEV No.	900106	Ref. No.	2885900 MA2885900
description	door seal profile 2440 W 490mm L 645mm external size Qty 1		
For models:	CON6G, CON6GP, CSM6E, CSM6EP, CSM6G, CSM6GP		

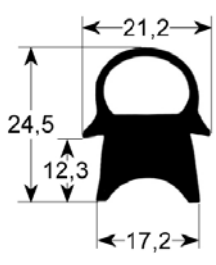

1

GEV No.	900724	Ref. No.	2725700 MA2725700
description	door seal profile 2440 W 530mm L 580mm external size Qty 1		
For models:	FC7E, FC7G		

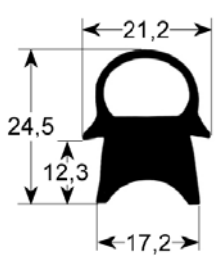

1

GEV No.	900107	Ref. No.	2891900 MA2891900
description	door seal profile 2440 W 645mm L 740mm external size Qty 1		
For models:	CON102E, CON102EP, CON102G, CON102GP, CON10E, CON10EP, CON10G, CON10GP, CS102E, CS102EP, CS102G, CS102GP, CSM102E, CSM102EP, CSM102G, CSM102GP, CSM10E, CSM10EP, CSM10G, CSM10GP		

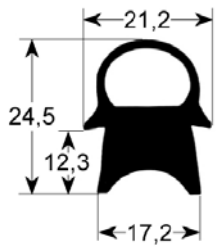
1

GEV No.	900108	Ref. No.	5113500 MA5113500
description	door seal profile 2440 W 720mm L 1460mm external size Qty 1		
For models:	CSM201, CSM202		

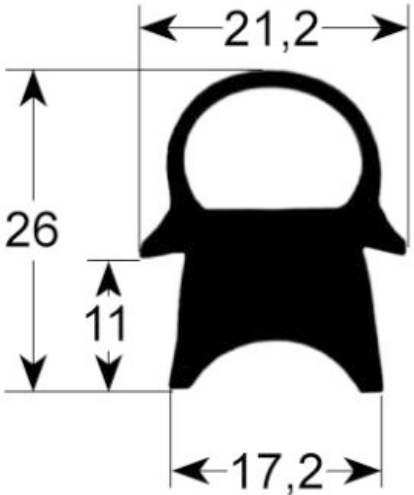

1

GEV No.	900769	Ref. No.	2842100 2842114
description	door seal profile 2441 W 340mm L 405mm external size Qty 1		
For models:	CS4E, CS4EP		



1

GEV No.	901573	Ref. No.	R70044270
description	door seal profile 2770/2771 H 1550mm W 470mm outer plug size Qty 1		
For models:	GMT20D, GVT20D, ME102D, MEMENT20D, MEMENT20P, MEMENT21D, MEMENT21P, MEVT20D, MEVT20P, MEVT21D, MEVT21P, MG102D, MGMT20D, MGMT20P, MGMT21D, MGMT21P, MGVT20D, MGVT20P, MGVT21D, MGVT21P		



1

GEV No.	900493	Ref. No.	R70044130
description	door seal profile 2770/2771 H 1550mm W 680mm outer plug size Qty 1		
For models:	ME201D, ME201M, ME201P, ME201T, MG201D, MG201M, MG201P, MG201T		



1

GEV No.	900494	Ref. No.	R70044140
description	door seal profile 2770/2771 H 1550mm W 700mm outer plug size Qty 1		
For models:	ME202D, ME202M, ME202P, ME202T, MEMENT40D, MEMENT40P, MEVT40D, MEVT40P, MG202D, MG202M, MG202P, MG202T, MGMT40D, MGMT40P, MGVT40D, MGVT40P		



1

GEV No.	900488	Ref. No.	R70044330
description	door seal profile 2770/2771 H 380mm W 420mm outer plug size Qty 1		
For models:	MACE04M, MVE042P		



GEV No.	900489	Ref. No.	R70044340
description	door seal profile 2770/2771 H 440mm W 600mm outer plug size Qty 1		
For models:	MACE05M, MACG05M, MVE051P, MVG051P		



GEV No.	900788	Ref. No.	R70044230
description	door seal profile 2770/2771 H 580mm W 680mm outer plug size Qty 1		
For models:	MACE07M, MACG07M		



GEV No.	901679	Ref. No.	R70044210
description	door seal profile 2770/2771 H 520mm W 470mm outer plug size suitable for LAINOX		
For models:	GMT06D, GVT06D, MEMT06D, MEMT06P, MEVT06D, MEVT06P, MG-MT06D, MGMT06P, MGVT06D, MGVT06P		

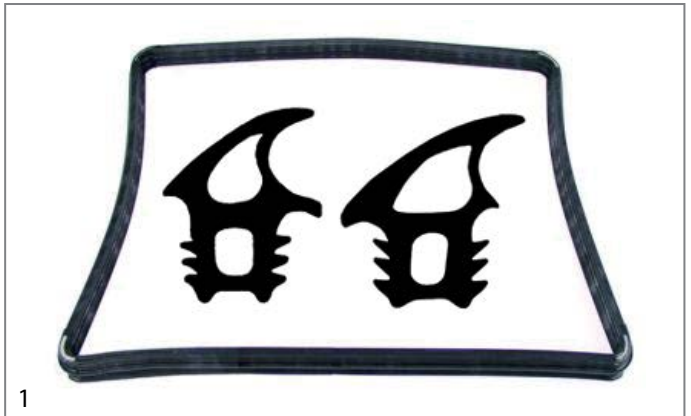

GEV No.	901276	Ref. No.	R70044220
description	door seal profile 2770/2771 H 800mm W 470mm outer plug size Qty 1 suitable for LAINOX		
For models:	MEMT10D, MEMT10P, MEVT10D, MEVT10P, MGMT10D, MGMT10P, MGVT10D, MGVT10P		



GEV No.	900490	Ref. No.	R70044100
description	door seal profile 2770/2771 H 520mm W 620mm outer plug size Qty 1		
For models:	ME061D, ME061M, ME061P, ME061T, MG061D, MG061M, MG061P, MG061T		

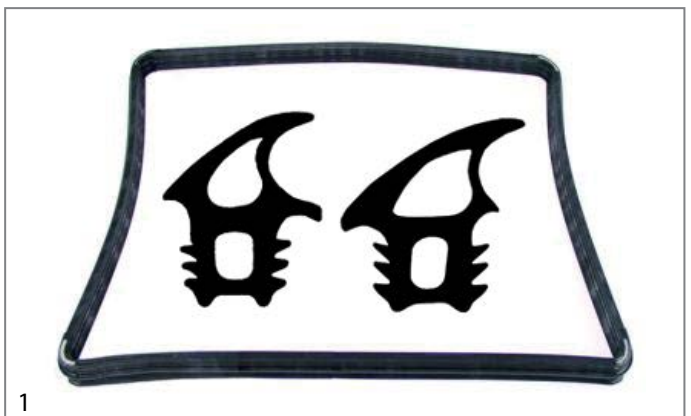

GEV No.	900491	Ref. No.	R70044110
description	door seal profile 2770/2771 H 800mm W 680mm outer plug size Qty 1		
For models:	MACE10M, MACG10M, ME101D, ME101M, ME101P, ME101T, MG101D, MG101M, MG101P, MG101T		



1

GEV No.	900492	Ref. No.	R70044120
description	door seal profile 2770/2771 H 800mm W 700mm outer plug size Qty 1		
For models:	GMT20D, GVT20D, ME102D, ME102M, ME102P, MEMT20D, MEMT20P, MEVT20D, MEVT20P, MG102D, MG102M, MG102P, MG102T, MG-MT20D, MGMT20P, MGVT20D, MGVT20P		

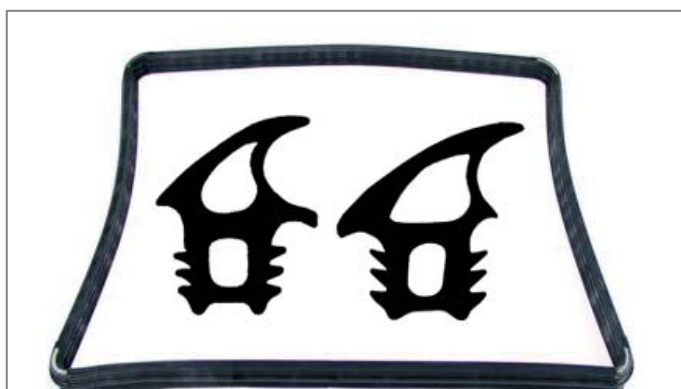

1

GEV No.	901603	Ref. No.	R70044240
description	door seal profile 2770/2771 H 800mm W 760mm outer plug size Qty 1		
For models:	MACE20M, MACG20M		

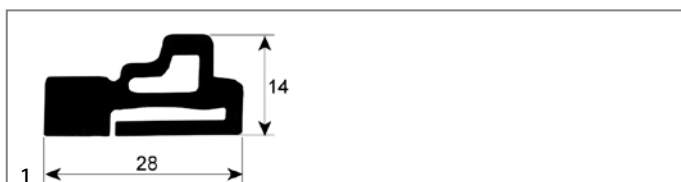

1

GEV No.	900745	Ref. No.	R70044300
description	door seal profile 2954 L 700mm		
For models:	ME201D, ME201M, ME201P, ME201T, ME202D, ME202M, ME202P, ME202T, MEMT40D, MEMT40P, MEVT40D, MEVT40P, MG201D, MG201M, MG201P, MG201T, MG202D, MG202M, MG202P, MG202T, MGMT40D, MGMT40P, MGVT40D, MGVT40P		

door seals with fixing hook



1

GEV No.	901917	Ref. No.	CR0931990
description	door seal L 570mm W 295mm 4-sided		



1

GEV No.	900405	Ref. No.	1036101400 MA1036101400
description	oven gasket L 430mm W 260mm external size		
For models:	FOE60M, OFOE60M		

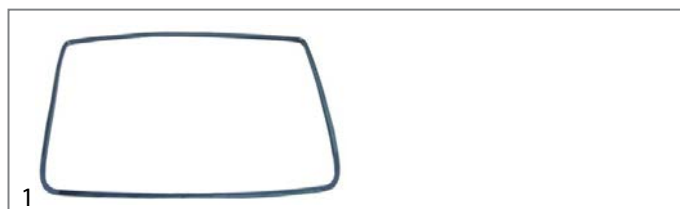

1

GEV No.	900404	Ref. No.	1036608000 MA1036608000
description	oven gasket L 450mm W 330mm external size		
For models:	CFE60, CFE60P, CFGE61, CFGE61D, CFGE61L, CFGE61P, CFVE60, OCFE60, OCFGE61		

door seals with tension springs

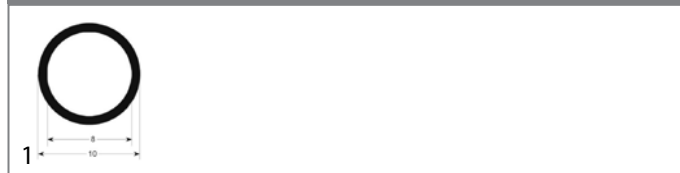

1

GEV No.	900959	Ref. No.	17319099 17319099R MA17319099 MA17319099R
description	oven gasket profile 2960 L 2000mm		
For models:	BF912G, BF912GH, C7FGM12G, C9FGM12G, NC7FGM12G		



1

GEV No.	900105	Ref. No.	1336200
description	oven gasket profile 2960 L 310mm Qty 1 mounting pos. lateral		
For models:	C9F4E, C9F4GS, C9F6E, C9F6GS, C9F8GS, C9FE6GS, C9FP4GS, C9FP6GS, C9FP8GS, C9V2E, C9V4E, T9F4G, T9F6GS, T9FP4G, V9F4E, V9FP4E, V9V2E, V9V4E, V9VP2E, V9VP4E		



GEV No.	900103	Ref. No.	1336100
description	oven gasket profile 2960 L 575mm Qty 1 mounting pos. lower		
For models:	C7011EFE, C7011EFEQ, C7011GFE, C7011GFG, C707EFE, C707EFEQ, C707GFE, C707GFG, C9F4E, C9F4GS, C9F6E, C9F6GS, C9F8GS, C9FE6GS, C9FP4GS, C9FP6GS, C9FP8GS, C9V2E, C9V4E, CFE70, CFG101, CFG120, CFG70, CFG70M, EC74EVG, EC74GVG, EC78EVG, EC78GVG, EC7FE8E, EC7FG8G, OCFG101, OCFG120, OCFG70, T7011GFG, T707GFG, T9F4G, T9F6GS, T9FP4G, V9F4E, V9FP4E, V9V2E, V9V4E, V9VP2E, V9VP4E		



GEV No.	900102	Ref. No.	1706300
description	oven gasket profile 2960 L 650mm Qty 1 mounting pos. upper		
For models:	C7011EFE, C7011EFEQ, C7011GFE, C7011GFG, C707EFE, C707EFEQ, C707GFE, C707GFG, CFE70, CFG101, CFG120, CFG70, EC74EVG, EC74GVG, EC78EVG, EC78GVG, EC7FE8E, EC7FG8G, OCFG101, OCFG120, OCFG70, T7011GFG, T707GFG		



GEV No.	900249	Ref. No.	1662814R MA1662814R
description	oven gasket profile 2965 L 305mm Qty 1 mounting pos. lateral		



GEV No.	900258	Ref. No.	1662800
description	oven gasket profile 2965 Qty supplied by meter		



GEV No.	570001	Ref. No.	N/A
description	silicone hose ID \varnothing 6.5mm ED \varnothing 7.9mm thickness 0.7mm Qty supplied by meter		



GEV No.	514004	Ref. No.	1336000 MA1336000
description	spring L 325mm for gasket mounting pos. lateral		
For models:	BF912G, BF912GH, C7FGM12G, C9F4E, C9F4GS, C9F6E, C9F6GS, C9F8GS, C9FE6GS, C9FGM12G, C9FP4GS, C9FP6GS, C9FP8GS, C9V2E, C9V4E, NC7FGM12G, T9F4G, T9F6GS, T9FP4G, V9F4E, V9FP4E, V9V2E, V9V4E, V9VP2E, V9VP4E		



GEV No.	514003	Ref. No.	1662614 MA1662614
description	spring L 370mm for gasket mounting pos. lateral		
For models:	C7011EFE, C7011EFEQ, C7011GFE, C7011GFG, C707EFE, C707EFEQ, C707GFE, C707GFG, CFE70, CFG101, CFG120, CFG70, CFG70M, EC74EVG, EC74GVG, EC78EVG, EC78GVG, EC7FE8E, EC7FG8G, OCFG101, OCFG120, OCFG70, T7011GFG, T707GFG		



GEV No.	514002	Ref. No.	1335900 MA1335900
description	spring L 595mm for gasket mounting pos. upper		
For models:	C7011EFE, C7011EFEQ, C7011GFE, C7011GFG, C707EFE, C707EFEQ, C707GFE, C707GFG, C9F4E, C9F4GS, C9F6E, C9F6GS, C9F8GS, C9FE6GS, C9FP4GS, C9FP6GS, C9FP8GS, C9V2E, C9V4E, CFE70, CFG101, CFG120, CFG70, EC74EVG, EC74GVG, EC78EVG, EC78GVG, EC7FE8E, EC7FG8G, OCFG101, OCFG120, OCFG70, T7011GFG, T707GFG, T9F4G, T9F6GS, T9FP4G, V9F4E, V9FP4E, V9V2E, V9V4E, V9VP2E, V9VP4E		



GEV No.	514001	Ref. No.	1706200 MA1706200
description	spring L 655mm for gasket mounting pos. upper		
For models:	C7011EFE, C7011EFEQ, C7011GFE, C7011GFG, C707EFE, C707EFEQ, C707GFE, C707GFG, CFE70, CFG101, CFG120, CFG70, EC74EVG, EC74GVG, EC78EVG, EC78GVG, EC7FE8E, EC7FG8G, OCFG101, OCFG120, OCFG70, T7011GFG, T707GFG, T9F4G, T9F6GS, T9FP4G, V9F4E, V9FP4E, V9V2E, V9V4E, V9VP2E, V9VP4E		

gaskets for tray rack trolleys

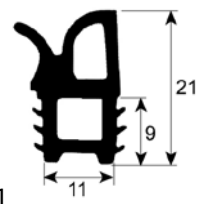

GEV No.	900776	Ref. No.	R70041150
description	tray rack trolley gasket profile 4050 L 1020mm Qty 1		
For models:	MEC24H, MEC40M, MGC20X, MGC24H, MGC40H		



O-rings

EPDM

GEV No.	510302	Ref. No.	200824
description	O-ring EPDM ID ø 12.42mm thickness 1.78mm Qty 1 pcs		

GEV No.	510303	Ref. No.	200818
description	O-ring EPDM thickness 1.78mm ID ø 6.75mm Qty 1 pcs		

GEV No.	530293	Ref. No.	200809
description	O-ring EPDM thickness 1.78mm ID ø 8.73mm Qty 1 pcs		

GEV No.	511191	Ref. No.	200813
description	O-ring EPDM thickness 2.21mm ID ø 16.36mm Qty 1 pcs		

GEV No.	540119	Ref. No.	1420925 MA1420925
description	O-ring EPDM thickness 2.5mm ID ø 59mm Qty 1 pcs		
For models:	NPD98E10, NPD98E15, NPD98G10, NPD98G15, NPD98G15A, NPI98E10, NPI98E15, NPI98G10, NPI98G14, NPI98G14A, P9D10E, P9D10G, P9D15E, P9D15G, P9D5G, P9DA10E, P9DA10G, P9DA15E, P9DA15G, P9DSB10E, P9DSB10G, P9I10E, P9I10G, P9I15E, P9I5G, P9IA10E, P9IA10G, P9IA15E, PD98E10, PD98E15, PD98G10, PD98G15, PD98G15A, PD9S8E10, PD9S8G10, PDASB10E, PDASB10G, PI98E10, PI98E15, PI98G10, PI98G14, PI98G14A, PI9S8E10		

GEV No.	528333	Ref. No.	200806
description	O-ring EPDM thickness 2.62mm ID ø 13.1mm Qty 1 pcs		

GEV No.	532062	Ref. No.	1036502300
description	O-ring EPDM thickness 2.62mm ID ø 29.82mm Qty 10 pcs		
For models:	DLS30, DLS303, DLS30P, DLS30P3, DLS31, DLS313, DLS31P3, MLC50, MLC503, MLC65, MLC653, MLS30, MLS303, MLS30P, MLS30P3, MLS31, MLS313, MLS31P3, MLS35, MLS353, MPLS30P		

GEV No.	510974	Ref. No.	200852
description	O-ring EPDM thickness 2.62mm ID ø 58.42mm Qty 1 pcs		

GEV No.	528583	Ref. No.	200845
description	O-ring EPDM thickness 2.62mm ID ø 9.13mm Qty 1 pcs		

GEV No.	528487	Ref. No.	2867700 MA2867700
description	O-ring EPDM thickness 2.62mm ID ø 9.19mm Qty 1 pcs		
For models:	CON10G, CON10GP, CON201G, CON201GP, CON202G, CON202GP, CON6G, CON6GP, CS4E, CS4EP, CSM10G, CSM10GP, CSM201E, CSM201EP, CSM201G, CSM201GP, CSM202G, CSM202GP, CSM6G, CSM6GP, NBR912EFM, NBR912EIM, NBR912GFM, NBR912GIM, NBR98EF, NBR98EFM, NBR98EI, NBR98EIM, NBR98GF, NBR98GFM, NBR98GI, NBR98GIM, NPC74E, NPC74G, NPC76E, NPC76G, NPC78E, NPC78G, NPC94E, NPC94G, NPC96E, NPC96G, NPC98E, NPC98G, NPD76G5, NPD78G8, NPD96G5, NPD98E10, NPD98E15, NPD98G10... (Other models you can see in the webshop)		

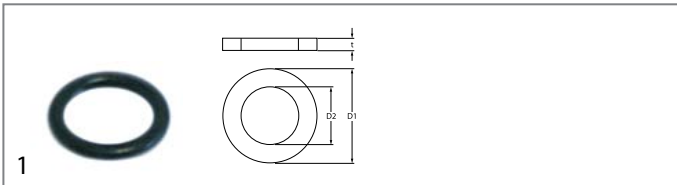

GEV No. 510893 **Ref. No.** 200810
description O-ring EPDM thickness 2.62mm ID ø 9.92mm Qty 1 pcs

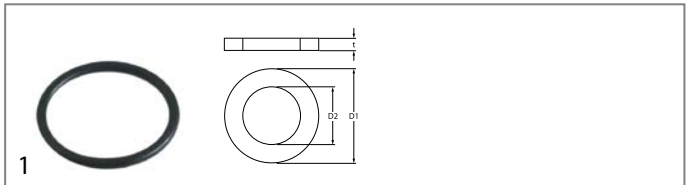

GEV No. 506015 **Ref. No.** 200822
description O-ring EPDM thickness 3.53mm ID ø 39.69mm Qty 1 pcs

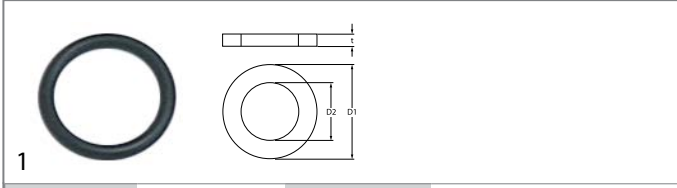

GEV No. 510901 **Ref. No.** 200843
description O-ring EPDM thickness 2mm ID ø 13mm Qty 1 pcs

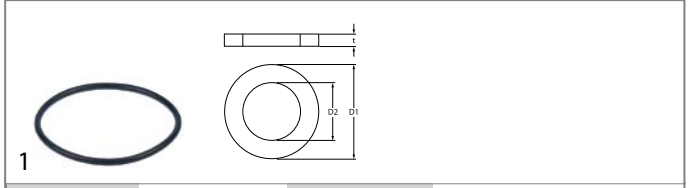

GEV No. 510811 **Ref. No.** 200816
description O-ring EPDM thickness 3mm ID ø 59.2mm Qty 1 pcs

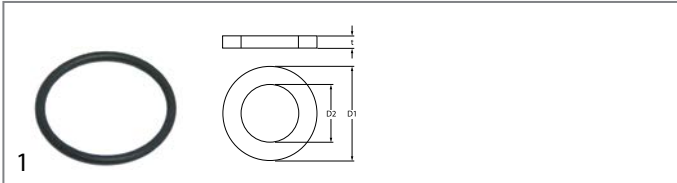

GEV No. 100809 **Ref. No.** 1394000
 BN6A011606
 MA1394000
description O-ring EPDM thickness 2mm ID ø 21mm Qty 1 pcs
For models: BMG40, BMG60, BR707G, FQG40, FQG60, FR74G, FR77G, MM10IG, P9110G, P915G, P91A10G, PI707G

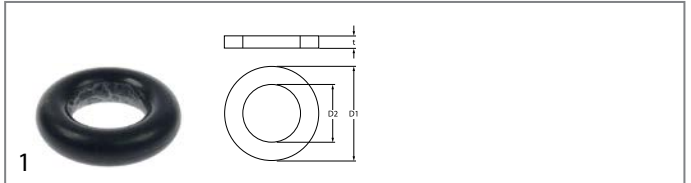

GEV No. 510955 **Ref. No.** 200854
description O-ring EPDM thickness 3mm ID ø 6mm Qty 1 pcs

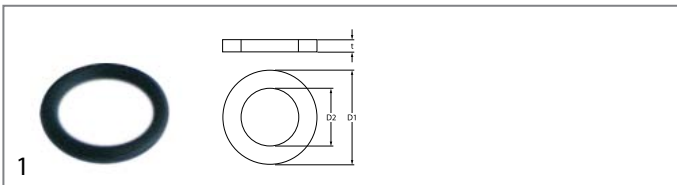

GEV No. 510902 **Ref. No.** 200844
description O-ring EPDM thickness 2mm ID ø 9.5mm Qty 1 pcs

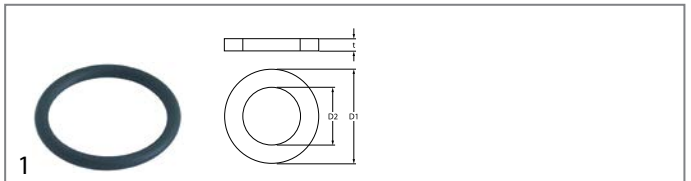

GEV No. 505092 **Ref. No.** 2604100
 BN0119472130
 MA2604100
description O-ring EPDM thickness 5.34mm ID ø 43.82mm Qty 1 pcs
For models: CS102E, CS102EP, CS10E, CS10EP, CS6E, CS6EP, FV4E, FV4E1, P915E, PI707E, PI76E5, PI96E5, PI98E10, PI98E15, PI9S8E10

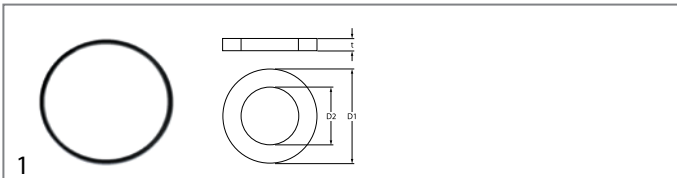

GEV No. 510896 **Ref. No.** 200828
description O-ring EPDM thickness 3.53mm ID ø 183.75mm Qty 1 pcs

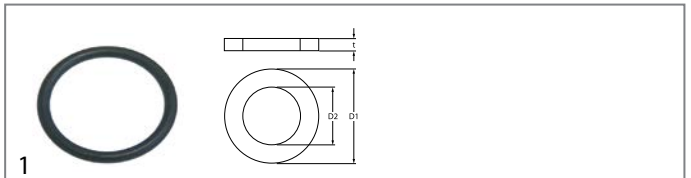

GEV No. 510408 **Ref. No.** 200820
 BN0118462630
description O-ring EPDM thickness 5.34mm ID ø 47mm Qty 1 pcs

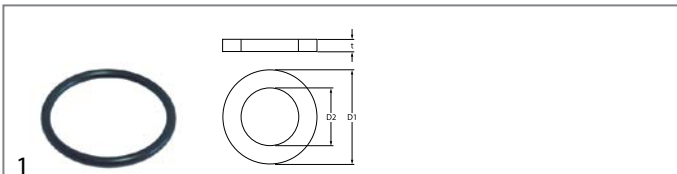

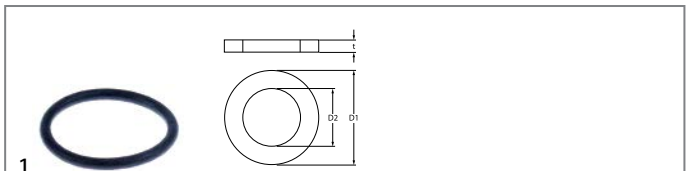

GEV No. 510895 **Ref. No.** 200814
description O-ring EPDM thickness 3.53mm ID ø 34.52mm Qty 1 pcs



GEV No. 505517 **Ref. No.** 77121600
 MA77121600
description O-ring EPDM thickness 5.34mm ID ø 53.34mm Qty 1 pcs
For models: PD98E10, PD98E15, PD98G10, PD98G15, PD98G15A, PD9S8E10, PD9S8G10, PI98E10, PI98E15, PI98G10, PI98G14, PI98G14A, PI9S8E10



			
GEV No.	510409	Ref. No.	1036504200 LA70045010 LAR70045010
description	O-ring EPDM thickness 5.34mm ID ø 56.52mm Qty 1 pcs		
For models:	DLS30, DLS303, DLS30P, DLS30P3, DLS31, DLS313, DLS31P3, ME101M, ME101P, ME101T, ME102D, ME102M, ME102P, ME102T, ME201D, ME201M, ME201P, ME201T, ME202D, ME202M, ME202P, ME202T, MEMENT06D, MEMENT06P, MEMENT10D, MEMENT10P, MEMENT20D, MEMENT20P, MEMENT21D, MEMENT21P, MEMENT40D, MEMENT40P, MLC50, MLC503, MLC65, MLC653, MLS30, MLS303, MLS30P, MLS30P3, MLS31, MLS313, MLS31P3, MLS35, MLS353, MPLS30P		

			
GEV No.	510447	Ref. No.	200829
description	O-ring EPDM thickness 5.34mm ID ø 81.92mm Qty 1 pcs		

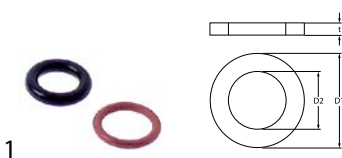
			
GEV No.	532492	Ref. No.	R70010050
description	O-ring set EPDM thickness 1.78/2.62mm ID ø 9.25/7.59mm Qty 2 pcs		
For models:	ME061T, ME101T, ME102T, ME201T, MEMENT06P, MEMENT10P, MEMENT20P, MEMENT21P, MEMENT40P, MG102T, MG201T, MG202T, MGMT06P, MGMT10P, MGMT20P, MGMT21P, MGMT40P		

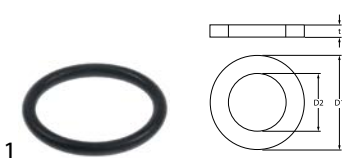
			
GEV No.	501478	Ref. No.	77121700 77122000 MA77121700 MA77122000
description	O-ring set EPDM thickness 5.34mm ID ø 44.45mm Qty 3 pcs		
For models:	PD76G5, PD96G5, PI76E5, PI76G5, PI96E5, PI96G5, PV, PVA		

			
GEV No.	510551	Ref. No.	630441
description	pump cover gasket ID ø 158.3mm pump type 1214/1293/1225/2243/1226/1204/3473/1241 thickness 3.53mm EPDM Qty 1 pcs		

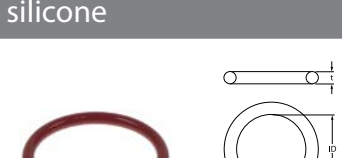
<p>silicone</p> 			
GEV No.	514017	Ref. No.	0105246 1036500200 1814400 MA1814400 R0105246 SIR0105246
description	O-ring silicone thickness 3.53mm ID ø 32.93mm Qty 1 pcs		
For models:	CP704E, CP92E, CP92E2, CP94E, CP94E2, CP95B2E, CP95B2E2, CP95B4E, CP95B4E2, CPE40, CPE402, CPE60, CPE602, CPE60DB, DE92142, DE94242, EPC74E, OCPE6, OCPE60, PC12C4E, PC12C9E, PC74E, PC76E, PC78E, PC94E, PC96E, PC98E, PC954E, PC956E, PC958E		

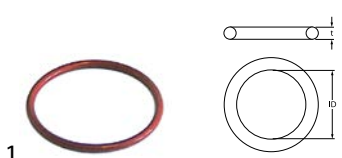
			
GEV No.	514021	Ref. No.	1036500300 1814700 MA1814700
description	O-ring silicone thickness 3.53mm ID ø 49.21mm Qty 1 pcs		
For models:	CP704E, CP92E, CP92E2, CP94E, CP94E2, CP95B2E, CP95B2E2, CP95B4E, CP95B4E2, CPE40, CPE402, CPE60, CPE602, CPE60DB, EPC74E, OCPE6, OCPE60, PC12C4E, PC12C9E, PC74E, PC76E, PC78E, PC94E, PC96E, PC98E, PC954E, PC956E, PC958E		

<p>Viton</p> 			
GEV No.	528687	Ref. No.	CM097900 MACM097900
description	O-ring Viton thickness 1.78mm ID ø 3.69mm Qty 1 pcs		
For models:	EF74E10VG, EF74E12, EF74G15, EF74G8VA, EF74G8VG, F12C4E12, F12C4G15, F74E10, F74E12, F74E6, F74G10, F74G15, F74G6, F76E10, F76G10, F78E12, F78G15, F94E10, F94E12, F94E18, F94E18K, F94E6, F94G10, F94G15, F94G22, F94G22K, F94G6, F96E10, F96G10, F98E12, F98E18, F98E18K, F98G15, F98G22, F98G22K, F954E12, F954E18, F954E18K, F954G15, F954G22, F954G22K, F958E12, F958E18, F958E18K, F958G15, F958G22, F958G22K, FQE41R, FQE41RL, FQE41RL2...(Other models you can see in the webshop)		

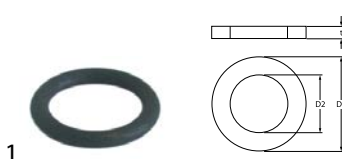
			
GEV No.	514222	Ref. No.	CM142000 MACM142000
description	O-ring Viton thickness 3.53mm ID ø 20.22mm Qty 1 pcs		
For models:	B124E, B74E, B74G, B78E, B78G, B94E, B94G, B98E, B98G, NB74E, NB74G, NB78E, NB78G, NB94E, NB94G, NB98E, NB98G		

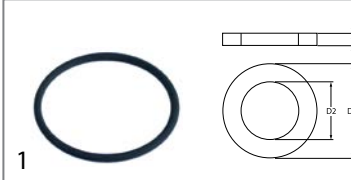

GEV No.	550496	Ref. No.	CM099200 MACM099200
description	O-ring Viton thickness 3.53mm ID ø 50.39mm Qty 1 pcs		
For models:	EF74E10VG, EF74E12, F12C4E12, F74E10, F74E12, F74E6, F76E10, F78E12, F94E10, F94E12, F94E18, F94E18K, F94E6, F96E10, F98E12, F98E18, F98E18K, F9S4E12, F9S4E18, F9S4E18K, F9S8E12, F9S8E18, F9S8E18K, FQE41R, FQE41RL, FQE41RL2, FQE61R, FQE61RL, NF74E10, NF74E15, NF76E10, NF78E15, NF94E10, NF94E15, NF94E22, NF94E222, NF94E222K, NF94E22K, NF96E10, NF98E15, NF98E22, NF98E222, NF98E222K, NF98E22K, NPC74E, NPC76E, NPC78E, NPC94E, NPC96E, NPC98E		

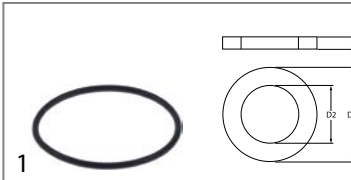

GEV No.	532681	Ref. No.	CR0582140
description	O-ring Viton thickness 3.53mm ID ø 66.27mm Qty 1 pcs		
For models:	NF74E15, NF78E15, NF94E15, NF98E15, NPC74E, NPC76E, NPC78E, NPC94E, NPC98E		

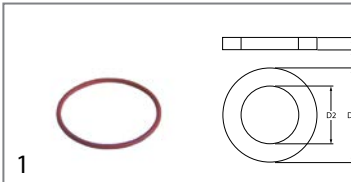

GEV No.	521116	Ref. No.	1422200 MA1422200
description	O-ring Viton thickness 3.53mm ID ø 78.97mm Qty 1 pcs		
For models:	P9D10E, P9D15E, P9DA10E, P9DA15E, P9I10E, P9I15E, P9IA10E, P9IA15E		

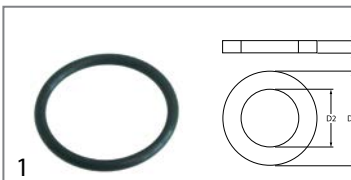

GEV No.	521146	Ref. No.	CM046200 MACM046200
description	O-ring Viton thickness 5.34mm ID ø 56.52mm Qty 1 pcs		
For models:	NPI76E5, NPI78E8, NPI96E5, NPI98E10, NPI98E15, PI76E5, PI96E5, PI98E10, PI98E15, PI9S8E10		

sealing washers

fibre gaskets



GEV No.	504209	Ref. No.	14072299 MA14072299
description	flat gasket FIBER ED ø 18.5mm ID ø 11mm thickness 2mm Qty 1 pcs		
For models:	BR78EF, BR78EI, BR78GF, BR78GI, BR912EFM, BR912EIM, BR912GFM, BR912GIM, BR98EF, BR98EFM, BR98EI, BR98EIM, BR98GF, BR98GFM, BR98GI, BR98GIM, BR9S8EF, BR9S8EI, BR9S8GF, BR9S8GI, CP92G, CP94G, NBR78EF, NBR78EI, NBR78GF, NBR78GI, NBR912EFM, NBR912EIM, NBR912GFM, NBR912GIM, NBR98EF, NBR98EFM, NBR98EI, NBR98EIM, NBR98GF, NBR98GFM, NBR98GI, NBR98GIM, P9D10E, P9D10G, P9D15E, P9D15G, P9D5G, P9DA10E, P9DA10G, P9DA15E, P9DA15G, P9DSB10E, P9DSB10G, P9I10E... (Other models you can see in the webshop)		



GEV No.	518393	Ref. No.	R70030050
description	flat gasket FIBER ED ø 24mm ID ø 17mm thickness 2mm Qty 1 pcs		
For models:	MG120M, MG120P, MG120X, MGC20X		



GEV No.	510996	Ref. No.	460502
description	flat gasket FIBER ED ø 31mm ID ø 21.5mm thickness 2mm for thread 1/2" Qty 1 pcs		



GEV No.	510404	Ref. No.	CR0682770
description	flat gasket fibre ED ø 44mm ID ø 34mm thickness 2mm Qty 1 pcs		
For models:	NPI76E5, NPI76G5, NPI78E8, NPI78G8, NPI96E5, NPI96G5, NPI98E10, NPI98E15, NPI98G10, NPI98G14, NPI98G14A		



GEV No.	510355	Ref. No.	460501
description	gasket fibre ED ø 24mm ID ø 17mm thickness 2mm Qty 1 pcs		



rubber gaskets

			
1			
GEV No.	510877	Ref. No.	200415
description	flat gasket rubber ED ø 18mm ID ø 10mm thickness 3mm Qty 1 pcs		

			
1			
GEV No.	510989	Ref. No.	160811
description	flat gasket rubber ED ø 18mm ID ø 8.5mm thickness 1mm Qty 1 pcs		

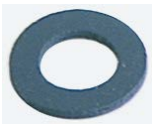
			
1			
GEV No.	510886	Ref. No.	200467
description	flat gasket rubber ED ø 21mm ID ø 11.5mm thickness 2mm Qty 1 pcs		

			
1			
GEV No.	520054 ¹	Ref. No.	200416
description	flat gasket rubber ED ø 23.5mm ID ø 14mm thickness 2.3mm Qty 10 pcs		

¹Qty 10 pieces

			
1			
GEV No.	511180	Ref. No.	200457
description	flat gasket rubber ED ø 24mm ID ø 16mm thickness 3mm Qty 1 pcs		

			
1			
GEV No.	511283	Ref. No.	200927
description	flat gasket rubber ED ø 30mm ID ø 20mm thickness 2mm Qty 1 pcs		

			
1			
GEV No.	510876	Ref. No.	200412
description	flat gasket rubber ED ø 45mm ID ø 33mm thickness 3mm Qty 1 pcs		

			
1			
GEV No.	516254	Ref. No.	200410
description	flat gasket rubber ED ø 66mm ID ø 46mm thickness 2.1mm Qty 1 pcs		

			
1			
GEV No.	510947	Ref. No.	200489
description	flat gasket rubber ED ø 85mm ID ø 73mm thickness 2mm Qty 1 pcs equiv. no. 200489 suitable for COMENDA		

			
1			
GEV No.	510832	Ref. No.	200906
description	flat gasket rubber ED ø 92mm ID ø 66mm thickness 2mm Qty 1 pcs equiv. no. 200906/33456		

			
1			
GEV No.	511158	Ref. No.	200482
description	gasket rubber ED ø 50mm ID ø 35mm thickness 4mm Qty 1 pcs		

plastic gaskets

			
1			
GEV No.	510838	Ref. No.	160803
description	gasket plastic ED ø 10.5mm ID ø 5mm thickness 3mm Qty 1 pcs		

			
1			
GEV No.	510840	Ref. No.	160805
description	gasket plastic ED ø 16mm ID ø 8.5mm thickness 4mm Qty 1 pcs		

PTFE gaskets

			
1			
GEV No.	514016	Ref. No.	1036500400 1814500 MA1814500
description	flat gasket PTFE ED ø 45mm ID ø 40mm thickness 4mm Qty 1 pcs equiv. no. 1036500400/1814500 suitable for MARENO		
For models:	CP704E, CP92E, CP92E2, CP94E, CP94E2, CP95B2E, CP95B2E2, CP95B4E, CP95B4E2, CPE40, CPE402, CPE60, CPE602, CPE60DB, DE92142, DE94242, EPC74E, OCP6E, OCP6E0, PC12C4E, PC12C9E, PC74E, PC76E, PC78E, PC94E, PC96E, PC98E, PC9S4E, PC9S6E, PC9S8E		

silicone gaskets

			
1			
GEV No.	691332	Ref. No.	2993700 MA2993700
description	flat gasket silicone ED ø 13.8mm ID ø 6mm thickness 1.5mm Qty 1 pcs		
For models:	B124E, B74E, B78E, B94E, B98E, B9SB2E, B9SB4E, B9V2E, B9V4E, B9VP2E, B9VP4E, BF78E, BF98E, BIE40, BIE40B, BIE60, BIE60B, BM74E, BM77E, BME40DM, BME40DMB, BME40M, BME60, BME602, BME60DM, BME60DMB, BME60M, BME80M, BR707E, BR707EI, BR78EF, BR78EI, BR912EFM, BR912EIM, BR912GFM, BR912GIM, BR94E, BR94EI, BR94G, BR94GI, BR98EF, BR98EFM, BR98EI, BR98EIM, BR98GF, BR98GFM, BR98GI, BR98GIM, BR9M4E, BR9M4EI...(Other models you can see in the webshop)		

foam rubber gaskets

			
1			
GEV No.	691329	Ref. No.	1036607700 MA1036607700
description	foam rubber gasket W 10mm thickness 5mm self-adhesive Qty supplied by meter		
For models:	FQE41, FQE41L, FQE41L2, FQE61, FQE61L, FQE61L2, FR74E10, FR74E10L, FR74E10L2, FR77E10, FR77E10L, FR77E10L2, OFQE41, OFQE61		

			
1			
GEV No.	511391	Ref. No.	200402
description	foam rubber gasket W 24mm thickness 4mm self-adhesive Qty 1m suitable for COMENDA		

			
1			
GEV No.	510881	Ref. No.	200433
description	foam rubber gasket W 6mm thickness 2.5mm self-adhesive Qty 1m		

			
1			
GEV No.	510880	Ref. No.	200432
description	foam rubber gasket W 8mm thickness 4mm self-adhesive Qty supplied by meter		

shaft gaskets

			
1			
Image not available			
GEV No.	514191	Ref. No.	4609200 MA4609200
description	V-ring ID ø 14mm ED ø 20mm thickness 6mm		
For models:	AF140B, AF140C, AF140F, AF140I, AF140MB, AF140MC, AF140MF, AF140MI, AF140MN, AF140MP, AF140N, AF140P, AF14F, AF14G, AF14N, AF70B, AF70C, AF70F, AF70I, AF70MB, AF70MC, AF70MF, AF70MI, AF70MN, AF70MP, AF70N, AF70P, EF140DF, EF140DN, EF140DP, EF140MB, EF140MC, EF140MF, EF140MI, EF140MN, EF140MP, EF143MNI, EF70DF, EF70DN, EF70DP, EF70MB, EF70MC, EF70MF, EF70MI, EF70MN, EF70MP, EF72MNF, F140DF, F140DI, F140DN...(Other models you can see in the webshop)		

shaft gaskets

			
1			
GEV No.	511171	Ref. No.	LA70020040 LAR70020040
description	shaft seal ID ø 14.5mm ED ø 20mm thickness 3mm		
For models:	CVE105H, CVE105M, CVG105H, CVG105M, EC106M, EM106H, EM106M, EM106M+SC, EM106P, EV006M, EV106H, EV106M, EV106M+SC, EV106P, FE105M, FE105X, FG105M, FG105X, GC106M, GM106H, GM106M, GM106M+SC, GM106P, GMT06D, GV106H, GV106M, GV106M+SC, GV106P, GVT06D, MACE07M, MACG07M, ME061D, ME061M, ME061P, ME061T, ME106M, ME106P, ME106X, MEMT06D, MEMT06P, MEVT06D, MEVT06P, MG061D, MG061M, MG061P, MG061T, MG106M, MG106P, MG106X, MGMT06D...(Other models you can see in the webshop)		

			
1			
GEV No.	511170	Ref. No.	R70020010
description	shaft seal ID ø 7mm ED ø 22mm thickness 7mm		
For models:	CVE004H, CVE004M, CVE104H, CVE104M, VE004M, VE004X, VE104M, VE104X		



			
1			
GEV No.	511172	Ref. No.	R70020050
description	shaft sealing ID ø 24mm ED ø 29mm thickness 3mm		
For models:	EC110M, EC210M, EM010M+SC, EM110H, EM110M, EM110M+SC, EM110P, EM210H, EM210M, EM210M+SC, EM210P, EV110H, EV110M, EV110M+SC, EV110P, EV210H, EV210M, EV210M+SC, EV210P, FE110M, FE110X, FE210M, FG110M, FG110X, FG210M, FG210X, GC110M, GC210M, GM110H, GM110M, GM110M+SC, GM110P, GM210H, GM210M, GM210M+SC, GM210P, GMT20D, GV110H, GV110M, GV110M+SC, GV110P, GV210H, GV210M, GV210M+SC, GV210P, GVT20D, MACE10M, MACE20M, MACG10M, MACG20M...(Other models you can see in the webshop)		

			
1			
GEV No.	699246	Ref. No.	R70045110
description	service kit gasket for combi-steamer		
For models:	ME201T, MEMT21P, MEMT40P, MG201T, MG202T, MGMT21P, MG-MT40P		

special gaskets

for combi-steamers

			
1			
GEV No.	699384	Ref. No.	R63140050
description	gasket suitable for LAINOX ED ø 84mm ID ø 50mm fibre thickness 2mm hole distance 50mm hole ø 6mm		
For models:	GMT06D, GMT20D, GVT06D, GVT20D, MACG05M, MACG07M, MACG10M, MACG20M, MG061D, MG061M, MG061P, MG061T, MG101D, MG101M, MG101P, MG101T, MG102D, MG102M, MG102P, MG102T, MG201D, MG201M, MG201P, MG201T, MG202D, MG202M, MG202P, MG202T, MGMT06D, MGMT06P, MGMT10D, MGMT10P, MGMT20D, MGMT20P, MGMT21D, MGMT21P, MGMT40D, MGMT40P, MGVT06D, MGVT06P, MGVT10D, MGVT10P, MGVT20D, MGVT20P, MGVT21D, MGVT21P, MGVT40D, MGVT40P, MVG051P		

			
1			
GEV No.	694955	Ref. No.	R63140010
description	gasket suitable for LAINOX L 80mm W 65mm combi-steamer ID ø 51mm graphite thickness 3mm hole distance 45x60mm		
For models:	GMT06D, GVT06D, MACG05M, MACG07M, MG061D, MG061M, MG061P, MG061T, MGMT06D, MGMT06P, MGVT06D, MGVT06P, MVG051P		

			
1			
GEV No.	699385	Ref. No.	R70045100
description	gasket set suitable for LAINOX for cleaning system		
For models:	ME102T, MEMT10P, MEMT20P, MG102T, MGMT10P, MGMT20P		

door seals for dishwashers

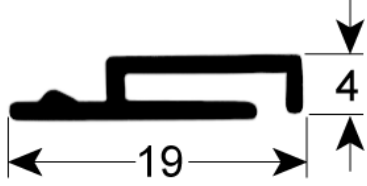
			
1			
GEV No.	511311	Ref. No.	200923
description	door seal L 1000mm dishwasher suitable for COMENDA equiv. no. 200923		

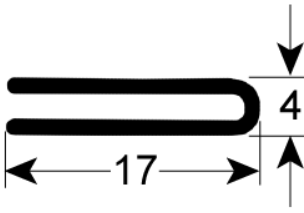
			
1			
GEV No.	511390	Ref. No.	200215
description	door seal L 930mm dishwasher suitable for COMENDA equiv. no. 200215		

			
1			
GEV No.	511391	Ref. No.	200402
description	foam rubber gasket W 24mm thickness 4mm self-adhesive Qty 1m suitable for COMENDA		

			
1			
GEV No.	510881	Ref. No.	200433
description	foam rubber gasket W 6mm thickness 2.5mm self-adhesive Qty 1m		

			
1			
GEV No.	510880	Ref. No.	200432
description	foam rubber gasket W 8mm thickness 4mm self-adhesive Qty supplied by meter		

miscellaneous



1

GEV No.	510882	Ref. No.	200451
description	gasket for opposite support L 100mm hood mechanics rubber H 3mm black W 30mm		



1

GEV No.	511370	Ref. No.	160837
description	gasket L 34mm W 14mm for door guides ID ø 7mm thickness 3mm		



1

GEV No.	510847	Ref. No.	440405
description	gasket polishing agent dosing ID ø 22mm ED ø 32mm external height 5mm		

thermostat gaskets



1

GEV No.	512154	Ref. No.	200494
description	gasket for thermostat ID ø 20mm equiv. no. 200494/H200494 hole distance 41mm suitable for COMENDA, HOONVED		

miscellaneous



1

GEV No.	550862	Ref. No.	R70045090
description	gasket set for wash arm		
For models:	ME061T, ME101T, MEMT06P, MGMT06P		

evaporators

for fridges

producer-specific



1

GEV No.	750272	Ref. No.	2474763 MA2474763
description	evaporator		
For models:	EF143MNI, EF70MF, EF70MN, EF70MP, EF72MNF, FB140FN, FB140NN, FB140PF, FB140PN, FB140PP, FB143NI, FB55F, FB55N, FB55P, FB70F, FB70N, FB70P, FB72F, FB72N, FB72NF, FB72P, FS140FI, FS140FN, FS140I, FS140NI, FS140NN, FS140PN, FS140PP, FS143FI, FS143NF, FS143NI, FS143NN, FS143NP, FS70F, FS70FG, FS70I, FS70N, FS70NG, FS70P, FS72F, FS72FI, FS72IN, FS72N, FS72NF, FS72NN, FS72P, HF140DFN, HF140DNN, HF140DPF, HF140DPN...(Other models you can see in the webshop)		

transmission technology and ball bearings

ball bearings

thrust ball bearings



1

GEV No.	523537	Ref. No.	288700 MA288700
description	thrust ball bearing shaft ø 20mm ED ø 35mm W 10mm type 51104 DIN 711		
For models:	BR78EF, BR78EI, BR78GF, BR78GI, BR912EFM, BR912EIM, BR912GFM, BR912GIM, BR94E, BR94EI, BR94G, BR94GI, BR98EF, BR98EFM, BR98EI, BR98EIM, BR98GF, BR98GFM, BR98GI, BR98GIM, BR9M4E, BR9M4EI, BR9M4G, BR9M4GI, BR9M6E, BR9M6EI, BR9M6G, BR9M6GI, BR9S8EF, BR9S8EI, BR9S8GF, BR9S8GI, BR9S84E, BR9S84EI, BR9S84G, BR9S84GI		

springs

torsion springs



1

GEV No.	514234	Ref. No.	810210 MA810210
description	torsion spring ø 32.3mm L2 188mm wire gauge ø 5.7mm L1 15mm tilting bratt pan series 900		
For models:	BR78EF, BR78EI, BR78G, BR78GF, BR78GI, BR912EFM, BR912EIM, BR912GFM, BR912GIM, BR98EF, BR98EFM, BR98EI, BR98EIM, BR98GF, BR98GFM, BR98GI, BR98GIM, BR9S8EF, BR9S8EI, BR9S8GF, BR9S8GI, CP9A15GD, NPD78G8, NPI78E8, NPI78G8		



			
GEV No.	514226	Ref. No.	139732 MA139732
description	torsion spring ø 32.3mm L2 192mm wire gauge ø 5.9mm L1 14mm kettle type series 700 series 900		
For models:	BR707E, BR707EI, BR707G, BR707GI, BR78EF, BR78EI, BR78G, BR78GF, BR78GI, BR912EFM, BR912EIM, BR912GFM, BR912GIM, BR94E, BR94EI, BR94G, BR94GI, BR96E, BR96EI, BR96G, BR96GI, BR98EF, BR98EIM, BR98EI, BR98EIM, BR98GF, BR98GFM, BR98GI, BR98GIM, BR9M4E, BR9M4EI, BR9M4G, BR9M4GI, BR9M6E, BR9M6EI, BR9M6G, BR9M6GI, BR9S8EF, BR9S8EI, BR9S8GF, BR9S8GI, BR9S84E, BR9S84EI, BR9S84G, BR9S84GI, CP9A15GD, NPD76G5, NPD96G5, NPI76E5, NPI76G5... (Other models you can see in the webshop)		

			
GEV No.	690095	Ref. No.	R61620012
description	torsion spring ø 6mm L2 15mm wire gauge ø 0.9mm L1 2x6mm L3 15mm Qty 1 pcs for closing hub		
For models:	CVE004H, CVE004M, CVE104H, CVE104M, CVE105H, CVE105M, CVG105H, CVG105M, EC106M, EC110M, EC210M, EM010M+SC, EM106H, EM106M, EM106M+SC, EM106P, EM110H, EM110M, EM110M+SC, EM110P, EM210H, EM210M, EM210M+SC, EM210P, EV006M, EV106H, EV106M, EV106M+SC, EV106P, EV110H, EV110M, EV110M+SC, EV110P, EV210H, EV210M, EV210M+SC, EV210P, FE105M, FE105X, FE110M, FE110X, FE210M, FG105M, FG105X, FG110M, FG110X, FG210M, FG210X, GC106M, GC110M...(Other models you can see in the webshop)		

compression springs

			
GEV No.	690091	Ref. No.	R61620041
description	compression spring ø 12mm L 49mm wire gauge ø 1mm		
For models:	CVE004H, CVE004M, CVE104H, CVE104M, CVE105H, CVE105M, CVG105H, CVG105M, EC106M, EC110M, EC210M, EM010M+SC, EM106H, EM106M, EM106M+SC, EM106P, EM110H, EM110M, EM110M+SC, EM110P, EM210H, EM210M, EM210M+SC, EM210P, EV006M, EV106H, EV106M, EV106M+SC, EV106P, EV110H, EV110M, EV110M+SC, EV110P, EV210H, EV210M, EV210M+SC, EV210P, FE105M, FE105X, FE110M, FE110X, FE210M, FG105M, FG105X, FG110M, FG110X, FG210M, FG210X, GC106M, GC110M...(Other models you can see in the webshop)		

miscellaneous

			
GEV No.	697932	Ref. No.	R10205120
description	spring for controllers/switches shaft diameter 6x4.6mm ømm L 40mm W 23mm H 7mm wire gauge ø 1mm		
For models:	CVE004H, CVE104H, CVE105H, CVG105H, EM106H, EM106P, EM110H, EM110P, EM210H, EM210P, EV106H, EV106P, EV110H, EV110P, EV210H, EV210P, GM106H, GM106P, GM110H, GM110P, GM210H, GM210P, GV106H, GV106P, GV110H, GV110P, GV210H, GV210P, ME106P, ME110P, ME120P, ME210P, ME220P, MEC24H, MG106P, MG110P, MG120P, MG210P, MG220P, MGC24H, MGC40H, VE106P, VE120P, VE210P, VE220P, VG106P, VG110P, VG120P, VG210P, VG220P		

tension springs

			
GEV No.	510926	Ref. No.	391312
description	tension spring for hood		

			
GEV No.	517406	Ref. No.	CR0589520
description	tension spring ø 29mm total length 230mm wire gauge ø 4mm for tilting bratt pan		
For models:	NBR78EF, NBR78EI, NBR78GF, NBR78GI, NBR912EFM, NBR912EIM, NBR912GFM, NBR912GIM, NBR98EF, NBR98EIM, NBR98EI, NBR98EIM, NBR98GF, NBR98GFM, NBR98GI, NBR98GIM, XCABR7E, XCABR7G		

			
GEV No.	510928	Ref. No.	391316
description	tension spring ø 37mm total length 910mm wire gauge ø 5.3mm for hood C85/140-G75		

kitchen accessories

gastronorm

bridges

			
GEV No.	691337	Ref. No.	CR0506490
description	bridge for Gastronorm container L1 525mm L2 505mm SS W 72mm H 15mm Qty 1 pcs		

hose reels and spray guns

spray guns

			
GEV No.	548455	Ref. No.	R62200133
description	spray gun for appliances 3/8" IT		
For models:	ME061P, ME061T, ME101P, ME101T, ME102P, ME201P, ME201T, ME202P, ME202T, MG061P, MG061T, MG101P, MG101T, MG102P, MG102T, MG201P, MG201T, MG202P, MG202T		







hose reels

appliance hose reels





1				
GEV No.	542099	Ref. No.	R62200131	
description	hose reel complete with spray gun hose length 1.6m connection John Guest 10mm hose ø 6x12mm			
For models:	ME061P, ME061T, ME101P, ME101T, ME102P, ME201P, ME201T, ME202P, ME202T, MG061P, MG061T, MG101P, MG101T, MG102P, MG102T, MG201P, MG201T, MG202P, MG202T			
accessories for	542099			
	GEV No.	542098	Ref. No.	—
	spray gun for appliances 3/8" IT L 130mm type LAINOX			

spare parts for	361002			
	GEV No.	510870	Ref. No.	191018
	filter support for dosing pump			
	GEV No.	510894	Ref. No.	381105
	press ring for membrane			
	GEV No.	510916	Ref. No.	330543
	filter for dosing pump			

spare parts				
	1			
GEV No.	510916	Ref. No.	330543	
description	filter for dosing pump			

	1			
GEV No.	510870	Ref. No.	191018	
description	filter support for dosing pump			

	1			
GEV No.	510847	Ref. No.	440405	
description	gasket polishing agent dosing ID ø 22mm ED ø 32mm external height 5mm			

	1			
GEV No.	510297	Ref. No.	630614	
description	membrane for dosing pump ED ø 83mm thickness 1mm dosing pump equiv. no. 630614 suitable for COMENDA			

	1			
GEV No.	510338	Ref. No.	170701	
description	union nut dosing pump thread 1/2" ø 32mm H 15mm for dosing pump			

dosing pumps

membrane dosing pumps

self-priming

various



1				
GEV No.	361002	Ref. No.	620120	
description	dosing pump rinse aid inlet 6x8mm outlet 4x6mm pressure connection ø 4x6mm suction connection ø 6x8mm			
spare parts for	361002			
	GEV No.	510297	Ref. No.	630614
	membrane for dosing pump ED ø 83mm thickness 1mm dosing pump equiv. no. 630614 suitable for COMENDA			
	GEV No.	510298	Ref. No.	—
	lip valve dosing pump suitable for DB2/DS5			
	GEV No.	510299	Ref. No.	180306
	hose connector for dosing pump			
	GEV No.	510328	Ref. No.	340483
	plunger rinse aid dosing pump			
	GEV No.	510338	Ref. No.	170701
	union nut dosing pump thread 1/2" ø 32mm H 15mm for dosing pump			
	GEV No.	510847	Ref. No.	440405
	gasket polishing agent dosing ID ø 22mm ED ø 32mm external height 5mm			



self-priming with supporting pressure

HOONVED



1			
GEV No.	361383	Ref. No.	200444
description	lip valve rinse aid pressure connection 8mm suction connection 8mm auxiliary pressure connectionmm		

accessories

container filters with non-return valve



1			
GEV No.	361058	Ref. No.	R65110650
description	container filter with non-return valve SS hose ø 4x6mm ø 20mm L 56mm		
For models:	ME061T, ME101T, ME102T, ME201T, MEMT06P, MEMT10P, MEMT20P, MEMT21P, MENT40P, MG102T, MG201T, MG202T, MGMT06P, MGMT10P, MGMT20P, MGMT21P, MGMT40P		

intake lances



1			
GEV No.	361118	Ref. No.	180719
description	intake lance with filter L 415mm ø 17mm tube ø 10mm hose ø 4x6mm cable lengthmm PVC		

hoses

stainless steel flexi hoses

universal hoses

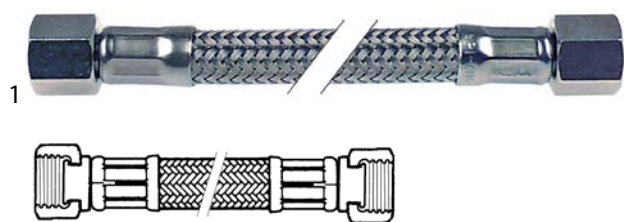

1			
GEV No.	520627	Ref. No.	200715
description	flex hose SS braid straight-straight DN12 connections 3/4" L 2000mm approval DVGW operating p. 10bar test pressure 32bar burst p. 95bar		

drain hoses

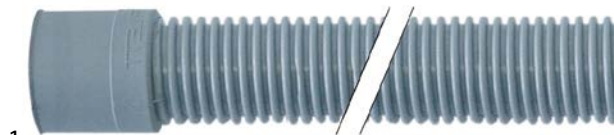

1			
GEV No.	530587	Ref. No.	200721
description	drain hose DN28 L 2000mm straight ø inside 32mm straight ext. ø 40mm outer hose ø 35mm		

industrial hoses

Niplaflex hoses



1			
GEV No.	530561	Ref. No.	200122
description	pressure hose ID ø 10mm ED ø 17mm L 5m thickness 3.5mm operating p. 10bar burst p. 30bar t.max. 110°C		

PE hoses



1			
GEV No.	520973	Ref. No.	R70070040 R70070050
description	hose John Guest thickness 1.5mm LLDPE blue ID ø 7mm ED ø 10mm		

For models: GMT06D, GMT20D, GVT06D, ME061P, ME061T, ME101D, ME101M, ME101P, ME101T, ME102D, ME102M, ME102P, ME102T, ME201D, ME201M, ME201P, ME201T, ME202D, ME202M, ME202P, ME202T, MEMT06P, MEMT10D, MEMT10P, MEMT20D, MEMT20P, MEMT21D, MEMT21P, MENT40D, MENT40P, MEVT06P, MEVT10D, MEVT10P, MEVT21D, MEVT21P, MEVT40D, MEVT40P, MG061D, MG061M, MG061P, MG061T, MG101D, MG101M, MG101P, MG101T, MG102D, MG102M, MG102P, MG102T, MG201D...(Other models you can see in the webshop)

accessories for	520973		
	GEV No.	440564	Ref. No. —
	push-in fitting John Guest straight thread 1/4" BSP pipe connection ø10mm		
	GEV No.	440565	Ref. No. —
	push-in fitting John Guest straight thread 3/8" BSP pipe connection ø10mm		
	GEV No.	440608	Ref. No. —
	push-in fitting John Guest straight thread 1/2" BSP stub ø 10mm		
	GEV No.	440639	Ref. No. —
	push-in fitting John Guest angled thread 1/4" BSP pipe connection ø10mm		
	GEV No.	520359	Ref. No. R62090528
	push-in fitting John Guest angled pipe connection ø10mm grommet ø 10mm		
	GEV No.	520363	Ref. No. R62090468
	push-in fitting John Guest T-piece pipe connection ø10mm - ø10mm		

Table continues overleaf





accessories for 520973			
	GEV No.	520494	Ref. No. R62090478
push-in fitting John Guest angled pipe connection ø10mm - ø10mm			

pressure control hoses			
			
GEV No.	530560	Ref. No.	160121
description	pressure control hose ID ø 5mm ED ø 9mm L 5m operating p. 30bar burst p. 90bar temp.-resist. 60°C		

PVC hoses			
PVC hoses without fabric			
			
GEV No.	520026	Ref. No.	160105
description	PVC hose ID ø 4mm ED ø 6mm L 10m thickness 1mm t.max. 60°C transparent		

accessories for 520026			
	GEV No.	361058	Ref. No. R65110650
container filter with non-return valve SS hose ø 4x6mm L 56mm			
	GEV No.	361066	Ref. No. —
container filter straight SS hose ø 4x6mm L 37mm non return valve ball valve			
	GEV No.	361106	Ref. No. —
container filter with weight and non-return valve SS hose ø 4x6mm L 21mm L 51mm non return valve lip valve			
	GEV No.	361141	Ref. No. —
container filter with weight ceramic hose ø 4mm			
	GEV No.	361230	Ref. No. —
container filter with weight stainless steel hose ø 4x6mm			
	GEV No.	361462	Ref. No. —
container filter with weight SS hose ø 4x6mm			
	GEV No.	361728	Ref. No. —
container filter with 4m 4x6 hose SS hose ø 4x6mm hose length 4000mm			

			
GEV No.	520278	Ref. No.	R70070100
description	PVC hose ID ø 6mm ED ø 8mm L 2m thickness 1mm t.max. 60°C transparent		
For models:	ME061T, ME101T, ME102T, ME201T, MEMT06P, MEMT10P, MEMT20P, MEMT21P, MEMT40P, MG102T, MG201T, MG202T, MGMT06P, MGMT10P, MGMT20P, MGMT21P, MGMT40P		

silicone hoses			
without fabric			
			
GEV No.	530899	Ref. No.	R70060080
description	silicone hose ID ø 13mm ED ø 18mm L 0.08m thickness 2.5mm red for combi-steamer		
For models:	EM010M+SC, EM106H, EM106M, EM106M+SC, EM106P, EM110H, EM110M, EM110M+SC, EM110P, EM210H, EM210M, EM210M+SC, EM210P, EV006M, EV106H, EV106M, EV106M+SC, EV106P, EV110H, EV110M, EV110M+SC, EV110P, EV210H, EV210M, EV210M+SC, EV210P, GM106H, GM106M, GM106M+SC, GM106P, GM110H, GM110M, GM110M+SC, GM110P, GM210H, GM210M, GM210M+SC, GM210P, GMT06D, GMT20D, GV106H, GV106M, GV106M+SC, GV106P, GV110H, GV110M, GV110M+SC, GV110P, GV210H, GV210M...(Other models you can see in the webshop)		

			
GEV No.	530884	Ref. No.	R70060060 R70060070
description	silicone hose ID ø 15mm ED ø 19mm L 0.08m thickness 3mm red for combi-steamer		
For models:	CVE004H, CVE004M, CVE104H, CVE104M, CVE105H, CVE105M, CVG105H, CVG105M, EM010M+SC, EM106H, EM106M, EM106M+SC, EM106P, EM110H, EM110M, EM110M+SC, EM110P, EM210H, EM210M, EM210M+SC, EM210P, GM106H, GM106M, GM106M+SC, GM106P, GM110H, GM110M, GM110M+SC, GM110P, GM210H, GM210M, GM210M+SC, GM210P, ME106M, ME106P, ME106X, ME110M, ME110P, ME110X, ME120M, ME120P, ME120X, ME210M, ME210P, ME210X, ME220M, ME220P, ME220X, MEC24H, MEC40M...(Other models you can see in the webshop)		

			
GEV No.	530063	Ref. No.	MA1036100700
description	silicone hose ID ø 18mm ED ø 25mm L 1m t.max. 200°C transparent		



formed hoses

straight



1

GEV No.	511362	Ref. No.	200758
description	formed hose dishwasher straight equiv. no. 200758		



1

GEV No.	520534	Ref. No.	R70060040
description	hose ID ø 50mm ED ø 58mm L 50mm silicone Qty 1 for combi-steamer thickness 4mm		
For models:	FE105M, FE105X, FE110M, FE110X, FG105M, FG105X, FG110M, FG110X, GMT20D, ME061P, ME061T, ME101M, ME101P, ME101T, ME102M, ME102P, ME102T, ME106M, ME106P, ME106X, ME110M, ME110P, ME110X, ME120M, ME120P, ME120X, ME201D, ME201M, ME201P, ME201T, ME202D, ME202M, ME202P, ME202T, ME210M, ME210P, ME210X, ME220M, ME220P, ME220X, MEC24H, MEC40M, MEMENT21D, MEMENT21P, MEMENT40D, MEMENT40P, MEVT21D, MEVT21P, MEVT40D, MEVT40P...(Other models you can see in the webshop)		



1

GEV No.	530901	Ref. No.	R70060050
description	hose ID ø 54mm ED ø 60mm L 50mm for combi-steamer		
For models:	FE210M, FG210M, FG210X, ME102P, ME102T, ME202D, ME202M, ME202P, ME202T, MEMENT40D, MEMENT40P, MEVT40D, MEVT40P, MG102P, MG102T, MG202D, MG202M, MG202P, MG202T, MGMT40D, MGMT40P, MGVT40D, MGVT40P		



1

GEV No.	694499	Ref. No.	R70070060
description	hose ID ø 7mm L 2000mm LLDPE for beverage technology ED ø 10mm John Guest		
For models:	GVT20D, MACE07M, MACE10M, MACE20M, MACG07M, MACG10M, MACG20M, ME061D, MEMENT06D, MEVT06D, MEVT20D, MEVT20P, MGVT20D, MGVT20P		

form L



1

GEV No.	530577	Ref. No.	200750
description	formed hose L 350mm warewashing L-shape equiv. no. 200750 ID ø 60mm		



1

GEV No.	530579	Ref. No.	200724
description	formed hose warewashing L-shape equiv. no. 200724		



1

GEV No.	530544	Ref. No.	200769
description	formed hose warewashing L-shape equiv. no. 200769		



1

GEV No.	511348	Ref. No.	200781
description	formed hose warewashing L-shape equiv. no. 200781		



with branch



1	GEV No.	524930	Ref. No.	1036506200 2703130
	description	formed hose ext. ø 62/55 D1 ø 43mm D2 ø 49mm L 170mm warewashing black		
	For models:	MLC50, MLC503, MLC65, MLC653		



2	GEV No.	511208	Ref. No.	200768
	description	formed hose warewashing equiv. no. 200768 with piggyback		

form S



1	GEV No.	511226	Ref. No.	200755
	description	formed hose		



1	GEV No.	511342	Ref. No.	200719
	description	formed hose S-shape warewashing equiv. no. 200719		

for dishwashers

miscellaneous



1	GEV No.	510806	Ref. No.	1036602000 160108
	description	extraction hose ED ø 8mm ID ø 5mm Qty supplied by meter		
	For models:	DLS30, DLS303, DLS30P, DLS30P3, DLS31, DLS313, DLS31P3, MLC50, MLC503, MLC65, MLC653, MLS30, MLS303, MLS30P, MLS30P3, MLS31, MLS313, MLS31P3, MLS35, MLS353, MPLS30P		



1	GEV No.	530590	Ref. No.	200117
	description	hose ED ø 15mm ID ø 8mm equiv. no. 200117 Qty supplied by meter		



1	GEV No.	530589	Ref. No.	200113
	description	hose ED ø 22mm ID ø 12mm L 1000mm		



1	GEV No.	511289	Ref. No.	161312
	description	hose ED ø 9.5mm ID ø 5mm L 420mm equiv. no. 161312		

fittings, hose and pipe connectors

hose connectors

without screw connection



1	GEV No.	510843	Ref. No.	180408
	description	T-piece plastic hose ø 10-6-10mm		



push-in fittings

JOHN GUEST



1			
GEV No.	440019	Ref. No.	R62090548
description	push-in fitting John Guest straight pipe connection ø6mm grommet ø 10mm		
For models:	ME061T, ME101T, ME102T, ME201T, MEMT06P, MEMT10P, MEMT20P, MEMT21P, MEMT40P, MG102T, MG201T, MG202T, MGMT06P, MGMT10P, MGMT20P, MGMT21P, MGMT40P, MGMT40P, MGMT40P		
accessories for	440019		
	GEV No.	520971	Ref. No. —
	hose thickness 1mm LLDPE blue ID ø 4mm ED ø 6mm operating pressure at 20°C 16bar		



1			
GEV No.	520359	Ref. No.	R62090528
description	push-in fitting John Guest angled pipe connection ø10mm grommet ø 10mm		
For models:	ME061T, ME101T, ME102T, ME201T, MEMT06P, MEMT10P, MEMT20P, MEMT21P, MEMT40P, MG102T, MG201T, MG202T, MGMT06P, MGMT10P, MGMT20P, MGMT21P, MGMT40P, MGMT40P		
accessories for	520359		
	GEV No.	520973	Ref. No. R70070040 R70070050
	hose John Guest thickness 1.5mm LLDPE blue ID ø 7mm ED ø 10mm		



1			
GEV No.	520493	Ref. No.	R62090618
description	hose connector John Guest straight pipe connection ø8mm - ø10mm L 41mm PM201008E NSF, SK		
For models:	ME061T, ME101T, ME102T, MEMT06P, MEMT10P, MEMT20P, MEMT21P, MG102T, MG202D, MG202M, MG202P, MG202T, MGMT06P, MGMT10P, MGMT20P, MGMT21P, MGMT40D, MGMT40P, MGMT40P		



1			
GEV No.	520492	Ref. No.	R62090458
description	push-in fitting John Guest straight pipe connection ø10mm - ø10mm		
For models:	GMT06D, GMT20D, GVT06D, GVT20D, MACE04M, MACE05M, MACG05M, ME061D, ME061T, ME101D, ME101M, ME101P, ME101T, ME102D, ME102M, ME102P, ME102T, ME201D, ME201M, ME201P, ME201T, ME202D, ME202M, MEMT06D, MEMT06P, MEMT10D, MEMT10P, MEMT20D, MEMT20P, MEMT21D, MEMT21P, MEMT40D, MEMT40P, MEVT06D, MEVT06P, MEVT10D, MEVT10P, MEVT20D, MEVT20P, MEVT21D, MEVT21P, MEVT40D, MEVT40P, MG061D, MG061M, MG101D, MG101M, MG101P, MG101T, MG102D...(Other models you can see in the webshop)		



1			
GEV No.	520494	Ref. No.	R62090478
description	push-in fitting John Guest angled pipe connection ø10mm - ø10mm		
For models:	GMT20D, GVT06D, GVT20D, MACE04M, MACE05M, MACE07M, MACE10M, MACE20M, MACG05M, MACG07M, MACG10M, MACG20M, ME061D, ME061P, ME061T, ME101D, ME101M, ME101P, ME101T, ME102D, ME102M, ME102P, ME102T, ME201D, ME201M, ME201P, ME201T, ME202D, ME202M, ME202P, ME202T, MEMT06D, MEMT06P, MEMT10D, MEMT10P, MEMT20D, MEMT20P, MEMT21D, MEMT21P, MEMT40D, MEMT40P, MEVT06D, MEVT06P, MEVT10D, MEVT10P, MEVT20D, MEVT20P, MEVT21D, MEVT21P, MEVT40D...(Other models you can see in the webshop)		
accessories for	520494		
	GEV No.	520973	Ref. No. R70070040 R70070050
	hose John Guest thickness 1.5mm LLDPE blue ID ø 7mm ED ø 10mm		



1			
GEV No.	520363	Ref. No.	R62090468
description	push-in fitting John Guest T-piece pipe connection ø10mm - ø10mm		
For models:	ME061P, ME061T, ME101M, ME101P, ME101T, ME102M, ME102P, ME102T, ME201D, ME201M, ME201P, ME201T, ME202D, ME202M, ME202P, ME202T, MEMT06P, MEMT10P, MEMT20P, MEMT21D, MEMT21P, MEMT40D, MEMT40P, MEVT21D, MEVT21P, MEVT40D, MEVT40P, MG061M, MG061P, MG061T, MG101M, MG101P, MG101T, MG102M, MG102P, MG102T, MG201D, MG201M, MG201P, MG201T, MG202D, MG202M, MG202P, MG202T, MGMT06P, MGMT10P, MGMT20P, MGMT21D, MGMT21P, MGMT40D...(Other models you can see in the webshop)		
accessories for	520363		
	GEV No.	520973	Ref. No. R70070040 R70070050
	hose John Guest thickness 1.5mm LLDPE blue ID ø 7mm ED ø 10mm		



1			
GEV No.	520495	Ref. No.	R62090608
description	push-in fitting John Guest straight thread 1/8" BSP stub ø 8mm		
For models:	ME061T, ME101T, ME102T, ME201T, MEMT06P, MEMT10P, MEMT20P, MEMT21P, MEMT40P, MG102T, MG201T, MG202D, MG202M, MG202P, MG202T, MGMT06P, MGMT10P, MGMT20P, MGMT21P, MGMT40D, MGMT40P, MGMT40P		
accessories for	520495		
	GEV No.	520971	Ref. No. —
	hose thickness 1mm LLDPE blue ID ø 4mm ED ø 6mm operating pressure at 20°C 16bar		



valves and tank inlets

ball valves

universal

ball valves with butterfly handle



1

GEV No.	540658	Ref. No.	1450500 MA1450500
description	ball valve connection 3/4" IT - 3/4" IT DN20 total length 69mm		
For models:	CP704E, CP704G, CP92E, CP92E2, CP92G, CP94E, CP94E2, CP94G, CP95B2E, CP95B2E2, CP95B2G, CP95B4E, CP95B4E2, CP95B4G, CPE40, CPE402, CPE60, CPE602, CPE60DB, F74E10, F74E6, F76E10, F94E10, F94E6, F96E10, FR74E, FR74E10, FR74E10L, FR74E10L2, FR74G, FR77E, FR77E10, FR77E10L, FR77E10L2, FR77G, FR92E10, FR92E10L, FR92E10L2, FR92E13, FR92E22, FR92G22, FR94E10, FR94E10L, FR94E10L2, FR94E13, FR94E22, FR94G23, FR9P2E10, FR9P4E10, NF74E10...(Other models you can see in the webshop)		

ball valves with lever handle



1

GEV No.	514325	Ref. No.	1950700 MA1950700
description	ball valve connection 1" IT - 1" IT DN25 total length 83mm with lever handle		
For models:	EF74E12, EF74G15, F12C4E12, F12C4G15, F74E10, F74E12, F74G15, F76E10, F78E12, F78G15, F94E10, F94E12, F94E18, F94E18K, F94G15, F94G22, F94G22K, F96E10, F98E12, F98E18, F98E18K, F98G15, F98G22, F98G22K, F9S4E12, F9S4E18, F9S4E18K, F9S4G15, F9S4G22, F9S4G22K, F9S8E12, F9S8E18, F9S8E18K, F9S8G15, F9S8G22, F9S8G22K, FR74E, FR74E2, FR74G, FR77E, FR77E2, FR77G, FR92E13, FR92E132, FR92E22, FR92G13, FR92G22, FR92G22T, FR94E13, FR94E132...(Other models you can see in the webshop)		

producer-specific

MARENO





1

GEV No.	514400	Ref. No.	1031400300 1031400313 MA1031400313
description	ball valve connection 1/2" IT - 1/2" IT total length 47mm handle length 68mm		
For models:	CPE60, CPE602, CPE60DB, OCPE6, OCPE60		
accessories for	514400		
	GEV No.	514098	Ref. No. CM149100 CM149101 MACM149100 MACM149101
extension for lever L 220mm			





1

GEV No.	514097	Ref. No.	CR0412260
description	ball valve inlet 1" IT outlet 1" IT L 84mm H 82mm		
For models:	PC12C4E, PC12C4G, PC12C9E, PC12C9G, PC74E, PC74G, PC76E, PC76G, PC78E, PC78G, PC94E, PC94G, PC96E, PC96G, PC98E, PC98G		
accessories for	514097		
	GEV No.	514059	Ref. No. CM155200 MACM155200
lever			
	GEV No.	514098	Ref. No. CM149100 CM149101 MACM149100 MACM149101
extension for lever L 220mm			
	GEV No.	514099	Ref. No. 1515900 MA1515900
centring piece L 20mm for extension thread ID ø 10mm D1 ø 18mm D2 ø 20mm			



1

GEV No.	540698	Ref. No.	1031401900 MA1031401900
description	ball valve inlet 1/2" IT outlet 1/2" ET L 59mm without handle shaft ø 10x7mm		
For models:	FQE6, FQE6+6		
accessories for	540698		
	GEV No.	514059	Ref. No. CM155200 MACM155200
lever			
	GEV No.	514098	Ref. No. CM149100 CM149101 MACM149100 MACM149101
extension for lever L 220mm			
	GEV No.	514099	Ref. No. 1515900 MA1515900
centring piece L 20mm for extension thread ID ø 10mm D1 ø 18mm D2 ø 20mm			



1

GEV No.	514098	Ref. No.	CM149100 CM149101 MACM149100 MACM149101
description	extension for lever L 220mm		
For models:	PC74E, PC74G, PC76E, PC76G, PC78E, PC78G, PC94E, PC94G, PC96E, PC96G, PC98E, PC98G, PC9S4E, PC9S4G, PC9S6E, PC9S6G, PC9S8E, PC9S8G		

			
1			
GEV No.	514492	Ref. No.	2863500 MA2863500
description	handle for drain tap shaft diameter 6x6mm L 70mm H 37mm		
For models:	BR94E, BR94EI, BR94G, BR94GI, BR9M4E, BR9M4EI, BR9M4G, BR9M4GI, BR9M6E, BR9M6EI, BR9M6G, BR9M6GI, BR9SB4E, BR9SB4EI, BR9SB4G, BR9SB4GI, CP9A15GD, CSM102E, CSM102EP, CSM102G, CSM102GP, CSM10E, CSM10EP, CSM10G, CSM10GP, CSM201E, CSM201EP, CSM201G, CSM201GP, CSM202E, CSM202EP, CSM202G, CSM202GP, CSM6E, CSM6EP, CSM6G, CSM6GP, NPC94E, NPC94G, NPC96E, NPC96G, NPC98E, NPC98G, PC74E, PC74G, PC76E, PC76G, PC78E, PC78G, PC94E...(Other models you can see in the webshop)		

ball valves electric



			
1			
GEV No.	403026 ¹	Ref. No.	R65110540
description	ball valve inlet 1/2" IT outlet 1/2" IT 230V L 90mm 50/60Hz off-current open mode of operation electric W 60mm H 100mm connection cable 450mm IT 1/2"		
For models:	EM010M+SC, EM106H, EM106M, EM106M+SC, EM106P, EM110H, EM110M, EM110M+SC, EM110P, EM210H, EM210M, EM210M+SC, EM210P, GM106H, GM106M, GM106M+SC, GM106P, GM110H, GM110M, GM110M+SC, GM110P, GM210H, GM210M, GM210M+SC, GM210P, ME106M, ME106P, ME106X, ME110M, ME110P, ME110X, ME120M, ME120P, ME120X, ME210M, ME210P, ME210X, ME220M, ME220P, ME220X, MEC24H, MEC40M, MG106M, MG106P, MG106X, MG110M, MG110P, MG110X, MG120M, MG120P...(Other models you can see in the webshop)		

¹off-current open

			
1			
GEV No.	403042	Ref. No.	R65110560
description	ball valve inlet 3/4" IT outlet 3/4" IT 230V L 68mm closed off-current mode of operation electric connection cable 400mm		
For models:	GMT06D, GMT20D, ME061D, ME061P, ME061T, ME101D, ME101M, ME101P, ME101T, ME102D, ME102M, ME102P, ME102T, ME201D, ME201M, ME201P, ME201T, ME202D, ME202M, ME202P, ME202T, MEMT06D, MEMT06P, MEMT10D, MEMT10P, MEMT20D, MEMT20P, MEMT21D, MEMT21P, MEMT40D, MEMT40P, MG061D, MG061M, MG061P, MG061T, MG101D, MG101M, MG101P, MG101T, MG102D, MG102M, MG102P, MG102T, MG201D, MG201M, MG201P, MG201T, MG202D, MG202M, MG202P...(Other models you can see in the webshop)		

shut-off valves

universal

				
1				
GEV No.	514052	Ref. No.	1475300 700700 MA1475300	
description	shut-off valve connection 1/2" 1/2" straight total length 123mm mounting pos.			
For models:	BR94E, BR94EI, BR94G, BR94GI, BR96G, BR96GI, BR9M4E, BR9M4EI, BR9M4G, BR9M4GI, BR9M6E, BR9M6EI, BR9M6G, BR9M6GI, BR9SB4E, BR9SB4EI, BR9SB4G, BR9SB4GI, CP92E, CP92E2, CP92G, CP94E, CP94E2, CP94G, CP95B2E, CP95B2E2, CP95B2G, CP95B4E, CP95B4E2, CP95B4G, P9D2G			
spare parts for	514052			
	GEV No.	514244	Ref. No.	955600 MA955600
	tap head without handle T1: 26x19G engagement length H1 38mm shaft length H3 52mm shaft ø 6/12mm rosette thread G2 32x19G			
accessories for	514052			
	GEV No.	693081	Ref. No.	832400 MA832400
	cross handle ø 80mm H 40mm shaft diameter 9x9mm marking blue chrome-plated brass suitable for MONOLITH			

producer-specific

MARENO

			
1			
GEV No.	693081	Ref. No.	832400 MA832400
description	cross handle ø 80mm H 40mm shaft diameter 9x9mm marking blue chrome-plated brass suitable for MONOLITH		
For models:	B9SB2E, B9SB2G, B9SB4E, B9SB4G, B9V2E, B9V2G, B9V4E, B9V4G, BR94E, BR94EI, BR94G, BR94GI, BR96G, BR96GI, BR9M4E, BR9M4EI, BR9M4G, BR9M4GI, BR9M6E, BR9M6EI, BR9M6G, BR9M6GI, BR9SB4E, BR9SB4EI, BR9SB4G, BR9SB4GI, CP92E, CP92E2, CP92G, CP94E, CP94E2, CP94G, CP95B2E, CP95B2E2, CP95B2G, CP95B4E, CP95B4E2, CP95B4G, P9D10E, P9D10G, P9D15E, P9D15G, P9D2G, P9D5G, P9DA10E, P9DA10G, P9DA15E, P9DA15G, P9DSB10E, P9DSB10G...(Other models you can see in the webshop)		



1

GEV No.	514061	Ref. No.	CM143100 MACM143100
description	knob water cold t.max.°C ø 67mm shaft ø 10x8mm shaft flat variable		
For models:	BR78EF, BR78EI, BR78GF, BR78GI, BR912EFM, BR912EIM, BR912GFM, BR912GIM, BR98EF, BR98EFM, BR98EI, BR98EIM, BR98GF, BR98GFM, BR98GI, BR98GIM, BR9S8EF, BR9S8EI, BR9S8GF, BR9S8GI, PC12C4E, PC12C4G, PC12C9E, PC12C9G, PC74E, PC74G, PC76E, PC76G, PC78E, PC78G, PC94E, PC94G, PC96E, PC96G, PC98E, PC98G, PC9S4E, PC9S4G, PC9S6E, PC9S6G, PC9S8E, PC9S8G, PD96G5, PD98E10, PD98E15, PD98G10, PD98G15, PD98G15A, PD9S8E10, PD9S8G10... (Other models you can see in the webshop)		



2

GEV No.	514245	Ref. No.	CM143200 MACM143200
description	knob water hot t.max.°C ø 67mm shaft ø 10x8mm shaft flat variable		
For models:	PD96G5, PD98E10, PD98E15, PD98G10, PD98G15, PD98G15A, PD9S8E10, PD9S8G10, PI96E5, PI96G5, PI98E10, PI98E15, PI98G10, PI98G14, PI98G14A, PI9S8E10		

1

GEV No.	514055	Ref. No.	700714 MA700714
description	shut-off valve		
For models:	CP704E, CP704G		

1

GEV No.	514052	Ref. No.	1475300 700700 MA1475300	
description	shut-off valve connection 1/2" 1/2" straight total length 123mm mounting pos.			
For models:	BR94E, BR94EI, BR94G, BR94GI, BR96G, BR96GI, BR9M4E, BR9M4EI, BR9M4G, BR9M4GI, BR9M6E, BR9M6EI, BR9M6G, BR9M6GI, BR9SB4E, BR9SB4EI, BR9SB4G, BR9SB4GI, CP92E, CP92E2, CP92G, CP94E, CP94E2, CP94G, CP9SB2E, CP9SB2E2, CP9SB2G, CP9SB4E, CP9SB4E2, CP9SB4G, P9D2G			
spare parts for	514052			
	GEV No.	514244	Ref. No.	955600 MA955600
	tap head without handle T1: 26x19G engagement length H1 38mm shaft length H3 52mm shaft ø 6/12mm rosette thread G2 32x19G			
accessories for	514052			
	GEV No.	693081	Ref. No.	832400 MA832400
	cross handle ø 80mm H 40mm shaft diameter 9x9mm marking blue chrome-plated brass suitable for MONOLITH			

1











GEV No.	540930	Ref. No.	CM127800 MACM127800	
description	shut-off valve connection 1/2" 1/2" total length 48mm mounting pos. left shaft ø 8x10mm shaft L 61mm marking S rosette thread G2 27x19G			
For models:	BR78EF, BR78EI, BR78GF, BR78GI, BR912EFM, BR912EIM, BR912GFM, BR912GIM, BR98EF, BR98EFM, BR98EI, BR98EIM, BR98GF, BR98GFM, BR98GI, BR98GIM, BR9S8EF, BR9S8EI, BR9S8GF, BR9S8GI, DE92142, DE94242, PC12C4E, PC12C4G, PC12C9E, PC12C9G, PC74E, PC74G, PC76E, PC76G, PC78E, PC78G, PC94E, PC94G, PC96E, PC96G, PC98E, PC98G, PC9S4E, PC9S4G, PC9S6E, PC9S6G, PC9S8E, PC9S8G, PD96G5, PD98E10, PD98E15, PD98G10, PD98G15, PD98G15A...(Other models you can see in the webshop)			
spare parts for	540930			
	GEV No.	111642	Ref. No.	—
	knob water cold ø 70mm shaft ø 10x8mm shaft flat upper black H 39mm			
	GEV No.	111678	Ref. No.	—
	knob water hot ø 70mm shaft ø 10x8mm shaft flat upper black/red H 29mm			
	GEV No.	514061	Ref. No.	CM143100 MACM143100
	knob water cold t.max.°C ø 67mm shaft ø 10x8mm shaft flat variable			

Table continues overleaf

spare parts for 540930			
	GEV No.	514083	Ref. No. —
rosette connection 27x19G chrome-plated total lengthmm mounting pos.			
	GEV No.	514084	Ref. No. —
nut thread 27x19G WS 34			
	GEV No.	514245	Ref. No. CM143200 MACM143200
knob water hot t.max.°C ø 67mm shaft ø 10x8mm shaft flat variable			





			
1			
GEV No.	514244	Ref. No.	955600 MA955600
description tap head without handle T1: 26x19G engagement length H1 38mm shaft length H3 52mm shaft ø 6/12mm rosette thread G2 32x19G			
For models: B9SB4E, B9V4E, P9D10E, P9D10G, P9D15E, P9D15G, P9D5G, P9DA10E, P9DA10G, P9DA15E, P9DA15G, P9DSB10E, P9DSB10G, P9I10E, P9I10G, P9I15E, P9I5G, P9IA10E, P9IA10G, P9IA15E, PDASB10E, PDASB10G			
accessories for 514244			
	GEV No.	693081	Ref. No. 832400 MA832400
cross handle ø 80mm H 40mm shaft diameter 9x9mm marking blue chrome-plated brass suitable for MONOLITH			

accessories			
			
1			
GEV No.	514247	Ref. No.	675100 MA675100
description marking cap for handle blue			
For models: B9SB2E, B9SB2G, B9SB4E, B9SB4G, B9V2E, B9V2G, B9V4E, B9V4G, BR94E, BR94EI, BR94G, BR94GI, BR96G, BR96GI, BR9M4E, BR9M4EI, BR9M4G, BR9M4GI, BR9M6E, BR9M6EI, BR9M6G, BR9M6GI, BR9SB4E, BR9SB4EI, BR9SB4G, BR9SB4GI, CP92E, CP92E2, CP92G, CP94E, CP94E2, CP94G, CP9SB2E, CP9SB2E2, CP9SB2G, CP9SB4E, CP9SB4E2, CP9SB4G, P9D10E, P9D10G, P9D15E, P9D15G, P9D2G, P9D5G, P9DA10E, P9DA10G, P9DA15E, P9DA15G, P9DSB10E, P9DSB10G... (Other models you can see in the webshop)			

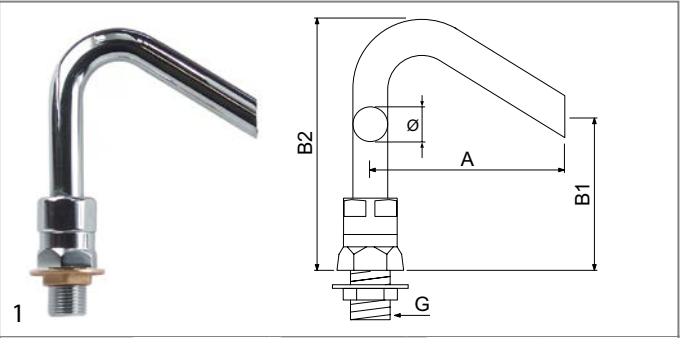
			
1			
GEV No.	514246	Ref. No.	677700 MA677700
description marking cap for handle red			
For models: P9D10E, P9D10G, P9D15E, P9D15G, P9D5G, P9DA10E, P9DA10G, P9DA15E, P9DA15G, P9DSB10E, P9DSB10G, P9I10E, P9I10G, P9I15E, P9I5G, P9IA10E, P9IA10G, P9IA15E, PDASB10E, PDASB10G			

inlet taps



GEV No.	540950	Ref. No.	450000 MA450000
description inlet spout connection 1/2" ET tube ø 18mm projection 105mm overall height 130mm spout height 70mm rotation 90°			
For models: CP92E, CP92E2, CP92G, CP94E, CP94E2, CP94G, CP9SB2E, CP9SB2E2, CP9SB2G, CP9SB4E, CP9SB4E2, CP9SB4G, P9D10E, P9D10G, P9D15E, P9D15G, P9D2G, P9D5G, P9DA10E, P9DA10G, P9DA15E, P9DA15G, P9DSB10E, P9DSB10G, P9I10E, P9I10G, P9I15E, P9I5G, P9IA10E, P9IA10G, P9IA15E, PC12C4E, PC12C4G, PC12C9E, PC12C9G, PC74E, PC74G, PC76E, PC76G, PC78E, PC78G, PC94E, PC94G, PC96E, PC96G, PC98E, PC98G, PC9S4E, PC9S4G, PC9S6E... (Other models you can see in the webshop)			
spare parts for 540950			
	GEV No.	511470	Ref. No. —
nut thread 1/2" ø 40mm H 8mm WS 25 brass Qty 1 pcs			
	GEV No.	512071	Ref. No. —
O-ring EPDM thickness 2.62mm ID ø 22.22mm Qty 1 pcs			
accessories for 540950			
	GEV No.	511474	Ref. No. —
flat washer for thread 1/2"			
	GEV No.	511477	Ref. No. —
flat gasket rubber ED ø 42mm ID ø 21mm thickness 2mm Qty 1 pcs			

			
1			
GEV No.	514401	Ref. No.	1031112300
description inlet spout connection M16x1.5 tube ø 10mm projection 48mm overall height 35mm spout height 15mm rotation°			
For models: CPE60, CPE602, CPE60DB, OCPE6, OCPE60			
accessories for 514401			
	GEV No.	101278	Ref. No. 867-20 MA86720
olive for pipe ø 10mm Qty 1 pcs			
	GEV No.	101300	Ref. No. 1326500 MA1326500
union nut thread M16x1.5 tube ø 10mm			









drain systems and wash basins

drain fittings

universal



1

GEV No.	515042	Ref. No.	1031402200 MA1031402200
description	drain fitting size 1½" usable heightmm overall height 32mm ED ø 69mm chrome-plated brass		
For models:	LA60, OLA60		
accessories for	515042		
	GEV No.	515051	Ref. No. —
	standpipe size 1½" usable height 170mm overall height 185mm ED ø 40mm SS		
	GEV No.	515052	Ref. No. —
	standpipe size 1½" usable height 220mm overall height 235mm ED ø 40mm SS		
	GEV No.	515053	Ref. No. —
	standpipe size 1½" usable height 260mm overall height 275mm ED ø 40mm SS		
	GEV No.	515054	Ref. No. —
	standpipe size 1½" usable height 310mm overall height 325mm ED ø 40mm SS		
	GEV No.	515062	Ref. No. —
	standpipe size 1½" usable height 190mm overall height 200mm ED ø 46mm chrome-plated brass with filter		
	GEV No.	515063	Ref. No. —
	standpipe size 1½" usable height 230mm overall height 240mm ED ø 46mm chrome-plated brass with filter		
	GEV No.	515064	Ref. No. —
	standpipe size 1½" usable height 280mm overall height 290mm ED ø 46mm chrome-plated brass with filter		

standpipes

¾"







1

GEV No.	515118	Ref. No.	4330200 MA4330200
description	standpipe size ¾" usable height 38mm overall height 64mm ED ø 20mm chrome-plated brass with O-ring		
For models:	SNA12, SNA16, SNA20, SNAC12, SNAC16, SNAC20, SNG08, SNG12, SNG16, SNG20, SVAC16, SVAC20, SVCG08, SVCG12, SVCG16, SVCG20, SVCG8		

1¼"



1

GEV No.	515042	Ref. No.	1031402200 MA1031402200
description	drain fitting size 1¼" usable heightmm overall height 32mm ED ø 69mm chrome-plated brass		
For models:	LA60, OLA60		
accessories for	515042		
	GEV No.	515051	Ref. No. —
	standpipe size 1¼" usable height 170mm overall height 185mm ED ø 40mm SS		
	GEV No.	515052	Ref. No. —
	standpipe size 1¼" usable height 220mm overall height 235mm ED ø 40mm SS		
	GEV No.	515053	Ref. No. —
	standpipe size 1¼" usable height 260mm overall height 275mm ED ø 40mm SS		
	GEV No.	515054	Ref. No. —
	standpipe size 1¼" usable height 310mm overall height 325mm ED ø 40mm SS		
	GEV No.	515062	Ref. No. —
	standpipe size 1¼" usable height 190mm overall height 200mm ED ø 46mm chrome-plated brass with filter		
	GEV No.	515063	Ref. No. —
	standpipe size 1¼" usable height 230mm overall height 240mm ED ø 46mm chrome-plated brass with filter		
	GEV No.	515064	Ref. No. —
	standpipe size 1¼" usable height 280mm overall height 290mm ED ø 46mm chrome-plated brass with filter		

1½"



1















GEV No.	515042	Ref. No.	1031402200 MA1031402200
description	drain fitting size 1½" usable heightmm overall height 32mm ED ø 69mm chrome-plated brass		
For models:	LA60, OLA60		
accessories for	515042		
	GEV No.	515051	Ref. No. —
	standpipe size 1½" usable height 170mm overall height 185mm ED ø 40mm SS		
	GEV No.	515052	Ref. No. —
	standpipe size 1½" usable height 220mm overall height 235mm ED ø 40mm SS		
	GEV No.	515053	Ref. No. —
	standpipe size 1½" usable height 260mm overall height 275mm ED ø 40mm SS		
	GEV No.	515054	Ref. No. —
	standpipe size 1½" usable height 310mm overall height 325mm ED ø 40mm SS		
	GEV No.	515062	Ref. No. —
	standpipe size 1½" usable height 190mm overall height 200mm ED ø 46mm chrome-plated brass with filter		



Table continues overleaf











accessories for	515042			
	GEV No.	515063	Ref. No.	—
	standpipe size 1½" usable height 230mm overall height 240mm ED ø 46mm chrome-plated brass with filter			
	GEV No.	515064	Ref. No.	—
	standpipe size 1½" usable height 280mm overall height 290mm ED ø 46mm chrome-plated brass with filter			

 <p>1</p>				
GEV No.	515042	Ref. No.	1031402200 MA1031402200	
description	drain fitting size 1½" usable height 32mm overall height 32mm ED ø 69mm chrome-plated brass			
For models:	LA60, OLA60			
accessories for	515042			
	GEV No.	515051	Ref. No.	—
	standpipe size 1½" usable height 170mm overall height 185mm ED ø 40mm SS			
	GEV No.	515052	Ref. No.	—
	standpipe size 1½" usable height 220mm overall height 235mm ED ø 40mm SS			
	GEV No.	515053	Ref. No.	—
	standpipe size 1½" usable height 260mm overall height 275mm ED ø 40mm SS			
	GEV No.	515054	Ref. No.	—
	standpipe size 1½" usable height 310mm overall height 325mm ED ø 40mm SS			
	GEV No.	515062	Ref. No.	—
	standpipe size 1½" usable height 190mm overall height 200mm ED ø 46mm chrome-plated brass with filter			
	GEV No.	515063	Ref. No.	—
	standpipe size 1½" usable height 230mm overall height 240mm ED ø 46mm chrome-plated brass with filter			
	GEV No.	515064	Ref. No.	—
	standpipe size 1½" usable height 280mm overall height 290mm ED ø 46mm chrome-plated brass with filter			

 <p>1</p>				
GEV No.	515042	Ref. No.	1031402200 MA1031402200	
description	drain fitting size 1½" usable height 32mm overall height 32mm ED ø 69mm chrome-plated brass			
For models:	LA60, OLA60			
accessories for	515042			
	GEV No.	515051	Ref. No.	—
	standpipe size 1½" usable height 170mm overall height 185mm ED ø 40mm SS			
	GEV No.	515052	Ref. No.	—
	standpipe size 1½" usable height 220mm overall height 235mm ED ø 40mm SS			
	GEV No.	515053	Ref. No.	—
	standpipe size 1½" usable height 260mm overall height 275mm ED ø 40mm SS			
	GEV No.	515054	Ref. No.	—
	standpipe size 1½" usable height 310mm overall height 325mm ED ø 40mm SS			

accessories for	515042			
	GEV No.	515062	Ref. No.	—
	standpipe size 1½" usable height 190mm overall height 200mm ED ø 46mm chrome-plated brass with filter			
	GEV No.	515063	Ref. No.	—
	standpipe size 1½" usable height 230mm overall height 240mm ED ø 46mm chrome-plated brass with filter			
	GEV No.	515064	Ref. No.	—
	standpipe size 1½" usable height 280mm overall height 290mm ED ø 46mm chrome-plated brass with filter			

 <p>1</p>				
GEV No.	515042	Ref. No.	1031402200 MA1031402200	
description	drain fitting size 1½" usable height 32mm overall height 32mm ED ø 69mm chrome-plated brass			
For models:	LA60, OLA60			
accessories for	515042			
	GEV No.	515051	Ref. No.	—
	standpipe size 1½" usable height 170mm overall height 185mm ED ø 40mm SS			
	GEV No.	515052	Ref. No.	—
	standpipe size 1½" usable height 220mm overall height 235mm ED ø 40mm SS			
	GEV No.	515053	Ref. No.	—
	standpipe size 1½" usable height 260mm overall height 275mm ED ø 40mm SS			
	GEV No.	515054	Ref. No.	—
	standpipe size 1½" usable height 310mm overall height 325mm ED ø 40mm SS			
	GEV No.	515062	Ref. No.	—
	standpipe size 1½" usable height 190mm overall height 200mm ED ø 46mm chrome-plated brass with filter			
	GEV No.	515063	Ref. No.	—
	standpipe size 1½" usable height 230mm overall height 240mm ED ø 46mm chrome-plated brass with filter			
	GEV No.	515064	Ref. No.	—
	standpipe size 1½" usable height 280mm overall height 290mm ED ø 46mm chrome-plated brass with filter			

producer-specific

MARENO









 <p>1</p>				
GEV No.	515042	Ref. No.	1031402200 MA1031402200	
description	drain fitting size 1½" usable height 32mm overall height 32mm ED ø 69mm chrome-plated brass			
For models:	LA60, OLA60			
accessories for	515042			
	GEV No.	515051	Ref. No.	—
	standpipe size 1½" usable height 170mm overall height 185mm ED ø 40mm SS			
	GEV No.	515052	Ref. No.	—
	standpipe size 1½" usable height 220mm overall height 235mm ED ø 40mm SS			

Table continues overleaf



accessories for		515042	
	GEV No.	515053	Ref. No. —
	standpipe size 1½" usable height 260mm overall height 275mm ED ø 40mm SS		
	GEV No.	515054	Ref. No. —
	standpipe size 1½" usable height 310mm overall height 325mm ED ø 40mm SS		
	GEV No.	515062	Ref. No. —
	standpipe size 1½" usable height 190mm overall height 200mm ED ø 46mm chrome-plated brass with filter		
	GEV No.	515063	Ref. No. —
	standpipe size 1½" usable height 230mm overall height 240mm ED ø 46mm chrome-plated brass with filter		
	GEV No.	515064	Ref. No. —
	standpipe size 1½" usable height 280mm overall height 290mm ED ø 46mm chrome-plated brass with filter		

	1		
GEV No.	515086	Ref. No.	1031402300 MA1031402300
description	standpipe usable height 135mm overall height 150mm size 1½" SS ED ø 40mm		
For models:	LA60, OLA60		

U-bends

	1		
GEV No.	515122	Ref. No.	1031402400 MA1031402400
description	drain connection thread 1½" hose ø 50mm		
For models:	LA60, OLA60		

beverage technology

valves

non-return valves

	1		
GEV No.	440026	Ref. No.	R62300018
description	non-return valve kit John Guest pipe connection ø10x10mm operating pressure at 20°C 10bar opening pressure 0.02bar POM		
For models:	ME061T, ME101T, ME102T, ME201T, MG102T, MG201T, MG202T		

water cycle components

supply filters

	1		
GEV No.	510836	Ref. No.	620209
description	supply filter thread 3/4" ET - 3/4" IT total length 76mm plastic		

ancillary products

clamps

hose clamps

DIN 3017 - W2

	1		
GEV No.	520111	Ref. No.	450102
description	hose clamp ø 10-16mm width 9mm Qty 10 pcs DIN 3017		

	1		
GEV No.	520112	Ref. No.	450103 R61630011
description	hose clamp ø 12-20mm width 9mm Qty 10 pcs DIN 3017		
For models:	CVE004H, CVE004M, CVE104H, CVE104M, CVE105H, CVE105M, CVG105H, CVG105M, EC106M, EC110M, EC210M, EM010M+SC, EM106H, EM106M, EM106M+SC, EM106P, EM110H, EM110M, EM110M+SC, EM110P, EM210H, EM210M, EM210M+SC, EM210P, EV006M, EV106H, EV106M, EV106M+SC, EV106P, EV110H, EV110M, EV110M+SC, EV110P, EV210H, EV210M, EV210M+SC, EV210P, GC106M, GC110M, GC210M, GM106H, GM106M, GM106M+SC, GM106P, GM110H, GM110M, GM110M+SC, GM110P, GM210H, GM210M...(Other models you can see in the webshop)		

	1		
GEV No.	520113	Ref. No.	450104
description	hose clamp ø 16-27mm width 9mm Qty 10 pcs DIN 3017		



			
1			
GEV No.	520115	Ref. No.	450105
description	hose clamp ø 25-40mm width 9mm Qty 10 pcs DIN 3017		

			
1			
GEV No.	520116	Ref. No.	450107
description	hose clamp ø 32-50mm width 9mm Qty 5 pcs DIN 3017		

			
1			
GEV No.	520119	Ref. No.	450119
description	hose clamp ø 60-80mm width 9mm Qty 5 pcs DIN 3017		

			
1			
GEV No.	520117	Ref. No.	450135
description	hose clamp stainless steel ø 40-60mm width 9mm Qty 5 pcs DIN 3017		

double wire clamps

			
1			
GEV No.	511286	Ref. No.	450143
description	hose clamp ø 38mm wire gauge ø 3.2mm Qty 1 pcs		

			
1			
GEV No.	510959	Ref. No.	450115
description	hose clamp ø 8mm wire gauge ø 1mm Qty 1 pcs		

			
1			
GEV No.	511147	Ref. No.	450125
description	wire clamp ø 12-14mm wire gauge ø 1.5mm zinc-coated steel Qty 1 pcs		

tools

cleaning tools

scrapers

			
1			
GEV No.	705008	Ref. No.	2510513 BN2510513
description	scraper for griddle		
spare parts for	705008		
	GEV No.	705021	Ref. No.
			—
	spare blades for scraper Qty 10 pcs		

			
1			
GEV No.	705009	Ref. No.	1030000600 2510513 (old version) BN2510513 (old version) MA1030000600
description	scraper for griddle W 80mm		
For models:	BIE40, BIE40B, BIE60, BIE60B, BIG40, BIG60, EFT74ELVG, EFT74ERVG, EFT74GLVG, EFT74GRVG, EFT78ELVG, EFT78EMVG, EFT78GLVG, EFT78GMVG, F9V2E, F9V2E2, F9V2ER, F9V2ER2, F9V4E, F9V4E2, F9V4EC, F9V4EC2, F9V4ECRL, F9V4ECRL2, F9V4ER, F9V4ER2, F9V4ERL, F9V4ERL2, FT129ELC, FT129EM, FT129GLC, FT129GM, FT12C9EL, FT12C9ELC, FT12C9EM, FT12C9EMC, FT12C9GL, FT12C9GM, FT12C9GTL, FT12C9GTMC, FT12G7L70, FT12G7LC70, FT12G7R70, FT12G7RC70, FT12G7RL70, FT12G7RLC70, FT14G8L90, FT14G8LC90, FT14G8R2L90, FT14G8R2LC90...(Other models you can see in the webshop)		



measuring equipment

thermometers

built-in thermometers



1

GEV No.	541080	Ref. No.	24831.00 MA2483100
description	thermometer mounting measurements 58x25.5mm -40 up to +40°C capillary pipe 2500mm probe ø 6mm probe L 30mm		
For models:	EF140MB, EF140MC, EF140MF, EF140MI, EF140MN, EF140MP, EF143MNI, EF70MB, EF70MC, EF70MF, EF70MI, EF70MN, EF70MP, EF72MNF, SF100MB, SF100MC, SF100MF, SF100MI, SF100MN, SF100MP, SF110MF, SF110MI, SF110MN, SF110MP, SF50MB, SF50MC, SF50MF, SF50MI, SF50MN, SF50MP, SF55MF, SF55MI, SF55MN, SF55MP		

ø52mm



1

GEV No.	541065	Ref. No.	450905
description	thermometer mounting ø 52mm t.max. 120°C 0 up to +120°C probe ø 6.5mm probe L 28mm capillary pipe 1500mm		



1

GEV No.	541582	Ref. No.	2715000 27727000
description	thermometer mounting ø 52mm t.max. 350°C +50 up to +350°C probe ø 6mm probe L 17mm capillary pipe 1700mm		



1

GEV No.	541077	Ref. No.	65340050 LA65340050 LAR65340050 MA65340050
description	thermometer mounting ø 52mm t.max. 350°C +50 up to +350°C probe ø 6mm probe L 30mm capillary pipe 1000mm built-in depth 28mm		
For models:	EC106M, EC110M, EC210M, EM010M+SC, EM106M, EM106M+SC, EM110M, EM110M+SC, EM210M, EM210M+SC, EV006M, EV106M, EV106M+SC, EV110M, EV110M+SC, EV210M, EV210M+SC, FE105M, FE105X, FE110M, FE110X, FE210M, FG105M, FG105X, FG110M, FG110X, FG210M, FG210X, GC106M, GC110M, GC210M, GM106M, GM106M+SC, GM110M, GM110M+SC, GM210M, GM210M+SC, GV106M, GV106M+SC, GV110M, GV110M+SC, GV210M, GV210M+SC, MEC40M, MGC20X, PE040M, PE040X, PE080M, PE080X, PG040M... (Other models you can see in the webshop)		



1

GEV No.	541148	Ref. No.	24826.00 MA2482600
description	thermometer mounting ø 52mm t.max. 40°C -40 up to +40°C probe ø 6mm probe L 44mm capillary pipe 1400mm		
For models:	AF140MB, AF140MC, AF140MF, AF140MI, AF140MN, AF140MP, AF70MB, AF70MC, AF70MF, AF70MI, AF70MN, AF70MP, SPAR, SPAR15, SPAR16, SPAR18, SPAR20, SPRG, SPRG12, SPRG16, SPRG20, SVAR, SVAR15, SVAR16, SVAR18, SVAR20, SVRG, SVRG12, SVRG15, SVRG16, SVRG18, SVRG20		

fastening material

screws

flat-headed bolts



1

GEV No.	560021	Ref. No.	15534899 MA15534899
description	flat-headed bolt thread M3 thread L 10mm SS DIN 7985/ISO 7045 Qty 20 pcs head ø 6mm head thickness 2mm Phillips		
For models:	SER15, SER15A, SER18, SER18A, SER21		

			
1			
GEV No.	511004	Ref. No.	260226
description	flat-headed bolt thread M4 thread L 12mm SS DIN 84/ISO 1207 Qty 1 pcs intake slotted L 14.5mm		

raised countersunk head screws			
			
1			
GEV No.	560541	Ref. No.	R61040272
description	raised countersunk head screw thread M6 thread L 13mm SS DIN 966/ISO 7047 Qty 1 pcs intake slotted head ø 11mm head thickness 5mm		
For models:	ME201D, ME201M, ME201P, ME201T, ME202D, ME202M, ME202P, ME202T, MEC24H, MEC40M, MEMT21D, MEMT21P, MEMT40D, MEMT40P, MEVT21D, MEVT21P, MEVT40D, MEVT40P, MG201D, MG201M, MG201P, MG201T, MG202D, MG202M, MG202P, MG202T, MGC20X, MGC24H, MGC40H, MGMT21D, MGMT21P, MGMT40D, MGMT40P, MGVT21D, MGVT21P, MGVT40D, MGVT40P		

hexagonal screws			
			
1			
GEV No.	560087	Ref. No.	260104
description	hexagonal screw thread M6 thread L 16mm SS WS 10 Qty 20 pcs DIN 933 / ISO 4017		

			
1			
GEV No.	510990	Ref. No.	260113
description	hexagonal screw thread M8 thread L 20mm SS WS 13 Qty 1 pcs DIN 933 / ISO 4017		

			
1			
GEV No.	560594	Ref. No.	R61020562
description	hexagonal screw thread M6 thread L 20mm WS 10 total length 59mm		
For models:	EC110M, EC210M, EM010M+SC, EM110H, EM110M, EM110M+SC, EM110P, EM210H, EM210M, EM210M+SC, EM210P, EV110H, EV110M, EV110M+SC, EV110P, EV210H, EV210M, EV210M+SC, EV210P, FE110M, FE110X, FE210M, FG110M, FG110X, FG210M, FG210X, GC110M, GC210M, GM110H, GM110M, GM110M+SC, GM110P, GM210H, GM210M, GM210M+SC, GM210P, GMT20D, GV110H, GV110M, GV110M+SC, GV110P, GV210H, GV210M, GV210M+SC, GV210P, GVT20D, MACE10M, MACE20M, MACG10M, MACG20M...(Other models you can see in the webshop)		

cylinder head bolts			
DIN 912/ISO 4762			
			
1			
GEV No.	520455	Ref. No.	R61030601
description	screw thread M8 thread L 20mm WS 6 SS Qty 1 pcs DIN 912/ISO 4762		
For models:	ME201D, ME201M, ME201P, ME201T, ME202D, ME202M, ME202P, ME202T, MEMT21D, MEMT21P, MEMT40D, MEMT40P, MEVT21D, MEVT21P, MEVT40D, MEVT40P, MG201D, MG201M, MG201P, MG201T, MG202D, MG202M, MG202P, MG202T, MGMT21D, MGMT21P, MGMT40D, MGMT40P, MGVT21D, MGVT21P, MGVT40D, MGVT40P		

miscellaneous			
			
1			
GEV No.	510953	Ref. No.	260213
description	cylinder head bolt thread M5 thread L 25mm SS Qty 1 pcs intake slotted		

side bolts			
			
1			
GEV No.	560052	Ref. No.	260223
description	side bolts thread M5 L 10mm SS Qty 20 pcs intake slotted head ø 12.5mm		

grub screws			
DIN 913/ISO 4026			
			
1			
GEV No.	560024	Ref. No.	R61090052
description	grub screw thread M6 L 16mm SS DIN 913/ISO 4026 intake internal hexagon WS 3 Qty 20 pcs		
For models:	ME120M, ME120P, ME120X, ME201D, ME201M, ME201P, ME201T, ME202D, ME202M, ME202P, ME202T, ME220M, ME220P, ME220X, MEC24H, MEC40M, MEMT21D, MEMT21P, MEMT40D, MEMT40P, MEVT21D, MEVT21P, MEVT40D, MEVT40P, MG120M, MG120P, MG120X, MG201D, MG201M, MG201P, MG201T, MG202D, MG202M, MG202P, MG202T, MG220M, MG220P, MG220X, MGC20X, MGC24H, MGC40H, MGMT21D, MGMT21P, MGMT40D, MGMT40P, MGVT21D, MGVT21P, MGVT40D, MGVT40P, VE120M...(Other models you can see in the webshop)		





DIN 914/ISO 4027			
 <p>1</p>			
GEV No.	504230	Ref. No.	15119299 MA15119299
description	grub screw thread M5 L 8mm A2-A2L DIN 914/ISO 4027 WS 2.5 Qty 1 pcs		
For models:	EF74E10VG, EF74E12, EPC74E, EPC74G, F74E10, F74E12, F74E6, F76E10, F78E12, F94E10, F94E12, F94E18, F94E18K, F94E6, F96E10, F98E12, F98E18, F98E18K, F9S4E18K, F9S8E18K, FQE41R, FQE41RL, FQE41RL2, FQE61R, FQE61RL, NF74E10, NF74E15, NF76E10, NF78E15, NF94E10, NF94E15, NF94E22, NF94E222, NF94E222K, NF94E22K, NF96E10, NF98E15, NF98E22, NF98E222, NF98E222K, NF98E22K, NPC74E, NPC74G, NPC76E, NPC76G, NPC78E, NPC78G, NPC94E, NPC96E, NPC98E...(Other models you can see in the webshop)		

 <p>1</p>			
GEV No.	560175	Ref. No.	15131099
description	grub screw thread M8 L 16mm DIN 914/ISO 4027 intake internal hexagon WS 4 Qty 1 pcs		
For models:	BR707E, BR707G, BR94E, BR94EI, BR94G, BR94GI, BR96E, BR96EI, BR96G, BR96GI, BR9M4E, BR9M4EI, BR9M6E, BR9M6EI		

DIN 916/ISO 4029			
 <p>1</p>			
GEV No.	510906	Ref. No.	250206
description	grub screw thread M6 L 8mm stainless steel DIN 914/ISO 4027 WS 3 Qty 1 pcs		

threaded rods			
miscellaneous			
 <p>1</p>			
GEV No.	514019	Ref. No.	1033202200 1033709000 MA1033202200
description	threaded rod thread M8 L 45mm brass		
For models:	CPE60		

knurled screws			
 <p>1</p>			
GEV No.	510307	Ref. No.	261009
description	Thumb screw thread M6 H 3mm thread L 8mm ø 28mm SS		

miscellaneous			
 <p>1</p>			
GEV No.	690594	Ref. No.	R58002560
description	pressure screw for door hinge		
For models:	ME120M, ME120P, ME120X, ME201D, ME201M, ME201P, ME201T, ME202D, ME202M, ME202P, ME202T, ME220M, ME220P, ME220X, MEC24H, MEC40M, MEMT21D, MEMT21P, MEMT40D, MEMT40P, MEVT21D, MEVT21P, MEVT40D, MEVT40P, MG120M, MG120P, MG120X, MG201D, MG201M, MG201P, MG201T, MG202D, MG202M, MG202P, MG202T, MG220M, MG220P, MG220X, MGC20X, MGC24H, MGC40H, MGMT21D, MGMT21P, MGMT40D, MGMT40P, MGVT21D, MGVT21P, MGVT40D, MGVT40P, VE120M...(Other models you can see in the webshop)		

 <p>1</p>			
GEV No.	511006	Ref. No.	260228
description	screw		

 <p>1</p>			
GEV No.	694991	Ref. No.	R58006400
description	screw thread M6 L 16mm for air baffle combi-steamer		
For models:	CVE004H, CVE004M, CVE104H, CVE104M, CVE105H, CVE105M, CVG105H, CVG105M, EC106M, EC110M, EC210M, EM010M+SC, EM106H, EM106M, EM106M+SC, EM106P, EM110H, EM110M, EM110M+SC, EM110P, EM210H, EM210M, EM210M+SC, EM210P, EV006M, EV106H, EV106M, EV106M+SC, EV106P, EV110H, EV110M, EV110M+SC, EV110P, EV210H, EV210M, EV210M+SC, EV210P, GC106M, GC110M, GC210M, GM106H, GM106M, GM106M+SC, GM106P, GM110H, GM110M, GM110M+SC, GM110P, GM210H, GM210M...(Other models you can see in the webshop)		

nuts

long nuts



1

GEV No.	540438	Ref. No.	1868700 MA1868700
description	long nut thread M10 L 25mm WS 13 brass Qty 1 pcs		
For models:	CP704E, CP92E, CP92E2, CP94E, CP94E2, CP9SB2E, CP9SB2E2, CP9SB4E, CP9SB4E2, CPE40, CPE402, CPE60, CPE602, CPE60DB, DE92142, DE94242, EPC74E, OCP6, OCP60, PC12C4E, PC12C9E, PC74E, PC76E, PC78E, PC94E, PC96E, PC98E, PC9S4E, PC9S6E, PC9S8E		

knurled nuts



1

GEV No.	510346	Ref. No.	280409
description	knurled nut thread M17x1 ø 35mm H 6mm SS		

hexagonal nuts

DIN 934 / ISO 4032/8673



1

GEV No.	560133	Ref. No.	260404
description	hexagonal nut thread M6 H 5mm WS 10 SS DIN/ISO DIN 934 / ISO 4032/8673 Qty 20 pcs		



1

GEV No.	560197	Ref. No.	260407
description	nut thread M10 H 8mm WS 17 SS DIN/ISO DIN 934 / ISO 4032/8673 Qty 1 pcs		



1

GEV No.	506166	Ref. No.	260408
description	nut thread M12 H 10mm WS 19 SS DIN/ISO DIN 934 / ISO 4032/8673 Qty 1 pcs		

ISO 4033 / UNI5587



1

GEV No.	550866	Ref. No.	R58004020
description	nut thread M10x1.5 H 10mm SS WS 17 Qty 1 pcs DIN/ISO DIN 934 / ISO 4032/8673 left-hand thread		
For models:	CVE105H, CVE105M, CVG105H, CVG105M, EC106M, EM106H, EM106M, EM106M+SC, EM106P, EV006M, EV106H, EV106M, EV106M+SC, EV106P, FE105M, FE105X, FG105M, FG105X, GC106M, GM106H, GM106M, GM106M+SC, GM106P, GMT06D, GV106H, GV106M, GV106M+SC, GV106P, GVT06D, MACE07M, MACG07M, ME061D, ME061M, ME061P, ME061T, ME106M, ME106P, ME106X, MEMT06D, MEMT06P, MEVT06D, MEVT06P, MG061D, MG061M, MG061P, MG061T, MG106M, MG106P, MG106X, MGMT06D...(Other models you can see in the webshop)		

DIN 985



1

GEV No.	560227	Ref. No.	15774399 MA15774399
description	hexagonal nut thread M3 H 4mm SS WS 5.5 Qty 1 pcs self-locking		
For models:	SER15, SER15A, SER18, SER18A, SER21		



1

GEV No.	560140	Ref. No.	260402
description	hexagonal nut thread M4 H 4.8mm SS WS 7 Qty 20 pcs DIN/ISO DIN 985 self-locking		

hexagonal nuts metric (without norm)



1

GEV No.	540436	Ref. No.	1033514900 MA1033514900
description	hexagonal nut thread M10x1.25 H 4mm WS 13 brass Qty 1 pcs		
For models:	C74GS, C78GS, C79G, C7FE12GS, C7FE8GS, C7FG12GS, C7FG8GS, C7FG9G, CFGE61, CFGE61D, CFGE61L, CFGE61P, CP704E, CP92E, CP92E2, CP94E, CP94E2, CP9SB2E, CP9SB2E2, CP9SB4E, CP9SB4E2, CPE40, CPE402, CPE60, CPE602, CPE60DB, DE92142, DE94242, EC74GVG, EC78GVG, EC7FG8G, EPC74E, OCFGE61, OCP6, OCP60, OCPG41, OCPG61, PC12C4E, PC12C9E, PC74E, PC76E, PC78E, PC94E, PC96E, PC98E, PC9S4E, PC9S6E, PC9S8E, PCG41, PCG41L...(Other models you can see in the webshop)		



 <p>1</p>			
GEV No.	550681	Ref. No.	R58004050
description	nut thread M12x1.25 H 5mm WS 17 brass Qty 1 pcs		
For models:	EC106M, EC110M, EC210M, EM010M+SC, EM106H, EM106M, EM106M+SC, EM106P, EM110H, EM110M, EM110M+SC, EM110P, EM210H, EM210M, EM210M+SC, EM210P, EV006M, EV106H, EV106M, EV106M+SC, EV106P, EV110H, EV110M, EV110M+SC, EV110P, EV210H, EV210M, EV210M+SC, EV210P, GC106M, GC110M, GC210M, GM106H, GM106M, GM106M+SC, GM106P, GM110H, GM110M, GM110M+SC, GM110P, GM210H, GM210M, GM210M+SC, GM210P, GMT06D, GMT20D, GV106H, GV106M, GV106M+SC, GV106P..(Other models you can see in the webshop)		

 <p>2</p>			
GEV No.	102382	Ref. No.	1033700200 MA1033700200
description	nut thread M14x1 H 3.5mm WS 18 brass Qty 1 pcs		
For models:	BF78G, BF912G, BF912GH, BF98G, C12FGP9G, C7FG12G, C7FG8G, C7FG9G, C7FGM12G, C9FG12G, C9FG16G, C9FG8G, C9FG8GP, C9FG-M12G, EF74G15, EF74G8VA, EF74G8VG, EFT74GLVG, EFT74GRVG, EFT-78GLVG, EFT78GMVG, EPC74G, ET78GVG, ET7FG8G, F74G6, F94G6, FQG41, FQG61, FT129GLC, FT129GM, GL12C4G, GL12C9G, NB74G, NB78G, NB94G, NB98G, NBR78GF, NBR78GI, NBR912GFM, NBR-912GIM, NBR98GF, NBR98GFM, NBR98GI, NBR98GIM, NC7FG12G44, NC7FG8G32, NC7FG8G36, NC7FG8G48, NC7FGM12G, NC9FG12G52... (Other models you can see in the webshop)		

 <p>1</p>			
GEV No.	521133	Ref. No.	1325313 MA1325313
description	nut thread M14x1.5 H 6mm WS 19 zinc-coated steel Qty 1 pcs		
For models:	B9SB2G, B9SB4G, B9V2G, B9V4G, B9VP4G, BM74G, BM77G, C124G, C129G, C12C2G9, C12C9G, C12FG9G, C7011G, C7011GFE, C7011GFG, C704G, C707G, C707GFE, C707GFG, C712G, C74G, C78G, C7FE12G, C7FE8G, C7FG12G, C7FG8G, C7FGM12G, C912G, C912GS, C94G, C94GP, C94GS, C98G, C98GP, C98GS, C9F4E, C9F4GS, C9F6E, C9F6GS, C9F8GS, C9FE12G, C9FE12GS, C9FE4GS, C9FE6GS, C9FE8G, C9FE8GS, C9FEP4GS, C9FEP6GS, C9FEP8GS, C9FG12G...(Other models you can see in the webshop)		

 <p>1</p>			
GEV No.	510374	Ref. No.	270118
description	nut thread M15x1.25 H 6.5mm WS 27 SS Qty 1 pcs		

 <p>1</p>			
GEV No.	691289	Ref. No.	R58004830
description	nut thread M18x1 H 5mm WS 22 brass Qty 1 pcs for door handle		
For models:	CVE004H, CVE004M, CVE104H, CVE104M, CVE105H, CVE105M, CVG105H, CVG105M, EC106M, EC110M, EC210M, EM010M+SC, EM106H, EM106M, EM106M+SC, EM106P, EM110H, EM110M, EM110M+SC, EM110P, EM210H, EM210M, EM210M+SC, EM210P, EV006M, EV106H, EV106M, EV106M+SC, EV106P, EV110H, EV110M, EV110M+SC, EV110P, EV210H, EV210M, EV210M+SC, EV210P, FE105M, FE105X, FE110M, FE110X, FE210M, FG105M, FG105X, FG110M, FG110X, FG210M, FG210X, GC106M, GC110M...(Other models you can see in the webshop)		

 <p>1</p>			
GEV No.	102067	Ref. No.	6A012300 939300 BN6A012300 MA939300
description	nut thread M8x1 H 3mm brass Qty 1 pcs type SEF 1		
For models:	702BMG, 704S, 706, 706S, C7011G, C7011GFE, C7011GFG, C704G, C707G, C707GFE, C707GFG, C9F4GS, C9F6G, C9F6GS, C9F8GS, C9SB-4GS, C9V2GS, C9V4GS, C9V6GS, C9V8GS, CFG101, CFG101D, CFG101L, CFG101P, CFG120, CFG70, CFG70D, CFG70L, CFG70M, CFG70P, EC74G-VG, EC78GVG, EC7FG8G, OCFG101, OCFG120, OCFG70, T7011GFG, T707GFG, T9F6GS, TPF706, TPF706S		

hexagonal nuts inch thread

 <p>1</p>			
GEV No.	510331	Ref. No.	270101
description	nut thread 1/2" H 7mm SS WS 30 Qty 1 pcs		

 <p>1</p>			
GEV No.	514022	Ref. No.	1032300100 14044599 MA14044599
description	nut thread 1 1/2" H 12mm SS WS 59 Qty 1 pcs		
For models:	CP704E, CP92E, CP92E2, CP94E, CP94E2, CP9SB2E, CP9SB2E2, CP9S-B4E, CP9SB4E2, CPE40, CPE402, CPE60, CPE602, CPE60DB, DE92142, DE94242, EPC74E, OCPPE6, OCPPE60, PC12C4E, PC12C9E, PC74E, PC76E, PC78E, PC94E, PC96E, PC98E, PC9S4E, PC9S6E, PC9S8E		

 <p>1</p>			
GEV No.	511309	Ref. No.	270104
description	nut thread 1 1/2" ø 66mm H 9mm WS 51 brass Qty 1 pcs		

washers

spring washers



GEV No.	697933	Ref. No.	R61420021
description	spring washer ID ø 13mm ED ø 24mm Qty 1 pcs		
For models:	ME120M, ME120P, ME120X, ME201D, ME201M, ME201P, ME201T, ME202D, ME202M, ME202P, ME202T, ME220M, ME220P, ME220X, MEC24H, MEC40M, MEMT21D, MEMT21P, MEMENT40D, MEMENT40P, MEVT21D, MEVT21P, MEVT40D, MEVT40P, MG120M, MG120P, MG120X, MG201D, MG201M, MG201P, MG201T, MG202D, MG202M, MG202P, MG202T, MG220M, MG220P, MG220X, MGC20X, MGC24H, MGC40H, MGMT21D, MGMT21P, MGMT40D, MGMT40P, MGVT21D, MGVT21P, MGVT40D, MGVT40P, VE120M...(Other models you can see in the webshop)		



GEV No.	696397	Ref. No.	R61620091
description	spring washer ID ø 6.3mm ED ø 14mm Qty 1 pcs		
For models:	ME120M, ME120P, ME120X, ME201D, ME201M, ME201P, ME201T, ME202D, ME202M, ME202P, ME202T, ME220M, ME220P, ME220X, MEC24H, MEC40M, MEMT21D, MEMT21P, MEMENT40D, MEMENT40P, MEVT21D, MEVT21P, MEVT40D, MEVT40P, MG120M, MG120P, MG120X, MG201D, MG201M, MG201P, MG201T, MG202D, MG202M, MG202P, MG202T, MG220M, MG220P, MG220X, MGC20X, MGC24H, MGC40H, MGMT21D, MGMT21P, MGMT40D, MGMT40P, MGVT21D, MGVT21P, MGVT40D, MGVT40P, VE120M...(Other models you can see in the webshop)		

washers

DIN 125A



GEV No.	540437	Ref. No.	15800699 MA15800699
description	plain washer ED ø 20mm for thread M10		
For models:	90HTGA2H2, 90HTGA2H5, 90HTGA4H2, 90HTGA4H5, 90HTGABR, 90HTSC2C, 90HTSC2F, 90HTSC4C, 90HTSC4F, CPE60, CPE602, CPE60DB, OCPE6, OCPE60		



GEV No.	560112	Ref. No.	15830499 MA15830499
description	plain washer ID ø 5.3mm ED ø 10mm thickness 1mm SS Qty 20 pcs DIN 125A for thread M5		
For models:	BR707E, BR707EI, BR707G, BR707GI, BR94E, BR94EI, BR94G, BR94GI, BR96E, BR96EI, BR96G, BR96GI, BR9M4E, BR9M4EI, BR9M4G, BR9M4GI, BR9M6E, BR9M6EI, BR9M6G, BR9M6GI, BR9SB4E, BR9SB4EI, BR9SB4G, BR9SB4GI, EPC74E, EPC74G, PC12C4E, PC12C4G, PC12C9E, PC12C9G, PC74E, PC74G, PC76E, PC76G, PC78E, PC78G, PC94E, PC94G, PC96E, PC96G, PC98E, PC98G, PD707G, PI707E, PI707G, SER15, SER15A, SER18, SER18A, SER21		

miscellaneous



GEV No.	511254	Ref. No.	260537
description	disc ø 13mm D1 ø 20mm thickness 0.8mm		



GEV No.	691296	Ref. No.	R61400052
description	plain washer ID ø 10.5mm ED ø 21mm thickness 2mm SS Qty 1 pcs for fan wheel		
For models:	CVE105H, CVE105M, CVG105H, CVG105M, EC106M, EM106H, EM106M, EM106M+SC, EM106P, EV006M, EV106H, EV106M, EV106M+SC, EV106P, FE105M, FE105X, FG105M, FG105X, GC106M, GM106H, GM106M, GM106M+SC, GM106P, GMT06D, GV106H, GV106M, GV106M+SC, GV106P, GVT06D, MACE07M, MACG07M, ME061D, ME061M, ME061P, ME061T, ME106M, ME106P, ME106X, MEMENT06D, MEMENT06P, MEVT06D, MEVT06P, MG061D, MG061M, MG061P, MG061T, MG106M, MG106P, MG106X, MGMT06D...(Other models you can see in the webshop)		



GEV No.	691292	Ref. No.	R10401710
description	plain washer ID ø 12mm ED ø 17.5mm thickness 1mm SS Qty 1 pcs		
For models:	GMT06D, GMT20D, GVT06D, GVT20D, MACE07M, MACE10M, MACE20M, MACG07M, MACG10M, MACG20M, ME061D, ME061M, ME061P, ME061T, ME101D, ME101M, ME101P, ME101T, ME102D, ME102M, ME102P, ME102T, ME106M, ME106P, ME106X, ME110M, ME110P, ME110X, ME210M, ME210P, ME210X, MEMENT06D, MEMENT06P, MEMENT10D, MEMENT10P, MEMENT20D, MEMENT20P, MEVT06D, MEVT06P, MEVT10D, MEVT10P, MEVT20D, MEVT20P, MG061D, MG061M, MG061P, MG061T, MG101D, MG101M, MG101P...(Other models you can see in the webshop)		



GEV No.	690593	Ref. No.	R58002570
description	plain washer ID ø 15mm ED ø 30mm thickness 3mm Qty 1 pcs for door hinge		
For models:	ME120M, ME120P, ME120X, ME201D, ME201M, ME201P, ME201T, ME202D, ME202M, ME202P, ME202T, ME220M, ME220P, ME220X, MEC24H, MEC40M, MEMT21D, MEMT21P, MEMENT40D, MEMENT40P, MEVT21D, MEVT21P, MEVT40D, MEVT40P, MG120M, MG120P, MG120X, MG201D, MG201M, MG201P, MG201T, MG202D, MG202M, MG202P, MG202T, MG220M, MG220P, MG220X, MGC20X, MGC24H, MGC40H, MGMT21D, MGMT21P, MGMT40D, MGMT40P, MGVT21D, MGVT21P, MGVT40D, MGVT40P, VE120M...(Other models you can see in the webshop)		



			
1			
GEV No.	551434	Ref. No.	R58004010
description	plain washer ø 30mm thickness 3mm hole ø 12.5mm for fan wheel combi-steamer		
For models:	EC110M, EC210M, EM010M+SC, EM110H, EM110M, EM110M+SC, EM110P, EM210H, EM210M, EM210M+SC, EM210P, EV110H, EV110M, EV110M+SC, EV110P, EV210H, EV210M, EV210M+SC, EV210P, FE110M, FE110X, FE210M, FG110M, FG110X, FG210M, FG210X, GC110M, GC210M, GM110H, GM110M, GM110M+SC, GM110P, GM210H, GM210M, GM210M+SC, GM210P, GMT20D, GV110H, GV110M, GV110M+SC, GV110P, GV210H, GV210M, GV210M+SC, GV210P, GVT20D, MACE10M, MACE20M, MACG10M, MACG20M...(Other models you can see in the webshop)		

tooth lock washers

DIN 6798A			
			
1			
GEV No.	560193	Ref. No.	15812699 MA15812699
description	tooth lock washer ID ø 10.4mm ED ø 18mm zinc-coated steel DIN/ISO DIN 6798A Qty 1 pcs for thread M10		
For models:	CPE60, CPE602, CPE60DB, OCPE6, OCPE60		

fasteners

clamps

hose clamps

DIN 3017 - W2

			
1			
GEV No.	520111	Ref. No.	450102
description	hose clamp ø 10-16mm width 9mm Qty 10 pcs DIN 3017		

			
1			
GEV No.	520112	Ref. No.	450103 R61630011
description	hose clamp ø 12-20mm width 9mm Qty 10 pcs DIN 3017		
For models:	CVE004H, CVE004M, CVE104H, CVE104M, CVE105H, CVE105M, CVG105H, CVG105M, EC106M, EC110M, EC210M, EM010M+SC, EM106H, EM106M, EM106M+SC, EM106P, EM110H, EM110M, EM110M+SC, EM110P, EM210H, EM210M, EM210M+SC, EM210P, EV006M, EV106H, EV106M, EV106M+SC, EV106P, EV110H, EV110M, EV110M+SC, EV110P, EV210H, EV210M, EV210M+SC, EV210P, GC106M, GC110M, GC210M, GM106H, GM106M, GM106M+SC, GM106P, GM110H, GM110M, GM110M+SC, GM110P, GM210H, GM210M...(Other models you can see in the webshop)		

			
1			
GEV No.	520113	Ref. No.	450104
description	hose clamp ø 16-27mm width 9mm Qty 10 pcs DIN 3017		

			
1			
GEV No.	520115	Ref. No.	450105
description	hose clamp ø 25-40mm width 9mm Qty 10 pcs DIN 3017		

			
1			
GEV No.	520116	Ref. No.	450107
description	hose clamp ø 32-50mm width 9mm Qty 5 pcs DIN 3017		

			
1			
GEV No.	520119	Ref. No.	450119
description	hose clamp ø 60-80mm width 9mm Qty 5 pcs DIN 3017		

			
1			
GEV No.	520117	Ref. No.	450135
description	hose clamp stainless steel ø 40-60mm width 9mm Qty 5 pcs DIN 3017		

double wire clamps

			
1			
GEV No.	511286	Ref. No.	450143
description	hose clamp ø 38mm wire gauge ø 3.2mm Qty 1 pcs		



1

GEV No.	510959	Ref. No.	450115
description	hose clamp ø 8mm wire gauge ø 1mm Qty 1 pcs		



1

GEV No.	511147	Ref. No.	450125
description	wire clamp ø 12-14mm wire gauge ø 1.5mm zinc-coated steel Qty 1 pcs		

miscellaneous



1

GEV No.	510923	Ref. No.	440817
description	clamping ring for shaft ø 10mm ID ø 9.4mm H 6mm		

retaining rings

DIN 471



1

GEV No.	514030	Ref. No.	15901700 15901799 MA15901799
description	retaining ring shaft ø 20mm thickness 1.3mm steel DIN 471		
For models:	BR707E, BR707EI, BR707G, BR707GI, BR78EF, BR78EI, BR78GF, BR78GI, BR912EFM, BR912EIM, BR912GFM, BR912GIM, BR94E, BR94EI, BR94G, BR94GI, BR96E, BR96EI, BR96G, BR96GI, BR98EF, BR98EFM, BR98EI, BR98EIM, BR98GF, BR98GFM, BR98GI, BR98GIM, BR9M4E, BR9M4EI, BR9M4G, BR9M4GI, BR9M6E, BR9M6EI, BR9M6G, BR9M6GI, BR9S8EF, BR9S8EI, BR9S8GF, BR9S8GI, BR9SB4E, BR9SB4EI, BR9SB4G, BR9SB4GI		

DIN 472



1

GEV No.	511248	Ref. No.	440816
description	retaining ring bore ø 48mm thickness 1.9mm stainless steel DIN 472		

roll pins



1

GEV No.	692210	Ref. No.	1891900 MA1891900
description	roll pin ø 3.5mm L 8mm steel burnished		
For models:	BR78EF, BR78EI, BR78G, BR78GF, BR78GI, BR912EFM, BR912EIM, BR912GFM, BR912GIM, BR98EF, BR98EFM, BR98EI, BR98EIM, BR98GF, BR98GFM, BR98GI, BR98GIM, BR9S8EF, BR9S8EI, BR9S8GF, BR9S8GI, C12C2G9, C12C9G		



1

GEV No.	516092	Ref. No.	15935599 MA15935599
description	roll pin ø 3mm L 30mm		
For models:	CP704E, CP704G, CP92E, CP92E2, CP92G, CP94E, CP94E2, CP94G, CP95B2E, CP95B2E2, CP95B2G, CP95B4E, CP95B4E2, CP95B4G		

consumables

lubricants

oils

for boiling pans



1

GEV No.	890005	Ref. No.	18176999 (20L) MA18176999 (20L)
description	oil Qty 1 pcs for kettle content 8.5kg 10l		



fuses

fine fuses



1			
GEV No.	358532	Ref. No.	R65200200
description	fine fuse size ϕ 5x20mm 2A fast-acting rated 250V Qty 10 pcs		
For models:	CVE004H, CVE004M, CVE104H, CVE104M, CVE105H, CVE105M, CVG105H, CVG105M, EC106M, EC110M, EC210M, EM010M+SC, EM106H, EM106M, EM106M+SC, EM106P, EM110H, EM110M, EM110M+SC, EM110P, EM210H, EM210M, EM210M+SC, EM210P, EV006M, EV106H, EV106M, EV106M+SC, EV106P, EV110H, EV110M, EV110M+SC, EV110P, EV210H, EV210M, EV210M+SC, EV210P, FE105M, FE105X, FE110M, FE110X, FE210M, FG105M, FG105X, FG110M, FG110X, FG210M, FG210X, GC106M, GC110M...(Other models you can see in the webshop)		



1			
GEV No.	358593	Ref. No.	R65200086
description	fine fuse size ϕ 5x20mm 0.125A slow-acting rated 250V Qty 10 pcs		
For models:	CVE004H, CVE104H, CVE105H, CVG105H, EM010M+SC, EM106H, EM106M+SC, EM106P, EM110M+SC, EM110P, EM210M+SC, EM210P, EV106H, EV106M+SC, EV106P, EV110M+SC, EV110P, EV210M+SC, EV210P, GM106H, GM106M+SC, GM106P, GM110M+SC, GM110P, GM210M+SC, GM210P, GV106H, GV106M+SC, GV106P, GV110M+SC, GV110P, GV210M+SC, GV210P, ME061P, ME061T, ME101P, ME101T, ME102P, ME102T, ME106M, ME106P, ME106X, ME110M, ME110P, ME110X, ME120M, ME120P, ME120X, ME201P, ME201T...(Other models you can see in the webshop)		



1			
GEV No.	358592	Ref. No.	R65200140
description	fine fuse size ϕ 5x20mm 0.1A slow-acting rated 250V Qty 10 pcs		
For models:	GMT20D, MG061M, MG101D, MG101M, MG102D, MG102M, MG201D, MG201M, MGMT20D		



1			
GEV No.	358595	Ref. No.	R65200320
description	fine fuse size ϕ 5x20mm 0.2A slow-acting rated 250V Qty 10 pcs		
For models:	EC106M, EM106H, EM106M, EM106M+SC, EM106P, EM110H, EM110P, EM210H, EM210P, EV006M, EV106H, EV106M, EV106M+SC, EV106P, EV110H, EV110P, EV210H, EV210P, FG105X, GC106M, GM106H, GM106M, GM106M+SC, GM106P, GM110H, GM210H, GV106H, GV106M, GV106M+SC, GV106P, GV110H, GV210H, MACE10M, MACE20M, ME061P, ME061T, ME101D, ME101M, ME102D, ME102M, ME106P, ME106X, ME110P, ME120P, ME201D, ME201M, ME210P, ME220P, MEC24H, MEMT10D...(Other models you can see in the webshop)		



1			
GEV No.	358703	Ref. No.	R65200350
description	fine fuse size ϕ 5x20mm 0.4A slow-acting rated 250V Qty 10 pcs		
For models:	EC110M, EC210M, EM010M+SC, EM110H, EM110M, EM110M+SC, EM110P, EM210H, EM210M, EM210M+SC, EM210P, EV110H, EV110M, EV110M+SC, EV110P, EV210H, EV210M, EV210M+SC, EV210P, FE105X, FG110X, FG210X, GC110M, GC210M, GM110H, GM110M, GM110M+SC, GM110P, GM210H, GM210M, GM210M+SC, GM210P, GV110H, GV110M, GV110M+SC, GV110P, GV210H, GV210M, GV210M+SC, GV210P, ME110P, ME110X, ME120P, ME120X, ME210P, ME210X, ME220P, MEC24H, MEC40M...(Other models you can see in the webshop)		

ϕ 10x38mm 500V



1			
GEV No.	358196	Ref. No.	130246
description	fine fuse size ϕ 10x38mm 12A rated 500V type Gg fast-acting Qty 1 pcs		



1			
GEV No.	358028	Ref. No.	130248
description	fine fuse size ϕ 10x38mm 20A rated 500V type Gg fast-acting Qty 1 pcs		



1			
GEV No.	358024	Ref. No.	130245
description	fine fuse size ϕ 10x38mm 8A rated 500V type gI fast-acting Qty 1 pcs		



1			
GEV No.	358033	Ref. No.	130259
description	fine fuse size ϕ 10x38mm 1A slow-acting rated 500V type aM Qty 1 pcs		



1			
GEV No.	358034	Ref. No.	130260
description	fine fuse size ϕ 10x38mm 2A slow-acting rated 500V type aM Qty 1 pcs		

			
1			
GEV No.	358035	Ref. No.	130230
description	fine fuse size ø10x38mm 4A slow-acting rated 500V type aM Qty 1 pcs		

fine fuse holders			
			
1			
GEV No.	358512	Ref. No.	208021-99 208021-99 n.m.liefe LA65210020 LAR65210020
description	fuse holder		
For models:	CS102E, CS102EP, CS102G, CS102GP, CVE004H, CVE004M, CVE104H, CVE104M, CVE105H, CVE105M, CVG105H, CVG105M, EC106M, EC110M, EC210M, EM010M+SC, EM106H, EM106M, EM106M+SC, EM106P, EM110H, EM110M, EM110M+SC, EM110P, EM210H, EM210M, EM210M+SC, EM210P, EV006M, EV106H, EV106M, EV106M+SC, EV106P, EV110H, EV110M, EV110M+SC, EV110P, EV210H, EV210M, EV210M+SC, EV210P, FE105M, FE105X, FE110M, FE110X, FE210M, FG105M, FG105X, FG110M, FG110X...(Other models you can see in the webshop)		

A			
alarm devices	65	electronic controllers	75
appliance hose reels	282	energy regulators	31
audible timers	65	espagnolette locks	239
axial fans	93	evaporators	280
B		F	
ball valves	289	fans	93
ball valves electric	89, 290	fasteners	303
bar burners	176	fastening material	297
beverage technology	295	female bullets	113
bi-metal thermostats	32, 32	ferrite rings	110
booster pumps II	108	filters	110
C		fine fuses	305
cable glands	112	fittings	287
cables	112	flat-headed bolts	297
cam switches	50	foam rubber gaskets	278
capillary tube clips	45	foil heating elements	26
castors and bumper angles	255	forced air burners	182
ceramic heaters	19	formed hoses	285
clamps	295, 303	fuses	110, 305
cleaning tools	296	G	
cold air circulating fans (complete)	96	gas burners	158
compressors	92	gas control valves	132
condensators & interference suppression filters	109	gas lines	197
consumables	304	gas nozzles	184
contactors	66	gas taps	115
container filters	283	gas thermostats	124
control equipment	55	gaskets for heated units	263
control thermostats	32, 43	gaskets for tray rack trolleys	272
cross flow fans	96	gastronorm	281
cylinder head bolts	298	grates	258
D		grub screws	298
digital timers	64	H	
door catches	239	halogen lamp	59
door seals	265	handle latches	239
door seals for dishwashers	279	heating cables	18
door seals with fixing hook	271	heating cartridges	18
door seals with tension springs	271	heating elements	3
dosing pumps	282	heating elements for bain maries	4
double wire clamps	296, 303	heating elements for charrills	17
drain fittings	293	heating elements for chip scuttles	5
drain hoses	283	heating elements for convection	22
drain pumps	108	heating elements for defrosting	12
drain systems and wash basins	293	heating elements for fryers	5
E		heating elements for frying pans	5
edgemount latches	238	heating elements for griddles	11
electric accessories	112	heating elements for heated cabinets	18
electrodes	91	heating elements for heating bridges	18
		heating elements for ovens	3
		heating elements for pasta cookers	14
		heating elements for pizza ovens	16

heating elements for refrigeration	12	oven hinges	242
heating elements for salamanders/toasters	17	oven lamps	59
heating elements for tilting bratt pan	13		
hexagonal nuts	300	P	
hexagonal screws	298	PE hoses	283
hob burners	158	piezoelectric igniters	153
hose clamps	295, 303	pilot burners	139
hose connectors	286, 287	plug-in gaskets	260
hose reels	282	plunger sockets	45
hoses	283	position switches	49
hot air fans	104	pressure control hoses	284
hot air motors	97	pressure switches	89, 197
hot plates	29	probe clips	45
		probes	75
I		programme timers	61
ignition boxes	139	pumps	105
ignition cables	151	push button latches	238
ignition switches	154	push/momentary push switches	48
ignition units	154	push-in fittings	288
immersion heating elements	19	PVC hoses	284
indicator lights	56		
indicator lights (complete)	56	R	
industrial hoses	283	radial fans	105
inlet spouts	292	radiation heaters	24
inlet taps	292	raised countersunk head screws	298
intake lances	283	refrigeration fans	94
		refrigeration gaskets	260
K		refrigeration motors universal	94
knurled nuts	300	refrigeration thermostats	44
knurled screws	299	relays	69
		residual heat indicators	61
L		retaining rings	304
lamps	56	ribbon cables	113
light bulbs	59	rocker/momentary rocker switches	46
long nuts	300	roll pins	304
lubricants	304	rotary switches	53
M		S	
magnetic switches	54	safety thermostats	38, 44
measuring equipment	297	safety valves	139
mechanical timers	64	screw-in gaskets	262
microswitches	49	screws	297
motors	105	sealing washers	276
		shaft gaskets	278
N		shelves and shelf rails	258
Niplaflex hoses	283	shut-off valves	290
non-return valves	295	side bolts	298
nuts	300	silicone hoses	284
		snap locks	239
O		solenoid valves	82
oils	304	solid top burners	182
operating capacitors	109	spray guns	281
O-rings	273	spring assisted hinges	241

spring clips	45
spring washers	302
stainless steel flexi hoses	283
standpipes	293
supply filters	295, 295
supply hoses	283
switches and momentary switches	46
system switches (ROLD)	50

T

temperature probes	75
terminals	113
terminals and connectors	113
thermocouples	154
thermostat gaskets	280
thermostats	32
threaded cable glands	112
threaded rods	299
time relays	73
timers	61
tools	296
tooth lock washers	303
touch sensitive light switches	54
transformers	73
tube burners	181

U

U-bends	295
universal hoses	283
universal probes	75

V

valves	295
valves and tank inlets	289
vibration pumps	109

W

wash and rinse pumps	105
washers	302
water cycle components	295
window seals	263