



GAS COMPONENTS



ELECTRIC COMPONENTS



WATER TECHNOLOGY



MECHANICAL COMPONENTS



TOOLS

Spare parts suitable for

MAZZER

Find the complete and up-to-date range of products in our GEV Webshop



Manufacturer catalogue

The most important spare parts and accessories arranged clearly for every manufacturer

- ✓ Complete product range and all appliance data always up to date in the GEV Webshop
- ✓ Alphabetical Index at the end of the catalogue

GEV Webshop

www.gev-online.co.uk

www.gev-online.com



- 🔍 Add to Favourites
- 🔍 Sign In with email address and usual password
- 🔍 Easy-order – place several items in your basket at the same time
- 🔍 Quick Item search – no login needed





thermostats

control and safety thermostats

CAEM

control thermostats



GEV No.	390672	Ref. No.	236042
description	thermostat t.max. 53°C temperature range fixed 53°C 1-pole 1CO 16A probe ø 9.5mm probe L 30mm capillary pipe 600mm capillary pipe isolated 540mm gland nut shaft Lmm screw-in probe probe thread M14x1		
spare parts for	390672		
	GEV No.	510417	Ref. No. —
	flat gasket fibre ED ø 20mm ID ø 14mm thickness 2mm Qty 1 pcs		
	GEV No.	550261	Ref. No. —
	nut thread M14x1 H 4mm WS 19 SS Qty 1 pcs		

switches and momentary switches

push/momentary push switches

30x22mm



GEV No.	301082	Ref. No.	S000INA12 S000INA12/AQQ
description	push switch mounting measurements 30x22mm green 2NO 250V 12A connection male faston 6.3mm ambient temperature max. 85/55°C protection IP54 with protective collar		
For models:	LUX, Macinadosatore-Mini, MINI, MINI-elettronico-mod-A, MINI-elettronico-mod-B		

microswitches

lever actuated



GEV No.	346151	Ref. No.	S00SMIA01 S00SMIA07 S00SMIA07/QQQ S00SMIA09
description	microswitch 1NO connection cable ambient temperature max. 85°C upper actuating force: 12g		
For models:	KONY, LUX, Macinadosatore-Major, Macinadosatore-Mini, Macinadosatore-Robur, Macinadosatore-Super-Jolly, MAJOR, MINI, ROBUR, ROYAL, SUPER-JOLLY		

roller-lever actuated

with mounting components



GEV No.	346152	Ref. No.	S00SMIA04 S00SMIA11 S00SMIA11/QQQ
description	microswitch with handle with a switch 250V 16A 1NO connection male faston 6.3mm L 28mm ambient temperature max. 125°C mounting distance 22mm type U83161.3 actuating force: 40g white		
For models:	KONY, LUX, Macinadosatore-Major, Macinadosatore-Mini, Macinadosatore-Robur, Macinadosatore-Super-Jolly, MAJOR, MINI, ROBUR, ROYAL, SUPER-JOLLY		

pin-plunger actuated



GEV No.	345326	Ref. No.	S000INR01 S000INR01/QQQ
description	microswitch with plunger 250V 16A 1NO connection male faston 6.3mm ambient temperature max. 85°C mounting distance 22mm type XP52Z11 actuating force: 350g red stroke 15mm		
For models:	KONY, KONY-ELETTRONICO, Macinadosatore-Major, Macinadosatore-Robur, MAJOR, MAJOR-ELETTRONICO, ROBUR, ROBUR-ELETTRONICO, ROYAL, ROYAL-ELETTRONICO		

rotary switches



BREMAS

A1700 series





GEV No.	347085	Ref. No.	S000INA09 S000INA09/BQQ S000INA09/QQQ
description	rotary switch 2 0-1 sets of contacts 2 type CA0170002V 400V 20A shaft ø 5x5mm shaft L 18mm shaft square connection screw		
For models:	KONY-ELETTRONICO, Macinadosatore-Major, Macinadosatore-Super-Jolly, MAJOR, MAJOR-ELETTRONICO, ROBUR-ELETTRONICO, ROYAL-ELETTRONICO, SUPER-JOLLY		



			
1			
GEV No.	346104	Ref. No.	S000INA04 S000INA04/AQQ
description	rotary switch 2 0-1 sets of contacts 3 type CA0170003 400V 20A shaft ø 5x5mm shaft L 21mm shaft square connection screw		
accessories for	346104		
	GEV No.	111012	Ref. No. —
knob switch zero mark t.max.°C° 34/60mm shaft ø 5x5mm shaft flat black H 22mm L 50mm			

			
1			
GEV No.	346147	Ref. No.	S000INA04
description	rotary switch 20A shaft L 18mm 2 operating positions 3-pole		
For models:	Macinadosatore-Major, Macinadosatore-Super-Jolly, MAJOR, SUPER-JOLLY		

			
1			
GEV No.	347086	Ref. No.	S000INA13 S000INA13/AQQ S000INA13/QQQ
description	rotary switch 3 0-1 momentary switch sets of contacts 3 type CS0178293V 400V 20A shaft ø 5x5mm shaft L 18mm shaft square connection screw		
For models:	KONY, LUX, Macinadosatore-Major, Macinadosatore-Mini, Macinadosatore-Robur, Macinadosatore-Super-Jolly, MAJOR, MINI, ROBUR, ROYAL, SUPER-JOLLY		

			
1			
GEV No.	346148	Ref. No.	S000INA10 S000INA10/AQQ
description	rotary switch 3 0-1 momentary switch sets of contacts 4 type CS0178377 400V 20A shaft ø 5x5mm shaft L 18mm shaft square connection screw		
For models:	KONY, Macinadosatore-Major, Macinadosatore-Robur, Macinadosatore-Super-Jolly, MAJOR, ROBUR, ROYAL, SUPER-JOLLY		

encoders and potentiometers

			
1			
GEV No.	402343	Ref. No.	S000POT01 S000POT01/CQQ
description	potentiometer shaft ø 6.3mm shaft L 12mm plug type black cable length 250mm		
For models:	MINI-elettronico-mod-A, MINI-elettronico-mod-B		

			
1			
GEV No.	402339	Ref. No.	S000POT02 S000POT02/AQQ
description	potentiometer shaft ø 6.3mm shaft L 12mm plug type red cable length 250mm		
For models:	MINI-elettronico-mod-A, MINI-elettronico-mod-B		

lamps

indicator lights

indicator lights (complete)

ø10mm

with screw socket

			
1			
GEV No.	359312	Ref. No.	S000LAA06
description	indicator light ø 10mm 230V green		

			
1			
GEV No.	359447	Ref. No.	S000LAA06 S000LAA06/QQQ
description	indicator light ø 10mm 250/400V cable length 400mm		
For models:	KONY, KONY-ELETTRONICO, LUX, Macinadosatore-Major, Macinadosatore-Mini, Macinadosatore-Robur, Macinadosatore-Super-Jolly, MAJOR, MAJOR-ELETTRONICO, MINI, ROBUR, ROBUR-ELETTRONICO, ROYAL, ROYAL-ELETTRONICO, SUPER-JOLLY		



timers

mechanical timers

			
1			
GEV No.	350110	Ref. No.	S000TIA02 S000TIA02/AQQ
description	timer M2 2-pole operation time 50s impulse mechanical 2NO at 250V 16A permanent position no shaft ø 3.5 x 3.5mm shaft 3.5 x 3.5mm shaft L 20mm mounting distance 28mm connection rear		
For models:	LUX, Macinadosatore-Major, Macinadosatore-Mini, Macinadosatore-Super-Jolly, MAJOR, MINI, SUPER-JOLLY		

			
1			
GEV No.	360354	Ref. No.	S000TIA03 S000TIA03/AQQ
description	timer M2 3-pole operation time 50s impulse mechanical 3NO at 250V 16A permanent position no shaft ø 3.5 x 3.5mm shaft L 17mm mounting distance 28mm connection rear		
For models:	Macinadosatore-Major, Macinadosatore-Super-Jolly, MAJOR, SUPER-JOLLY		
accessories for	360354		
		GEV No.	110365
	knob switch zero mark t.max.°C ø 44mm shaft ø 3.5x3.5mm shaft flat black	Ref. No.	—

contactors

ISKRA (FANAL)



power contactors

			
1			
GEV No.	380212	Ref. No.	S000COC02 S000COC02/QQQ
description	power contactor resistive load 20A 230VAC (AC3/400V) 8.5A/5.5kW main contacts 3NO auxiliary contacts 1NC connection screw connection type Fanal K07M 01 type ISKRA DSL7 01		
For models:	KONY, Macinadosatore-Major, Macinadosatore-Mini, Macinadosatore-Super-Jolly, MAJOR, MINI, SUPER-JOLLY		

			
1			
GEV No.	380413	Ref. No.	S000COC08 S000COC08/QQQ
description	power contactor resistive load 20A 400VAC (AC3/400V) 8.5A/5.5kW main contacts 3NO auxiliary contacts 1NC connection screw connection type Fanal DSL7 01 type ISKRA K07M 01		
For models:	KONY, Macinadosatore-Major, Macinadosatore-Super-Jolly, MAJOR, SUPER-JOLLY		

LOVATO

power contactors

			
1			
GEV No.	380705	Ref. No.	S000COC18 S005COC02 S005COC02/QQQ S005COC18 S005COC18/QQQ
description	power contactor resistive load 20A 230VAC (AC3/400V) 9A/4kW main contacts 3NO auxiliary contacts 1NO connection screw connection type 11BG0910A230		
For models:	KONY, LUX, Macinadosatore-Major, Macinadosatore-Mini, Macinadosatore-Super-Jolly, MAJOR, MINI, SUPER-JOLLY		
accessories for	380705		
		GEV No.	380057
	auxiliary contact contacts 1NO/1NC AC1 10A for contactors BG series connection screw type BGX1011	Ref. No.	—

			
1			
GEV No.	380710	Ref. No.	S005COC08 S005COC08/QQQ
description	power contactor resistive load 20A 400VAC (AC3/400V) 9A/4kW main contacts 3NO auxiliary contacts 1NO connection screw connection type 11BG0910A400		



1

GEV No.	380896	Ref. No.	S000COC12 S000COC12/AQQ
description	power contactor resistive load 25A 230VAC (AC3/400V) 16A/7.7kW main contacts 3NO auxiliary contacts 1NO connection screw connection type BF1610230		
For models:	Macinadosatore-Robur, ROBUR, ROYAL		



1

GEV No.	380895	Ref. No.	S000COC13 S000COC13/QQQ
description	power contactor resistive load 25A 400VAC (AC3/400V) 16A/7.7kW main contacts 3NO auxiliary contacts 1NO connection screw connection type BF12012205060		
For models:	Macinadosatore-Robur, ROBUR, ROYAL		



1

GEV No.	402350	Ref. No.	S000SPU02
description	PCB		
For models:	KONY-ELETTRONICO, MAJOR-ELETTRONICO, ROBUR-ELETTRONICO		



1

GEV No.	402346	Ref. No.	S000SCT06 S000SCT06/AQQ S000SCT06/QQQ
description	PCB L 100mm W 73mm 220/240V 18V		
For models:	KONY-ELETTRONICO, MAJOR-ELETTRONICO, ROBUR-ELETTRONICO, ROYAL-ELETTRONICO		

electronics

PCBs



1

GEV No.	402349	Ref. No.	S000SCT03 S000SCT03/QQQ
description	display PCB for dosing unit		
For models:	MINI-elettronico-mod-B		



1

GEV No.	402348	Ref. No.	S000SPU03 S000SPU03/AQQ S000SPU03/BQQ S000SPU03/CQQ S000SPU03/DQQ
description	key pad PCB 18V with display		
For models:	KONY-ELETTRONICO, MAJOR-ELETTRONICO, ROBUR-ELETTRONICO, ROYAL-ELETTRONICO		

keypads

keypad units

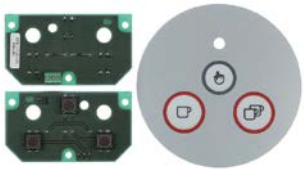

1

GEV No.	402347	Ref. No.	S000SPU01/AQQ+S000MEM01/AQQ S00SSPU01 S00SSPU01/BQQ
description	keypad unit buttons 3 grey ø 120mm		
For models:	MINI-elettronico-mod-A		

compressors

accessories

starting relays

klixons



1

GEV No.	380901	Ref. No.	S000DIS02 S000DIS02/QQQ
description	start relay 2CR4-170 230V connection F6.3		
For models:	KONY, KONY-ELETTRONICO, Macinadosatore-Robur, ROBUR, ROBUR-ELETTRONICO		



			
1			
GEV No.	380903	Ref. No.	S000DIS07 S000DIS07/QQQ S000DIS13 S000DIS13/QQQ
description	start relay 4CR-1-630 230V connection F6.3		
For models:	KONY, KONY-ELETTRONICO		

			
1			
GEV No.	381120	Ref. No.	S000DIS14 S000DIS14/QQQ
description	start relay 4CR-1-670 230V connection F6.3		

pumps

booster pumps II

accessories

			
1			
GEV No.	365015	Ref. No.	S000COE02 S000COE02/QQQ
description	operating capacitor capacity 10µF 400V tolerance 5%Hz ambient temperature max. -25 to +85°C ø 35.5mm L 59mm M8 plastic connection male faston 6.3mm protection		
For models:	KONY, KONY-ELETTRONICO, SUPER-JOLLY		

			
1			
GEV No.	365012	Ref. No.	S000COE14 S000COE14/QQQ
description	operating capacitor capacity 6.3µF 450V tolerance 5% 50Hz ambient temperature max. -25 to +85°C ø 30mm L 61mm M8 plastic connection male faston 6.3mm protection		
For models:	LUX, Macinadosatore-Mini, MINI		

condensators & interference suppression filters

operating capacitors

plastic

			
1			
GEV No.	365015	Ref. No.	S000COE02 S000COE02/QQQ
description	operating capacitor capacity 10µF 400V tolerance 5%Hz ambient temperature max. -25 to +85°C ø 35.5mm L 59mm M8 plastic connection male faston 6.3mm protection		
For models:	KONY, KONY-ELETTRONICO, SUPER-JOLLY		

			
1			
GEV No.	365014	Ref. No.	S000COE16 S000COE16/QQQ
description	operating capacitor capacity 12.5µF 450V tolerance 5%Hz ambient temperature max. -25 to +85°C ø 35mm L 70mm M8 plastic connection male faston 6.3mm 45S.C3DS.12.5 protection		
For models:	KONY, KONY-ELETTRONICO		

			
1			
GEV No.	365021	Ref. No.	S000COE03 S000COE03/QQQ
description	operating capacitor capacity 16µF 425V tolerance 5% 50/60Hz ambient temperature max. -25 to +85°C ø 35mm L 73mm single M8 plastic connection male faston 6.3mm 416.10.99 protection		
For models:	Macinadosatore-Robur, MAJOR, MAJOR-ELETTRONICO, ROBUR, ROBUR-ELETTRONICO, ROYAL, ROYAL-ELETTRONICO		

			
1			
GEV No.	365019	Ref. No.	S000COE04 S000COE04/QQQ
description	operating capacitor capacity 20µF 400V tolerance 5% 50/60Hz ambient temperature max. -25 to +85°C ø 39.5mm L 70mm M8 plastic connection male faston 6.3mm 16.10.25. protection		
For models:	Macinadosatore-Robur, MAJOR, ROBUR, ROBUR-ELETTRONICO		

			
1			
GEV No.	365012	Ref. No.	S000COE14 S000COE14/QQQ
description	operating capacitor capacity 6.3µF 450V tolerance 5% 50Hz ambient temperature max. -25 to +85°C ø 30mm L 61mm M8 plastic connection male faston 6.3mm protection		
For models:	LUX, Macinadosatore-Mini, MINI		

			
1			
GEV No.	365013	Ref. No.	S000COE01 S000COE01/QQQ
description	operating capacitor capacity 8µF 400V tolerance 5%Hz ambient temperature max. -25 to +85°C ø 31.5mm L 55mm M8 plastic connection male faston 6.3mm protection		
For models:	SUPER-JOLLY		

			
1			
GEV No.	526716	Ref. No.	FMA00195D FMA00195D/AQQ FMA00195D/QQQ
description	grinding burrs pair turn direction right D1 ø 61mm ID ø 35mm H 8.4mm tooth spacing 3mm hole ø 5mm bore ø 9mm mounting ø 45		
For models:	LUX		

			
1			
GEV No.	527231	Ref. No.	FMA00033M FMA00189D FMA0033M
description	grinding burrs pair turn direction right D1 ø 64mm ID ø 37mm H 8.4mm tooth spacing 3mm hole ø 5.5mm bore ø 9mm mounting ø 49 straight suitable for GAGGIA, ARISTARCO, MAZZER, MACDOBAR		
For models:	Macinadosatore-Super-Jolly, MINI-elettronico-mod-A, MINI-elettronico-mod-B, SUPER-JOLLY		

			
1			
GEV No.	531122	Ref. No.	FMA00151C FMA00151C/QQQ
description	grinding burrs pair turn direction right D1 ø 83mm ID ø 49mm H 9.6mm tooth spacing 3.5mm hole ø 6mm bore ø 10mm mounting ø 76 three-phase suitable for MAZZER		
For models:	MAJOR, ROYAL		

			
1			
GEV No.	527232	Ref. No.	FMA00151A FMA00151A/QQQ FMA00151B
description	grinding burrs pair turn direction right D1 ø 83mm ID ø 49mm H 9.6mm tooth spacing 3mm hole ø 6mm bore ø 10mm mounting ø 65 straight suitable for MAZZER (Major)		
For models:	Macinadosatore-Major, MAJOR, MAJOR-ELETTRONICO		

equipment-specific units

for coffee grinders

grinding burrs

grinding burrs straight

standard

			
1			
GEV No.	527405	Ref. No.	FMA00151B
description	grinding burrs pair		
For models:	Macinadosatore-Major, MAJOR, ROYAL, ROYAL-ELETTRONICO		

			
1			
GEV No.	527914	Ref. No.	FMA00182D FMA00182D/QQQ
description	grinding burrs pair turn direction right D1 ø 58mm ID ø 33mm H 8.5mm tooth spacing 3mm hole ø 5mm bore ø 8mm mounting ø 44		
For models:	Macinadosatore-Mini, MINI		

grinding burrs conical

1 

GEV No.	527915	Ref. No.	FMA00191C FMA00191C/CQQ
description	grinding burrs pair turn direction right D1 ø 63mm D2 ø 40mm H 23mm shaft ø 12mm with flute suitable for MAZZER		
For models:	KONY, KONY-ELETTRONICO		

1 

GEV No.	527383	Ref. No.	FMA00186C FMA00186C/CQQ
description	grinding burrs pair turn direction right D1 ø 71mm D2 ø 49mm H 25mm shaft ø 14mm with flute		
For models:	Macinadosatore-Robur, ROBUR, ROBUR-ELETTRONICO		

1 

GEV No.	527382	Ref. No.	FMA00187C FMA00187C/CQQ
description	grinding burrs pair turn direction right D1 ø 83mm D2 ø 58.3mm H 25mm shaft ø 14mm with flute		
For models:	Macinadosatore-Robur, ROBUR		

1 

GEV No.	525300	Ref. No.	FMA00187C FMA00187C/CQQ
description	grinding burrs pair turn direction right D1 ø 83mm D2 ø 58.3mm H 25mm shaft ø 14mm with flute MAZZER		

grinding burrs holders

1 

GEV No.	527908	Ref. No.	SSJ0POA03 SSJ0POA03/AQQ SSJ0POA03/BQQ
description	grinding burr holder D1 ø 65.5mm D2 ø 55mm H 54mm mounting pos. upper suitable for JOLLY		
For models:	SUPER-JOLLY		

1 

GEV No.	527907	Ref. No.	SRL0POA06 SRL0POA06/AQQ
description	grinding burr holder D1 ø 70mm H 44mm mounting pos. upper suitable for ROYAL-STARK-MAJOR		
For models:	MAJOR, MAJOR-ELETTRONICO, ROYAL, ROYAL-ELETTRONICO		

1 

GEV No.	527262	Ref. No.	SSJ0POA04 SSJ0POA04/QQQ
description	grinding burr holder type JOLLY suitable for MAZZER		
For models:	MINI-elettronico-mod-A, MINI-elettronico-mod-B, SUPER-JOLLY		

1 

GEV No.	527263	Ref. No.	SMJ0POA07 SMJ0POA07/QQQ
description	grinding burr holder type MAJOR suitable for MAZZER		
For models:	MAJOR, MAJOR-ELETTRONICO, ROYAL, ROYAL-ELETTRONICO		

spillage trays

1 

GEV No.	527390	Ref. No.	SMJ0PIB02 SMJ0PIB02/AQQ SSJ0PIB02 SSJ0PIB02/QQQ
description	drain tray		
For models:	Macinadosatore-Robur, ROBUR, ROBUR-ELETTRONICO, ROYAL, ROYAL-ELETTRONICO		



1

GEV No.	526717	Ref. No.	SMI0PIB02 SMI0PIB02/QQQ
description	drain tray L 187mm W 160mm		
For models:	LUX, Macinadosatore-Mini, MINI, MINI-elettronico-mod-A, MINI-elettronico-mod-B		



1

GEV No.	527901	Ref. No.	SSJ0PIB02 SSJ0PIB02/QQQ
description	drain tray L 240mm W 220mm suitable for JOLLY-MAJOR-KONY		
For models:	KONY, KONY-ELETTRONICO, Macinadosatore-Major, Macinadosatore-Super-Jolly, MAJOR, MAJOR-ELETTRONICO, SUPER-JOLLY		

dosing containers

dosing containers (complete)



1

GEV No.	527509	Ref. No.	SSJSGRL03 SSJSGRL03/QAQ SSJSGRL04
description	dosing unit automatic ø 120mm H 160mm suitable for JOLLY		
For models:	KONY, Macinadosatore-Super-Jolly, SUPER-JOLLY		



1

GEV No.	527388	Ref. No.	SMJSGRL04 SMJSGRL04/QAQ SMJSGRL05
description	dosing unit automatic ø 120mm H 190mm suitable for MAJOR		
For models:	Macinadosatore-Major, Macinadosatore-Robur, MAJOR, ROBUR, ROYAL		



1

GEV No.	527900	Ref. No.	SMISGRA04 SMISGRA04/BQQ SMISGRL03
description	dosing unit complete automatic ø 122mm H 140mm suitable for MINI		
For models:	LUX, Macinadosatore-Mini, MINI		



GEV No.	527899	Ref. No.	SMISGRA01 SMISGRA02 SMISGRA02/BCQ
description	dosing unit complete manual ø 122mm H 140mm suitable for MINI		
For models:	LUX, Macinadosatore-Mini, MINI		



GEV No.	527512	Ref. No.	SMJSGRA02 SMJSGRA02/AAQ SMJSGRA03
description	dosing unit manual		
For models:	Macinadosatore-Major, MAJOR		



GEV No.	527510	Ref. No.	SSJSGRA05 SSJSGRA05/BQQ SSJSGRA06
description	dosing unit manual ø 120mm H 160mm suitable for JOLLY		
For models:	Macinadosatore-Super-Jolly, SUPER-JOLLY		

dosing container lids

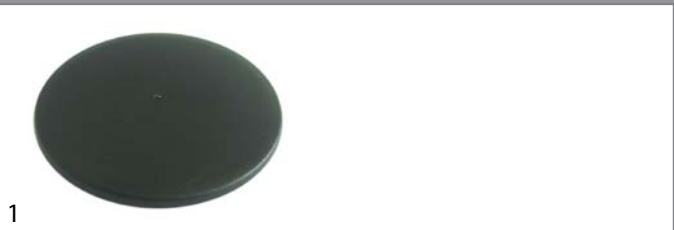

GEV No.	527331	Ref. No.	S000COD02 S000COD02/QQQ
description	lid for dosing container ø 118mm		
For models:	KONY, LUX, Macinadosatore-Major, Macinadosatore-Mini, Macinadosatore-Robur, Macinadosatore-Super-Jolly, MAJOR, MINI, MINI-elettronico-mod-B, ROBUR, ROYAL, SUPER-JOLLY		

adjusting screws



GEV No.	527513	Ref. No.	S000MAB02 S000MAB02/AQQ
description	adjusting screw for dosing container		
For models:	KONY, LUX, Macinadosatore-Major, Macinadosatore-Mini, Macinadosatore-Robur, Macinadosatore-Super-Jolly, MAJOR, MINI, ROBUR, ROYAL, SUPER-JOLLY		

springs

group 1

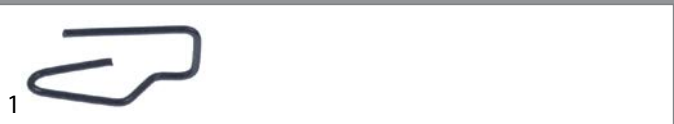

GEV No.	527904	Ref. No.	S000MOB04 S000MOB04/QQQ
description	spring L1 17mm wire gauge ø 1mm L2 12mm L3 10mm total length 21mm		
For models:	KONY, LUX, Macinadosatore-Major, Macinadosatore-Mini, Macinadosatore-Robur, Macinadosatore-Super-Jolly, MAJOR, MINI, ROBUR, ROYAL, SUPER-JOLLY		



GEV No.	527385	Ref. No.	S000MOB03 S000MOB03/QQQ
description	spring ø 30.5mm L1 28mm wire gauge ø 1.5mm L2 15mm L3 10mm total length 72mm for lever		
For models:	KONY, LUX, Macinadosatore-Major, Macinadosatore-Mini, Macinadosatore-Robur, Macinadosatore-Super-Jolly, MAJOR, MINI, ROBUR, ROYAL, SUPER-JOLLY		

glass cylinders



1

GEV No.	527909	Ref. No.	S000CIA02 S000CIA02/QQQ
description	cylinder ø 120mm H 68mm plexiglas		
For models:	LUX, Macinadosatore-Mini, MINI		



1

GEV No.	527910	Ref. No.	S000CIA03 S000CIA03/QQQ
description	cylinder ø 120mm H 90mm plexiglas		
For models:	Macinadosatore-Major, Macinadosatore-Robur, MAJOR, ROBUR, ROYAL		



1

GEV No.	527332	Ref. No.	S000CIA01 S000CIA01/QQQ
description	glass cylinder for dosing container		
For models:	KONY, Macinadosatore-Super-Jolly, SUPER-JOLLY		

levers

levers



1

GEV No.	527916	Ref. No.	702332 S00SLEA02 S00SLEA02/QQQ
description	lever for dosing container L 105mm steel		
For models:	KONY, LUX, Macinadosatore-Major, Macinadosatore-Mini, Macinadosatore-Robur, Macinadosatore-Super-Jolly, MAJOR, MINI, ROBUR, ROYAL, SUPER-JOLLY		

coffee presses

coffee presses



1

GEV No.	527521	Ref. No.	S000PRA01 S000PRA02 S000PRA02/QAQ
description	coffee press ø 53mm H 40mm plastic		
For models:	KONY, LUX, Macinadosatore-Major, Macinadosatore-Mini, Macinadosatore-Robur, Macinadosatore-Super-Jolly, MAJOR, MINI, ROBUR, ROYAL, SUPER-JOLLY		



1

GEV No.	527398	Ref. No.	S000PRA02 S000PRA02/QQQ
description	coffee press ø 54.5mm H 42mm plastic		

return spring



1

GEV No.	527387	Ref. No.	S00SFOA01
description	bearing		



1

GEV No.	527917	Ref. No.	S00SFOA01 S00SFOA01/QQQ S00SFOA03/QQQ
description	cover plate with lever mounting pos. lower ø 119mm aluminium for dosing container		
For models:	KONY, LUX, Macinadosatore-Major, Macinadosatore-Mini, Macinadosatore-Robur, Macinadosatore-Super-Jolly, MAJOR, MINI, ROBUR, ROYAL, SUPER-JOLLY		

sector plates

			
1			
GEV No.	527515	Ref. No.	S000SEA01 S000SEA01/QQQ
description	sector plates		
For models:	KONY, LUX, Macinadosatore-Major, Macinadosatore-Mini, Macinadosatore-Robur, Macinadosatore-Super-Jolly, MAJOR, MINI, ROBUR, ROYAL, SUPER-JOLLY		

miscellaneous

			
1			
GEV No.	531126	Ref. No.	S00SGUA01/AQQ
description	grid with gasket for dosing container suitable for MAZZER for model Mini Electronic countries Europe		

ratches

ratches

			
1			
GEV No.	527905	Ref. No.	S000NAA01 S000NAA01/AQQ
description	ratchet int. \varnothing 17mm total length 23mm		
For models:	KONY, LUX, Macinadosatore-Major, Macinadosatore-Mini, Macinadosatore-Robur, Macinadosatore-Super-Jolly, MAJOR, MINI, ROBUR, ROYAL, SUPER-JOLLY		

stars

central

			
1			
GEV No.	527516	Ref. No.	S000STA03 S000STA03/BQQ
description	star mounting pos. centre \varnothing 109mm hole \varnothing 10mm H 15mm		
For models:	KONY, LUX, Macinadosatore-Major, Macinadosatore-Mini, Macinadosatore-Robur, Macinadosatore-Super-Jolly, MAJOR, MINI, ROBUR, ROYAL, SUPER-JOLLY		

			
1			
GEV No.	527913	Ref. No.	S005GRA08 S005GRA08/AQQ
description	star mounting pos. centre \varnothing 109mm hole \varnothing 10mm H 24mm with handle		
For models:	KONY, LUX, Macinadosatore-Major, Macinadosatore-Mini, Macinadosatore-Robur, Macinadosatore-Super-Jolly, MAJOR, MINI, ROBUR, ROYAL, SUPER-JOLLY		

upper

			
1			
GEV No.	527912	Ref. No.	SMISSTA04 SMISSTA04/QQQ
description	star mounting pos. upper \varnothing 108mm hole \varnothing 12mm H 52mm thread M3		
For models:	LUX, Macinadosatore-Mini, MINI		

			
1			
GEV No.	526589	Ref. No.	SMJSSTA04 SMJSSTA04/QQQ
description	star mounting pos. upper \varnothing 108mm hole \varnothing 12mm H 94mm thread M3		
For models:	Macinadosatore-Major, Macinadosatore-Robur, MAJOR, ROBUR, ROYAL		

			
1			
GEV No.	527514	Ref. No.	SSJSSTA04 SSJSSTA04/QQQ
description	star mounting pos. upper \varnothing 109mm hole \varnothing 12mm H 73mm thread M3		
For models:	KONY, Macinadosatore-Super-Jolly, SUPER-JOLLY		

bottom

			
1			
GEV No.	527519	Ref. No.	S000STA02 S000STA02/BQQ
description	star mounting pos. lower		
For models:	KONY, LUX, Macinadosatore-Major, Macinadosatore-Mini, Macinadosatore-Robur, Macinadosatore-Super-Jolly, MAJOR, MINI, ROBUR, ROYAL, SUPER-JOLLY		

adjustment mechanism

setting rings



1

GEV No.	527911	Ref. No.	SSJ0GHA02 SSJ0GHA02/QQQ
description	setting ring \varnothing 105mm ID \varnothing 66mm H 21mm thread M7x1.5 suitable for JOLLY-KONY-MINI		
For models:	KONY, KONY-ELETTRONICO, LUX, Macinadosatore-Mini, Macinadosatore-Super-Jolly, MINI, MINI-elettronico-mod-A, MINI-elettronico-mod-B, SUPER-JOLLY		



1

GEV No.	528477	Ref. No.	SMJ0GHA04 SMJ0GHA04/AQQ SRO0GHA01/QQQ
description	setting ring \varnothing 126mm ID \varnothing 70mm H 21mm thread M9x1.5 suitable for MAJOR		
For models:	Macinadosatore-Major, Macinadosatore-Robur, MAJOR, MAJOR-ELETTRONICO, ROBUR, ROBUR-ELETTRONICO, ROYAL, ROYAL-ELETTRONICO		

springs



1

GEV No.	527389	Ref. No.	S000MOB14/AQQ SSJ0MOB01 SSJ0MOB01/AQQ
description	compression spring \varnothing 10mm L 23mm wire gauge \varnothing 1.5mm		
For models:	KONY, KONY-ELETTRONICO, LUX, Macinadosatore-Mini, MAJOR, MAJOR-ELETTRONICO, MINI, MINI-elettronico-mod-A, MINI-elettronico-mod-B, ROYAL, ROYAL-ELETTRONICO, SUPER-JOLLY		

screw connections



1

GEV No.	527898	Ref. No.	S00SPEA00/QQQ SSJSPEA04 SSJSPEA04/AQQ
description	thread bolt \varnothing 10.5mm thread M5 L 25mm		
For models:	KONY, KONY-ELETTRONICO, LUX, Macinadosatore-Major, Macinadosatore-Mini, Macinadosatore-Robur, Macinadosatore-Super-Jolly, MAJOR, MAJOR-ELETTRONICO, MINI, MINI-elettronico-mod-A, MINI-elettronico-mod-B, ROBUR, ROBUR-ELETTRONICO, ROYAL, ROYAL-ELETTRONICO, SUPER-JOLLY		

coffee powder dispenser

springs



1

GEV No.	527384	Ref. No.	S000MOB09 S000MOB09/QQQ
description	tension spring		
For models:	MAJOR, SUPER-JOLLY		

coffee beans containers

container lids



1

GEV No.	527386	Ref. No.	SMI0COD01
description	lid for coffee beans container		



1

GEV No.	527897	Ref. No.	SMI0COD01 SMI0COD01/QQQ
description	lid for coffee beans container \varnothing 157mm suitable for MINI		
For models:	Macinadosatore-Mini, MINI, MINI-elettronico-mod-A, MINI-elettronico-mod-B		



1

GEV No.	527327	Ref. No.	S000COD01 S000COD01/AQQ S000COD01/QQQ
description	lid for coffee beans container \varnothing 210mm		
For models:	KONY, KONY-ELETTRONICO, LUX, Macinadosatore-Robur, MAJOR, MAJOR-ELETTRONICO, ROBUR, ROBUR-ELETTRONICO, ROYAL, ROYAL-ELETTRONICO, SUPER-JOLLY		



coffee beans containers

glass cylinders



1

GEV No.	527332	Ref. No.	S000CIA01 S000CIA01/QQQ
description	glass cylinder for dosing container		
For models:	KONY, Macinadosatore-Super-Jolly, SUPER-JOLLY		

supports



1

GEV No.	531166	Ref. No.	N/A
description	support for coffee beans container intake conical seat ø 57-60mm suitable for MAZZER		

locks



1

GEV No.	527329	Ref. No.	S000BOB05+S000SEB01
description	catch for coffee beans container H 57.5mm int. ø 1 47.5mm int. ø 2 49.8mm		



1

GEV No.	527903	Ref. No.	SMI0SEB01 SMI0SEB01/AQQ
description	catch L 82mm W 47mm thickness 1.8mm plastic		
For models:	LUX, Macinadosatore-Mini, Macinadosatore-Super-Jolly, MINI, MINI-elettronico-mod-A, MINI-elettronico-mod-B, SUPER-JOLLY		



1

GEV No.	527902	Ref. No.	S000SEB02 S000SEB02/AQQ
description	catch L 88mm W 54mm thickness 2.5mm plastic		
For models:	KONY, KONY-ELETTRONICO, Macinadosatore-Major, Macinadosatore-Robur, MAJOR, MAJOR-ELETTRONICO, ROBUR, ROBUR-ELETTRONICO, ROYAL, ROYAL-ELETTRONICO		

support for filter holder



1

GEV No.	527520	Ref. No.	S000FOB02 S000FOB02/BQQ S000FOB02/CQQ
description	bracket for filter holder		
For models:	KONY, LUX, Macinadosatore-Mini, Macinadosatore-Robur, MAJOR, MINI, ROBUR, ROYAL, SUPER-JOLLY		

counters

counters



1

GEV No.	527399	Ref. No.	S005COB02 S005COB02/QQQ
description	counter for dosing unit		
For models:	KONY, LUX, Macinadosatore-Major, Macinadosatore-Mini, Macinadosatore-Robur, Macinadosatore-Super-Jolly, MAJOR, MINI, ROBUR, ROYAL, SUPER-JOLLY		

knobs

producer-specific knobs

MAZZER



1

GEV No.	111175	Ref. No.	S000MAB01/QQQ
description	knob switch zero mark ø 42mm shaft ø 4x4mm black		

equipment feet and end caps

bolting feet



1

GEV No.	527906	Ref. No.	S00SPIA01 S00SPIA01/QQQ
description	equipment foot ø 22mm H 16mm bore ø 5mm Qty 1 pcs		
For models:	KONY, KONY-ELETTRONICO, LUX, Macinadosatore-Major, Macinadosatore-Mini, Macinadosatore-Super-Jolly, MAJOR, MAJOR-ELETTRONICO, MINI, MINI-elettronico-mod-A, MINI-elettronico-mod-B, SUPER-JOLLY		

springs

torsion springs



1

GEV No.	527384	Ref. No.	S000MOB09 S000MOB09/QQQ
description	tension spring		
For models:	MAJOR, SUPER-JOLLY		

compression springs



1

GEV No.	527389	Ref. No.	S000MOB14/AQQ SSJ0MOB01 SSJ0MOB01/AQQ
description	compression spring ø 10mm L 23mm wire gauge ø 1.5mm		
For models:	KONY, KONY-ELETTRONICO, LUX, Macinadosatore-Mini, MAJOR, MAJOR-ELETTRONICO, MINI, MINI-elettronico-mod-A, MINI-elettronico-mod-B, ROYAL, ROYAL-ELETTRONICO, SUPER-JOLLY		



1

GEV No.	527517	Ref. No.	S000MOB05 S000MOB05/QQQ
description	compression spring ø 14.8mm L 49mm wire gauge ø 1.3mm		
For models:	KONY, LUX, Macinadosatore-Major, Macinadosatore-Mini, Macinadosatore-Robur, Macinadosatore-Super-Jolly, MAJOR, MINI, ROBUR, ROYAL, SUPER-JOLLY		

B

booster pumps II 7

C

compressors 6

condensators & interference suppression filters 7

contactors 5

I

indicator lights 4

indicator lights (complete) 4

L

lamps 4

M

mechanical timers 5

microswitches 3

O

operating capacitors 7

P

pumps 7

push/momentary push switches 3

R

rotary switches 3

S

switches and momentary switches 3

T

thermostats 3

timers 5