



GAS COMPONENTS



ELECTRIC COMPONENTS



WATER TECHNOLOGY



MECHANICAL COMPONENTS



TOOLS

Spare parts suitable for

MELITTA

Find the complete and up-to-date range of products in our GEV Webshop



Manufacturer catalogue

The most important spare parts and accessories arranged clearly for every manufacturer

- ✓ Complete product range and all appliance data always up to date in the GEV Webshop
- ✓ Alphabetical Index at the end of the catalogue

GEV Webshop

www.gev-online.co.uk

www.gev-online.com



- 🔍 Add to Favourites
- 🔍 Sign In with email address and usual password
- 🔍 Easy-order – place several items in your basket at the same time
- 🔍 Quick Item search – no login needed



heating elements

heating elements for coffee machine



1

GEV No.	415546	Ref. No.	5 507 986
description	heating element 1000W 220V L 435mm W 120mm connection M4 dry heating element		



1

GEV No.	417305	Ref. No.	203197
description	heating element 160W 230V heating circuits 1 ID ø 138mm ED ø 150mm L1 40mm L2 105mm connection male faston 6.3mm connection distance 30mm W1 61mm tube ø 6.3mm dry heating element W 157mm H 15mm		



1

GEV No.	417454	Ref. No.	15633
description	heating element 2000W 230V heating circuits 1 ø 93mm flange 50x26mm H 63mm H1 29mm H2 34mm connection male faston 6.3mm compression flange tube ø 8.5mm immersion heater		



1

GEV No.	417471	Ref. No.	15911
description	heating element 2000W 400V heating circuits 1 flange 47x24mm L 190mm W 42mm H 45mm compression flange connection male faston 6.3mm tube ø 6.5mm immersion heater		





1

GEV No.	417462	Ref. No.	12133
description	heating element 2200W 230V heating circuits 1 flange 47x24mm L 315mm W 135mm L1 215mm L2 100mm W1 100mm W2 32.5mm windings 1 compression flange connection male faston 6.3mm tube ø 8.5mm		





1

GEV No.	415547	Ref. No.	N/A
description	heating element 2280W 220V heating circuits 1 flange 50x26mm L 310mm W 140mm L1 210mm L2 100mm W1 105mm W2 35mm windings 3 compression flange connection male faston 6.3mm tube ø 8.5mm immersion heater		
accessories for	415547		
	GEV No.	510387	Ref. No. —
	gasket L 46mm W 22mm ømm EPDM for heating element for flange 50x26mm		
	GEV No.	510388	Ref. No. —
	counterflange ømm hole distancemm perforation ømm L 43mm W 21mm SS for heating element for flange 50x26mm		





1

GEV No.	415548	Ref. No.	N/A
description	heating element 2660W 220V heating circuits 1 flange 50x26mm L 370mm W 173mm L1 220mm L2 150mm W1 141mm W2 32mm windings 4 compression flange connection male faston 6.3mm immersion heater		
accessories for	415548		
	GEV No.	510387	Ref. No. —
	gasket L 46mm W 22mm ømm EPDM for heating element for flange 50x26mm		
	GEV No.	510388	Ref. No. —
	counterflange ømm hole distancemm perforation ømm L 43mm W 21mm SS for heating element for flange 50x26mm		



1

GEV No.	415778	Ref. No.	212113
description	heating element 3000W 230V heating circuits 1 L 160mm W 140mm H 28mm thread 3/4" connection male faston 6.3mm flange with thread tube ø 6.4mm immersion heater		
accessories for	415778		
	GEV No.	510403	Ref. No. —
	flat gasket fibre ED ø 36.5mm ID ø 27mm thickness 2mm Qty 1 pcs		
	GEV No.	510421	Ref. No. —
	gasket copper ED ø 31.8mm ID ø 26.4mm thickness 2.2mm for thread 3/4"		
	GEV No.	520234	Ref. No. —
	nut thread 3/4" H 5mm brass WS 30 Qty 1 pcs		



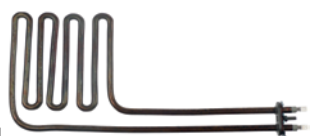

			
GEV No.	417470	Ref. No.	15910
description	heating element 3000W 400V heating circuits 1 flange 47x24mm L 185mm W 42mm H 45mm compression flange connection male faston 6.3mm tube ø 6.5mm immersion heater		

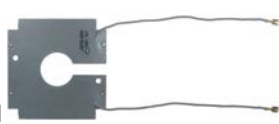
			
GEV No.	417461	Ref. No.	12134 561990 83010277
description	heating element 3810W 230V heating circuits 1 flange 47x24mm L 375mm W 165mm L1 230mm L2 145mm W1 135mm W2 30mm windings 3 compression flange connection male faston 6.3mm tube ø 8.5mm		

			
GEV No.	417472	Ref. No.	11574
description	hot plate 115W 230V L 132mm W 132mm connection Faston 6.3mm cable length 250mm suitable for MELITTA		

			
GEV No.	417473	Ref. No.	11582
description	hot plate 220W 230V L 210mm W 132mm connection Faston 6.3mm cable length 250mm suitable for MELITTA		

			
GEV No.	417474	Ref. No.	11583
description	hot plate 270W 230V L 210mm W 132mm connection Faston 6.3mm cable length 250mm suitable for MELITTA		

			
GEV No.	417456	Ref. No.	11624
description	hot plate 70W 230V coffee machine connection male faston 6.3mm heating circuits 1 cable length 350mm H 2mm L 128mm W 38mm		

			
GEV No.	419027	Ref. No.	16218
description	hot plate 80W 230V L 105mm W 60mm cable length 350mm		

			
GEV No.	417501	Ref. No.	308397
description	hot plate 90W 230V heating circuits 1 ø 120mm connection Faston 6.3mm cable length 450mm H 2mm suitable for MELITTA		

			
GEV No.	417455	Ref. No.	11533
description	hot plate 90W 240V ø 99mm H 12mm hole ø 11mm connection male faston 6.3mm		

heating plates

			
GEV No.	417456	Ref. No.	11624
description	hot plate 70W 230V coffee machine connection male faston 6.3mm heating circuits 1 cable length 350mm H 2mm L 128mm W 38mm		

flow heaters

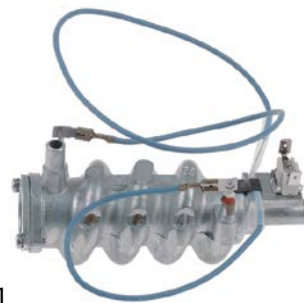
			
GEV No.	417457	Ref. No.	10820
description	flow heater 1300W 230V ø 56mm L 155mm Wmm connection male faston 6.3mm suitable for 190/193W		
spare parts for	417457		
GEV No.	358854	Ref. No.	10915
description	thermal fuse switch-off temp. 167°C nominalA cable length 830mm		
GEV No.	390627	Ref. No.	17779
description	bi-metal thermostat hole distancemm switch-off temp. 110°C 1NCA connection F6.3 M4		



			
1			
GEV No.	417350	Ref. No.	10819
description	flow heater 1800W 230V ø 55mm L 152mm Wmm connection male faston 6.3mm suitable for 170/171/172/173		

			
1			
GEV No.	525428	Ref. No.	12588
description	flow heater 3100W 230V ø 56mm L 300mm Wmm connection Faston 6.3mm		

accessories

capillary tube clips

			
1			
GEV No.	551046	Ref. No.	770125
description	capillary tube clip for pipe ø 8mm for thermostat		

thermostats

bi-metal thermostats

bi-metal thermostats

			
1			
GEV No.	390722	Ref. No.	203227
description	bi-metal thermostat hole distance 40mm switch-off temp. 180°C 1NC 1-pole 16A 250V connection F6.3 2 hole flange probe ø 23mm suitable for MELITTA		

			
1			
GEV No.	390627	Ref. No.	17779
description	bi-metal thermostat hole distancemm switch-off temp. 110°C 1NCA connection F6.3 M4		

			
1			
GEV No.	375905	Ref. No.	11074
description	bi-metal thermostat switch-off temp. 140°C 1NC 1-pole connection F6.3 M4		

control and safety thermostats

EGO

safety thermostats

55.33_ series

			
1			
GEV No.	375903	Ref. No.	14995
description	safety thermostat switch-off temp. 145°C 3-pole 20A probe ø 3mm probe L 299mm capillary pipe 870mm capillary pipe isolated 700mm probe SS screw connection M9x1 sealing sleeve 7.5mm 400V		

56_ series

			
1			
GEV No.	375895	Ref. No.	16522 17764
description	safety thermostat switch-off temp. 132°C 1-pole 16A probe ø 3.1mm probe L 200mm capillary pipe 860mm capillary pipe isolated 400mm gland nut M9x1 probe with gland nut adapter front fixing M10		
accessories for	375895		
		GEV No.	695621
		Ref. No.	16529
	duct ET M8x1 IT M10x1 probe ø max. 5mm WS 13		



accessories

capillary tube clips



1

GEV No.	551046	Ref. No.	770125
description	capillary tube clip for pipe \varnothing 8mm for thermostat		

gland nut accessories

ducts



1

GEV No.	695621	Ref. No.	16529
description	duct ET M8x1 IT M10x1 probe \varnothing max. 5mm WS 13		



1

GEV No.	550271	Ref. No.	741415
description	gland duct ET M12x0.75 IT M9x1 with gasket and nut		

switches and momentary switches

rocker/momentary rocker switches

30x11mm



1

GEV No.	301053	Ref. No.	16986
description	rocker switch mounting measurements 30x11mm white 1NO/indicator light 250V 16A 0-1 connection male faston 6.3mm		

30x22mm



1

GEV No.	301718	Ref. No.	18316
description	momentary rocker switch mounting measurements 30x22mm white 1NO/indicator light 250V 16A connection male faston 6.3mm ambient temperature max. male faston 6.3mm°C protection IP40		



1

GEV No.	301717	Ref. No.	10173 16988 21743
description	momentary rocker switch mounting measurements 30x22mm white 1NO 250V 16A START connection male faston 6.3mm ambient temperature max. 125/55°C protection IP40		



1

GEV No.	301716	Ref. No.	16987
description	rocker switch mounting measurements 30x22mm white 2NO 250V 16A illuminated 0-1 connection male faston 6.3mm ambient temperature max. 125/55°C protection IP40		

microswitches

lever actuated



1

GEV No.	347407	Ref. No.	16364
description	microswitch with lever 250V 0.1A 1CO connection male faston 2.8mm ambient temperature max. 120°C lever length 15mm		

magnetic switches

29x19mm



1

GEV No.	347408	Ref. No.	15888
description	magnetic switch double L 29mm W 19mm NO 250V 1.5A connection plug-in connection cable length 150mm 50W		



1

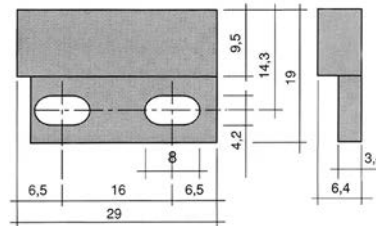

GEV No.	347405	Ref. No.	20152 9501638
description	magnetic switch L 29mm W 19mm 1NO 250V 1.5A P max. 50W connection cable cable length 500mm PIC		



encoders and potentiometers

 <p>1</p>			
GEV No.	402698	Ref. No.	12486
description	potentiometer with PCB		

lamps

indicator lights

indicator lights (complete)

ø10mm

with plug-in socket

 <p>1</p>			
GEV No.	359422	Ref. No.	671002
description	indicator light ø 10mm green 12V connection male faston 2.8mm Qty 1 pcs		

 <p>1</p>			
GEV No.	359139	Ref. No.	680059
description	indicator light ø 10mm green 230V connection male faston 6.3mm Qty 1 pcs		



 <p>1</p>			
GEV No.	360479	Ref. No.	1020953
description	indicator light ø 10mm green 6V connection male faston 2.8mm Qty 1 pcs		

 <p>1</p>			
GEV No.	359140	Ref. No.	671026
description	indicator light ø 10mm yellow 230V connection male faston 6.3mm Qty 1 pcs		

 <p>1</p>			
GEV No.	360480	Ref. No.	1020748
description	indicator light ø 10mm yellow 6V connection male faston 2.8mm Qty 1 pcs		

ø16mm

with screw socket

 <p>1</p>			
GEV No.	359834	Ref. No.	203180
description	indicator light ø 16mm 230V yellow connection male faston 6.3mm temp.-resist. 120°C		
accessories for	359834		
			
GEV No.	550559	Ref. No.	—
description	nut thread M16x1 H 5.5mm WS 19		

30x11mm

 <p>1</p>			
GEV No.	359160	Ref. No.	1029727 16992
description	indicator light mounting measurements 30x11mm 230V green connection male faston 6.3mm rectangular temp.-resist. 125°C		

contactors

ABB

power contactors

 <p>1</p>			
GEV No.	380092	Ref. No.	1032017
description	power contactor resistive load 20A 230VAC (AC3/400V) 12A/5.5kW main contacts 4NO auxiliary contacts connection screw connection type B6-40-00 / B7-40-00		

probes

producer-specific probes

probes

 <p>1</p>			
GEV No.	402727	Ref. No.	1040609
description	temperature probe NTC cable silicone probe -40 up to +110°C cable -50 up to +180°C connection plug thread M12x1 probe ø4x136mm cable length 0.2m		



			
1			
GEV No.	402105	Ref. No.	1011296
description	temperature probe PTC 2kOhm cable probe -50 up to +150°C cable°C connection male faston 2.8mm thread probe ø10x30mm cable lengthm		

			
1			
GEV No.	402728	Ref. No.	15133 21364
description	EPROM type M600-1 suitable for MELITTA		

electronics

electronics accessories



			
1			
GEV No.	525436	Ref. No.	16803
description	distance washer for display L 8mm ø 5mm ID ø 3.2mm		

			
1			
GEV No.	402699	Ref. No.	19909 22057
description	EPROM type MC M505-2 suitable for MELITTA		

EPROMS

			
1			
GEV No.	402731	Ref. No.	19912
description	EPROM type 6610-1 suitable for MELITTA		

PCBs

			
1			
GEV No.	402107	Ref. No.	11231
description	control PCB coffee machine 16889		
accessories for	402107		
	GEV No.	112948	Ref. No. 11543
	knob switch zero mark ø 30mm shaft ø 6x4.6mm shaft flat right grey		

			
1			
GEV No.	402732	Ref. No.	19913
description	EPROM type 6620-1 suitable for MELITTA		

			
1			
GEV No.	402108	Ref. No.	15710
description	control PCB coffee machine 16889		

1

GEV No.	402109	Ref. No.	1011319
description	control PCB coffee machine 16889		



1

GEV No.	402730	Ref. No.	15225
description	display L 58mm W 32mm for MELITTA		



1

GEV No.	402701	Ref. No.	19929 22304
description	PCB L 120mm W 80mm 230V without EPROM for MELITTA		



1

GEV No.	402703	Ref. No.	15118 21311
description	PCB L 180mm W 175mm 230V without EPROM for MELITTA		

Triacs



1

GEV No.	402729	Ref. No.	13550
description	Triac 25A 800W		

keypads

membrane keypads



1

GEV No.	525434	Ref. No.	15117
description	membrane keypad buttons 5 suitable for MELITTA L 135mm W 70mm		

solenoid valves

solenoid valves (water)

ELBI



1

GEV No.	370601	Ref. No.	12592
description	solenoide valve single straight 220-240VAC inlet 3/8" outlet 11.5mm input 5.5l/min t.max. 60°C 329 flow regulating valve inlet black		



1

GEV No.	370602	Ref. No.	12591
description	solenoide valve double straight 220-240VAC inlet 3/4" outlet 11.5mm input 5.5l/min ELBI flow regulating valve inlet black output A 5.5l/min output B 2.5l/min flow regulating valve outlet B orange		



MÜLLER

medium temperature: 90°C
duty cycle: 100%

solenoid valves with reducers

single



GEV No.	370606	Ref. No.	679572
description	solenoid valve single straight 220-240VAC inlet 3/4" outlet 14.5mm output 1.4l/min DN10 t.max. 90°C duty cycle 100% MÜLLER flow regulating valve outlet light blue		



GEV No.	370618	Ref. No.	679510
description	solenoid valve single straight 230VAC inlet 3/4" outlet 14.5mm output 3l/min t.max. 90°C MÜLLER flow regulating valve outlet violet		

2-fold



GEV No.	370522	Ref. No.	679459
description	solenoid valve double 230VAC inlet 3/4" outlet 14.5mm DN10 t.max. 90°C duty cycle 100% MÜLLER plastic output A 3l/min output B 3l/min		

spare parts for 370522



GEV No.	371017	Ref. No.	—
description	solenoid coil MÜLLER 230VAC connection male faston 6.3mm		



GEV No.	371285	Ref. No.	—
description	reducer MÜLLER type MR07 flow rate 3l/min mounting measurements 10mm nominal flow at 4bar pressure range 1-10bar approval KTW tolerance ±20% violet		

3-fold



GEV No.	370638	Ref. No.	11308
description	solenoid valve triple 230VAC inlet 3/4" outlet 14.5mm DN10 t.max. 90°C duty cycle 100% MÜLLER output A 3l/min output B 3l/min output C 3l/min		

metal

M&M

spare parts and accessories

solenoid coils



GEV No.	370524	Ref. No.	15385
description	membrane silicone ø 12mm L 16mm		

solenoid valves (various)



GEV No.	370523	Ref. No.	11753
description	solenoid valve 230VAC connection M&M coil type 2700 230V brass		

spare parts for 370523



GEV No.	370524	Ref. No.	15385
description	membrane silicone ø 12mm L 16mm		



GEV No.	371022	Ref. No.	—
description	solenoid coil M&M 230VAC 10VA 50Hz coil type 2700 seat ø 10mm		

pressure switches

for coffee machines

ø 45mm



GEV No.	541930	Ref. No.	17955
description	pressure control ø 45mm pressure range 0.155/0.125bar 155/125mmWS p max 0.5bar connection 8mm pressure connection 8mm		

electrodes

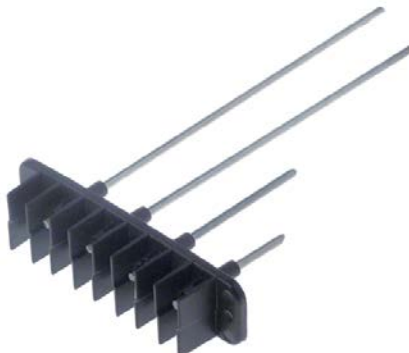

GEV No.	402106	Ref. No.	13926
description	electrode push-in total length 50mm probe L 40mm insulated probe length 35mm connection F2.8 ø 5mm		

1

GEV No.	402734	Ref. No.	12636
description	electrode bloc 2 hole flange total length 175mm probe L 30/50.5/141.5/155.5mm connection male faston 2.8mm ø 3mm		

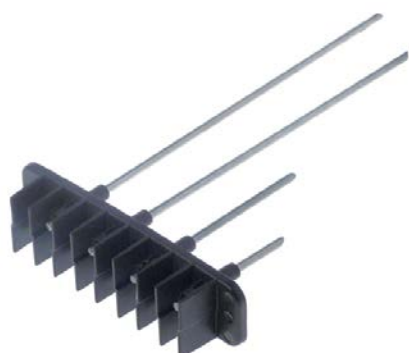

1

GEV No.	402733	Ref. No.	12635
description	electrode bloc 2 hole flange total length 175mm probe L 32/55/141.5/155.5mm connection male faston 2.8mm ø 3mm		

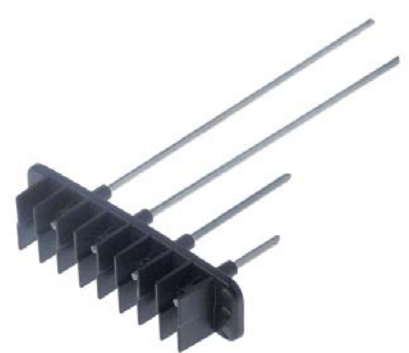

1

GEV No.	402700	Ref. No.	12521
description	electrode bloc 2 hole flange total length 175mm probe L 33/59/142/155mm connection male faston 2.8mm ø 3mm		



1

GEV No.	402104	Ref. No.	687867
description	electrode bloc flange with thread total length 175mm probe L 155/115/90/60/45/30mm insulated probe length 10mm connection F2.8		



1

GEV No.	402725	Ref. No.	15299
description	level electrode 1/8" total length 150mm probe L 116mm insulated probe length 105mm connection male faston 2.8mm ø 3mm		



1

GEV No.	402726	Ref. No.	15314
description	level electrode 1/8" total length 76mm probe L 42mm insulated probe length 31mm connection male faston 2.8mm ø 3mm		

pumps

miscellaneous

pumps



1

GEV No.	501378	Ref. No.	13767
description	pump 28/35W 220/240V 50Hz inlet ø 15mm outlet ø 13mm L 200mm rotation direction right		

fuses

fine fuses



1

GEV No.	358601	Ref. No.	1020540
description	fine fuse size ø5x20mm 1.25A slow-acting rated 250V Qty 10 pcs		



1

GEV No.	358603	Ref. No.	510547
description	fine fuse size ø5x20mm 2A slow-acting rated 250V Qty 10 pcs		





fine fuse holders

			
1			
GEV No.	551038	Ref. No.	19213
description	fuse holder suitable fuse \varnothing 5x20mm \varnothing 10mm H 10.5mm		

thermal fuses

			
1			
GEV No.	358018	Ref. No.	12738
description	thermal fuse switch-off temp. 167°C cable length 750mm 1.5mm ² cable black		

			
1			
GEV No.	358853	Ref. No.	1002584
description	thermal fuse switch-off temp. 167°C nominalA cable length 460mm		

			
1			
GEV No.	358017	Ref. No.	14473
description	thermal fuse switch-off temp. 167°C nominalA cable length 500mm 1.5mm ² cable blue		

			
1			
GEV No.	358854	Ref. No.	10915
description	thermal fuse switch-off temp. 167°C nominalA cable length 830mm		

electric accessories

plugs - couplings - power sockets

protective contact power sockets

producer-specific power sockets

miscellaneous

			
1			
GEV No.	550054	Ref. No.	15111
description	power socket CEE7/4 type F built-in version contacts P+N+E max. 16A max 230V protection IP44 with fine fuse countries DE H 62mm mounting \varnothing 45mm W 50mm		

			
1			
GEV No.	551045	Ref. No.	12190
description	power socket with fine fuse max. 10A countries DE 240V mounting \varnothing 45mm 1 phase L/N/PE		

appliance sockets/plugs

high temperature appliances 155°C

			
1			
GEV No.	551039	Ref. No.	9501409
description	high temperature appliance plug C16A male faston 6.3mm max 10A/250V T155 mounting distance 36mm hole \varnothing 3mm thermoplastic		

cables

accessories

cable glands

threaded cable glands

screw connections

			
1			
GEV No.	551050	Ref. No.	815161
description	cable gland thread PG16 cable \varnothing 16mm mounting \varnothing 22mm plastic		

terminals

terminal blocks

			
1			
GEV No.	550232	Ref. No.	341493
description	lustre terminal 12-pole cross section 2.5mm ² max. 32A max 450V temp.-resist. 150°C		



connection terminals with screw/faston connections



1			
GEV No.	550110	Ref. No.	1001815
description	power terminal block 5-pole max. 40A max 250V connection M6/ male faston 6.3mm temp.-resist. 130°C		

connection terminals with faston connections



1			
GEV No.	551049	Ref. No.	9503045
description	connection terminal 2-pole max. 20A max 600V connection F6.3/F6.3 temp.-resist. 90°C cross section 2.5/4mm ²		



1			
GEV No.	550989	Ref. No.	1029406
description	connection terminal 4-pole max. 25A max 450V connection F6.3/F6.3 temp.-resist. 90°C cross section 2.5/4mm ²		

connection terminals with strain relief



1			
GEV No.	550988	Ref. No.	17242
description	power terminal block 2-pole max 400V max. 16A cable ø 10.5mm cross section 2.5mm ² connection male faston 6.3mm/screw connection with strain relief		



1			
GEV No.	551047	Ref. No.	11601
description	power terminal block 2-pole max 400V max. 16A cable ø 8.5mm cross section 2.5mm ² connection male faston 6.3mm/screw connection with strain relief		



1			
GEV No.	551051	Ref. No.	695831
description	power terminal block 3-pole max 400V max. 16A cable ø 10.5mm cross section 2.5mm ² connection male faston 6.3mm/screw connection		



1			
GEV No.	551048	Ref. No.	695855
description	power terminal block 4-pole max 400V max. 16A cable ø 12.5mm cross section 2.5mm ² 3 phase connection male faston 6.3mm/screw connection with strain relief		

equipment-specific units

for pour machines

coffee pots



1			
GEV No.	960008	Ref. No.	16208
description	coffee pot 2.2l glas suitable for MELITTA		

coffee filters

paper filters

pyramid filters



1			
GEV No.	960013	Ref. No.	1014228
description	paper filter type 220 Qty 100 pcs suitable for MELITTA		

			
1			
GEV No.	960010	Ref. No.	14576
description	paper filter W 140mm L 170mm type 202s Qty 100 pcs suitable for MELITTA		

			
1			
GEV No.	960012	Ref. No.	1014259
description	paper filter W 240mm L 255mm type 206 Qty 200 pcs suitable for MELITTA		

filter pans

filter pans

MELITTA

			
1			
GEV No.	960011	Ref. No.	16394
description	filter pan plastic W 185mm D 167mm H 135mm black type SF202S filter no. 960010 suitable for MELITTA		

			
1			
GEV No.	960009	Ref. No.	14667 16615
description	filter pan plastic W 185mm D 167mm H 135mm brown filter no. 960010 suitable for MELITTA		



			
1			
GEV No.	525211	Ref. No.	12662
description	filter pan plastic W 260mm D 260mm H 170mm type SF206/1 filter no. 960012 suitable for MELITTA		

			
1			
GEV No.	525452	Ref. No.	15224
description	filter pan plastic W 280mm D 280mm H 250mm type SF206/2-P filter no. 960012 suitable for MELITTA		

			
1			
GEV No.	525451	Ref. No.	15223
description	filter pan plastic W 380mm D 380mm H 250mm type KU220/2-P filter no. 960013 suitable for MELITTA		

drain taps



drain taps

			
1			
GEV No.	525439	Ref. No.	645317
description	outlet tap complete pipe length 32mm thread 3/4" black/chrome suitable for MELITTA		
accessories for	525439		
	GEV No.	514186	Ref. No. 9308558
	tap suitable for MELITTA		
	GEV No.	525433	Ref. No. 14130
	gasket for tap H 29mm ø 31mm		





			
1			
GEV No.	525431	Ref. No.	766272
description	outlet tap complete pipe length 60mm thread 1/2" black		

components			
			
1			
GEV No.	525433	Ref. No.	14130
description	gasket for tap H 29mm ø 31mm		

			
1			
GEV No.	514186	Ref. No.	9308558
description	tap suitable for MELITTA		
accessories for	514186		
	GEV No.	Ref. No.	
	525433	14130	
	gasket for tap H 29mm ø 31mm		

			
1			
GEV No.	525432	Ref. No.	1003147
description	tap tap head ø 35mm thread M28x1.5		

			
1			
GEV No.	525435	Ref. No.	15200
description	tap tap head thread M35x1.5 grey/chrome		

			
1			
GEV No.	525437	Ref. No.	203166
description	tap body D 65mm W 35mm H 62mm thread M35x1.5 connection 1/2"		

liquid level pipes			
			
1			
GEV No.	525429	Ref. No.	12654
description	water level tube ED ø 10.4mm ID ø 8.2mm H 226mm marking 1-5 for MELITTA		

			
1			
GEV No.	525446	Ref. No.	344838
description	water level tube ED ø 11.8mm ID ø 8.5mm H 423mm marking blue for MELITTA		

			
1			
GEV No.	525445	Ref. No.	344821
description	water level tube ED ø 11.8mm ID ø 8.6mm H 320mm marking blue for MELITTA		

			
1			
GEV No.	525438	Ref. No.	319843
description	water level tube ED ø 11.8mm ID ø 8.8mm H 233mm marking blue for MELITTA		

			
1			
GEV No.	525447	Ref. No.	1029024
description	water level tube ED ø 15.5mm ID ø 11.5mm H 303mm for MELITTA		

			
1			
GEV No.	525448	Ref. No.	1029031
description	water level tube ED ø 15.5mm ID ø 11.5mm H 405mm for MELITTA		

protective tube			
plastic			
			
1			
GEV No.	527023	Ref. No.	203111
description	protection pipe ø 15mm ID ø 12mm L 220mm for water level tube		

metal			
			
1			
GEV No.	525449	Ref. No.	1029048
description	protection pipe ø 19mm ID ø 16mm L 305mm M19x1 aluminium		

			
1			
GEV No.	525450	Ref. No.	1029055
description	protection pipe ø 19mm ID ø 16mm L 406mm M19x1 aluminium		

accessories

gaskets



1

GEV No.	525440	Ref. No.	1029017
description	flat gasket EPDM ED ø 15mm ID ø 8mm thickness 4.8mm for water level tube Qty 1 pcs		

end caps



1

GEV No.	525443	Ref. No.	1028980
description	screw cap ø 22mm H 13mm		

funnels



1

GEV No.	527838	Ref. No.	11090
description	funnel plastic ED ø 115mm MELITTA 193W L 66mm		
accessories for	527838		
	GEV No.	527842	Ref. No.
			17842
	lid plastic ø 95mm black		



1

GEV No.	527836	Ref. No.	16268
description	funnel plastic ED ø 182mm MELITTA M170		

housing and bezels

control panel



1

GEV No.	527835	Ref. No.	16267
description	control panel M170 plastic ED ø 190mm MELITTA		

lids



1

GEV No.	527837	Ref. No.	16266
description	lid plastic ED ø 182mm MELITTA M170		



1

GEV No.	527841	Ref. No.	14129
description	lid plastic ED ø 190mm MELITTA 193W		
accessories for	527841		
	GEV No.	532528	Ref. No.
			19398
	O-ring silicone thickness 4.5mm ID ø 170.5mm Qty 1 pcs		



1

GEV No.	527842	Ref. No.	17842
description	lid plastic ø 95mm black		

filters



1

GEV No.	528979	Ref. No.	673679
description	screen ø 60mm thickness 1.5mm SS		

water containers

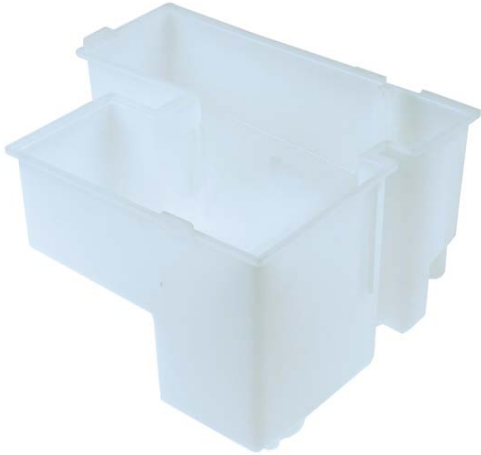

1

GEV No.	527839	Ref. No.	653893
description	water container plastic H 140mm L 246mm W 205mm MELITTA 193W		



1

GEV No.	527840	Ref. No.	16269
description	water container plastic H 180mm L 305mm W 150mm MELITTA M170		

for dishwashers

boilers

accessories



1

GEV No.	530821	Ref. No.	413169
description	silicone hose ID ø 10mm ED ø 15mm L 1m thickness 2.5mm operating pressure without pressure burst pressure non defined t.max. 200°C transparent Shore 60°		

knobs

producer-specific knobs

MELITTA



1

GEV No.	112948	Ref. No.	11543
description	knob switch zero mark ø 30mm shaft ø 6x4.6mm shaft flat right grey		

gaskets

O-rings

silicone



1

GEV No.	532530	Ref. No.	18689
description	O-ring silicone thickness 1.78mm ID ø 15.08mm Qty 1 pcs		



1

GEV No.	532526	Ref. No.	9400320
description	O-ring silicone thickness 2mm ID ø 30mm Qty 1 pcs		



1

GEV No.	532528	Ref. No.	19398
description	O-ring silicone thickness 4.5mm ID ø 170.5mm Qty 1 pcs		

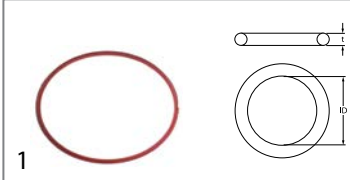

1

GEV No.	532593	Ref. No.	14873
description	O-ring silicone thickness 5.34mm ID ø 113.7mm Qty 1 pcs		

sealing washers

rubber gaskets



1

GEV No.	525440	Ref. No.	1029017
description	flat gasket EPDM ED ø 15mm ID ø 8mm thickness 4.8mm for water level tube Qty 1 pcs		

special gaskets

miscellaneous



1

GEV No.	532527	Ref. No.	11127
description	gasket foam seal silicone		

coffee accessories

measuring spoons



1

GEV No.	960096	Ref. No.	196611 24474 506731
description	coffee spoon amount of coffee 50g plastic		

measuring cups



1

GEV No.	960095	Ref. No.	12414
description	measuring cup 2l plastic		

hoses

industrial hoses

silicone hoses

without fabric

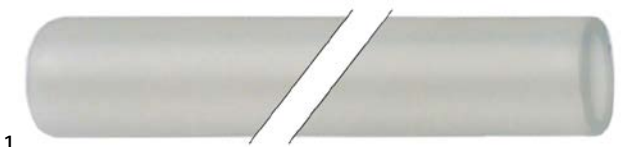

1

GEV No.	530821	Ref. No.	413169
description	silicone hose ID ø 10mm ED ø 15mm L 1m thickness 2.5mm operating pressure without pressure burst pressure non defined t.max. 200°C transparent Shore 60°		



1

GEV No.	530822	Ref. No.	1003369
description	silicone hose ID ø 10mm ED ø 16mm L 1m thickness 3mm operating pressure without pressure burst pressure non defined t.max. 200°C transparent		

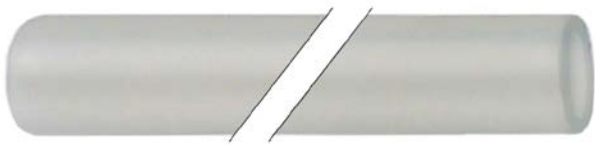

			
1			
GEV No.	530823	Ref. No.	9000292
description	silicone hose ID ø 12mm ED ø 16mm L 1m thickness 2mm operating pressure without pressure burst pressure non defined t.max. 200°C transparent		

			
1			
GEV No.	530820	Ref. No.	9000261
description	silicone hose ID ø 8mm ED ø 14mm L 1m thickness 3mm operating pressure without pressure burst pressure non defined t.max. 200°C transparent Shore 60°		

water cycle components

supply filters

			
1			
GEV No.	520146	Ref. No.	14666
description	supply filter thread 3/4" IT - 3/4" ET total length 122mm plastic DN17		

consumables

containers

measuring cups

			
1			
GEV No.	960095	Ref. No.	12414
description	measuring cup 2l plastic		

coffee filters

basket filters

paper filters

			
1			
GEV No.	960013	Ref. No.	1014228
description	paper filter type 220 Qty 100 pcs suitable for MELITTA		

			
1			
GEV No.	960010	Ref. No.	14576
description	paper filter W 140mm L 170mm type 202s Qty 100 pcs suitable for MELITTA		

			
1			
GEV No.	960012	Ref. No.	1014259
description	paper filter W 240mm L 255mm type 206 Qty 200 pcs suitable for MELITTA		

fuses

fine fuses

			
1			
GEV No.	358601	Ref. No.	1020540
description	fine fuse size ø5x20mm 1.25A slow-acting rated 250V Qty 10 pcs		

			
1			
GEV No.	358603	Ref. No.	510547
description	fine fuse size ø5x20mm 2A slow-acting rated 250V Qty 10 pcs		

fine fuse holders

	
1	
GEV No.	551038
Ref. No.	19213
description	fuse holder suitable fuse ø5x20mm ø 10mm H 10.5mm

thermal fuses

	
1	
GEV No.	358018
Ref. No.	12738
description	thermal fuse switch-off temp. 167°C cable length 750mm 1.5mm ² cable black

	
1	
GEV No.	358853
Ref. No.	1002584
description	thermal fuse switch-off temp. 167°C nominalA cable length 460mm

	
1	
GEV No.	358017
Ref. No.	14473
description	thermal fuse switch-off temp. 167°C nominalA cable length 500mm 1.5mm ² cable blue

	
1	
GEV No.	358854
Ref. No.	10915
description	thermal fuse switch-off temp. 167°C nominalA cable length 830mm

A			
appliance sockets/plugs	12		
B			
bi-metal thermostats	5, 5		
C			
cable glands	12		
cables	12		
capillary tube clips	6		
coffee filters	19		
consumables	19		
contactors	7		
containers	19		
E			
electric accessories	12		
electrodes	10		
F			
fine fuses	19		
flow heaters	4		
fuses	11, 19		
H			
heating elements	3		
heating elements for coffee machine	3		
heating plates	4		
hoses	18		
I			
indicator lights	7		
indicator lights (complete)	7		
industrial hoses	18		
L			
lamps	7		
M			
magnetic switches	6		
measuring cups	18, 19		
measuring spoons	18		
microswitches	6		
O			
O-rings	17		
P			
plugs - couplings - power sockets	12		
pressure switches	10		
probes	7		
protective contact power sockets	12		
pumps			11
R			
rocker/momentary rocker switches			6
S			
safety thermostats			5
sealing washers			18
silicone hoses			18
solenoid valves			9
supply filters			19, 19
switches and momentary switches			6
T			
terminals			12
thermal fuses			20
thermostats			5
threaded cable glands			12
W			
water cycle components			19