



GAS COMPONENTS



ELECTRIC COMPONENTS



WATER TECHNOLOGY



MECHANICAL COMPONENTS



TOOLS

Spare parts suitable for

MERCATUS

Find the complete and up-to-date range of products in our GEV Webshop



Manufacturer catalogue

The most important spare parts and accessories arranged clearly for every manufacturer

- ✓ Complete product range and all appliance data always up to date in the GEV Webshop
- ✓ Alphabetical Index at the end of the catalogue

GEV Webshop

www.gev-online.co.uk

www.gev-online.com



- 🔍 Add to Favourites
- 🔍 Sign In with email address and usual password
- 🔍 Easy-order – place several items in your basket at the same time
- 🔍 Quick Item search – no login needed



switches and momentary switches

rocker/momentary rocker switches

30x22mm



1

GEV No.	301003	Ref. No.	43201004
description	rocker switch mounting measurements 30x22mm green 2NO 250V 16A illuminated 0-I connection male faston 6.3mm ambient temperature max. 125/55°C protection IP65		
accessories for	301003		
	GEV No.	301036	Ref. No.
	protective cover internal size 30x22mm for rocker switch mounting measurementsmm		



1

GEV No.	346474	Ref. No.	43201014
description	dummy element external size 30x22mm suitable for rocker switch		



1

GEV No.	346473	Ref. No.	43201005
description	rocker switch mounting measurements 30x22mm orange 2NO 230V 16A illuminated fan connection male faston 6.3mm ambient temperature max. 100/55°C protection IP40		

lamps

indicator lights

indicator lights (complete)

30x22mm



1

GEV No.	359177	Ref. No.	43201006
description	indicator light mounting measurements 30x22mm 230V red connection male faston 6.3mm temp.-resist. 85°C type Marquardt 1667.. IP44		
accessories for	359177		
	GEV No.	301036	Ref. No.
	protective cover internal size 30x22mm for rocker switch mounting measurementsmm		

electronic controllers

CAREL

refrigeration controllers

built-in version



1

GEV No.	378333 ¹	Ref. No.	41103010
description	electronic controller CAREL IRMEC0HB011 mounting measurements 71x29mm built-in depth 94mm 115-230V voltage AC NTC/PTC relay outputs 4 CO-12A(2) CO-8A(4) CO-8A(4) CO-8A(4) NTC/PTC NTC/PTC DI DI IR/RS-485 protection IP65 -50 up to +99/+150°C display 3 digits		

¹with IR/RS-485 interface



1

GEV No.	379586	Ref. No.	41103001
description	electronic controller CAREL mounting measurements 71x29mm 12V voltage AC protection IP65 heating or cooling refrigeration type IR325E0001		



1

GEV No.	378236 ¹	Ref. No.	41103006
description	electronic controller CAREL PBMEH0HB111 mounting measurements 138.5x29mm built-in depth 75mm 115-230V voltage AC NTC/PTC relay outputs 5 NO-10A(10) CO-12A(2) NO-8A(4) NO-8A(4) CO-8A(4) NTC NTC DI DI yes IR/RS-485 yes protection IP54 -50 up to +150°C display 3½ digits		
spare parts for	378236		
	GEV No.	378255	Ref. No.
	frame W 197mm H 50mm plastic black for CAREL		

¹with IR/RS-485 interface



1

GEV No.	378326	Ref. No.	41103038
description	electronic controller CAREL PYMT1Z054G mounting measurements 71x29mm built-in depth 59mm 230V voltage AC NTC relay outputs 1 CO-12A(2) NTC NTC DI yes protection IP54 -50 up to +90°C display 3½ digits		

built-in version 2-piece

CAREL 140 x 110mm



1

GEV No.	378465	Ref. No.	41103005 PSB0001000
description	electronic controller CAREL PSB0001000 mounting measurements 145x110mm built-in depth 30mm 230V voltage AC NTC relay outputs 4 NO-16A(12) CO-16A(12) NO-10A(4) NO-16A(12) NTC NTC DI DI yes yes installation kit inclusive yes protection IP44 DIN rail°C display		



71 x 29mm

1

GEV No.	378251	Ref. No.	41201003
description	keypad unit CAREL PST mounting measurements 71x29mm built-in depth 35mmV voltage relay outputs protection IP65°C display		

accessories



1

GEV No.	378255	Ref. No.	41401011
description	frame W 197mm H 50mm plastic black for CAREL		

DIXELL

refrigeration controllers

built-in version



71 x 29mm

1

GEV No.	378488	Ref. No.	41103064
description	electronic controller DIXELL XR20CH-5G0C3 mounting measurements 71x29mm built-in depth 61mm 230V voltage AC NTC/PTC relay outputs 1 NO-16A(5) NTC/PTC NTC/PTC/DI protection IP55°C display 3½ digits		



1

GEV No.	378676	Ref. No.	41103087
description	electronic controller DIXELL XW20LH mounting measurements 149x30mm built-in depth 65mm 230V NTC display 3 digits		



1

GEV No.	378530	Ref. No.	41103042 41103075
description	electronic controller DIXELL XW70LH-5N0W0-B mounting measurements 150x31mm built-in depth 76mm 230V voltage AC NTC relay outputs 5 NO-20A(8) CO-8A(3) NO-8A(3) NO-8A(3) NTC NTC DI DI yes yes IR/RS-485 yes protection IP65 -50 up to +150°C display 2½ digit		

accessories universal for electronic con-

electronic controller accessories

fitting parts



1

GEV No.	692723	Ref. No.	41401005
description	bracket plastic dimensions 51.5x198mm cut-out 28x70mm for electronic controller		



probes

universal probes

temperature probes

1			
GEV No.	379160	Ref. No.	41201006
description	temperature probe NTC 10kOhm cable thermoplastic probe -40 up to +110°C cable -40 up to +110°C probe ø6x14mm cable length 1.5m without screw connection 2-wire		

1			
GEV No.	379161	Ref. No.	41201005
description	temperature probe NTC 10kOhm cable thermoplastic probe -40 up to +110°C cable -40 up to +110°C probe ø6x14mm cable length 3m without screw connection 2-wire		

keypads

front foils

1			
GEV No.	403773	Ref. No.	5901326
description	front foil refrigeration MERCATUS L 332mm W 65mm		

pressure switches

for refrigeration

DANFOSS

1			
GEV No.	541464	Ref. No.	41301001
description	pressure control DANFOSS type KP1 60-1101 pressure connection vertical ND refrigeration reset automatic switching diff. 0.7 - 4.0bar pressure range -0.2 up to +7.5bar connection 7/16" UNF (1/4" SAE)		

compressors

ACC/ZEL

R134A

HMBP monophase

High/Medium evaporation temperature above -20/-15 °C

1			
GEV No.	605006	Ref. No.	40103007
description	compressor coolant R134a type GD40MB 220-240V 50Hz HMBP fully hermetic 6.7kg 1/8HP power input 200W cylinder capacity 4.1cm ³ CSIR H 162.5mm 64W 87W 117W 153W 196W 245W 301W 363W test method ASHRAE		

1			
GEV No.	605012	Ref. No.	40103008
description	compressor coolant R134a type GL45TB 220-240V 50Hz HMBP fully hermetic 8.4kg 1/6HP power input 342W cylinder capacity 4.5cm ³ CSIR H 175.5mmW 76W 101W 134W 175W 223W 278W 342W 413W test method ASHRAE ambient temperature max. 43°C		

1			
GEV No.	605007	Ref. No.	40103009
description	compressor coolant R134a type GL60TB 220-240V 50Hz HMBP fully hermetic 9.5kg 1/5HP power input 437W cylinder capacity 5.7cm ³ CSIR H 175.5mm 95W 128W 170W 222W 284W 355W 437W 528W test method ASHRAE ambient temperature max. 43°C		



1

GEV No.	605008	Ref. No.	40103001
description	compressor coolant R134a type GL80TB 220-240V 50Hz HMBP fully hermetic 9.5kg 1/5HP power input 554W cylinder capacity 7.6cm ³ CSIR H 175.5mm 165W 215W 290W 390W 500W 615W 727W 840W test method ASHRAE ambient temperature max. 43°C		



1

GEV No.	605009	Ref. No.	40103002
description	compressor coolant R134a type GL90TB 220-240V 50Hz HMBP fully hermetic 10.8kg 1/4HP power input 293W cylinder capacity 8.8cm ³ CSIR H 175.5mmW 143W 194W 259W 339W 432W 539W 661W 796W test method ASHRAE		



1

GEV No.	605010	Ref. No.	40103003
description	compressor coolant R134a type GP12TB 220-240V 50Hz HMBP fully hermetic 11.2kg 3/8HP power input 661W cylinder capacity 12cm ³ CSIR H 203.6mmW 143W 194W 259W 339W 432W 539W 661W 796W test method ASHRAE ambient temperature max. 43°C		



1

GEV No.	605011	Ref. No.	40103004
description	compressor coolant R134a type GP14TB 220-240V 50Hz HMBP fully hermetic 11.5kg 3/8HP power input 566W cylinder capacity 14cm ³ CSIR H 203.6mm 191W 271W 373W 497W 643W 810W 999W 1209W test method ASHRAE ambient temperature max. 43°C		

fans

axial fans

ebm-papst



1

GEV No.	601038 ¹	Ref. No.	40701007
description	axial fan L 80mm W 80mm H 38mm 230VAC 50/60Hz 12W bearing ball bearing manuf. no. 8556N metal connection cable 300mm ebm-papst fan wheel ø 75mm temp.-resist. 90°C airflow 50m ³ /h		
accessories for	601038		
	GEV No.	691102	Ref. No. —
	guard ø 75mm mounting distance 71mm for axial fan 80mm		

¹with ball bearings

refrigeration fans

refrigeration motors universal

ebm-papst

IQ series

ebmpapst



1

GEV No.	601893	Ref. No.	40701060
description	fan motor 10W 230V 50/60Hz L1 43.5mm L3 82mm W 67mm cable length 1500mm 1300rpm ebm-papst IQ3612 5 mounting options bearing ball bearing		

standard motors



1

GEV No.	601287	Ref. No.	40701002
description	fan motor 10W 230V 50Hz L1 43mm L3 81mm W 83mm cable length 450mm		
spare parts for	601287		
	GEV No.	601413	Ref. No. —
	fixing plate suitable for fanwheel ED ø 32mm shaft ø 7 mounting distance 26mm		



1

GEV No.	601286	Ref. No.	40701001
description	fan motor M4Q045-CA01-01 7W 230V 50Hz L1 43mm L3 81mm W 83mm cable length 450mm		
spare parts for	601286		
	GEV No.	601413	Ref. No. —
	fixing plate suitable for fanwheel ED ø 32mm shaft ø 7 mounting distance 26mm		

multi fit fan motors



1

GEV No.	601758	Ref. No.	40701012
description	fan motor 16W 230V 50/60Hz L1 43.5mm L3 87mm W 72mm cable length 1500mm 1300/1550rpm ebm-papst M4Q045-CF01-75 5 mounting options bearing slide bearing		
spare parts for	601758		
	GEV No.	601413	Ref. No. —
	fixing plate suitable for fanwheel ED ø 32mm shaft ø 7 mounting distance 26mm		



1

GEV No.	601759	Ref. No.	40701011
description	fan motor 18W 230V 50/60Hz L1 43.5mm L3 93mm W 78mm cable length 1500mm 1300/1550rpm ebm-papst M4Q045-DA01-75 5 mounting options bearing slide bearing		
spare parts for	601759		
	GEV No.	601413	Ref. No. —
	fixing plate suitable for fanwheel ED ø 32mm shaft ø 7 mounting distance 26mm		

accessories

fan wheels

aluminium

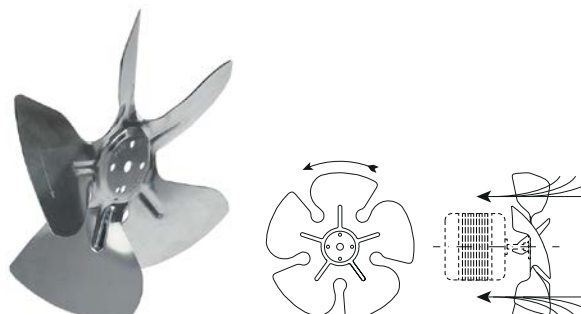

1

GEV No.	601385	Ref. No.	40801005
description	fan wheel sucking ø 172mm fan wheel mounting 25.4mm blade angle 34° W 42mm aluminium		

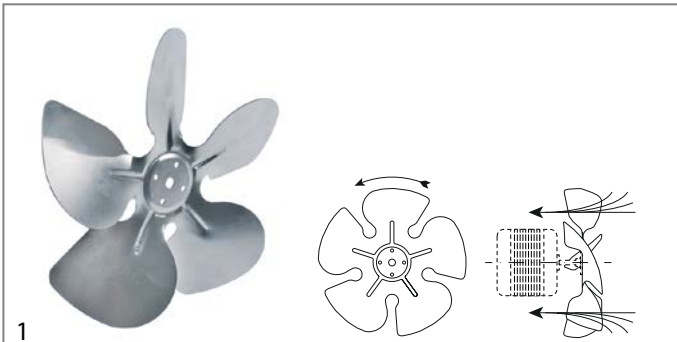

1

GEV No.	601282	Ref. No.	40801001
description	fan wheel sucking \varnothing 200mm fan wheel mounting 25.4mm blade angle 34° W 44mm aluminium		

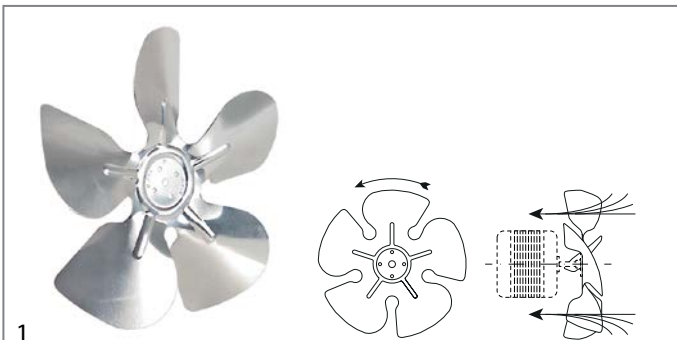

1

GEV No.	601283	Ref. No.	40801002
description	fan wheel sucking \varnothing 230mm fan wheel mounting 25.4mm blade angle 28° W 41mm aluminium		

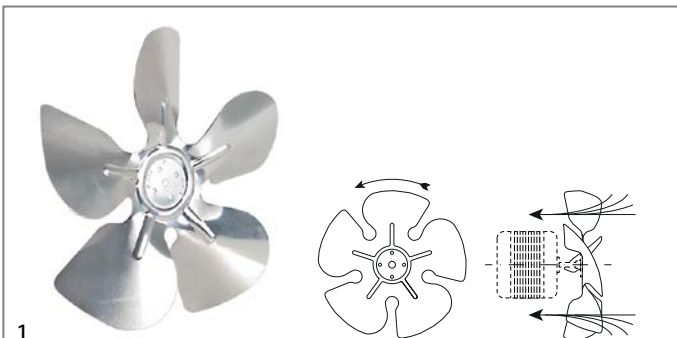

1

GEV No.	601284	Ref. No.	40801003
description	fan wheel sucking \varnothing 254mm fan wheel mounting 25.4mm blade angle 28° W 42mm aluminium		

cold air circulating fans (complete)



1

GEV No.	601964	Ref. No.	40701045	
description	fan A2E250AM06-12 fan wheel \varnothing 250mm blades 9 230V 50/60Hz 115/150W \varnothing 250mm 2450rpm cable length 1400mm sucking suitable capacitor 3 μ F			
spare parts for	601964			
	GEV No.	365137	Ref. No.	—
	capacitor capacity 3 μ F 450V tolerance 5% 50/60Hz ambient temperature max. -25 to +85°C \varnothing 25mm L 56mm M8 plastic connection cable 250mm 416.17.77GF protection			

cross flow fans

ebm-papst



1

GEV No.	601291	Ref. No.	40701006	
description	cross flow fan QLZ06/0018A335-2524L-74rk roller \varnothing 60mm roller length 180mm laminated core thickness 23mm motor position left 220-240V/50-60Hz 30W bearing silicone connection male faston 6.3mm airflow 150m ³ /h 0 up to +60°C 220-240V 50Hz			
accessories for	601291			
	GEV No.	550782	Ref. No.	44303016
	connecting cable L 3100mm			

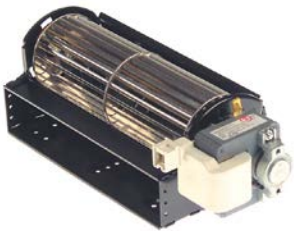
1

GEV No.	601290	Ref. No.	40701008
description	cross flow fan QZ06/1800A310-2524L-71rk roller ø 60mm roller length 180mm laminated core thickness 23mm motor position right 220-240V/50-60Hz 30W universal bearing silicone connection male faston 6.3mm airflow 170m ³ /h 0 up to +60°C 230V 50Hz		
accessories for	601290		
	GEV No.	Ref. No.	44303016
	connecting cable L 3100mm		

COPREL
with moulded coils



1

GEV No.	602103	Ref. No.	40701051
description	cross flow fan COPREL TFL roller ø 45mm roller length 240mm laminated core thickness 15mm motor position left 230V/50-60Hz 16W universal bearing silicone connection cable 3000mm airflow 110m ³ /h -10 up to +50°C		



1

GEV No.	602105	Ref. No.	40701050
description	cross flow fan COPREL TFR roller ø 45mm roller length 240mm laminated core thickness 15mm motor position right 230V/50-60Hz 16W universal bearing silicone connection cable 3000mm airflow 110m ³ /h -10 up to +50°C		

electric accessories

cables

connection cables



1

GEV No.	550782	Ref. No.	44303016
description	connecting cable L 3100mm		

equipment-specific units

for fridges

drawers

drawers



1

GEV No.	695269	Ref. No.	60602686
description	drawer L 550mm W 320mm H 100mm		

for refrigerated counters

worktops



1

GEV No.	695268	Ref. No.	45205014
description	cutting board L 1295mm W 150mm H 25mm		



1

GEV No.	695267	Ref. No.	45205013
description	cutting board L 860mm W 150mm H 25mm		



1

GEV No.	695266	Ref. No.	45205015 61001081
description	cutting board L 880mm W 150mm H 25mm		



1

GEV No.	693817	Ref. No.	44901021
description	glass panel L 1460mm W 280mm thickness 10mm rectangular		

for freezer cabinets
spare parts and accessories



1

GEV No.	692116	Ref. No.	60607149
description	mounting set		



1

GEV No.	693822	Ref. No.	44901058
description	glass panel L 1460mm W 340mm thickness 10mm rectangular		

glass panels

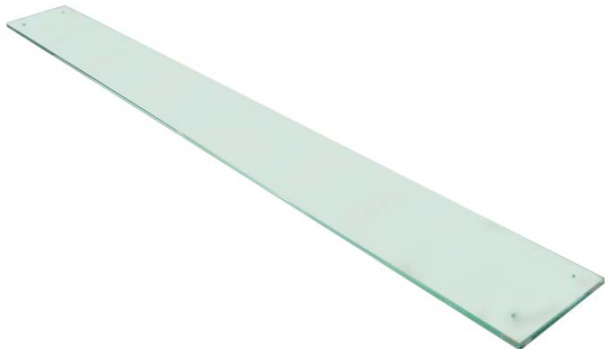

1

GEV No.	693818	Ref. No.	44901016
description	glass panel L 1440mm W 156mm thickness 10mm rectangular		

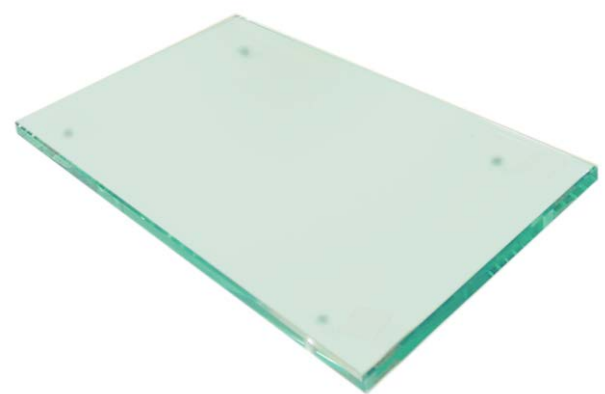

1

GEV No.	693816	Ref. No.	44901015
description	glass panel L 342/378mm W 165/185mm thickness 10mm trapezoidal Qty 2 pcs		

1

GEV No.	693821	Ref. No.	44901056
description	glass panel L 380mm W 183mm thickness 10mm dimensions 380(340)x183(163)mm		



1

GEV No.	693811	Ref. No.	44901068
description	glass panel L 571mm W 260mm thickness 8mm		

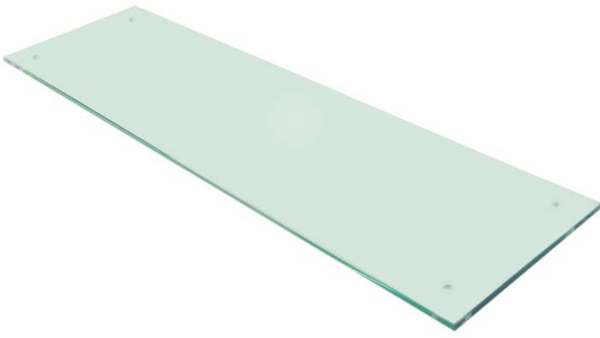

1

GEV No.	693812	Ref. No.	44901067
description	glass panel L 854mm W 260mm thickness 8mm rectangular		

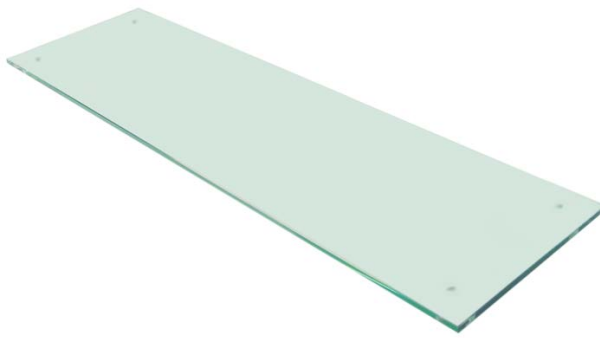

1

GEV No.	693813	Ref. No.	44901066
description	glass panel L 870mm W 250mm thickness 10mm rectangular		



Image not available

1

GEV No.	693814	Ref. No.	61004004
description	glass panel set 2-piece		



Image not available

1

GEV No.	693819	Ref. No.	60607168
description	glass panel set 2-piece		



Image not available

1

GEV No.	693820	Ref. No.	60607167
description	glass panel set 2-piece		



Image not available

1

GEV No.	693823	Ref. No.	60607218
description	glass panel set 2-piece		



1

GEV No.	693825	Ref. No.	60607217
description	glass panel set 2-piece		

for display coolers

glass panels

accessories



1

GEV No.	695264	Ref. No.	42001007
description	bracket for glass plate double		



1

GEV No.	695265	Ref. No.	42001008
description	bracket for glass plate triple		

for espresso machines

brewing units

shower screens

screws



1

GEV No.	560300	Ref. No.	44404002
description	countersunk screw thread M5 L 16mm SS DIN 963/ISO 2009 Qty 1 pcs intake slotted head ø 9mm		

for convection ovens/combi-steamers

doors



1

GEV No.	695263	Ref. No.	42001005
description	bracket for glass plate		

door mechanics

holders



1

GEV No.	695263	Ref. No.	42001005
description	bracket for glass plate		

handles and hand wheels

bracket handles



1

GEV No.	690450	Ref. No.	42201011
description	pull handle L 275mm H 43mm mounting distance 227mm		

recessed handles



1

GEV No.	695262	Ref. No.	42601036
description	recessed handle		

hinges

piano hinges

producer-specific

MERCATUS

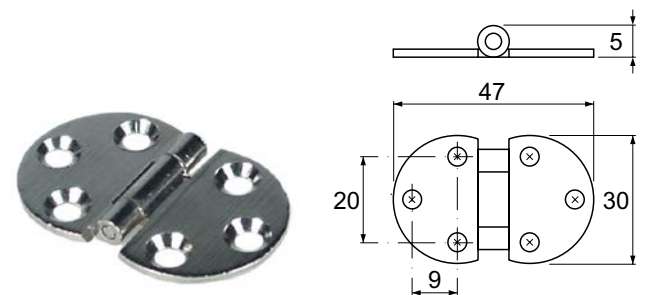

1



GEV No.	690961	Ref. No.	42001001
description	hinge L 47mm W 30mm H 5mm mounting distance 20mm mounting distance 19mm hole ø 4.5mm thickness 2mm		

spring assisted hinges

producer-specific

MERCATUS

 <p>1</p>			
GEV No.	690957	Ref. No.	42001059 + 42001026 60601201
description	hinge mounting pos. left		

 <p>1</p>			
GEV No.	690956	Ref. No.	42001025 42001025+42001058 60601202
description	hinge mounting pos. right		
spare parts for	690956		
 <p>hinge bearing without bolt</p>			
GEV No.	690958	Ref. No.	42001027 42001058 42001059 60601041

door bearing

 <p>1</p>			
GEV No.	695260	Ref. No.	44601011
description	bush		

 <p>1</p>			
GEV No.	700896	Ref. No.	60701220
description	hinge L 175mm mounting pos. lower with bolt shaft ø 7mm		

 <p>1</p>			
GEV No.	690960	Ref. No.	60605086
description	hinge bearing mounting pos. left without bolt		

 <p>1</p>			
GEV No.	690959	Ref. No.	60605085
description	hinge bearing mounting pos. right without bolt		

 <p>1</p>			
GEV No.	690958	Ref. No.	42001027 42001058 42001059 60601041
description	hinge bearing without bolt		

miscellaneous

 <p>1</p>			
GEV No.	690963	Ref. No.	42001004
description	hinge left		

 <p>1</p>			
GEV No.	690962	Ref. No.	42001003
description	hinge right		

pullouts

frame



1

GEV No.	690797	Ref. No.	60602692
description	frame fortelescopic rail mounting pos. left		



1

GEV No.	690796	Ref. No.	60602691
description	frame fortelescopic rail mounting pos. right		

equipment feet and end caps

equipment feet

with fixing plate



1

GEV No.	700712	Ref. No.	42101001
description	equipment foot tube ø 57mm plate size 80x100mm hole distance 60x78mm H 135-215mm SS size 2 1/4" Qty 1 pcs		



1

GEV No.	700120	Ref. No.	42101004
description	equipment foot tube ø 57mm plate size 90x100mm hole distance 60x78mm H 130-210mm SS size 2" Qty 1 pcs		

TENTE

with fixing plate

chrome-plated steel



1

GEV No.	700344	Ref. No.	42701003 42701005
description	swivel castor ø 100mm plate fixing housing zinc-plated sheet steel plate size 105x85mm hole distance 60x78mm capacity 80kg bearing slide bearing wheel body polypropylene tread TPE tyres H 128mm wheel width 32mm Qty 1 pcs		

miscellaneous

with fixing plate

ø100mm



1

GEV No.	700345	Ref. No.	42701004
description	swivel castor with swivel brake ø 100mm plates fixing 105x85mm		



diverse sets





 <p>1</p>			
GEV No.	700912	Ref. No.	10001009-0-0-0
description	swivel castor set ø 100mm plates fixing 105x85mm bearing ball bearing H 127mm wheel width 38mm 2x with swivel brake 4-piece		

shelves and shelf rails

grates

universal



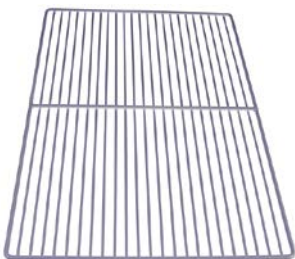

without upstand

 <p>1</p>			
GEV No.	970125	Ref. No.	46501009
description	grate W 325mm D 530mm GN 1/1 plastic-coated steel crossing wires 1 white suitable for refrigerator		
accessories for	970125		
	GEV No.	690330	Ref. No. —
	rack L 1000mm W 22mm H 4mm aperture 3x8mm hole distance 12.5mm stainless steel		
	GEV No.	694700	Ref. No. —
	shelf support L 31/28mm W 22mm H 18mm SS Qty 12 pcs		
	GEV No.	694701	Ref. No. —
	shelf support L 31/28mm W 22mm H 17mm SS with hook Qty 12 pcs		
 <p>1</p>			
GEV No.	970468	Ref. No.	46501003 46502001
description	grate W 400mm D 480mm plastic-coated steel crossing wires 1 suitable for refrigerator		

 <p>1</p>			
GEV No.	970469	Ref. No.	46501002 46502007
description	grate W 400mm D 600mm plastic-coated steel crossing wires 1 suitable for refrigerator		

 <p>1</p>			
GEV No.	970660	Ref. No.	61404045
description	grate W 835mm D 805mm		

with upstand

 <p>1</p>			
GEV No.	970556	Ref. No.	46502004
description	grate W 530mm D 650mm GN 2/1 plastic-coated steel with hinge camp wire gauge frame 9mm lengthwise wires gauge 5mm crossing wires 2 white suitable for refrigerator		
accessories for	970556		
	GEV No.	690330	Ref. No. —
	rack L 1000mm W 22mm H 4mm aperture 3x8mm hole distance 12.5mm stainless steel		
	GEV No.	690332	Ref. No. —
	shelf support L 31/28mm W 22mm H 17mm SS with hook Qty 1 pcs		
	GEV No.	694700	Ref. No. —
	shelf support L 31/28mm W 22mm H 18mm SS Qty 12 pcs		
	GEV No.	694701	Ref. No. —
	shelf support L 31/28mm W 22mm H 17mm SS with hook Qty 12 pcs		

producer-specific

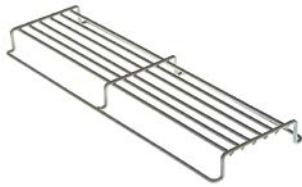

1	GEV No.	970467	Ref. No.	46501004
	description	grate W 125mm D 385mm H 30mm steel suitable for refrigerator		

shelf rails and supports

producer-specific



1	GEV No.	700889	Ref. No.	45907006
	description	bolt ø 7mm L 10mm M5 stainless steel		



1	GEV No.	695249	Ref. No.	60602677
	description	pair of setting bar E-shape L 560mm W 31mm H 14mm mounting pos. left/right		



1	GEV No.	695252	Ref. No.	61001070
	description	pair of setting bar E-shape L 568mm W 10mm H 30mm mounting pos. left/right		



1	GEV No.	695860	Ref. No.	60701431
	description	pair of setting bar E-shape L 635mm W 14mm H 15mm mounting pos. left/right		

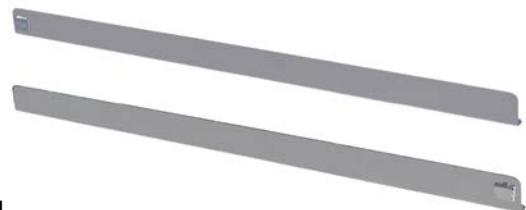

1	GEV No.	695250	Ref. No.	60603128
	description	pair of setting bar L-shape L 580mm W 31mm H 18mm mounting pos. left/right		
	For models:	PK20, PK25		



1	GEV No.	695248	Ref. No.	60601785
	description	pair of setting bar U-shape L 460mm W 16mm H 29mm mounting pos. left/right		



1	GEV No.	695251	Ref. No.	60604292
	description	pair of setting bar U-shape L 473mm W 16mm H 29mm mounting pos. left/right		



1	GEV No.	695253	Ref. No.	60601694
	description	rack L 285mm W 31mm		



1	GEV No.	695258	Ref. No.	60601470
	description	rack L 338mm W 48mm		



1



GEV No.	695259	Ref. No.	61001028
description	rack L 340mm W 31mm		

1



GEV No.	695256	Ref. No.	60604278
description	rack L 410mm W 32mm		

1



GEV No.	695255	Ref. No.	60602574
description	rack L 483mm W 31mm mounting pos. rear		

1



GEV No.	695254	Ref. No.	60601693
description	rack L 505mm W 31mm		

1

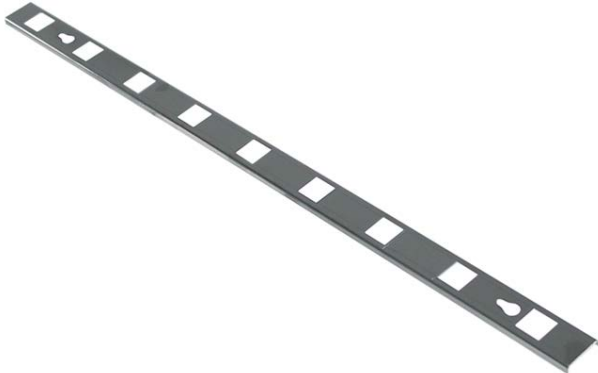

GEV No.	695257	Ref. No.	60604277
description	rack L 650mm W 32mm		

1



GEV No.	700888	Ref. No.	61503011
description	rack L 990mm W 32mm mounting pos. left/right hole distance 225mm aperture 20x20mm		

gaskets

refrigeration gaskets

plug-in gaskets

profile 9048

We offer custom-made gaskets for this profile

1

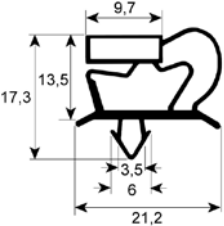

GEV No.	900549	Ref. No.	41801031
description	refrigeration gasket profile 9048 W 160mm L 395mm plug size		

1

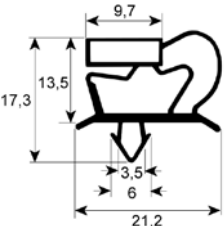

GEV No.	901346	Ref. No.	41801023
description	refrigeration gasket profile 9048 W 222mm L 400mm plug size		

1

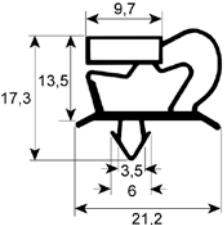

GEV No.	900548	Ref. No.	41801030
description	refrigeration gasket profile 9048 W 267mm L 394mm plug size		

GEV No.	900546	Ref. No.	41801028
description	refrigeration gasket profile 9048 W 267mm L 472mm plug size		

GEV No.	900553	Ref. No.	41801021
description	refrigeration gasket profile 9048 W 394mm L 484mm plug size		

GEV No.	900557	Ref. No.	41801016
description	refrigeration gasket profile 9048 W 285mm L 390mm plug size		

GEV No.	900550	Ref. No.	41801029
description	refrigeration gasket profile 9048 W 394mm L 600mm plug size		

GEV No.	900555	Ref. No.	41801004
description	refrigeration gasket profile 9048 W 285mm L 465mm plug size		

GEV No.	900554	Ref. No.	41801002
description	refrigeration gasket profile 9048 W 465mm L 618mm plug size		

GEV No.	900551	Ref. No.	41801011
description	refrigeration gasket profile 9048 W 363mm L 466mm plug size		

GEV No.	900547	Ref. No.	41801027
description	refrigeration gasket profile 9048 W 470mm L 600mm plug size		

GEV No.	900556	Ref. No.	41801015
description	refrigeration gasket profile 9048 W 390mm L 618mm plug size		

GEV No.	900552	Ref. No.	41801007
description	refrigeration gasket profile 9048 W 470mm L 770mm plug size		

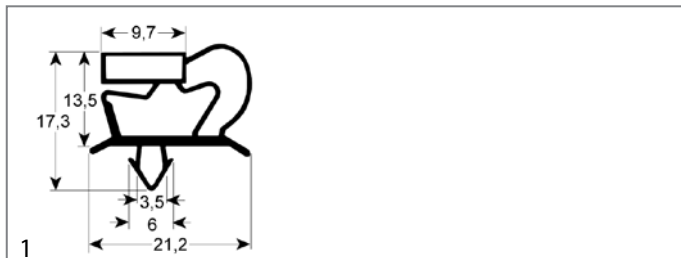

GEV No.	902258	Ref. No.	N/A
description	refrigeration gasket profile 9048 Wmm L 2500mm		

profile 9703

We offer custom-made gaskets for this profile

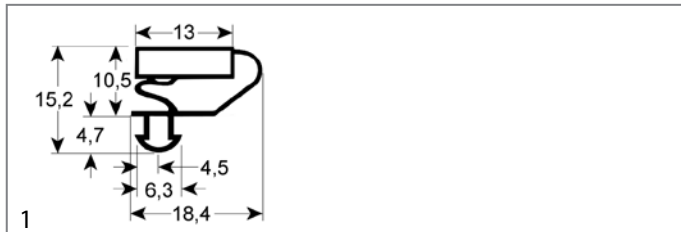

GEV No.	901506	Ref. No.	41801056
description	refrigeration gasket profile 9703 W 478mm L 632mm glass door		

profile 9194

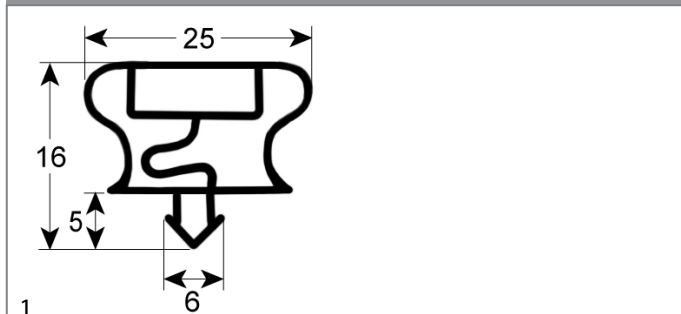

GEV No.	902403	Ref. No.	41801037
description	refrigeration gasket profile 9194 W 210mm L 395mm plug size		

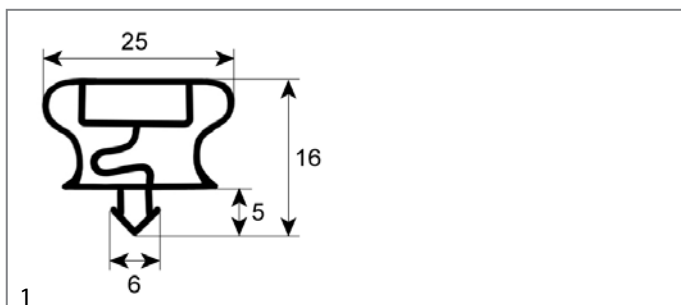

GEV No.	901344	Ref. No.	41801022
description	refrigeration gasket profile 9194 W 400mm L 174mm plug size Qty 1		

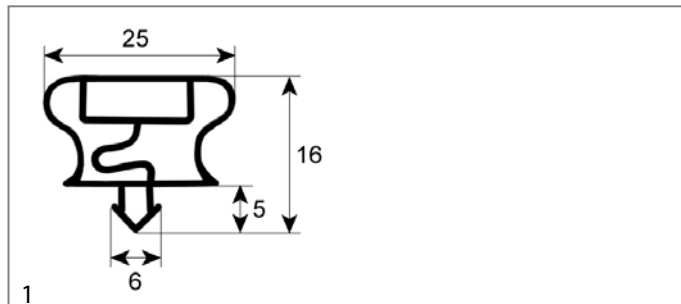

GEV No.	901345	Ref. No.	41801024
description	refrigeration gasket profile 9194 W 405mm L 400mm plug size Qty 1		

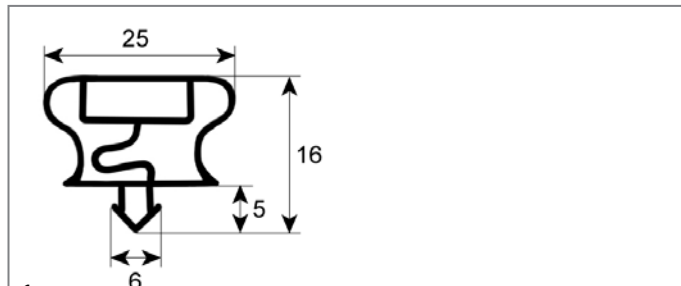

GEV No.	901309	Ref. No.	41801025
description	refrigeration gasket profile 9194 W 650mm L 1480mm plug size Qty 1		

refrigeration cycle components

valves

expansion valves

DANFOSS

valves

type TUA/TUB/TUC



GEV No.	750016	Ref. No.	41604006
description	expansion valve DANFOSS type TUB coolant R134a angled 90° thermostatically controlled inlet 6mm ODF outlet 12mm ODF p max 34bar -40 up to +10°C capillary pipe 800mm		

shut-off valves

3-way



GEV No.	750073	Ref. No.	41602002
description	shut-off valve CASTEL type 6070/23M8 3-way connection 1: 7/16" UNF (1/4" SAE) connection 2: 5/8" UNF (3/8" SAE) connection 3: 8mm soldering connection throughput 1.29m ³ /h p max 30bar -60 up to +120°C		

filter driers

DANFOSS



GEV No.	750037	Ref. No.	41002006
description	dryer connection 7/16" UNF (1/4" SAE) 41cm ³ p max 46bar -40 up to +70°C 216g type DCL 032 size 3 cubic inches		

GEV No.	750159	Ref. No.	40209004
description	evaporator L 2244mm W 153mm H 80mm		

GEV No.	750163	Ref. No.	40211003
description	evaporator L 370mm W 370mm complete with fan		
spare parts for	750163		
GEV No.	601030	Ref. No.	—
description	axial fan L 119mm W 119mm H 38mm 230VAC 50Hz 18W bearing ball bearing manuf. no. 4656Z metal connection male faston 2.8mm ebm-papst fan wheel ø 110mm temp.-resist. 75°C		

GEV No.	750162	Ref. No.	40211001
description	evaporator L 420mm W 85mm H 345mm complete with fan		
spare parts for	750162		
GEV No.	601030	Ref. No.	—
description	axial fan L 119mm W 119mm H 38mm 230VAC 50Hz 18W bearing ball bearing manuf. no. 4656Z metal connection male faston 2.8mm ebm-papst fan wheel ø 110mm temp.-resist. 75°C		

GEV No.	750158	Ref. No.	40209003
description	evaporator L 1750mm W 155mm H 80mm		
GEV No.	750161	Ref. No.	40210001
description	evaporator L 445mm W 355mm H 68mm		

evaporators

for fridges

producer-specific



GEV No.	750157	Ref. No.	40209002
description	evaporator L 1250mm W 75mm H 150mm		



GEV No.	750158	Ref. No.	40209003
description	evaporator L 1750mm W 155mm H 80mm		

GEV No.	750161	Ref. No.	40210001
description	evaporator L 445mm W 355mm H 68mm		



			
1			
GEV No.	750156	Ref. No.	40209001
description	evaporator L 710mm W 80mm H 155mm		

evaporation and condensing trays

unheated condensing trays

			
1			
GEV No.	750707	Ref. No.	42601063
description	condensing tray L 545mm W 81mm H 25mm plastic		

fastening material

screws

countersunk screws

			
1			
GEV No.	560300	Ref. No.	44404002
description	countersunk screw thread M5 L 16mm SS DIN 963/ISO 2009 Qty 1 pcs intake slotted head ø 9mm		

hexagonal screws

			
1			
GEV No.	560089	Ref. No.	44401003
description	hexagonal screw thread M6 thread L 25mm SS WS 10 Qty 20 pcs DIN 933 / ISO 4017		

			
1			
GEV No.	695261	Ref. No.	44401050
description	hexagonal screw thread M5 thread L 12mm		

nuts

cap nuts

			
1			
GEV No.	560136	Ref. No.	44503007
description	cap nuts thread M5 WS 8 SS Qty 20 pcs DIN/ISO DIN 1587		

A

axial fans 6

C

cables 9

cap nuts 21

castors and bumper angles 14

cold air circulating fans (complete) 8

compressors 5

connection cables 9

countersunk screws 21

cross flow fans 8

E

electric accessories 9

electronic controllers 3

evaporators 20

expansion valves 19

F

fans 6

fastening material 21

filter driers 20

G

grates 15

H

hexagonal screws 21

I

indicator lights 3

indicator lights (complete) 3

L

lamps 3

N

nuts 21

P

piano hinges 12

plug-in gaskets 17

pressure switches 5

probes 5

R

refrigeration cycle components 19

refrigeration fans 7

refrigeration gaskets 17

refrigeration motors universal 7

rocker/momentary rocker switches 3

S

screws 21

shelves and shelf rails 15

shut-off valves 20

spring assisted hinges 13

switches and momentary switches 3

T

temperature probes 5

U

universal probes 5