



GAS COMPONENTS



ELECTRIC COMPONENTS



WATER TECHNOLOGY



MECHANICAL COMPONENTS



TOOLS

Spare parts suitable for

MODULAR

Find the complete and up-to-date range of products in our GEV Webshop



Manufacturer catalogue

The most important spare parts and accessories arranged clearly for every manufacturer

- ✓ Complete product range and all appliance data always up to date in the GEV Webshop
- ✓ Alphabetical Index at the end of the catalogue

GEV Webshop

www.gev-online.co.uk

www.gev-online.com



- 🔍 Add to Favourites
- 🔍 Sign In with email address and usual password
- 🔍 Easy-order – place several items in your basket at the same time
- 🔍 Quick Item search – no login needed



heating elements

heating elements for ovens

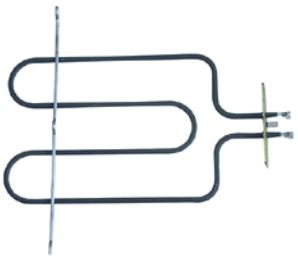

GEV No.	416533	Ref. No.	66506200
description	heating element 1400W 230V heating circuits 1 L 305mm W 180mm L1 52mm L2 250mm W1 75mm W2 30mm flange length 100mm flange width 22mm hole distance 79mm bridge length 300mm hole ø 4mm tube ø 6.3mm connection male faston 6.3mm rectangular flange grill setting oven		
For models:	60/60CFE, 60/60CFG, 60/60CFGE		

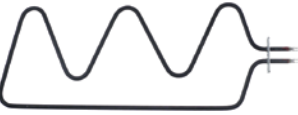

GEV No.	420111	Ref. No.	965.060.00
description	heating element 1500W 230V heating circuits 1 L 555mm W 210mm L1 70mm L2 485mm W1 88mm W2 33mm flange length 70mm flange width 22mm hole distance 56mm hole ø 5mm tube ø 8.5mm connection male faston 6.3mm connection length 17mm windings 3 flange connection dry heating element for oven		

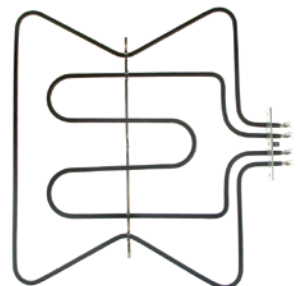

GEV No.	417441	Ref. No.	66508200
description	heating element 2300W 230V heating circuits 2 L 355mm W 393mm L1 38mm L2 317mm W1 165mm W2 67mm flange length 100mm flange width 22mm hole distance 86mm hole ø 4mm tube ø 6.3mm connection male faston 6.3mm rectangular flange dry heating element oven		

heating elements for bain maries



GEV No.	415927	Ref. No.	66500400
description	heating element 1200W 240V heating circuits 1 L 405mm W 88mm H 32mm lug length 40mm lug width 18mm dry heating element hole distance 44mm connection M5 bracket mounting mounting thread M5		
For models:	65/70BME, 70/70BME		



GEV No.	416538	Ref. No.	96500200
description	heating element 1470W 230V heating circuits 1 L 528mm W 95mm H 30mm lug length 40mm lug width 19mm tube ø 8.5mm dry heating element hole distance 46mm connection M5 bracket mounting connection length 34mm hole ø 5mm water bath		



GEV No.	416536	Ref. No.	66505600
description	heating element 1500W 230V L 275mm W 80mm connection M4 tube ø 6.3mm 2 hole fixing thread 1/8" immersion heater H 22mm mounting distance 74mm		
For models:	60/30BME		

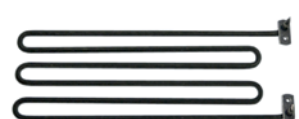

GEV No.	415926	Ref. No.	66500300
description	heating element 1800W 240V heating circuits 1 L 403mm W 128mm H 32mm lug length 40mm lug width 18mm tube ø 8.5mm dry heating element hole distance 80mm bracket mounting mounting thread M5		
For models:	65/40BME, 70/40BME		



GEV No.	416537	Ref. No.	96500100
description	heating element 2200W 230V heating circuits 1 L 523mm W 134mm H 32mm lug length 40mm lug width 18mm tube ø 9mm dry heating element hole distance 79mm connection M5 bracket mounting connection length 30mm mounting thread M5 bain marie		





GEV No.	417724	Ref. No.	965.062.00
description	heating element 2500W 230V heating circuits 1 L 630mm W 90mm flange length 100mm flange width 35mm hole distance 88mm connection M5 tube ø 8.5mm rectangular flange hole ø 6mm immersion heater bain marie		



GEV No.	417346	Ref. No.	66505800	
description	heating element 3000W 230V heating circuits 1 L 278mm W 162mm connection M4 tube ø 6.5mm 2 hole fixing thread M10x1 immersion heater/dry heating element bain marie H 23mm mounting distance 156mm			
For models:	60/60BME			
accessories for	417346			
	GEV No.	510416	Ref. No.	—
	flat gasket fibre ED ø 19mm ID ø 10.5mm thickness 1.5mm for thread M10 Qty 1 pcs			

Table continues overleaf



accessories for	417346			
	GEV No.	510893	Ref. No.	—
	O-ring EPDM thickness 2.62mm ID ø 9.92mm Qty 1 pcs			
	GEV No.	520231	Ref. No.	—
	nut thread M10x1 H 6mm WS 14 zinc-coated steel Qty 1 pcs			
	GEV No.	521129	Ref. No.	—
	nut thread M10 H 6mm SS WS 17 Qty 1 pcs DIN/ISO DIN 439			

heating elements for fryers

off-center connection

with thread

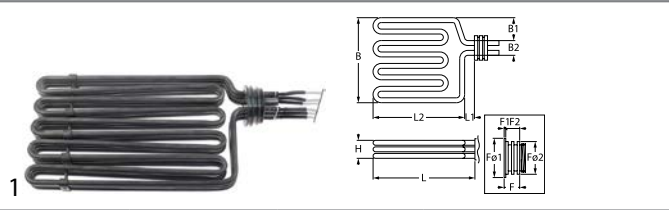

1

GEV No.	420482	Ref. No.	665.101.00
description	heating element 12000W 230V heating circuits 3 L 315mm W 175mm H 32mm flange length 26mm flange ø1 62mm sensor screw connection M10x1 number of thermostat sleeves 2 thermostat sleeve upper/lower L1 15mm L2 300mm W1 30mm W2 33mm for o-ring ø 51/56mm tube ø 8.5mm cable length 515mm connection cable		

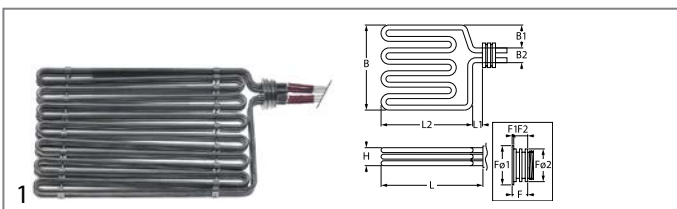

1

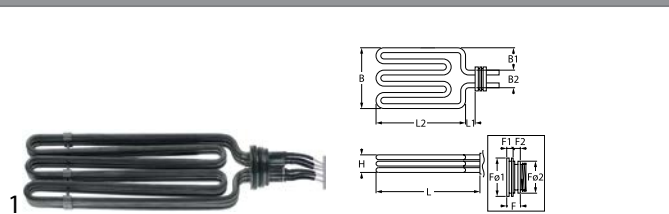

GEV No.	420560	Ref. No.	965.065.00
description	heating element 20000W 400V heating circuits 3 L 425mm W 255mm H 35mm flange length 19mm flange ø1 62mm flange ø2 57mm L1 21mm L2 408mm W2 34mm thread M54x1.5 tube ø 8.5mm cable length 510mm fryer		

center connection



1

GEV No.	416824	Ref. No.	66509900
description	heating element 7000W 230/400V heating circuits 3 L 325mm W 110mm H 33mm flange length 19.5mm flange length 1 9.5mm flange length 2 9.8mm flange ø1 62mm flange ø2 57mm thermostat sleeves ø 8mm sensor screw connection 2x M10x1 thermostat sleeve upper/lower L1 18mm L2 307mm W1 40mm W2 35mm thread M54x1.5 tube ø 8.5mm cable length 520mm rotation flange immersion heater fryer connection length 50mm 2		

spare parts for	416824			
	GEV No.	510243	Ref. No.	653.018.00
	O-ring Viton thickness 3.53mm ID ø 55.56mm Qty 1 pcs			
	GEV No.	550496	Ref. No.	—
	O-ring Viton thickness 3.53mm ID ø 50.39mm Qty 1 pcs			

accessories for	416824			
	GEV No.	550447	Ref. No.	—
	ring nut thread M54x1.5			

2 hole fixing

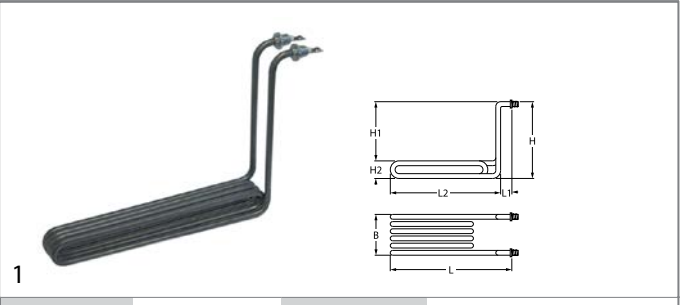

1

GEV No.	420177	Ref. No.	665001 66500100
description	heating element 2100W 230V heating circuits 1 L 293mm W 40mm H 205mm L1 23mm L2 270mm H1 165mm H2 40mm thread M14x1.5 mounting distance 35mm tube ø 8.5mm 2 hole fixing connection M5 connection length 23mm immersion heater windings 4		

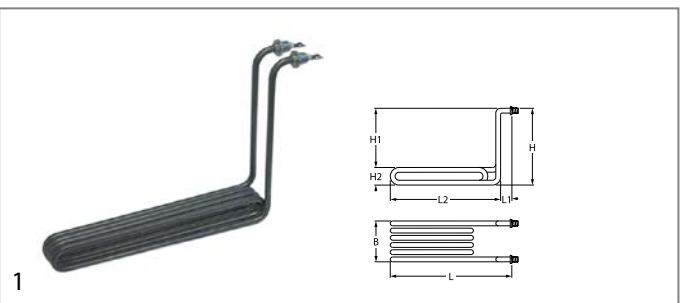

1

GEV No.	415929	Ref. No.	66502800
description	heating element 2500W 230V heating circuits 1 L 293mm W 40mm H 205mm L1 23mm L2 270mm H1 165mm H2 40mm thread M14x1.5 mounting distance 35mm tube ø 8.5mm 2 hole fixing connection M5 connection length 23mm immersion heater windings 4		

spare parts for	415929			
	GEV No.	510417	Ref. No.	—
	flat gasket fibre ED ø 20mm ID ø 14mm thickness 2mm Qty 1 pcs			

accessories for	415929			
	GEV No.	520228	Ref. No.	—
	tooth lock washer ID ø 15.3mm ED ø 24mm steel Qty 1 pcs for thread M14			
	GEV No.	520230	Ref. No.	—
	nut thread M14x1.5 H 5mm WS 19 zinc-coated steel Qty 1 pcs			
	GEV No.	521101	Ref. No.	—
	nut thread M14x1.5 H 5mm WS 19 SS Qty 1 pcs			
	GEV No.	550262	Ref. No.	—
	flat gasket copper ED ø 20mm ID ø 14mm thickness 2mm			
	GEV No.	560112	Ref. No.	—
	plain washer ID ø 5.3mm ED ø 10mm thickness 1mm SS Qty 20 pcs DIN 125A for thread M5			
	GEV No.	560132	Ref. No.	—
	hexagonal nut thread M5 H 4mm WS 8 SS DIN/ISO DIN 934 / ISO 4032/8673 Qty 20 pcs			





			
GEV No.	419031	Ref. No.	965.009.00
description	heating element 3400/3700W 230/240V heating circuits 1 L 405mm W 44mm H 228mm L1 25mm L2 380mm H1 192mm H2 36mm thread M14x1.5 mounting distance 36mm tube ø 8.5mm 2 hole fixing connection M5 immersion heater windings 4 fryer		
For models:	90/40 10.2KW		

heating elements for griddles

			
GEV No.	417659	Ref. No.	965.033.00 965.052.00
description	heating element 1000W 230V heating circuits 1 L 295mm W 85mm H 80mm tube ø 8.5mm		

			
GEV No.	416534	Ref. No.	66505700
description	heating element 1000W 230V heating circuits 1 L 422mm W 70mm H 66mm tube ø 8.5mm connection M5 connection distance 61mm dry heating element		
For models:	60/30FTRE, 60/30FTRE-CR, 60/60FTE, 60/60FTE-CR, 60/60FTRE, 60/60FTRE-CR, 60/60FTRRE, 60/60FTRRE-CR, 60/60FTRRG		

			
GEV No.	417736	Ref. No.	665.095.00 665.095.12
description	heating element 1800W 230V heating circuits 1 L 470mm W 95mm H 95mm tube ø 8.5mm connection M4		

			
GEV No.	415928	Ref. No.	66500200
description	heating element 1800W 240V heating circuits 1 L 470mm W 90mm H 65mm tube ø 8.5mm connection M5 connection distance 82mm dry heating element		
For models:	65/40FTE, 65/40FTRE, 65/70FTE, 65/70FTRE, 65/70FTRRE, 70/40FTE, 70/40FTE-CR, 70/40FTES, 70/40FTRE, 70/40FTRE-CR, 70/70CFE, 70/70FTE, 70/70FTE-CR, 70/70FTES, 70/70FTRE, 70/70FTRE-CR, 70/70FTRRE, 70/70FTRRE-CR		

			
GEV No.	420105	Ref. No.	665.102.00
description	heating element 2000W 230V heating circuits 1 L 480mm W 90mm H 42mm tube ø 8.5mm IRCA L1 50mm L2 430mm W1 49mm W2 20mm flange connection connection M5 hole distance 89mm flange length 100mm flange width 35mm hole ø 6mm windings 2 dry heating element		

			
GEV No.	415932	Ref. No.	96500000
description	heating element 2186/2380W 230/240V heating circuits 1 L 650mm W 78mm H 72mm tube ø 8.5mm connection M5 connection length 20mm griddle connection distance 65mm dry heating element		

			
GEV No.	417735	Ref. No.	965.059.12
description	heating element 2500W 230V heating circuits 1 L 610mm W 80mm H 95mm tube ø 8.5mm connection M4		

heating elements for tilting bratt pan

			
GEV No.	416539	Ref. No.	66502300
description	heating element 2100W 230V heating circuits 1 L 383mm W 170mm H 60mm W1 35mm W2 100mm connection M5 connection distance 92mm tube ø 8.5mm dry heating element tilting bratt pan		
For models:	70/70BRE, 70/70BREM		

			
GEV No.	417737	Ref. No.	665.105.00
description	heating element for tilting bratt pan 1500W 230V L 455mm W 80mm H 60mm heating circuits 1 tube ø 6.5mm		

			
GEV No.	420556	Ref. No.	965.074.00
description	heating element for tilting bratt pan 6350W 230V L 550mm W 310mm H 30mm connection screw heating circuits 1 tube ø 8.5mm		



			
GEV No.	417726	Ref. No.	665.110.00
description	heating element tilting bratt pan 3330W 230V L 385mm W 220mm H 35mm connection M4 dry heating element heating circuits 1 tube ø 8.5mm		







			
GEV No.	416540	Ref. No.	96500700 96500715
description	heating element tilting bratt pan 3330W 230V L 506mm W 200mm H 63mm dry heating element heating circuits 1 tube ø 8.5mm W1 30mm W2 140mm		

			
GEV No.	417725	Ref. No.	965.073.00
description	heating element tilting bratt pan 5000W 230V L 550mm W 190mm H 25mm connection M4 dry heating element heating circuits 1 tube ø 8.5mm		

heating elements for pasta cookers

			
GEV No.	416535	Ref. No.	66503200
description	heating element 3000W 230V heating circuits 1 L 303mm W 170mm Hmm 2 hole fixing connection M4 thread M10x1 tube ø 6.3mm mounting distance 164mm immersion heater		
For models:	60/30CPE, 60/60CPE		
spare parts for	416535		
	GEV No.	510893	Ref. No. —
O-ring EPDM thickness 2.62mm ID ø 9.92mm Qty 1 pcs			

			
GEV No.	418046	Ref. No.	46500000 66504100 66507400
description	heating element 3800W 230V heating circuits 3 L 250mm W 41mm H 34mm round flange connection male faston 6.3mm tube ø 6.3mm mounting ø 57.5mm immersion heater with gasket		
For models:	70/40CPE, 70/70CPE		
spare parts for	418046		
	GEV No.	510409	Ref. No. 835535651
O-ring EPDM thickness 5.34mm ID ø 56.52mm Qty 1 pcs			
accessories for	418046		
	GEV No.	550002	Ref. No. —
tension strap H 10mm L 21mm W 10mm hole ø 6.5mm for heating element			

			
GEV No.	419247	Ref. No.	665.103.00
description	heating element 4500W 230V heating circuits 3 L 350mm connection male faston 6.3mm tube ø 6.3mm flange ø 72mm thermostat sleeves ø 8.5mm length thermostat sleeves 200mm immersion heater		



heating elements for salamanders/toast-

			
GEV No.	418828	Ref. No.	66502700 66502713
description	heating element 2000W 240V L 225mm W 230mm L1 25mm L2 200mm W1 85mm W2 60mm hole distance 39mm tube ø 6.5mm flange length 104mm flange width 32mm heating circuits 1 hole ø 4.5mm tilting flange and adapter dry heating element H 6.5mm		



			
Image not available			
GEV No.	418827	Ref. No.	66502600
description	heating element 2000W 240V L 230mm W 225mm L1 25mm L2 200mm W1 85mm W2 55mm tube ø 6.5mm flange length 104mm flange width 32mm heating circuits 1 tilt flange dry heating element		



ceramic heaters

245x60mm



			
GEV No.	415104	Ref. No.	66501000
description	ceramic emitter 1000W 230V cable beaded cord L 245mm W 60mm H 35mm		
For models:	60/60BME, 65/40SPE, 70/40SPE		
spare parts for	415104		
	GEV No.	415109	Ref. No. —
spring clip			
accessories for	415104		
	GEV No.	415110	Ref. No. —
reflector L 245mm W 95mm H 31mm thickness 0.75mm hole ø 15x40mm			

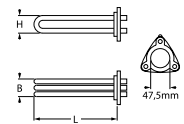



			
1			
GEV No.	415102	Ref. No.	M563001013
description	ceramic emitter 400W 230V cable beaded cord L 245mm W 60mm H 35mm		
spare parts for	415102		
	GEV No.	415109	Ref. No. —
	spring clip		
accessories for	415102		
	GEV No.	415110	Ref. No. —
	reflector L 245mm W 95mm H 31mm thickness 0.75mm hole ø 15x40mm		

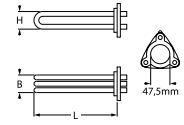

3 hole flange ø47.5mm			
 			
1			
GEV No.	419032	Ref. No.	465.010.13
description	heating element 4500W 230V mounting ø 47.5mm heating circuits 3 L 285mm W 32mm H 40mm number of thermostat sleeves 1 thermostat sleeves ø 7.5mm length thermostat sleeves 233mm thermostat sleeve eccentric, clinging tube ø 6.3mm hole distance 63mm hole ø 8mm connection length 25mm connection M4 3 hole flange immersion heater		
accessories for	419032		
	GEV No.	510408	Ref. No. 0835534701
	O-ring EPDM thickness 5.34mm ID ø 47mm Qty 1 pcs		

immersion heating elements

3 hole flange ø38.5mm			
connection angled			
			
1			
GEV No.	420212	Ref. No.	465.008.14
description	heating element 2000W 230V mounting ø 38.5mm heating circuits 1 L 330mm W 33mm H 16mm hole distance 57mm hole ø 10mm tube ø 6mm connection male faston 6.3mm immersion heater 3 hole flange		
accessories for	420212		
	GEV No.	532577	Ref. No. —
	O-ring EPDM thickness 5.34mm ID ø 40.65mm Qty 1 pcs		

 			
1			
GEV No.	416664	Ref. No.	46500600
description	heating element 6000W 230V mounting ø 47.5mm heating circuits 3 L 405mm W 31mm H 34mm number of thermostat sleeves 1 thermostat sleeves ø 7mm length thermostat sleeves 225mm thermostat sleeve eccentric, non clinging		

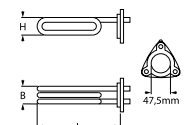
			
1			
GEV No.	419033	Ref. No.	465.009.00
description	heating element 4500W 230V mounting ø 38.5mm heating circuits 3 L 295mm W 28mm H 35mm L1 30mm L2 265mm H2 30mm hole distance 58mm hole ø 10mm tube ø 6.3mm connection male faston 6.3mm immersion heater 3 hole flange		
spare parts for	419033		
	GEV No.	521120	Ref. No. —
	O-ring EPDM thickness 5.34mm ID ø 37.47mm Qty 1 pcs		

 			
1			
GEV No.	415014	Ref. No.	465.011.00
description	heating element 3000W 230V mounting ø 47.5mm heating circuits 1 L 240mm W 28mm H 44mm number of thermostat sleeves 1 thermostat sleeves ø 7mm length thermostat sleeves 220mm thermostat sleeve not clinging tube ø 6.3mm hole distance 62mm hole ø 8mm connection male faston 6.3mm 3 hole flange immersion heater		
accessories for	415014		
	GEV No.	510408	Ref. No. 0835534701
	O-ring EPDM thickness 5.34mm ID ø 47mm Qty 1 pcs		
	GEV No.	510562	Ref. No. —
	O-ring silicone thickness 5.34mm ID ø 47mm Qty 1 pcs		

3 hole flange ø57.5mm

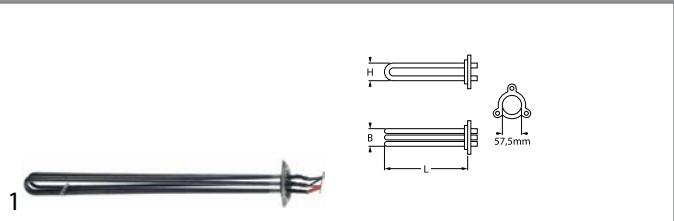

GEV No.	417738	Ref. No.	965.068.00
description	heating element 10500W 230V mounting ø 57.5mm heating circuits 3 L 575mm W 30mm H 40mm tube ø 8.5mm hole distance 75mm hole ø 8/10mm cable length 700mm connection cable 3 hole flange kettle		

with round flange ø57.5mm



GEV No.	416662	Ref. No.	66502200
description	heating element 6000W 230V heating circuits 3 L 405mm W 31mm H 46mm tube ø 6.3mm thermostat sleeves ø 7.5mm length thermostat sleeves 270mm number of thermostat sleeves 1 thermostat sleeve eccentric, clinging connection male faston 6.3mm immersion heater round flange mounting ø 57.5mm		

For models:	70/70PEI		
spare parts for	416662		

	GEV No.	510409	Ref. No.	835535651
	O-ring EPDM thickness 5.34mm ID ø 56.52mm Qty 1 pcs			

accessories for	416662		
------------------------	--------	--	--

	GEV No.	520235	Ref. No.	63501100
	3 hole flange hole distance 70.5mm perforation ø 6.5mm ID ø 53.5mm			

	GEV No.	550002	Ref. No.	—
	tension strap H 10mm L 21mm W 10mm hole ø 6.5mm for heating element			



GEV No.	416663	Ref. No.	96502500
description	heating element 8000W 230V heating circuits 3 L 510mm W 43mm H 30mm tube ø 6.3mm thermostat sleeves ø 7.5mm length thermostat sleeves 275mm number of thermostat sleeves 1 thermostat sleeve eccentric, clinging connection male faston 6.3mm immersion heater round flange mounting ø 57.5mm		

accessories for	416663		
------------------------	--------	--	--

	GEV No.	520235	Ref. No.	63501100
	3 hole flange hole distance 70.5mm perforation ø 6.5mm ID ø 53.5mm			

	GEV No.	550002	Ref. No.	—
	tension strap H 10mm L 21mm W 10mm hole ø 6.5mm for heating element			

with round flange (miscellaneous)



GEV No.	419247	Ref. No.	665.103.00
description	heating element 4500W 230V heating circuits 3 L 350mm connection male faston 6.3mm tube ø 6.3mm flange ø 72mm thermostat sleeves ø 8.5mm length thermostat sleeves 200mm immersion heater		

1"



GEV No.	420074	Ref. No.	965.066.00
----------------	--------	-----------------	------------

description	heating element 260W 230V heating circuits 1 L 242mm W 18mm H 6.25mm tube ø 6.25mm thermostat sleeves ø 5mm length thermostat sleeves 230mm number of thermostat sleeves 1 thermostat sleeve centred, adjacent connection male faston 6.3mm connection length 35mm immersion heater flange with thread WS 32 thread 1"		
--------------------	--	--	--

spare parts for	420074		
------------------------	--------	--	--

	GEV No.	503158	Ref. No.	—
	flat gasket FIBER ED ø 44mm ID ø 33mm thickness 2mm Qty 1 pcs			

accessories for	420074		
------------------------	--------	--	--

	GEV No.	507532	Ref. No.	—
	nut thread 1" H 10mm WS 40 brass Qty 1 pcs			

heating elements for convection

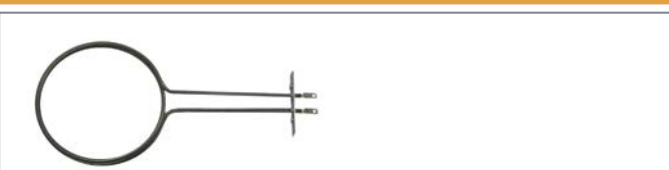

GEV No.	415925	Ref. No.	66500800
----------------	--------	-----------------	----------

description	heating element 1260W 230V heating circuits 1 ID ø 180mm L 380mm H 19mm L1 188mm W1 32mm flange length 100mm flange width 22mm hole distance 86mm ED ø 192mm connection M5 connection length 30mm tube ø 6.3mm convection heating element hole ø 5mm rectangular flange		
--------------------	---	--	--

For models:	65/110CFGE, 65/70CFE, 65/80BFE, 65/80TFE, 70/110CFGE, 70/70CFE, 70/70CFEQ, 70/70CFGE, 70/70CFVE		
--------------------	---	--	--





GEV No.	418317	Ref. No.	M563000900
----------------	--------	-----------------	------------



description	heating element 1450W 240V heating circuits 1 ID ø 185mm ED ø 200mm Lmm H 30mm L1 12mm W1 31mm H1 25mm H2 10mm flange length 70mm flange width 22mm hole distance 56mm connection male faston 6.3mm tube ø 6.3mm convection heating element mounting thread M4 rectangular flange		
--------------------	---	--	--

accessories for	418317		
------------------------	--------	--	--

	GEV No.	510368	Ref. No.	—
	gasket L 70mm W 23.5mm hole ø 5mm hole distance 56mm FIBER thickness 2mm for heating element			





			
1			
GEV No.	416532	Ref. No.	66506100
description	heating element 2300W 230V heating circuits 1 ID ø 183mm ED ø 197mm L 212mm H 30mm L1 15mm W1 31mm H1 5mm H2 25mm flange length 70mm flange width 22mm hole distance 56mm connection male faston 6.3mm tube ø 6.5mm convection heating element hole ø 5mm rectangular flange		
For models:	60/60CFE		
accessories for	416532		
		GEV No.	510368 Ref. No. —
	gasket L 70mm W 23.5mm hole ø 5mm hole distance 56mm FIBER thickness 2mm for heating element		

			
1			
GEV No.	415966	Ref. No.	M563000800
description	heating element 2500W 230V heating circuits 1 ID ø 176mm ED ø 188mm L 210mm H 28mm L1 22mm W1 30mm H1 3mm H2 25mm flange length 70mm flange width 22mm hole distance 56mm connection male faston 6.3mm tube ø 6.3mm convection heating element hole ø 5mm rectangular flange		
spare parts for	415966		
		GEV No.	510368 Ref. No. —
	gasket L 70mm W 23.5mm hole ø 5mm hole distance 56mm FIBER thickness 2mm for heating element		
accessories for	415966		
		GEV No.	510368 Ref. No. —
	gasket L 70mm W 23.5mm hole ø 5mm hole distance 56mm FIBER thickness 2mm for heating element		

			
1			
GEV No.	418020	Ref. No.	999.22.042
description	heating element 7800W 230V heating circuits 3 ID ø 264mm ED ø 277mm L 315mm H 100mm L1 35mm W1 101mm H1 29mm H2 67mm flange length 142mm flange width 23mm hole distance 63mm connection M4 connection length 75mm tube ø 6.3mm convection heating element mounting thread M4 rectangular flange		

radiation heaters

			
1			
GEV No.	490151	Ref. No.	665.054.00
description	radiation heater octagonal 2100W 230V L 230mm W 230mm heating circuits 1 with heating coil energy regulation with temperature signalization connections 2+2 connection type cable AD		

			
1			
GEV No.	490079	Ref. No.	965.041.00
description	radiation heater octagonal 3400W 230V L 300mm W 300mm heating circuits 2 H 30mm with heating coil energy regulation with temperature signalization connections 4+2 connection type cable AD		
spare parts for	490079		
		GEV No.	390931 Ref. No. —
	safety thermostat for radiation heater		

			
1			
GEV No.	490222	Ref. No.	96506900
description	radiation heater octagonal 3400W 230V L 300mm W 300mm heating circuits 2 H 35mm with heating coil energy regulation with temperature signalization		

			
1			
GEV No.	490156	Ref. No.	965.037.00
description	radiation heater rectangular 7500W 400V L 280mm W 400mm heating circuits 3 connections 6 connection type cable AD		

1-circuit



GEV No.	490042	Ref. No.	665.065.00
description	radiation heater ø 200mm 1800W 230V heating circuits 1 energy regulation with temperature signalization with ribbon heater connections 2+2 connection type male faston 6.3mm EGO		

2-circuit



GEV No.	490139	Ref. No.	66510600
description	radiation heater ø 250mm 2500W 230V heating circuits 2 energy regulation with temperature signalization partial power 1000W with ribbon heater connections 3+2 connection type male faston 6.3mm EGO		



GEV No.	490118	Ref. No.	665.052.00
description	radiation heater ø 250mm 2500W heating circuits 2 partial power 1000W		

hot plates

square & rectangular

with radiused edge



GEV No.	490068 ¹	Ref. No.	665.060.00
description	hot plate dimensions 220x220mm 2600W 400V with spill ring connection 4 screw clamps protector yes square		

¹incl. protector



GEV No.	490056 ¹	Ref. No.	96500300
description	hot plate dimensions 300x300mm 3000W 230V with spill ring connection 4 screw clamps protector yes square		

¹incl. protector



GEV No.	490057 ¹	Ref. No.	96501000
description	hot plate dimensions 300x300mm 3000W 400V with spill ring connection 4 screw clamps protector yes square		

¹incl. protector



GEV No.	490177	Ref. No.	965.013.00
description	hot plate dimensions 300x300mm 3000W 440V with spill ring connection 4 screw clamps protector no		



GEV No.	490212	Ref. No.	965.063.00
description	hot plate dimensions 300x300mm 3500W 230V with spill ring connection 4 screw clamps protector yes square		



GEV No.	490074 ¹	Ref. No.	965.011.00
description	hot plate dimensions 300x300mm 4000W 400V with spill ring connection 4 screw clamps protector yes square		

¹incl. protector



			
1			
GEV No.	490194 ¹	Ref. No.	965.015.00
description	hot plate dimensions 300x300mm 4000W 440V with spill ring connection M5 protector yes		

¹incl. protector



<p>tiltable</p> 			
1			
GEV No.	490215	Ref. No.	965.083.00
description	hot plate dimensions 300x300mm 4000W 230V with cast edge tilt boiling plate connection 4 screw clamps H 45mm square		

			
1			
GEV No.	490021	Ref. No.	665.033.00
description	hot plate ø 220mm 2600W 400V connection 4 screw clamps with 8mm spill ring		



			
1			
GEV No.	490175	Ref. No.	665.016.00
description	hot plate ø 220mm 2600W 440V connection 4 screw clamps with 8mm spill ring		

round

with radiused edge
for domestic and commercial kitchens

 			
1			
GEV No.	490014	Ref. No.	66505900
description	hot plate ø 180mm 1500W 230V connection 4 screw clamps with 8mm spill ring		
For models:	60/30PCE, 60/60CFE, 60/60PCE		



			
1			
GEV No.	490018	Ref. No.	665005
description	hot plate ø 220mm 2000W 230V connection 4 screw clamps with 8mm spill ring		



			
1			
GEV No.	490020	Ref. No.	66500600
description	hot plate ø 220mm 2600W 230V connection 4 screw clamps with 8mm spill ring		
For models:	65/40PCE, 65/70CFE, 65/70PCE, 70/40PCE, 70/70PCE		
accessories for	490020		
	GEV No.	Ref. No.	
	550796	—	
	fixing plate for hot plate ø220mm		

energy regulators

EGO

<p>1-circuit</p> 			
1			
GEV No.	380034	Ref. No.	661.069.00
description	energy regulator 230V 13A 2-stage turn direction clockwise shaft ø 6x4.6mm shaft L 36mm power release 6-100%		

 			
1			
GEV No.	380015	Ref. No.	66105800
description	energy regulator 230V 13A single-circuit turn direction right shaft ø 6x4.6mm shaft L 23mm mounting thread M4 power release 6-100% no. 50.57021.010		
For models:	60/30CPE		

<p>2-circuit</p>  			
1			
GEV No.	380024	Ref. No.	6610680 661068000
description	energy regulator 240V 13A turn direction right shaft ø 6x4.6mm shaft L 36mm mounting thread M4 no. 50.67079.601 with operation switch 1-pole		



GEV No.	380027	Ref. No.	661.102.00 66106800
description	energy regulator EGO 230V 13A dual circuit turn direction right shaft ø 6x4.6mm shaft L 23mm mounting thread M4 power release 6-70% no. 50.55021.100		



GEV No.	375548	Ref. No.	961.039.00
description	thermostat t.max. 142°C temperature range fixed 142°C 1-pole 1CO 16A probe ø 4mm probe L 157mm capillary pipe 870mm capillary pipe isolated 870mm gland nut shaft ø 6x4.6mm shaft Lmm shaft position		

thermostats

bi-metal thermostats

safety bi-metal thermostats



GEV No.	375753	Ref. No.	M564011000
description	bi-metal safety thermostat hole distance 23.5mm switch-off temp. 120°C 1NC 1-pole 16A connection F6.3 2 hole fixing		



GEV No.	375216	Ref. No.	66107300
description	thermostat t.max. 280°C temperature range 50-280°C 1-pole 1NO 16A probe ø 3mm probe L 228mm capillary pipe 1300mm capillary pipe isolated 1150mm gland nut shaft L 23mm shaft position upper rotation 318°		
For models:	60/60CFE, 60/60CFGE		

control and safety thermostats

EGO

control thermostats

55.10/19_ series



GEV No.	375001	Ref. No.	66100400
description	thermostat t.max. 112°C temperature range 30-110°C 1-pole 1NO 16A probe ø 6mm probe L 130mm capillary pipe 900mm capillary pipe isolateddmm gland nut M9x1 shaft L 23mm shaft position upper rotation 270°		
For models:	65/40BME, 70/40BME		



GEV No.	375945	Ref. No.	661.121.00
description	thermostat t.max. 470°C temperature range 90-470°C 1-pole 1NO 16A probe ø 3.9mm probe L 163mm capillary pipe 870mm capillary pipe isolated 600mm shaft ø 4.5x6mm shaft L 23mm shaft position upper rotation 270°		



E-G-O



1

GEV No.	375948	Ref. No.	461.016.00 461.016.01
description	thermostat t.max. 90°C temperature range 30-90°C 1-pole 1CO 16A probe ø 6mm probe L 102mm capillary pipe 1000mm capillary pipe isolated 960mm gland nut shaft Lmm shaft position rotation 180°		

E-G-O

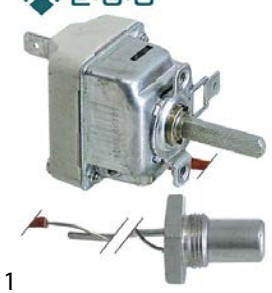

1

GEV No.	375321	Ref. No.	66107000
description	thermostat t.max. 90°C temperature range 35-90°C 1-pole 1NO 16A probe ø 11mm probe L 24mm capillary pipe 900mm capillary pipe isolated 900mm gland nut shaft ø 6x4.6mm shaft L 23mm shaft position upper rotation 270° screw-in probe probe thread M14x1		
For models:	60/30BME, 60/60BME		

55.13_series

E-G-O



1

GEV No.	375492	Ref. No.	961.034.00
description	thermostat t.max. 190°C temperature range 94-190°C 1-pole 1NO 16A probe ø 6mm probe L 94mm capillary pipe 1090mm capillary pipe isolated 960mm gland nut M10x1 shaft ø 6x4.6mm shaft L 23mm shaft position upper rotation 310° probe material SS		

55.34_series

E-G-O



1

GEV No.	375143	Ref. No.	66100500
description	thermostat t.max. 110°C temperature range 32-110°C 3-pole 3NO 16A probe ø 6mm probe L 138mm capillary pipe 1480mm capillary pipe isolated 1100mm gland nut M9x1 shaft ø 6x4.6mm shaft L 23mm shaft position upper rotation 270°		
For models:	65/70BME, 70/70BME		

E-G-O



1

GEV No.	375097	Ref. No.	66104100 66104112
description	thermostat t.max. 195°C temperature range 95-195°C 3-pole 3NO 16A probe ø 6mm probe L 117mm capillary pipe 1780mm capillary pipe isolated 1400mm gland nut M9x1 shaft ø 6x4.6mm shaft L 23mm shaft position upper rotation 270°		
For models:	60/30FRE, 60/60FRE, 65/40FRE, 65/70FRE, 70/40FRE10, 70/70FRE10		

E-G-O



1

GEV No.	375559	Ref. No.	66112300
description	thermostat t.max. 230°C temperature range 95-230°C 3-pole 3NO 16A probe ø 4mm probe L 128mm capillary pipe 1250mm capillary pipe isolated 1000mm gland nut shaft ø 6x4.6mm shaft L 23mm shaft position upper rotation 270°		

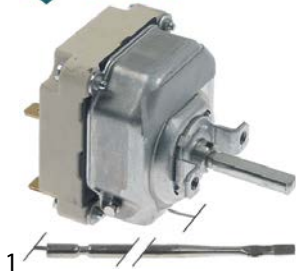

GEV No.	375192	Ref. No.	66102700 66111400
description	thermostat t.max. 300°C temperature range 50-300°C 3-pole 3NO 16A probe ø 3mm probe L 219mm capillary pipe 900mm capillary pipe isolatedmm gland nut shaft ø 6x4.6mm shaft L 23mm shaft position upper rotation 270°		
For models:	65/110CFGE, 65/70CFE, 65/80BFE, 65/80TFE, 70/110CFGE, 70/70CFE, 70/70CFEQ, 70/70CFGE, 70/70CFVE		



GEV No.	375614	Ref. No.	66100700
description	thermostat t.max. 330°C temperature range 100-330°C 3-pole 3NO 16A probe ø 6mm probe L 75mm capillary pipe 870mm capillary pipe isolated 870mm gland nut shaft ø 6x4.6mm shaft L 23mm shaft position upper rotation 270°		
For models:	60/30FTE, 60/30FTE-CR, 60/30FTRE, 60/30FTRE-CR, 60/60FTE, 60/60FTE-CR, 60/60FTRE, 60/60FTRE-CR, 60/60FTRRE, 60/60FTRRE-CR, 65/40FTE, 65/40FTRE, 65/70FTE, 65/70FTRE, 65/70FTRRE, 70/40FTE, 70/40FTE-CR, 70/40FTES, 70/40FTRE, 70/40FTRE-CR, 70/70BRE, 70/70BREM, 70/70FTE, 70/70FTE-CR, 70/70FTES, 70/70FTRE, 70/70FTRE-CR, 70/70FTRRE, 70/70FTRRE-CR		



GEV No.	375944	Ref. No.	66111600
description	thermostat t.max. 350°C temperature range 100-350°C 3-pole 3NOA probe ø 3mm probe L 147mm capillary pipe 900mm capillary pipe isolatedmm gland nut shaft ø 6x4.6mm shaft L 26mm shaft position upper rotation 270° probe material SS		

safety thermostats

55.10/19_series



GEV No.	375319	Ref. No.	66103400
description	safety thermostat switch-off temp. 230°C 1-pole 0.5A probe ø 11mm probe L 18mm capillary pipe 900mm capillary pipe isolatedmm gland nut probe screw-in probe probe thread M14x1		
For models:	70/40FRG13, 70/70FRG13		

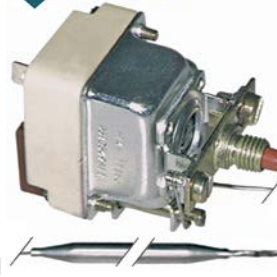

GEV No.	390062	Ref. No.	66102100
description	safety thermostat switch-off temp. 235°C 1-pole 0.5A probe ø 6mm probe L 130mm capillary pipe 1800mm capillary pipe isolated 1500mm gland nut M9x1 probe SS		
For models:	60/30FRG, 60/60FRG, 65/40FRG, 65/70FRG		

accessories for	390062		
	GEV No.	551083	Ref. No.
			66103600
	cap for safety thermostat thread M8x1		

55.31_series



GEV No.	390168	Ref. No.	66100900
description	safety thermostat switch-off temp. 230°C 3-pole 3NC 20A probe ø 6mm probe L 239mm capillary pipe 830mm capillary pipe isolatedmm gland nut M9x1 probe SS		



55.32_series



GEV No.	375316	Ref. No.	66105100
description	safety thermostat switch-off temp. 140°C 3-pole 20A probe ø 6mm probe L 173mm capillary pipe 830mm capillary pipe isolated 800mm gland nut probe SS		
For models:	70/70PEI		



GEV No.	375375	Ref. No.	961.033.00
description	safety thermostat switch-off temp. 230°C 3-pole 20A probe ø 6mm probe L 94mm capillary pipe 900mm capillary pipe isolated 670mm gland nut M10x1 probe SS		

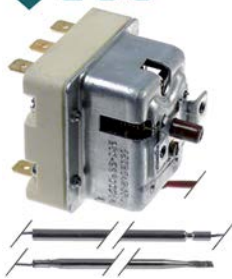

GEV No.	375445	Ref. No.	96104400
description	safety thermostat switch-off temp. 230°C 3-pole 2x20/1x0.5A probe ø 4mm probe L 120mm capillary pipe 900mm capillary pipe isolated 700mm gland nut probe		



GEV No.	375312	Ref. No.	66104800
description	safety thermostat switch-off temp. 245°C 3-pole 3NC 20A probe ø 4mm probe L 120mm capillary pipe 1800mm capillary pipe isolated 1800mm gland nut probe SS		
For models:	60/30FRE, 60/60FRE, 65/40FRE, 65/70FRE, 70/40FRE10, 70/70FRE10		

accessories for	375312		
	GEV No.	550981	Ref. No.
			—
	probe clip for pipe ø 8.5mm for probe ø 6mm for heating elements spacing 0.4mm Qty 1 pcs		



GEV No.	375262	Ref. No.	66104500
description	safety thermostat switch-off temp. 350°C 3-pole 20A probe ø 4mm probe L 120mm capillary pipe 900mm capillary pipe isolated 900mm gland nut probe		

For models:	60/30FTE, 60/30FTE-CR, 60/30FTRE, 60/30FTRE-CR, 60/60FTE, 60/60FTE-CR, 60/60FTRE, 60/60FTRE-CR, 60/60FTRRE, 60/60FTRRE-CR, 65/110CFGE, 65/40FTE, 65/40FTRE, 65/70CFE, 65/70FTE, 65/70FTRE, 65/70FTRRE, 65/80BFE, 65/80TFE, 70/110CFGE, 70/40FTE, 70/40FTE-CR, 70/40FTES, 70/40FTRE, 70/40FTRE-CR, 70/70BRE, 70/70BREM, 70/70CFE, 70/70CFEQ, 70/70CFGE, 70/70CFVE, 70/70FTE, 70/70FTE-CR, 70/70FTES, 70/70FTRE, 70/70FTRE-CR, 70/70FTRRE, 70/70FTRRE-CR		
--------------------	--	--	--

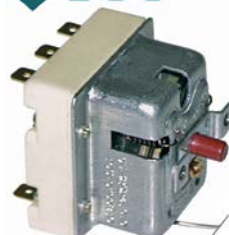

GEV No.	375350	Ref. No.	40100062
description	safety thermostat switch-off temp. 360°C 3-pole 20A probe ø 4mm probe L 120mm capillary pipe 1800mm capillary pipe isolated 1800mm gland nut probe SS		



GEV No.	375187	Ref. No.	66111500
description	safety thermostat switch-off temp. 360°C 3-pole 3NC 2x20/1x0.5A probe ø 6mm probe L 79mm capillary pipe 890mm capillary pipe isolatedmm gland nut probe SS		

56._ series



GEV No.	375783	Ref. No.	961.035.00
description	safety thermostat switch-off temp. 240°C 1-pole 0.5A probe ø 6mm probe L 77mm capillary pipe 860mm capillary pipe isolated 750mm gland nut M10x1 probe SS		

accessories



GEV No.	551083	Ref. No.	66103600
description	cap for safety thermostat thread M8x1		

control thermostats with operation switch

55.13_ series

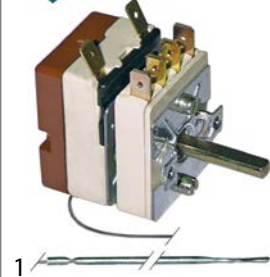

GEV No.	375073	Ref. No.	961.045.00
description	thermostat t.max. 320°C temperature range 50-320°C 1-pole capillary pipe isolatedmm gland nut		

IMIT / TEMPOMATIC / ARTHERMO

control thermostats



GEV No.	390421	Ref. No.	461.016.00 old version
description	thermostat t.max. 85°C temperature range 0-90°C 1-pole 1CO 16A probe ø 6.5mm probe L 95mm capillary pipe 1500mm capillary pipe isolated 1450mm gland nut shaft ømm shaft Lmm shaft position rotation 270° probe material copper		

safety thermostats



GEV No.	375500	Ref. No.	461.071.00
description	safety thermostat switch-off temp. 140°C 1-pole 1CO 15A probe ø 5mm probe L 125mm capillary pipe 1000mm capillary pipe isolated 900mm gland nut probe		

CAEM

control thermostats





GEV No.	390672	Ref. No.	46101500
description	thermostat t.max. 53°C temperature range fixed 53°C 1-pole 1CO 16A probe ø 9.5mm probe L 30mm capillary pipe 600mm capillary pipe isolated 540mm gland nut shaft Lmm screw-in probe probe thread M14x1		
spare parts for	390672		
	GEV No.	510417	Ref. No. —
	flat gasket fibre ED ø 20mm ID ø 14mm thickness 2mm Qty 1 pcs		
	GEV No.	550261	Ref. No. —
	nut thread M14x1 H 4mm WS 19 SS Qty 1 pcs		

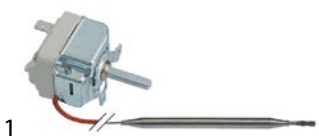



various			
control thermostats			
			
GEV No.	375756	Ref. No.	M564010000
description	thermostat t.max. 90°C temperature range 30-90°C 1-pole 1CO probe ø 6mm probe L 126mm capillary pipe 900mm shaft ø 6x4.6mm shaft position upper rotation 270°		

accessories			
probe clips			
spring clips			
for thermostat			
			
GEV No.	550419	Ref. No.	238.003.00
description	probe clip for pipe ø 8.5mm for probe ø 6mm Qty 1 pcs		

connecting bows			
			
GEV No.	550060	Ref. No.	66101300
description	connecting bow long for thermostat Qty 1 pcs		
For models:	60/30BME, 60/30FRE, 60/30FTE, 60/30FTE-CR, 60/30FTRE, 60/30FTRE-CR, 60/60BME, 60/60FRE, 60/60FTE, 60/60FTRE, 60/60FTRE-CR, 60/60FTRRE, 60/60FTRRE-CR, 65/110CFGE, 65/40BME, 65/40FRE, 65/40FTE, 65/40FTRE, 65/70BME, 65/70CFE, 65/70FRE, 65/70FTE, 65/70FTRE, 65/70FTRRE, 65/80BFE, 65/80TFE, 70/110CFGE, 70/40BME, 70/40FRE10, 70/40FTE, 70/40FTE-CR, 70/40FTES, 70/40FTRE, 70/40FTRE-CR, 70/70BME, 70/70BRE, 70/70BREM, 70/70CFE, 70/70CFEQ, 70/70CFGE, 70/70CFVE, 70/70FRE10, 70/70FTE, 70/70FTE-CR, 70/70FTES, 70/70FTRE, 70/70FTRE-CR, 70/70FTRRE, 70/70FTRRE-CR		

switches and momentary switches				
rocker/momentary rocker switches				
19x13mm				
				
GEV No.	301066	Ref. No.	66107200	
description	rocker switch mounting measurements 19x13mm black 2NO 250V 6A 0-1 connection male faston 4.8mm ambient temperature max. 85°C protection IP40			
For models:	60/60CFE, 60/60CFGE			
accessories for	301066			
	GEV No.	301064	Ref. No.	—
	protective cover for pressure switch external size 23.4x17.4mm internal size 19x13mm H 7.5mm clear mounting measurementsmm			

push/momentary push switches			
28.5x28.5mm			
			
GEV No.	346661	Ref. No.	46102300 46102313
description	momentary push switch mounting measurements 28.5x28.5mm yellow 1NO 250V 16A connection male faston 6.3mm ambient temperature max. 150°C protection IP40		

28.5x52.6mm			
			
GEV No.	346664	Ref. No.	46102600 46102613
description	switch combination latching/momentary mounting measurements 28.5x52.6mm yellow 2CO/1NO 250V 16A connection male faston 6.3mm ambient temperature max. 150°C protection IP40		

30x22mm			
			
GEV No.	301086	Ref. No.	M561003500
description	push switch mounting measurements 30x22mm black 2NO 250V 12A 0-1 connection male faston 6.3mm ambient temperature max. 85/55°C protection IP54 with protective collar		

ø16mm			
			
GEV No.	301100	Ref. No.	66304100
description	momentary push switch mounting ø 16mm red 1NO 250V 3A ignition connection male faston 6.3mm ambient temperature max. 85°C protection IP40		
For models:	60/30FRE, 60/60CFG, 60/60CFGE		

			
GEV No.	346895	Ref. No.	461.042.00 461.042.13
description	momentary push switch mounting ø 16mm yellow 1NO 250V 16A connection male faston 6.3mm protection IP40 ambient temperature max. 150°C		



ø25mm



1

GEV No.	348219	Ref. No.	961.048.00
description	momentary push switch mounting ø 25mm black 1NO 250V 16A connection male faston 6.3mm ambient temperature max. 120°C		



1

GEV No.	345039	Ref. No.	961.049.00
description	protective cover round ED ø 33mm external size 23mm internal size 21mm H 12mm clear mounting ø 25mm		
accessories for	345039		
	GEV No.	Ref. No.	—
	momentary push switch mounting ø 25mm yellow 1NO/indicator light 250V 16A cover connection male faston 6.3mm ambient temperature max. 85°C protection IP65		

accessories

gaskets



1

GEV No.	551456	Ref. No.	953.020.00
description	gasket for switch ED ø 14mm ID ø 2.5mm thickness 3.5mm white		

microswitches

lever actuated



1

GEV No.	345773	Ref. No.	76100400
description	microswitch with lever 250V 16A 1CO connection male faston 6.3mm L 60mm ambient temperature max. 125°C mounting distance 22mm actuating force: 65g lever length 51mm		



1

GEV No.	345044	Ref. No.	66101500
description	microswitch with lever 250V 16A 1CO connection male faston 6.3mm ambient temperature max. 85°C mounting distance 25mm type C99ZP3 actuating force: 25g lever length 71mm		



1

GEV No.	346506	Ref. No.	66101900
description	microswitch with lever 1NO lever length 66mm		
For models:	60/30FRE, 60/60FRE, 65/40FRE, 65/70FRE, 70/40FRE10, 70/70FRE10		

roller-lever actuated

microswitches



1

GEV No.	345250	Ref. No.	66105200
description	microswitch with handle with a switch 250V 16A 1CO connection male faston 6.3mm L 27mm L1 36mm ambient temperature max. 125°C mounting distance 22mm type RL6-1-FGE-P12-5-L actuating force: 90g		
For models:	70/70BRE, 70/70BREM, 70/70BRGM		

pin-plunger actuated

M10



1

GEV No.	347216	Ref. No.	961.021.00
description	microswitch with plunger thread M10x0.75 thread L 14mm 250V 10A 1CO connection male faston 6.3mm stroke 7.5mm mounting distance 22mm L 28mm ambient temperature max. 125°C type NR6K5 actuating force: 260g		

non-standard



1

GEV No.	346962	Ref. No.	610.155.00
description	microswitch mounting distance 22mm 250V 16A 2CO connection male faston 6.3mm ambient temperature max. 85°C kit		





cam switches

7-position



1

GEV No.	300025	Ref. No.	66100200
description	cam switch 7 operating positions 1NO/2CO sequence 0-1-2-3-4-5-6 16A shaft ø 6x4.6mm shaft L 23mm connection screw 7-position ceramic		
For models:	60/30PCE, 60/60CFE, 60/60PCE, 65/40PCE, 65/70CFE, 65/70PCE, 70/40PCE, 70/40PCEQ, 70/70CFE, 70/70CFEQ, 70/70PCE, 70/70PCEQ		
accessories for	300025		
	GEV No.	112172	Ref. No. —
	knob universal ø 70mm black without adaptor/dial plate		
	GEV No.	112213	Ref. No. —
	knob dial plate silver switch 7-position t.max.°C ED ø 63mm ID ø 45.5mm		
	GEV No.	112311	Ref. No. —
	knob adapter shaft ø 6x4.6mm L 0mm with spring		



1

GEV No.	300081	Ref. No.	661.113.00
description	cam switch 4 operating positions 3NO/2CO sequence 0-1-2-3 16A shaft ø 6x4.6mm shaft L 23mm connection screw		



1

GEV No.	300210	Ref. No.	66103700
description	cam switch 4 operating positions 4NO sequence 0-1-2-3 16A shaft ø 6x4.6mm shaft L 23mm connection screw ceramic		
For models:	60/60CPE, 70/40CPE, 70/70CPE		
accessories for	300210		
	GEV No.	551456	Ref. No. 953.020.00
	gasket for switch ED ø 14mm ID ø 2.5mm thickness 3.5mm white		



1

GEV No.	300106	Ref. No.	96100000
description	cam switch 7 operating positions 1NO/2CO sequence 0-1-2-3-4-5-6 32A shaft ø 6x4.6mm shaft L 23mm connection screw 7-position shaft flat upper		



1

GEV No.	300145	Ref. No.	66106200
description	cam switch 4 operating positions 4NO sequence 0-1-2-3 32A shaft ø 6x4.6mm shaft L 23mm connection screw ceramic		
For models:	70/70PEI		

4 operating positions

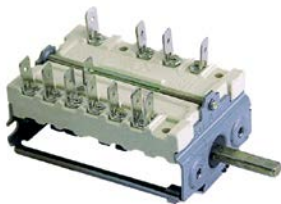

1

GEV No.	300010	Ref. No.	661.117.00
description	cam switch 4 operating positions 2NO/2CO sequence 0-1-2-3 16A shaft ø 6x4.6mm shaft L 23mm connection male faston 6.3mm ceramic		

5 operating positions

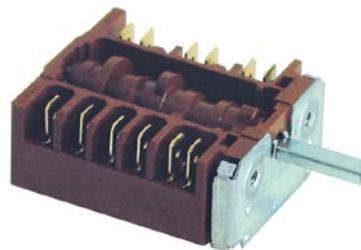

1

GEV No.	300114	Ref. No.	66107400
description	cam switch 5 operating positions 5NO sequence 0-1-2-3-4 16A shaft ø 6x4.6mm shaft L 23mm connection male faston 6.3mm		
For models:	60/60CFGE		



7 operating positions



1	GEV No.	300269	Ref. No.	661.125.00
description	cam switch 7 operating positions 16A sequence 0-1-2-3-4-5-6 shaft \varnothing 6x4.6mm shaft L 23mm connection screw			

with potentiometer



1	GEV No.	300252	Ref. No.	961.042.00
description	potentiometer 2 operating positions 2NO sequence 0-1 16A shaft \varnothing 6x4.6mm shaft L 23mm connection coded plug cable length 1420mm 10kOhm 12V with cable and indicator light			

operation switches



1	GEV No.	300080	Ref. No.	66100000
description	cam switch 2 operating positions 4NO 16A sequence 0-1 shaft \varnothing 6x4.6mm shaft L 23mm connection screw operation switch ceramic ambient temperature max. 150°C			
For models:	60/30FRE, 60/30FTE, 60/30FTE-CR, 60/30FTRE, 60/30FTRE-CR, 60/30SPE, 60/60BME, 60/60FRE, 60/60FTE, 60/60FTE-CR, 60/60FTRE, 60/60FTRE-CR, 60/60FTRRE, 60/60FTRRE-CR, 65/110CFGE, 65/40BME, 65/40FRE, 65/40FTE, 65/40FTRE, 65/40SPE, 65/70BME, 65/70CFE, 65/70FRE, 65/70FTE, 65/70FTRE, 65/70FTRRE, 65/80BFE, 65/80TFE, 70/110CFGE, 70/40BME, 70/40FRE10, 70/40FTE, 70/40FTE-CR, 70/40FTES, 70/40FTRE, 70/40FTRE-CR, 70/40SPE, 70/70BME, 70/70BRE, 70/70BREM, 70/70CFE, 70/70CFEQ, 70/70CFGE, 70/70CFVE, 70/70FRE10, 70/70FTE, 70/70FTE-CR, 70/70FTES, 70/70FTRE, 70/70FTRE-CR...(Other models you can see in the webshop)			
accessories for	300080			
	GEV No.	551456	Ref. No.	953.020.00
gasket for switch ED \varnothing 14mm ID \varnothing 2.5mm thickness 3.5mm white				

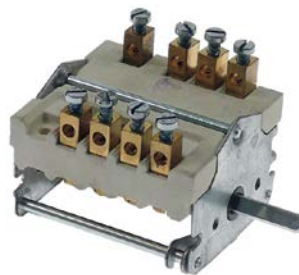

1	GEV No.	300180	Ref. No.	961.031.00
description	cam switch 2 operating positions operation switch 32A sequence 0-1 shaft \varnothing 6x4.6mm shaft L 23mm connection screw ceramic			



1	GEV No.	300269	Ref. No.	661.125.00
description	cam switch 7 operating positions 16A sequence 0-1-2-3-4-5-6 shaft \varnothing 6x4.6mm shaft L 23mm connection screw			

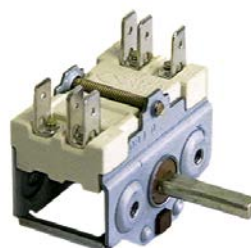

1	GEV No.	300001	Ref. No.	661.093.00
description	cam switch operation switch 16A sequence 0-1 shaft \varnothing 6x4.6mm connection male faston 6.3mm 2-pole			
accessories for	300001			
	GEV No.	551456	Ref. No.	953.020.00
gasket for switch ED \varnothing 14mm ID \varnothing 2.5mm thickness 3.5mm white				

rotary switches

TECNOMATIC



1	GEV No.	300331	Ref. No.	461.030.00
description	rotary switch 2 0-1 sets of contacts 2 type HD1602R000 600V 16A shaft \varnothing 4x6mm shaft L 17mm shaft 6x6 connection screw ED \varnothing 43mm L 39mm			
accessories for	300331			
	GEV No.	111254	Ref. No.	—
knob switch zero mark t.max.°C°C \varnothing 26mm shaft \varnothing 5x5mm shaft flat black H 20mm L 36mm				



miscellaneous



GEV No.	300329	Ref. No.	461.045.00
description	rotary switch sets of contacts 4 3 1-0-2 momentary type HD16 600V 16A shaft square connection screw ambient temperature max. 75°C		

control equipment

BRETER

switches (complete)



GEV No.	345770	Ref. No.	66105700 old version
description	momentary push switch blue 1NC/1NO		



GEV No.	345771	Ref. No.	66105600
description	momentary push switch yellow 1NC/1NO		
For models:	70/70BREM, 70/70BRGM		

LOVATO



GEV No.	301321	Ref. No.	961.051.00
description	contact block LOVATO LPX C10 1NO max 690V 10A light grey		

plastic series

rotary switches



GEV No.	301320	Ref. No.	961.050.00
description	rotary selector mounting measurements ø22mm black/silver sequence 1-0-2 latching		

TELEMECANIQUE (EFA)

XB4 series

switches (complete)



GEV No.	346934	Ref. No.	66105700
description	momentary push switch mounting measurements ø22mm blue 1NO/1NC		
For models:	70/70BREM, 70/70BRGM		

encoders and potentiometers



GEV No.	401169	Ref. No.	999.23.038
description	encoder cable length 125mm		



GEV No.	300252	Ref. No.	961.042.00
description	potentiometer 2 operating positions 2NO sequence 0-1 16A shaft ø 6x4.6mm shaft L 23mm connection coded plug cable length 1420mm 10kOhm 12V with cable and indicator light		

lamps

indicator lights

indicator lights 2-piece (lens and indicator lamp)

indicator light lenses

ø10mm (type SRZ-3)



GEV No.	359123	Ref. No.	M568000200
description	indicator light housings mounting measurements ø10mm green round Qty 1 pcs		

accessories for	359123		
GEV No.	359132	Ref. No.	M568000300
description	indicator lamp green 250V connection male faston 6.3mm protection IP54 ambient temperature max. 85°C		



indicator lamps for socket type SA / SC / SD / SF / SR



1

GEV No.	360736	Ref. No.	663.082.00
description	indicator light 250V red connection 2-wire cable length 800mm cable material silicone		

indicator lamps for socket type SRZ / SDK / SDY / SFK



1

GEV No.	359132	Ref. No.	M568000300
description	indicator lamp green 250V connection male faston 6.3mm protection IP54 ambient temperature max. 85°C		

indicator lights (complete)

ø 8mm



1

GEV No.	360742	Ref. No.	963.016.00
description	indicator light ø 8mm green 28V connection male faston 2.8mm		

ø10mm

with plug-in socket



1

GEV No.	359140	Ref. No.	463.012.00
description	indicator light ø 10mm yellow 230V connection male faston 6.3mm Qty 1 pcs		

ø12mm

with screw socket



1

GEV No.	359291	Ref. No.	66304300
description	indicator light ø 12mm 400V green connection male faston 6.3mm		
For models:	60/30BME, 60/30CPE, 60/30FRE, 60/30FTE, 60/30FTE-CR, 60/30FTRE, 60/30FTRE-CR, 60/30PCE, 60/30SPE, 60/60BME, 60/60CFG, 60/60CFGE, 60/60CPE, 60/60FRE, 60/60FTE, 60/60FTE-CR, 60/60FTRE, 60/60FTRE-CR, 60/60FTRRE, 60/60FTRRE-CR, 60/60PCE		



1

GEV No.	359290	Ref. No.	66304400
description	indicator light ø 12mm 400V yellow connection male faston 6.3mm		
For models:	60/30CPE, 60/30FRE, 60/30FTE, 60/30FTE-CR, 60/30FTRE, 60/30FTRE-CR, 60/60BME, 60/60CFE, 60/60CFGE, 60/60CPE, 60/60FRE, 60/60FTE, 60/60FTE-CR, 60/60FTRE, 60/60FTRE-CR, 60/60FTRRE, 60/60FTRRE-CR		



1

GEV No.	360763	Ref. No.	96301400
description	indicator light ø 12mm red 230V connection male faston 6.3mm with O-ring		

ø13mm

with screw socket



1

GEV No.	359146	Ref. No.	96301300
description	indicator light ø 13mm 230V yellow		

accessories for 359146



GEV No.	510302	Ref. No.	0835.17124.1
----------------	--------	-----------------	--------------

O-ring EPDM ID ø 12.42mm thickness 1.78mm Qty 1 pcs



GEV No.	511505	Ref. No.	—
----------------	--------	-----------------	---

O-ring EPDM thickness 1.78mm ID ø 12.42mm Qty 10 pcs



1

GEV No.	359049	Ref. No.	66300000
----------------	--------	-----------------	----------

description indicator light ø 13mm 400V green

For models: 65/110CFGE, 65/40BME, 65/40FRE, 65/40FTE, 65/40FTRE, 65/40PCE, 65/40PVE, 65/40SPE, 65/70BME, 65/70CFE, 65/70FRE, 65/70FTE, 65/70FTRE, 65/70FTRRE, 65/70PCE, 65/70PVE, 65/80BFE, 65/80TFE, 70/110CFGE, 70/40BME, 70/40CPE, 70/40FRE10, 70/40FTE, 70/40FTE-CR, 70/40FTES, 70/40FTRE, 70/40FTRE-CR, 70/40PCE, 70/40PCEQ, 70/40PVE, 70/40SPE, 70/70BME, 70/70BRE, 70/70BREM, 70/70CFE, 70/70CFEQ, 70/70CFGE, 70/70CFVE, 70/70CPE, 70/70FRE10, 70/70FTE, 70/70FTE-CR, 70/70FTES, 70/70FTRE, 70/70FTRE-CR, 70/70FTRRE, 70/70FTRRE-CR, 70/70PCE, 70/70PCEQ, 70/70PEI...(Other models you can see in the webshop)

accessories for 359049



GEV No.	510302	Ref. No.	0835.17124.1
----------------	--------	-----------------	--------------

O-ring EPDM ID ø 12.42mm thickness 1.78mm Qty 1 pcs



GEV No.	511505	Ref. No.	—
----------------	--------	-----------------	---

O-ring EPDM thickness 1.78mm ID ø 12.42mm Qty 10 pcs



1

GEV No.	359050	Ref. No.	66300100
----------------	--------	-----------------	----------

description indicator light ø 13mm 400V yellow

For models: 65/110CFGE, 65/40BME, 65/40FRE, 65/40FTE, 65/40FTRE, 65/70BME, 65/70CFE, 65/70FRE, 65/70FTE, 65/70FTRE, 65/70FTRRE, 65/80BFE, 65/80TFE, 70/110CFGE, 70/40BME, 70/40FRE10, 70/40FTE, 70/40FTE-CR, 70/40FTES, 70/40FTRE, 70/40FTRE-CR, 70/70BME, 70/70BRE, 70/70BREM, 70/70CFE, 70/70CFEQ, 70/70CFGE, 70/70CFVE, 70/70FRE10, 70/70FTE, 70/70FTE-CR, 70/70FTES, 70/70FTRE, 70/70FTRE-CR, 70/70FTRRE, 70/70FTRRE-CR

accessories for 359050



GEV No.	510302	Ref. No.	0835.17124.1
----------------	--------	-----------------	--------------

O-ring EPDM ID ø 12.42mm thickness 1.78mm Qty 1 pcs

Table continues overleaf



accessories for	359050			
	GEV No.	511505	Ref. No.	—
	O-ring EPDM thickness 1.78mm ID ø 12.42mm Qty 10 pcs			

LED

indicator lamps

mounting diameter 8mm



1

GEV No.	360744	Ref. No.	963.015.00
description	indicator light LED mounting ø 8mm red 5-28VDC connection F2.8x0.8 mounting thread M8		

screw-on/push-on fit

light bulbs

for ovens



1

GEV No.	359610	Ref. No.	66304500
description	light bulb t.max. 300°C socket E14 15W 230V ø 22mm L 47mm lens L 20mm for oven lamp type Philips		
For models:	60/60CFE, 60/60CFG, 60/60CFGE		



oven lamps

universal oven lamps

mounting diameter 35.5mm



1

GEV No.	359718	Ref. No.	66304700	
description	oven lamp mounting ø 35.5mm 230V 15W socket E14 temp.-resist. 300°C connection male faston 6.3mm hard glas			
For models:	60/60CFE, 60/60CFG, 60/60CFGE			
spare parts for	359718			
	GEV No.	359701	Ref. No.	—
	lamp socket socket E14 220-230V mounting ø 35.5mm connection male faston 6.3mm 15W			
	GEV No.	359740	Ref. No.	—
	light bulb t.max. 300°C socket E14 15W 230V ø 22mm L 48mm lens L 20mm for oven lamp IMPORT			

lamps

light bulbs



1

GEV No.	359610	Ref. No.	66304500
description	light bulb t.max. 300°C socket E14 15W 230V ø 22mm L 47mm lens L 20mm for oven lamp type Philips		
For models:	60/60CFE, 60/60CFG, 60/60CFGE		

timers

programme timers



1

GEV No.	360528	Ref. No.	561.035.00
description	timer CDC 11902F3 engines 1 chambers 2 operation time 450s 230V motor type M48L ATS voltage AC		



1

GEV No.	360498	Ref. No.	461.047.00
description	timer CDC 4904DV engines 2 chambers 4 230V manuf. no. 46104700 voltage AC run-time 60s operation time 4min		



1

GEV No.	360025	Ref. No.	46102900
description	timer CDC 7003F engines 1 chambers 3 operation time 360s 230V 50Hz shaft ø 6x7mm shaft L 26mm manuf. no. 7003F3 / 360025 motor type M37LN		





spare parts for	360025			
	GEV No.	360131	Ref. No.	—
	motor CDC pinion ø 5.4mm teeth 12 230V turn direction left motor ø 37mm motor type M37LN for timer			

Table continues overleaf



accessories for	360025		
	GEV No.	110085	Ref. No. —
	push button t.max.°C°C ø 36mm shaft ømm shaft flat grey for knob		
	GEV No.	110086	Ref. No. —
	knob switch zero mark t.max.°C°C ø 45mm shaft ømm shaft flat special black		
	GEV No.	110087	Ref. No. —
	retaining ring shaft ø 8mm DIN 471		



GEV No.	360356	Ref. No.	461.036.00
description	timer CDC 7804F engines 1 chambers 4 operation time 144s 230V shaft ømm shaft Lmm manuf. no. 7804F1/ 46103600 motor type M37RN		
spare parts for	360356		
	GEV No.	360119	Ref. No. —
	motor CDC pinion ø 5.4mm teeth 12 230V turn direction right motor ø 37mm motor type M37RN for timer		

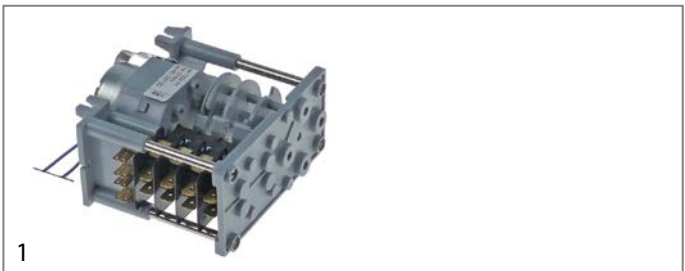

GEV No.	360469	Ref. No.	461.037.00
description	timer CDC 7804F engines 1 chambers 4 operation time 20min 230V 50/60Hz manuf. no. 7804 motor type M37RN voltage AC		

electric timers

with time spread



GEV No.	350074	Ref. No.	RRC5365-00
description	timer MS65 operation time 120min time spread 30min 1CO/2NO/1NC at 250V 16A permanent position yes impulse electric shaft ø 6x4.6mm shaft L 22mm mounting distance 28mm connection lateral Invensys 4-pole shaft position lower*		

mechanical timers

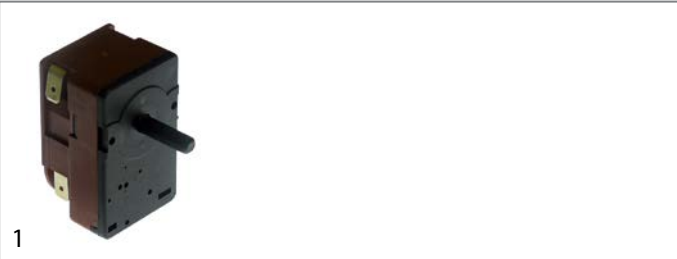

GEV No.	350089	Ref. No.	66103100
description	timer C20 2-pole operation time 120min impulse mechanical 2NO at 250V 16A permanent position yes shaft ø 6x4.6mm shaft 6x4.6mm shaft L 20mm mounting distance 28mm connection lateral		
For models:	65/80BFE, 65/80TFE		

audible timers



GEV No.	350036	Ref. No.	RRC2191-00
description	audible timer operation time 60min ø 55mm shaft ø 6x4.6mm shaft L 22mm mounting distance 28mm		

contactors

ISKRA (FANAL)

power contactors



GEV No.	380547	Ref. No.	461.021.00 461.051.00
description	power contactor resistive load 20A 230VAC (AC3/400V) 5A/2.2kW main contacts 3NO auxiliary contacts 1NC connection screw connection type Fanal DSL3 01 type ISKRA K03M 01		



LOVATO

power contactors



1

GEV No.	380087	Ref. No.	66106600
description	power contactor resistive load 16A 230VAC (AC3/400V) 5A/2.2kW main contacts 3NO auxiliary contacts 1NO connection screw connection type 11BG0610A230		
For models:	70/70BRE, 70/70BREM		



1

GEV No.	380716	Ref. No.	961.002.00
description	power contactor resistive load 28A 230VAC (AC3/400V) 12A/5.7kW main contacts 3NO auxiliary contacts 1NO connection screw connection type BF1210A230		

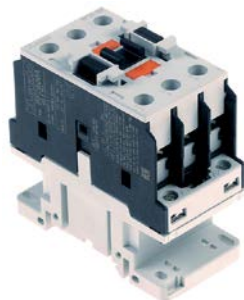

1

GEV No.	380721	Ref. No.	961.043.00
description	power contactor resistive load 45A 230VAC (AC3/400V) 26A/13kW main contacts 3NO auxiliary contacts connection screw connection type BF2600A230		

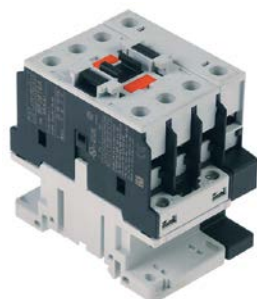

1

GEV No.	380787	Ref. No.	961.005.00
description	power contactor resistive load 45A 230VAC (AC3/400V) 26A/13kW main contacts 4NO connection screw connection type BF26T4A230		

relays

power relays

with bracket mounting



1

GEV No.	380808	Ref. No.	461.063.00
description	power relays FINDER 230VAC 16A 3CO connection male faston 6.3mm bracket mounting manuf. no. 62.83.8.230.0000		

with male contacts

bullet connectors, 8 contacts



1

GEV No.	380951	Ref. No.	961.036.00
description	power relays FINDER 230VAC 10A 2CO connection plug-in connection round 8-pole manuf. no. 60.12.4.101.0040 90.26/ZVE8 250V		

relay sockets



1

GEV No.	380638	Ref. No.	961.037.00
description	relay socket 8-pole dimensions 51x41x23mm 250V 10A FINDER manuf. no. 90.26		



electric components

transformers

encapsulated transformers



with screw connection

			
1			
GEV No.	402950	Ref. No.	96104600
description	transformer primary 230V secondary 24V 100VA connection screw 50/60Hz type 192		

probes

universal probes

temperature probes

			
1			
GEV No.	379051	Ref. No.	561.044.00
description	temperature probe thermocouple J (Fe-CuNi) cable Vetrotex probe -50 up to +750°C cable -50 up to +350°C probe ø6x100mm cable length 3m without screw connection cable colours red/blue 2-wire		
accessories for	379051		
	GEV No.	Ref. No.	—
	 electronic controller HONEYWELL type DC10N-400 mounting measurements 92x92mm 24/230V voltage AC TC (J) relay outputs 1 CO-10A(6) TC (J) universal built-in depth 55mm protection IP54 accuracy 1% built-in version defr. funct. no 0 up to +400°C display 3 digits		

producer-specific probes

core probes

			
1			
GEV No.	379748	Ref. No.	999.24.007 RIC.S506,3
description	core temperature probe PTC 1kOhm cable silicone probe -40 up to +120°C cable -50 up to +180°C connection 2-wire probe ø4x75mm thread cable length 5m handle ø 10mm handle length 120mm L1 150mm L2 85mm		

electronics

PCBs

			
1			
GEV No.	400200	Ref. No.	relay-board 4relays
description	PCB		

			
1			
GEV No.	401451	Ref. No.	663.048.00 relay board 2relays
description	PCB pyroceram range 110/920 series		

solenoid valves

solenoid valves (water)

			
1			
GEV No.	370357	Ref. No.	61115000
description	solenoid valve double straight 230VAC inlet 3/4" outlet 11.5mm plastic flow regulating valve outlet A 0.25		
For models:	65/70GRG		

			
1			
GEV No.	370860	Ref. No.	25634700
description	solenoid valve single angled 230VAC inlet 3/4" outlet 11.5mm DN10 TP		



pressure switches

for warewashing

ø 58mm with male faston 6.3mm

with connection horizontal



GEV No.	542137	Ref. No.	462.012.00
description	pressure control pressure range 100/65mbar connection male faston 6.3mm ø 58mm pressure connection horizontal warewashing pressure connection ø 6mm		



GEV No.	541133	Ref. No.	462.003.00
description	pressure control pressure range 60/25mbar connection male faston 6.3mm ø 58mm pressure connection horizontal warewashing pressure connection ø 6mm		

for steam control



GEV No.	542406	Ref. No.	962.001.00
description	pressure control ø 45mm kettle pressure range 0.45/0.4bar connection 1/4" p max 1/1bar		

accessories



GEV No.	542440	Ref. No.	931.217.00
description	screw connection for pressure switches ø 6mm 3/8"		

compressors

EMBRACO / ASPERA

R404a/R507

HMBP monophase

High/Medium evaporation temperature above -20/-15 °C



GEV No.	605004	Ref. No.	764.050.00
description	compressor coolant R404a/R507 type EMT6152GK 220-240V 50Hz HMBP fully hermetic 7.8kg 1/5HP cylinder capacity 4.5cm ³ CSIR H 166mmWWW 267W 332W 351W 437W 535W 646W 769W test method ASHRAE		

L'UNITE HERMETIQUE / TECUMSEH

R404A

HMBP monophase

High/Medium evaporation temperature above -20/-15 °C



GEV No.	605021	Ref. No.	76402500
description	compressor coolant R404A type AEZ4425Z 220-240V 50Hz HMBP fully hermetic 9.8kg 1/5HP cylinder capacity 4.5cm ³ CSIR H 186mmWW 198W 263W 341W 432W 537W 629W test method EN 12900 723W		



fans

axial fans

ebm-papst



GEV No.	601030 ¹	Ref. No.	6033175
description	axial fan L 119mm W 119mm H 38mm 230VAC 50Hz 18W bearing ball bearing manuf. no. 4656Z metal connection male faston 2.8mm ebm-papst fan wheel ø 110mm temp.-resist. 75°C		
accessories for	601030		
	GEV No.	550898	Ref. No. —
	connecting cable cable length 2000mm connection F 2.8 connection distance 7.9mm for axial flow fan		
	GEV No.	692497	Ref. No. —
	guard ø 105mm mounting distance 150mm for axial fan ebm-papst-mm		

¹with ball bearings

import



GEV No.	602165	Ref. No.	764.055.00
description	axial fan L 119mm W 119mm H 38mm 230VAC 50/60Hz 15/14W manuf. no. 4715MS-23T-B5A connection male faston 2.8mm NMB fan wheel ø 110mm		

hot air motors

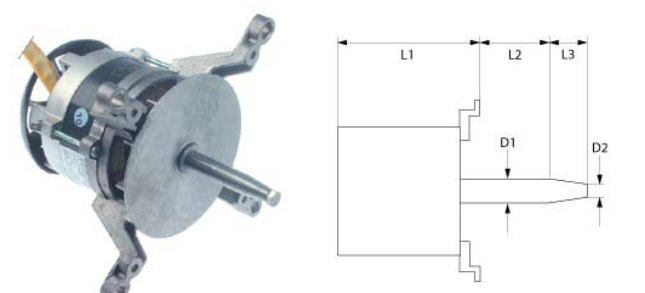

1

GEV No.	500630	Ref. No.	RRC2901-00
description	fan motor 230/400V 3 phase 50Hz 0.37kW 2600rpm speeds 1 L1 175mm L2 50mm L3 28mm D1 ø 17mm D2 ø 12mm M8 IT 1.1/1.9A Cos(φ) 0.75 at 50Hz 2600rpm type 1020.5450		



1

GEV No.	601178	Ref. No.	66400000 66403400
description	fan motor 230V 1 phase 50Hz 0.12kW 1400rpm speeds 1 L1 120mm L2 77mm D1 ø 12mm 1.1A suitable capacitor at 50Hz 230V type MA71TYP01DX		
For models:	65/110CFGE, 65/70CFE, 65/80BFE, 65/80TFE, 70/110CFGE, 70/70CFE, 70/70CFEQ, 70/70CFGE, 70/70CFVE		
spare parts for	601178		
	GEV No.	365013	Ref. No. —
	operating capacitor capacity 8µF 400V tolerance 5%Hz ambient temperature max. -25 to +85°C ø 31.5mm L 55mm M8 plastic connection male faston 6.3mm protection		



1

GEV No.	601993	Ref. No.	56403914
description	fan motor 230V 1 phase 50Hz 0.18/0.12kW 2800rpm speeds 1 L1 85mm L2 65mm L3 23mm D1 ø 8mm D2 ø 6mm M5x0.8 0.8A suitable capacitor 5µF/450V		
accessories for	601993		
	GEV No.	365017	Ref. No. —
	operating capacitor capacity 5µF 450V tolerance 5% 50/60Hz ambient temperature max. -25 to +85°C ø 28mm L 54mm M8 plastic connection male faston 6.3mm 16.10.08 protection		



1

GEV No.	601819	Ref. No.	644.000.00
description	fan wheel D1 ø 160mm H1 60mm blades 36 D2 ø 12mm D3 ø 12mm H2 23mm		

hot air fans

miscellaneous



1

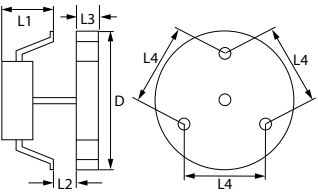



GEV No.	500902	Ref. No.	56404700	
description	fan motor 220V 55W 50/60Hz L1 68mm FIME type L25R without fan wheel			
accessories for	500902			
	GEV No.	550879	Ref. No.	M569011000
	insulation ø 130mm thickness 3mm hole ø 20mm for hot air fan			

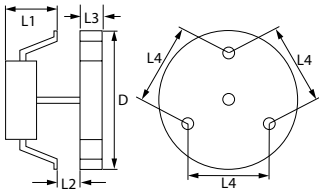

1



GEV No.	601699	Ref. No.	66402500	
description	hot air fan 220/240V 30W 50/60Hz L1 57mm L2 13mm L3 25mm L4 87mm fan wheel ø 150mm IMS type 7100VRD150H2023 fan wheel mounting 6x5mm			
For models:	60/60CFE, 60/60CFGE			
accessories for	601699			
	GEV No.	601441	Ref. No.	—
	fan wheel ø 150mm W 25mm shaft intake ø 6x5mm stainless steel blades 7			



1

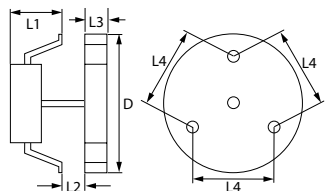

GEV No.	601273	Ref. No.	M569010100
description	hot air fan 220-240V 32W 50/60Hz L1 60mm L2 10mm L3 25mm L4 87mm fan wheel ø 155mm FIME type C20X0E01/15CLH		

accessories

miscellaneous



1

GEV No.	550879	Ref. No.	M569011000
description	insulation ø 130mm thickness 3mm hole ø 20mm for hot air fan		



motors

gear motors

for gyros grills



1			
GEV No.	500868	Ref. No.	66402600
description	gear motor BITRON type 323 4W 230V 50/60Hz 2.4rpm shaft ø 9mm shaft diameter 6x6mm L 81mm W 57mm H 31mm		
For models:	60/60CFG		

for tilting bratt pans



1			
GEV No.	501582	Ref. No.	964.003.00
description	gear motor type AO-4/M 24V for tilting bratt pan		





1			
GEV No.	500349	Ref. No.	66401000
description	gear motor type MB564A 150W 230V 50Hz 1 phase shaft ø 14mm L 280mm W 105mm H 160mm for tilting bratt pan		
For models:	70/70BREM, 70/70BRGM		

pumps

wash and rinse pumps

LGB



1				
GEV No.	500583	Ref. No.	464.082.00 464.083.00	
description	pump inlet ø 28mm outlet ø 26mm type ZF130SX 230V 50Hz 1 phase 0.2kW 0.27HP L 195mm rotation direction right capacitor 6.3µF LGB			
spare parts for	500583			
	GEV No.	509004	Ref. No.	46410600
	impellor ø 71mm H 16mm M7L rotation direction right shaft ø 13mm shaft length 13mm blades 8			
	GEV No.	510703	Ref. No.	—
	mechanical shaft seal for shaft ø 13mm slide ring H 13mm height counter ring 5.5mm ED ø 26mm			







1				
GEV No.	500384	Ref. No.	464.113.00	
description	pump inlet ø 30mm outlet ø 30mm type ZF160SX 230V 50Hz 1 phase 0.41kW 0.55HP L 180mm rotation direction right capacitor 12.5µF LGB			
spare parts for	500384			
	GEV No.	365014	Ref. No.	464.016.00
	operating capacitor capacity 12.5µF 450V tolerance 5%Hz ambient temperature max. -25 to +85°C ø 35mm L 70mm M8 plastic connection male faston 6.3mm 45S.C3DS.12.5 protection			
	GEV No.	510703	Ref. No.	—
	mechanical shaft seal for shaft ø 13mm slide ring H 13mm height counter ring 5.5mm ED ø 26mm			
	GEV No.	521527	Ref. No.	—
	pump cover LGB inlet ø 30mm outlet ø 30mm			





Table continues overleaf



spare parts for 500384				
	GEV No.	521701	Ref. No.	—
	pump cover gasket			
	GEV No.	521707	Ref. No.	—
	pump cover gasket			



1

GEV No.	500553	Ref. No.	464.013.00
description	pump inlet ø 45mm outlet ø 38mm type ZF290SX 230V 50Hz 1 phase 0.65kW 0.88HP L 200mm rotation direction right capacitor 12.5µF auxiliary pressure connection 13mm supporting pressure open LGB		
spare parts for 500553			
	GEV No.	365014	Ref. No. 464.016.00
	operating capacitor capacity 12.5µF 450V tolerance 5%Hz ambient temperature max. -25 to +85°C ø 35mm L 70mm M8 plastic connection male faston 6.3mm 45S.C3DS.12.5 protection		
	GEV No.	510702	Ref. No. —
	mechanical shaft seal height counter ring 5.5mm ID ø 12mm		
	GEV No.	521106	Ref. No. 464.021.00
	impellor ø 97mm H 24mm rotation direction right thread M8L seat ø 8.2mm blades 5		
	GEV No.	521542	Ref. No. —
	pump cover LGB inlet ø 45mm outlet ø 40mm auxiliary pressure connection 13mm supporting pressure open ø 150mm ID ø 120mm inner high 25mm		
	GEV No.	521714	Ref. No. —
	pump cover gasket thickness 4x4mm Qty 1 pcs		



1

GEV No.	500508	Ref. No.	464.014.00
description	pump inlet ø 45mm outlet ø 38mm type ZF320VSX 230V 50Hz 1 phase 0.75kW 1HP L 230mm rotation direction right capacitor 12.5µF LGB		
spare parts for 500508			
	GEV No.	365014	Ref. No. 464.016.00
	operating capacitor capacity 12.5µF 450V tolerance 5%Hz ambient temperature max. -25 to +85°C ø 35mm L 70mm M8 plastic connection male faston 6.3mm 45S.C3DS.12.5 protection		
	GEV No.	510702	Ref. No. —
	mechanical shaft seal height counter ring 5.5mm ID ø 12mm		
	GEV No.	521247	Ref. No. —
	impellor ø 90mm H 27mm rotation direction right thread M8L blades 6		
	GEV No.	521542	Ref. No. —
	pump cover LGB inlet ø 45mm outlet ø 40mm auxiliary pressure connection 13mm supporting pressure open ø 150mm ID ø 120mm inner high 25mm		
	GEV No.	521714	Ref. No. —
	pump cover gasket thickness 4x4mm Qty 1 pcs		



1

GEV No.	500512	Ref. No.	464.015.00
description	pump inlet ø 45mm outlet ø 40mm type ZF340VSX 230V 50Hz 1 phase 0.75kW 1HP L 245mm rotation direction right capacitor 16µF LGB		
spare parts for	500512		
	GEV No.	365021	Ref. No. —
	operating capacitor capacity 16µF 425V tolerance 5% 50/60Hz ambient temperature max. -25 to +85°C ø 35mm L 73mm single M8 plastic connection male faston 6.3mm 416.10.99 protection		
	GEV No.	510702	Ref. No. —
	mechanical shaft seal height counter ring 5.5mm ID ø 12mm		
	GEV No.	521246	Ref. No. 464.022.00
	impellor ø 103mm H 26mm thread M8L shaft ø 20mm shaft length 7mm seat ø 8.2mm blades 6		
	GEV No.	521542	Ref. No. —
	pump cover LGB inlet ø 45mm outlet ø 40mm auxiliary pressure connection 13mm supporting pressure open ø 150mm ID ø 120mm inner high 25mm		
	GEV No.	521714	Ref. No. —
	pump cover gasket thickness 4x4mm Qty 1 pcs		

accessories for	500209		
	GEV No.	500197	Ref. No. —
	body drain pump		
	GEV No.	500300	Ref. No. —
	pump cover inlet ø 39mm outlet ø 31mm		
	GEV No.	500301	Ref. No. —
	pump cover inlet ø 35mm outlet ø 31mm		
	GEV No.	500303	Ref. No. —
	body inlet ø 24mm outlet ø 22mm suitable for drain pump		
	GEV No.	500304	Ref. No. —
	pump cover inlet ø 30mm outlet ø 22mm ø 78mm		
	GEV No.	500305	Ref. No. —
	pump cover inlet ø 30mm outlet ø 22mm		
	GEV No.	560483	Ref. No. —
	screw ø 3.7mm L 20mm SS Qty 1 pcs head ø 7mm		

drain pumps

ASKOLL



1

GEV No.	500209	Ref. No.	464.037.00
description	drain pump inlet ømm outlet ømm 230V 40W 50Hz ASKOLL type M231 XP with holder		
spare parts for	500209		
	GEV No.	512175	Ref. No. —
	O-ring EPDM thickness 2.62mm ID ø 53.65mm Qty 1 pcs		

condensators & interference suppression filters

operating capacitors

plastic



1

GEV No.	365014	Ref. No.	464.016.00
description	operating capacitor capacity 12.5µF 450V tolerance 5%Hz ambient temperature max. -25 to +85°C ø 35mm L 70mm M8 plastic connection male faston 6.3mm 45S.C3DS.12.5 protection		

filters

interference suppression filters





1

GEV No.	365221	Ref. No.	661.120.00
description	interference suppression filter 250V 50/60Hz connection 5 male faston 6.3mm M8 plastic capacity 0,22µF(X2)+2x2mH+2X2,5nF(Y2)+1MOhmµF		



fuses

thermal fuses

1			
GEV No.	358193	Ref. No.	66307800
description	thermal fuse switch-off temp. 110°C		
1			
GEV No.	358190	Ref. No.	663.077.00
description	thermal fuse switch-off temp. 98°C		

electric accessories

cables



accessories

protection hoses

1			
GEV No.	550044	Ref. No.	96600000
description	protective metal tube PG16 ID ø 18mm ED ø 22mm zinc-coated steel Qty 10m		

terminals

connection terminals with screw/faston connections

1			
GEV No.	550278	Ref. No.	M566050000
description	power terminal block 3-pole max. 40A max 400V connection ø6mm ² / F6.3 temp.-resist. 150°C cross section 6mm ²		
1			
GEV No.	550411	Ref. No.	M566050500
description	power terminal block 6-pole max. 40A max 450V connection ø6mm ² / F6.3 temp.-resist. 150°C cross section 6mm ²		

connection terminals with screw connection

1			
GEV No.	551402	Ref. No.	463.026.00
description	power terminal block 3-pole max. 40A max 450V connection M5 temp.-resist. 150°C		

1			
GEV No.	550507	Ref. No.	66303600
description	power terminal block 4-pole max. 40A max 400V connection M6/M6 temp.-resist. 150°C		

1			
GEV No.	550355	Ref. No.	963.007.00
description	power terminal block 6-pole max. 40A max 400V connection M6/M6 temp.-resist. 150°C cross section 6mm ² hole distance 122mm		

connection boxes

1			
GEV No.	550671	Ref. No.	663040000
description	power terminal block 6-pole contacts 3P+N+E		

rail-mounted terminals

SIEMENS

feed-through terminals

1			
GEV No.	551238	Ref. No.	663.061.00
description	rail-mounted terminal 16mm ² beige 1-pole		



gas taps

PEL

20S series



GEV No.	101094	Ref. No.	67100000
----------------	--------	-----------------	----------

description gas tap PEL type 20S gas inlet M16x1.5 (tube ø 10mm) bypass nozzle ø 0.35mm gas outlet M16x1.5 (tube ø 10/8mm) thermocouple connection M8x1 pilot connection shaft ø 8x6.5mm shaft L 22/15mm shaft flat lower

For models: 65/110CFG, 65/110CFGE, 65/110CFGG, 65/110TPFG, 65/40PCG, 65/70CFG, 65/70PCG, CEG110, CEG70

spare parts for 101094

GEV No.	100408	Ref. No.	—
----------------	--------	-----------------	---

 bypass nozzle type PEL20/21 bore ø 0.35mm thread M5x0.5

GEV No.	101060	Ref. No.	—
----------------	--------	-----------------	---

 magnet unit standard L 39mm D1 ø 15.4mm D2 ø 11mm suitable for PEL20-21/JUNKERS/EGA

GEV No.	101205	Ref. No.	—
----------------	--------	-----------------	---

 gas tap front part shaft ø 8x6.5mm shaft L 22/15mm shaft flat upper/lower suitable for PEL20

GEV No.	101230	Ref. No.	—
----------------	--------	-----------------	---

 thermocouple nut T1: M8x1 T2: M18x1 aluminium

accessories for 101094

GEV No.	101278	Ref. No.	67300100
----------------	--------	-----------------	----------

 olive for pipe ø 10mm Qty 1 pcs

GEV No.	101300	Ref. No.	—
----------------	--------	-----------------	---

 union nut thread M16x1.5 tube ø 10mm

GEV No.	101450	Ref. No.	—
----------------	--------	-----------------	---

 olive for pipe ø 8mm L 12.7mm Qty 1 pcs ED ø 10mm

GEV No.	101451	Ref. No.	—
----------------	--------	-----------------	---

 union nut thread M16x1.5 tube ø 8mm

GEV No.	110081	Ref. No.	—
----------------	--------	-----------------	---

 knob ø 70mm shaft ø 8x6.5mm shaft flat universal

GEV No.	110083	Ref. No.	—
----------------	--------	-----------------	---

 knob dial plate gas tap without ignition flame silver

	GEV No.	551420	Ref. No.	663.059.00
description	rail-mounted terminal 16mm ² beige for grill			

	GEV No.	551431	Ref. No.	663.076.00
description	rail-mounted terminal SIEMENS 16mm ² blue H 46mm W 41mm L 10mm			

	GEV No.	551396	Ref. No.	663.060.00
description	rail-mounted terminal SIEMENS type 8WA1011-1PK00 16mm ² yellow/green for DIN rail 35mm H 40mm W 10mm L 53mm			

accessories universal

connection bridges

	GEV No.	551457	Ref. No.	663.056.00
description	connection bridge for rail-mounted terminal			



21S series



1





GEV No.	103342	Ref. No.	671.090.00
description	flange PEL type 21S with plug tube ø 21mm		



1

GEV No.	101397	Ref. No.	67100100
description	gas tap PEL type 21S gas inlet M16x1.5 (tube ø 10mm) bypass nozzle ø 0.35mm gas outlet M16x1.5 (tube ø 10/8mm) thermocouple connection M9x1 pilot connection M10x1 shaft ø 8x6.5mm shaft L 22/15mm shaft flat lower		
For models:	60/30FTG, 60/30FTGR, 60/60FTG, 60/60FTRG, 60/60FTRRG, 65/110TPFG, 65/40FTG, 65/40FTRG, 65/40GRG, 65/40GRL, 65/40PG-40P, 65/70FTG, 65/70FTRG, 65/70GRG, 65/70GRL, 65/70TPFG, 65/70TPG, 70/110CFG, 70/110CFGE, 70/110PCG, 70/110TPFG, 70/40CPG, 70/40FTG, 70/40FTGS, 70/40FTRG, 70/40GRG, 70/40GRL, 70/40PCG, 70/70CFG, 70/70CFGE, 70/70CPG, 70/70FTG, 70/70FTGS, 70/70FTRG, 70/70FTRRG, 70/70GRG, 70/70GRL, 70/70K, 70/70PCG, 70/70TPFG, 70/70TPG		

spare parts for	101397			
	GEV No.	100408	Ref. No.	—
	bypass nozzle type PEL20/21 bore ø 0.35mm thread M5x0.5			
	GEV No.	101060	Ref. No.	—
	magnet unit standard L 39mm D1 ø 15.4mm D2 ø 11mm suitable for PEL20-21/JUNKERS/EGA			
	GEV No.	101206	Ref. No.	—
	gas tap front part shaft ø 8x6.5mm shaft L 22/15mm shaft flat upper/lower suitable for PEL21			
	GEV No.	101231	Ref. No.	—
	thermocouple nut T1: M9x1 T2: M18x1			
accessories for	101397			
	GEV No.	100908	Ref. No.	67301300
	union screw thread M10x1 for pipe ø 4mm Qty 1 pcs			
	GEV No.	100909	Ref. No.	—
	union screw thread M10x1 for pipe ø 6mm Qty 1 pcs			
	GEV No.	101246	Ref. No.	67300400
	olive for pipe ø 4mm Qty 1 pcs			
	GEV No.	101278	Ref. No.	67300100
	olive for pipe ø 10mm Qty 1 pcs			
	GEV No.	101286	Ref. No.	—
	olive ID ø 6mm Qty 1 pcs			



accessories for	101397			
	GEV No.	101300	Ref. No.	—
	union nut thread M16x1.5 tube ø 10mm			
	GEV No.	101450	Ref. No.	—
	olive for pipe ø 8mm L 12.7mm Qty 1 pcs ED ø 10mm			
	GEV No.	101451	Ref. No.	—
	union nut thread M16x1.5 tube ø 8mm			
	GEV No.	110081	Ref. No.	—
	knob ø 70mm shaft ø 8x6.5mm shaft flat universal			
	GEV No.	112206	Ref. No.	—
	knob dial plate silver gas tap PEL21/22/23 t.max. °C ED ø 63mm ID ø 45.5mm			



1













GEV No.	109515	Ref. No.	67108800	
description	gas tap PEL type 21S gas inlet pipe flange ø 21mm bypass nozzle ø 0mm gas outlet M16x1.5 (tube ø 10/8mm) thermocouple connection M8x1 pilot connection M10x1 shaft ø 8x6.5mm shaft L 22/15mm shaft flat upper			
spare parts for	109515			
	GEV No.	101060	Ref. No.	—
	magnet unit standard L 39mm D1 ø 15.4mm D2 ø 11mm suitable for PEL20-21/JUNKERS/EGA			
	GEV No.	101206	Ref. No.	—
	gas tap front part shaft ø 8x6.5mm shaft L 22/15mm shaft flat upper/lower suitable for PEL21			
	GEV No.	101230	Ref. No.	—
	thermocouple nut T1: M8x1 T2: M18x1 aluminium			
accessories for	109515			
	GEV No.	100908	Ref. No.	67301300
	union screw thread M10x1 for pipe ø 4mm Qty 1 pcs			
	GEV No.	100909	Ref. No.	—
	union screw thread M10x1 for pipe ø 6mm Qty 1 pcs			
	GEV No.	101246	Ref. No.	67300400
	olive for pipe ø 4mm Qty 1 pcs			
	GEV No.	101278	Ref. No.	67300100
	olive for pipe ø 10mm Qty 1 pcs			
	GEV No.	101286	Ref. No.	—
	olive ID ø 6mm Qty 1 pcs			
	GEV No.	101300	Ref. No.	—
	union nut thread M16x1.5 tube ø 10mm			
	GEV No.	101450	Ref. No.	—
	olive for pipe ø 8mm L 12.7mm Qty 1 pcs ED ø 10mm			

Table continues overleaf

accessories for		109515	
	GEV No.	101451	Ref. No. —
	union nut thread M16x1.5 tube ø 8mm		
	GEV No.	110078	Ref. No. —
	knob without symbol ø 70mm shaft ø 6x4.6mm shaft flat universal		
	GEV No.	112206	Ref. No. —
	knob dial plate silver gas tap PEL21/22/23 t.max.°C ED ø 63mm ID ø 45.5mm		

22S/O series



GEV No.	101086	Ref. No.	67103100
description	gas tap PEL type 22S/O gas inlet M20x1.5 (tube ø 12mm) bypass nozzle ø 0.35mm gas outlet M20x1.5 (tube ø 12/10mm) thermocouple connection M9x1 pilot connection M10x1 shaft ø 10x8mm shaft L 25/17mm shaft flat lower		
For models:	70/70PGI		
spare parts for	101086		
	GEV No.	100259	Ref. No. —
	bypass nozzle type PEL22 bore ø 0.35mm thread M6x0.5		
	GEV No.	101058	Ref. No. —
	magnet unit L 39mm D1 ø 15.4mm D2 ø 13.5mm suitable for PEL22/EGA24197 standard		
	GEV No.	101201	Ref. No. —
	gas tap front part shaft ø 10x8mm shaft L 25/17mm shaft flat upper/lower suitable for PEL22		
	GEV No.	101231	Ref. No. —
	thermocouple nut T1: M9x1 T2: M18x1		
	GEV No.	101240	Ref. No. —
	gas connection thread M20x1.5 tube ø 12/10mm for PEL gas taps with gasket and screws horizontal		
	GEV No.	101460	Ref. No. —
	O-ring ø 12.37mm D1 ø 2.62mm suitable for PEL22		
	GEV No.	101461	Ref. No. —
	screw kit suitable for PEL22 Qty 4 pcs		
accessories for	101086		
	GEV No.	100908	Ref. No. 67301300
	union screw thread M10x1 for pipe ø 4mm Qty 1 pcs		
	GEV No.	100909	Ref. No. —
	union screw thread M10x1 for pipe ø 6mm Qty 1 pcs		
	GEV No.	101241	Ref. No. —
	gas connection thread M20x1.5 tube ø 12/10mm for PEL gas taps vertical		
	GEV No.	101246	Ref. No. 67300400
	olive for pipe ø 4mm Qty 1 pcs		
	GEV No.	101248	Ref. No. —
	olive for pipe ø 12mm Qty 1 pcs suitable for PEL		

accessories for		101086	
	GEV No.	101249	Ref. No. —
	olive for pipe ø 10mm Qty 1 pcs		
	GEV No.	101250	Ref. No. —
	union nut thread M20x1.5 for pipe ø 10mm		
	GEV No.	101251	Ref. No. —
	union nut thread M20x1.5 for pipe ø 12mm		
	GEV No.	101286	Ref. No. —
	olive ID ø 6mm Qty 1 pcs		
	GEV No.	110080	Ref. No. —
	knob ø 70mm shaft ø 10x8mm shaft flat universal		
	GEV No.	112206	Ref. No. —
	knob dial plate silver gas tap PEL21/22/23 t.max.°C ED ø 63mm ID ø 45.5mm		

23S/O series











GEV No.	101893	Ref. No.	67103200
description	gas tap PEL type 23S/O gas inlet M28x1.5 (tube ø 20mm) bypass nozzle ø 0.35mm gas outlet M24x1.5 (tube ø 16mm) thermocouple connection M9x1 pilot connection M10x1 shaft ø 10x8mm shaft L 25/17mm shaft flat lower		
spare parts for	101893		
	GEV No.	101045	Ref. No. —
	magnet unit T1: M9x1 T2: M22x1 L 46mm ø 18mm suitable for PEL23S M9x1		
	GEV No.	101204	Ref. No. —
	gas tap front part shaft ø 10x8mm shaft L 25/17mm shaft flat upper/lower suitable for PEL23S		
	GEV No.	101244	Ref. No. —
	gas connection thread M24x1.5 tube ø 12/16mm horizontal for PEL gas taps		
	GEV No.	101463	Ref. No. —
	screw suitable for PEL23S Qty 4 pcs		
	GEV No.	528455	Ref. No. —
	O-ring Viton thickness 2.62mm ID ø 18.72mm Qty 1 pcs		
accessories for	101893		
	GEV No.	100908	Ref. No. 67301300
	union screw thread M10x1 for pipe ø 4mm Qty 1 pcs		
	GEV No.	100909	Ref. No. —
	union screw thread M10x1 for pipe ø 6mm Qty 1 pcs		
	GEV No.	101246	Ref. No. 67300400
	olive for pipe ø 4mm Qty 1 pcs		

Table continues overleaf



accessories for		101893		
	GEV No.	101252	Ref. No.	—
union nut thread M24x1.5 for pipe ø 12mm				
	GEV No.	101253	Ref. No.	67302800
union nut thread M24x1.5 PEL for pipe ø 16mm				
	GEV No.	101254	Ref. No.	67303000
union nut thread M28x1.5 tube ø 20mm				
	GEV No.	101255	Ref. No.	—
olive for pipe ø 12mm Qty 1 pcs				
	GEV No.	101256	Ref. No.	67302700
olive for pipe ø 16mm Qty 1 pcs				
	GEV No.	101257	Ref. No.	—
olive for pipe ø 20mm Qty 1 pcs				
	GEV No.	101286	Ref. No.	—
olive ID ø 6mm Qty 1 pcs				
	GEV No.	110080	Ref. No.	—
knob ø 70mm shaft ø 10x8mm shaft flat universal				
	GEV No.	112206	Ref. No.	—
knob dial plate silver gas tap PEL21/22/23 t.max.°C ED ø 63mm ID ø 45.5mm				

accessories for		101994		
	GEV No.	560082	Ref. No.	—
hexagonal screw thread M4 thread L 16mm SS WS 7 Qty 20 pcs DIN 933 / ISO 4017				

gas thermostats

SIT





630 Eurosit series

			
1			
GEV No.	107688	Ref. No.	256.277.00 671.089.00
description	gas thermostat 100-340°C gas inlet 3/8" gas outlet 3/8" thermocouple connection M9x1 pilot connection M10x1 probe ø 4mm probe L 72mm capillary pipe 1050mm		

			
1			
GEV No.	103310	Ref. No.	671.108.00
description	gas thermostat type 630 Eurosit series 110-190°C		

			
1			
GEV No.	103076	Ref. No.	256.408.00 671.104.00
description	gas thermostat type 630 Eurosit series t.max. 190°C 110-190°C gas inlet 3/8" gas outlet 3/8" thermocouple connection M9x1 pilot connection M10x1 probe ø 4mm probe L 202mm capillary pipe 1050mm SIT		

SABAF

				
1				
GEV No.	101994	Ref. No.	67106700 67107100 67107700	
description	gas tap SABAF type 10 gas inlet pipe flange ø16mm bypass nozzle ø 0.65mm gas outlet 1/4" (tube ø 8mm) front fixing thermocouple connection plug-in connection shaft ø 8x6.5mm shaft L 26/12mm shaft flat lower			
For models:	60/30PCG, 60/60CFG, 60/60CFGE, 60/60PCG			
spare parts for	101994			
	GEV No.	101376	Ref. No.	—
gasket ID ø 8mm ED ø 12mm H 3/5mm				
	GEV No.	106725	Ref. No.	—
magnet unit L 35mm D1 ø 12.5mm D2 ø 8.5mm suitable for SABAF				
accessories for	101994			
	GEV No.	101277	Ref. No.	673.005.00
olive ID ø 8mm Qty 1 pcs				
	GEV No.	101751	Ref. No.	—
bracket				
	GEV No.	520656	Ref. No.	—
union nut thread 1/4" tube ø 6/8mm				

1 gas components



710 Minisit series



GEV No.	101135	Ref. No.	67100400 67101800
description	gas thermostat SIT type MINISIT 710 t.max. 190°C 110-190°C gas inlet 1/2" gas outlet 3/8" thermocouple connection M9x1 pilot connection M10x1 probe ø 6mm probe L 102mm capillary pipe 1050mm probe type type A3 pressure controller no pressure regulator mbar gland nut		
For models:	60/30FRG, 60/60FRG, 65/40FRG, 65/70FRG		
spare parts for	101135		
	GEV No.	101053	Ref. No. —
	magnet unit T1: M9x1 T2: M24x1 L 45mm ø 17mm suitable for Minisit		
	GEV No.	102118	Ref. No. —
	probe 110-190°C probe ø 6mm probe L 102mm capillary pipe 1050mm t.max. 190°C fryer probe type type A3 suitable for MINISIT 710		
accessories for	101135		
	GEV No.	100809	Ref. No. —
	O-ring EPDM thickness 2mm ID ø 21mm Qty 1 pcs		
	GEV No.	100820	Ref. No. —
	gland duct ET M14x1.5 IT M10x0.75 probe ø max. 6.5mm WS 22		
	GEV No.	100904	Ref. No. —
	locking screw M10x1 for pipe ø 4mm Qty 1 pcs		
	GEV No.	100905	Ref. No. —
	locking screw M10x1 for pipe ø 6mm Qty 1 pcs		
	GEV No.	101054	Ref. No. —
	magnet unit T1: M10x1 T2: M24x1 L 45mm ø 17mm suitable for Minisit		
	GEV No.	101136	Ref. No. —
	piezoelectric igniter suitable for Minisit with cover cap ømm connection F6.3x0.8		
	GEV No.	101137	Ref. No. 67100500
	cover cap without piezoelectric igniter		
	GEV No.	101267	Ref. No. —
	reducer IT 3/8" ET 1/2" L 21mm		
	GEV No.	101268	Ref. No. —
	gas connection thread 3/8" angled with O-ring MINISIT 710		
	GEV No.	101269	Ref. No. —
	gas connection thread 1/2" angled with O-ring MINISIT 710		
	GEV No.	101270	Ref. No. —
	screw connection IT 3/8" ET 3/8" L 28mm		
	GEV No.	101272	Ref. No. —
	screw connection IT 1/2" ET 3/8" L 57mm		

accessories for	101135		
	GEV No.	101273	Ref. No. 673.006.00 673.008.00
	olive for pipe ø 12mm L 9.5mm brass Qty 1 pcs suitable for universal		
	GEV No.	101274	Ref. No. —
	olive for pipe ø 16mm Qty 1 pcs		
	GEV No.	101275	Ref. No. —
	union screw thread 1/2" for pipe ø 16mm Qty 1 pcs		
	GEV No.	101276	Ref. No. —
	union screw thread 3/8" tube ø 12mm Qty 1 pcs		
	GEV No.	110068	Ref. No. 67100600
	knob suitable for Minisit ø 37mm		

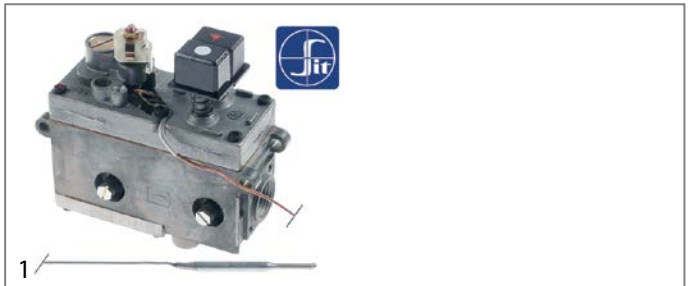

GEV No.	101132	Ref. No.	671.033.00 67102900
description	gas thermostat SIT type MINISIT 710 t.max. 340°C 100-340°C gas inlet 1/2" gas outlet 3/8" thermocouple connection M9x1 pilot connection M10x1 probe ø 5mm probe L 68mm capillary pipe 1050mm probe type type B1 pressure controller no pressure regulator mbar gland nut ignition gas no		
For models:	70/70BRG, 70/70BRGM		
spare parts for	101132		
	GEV No.	101053	Ref. No. —
	magnet unit T1: M9x1 T2: M24x1 L 45mm ø 17mm suitable for Minisit		
	GEV No.	102102	Ref. No. —
	probe 100-340°C probe ø 5mm probe L 68mm capillary pipe 1750mm t.max. 340°C oven/grill probe type type B1 suitable for MINISIT 710		
accessories for	101132		
	GEV No.	100809	Ref. No. —
	O-ring EPDM thickness 2mm ID ø 21mm Qty 1 pcs		
	GEV No.	100904	Ref. No. —
	locking screw M10x1 for pipe ø 4mm Qty 1 pcs		
	GEV No.	100905	Ref. No. —
	locking screw M10x1 for pipe ø 6mm Qty 1 pcs		
	GEV No.	101054	Ref. No. —
	magnet unit T1: M10x1 T2: M24x1 L 45mm ø 17mm suitable for Minisit		
	GEV No.	101136	Ref. No. —
	piezoelectric igniter suitable for Minisit with cover cap ømm connection F6.3x0.8		
	GEV No.	101137	Ref. No. 67100500
	cover cap without piezoelectric igniter		

Table continues overleaf



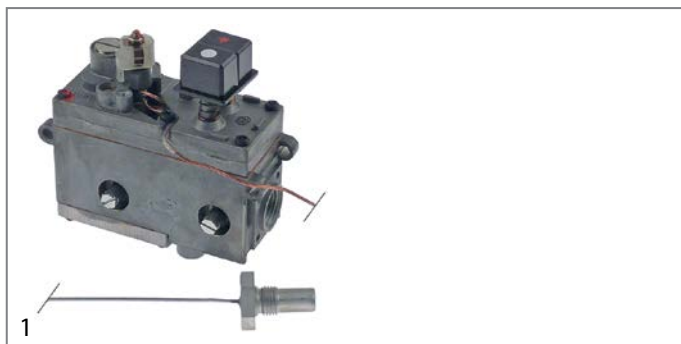

accessories for		101132		
	GEV No.	101267	Ref. No.	—
	reducer IT 3/8" ET 1/2" L 21mm			
	GEV No.	101268	Ref. No.	—
	gas connection thread 3/8" angled with O-ring MINISIT 710			
	GEV No.	101269	Ref. No.	—
	gas connection thread 1/2" angled with O-ring MINISIT 710			
	GEV No.	101270	Ref. No.	—
	screw connection IT 3/8" ET 3/8" L 28mm			
	GEV No.	101272	Ref. No.	—
	screw connection IT 1/2" ET 3/8" L 57mm			
	GEV No.	101273	Ref. No.	673.006.00 673.008.00
	olive for pipe ø 12mm L 9.5mm brass Qty 1 pcs suitable for universal			
	GEV No.	101274	Ref. No.	—
	olive for pipe ø 16mm Qty 1 pcs			
	GEV No.	101275	Ref. No.	—
	union screw thread 1/2" for pipe ø 16mm Qty 1 pcs			
	GEV No.	101276	Ref. No.	—
	union screw thread 3/8" tube ø 12mm Qty 1 pcs			
	GEV No.	110068	Ref. No.	67100600
	knob suitable for Minisit ø 37mm			



GEV No.	101678 ¹	Ref. No.	67102600
----------------	---------------------	-----------------	----------

description gas thermostat with threaded probe SIT type MINISIT 710 t.max. 190°C 110-190°C gas inlet 1/2" gas outlet 3/8" thermocouple connection M9x1 pilot connection M10x1 probe ø 10.5mm probe L 26mm capillary pipe 1050mm probe type type F3 pressure controller no pressure regulator mbar gland nut

spare parts for 101678

	GEV No.	101053	Ref. No.	—
	magnet unit T1: M9x1 T2: M24x1 L 45mm ø 17mm suitable for Minisit			
	GEV No.	102104	Ref. No.	—
	probe 110-190°C probe ø 11mm probe thread 1/4" probe L 26mm capillary pipe 1050mm t.max. 190°C fryer probe type type F3 suitable for MINISIT 710			

accessories for 101678

	GEV No.	100809	Ref. No.	—
	O-ring EPDM thickness 2mm ID ø 21mm Qty 1 pcs			

¹probe thread 1/4"

accessories for		101678		
	GEV No.	100904	Ref. No.	—
	locking screw M10x1 for pipe ø 4mm Qty 1 pcs			
	GEV No.	100905	Ref. No.	—
	locking screw M10x1 for pipe ø 6mm Qty 1 pcs			
	GEV No.	101054	Ref. No.	—
	magnet unit T1: M10x1 T2: M24x1 L 45mm ø 17mm suitable for Minisit			
	GEV No.	101136	Ref. No.	—
	piezoelectric igniter suitable for Minisit with cover cap ømm connection F6.3x0.8			
	GEV No.	101137	Ref. No.	67100500
	cover cap without piezoelectric igniter			
	GEV No.	101267	Ref. No.	—
	reducer IT 3/8" ET 1/2" L 21mm			
	GEV No.	101268	Ref. No.	—
	gas connection thread 3/8" angled with O-ring MINISIT 710			
	GEV No.	101269	Ref. No.	—
	gas connection thread 1/2" angled with O-ring MINISIT 710			
	GEV No.	101270	Ref. No.	—
	screw connection IT 3/8" ET 3/8" L 28mm			
	GEV No.	101272	Ref. No.	—
	screw connection IT 1/2" ET 3/8" L 57mm			
	GEV No.	101273	Ref. No.	673.006.00 673.008.00
	olive for pipe ø 12mm L 9.5mm brass Qty 1 pcs suitable for universal			
	GEV No.	101274	Ref. No.	—
	olive for pipe ø 16mm Qty 1 pcs			
	GEV No.	101275	Ref. No.	—
	union screw thread 1/2" for pipe ø 16mm Qty 1 pcs			
	GEV No.	101276	Ref. No.	—
	union screw thread 3/8" tube ø 12mm Qty 1 pcs			
	GEV No.	110068	Ref. No.	67100600
	knob suitable for Minisit ø 37mm			
	GEV No.	361182	Ref. No.	671.027.00
	nut thread 1/4" H 5mm nickel-plated brass WS 17 Qty 1 pcs			
	GEV No.	529251	Ref. No.	—
	O-ring EPDM thickness 2.62mm ID ø 15.08mm Qty 1 pcs			











GEV No.	107352 ¹	Ref. No.	67102500
description	gas thermostat with threaded probe type MINISIT 710 t.max. 190°C 110-190°C gas inlet 1/2" gas outlet 3/8" thermocouple connection M9x1 pilot connection M10x1 probe ø 14.4mm probe L 26mm capillary pipe 1050mm probe type type F3 pressure controller no pressure regulator mbar gland nut		
For models:	70/40FRG13, 70/70FRG13		
spare parts for	107352		
	GEV No.	107564	Ref. No. 67102800
	piezoelectric igniter body plastic blowing connection F6.3x0.8 ø 22mm		







¹probe thread 1/4"

PEL

25ST series



GEV No.	101172	Ref. No.	67103400 67108100
description	gas thermostat PEL type 25ST 100-300°C gas inlet M16x1.5 (tube ø 10mm) bypass nozzle ø 0.35mm gas outlet M16x1.5 (tube ø 10/8mm) thermocouple connection M9x1 pilot connection M10x1 capillary pipe 1200mm probe ø 6mm probe L 100mm shaft ø 8x6.5mm shaft L 21/15mm shaft flat upper		
For models:	60/30FTG-CR, 60/30FTRG-CR, 60/60FTG-CR, 60/60FTRG-CR, 60/60FTRRG-CR, 70/70FTG-CR, 70/70FTRG-CR, 70/70FTRRG-CR		
spare parts for	101172		
	GEV No.	100259	Ref. No. —
	bypass nozzle type PEL22 bore ø 0.35mm thread M6x0.5		
	GEV No.	101060	Ref. No. —
	magnet unit standard L 39mm D1 ø 15.4mm D2 ø 11mm suitable for PEL20-21/JUNKERS/EGA		
	GEV No.	106200	Ref. No. —
	nut thread M9x1 suitable for PEL 24/25S		
accessories for	101172		
	GEV No.	100908	Ref. No. 67301300
	union screw thread M10x1 for pipe ø 4mm Qty 1 pcs		
	GEV No.	100909	Ref. No. —
	union screw thread M10x1 for pipe ø 6mm Qty 1 pcs		
	GEV No.	101246	Ref. No. 67300400
	olive for pipe ø 4mm Qty 1 pcs		
	GEV No.	101278	Ref. No. 67300100
	olive for pipe ø 10mm Qty 1 pcs		

accessories for	101172		
	GEV No.	101286	Ref. No. —
	olive ID ø 6mm Qty 1 pcs		
	GEV No.	101300	Ref. No. —
	union nut thread M16x1.5 tube ø 10mm		
	GEV No.	101450	Ref. No. —
	olive for pipe ø 8mm L 12.7mm Qty 1 pcs ED ø 10mm		
	GEV No.	101451	Ref. No. —
	union nut thread M16x1.5 tube ø 8mm		
	GEV No.	110079	Ref. No. —
	knob dial plate gas thermostat 1-8 silver		
	GEV No.	110081	Ref. No. —
	knob ø 70mm shaft ø 8x6.5mm shaft flat universal		



GEV No.	101441	Ref. No.	97100000
description	gas thermostat PEL type 25ST 30-90°C gas inlet M16x1.5 (tube ø 10mm) bypass nozzle ø 0.35mm gas outlet M16x1.5 (tube ø 10/8mm) thermocouple connection M9x1 pilot connection M10x1 capillary pipe 1200mm probe ø 6mm probe L 160mm shaft ø 8x6.5mm shaft L 21/15mm shaft flat upper		
spare parts for	101441		
	GEV No.	100259	Ref. No. —
	bypass nozzle type PEL22 bore ø 0.35mm thread M6x0.5		
	GEV No.	101060	Ref. No. —
	magnet unit standard L 39mm D1 ø 15.4mm D2 ø 11mm suitable for PEL20-21/JUNKERS/EGA		
	GEV No.	106200	Ref. No. —
	nut thread M9x1 suitable for PEL 24/25S		
accessories for	101441		
	GEV No.	100908	Ref. No. 67301300
	union screw thread M10x1 for pipe ø 4mm Qty 1 pcs		
	GEV No.	100909	Ref. No. —
	union screw thread M10x1 for pipe ø 6mm Qty 1 pcs		
	GEV No.	101246	Ref. No. 67300400
	olive for pipe ø 4mm Qty 1 pcs		
	GEV No.	101278	Ref. No. 67300100
	olive for pipe ø 10mm Qty 1 pcs		
	GEV No.	101286	Ref. No. —
	olive ID ø 6mm Qty 1 pcs		
	GEV No.	101300	Ref. No. —
	union nut thread M16x1.5 tube ø 10mm		
	GEV No.	101450	Ref. No. —
	olive for pipe ø 8mm L 12.7mm Qty 1 pcs ED ø 10mm		

Table continues overleaf







accessories for	101441		
	GEV No.	101451	Ref. No. —
union nut thread M16x1.5 tube ø 8mm			

SABAF



GEV No.	101692	Ref. No.	67100200
description	gas thermostat SABAF t.max. 300°C gas inlet M13x1 IT (tube ø 8mm) bypass nozzle ø 0.5mm gas outlet 3/8" ET (tube ø 10mm) gas outlet 2 thermocouple connection M8x1 pilot connection capillary pipe 850mm probe ø 4mm probe L 140mm shaft ø 8x6.5mm shaft L 34/14mm shaft flat upper		
For models:	65/110CFG, 65/110CFGG, 65/110TPFG, 65/70CFG, 65/70TPFG, 70/110CFG, 70/110TPFG, 70/70CFG, 70/70TPFG		
spare parts for	101692		
	GEV No.	101060	Ref. No. —
magnet unit standard L 39mm D1 ø 15.4mm D2 ø 11mm suitable for PEL20-21/JUNKERS/EGA			
	GEV No.	106660	Ref. No. —
bypass nozzle bore ø 0.85mm thread M4x0.5 SABAF			
	GEV No.	106661	Ref. No. —
bypass nozzle bore ø 0.54mm thread M4x0.5 SABAF			
accessories for	101692		
	GEV No.	101277	Ref. No. 673.005.00
olive ID ø 8mm Qty 1 pcs			
	GEV No.	101278	Ref. No. 67300100
olive for pipe ø 10mm Qty 1 pcs			
	GEV No.	101476	Ref. No. —
union nut thread M13x1 for pipe ø 8mm			
	GEV No.	101478	Ref. No. —
union nut thread 3/8" for pipe ø 10mm			

	1		
GEV No.	106310	Ref. No.	671.086.00
description	gas thermostat SABAF t.max. 300°C gas inlet pipe flange bypass nozzle ø 0.39mm gas outlet 3/8" (tube ø 8mm) thermocouple connection M8x1 capillary pipe 850mm probe ø 4mm probe L 140mm shaft ø 8x6.5mm edition since year of construction 09/2002		
spare parts for	106310		
	GEV No.	101376	Ref. No. —
gasket ID ø 8mm ED ø 12mm H 3/5mm			

accessories for	106310		
	GEV No.	101277	Ref. No. 673.005.00
olive ID ø 8mm Qty 1 pcs			
	GEV No.	101477	Ref. No. 673.034.00
union screw thread M13x1 tube ø 8mm Qty 1 pcs			

gas valves and ignition boxes

gas control valves

SIT

NOVASIT













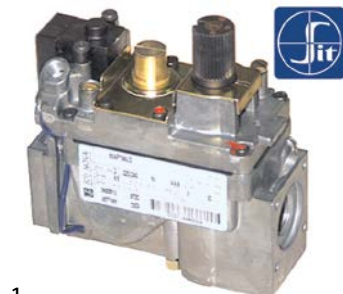











	1		
GEV No.	101162	Ref. No.	RMC222500
description	gas valve SIT series Novasit 820 230V 50Hz gas inlet 1/2" gas outlet 1/2" thermocouple connection M9x1 pilot connection M10x1 ignition pressure 3-5mbar pressure range 3-30mbar pressure regulator connection blind equiv. no. 0.820.010		
spare parts for	101162		
	GEV No.	101065	Ref. No. —
magnet unit with cable L 44mm D1 ø 30mm D2 ø 20mm suitable for NOVASIT			
	GEV No.	101313	Ref. No. —
solenoid coil 230V 50Hz			
accessories for	101162		
	GEV No.	100006	Ref. No. —
piezoelectric igniter suitable for ELETTRISIT body plastic blowing connection ø2.4mm ø 14mm			
	GEV No.	101305	Ref. No. —
gas connection straight 1/2" flange 45x45mm ELETTRISIT/V4400/4600/4605 suitable for SIT/HONEYWELL hole distance 36x36mm			
	GEV No.	101306	Ref. No. —
gas connection angled flange 45x45mm hole distance 36x36mm 1/2" ELETTRISIT/V4400/4600/4605 screw with O-ring suitable for SIT/HONEYWELL			
	GEV No.	101307	Ref. No. —
gas connection straight flange 45x45mm hole distance 36x36mm 3/4" ELETTRISIT/V4400/4600/4605 screw with O-ring suitable for SIT/HONEYWELL			
	GEV No.	101308	Ref. No. —
gas connection angled flange 45x45mm hole distance 36x36mm 3/4" ELETTRISIT/V4400/4600/4605 screw with O-ring suitable for SIT/HONEYWELL			
	GEV No.	101312	Ref. No. 968.501.00
microswitch			
	GEV No.	101314	Ref. No. —
solenoid coil 24V 50Hz			

Table continues overleaf

accessories for	101162		
	GEV No.	101317	Ref. No. —
	plug with cable L 1000mm suitable for NOVASIT		
	GEV No.	101318	Ref. No. —
	cover cap for solenoid coil suitable for NOVASIT		



1	GEV No.	101908	Ref. No.	256.331.00 256.335.00
description	gas valve SIT series Novasit 820 230V 50Hz gas inlet 1/2" gas outlet 1/2" thermocouple connection M9x1 pilot connection M10x1 ignition pressurebar pressure regulator connection blind equiv. no. 0.820.018 output pilot burner M10x1 input pressure max. 60bar setting range 3-30bar			
spare parts for	101908			
	GEV No.	101065	Ref. No.	—
	magnet unit with cable L 44mm D1 ø 30mm D2 ø 20mm suitable for NOVASIT			
	GEV No.	101313	Ref. No.	—
	solenoid coil 230V 50Hz			
accessories for	101908			
	GEV No.	100006	Ref. No.	—
	piezoelectric igniter suitable for ELETTROSIT body plastic blowing connection ø2.4mm ø 14mm			
	GEV No.	101305	Ref. No.	—
	gas connection straight 1/2" flange 45x45mm ELETTROSIT/V4400/4600/4605 suitable for SIT/HONEYWELL hole distance 36x36mm			
	GEV No.	101306	Ref. No.	—
	gas connection angled flange 45x45mm hole distance 36x36mm 1/2" ELETTROSIT/V4400/4600/4605 screw with O-ring suitable for SIT/HONEYWELL			
	GEV No.	101307	Ref. No.	—
	gas connection straight flange 45x45mm hole distance 36x36mm 3/4" ELETTROSIT/V4400/4600/4605 screw with O-ring suitable for SIT/HONEYWELL			
	GEV No.	101308	Ref. No.	—
	gas connection angled flange 45x45mm hole distance 36x36mm 3/4" ELETTROSIT/V4400/4600/4605 screw with O-ring suitable for SIT/HONEYWELL			
	GEV No.	101312	Ref. No.	968.501.00
	microswitch			
	GEV No.	101314	Ref. No.	—
	solenoid coil 24V 50Hz			
	GEV No.	101317	Ref. No.	—
	plug with cable L 1000mm suitable for NOVASIT			
	GEV No.	101318	Ref. No.	—
	cover cap for solenoid coil suitable for NOVASIT			

ignition boxes

SIT



1	GEV No.	102346	Ref. No.	572.015.00
description	ignition box SIT type 577DBC electrodes 2 waiting time 1.5s safety time 6s 220/240V 20VA 50/60Hz protection IP40			

ignition parts

pilot burners

SIT

100 series

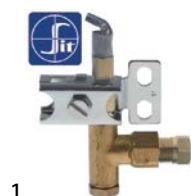



1	GEV No.	106901	Ref. No.	67208000
description	pilot burner SIT type 100 series 1 flame nozzle ø 0.2mm gas connection 6mm			
For models:	65/40PG-40P, 70/110CFG, 70/110CFGE, 70/110PCG, 70/110TPFG, 70/40PCG, 70/70CFG, 70/70CFGE, 70/70PCG			
spare parts for	106901			
	GEV No.	100854	Ref. No.	—
	pilot burner bracket double			
	GEV No.	100916	Ref. No.	—
	compression spring for pilot burner Qty 1 pcs			
	GEV No.	100917	Ref. No.	—
	gasket for pilot burner Qty 1 pcs aluminium			
	GEV No.	100918	Ref. No.	—
	screw for pilot burner			
accessories for	106901			
	GEV No.	100904	Ref. No.	—
	locking screw M10x1 for pipe ø 4mm Qty 1 pcs			
	GEV No.	100905	Ref. No.	—
	locking screw M10x1 for pipe ø 6mm Qty 1 pcs			
	GEV No.	102110	Ref. No.	97514000
	pilot tube copper pipe ø 4mm thickness 1mm L 3000mm			
	GEV No.	102111	Ref. No.	—
	pilot tube copper pipe ø 6mm thickness 1mm L 3000mm			

Table continues overleaf



accessories for 106901			
	GEV No.	102742	Ref. No. 67434600
pilot burner nozzle LPG code 25 bore ø 0.25mm Qty 1 pcs			



GEV No.	106902	Ref. No.	67206900
----------------	--------	-----------------	----------







description pilot burner SIT type 100 series 2 flames nozzle ø 0.2mm gas connection 6mm



For models: 65/110TPFG, 65/70TPFG, 65/70TPG, 70/110TPFG, 70/70TPFG, 70/70TPG

spare parts for 106902

	GEV No.	100245	Ref. No.	—
pilot burner nozzle LPG code 20 bore ø 0.2mm Qty 1 pcs thread M8x0.75				
	GEV No.	100842	Ref. No.	—
pilot burner cap 2 flames Qty 1 pcs				
	GEV No.	100885	Ref. No.	972.031.00
air mixing sleeve for pilot burner Qty 1 pcs				
	GEV No.	100916	Ref. No.	—
compression spring for pilot burner Qty 1 pcs				
	GEV No.	100917	Ref. No.	—
gasket for pilot burner Qty 1 pcs aluminium				
	GEV No.	100918	Ref. No.	—
screw for pilot burner				
	GEV No.	107161	Ref. No.	—
pilot burner cap SIT 2 flames Hmm Lmm Qty 1 pcs				
	GEV No.	107701	Ref. No.	672.094.00 97202900
pilot burner bottom part SIT 100 series nozzle ø 0.2mm				

accessories for 106902

	GEV No.	100246	Ref. No.	672.059.00
pilot burner nozzle natural gas bore ø 0.35mm Qty 1 pcs thread M8x0.75				
	GEV No.	100904	Ref. No.	—
locking screw M10x1 for pipe ø 4mm Qty 1 pcs				
	GEV No.	100905	Ref. No.	—
locking screw M10x1 for pipe ø 6mm Qty 1 pcs				
	GEV No.	102110	Ref. No.	97514000
pilot tube copper pipe ø 4mm thickness 1mm L 3000mm				
	GEV No.	102111	Ref. No.	—
pilot tube copper pipe ø 6mm thickness 1mm L 3000mm				
	GEV No.	107171	Ref. No.	—
pilot burner nozzle SIT natural/liquid gas bore ø 0.25mm Qty 1 pcs				

accessories for 106902				
	GEV No.	107700	Ref. No.	—
pilot burner bottom part SIT 100 series nozzle ø 0.25mm				
	GEV No.	107702	Ref. No.	—
pilot burner bottom part SIT 100 series nozzle ø 0.35mm				

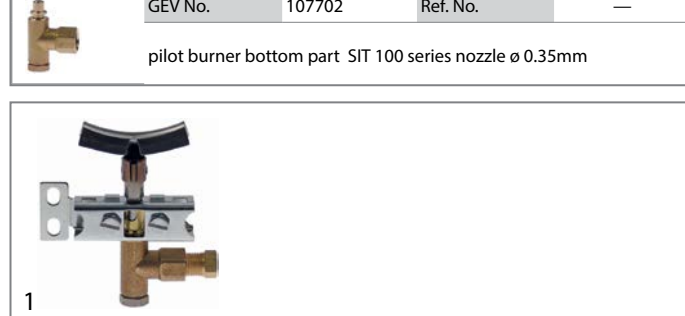

GEV No.	103344	Ref. No.	672.184.00
----------------	--------	-----------------	------------

description pilot burner SIT type 100 series 3 flames nozzle ø 0.35mm gas connection 4mm

spare parts for 103344

	GEV No.	100246	Ref. No.	672.059.00
pilot burner nozzle natural gas bore ø 0.35mm Qty 1 pcs thread M8x0.75				
	GEV No.	100855	Ref. No.	—
pilot burner bracket triple				
	GEV No.	100883	Ref. No.	—
pilot burner bottom part PRO-GAS 100 series nozzle ø 0.35mm				
	GEV No.	100885	Ref. No.	972.031.00
air mixing sleeve for pilot burner Qty 1 pcs				
	GEV No.	100904	Ref. No.	—
locking screw M10x1 for pipe ø 4mm Qty 1 pcs				
	GEV No.	102664	Ref. No.	—
pilot burner cap 3 flames suitable for 100 series H 29mm L 40mm				

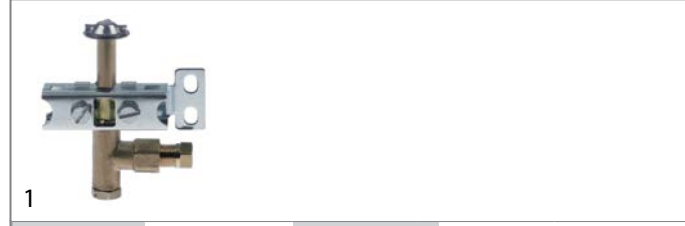

GEV No.	106907	Ref. No.	67205700
----------------	--------	-----------------	----------

description pilot burner SIT type 100 series 3 flames nozzle ø 0.35mm gas connection 6mm

spare parts for 106907



















	GEV No.	100246	Ref. No.	672.059.00
pilot burner nozzle natural gas bore ø 0.35mm Qty 1 pcs thread M8x0.75				
	GEV No.	100855	Ref. No.	—
pilot burner bracket triple				
	GEV No.	100885	Ref. No.	972.031.00
air mixing sleeve for pilot burner Qty 1 pcs				
	GEV No.	100916	Ref. No.	—
compression spring for pilot burner Qty 1 pcs				

Table continues overleaf

spare parts for 106907			
	GEV No.	100917	Ref. No. —
gasket for pilot burner Qty 1 pcs aluminium			
	GEV No.	100918	Ref. No. —
screw for pilot burner			
	GEV No.	107162	Ref. No. —
pilot burner cap SIT 3 flames Hmm Lmm Qty 1 pcs			
	GEV No.	107702	Ref. No. —
pilot burner bottom part SIT 100 series nozzle ø 0.35mm			

accessories for 106907			
	GEV No.	100245	Ref. No. —
pilot burner nozzle LPG code 20 bore ø 0.2mm Qty 1 pcs thread M8x0.75			
	GEV No.	100904	Ref. No. —
locking screw M10x1 for pipe ø 4mm Qty 1 pcs			
	GEV No.	100905	Ref. No. —
locking screw M10x1 for pipe ø 6mm Qty 1 pcs			
	GEV No.	102110	Ref. No. 97514000
pilot tube copper pipe ø 4mm thickness 1mm L 3000mm			
	GEV No.	102111	Ref. No. —
pilot tube copper pipe ø 6mm thickness 1mm L 3000mm			
	GEV No.	107171	Ref. No. —
pilot burner nozzle SIT natural/liquid gas bore ø 0.25mm Qty 1 pcs			
	GEV No.	107700	Ref. No. —
pilot burner bottom part SIT 100 series nozzle ø 0.25mm			
	GEV No.	107701	Ref. No. 672.094.00 97202900
pilot burner bottom part SIT 100 series nozzle ø 0.2mm			

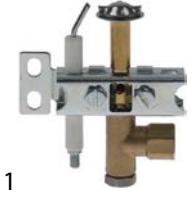
	1		
GEV No.	107881	Ref. No.	672.172.00
description pilot burner SIT type 100 series 3 flames nozzle ø 0.35mm gas connection 6mm with igniter			

accessories			
pilot burner caps			
	1		
GEV No.	107790	Ref. No.	973.002.00 973.003.00
description pilot burner cap 1 flame suitable for SIT H 60mm Qty 1 pcs			

	1		
GEV No.	107166	Ref. No.	97203000
description pilot burner head SIT 1 flame Hmm Lmm Qty 1 pcs			













pilot burner bottom parts			
	1		
GEV No.	107701	Ref. No.	672.094.00 97202900
description pilot burner bottom part SIT 100 series nozzle ø 0.2mm			
spare parts for 107701			
	GEV No.	100245	Ref. No. —
pilot burner nozzle LPG code 20 bore ø 0.2mm Qty 1 pcs thread M8x0.75			
	GEV No.	100916	Ref. No. —
compression spring for pilot burner Qty 1 pcs			
	GEV No.	100917	Ref. No. —
gasket for pilot burner Qty 1 pcs aluminium			
	GEV No.	100918	Ref. No. —
screw for pilot burner			
accessories for 107701			
	GEV No.	100246	Ref. No. 672.059.00
pilot burner nozzle natural gas bore ø 0.35mm Qty 1 pcs thread M8x0.75			
	GEV No.	100904	Ref. No. —
locking screw M10x1 for pipe ø 4mm Qty 1 pcs			
	GEV No.	100905	Ref. No. —
locking screw M10x1 for pipe ø 6mm Qty 1 pcs			
	GEV No.	102110	Ref. No. 97514000
pilot tube copper pipe ø 4mm thickness 1mm L 3000mm			

Table continues overleaf



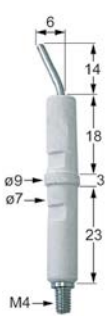

accessories for	107701		
	GEV No.	102111	Ref. No. —
	pilot tube copper pipe \varnothing 6mm thickness 1mm L 3000mm		
	GEV No.	102742	Ref. No. 67434600
	pilot burner nozzle LPG code 25 bore \varnothing 0.25mm Qty 1 pcs		

pilot burner nozzles			
1			
GEV No.	100246	Ref. No.	672.059.00
description	pilot burner nozzle natural gas bore \varnothing 0.35mm Qty 1 pcs thread M8x0.75		









ignition electrodes			
1			
GEV No.	100706	Ref. No.	67206000
description	ignition electrode connection M4 Qty 1 pcs		
For models:	65/110TPFG, 65/70TPFG, 65/70TPG, 70/110TPFG, 70/70TPFG, 70/70TPG		



miscellaneous			
1			
GEV No.	100885	Ref. No.	972.031.00
description	air mixing sleeve for pilot burner Qty 1 pcs		

1			
GEV No.	100967	Ref. No.	62324100
description	pilot burner bracket		
For models:	65/40PG-40P, 70/110CFG, 70/110CFGE, 70/110PCG, 70/110TPFG, 70/40PCG, 70/70CFG, 70/70CFGE, 70/70PCG		













140 - 145 -150 series			
1			
GEV No.	103357	Ref. No.	256.059.00
description	pilot burner SIT type 140 series 2 flames natural/liquid gas		
spare parts for	103357		
	GEV No.	100205	Ref. No. 67400100
	pilot burner nozzle SIT LPG code 19 bore \varnothing 0.23/0.26mm Qty 1 pcs suitable for SIT 150 series		
	GEV No.	100207	Ref. No. 674.091.00
	pilot burner nozzle SIT natural gas code 27 bore \varnothing 0.40/0.38mm suitable for SIT 140 series		
	GEV No.	100897	Ref. No. 67300300
	olive for pipe \varnothing 4mm Qty 1 pcs for pilot burner		
	GEV No.	100906	Ref. No. 67301400
	screw connection thread M10x1 for ignition electrode brass Qty 1 pcs WS 10		
	GEV No.	100908	Ref. No. 67301300
	union screw thread M10x1 for pipe \varnothing 4mm Qty 1 pcs		
	GEV No.	107114	Ref. No. 67201400
	pilot burner SIT type 140 series 2 flames nozzle \varnothing mm gas connectionmm		
accessories for	103357		
	GEV No.	100204	Ref. No. —
	pilot burner nozzle SIT LPG code 14 bore \varnothing 0.18/0.20mm Qty 1 pcs suitable for 140 series		
	GEV No.	100216	Ref. No. —
	pilot burner nozzle SIT natural gas code 38 bore \varnothing 0.45mm Qty 1 pcs suitable for SIT 150 series		
	GEV No.	100701	Ref. No. 256.017.00 256.060.00 67201500
	ignition electrode connection M4 Qty 1 pcs		
	GEV No.	100801	Ref. No. —
	gasket for pilot burner Qty 1 pcs		
	GEV No.	100898	Ref. No. —
	olive for pipe \varnothing 6mm Qty 1 pcs for pilot burner		
	GEV No.	100909	Ref. No. —
	union screw thread M10x1 for pipe \varnothing 6mm Qty 1 pcs		
	GEV No.	102110	Ref. No. 97514000
	pilot tube copper pipe \varnothing 4mm thickness 1mm L 3000mm		
	GEV No.	102111	Ref. No. —
	pilot tube copper pipe \varnothing 6mm thickness 1mm L 3000mm		



			
1			
GEV No.	107836	Ref. No.	672.173.00 67201300
description	pilot burner SIT type 140 series 2 flames nozzle ϕ 0.40/0.38mm complete		
For models:	60/30FTG, 60/30FTG-CR, 60/30FTGR, 60/30FTRG-CR, 60/60FTG, 60/60FTG-CR, 60/60FTRG, 60/60FTRRG, 60/60FTRRG-CR, 65/40FTG, 65/40FTRG, 65/40GRG, 65/40GRL, 65/70FTG, 65/70FTRG, 65/70GRL, 70/40CPG, 70/40FTG, 70/40FTGS, 70/40FTRG, 70/40GRG, 70/40GRL, 70/70BRG, 70/70BRGM, 70/70CPG, 70/70FTG, 70/70FTG-CR, 70/70FTGS, 70/70FTRG, 70/70FTRG-CR, 70/70FTRRG, 70/70FTRRG-CR, 70/70GRG, 70/70GRL, 70/70PGI		
spare parts for	107836		
	GEV No.	100207	Ref. No. 674.091.00
	pilot burner nozzle SIT natural gas code 27 bore ϕ 0.40/0.38mm suitable for SIT 140 series		
	GEV No.	100701	Ref. No. 256.017.00 256.060.00 67201500
	ignition electrode connection M4 Qty 1 pcs		
	GEV No.	100897	Ref. No. 67300300
	olive for pipe ϕ 4mm Qty 1 pcs for pilot burner		
	GEV No.	100906	Ref. No. 67301400
	screw connection thread M10x1 for ignition electrode brass Qty 1 pcs WS 10		
	GEV No.	100909	Ref. No. —
	union screw thread M10x1 for pipe ϕ 6mm Qty 1 pcs		
accessories for	107836		
	GEV No.	100801	Ref. No. —
	gasket for pilot burner Qty 1 pcs		
	GEV No.	102110	Ref. No. 97514000
	pilot tube copper pipe ϕ 4mm thickness 1mm L 3000mm		
	GEV No.	102111	Ref. No. —
	pilot tube copper pipe ϕ 6mm thickness 1mm L 3000mm		

			
1			
GEV No.	107114 ¹	Ref. No.	67201400
description	pilot burner SIT type 140 series 2 flames nozzle ϕ mm gas connectionmm		
spare parts for	107114		
	GEV No.	100907	Ref. No. —
	screw connection thread M10x1 Qty 1 pcs type SEF 1 ϕ mm for thermocouple		
accessories for	107114		
	GEV No.	100204	Ref. No. —
	pilot burner nozzle SIT LPG code 14 bore ϕ 0.18/0.20mm Qty 1 pcs suitable for 140 series		

¹incl. thermocouple fitting

accessories for	107114		
	GEV No.	100205	Ref. No. 67400100
	pilot burner nozzle SIT LPG code 19 bore ϕ 0.23/0.26mm Qty 1 pcs suitable for SIT 150 series		
	GEV No.	100206	Ref. No. 67400000
	pilot burner nozzle SIT natural gas code 36 bore ϕ 0.60/0.55mm Qty 1 pcs suitable for SIT 150 series		
	GEV No.	100207	Ref. No. 674.091.00
	pilot burner nozzle SIT natural gas code 27 bore ϕ 0.40/0.38mm suitable for SIT 140 series		
	GEV No.	100216	Ref. No. —
	pilot burner nozzle SIT natural gas code 38 bore ϕ 0.45mm Qty 1 pcs suitable for SIT 150 series		
	GEV No.	100701	Ref. No. 256.017.00 256.060.00 67201500
	ignition electrode connection M4 Qty 1 pcs		
	GEV No.	100801	Ref. No. —
	gasket for pilot burner Qty 1 pcs		
	GEV No.	100897	Ref. No. 67300300
	olive for pipe ϕ 4mm Qty 1 pcs for pilot burner		
	GEV No.	100898	Ref. No. —
	olive for pipe ϕ 6mm Qty 1 pcs for pilot burner		
	GEV No.	100906	Ref. No. 67301400
	screw connection thread M10x1 for ignition electrode brass Qty 1 pcs WS 10		
	GEV No.	100908	Ref. No. 67301300
	union screw thread M10x1 for pipe ϕ 4mm Qty 1 pcs		
	GEV No.	100909	Ref. No. —
	union screw thread M10x1 for pipe ϕ 6mm Qty 1 pcs		
	GEV No.	102110	Ref. No. 97514000
	pilot tube copper pipe ϕ 4mm thickness 1mm L 3000mm		
	GEV No.	102111	Ref. No. —
	pilot tube copper pipe ϕ 6mm thickness 1mm L 3000mm		

160 series



			
1			
GEV No.	100056	Ref. No.	672042 67204200
description	pilot burner SIT type 160 series 3 flames nozzle ϕ mm gas connectionmm		
For models:	60/30FRG, 60/60FRG, 65/40FRG, 65/70FRG, 70/40FRG13, 70/70FRG13		
spare parts for	100056		
	GEV No.	100907	Ref. No. —
	screw connection thread M10x1 Qty 1 pcs type SEF 1 ϕ mm for thermocouple		
accessories for	100056		
	GEV No.	100202	Ref. No. —
	pilot burner nozzle natural gas code 41 Qty 1 pcs nozzle ϕ 0.41mm		

Table continues overleaf



accessories for		100056	
	GEV No.	100203	Ref. No. —
pilot burner nozzle LPG code 25 Qty 1 pcs nozzle ø 0.25mm			
	GEV No.	100701	Ref. No. 256.017.00 256.060.00 67201500
ignition electrode connection M4 Qty 1 pcs			
	GEV No.	100801	Ref. No. —
gasket for pilot burner Qty 1 pcs			
	GEV No.	100869	Ref. No. —
pilot burner nozzle natural gas code 51 Qty 1 pcs suitable for 160 series nozzle ø 0.51mm			
	GEV No.	100870	Ref. No. 673.007.00
olive for pipe ø 4mm Qty 1 pcs suitable for 160 series for pilot burner			
	GEV No.	100906	Ref. No. 67301400
screw connection thread M10x1 for ignition electrode brass Qty 1 pcs WS 10			
	GEV No.	100908	Ref. No. 67301300
union screw thread M10x1 for pipe ø 4mm Qty 1 pcs			
	GEV No.	100909	Ref. No. —
union screw thread M10x1 for pipe ø 6mm Qty 1 pcs			
	GEV No.	101287	Ref. No. —
olive for pipe ø 6mm Qty 1 pcs			
	GEV No.	102110	Ref. No. 97514000
pilot tube copper pipe ø 4mm thickness 1mm L 3000mm			
	GEV No.	102111	Ref. No. —
pilot tube copper pipe ø 6mm thickness 1mm L 3000mm			
	GEV No.	107650	Ref. No. 674052 674.052.00
pilot burner nozzle SIT LPG code 30 Qty 1 pcs			

producer-specific pilot burners

MODULAR

650, 700, 900, 1100 series

			
1			
GEV No.	106758	Ref. No.	672.026.00
description	pilot burner SIT type 160 series 3 flames nozzle ø 0.51mm gas connection 4mm		

900 series



GEV No.	106771	Ref. No.	972.021.00
description	pilot burner 1 flame nozzle ø 0.2mm gas connectionmm suitable for MODULAR		

K_ series (wok burner)



GEV No.	100092	Ref. No.	37400600
description	pilot burner for wok range suitable for MODULAR		
For models:	70/70K		

accessories for		100092	
	GEV No.	100202	Ref. No. —
pilot burner nozzle natural gas code 41 Qty 1 pcs nozzle ø 0.41mm			
	GEV No.	100203	Ref. No. —
pilot burner nozzle LPG code 25 Qty 1 pcs nozzle ø 0.25mm			
	GEV No.	100908	Ref. No. 67301300
union screw thread M10x1 for pipe ø 4mm Qty 1 pcs			
	GEV No.	100909	Ref. No. —
union screw thread M10x1 for pipe ø 6mm Qty 1 pcs			
	GEV No.	101282	Ref. No. —
olive for pipe ø 4mm L 7.4mm Qty 1 pcs			
	GEV No.	101287	Ref. No. —
olive for pipe ø 6mm Qty 1 pcs			
	GEV No.	101860	Ref. No. 37200200
nut thread M10x1 H 4mm WS 14 chrome-plated brass Qty 1 pcs			
	GEV No.	107650	Ref. No. 674052 674.052.00
pilot burner nozzle SIT LPG code 30 Qty 1 pcs			

electrodes

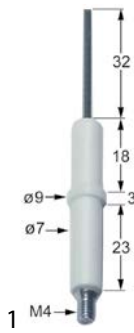

GEV No.	100701	Ref. No.	256..060.00 256.017.00 67201500
description	ignition electrode connection M4 Qty 1 pcs		
For models:	60/30FTG, 60/30FTG-CR, 60/30FTGR, 60/30FTRG-CR, 60/60FTG, 60/60FTG-CR, 60/60FTRG, 60/60FTRG-CR, 60/60FTRRG, 60/60FTRRG-CR, 65/40FTG, 65/40FTRG, 65/40GRG, 65/40GRL, 65/70FTG, 65/70FTRG, 65/70GRG, 65/70GRL, 70/40CPG, 70/40FTG, 70/40FTGS, 70/40FTRG, 70/40GRG, 70/40GRL, 70/70BRG, 70/70BRGM, 70/70CPG, 70/70FTG, 70/70FTG-CR, 70/70FTGS, 70/70FTRG, 70/70FTRG-CR, 70/70FTRRG, 70/70FTRRG-CR, 70/70GRG, 70/70GRL, 70/70PGI		
accessories for	100701		
	GEV No.	100906	Ref. No. 67301400
	screw connection thread M10x1 for ignition electrode brass Qty 1 pcs WS 10		



GEV No.	100706	Ref. No.	67206000
description	ignition electrode connection M4 Qty 1 pcs		
For models:	65/110TPFG, 65/70TPFG, 65/70TPG, 70/110TPFG, 70/70TPFG, 70/70TPG		

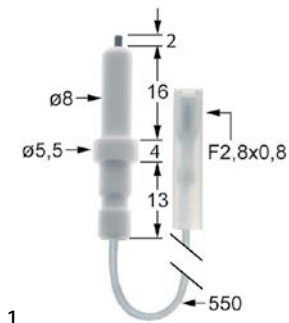

GEV No.	100808	Ref. No.	67211500
description	ignition electrode D1 ø 5.5mm cable length 550mm connection F 2.8x0.8mm D2 ø 8mm L1 2mm BL1 16mm BL2 4mm BL3 13mm		
For models:	60/30PCG, 60/60CFG, 60/60CFGE, 60/60PCG		



GEV No.	100817	Ref. No.	67211400
description	ignition electrode D1 ø 5mm cable length 700mm to clip		
For models:	60/30PCG, 60/60CFG, 60/60CFGE, 60/60PCG		



GEV No.	100815	Ref. No.	67201900
description	ignition electrode D1 ø 7mm L1 12mm BL1 18mm BL2 17mm BL3 9mm connection M4 M11x1		
For models:	65/110CFGG, 65/110TPFG, 65/70CFG, 65/70TPFG, 70/110CFG, 70/110TPFG, 70/70CFG, 70/70TPFG		



GEV No.	102315	Ref. No.	999.22.037
description	ignition electrode flange length 23mm flange width 15mm D1 ø 7mm L1 5mm BL1 30mm BL2 23mm connection F 2.8x0.8mm fixing dimensions ø5x4mm with flange		



GEV No.	102316	Ref. No.	999.22.036
description	ignition electrode flange length 23mm flange width 15mm D1 ø 7mm L1 5mm BL1 30mm BL2 24mm connection F 6.3 cable length 800mm fixing dimensions ø5x4mm with flange		

GEV No.	100729	Ref. No.	67200500
description	ignition electrode L1 5mm D1 ø 8mm D2 ø 10mm BL1 41mm BL2 14mm connection F 2.8x0.8mm to clip with spring		
For models:	65/110CFG, 65/110CFGE, 65/110TPFG, 65/40PCG, 65/70CFG, 65/70PCG		

GEV No.	100906	Ref. No.	67301400
description	screw connection thread M10x1 for ignition electrode brass Qty 1 pcs WS 10		
For models:	60/30FRG, 60/30FTG, 60/30FTG-CR, 60/30FTGR, 60/30FTRG-CR, 60/60FRG, 60/60FTG, 60/60FTG-CR, 60/60FTRG, 60/60FTRRG, 60/60FTRRG-CR, 65/40FRG, 65/40FTG, 65/40FTRG, 65/40GRG, 65/70FRG, 65/70FTG, 65/70FTRG, 65/70GRG, 70/40CPG, 70/40FRG13, 70/40FTG, 70/40FTGS, 70/40FTRG, 70/40GRG, 70/40GRL, 70/70BRG, 70/70BRGM, 70/70CPG, 70/70FRG13, 70/70FTG, 70/70FTG-CR, 70/70FTGS, 70/70FTRG, 70/70FTRG-CR, 70/70FTRRG, 70/70FTRRG-CR, 70/70GRG, 70/70GRL, 70/70PGI		

ignition cables

pre-assembled cables

GEV No.	100193	Ref. No.	66600200
description	ignition cable cable length 1200mm connection ø2.4mm / ø4mm		
For models:	65/110CFG, 65/110TPFG, 65/70CFG, 65/70TPFG, 70/110CFG, 70/110TPFG, 70/70CFG, 70/70TPFG		

GEV No.	100194	Ref. No.	66601400
description	ignition cable cable length 1900mm connection ø2.4mm / ø4mm		
For models:	65/110CFGG		

GEV No.	100018	Ref. No.	66600100
description	ignition cable cable length 600mm connection ø2.4mm / ø4mm permanent temperature 200°C		
For models:	60/30FRG, 60/30FTG-CR, 60/30FTGR, 60/30FTRG-CR, 60/60FRG, 60/60FTG, 60/60FTG-CR, 60/60FTRG, 60/60FTRG-CR, 60/60FTRRG, 60/60FTRRG-CR, 65/110TPFG, 65/40FRG, 65/40FTG, 65/40FTRG, 65/40GRG, 65/40GRL, 65/70FRG, 65/70FTG, 65/70FTRG, 65/70GRG, 65/70GRL, 65/70TPFG, 65/70TPG, 70/110TPFG, 70/40CPG, 70/40FTG, 70/40FTGS, 70/40FTRG, 70/40GRG, 70/40GRL, 70/70CPG, 70/70FTG, 70/70FTG-CR, 70/70FTGS, 70/70FTRG, 70/70FTRG-CR, 70/70FTRRG, 70/70FTRRG-CR, 70/70GRG, 70/70GRL, 70/70PGI, 70/70TPFG, 70/70TPG		

GEV No.	100025	Ref. No.	66605100
description	ignition cable cable length 600mm connection ø4mm / F6.3mm		
For models:	70/40FRG13, 70/70BRG, 70/70BRGM, 70/70FRG13		



GEV No.	100178	Ref. No.	66600000
description	ignition cable cable length 900mm connection F2.8mm / ø2.4mm		
For models:	65/110CFG, 65/110CFGE, 65/110TPFG, 65/40PCG, 65/70CFG, 65/70PCG		

piezoelectric igniters

mounting diameter 22mm

GEV No.	103341	Ref. No.	912.091.00
description	piezoelectric igniter body plastic blowing mounting ø 22mm connection ø2.4mm		
spare parts for	103341		
GEV No.	100013	Ref. No.	672.006.00
description	piezoelectric igniter body plastic blowing mounting ø 22mm connection ø2.4mm cable lengthmm		
GEV No.	101339	Ref. No.	951.047.00
description	cover cap for piezoelectric igniter		



			
1			
GEV No.	100013	Ref. No.	672.006.00
description	piezoelectric igniter body plastic blowing mounting ø 22mm connection ø2.4mm cable lengthmm		
For models:	60/30FRG, 60/30FTG, 60/30FTG-CR, 60/30FTGR, 60/30FTRG-CR, 60/30PCG, 60/60FRG, 60/60FTG, 60/60FTG-CR, 60/60FTRG, 60/60FTRG-CR, 60/60FTRRG, 60/60FTRRG-CR, 60/60PCG, 65/110CFG, 65/110CFGE, 65/110CFGG, 65/110TPFG, 65/40FRG, 65/40FTG, 65/40FTRG, 65/40GRG, 65/40GRL, 65/40PCG, 65/70CFG, 65/70FRG, 65/70FTG, 65/70FTRG, 65/70GRG, 65/70GRL, 65/70PCG, 65/70TPFG, 65/70TPG, 70/110CFG, 70/110CFG, 70/110TPFG, 70/40FTG, 70/40FTGS, 70/40FTRG, 70/40GRG, 70/40GRL, 70/70CFG, 70/70CPG, 70/70FTG, 70/70FTG-CR, 70/70FTGS, 70/70FTRG, 70/70FTRG-CR, 70/70FTRRG, 70/70FTRRG-CR, 70/70GRG...(Other models you can see in the webshop)		
accessories for	100013		
	GEV No.	100023	Ref. No. —
	female bullet size 2.3mm 0.5-1.5mm ² CuZn t.max. 125°C Qty 20 pcs		

miscellaneous			
			
1			
GEV No.	107564	Ref. No.	67102800
description	piezoelectric igniter body plastic blowing connection F6.3x0.8 ø 22mm		
accessories for	107564		
	GEV No.	100025	Ref. No. 66605100
	ignition cable cable length 600mm connection ø4mm / F6.3mm		

accessories			
			
1			
GEV No.	101339	Ref. No.	951.047.00
description	cover cap for piezoelectric igniter		

ignition units			
			
1			
GEV No.	101012	Ref. No.	96103000
description	ignition unit outputs 2 230VAC dimensions 48x32x32mm mounting distance 56mm inlet F2.8x0.8 outlet F2.8x0.8 type ZIG2 50-60Hz		

			
1			
GEV No.	101002	Ref. No.	661.118.00
description	ignition unit outputs 2 230VAC dimensions 88x23x34mm mounting distance 73mm inlet F6.3x0.8 outlet F2.8x0.8 0.6VA 50/60Hz		

			
1			
GEV No.	101023	Ref. No.	66304200
description	ignition unit outputs 4 230VAC dimensions 111x28x34mm mounting distance 98mm inlet F6.3x0.8 outlet F2.8x0.8 type ZAG4 0.3VA 50-60Hz		
For models:	60/60CFG, 60/60CFGE		
accessories for	101023		
	GEV No.	103257	Ref. No. —
	ignition unit outputs 4 230VAC dimensions 111x28x34mm mounting distance 98mm inlet F6.3x0.8 outlet F2.8x0.8 type FZ4 set 6-piece 0.3VA 50-60Hz		

ignition switches			
			
1			
GEV No.	348219	Ref. No.	961.048.00
description	momentary push switch mounting ø 25mm black 1NO 250V 16A connection male faston 6.3mm ambient temperature max. 120°C		

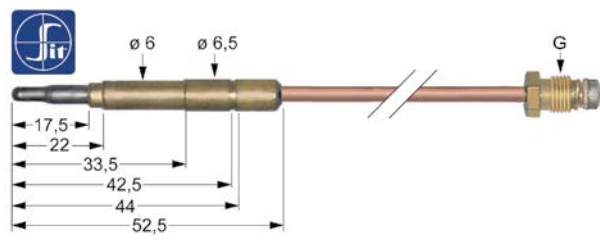
thermocouples			
plug-in thermocouples			
plug-in thermocouples standard			
with barrel socket ø6(6.5)mm			
thermocouples SIT			
			
1			
GEV No.	107613	Ref. No.	672.154.00
description	thermocouple SIT M9x1 L 1200mm plug connection ø6.0(6.5)mm		

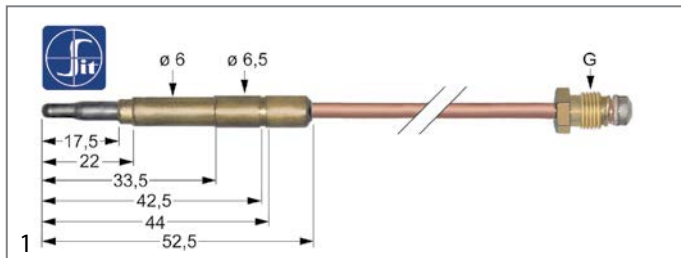

GEV No.	107614	Ref. No.	672.179.00 67210400
description	thermocouple SIT M9x1 L 1500mm plug connection ø6.0(6.5)mm		

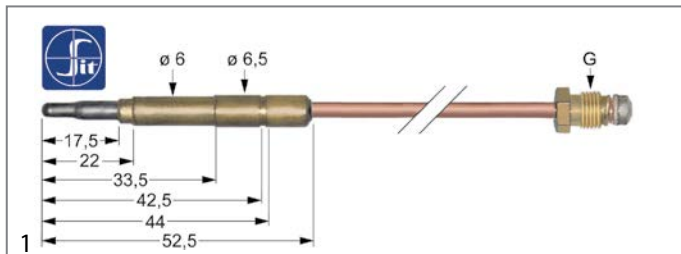

GEV No.	107608	Ref. No.	67200100 67202500
description	thermocouple SIT M9x1 L 500mm plug connection ø6.0(6.5)mm		

For models:
 60/30FTRG, 60/60FRG, 60/60FTG, 60/60FTG-CR, 60/60FTRG-CR, 60/60FTRRG-CR, 65/40FRG, 65/40FTG, 65/40FTRG, 65/40GRG, 65/40GRL, 65/40PG-40P, 65/70FRG, 65/70FTG, 65/70FTRG, 65/70GRG, 65/70GRL, 65/70TPFG, 65/70TPG, 70/110CFG, 70/110CFGE, 70/110PCG, 70/110TPFG, 70/40CPG, 70/40FRG13, 70/40FTG, 70/40FTGS, 70/40FTRG, 70/40GRG, 70/40GRL, 70/40PCG, 70/70BRG, 70/70BRGM, 70/70CFG, 70/70CFGE, 70/70CPG, 70/70FRG13, 70/70FTG, 70/70FTG-CR, 70/70FTGS, 70/70FTRG, 70/70FTRG-CR, 70/70FTRRG, 70/70FTRRG-CR, 70/70GRG, 70/70GRL, 70/70PCG, 70/70TPFG, 70/70TPG

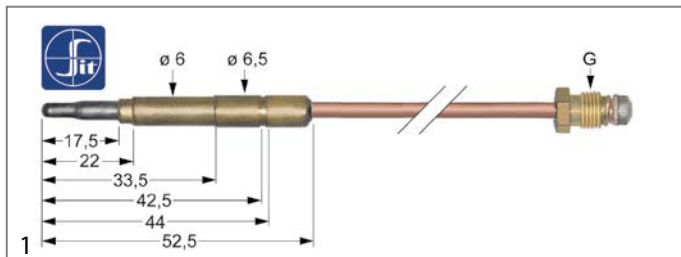

GEV No.	107611	Ref. No.	67208300 67209900
description	thermocouple SIT M9x1 L 850mm plug connection ø6.0(6.5)mm		
For models:	70/70PGI		

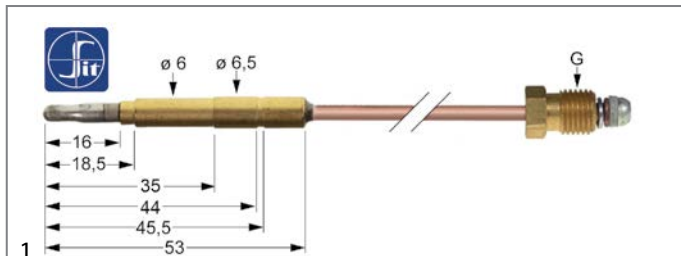

GEV No.	107876	Ref. No.	672.168.00
description	thermocouple SIT M9x1 L 850mm plug connection ø6.0(6.5)mm		

plug-in thermocouples with interruption

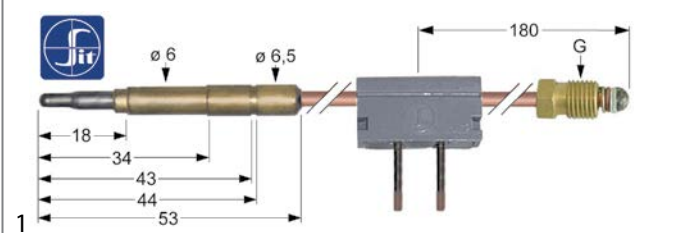

GEV No.	107864	Ref. No.	672.167.00
description	thermocouple SIT with interrupter M9x1 L 600mm plug connection ø6.0(6.5)mm soldering connection		

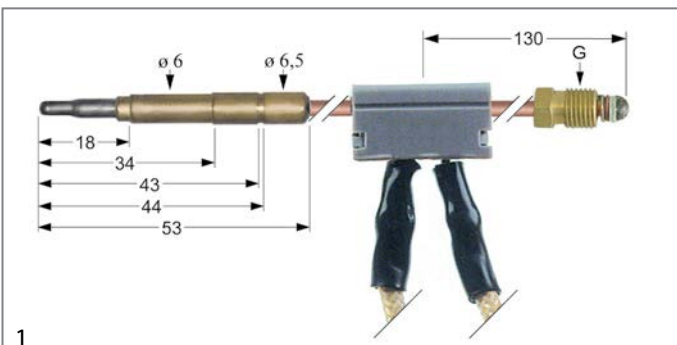

GEV No.	102247	Ref. No.	6101082.00 67216600
description	thermocouple with interrupter M9x1 L 600mm plug connection ø6.0mm cable 700mm		

threaded thermocouples

threaded thermocouples standard

with socket with thread M8x1

SIT

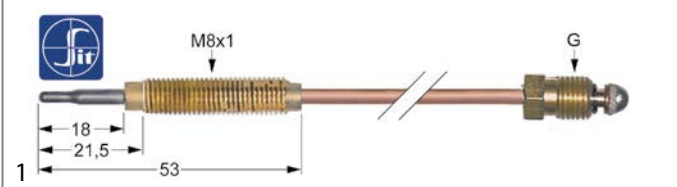

GEV No.	107633	Ref. No.	67201800
description	thermocouple SIT M8x1 L 1200mm M8x1		
For models:	65/110CFG, 65/110CFGG, 65/110TPFG, 65/70CFG, 65/70TPFG, 70/110CFG, 70/110TPFG, 70/70CFG, 70/70TPFG		

accessories for	107633		
	GEV No.	102067	Ref. No.
			—
	nut thread M8x1 H 3mm brass Qty 1 pcs type SEF 1		

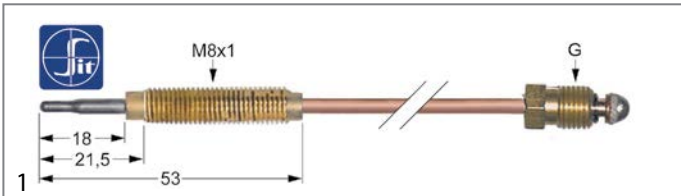

GEV No.	107630	Ref. No.	67200000
description	thermocouple SIT M8x1 L 600mm M8x1		
For models:	65/110CFG, 65/110CFGE, 65/110CFGG, 65/110TPFG, 65/40PCG, 65/70CFG, 65/70PCG, 70/70K, CEG110, CEG70		
accessories for	107630		
	GEV No.	102067	Ref. No.
			—
	nut thread M8x1 H 3mm brass Qty 1 pcs type SEF 1		

threaded thermocouples (miscellaneous)

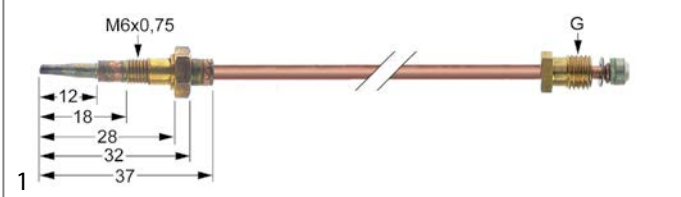



GEV No.	107350	Ref. No.	67212300
description	thermocouple M8x1 L 1200mm M6x0.75		
For models:	60/60CFG		

threaded thermocouples with cable link

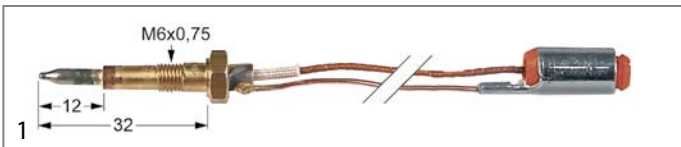

GEV No.	102127	Ref. No.	67211800 67213400
description	thermocouple with two-conductors L 600mm M6x0.75 ø 2mm		
For models:	60/30PCG, 60/60CFG, 60/60CFGE, 60/60PCG		
accessories for	102127		
	GEV No.	102680	Ref. No.
			—
	nut thread M6x0.75 H 2.6mm WS 8 brass Qty 1 pcs type SEF 2		



GEV No.	102152	Ref. No.	67211700 67213500
description	thermocouple with two-conductors L 750mm M6x0.75 ø 2mm		
For models:	60/30PCG, 60/60CFG, 60/60CFGE, 60/60PCG		
accessories for	102152		
	GEV No.	102680	Ref. No.
			—
	nut thread M6x0.75 H 2.6mm WS 8 brass Qty 1 pcs type SEF 2		

accessories

interrupters



GEV No.	101265	Ref. No.	67202000
description	interrupter thread M9x1		
For models:	60/30FRG, 60/60FRG, 65/40FRG, 65/70FRG		

miscellaneous



GEV No.	102649	Ref. No.	66600500
description	cable connection male faston 6.3mm cable length 900mm Qty 1m		

gas burners

hob burners

universal hob burners

SABAF

1 series



GEV No.	104286	Ref. No.	67212700
description	burner cap 3kW ø 90mm		
For models:	60/60CFG		

accessories for 104286

	GEV No.	104289	Ref. No.	67212900
	burner lower part 3/3.6kW for burner cap ø 90/120mm			

	GEV No.	105089	Ref. No.	67212400
	burner ring 3kW for burner cap ø 90mm			

	GEV No.	105090	Ref. No.	67212600
	burner head 3kW for burner cap ø 90mm			



GEV No.	105090	Ref. No.	67212600
description	burner head 3kW for burner cap ø 90mm		
For models:	60/60CFG		



accessories for 105090





	GEV No.	104286	Ref. No.	67212700
	burner cap 3kW ø 90mm			



	GEV No.	104289	Ref. No.	67212900
	burner lower part 3/3.6kW for burner cap ø 90/120mm			





	GEV No.	105089	Ref. No.	67212400
	burner ring 3kW for burner cap ø 90mm			



			
1			
GEV No.	104289	Ref. No.	67212900
description	burner lower part 3/3.6kW for burner cap ø 90/120mm		
For models:	60/60CFG		
accessories for	104289		
	GEV No.	104286	Ref. No. 67212700
burner cap 3kW ø 90mm			
	GEV No.	104288	Ref. No. —
burner cap 3.6kW ø 120mm			
	GEV No.	105086	Ref. No. —
burner ring 3.6kW for burner cap ø 120mm			
	GEV No.	105087	Ref. No. —
burner head 3.6kW for burner cap ø 120mm			
	GEV No.	105089	Ref. No. 67212400
burner ring 3kW for burner cap ø 90mm			
	GEV No.	105090	Ref. No. 67212600
burner head 3kW for burner cap ø 90mm			
	GEV No.	106482	Ref. No. —
gas injector thread M6x0.75 WS 7 bore ø 1.1mm			
	GEV No.	106485	Ref. No. —
gas injector thread M6x0.75 WS 7 bore ø 1.6mm			

			
1			
GEV No.	105089	Ref. No.	67212400
description	burner ring 3kW for burner cap ø 90mm		
For models:	60/60CFG		
accessories for	105089		
	GEV No.	104286	Ref. No. 67212700
burner cap 3kW ø 90mm			
	GEV No.	104289	Ref. No. 67212900
burner lower part 3/3.6kW for burner cap ø 90/120mm			
	GEV No.	105090	Ref. No. 67212600
burner head 3kW for burner cap ø 90mm			

2 series - standard			
			
1			
GEV No.	105054	Ref. No.	67211300
description	burner cap 3kW ø 100mm H 3.5mm bright finish		
For models:	60/30PCG, 60/60CFG, 60/60CFGE, 60/60PCG		
accessories for	105054		
	GEV No.	105058	Ref. No. 67211200
burner head 3kW for igniter ø 6mm for burner cap ø 100mm			
	GEV No.	105059	Ref. No. 67211100
burner lower part 3kW for igniter ø 6mm for thermocouple ø 6mm without nozzle for burner cap ø 100mm			

			
1			
GEV No.	105058	Ref. No.	67211200
description	burner head 3kW for igniter ø 6mm for burner cap ø 100mm		
For models:	60/30PCG, 60/60CFG, 60/60CFGE, 60/60PCG		
accessories for	105058		
	GEV No.	105054	Ref. No. 67211300
burner cap 3kW ø 100mm H 3.5mm bright finish			
	GEV No.	105059	Ref. No. 67211100
burner lower part 3kW for igniter ø 6mm for thermocouple ø 6mm without nozzle for burner cap ø 100mm			
	GEV No.	107374	Ref. No. —
burner cap 3kW ø 100mm H 3.5mm matt finish			

			
1			
GEV No.	105059	Ref. No.	67211100
description	burner lower part 3kW for igniter ø 6mm for thermocouple ø 6mm without nozzle for burner cap ø 100mm		
For models:	60/60CFG, 60/60CFGE, 60/60PCG		
accessories for	105059		
	GEV No.	105054	Ref. No. 67211300
burner cap 3kW ø 100mm H 3.5mm bright finish			
	GEV No.	105058	Ref. No. 67211200
burner head 3kW for igniter ø 6mm for burner cap ø 100mm			
	GEV No.	107374	Ref. No. —
burner cap 3kW ø 100mm H 3.5mm matt finish			

2 series - flat skirt version



GEV No.	105054	Ref. No.	67211300
description	burner cap 3kW ø 100mm H 3.5mm bright finish		
For models:	60/30PCG, 60/60CFG, 60/60CFGE, 60/60PCG		
accessories for	105054		
	GEV No.	105058	Ref. No. 67211200
	burner head 3kW for igniter ø 6mm for burner cap ø 100mm		
	GEV No.	105059	Ref. No. 67211100
	burner lower part 3kW for igniter ø 6mm for thermocouple ø 6mm without nozzle for burner cap ø 100mm		



GEV No.	105059	Ref. No.	67211100
description	burner lower part 3kW for igniter ø 6mm for thermocouple ø 6mm without nozzle for burner cap ø 100mm		
For models:	60/60CFG, 60/60CFGE, 60/60PCG		
accessories for	105059		
	GEV No.	105054	Ref. No. 67211300
	burner cap 3kW ø 100mm H 3.5mm bright finish		
	GEV No.	105058	Ref. No. 67211200
	burner head 3kW for igniter ø 6mm for burner cap ø 100mm		
	GEV No.	107374	Ref. No. —
	burner cap 3kW ø 100mm H 3.5mm matt finish		

triple ring burner series - standard version



GEV No.	105063	Ref. No.	67210800
description	burner cap 3.6kW ø 131mm H 4mm mounting pos. outer		
For models:	60/30PCG, 60/60CFG, 60/60CFGE, 60/60PCG		
accessories for	105063		
	GEV No.	105064	Ref. No. 67210900
	burner cap 3.6kW ø 61mm H 6.5mm mounting pos. inner bright finish		
	GEV No.	105065	Ref. No. 67210700
	burner head 3.6kW for burner cap ø 61/131mm		
	GEV No.	105717	Ref. No. —
	burner lower part 3.6kW for igniter ø 6mm for thermocouple ø 6mm with nozzle ø1.35mm ID ø 64mm for burner cap ø 61/131mm		
	GEV No.	105922	Ref. No. —
	burner lower part 3.6kW for igniter ø 6mm for thermocouple ø 6mm with nozzle ø1.35mm ID ø 75mm for burner cap ø 61/131mm		



GEV No.	105064	Ref. No.	67210900
description	burner cap 3.6kW ø 61mm H 6.5mm mounting pos. inner bright finish		
For models:	60/30PCG, 60/60CFG, 60/60CFGE, 60/60PCG		
accessories for	105064		
	GEV No.	105063	Ref. No. 67210800
	burner cap 3.6kW ø 131mm H 4mm mounting pos. outer		
	GEV No.	105065	Ref. No. 67210700
	burner head 3.6kW for burner cap ø 61/131mm		
	GEV No.	105717	Ref. No. —
	burner lower part 3.6kW for igniter ø 6mm for thermocouple ø 6mm with nozzle ø1.35mm ID ø 64mm for burner cap ø 61/131mm		
	GEV No.	105922	Ref. No. —
	burner lower part 3.6kW for igniter ø 6mm for thermocouple ø 6mm with nozzle ø1.35mm ID ø 75mm for burner cap ø 61/131mm		







GEV No.	105065	Ref. No.	67210700
description	burner head 3.6kW for burner cap ø 61/131mm		
For models:	60/30PCG, 60/60CFG, 60/60CFGE, 60/60PCG		
accessories for	105065		
	GEV No.	105063	Ref. No. 67210800
	burner cap 3.6kW ø 131mm H 4mm mounting pos. outer		
	GEV No.	105064	Ref. No. 67210900
	burner cap 3.6kW ø 61mm H 6.5mm mounting pos. inner bright finish		
	GEV No.	105717	Ref. No. —
	burner lower part 3.6kW for igniter ø 6mm for thermocouple ø 6mm with nozzle ø1.35mm ID ø 64mm for burner cap ø 61/131mm		







GEV No.	105066	Ref. No.	67210600
description	burner lower part 3.6kW for igniter ø 6mm for thermocouple ø 6mm without nozzle ID ø 64mm for burner cap ø 61/131mm		
For models:	60/30PCG, 60/60CFG, 60/60CFGE, 60/60PCG		
accessories for	105066		
	GEV No.	101277	Ref. No. 673.005.00
	olive ID ø 8mm Qty 1 pcs		
	GEV No.	101477	Ref. No. 673.034.00
	union screw thread M13x1 tube ø 8mm Qty 1 pcs		



triple ring burner series - flat skirt version

			
1			
GEV No.	105063	Ref. No.	67210800
description	burner cap 3.6kW ø 131mm H 4mm mounting pos. outer		
For models:	60/30PCG, 60/60CFG, 60/60CFGE, 60/60PCG		
accessories for	105063		
	GEV No.	105064	Ref. No. 67210900
	burner cap 3.6kW ø 61mm H 6.5mm mounting pos. inner bright finish		
	GEV No.	105065	Ref. No. 67210700
	burner head 3.6kW for burner cap ø 61/131mm		
	GEV No.	105717	Ref. No. —
	burner lower part 3.6kW for igniter ø 6mm for thermocouple ø 6mm with nozzle ø1.35mm ID ø 64mm for burner cap ø 61/131mm		
	GEV No.	105922	Ref. No. —
	burner lower part 3.6kW for igniter ø 6mm for thermocouple ø 6mm with nozzle ø1.35mm ID ø 75mm for burner cap ø 61/131mm		





			
1			
GEV No.	105064	Ref. No.	67210900
description	burner cap 3.6kW ø 61mm H 6.5mm mounting pos. inner bright finish		
For models:	60/30PCG, 60/60CFG, 60/60CFGE, 60/60PCG		
accessories for	105064		
	GEV No.	105063	Ref. No. 67210800
	burner cap 3.6kW ø 131mm H 4mm mounting pos. outer		
	GEV No.	105065	Ref. No. 67210700
	burner head 3.6kW for burner cap ø 61/131mm		
	GEV No.	105717	Ref. No. —
	burner lower part 3.6kW for igniter ø 6mm for thermocouple ø 6mm with nozzle ø1.35mm ID ø 64mm for burner cap ø 61/131mm		
	GEV No.	105922	Ref. No. —
	burner lower part 3.6kW for igniter ø 6mm for thermocouple ø 6mm with nozzle ø1.35mm ID ø 75mm for burner cap ø 61/131mm		

			
1			
GEV No.	105066	Ref. No.	67210600
description	burner lower part 3.6kW for igniter ø 6mm for thermocouple ø 6mm without nozzle ID ø 64mm for burner cap ø 61/131mm		
For models:	60/30PCG, 60/60CFG, 60/60CFGE, 60/60PCG		
accessories for	105066		
	GEV No.	101277	Ref. No. 673.005.00
	olive ID ø 8mm Qty 1 pcs		
	GEV No.	101477	Ref. No. 673.034.00
	union screw thread M13x1 tube ø 8mm Qty 1 pcs		



producer-specific hob burners





MODULAR





600 series



			
1			
GEV No.	105063	Ref. No.	67210800
description	burner cap 3.6kW ø 131mm H 4mm mounting pos. outer		
For models:	60/30PCG, 60/60CFG, 60/60CFGE, 60/60PCG		
accessories for	105063		
	GEV No.	105064	Ref. No. 67210900
	burner cap 3.6kW ø 61mm H 6.5mm mounting pos. inner bright finish		
	GEV No.	105065	Ref. No. 67210700
	burner head 3.6kW for burner cap ø 61/131mm		
	GEV No.	105717	Ref. No. —
	burner lower part 3.6kW for igniter ø 6mm for thermocouple ø 6mm with nozzle ø1.35mm ID ø 64mm for burner cap ø 61/131mm		
	GEV No.	105922	Ref. No. —
	burner lower part 3.6kW for igniter ø 6mm for thermocouple ø 6mm with nozzle ø1.35mm ID ø 75mm for burner cap ø 61/131mm		





			
1			
GEV No.	105064	Ref. No.	67210900
description	burner cap 3.6kW ø 61mm H 6.5mm mounting pos. inner bright finish		
For models:	60/30PCG, 60/60CFG, 60/60CFGE, 60/60PCG		
accessories for	105064		
	GEV No.	105063	Ref. No. 67210800
	burner cap 3.6kW ø 131mm H 4mm mounting pos. outer		
	GEV No.	105065	Ref. No. 67210700
	burner head 3.6kW for burner cap ø 61/131mm		
	GEV No.	105717	Ref. No. —
	burner lower part 3.6kW for igniter ø 6mm for thermocouple ø 6mm with nozzle ø1.35mm ID ø 64mm for burner cap ø 61/131mm		
	GEV No.	105922	Ref. No. —
	burner lower part 3.6kW for igniter ø 6mm for thermocouple ø 6mm with nozzle ø1.35mm ID ø 75mm for burner cap ø 61/131mm		

			
1			
GEV No.	105054	Ref. No.	67211300
description	burner cap 3kW ø 100mm H 3.5mm bright finish		
For models:	60/30PCG, 60/60CFG, 60/60CFGE, 60/60PCG		
accessories for	105054		
	GEV No.	105058	Ref. No. 67211200
	burner head 3kW for igniter ø 6mm for burner cap ø 100mm		
	GEV No.	105059	Ref. No. 67211100
	burner lower part 3kW for igniter ø 6mm for thermocouple ø 6mm without nozzle for burner cap ø 100mm		

			
1			
GEV No.	105065	Ref. No.	67210700
description	burner head 3.6kW for burner cap ø 61/131mm		
For models:	60/30PCG, 60/60CFG, 60/60CFGE, 60/60PCG		
accessories for	105065		
	GEV No.	105063	Ref. No. 67210800
	burner cap 3.6kW ø 131mm H 4mm mounting pos. outer		
	GEV No.	105064	Ref. No. 67210900
	burner cap 3.6kW ø 61mm H 6.5mm mounting pos. inner bright finish		
	GEV No.	105717	Ref. No. —
	burner lower part 3.6kW for igniter ø 6mm for thermocouple ø 6mm with nozzle ø 1.35mm ID ø 64mm for burner cap ø 61/131mm		

			
1			
GEV No.	105058	Ref. No.	67211200
description	burner head 3kW for igniter ø 6mm for burner cap ø 100mm		
For models:	60/30PCG, 60/60CFG, 60/60CFGE, 60/60PCG		
accessories for	105058		
	GEV No.	105054	Ref. No. 67211300
	burner cap 3kW ø 100mm H 3.5mm bright finish		
	GEV No.	105059	Ref. No. 67211100
	burner lower part 3kW for igniter ø 6mm for thermocouple ø 6mm without nozzle for burner cap ø 100mm		
	GEV No.	107374	Ref. No. —
	burner cap 3kW ø 100mm H 3.5mm matt finish		

			
1			
GEV No.	105066	Ref. No.	67210600
description	burner lower part 3.6kW for igniter ø 6mm for thermocouple ø 6mm without nozzle ID ø 64mm for burner cap ø 61/131mm		
For models:	60/30PCG, 60/60CFG, 60/60CFGE, 60/60PCG		
accessories for	105066		
	GEV No.	101277	Ref. No. 673.005.00
	olive ID ø 8mm Qty 1 pcs		
	GEV No.	101477	Ref. No. 673.034.00
	union screw thread M13x1 tube ø 8mm Qty 1 pcs		

			
1			
GEV No.	105059	Ref. No.	67211100
description	burner lower part 3kW for igniter ø 6mm for thermocouple ø 6mm without nozzle for burner cap ø 100mm		
For models:	60/60CFG, 60/60CFGE, 60/60PCG		
accessories for	105059		
	GEV No.	105054	Ref. No. 67211300
	burner cap 3kW ø 100mm H 3.5mm bright finish		
	GEV No.	105058	Ref. No. 67211200
	burner head 3kW for igniter ø 6mm for burner cap ø 100mm		
	GEV No.	107374	Ref. No. —
	burner cap 3kW ø 100mm H 3.5mm matt finish		

650 (LT) series

















			
1			
GEV No.	103127	Ref. No.	67201600
description	air mixing sleeve L 36mm ED ø 40mm ID ø 36mm aluminium		
For models:	65/110CFG, 65/110CFGE, 65/110CFGG, 65/110TPFG, 65/40PCG, 65/40PG-40P, 65/70CFG, 65/70PCG, 70/110CFG, 70/110CFGE, 70/110PCG, 70/110TPFG, 70/40PCG, 70/70CFG, 70/70CFGE, 70/70PCG, CEG110, CEG70		
accessories for	103127		
	GEV No.	103118	Ref. No. 67204400
	burner cap ø 61mm		
	GEV No.	103119	Ref. No. 67205100 67209800
	burner ring for burner cap ø 61mm		
	GEV No.	103120	Ref. No. 67205000
	burner head for burner cap ø 61mm		
	GEV No.	103121	Ref. No. 67201000
	venturi		
	GEV No.	103122	Ref. No. 67302000
	burner holder ø 35mm H 82mm nozzle mounting M10x1 mounting distance 55mm connection M16x1.5mm with nozzle holder		
	GEV No.	103124	Ref. No. 67210100
	burner head E ø 150mm for burner cap ø 110mm 7.5kW code 672.077 A		
	GEV No.	103125	Ref. No. 67207900
	burner cap D ø 110mm 5.5kW bore ø 2.6mm with central hole		
	GEV No.	103126	Ref. No. 67209300
	burner cap E ø 110mm 7.5kW bore ø 3mm with central hole		
	GEV No.	105067	Ref. No. 67207800
	burner cap C ø 84mm 3.5kW		





Table continues overleaf



accessories for	103127		
	GEV No.	105069	Ref. No. 67207600
	burner head C for burner cap ø 84mm 3.5kW		
	GEV No.	105070	Ref. No. 672.077.00
	burner head D ø 150mm for burner cap ø 110mm 5.5kW code 672.077 E		

	1		
GEV No.	103118	Ref. No.	67204400
description	burner cap ø 61mm		
For models:	65/110CFG, 65/110CFGE, 65/110CFGG, 65/110TPFG, 65/40PCG, 65/70CFG, 65/70PCG, CEG110, CEG70		
accessories for	103118		
	GEV No.	103119	Ref. No. 67205100 67209800
	burner ring for burner cap ø 61mm		
	GEV No.	103120	Ref. No. 67205000
	burner head for burner cap ø 61mm		
	GEV No.	103121	Ref. No. 67201000
	venturi		
	GEV No.	103122	Ref. No. 67302000
	burner holder ø 35mm H 82mm nozzle mounting M10x1 mounting distance 55mm connection M16x1.5mm with nozzle holder		
	GEV No.	103127	Ref. No. 67201600
	air mixing sleeve L 36mm ED ø 40mm ID ø 36mm aluminium		

	1		
GEV No.	103120	Ref. No.	67205000
description	burner head for burner cap ø 61mm		
For models:	65/110CFG, 65/110CFGE, 65/110TPFG, 65/40PCG, 65/70CFG, 65/70PCG		
accessories for	103120		
	GEV No.	103118	Ref. No. 67204400
	burner cap ø 61mm		
	GEV No.	103119	Ref. No. 67205100 67209800
	burner ring for burner cap ø 61mm		
	GEV No.	103121	Ref. No. 67201000
	venturi		
	GEV No.	103122	Ref. No. 67302000
	burner holder ø 35mm H 82mm nozzle mounting M10x1 mounting distance 55mm connection M16x1.5mm with nozzle holder		
	GEV No.	103127	Ref. No. 67201600
	air mixing sleeve L 36mm ED ø 40mm ID ø 36mm aluminium		

	1		
GEV No.	103122	Ref. No.	67302000
description	burner holder ø 35mm H 82mm nozzle mounting M10x1 mounting distance 55mm connection M16x1.5mm with nozzle holder		
For models:	65/110CFG, 65/110CFGE, 65/110CFGG, 65/110TPFG, 65/40PCG, 65/40PG-40P, 65/70CFG, 65/70PCG, 70/110CFG, 70/110CFGE, 70/110PCG, 70/110TPFG, 70/40PCG, 70/70CFG, 70/70CFGE, CEG110, CEG70		
accessories for	103122		
	GEV No.	103118	Ref. No. 67204400
	burner cap ø 61mm		
	GEV No.	103119	Ref. No. 67205100 67209800
	burner ring for burner cap ø 61mm		
	GEV No.	103120	Ref. No. 67205000
	burner head for burner cap ø 61mm		
	GEV No.	103121	Ref. No. 67201000
	venturi		
	GEV No.	103124	Ref. No. 67210100
	burner head E ø 150mm for burner cap ø 110mm 7.5kW code 672.077 A		
	GEV No.	103125	Ref. No. 67207900
	burner cap D ø 110mm 5.5kW bore ø 2.6mm with central hole		
	GEV No.	103126	Ref. No. 67209300
	burner cap E ø 110mm 7.5kW bore ø 3mm with central hole		
	GEV No.	103127	Ref. No. 67201600
	air mixing sleeve L 36mm ED ø 40mm ID ø 36mm aluminium		
	GEV No.	105067	Ref. No. 67207800
	burner cap C ø 84mm 3.5kW		
	GEV No.	105069	Ref. No. 67207600
	burner head C for burner cap ø 84mm 3.5kW		
	GEV No.	105070	Ref. No. 672.077.00
	burner head D ø 150mm for burner cap ø 110mm 5.5kW code 672.077 E		







	1		
GEV No.	103119	Ref. No.	67205100 67209800
description	burner ring for burner cap ø 61mm		
For models:	65/110CFG, 65/110CFGE, 65/110CFGG, 65/110TPFG, 65/40PCG, 65/70CFG, 65/70PCG, CEG110, CEG70		
accessories for	103119		
	GEV No.	103118	Ref. No. 67204400
	burner cap ø 61mm		

Table continues overleaf

accessories for 103119			
	GEV No.	103120	Ref. No. 67205000
burner head for burner cap ø 61mm			
	GEV No.	103121	Ref. No. 67201000
venturi			
	GEV No.	103122	Ref. No. 67302000
burner holder ø 35mm H 82mm nozzle mounting M10x1 mounting distance 55mm connection M16x1.5mm with nozzle holder			
	GEV No.	103127	Ref. No. 67201600
air mixing sleeve L 36mm ED ø 40mm ID ø 36mm aluminium			

			
1			
GEV No.	103121	Ref. No.	67201000
description	venturi		
For models:	65/110CFG, 65/110CFGE, 65/110CFGG, 65/110TPFG, 65/40PCG, 65/40PG-40P, 65/70CFG, 65/70PCG, 70/110CFG, 70/110CFGE, 70/110PCG, 70/110TPFG, 70/40PCG, 70/70CFG, 70/70CFGE, 70/70PCG, CEG110, CEG70		
accessories for 103121			
	GEV No.	103118	Ref. No. 67204400
burner cap ø 61mm			
	GEV No.	103119	Ref. No. 67205100 67209800
burner ring for burner cap ø 61mm			
	GEV No.	103120	Ref. No. 67205000
burner head for burner cap ø 61mm			
	GEV No.	103122	Ref. No. 67302000
burner holder ø 35mm H 82mm nozzle mounting M10x1 mounting distance 55mm connection M16x1.5mm with nozzle holder			
	GEV No.	103124	Ref. No. 67210100
burner head E ø 150mm for burner cap ø 110mm 7.5kW code 672.077 A			
	GEV No.	103125	Ref. No. 67207900
burner cap D ø 110mm 5.5kW bore ø 2.6mm with central hole			
	GEV No.	103126	Ref. No. 67209300
burner cap E ø 110mm 7.5kW bore ø 3mm with central hole			
	GEV No.	103127	Ref. No. 67201600
air mixing sleeve L 36mm ED ø 40mm ID ø 36mm aluminium			
	GEV No.	105067	Ref. No. 67207800
burner cap C ø 84mm 3.5kW			
	GEV No.	105069	Ref. No. 67207600
burner head C for burner cap ø 84mm 3.5kW			
	GEV No.	105070	Ref. No. 672.077.00
burner head D ø 150mm for burner cap ø 110mm 5.5kW code 672.077 E			

700, 900, 1100 (LD) series			
			
1			
GEV No.	103127	Ref. No.	67201600
description	air mixing sleeve L 36mm ED ø 40mm ID ø 36mm aluminium		
For models:	65/110CFG, 65/110CFGE, 65/110CFGG, 65/110TPFG, 65/40PCG, 65/40PG-40P, 65/70CFG, 65/70PCG, 70/110CFG, 70/110CFGE, 70/110PCG, 70/110TPFG, 70/40PCG, 70/70CFG, 70/70CFGE, 70/70PCG, CEG110, CEG70		
accessories for 103127			
	GEV No.	103118	Ref. No. 67204400
burner cap ø 61mm			
	GEV No.	103119	Ref. No. 67205100 67209800
burner ring for burner cap ø 61mm			
	GEV No.	103120	Ref. No. 67205000
burner head for burner cap ø 61mm			
	GEV No.	103121	Ref. No. 67201000
venturi			
	GEV No.	103122	Ref. No. 67302000
burner holder ø 35mm H 82mm nozzle mounting M10x1 mounting distance 55mm connection M16x1.5mm with nozzle holder			
	GEV No.	103124	Ref. No. 67210100
burner head E ø 150mm for burner cap ø 110mm 7.5kW code 672.077 A			
	GEV No.	103125	Ref. No. 67207900
burner cap D ø 110mm 5.5kW bore ø 2.6mm with central hole			
	GEV No.	103126	Ref. No. 67209300
burner cap E ø 110mm 7.5kW bore ø 3mm with central hole			
	GEV No.	105067	Ref. No. 67207800
burner cap C ø 84mm 3.5kW			
	GEV No.	105069	Ref. No. 67207600
burner head C for burner cap ø 84mm 3.5kW			
	GEV No.	105070	Ref. No. 672.077.00
burner head D ø 150mm for burner cap ø 110mm 5.5kW code 672.077 E			





			
1			
GEV No.	105067	Ref. No.	67207800
description	burner cap C ø 84mm 3.5kW		
For models:	70/110CFG, 70/110CFGE, 70/110PCG, 70/110TPFG, 70/40PCG, 70/70CFG, 70/70CFGE, 70/70PCG		
accessories for 105067			
	GEV No.	103121	Ref. No. 67201000
venturi			

Table continues overleaf



accessories for	105067			
	GEV No.	103122	Ref. No.	67302000
	burner holder ø 35mm H 82mm nozzle mounting M10x1 mounting distance 55mm connection M16x1.5mm with nozzle holder			
	GEV No.	103127	Ref. No.	67201600
	air mixing sleeve L 36mm ED ø 40mm ID ø 36mm aluminium			
	GEV No.	105069	Ref. No.	67207600
	burner head C for burner cap ø 84mm 3.5kW			

	1			
GEV No.	103125	Ref. No.	67207900	
description	burner cap D ø 110mm 5.5kW bore ø 2.6mm with central hole			
For models:	70/110CFG, 70/110CFGE, 70/110PCG, 70/110TPFG, 70/40PCG, 70/70CFG, 70/70CFGE, 70/70PCG			
accessories for	103125			
	GEV No.	103121	Ref. No.	67201000
	venturi			
	GEV No.	103122	Ref. No.	67302000
	burner holder ø 35mm H 82mm nozzle mounting M10x1 mounting distance 55mm connection M16x1.5mm with nozzle holder			
	GEV No.	103127	Ref. No.	67201600
	air mixing sleeve L 36mm ED ø 40mm ID ø 36mm aluminium			
	GEV No.	105070	Ref. No.	672.077.00
	burner head D ø 150mm for burner cap ø 110mm 5.5kW code 672.077 E			

	1			
GEV No.	103126	Ref. No.	67209300	
description	burner cap E ø 110mm 7.5kW bore ø 3mm with central hole			
For models:	65/40PG-40P			
accessories for	103126			
	GEV No.	103121	Ref. No.	67201000
	venturi			
	GEV No.	103122	Ref. No.	67302000
	burner holder ø 35mm H 82mm nozzle mounting M10x1 mounting distance 55mm connection M16x1.5mm with nozzle holder			
	GEV No.	103124	Ref. No.	67210100
	burner head E ø 150mm for burner cap ø 110mm 7.5kW code 672.077 A			
	GEV No.	103127	Ref. No.	67201600
	air mixing sleeve L 36mm ED ø 40mm ID ø 36mm aluminium			

	1			
GEV No.	105069	Ref. No.	67207600	
description	burner head C for burner cap ø 84mm 3.5kW			
For models:	70/110CFG, 70/110CFGE, 70/110PCG, 70/110TPFG, 70/40PCG, 70/70CFG, 70/70CFGE, 70/70PCG			
accessories for	105069			
	GEV No.	103121	Ref. No.	67201000
	venturi			
	GEV No.	103122	Ref. No.	67302000
	burner holder ø 35mm H 82mm nozzle mounting M10x1 mounting distance 55mm connection M16x1.5mm with nozzle holder			
	GEV No.	103127	Ref. No.	67201600
	air mixing sleeve L 36mm ED ø 40mm ID ø 36mm aluminium			
	GEV No.	105067	Ref. No.	67207800
	burner cap C ø 84mm 3.5kW			

	1			
GEV No.	105070	Ref. No.	672.077.00	
description	burner head D ø 150mm for burner cap ø 110mm 5.5kW code 672.077 E			
For models:	70/110CFG, 70/110CFGE, 70/110PCG, 70/110TPFG, 70/40PCG, 70/70CFG, 70/70CFGE, 70/70PCG			
accessories for	105070			
	GEV No.	103121	Ref. No.	67201000
	venturi			
	GEV No.	103122	Ref. No.	67302000
	burner holder ø 35mm H 82mm nozzle mounting M10x1 mounting distance 55mm connection M16x1.5mm with nozzle holder			
	GEV No.	103125	Ref. No.	67207900
	burner cap D ø 110mm 5.5kW bore ø 2.6mm with central hole			
	GEV No.	103127	Ref. No.	67201600
	air mixing sleeve L 36mm ED ø 40mm ID ø 36mm aluminium			





	1			
GEV No.	103124	Ref. No.	67210100	
description	burner head E ø 150mm for burner cap ø 110mm 7.5kW code 672.077 A			
For models:	65/40PG-40P			
accessories for	103124			
	GEV No.	103121	Ref. No.	67201000
	venturi			

Table continues overleaf

accessories for	103124			
	GEV No.	103122	Ref. No.	67302000
	burner holder ø 35mm H 82mm nozzle mounting M10x1 mounting distance 55mm connection M16x1.5mm with nozzle holder			
	GEV No.	103126	Ref. No.	67209300
	burner cap E ø 110mm 7.5kW bore ø 3mm with central hole			
	GEV No.	103127	Ref. No.	67201600
	air mixing sleeve L 36mm ED ø 40mm ID ø 36mm aluminium			

	1			
GEV No.	103122	Ref. No.	67302000	
description	burner holder ø 35mm H 82mm nozzle mounting M10x1 mounting distance 55mm connection M16x1.5mm with nozzle holder			
For models:	65/110CFG, 65/110CFGE, 65/110CFGG, 65/110TPFG, 65/40PCG, 65/40PG-40P, 65/70CFG, 65/70PCG, 70/110CFG, 70/110CFGE, 70/110PCG, 70/110TPFG, 70/40PCG, 70/70CFG, 70/70CFGE, CEG110, CEG70			
accessories for	103122			
	GEV No.	103118	Ref. No.	67204400
	burner cap ø 61mm			
	GEV No.	103119	Ref. No.	67205100 67209800
	burner ring for burner cap ø 61mm			
	GEV No.	103120	Ref. No.	67205000
	burner head for burner cap ø 61mm			
	GEV No.	103121	Ref. No.	67201000
	venturi			
	GEV No.	103124	Ref. No.	67210100
	burner head E ø 150mm for burner cap ø 110mm 7.5kW code 672.077 A			
	GEV No.	103125	Ref. No.	67207900
	burner cap D ø 110mm 5.5kW bore ø 2.6mm with central hole			
	GEV No.	103126	Ref. No.	67209300
	burner cap E ø 110mm 7.5kW bore ø 3mm with central hole			
	GEV No.	103127	Ref. No.	67201600
	air mixing sleeve L 36mm ED ø 40mm ID ø 36mm aluminium			
	GEV No.	105067	Ref. No.	67207800
	burner cap C ø 84mm 3.5kW			
	GEV No.	105069	Ref. No.	67207600
	burner head C for burner cap ø 84mm 3.5kW			
	GEV No.	105070	Ref. No.	672.077.00
	burner head D ø 150mm for burner cap ø 110mm 5.5kW code 672.077 E			

	1			
GEV No.	103121	Ref. No.	67201000	
description	venturi			
For models:	65/110CFG, 65/110CFGE, 65/110CFGG, 65/110TPFG, 65/40PCG, 65/40PG-40P, 65/70CFG, 65/70PCG, 70/110CFG, 70/110CFGE, 70/110PCG, 70/110TPFG, 70/40PCG, 70/70CFG, 70/70CFGE, 70/70PCG, CEG110, CEG70			
accessories for	103121			
	GEV No.	103118	Ref. No.	67204400
	burner cap ø 61mm			
	GEV No.	103119	Ref. No.	67205100 67209800
	burner ring for burner cap ø 61mm			
	GEV No.	103120	Ref. No.	67205000
	burner head for burner cap ø 61mm			
	GEV No.	103122	Ref. No.	67302000
	burner holder ø 35mm H 82mm nozzle mounting M10x1 mounting distance 55mm connection M16x1.5mm with nozzle holder			
	GEV No.	103124	Ref. No.	67210100
	burner head E ø 150mm for burner cap ø 110mm 7.5kW code 672.077 A			
	GEV No.	103125	Ref. No.	67207900
	burner cap D ø 110mm 5.5kW bore ø 2.6mm with central hole			
	GEV No.	103126	Ref. No.	67209300
	burner cap E ø 110mm 7.5kW bore ø 3mm with central hole			
	GEV No.	103127	Ref. No.	67201600
	air mixing sleeve L 36mm ED ø 40mm ID ø 36mm aluminium			
	GEV No.	105067	Ref. No.	67207800
	burner cap C ø 84mm 3.5kW			
	GEV No.	105069	Ref. No.	67207600
	burner head C for burner cap ø 84mm 3.5kW			
	GEV No.	105070	Ref. No.	672.077.00
	burner head D ø 150mm for burner cap ø 110mm 5.5kW code 672.077 E			

900A series

	1			
GEV No.	106772	Ref. No.	923.261.00	
description	air mixing sleeve ø 25mm suitable for MODULAR			



			
1			
GEV No.	106774	Ref. No.	923.262.00
description	air mixing sleeve ø 30mm suitable for MODULAR		





			
1			
GEV No.	106767	Ref. No.	972.023.00
description	burner cap ø 111mm 5.5kW 2-circuit suitable for MODULAR		

			
1			
GEV No.	106770	Ref. No.	972.024.00
description	burner cap ø 132mm 7.5-10kW 2-circuit suitable for MODULAR		

			
1			
GEV No.	106766	Ref. No.	972.019.00
description	burner head for burner cap ø 111mm 5.5kW suitable for MODULAR		

			
1			
GEV No.	106769	Ref. No.	972.020.00
description	burner head for burner cap ø 132mm 7.5-10kW suitable for MODULAR		



			
1			
GEV No.	106764	Ref. No.	911.778.00
description	burner lower part ø 160mm 5.5kW suitable for MODULAR		
accessories for	106764		
	GEV No.	106766	Ref. No. 972.019.00
	burner head for burner cap ø 111mm 5.5kW suitable for MODULAR		
	GEV No.	106767	Ref. No. 972.023.00
	burner cap ø 111mm 5.5kW 2-circuit suitable for MODULAR		
	GEV No.	106772	Ref. No. 923.261.00
	air mixing sleeve ø 25mm suitable for MODULAR		

			
1			
GEV No.	106768	Ref. No.	911.781.00
description	burner lower part ø 160mm 7.5-10kW suitable for MODULAR		
accessories for	106768		
	GEV No.	106769	Ref. No. 972.020.00
	burner head for burner cap ø 132mm 7.5-10kW suitable for MODULAR		
	GEV No.	106770	Ref. No. 972.024.00
	burner cap ø 132mm 7.5-10kW 2-circuit suitable for MODULAR		
	GEV No.	106774	Ref. No. 923.262.00
	air mixing sleeve ø 30mm suitable for MODULAR		

solid tops

			
1			
GEV No.	105072	Ref. No.	67205600
description	round burner		
For models:	65/110TPFG, 65/70TPFG, 65/70TPG, 70/110TPFG, 70/70TPFG, 70/70TPG		



wok burners

			
1			
GEV No.	103096	Ref. No.	37200300
description	burner cap ø 120mm 9.5kW for wok range		
For models:	70/70K		
accessories for	103096		
	GEV No.	104116	Ref. No. 37200000
	burner head 9.5kW for wok range		
	GEV No.	104117	Ref. No. —
	air mixing sleeve for wok range		

			
1			
GEV No.	104116	Ref. No.	37200000
description	burner head 9.5kW for wok range		
For models:	70/70K		
accessories for	104116		
	GEV No.	103096	Ref. No. 37200300
	burner cap ø 120mm 9.5kW for wok range		
	GEV No.	104117	Ref. No. —
	air mixing sleeve for wok range		

pan supports

			
1			
GEV No.	210173	Ref. No.	68306300
description	pan support W 265mm L 510mm		
For models:	60/30PCG, 60/60CFG, 60/60CFGE, 60/60PCG		

			
1			
GEV No.	210132	Ref. No.	681.008.14 68100500 68100800
description	pan support W 340mm L 570mm suitable for 700 series		
For models:	65/110CFG, 65/110CFGE, 65/110CFGG, 65/110TPFG, 65/40PCG, 65/70PCG, 70/110CFGE, 70/110PCG, 70/110TPFG, 70/40PCG, 70/70CFG, 70/70CFGE, 70/70PCG, CEG110, CEG70		
accessories for	210132		
	GEV No.	210050	Ref. No. N/A
	reducer for pan support L 260mm W 260mm chrome-plated steel suitable for universal		

			
1			
GEV No.	210060	Ref. No.	681.019.14
description	pan support W 400mm L 400mm enamelled		

			
1			
GEV No.	210137	Ref. No.	68101900
description	pan support W 400mm L 400mm suitable for 900 series		
For models:	65/40PG-40P		

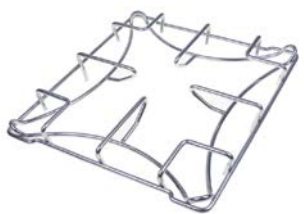
			
1			
GEV No.	106775	Ref. No.	983.031.13
description	pan support W 410mm L 360mm H 60mm suitable for MODULAR		

reducers for pan supports

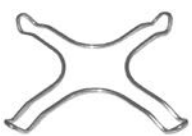
			
1			
GEV No.	210050	Ref. No.	N/A
description	reducer for pan support L 260mm W 260mm chrome-plated steel suitable for universal		

height extensions

			
1			
GEV No.	210114	Ref. No.	38100200
description	pan support ø 380mm suitable for wok range		
For models:	70/70K		



			
1			
GEV No.	210115	Ref. No.	38100100
description	pan support ø 380mm suitable for wok range		
For models:	70/70K		

accessories

reducers for pan supports



			
1			
GEV No.	210050	Ref. No.	N/A
description	reducer for pan support L 260mm W 260mm chrome-plated steel suitable for universal		

pan supports

			
1			
GEV No.	210114	Ref. No.	38100200
description	pan support ø 380mm suitable for wok range		
For models:	70/70K		

			
1			
GEV No.	210115	Ref. No.	38100100
description	pan support ø 380mm suitable for wok range		
For models:	70/70K		

			
1			
GEV No.	210173	Ref. No.	68306300
description	pan support W 265mm L 510mm		
For models:	60/30PCG, 60/60CFG, 60/60CFGE, 60/60PCG		

			
1			
GEV No.	210132	Ref. No.	681.008.14 68100500 68100800
description	pan support W 340mm L 570mm suitable for 700 series		
For models:	65/110CFG, 65/110CFGE, 65/110CFGG, 65/110TPFG, 65/40PCG, 65/70PCG, 70/110CFGE, 70/110PCG, 70/110TPFG, 70/40PCG, 70/70CFG, 70/70CFGE, 70/70PCG, CEG110, CEG70		
accessories for	210132		
		GEV No.	210050
		Ref. No.	N/A
	reducer for pan support L 260mm W 260mm chrome-plated steel suitable for universal		

			
1			
GEV No.	210060	Ref. No.	681.019.14
description	pan support W 400mm L 400mm enamelled		

			
1			
GEV No.	210137	Ref. No.	68101900
description	pan support W 400mm L 400mm suitable for 900 series		
For models:	65/40PG-40P		

air mixers



GEV No.	104696	Ref. No.	923.271.00
description	air mixer ED ø 95mm thickness 0.75mm hole ø 10mm round burner		



GEV No.	104693	Ref. No.	941.124.00
description	air mixer H 6mm ED ø 31mm ID ø 10mm hole ø 6.5 6 holemm		



GEV No.	103127	Ref. No.	67201600
description	air mixing sleeve L 36mm ED ø 40mm ID ø 36mm aluminium		

For models: 65/110CFG, 65/110CFGE, 65/110CFGG, 65/110TPFG, 65/40PCG, 65/40PG-40P, 65/70CFG, 65/70PCG, 70/110CFG, 70/110CFGE, 70/110PCG, 70/110TPFG, 70/40PCG, 70/70CFG, 70/70CFGE, 70/70PCG, CEG110, CEG70

accessories for	103127	GEV No.	103118	Ref. No.	67204400
------------------------	--------	----------------	--------	-----------------	----------



burner cap ø 61mm



GEV No.	103119	Ref. No.	67205100 67209800
description	burner ring for burner cap ø 61mm		



GEV No.	103120	Ref. No.	67205000
description	burner head for burner cap ø 61mm		



GEV No.	103121	Ref. No.	67201000
description	venturi		



GEV No.	103122	Ref. No.	67302000
description	burner holder ø 35mm H 82mm nozzle mounting M10x1 mounting distance 55mm connection M16x1.5mm with nozzle holder		



GEV No.	103124	Ref. No.	67210100
description	burner head E ø 150mm for burner cap ø 110mm 7.5kW code 672.077 A		



GEV No.	103125	Ref. No.	67207900
description	burner cap D ø 110mm 5.5kW bore ø 2.6mm with central hole		



GEV No.	103126	Ref. No.	67209300
description	burner cap E ø 110mm 7.5kW bore ø 3mm with central hole		



GEV No.	105067	Ref. No.	67207800
description	burner cap C ø 84mm 3.5kW		



GEV No.	105069	Ref. No.	67207600
description	burner head C for burner cap ø 84mm 3.5kW		



GEV No.	105070	Ref. No.	672.077.00
description	burner head D ø 150mm for burner cap ø 110mm 5.5kW code 672.077 E		



GEV No.	105711	Ref. No.	672.133.00
description	air mixing tube L 42mm ED ø 20mm brass		

bar burners

bar burners



GEV No.	104174	Ref. No.	67205200
description	bar burner 2 row L 485mm W 240mm ømm H 170mm gril		
For models:	65/40GRG, 65/40GRL, 65/70GRG, 65/70GRL, 70/40GRG, 70/40GRL, 70/70GRG, 70/70GRL		



GEV No.	105247	Ref. No.	67209700
description	bar burner 2 row L 500mm W 180mm ømm H 160mm		



GEV No.	105161	Ref. No.	97200600
description	bar burner 2 row L 585mm W 150mm ø 23mm Hmm bain marie		





GEV No.	106846	Ref. No.	972.017.00
description	bar burner 2 row L 610mm W 220mm ømm H 47mm chargrill		





GEV No.	104004	Ref. No.	97201500
description	bar burner 2 row L 620mm W 200mm ømm Hmm chargrill		





			
1			
GEV No.	105165	Ref. No.	67207400
description	bar burner 3 row L 390mm W 420mm ømm H 135mm tilting bratt pan		
For models:	70/70BRG, 70/70BRGM		

			
1			
GEV No.	107880	Ref. No.	672.174.00
description	bar burner 3 row L 450mm W 245mm ø 25mm for grill		

			
1			
GEV No.	105075	Ref. No.	67212200
description	bar burner 3 row L 455mm W 185mm ømm H 45mm griddle		
For models:	60/30FTG, 60/30FTG-CR, 60/30FTGR, 60/30FTRG-CR, 60/60FTG, 60/60FTG-CR, 60/60FTRG, 60/60FTRG-CR, 60/60FTRRG, 60/60FTRRG-CR		

			
1			
GEV No.	104173	Ref. No.	67202900
description	bar burner 3 row L 507mm W 240mm ømm H 50mm griddle		
For models:	65/40FTG, 65/40FTRG, 65/70FTG, 65/70FTRG, 70/40FTG, 70/40FTGS, 70/40FTRG, 70/70FTG, 70/70FTG-CR, 70/70FTGS, 70/70FTRG, 70/70FTRG-CR, 70/70FTRRG, 70/70FTRRG-CR		

			
1			
GEV No.	105162	Ref. No.	97200700
description	bar burner 3 row L 585mm W 455mm ømm H 40mm bain marie		

			
1			
GEV No.	104689	Ref. No.	972.043.00
description	bar burner 3 row L 620mm W 250mm ø 27mm for grill		

			
1			
GEV No.	105158	Ref. No.	97200000 97200200
description	bar burner 3 row L 625mm W 240mm ømm H 45mm griddle		

			
1			
GEV No.	105166	Ref. No.	97200400
description	bar burner 4 row L 545mm W 580mm ømm H 135mm tilting bratt pan		

			
1			
GEV No.	105167	Ref. No.	97200500
description	bar burner 6 row L 560mm W 940mm ømm H 40mm tilting bratt pan		

			
1			
GEV No.	104698	Ref. No.	972.052.00
description	bar burner 6 row L 580mm W 980mm ø 25mm H 300mm for tilting bratt pan		

			
1			
GEV No.	104171	Ref. No.	67203000
description	bar burner angled L 450mm W 185mm ømm Hmm oven		
For models:	65/110CFG, 65/110TPFG, 65/70CFG, 65/70TPFG, 70/110CFG, 70/110TPFG, 70/70CFG, 70/70TPFG		

			
1			
GEV No.	105073	Ref. No.	87200000
description	bar burner angled L 570mm W 185mm ømm Hmm oven		

			
1			
GEV No.	104691	Ref. No.	672.153.00
description	bar burner L 520mm W 200mm ø 25mm H 60mm for tilting bratt pan		



			
1			
GEV No.	104690	Ref. No.	672.183.00
description	bar burner L 590mm W 585mm ø 25mm H 170mm tilting bratt pan for model 70/80 BRG		

			
1			
GEV No.	104797	Ref. No.	972.051.00
description	bar burner L 590mm W 585mm ø 25mm H 170mm tilting bratt pan for model 90/80 BRG		

			
1			
GEV No.	104694	Ref. No.	672.053.00
description	bar burner ø 29/32/29mm for gas oven		



			
1			
GEV No.	103360	Ref. No.	972.042.00
description	bar burner ø 40mm L 600mm flange width 25mm flange length 48mm		

			
1			
GEV No.	105515	Ref. No.	97204100
description	bar burner ø 40mm Wmm Hmm L 250mm flange ø 61mm bain marie		

			
1			
GEV No.	103358	Ref. No.	672.145.00
description	bar burner ø 50mm L 343mm flange width 25mm flange length 60mm pasta cooker		

			
1			
GEV No.	103359	Ref. No.	672.175.00
description	bar burner ø 50mm L 365mm flange width 25mm flange length 60mm		

			
1			
GEV No.	105776	Ref. No.	999.23.050
description	bar burner ø 50mm Wmm Hmm L 305mm with bolt M5x12 flange width 52mm convection oven flange ø 75mm		

			
1			
GEV No.	105160	Ref. No.	67207200 67207215
description	bar burner ø 50mm Wmm Hmm L 428mm flange width 71mm kettle flange ø 75mm		
For models:	70/40CPG, 70/70CPG		
spare parts for	105160		
	GEV No.	105159	Ref. No. 64104200
end cap suitable for burner for pasta cooker			

			
1			
GEV No.	105523	Ref. No.	972.040.00
description	bar burner ø 50mm Wmm Hmm L 475mm flange ø 75mm		

			
1			
GEV No.	107862	Ref. No.	972.152.00
description	bar burner ø 50mm Wmm Hmm L 500mm flange width 61mm flange length 25mm for oven		





			
1			
GEV No.	103343	Ref. No.	972.045.00
description	bar burner ø 52mm L 490mm flange width 24mm flange length 60mm fryer		

			
1			
GEV No.	105074	Ref. No.	87200500
description	bar burner T-shape L 740mm Wmm ø 41mm Hmm oven		

			
1			
GEV No.	211019	Ref. No.	68101100
description	chargrill grid L 495mm W 160mm H 19mm		
For models:	65/40GRG, 65/40GRL, 65/70GRG, 70/40GRG, 70/40GRL, 70/70GRG, 70/70GRL		

			
1			
GEV No.	211033	Ref. No.	91134500
description	chargrill grid L 690mm W 350mm H 45mm meat		

			
1			
GEV No.	105159	Ref. No.	64104200
description	end cap suitable for burner for pasta cooker		
For models:	70/40CPG		

			
1			
GEV No.	211020	Ref. No.	61152400 81121200
description	lava rock grid L 440mm W 295mm H 15mm		
For models:	65/40GRL, 65/70GRL, 70/40GRL, 70/70GRL		

			
1			
GEV No.	211032	Ref. No.	91134400 91142200
description	lava rock grid L 605mm W 320mm H 20mm		

			
1			
GEV No.	693070	Ref. No.	61131200
description	lever for grill grid		
For models:	65/40GRL, 65/70GRL		

chargrill grids

			
1			
GEV No.	211019	Ref. No.	68101100
description	chargrill grid L 495mm W 160mm H 19mm		
For models:	65/40GRG, 65/40GRL, 65/70GRG, 70/40GRG, 70/40GRL, 70/70GRG, 70/70GRL		

			
1			
GEV No.	211033	Ref. No.	91134500
description	chargrill grid L 690mm W 350mm H 45mm meat		

			
1			
GEV No.	211050	Ref. No.	900.599.40
description	chargrill grid L 690mm W 365mm meat		

lava rock grids

			
1			
GEV No.	211020	Ref. No.	61152400 81121200
description	lava rock grid L 440mm W 295mm H 15mm		
For models:	65/40GRL, 65/70GRL, 70/40GRL, 70/70GRL		

			
1			
GEV No.	211032	Ref. No.	91134400 91142200
description	lava rock grid L 605mm W 320mm H 20mm		



1

GEV No.	211053	Ref. No.	84.19.90.85 911068.00 9111068.00
description	lava rock grid L 625mm W 325mm H 36mm stainless steel		

tube burners



1

GEV No.	105401	Ref. No.	672.181.00
description	burner L 300mm W 75mm H 42mm for fryer		



1

GEV No.	105164	Ref. No.	67207100
description	tubular burner L 190mm W 53mm H 64mm for fryer oval		
For models:	70/40FRG13, 70/70FRG13		



1

GEV No.	104172	Ref. No.	67203100
description	tubular burner ø 74mm L 180mm H 60mm round for fryer		
For models:	65/40FRG		



1

GEV No.	105163	Ref. No.	67207500
description	tubular burner ø 74mm L 180mm W 74mm H 60mm round for fryer		
For models:	60/30FRG, 60/60FRG, 65/70FRG		

solid top burners



1

GEV No.	105168	Ref. No.	67209000
description	solid top burner ø 120mm H 77mm L 340mm for kettle		
For models:	70/70PGI		



1

GEV No.	105485	Ref. No.	972.044.00
description	solid top burner ø 65mm H 102mm L 284mm		

accessories

nozzle holders



1

GEV No.	104699	Ref. No.	675.511.00
description	nozzle holder L 153mm screw pipe fitting 1/2" ET M14x1		





1

GEV No.	104697	Ref. No.	675.512.00
description	nozzle holder L 225mm screw pipe fitting 1/2" ET M14x1		



1

GEV No.	104108	Ref. No.	67302300	
description	nozzle holder nozzle mounting M10x1 tube ø 10mm gas inlet M16x1.5 gas outlet M14x1			
accessories for	104108			
	GEV No.	102382	Ref. No.	673.024.00
	nut thread M14x1 H 3.5mm WS 18 brass Qty 1 pcs			
	GEV No.	104105	Ref. No.	—
	burner lower part for burner cap ø 80mm 3.5kW			
	GEV No.	104107	Ref. No.	—
	burner lower part for burner cap ø 100mm 6.4kW			



miscellaneous



GEV No.	693070	Ref. No.	61131200
description	lever for grill grid		
For models:	65/40GRL, 65/70GRL		

gas nozzles

main nozzles

gas nozzles M6x0.75



GEV No.	102836	Ref. No.	37400200
description	gas injector thread M6x0.75 WS 7 bore ø 1.4mm		

gas nozzles M10x1



GEV No.	103285	Ref. No.	674.197.00
description	gas injector thread M10x1 ball port ø 0.88mm L 30mm WS 12		



GEV No.	100973	Ref. No.	674.056.00
description	gas injector thread M10x1 bore ø 0.8mm L 30mm WS 12		



GEV No.	100150	Ref. No.	674.060.00
description	gas injector thread M10x1 bore ø 0.95mm L 30mm WS 12		



GEV No.	106650	Ref. No.	674.065.00
description	gas injector thread M10x1 bore ø 1.2mm L 30mm WS 12		



GEV No.	100675	Ref. No.	674.096.00
description	gas injector thread M10x1 bore ø 1.4mm L 30mm WS 12		



GEV No.	101975	Ref. No.	67407200
description	gas injector thread M10x1 bore ø 1.55mm L 30mm WS 12		



GEV No.	100816	Ref. No.	67407100
description	gas injector thread M10x1 bore ø 1.5mm WS 12		



GEV No.	100676	Ref. No.	67406100
description	gas injector thread M10x1 bore ø 1mm L 30mm WS 12		



GEV No.	100157	Ref. No.	674.089.00
description	gas injector thread M10x1 bore ø 2.4mm L 30mm WS 12		



GEV No.	100420	Ref. No.	67400300
description	gas injector thread M10x1 WS 11 bore ø 0.95mm		
For models:	65/110CFG, 65/110CFGE, 65/110CFGG, 65/40PCG, 65/70CFG, CEG110, CEG70		



GEV No.	106503	Ref. No.	674.017.00
description	gas injector thread M10x1 WS 11 bore ø 1.1mm		





GEV No.	102704	Ref. No.	674.005.00
description	gas injector thread M10x1 WS 11 bore ø 1.2mm		





GEV No.	104779	Ref. No.	67402700
description	gas injector thread M10x1 WS 11 bore ø 1.6mm		





			
1			
GEV No.	106440	Ref. No.	674.032.00
description	gas injector thread M10x1 WS 11 bore ø 1.85mm		

			
1			
GEV No.	104672	Ref. No.	67403500
description	gas injector thread M10x1 WS 11 bore ø 2mm		

			
1			
GEV No.	106695	Ref. No.	67407000
description	gas injector thread M10x1 WS 12 bore ø 1.45mm L 30mm		

			
1			
GEV No.	102291	Ref. No.	67401200
description	gas injector thread M10x1 WS 12 bore ø 0.85mm		
For models:	65/70FRG		

			
1			
GEV No.	103284	Ref. No.	674.363.00
description	gas injector thread M10x1 WS 12 bore ø 0.88mm		

			
1			
GEV No.	100402	Ref. No.	67401600
description	gas injector thread M10x1 WS 12 bore ø 1.05mm		

			
1			
GEV No.	106501	Ref. No.	67402400
description	gas injector thread M10x1 WS 12 bore ø 1.45mm		

			
1			
GEV No.	106502	Ref. No.	67400700
description	gas injector thread M10x1 WS 12 bore ø 1.8mm		

			
1			
GEV No.	102691	Ref. No.	67401500
description	gas injector thread M10x1 WS 12 bore ø 1mm		

pilot burner nozzles

pilot burner nozzle AB

			
1			
GEV No.	102742	Ref. No.	67434600
description	pilot burner nozzle LPG code 25 bore ø 0.25mm Qty 1 pcs		

pilot burner nozzles SIT

100 series

			
1			
GEV No.	100246	Ref. No.	672.059.00
description	pilot burner nozzle natural gas bore ø 0.35mm Qty 1 pcs thread M8x0.75		

140/150 series

			
1			
GEV No.	100205	Ref. No.	67400100
description	pilot burner nozzle SIT LPG code 19 bore ø 0.23/0.26mm Qty 1 pcs suitable for SIT 150 series		

			
1			
GEV No.	100207	Ref. No.	674.091.00
description	pilot burner nozzle SIT natural gas code 27 bore ø 0.40/0.38mm suitable for SIT 140 series		



			
1			
GEV No.	100206	Ref. No.	67400000
description	pilot burner nozzle SIT natural gas code 36 bore ø 0.60/0.55mm Qty 1 pcs suitable for SIT 150 series		

160 series

			
1			
GEV No.	107172	Ref. No.	67405400
description	pilot burner nozzle SIT LPG code 25 Qty 1 pcs		
For models:	K4/240		

			
1			
GEV No.	107650	Ref. No.	674.052.00 674052
description	pilot burner nozzle SIT LPG code 30 Qty 1 pcs		

			
1			
GEV No.	107175	Ref. No.	674.051.00
description	pilot burner nozzle SIT natural gas code 51 Qty 1 pcs suitable for 160 series		

bypass nozzles

bypass nozzles PEL20/21

			
1			
GEV No.	100554	Ref. No.	671.036.00
description	bypass nozzle type PEL20/21 bore ø 0.45mm thread M5x0.5		

			
1			
GEV No.	100553	Ref. No.	671.016.00
description	bypass nozzle type PEL20/21 bore ø 0.4mm thread M5x0.5		

			
1			
GEV No.	100550	Ref. No.	671.055.00
description	bypass nozzle type PEL20/21 bore ø 0.55mm thread M5x0.5		

			
1			
GEV No.	100551	Ref. No.	671.037.00
description	bypass nozzle type PEL20/21 bore ø 0.6mm thread M5x0.5		

			
1			
GEV No.	100555	Ref. No.	671.038.00
description	bypass nozzle type PEL20/21 bore ø 0.8mm thread M5x0.5		

			
1			
GEV No.	100556	Ref. No.	67103000
description	bypass nozzle type PEL20/21 bore ø 0.95mm thread M5x0.5		

			
1			
GEV No.	106871	Ref. No.	671.094.00
description	bypass nozzle type PEL20/21 bore ø 2.2mm thread M5x0.5		

bypass nozzles PEL22

			
1			
GEV No.	100410	Ref. No.	971.004.00
description	bypass nozzle type PEL22 bore ø 0.85mm thread M6x0.5		

			
1			
GEV No.	100437	Ref. No.	671.044.00
description	bypass nozzle type PEL22 bore ø 1.15mm thread M6x0.5		

gas nozzles sets

			
1			
GEV No.	103346	Ref. No.	265.034.13
description	gas injector set natural/liquid gas 70/80 BRG		

			
1			
GEV No.	103345	Ref. No.	265.036.13
description	gas injector set natural/liquid gas 90/120 BRG		

			
1			
GEV No.	103356	Ref. No.	265.035.13
description	gas injector set natural/liquid gas BRG90/80EM		



auxiliary gas parts

screw connections

olives



1

GEV No.	101278	Ref. No.	67300100
----------------	--------	-----------------	----------

description olive for pipe ø 10mm Qty 1 pcs

accessories for 101278



GEV No.	100943	Ref. No.	—
----------------	--------	-----------------	---

union nut thread M17x1 tube ø 10mm



GEV No.	101300	Ref. No.	—
----------------	--------	-----------------	---

union nut thread M16x1.5 tube ø 10mm



GEV No.	101478	Ref. No.	—
----------------	--------	-----------------	---

union nut thread 3/8" for pipe ø 10mm



1

GEV No.	101273	Ref. No.	673.006.00 673.008.00
----------------	--------	-----------------	--------------------------

description olive for pipe ø 12mm L 9.5mm brass Qty 1 pcs suitable for universal

accessories for 101273



GEV No.	100944	Ref. No.	—
----------------	--------	-----------------	---

union nut thread M18x1.5 for pipe ø 12mm



GEV No.	101276	Ref. No.	—
----------------	--------	-----------------	---

union screw thread 3/8" tube ø 12mm Qty 1 pcs



1

GEV No.	101256	Ref. No.	67302700
----------------	--------	-----------------	----------

description olive for pipe ø 16mm Qty 1 pcs

accessories for 101256



GEV No.	101253	Ref. No.	67302800
----------------	--------	-----------------	----------

union nut thread M24x1.5 PEL for pipe ø 16mm



1

GEV No.	101246	Ref. No.	67300400
----------------	--------	-----------------	----------

description olive for pipe ø 4mm Qty 1 pcs

For models: 60/30FTG, 60/30FTG-CR, 60/30FTGR, 60/30FTRG-CR, 60/60FTG, 60/60FTG-CR, 60/60FTRG-CR, 60/60FTRRG, 60/60FTRRG-CR, 65/110TPFG, 65/40FTG, 65/40FTRG, 65/40GRG, 65/40GRL, 65/40PG-40P, 65/70FTG, 65/70FTRG, 65/70GRG, 65/70GRL, 65/70TPFG, 65/70TPG, 70/110CFGE, 70/110PCG, 70/110TPFG, 70/40CPG, 70/40FTG, 70/40FTGS, 70/40FTRG, 70/40GRG, 70/40GRL, 70/40PCG, 70/70BRG, 70/70BRGM, 70/70CFG, 70/70CPG, 70/70FTG, 70/70FTG-CR, 70/70FTGS, 70/70FTRG, 70/70FTRG-CR, 70/70FTRRG, 70/70FTRRG-CR, 70/70GRG, 70/70GRL, 70/70K, 70/70PCG, 70/70PGI

accessories for 101246



GEV No.	100908	Ref. No.	67301300
----------------	--------	-----------------	----------

union screw thread M10x1 for pipe ø 4mm Qty 1 pcs



1

GEV No.	100897	Ref. No.	67300300
----------------	--------	-----------------	----------

description olive for pipe ø 4mm Qty 1 pcs for pilot burner

For models: 60/30FTG, 60/30FTG-CR, 60/30FTGR, 60/30FTRG-CR, 60/60FTG, 60/60FTG-CR, 60/60FTRG, 60/60FTRG-CR, 60/60FTRRG, 60/60FTRRG-CR, 65/40FTG, 65/40FTRG, 65/70FTG, 65/70FTRG, 70/40CPG, 70/40FTG, 70/40FTGS, 70/40FTRG, 70/40GRG, 70/40GRL, 70/70BRG, 70/70BRGM, 70/70CPG, 70/70FTG, 70/70FTG-CR, 70/70FTGS, 70/70FTRG, 70/70FTRG-CR, 70/70FTRRG, 70/70FTRRG-CR, 70/70GRG, 70/70GRL, 70/70PGI



1

GEV No.	100870	Ref. No.	673.007.00
----------------	--------	-----------------	------------

description olive for pipe ø 4mm Qty 1 pcs suitable for 160 series for pilot burner

union nuts

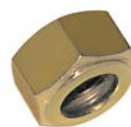

1

GEV No.	101253	Ref. No.	67302800
----------------	--------	-----------------	----------

description union nut thread M24x1.5 PEL for pipe ø 16mm



accessories for 101253



GEV No.	101256	Ref. No.	67302700
----------------	--------	-----------------	----------

olive for pipe ø 16mm Qty 1 pcs

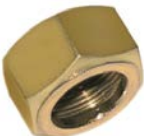

			
1			
GEV No.	101254	Ref. No.	67303000
description	union nut thread M28x1.5 tube ø 20mm		
accessories for	101254		
	GEV No.	101257	Ref. No. —
	olive for pipe ø 20mm Qty 1 pcs		

			
1			
GEV No.	101477	Ref. No.	673.034.00
description	union screw thread M13x1 tube ø 8mm Qty 1 pcs		

gas lines

main gas lines

producer-specific



			
1			
GEV No.	109204	Ref. No.	631.196.00
description	gas line tube ø 6mm L 255mm W 70mm connection with screw connection for kettle for pressure switch		





union screws

			
1			
GEV No.	100906	Ref. No.	67301400
description	screw connection thread M10x1 for ignition electrode brass Qty 1 pcs WS 10		
For models:	60/30FRG, 60/30FTG, 60/30FTG-CR, 60/30FTGR, 60/30FTRG-CR, 60/60FRG, 60/60FTG, 60/60FTG-CR, 60/60FTRG, 60/60FTRRG, 60/60FTRRG-CR, 65/40FRG, 65/40FTG, 65/40FTRG, 65/40GRG, 65/70FRG, 65/70FTG, 65/70FTRG, 65/70GRG, 70/40CPG, 70/40FRG13, 70/40FTG, 70/40FTGS, 70/40FTRG, 70/40GRG, 70/40GRL, 70/70BRG, 70/70BRGM, 70/70CPG, 70/70FRG13, 70/70FTG, 70/70FTG-CR, 70/70FTGS, 70/70FTRG, 70/70FTRG-CR, 70/70FTRRG, 70/70FTRRG-CR, 70/70GRG, 70/70GRL, 70/70PGI		

pilot tubes

universal

			
1			
GEV No.	102110	Ref. No.	97514000
description	pilot tube copper pipe ø 4mm thickness 1mm L 3000mm		
accessories for	102110		
	GEV No.	100908	Ref. No. 67301300
	union screw thread M10x1 for pipe ø 4mm Qty 1 pcs		
	GEV No.	101246	Ref. No. 67300400
	olive for pipe ø 4mm Qty 1 pcs		

			
1			
GEV No.	100908	Ref. No.	67301300
description	union screw thread M10x1 for pipe ø 4mm Qty 1 pcs		
For models:	60/30FRG, 60/30FTG, 60/30FTG-CR, 60/30FTGR, 60/30FTRG-CR, 60/60FRG, 60/60FTG, 60/60FTG-CR, 60/60FTRG, 60/60FTRRG, 60/60FTRRG-CR, 65/110TPFG, 65/40FTG, 65/40FTRG, 65/40GRG, 65/40GRL, 65/40PG-40P, 65/70FRG, 65/70FTG, 65/70FTRG, 65/70GRG, 65/70GRL, 65/70TPFG, 65/70TPG, 70/110CFG, 70/110CFGE, 70/110TPFG, 70/40CPG, 70/40FRG13, 70/40FTG, 70/40FTGS, 70/40FTRG, 70/40GRG, 70/40GRL, 70/40PCG, 70/70BRG, 70/70BRGM, 70/70CFG, 70/70CFGE, 70/70CPG, 70/70FRG13, 70/70FTG, 70/70FTG-CR, 70/70FTGS, 70/70FTRG, 70/70FTRG-CR, 70/70FTRRG, 70/70FTRRG-CR, 70/70GRG...(Other models you can see in the webshop)		
accessories for	100908		
	GEV No.	100897	Ref. No. 67300300
	olive for pipe ø 4mm Qty 1 pcs for pilot burner		
	GEV No.	101246	Ref. No. 67300400
	olive for pipe ø 4mm Qty 1 pcs		
	GEV No.	101280	Ref. No. —
	olive for pipe ø 4mm Qty 1 pcs		
	GEV No.	101282	Ref. No. —
	olive for pipe ø 4mm L 7.4mm Qty 1 pcs		

gas hoses

screw pipe fittings

			
1			
GEV No.	107879	Ref. No.	678.084.00
description	T-piece T-piece thread 1/4" for pipe ø 6mm L 55mm brass gas		

equipment-specific units

for espresso machines

brewing units

filter holder gaskets

O-rings



1

GEV No.	510409	Ref. No.	835535651
----------------	--------	-----------------	-----------

description	O-ring EPDM thickness 5.34mm ID ø 56.52mm Qty 1 pcs		
--------------------	---	--	--

for bain marie

spare parts and accessories



1

GEV No.	692889	Ref. No.	984.006.00
----------------	--------	-----------------	------------

description	door magnet H 6mm ø 20mm M5 thread L 15mm		
--------------------	---	--	--



1

GEV No.	691249	Ref. No.	62302700
----------------	--------	-----------------	----------

description	lever		
--------------------	-------	--	--

For models:	60/30BME, 60/30CPE, 60/60BME, 60/60CPE, 60/60FRE, 60/60FRG, 65/40BME, 65/70BME, 65/70FRE, 70/40BME		
--------------------	--	--	--



1

GEV No.	692796	Ref. No.	256.431.00
----------------	--------	-----------------	------------

description	mounting set hexagon L 31mm thread M5		
--------------------	---------------------------------------	--	--



1

GEV No.	705023	Ref. No.	610.272.00
----------------	--------	-----------------	------------

description	scraper W 100mm L 420mm		
--------------------	-------------------------	--	--

housing and bezels



1

GEV No.	691634	Ref. No.	623.002.00 623.002.15
----------------	--------	-----------------	--------------------------

description	fastening angle L 33mm W 14mm H 14mm SS		
--------------------	---	--	--

for pyroceram ranges

spare parts and accessories



1

GEV No.	694978	Ref. No.	256.424.00
----------------	--------	-----------------	------------

description	mounting set		
--------------------	--------------	--	--

ceramic hobs

ceramic hobs (complete)



1

GEV No.	416528	Ref. No.	61170100
----------------	--------	-----------------	----------

description	ceramic hob complete		
--------------------	----------------------	--	--

For models:	65/40PVE, 70/40PVE		
--------------------	--------------------	--	--



1

GEV No.	416530	Ref. No.	91120000
----------------	--------	-----------------	----------

description	ceramic hob complete		
--------------------	----------------------	--	--



1

GEV No.	416531	Ref. No.	91120100
description	ceramic hob complete		



1

GEV No.	416529	Ref. No.	61170200
description	ceramic hob L 700mm W 650mm H 100mm complete		
For models:	65/70PVE, 70/70CFVE, 70/70PVE		

for deep fryers

spare parts and accessories



1

GEV No.	691633	Ref. No.	611.038.00
description	bracket fryer heaters		



1

GEV No.	692810	Ref. No.	256.420.00
description	cover for holder fryer heaters L 64mm W 56mm H 80mm mounting pos. left		



1

GEV No.	692778	Ref. No.	611.042.00
description	cover for holder fryer heaters L 64mm W 56mm H 80mm mounting pos. right		



1

GEV No.	692795	Ref. No.	941.130.00
description	fixing plate L 35mm W 10mm H 8mm M5 mounting distance 17mm		



1

GEV No.	691249	Ref. No.	62302700
description	lever		
For models:	60/30BME, 60/30CPE, 60/60BME, 60/60CPE, 60/60FRE, 60/60FRG, 65/40BME, 65/70BME, 65/70FRE, 70/40BME		



1

GEV No.	514447	Ref. No.	623.201.00
description	lever L 42mm W 15mm thickness 2mm H 25mm		



1

GEV No.	692796	Ref. No.	256.431.00
description	mounting set hexagon L 31mm thread M5		



1

GEV No.	692886	Ref. No.	6211992.00 6211992.15
description	protective plate cover for fryer L 210mm W 60mm H 38mm mounting pos. heating element		



1

GEV No.	692779	Ref. No.	631.175.00
description	drain connection for griddle ø 45mm L 60mm W 85mm mounting distance 65mm		

housing and bezels



1

GEV No.	691634	Ref. No.	623.002.00 623.002.15
description	fastening angle L 33mm W 14mm H 14mm SS		



1

GEV No.	692795	Ref. No.	941.130.00
description	fixing plate L 35mm W 10mm H 8mm M5 mounting distance 17mm		

door magnets



1

GEV No.	692889	Ref. No.	984.006.00
description	door magnet H 6mm ø 20mm M5 thread L 15mm		



1

GEV No.	692805	Ref. No.	683.028.00
description	hook for solid top L 360mm		

miscellaneous



1

GEV No.	692776	Ref. No.	983.009.00
description	support bracket for heating element		

housing and bezels



1

GEV No.	691634	Ref. No.	623.002.00 623.002.15
description	fastening angle L 33mm W 14mm H 14mm SS		

for griddles

spare parts and accessories



1

GEV No.	692889	Ref. No.	984.006.00
description	door magnet H 6mm ø 20mm M5 thread L 15mm		

sumps



1

GEV No.	696805	Ref. No.	6111127.13
description	grease collecting tray for griddle L 175mm W 185mm H 110mm		



1

GEV No.	696811	Ref. No.	6111249.00
description	grease collecting tray for griddle L 270mm W 205mm H 110mm		

drain stoppers



1

GEV No.	691250	Ref. No.	641.023.00
description	plug for griddle ø 30mm		

for tilting bratt pans

spare parts and accessories



1

GEV No.	699598	Ref. No.	941.154.00
description	bolt L 24mm ø 14mm for tilting bratt pan		



1

GEV No.	694964	Ref. No.	941.164.00
description	bolt L 78mm ø 10mm stainless steel		



1

GEV No.	694976	Ref. No.	9111769.00
description	bracket for spindle zinc-coated steel mounting pos. centre		



1

GEV No.	514518	Ref. No.	951.069.00
description	disc ø 17.5mm plastic		



1

GEV No.	692773	Ref. No.	941.157.00
description	fixing plate L 60mm W 40mm H 15mm		



1

GEV No.	542394	Ref. No.	256.466.00
description	inlet spout connection 1/2" tube ø 25mm overall height 150mm rotation°		



1

GEV No.	699450	Ref. No.	256.460.00
description	mounting set for hinge		



1

GEV No.	699597	Ref. No.	256.461.00
description	mounting set for hinge for lid WS 13		



1	GEV No.	514514	Ref. No.	256.370.00
	description	plug ø 60mm stainless steel H 145mm		



1	GEV No.	692777	Ref. No.	941.165.00
	description	spacer bush thickness 2.3mm ID ø 10mm ED ø 15mm H 19mm		



1	GEV No.	551432	Ref. No.	561.012.00
	description	terminal plastic		



1	GEV No.	542390	Ref. No.	0777.10073.8 M538003000
	description	thread bolt thread M10x1.5		

housing and bezels



1	GEV No.	692799	Ref. No.	256.304.00
	description	protector ø 108mm plastic		

spindles



1	GEV No.	693091	Ref. No.	94100700
	description	bearing block for tilting bratt pan		



1	GEV No.	692887	Ref. No.	941.163.00
	description	bearing block hinge for tilting bratt pan ø 20mm ID ø 15.5mm L 54mm		



1	GEV No.	693085	Ref. No.	64106700
	description	bushing		
	For models:	70/70BRE, 70/70BRG		



1	GEV No.	693083	Ref. No.	64106600
	description	thread block		
	For models:	70/70BRE, 70/70BREM, 70/70BRG, 70/70BRGM		



1	GEV No.	693084	Ref. No.	64106500
	description	threaded rod		
	For models:	70/70BRE, 70/70BRG		



1	GEV No.	693087	Ref. No.	64107700
	description	threaded rod		
	For models:	70/70BREM, 70/70BRGM		



1	GEV No.	693089	Ref. No.	94100100
	description	threaded rod		



1	GEV No.	692891	Ref. No.	910.732.00
	description	threaded rod for tilting bratt pan ID ø 25mm ED ø 30mm L 670mm		



1	
GEV No.	691248
Ref. No.	61140100
description	threaded rod L 535mm ø 25mm

1	
GEV No.	530900
Ref. No.	941.162.00
description	threaded rod thread M12x1.5 zinc-coated steel thread L 80mm

1	
GEV No.	691136
Ref. No.	911.082.00
description	threaded rod thread Tr24x5 L 730mm manual tilting bratt pan

miscellaneous

1	
GEV No.	523510
Ref. No.	06501503500
description	deep-groove ball bearing type 6202-2RS shaft ø 15mm ED ø 35mm W 11mm with sealing discs deep-groove ball bearing DIN 625-1
For models:	70/70BRE, 70/70BRG

1	
GEV No.	692888
Ref. No.	941.181.00
description	fixing bolt L 35mm ø 12mm for tilting bratt pan WS 19
accessories for	692888
	GEV No. 692798 Ref. No. 256.471.00
description	fixing bolt L 35mm ø 12mm with nut with disc tilting bratt pan WS 19

1	
GEV No.	692798
Ref. No.	256.471.00
description	fixing bolt L 35mm ø 12mm with nut with disc tilting bratt pan WS 19
spare parts for	692798
	GEV No. 692888 Ref. No. 941.181.00
description	fixing bolt L 35mm ø 12mm for tilting bratt pan WS 19

1	
GEV No.	691211
Ref. No.	61140000
description	tilting mechanism L 590mm for tilting bratt pan

for boiling pans

spare parts and accessories

1	
GEV No.	692783
Ref. No.	941.139.15
description	adjusting bush for kettle ø 40/20mm L 80mm

1	
GEV No.	514517
Ref. No.	641.149.00
description	bracket for kettle

1	
GEV No.	514528
Ref. No.	941.137.00
description	bush for kettle lid ø 39mm ID ø 16mm H 12mm

1	
GEV No.	692797
Ref. No.	941.138.00
description	bush for kettle ø 39mm L 55mm

1	
GEV No.	692782
Ref. No.	641.150.00
description	spindle for kettle L 285mm ED ø 16mm



1

GEV No.	692787	Ref. No.	631.195.00
description	threaded part brass L 160mm ID ø 34mm 1 1/2"		



1

GEV No.	692801	Ref. No.	931.213.00
description	threaded part for drain tap L 140mm thread 2"		

filters



1

GEV No.	514521	Ref. No.	611.373.00
description	drain filter for kettle L 145mm W 75mm		

miscellaneous



1

GEV No.	514519	Ref. No.	678.087.00
description	closing clamp for kettle with locking schrew		



1

GEV No.	542398	Ref. No.	678.082.00
description	water inlet for kettle fixed		

for lava stone grill



1

GEV No.	692889	Ref. No.	984.006.00
description	door magnet H 6mm ø 20mm M5 thread L 15mm		



1

GEV No.	692892	Ref. No.	9221341.00
description	grease collecting tray L 750mm W 157mm H 22mm		



1

GEV No.	692809	Ref. No.	512.002.00
description	level glass size 35x35 2 bracket mounting for lava rock grill		

for neutral elements

doors



1			
GEV No.	692889	Ref. No.	984.006.00
description	door magnet H 6mm ø 20mm M5 thread L 15mm		

for pasta cookers

spare parts and accessories



1			
GEV No.	692889	Ref. No.	984.006.00
description	door magnet H 6mm ø 20mm M5 thread L 15mm		



1			
GEV No.	692795	Ref. No.	941.130.00
description	fixing plate L 35mm W 10mm H 8mm M5 mounting distance 17mm		



1			
GEV No.	699392	Ref. No.	256.216.00
description	hinge 1 pair for door		



1			
GEV No.	542393	Ref. No.	256.313.00
description	inlet spout connection 3/8" tube ø 12mm overall height 67mm rotation°		



1			
GEV No.	692796	Ref. No.	256.431.00
description	mounting set hexagon L 31mm thread M5		



1

GEV No.	693080	Ref. No.	61157600
description	shaft extension		
For models:	70/70CPE, 70/70CPG		

for ovens
spare parts and accessories



1

GEV No.	692889	Ref. No.	984.006.00
description	door magnet H 6mm ø 20mm M5 thread L 15mm		



1

GEV No.	692795	Ref. No.	941.130.00
description	fixing plate L 35mm W 10mm H 8mm M5 mounting distance 17mm		



1

GEV No.	692774	Ref. No.	6221484.00
description	fixing plate L 60mm W 40mm H 1.5mm		



1

GEV No.	692805	Ref. No.	683.028.00
description	hook for solid top L 360mm		



1

GEV No.	692796	Ref. No.	256.431.00
description	mounting set hexagon L 31mm thread M5		

housing and bezels



1

GEV No.	691634	Ref. No.	623.002.00 623.002.15
description	fastening angle L 33mm W 14mm H 14mm SS		



1

GEV No.	691640	Ref. No.	60036540
description	joint cover L 573mm W 7mm H 13.5mm suitable for MODULAR		

miscellaneous



1

GEV No.	699368	Ref. No.	935.045.13
description	bottom plate L 640mm W 425mm H 5mm SS		



1

GEV No.	696806	Ref. No.	256.425.00
description	support plate for heating element L 372mm W 180mm H 25mm		



for dishwashers

drain and intake components

MODULAR

drain /intake bodies



1

GEV No.	511918	Ref. No.	451.025.00
description	intake body		
spare parts for	511918		
	GEV No.	511919	Ref. No. 451.022.01 451.022.14
	quick-fit retaining nut		

filters



1

GEV No.	507378	Ref. No.	411.073.00
description	flat filter L 230mm W 200mm mounting pos. rear		



1

GEV No.	507379	Ref. No.	412.055.14
description	round filters suction ø 132mm H 77mm stainless steel		



1

GEV No.	507377	Ref. No.	411.087.00
description	round filters suction ø 85mm H 50mm stainless steel		



1

GEV No.	507380	Ref. No.	411.088.00
description	round filters suction ø 85mm H 80mm		

overflow pipes



1

GEV No.	696593	Ref. No.	410.283.00
description	overflow pipe L 195mm ø 32mm		

containers

salt tanks



1







GEV No.	510929	Ref. No.	130518
description	salt tank ø 120mm H 117mm hose ø 10mm mounting ø 70mm overall height 157mm		
spare parts for	510929		
	GEV No.	506015	Ref. No. —
	O-ring EPDM thickness 3.53mm ID ø 39.69mm Qty 1 pcs		
	GEV No.	510018	Ref. No. —
	nut ø 92mm H 10.5mm for salt tank ID ø 64mm		
	GEV No.	524177	Ref. No. —
	lid ø 69mm H 20mm for salt tank ID ø 50mm		
accessories for	510929		
	GEV No.	510071	Ref. No. —
	flat gasket rubber ED ø 81mm ID ø 68mm thickness 3mm for salt tank Qty 1 pcs		
	GEV No.	510654	Ref. No. —
	gasket H 6mm D1 ø 82mm D2 ø 68mm		

Table continues overleaf



accessories for	510929		
	GEV No.	510883	Ref. No. —
	gasket rubber ED ø 86mm ID ø 66mm thickness 2mm for salt tank Qty 1 pcs		

hood mechanics for dishwashers

bolts

	1		
GEV No.	510793	Ref. No.	441.079.00
description	screw bolt ED ø 10mm L 33mm thread M6		

springs

	Image not available		
	1		
GEV No.	519403	Ref. No.	260.014.00
description	spring hood mechanics L 475mm ø 20mm		

linkage

	1		
GEV No.	510708	Ref. No.	412.130.00
description	linkage L 270mm for dishwasher hood mechanics		

	1		
GEV No.	510689	Ref. No.	412.078.00
description	linkage L 530mm for dishwasher hood mechanics		

friction rings

	1		
GEV No.	510796	Ref. No.	451.024.00
description	slide ring for dishwasher ED ø 19mm ID ø 12mm thickness 1.5mm		

rollers

	1		
GEV No.	510795	Ref. No.	451.079.00
description	roller ø 36mm H 19mm for hood mechanics plastic grey hole ø 10mm		

air traps

	1		
GEV No.	518200	Ref. No.	451.059.00
description	air trap ø 34mm H 78mm hose ø 6mm plastic		
spare parts for	518200		
	GEV No.	504618	Ref. No. —
	O-ring EPDM thickness 2.62mm ID ø 15.54mm Qty 1 pcs		
	GEV No.	510075	Ref. No. —
	flat gasket rubber ED ø 22mm ID ø 13mm thickness 1.5mm Qty 1 pcs		
	GEV No.	510106	Ref. No. —
	hose connector for air trap		

	1		
GEV No.	510653	Ref. No.	451.036.00
description	air trap ø 34mm H 95mm hose ø 6mm plastic		

backflow preventers

backflow preventers



1			
GEV No.	506210	Ref. No.	451.033.00
description	backflow preventer dishwasher		

door mechanics

springs

tension springs



1			
GEV No.	519404	Ref. No.	260.018.00
description	spring L 255mm ø 19mm		



1			
GEV No.	519394	Ref. No.	260.017.00
description	tension spring ø 19mm L1 230mm		



1			
GEV No.	519400	Ref. No.	260.012.00
description	tension spring ø 19mm L1 300mm		

linkage



1			
GEV No.	518591	Ref. No.	412.094.00
description	tie bar L 215mm ø 5mm		

sliding plates



1			
GEV No.	518590	Ref. No.	451.091.00
description	sliding plate		

hinges



1			
GEV No.	519401	Ref. No.	412.038.00
description	hinge mounting pos. left		

door bumpers



1			
GEV No.	510798	Ref. No.	451.077.00
description	door bumper round ø 30mm H 11mm		

screw connections



1			
GEV No.	511919	Ref. No.	451.022.01 451.022.14
description	quick-fit retaining nut		

washing and rinsing systems



1			
GEV No.	524654	Ref. No.	441.041.00
description	rinse arm shaft mounting pos. upper ø 16mm H 61mm thread M12x1		



1

GEV No.	510794	Ref. No.	441.040.00
description	rinse jet H 11.6mm thread M6 WS 8		



1

GEV No.	510796	Ref. No.	451.024.00
description	slide ring for dishwasher ED ø 19mm ID ø 12mm thickness 1.5mm		



1

GEV No.	524653	Ref. No.	411.049.00
description	throttle disc ED ø 90mm ID ø 16mm		



1

GEV No.	510797	Ref. No.	412.173.00
description	wash pipe suitable for MARELS, MODULAR		

for woks



1

GEV No.	694580	Ref. No.	955.016.00
description	wok bowl for induction wok ø 310mm H 69mm Ceran		

knobs

producer-specific knobs

MODULAR



1

GEV No.	110015	Ref. No.	61200100
description	knob gas tap with ignition flame t.max.°C ø 62mm shaft ø 8x6.5mm shaft flat upper black		
For models:	60/30FTG, 60/30FTGR, 60/60FTG, 60/60FTRG, 60/60FTRRG, 65/110TPFG, 65/40FTG, 65/40FTRG, 65/40GRG, 65/40PG-40P, 65/70FTG, 65/70FTRG, 65/70GRG, 65/70GRL, 65/70TPFG, 65/70TPG		



1

GEV No.	110672	Ref. No.	61200000
description	knob gas tap without ignition flame t.max.°C ø 62mm shaft ø 8x6.5mm shaft flat upper black		
For models:	60/60CFG, 60/60CFGE, 65/110CFG, 65/110CFGE, 65/110CFGG, 65/110TPFG, 65/40PCG, 65/70CFG, 65/70PCG, CEG110, CEG70		



1

GEV No.	110688	Ref. No.	61203100
description	knob gas thermostat ø 62mm shaft ø 8x6.5mm shaft flat upper black		
For models:	60/30FTG-CR, 60/60FTG-CR, 60/60FTRG-CR, 60/60FTRRG-CR		



1

GEV No.	110683	Ref. No.	61200800
description	knob gas thermostat t.max. 300°C ø 62mm shaft ø 8x6.5mm shaft flat upper black temperature range 150-300°C		
For models:	65/110CFG, 65/110CFGG, 65/110TPFG, 65/70CFG, 65/70TPFG		





			
1			
GEV No.	110019	Ref. No.	61202800
description	knob graduated Min/Max t.max.°C°C ø 62mm shaft ø 6x4.6mm shaft flat upper black		
For models:	60/30CPE, 65/40PVE, 65/70PVE		

			
1			
GEV No.	110717	Ref. No.	61201000
description	knob switch zero mark ø 62mm shaft ø 6x4.6mm shaft flat upper black		
For models:	60/30SPE, 65/40SPE		

			
1			
GEV No.	110678	Ref. No.	61204400
description	knob oven ø 62mm shaft ø 6x4.6mm shaft flat upper black		
For models:	60/60CFE, 60/60CFGE		

			
1			
GEV No.	110673	Ref. No.	61201200
description	knob thermostat t.max. 110°C ø 62mm shaft ø 6x4.6mm shaft flat upper black temperature range 0-110°C		
For models:	65/80BFE, 65/80TFE		

			
1			
GEV No.	111798	Ref. No.	451.070.00
description	knob shaft 5x4 suitable for MARELS, MODULAR		

			
1			
GEV No.	110699	Ref. No.	61200400
description	knob thermostat t.max. 180°C ø 62mm shaft ø 6x4.6mm shaft flat upper black temperature range 100-180°C rotation 270°		
For models:	60/30FRE, 60/60FRE, 65/40FRE, 65/70FRE		

			
1			
GEV No.	110691	Ref. No.	61201500
description	knob switch 4-position ø 62mm shaft ø 6x4.6mm shaft flat upper black		
For models:	60/60CPE		

			
1			
GEV No.	110682	Ref. No.	61204200
description	knob thermostat t.max. 270°C ø 62mm shaft ø 8x6.5mm shaft flat upper black temperature range 100-270°C		
For models:	60/60CFG, 60/60CFGE		

			
1			
GEV No.	110675	Ref. No.	61200200
description	knob switch 7-position t.max.°C°C ø 62mm shaft ø 6x4.6mm shaft flat upper black		
For models:	60/30PCE, 60/60CFE, 60/60PCE, 65/40PCE, 65/70CFE, 65/70PCE		

			
1			
GEV No.	110685	Ref. No.	61200300
description	knob thermostat t.max. 300°C ø 62mm shaft ø 6x4.6mm shaft flat upper black temperature range 50-300°C rotation 270°		
For models:	60/30FTE, 60/30FTE-CR, 60/30FTRE, 60/30FTRE-CR, 60/60FTE, 60/60FTE-CR, 60/60FTRE, 60/60FTRE-CR, 60/60FTRRE, 60/60FTRRE-CR, 65/110CFGE, 65/40FTE, 65/40FTRE, 65/70CFE, 65/70FTE, 65/70FTRE, 65/70FTRRE, 65/80BFE, 65/80TFE		



1

GEV No.	110694	Ref. No.	61200500
description	knob thermostat t.max. 90°C ø 62mm shaft ø 6x4.6mm shaft flat upper black temperature range 30-90°C rotation 270°		
For models:	60/30BME, 60/60BME, 65/40BME, 65/70BME		



1

GEV No.	112847	Ref. No.	651.059.00
description	knob switch zero mark ø 72mm shaft ø 8x6.5mm shaft flat upper red		



1

GEV No.	110735	Ref. No.	61202900alt
description	knob gas tap with ignition flame ø 72mm shaft ø 10x8mm shaft flat upper black		



1

GEV No.	110016	Ref. No.	61201700
description	knob gas tap with ignition flame t.max.°C ø 72mm shaft ø 8x6.5mm shaft flat upper black		
For models:	70/110CFG, 70/110CFGE, 70/110PCG, 70/110TPFG, 70/40CPG, 70/40FTG, 70/40FTGS, 70/40FTRG, 70/40GRG, 70/40GRL, 70/40PCG, 70/70CFG, 70/70CFGE, 70/70CPG, 70/70FTG, 70/70FTGS, 70/70FTRG, 70/70FTRRG, 70/70GRG, 70/70GRL, 70/70K, 70/70PCG, 70/70TPFG, 70/70TPG		



1

GEV No.	112768	Ref. No.	612.016.00
description	knob gas tap without ignition flame ø 72mm shaft ø 8x6.5mm shaft flat upper black		



1

GEV No.	110689	Ref. No.	61203200
description	knob gas thermostat ø 72mm shaft ø 8x6.5mm shaft flat upper black		
For models:	70/70FTG-CR, 70/70FTRG-CR, 70/70FTRRG-CR		



1

GEV No.	110684	Ref. No.	61202200
description	knob gas thermostat t.max. 300°C ø 72mm shaft ø 8x6.5mm shaft flat upper black temperature range 150-300°C		
For models:	70/110CFG, 70/110TPFG, 70/70CFG, 70/70TPFG		



1

GEV No.	110679	Ref. No.	61202600
description	knob graduated Min/Max ø 72mm shaft ø 6x4.6mm shaft flat upper black		
For models:	70/40PVE, 70/70CFVE, 70/70PVE		



1

GEV No.	110692	Ref. No.	61202400
description	knob switch 4-position t.max.°C ø 72mm shaft ø 6x4.6mm shaft flat upper black		
For models:	60/60FRG, 70/40CPE, 70/70CPE, 70/70PEI		



1

GEV No.	110676	Ref. No.	61201800
description	knob switch 7-position t.max.°C ø 72mm shaft ø 6x4.6mm shaft flat upper black		
For models:	70/40PCE, 70/40PCEQ, 70/70CFE, 70/70CFEQ, 70/70PCE, 70/70PCEQ		



1

GEV No.	110928	Ref. No.	61202300
description	knob switch zero mark ø 72mm shaft ø 6x4.6mm shaft flat upper silver		
For models:	70/40SPE		



1

GEV No.	112867	Ref. No.	951.062.00
description	knob ø 72mm shaft ø 10x8mm shaft flat upper		



1

GEV No.	110700	Ref. No.	61202000
description	knob thermostat t.max. 180°C ø 72mm shaft ø 6x4.6mm shaft flat upper black temperature range 100-180°C rotation 270°		
For models:	70/40FRE10, 70/70FRE10		



1

GEV No.	112845	Ref. No.	951.061.00
description	knob t.max.°C ø 72mm shaft ø 10x8mm shaft flat upper 6.5		



1

GEV No.	110686	Ref. No.	61201900
description	knob thermostat t.max. 300°C 50-300°C ø 72mm shaft ø 6x4.6mm shaft flat upper black temperature range 50-300°C		
For models:	70/110CFGE, 70/40FTE, 70/40FTE-CR, 70/40FTES, 70/40FTRE, 70/40FTRE-CR, 70/70BRE, 70/70BREM, 70/70CFE, 70/70CFEQ, 70/70CFGE, 70/70CFVE, 70/70FTE, 70/70FTE-CR, 70/70FTES, 70/70FTRE, 70/70FTRE-CR, 70/70FTRRE, 70/70FTRRE-CR		



1

GEV No.	110736	Ref. No.	91201200
description	knob gas tap with ignition flame t.max.°C ø 82mm shaft ø 10x8mm shaft flat upper black		



1

GEV No.	110695	Ref. No.	61202100
description	knob thermostat t.max. 90°C ø 72mm shaft ø 6x4.6mm shaft flat upper black temperature range 30-90°C rotation 270°		
For models:	70/40BME, 70/70BME		



1

GEV No.	110674	Ref. No.	91200300
description	knob gas tap with ignition flame t.max.°C ø 82mm shaft ø 8x6.5mm shaft flat upper black		



1

GEV No.	111462	Ref. No.	612.060.00 61202900
description	knob gas tap with ignition flame t.max.°C ø 72mm shaft ø 10x8mm shaft flat upper silver		
For models:	70/70PGI		



1

GEV No.	110681	Ref. No.	91200400
description	knob gas thermostat t.max.°C ø 82mm shaft ø 8x6.5mm shaft flat upper black		



1

GEV No.	110680	Ref. No.	91200700
description	knob graduated Min/Max ø 82mm shaft ø 6x4.6mm shaft flat upper black		

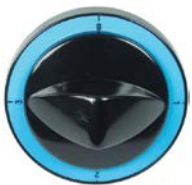

1

GEV No.	110693	Ref. No.	91200800
description	knob switch 4-position ø 82mm shaft ø 6x4.6mm shaft flat upper black		



1

GEV No.	110677	Ref. No.	91201100
description	knob switch 7-position t.max. °C ø 82mm shaft ø 6x4.6mm shaft flat upper black		



1

GEV No.	110698	Ref. No.	91201300
description	knob switch zero mark ø 82mm shaft ø 6x4.6mm shaft flat upper black		



1

GEV No.	110733	Ref. No.	91200900
description	knob thermostat t.max. 180°C ø 82mm shaft ø 6x4.6mm shaft flat upper black temperature range 100-180°C rotation 270°		



1

GEV No.	110687	Ref. No.	91200500alt
description	knob thermostat t.max. 300°C ø 82mm shaft ø 6x4.6mm shaft flat upper black temperature range 50-300°C rotation 270°		



1

GEV No.	110696	Ref. No.	91201000
description	knob thermostat t.max. 90°C ø 82mm shaft ø 6x4.6mm shaft flat upper black temperature range 30-90°C		

silver



1

GEV No.	112839	Ref. No.	951.059.00
description	knob switch zero mark shaft ø 6x4mm shaft flat upper chrome		



1

GEV No.	112849	Ref. No.	951.060.00
description	knob switch zero mark shaft ø 8x7mm shaft flat upper chrome		





1

GEV No.	111454	Ref. No.	91200500
description	knob thermostat temperature range 50-300°C ø 82mm shaft ø 6x4.6mm shaft flat upper silver rotation 270°		





			
1			
GEV No.	112838	Ref. No.	256.234.00
description	knob switch zero mark shaft ø 6x4mm shaft flat upper black/silver for pasta cooker		

			
1			
GEV No.	112830	Ref. No.	910.172.00
description	knob dial plate energy regulator 2-circuit ø 95mm black top heat		

			
1			
GEV No.	111914	Ref. No.	M564010800
description	knob thermostat t.max. 90°C ø 30mm shaft ø 6x4.6mm shaft flat upper black temperature range 30-90°C		

			
1			
GEV No.	112822	Ref. No.	910.171.00
description	knob dial plate energy regulator 2-circuit t.max.°C ø 95mm black bottom heat		

			
1			
GEV No.	112848	Ref. No.	256.235.00
description	knob kit switch zero mark shaft ø 10x8mm shaft flat upper black/silver for pasta cooker		

			
1			
GEV No.	112836	Ref. No.	910.230.00
description	knob dial plate energy regulator ø 95mm black upper/lower heat		

			
1			
GEV No.	112833	Ref. No.	256.218.00
description	knob kit switch zero mark shaft ø 8x6mm shaft flat upper black/silver for griddle/oven		

			
1			
GEV No.	112829	Ref. No.	910.166.00
description	knob dial plate gas tap with ignition flame ø 95mm		

			
1			
GEV No.	111915	Ref. No.	M564001500
description	rosette ø 37mm knob knob ø 30mm		

			
1			
GEV No.	112866	Ref. No.	910.164.00
description	knob dial plate gas tap with ignition flame ø 95mm black		

			
1			
GEV No.	112837	Ref. No.	910.167.00
description	knob dial plate bottom heat ø 95mm black		

			
1			
GEV No.	112842	Ref. No.	910.163.00
description	knob dial plate gas tap with ignition flame ø 96mm		

			
1			
GEV No.	112844	Ref. No.	910.169.00
description	knob dial plate switch 4-position ø 96mm		

			
1			
GEV No.	112821	Ref. No.	910.165.00
description	knob dial plate gas tap with ignition flame t.max.°C ø 95mm black		

			
1			
GEV No.	112835	Ref. No.	910.174.00
description	knob dial plate thermostat t.max. 180°C 100-180°C ø 95mm black		

			
1			
GEV No.	112843	Ref. No.	910.187.00
description	knob dial plate gas thermostat t.max. 185°C 100-185°C ø 96mm		

			
1			
GEV No.	112828	Ref. No.	910.229.00
description	knob dial plate thermostat t.max. 280°C 110-280°C ø 95mm black		

			
1			
GEV No.	112831	Ref. No.	910.871.00
description	knob dial plate ø 95mm black		

			
1			
GEV No.	112820	Ref. No.	910.739.00
description	knob dial plate thermostat t.max. 285°C 100-285°C ø 95mm black		

			
1			
GEV No.	112841	Ref. No.	910.551.00
description	knob dial plate ø 96mm		

			
1			
GEV No.	112840	Ref. No.	910.175.00
description	knob dial plate thermostat t.max. 300°C 50-300°C ø 95mm black		

			
1			
GEV No.	112864	Ref. No.	910.193.00
description	knob dial plate oven TH/BH/TH+BH ø 95mm black		

			
1			
GEV No.	112819	Ref. No.	910.228.00
description	knob dial plate thermostat t.max. 300°C 95-300°C ø 95mm black		

1

GEV No.	112865	Ref. No.	910.170.00
description	knob dial plate thermostat t.max. 90°C 30-90°C ø 95mm black		



1

GEV No.	112850	Ref. No.	910.168.00
description	knob dial plate top heat ø 95mm black		

accessories

rosettes



1

GEV No.	111915	Ref. No.	M564001500
description	rosette ø 37mm knob knob ø 30mm		

handles and hand wheels

hand wheels

hand wheels



1

GEV No.	691018	Ref. No.	65101800	
description	hand wheel ø 150mm D1 ø 32mm bore ø 15mm depth of bore 22mm thread M6 hole distance 6mm groove widthmm L1 20mm L2 45mm handle length 82mm with folding handle			
For models:	70/70BRE, 70/70BRG			
spare parts for	691018			
	GEV No.	690855	Ref. No.	—
	folding handle ø 25mm seat ø 19mm shaft ø 8mm thread M6 with shaft and pin L 82mm			



1

GEV No.	694351	Ref. No.	951.000.00
description	hand wheel ø 200mm D1 ø 40mm bore ø 18mm depth of bore 23mm thread M6 hole distance 9mm groove widthmm L1 40mm L2 60mm handle length 108mm with folding handle		



1

GEV No.	692430	Ref. No.	SMB063600
description	hand wheel ø 200mm D1 ø 50mm bore ø 20mm thread groove width 6mm groove depth 13mm mounting distance 30mm L1 47mm L2 50mm handle length 90mm with folding handle		

cylindrical handles

fixed



1

GEV No.	691314	Ref. No.	65101200
description	cylindrical handle thread M8 ø 28mm L 86mm		
For models:	65/40GRL, 65/70GRL, 70/40GRL, 70/70GRL		

bracket handles



1

GEV No.	502297	Ref. No.	9211711.00
description	pull handle L 230mm H 65mm mounting distance 180mm for oven right stainless steel		

			
1			
GEV No.	502292	Ref. No.	9211812.00
description	pull handle L 230mm H 65mm mounting distance 180mm for oven stainless steel		

			
1			
GEV No.	692802	Ref. No.	256.459.00
description	pull handle L 245mm mounting distance 224mm thread M6 for tilting bratt pan ø 20mm with fixing sheet silver		

fasteners

locking levers

			
1			
GEV No.	514519	Ref. No.	678.087.00
description	closing clamp for kettle with locking screw		

levers

with handle

			
1			
GEV No.	514529	Ref. No.	256.310.00
description	lever handle plastic/metal L 150mm for valve W 120mm H 25mm handle ø 28mm		

locks

edgemoount latches

door catches

			
1			
GEV No.	690487	Ref. No.	RRC2211-02
description	door catch H 41mm L 70mm W 21mm mounting distance 40mm nickel-plated brass with roller rollerø 8mm		

hinges

spring assisted hinges

universal

INTERKLIMAT

hinges

			
1			
GEV No.	690622	Ref. No.	71101000
description	spring assisted hinge series 28L mounting pos. left/right L 75mm W 25mm H 103mm A 13mm B 18mm mounting measurements 22x22mm intake 7.5x7.5 refrigeration units		

GEV No.	690622	Ref. No.	71101000
description	spring assisted hinge series 28L mounting pos. left/right L 75mm W 25mm H 103mm A 13mm B 18mm mounting measurements 22x22mm intake 7.5x7.5 refrigeration units		

			
1			
GEV No.	690714	Ref. No.	711.190.00
description	spring assisted hinge series 28XC mounting pos. left/right L 75mm W 25mm H 103mm A 8mm B 11mm intake 7.5x7.5 refrigeration units mounting distance 25mm		

GEV No.	690714	Ref. No.	711.190.00
description	spring assisted hinge series 28XC mounting pos. left/right L 75mm W 25mm H 103mm A 8mm B 11mm intake 7.5x7.5 refrigeration units mounting distance 25mm		



oven hinges

GEV No.	700003	Ref. No.	68402300
description	opposite support L 110mm W 12mm mounting distance 94mm		
For models:	60/60CFE, 60/60CFG, 60/60CFGE		

GEV No.	700001	Ref. No.	68401100
description	opposite support L 118mm W 17mm mounting distance 94mm		
For models:	65/110CFG, 65/110CFGE, 65/110TPFG, 65/70CFE, 65/70CFG, 65/70TPFG, 65/80BFE, 65/80TFE		

GEV No.	690030	Ref. No.	68402200								
description	oven hinge mounting distance 118mm lug mounting 13mm lever length 117mm groove distance 10mm spring thickness 3.5mm mounting ear position left/right spring length 60mm L 155mm W 21mm										
For models:	60/60CFE, 60/60CFG, 60/60CFGE										
accessories for	690030										
<table border="1"> <tr> <td>GEV No.</td> <td>700003</td> <td>Ref. No.</td> <td>68402300</td> </tr> <tr> <td colspan="4">opposite support L 110mm W 12mm mounting distance 94mm</td> </tr> </table>				GEV No.	700003	Ref. No.	68402300	opposite support L 110mm W 12mm mounting distance 94mm			
GEV No.	700003	Ref. No.	68402300								
opposite support L 110mm W 12mm mounting distance 94mm											

GEV No.	701621	Ref. No.	684.030.00
description	oven hinge mounting distance 173mm lug mounting 14mm lever length 115mm groove distance 7mm spring thickness 3.8mm mounting ear position left/right spring length 110mm L 207mm W 25mm		

GEV No.	700006	Ref. No.	684.027.00 68400900								
description	oven hinge mounting distance 173mm mounting distance 2 105mm lug mounting 14mm lever length 120mm groove distance 11mm spring thickness 3.5mm mounting ear position left spring length 112mm W 25mm										
For models:	65/110CFG, 65/110CFGE, 65/110TPFG, 65/70CFE, 65/70CFG, 65/70TPFG, 65/80BFE, 65/80TFE, 70/110CFG, 70/110CFGE, 70/110TPFG, 70/70CFE, 70/70CFG, 70/70CFGE, 70/70TPFG										
accessories for	700006										
<table border="1"> <tr> <td>GEV No.</td> <td>700001</td> <td>Ref. No.</td> <td>68401100</td> </tr> <tr> <td colspan="4">opposite support L 118mm W 17mm mounting distance 94mm</td> </tr> </table>				GEV No.	700001	Ref. No.	68401100	opposite support L 118mm W 17mm mounting distance 94mm			
GEV No.	700001	Ref. No.	68401100								
opposite support L 118mm W 17mm mounting distance 94mm											
<table border="1"> <tr> <td>GEV No.</td> <td>700007</td> <td>Ref. No.</td> <td>68401000 684.026.00</td> </tr> <tr> <td colspan="4">oven hinge mounting distance 173mm mounting distance 2 105mm lug mounting 14mm lever length 120mm groove distance 11mm spring thickness 3.5mm mounting ear position right spring length 112mm W 25mm</td> </tr> </table>				GEV No.	700007	Ref. No.	68401000 684.026.00	oven hinge mounting distance 173mm mounting distance 2 105mm lug mounting 14mm lever length 120mm groove distance 11mm spring thickness 3.5mm mounting ear position right spring length 112mm W 25mm			
GEV No.	700007	Ref. No.	68401000 684.026.00								
oven hinge mounting distance 173mm mounting distance 2 105mm lug mounting 14mm lever length 120mm groove distance 11mm spring thickness 3.5mm mounting ear position right spring length 112mm W 25mm											

GEV No.	700007	Ref. No.	684.026.00 68401000
description	oven hinge mounting distance 173mm mounting distance 2 105mm lug mounting 14mm lever length 120mm groove distance 11mm spring thickness 3.5mm mounting ear position right spring length 112mm W 25mm		
For models:	65/110CFG, 65/110CFGE, 65/110TPFG, 65/70CFE, 65/70CFG, 65/70TPFG, 65/80BFE, 65/80TFE, 70/110CFG, 70/110CFGE, 70/110TPFG, 70/70CFE, 70/70CFEQ, 70/70CFG, 70/70CFGE, 70/70CFVE, 70/70TPFG		
accessories for	700007		
GEV No.	700001	Ref. No.	68401100
description	opposite support L 118mm W 17mm mounting distance 94mm		

door bearing

GEV No.	519402	Ref. No.	451.099.00
description	bush for door hinge		

miscellaneous

GEV No.	519395	Ref. No.	412.037.00
description	door hinge mounting pos. right		

fittings for catering equipment

outlet taps

producer-specific

MODULAR



GEV No.	514006	Ref. No.	63100000
description	drain pipe L 200mm thread \varnothing 22mm		
For models:	60/30BME, 60/30CPE, 60/30FRE, 60/30FRG, 60/60BME, 60/60CPE, 60/60FRE, 60/60FRG, 65/40BME, 65/40FRE, 65/70BME, 65/70FRE, 70/40BME, 70/70BME		

GEV No.	693082	Ref. No.	62302400
description	lever handle thread		
For models:	60/30FRE, 60/30FRG, 60/60FRE, 60/60FRG, 65/40FRE, 65/40FRG, 65/70FRE, 65/70FRG		

GEV No.	540776	Ref. No.	67800100
description	outlet tap L 83mm without handle thread 3/4" IT shaft L 9mm shaft \varnothing 10x7.3mm handle M6		
For models:	60/30BME, 60/30CPE, 60/30FRE, 60/30FRG, 60/60BME, 60/60CPE, 60/60FRE, 60/60FRG, 65/40BME, 65/40FRE, 65/40FRG, 65/70BME, 65/70FRE, 65/70FRG, 70/40BME, 70/70BME		
accessories for	540776		
GEV No.	532453	Ref. No.	—
description	O-ring EPDM thickness 2.62mm ID \varnothing 21.89mm Qty 1 pcs		
accessories for	540776		
GEV No.	110734	Ref. No.	—
description	lever for outlet tap		
GEV No.	514006	Ref. No.	63100000
description	drain pipe L 200mm thread \varnothing 22mm		
GEV No.	514217	Ref. No.	—
description	handle for outlet tap		
GEV No.	540651	Ref. No.	—
description	drain pipe total length 210mm shaft \varnothing 22mm		



Table continues overleaf



accessories for	540776			
	GEV No.	540734	Ref. No.	—
	drain pipe thread			
	GEV No.	693082	Ref. No.	62302400
	lever handle thread			

aerators and air bleeders

	1			
GEV No.	540827	Ref. No.	67802300	
description	aerator and air bleeder thread 3/4" ET chrome-plated L 45mm ø 36mm			
For models:	70/70PEI, 70/70PGI			

	1			
GEV No.	542408	Ref. No.	256.334.00	
description	aerator and air bleeder thread 3/8" ET WS 24 chrome-plated with adapter for kettle L 37mm			
spare parts for	542408			
	GEV No.	540825	Ref. No.	—
	aerator and air bleeder thread 3/8" ET WS 24 chrome-plated L 37mm			

lid hinges

MODULAR

lid hinges

	1			
GEV No.	514520	Ref. No.	6111636.00	
description	lid hinge L 250mm ID ø 40mm ED ø 42mm lid radius 215mm			

spare parts

	1			
GEV No.	692783	Ref. No.	941.139.15	
description	adjusting bush for kettle ø 40/20mm L 80mm			

	1			
GEV No.	692797	Ref. No.	941.138.00	
description	bush for kettle ø 39mm L 55mm			

lid catches

	1			
GEV No.	514519	Ref. No.	678.087.00	
description	closing clamp for kettle with locking schrew			

drain taps



brass

drain taps





GEV No.	541672	Ref. No.	678.086.00
description	drain tap 1 1/2" IT conical seal A 85mm B1 58mm B2 126mm		
spare parts for	541672		
	GEV No.	540213	Ref. No. —
	handle ID ø 5mm L 117mm		
	GEV No.	540956	Ref. No. —
	gasket for drain tap hose ext. ø 46mm ID ø 38mm H 2mm		
accessories for	541672		
	GEV No.	510404	Ref. No. 953.031.00
	flat gasket fibre ED ø 44mm ID ø 34mm thickness 2mm Qty 1 pcs		
	GEV No.	890116	Ref. No. —
	fitting grease FERMIT GLISSA tube 60g -20 up to +140°C approval complies with KTW recommendation		
	GEV No.	890118	Ref. No. —
	fitting grease FERMIT GLISSA can 1000g -20 up to +140°C approval complies with KTW recommendation		
	GEV No.	890119	Ref. No. —
	fitting grease FERMIT GLISSA tube 30g -20 up to +140°C approval complies with KTW recommendation		



GEV No.	540275	Ref. No.	67805100 S0102000003
description	drain tap 2" IT with union nut A 90mm B 151mm B1 80mm chrome-plated brass		
spare parts for	540275		
	GEV No.	540214	Ref. No. —
	handle ID ø 6mm L 145mm		
accessories for	540275		
	GEV No.	529484	Ref. No. 953.030.00
	flat gasket fibre ED ø 58mm ID ø 50mm thickness 2mm Qty 1 pcs		
	GEV No.	542448	Ref. No. —
	gasket silicone 60x49x2 for drain tap 2"		



GEV No.	540276	Ref. No.	67805800
description	drain tap connection with union nut thread 1 1/2"		
For models:	70/70PEI, 70/70PGI		
spare parts for	540276		
	GEV No.	532374	Ref. No. —
	O-ring silicone thickness 5.34mm ID ø 43.82mm Qty 10 pcs		
accessories for	540276		
	GEV No.	514251	Ref. No. —
	gasket fibre ED ø 46mm ID ø 38mm thickness 2mm Qty 1 pcs		

test taps

test taps



GEV No.	540818	Ref. No.	67803100
description	test tap thread 1/2" ET W 88mm W1 38mm		
For models:	70/70PEI, 70/70PGI		



GEV No.	542396	Ref. No.	678.079.00
description	test tap thread 3/8" IT W 78mm W1 22mm head ø 45mm head thickness 18mm		



safety fittings

accessories



1			
GEV No.	540817	Ref. No.	67802700
description	fitting support thread 1/2" ET suitable for manometer		





1			
GEV No.	540821	Ref. No.	67804800
description	fitting support thread 1 1/4"		



1			
GEV No.	540822	Ref. No.	67804100
description	fitting support thread 3/4"		
For models:	70/70PEI, 70/70PGI		



1			
GEV No.	540835	Ref. No.	67805400
description	screw cap thread 3/4"		
spare parts for	540835		
	GEV No.	513016	Ref. No.
			—
	O-ring EPDM thickness 3.53mm ID ø 26.58mm Qty 1 pcs		
accessories for	540835		
	GEV No.	513016	Ref. No.
			—
	O-ring EPDM thickness 3.53mm ID ø 26.58mm Qty 1 pcs		



1			
GEV No.	540833	Ref. No.	67802800
description	screw cap thread 3/8"		
For models:	70/70PEI, 70/70PGI		



1			
GEV No.	540828	Ref. No.	67802500
description	manometer siphon thread 3/8"		

safety valves



1			
GEV No.	514415	Ref. No.	678.052.00
description	safety valve for kettle thread M33		



1			
GEV No.	514121	Ref. No.	678.049.00 679.049.00
description	safety valve triggering pressure 0.5bar with CE approval M88 thread 1 1/4"		

filters

grease filters

grease filter



1			
GEV No.	970962	Ref. No.	643.007.00
description	grease filter W 270mm L 270mm thickness 12mm for induction device		

equipment feet and end caps

equipment feet

with fixing plate



1			
GEV No.	701616	Ref. No.	912.090.14
description	equipment foot tube ø 64mm plate size 74x74mm hole distance 56x56mm H 130-190mm SS size 2" Qty 1 pcs		

screw-in feet



GEV No.	692781	Ref. No.	951.083.00
description	equipment foot thread M8 thread L 54mm ø 25mm H 11mm Qty 1 pcs		

baskets

fryer baskets

MODULAR



GEV No.	970663	Ref. No.	600.202.40
description	fryer basket L1 255mm W1 115mm H1 110mm		



GEV No.	970330	Ref. No.	68301100
description	fryer basket L1 255mm W1 230mm H1 110mm		
For models:	60/60FRG, 65/40FRG, 65/70FRG		



GEV No.	970331	Ref. No.	60020140 68303100
description	fryer basket L1 290mm W1 260mm H1 140mm L2 460mm H2 210mm H3 240mm chrome-plated steel		
For models:	70/40FRG13, 70/70FRG13		



GEV No.	970300	Ref. No.	68308300
description	fryer basket L1 390mm W1 235mm H1 120mm L2 560mm H3 300mm chrome-plated steel		



GEV No.	970576	Ref. No.	983.014.00
description	fryer basket L1 400mm W1 150mm H1 135mm chrome-plated steel		



GEV No.	970679	Ref. No.	600.203.40 683.000.00
description	fryer basket W1 220mm L1 300mm H1 110mm		
For models:	60/30FRE, 60/60FRE, 65/40FRE, 65/70FRE, 70/40FRE10, 70/70FRE10		

pasta baskets

MODULAR



GEV No.	970961	Ref. No.	911.758.15
description	chargrill grid L 470mm W 295mm H 80mm for pasta cooker		



GEV No.	970958	Ref. No.	6111186.00 6111186.15
description	chargrill grid L1 300mm W1 295mm H1 90mm for pasta cooker		



GEV No.	970723	Ref. No.	600.747.40 CPC8
description	pasta basket L1 100mm W1 140mm H1 160mm H3 360mm stainless steel		



1

GEV No.	970724	Ref. No.	600.749.40 CPC4
description	pasta basket L1 140mm W1 140mm H1 160mm H3 360mm stainless steel		



1

GEV No.	970680	Ref. No.	600.751.40 CPC6
description	pasta basket L1 140mm W1 140mm H1 200mm H3 420mm stainless steel		



1

GEV No.	970223	Ref. No.	600.752.40 CPC13
description	pasta basket L1 160mm W1 290mm H1 200mm H3 340mm stainless steel		



1

GEV No.	970720	Ref. No.	600.753.40 CPC12
description	pasta basket L1 240mm W1 290mm H1 200mm H2 340mm stainless steel		

crumb screens

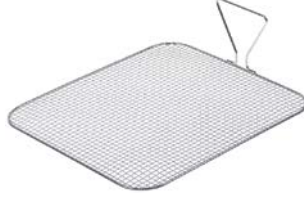

1

GEV No.	970965	Ref. No.	983.048.00 983.048.12
description	crumb screen L 332mm W 297mm H 100mm chrome-plated steel for grill		

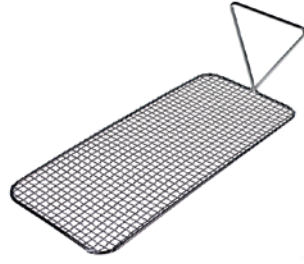

1

GEV No.	970632	Ref. No.	683.095.00
description	crumb screen L 338mm W 134mm H 100mm		

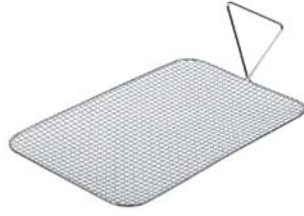

1

GEV No.	970983	Ref. No.	683.096.00
description	crumb screen L 339mm W 220mm H 100mm chrome-plated steel suitable for for fryer 13 L		

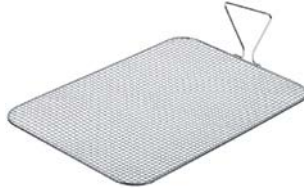

1

GEV No.	970964	Ref. No.	983.045.00
description	crumb screen L 430mm W 297mm H 110mm		



1

GEV No.	970545	Ref. No.	683.001.23
description	crumb screen L 330mm W 235mm suitable for fryer		

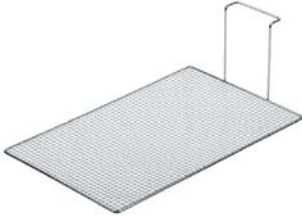

1

GEV No.	970963	Ref. No.	983.010.00
description	crumb screen L 410mm W 260mm H 140mm for fryer		

warewashing baskets

accessories

cutlery inserts



1

GEV No.	976011	Ref. No.	45100400
description	cutlery insert Lmm Wmm ø 110mm H 130mm		

shelves and shelf rails

chargrill grids



1

GEV No.	211099	Ref. No.	611.937.00
description	chargrill grid L 440mm W 325mm H 20mm stainless steel for lava rock grill		



1

GEV No.	211019	Ref. No.	68101100
description	chargrill grid L 495mm W 160mm H 19mm		
For models:	65/40GRG, 65/40GRL, 65/70GRG, 70/40GRG, 70/40GRL, 70/70GRG, 70/70GRL		

grates



1

GEV No.	692770	Ref. No.	982.024.00
description	chimney grate L 400mm W 80mm cast iron		

grid attachments



1

GEV No.	694963	Ref. No.	622.967.00	
description	rack support L 630mm H 175mm mounting pos. left/right W 40mm mounting distance 603mm			
accessories for	694963			
	GEV No.	701650	Ref. No.	641.090.00
	bolt for grid attachment L 18mm head ø 15mm M6			



1

GEV No.	692890	Ref. No.	9111317.00
description	rack support L 630mm H 190mm mounting pos. left/right W 50mm mounting distance 608mm		

shelf rails and supports

producer-specific



1

GEV No.	701650	Ref. No.	641.090.00
description	bolt for grid attachment L 18mm head ø 15mm M6		

1

GEV No.	693481	Ref. No.	M502000300
description	shelf support L 23mm W 20mm H 26mm		

gaskets

refrigeration gaskets

plug-in gaskets

profile 9048

We offer custom-made gaskets for this profile

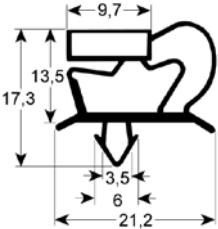

1

GEV No.	901872	Ref. No.	752.013.00
description	refrigeration gasket profile 9048 W 290mm L 430mm plug size		

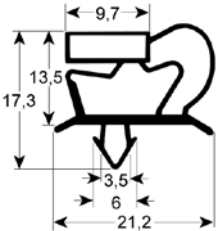

1

GEV No.	901874	Ref. No.	752.015.00
description	refrigeration gasket profile 9048 W 430mm L 615mm plug size		

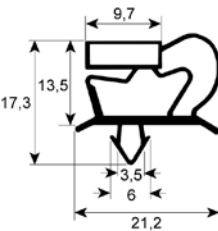

1

GEV No.	901596	Ref. No.	752.008.00
description	refrigeration gasket profile 9048 W 540mm L 1360mm plug size		

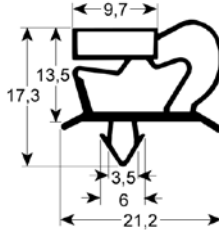

1

GEV No.	902132	Ref. No.	752.019.00
description	refrigeration gasket profile 9048 W 612mm L 1531mm plug size		

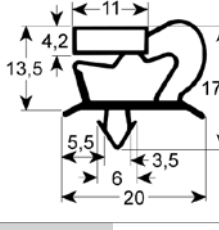

1

GEV No.	902070	Ref. No.	752.002.00
description	refrigeration gasket profile 9048 W 640mm L 1540mm plug size		

gaskets for heated units

door seals

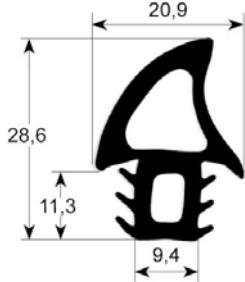

1

GEV No.	900439	Ref. No.	7070166
description	door seal profile 2750 Qty supplied by meter		

door seals with fixing hook



1

GEV No.	900599	Ref. No.	65201300
description	door seal W 550mm with mounting clip H 310mm		
For models:	90/80CFES, CFG		

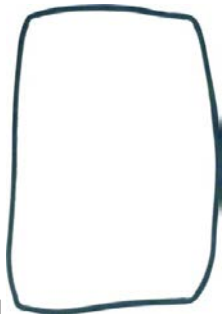

1

GEV No.	900735	Ref. No.	652.014.00
description	oven gasket L 310mm W 550mm 6 hooks external size		



1

GEV No.	900247	Ref. No.	65200900
description	oven gasket L 340mm W 460mm with 4 mounting clips external size		
For models:	60/60CFE, 60/60CFG, 60/60CFGE		

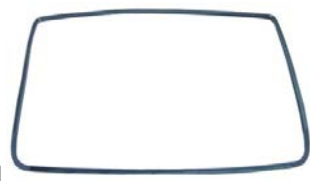

1

GEV No.	900404	Ref. No.	65201000
description	oven gasket L 450mm W 330mm external size		
For models:	60/60CFE, 60/60CFG		

door gaskets (wire reinforced)



1

GEV No.	900248	Ref. No.	65201100
description	oven gasket wire reinforced L 295mm W 440mm		
For models:	60/60CFE, 60/60CFG, 60/60CFGE		

door seals with tension springs

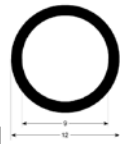

1

GEV No.	900249	Ref. No.	652002 65200200
description	oven gasket profile 2965 L 305mm Qty 1 mounting pos. lateral		
For models:	65/110CFG, 65/110CFGE, 65/110TPFG, 65/70CFE, 65/70CFG, 65/70TPFG, 65/80BFE, 65/80TFE, 70/110CFG, 70/110CFGE, 70/110TPFG, 70/70CFE, 70/70CFEQ, 70/70CFG, 70/70CFGE, 70/70TPFG		

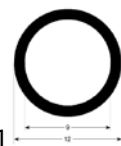

1

GEV No.	900250	Ref. No.	65200100
description	oven gasket profile 2965 L 615mm Qty 1 mounting pos. upper		
For models:	65/110CFG, 65/110CFGE, 65/110TPFG, 65/70CFE, 65/70CFG, 65/70TPFG, 65/80BFE, 65/80TFE, 70/110CFG, 70/110CFGE, 70/110TPFG, 70/70CFE, 70/70CFG, 70/70CFGE, 70/70CFVE, 70/70TPFG		



1

GEV No.	514003	Ref. No.	260.004.00
description	spring L 370mm for gasket mounting pos. lateral		



1

GEV No.	514001	Ref. No.	26000300
description	spring L 655mm for gasket mounting pos. upper		

boiling pan gaskets

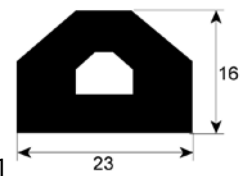

1

GEV No.	900510	Ref. No.	952.000.00
description	boiling pan gasket profile 3020 L 2000mm		

O-rings

EPDM



1

GEV No.	510302	Ref. No.	0835.17124.1
description	O-ring EPDM ID \varnothing 12.42mm thickness 1.78mm Qty 1 pcs		

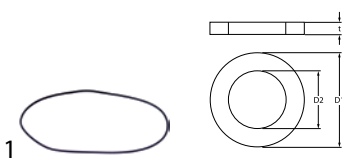
GEV No.	521717	Ref. No.	464.048.00
description	O-ring EPDM thickness 1.78mm ID ø 120.37mm Qty 1 pcs		

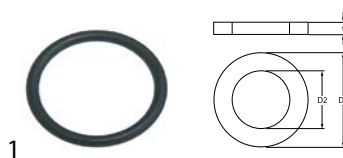

GEV No.	510408	Ref. No.	0835534701
description	O-ring EPDM thickness 5.34mm ID ø 47mm Qty 1 pcs		

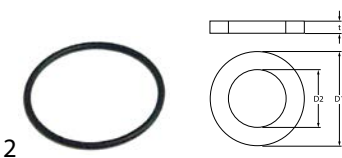

GEV No.	532021	Ref. No.	953.018.00
description	O-ring EPDM thickness 1.78mm ID ø 33.05mm Qty 10 pcs		



GEV No.	510409	Ref. No.	835535651
description	O-ring EPDM thickness 5.34mm ID ø 56.52mm Qty 1 pcs		



GEV No.	510769	Ref. No.	0835.25303.1
description	O-ring EPDM thickness 2.62mm ID ø 25.07mm Qty 1 pcs		

Viton



GEV No.	510243	Ref. No.	653.018.00
description	O-ring Viton thickness 3.53mm ID ø 55.56mm Qty 1 pcs		

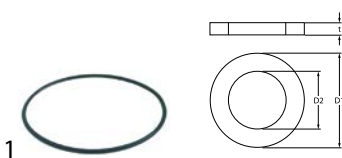

GEV No.	528800	Ref. No.	46404300
description	O-ring EPDM thickness 2.62mm ID ø 75.87mm Qty 1 pcs		

sealing washers

fibre gaskets

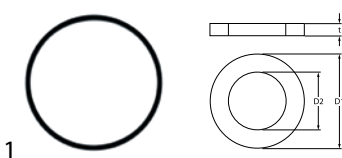

GEV No.	510009	Ref. No.	0835.35101.1 0835.40100.1
description	O-ring EPDM thickness 3.53mm ID ø 101.2mm Qty 1 pcs		



GEV No.	510730	Ref. No.	0540.25122.0 0840.20142.00 0840.25122.0
description	flat gasket fibre ED ø 25mm ID ø 12mm thickness 2mm Qty 1 pcs		

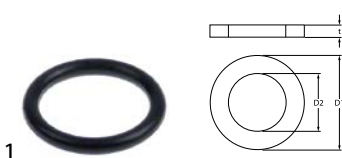

GEV No.	511322	Ref. No.	953.025.00
description	O-ring EPDM thickness 3.53mm ID ø 20.22mm Qty 1 pcs		



GEV No.	510404	Ref. No.	953.031.00
description	flat gasket fibre ED ø 44mm ID ø 34mm thickness 2mm Qty 1 pcs		



GEV No.	532118	Ref. No.	653.017.00
description	O-ring EPDM thickness 3.53mm ID ø 55.56mm Qty 10 pcs		



GEV No.	529484	Ref. No.	953.030.00
description	flat gasket fibre ED ø 58mm ID ø 50mm thickness 2mm Qty 1 pcs		

rubber gaskets



GEV No.	510876	Ref. No.	N/A
description	flat gasket rubber ED ø 45mm ID ø 33mm thickness 3mm Qty 1 pcs		

sealing cords

square



GEV No.	694980	Ref. No.	953.004.00
description	sealing cord square size 12x12mm braided L 1.05m for hob		

special gaskets

miscellaneous



GEV No.	551456	Ref. No.	953.020.00
description	gasket for switch ED ø 14mm ID ø 2.5mm thickness 3.5mm white		

springs

torsion springs



GEV No.	700177	Ref. No.	26001000
description	torsion spring for tilting bratt pan		
For models:	70/70BRE, 70/70BREM, 70/70BRG, 70/70BRGM, 70/70PEI, 70/70PGI		



GEV No.	514527	Ref. No.	260.119.00
description	torsion spring ø 32mm wire gauge ø 5.6mm L1 195mm L2 20mm L3 30mm mounting pos. lid Qty 1 pcs for kettle		



GEV No.	514522	Ref. No.	260.116.00
description	torsion spring ø 34mm wire gauge ø 6mm L1 370mm L2 22mm L3 22mm mounting pos. left Qty 1 pcs for kettle		



GEV No.	700179	Ref. No.	26001600
description	torsion spring ø 52.4mm wire gauge ø 4.1mm L1 27mm L2 97mm L3 27mm mounting pos. left		



GEV No.	700178	Ref. No.	26001500
description	torsion spring ø 52.6mm wire gauge ø 4.2mm L1 25mm L2 97mm L3 25mm mounting pos. right		

roller springs

roller springs



GEV No.	511552	Ref. No.	N/A
description	roller spring complete incl. holder W 40mm ID ømm lug length 70mm		

tension springs



GEV No.	516500	Ref. No.	26001900
description	tension spring		



GEV No.	519394	Ref. No.	260.017.00
description	tension spring ø 19mm L1 230mm		



GEV No.	519400	Ref. No.	260.012.00
description	tension spring ø 19mm L1 300mm		



GEV No.	517406	Ref. No.	260.120.00
description	tension spring ø 29mm total length 230mm wire gauge ø 4mm for tilting bratt pan		



GEV No.	501581	Ref. No.	260.122.00
description	tension spring ø 30mm total length 210mm wire gauge ø 4mm L2 137mm for lid tilting bratt pan		





GEV No.	701625	Ref. No.	260.123.00
description	tension spring ø 44mm total length 350mm wire gauge ø 5.8mm for tilting bratt pan		



			
1			
GEV No.	701617	Ref. No.	260.121.00
description	tension spring ø 65mm total length 420mm wire gauge ø 8.5mm for tilting bratt pan		

manometers

			
1			
GEV No.	542405	Ref. No.	678.083.00
description	manometer ø 63mm pressure range 0 up to 1bar 0 up to 14.5PSI filled with glycerin thread 1/4" for kettle connection on the backside		

			
1			
GEV No.	541062	Ref. No.	67803000
description	manometer ø 63mm pressure range 0 up to 1bar connection marking adjustable kettle thread 1/4"		
spare parts for	541062		
	GEV No.	Ref. No.	
	541130	—	
	glass panel ø 58mm thickness 2mm		

dosing pumps

membrane dosing pumps

self-priming

various

			
1			
GEV No.	361015	Ref. No.	471.006.00
description	dosing pump membrane dosing pump rinse aid inlet 6x8mm outlet 4x6mm pressure connection ø 4x6mm suction connection ø 6x8mm		
spare parts for	361015		
	GEV No.	Ref. No.	
	361132	—	
	membrane dosing pump		
	GEV No.	Ref. No.	
	510298	—	
	lip valve dosing pump suitable for DB2/DS5		

			
1			
GEV No.	361731	Ref. No.	471.007.00 471.008.00 471.011.00
description	dosing pump without auxiliary pressure connection rinse aid inlet 4mm outlet 8mm pressure connection ø 8mm suction connection ø 4mm		

self-priming with supporting pressure

GERMAC

type 2000













			
1			
GEV No.	361536	Ref. No.	47101000
description	dosing pump type 2000 rinse aid inlet 4x6mm outlet 8mm suction connection ø 4x6mm supporting pressure 11mm rebound ball PTFE 1mm GERMAC CODE VNR/D3		
spare parts for	361536		
	GEV No.	Ref. No.	
	361550	—	
	hose connector hose ø 4x6mm		
	GEV No.	Ref. No.	
	361551	—	
	compression spring wire gauge ø 1mm		
	GEV No.	Ref. No.	
	361701	—	
	hose connector thread M10x1 grommet ø 7.5mm		
	GEV No.	Ref. No.	
	361705	—	
	gasket for hose connector M12x1		
	GEV No.	Ref. No.	
	510298	—	
	lip valve dosing pump suitable for DB2/DS5		
accessories for	361536		
	GEV No.	Ref. No.	
	361553	—	
	membrane EPDM		
	GEV No.	Ref. No.	
	361700	—	
	hose connector rotary hose ø 4x6mm plastic connection M10x1		
	GEV No.	Ref. No.	
	361702	—	
	hose connector brass hose ø 4x6mm		
	GEV No.	Ref. No.	
	361703	—	
	hose connector thread M10x1 brass pipe connection ø 4x6mmmm		
	GEV No.	Ref. No.	
	361704	—	
	hose connector brass straight thread M12x1 hose ø 11mm Qty 1 pcs		

Table continues overleaf

accessories for	361536		
	GEV No.	510296	Ref. No. —
	membrane silicone		
	GEV No.	520022	Ref. No. —
	PVC hose ID ø 8mm ED ø 12mm L 10m thickness 2mm t.max. 60°C transparent		

accessories

container filters with non-return valve

	1		
GEV No.	361058	Ref. No.	451.048.00
description	container filter with non-return valve SS hose ø 4x6mm ø 20mm L 56mm		

hose couplings

metal			
	1		
GEV No.	361182	Ref. No.	671.027.00
description	nut thread 1/4" H 5mm nickel-plated brass WS 17 Qty 1 pcs		

hoses

drain hoses

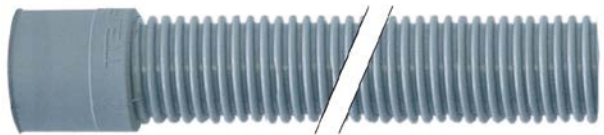
	1		
GEV No.	530587	Ref. No.	452.034.00
description	drain hose DN28 L 2000mm straight ø inside 32mm straight ext. ø 40mm outer hose ø 35mm		

fittings, hose and pipe connectors

fittings

sleeves

	1		
GEV No.	520175	Ref. No.	63103800
description	sleeve thread 1/2" - 1/2" nickel-plated brass WS 26 total length 30mm		

angle pieces

	1		
GEV No.	520825	Ref. No.	678.085.00
description	angle piece thread 1/4" ET - 1/4" IT nickel-plated brass		

hose connectors

producer-specific

	1		
GEV No.	691661	Ref. No.	412.032.00 412.032.15 451.098.00
description	angle piece thread M12x1 for hose ID 12mm		

	1		
GEV No.	524449	Ref. No.	45104200
description	manifold		



valves and tank inlets

ball valves

universal

ball valves with butterfly handle



1

GEV No.	540775	Ref. No.	67801400
description	ball valve connection 1" IT - 1" IT DN25 total length 68mm		
For models:	70/40CPE, 70/40CPG, 70/70CPE, 70/70CPG		
accessories for	540775		
	GEV No.	514529	Ref. No. 256.310.00
	lever handle plastic/metal L 150mm for valve W 120mm H 25mm handle ø 28mm		

accessories



1

GEV No.	514529	Ref. No.	256.310.00
description	lever handle plastic/metal L 150mm for valve W 120mm H 25mm handle ø 28mm		

shut-off valves

universal





1

GEV No.	520548	Ref. No.	678.065.00 678.065.25
description	ball valve complete with star handle H 84mm L 101mm W 26mm shaft ø 7.5mm intake tap ET 3/8"		



1

GEV No.	514478	Ref. No.	678.010.14
description	shut-off valve connection 1/2" 1/2" straight total length 65/110mm mounting thread 26x19G		
spare parts for	514478		
	GEV No.	547707	Ref. No. —
	tap head without plunger bush bearing thread 1/2" T2: M24x1 shaft intake ø 8mm suitable for MONOLITH		
accessories for	514478		
	GEV No.	514085	Ref. No. —
	rosette connection 26x19G chrome-plated total lengthmm mounting pos.		
	GEV No.	514086	Ref. No. —
	hexagonal nut connection 26x19G brass total lengthmm mounting pos. H 6mm WS 34 Qty 1 pcs		

inlet taps



1

GEV No.	542394	Ref. No.	256.466.00
description	inlet spout connection 1/2" tube ø 25mm overall height 150mm rotation°		



1

GEV No.	542393	Ref. No.	256.313.00
description	inlet spout connection 3/8" tube ø 12mm overall height 67mm rotation°		

tools

cleaning tools

scrapers



1			
GEV No.	705023	Ref. No.	610.272.00
description	scraper W 100mm L 420mm		

measuring equipment

thermometers

built-in thermometers

ø52mm



1			
GEV No.	541413	Ref. No.	M564001700
description	thermometer mounting ø 52mm t.max. 120°C 0 up to +120°C probe ø 6mm probe L 36mm capillary pipe 1500mm		



1			
GEV No.	541090	Ref. No.	66103000
description	thermometer mounting ø 52mm t.max. 350°C 0 up to +350°C probe ø 6.5mm probe L 22mm capillary pipe 1450mm		
For models:	65/80BFE, 65/80TFE		

fastening material

screws

threaded rods

miscellaneous

1			
GEV No.	530900	Ref. No.	941.162.00
description	threaded rod thread M12x1.5 zinc-coated steel thread L 80mm		

nuts

hexagonal nuts

DIN 982 (self-locking, tall version)

1			
GEV No.	560660	Ref. No.	CDI205AU
description	hexagonal nut thread M5 H 5.4mm zinc-coated steel WS 8 Qty 20 pcs DIN/ISO DIN 982 self-locking		

hexagonal nuts metric (without norm)

1			
GEV No.	510792	Ref. No.	441.045.00
description	hexagonal nut thread M12x1 H 4mm WS 17 stainless steel Qty 1 pcs		

1			
GEV No.	101860	Ref. No.	37200200
description	nut thread M10x1 H 4mm WS 14 chrome-plated brass Qty 1 pcs		
For models:	70/70K		

1			
GEV No.	102382	Ref. No.	673.024.00
description	nut thread M14x1 H 3.5mm WS 18 brass Qty 1 pcs		

hexagonal nuts inch thread

1			
GEV No.	361182	Ref. No.	671.027.00
description	nut thread 1/4" H 5mm nickel-plated brass WS 17 Qty 1 pcs		



washers

washers

miscellaneous



GEV No.	512509	Ref. No.	9221747.00
description	plain washer ID ø 8.4mm ED ø 40mm thickness 2mm		

fasteners

retaining rings

DIN 6799



GEV No.	518557	Ref. No.	0552.05065.4 238.000.00
description	retaining ring E D1 ø 5mm D2 ø 11mm SS DIN 6799 thickness 0.7mm		

roll pins



GEV No.	693090	Ref. No.	0561603608
description	roll pin ø 6mm L 36mm		

consumables

fuses

thermal fuses



GEV No.	358190	Ref. No.	663.077.00
description	thermal fuse switch-off temp. 98°C		

A			
audible timers	24	gas nozzles	69
axial fans	28	gas taps	34
B		gas thermostats	37
ball valves	109	gaskets for heated units	103
bar burners	64	H	
bi-metal thermostats	12	heating elements	3
boiling pan gaskets	104	heating elements for bain maries	3
C		heating elements for convection	8
cables	33	heating elements for fryers	4
cam switches	19	heating elements for griddles	5
ceramic heaters	6	heating elements for ovens	3
cleaning tools	110	heating elements for pasta cookers	6
compressors	27	heating elements for salamanders/toasters	6
condensators & interference suppression filters	32	heating elements for tilting bratt pan	5
consumables	111	hexagonal nuts	110
contactors	24	hob burners	52
container filters	108	hose connectors	108
control equipment	21	hose couplings	108
control thermostats	12, 16	hoses	108
D		hot air fans	29
door catches	94	hot air motors	28
door gaskets (wire reinforced)	104	hot plates	10
door seals	103	I	
door seals with fixing hook	103	ignition boxes	42
door seals with tension springs	104	ignition cables	49
dosing pumps	107	ignition switches	50
drain hoses	108	ignition units	50
drain pumps	32	immersion heating elements	7
E		indicator lights	21
edgemount latches	94	indicator lights (complete)	22
electric accessories	33	inlet spouts	109
electric timers	24	inlet taps	109
energy regulators	11	L	
F		lamps	21
fans	28	LED	23
fasteners	111	light bulbs	23
fastening material	110	M	
filters	32	measuring equipment	110
fittings	108	mechanical timers	24
fuses	33, 111	microswitches	18
G		motors	30
gas burners	52	N	
gas control valves	41	nuts	110
gas hoses	73	O	
gas lines	73	operating capacitors	32
		O-rings	104
		oven hinges	95

oven lamps 23

P

piezoelectric igniters 49
 pilot burners 42
 plug-in gaskets 103
 pressure switches 27
 probe clips 17
 probes 26
 programme timers 23
 protection hoses 33
 pumps 30
 push/momentary push switches 17

R

radiation heaters 9
 refrigeration gaskets 103
 relays 25
 retaining rings 111
 rocker/momentary rocker switches 17
 roll pins 111
 rotary switches 20

S

safety bi-metal thermostats 12
 safety thermostats 14, 16
 screws 110
 sealing cords 106
 sealing washers 105
 shelves and shelf rails 102
 shut-off valves 109
 sleeves 108
 solenoid valves 26
 solid top burners 68
 spring assisted hinges 94
 spring clips 17
 switches and momentary switches 17

T

temperature probes 26
 terminals 33
 thermal fuses 111
 thermocouples 50
 thermostats 12
 threaded rods 110
 timers 23
 tools 110
 transformers 26
 tube burners 68

U

universal probes 26

V

valves and tank inlets 109

W

wash and rinse pumps 30
 washers 111