



GAS COMPONENTS



ELECTRIC COMPONENTS



WATER TECHNOLOGY



MECHANICAL COMPONENTS



TOOLS

Spare parts suitable for

MONDIAL

Find the complete and up-to-date range of products in our GEV Webshop



Manufacturer catalogue

The most important spare parts and accessories arranged clearly for every manufacturer

- ✓ Complete product range and all appliance data always up to date in the GEV Webshop
- ✓ Alphabetical Index at the end of the catalogue

GEV Webshop

www.gev-online.co.uk

www.gev-online.com



- 🔍 Add to Favourites
- 🔍 Sign In with email address and usual password
- 🔍 Easy-order – place several items in your basket at the same time
- 🔍 Quick Item search – no login needed



heating elements

heating elements for refrigeration

heating elements for defrosting



GEV No.	419137	Ref. No.	4003116147000
description	heating element 1100W 230V L 1000mm W 70mm cable length 1800mm tube ø 8.5mm defrosting		

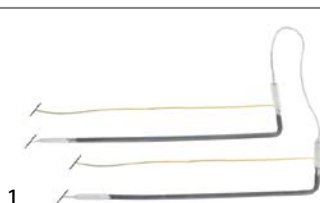

GEV No.	417587	Ref. No.	TDE072220
description	heating element 350W 230V L 380mm Wmm Hmm cable length 3.3m tube ø 8.7mm		

heating cartridges



GEV No.	417577	Ref. No.	1192081 (alternativ)
description	heating cartridge 190W 230V ø 12mm L 180mm thread 3/8" cable length 300mm suitable for MONDIAL		



GEV No.	417571	Ref. No.	1192081
description	heating cartridge 230W 230V ø 12mm L 180mm thread 3/8" cable length 1000mm universal		

thermostats

refrigeration thermostats

RANCO

K50 series

RANCO



GEV No.	390988	Ref. No.	1101031
description	thermostat RANCO type K50B-S3508 probe ø 2mm capillary pipe 1500mm		

RANCO



GEV No.	390780	Ref. No.	1001086
description	thermostat RANCO type K50-L3085 probe ømm probe Lmm capillary pipe 1800mm		

RANCO



GEV No.	390528	Ref. No.	1101043
description	thermostat RANCO type K50L3417 probe ø 10mm probe L 100mm capillary pipe 1400mm probe ø9.5x112mm		

RANCO



GEV No.	390803	Ref. No.	1101005
description	thermostat RANCO type K50-P1569/001 probe L 50mm capillary pipe 900mm		

K54 series

RANCO



GEV No.	390782	Ref. No.	1001118 1101001G
description	thermostat RANCO type K54L2097 probe ø 2mm capillary pipe 900mm		



ATEA



GEV No.	390794	Ref. No.	1101028
description	thermostat ATEA type A01 0806 probe ø 10mm probe L 52mm capillary pipe 1150mm		



GEV No.	390781	Ref. No.	1101029
description	thermostat T war -15°C T cold -32°C probe ø 2mm capillary pipe 2500mm type A01 0791		



GEV No.	346377	Ref. No.	1014073
description	rocker switch mounting measurements 30x22mm black 2CO 230V 16A 0-I connection male faston 6.3mm ambient temperature max. 125/55°C protection IP40		

accessories for	346377			
	GEV No.	301036	Ref. No.	—
	protective cover internal size 30x22mm for rocker switch mounting measurementsmm			



GEV No.	301287	Ref. No.	1114001G 1114018
description	rocker switch mounting measurements 30x22mm orange 2NO 250V 16A illuminated 0-I connection male faston 6.3mm ambient temperature max. 100/55°C protection IP40		

switches and momentary switches

rocker/momentary rocker switches

30x22mm



GEV No.	301002	Ref. No.	1014056
description	rocker switch mounting measurements 30x22mm orange 2NO 250V 16A illuminated 0-I connection male faston 6.3mm ambient temperature max. 85/125°C protection IP65		

accessories for	301002			
	GEV No.	301036	Ref. No.	—
	protective cover internal size 30x22mm for rocker switch mounting measurementsmm			



GEV No.	301009	Ref. No.	1114014
description	rocker switch mounting measurements 30x22mm white 2NO 250V 16A illuminated 0-I connection male faston 6.3mm ambient temperature max. 125/55°C protection IP65		

accessories for	301009			
	GEV No.	301036	Ref. No.	—
	protective cover internal size 30x22mm for rocker switch mounting measurementsmm			

push/momentary push switches

ø16mm



GEV No.	301295	Ref. No.	1114013
description	push switch mounting ø 16mm black 1NO 250V 16A connection male faston 6.3mm protection IP40 ambient temperature max. 150°C		

microswitches

with push button

switches with snap-fit



GEV No.	348148	Ref. No.	1195012
description	microswitch with push button 250V 0.25A 1NO connection male faston 6.3mm L 26x12mm ambient temperature max. 85°C actuating force: 500g		
For models:	EBA01W540		



roller actuated

roller 90°



1

GEV No.	347640	Ref. No.	1095001
description	microswitch with roller plunger 250V 16A connection male faston 6.3mm ambient temperature max. 85°C thread M12		

lamps

indicator lights

indicator lights (complete)

30x22mm



1

GEV No.	359157	Ref. No.	1111002G
description	indicator light mounting measurements 30x22mm 230V green connection male faston 6.3mm temp.-resist. 125/55°C type RL2		
accessories for	359157		
	GEV No.	301036	Ref. No.
			—
description	protective cover internal size 30x22mm for rocker switch mounting measurementsmm		



1

GEV No.	347641	Ref. No.	10110141 1111001G
description	indicator light mounting measurements 30x22mm 230V red connection male faston 6.3mm		

fluorescent lamps

fluorescent lamps

G13



1

GEV No.	359371	Ref. No.	1112007
description	fluorescent lamp socket G13 L 590mm 18W 230V Qty 1 pcs		

timers

defrost timers

CDC



1

GEV No.	360193	Ref. No.	1186003
description	defrost timer CDC type 13102 defrosting interval 1-12x in 24h defrosting time 2-50min fan delay 0-10min 230V 50Hz defr. funct. 1-12x per 24h with delay of fan 0-10min		

miscellaneous



1

GEV No.	360187	Ref. No.	1186010
description	defrost timer type RZ-2001-21 defrosting interval 4H defrosting time 15min fan delay 5min 230V 50Hz defr. funct. 4x per 24h		

relays

power relays

with bracket mounting



1

GEV No.	380815	Ref. No.	1142005
description	power relays 230VAC 16A 2NO connection male faston 6.3mm flange dimensions 36x38x68mm		

1

GEV No.	380185	Ref. No.	1042007
description	power relays Italiana Relè 230VAC 30A 1NO connection F6.3 bracket mounting dimensions 36.5x32.2x51.8mm manuf. no. A10-230AC-FA		

electronic controllers

DIXELL

refrigeration controllers

built-in version



1

GEV No.	378307	Ref. No.	1188054
description	electronic controller DIXELL XR40C-5N1C1 mounting measurements 71x29mm 230V voltage AC NTC/PTC relay outputs 2 NO-20A(8) CO-8A(3) NTC/PTC DI protection IP54 0-60°C display 3½ digits		

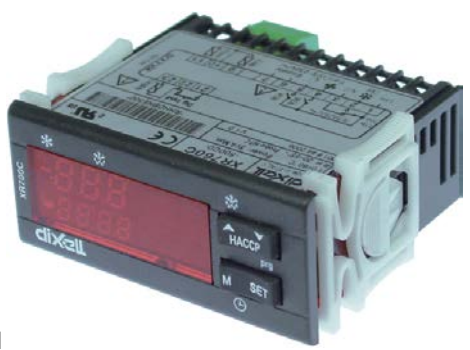

1

GEV No.	378020	Ref. No.	N/A
description	electronic controller DIXELL XR760C-500C0 mounting measurements 71x29mm defr. funct. no		

TECNOLOGIC

universal controllers

built-in version



1

GEV No.	379796	Ref. No.	1188053
description	electronic controller TECNOLOGIC type TLZ11FR-21 mounting measurements 71x29mm 12V voltage AC/DC NTC/PTC relay outputs 1 CO-8A(3) NTC/PTC DI built-in depth 64mm defr. funct. no -50 up to +150°C display 4 digits		

refrigeration controllers

built-in version



1

GEV No.	379206	Ref. No.	1088016
description	electronic controller TECNOLOGIC type TDF11F mounting measurements 71x29mm 12V voltage AC/DC NTC/PTC/Pt100/Pt1000/TC(J,K) -50 up to +150°C display 2½ digit		
accessories for	379206		
	GEV No.	Ref. No.	—
	temperature probe PTC 1kOhm cable silicone probe -50 up to +150°C cable -50 up to +180°C probe ø6x40mm cable length 1.5m without screw connection 2-wire		
	GEV No.	Ref. No.	—
	temperature probe PTC 1kOhm cable PVC probe -50 up to +150°C cable -10 up to 100°C probe ø6x30mm cable length 3m without screw connection 2-wire		
	GEV No.	Ref. No.	—
	transformer primary 230VAC secondary 12VAC 3VA secondary 0.25A H 40mm L 45mm W 50mm connection screw 50/60Hz type 153/M		



1

GEV No.	379796	Ref. No.	1188053
description	electronic controller TECNOLOGIC type TLZ11FR-21 mounting measurements 71x29mm 12V voltage AC/DC NTC/PTC relay outputs 1 CO-8A(3) NTC/PTC DI built-in depth 64mm defr. funct. no -50 up to +150°C display 4 digits		



			
1			
GEV No.	378519	Ref. No.	1188179
description	electronic controller TECNOLOGIC type Y395E mounting measurements 71x29mm 100-240V voltage AC NTC/PTC relay outputs 3 NO-16A CO-10A NO-5A NTC/PTC NTC/PTC DI front measurements 78x35mm built-in depth 64mm protection IP65 yes yes defr. funct. yes -50 up to +150°C display 3 digits		

			
1			
GEV No.	378458 ¹	Ref. No.	N/A
description	electronic controller TECNOLOGIC type Y395-HRRRB--A-E---- mounting measurements 74x32mm 100-240V voltage AC NTC/PTC relay outputs 3 NO-16A(9) CO-8A(3) NO-5A(2) NTC/PTC NTC/PTC DI built-in depth 64mm yes defr. funct. yes -99 up to +150°C display 3½ digits		
accessories for	378458		
	GEV No.	378261	Ref. No. —
	temperature probe NTC 10kOhm cable thermoplastic probe -40 up to +110°C cable -40 up to +110°C probe ø6x35mm cable length 3m without screw connection 2-wire		
	GEV No.	379052	Ref. No. —
	temperature probe PTC 1kOhm cable silicone probe -50 up to +150°C cable -50 up to +180°C probe ø6x40mm cable length 1.5m without screw connection 2-wire		
	GEV No.	379053	Ref. No. —
	temperature probe PTC 1kOhm cable PVC probe -50 up to +150°C cable -10 up to 100°C probe ø6x30mm cable length 3m without screw connection 2-wire		
	GEV No.	379064	Ref. No. —
	temperature probe PTC 1kOhm cable silicone probe -50 up to +150°C cable -50 up to +180°C probe ø6x40mm cable length 3m without screw connection 2-wire		
	GEV No.	379142	Ref. No. —
	temperature probe PTC 1kOhm cable PVC probe -50 up to +150°C cable -10 up to 100°C probe ø6x30mm cable length 1.5m without screw connection 2-wire		
	GEV No.	379160	Ref. No. —
	temperature probe NTC 10kOhm cable thermoplastic probe -40 up to +110°C cable -40 up to +110°C probe ø6x14mm cable length 1.5m without screw connection 2-wire		
	GEV No.	379161	Ref. No. —
	temperature probe NTC 10kOhm cable thermoplastic probe -40 up to +110°C cable -40 up to +110°C probe ø6x14mm cable length 3m without screw connection 2-wire		
	GEV No.	379342	Ref. No. —
	temperature probe NTC 10kOhm cable PVC probe -20 up to +80°C cable -10 up to 100°C probe ø6x25mm cable length 1.5m 2-wire protection IP67		
	GEV No.	379343	Ref. No. —
	temperature probe NTC 10kOhm cable silicone probe -40 up to +110°C cable -50 up to +180°C probe ø6x40mm cable length 3m 2-wire		
	GEV No.	379458	Ref. No. —
	temperature probe NTC 10kOhm cable silicone probe -40 up to +110°C cable -50 up to +180°C probe ø6x40mm cable length 1.5m without screw connection 2-wire		

¹application by touchscreen

accessories for	378458		
	GEV No.	379637	Ref. No. —
	temperature probe PTC 1kOhm cable PVC probe -50 up to +150°C cable -10 up to 100°C probe ø6x35mm cable length 2m without screw connection 2-wire		
	GEV No.	379781	Ref. No. —
	temperature probe PTC 1kOhm cable thermoplastic probe -50 up to +150°C cable -40 up to +110°C probe ø6x14mm cable length 1.5m without screw connection 2-wire		
	GEV No.	379782	Ref. No. —
	temperature probe PTC 1kOhm cable thermoplastic probe -50 up to +150°C cable -40 up to +110°C probe ø6x14mm cable length 3m 2-wire resistor 1kOhm		
	GEV No.	379804	Ref. No. —
	protector for electronic controller 71x29 L 93mm W 65mm plexiglas		
	GEV No.	379860	Ref. No. —
	temperature probe NTC 10kOhm cable PVC probe -20 up to +80°C cable -10 up to 100°C probe ø6x40mm cable length 1.5m without screw connection 2-wire		

compressors

ACC/ZEL

R134A

LBP monophase

Lower evaporation temperature below -20°C

			
1			
GEV No.	605062	Ref. No.	4106006+1147033
description	compressor coolant R134a type GL80AA 220-240V 50Hz LBP fully hermetic 9kg 1/5HP cylinder capacity 7.39cm ³ RSIR H 175mm 102W 144W 196W 256W 326W test method ASHRAE ambient temperature max. 43°C		



R404a/R507

HMBP monophase

High/Medium evaporation temperature above -20/-15 °C



1

GEV No.	605014	Ref. No.	4106053 4106053+1147263
description	compressor coolant R404a/R507 type ML80TB 220-240V 50Hz HMBP fully hermetic 11.4kg 3/8HP cylinder capacity 7.57cm ³ CSIR H 175.5mmW 261W 346W 446W 561W 691W 835W 993W 1167W test method ASHRAE ambient temperature max. 43°C		



1

GEV No.	605028	Ref. No.	4106054 4106054+1147282
description	compressor coolant R404a/R507 type ML90TB 220-240V 50Hz HMBP fully hermetic 11.6kg 3/8HP cylinder capacity 8.85cm ³ CSIR H 175.5mmW 323W 418W 532W 666W 819W 990W 1181W 1391W test method ASHRAE ambient temperature max. 43°C		

CUBIGEL

R134A

LBP monophase

Lower evaporation temperature below -20°C



1

GEV No.	605197	Ref. No.	4106004 4106004+1147031
description	compressor coolant R134a type GL60AA 220-240V 50Hz LBP 9.1kg 1/6HP power input 126W cylinder capacity 5.99cm ³ RSIR H 175mm 98W 135W 178W 227W 283W test method ASHRAE ambient temperature max. 43°C		



1

GEV No.	605185	Ref. No.	4106017+1147210
description	compressor coolant R134a type GL90AA 220-240V 50Hz LBP 9.4kg 1/4HP power input 184W cylinder capacity 8.1cm ³ RSIR H 185.6mm 148W 200W 261W 330W 407W test method ASHRAE ambient temperature max. 43°C		



R404a/R507

LBP monophase

Lower evaporation temperature below -20°C



1

GEV No.	605207	Ref. No.	4106033+1147260 4106051
description	compressor coolant R404a/R507 type ML80FB 220-240V 50Hz LBP 10.9kg 1/4HP cylinder capacity 8.1cm ³ CSIR H 185mm 276W 314W 356W 401W 450WWWWWW test method ASHRAE ambient temperature max. 43°C		

EMBRACO / ASPERA

R134A

LBP monophase

Lower evaporation temperature below -20°C



1

GEV No.	605265	Ref. No.	4108050+1147500
description	compressor coolant R134a type NE2134Z 220-240V 50Hz LBP 11.65kg 1/2HP cylinder capacity 14.28cm ³ CSIR 261W 350W 458W 588W 741WWWWWW test method ASHRAE		



1

GEV No.	605176	Ref. No.	4106034
description	compressor coolant R404a/R507 type ML90FB 220-240V 50Hz LBP 11kg 1/3HP cylinder capacity 8.85cm ³ CSIR H 198mm 305W 394W 495W 606W 729WWWWWW test method ASHRAE		

R404a/R507

LBP monophase

Lower evaporation temperature below -20°C



1

GEV No.	605260	Ref. No.	4106112+1147424
description	compressor coolant R404A type NT2192GK 220/240V 50Hz LBP 17.5kg 1.1HP cylinder capacity 22.37cm ³ CSCR 815W 1066W 1361W 1701W 2085WWWWWW		

HMBP monophase

High/Medium evaporation temperature above -20/-15 °C



1

GEV No.	605029	Ref. No.	4106070 4106113 4106113+1147428
description	compressor coolant R404a/R507 type MP12RB 220-240V 50Hz HMBP fully hermetic 13.5kg 1/2HP cylinder capacity 12cm ³ CSR H 203.6mmW 561W 734W 933W 1157W 1407W 1681W 1982WW test method ASHRAE ambient temperature max. 43°C		

HMBP monophase

High/Medium evaporation temperature above -20/-15 °C



1

GEV No.	605125	Ref. No.	4108043
description	compressor coolant R404a/R507 type NEK6213GK 220-240V 50Hz HMBP 11.6kg 1/2HP cylinder capacity 12.12cm ³ CSIR H 206mmW 695W 884W 1093W 1333W 1600W 1894W 2215W test method ASHRAE		

SECOP DANFOSS

R404a/R507

LBP monophase

Lower evaporation temperature below -20°C



1

GEV No.	605178	Ref. No.	4108045
description	compressor coolant R404a/R507 type NEK6217GK 220-240V 50Hz HMBP 11.6kg 5/8HP cylinder capacity 14.3cm ³ CSR H 206mmW 777W 954W 955W 1171W 1386W 1651W 1916W		



1

GEV No.	605132	Ref. No.	4108069	
description	compressor coolant R404a/R507 type NT6222GK 200-240V 50Hz HMBP fully hermetic 17kg 1HP cylinder capacity 17.39cm ³ CSR H 252mmW 810W 1032W 1040W 1174W 1307W 1583W 2247W test method ASHRAE			
accessories for	605132			
	GEV No.	365142	Ref. No.	—
	operating capacitor capacity 15µF 450V with metal case tolerance 5% 50/60Hz ø 40mm L 110mm M8x1.25			
	GEV No.	365153	Ref. No.	—
	starting capacitor 52µF 330V 50/60Hz duty cycle 3s 41280A133 2252347 ø 36mm L 83mm M8 plastic connection cable 350mm			
	GEV No.	390981	Ref. No.	—
	klixon suitable for NT6222GK			



1

GEV No.	605057	Ref. No.	4109024 4109024+1147206	
description	compressor coolant R404a/R507 type SC12CL 220-240V 50Hz LBP fully hermetic 12.5kg 3/8HP cylinder capacity 12.87cm ³ CSIR H 209mm 410W 568W 754W 971W 1220W 1505W test method ASHRAE			
spare parts for	605057			
	GEV No.	380078	Ref. No.	—
	start relay DANFOSS 117U6005 HST			



1

GEV No.	605058	Ref. No.	4109054 4109054+1147324	
description	compressor coolant R404a/R507 type SC15CL 220-240V 50Hz LBP fully hermetic 13.8kg 1/2HP cylinder capacity 15.28cm ³ CSIR H 219mm 486W 637W 813W 1017W 1251W 1699W test method ASHRAE 175W 358W			
spare parts for	605058			
	GEV No.	380058	Ref. No.	—
	start relay DANFOSS 117U6019/F278 HST			



1

GEV No.	605056	Ref. No.	4109026+1147323
description	compressor coolant R404a/R507 type SC18CLX.2 220-240V 50Hz LBP fully hermetic 13.7kg 5/8HP cylinder capacity 17.69cm ³ CSR H 219mm 562W 691W 881W 1095W 1332W 1593W test method ASHRAE		
spare parts for	605056		
	GEV No.	381548	Ref. No. —
	start relay DANFOSS		

fans

axial fans

import



1

GEV No.	601510 ¹	Ref. No.	4021019
description	axial fan L 119mm W 119mm H 38mm 230VAC 50/60Hz 22/21W bearing ball bearing connection male faston 6.3mm SUNON temp.-resist. 70°C		

¹with ball bearings

evaporation and condensing trays

condensing trays heated

universal

heating cartridges



1

GEV No.	417577	Ref. No.	1192081 (alternativ)
description	heating cartridge 190W 230V ø 12mm L 180mm thread 3/8" cable length 300mm suitable for MONDIAL		



1

GEV No.	417571	Ref. No.	1192081
description	heating cartridge 230W 230V ø 12mm L 180mm thread 3/8" cable length 1000mm universal		



refrigeration fans

cold air circulating fans

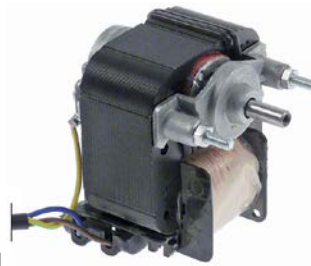
cold air circulating fans



1

GEV No.	750398	Ref. No.	4121093
description	fan motor 230/240V 50/60Hz 35W shaft ø 6mm shaft L 14mm W 62mm H 73mm		
accessories for	750398		
	GEV No.	601413	Ref. No. —
	fixing plate suitable for fanwheel ED ø 32mm shaft ø 7 mounting distance 26mm		
	GEV No.	602184	Ref. No. —
	fixing plate suitable for fanwheel ED ø 33mm shaft ø 6 mounting distance 17mm		



cross flow fans

EMMEVI - FERGAS

with standard coil



1

GEV No.	602070	Ref. No.	4022150
description	cross flow fan 116299 roller ø 60mm roller length 180mm laminated core thickness 20mm 220/240V - 50/60Hz 28W bearing rubber connection male faston 6.3mm		

with moulded coils



1

GEV No.	601110	Ref. No.	4022142 4022149
description	cross flow fan TGO 60/1-180/20 roller ø 60mm roller length 180mm laminated core thickness 20mm motor position left 230V/50Hz 28W refrigeration bearing rubber connection male faston 6.3mm -30 up to +100°C 230V cable length 1800mm		
For models:	EBA01W540		

COPREL

with standard coil



1

GEV No.	602044	Ref. No.	4022141 4022148
description	cross flow fan COPREL TFR 180/20-14CSN roller ø 60mm roller length 180mm laminated core thickness 20mm motor position right 230V/50Hz 27W refrigeration bearing rubber connection male faston 6.3mm t.max. 60°C airflow 144m³/h -30 bis +60°C		
For models:	EBA01W540		

equipment-specific units

for fridges

miscellaneous



1

GEV No.	694849	Ref. No.	1721625
description	cover with sump for evaporator L 390mm W 355mm H 140mm plastic		

handles and hand wheels

bracket handles



1

GEV No.	502270	Ref. No.	1721369
description	pull handle L 300mm H 50mm mounting distance 218mm hole ø 5mm grey		
accessories for	502270		
	GEV No.	692567	Ref. No. 1721370
	cover L 295mm H 26mm ABS plastic		



1

GEV No.	502268	Ref. No.	1721349
description	pull handle L 300mm H 50mm mounting distance 218mm hole ø 5mm white		





1

GEV No.	502269	Ref. No.	1721343
description	pull handle L 300mm H 50mm mounting distance 218mm hole ø 5mm white		



			
1			
GEV No.	690451	Ref. No.	2121009
description	pull handle L 426mm H 40mm mounting distance 376mm black		

covers			
			
1			
GEV No.	692566	Ref. No.	1721345
description	cover L 295mm H 26mm ABS plastic		

			
1			
GEV No.	692567	Ref. No.	1721370
description	cover L 295mm H 26mm ABS plastic		
accessories for	692567		
	GEV No.	502270	Ref. No. 1721369
	pull handle L 300mm H 50mm mounting distance 218mm hole ø 5mm grey		

recessed handles

			
1			
GEV No.	692568	Ref. No.	17210674
description	recessed handle L 120mm W 40mm H 22mm mounting distance 80mm ABS plastic		

			
1			
GEV No.	692569	Ref. No.	1721039
description	recessed handle L 140mm W 30mm H 25mm mounting distance 80mm ABS plastic		

			
1			
GEV No.	692571	Ref. No.	1721373
description	recessed handle L 250mm W 40mm H 20mm ABS plastic		

locks

locking devices

producer-specific

MONDIAL

			
1			
GEV No.	692209	Ref. No.	5601058
description	key cylinder with slide latch ø 17mm thread M4 cam length 76mm cam width 13mm thread L 5.5mm		

shelves and shelf rails

grates

universal

without upstand

			
1			
GEV No.	970126	Ref. No.	0621117
description	grate W 530mm D 650mm GN 2/1 plastic-coated steel wire gauge frame 8mm lengthwise wires gauge 5mm crossing wires 2 white suitable for refrigerator		

accessories for	970126		
	GEV No.	690330	Ref. No. —
	rack L 1000mm W 22mm H 4mm aperture 3x8mm hole distance 12.5mm stainless steel		

	GEV No.	694700	Ref. No. —
	shelf support L 31/28mm W 22mm H 18mm SS Qty 12 pcs		

	GEV No.	694701	Ref. No. —
	shelf support L 31/28mm W 22mm H 17mm SS with hook Qty 12 pcs		

producer-specific



GEV No.	970549	Ref. No.	0621130
description	grate W 448mm D 453mm steel with layer RILSAN white suitable for refrigerator with hinge camp		



GEV No.	970491	Ref. No.	0621140
description	grate W 518mm D 408mm plastic-coated steel		

gaskets

refrigeration gaskets

plug-in gaskets

profile 9431

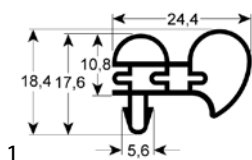

GEV No.	902407	Ref. No.	N/A
description	refrigeration gasket profile 9431 Wmm L 2500mm		

profile 9050

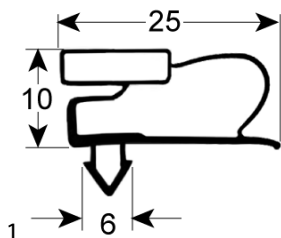

GEV No.	901441	Ref. No.	4612003
description	refrigeration gasket profile 9050 W 518mm L 1627mm plug size L1 1640mm W1 531mm external size		

profile 9773

We offer custom-made gaskets for this profile

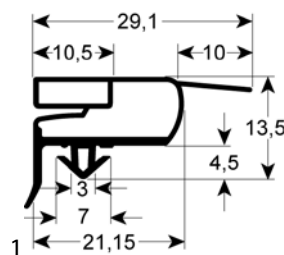

GEV No.	901782	Ref. No.	4612040
description	refrigeration gasket profile 9773 W 520mm L 1640mm external size W1 507mm L1 1627mm plug size		

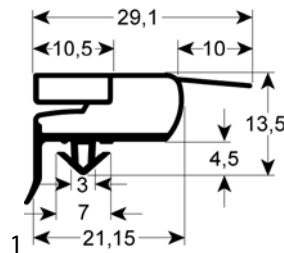

GEV No.	901334	Ref. No.	4612135
description	refrigeration gasket profile 9773 W 558mm L 732mm plug size		

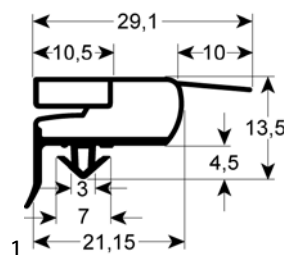

GEV No.	901090	Ref. No.	4612084
description	refrigeration gasket profile 9773 W 566mm L 1455mm external size W1 553mm L1 1442mm plug size		

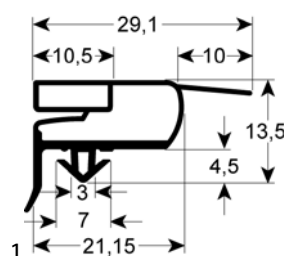

GEV No.	901088	Ref. No.	4612082
description	refrigeration gasket profile 9773 W 566mm L 1705mm external size W1 553mm L1 1692mm plug size		



GEV No.	901487	Ref. No.	4612091
description	refrigeration gasket profile 9773 W 635mm L 1530mm external size W1 622mm L1 1517mm plug size grey		

GEV No.	901977	Ref. No.	4612039
description	refrigeration gasket profile 9773 W 736mm L 1540mm plug size suitable for MONDIAL		

GEV No.	901781	Ref. No.	4612120
description	refrigeration gasket profile 9773 W 635mm L 1530mm external size W1 622mm L1 1517mm plug size white		

GEV No.	901087	Ref. No.	4612083
description	refrigeration gasket profile 9773 W 740mm L 1700mm external size W1 727mm L1 1687mm plug size		

GEV No.	901089	Ref. No.	4612038
description	refrigeration gasket profile 9773 W 640mm L 1540mm external size W1 627mm L1 1527mm plug size		

GEV No.	902305	Ref. No.	N/A
description	refrigeration gasket profile 9773 Wmm L 2500mm		

GEV No.	901783	Ref. No.	4612041
description	refrigeration gasket profile 9773 W 705mm L 1640mm external size W1 692mm L1 1627mm plug size		

profile 9151

We offer custom-made gaskets for this profile

GEV No.	901098	Ref. No.	4612069
description	refrigeration gasket profile 9151 W 565mm L 1690mm plug size		

GEV No.	901174	Ref. No.	4612138
description	refrigeration gasket profile 9151 W 572mm L 1709mm external size L1 1699mm W1 562mm plug size		

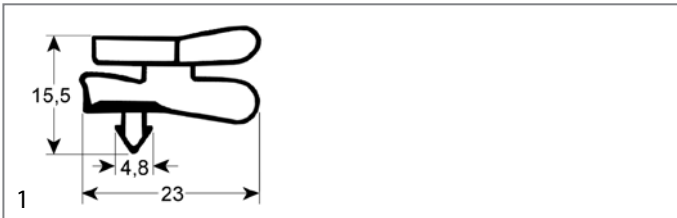

GEV No.	902127	Ref. No.	4612156
description	refrigeration gasket profile 9151 W 632mm L 1525mm plug size grey		

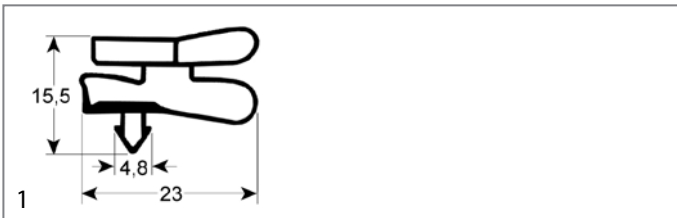

GEV No.	902114	Ref. No.	4612155
description	refrigeration gasket profile 9151 W 632mm L 1525mm white		

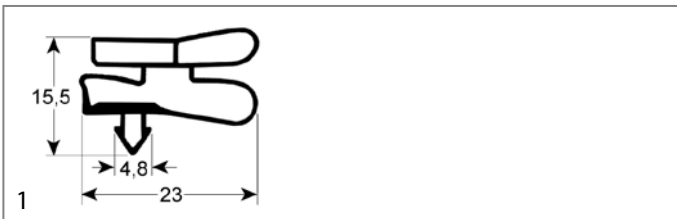

GEV No.	901093	Ref. No.	4612005
description	refrigeration gasket profile 9151 W 720mm L 1655mm plug size L1 1645mm W1 710mm external size		

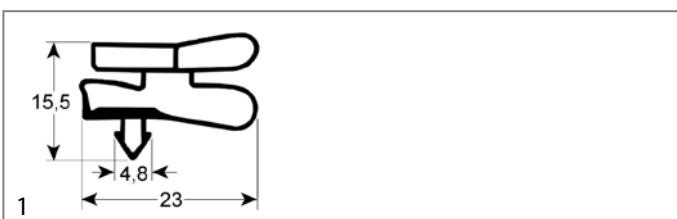

GEV No.	901168	Ref. No.	4612139
description	refrigeration gasket profile 9151 W 737mm L 1699mm plug size		

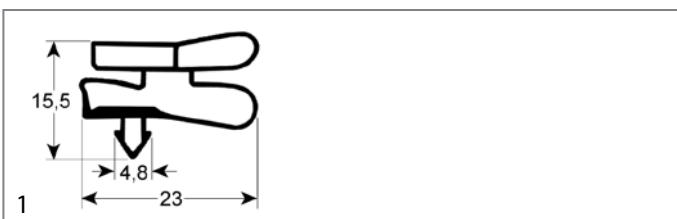

GEV No.	901092	Ref. No.	4612068
description	refrigeration gasket profile 9151 W 755mm L 1705mm plug size L1 1695mm W1 745mm external size		

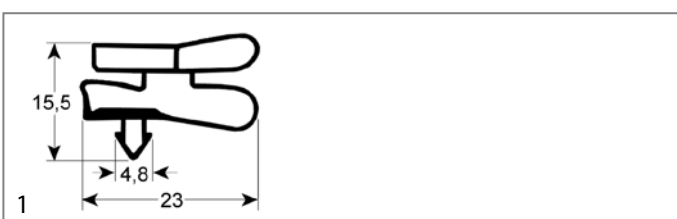

GEV No.	902265	Ref. No.	N/A
description	refrigeration gasket profile 9151 Wmm L 2500mm		

profile 9010

We offer custom-made gaskets for this profile

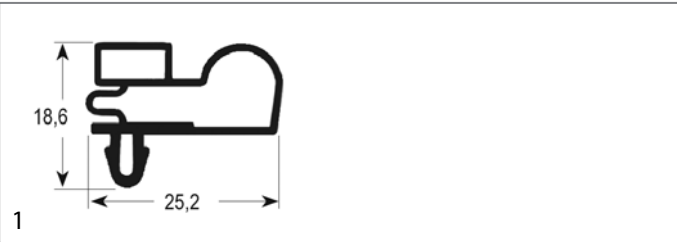

GEV No.	900617	Ref. No.	TDE072290
description	refrigeration gasket profile 9010 W 515mm L 620mm plug size		

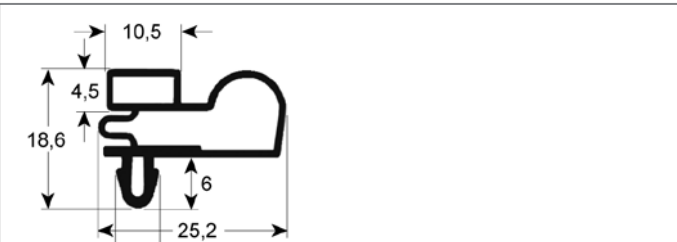

GEV No.	902115	Ref. No.	4612154
description	refrigeration gasket profile 9010 W 643mm L 1407mm plug size		

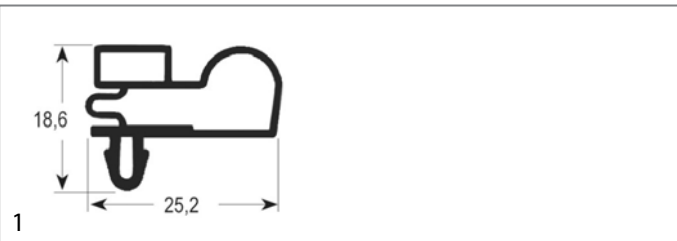

GEV No.	901091	Ref. No.	4512017
description	refrigeration gasket profile 9010 W 650mm L 1545mm plug size		

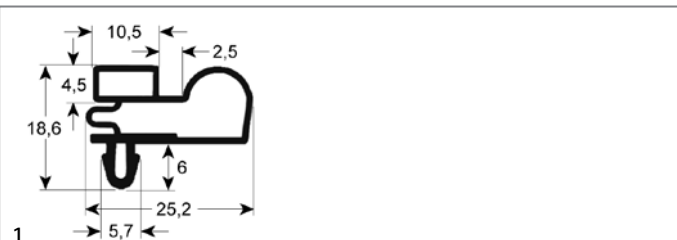

GEV No.	902251	Ref. No.	N/A
description	refrigeration gasket profile 9010 Wmm L 2500mm		

profile 9373

We offer custom-made gaskets for this profile

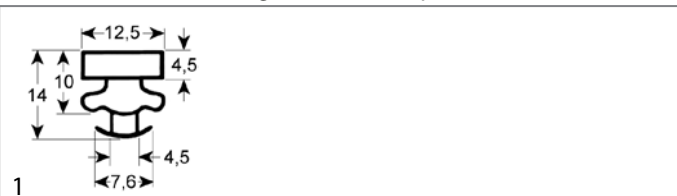

GEV No.	902163	Ref. No.	N/A
description	refrigeration gasket profile 9373 Wmm L 2500mm		



refrigeration cycle components

filter driers

miscellaneous



1

GEV No.	750244	Ref. No.	3141035
description	dryer size 15g ø 19mm L 117mm connection 3,2/6,2mm		
For models:	EBA01W540		



1

GEV No.	750619	Ref. No.	3141033
description	dryer size 30g ø 24mm L 140mm connection 2,6/6,5mm Qty 1 pcs		

evaporators

for fridges

producer-specific



1

GEV No.	750354	Ref. No.	4133007
description	evaporator L 1000mm W 470mm Hmm suitable for BEV/KIC		



1

GEV No.	750627	Ref. No.	4132069
description	evaporator L 335mm W 95mm H 275mm total length 355mm for fridge		



1

GEV No.	750181	Ref. No.	TDE072247
description	evaporator L 360mm W 95mm H 350mm for Desmon refrigerated counter (PTR,LUX,TLM2A)		

measuring equipment

thermometers

built-in thermometers



1

GEV No.	541081	Ref. No.	2531018
description	thermometer mounting measurements 58x25.5mm -40 up to +40°C capillary pipe 1500mm probe ø 8mm probe L 22mm		

battery powered



1

GEV No.	379798	Ref. No.	1188017	
description	thermometer mounting measurements 47x27mm battery comp. rear -40 up to +70°C cable length 2000mm white			
accessories for	379798			
	GEV No.	379808	Ref. No.	—
	frame for thermometer internal size 47x27mm W 53mm H 33mm D 17mm lug length 11mm hole distance 64.2mm			

A			
axial fans	11		
C			
cold air circulating fans	11		
compressors	7		
condensing trays heated	11		
cross flow fans	12		
D			
defrost timers	5		
E			
electronic controllers	6		
evaporators	17		
F			
fans	11		
filter driers	17		
fluorescent lamps	5, 5		
G			
grates	13		
H			
heating cartridges	3		
heating elements	3		
heating elements for defrosting	3		
heating elements for refrigeration	3		
I			
indicator lights	5		
indicator lights (complete)	5		
L			
lamps	5		
M			
measuring equipment	17		
microswitches	4		
P			
plug-in gaskets	14		
push/momentary push switches	4		
R			
refrigeration cycle components	17		
refrigeration fans	11		
refrigeration gaskets	14		
refrigeration thermostats	3		
relays	5		
rocker/momentary rocker switches	4		
S			
shelves and shelf rails	13		
switches and momentary switches	4		
T			
thermostats	3		
timers	5		