



GAS COMPONENTS



ELECTRIC COMPONENTS



WATER TECHNOLOGY



MECHANICAL COMPONENTS



TOOLS

Spare parts suitable for

MULTI

Find the complete and up-to-date range of products in our GEV Webshop



Manufacturer catalogue

The most important spare parts and accessories arranged clearly for every manufacturer

- ✓ Complete product range and all appliance data always up to date in the GEV Webshop
- ✓ Alphabetical Index at the end of the catalogue

GEV Webshop

www.gev-online.co.uk

www.gev-online.com





- 🔍 Add to Favourites
- 🔍 Sign In with email address and usual password
- 🔍 Easy-order – place several items in your basket at the same time
- 🔍 Quick Item search – no login needed



heating elements

heating elements for bain maries

			
GEV No.	415927	Ref. No.	665004
description	heating element 1200W 240V heating circuits 1 L 405mm W 88mm H 32mm lug length 40mm lug width 18mm dry heating element hole distance 44mm connection M5 bracket mounting mounting thread M5		

			
GEV No.	415926	Ref. No.	665003
description	heating element 1800W 240V heating circuits 1 L 403mm W 128mm H 32mm lug length 40mm lug width 18mm tube ø 8.5mm dry heating element hole distance 80mm bracket mounting mounting thread M5		

heating elements for fryers









side connection

miscellaneous

			
GEV No.	418077	Ref. No.	537026800
description	heating element 19500W 230/400V heating circuits 3 mounting pos. right L 458mm W 190mm H 35mm flange length 36.5mm flange length 1 3mm flange length 2 33.5mm flange ø1 65mm flange ø2 60mm thermostat sleeves ø 6mm length thermostat sleeves 180mm number of thermostat sleeves 2 thermostat sleeve eccentric, clinging/not clinging L1 18mm L2 440mm W1 38mm W2 152mm tube ø 8.5mm cable length 500mm rotation flange fryer heaters connection length 30mm		
accessories for	418077		
		GEV No.	550494
		Ref. No.	—
	O-ring Viton thickness 3.53mm ID ø 47.22mm Qty 1 pcs		

2 hole fixing

			
GEV No.	420177	Ref. No.	665001
description	heating element 2100W 230V heating circuits 1 L 293mm W 40mm H 205mm L1 23mm L2 270mm H1 165mm H2 40mm thread M14x1.5 mounting distance 35mm tube ø 8.5mm 2 hole fixing connection M5 connection length 23mm immersion heater windings 4		

			
GEV No.	415929	Ref. No.	665028
description	heating element 2500W 230V heating circuits 1 L 293mm W 40mm H 205mm L1 23mm L2 270mm H1 165mm H2 40mm thread M14x1.5 mounting distance 35mm tube ø 8.5mm 2 hole fixing connection M5 connection length 23mm immersion heater windings 4		
spare parts for	415929		
		GEV No.	510417
		Ref. No.	—
	flat gasket fibre ED ø 20mm ID ø 14mm thickness 2mm Qty 1 pcs		
accessories for	415929		
		GEV No.	520228
		Ref. No.	—
	tooth lock washer ID ø 15.3mm ED ø 24mm steel Qty 1 pcs for thread M14		
		GEV No.	520230
		Ref. No.	—
	nut thread M14x1.5 H 5mm WS 19 zinc-coated steel Qty 1 pcs		
		GEV No.	521101
		Ref. No.	—
	nut thread M14x1.5 H 5mm WS 19 SS Qty 1 pcs		
		GEV No.	550262
		Ref. No.	—
	flat gasket copper ED ø 20mm ID ø 14mm thickness 2mm		
		GEV No.	560112
		Ref. No.	—
	plain washer ID ø 5.3mm ED ø 10mm thickness 1mm SS Qty 20 pcs DIN 125A for thread M5		
		GEV No.	560132
		Ref. No.	—
	hexagonal nut thread M5 H 4mm WS 8 SS DIN/ISO DIN 934 / ISO 4032/8673 Qty 20 pcs		

heating elements for griddles

			
GEV No.	415928	Ref. No.	665002
description	heating element 1800W 240V heating circuits 1 L 470mm W 90mm H 65mm tube ø 8.5mm connection M5 connection distance 82mm dry heating element		

			
GEV No.	415932	Ref. No.	965000
description	heating element 2186/2380W 230/240V heating circuits 1 L 650mm W 78mm H 72mm tube ø 8.5mm connection M5 connection length 20mm griddle connection distance 65mm dry heating element		







			
1			
GEV No.	415933	Ref. No.	965008
description	heating element 2580W 240V heating circuits 1 L 530mm W 130mm H 65mm tube ø 8.5mm W1 40mm W2 50mm connection M5 connection length 21mm tilting bratt pan connection distance 35mm dry heating element		

heating elements for tilting bratt pan







			
1			
GEV No.	415930	Ref. No.	965007
description	heating element tilting bratt pan 3440W 240V L 530mm W 205mm H 60mm connection M4 dry heating element heating circuits 1 tube ø 8.5mm W1 30mm W2 140mm connection distance 130mm		





heating elements for pasta cookers

			
1			
GEV No.	416535	Ref. No.	665032
description	heating element 3000W 230V heating circuits 1 L 303mm W 170mm H mm 2 hole fixing connection M4 thread M10x1 tube ø 6.3mm mounting distance 164mm immersion heater		
spare parts for	416535		
	GEV No.	510893	Ref. No. —
	O-ring EPDM thickness 2.62mm ID ø 9.92mm Qty 1 pcs		



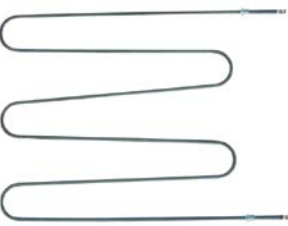

			
1			
GEV No.	418046	Ref. No.	465000
description	heating element 3800W 230V heating circuits 3 L 250mm W 41mm H 34mm round flange connection male faston 6.3mm tube ø 6.3mm mounting ø 57.5mm immersion heater with gasket		
spare parts for	418046		
	GEV No.	510409	Ref. No. —
	O-ring EPDM thickness 5.34mm ID ø 56.52mm Qty 1 pcs		
accessories for	418046		
	GEV No.	550002	Ref. No. —
	tension strap H 10mm L 21mm W 10mm hole ø 6.5mm for heating element		

heating elements for pizza ovens

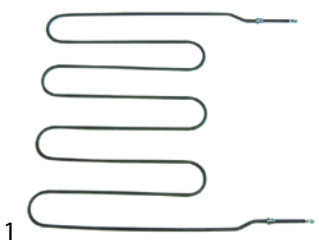
			
1			
GEV No.	415941	Ref. No.	501001
description	heating element 2000W 230V L 470mm W 506mm L1 30mm L2 50mm L3 390mm W1 18mm W2 470mm thread 1/4" mounting distance 461mm connection length 115mm connection M5 windings 4 tube ø 8.5mm heating circuits 1 dry heating element 2 hole fixing pizza oven		
spare parts for	415941		
	GEV No.	510417	Ref. No. —
	flat gasket fibre ED ø 20mm ID ø 14mm thickness 2mm Qty 1 pcs		
accessories for	415941		
	GEV No.	361182	Ref. No. —
	nut thread 1/4" H 5mm nickel-plated brass WS 17 Qty 1 pcs		
	GEV No.	520228	Ref. No. —
	tooth lock washer ID ø 15.3mm ED ø 24mm steel Qty 1 pcs for thread M14		
	GEV No.	550262	Ref. No. —
	flat gasket copper ED ø 20mm ID ø 14mm thickness 2mm		
	GEV No.	560112	Ref. No. —
	plain washer ID ø 5.3mm ED ø 10mm thickness 1mm SS Qty 20 pcs DIN 125A for thread M5		
	GEV No.	560132	Ref. No. —
	hexagonal nut thread M5 H 4mm WS 8 SS DIN/ISO DIN 934 / ISO 4032/8673 Qty 20 pcs		



			
1			
GEV No.	416638	Ref. No.	501131
description	heating element 2100W 230V L 580mm W 460mm thread 1/4" mounting distance 425mm connection length 102mm connection M5 tube ø 8.5mm heating circuits 1 dry heating element 2 hole fixing		
accessories for	416638		
	GEV No.	361182	Ref. No. —
	nut thread 1/4" H 5mm nickel-plated brass WS 17 Qty 1 pcs		
	GEV No.	510417	Ref. No. —
	flat gasket fibre ED ø 20mm ID ø 14mm thickness 2mm Qty 1 pcs		
	GEV No.	520228	Ref. No. —
	tooth lock washer ID ø 15.3mm ED ø 24mm steel Qty 1 pcs for thread M14		
	GEV No.	550262	Ref. No. —
	flat gasket copper ED ø 20mm ID ø 14mm thickness 2mm		

GEV No.	415942	Ref. No.	501022
description	heating element 2280W 230V L 600mm W 610mm L1 30mm L2 50mm L3 520mm W1 20mm W2 570mm thread 1/4" mounting distance 561mm connection length 101mm connection M5 windings 4 tube ø 8.6mm heating circuits 1 dry heating element 2 hole fixing		
accessories for	415942		
	GEV No.	361182	Ref. No. —
	nut thread 1/4" H 5mm nickel-plated brass WS 17 Qty 1 pcs		
	GEV No.	510417	Ref. No. —
	flat gasket fibre ED ø 20mm ID ø 14mm thickness 2mm Qty 1 pcs		
	GEV No.	520228	Ref. No. —
	tooth lock washer ID ø 15.3mm ED ø 24mm steel Qty 1 pcs for thread M14		
	GEV No.	550262	Ref. No. —
	flat gasket copper ED ø 20mm ID ø 14mm thickness 2mm		

with round flange ø57.5mm



GEV No.	415265	Ref. No.	130011
description	heating element 9000W 230V heating circuits 3 mounting ø 57.5mm L 470mm W 35mm H 41mm round flange connection M5 immersion heater tube ø 8.5mm connection length upper centre not clinging-mm thermostat sleeves ø 7.5mm number of thermostat sleeves 1 length thermostat sleeves 295mm		
spare parts for	415265		
	GEV No.	510409	Ref. No. —
	O-ring EPDM thickness 5.34mm ID ø 56.52mm Qty 1 pcs		
accessories for	415265		
	GEV No.	550002	Ref. No. —
	tension strap H 10mm L 21mm W 10mm hole ø 6.5mm for heating element		

immersion heating elements

3 hole flange ø47.5mm

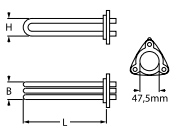
GEV No.	419032	Ref. No.	150023
description	heating element 4500W 230V mounting ø 47.5mm heating circuits 3 L 285mm W 32mm H 40mm number of thermostat sleeves 1 thermostat sleeves ø 7.5mm length thermostat sleeves 233mm thermostat sleeve eccentric, clinging tube ø 6.3mm hole distance 63mm hole ø 8mm connection length 25mm connection M4 3 hole flange immersion heater		
accessories for	419032		
	GEV No.	510408	Ref. No. 0835534701 107000 130040
	O-ring EPDM thickness 5.34mm ID ø 47mm Qty 1 pcs		

heating elements for convection



GEV No.	415925	Ref. No.	665008
description	heating element 1260W 230V heating circuits 1 ID ø 180mm L 380mm H 19mm L1 188mm W1 32mm flange length 100mm flange width 22mm hole distance 86mm ED ø 192mm connection M5 connection length 30mm tube ø 6.3mm convection heating element hole ø 5mm rectangular flange		

accessories

sealing washers

O-rings

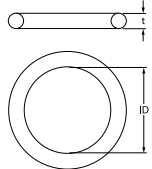
GEV No.	510408	Ref. No.	0835534701 107000 130040
description	O-ring EPDM thickness 5.34mm ID ø 47mm Qty 1 pcs		

with compression flange 62 x 26mm

GEV No.	415270	Ref. No.	130805
description	heating element 2700W 230V heating circuits 1 compression flange flange 62x26mm L 335mm W 43mm H 25mm tube ø 6.3mm connection male faston 6.3mm immersion heater		

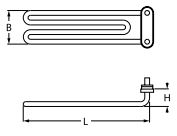

thermostats

bi-metal thermostats

safety bi-metal thermostats



GEV No.	390480	Ref. No.	130803
description	bi-metal safety thermostat hole distance 23.8mm switch-off temp. 105°C 1NC 1-pole 16A connection F6.3 2 hole fixing		

control and safety thermostats

EGO

control thermostats

55.34_ series



GEV No.	375092	Ref. No.	661005
description	thermostat t.max. 90°C temperature range 30-90°C 3-pole capillary pipe isolatedmm gland nut		

safety thermostats

55.10/19_ series



GEV No.	390063	Ref. No.	661021
description	safety thermostat switch-off temp. 220°C 1-pole 1NC 15A probe ø 6mm probe L 77mm capillary pipe 870mm capillary pipe isolatedmm gland nut starting temperature 205°C probe SS		

55.31_ series



GEV No.	390168	Ref. No.	661009
description	safety thermostat switch-off temp. 230°C 3-pole 3NC 20A probe ø 6mm probe L 239mm capillary pipe 830mm capillary pipe isolatedmm gland nut M9x1 probe SS		

55.32_ series

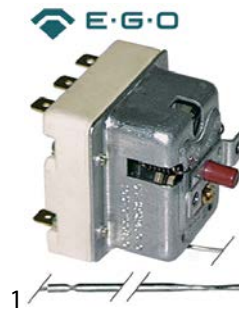

GEV No.	390142	Ref. No.	661045
description	safety thermostat switch-off temp. 360°C 3-pole 20A probe ø 3.1mm probe L 188mm capillary pipe 1490mm capillary pipe isolated 800mm gland nut probe SS		

IMIT / TEMPOMATIC / ARTHERMO

safety thermostats



GEV No.	375500	Ref. No.	150026
description	safety thermostat switch-off temp. 140°C 1-pole 1CO 15A probe ø 5mm probe L 125mm capillary pipe 1000mm capillary pipe isolated 900mm gland nut probe		



switches and momentary switches

push/momentary push switches

28.5x77.5mm



1

GEV No.	345866	Ref. No.	130825
description	switch combination latching mounting measurements 28.5x77.5mm green 2NO/1NO/indicator light 250V 16A START/indicator light/on-off connection male faston 6.3mm ambient temperature max. 85°C protection IP40		



1

GEV No.	345868	Ref. No.	130827
description	switch combination momentary mounting measurements 28.5x77.5mm green 2NO/indicator light 250V 16A drain/temperature connection male faston 6.3mm ambient temperature max. 85°C protection IP40		

microswitches

pin-plunger actuated

M10



1

GEV No.	345032	Ref. No.	800267
description	microswitch with plunger thread M10x1 thread L 12mm 250V 16A 1CO connection male faston 6.3mm stroke 7mm mounting distance 22mm L 28mm ambient temperature max. 125°C type SP9603 actuating force: 180g		

timers

programme timers



1

GEV No.	360356	Ref. No.	150045	
description	timer CDC 7804F engines 1 chambers 4 operation time 144s 230V shaft ømm shaft Lmm manuf. no. 7804F1/ 46103600 motor type M37RN			
spare parts for	360356			
	GEV No.	360119	Ref. No.	—
	motor CDC pinion ø 5.4mm teeth 12 230V turn direction right motor ø 37mm motor type M37RN for timer			

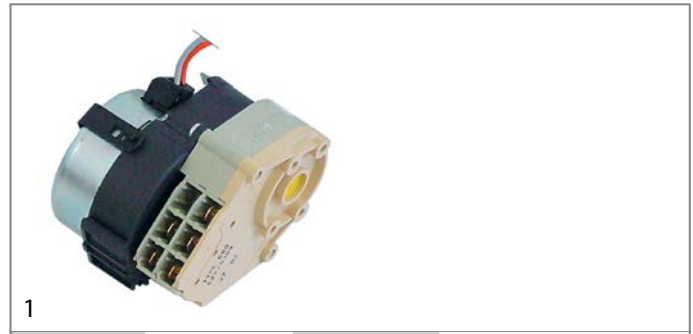

1

GEV No.	360289	Ref. No.	130831
description	timer CROUZET engines 1 chambers 2 operation time 120s 230V shaft ømm shaft Lmm manuf. no. 627/5309 motor type 600		

contactors

ISKRA (FANAL)

power contactors



1

GEV No.	380547	Ref. No.	150348
description	power contactor resistive load 20A 230VAC (AC3/400V) 5A/2.2kW main contacts 3NO auxiliary contacts 1NC connection screw connection type Fanal DSL3 01 type ISKRA K03M 01		

electronics

PCBs



1

GEV No.	402953	Ref. No.	M500086900
description	control PCB dishwasher MB630/930 L 133mm W 82mm		



pressure switches

for warewashing

ø 58mm with male faston 6.3mm

with connection horizontal



GEV No.	541314	Ref. No.	10706/A
description	pressure control pressure range 46/26mbar connection 6mm ø 58mm pressure connection horizontal warewashing pressure connection ø 6mm		



GEV No.	541140	Ref. No.	130002
description	pressure control pressure range 55/30mbar connection 6mm ø 58mm pressure connection horizontal warewashing		



GEV No.	541311	Ref. No.	130014
description	pressure control pressure range 76/38mbar connection 6mm ø 58mm pressure connection horizontal warewashing pressure connection ø 6mm		

fans

hot air motors



GEV No.	601178	Ref. No.	664000	
description	fan motor 230V 1 phase 50Hz 0.12kW 1400rpm speeds 1 L1 120mm L2 77mm D1 ø 12mm 1.1A suitable capacitor at 50Hz 230V type MA711TYP01DX			
spare parts for	601178			
	GEV No.	365013	Ref. No.	—
	operating capacitor capacity 8µF 400V tolerance 5%Hz ambient temperature max. -25 to +85°C ø 31.5mm L 55mm M8 plastic connection male faston 6.3mm protection			

pumps

wash and rinse pumps

FIR

pumps



GEV No.	500527	Ref. No.	133025	
description	pump inlet ø 60mm outlet ø 50/30mm type 2233.B140 230V 50Hz 1 phase 0.55kW 0.75HP L 210mm rotation direction right capacitor 12.5µF FIR inlet ø 60mm			
spare parts for	500527			
	GEV No.	365014	Ref. No.	—
	operating capacitor capacity 12.5µF 450V tolerance 5%Hz ambient temperature max. -25 to +85°C ø 35mm L 70mm M8 plastic connection male faston 6.3mm 45S.C3DS.12.5 protection			
	GEV No.	510552	Ref. No.	—
	pump cover gasket pump type 1292-2/3942/3981/3911/3983			
	GEV No.	510608	Ref. No.	—
	impellor ø 93mm H 32mm shaft intake ø 9/8mm blades 6 inner height 11mm			
	GEV No.	510692	Ref. No.	—
	mechanical shaft seal for shaft ø 11mm slide ring ext. ø 24mm slide ring H 13mm counter ring mounting ø 26mm height counter ring 8mm counter ring int. ø 14mm			
	GEV No.	521511	Ref. No.	—
	pump cover inlet ø 60mm outlet ø 50/30mm supporting pressure M12x1.75 supporting pressure open pump type 2233 turn direction right ø 160mm ID ø 120mm inner height 23mm			

OLYMPIA

pumps



1

GEV No.	500521	Ref. No.	131125
description	pump inlet \varnothing 1" IT outlet \varnothing 26mm type T33 230V 50Hz 1 phase 0.25kW 0.34HP L 225mm rotation direction right capacitor 5 μ F auxiliary pressure connection 11mm supporting pressure closed OLYMPIA		
spare parts for	500521		
	GEV No.	365017	Ref. No. —
	operating capacitor capacity 5 μ F 450V tolerance 5% 50/60Hz ambient temperature max. -25 to +85°C \varnothing 28mm L 54mm M8 plastic connection male faston 6.3mm 16.10.08 protection		
	GEV No.	510693	Ref. No. —
	mechanical shaft seal for shaft \varnothing 12mm slide ring ext. \varnothing 24mm slide ring H 15.5mm slide ring int. \varnothing 11mm counter ring mounting \varnothing 24mm height counter ring 8mm counter ring int. \varnothing 13.5mm		
	GEV No.	521256	Ref. No. —
	impellor \varnothing 74mm H 14mm thread M10L shaft \varnothing 12mm shaft length 7.5mm blades 8		
	GEV No.	521554	Ref. No. —
	pump cover OLYMPIA inlet 1" \varnothing 90mm ID \varnothing 66mm inner height 5mm		
	GEV No.	521724	Ref. No. —
	O-ring EPDM thickness 1.78mm ID \varnothing 72.75mm Qty 1 pcs		
	GEV No.	528800	Ref. No. —
	O-ring EPDM thickness 2.62mm ID \varnothing 75.87mm Qty 1 pcs		



1

GEV No.	500519	Ref. No.	133029
description	pump inlet \varnothing 33mm outlet \varnothing 30mm type T33 230V 50Hz 1 phase 0.25kW 0.34HP L 195mm rotation direction left capacitor 5 μ F OLYMPIA		
spare parts for	500519		
	GEV No.	365017	Ref. No. —
	operating capacitor capacity 5 μ F 450V tolerance 5% 50/60Hz ambient temperature max. -25 to +85°C \varnothing 28mm L 54mm M8 plastic connection male faston 6.3mm 16.10.08 protection		
	GEV No.	510693	Ref. No. —
	mechanical shaft seal for shaft \varnothing 12mm slide ring ext. \varnothing 24mm slide ring H 15.5mm slide ring int. \varnothing 11mm counter ring mounting \varnothing 24mm height counter ring 8mm counter ring int. \varnothing 13.5mm		
	GEV No.	521257	Ref. No. —
	impellor \varnothing 80mm H 12mm rotation direction left thread M10R shaft \varnothing 12mm shaft length 7.5mm blades 6		
	GEV No.	521553	Ref. No. —
	pump cover OLYMPIA inlet \varnothing 33mm outlet \varnothing 30mm turn direction left \varnothing 103mm ID \varnothing 93mm inner height 25mm		
	GEV No.	521723	Ref. No. —
	pump cover gasket EPDM thickness 2mm ID \varnothing 90mm Qty 1 pcs		

drain pumps

PLASET



1

GEV No.	500514	Ref. No.	130010
description	drain pump inlet \varnothing 30mm outlet \varnothing 22mm 230V 34W		



gas thermostats

SIT

710 Minisit series

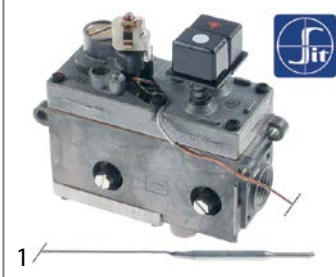

GEV No.	101132	Ref. No.	671033
description	gas thermostat SIT type MINISIT 710 t.max. 340°C 100-340°C gas inlet 1/2" gas outlet 3/8" thermocouple connection M9x1 pilot connection M10x1 probe ø 5mm probe L 68mm capillary pipe 1050mm probe type type B1 pressure controller no pressure regulator bar gland nut ignition gas no		
spare parts for	101132		
	GEV No.	101053	Ref. No. —
	magnet unit T1: M9x1 T2: M24x1 L 45mm ø 17mm suitable for Minisit		
	GEV No.	102102	Ref. No. —
	probe 100-340°C probe ø 5mm probe L 68mm capillary pipe 1750mm t.max. 340°C oven/grill probe type type B1 suitable for MINISIT 710		
accessories for	101132		
	GEV No.	100809	Ref. No. —
	O-ring EPDM thickness 2mm ID ø 21mm Qty 1 pcs		
	GEV No.	100904	Ref. No. —
	locking screw M10x1 for pipe ø 4mm Qty 1 pcs		
	GEV No.	100905	Ref. No. —
	locking screw M10x1 for pipe ø 6mm Qty 1 pcs		
	GEV No.	101054	Ref. No. —
	magnet unit T1: M10x1 T2: M24x1 L 45mm ø 17mm suitable for Minisit		
	GEV No.	101136	Ref. No. —
	piezoelectric igniter suitable for Minisit with cover cap ømm connection F6.3x0.8		
	GEV No.	101137	Ref. No. —
	cover cap without piezoelectric igniter		
	GEV No.	101267	Ref. No. —
	reducer IT 3/8" ET 1/2" L 21mm		
	GEV No.	101268	Ref. No. —
	gas connection thread 3/8" angled with O-ring MINISIT 710		
	GEV No.	101269	Ref. No. —
	gas connection thread 1/2" angled with O-ring MINISIT 710		
	GEV No.	101270	Ref. No. —
	screw connection IT 3/8" ET 3/8" L 28mm		
	GEV No.	101272	Ref. No. —
	screw connection IT 1/2" ET 3/8" L 57mm		

accessories for	101132		
	GEV No.	101273	Ref. No. —
	olive for pipe ø 12mm L 9.5mm brass Qty 1 pcs suitable for universal		
	GEV No.	101274	Ref. No. —
	olive for pipe ø 16mm Qty 1 pcs		
	GEV No.	101275	Ref. No. —
	union screw thread 1/2" for pipe ø 16mm Qty 1 pcs		
	GEV No.	101276	Ref. No. —
	union screw thread 3/8" tube ø 12mm Qty 1 pcs		
	GEV No.	110068	Ref. No. —
	knob suitable for Minisit ø 37mm		

SABAF



GEV No.	101692	Ref. No.	671002
description	gas thermostat SABAF t.max. 300°C gas inlet M13x1 IT (tube ø 8mm) bypass nozzle ø 0.5mm gas outlet 3/8" ET (tube ø 10mm) gas outlet 2 thermocouple connection M8x1 pilot connection capillary pipe 850mm probe ø 4mm probe L 140mm shaft ø 8x6.5mm shaft L 34/14mm shaft flat upper		
spare parts for	101692		
	GEV No.	101060	Ref. No. —
	magnet unit standard L 39mm D1 ø 15.4mm D2 ø 11mm suitable for PEL20-21/JUNKERS/EGA		
	GEV No.	106660	Ref. No. —
	bypass nozzle bore ø 0.85mm thread M4x0.5 SABAF		
	GEV No.	106661	Ref. No. —
	bypass nozzle bore ø 0.54mm thread M4x0.5 SABAF		
accessories for	101692		
	GEV No.	101277	Ref. No. —
	olive ID ø 8mm Qty 1 pcs		
	GEV No.	101278	Ref. No. —
	olive for pipe ø 10mm Qty 1 pcs		
	GEV No.	101476	Ref. No. —
	union nut thread M13x1 for pipe ø 8mm		
	GEV No.	101478	Ref. No. —
	union nut thread 3/8" for pipe ø 10mm		



ignition parts

pilot burners

SIT











100 series

accessories

pilot burner bottom parts



1

GEV No.	107701	Ref. No.	672.094.00
description	pilot burner bottom part SIT 100 series nozzle \varnothing 0.2mm		
spare parts for	107701		
	GEV No.	100245	Ref. No. —
	pilot burner nozzle LPG code 20 bore \varnothing 0.2mm Qty 1 pcs thread M8x0.75		
	GEV No.	100916	Ref. No. —
	compression spring for pilot burner Qty 1 pcs		
	GEV No.	100917	Ref. No. —
	gasket for pilot burner Qty 1 pcs aluminium		
	GEV No.	100918	Ref. No. —
	screw for pilot burner		
accessories for	107701		
	GEV No.	100246	Ref. No. —
	pilot burner nozzle natural gas bore \varnothing 0.35mm Qty 1 pcs thread M8x0.75		
	GEV No.	100904	Ref. No. —
	locking screw M10x1 for pipe \varnothing 4mm Qty 1 pcs		
	GEV No.	100905	Ref. No. —
	locking screw M10x1 for pipe \varnothing 6mm Qty 1 pcs		
	GEV No.	102110	Ref. No. —
	pilot tube copper pipe \varnothing 4mm thickness 1mm L 3000mm		
	GEV No.	102111	Ref. No. —
	pilot tube copper pipe \varnothing 6mm thickness 1mm L 3000mm		
	GEV No.	102742	Ref. No. —
	pilot burner nozzle LPG code 25 bore \varnothing 0.25mm Qty 1 pcs		

miscellaneous



1

GEV No.	100967	Ref. No.	623241
description	pilot burner bracket		

160 series



1















GEV No.	100056	Ref. No.	672042
description	pilot burner SIT type 160 series 3 flames nozzle \varnothing mm gas connectionmm		
spare parts for	100056		
	GEV No.	100907	Ref. No. —
	screw connection thread M10x1 Qty 1 pcs type SEF 1 \varnothing mm for thermocouple		
accessories for	100056		
	GEV No.	100202	Ref. No. —
	pilot burner nozzle natural gas code 41 Qty 1 pcs nozzle \varnothing 0.41mm		
	GEV No.	100203	Ref. No. —
	pilot burner nozzle LPG code 25 Qty 1 pcs nozzle \varnothing 0.25mm		
	GEV No.	100701	Ref. No. —
	ignition electrode connection M4 Qty 1 pcs		
	GEV No.	100801	Ref. No. —
	gasket for pilot burner Qty 1 pcs		
	GEV No.	100869	Ref. No. —
	pilot burner nozzle natural gas code 51 Qty 1 pcs suitable for 160 series nozzle \varnothing 0.51mm		
	GEV No.	100870	Ref. No. —
	olive for pipe \varnothing 4mm Qty 1 pcs suitable for 160 series for pilot burner		
	GEV No.	100906	Ref. No. —
	screw connection thread M10x1 for ignition electrode brass Qty 1 pcs WS 10		
	GEV No.	100908	Ref. No. —
	union screw thread M10x1 for pipe \varnothing 4mm Qty 1 pcs		
	GEV No.	100909	Ref. No. —
	union screw thread M10x1 for pipe \varnothing 6mm Qty 1 pcs		
	GEV No.	101287	Ref. No. —
	olive for pipe \varnothing 6mm Qty 1 pcs		
	GEV No.	102110	Ref. No. —
	pilot tube copper pipe \varnothing 4mm thickness 1mm L 3000mm		

Table continues overleaf

accessories for	100056		
	GEV No.	102111	Ref. No. —
	pilot tube copper pipe ϕ 6mm thickness 1mm L 3000mm		
	GEV No.	107650	Ref. No. 674052
	pilot burner nozzle SIT LPG code 30 Qty 1 pcs		

electrodes

			
GEV No.	100729	Ref. No.	672005
description	ignition electrode L1 5mm D1 ϕ 8mm D2 ϕ 10mm BL1 41mm BL2 14mm connection F 2.8x0.8mm to clip with spring		

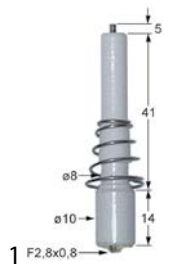

thermocouples

threaded thermocouples

threaded thermocouples standard

with socket with thread M8x1

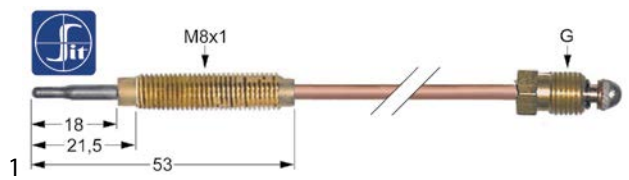
SIT

			
GEV No.	107636	Ref. No.	672000
description	thermocouple SIT M9x1 L 600mm M8x1		
accessories for	107636		
	GEV No.	102067	Ref. No. —
	nut thread M8x1 H 3mm brass Qty 1 pcs type SEF 1		

gas burners

hob burners

accessories

pan supports

			
GEV No.	210132	Ref. No.	681008
description	pan support W 340mm L 570mm suitable for 700 series		
accessories for	210132		
	GEV No.	210050	Ref. No. —
	reducer for pan support L 260mm W 260mm chrome-plated steel suitable for universal		





			
GEV No.	210137	Ref. No.	681019
description	pan support W 400mm L 400mm suitable for 900 series		

air mixers

			
GEV No.	103127	Ref. No.	672016
description	air mixing sleeve L 36mm ED ϕ 40mm ID ϕ 36mm aluminium		
accessories for	103127		
	GEV No.	103118	Ref. No. 672044
	burner cap ϕ 61mm		
	GEV No.	103119	Ref. No. 672051 672098
	burner ring for burner cap ϕ 61mm		
	GEV No.	103120	Ref. No. —
	burner head for burner cap ϕ 61mm		
	GEV No.	103121	Ref. No. 672010
	venturi		
	GEV No.	103122	Ref. No. 673020
	burner holder ϕ 35mm H 82mm nozzle mounting M10x1 mounting distance 55mm connection M16x1.5mm with nozzle holder		
	GEV No.	103124	Ref. No. 672101
	burner head E ϕ 150mm for burner cap ϕ 110mm 7.5kW code 672.077 A		
	GEV No.	103125	Ref. No. 672079
	burner cap D ϕ 110mm 5.5kW bore ϕ 2.6mm with central hole		

Table continues overleaf





accessories for	103127		
	GEV No.	103126	Ref. No. 672093
	burner cap E ø 110mm 7.5kW bore ø 3mm with central hole		
	GEV No.	105067	Ref. No. —
	burner cap C ø 84mm 3.5kW		
	GEV No.	105069	Ref. No. 672076
	burner head C for burner cap ø 84mm 3.5kW		
	GEV No.	105070	Ref. No. —
	burner head D ø 150mm for burner cap ø 110mm 5.5kW code 672.077 E		

bar burners

bar burners

	1		
GEV No.	104174	Ref. No.	672052
description	bar burner 2 row L 485mm W 240mm ømm H 170mm gril		

	1		
GEV No.	104173	Ref. No.	672029
description	bar burner 3 row L 507mm W 240mm ømm H 50mm griddle		

	1		
GEV No.	104171	Ref. No.	672030
description	bar burner angled L 450mm W 185mm ømm Hmm oven		

tube burners

	1		
GEV No.	104172	Ref. No.	672031
description	tubular burner ø 74mm L 180mm H 60mm round for fryer		

gas nozzles

pilot burner nozzles

pilot burner nozzles SIT

160 series

	1		
GEV No.	107650	Ref. No.	674052
description	pilot burner nozzle SIT LPG code 30 Qty 1 pcs		

equipment-specific units

for dishwashers

drain and intake components

miscellaneous

filters

	1		
GEV No.	517019	Ref. No.	130075
description	round filters		

containers

dosing containers

	1		
GEV No.	517380	Ref. No.	131051
description	cleaner container L 94mm W 80mm H 130mm suitable for Dihr		

salt tanks



1

GEV No.	524177	Ref. No.	130975 16067/D
----------------	--------	-----------------	-------------------

description lid ø 69mm H 20mm for salt tank ID ø 50mm

accessories for 524177



GEV No.	524148	Ref. No.	—
----------------	--------	-----------------	---

O-ring EPDM thickness 3.53mm ID ø 40.86mm Qty 1 pcs

boilers

boilers for dishwashers



1

GEV No.	517302	Ref. No.	130066
----------------	--------	-----------------	--------

description boiler with insulation ø 160mm L 500mm

accessories for 517302



GEV No.	517337	Ref. No.	—
----------------	--------	-----------------	---

insulating mat boiler ø 160mm

housing and bezels

miscellaneous



1

GEV No.	524803	Ref. No.	131197
----------------	--------	-----------------	--------

description bracket for dishwasher rack SS L 25mm ED ø 10mm thread M6

air traps

air traps



1

GEV No.	517171	Ref. No.	130025
----------------	--------	-----------------	--------

description air trap L 90mm W 55mm H 31mm

accessories for 517171



GEV No.	517173	Ref. No.	—
----------------	--------	-----------------	---

flat gasket FIBER ED ø 14mm ID ø 8mm thickness 1.5mm Qty 1 pcs

accessories for 517171



GEV No.	517174	Ref. No.	—
----------------	--------	-----------------	---

nut thread M8 H 6.5mm WS 13 SS DIN/ISO DIN 934 / ISO 4032/8673 Qty 1 pcs

backflow preventers

backflow preventers



1

GEV No.	506210	Ref. No.	150077
----------------	--------	-----------------	--------

description backflow preventer dishwasher

miscellaneous

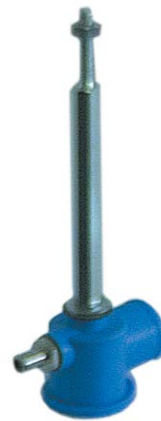

1

GEV No.	517018	Ref. No.	130057
----------------	--------	-----------------	--------

description supply tube complete

door mechanics

hinges



1

GEV No.	517267	Ref. No.	130955
----------------	--------	-----------------	--------

description door hinge hinge mounting pos. left

accessories for 517267



GEV No.	517266	Ref. No.	130953
----------------	--------	-----------------	--------



door hinge hinge mounting pos. right





GEV No.	517268	Ref. No.	—
----------------	--------	-----------------	---

bush ID ø 8mm H 9mm bush thread M11x1 WS 13





			
1			
GEV No.	517266	Ref. No.	130953
description	door hinge hinge mounting pos. right		
accessories for	517266		
	GEV No.	517267	Ref. No. 130955
	door hinge hinge mounting pos. left		
	GEV No.	517268	Ref. No. —
	bush ID ø 8mm H 9mm bush thread M11x1 WS 13		



screw connections			
			
1			
GEV No.	511919	Ref. No.	150061
description	quick-fit retaining nut		

washing and rinsing systems			
			
1			
GEV No.	517012	Ref. No.	130047
description	bush		

			
1			
GEV No.	504370	Ref. No.	131040
description	cover for rinse arm shaft mounting pos. lower H 102mm D1 ø 27.5mm D2 ø 30mm L1 32mm L2 59mm ID ø 25mm		

			
1			
GEV No.	517154	Ref. No.	130818
description	nut mounting pos. upper for wash arm support		

			
1			
GEV No.	517016	Ref. No.	130813
description	rinse arm shaft		

			
1			
GEV No.	517143	Ref. No.	130659
description	rinse arm support mounting pos. upper		
accessories for	517143		
	GEV No.	517066	Ref. No. —
	Thumb screw thread M8 thread L 8mm ø 30mm H 3mm SS mounting pos. upper		

 Image not available			
1			
GEV No.	517017	Ref. No.	130678
description	rinse pipe		

			
1			
GEV No.	517126	Ref. No.	130965
description	rinse pipe		

			
1			
GEV No.	517140	Ref. No.	131216
description	rinse pipe mounting pos. lower		

			
1			
GEV No.	517139	Ref. No.	131219
description	throttle disc		

			
1			
GEV No.	517014	Ref. No.	131099
description	wash pipe SS		

gaskets

gaskets for heated units

door seals with tension springs

			
1			
GEV No.	514001	Ref. No.	260003
description	spring L 655mm for gasket mounting pos. upper		

O-rings

EPDM

			
1			
GEV No.	510302	Ref. No.	131036
description	O-ring EPDM ID ø 12.42mm thickness 1.78mm Qty 1 pcs		

			
1			
GEV No.	517004	Ref. No.	130554
description	O-ring EPDM thickness 2.62mm ID ø 34.6mm Qty 1 pcs		

			
1			
GEV No.	517056	Ref. No.	130603
description	O-ring EPDM thickness 2mm ID ø 6.5mm Qty 1 pcs		

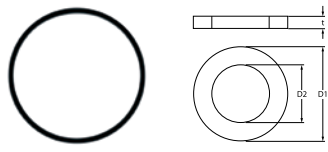
			
1			
GEV No.	510009	Ref. No.	150060
description	O-ring EPDM thickness 3.53mm ID ø 101.2mm Qty 1 pcs		

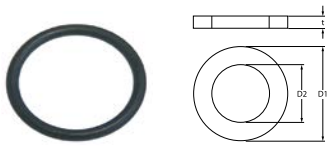
			
1			
GEV No.	510408	Ref. No.	0835534701 107000 130040
description	O-ring EPDM thickness 5.34mm ID ø 47mm Qty 1 pcs		

miscellaneous

			
1			
GEV No.	517011	Ref. No.	130555
description	O-ring		

sealing washers

fibre gaskets

			
1			
GEV No.	510730	Ref. No.	150130
description	flat gasket fibre ED ø 25mm ID ø 12mm thickness 2mm Qty 1 pcs		





dosing pumps

membrane dosing pumps

self-priming with supporting pressure

DIHR







GEV No.	361744	Ref. No.	130997
description	dosing pump type DW with auxiliary pressure connection rinse aid inlet 4mm outlet 8mm suction connection \varnothing 4mm auxiliary pressure connection 10mm		
spare parts for	361744		
	GEV No.	520026	Ref. No. —
	PVC hose ID \varnothing 4mm ED \varnothing 6mm L 10m thickness 1mm t.max. 60°C transparent		
	GEV No.	520090	Ref. No. —
	PVC hose ID \varnothing 4mm ED \varnothing 6mm L 2m thickness 1mm t.max. 60°C transparent		

GERMAC

type 2000



GEV No.	361536	Ref. No.	150331
description	dosing pump type 2000 rinse aid inlet 4x6mm outlet 8mm suction connection \varnothing 4x6mm supporting pressure 11mm rebound ball PTFE 1mm GERMAC CODE VNR/D3		
spare parts for	361536		
	GEV No.	361550	Ref. No. —
	hose connector hose \varnothing 4x6mm		
	GEV No.	361551	Ref. No. —
	compression spring wire gauge \varnothing 1mm		
	GEV No.	361701	Ref. No. —
	hose connector thread M10x1 grommet \varnothing 7.5mm		
	GEV No.	361705	Ref. No. —
	gasket for hose connector M12x1		
	GEV No.	510298	Ref. No. —
	lip valve dosing pump suitable for DB2/DS5		
accessories for	361536		
	GEV No.	361553	Ref. No. —
	membrane EPDM		
	GEV No.	361700	Ref. No. —
	hose connector rotary hose \varnothing 4x6mm plastic connection M10x1		

accessories for	361536		
	GEV No.	361702	Ref. No. —
	hose connector brass hose \varnothing 4x6mm		
	GEV No.	361703	Ref. No. —
	hose connector thread M10x1 brass pipe connection \varnothing 4x6mmmm		
	GEV No.	361704	Ref. No. —
	hose connector brass straight thread M12x1 hose \varnothing 11mm Qty 1 pcs		
	GEV No.	510296	Ref. No. —
	membrane silicone		
	GEV No.	520022	Ref. No. —
	PVC hose ID \varnothing 8mm ED \varnothing 12mm L 10m thickness 2mm t.max. 60°C transparent		

hoses

drain hoses



GEV No.	508043	Ref. No.	150062
description	drain hose DN19 L 2000mm straight \varnothing inside 19/30mm straight ext. \varnothing 26/34mm outer hose \varnothing 25mm		

formed hoses

form U



GEV No.	517252	Ref. No.	131008
description	formed hose ext. \varnothing 35 D1 \varnothing 28mm D2 \varnothing 28mm warewashing U-shape		



fittings, hose and pipe connectors

fittings

double nipples



1

GEV No.	517005	Ref. No.	130550
description	double nipple		

hose connectors

producer-specific



1

GEV No.	691661	Ref. No.	150073
description	angle piece thread M12x1 for hose ID 12mm		

measuring equipment

thermometers

built-in thermometers



1

GEV No.	541095	Ref. No.	130060
description	thermometer mounting measurements 58x25.5mm 0 up to +120°C capillary pipe 3000mm probe ø 6.5mm probe L 20mm		

fastening material

screws

knurled screws



1

GEV No.	517075	Ref. No.	131447
description	Thumb screw thread M8 SS ø 30mm H 3mm thread L 8mm		

nuts

hexagonal nuts

hexagonal nuts inch thread



1

GEV No.	520499	Ref. No.	130620
description	nut thread 1¼" H 6mm WS 50 brass Qty 1 pcs		

B			
bar burners	13		
bi-metal thermostats	6		
C			
contactors	7		
control thermostats	6		
D			
door seals with tension springs	16		
dosing pumps	17		
double nipples	18		
drain hoses	17		
drain pumps	9		
F			
fans	8		
fastening material	18		
fittings	18		
formed hoses	17		
G			
gas burners	12		
gas nozzles	13		
gas thermostats	10		
gaskets for heated units	16		
H			
heating elements	3		
heating elements for bain maries	3		
heating elements for convection	5		
heating elements for fryers	3		
heating elements for griddles	3		
heating elements for pasta cookers	4		
heating elements for pizza ovens	4		
heating elements for tilting bratt pan	4		
hexagonal nuts	18		
hob burners	12		
hose connectors	18		
hoses	17		
hot air motors	8		
I			
immersion heating elements	5		
K			
knurled screws	18		
M			
measuring equipment	18		
microswitches	7		
N			
nuts	18		
O			
O-rings	16		
P			
pilot burners	11		
pressure switches	8		
programme timers	7		
pumps	8		
push/momentary push switches	7		
S			
safety bi-metal thermostats	6		
safety thermostats	6,6		
screws	18		
sealing washers	16		
switches and momentary switches	7		
T			
thermocouples	12		
thermostats	6		
timers	7		
tube burners	13		
W			
wash and rinse pumps	8		