



**GAS COMPONENTS**



**ELECTRIC COMPONENTS**



**WATER TECHNOLOGY**



**MECHANICAL COMPONENTS**



**TOOLS**

Spare parts suitable for

**NAOMI-GRILLS**

Find the complete and up-to-date range of products in our GEV Webshop



# Manufacturer catalogue

The most important spare parts and accessories arranged clearly for every manufacturer

- ✓ Complete product range and all appliance data always up to date in the GEV Webshop
- ✓ Alphabetical Index at the end of the catalogue

## GEV Webshop

[www.gev-online.co.uk](http://www.gev-online.co.uk)

[www.gev-online.com](http://www.gev-online.com)



- 🔍 Add to Favourites
- 🔍 Sign In with email address and usual password
- 🔍 Easy-order – place several items in your basket at the same time
- 🔍 Quick Item search – no login needed



## heating elements

### radiation heaters



1

<b>GEV No.</b>	418224	<b>Ref. No.</b>	400 (1250W)
<b>description</b>	radiation heater 1250W 230V L 211mm W 175mm H 52mm heating circuits 1		



1

<b>GEV No.</b>	418260	<b>Ref. No.</b>	400 400 (1600W)
<b>description</b>	radiation heater 1600W 230V L 230mm W 160mm heating circuits 1 connection type cable		

### foil heating elements



1

<b>GEV No.</b>	418262	<b>Ref. No.</b>	165
<b>description</b>	foil heating element L 195mm W 140mm 150W 230V t.max. 175°C without temperature limiter silicone cable length 200mm thickness 1mm		

## energy regulators

### EGO

#### 1-circuit



1

<b>GEV No.</b>	380015	<b>Ref. No.</b>	160 414
<b>description</b>	energy regulator 230V 13A single-circuit turn direction right shaft ø 6x4.6mm shaft L 23mm mounting thread M4 power release 6-100% no. 50.57021.010		

### accessories

#### knobs



1

<b>GEV No.</b>	110075	<b>Ref. No.</b>	161 411
<b>description</b>	knob energy regulator 1-3 t.max.°C ø 50mm shaft ø 6x4.6mm shaft flat upper black		
<b>accessories for</b>	110075		
	<b>GEV No.</b>	110135	<b>Ref. No.</b> 413
	rosette knob up to ø 52mm		

## switches and momentary switches

### rocker/momentary rocker switches

#### 30x11mm



1

<b>GEV No.</b>	345575	<b>Ref. No.</b>	117
<b>description</b>	rocker switch mounting measurements 30x11mm black 1CO 250V 16A I O II connection male faston 6.3mm ambient temperature max. 90°C protection IP40 with neutral position		



## motors

### gear motors

#### for grills



1

<b>GEV No.</b>	500929	<b>Ref. No.</b>	Getriebemotor SH.B.2G.
<b>description</b>	gear motor BITRON type 97109 14W 230V 50Hz 1.8rpm shaft ø 6x8mm L 106mm W 72mm H 65mm		

#### for gyros grills



1

<b>GEV No.</b>	500803	<b>Ref. No.</b>	101A old
<b>description</b>	gear motor CROUZET type 80527402 230V 1rpm		



1

<b>GEV No.</b>	500608	<b>Ref. No.</b>	101A
<b>description</b>	gear motor CROUZET type 80527437 16.7W 230V 50Hz 1rpm shaft ø 8mm L 64mm W 64mm H 59mm for gyro grill		



1

<b>GEV No.</b>	601767	<b>Ref. No.</b>	101A
<b>description</b>	gear motor MECHTEX 230V voltage AC 50Hz 1rpm shaft ø 8mm L 64mm W 64mm shaft length 24mm		



1

<b>GEV No.</b>	500802	<b>Ref. No.</b>	100
<b>description</b>	gear motor 230V 1rpm		



1

<b>GEV No.</b>	500682	<b>Ref. No.</b>	100 (bis Bj. 2016)
<b>description</b>	gear motor 230V 1rpm shaft ø 24mm L 190mm W 110mm H 105mm voor bj 2016		



1

<b>GEV No.</b>	501590	<b>Ref. No.</b>	100 (ab Bj. 2016)
<b>description</b>	gear motor voltage 230 shaft ø 20mm L 190mm W 110mm H 110mm after Bj. 2016		

## condensators & interference suppression filters

### filters

#### RC circuits



1

<b>GEV No.</b>	365151	<b>Ref. No.</b>	118
<b>description</b>	capacitor capacity 0.15µF		



1

<b>GEV No.</b>	365038	<b>Ref. No.</b>	118
<b>description</b>	RC circuit capacity 0.15µF		



## electric accessories

### plugs - couplings - power sockets

#### protective contact power sockets

##### universal



<b>GEV No.</b>	550799	<b>Ref. No.</b>	430
<b>description</b>	power socket CEE7/4 type F built-in version 3-pole contacts P+N+E max. 16A max 230V protection IP54 with lid countries D/I mounting ø 43mm		

### terminals

#### porcelain clamps



<b>GEV No.</b>	550593	<b>Ref. No.</b>	402
<b>description</b>	porcelain terminal block 1-pole 4mm <sup>2</sup> max. 20A max 450V L 25mm W 12mm H 20mm mounting distancemm Qty 1 pcs		

## gas taps

### MADEC (MP)

#### with pipe outlet



<b>GEV No.</b>	106020	<b>Ref. No.</b>	129	
<b>description</b>	gas tap MADEC gas inlet pipe flange ø16mm bypass nozzle ø 1.4mm gas outlet M12x1 (tube ø 8mm) thermocouple connection M8x1 front fixing M12x1 shaft ø 6x4.6mm shaft L 27/20mm shaft flat right pipe input ø 6mm			
<b>spare parts for</b>	106020			
	<b>GEV No.</b>	101051	<b>Ref. No.</b>	—
	magnet unit L 27mm D1 ø 12.5mm D2 ø 8.5mm suitable for JUNKERS/EGA/MADEC/SABAF standard			
	<b>GEV No.</b>	101234	<b>Ref. No.</b>	—
	union nut T1: M8x1 T2: M15			
<b>accessories for</b>	106020			
	<b>GEV No.</b>	101277	<b>Ref. No.</b>	—
	olive ID ø 8mm Qty 1 pcs			
	<b>GEV No.</b>	101296	<b>Ref. No.</b>	—
	union nut thread M12x1 for pipe ø 8mm			
	<b>GEV No.</b>	101299	<b>Ref. No.</b>	—
	nut thread M12x1			

<b>accessories for</b>	106020			
	<b>GEV No.</b>	101592	<b>Ref. No.</b>	221
	bypass nozzle bore ø 1.4mm thread M5x0.5			
	<b>GEV No.</b>	103260	<b>Ref. No.</b>	222
	bypass nozzle bore ø 0.75mm thread M5x0.5			

## ignition parts

### thermocouples

#### plug-in thermocouples

##### plug-in thermocouples standard

##### threaded thermocouples (miscellaneous)



<b>GEV No.</b>	102266	<b>Ref. No.</b>	131
<b>description</b>	thermocouple M8x1 L 350mm		

## gas burners

### ceramic burners



<b>GEV No.</b>	105987	<b>Ref. No.</b>	BV/C
<b>description</b>	ceramic burner L 203mm W 143mm firing range 160x109mm		



<b>GEV No.</b>	104281	<b>Ref. No.</b>	300
<b>description</b>	ceramic burner L 216mm W 160mm firing range 177x125mm pipe connection ø 8mm nozzle ø 1.45mm		

<b>spare parts for</b>	104281			
	<b>GEV No.</b>	104282	<b>Ref. No.</b>	—
	ceramic plate L 132mm W 92mm H 12mm			

<b>accessories for</b>	104281			
	<b>GEV No.</b>	100613	<b>Ref. No.</b>	203
	gas injector bore ø 0.81mm LPG			
	<b>GEV No.</b>	100614	<b>Ref. No.</b>	202
	gas injector bore ø 1.45mm natural gas			
	<b>GEV No.</b>	850029	<b>Ref. No.</b>	—
	burner grid L 230mm W 150mm new edition			

Table continues overleaf

accessories for	104281			
	GEV No.	850031	Ref. No.	—
	burner grid L 170mm W 165mm			

accessories

burner grids

1 				
<b>GEV No.</b>	850033	<b>Ref. No.</b>	330	
<b>description</b>	burner grid L 190mm W 160mm			

gas nozzles

main nozzles

gas nozzles (other)

1 				
<b>GEV No.</b>	100613	<b>Ref. No.</b>	203	
<b>description</b>	gas injector bore ø 0.81mm LPG			

1 				
<b>GEV No.</b>	100614	<b>Ref. No.</b>	202	
<b>description</b>	gas injector bore ø 1.45mm natural gas			

1 				
<b>GEV No.</b>	101541	<b>Ref. No.</b>	201	
<b>description</b>	gas injector bore ø 1.53mm			

bypass nozzles

bypass nozzles MADEC

1 				
<b>GEV No.</b>	101591	<b>Ref. No.</b>	222 (old version)	
<b>description</b>	bypass nozzle bore ø 0.75mm thread M5x0.5			

1 				
<b>GEV No.</b>	103260	<b>Ref. No.</b>	222	
<b>description</b>	bypass nozzle bore ø 0.75mm thread M5x0.5			

1 				
<b>GEV No.</b>	101592	<b>Ref. No.</b>	221	
<b>description</b>	bypass nozzle bore ø 1.4mm thread M5x0.5			

equipment-specific units  
for gyros grills

brakes

1 				
<b>GEV No.</b>	693467	<b>Ref. No.</b>	110	
<b>description</b>	slide for gyro grills mounting pos. upper			

glass panels

1 				
<b>GEV No.</b>	693452	<b>Ref. No.</b>	453EC	
<b>description</b>	glass panel L 575mm W 224mm thickness 4mm EC			

1 				
<b>GEV No.</b>	694559	<b>Ref. No.</b>	453DK	
<b>description</b>	glass panel L 710mm W 260mm thickness 4mm DK			

			
1			
<b>GEV No.</b>	693453	<b>Ref. No.</b>	454
<b>description</b>	glass panel L 740mm W 224mm thickness 4mm rectangular		

<p>skewers</p> 			
1			
<b>GEV No.</b>	693760	<b>Ref. No.</b>	1011
<b>description</b>	skewer for gyro grills size 12x12mm L 895mm		

			
1			
<b>GEV No.</b>	693454	<b>Ref. No.</b>	1010
<b>description</b>	skewer size 11x11mm L 695mm		

<p>skewer plates</p> 			
1			
<b>GEV No.</b>	693456	<b>Ref. No.</b>	1015
<b>description</b>	skewer plate ø 195mm		

<p>cotter pins</p> 			
1			
<b>GEV No.</b>	693457	<b>Ref. No.</b>	1020
<b>description</b>	retainer clip L 73mm wire gauge ø 3mm zinc-coated steel Qty 1 pcs		

<p>miscellaneous</p> 			
1			
<b>GEV No.</b>	693470	<b>Ref. No.</b>	155
<b>description</b>	bush		

			
1			
<b>GEV No.</b>	693462	<b>Ref. No.</b>	150
<b>description</b>	coupling for skewer holder mounting pos. lower		

			
1			
<b>GEV No.</b>	693469	<b>Ref. No.</b>	152
<b>description</b>	nut		

			
1			
<b>GEV No.</b>	693458	<b>Ref. No.</b>	1033
<b>description</b>	skewer intake for gyro grills mounting pos. lower		

			
1			
<b>GEV No.</b>	693463	<b>Ref. No.</b>	1030
<b>description</b>	skewer intake for gyro grills mounting pos. lower		

			
1			
<b>GEV No.</b>	693459	<b>Ref. No.</b>	1032
<b>description</b>	skewer intake for gyro grills mounting pos. upper		

## knobs

### universal knobs



1

<b>GEV No.</b>	110250	<b>Ref. No.</b>	130
<b>description</b>	knob gas tap without ignition flame t.max.°C°C ø 50mm shaft ø 6x4.6mm shaft flat upper black		

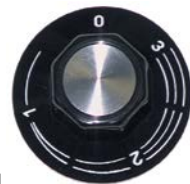

1

<b>GEV No.</b>	110075	<b>Ref. No.</b>	161 411
<b>description</b>	knob energy regulator 1-3 t.max.°C°C ø 50mm shaft ø 6x4.6mm shaft flat upper black		
<b>accessories for</b>	110075		
	<b>GEV No.</b>	<b>Ref. No.</b>	110135 413
	rosette knob up to ø 52mm		

### producer-specific knobs

#### NAOMI GRILLS



1

<b>GEV No.</b>	110075	<b>Ref. No.</b>	161 411
<b>description</b>	knob energy regulator 1-3 t.max.°C°C ø 50mm shaft ø 6x4.6mm shaft flat upper black		
<b>accessories for</b>	110075		
	<b>GEV No.</b>	<b>Ref. No.</b>	110135 413
	rosette knob up to ø 52mm		



1

<b>GEV No.</b>	110250	<b>Ref. No.</b>	130
<b>description</b>	knob gas tap without ignition flame t.max.°C°C ø 50mm shaft ø 6x4.6mm shaft flat upper black		

## accessories

### rosettes



1

<b>GEV No.</b>	110135	<b>Ref. No.</b>	413
<b>description</b>	rosette knob up to ø 52mm		

## handles and hand wheels

### fasteners

#### locking screws



1

<b>GEV No.</b>	693460	<b>Ref. No.</b>	114
<b>description</b>	locking screw thread M10 thread L 75mm mounting pos. upper for skewer holder		



1

<b>GEV No.</b>	693461	<b>Ref. No.</b>	156
<b>description</b>	locking screw thread M6		

## transmission technology and ball bearings

### ball bearings

#### thrust ball bearings



1

<b>GEV No.</b>	523537	<b>Ref. No.</b>	151
<b>description</b>	thrust ball bearing shaft ø 20mm ED ø 35mm W 10mm type 51104 DIN 711		





## fastening material

fasteners

retainer clips



1

<b>GEV No.</b>	693457	<b>Ref. No.</b>	1020
<b>description</b>	retainer clip L 73mm wire gauge ø 3mm zinc-coated steel Qty 1 pcs		



**C**

ceramic burners	5
condensators & interference suppression filters	4

**E**

electric accessories	5
energy regulators	3

**F**

fasteners	9
fastening material	9
filters	4
foil heating elements	3

**G**

gas burners	5
gas nozzles	6
gas taps	5

**H**

heating elements	3
------------------	---

**M**

motors	4
--------	---

**P**

plugs - couplings - power sockets	5
protective contact power sockets	5

**R**

radiation heaters	3
retainer clips	9
rocker/momentary rocker switches	3

**S**

switches and momentary switches	3
---------------------------------	---

**T**

terminals	5
thermocouples	5