



GAS COMPONENTS



ELECTRIC COMPONENTS



WATER TECHNOLOGY



MECHANICAL COMPONENTS



TOOLS

Spare parts suitable for

NINGBO-ROTOR

Find the complete and up-to-date range of products in our GEV Webshop



Manufacturer catalogue

The most important spare parts and accessories arranged clearly for every manufacturer

- ✓ Complete product range and all appliance data always up to date in the GEV Webshop
- ✓ Alphabetical Index at the end of the catalogue

GEV Webshop

www.gev-online.co.uk

www.gev-online.com



- 🔍 Add to Favourites
- 🔍 Sign In with email address and usual password
- 🔍 Easy-order – place several items in your basket at the same time
- 🔍 Quick Item search – no login needed



thermostats

control and safety thermostats

various

control thermostats

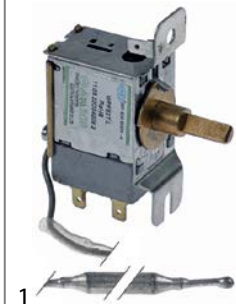

GEV No.	390871	Ref. No.	1.1.A.A06.02 GGC1078-05 GGC1078-5
description	thermostat t.max. 95°C temperature range 0-95°C 1-pole 1NO 6A probe ø 6mm probe L 95mm capillary pipe 550mm capillary pipe isolated 490mm gland nut shaft ø 6x4mm shaft L 23mm shaft position 45° rotation 270° probe material zinc-coated steel 250V contacts male faston 4.8mm Qty 1 pcs		

			
GEV No.	357244	Ref. No.	1.1.A.A01.01.19 A1.1.A.A01.01.19
description	LED bar L 580mm W 18mm H 13mmV black/transparent number of lamps 25 cable length 210mm		

			
GEV No.	357243	Ref. No.	1.1.A.A01.01.18 A1.1.A.A01.01.18
description	LED bar L 580mm W 18mm H 13mmV black/transparent number of lamps 25 cable length 850mm		

switches and momentary switches

rocker/momentary rocker switches

30x22mm



GEV No.	347791	Ref. No.	1.1.A.A07.10 GCV1600-36
description	rocker switch mounting measurements 30x22mm green 2NO 230V 20A illuminated 0-I connection male faston 6.3mm ambient temperature max. 125/55°C protection IP65 with rubber collar		

			
GEV No.	357138	Ref. No.	1.1.A.A01.03.03 GCV1600-18
description	LED bar L 698mm W 13mm H 13mm 230V number of lamps 27 cable length 800mm		

lamps

LED

LED bars



GEV No.	357245	Ref. No.	1.1.A.A01.09.65
description	LED bar L 344mm W 13mm H 13mmV white number of lamps 16 cable length 1030mm		

accessories

			
GEV No.	357152	Ref. No.	1.1.B.B25.20 GCV1600-38
description	power supply for LEDs RT-130-2-24cm Qty 1 pcs		

			
GEV No.	357246	Ref. No.	1.1.A.A01.10.04
description	power supply primary 85-265V secondary 0.2A Qty 1 pcs		

1

GEV No.	357247	Ref. No.	1.1.A.A06.01 1.1.A.A07.01.01 A1.1.A.A06.01 A1.1.A.A07.01.01
description	power supply with bush primary 85-265V secondary 0.2A		

fluorescent lamps

accessories

starter

1

GEV No.	357150	Ref. No.	1.1.A.A01.02.01 GGC1078-33 GGC2270-36
description	starter for fluorescent lamps L 69mm W 38.5mm 11W type HG-YZ11E Qty 1 pcs		

timers

defrost timers

miscellaneous

1

GEV No.	360553	Ref. No.	1.1.A.A05.06 GGC1078-06 GGC1078-6
description	defrost timer SONXIE type DBZF-625-2G2B defrosting interval 6h defrosting time 2minmin fan delaymin 200-240V Qty 1 pcs		

electronic controllers

DIXELL

refrigeration controllers

built-in version

1

GEV No.	379843 ¹	Ref. No.	1.1.A.A06.03.31 GCV1600-39	
description	electronic controller kit DIXELL XR30CX-5N2C1 mounting measurements 71x29mm 230V voltage AC NTC/PTC relay outputs 2 1x NTC probe inclusive -50 up to +150°C display 3½ digits 2 RoomTempIN NTC/PTC DEF Probe DigiIN1 DigiIN2 DEF Relay fan relay Temp4/Dig1 NTC/PTC/DIGI evaporator probe defr. funct. compressor relay NO-20A(8) light relay alarm relay CO-8A(3) auxiliary relay			
spare parts for	379843			
	GEV No.	379160	Ref. No.	—
	temperature probe NTC 10kOhm cable thermoplastic probe -40 up to +110°C cable -40 up to +110°C probe ø6x14mm cable length 1.5m without screw connection 2-wire			

¹Incl. 1x NTC probe

accessories universal for electronic con-

miscellaneous

1

GEV No.	692369	Ref. No.	1.1.C.C63.71 GCV1600-47
description	bracket for thermometer W 81mm H 41mm plastic Qty 1 pcs		

electronics

PCBs

1

GEV No.	403665	Ref. No.	1.1.A.A13.01.51
description	control PCB for vitrine HCV1100 with display unit with probe		

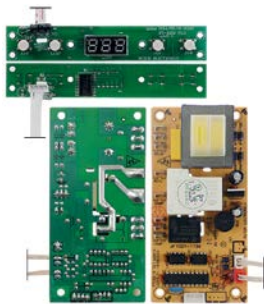

			
1			
GEV No.	361873	Ref. No.	1.1.A.A17.01.01 1.1.A.A17.04.06 1.1.A.A17.04.06+1.1.A.A17.01.01 GGC2270-31 GGC2270-49
description	control PCB refrigerated show case GGC 1270/2270 cable length 225mm 2-piece type KB3150		

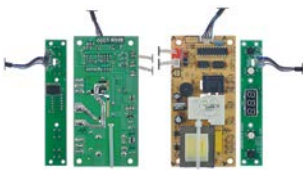
			
1			
GEV No.	403664	Ref. No.	1.1.A.05.01.09 A1.1.A.05.01.09
description	PCB refrigerated show case GRV1100 incl. probe		

compressors

ACC/ZEL

R600A

LBP monophase

Lower evaporation temperature below -20°C

			
1			
GEV No.	605150	Ref. No.	1.1.A.A02.01 1.1.A.A02.14 A1.1.A.A02.01 A1.1.A.A02.14 GCV1600-37 GRV1100-08 HCV1100-30
description	compressor coolant R600a type HVM10AA 220-240V 50Hz LBP 8.7kg 1/6HP cylinder capacity 10cm ³ RSIR H 180mmWWWWWWWWWW		

			
1			
GEV No.	605142	Ref. No.	1.1.A.A02.04 GGC1078-46
description	compressor coolant R600a type HVM86AA 220-240V 50Hz LBP fully hermetic 7.83kg 1/7HP cylinder capacity 8.6cm ³ RSIR H 174mmWWWW		

miscellaneous

R600A

			
1			
GEV No.	605143	Ref. No.	1.1.A.A02.25 GGC2270-12
description	compressor DONPER type QD167YU coolant R600a 220-240V 50Hz fully hermetic 11.9kg power input 276W cylinder capacity 16.7cm ³ RSCR H 220mm 169W 199W 236W 280W 334W 391WWWWWW test method ASHRAE capacitor 6µF		

accessories

miscellaneous

			
1			
GEV No.	699425	Ref. No.	1.1.C.C41.01 GGC1078-45
description	vibration damper ø 25mm H 10mm		



fans

axial fans

import



GEV No.	602080	Ref. No.	1.1.A.A03.01.06 A1.1.A.A03.01.06
description	axial fan L 119mm W 119mm H 38mm 220/240VAC 50/60HzW bearing ball bearing connection cable cable length 640mm XINRUILIAN fan wheel ø 110mm temp.-resist.°C input current 0.2A		



GEV No.	601834 ¹	Ref. No.	1.1.A.A03.01.31 GCV1600-34
description	axial fan L 119mm W 119mm H 38mm 230VAC 50/60Hz 16/15W bearing ball bearing manuf. no. RAM1238B1 connection cable cable length 900mm XINRUILIAN fan wheel ø 110mm temp.-resist. -10 up to +70°C input current 0.16A		

¹with ball bearings

refrigeration fans

refrigeration motors universal

miscellaneous



GEV No.	601789	Ref. No.	1.1.A.A03.01.10 GGC2270-48
description	fan motor 10W 220-240V 50/60Hz L1 50mm L2 72mm L3 90mm W 84mm cable length 460mm 1300rpm HANGZOU SAIWEI MOTOR YZ10-20		
spare parts for	601789		
	GEV No.	601413	Ref. No. —
	fixing plate suitable for fanwheel ED ø 32mm shaft ø 7 mounting distance 26mm		

accessories

fan wheels

aluminium

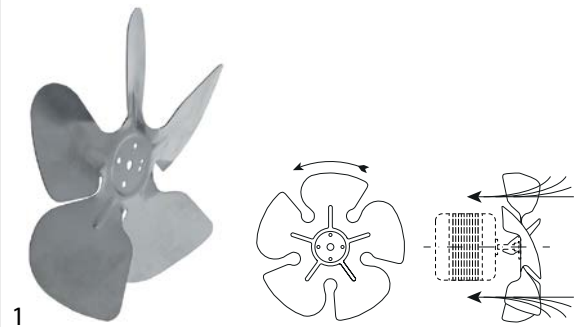

GEV No.	601070	Ref. No.	1.1.A.A03.03.05 GGC2270-09 GGC2270-9
description	fan wheel sucking ø 200mm fan wheel mounting 25.4mm blade angle 28° W 38mm aluminium		

fan guards

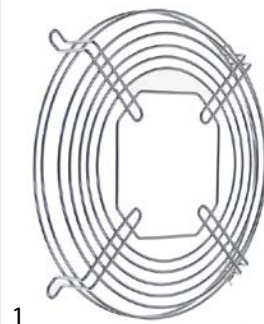

GEV No.	699432	Ref. No.	1.1.B.B10.36 GGC2270-10
description	guard ø 215mm mounting distance 230mm		

cooling motors (complete)



GEV No.	601791	Ref. No.	1.1.A.A03.02.04 GGC2270-47
description	fan motor pair 220-240V 10W 50Hz fan wheel ø 110mm mounting distance 137mm cable length 800mm		



cold air circulating fans

cold air circulating fans



GEV No.	602078	Ref. No.	A1.1.A.A03.01.08
description	fan motor 220-240V 50Hz 5W shaft ø 4mm shaft L 15mm L 205mm W 147mm H 80mm		
spare parts for	602078		
	GEV No.	Ref. No.	1.1.A.A03.01.07
	fan wheel blowing ø 148mm shaft intake ø 3mm blade angle° W 17.5mm plastic Qty 1 pcs blades 4		

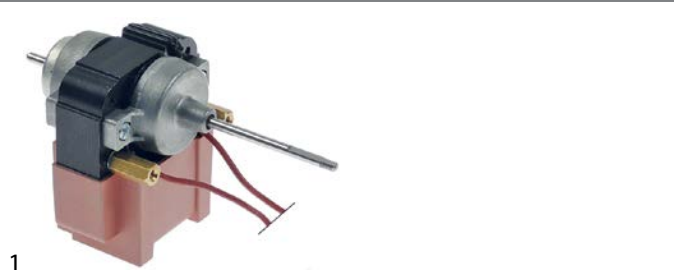

GEV No.	602079	Ref. No.	1.1.A.A03.01.73
description	fan motor 220-240V 50Hz 5W shaft ø 4mm shaft L 16/55mm L 140mm W 65mm H 76mm		



GEV No.	601845	Ref. No.	1.1.A.A03.01.08 GGC1078-40
description	fan motor 220-240V 50Hz IN 22W / OUT 5W shaft ø 4mm shaft L 20/48mm L 65mm W 66mm H 73mm Qty 1 pcs		
accessories for	601845		

	GEV No.	Ref. No.	1.1.C.C17.01 1.1.C.C17.04 A1.1.C.C17.01 GGC1078-39
	fan wheel blowing ø 150mm shaft intake ø 4mm W 33mm plastic Qty 1 pcs		

accessories

fan wheels for cold air circulating fans

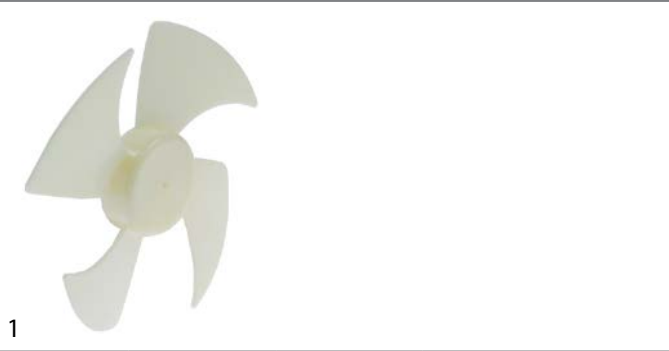

GEV No.	698913	Ref. No.	1.1.A.A03.01.07 A1.1.A.A03.01.07
description	fan wheel blowing ø 148mm shaft intake ø 3mm blade angle° W 17.5mm plastic Qty 1 pcs blades 4		



GEV No.	601846	Ref. No.	1.1.C.C17.01 1.1.C.C17.04 A1.1.C.C17.01 GGC1078-39
description	fan wheel blowing ø 150mm shaft intake ø 4mm W 33mm plastic Qty 1 pcs		



GEV No.	698933	Ref. No.	1.1.A.A03.01.59
description	fan wheel sucking ø 150mm shaft intake ø 3.5x4mm W 10.5mm Qty 1 pcs blades 6		



accessories universal

			
1			
GEV No.	699426	Ref. No.	1.1.C.C46.04.16
description	frame ø 160/210mm for fan		

			
1			
GEV No.	692402	Ref. No.	1.1.C.C12.14 GGC1078-15-white GGC1078-WHITE-15
description	handle grey for vitrine H 9.5mm L 85mm W 25mm mounting distance 70mm Qty 1 pcs		

electric accessories

cables

power supply cables

			
1			
GEV No.	551218	Ref. No.	1.1.A.A08.02.02 1.1.A.A08.02.36 1.1.A.A08.02.79 1.1.A.A08.02.87 A1.1.A.A07.02.01 GCV1600-45 GGC1078-51 GGC2270-53 GGC2270-53-white
description	power lead CEE7/7 type E+F 3-pole contacts P+N+E 0.75mm ² max. 16A max 230V 2m Qty 1 pcs grey		

			
1			
GEV No.	692401	Ref. No.	1.1.C.C23.01 GGC1078-11
description	knob ø 27mm grey zero mark shaft ø 6x4.6mm shaft flat left for thermostat to clip Qty 1		

housing and bezels

fascias

			
1			
GEV No.	692411	Ref. No.	1.1.C.C40.02 GGC2270-45
description	base plate for evaporator L 305mm W 241mm thickness 1.5mm plastic Qty 1 pcs		

equipment-specific units

for display coolers

control parts

			
1			
GEV No.	692700	Ref. No.	1.1.C.C12.07 GGC2270-18-black
description	door handle L 100mm W 32mm hole distance 68mm black Qty 1 pcs		

			
1			
GEV No.	698929	Ref. No.	1.1.C.C46.04.08
description	bezel mounting pos. for electronic controller W 185mm D 16mm H 93mm plastic Qty 1 pcs		

			
1			
GEV No.	692409	Ref. No.	1.1.C.C12.06 GGC2270-18 GGC2270-18-white
description	door handle L 100mm W 32mm hole distance 68mm white		

			
1			
GEV No.	698927	Ref. No.	1.1.C.C46.04.09
description	bezel mounting pos. front for vitrine W 696mm D 16mm H 205mm plastic Qty 1 pcs		



			
1			
GEV No.	698935	Ref. No.	A1.1.B.B19.07
description	bezel mounting pos. lower for vitrine H 235mm Qty 1 pcs ø 490mm		

			
1			
GEV No.	698907	Ref. No.	1.1.B.B19.03 A1.1.B.B19.03
description	bezel mounting pos. right for vitrine W 34mm D 10mm H 710mm 1 pair chrome-plated steel		

			
1			
GEV No.	692405	Ref. No.	1.1.C.C22.08 GGC1078-10
description	control panel for vitrine temperature MIN/MAX W 130mm D 23mm H 145mm plastic Qty 1 pcs		

			
1			
GEV No.	698914	Ref. No.	1.1.C.C19.05 A1.1.C.C19.05
description	cover mounting pos. lower for switch W 135mm D 20mm H 30mm plastic		

			
1			
GEV No.	698928	Ref. No.	1.1.C.C46.04.11
description	cover mounting pos. rear-upper for vitrine W 625mm D 165mm H 40mm plastic		

			
1			
GEV No.	699158	Ref. No.	A1.1.C.C21.06
description	cover plate mounting pos. upper/lower for door W 420mm D 110mm H 12mm Qty 1 pcs		

			
1			
GEV No.	699160	Ref. No.	A1.1.C.C21.07
description	end barrier mounting pos. upper/lateral for door W 420mm D 110mm H 23mm Qty 1 pcs		

			
1			
GEV No.	699181	Ref. No.	A1.1.C21.23
description	filter W 260mm D 90mm H 296mm black Qty 1 pcs		

			
1			
GEV No.	699410	Ref. No.	1.1.C.C15.03.35 GGC2270-06-black
description	front panel mounting pos. front W 518mm D 35mm H 440mm black		

			
1			
GEV No.	699409	Ref. No.	1.1.C.C15.03.03 GGC2270-06 GGC2270-06-white
description	front panel mounting pos. front W 518mm D 35mm H 440mm white		

			
1			
GEV No.	698854	Ref. No.	1.1.C.C15.01.02 GGC1078-04-black GGC1078-50-black
description	front panel mounting pos. in the front/at the back black W 427mm D 33mm H 190mm plastic Qty 1 pcs for vitrine		

			
1			
GEV No.	692417	Ref. No.	1.1.C.C21.01 GGC1078-09 GGC1078-9
description	housing for control W 130mm D 75mm H 145mm plastic Qty 1 pcs		

			
1			
GEV No.	699415	Ref. No.	1.1.C.C02.02 GGC2270-30-black
description	lamp cover W 310mm D 5mm H 172mm black		

			
1			
GEV No.	699414	Ref. No.	1.1.C.C02.01 GGC2270-30-white
description	lamp cover W 310mm D 5mm H 172mm white		

lids

			
1			
GEV No.	698904	Ref. No.	1.1.C.C21.02 A1.1.C.C21.02
description	lid black W 475mm H 33mm L 355mm		

			
1			
GEV No.	698922	Ref. No.	A1.1.C.C21.01
description	lid for vitrine black W 474mm D 364mm H 24mm Qty 1 pcs		

			
1			
GEV No.	692414	Ref. No.	GGC1078-29-white GGC1078-WHITE-29
description	lid L 313mm W 163mm for lighting Qty 1 pcs		

shelf supports

			
1			
GEV No.	698940	Ref. No.	A1.1.C.C21.16 A1.1.C.C21.18 A1.1.C.C21.19
description	shelf support L 55mm W 18mm H 40mm mounting pos. left/right with ball		

			
1			
GEV No.	698941	Ref. No.	A1.1.C.C21.04
description	shelf support L 55mm W 18mm H 40mm mounting pos. rear		

housings

			
1			
GEV No.	698851	Ref. No.	1.1.C.C15.01.06 GGC2270-51-black
description	back panel for vitrine W 515mm D 45mm H 410mm black		

			
1			
GEV No.	692269	Ref. No.	1.1.C.C15.01.05 GGC2270-51 GGC2270-51-white
description	back panel for vitrine W 515mm D 45mm H 410mm white		



			
1			
GEV No.	698936	Ref. No.	A1.1.C.C21.09
description	base mounting pos. lower H 160mm plastic ø 490mm		

			
1			
GEV No.	698917	Ref. No.	1.1.C.C04.15 A1.1.C.C04.15
description	base part mounting pos. for housing W 153mm D 4mm H 85mm plastic Qty 1 pcs white		

			
1			
GEV No.	692416	Ref. No.	1.1.C.C25.15 GGC1078-49
description	bottom for vitrine W 378mm H 115mm L 425mm Qty 1 pcs		



			
1			
GEV No.	698868	Ref. No.	GGC1078-black
description	casing cover for display refrigerator W 425mm L 380mm plastic black		

			
1			
GEV No.	692419	Ref. No.	1.1.C.C01.15 GGC1078-27-white GGC1078-WHITE-27
description	casing cover for display refrigerator W 425mm L 380mm plastic Qty 1 pcs white		
accessories for	692419		
			
GEV No.	692414	Ref. No.	GGC1078-29-white GGC1078-WHITE-29
description	lid L 313mm W 163mm for lighting Qty 1 pcs		

			
1			
GEV No.	692437	Ref. No.	1.1.C.C22.07 GGC2270-55
description	casing cover W 130mm D 70mm H 6mm plastic Qty 1 pcs		

			
1			
GEV No.	692413	Ref. No.	GGC2270-59
description	casing cover W 40mm D 18mm plastic Qty 1 pcs		

			
1			
GEV No.	692420	Ref. No.	1.1.B.B05.02 GGC1078-08 GGC1078-8
description	cover for condenser W 365mm D 220mm H 130mm plate Qty 1 pcs		

			
1			
GEV No.	692422	Ref. No.	1.1.C.C16.02 GGC1078-41
description	cover for evaporator W 280mm D 345mm H 35mm plastic Qty 1 pcs		

			
1			
GEV No.	698916	Ref. No.	1.1.C.C04.14 A1.1.C.C04.14
description	cover mounting pos. for PCB W 140mm D 38mm H 80mm plastic Qty 1 pcs		

			
1			
GEV No.	692403	Ref. No.	1.1.C.C15.01.01 GGC1078-04-white GGC1078-WHITE-04 GGC1078-WHITE-4
description	front panel mounting pos. front for vitrine W 427mm D 33mm H 190mm plastic Qty 1 pcs white		

			
1			
GEV No.	698860	Ref. No.	1.1.C.C56.84 GGC1078-18-black
description	guide mounting pos. front for side part W 23mm D 30mm H 635mm Qty 1 pcs		

			
1			
GEV No.	698861	Ref. No.	1.1.C.C56.85 GGC1078-38-black
description	guide mounting pos. rear for side part W 30mm D 30mm H 635mm Qty 1 pcs		

			
1			
GEV No.	692415	Ref. No.	1.1.C.C18.04 GGC1078-44
description	housing for evaporator W 370mm H 175mm L 420mm Qty 1 pcs		

			
1			
GEV No.	692436	Ref. No.	1.1.C.C21.03 GGC2270-54
description	housing W 128mm D 65mm H 38mm plastic Qty 1 pcs		

			
1			
GEV No.	692412	Ref. No.	GGC2270-58
description	housing W 40mm H 21mm plastic Qty 1 pcs		

			
1			
GEV No.	698937	Ref. No.	A1.1.C.C21.08
description	insert mounting pos. centre for vitrine H 210mm plastic ø 490mm		

			
1			
GEV No.	692270	Ref. No.	1.1.C.C15.03.08 1.1.C.C15.03.08+1.1.C.C15.03.09 GGC2270-50 GGC2270-50-white
description	side panel W 418mm H 410mm plastic white		

ventilation grilles			
			
1			
GEV No.	698855	Ref. No.	1.1.C.C14.02 GGC1078-12-black
description	cover for fan W 425mm D 380mm H 36mm plastic Qty 1 pcs black		

			
1			
GEV No.	699411	Ref. No.	1.1.C.C14.01 GGC1078-12-white
description	cover for fan W 425mm D 380mm H 36mm plastic Qty 1 pcs white		

			
1			
GEV No.	698915	Ref. No.	1.1.C.C21.20 A1.1.C.C21.20
description	cover mounting pos. for air fan W 270mm D 10mm H 63mm plastic		

			
1			
GEV No.	698912	Ref. No.	1.1.C.C21.21 A1.1.C.C21.21
description	cover mounting pos. for aspiration W 290mm D 10mm H 40mm plastic Qty 1 pcs		

			
1			
GEV No.	698911	Ref. No.	1.1.C.C21.10 A1.1.C.C21.10
description	frame mounting pos. lower for vitrine W 370mm D 75mm H 70mm plastic		

			
1			
GEV No.	698853	Ref. No.	1.1.C.C26.02 GGC1078-02-black
description	grid mounting pos. lower for ventilation W 350mm D 12mm H 57mm plastic Qty 1 pcs black		

			
1			
GEV No.	699417	Ref. No.	1.1.C.C26.01 GGC1078-02-white GGC1078-2-white
description	grid mounting pos. lower for ventilation W 350mm D 12mm H 57mm plastic Qty 1 pcs white		



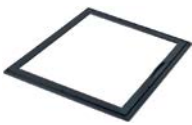

			
1			
GEV No.	701253	Ref. No.	1.1.C.C49.09 GCV1600-33
description	ventilation grille for air fan plastic black H 50mm L 620mm Qty 1 pcs		

			
1			
GEV No.	701254	Ref. No.	1.1.C.C49.10 GCV1600-32
description	ventilation grille for aspiration plastic black H 50mm L 260mm Qty 1 pcs		

frame			
			
1			
GEV No.	699412	Ref. No.	1.1.C.C63.14 GCV1600-29 GCV1600-29-black
description	door frame inner W 378mm D 10mm H 385mm		

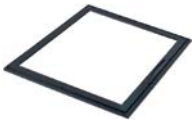
			
1			
GEV No.	699413	Ref. No.	1.1.C.C63.13 GCV1600-28 GCV1600-28-black
description	door frame outer W 375mm D 10mm H 375mm		

			
1			
GEV No.	698925	Ref. No.	1.1.C.C46.01.09
description	frame mounting pos. inner for door W 385mm D 7mm H 330mm plastic Qty 1 pcs		

			
1			
GEV No.	698926	Ref. No.	1.1.C.C16.01.10
description	frame mounting pos. outer for door W 375mm D 16mm H 325mm plastic Qty 1 pcs		

side parts			
			
1			
GEV No.	698862	Ref. No.	1.1.C.C38.19 GGC1078-20-black
description	side panel for door L 590mm thickness 17mm		

			
1			
GEV No.	698906	Ref. No.	1.1.C.C21.12 A1.1.C.C21.12
description	side panel for door W 47mm D 29mm H 660mm plastic		

			
1			
GEV No.	698919	Ref. No.	1.1.C.C46.04.01
description	side panel mounting pos. left for vitrine W 34mm D 448mm H 450mm plastic Qty 1 pcs		

			
1			
GEV No.	698852	Ref. No.	1.1.C.C15.02.02 GGC1078-01-black
description	side panel mounting pos. left/right black W 316mm D 13.5mm H 190mm plastic Qty 1 pcs for vitrine		

			
1			
GEV No.	692404	Ref. No.	1.1.C.C15.02.01 GGC1078-01-white GGC1078-WHITE-01 GGC1078-WHITE-1
description	side panel mounting pos. left/right white W 316mm D 13.5mm H 190mm plastic Qty 1 pcs for vitrine		

			
1			
GEV No.	698921	Ref. No.	1.1.C.C46.04.02
description	side panel mounting pos. right for vitrine W 34mm D 448mm H 450mm plastic Qty 1 pcs		

			
1			
GEV No.	699444	Ref. No.	1.1.C.C56.06 GGC2270-40-black
description	side panel mounting pos. vertical W 40mm D 40mm H 1370mm black		

			
1			
GEV No.	699443	Ref. No.	1.1.C.C56.03 GGC2270-40-white
description	side panel mounting pos. vertical W 40mm D 40mm H 1370mm white		

			
1			
GEV No.	698850	Ref. No.	1.1.C.C15.03.10 GGC2270-50-black
description	side panel W 418mm H 410mm plastic black		

miscellaneous

			
1			
GEV No.	699427	Ref. No.	1.1.C.C03.01 GGC1078-28-white GGC2270-32-white
description	blank H 5mm ø 12mm		

			
1			
GEV No.	699428	Ref. No.	1.1.C.C03.02 GGC1078-28-black GGC2270-32-black
description	blank H 5mm ø 12mm		

			
1			
GEV No.	692369	Ref. No.	1.1.C.C63.71 GCV1600-47
description	bracket for thermometer W 81mm H 41mm plastic Qty 1 pcs		

			
1			
GEV No.	692410	Ref. No.	1.1.C.C09.01 GGC1078-26 GGC2270-27 GGC2270-33
description	cover for lighting mounting pos. inner L 230mm W 84mm H 2.5mm plastic Qty 1 pcs		

			
1			
GEV No.	698909	Ref. No.	1.1.B.B19.02 A1.1.B.B19.02
description	fixing plate for condenser L 300mm W 170mm H 55mm thickness 1mm		

			
1			
GEV No.	692370	Ref. No.	1.1.C.C63.70 GCV1600-06
description	rail for gasket L 740mm W 42mm H 19mm plastic Qty 1 pcs		

shelf rails

			
1			
GEV No.	698905	Ref. No.	1.1.C.C21.14 A1.1.C.C21.14
description	centre web mounting pos. rear for vitrine W 65mm D 26.5mm H 665mm plastic		

			
1			
GEV No.	698908	Ref. No.	1.1.C.C21.13 A1.1.C.C21.13
description	guide mounting pos. left/right for vitrine W 45mm D 38mm H 665mm 1 pair plastic		



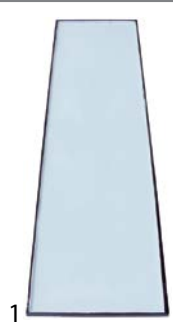

glass panels

glass panels

 <p>1</p>			
GEV No.	692293	Ref. No.	1.1.E.E2.02.44 GGC2270-38
description	glass panel L 1392mm W 376mm thickness 10mm flat mounting pos. lateral for display refrigerator		

 <p>1</p>			
GEV No.	699328	Ref. No.	1.1.E.E2.02.45 GGC2270-39
description	glass panel L 1395mm W 464mm thickness 17.5mm mounting pos. rear refrigerated show case GGC2270		

 <p>1</p>			
GEV No.	699330	Ref. No.	1.1.E.E2.02.76 GCV1600-27
description	glass panel L 360mm W 357mm thickness 10.5mm for door GCV1600		

 <p>1</p>			
GEV No.	692668	Ref. No.	1.1.E.E2.08.47
description	glass panel L 435mm W 445mm thickness 10.5mm mounting pos. left/right for vitrine		

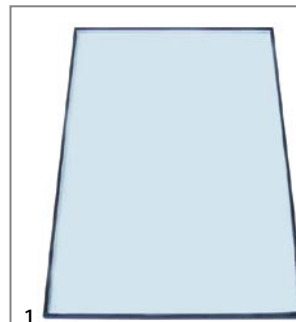
 <p>1</p>			
GEV No.	692291	Ref. No.	1.1.E.E2.02.64 GGC1078-21
description	glass panel L 635mm W 390mm thickness 10mm flat mounting pos. door for display refrigerator		

 <p>1</p>			
GEV No.	699326	Ref. No.	1.1.E.E2.02.74 GCV1600-21
description	glass panel L 645mm W 595mm H 16mm thickness 8mm mounting pos. left for display refrigerator GCV1600		

 <p>1</p>			
GEV No.	699327	Ref. No.	1.1.E.E2.02.75 GCV1600-26
description	glass panel L 645mm W 595mm H 16mm thickness 8mm mounting pos. right for display refrigerator GCV1600		

 <p>1</p>			
GEV No.	698924	Ref. No.	1.1.E.E2.08.16
description	glass panel L 650mm W 523mm H 12.5mm		

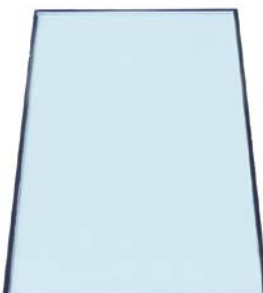
			
1			
GEV No.	692292	Ref. No.	1.1.E.E2.02.12 GGC1078-37
description	glass panel L 655mm W 390mm thickness 10mm flat mounting pos. rear for display refrigerator		

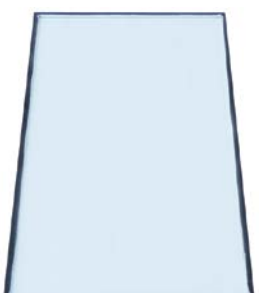
			
1			
GEV No.	692290	Ref. No.	1.1.E.E2.02.11 GGC1078-17
description	glass panel L 660mm W 332mm thickness 10mm flat mounting pos. lateral for fridge		

			
1			
GEV No.	698939	Ref. No.	A1.1.E.E07.09.02
description	glass panel L 715mm W 420mm H 120mm thickness 20mm arched mounting pos. left/right		

			
1			
GEV No.	699329	Ref. No.	1.1.E.E2.04.15.A0 GCV1600-16
description	glass panel L 773mm W 710mm thickness 12mm mounting pos. front-side for display refrigerator GCV1600		

			
1			
GEV No.	698930	Ref. No.	1.1.E.E2.02.39
description	glass panel Lmm W 360mm H 308mm thickness 10.5mm for door		

			
1			
GEV No.	698923	Ref. No.	1.1.E.E07.09.03 A1.1.E.E07.09.03
description	glass panel ø 390mm thickness 6mm		

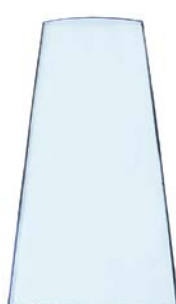
			
1			
GEV No.	692289	Ref. No.	1.1.E.E2.02.65 GGC2270-20
description	glass panel W 460mm H 1360mm thickness 17mm curved for fridge		

accessories

			
1			
GEV No.	699159	Ref. No.	A1.1.D.D06.06.02
description	insulation for door L 315mm thickness 19mm W 85mm		

			
1			
GEV No.	699431	Ref. No.	1.1.B.B14.05 GCV1600-13
description	rail L 775mm		

doors

			
1			
GEV No.	698859	Ref. No.	1.1.C.C11.02 GGC1078-16-black GGC1078-23-black
description	door frame L 425mm W 15mm H 28mm mounting pos. upper/lower		



			
1			
GEV No.	698938	Ref. No.	A1.1.E-E07.09.01
description	glass door L 725mm W 418mm H 122mm for vitrine		

door mechanics

bolts

			
1			
GEV No.	699424	Ref. No.	1.1.B.B09.03 GGC1078-36
description	door bolt H 7mm W 7mm L 20.5mm mounting pos. upper		

			
1			
GEV No.	699433	Ref. No.	A1.1.B.B19.09
description	door bolt L 45.5mm ø 7mm		

bushes

			
1			
GEV No.	699161	Ref. No.	A1.1.B.B15.18
description	bush for door H 11.5mm ø 10mm		

			
1			
GEV No.	699429	Ref. No.	GGC1078-34-white
description	bush H 15mm ø 10mm		

			
1			
GEV No.	699430	Ref. No.	1.1.C.C13.02 GGC1078-34-black
description	bush H 15mm ø 10mm		

			
1			
GEV No.	699435	Ref. No.	A1.1.C.C19.07
description	bush H 17.5mm ø 16.8mm		

door bumpers

			
1			
GEV No.	699442	Ref. No.	A1.1.B.B19.05
description	door bumper H 3mm W 14mm L 664mm mounting pos. vertical		

			
1			
GEV No.	699441	Ref. No.	A1.1.B.B19.06
description	door bumper H 7mm W 9mm L 355mm mounting pos. horizontal		

handles and hand wheels

miscellaneous

			
1			
GEV No.	692409	Ref. No.	1.1.C.C12.06 GGC2270-18 GGC2270-18-white
description	door handle L 100mm W 32mm hole distance 68mm white		

			
1			
GEV No.	698858	Ref. No.	1.1.C.C12.15 GGC1078-15-black
description	handle black for vitrine H 9.5mm L 85mm W 25mm mounting distance 70mm Qty 1 pcs		

			
1			
GEV No.	692402	Ref. No.	1.1.C.C12.14 GGC1078-15-white GGC1078-WHITE-15
description	handle grey for vitrine H 9.5mm L 85mm W 25mm mounting distance 70mm Qty 1 pcs		

hinges

door bearing

			
1			
GEV No.	692406	Ref. No.	1.1.B.B10.17 GGC1270-42-brass GGC2270-44
description	bolt H 16.5mm ø 10/14mm ID ø 7mm brass for door hinge Qty 1 pcs		

			
1			
GEV No.	692421	Ref. No.	1.1.C.C13.01 GGC1078-34 GGC1270-42-plastic GGC2270-42-plastic
description	bush H 15mm ø 10/13mm ID ø 7mm plastic for door hinge Qty 1 pcs		

			
1			
GEV No.	699419	Ref. No.	1.1.B.B09.01 GGC1078-25
description	hinge bearing L 55mm W 15mm H 14mm mounting distance 26mm mounting pos. upper		

			
1			
GEV No.	698918	Ref. No.	1.1.B.B19.08 A1.1.B.B19.08
description	hinge bearing L 60mm W 37mm H 27mm mounting distance 23mm mounting distance 2 23mm mounting pos. upper right bolt 23mm bolt ø 7mm		

			
1			
GEV No.	699423	Ref. No.	1.1.B.B09.17 GGC2270-25
description	hinge bearing L 85mm W 17mm H 17mm mounting distance 48mm mounting pos. upper		

equipment feet and end caps

screw-in feet

			
1			
GEV No.	699434	Ref. No.	1.1.C.C32.18
description	equipment foot thread M8 thread L 24mm ø 28mm		

miscellaneous

with spigot

ø40mm

			
1			
GEV No.	701120	Ref. No.	1.1.B.B10.95 1.1.B.B10.95+1.1.B.B10.96 GGC2270-03 GGC2270-3
description	castor set 2 with & 2 without brake ø 40mm with thread bolt housing chrome-plated steel thread L 24mm thread ø M10x1.5mm capacity 60kg bearing ball bearing wheel body nylon tread nylon H 68mm wheel width 20mm Qty 4 pcs		

shelves and shelf rails

grates

universal

with upstand



			
1			
GEV No.	970795	Ref. No.	1.1.B.B25.15 GCV1600-15
description	grate W 735mm D 235mm H 37mm chrome-plated steel wire gauge frame 8mm lengthwise wires gauge 3mm crossing wires 1		





			
GEV No.	970794	Ref. No.	1.1.B.B25.16 GCV1600-14
description	grate W 735mm D 365mm H 35mm chrome-plated steel wire gauge frame 8mm lengthwise wires gauge 3mm crossing wires 1		

			
GEV No.	970916	Ref. No.	1.1.B.B02.05.03
description	grate W 610mm D 310mm chrome-plated steel wire gauge frame 5mm lengthwise wires gauge 3mm crossing wires 5		

producer-specific

			
GEV No.	698856	Ref. No.	1.1.B.B02.01.03 GGC1078-13-black
description	grate W 360mm D 305mm plastic-coated steel		
accessories for	698856		
	GEV No.	692400	Ref. No.
			1.1.C.C10.07 GGC1078-14 GGC1078-14-white
shelf support L 28.5mm W 14mm H 17.5mm plastic Qty 1 pcs			
	GEV No.	698857	Ref. No.
			1.1.C.C10.08 GGC1078-14-black
shelf support L 28.5mm W 14mm H 17.5mm plastic Qty 1 pcs			

			
GEV No.	970876	Ref. No.	1.1.B.B02.01.01 GGC1078-13
description	grate W 360mm D 305mm plastic-coated steel		

			
GEV No.	692696	Ref. No.	1.1.B.B02.04.02 GGC2270-41-black
description	grate W 430mm D 390mm H 8mm plastic-coated steel refrigeration wire gauge frame 8mm lengthwise wires gauge 3.6mm crossing wires 5 black		

			
GEV No.	692339	Ref. No.	1.1.B.B02.04.01 GGC1270-41 GGC1270-41-white GGC2270-41 GGC2270-41-white
description	grate W 430mm D 390mm H 8mm plastic-coated steel refrigeration wire gauge frame 8mm lengthwise wires gauge 3.6mm crossing wires 5 white		

grid attachments

			
GEV No.	692368	Ref. No.	1.1.B.B25.27 GCV1600-44
description	rack support L 220mm H 83mm mounting pos. bottom right SS Qty 1 pcs		

			
GEV No.	692365	Ref. No.	1.1.B.B25.28 GCV1600-41
description	rack support L 220mm H 83mm mounting pos. upper left SS Qty 1 pcs		

			
GEV No.	692366	Ref. No.	1.1.B.B25.29 GCV1600-42
description	rack support L 220mm H 83mm mounting pos. upper right SS Qty 1 pcs		

			
GEV No.	692367	Ref. No.	1.1.B.B25.26 GCV1600-43
description	rack support L 320mm H 83mm mounting pos. bottom left SS Qty 1 pcs		

			
1			
GEV No.	701252	Ref. No.	1.1.B.B25.35 GCV1600-46
description	rail for grid attachment L 405mm Hmm mounting pos. left/right W 19mm SS Qty 1 pcs		

shelf rails and supports

producer-specific

			
1			
GEV No.	692400	Ref. No.	1.1.C.C10.07 GGC1078-14 GGC1078-14-white
description	shelf support L 28.5mm W 14mm H 17.5mm plastic Qty 1 pcs		

			
1			
GEV No.	698857	Ref. No.	1.1.C.C10.08 GGC1078-14-black
description	shelf support L 28.5mm W 14mm H 17.5mm plastic Qty 1 pcs		

			
1			
GEV No.	692408	Ref. No.	1.1.C.C10.09 GGC2270-17 GGC2270-17-white
description	shelf support L 38.5mm W 14mm H 18mm plastic Qty 1 pcs		

			
1			
GEV No.	699416	Ref. No.	1.1.C.C10.10 GGC2270-17-black
description	shelf support L 38.5mm W 14mm H 18mm plastic Qty 1 pcs		

gaskets

refrigeration gaskets

plug-in gaskets

profile 9930

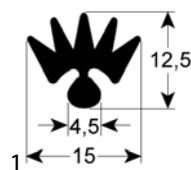

GEV No.	901645	Ref. No.	1.1.C.63.69 GCV1600-07
description	refrigeration gasket profile 9930 Wmm L 746mm plug size		

screw-in gaskets

profile 9997

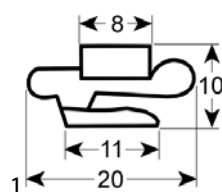

GEV No.	902150	Ref. No.	A1.1.C.C21.17
description	refrigeration gasket profile 9997 W 408mm L 720mm external size		

profile 9968

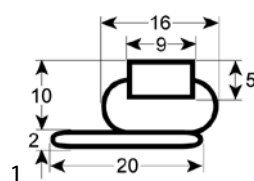

GEV No.	901649	Ref. No.	1.1.E.E1.35 GGC1078-19 GGC1078-19-black
description	refrigeration gasket profile 9968 W 418mm L 658mm external size with metal reinforcement Qty 1 pcs		

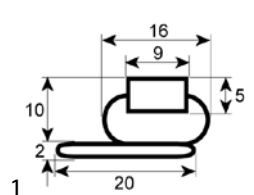

GEV No.	901650	Ref. No.	1.1.E.E1.25 GGC2270-23 GGC2270-23 white
description	refrigeration gasket profile 9968 W 515mm L 1390mm external size with metal reinforcement Qty 1 pcs		



profile 9910

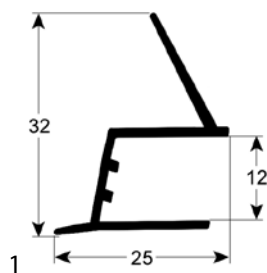

GEV No.	901651	Ref. No.	1.1.C.C63.67 GCV1600-23
description	refrigeration gasket profile 9910 Wmm L 735mm Qty 1 mounting pos. left		

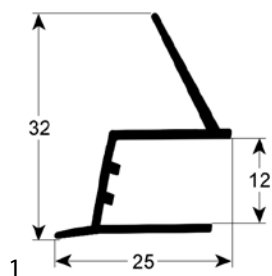

GEV No.	901646	Ref. No.	1.1.C.C63.76 GCV1600-24
description	refrigeration gasket profile 9910 Wmm L 735mm Qty 1 mounting pos. right		

refrigeration cycle components

filter driers

miscellaneous



GEV No.	750381	Ref. No.	A1.1.A.A04.01
description	dryer ø 18.5mm L 115.5mm connection 2,4/5,2mm Qty 1 pcs		



GEV No.	750693	Ref. No.	1.1.A.A04.01 GCV1600-40
description	dryer ø 19mm L 120.5mm connection 2/5mm Qty 1 pcs		



GEV No.	750383	Ref. No.	GGC2270-08 GGC2270-8
description	dryer ø 19mm L 182mm connection 6,5/6,5mm Qty 1 pcs		



GEV No.	750694	Ref. No.	1.1.A.A04.06 GGC2270-07 GGC2270-7
description	dryer ø 25mm L 144mm connection 6/8mm Qty 1 pcs		

refrigeration pipes

copper pipes uninsulated



GEV No.	692407	Ref. No.	1.1.B.B06.21 GGC2270-57
description	copper pipe copper ID ø 3.8mm ED ø 4.8mm L 0.1m Qty 1 pcs		



GEV No.	692667	Ref. No.	1.1.B.B02.07 A1.1.B.B02.07
description	copper pipe ID ø 5mm ED ø 6mm L 0.23m Qty 1		



GEV No.	692418	Ref. No.	1.1.B.B06.26 GGC2270-56
description	refrigeration pipe copper ID ø 5mm ED ø 6mm L 1m Qty 1		



GEV No.	692699	Ref. No.	1.1.B.B06.27 A1.1.B..B02.04
description	refrigeration pipe ID ø 3.5mm ED ø 5mm L 0.1m		

heating tubes

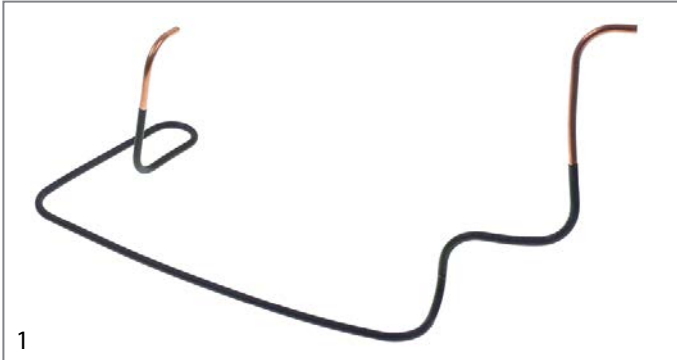

1	GEV No.	699421	Ref. No.	GCV1600-49
	description	heater ED ø 5mm ID ø 3.3mm L 320mm copper Qty 1m		

for display coolers

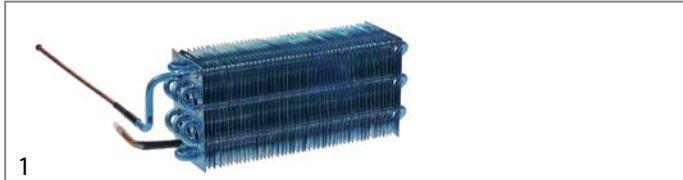

1	GEV No.	750646	Ref. No.	A1.1.A.A09.03
	description	evaporator L 280mm W 82mm H 116mm total length 330mm overall width 120mm		



1	GEV No.	750648	Ref. No.	1.1.A.A10.85
	description	evaporator L 305mm W 50mm H 115mm total length 305mm overall width 50mm overall height 150mm		

evaporators

for fridges

producer-specific



1	GEV No.	750352	Ref. No.	1.1.A.A10.27 GGC1078-43
	description	evaporator L 250mm W 50mm H 117mm		

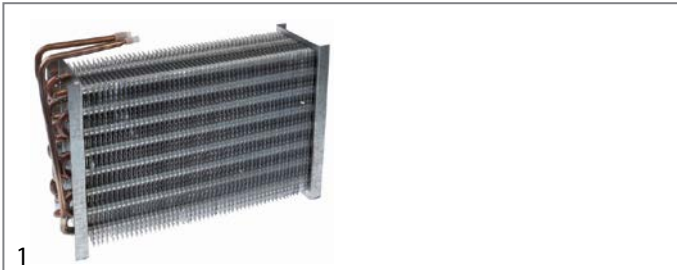

1	GEV No.	750350	Ref. No.	1.1.A.A10.40 GGC2270-15
	description	evaporator L 345mm W 100mm H 215mm total length 345mm overall width 100mm overall height 240mm for fridge		



1	GEV No.	750371	Ref. No.	1.1.A.A10.23 GCV1600-09
	description	evaporator L 545mm W 50mm H 110mm total length 600mm overall width 50mm overall height 123mm		

condensers

condensers



1	GEV No.	750647	Ref. No.	A1.1.A.A06.03
	description	condenser for vitrine W 160mm D 312mm H 110mm Qty 1 pcs		



1	GEV No.	750649	Ref. No.	1.1.A.A09.08
	description	condenser for vitrine W 330mm D 140mm H 280mm Qty 1 pcs		



1

GEV No.	750384	Ref. No.	1.1.A.A09.01 GGC1078-07 GGC1078-7
description	condenser W 220mm D 60mm H 280mm Qty 1 pcs		

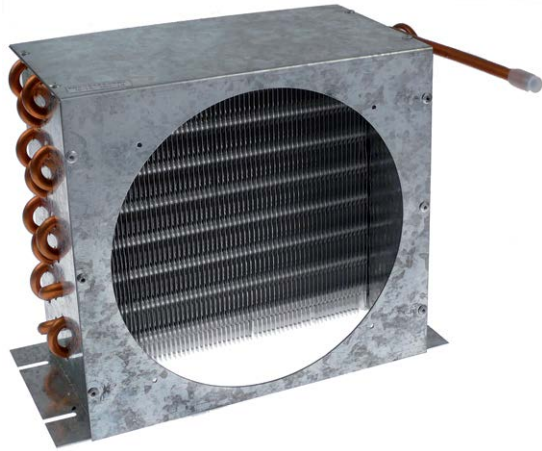

1

GEV No.	750351	Ref. No.	1.1.A.A09.09 GGC2270-11
description	condenser W 255mm D 130mm H 235mm		



1

GEV No.	750370	Ref. No.	1.1.A.A09.21 GCV1600-30
description	condenser W 265mm D 93mm H 140mm Qty 1 pcs		

evaporation and condensing trays

unheated condensing trays



1

GEV No.	699418	Ref. No.	1.1.C.C29.02 GGC2270-04 GGC2270-4
description	drip tray L 400mm W 144mm H 50mm plastic		

springs

compression springs



1

GEV No.	692701	Ref. No.	1.1.B.B10.06
description	spring L 4mm wire gauge ϕ 1mm windings 5 D1 ϕ 9.5mm		

hoses

industrial hoses

PVC hoses

PVC hoses without fabric



1

GEV No.	699440	Ref. No.	A1.1.K.K04.08
description	hose ID ϕ 10mm ED ϕ 13mm L 196m		



1

GEV No.	699439	Ref. No.	A1.1.E.E06.03
description	hose ID ϕ 8mm ED ϕ 10mm L 0.36m		



formed hoses

miscellaneous



GEV No.	699420	Ref. No.	1.1.C.C41.13 GGC1078-47
description	formed hose ID ø 19mm ED ø 24mm L 150mm		

A

axial fans 6

C

cables 8

castors and bumper angles 18

cold air circulating fans 7

compressors 5

copper pipes uninsulated 21

D

defrost timers 4

E

electric accessories 8

electronic controllers 4

evaporators 22

F

fans 6

filter driers 21

fluorescent lamps 4

formed hoses 24

G

grates 18

H

hoses 23

I

industrial hoses 23

L

lamps 3

LED 3

P

plug-in gaskets 20

power supply cables 8

PVC hoses 23

R

refrigeration cycle components 21

refrigeration fans 6

refrigeration gaskets 20

refrigeration motors universal 6

refrigeration pipes 21

rocker/momentary rocker switches 3

S

screw-in gaskets 20

shelves and shelf rails 18

starter 4

switches and momentary switches 3

T

thermostats 3

timers 4