



GAS COMPONENTS



ELECTRIC COMPONENTS



WATER TECHNOLOGY



MECHANICAL COMPONENTS



TOOLS

Spare parts suitable for

NUOVA SIMONELLI

Find the complete and up-to-date range of products in our GEV Webshop



Manufacturer catalogue

The most important spare parts and accessories arranged clearly for every manufacturer

- ✓ Complete product range and all appliance data always up to date in the GEV Webshop
- ✓ Alphabetical Index at the end of the catalogue

GEV Webshop

www.gev-online.co.uk

www.gev-online.com







- 🔍 Add to Favourites
- 🔍 Sign In with email address and usual password
- 🔍 Easy-order – place several items in your basket at the same time
- 🔍 Quick Item search – no login needed











heating elements

heating elements for coffee machine

			
GEV No.	417193	Ref. No.	14100035
description	heating cartridge 14W 230V ø 12mm L 64mm connection cable cable length 230mm		

			
GEV No.	417194	Ref. No.	14100037
description	heating cartridge 600W 230V heating circuits 1 L 74mm ø 10mm thread 3/8" cable length 250mm immersion heater screw mounting		
accessories for	417194		
	GEV No.	Ref. No.	
	518393	—	
	flat gasket FIBER ED ø 24mm ID ø 17mm thickness 2mm Qty 1 pcs		
	GEV No.	Ref. No.	
	528885	—	
	flat gasket PTFE ED ø 26mm ID ø 17mm thickness 2mm Qty 1 pcs suitable for SPAZIALE		

			
GEV No.	417132	Ref. No.	14100008
description	heating element 1200W 230V heating circuits 1 ø 88mm H 42mm W1 70mm H1 20mm H2 22mm mounting distance 62mm thread 1/4" copper windings 2 tube ø 8mm immersion heater 2 hole fixing connection M4		
accessories for	417132		
	GEV No.	Ref. No.	
	361182	18010386	
	nut thread 1/4" H 5mm nickel-plated brass WS 17 Qty 1 pcs		
	GEV No.	Ref. No.	
	510417	—	
	flat gasket fibre ED ø 20mm ID ø 14mm thickness 2mm Qty 1 pcs		
	GEV No.	Ref. No.	
	520228	—	
	tooth lock washer ID ø 15.3mm ED ø 24mm steel Qty 1 pcs for thread M14		
	GEV No.	Ref. No.	
	550262	—	
	flat gasket copper ED ø 20mm ID ø 14mm thickness 2mm		

			
GEV No.	417195	Ref. No.	14100040
description	heating element 1200W 230V heating circuits 1 thread 1" L 155mm W 22mm H 22mm tube ø 8.5mm thermostat sleeves ø 7mm length thermostat sleeves 160mm number of thermostat sleeves 1 thermostat sleeve eccentric, clinging connection male faston 6.3mm immersion heater flange with thread WS 30		
accessories for	417195		
	GEV No.	Ref. No.	
	510404	—	
	flat gasket fibre ED ø 44mm ID ø 34mm thickness 2mm Qty 1 pcs		
	GEV No.	Ref. No.	
	528018	—	
	flat gasket PTFE ED ø 41mm ID ø 33mm thickness 3mm size 1" Qty 1 pcs		

			
GEV No.	417054	Ref. No.	14100009
description	heating element 1400W 230V heating circuits 1 ø 70mm H 60mm H1 18mm H2 42mm mounting distance 40mm thread 1/4" windings 4 tube ø 8.5mm immersion heater 2 hole fixing connection M3		
accessories for	417054		
	GEV No.	Ref. No.	
	361182	18010386	
	nut thread 1/4" H 5mm nickel-plated brass WS 17 Qty 1 pcs		
	GEV No.	Ref. No.	
	510417	—	
	flat gasket fibre ED ø 20mm ID ø 14mm thickness 2mm Qty 1 pcs		
	GEV No.	Ref. No.	
	520228	—	
	tooth lock washer ID ø 15.3mm ED ø 24mm steel Qty 1 pcs for thread M14		
	GEV No.	Ref. No.	
	527169	—	
	hexagonal nut thread M3 H 2.8mm WS 5.5 brass Qty 1 pcs		
	GEV No.	Ref. No.	
	550262	—	
	flat gasket copper ED ø 20mm ID ø 14mm thickness 2mm		
	GEV No.	Ref. No.	
	560110	—	
	plain washer ID ø 3.2mm ED ø 7mm thickness 0.5mm SS Qty 20 pcs DIN 125A for thread M3		
	GEV No.	Ref. No.	
	560130	—	
	hexagonal nut thread M3 H 2.4mm WS 5.5 SS DIN/ISO DIN 934 / ISO 4032/8673 Qty 20 pcs		

			
GEV No.	417052	Ref. No.	14100024 14100084
description	heating element 1800W 230V heating circuits 3 mounting ø 54mm hole distance 54/76mm L 165mm W 31mm H 46mm L1 20mm L2 36mm L3 120mm H1 26mm H2 20mm tube ø 8.5mm connection M4 immersion heater 6 hole flange		
accessories for	417052		
	GEV No.	Ref. No.	
	528805	—	
	flat gasket PTFE ED ø 68mm ID ø 55mm thickness 2.4mm Qty 1 pcs suitable for NUOVA SIMONELLI		







			
GEV No.	415202	Ref. No.	14100038 14100054
description	heating element 2000W 230V heating circuits 1 thread 1" L 170mm W 22mm H 23mm tube ø 8mm connection male faston 6.3mm immersion heater flange with thread		
accessories for	415202		
	GEV No.	Ref. No.	
	510404	—	
	flat gasket fibre ED ø 44mm ID ø 34mm thickness 2mm Qty 1 pcs		





Table continues overleaf









accessories for	415202			
	GEV No.	510422	Ref. No.	—
	gasket copper ED ϕ 37.7mm ID ϕ 32.5mm thickness 2.7mm for thread 1"			
	GEV No.	520233	Ref. No.	—
	nut thread 1" H 6mm brass WS 47 Qty 1 pcs			



	1			
GEV No.	417490	Ref. No.	14100054	
description	heating element 2300W 230V heating circuits 1 thread 1" L 172mm W 22mm H 25mm tube ϕ 8.5mm connection male faston 6.3mm WS 30 coffee machine parts stainless steel			





	1			
GEV No.	417131	Ref. No.	14100027	
description	heating element 2700W 230V heating circuits 3 mounting ϕ 54mm hole distance 77mm L 182mm W 32mm H 52mm L1 120mm L2 36mm L3 120mm H1 25mm H2 27mm hole ϕ 8mm tube ϕ 8mm connection M4 immersion heater 6 hole flange			
accessories for	417131			
	GEV No.	528804	Ref. No.	—
	flat gasket fibre ED ϕ 66mm ID ϕ 56mm thickness 2mm Qty 1 pcs			

	1			
GEV No.	417053	Ref. No.	14100011	
description	heating element 3000W 230V heating circuits 3 mounting ϕ 54mm hole distance 55mm L 330mm W 38mm H 55mm L1 22mm L2 66mm L3 237mm H1 26mm H2 29mm hole ϕ 8mm tube ϕ 8.5mm connection M3 immersion heater 6 hole flange			
accessories for	417053			
	GEV No.	527169	Ref. No.	—
	hexagonal nut thread M3 H 2.8mm WS 5.5 brass Qty 1 pcs			
	GEV No.	560110	Ref. No.	—
	plain washer ID ϕ 3.2mm ED ϕ 7mm thickness 0.5mm SS Qty 20 pcs DIN 125A for thread M3			
	GEV No.	560130	Ref. No.	—
	hexagonal nut thread M3 H 2.4mm WS 5.5 SS DIN/ISO DIN 934 / ISO 4032/8673 Qty 20 pcs			

	1			
GEV No.	417182	Ref. No.	14100004	
description	heating element 3400W 230V heating circuits 3 mounting ϕ 54mm hole distance 55mm L 340mm W 39mm H 24mm hole ϕ 8mm tube ϕ 8.5mm connection 1/8" immersion heater 6 hole flange			
accessories for	417182			
	GEV No.	528804	Ref. No.	—
	flat gasket fibre ED ϕ 66mm ID ϕ 56mm thickness 2mm Qty 1 pcs			



	1			
GEV No.	417184	Ref. No.	14100031	
description	heating element 4500W 230V heating circuits 2 mounting ϕ 54mm hole distance 55mm L 335mm W 37mm H 51mm L1 35mm L2 50mm L3 255mm H1 23mm H2 28mm hole ϕ 8mm tube ϕ 8.5mm connection M3 immersion heater 6 hole flange			
accessories for	417184			
	GEV No.	527169	Ref. No.	—
	hexagonal nut thread M3 H 2.8mm WS 5.5 brass Qty 1 pcs			
	GEV No.	560110	Ref. No.	—
	plain washer ID ϕ 3.2mm ED ϕ 7mm thickness 0.5mm SS Qty 20 pcs DIN 125A for thread M3			
	GEV No.	560130	Ref. No.	—
	hexagonal nut thread M3 H 2.4mm WS 5.5 SS DIN/ISO DIN 934 / ISO 4032/8673 Qty 20 pcs			

	1			
GEV No.	417292	Ref. No.	14100012	
description	heating element 5000W 220V heating circuits 3 mounting ϕ 55mm hole distance 77mm L 575mm W 36mm H 60mm L1 25mm L2 60mm L3 490mm H1 24mm H2 36mm hole ϕ 8mm tube ϕ 8.3mm connection M3 immersion heater 6 hole flange			
accessories for	417292			
	GEV No.	526402	Ref. No.	02060015
	flat gasket PTFE ED ϕ 67mm ID ϕ 54mm thickness 2mm Qty 1 pcs			

	1			
GEV No.	417130	Ref. No.	14100012	
description	heating element 5000W 230V heating circuits 3 mounting ϕ 54mm hole distance 30mm L 522mm W 27mm H 38mm hole ϕ 7.5mm connection M3 immersion heater 8 hole flange			
accessories for	417130			
	GEV No.	527169	Ref. No.	—
	hexagonal nut thread M3 H 2.8mm WS 5.5 brass Qty 1 pcs			
	GEV No.	560110	Ref. No.	—
	plain washer ID ϕ 3.2mm ED ϕ 7mm thickness 0.5mm SS Qty 20 pcs DIN 125A for thread M3			
	GEV No.	560130	Ref. No.	—
	hexagonal nut thread M3 H 2.4mm WS 5.5 SS DIN/ISO DIN 934 / ISO 4032/8673 Qty 20 pcs			

	1			
GEV No.	417293	Ref. No.	14100084	
description	heating element INCOLOY 1800W 230V heating circuits 3 mounting ϕ 55mm hole distance 77mm L 155mm W 36mm H 50mm L1 20mm L2 55mm L3 80mm H1 24mm H2 26mm hole ϕ 8mm tube ϕ 8.5mm connection M4 6 hole flange			





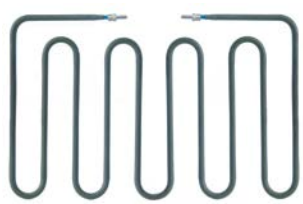

			
1			
GEV No.	417228	Ref. No.	14100050 14100088
description	heating element INCOLOY 2600W 230V heating circuits 1 thread 1 1/4" L 155mm ϕ 35mm tube ϕ 6.3mm thermostat sleeves ϕ 7.5mm length thermostat sleeves 150mm number of thermostat sleeves 1 thermostat sleeve eccentric, clinging connection male faston 6.3mm immersion heater flange with thread WS 37 W 52mm H 52mm		
spare parts for	417228		
	GEV No.	510405	Ref. No. 18010760
		flat gasket fibre ED ϕ 56mm ID ϕ 42mm thickness 2mm for thread 1 1/4" Qty 1 pcs	
accessories for	417228		
	GEV No.	528021	Ref. No. —
		flat gasket PTFE ED ϕ 53mm ID ϕ 42.5mm thickness 3mm Qty 1 pcs equiv. no. 12001/02286 suitable for Astoria/Aurora/Brasilia/Wega	

heating elements for contact grills

			
1			
GEV No.	416590	Ref. No.	15320004
description	heating element 1150W 230V L 192mm W 304mm H 18mm W1 98mm W2 108mm connection length 24mm tube ϕ 6.3mm windings 5 connection M4 mounting pos. lower dry heating element		





heating cartridges

			
1			
GEV No.	417194	Ref. No.	14100037
description	heating cartridge 600W 230V heating circuits 1 L 74mm ϕ 10mm thread 3/8" cable length 250mm immersion heater screw mounting		
accessories for	417194		
	GEV No.	518393	Ref. No. —
		flat gasket FIBER ED ϕ 24mm ID ϕ 17mm thickness 2mm Qty 1 pcs	
	GEV No.	528885	Ref. No. —
		flat gasket PTFE ED ϕ 26mm ID ϕ 17mm thickness 2mm Qty 1 pcs suitable for SPAZIALE	

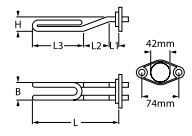

			
1			
GEV No.	417193	Ref. No.	14100035
description	heating cartridge 14W 230V ϕ 12mm L 64mm connection cable cable length 230mm		

immersion heating elements

2 hole flange 74mm

 			
1			
GEV No.	415191	Ref. No.	18000003
description	heating element 2300W 220V heating circuits 1 mounting ϕ 42mm L 240mm W 29mm H 27mm L1 35mm L2 35mm L3 170mm tube ϕ 8.5mm hole distance 74mm hole ϕ 8mm connection M4 immersion heater 2 hole flange H1 8mm H2 23mm flange length 94mm flange width 58mm		
accessories for	415191		
	GEV No.	521103	Ref. No. —
		nut thread M4 H 3mm WS 7 brass Qty 20 pcs	
	GEV No.	521104	Ref. No. —
		washer ID ϕ 4.3mm ED ϕ 8mm thickness 0.5mm brass Qty 20 pcs for thread M4	
	GEV No.	560111	Ref. No. —
		plain washer ID ϕ 4.3mm ED ϕ 9mm thickness 0.8mm SS Qty 20 pcs DIN 125A for thread M4	
	GEV No.	560131	Ref. No. —
		hexagonal nut thread M4 H 3.2mm WS 7 SS DIN/ISO DIN 934 / ISO 4032/8673 Qty 20 pcs	

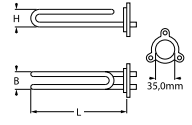
3 hole flange ϕ 35.0mm

 			
1			
GEV No.	416210	Ref. No.	18011020
description	heating element 2200W 230V heating circuits 1 mounting ϕ 35mm L 253mm W 25mm H 25mm tube ϕ 6.5mm hole distance 44mm hole ϕ 10mm connection M5 immersion heater 3 hole flange connection length 16mm		
accessories for	416210		
	GEV No.	507048	Ref. No. —
		gasket ID ϕ 30mm silicone thickness 3mm hole ϕ 10mm hole distance 41mm for heating element warewashing	

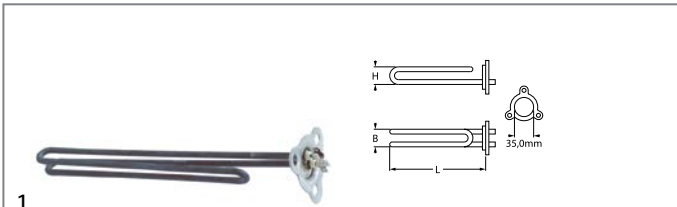

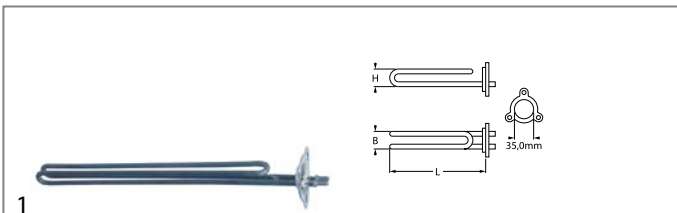

1

GEV No.	416211	Ref. No.	18010296
description	heating element 2700W 230V heating circuits 1 mounting \varnothing 35mm L 300mm W 25mm H 24mm tube \varnothing 6.3mm hole distance 44mm hole \varnothing 10mm connection male faston 6.3mm immersion heater 3 hole flange connection length 15mm		
accessories for	416211		
	GEV No.	507048	Ref. No. —
	gasket ID \varnothing 30mm silicone thickness 3mm hole \varnothing 10mm hole distance 41mm for heating element warewashing		



1

GEV No.	416212	Ref. No.	18010028.1
description	heating element 3000W 230V heating circuits 1 mounting \varnothing 35mm L 330mm W 28.5mm H 25mm tube \varnothing 6.25mm hole distance 44mm hole \varnothing 10mm connection M5 immersion heater 3 hole flange connection length 15mm		
accessories for	416212		
	GEV No.	507048	Ref. No. —
	gasket ID \varnothing 30mm silicone thickness 3mm hole \varnothing 10mm hole distance 41mm for heating element warewashing		

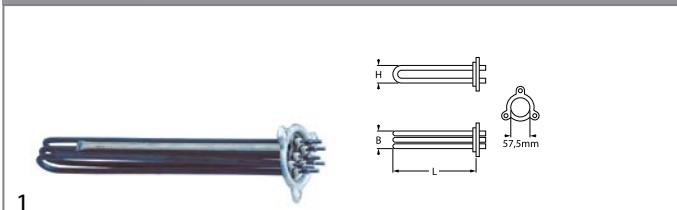

3 hole flange \varnothing 57.5mm

1

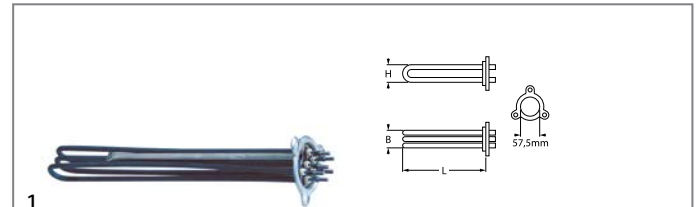
GEV No.	416213	Ref. No.	18010743
description	heating element 4500W 230V mounting \varnothing 57.5mm heating circuits 3 L 383mm W 50mm H 38mm number of thermostat sleeves 1 thermostat sleeves \varnothing 8mm length thermostat sleeves 290mm thermostat sleeve eccentric, non clinging tube \varnothing 8mm hole distance 70mm hole \varnothing 8mm connection M5 3 hole flange immersion heater		
accessories for	416213		
	GEV No.	550002	Ref. No. —
	tension strap H 10mm L 21mm W 10mm hole \varnothing 6.5mm for heating element		



1

GEV No.	416214	Ref. No.	18010744
description	heating element 6000W 230V mounting \varnothing 57.5mm heating circuits 3 L 410mm W 32mm H 50mm thermostat sleeves \varnothing 8.5mm length thermostat sleeves 270mm thermostat sleeve upper centre not clinging tube \varnothing 8.5mm hole distance 70mm hole \varnothing 10mm connection length 30mm connection M5 3 hole flange immersion heater		
accessories for	416214		
	GEV No.	510409	Ref. No. 18010746
	O-ring EPDM thickness 5.34mm ID \varnothing 56.52mm Qty 1 pcs		
	GEV No.	520332	Ref. No. —
	protection cap for heating element		

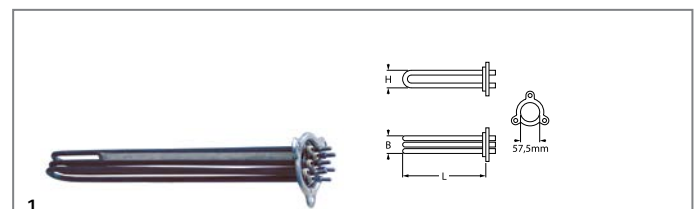

1

GEV No.	416215	Ref. No.	18010745
description	heating element 9000W 230V mounting \varnothing 57.5mm heating circuits 3 L 410mm W 35mm H 52mm number of thermostat sleeves 1 thermostat sleeves \varnothing 7.5mm length thermostat sleeves 290mm thermostat sleeve eccentric, non clinging tube \varnothing 8mm hole distance 70mm hole \varnothing 8mm connection M5 3 hole flange immersion heater		



1"

1

GEV No.	415195	Ref. No.	18000004
description	heating element 2500W 230V heating circuits 1 thread 1" L 200mm W 20mm H 20mm tube \varnothing 8.5mm connection male faston 6.3mm immersion heater flange with thread		
accessories for	415195		
	GEV No.	510404	Ref. No. —
	flat gasket fibre ED \varnothing 44mm ID \varnothing 34mm thickness 2mm Qty 1 pcs		
	GEV No.	510422	Ref. No. —
	gasket copper ED \varnothing 37.7mm ID \varnothing 32.5mm thickness 2.7mm for thread 1"		
	GEV No.	520233	Ref. No. —
	nut thread 1" H 6mm brass WS 47 Qty 1 pcs		



1 1/4"			
1			
GEV No.	416218	Ref. No.	18010716
description	heating element 4500W 230V heating circuits 3 thread 1 1/4" L 275mm W 95mm H 45mm L1 40mm L2 25mm L3 210mm W1 32mm W2 29mm H1 23mm H2 22mm connection male faston 6.3mm immersion heater flange with thread		
spare parts for	416218		
	GEV No.	510405	Ref. No. 18010760
	flat gasket fibre ED ø 56mm ID ø 42mm thickness 2mm for thread 1 1/4" Qty 1 pcs		
accessories for	416218		
	GEV No.	507333	Ref. No. —
	flat gasket rubber ED ø 52mm ID ø 41.5mm thickness 3mm Qty 1 pcs equiv. no. G50403GT suitable for IME/Omniwash		
	GEV No.	528021	Ref. No. —
	flat gasket PTFE ED ø 53mm ID ø 42.5mm thickness 3mm Qty 1 pcs equiv. no. 12001/02286 suitable for Astoria/Aurora/Brasilia/Wega		

1			
GEV No.	416216	Ref. No.	18010044.0
description	heating element 1800W 230V heating circuits 1 L 330mm W 48mm H 32mm thread M12x1 mounting distance 40mm tube ø 8.5mm connection male faston 6.3mm 2 hole fixing immersion heater		
accessories for	416216		
	GEV No.	507332	Ref. No. 02060029
	flat gasket fibre ED ø 18mm ID ø 12mm thickness 2mm Qty 1 pcs		
	GEV No.	511923	Ref. No. 18010515
	protection cap for heating element thread M12		
	GEV No.	550681	Ref. No. —
	nut thread M12x1.25 H 5mm WS 17 brass Qty 1 pcs		

1			
GEV No.	416217	Ref. No.	18010385
description	heating element 2500W 230V heating circuits 1 L 410mm W 147mm H 27mm thread M12x1 mounting distance 35mm tube ø 8.3mm connection male faston 6.3mm 2 hole fixing immersion heater L1 195mm L2 215mm W1 96mm W2 43mm		
accessories for	416217		
	GEV No.	507332	Ref. No. 02060029
	flat gasket fibre ED ø 18mm ID ø 12mm thickness 2mm Qty 1 pcs		

1			
GEV No.	416219	Ref. No.	18010044.1 18011021
description	heating element 800W 230V heating circuits 1 L 317mm W 55mm H 32mm thread M12x1 mounting distance 46.5mm tube ø 8.5mm connection male faston 6.3mm 2 hole fixing immersion heater		
accessories for	416219		
	GEV No.	507332	Ref. No. 02060029
	flat gasket fibre ED ø 18mm ID ø 12mm thickness 2mm Qty 1 pcs		
	GEV No.	520229	Ref. No. —
	nut thread M12x1 H 4mm WS 16 zinc-coated steel Qty 1 pcs		

thermostats

bi-metal thermostats

safety bi-metal thermostats

Image not available			
1			
GEV No.	390295	Ref. No.	09500006
description	bi-metal safety thermostat		

1			
GEV No.	375754	Ref. No.	09500002
description	bi-metal safety thermostat hole distance 23.5mm switch-off temp. 125°C 1NC 1-pole 16A connection F6.3 2 hole fixing		

1			
GEV No.	390197	Ref. No.	09500004
description	bi-metal safety thermostat hole distance 23.8mm switch-off temp. 135°C 1NC 1-pole 16A connection F6.3 2 hole fixing		

1			
GEV No.	390455	Ref. No.	18010789
description	bi-metal safety thermostat hole distance 40mm switch-off temp. 100°C 2NC 2-pole 16A connection F6.3 2 hole fixing		



1

GEV No.	390456	Ref. No.	18010955
description	bi-metal safety thermostat hole distance 40mm switch-off temp. 85°C 2NC 2-pole 16A connection F6.3 2 hole fixing		

control and safety thermostats

IMIT / TEMPOMATIC / ARTERMO

control thermostats



1

GEV No.	390186	Ref. No.	18010042
description	thermostat t.max. 52°C temperature range fixed 52°C 1-pole 1CO 16A probe ø 6.5mm probe L 95mm capillary pipe 1000mm capillary pipe isolated 1000mm gland nut shaft Lmm contacts 1CO		





1

GEV No.	390457	Ref. No.	18010043
description	thermostat t.max. 85°C temperature range 0-90°C 1-pole 1CO 16A probe ø 6.5mm probe L 110mm capillary pipe 1000mm capillary pipe isolated 950mm gland nut shaft ø 6x4.6mm shaft L 19mm shaft position upper shaft position +135° rotation 270° probe material copper		



1

GEV No.	390006	Ref. No.	18010043
description	thermostat t.max. 86°C temperature range 0-86°C 1-pole 1CO 16A probe ø 6.5mm probe L 95mm capillary pipe 1500mm capillary pipe isolatedmm gland nut shaft ø 6x4.6mm shaft L 19mm rotation 270°		
accessories for	390006		
	GEV No.	110100	Ref. No. 18010388
	knob thermostat t.max. 90°C 0-90°C ø 42mm shaft ø 6x4.6mm shaft flat -135° black		
	GEV No.	110105	Ref. No. —
	rosette knob ø 42mm ø 56mm zero mark		

switches and momentary switches
rocker/momentary rocker switches

19x22mm



1

GEV No.	346549	Ref. No.	04200057
description	rocker switch mounting measurements 19x22mm black 2NO 250V 10A 0-I connection male faston 4.8mm protection IP40		



1

GEV No.	347275	Ref. No.	04200056
description	rocker switch mounting measurements 19x22mm black 1NO/NO 250V 10A 0-I/0-II connection male faston 4.8mm protection IP40		

30x22mm





1

GEV No.	301135	Ref. No.	18010786
description	momentary rocker switch mounting measurements 30x22mm orange 2NO 24V 16A illuminated connection male faston 6.3mm ambient temperature max. 100/55°C protection IP40		



1

GEV No.	301018	Ref. No.	18010589
description	momentary rocker switch mounting measurements 30x22mm orange 2NO 250V 16A illuminated 0-I connection male faston 6.3mm ambient temperature max. 125/55°C protection IP65		
accessories for	301018		
	GEV No.	301036	Ref. No. —
	protective cover internal size 30x22mm for rocker switch mounting measurementsmm		





1

GEV No.	301001	Ref. No.	04200011
description	rocker switch mounting measurements 30x22mm red 2NO 250V 16A illuminated 0-I connection male faston 6.3mm ambient temperature max. 125/55°C protection IP65		
accessories for	301001		
	GEV No.	301036	Ref. No. —
	protective cover internal size 30x22mm for rocker switch mounting measurementsmm		





			
1			
GEV No.	301278	Ref. No.	18010785
description	rocker switch mounting measurements 30x22mm green 2CO 24V 6A illuminated connection male faston 6.3mm ambient temperature max. 85°C protection IP40		



			
1			
GEV No.	301132	Ref. No.	18010225
description	momentary rocker switch mounting measurements 30x22mm green 2NO 250V 16A illuminated rinsing warm/cold connection male faston 6.3mm ambient temperature max. 85°C protection IP40		

			
1			
GEV No.	301017	Ref. No.	18010053
description	rocker switch mounting measurements 30x22mm green 2CO 250V 16A illuminated connection male faston 6.3mm ambient temperature max. 125/55°C protection IP40		
accessories for	301017		
	GEV No.	301036	Ref. No. —
	protective cover internal size 30x22mm for rocker switch mounting measurementsmm		



			
1			
GEV No.	301134	Ref. No.	18010420
description	momentary rocker switch mounting measurements 30x22mm orange 2NO 250V 16A illuminated outflow connection male faston 6.3mm ambient temperature max. 100/55°C protection IP40		

			
1			
GEV No.	301015	Ref. No.	04200027
description	rocker switch mounting measurements 30x22mm red 2CO 250V 16A illuminated connection male faston 6.3mm ambient temperature max. 125/55°C protection IP40		

			
1			
GEV No.	301133	Ref. No.	18010058
description	momentary rocker switch mounting measurements 30x22mm orange 2NO 250V 16A illuminated regeneration connection male faston 6.3mm ambient temperature max. 85/125°C protection IP40		

			
1			
GEV No.	301188	Ref. No.	16300122
description	rocker switch mounting measurements 30x22mm black 2NO/2NO 250V 16A IO II connection male faston 6.3mm ambient temperature max. 125/55°C protection IP40		
accessories for	301188		
	GEV No.	301036	Ref. No. —
	protective cover internal size 30x22mm for rocker switch mounting measurementsmm		

34.2x12.6mm			
			
1			
GEV No.	301131	Ref. No.	18010609
description	momentary rocker switch mounting measurements 34.2x12.6mm orange 2NO 250V 16A illuminated rinsing warm/cold connection male faston 6.3mm		

			
1			
GEV No.	347465	Ref. No.	18010826
description	momentary rocker switch mounting measurements 30x22mm orange 2NO 250V 16A illuminated connection male faston 6.3mm ambient temperature max. 100/55°C protection IP44		
accessories for	347465		
	GEV No.	301036	Ref. No. —
	protective cover internal size 30x22mm for rocker switch mounting measurementsmm		

push/momentary push switches			
27.2x22.2mm			
			
1			
GEV No.	345090 ¹	Ref. No.	04200032
description	momentary push switch mounting measurements 27.2x22.2mm red 2NO 250V 16A illuminated connection male faston 6.3mm ambient temperature max. 85°C protection IP40		

			
1			
GEV No.	345033 ¹	Ref. No.	04200030
description	push switch mounting measurements 27.2x22.2mm red 2NO 250V 16A illuminated connection male faston 6.3mm ambient temperature max. 85°C protection IP40		

¹illuminated

¹illuminated



ø25mm



1

GEV No.	346121	Ref. No.	04200038
description	momentary push switch mounting ø 25mm red 2NO 250V 16A illuminated connection male faston 6.3mm ambient temperature max. 85°C protection IP40		



1

GEV No.	345162 ¹	Ref. No.	04200039
description	push switch mounting ø 25mm yellow 2NO 250V 16A illuminated connection male faston 6.3mm ambient temperature max. 85°C protection IP40		

¹illuminated

accessories

push buttons



1

GEV No.	112017	Ref. No.	05000176
description	push button mounting ø 19mm shaft 3.5x3.5mm grey		

microswitches

lever actuated



1

GEV No.	346169	Ref. No.	04200043
description	microswitch with lever connection male faston		



1

GEV No.	346168	Ref. No.	04200042
description	microswitch with lever		



1

GEV No.	345270	Ref. No.	04200042
description	microswitch with lever 250V 16A 1CO connection male faston 6.3mm ambient temperature max. 85°C mounting distance 25mm type C99ZP3 actuating force: 30g lever length 140mm		

roller-lever actuated

with mounting components



1

GEV No.	345370	Ref. No.	16000019
description	microswitch with handle with a switch 250V 16A 1CO connection male faston 6.3mm L 27mm ambient temperature max. 125°C mounting distance 24mm actuating force: 45g lever length 26.5mm		

pin-plunger actuated



1

GEV No.	345528	Ref. No.	18010145 18010625
description	microswitch 250V 4A 1CO connection male faston 6.3mm ambient temperature max. 125°C mounting distance 22mm with plunger white		

M10



1

GEV No.	345156	Ref. No.	04200041
description	microswitch with plunger thread M10x1 thread L 13mm 250V 16A 1CO connection male faston 6.3mm stroke 6mm mounting distance 25mm L 46mm L1 13mm ambient temperature max. 85°C type C4A-ZN3 actuating force: 340g		

with push button

switches with snap-fit





1

GEV No.	346166	Ref. No.	04200063
description	microswitch mounting measurements 28.5/13.5mm mounting ømm white 1NO 250V 4A connection male faston 6.3mm ambient temperature max. 85°C protection IP40 with plunger actuating force: 150g		





 <p>1</p>			
GEV No.	346772	Ref. No.	15030009
description	microswitch with push button 250V 5A 1CO connection male faston 4.8mm L 24x27mm ambient temperature max. 85°C actuating force: 160g		

 <p>1</p>			
GEV No.	345651	Ref. No.	18011025
description	switch 2CO 250V 16A connection male faston 6.3mm		

accessories			
 <p>1</p>			
GEV No.	507037	Ref. No.	18010045 18010398
description	back part for microswitch		

 <p>1</p>			
GEV No.	346165	Ref. No.	04200051
description	switch 2NO 250V 16A connection male faston 6.3mm		

 <p>1</p>			
GEV No.	507041	Ref. No.	18010045
description	front part for microswitch		

float switches			
 <p>1</p>			
GEV No.	345371	Ref. No.	16000475
description	float switch with plunger 250V 16A 1CO male faston 6.3mm L 60mm ambient temperature max. 125°C mounting distance 22mm type EF83161.5 actuating force: 20g blue/black		

system switches (ROLD)			
 <p>1</p>			
GEV No.	345650	Ref. No.	18011026
description	momentary switch unit 2CO 250V 16A connection male faston 6.3mm		

floats			
 <p>1</p>			
GEV No.	695044	Ref. No.	16000520
description	float		

 <p>1</p>			
GEV No.	347466	Ref. No.	40900005
description	push button ø 11.9mm shaft ø 3.6x3.6mm gold shaft L 9mm		

rotary switches			
BREMAS			
A1700 series			
 <p>1</p>			
GEV No.	347085	Ref. No.	04200015
description	rotary switch 2 0-1 sets of contacts 2 type CA0170002V 400V 20A shaft ø 5x5mm shaft L 18mm shaft square connection screw		

 <p>1</p>			
GEV No.	345524	Ref. No.	18010953
description	push button ø 23mm red ON-OFF		



			
1			
GEV No.	346004	Ref. No.	04200015
description	rotary switch 20A shaft L 23mm 2 operating positions 2-pole shaft 5x5mm screw		

BRETER
rotary switches

			
1			
GEV No.	346071	Ref. No.	04200023
description	rotary switch 2 0-1 sets of contacts 4 type 11284 600V 16A shaft square connection screw		

			
1			
GEV No.	346070	Ref. No.	04200015
description	rotary switch connection screw clamp		

GIOVENZANA
rotary switches



			
1			
GEV No.	347404	Ref. No.	04200023
description	rotary switch 0-1 20A shaft ø 5x5mm shaft L 23mm ø 44/48mm L 49mm 2 operating positions 4-pole rotation 60°		

			
1			
GEV No.	346901	Ref. No.	04200022
description	rotary switch 2 0-1 sets of contacts 4 type C052 690V 32A shaft ø 5x5mm shaft L 25mm shaft square connection screw		

			
1			
GEV No.	346069	Ref. No.	04200022
description	rotary switch 20A 2 operating positions 4-pole		

VM			
			
1			
GEV No.	346097	Ref. No.	04200020 40402001
description	rotary switch 3 0-1-2 sets of contacts 3 type P600184 400V 40A shaft ø 5x5mm shaft L 23mm shaft square connection screw		

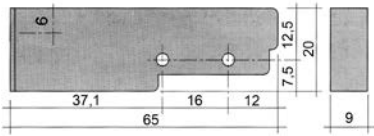
magnetic switches

65x20mm			
			
1			
			
GEV No.	345116	Ref. No.	18010706
description	magnetic switch L 65mm W 20mm 1NO 250V 0.4A P max. 100W connection cable cable length 3000mm		
accessories for	345116		
	GEV No.	345399	Ref. No. —
	magnet ø 3.3mm L 40mm H 8mm W 13mm hole distance 30mm M3		

control equipment
SIEMENS

3SB series ø22mm old			
rotary switches			
			
1			
GEV No.	345526	Ref. No.	18010772 18010777
description	rotary selector mounting measurements ø22mm sequence 0-1 latching black		



3SB series ø22mm new



1			
GEV No.	346631	Ref. No.	18010778
description	contact block SIEMENS 3SB3400-0C 1NC max 400V 10A black		

lamps

indicator lights

indicator lights 2-piece (lens and indicator lamp)

indicator light lenses

ø10mm (type SRZ-2)



1			
GEV No.	359359	Ref. No.	18010771
description	indicator light housings mounting measurements ø10mm green square		



1			
GEV No.	359358	Ref. No.	18010776
description	indicator light housings mounting measurements ø10mm orange square		

indicator lamps for socket type SRZ / SDK / SDY / SFK



1			
GEV No.	359129	Ref. No.	18010788
description	indicator lamp 24V clear connection male faston 6.3mm		

indicator lights (complete)

ø 9mm



1			
GEV No.	359421	Ref. No.	04200052
description	indicator light ø 9mm 230V red connection male faston 6.3mm		

27.2x22.2mm



1			
GEV No.	359209	Ref. No.	04200031
description	indicator light mounting measurements 27.2x22.2mm 230V red connection male faston 6.3mm temp.-resist. 125°C		

30x22mm



1			
GEV No.	359155	Ref. No.	04200012
description	indicator light mounting measurements 30x22mm 230V red connection male faston 6.3mm temp.-resist. 125°C type RL2		



1			
GEV No.	301138	Ref. No.	18010408 18010612
description	indicator light mounting measurements 30x22mm 230V red/green connection male faston 6.3mm temp.-resist. 125/55°C type RL2		

blank elements



1			
GEV No.	359776	Ref. No.	18010951
description	bezel ø 10mm cycle		



1			
GEV No.	359774	Ref. No.	18010949
description	bezel ø 10mm tank		



1			
GEV No.	359775	Ref. No.	18010950
description	bezel ø 13mm boiler mounting ø 10mm		

LED

indicator lamps

miscellaneous



1			
GEV No.	359229	Ref. No.	04500038
description	indicator light LED		





timers

programme timers

electric components



1

GEV No.	360217	Ref. No.	18010714
description	timer CDC 7807DV engines 2 chambers 7 operation time 6s / 3min 24V manuf. no. 7807DV motor type M37RN/M37LN		
spare parts for	360217		
	GEV No.	360324	Ref. No.
	motor CDC pinion ø 5.4mm teeth 12 24V voltage AC turn direction right motor ø 37mm motor type M37RN		
	GEV No.	360325	Ref. No.
	motor CDC pinion ø 5.4mm teeth 12 24V voltage AC turn direction left motor ø 37mm motor type M37LN		





1

GEV No.	360040	Ref. No.	18000094
description	timer CDC 9003F engines 1 chambers 3 operation time 6min 230V shaft ø 6x4.6mm shaft L 21mm manuf. no. 9003F3 / PRCIH5 motor type M48R ATS		
spare parts for	360040		
	GEV No.	360118	Ref. No.
	motor CDC pinion ø 4.9mm teeth 10 230V voltage AC 50/60Hz turn direction right motor ø 47mm H 19.3mm motor type M48R ATS for timer cable length 260mm 1.9/2.5W		
accessories for	360040		
	GEV No.	110197	Ref. No.
	knob switch zero mark ø 42mm shaft ø 6x4.6mm shaft flat adjustable black		





1

GEV No.	360219	Ref. No.	18010591
description	timer FIBER P25 engines 1 chambers 3 operation time 120s 230V shaft ømm shaft Lmm manuf. no. P255J03H3C1 motor type M51B-J0R6400		
spare parts for	360219		
	GEV No.	360673	Ref. No.
	motor kit pinion ø 6.8mm teeth 15 230V voltage AC 50/60Hz turn direction clockwise motor ø 48mm H 18.5mm motor type UDS-40NE1RNZ165 cable length 150mm with holder		



1

GEV No.	360249	Ref. No.	18011030
description	timer FIBER P25 engines 1 chambers 3 operation time 150s 230V shaft ømm shaft Lmm manuf. no. P255J03H4U7 motor type M51B-J0R6400 / 230V		
spare parts for	360249		
	GEV No.	360673	Ref. No.
	motor kit pinion ø 6.8mm teeth 15 230V voltage AC 50/60Hz turn direction clockwise motor ø 48mm H 18.5mm motor type UDS-40NE1RNZ165 cable length 150mm with holder		



1

GEV No.	360228	Ref. No.	18010421
description	timer FIBER P26 engines 1 chambers 2 operation time 180s 230V shaft ømm shaft Lmm manuf. no. P265J02H545 motor type M61B40R6400		

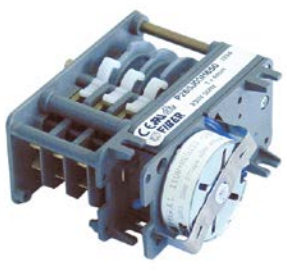
1

GEV No.	360222	Ref. No.	18010593
description	timer FIBER P26 engines 1 chambers 3 operation time 4min 230V shaft ømm shaft Lmm manuf. no. P265J03H649 motor type M61B40R6400		

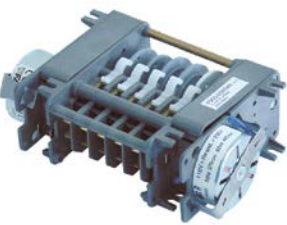

1

GEV No.	360218	Ref. No.	18010593
description	timer FIBER P26 engines 2 chambers 5 operation time 40s/4min 230V shaft ømm shaft Lmm manuf. no. P265J05KN48 motor type M61B40R6400 / M61B40L6400		

contactors

ISKRA (FANAL)

power contactors



1

GEV No.	380415	Ref. No.	18010823 18011029
description	power contactor resistive load 16A 230VAC (AC3/400V) 8.5A/5.5kW main contacts 3NO auxiliary contacts 1NC connection male faston 6.3mm type Fanal DSL7 01 type ISKRA K07MF 01		



1

GEV No.	380411	Ref. No.	18010705
description	power contactor resistive load 20A 24VAC (AC3/400V) 8.5A/5.5kW main contacts 3NO auxiliary contacts 1NC connection screw connection type Fanal DSL7 10 type ISKRA K07M 01		

relays

power relays

with bracket mounting



GEV No.	380366	Ref. No.	04200046
description	power relays 16A 2CO connection male faston bracket mounting 230V voltage AC		



1





GEV No.	380365	Ref. No.	04200044	
description	power relays 230VAC 12A 2CO connection male faston 4.8mm bracket mounting			
accessories for	380365			
	GEV No.	380476	Ref. No.	—
	relay socket dimensions 78x27x33.5mm 250V voltage AC 10A FINDER manuf. no. 96.72			

with male contacts

female contact 2.0mm



1

GEV No.	380129	Ref. No.	15010055	
description	power relays 24VAC 12A 2CO connection F2 plug-in connection 94.92.3 250V connection 2mm			
accessories for	380129			
	GEV No.	380341	Ref. No.	—
	relay socket 4-pole contacts 12 300V voltage AC 6A Italiana Relè manuf. no. ZMD4			
	GEV No.	380378	Ref. No.	—
	relay socket 2-pole 55/85 dimensions 70.5x30x27mm 250V voltage AC 10A FINDER manuf. no. 94.72			
	GEV No.	380384	Ref. No.	—
	relay socket 2-pole contacts male faston 2.8mm 250V voltage AC 10A W 23mm for			
	GEV No.	380399	Ref. No.	—
	relay socket 4-pole dimensions 76.2x27x86.1mm 250V voltage AC 1A FINDER manuf. no. 94.94.3			



relay sockets



1

GEV No.	380137	Ref. No.	0900011
description	relay socket 8-pole connection plug-in connection round 8-pole dimensions 65x28x40mm 380V voltage AC 10A Italiana Relè manuf. no. ZVE8		
accessories for	380137		
	GEV No.	380805	Ref. No. —
	support bracket		

time relays

time relays



1

GEV No.	360223	Ref. No.	18010793
description	time relay CDC Sc815 time range 6s 24VAC/DC 10A 1CO connection plug-in connection round 8-pole		
accessories for	360223		
	GEV No.	360230	Ref. No. —
	base		

level relays

GICAR



1

GEV No.	400240	Ref. No.	0900015
description	level relay 230V voltage AC 50/60Hz 8-pole 5A connection plug-in connection round 8-pole type RL30/1E-2C/8		

miscellaneous



1

GEV No.	400596	Ref. No.	04900195
description	level relay 230V voltage AC connection male faston 6.3mm type MFC-2SN		

transformers

open transformers

with clamp terminal



1

GEV No.	400134	Ref. No.	18010792
description	transformer primary 230/400VAC secondary 24VAC 100VA secondary 5A H 95mm L 85mm W 85mm connection screw 50/60Hz type USE10BB		

probes

producer-specific probes

probes



1

GEV No.	379470	Ref. No.	04900720
description	probe Pt1000 cable silicone probe -100 up to 450°C cable -50 up to +180°C connection plug thread probe ø3-6x140mm cable length 1m		



1

GEV No.	379474	Ref. No.	04900154
description	temperature probe NTC cable silicone probe -40 up to +110°C cable -50 up to +180°C connection male faston 6.3mm thread 1/4" probe ø8x30mm cable length 0.3m		



1 

GEV No.	379659	Ref. No.	04900561
description	temperature probe NTC cable silicone probe -40 up to +110°C cable -50 up to +180°C connection plug thread 1/8" probe ø8x50mm cable length 0.4m		

1 

GEV No.	698662	Ref. No.	04900775 04900775.1
description	temperature probe NTC cable silicone probe -40 up to +150°C cable -40 up to +120°C connection plug thread 1/8" cable length 0.465m probe L 20mm		

electronics

PCBs

1 

GEV No.	402401	Ref. No.	04900712
description	display L 100mm W 47mm with keypad		

1 

GEV No.	400369	Ref. No.	04900035
description	keypad PCB		

1 

GEV No.	400370	Ref. No.	04900036
description	keypad PCB		

1 

GEV No.	400371	Ref. No.	04900037
description	keypad PCB		

1 

GEV No.	400372	Ref. No.	04900042
description	keypad PCB		

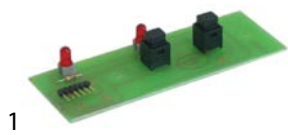
1 

GEV No.	400373	Ref. No.	04900044
description	keypad PCB		

1 

GEV No.	400374	Ref. No.	04900043
description	keypad PCB		

1 

GEV No.	400454	Ref. No.	04900051
description	keypad PCB		

1 

GEV No.	400455	Ref. No.	04900052
description	keypad PCB		

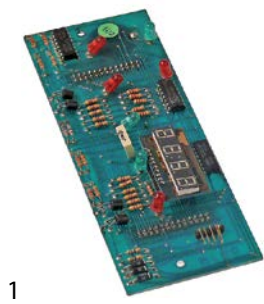
1 

GEV No.	400456	Ref. No.	04900053
description	keypad PCB		

1 

GEV No.	400461	Ref. No.	04900090
description	keypad PCB		

1

GEV No.	400462	Ref. No.	04900081
description	keypad PCB		



1

GEV No.	400552	Ref. No.	04900116
description	keypad PCB		



1

GEV No.	400554	Ref. No.	04900067
description	keypad PCB		



1

GEV No.	400591	Ref. No.	04900120
description	keypad PCB		

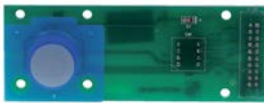

1

GEV No.	402412	Ref. No.	04900707
description	keypad PCB L 100mm W 37mm		



1

GEV No.	402399	Ref. No.	04900742
description	keypad PCB L 135mm W 34mm		



1

GEV No.	402413	Ref. No.	04900704
description	keypad PCB L 135mm W 37mm		



1

GEV No.	402394	Ref. No.	04900705
description	keypad PCB L 136mm W 37mm		



1

GEV No.	402398	Ref. No.	04900738
description	keypad PCB L 160mm W 34mm		



1

GEV No.	402395	Ref. No.	04900706
description	keypad PCB L 160mm W 37mm		



1

GEV No.	402400	Ref. No.	04900744
description	keypad PCB L 182mm W 34mm		



1

GEV No.	402396	Ref. No.	04900735
description	keypad PCB L 210mm W 15mm		

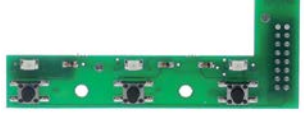

1

GEV No.	402397	Ref. No.	04900737
description	keypad PCB L 84mm W 33mm		



1

GEV No.	400592	Ref. No.	04900121
description	keypad PCB suitable for NUOVA SIMONELLI with display		



1

GEV No.	400599	Ref. No.	04900153
description	keypad PCB with display		

1

GEV No.	403253	Ref. No.	15030005
description	net board coffee grinder MYTHOS 115V with housing 110V		



1

GEV No.	403624	Ref. No.	04900732
description	PCB coffee machine Appia L 162mm W 74mm		



1

GEV No.	400466	Ref. No.	04900045
description	PCB		



1

GEV No.	402409	Ref. No.	04900732 old
description	PCB coffee machine Appia L 164mm W 75mm 12V type ECO2AAPPI-A220V supply 230VAC		



1

GEV No.	400467	Ref. No.	04900046 04900047
description	PCB		



1

GEV No.	402411	Ref. No.	04900740
description	PCB coffee machine Appia L 75mm W 164mm 12V type ECO-2COMP220V supply 230VAC		



1

GEV No.	400597	Ref. No.	04900152
description	PCB 3/4 groups suitable for NUOVA SIMONELLI		



1

GEV No.	402403	Ref. No.	04900714
description	PCB coffee machine Aurelia L 160mm W 132mm 12V type AVR4VI-P220V supply 230VAC		



1

GEV No.	403679	Ref. No.	04900732
description	PCB coffee machine Appia L 130mm W 115mm		



1

GEV No.	403762	Ref. No.	04900740
description	PCB coffee machine L 122mm W 106mm		



1	GEV No. 400459	Ref. No.	04900112
	description	PCB dosing	



1	GEV No. 402877	Ref. No.	04900653
	description	PCB for coffee machine Microbar L 180mm W 110mm	



1	GEV No. 402410	Ref. No.	04900733
	description	PCB L 118mm W 132mm 230V 12V	



1	GEV No. 402408	Ref. No.	04900730
	description	PCB L 122mm W 65mm 12V type NEWAPPIA1220V supply 230VAC	



1	GEV No. 402406	Ref. No.	04900717
	description	PCB L 132mm W 116mm 12V type AVR2S220V supply 230VAC	



1	GEV No. 402407	Ref. No.	04900718
	description	PCB L 132mm W 116mm 12V type AVR4S220V supply 230VAC	



1	GEV No. 402405	Ref. No.	04900716
	description	PCB L 132mm W 116mm 12V type AVR4V220V supply 230VAC	



1	GEV No. 402402	Ref. No.	04900713
	description	PCB L 160mm W 132mm 12V type AVR2VIP220V supply 230VAC	



1	GEV No. 402404	Ref. No.	04900715
	description	PCB L 162mm W 74mm 12V type ECO2VR220V supply 230VAC	



1	GEV No. 400594	Ref. No.	04900123
	description	PCB with display	



central units



1

GEV No.	400476	Ref. No.	04900117
description	control box		



1

GEV No.	400363	Ref. No.	04900082
description	control box 2-group for coffee machine		



1

GEV No.	400364	Ref. No.	04900031
description	control box 2-group for coffee machine 230V		



1

GEV No.	400367	Ref. No.	04900113
description	control box 2-group for coffee machine 230V type ECO2PREM		



1

GEV No.	400473	Ref. No.	04900084
description	control box 3-4-group		



1

GEV No.	400472	Ref. No.	04900126
description	control box 3-group for coffee machine 230V type ECO3PREM		



1

GEV No.	400471	Ref. No.	04900055 04900055.1
description	control box 4-group for coffee machine 230V		



1

GEV No.	400572	Ref. No.	04900162
description	control box for coffee machine 230V		



			
1			
GEV No.	400593	Ref. No.	04900122
description	control box for coffee machine 230V		

dosing electronics

GICAR

			
1			
GEV No.	402393	Ref. No.	04900195
description	dosing electronics 2-group 230V 50/60Hz type RL30/2S/3R		

keypads

front foils

			
1			
GEV No.	400587	Ref. No.	05000131.0
description	keypad foil		

			
1			
GEV No.	400588	Ref. No.	05000132.0
description	keypad foil		

			
1			
GEV No.	400589	Ref. No.	05000133.0
description	keypad foil		

			
1			
GEV No.	400590	Ref. No.	05000134.0
description	keypad foil		

			
1			
GEV No.	400458	Ref. No.	78016004
description	keypad foil 3 groups		

			
1			
GEV No.	402591	Ref. No.	79016082
description	keypad foil with control panel L 310mm W 88mm buttons 7		

membrane keypads

			
1			
GEV No.	401896	Ref. No.	04900668.1
description	membrane keypad buttons 8 suitable for NUOVA SIMONELLI L 145mm W 69mm		

keypad units

			
1			
GEV No.	400463	Ref. No.	04900033 04900034
description	keypad unit		



→ electric components

control panel

			
1			
GEV No.	525009	Ref. No.	78016020
description	control panel L 594mm grey H 75mm 2-group		

			
1			
GEV No.	525016	Ref. No.	78016021
description	control panel L 594mm grey H 75mm 2-group		

			
1			
GEV No.	525014	Ref. No.	78016030
description	control panel L 824mm grey H 75mm 3-group		

			
1			
GEV No.	525015	Ref. No.	78016031
description	control panel L 824mm grey H 75mm 3-group		

			
1			
GEV No.	502253	Ref. No.	18010846
description	control panel warewashing L 310mm W 133mm H 7mm black		

accessories

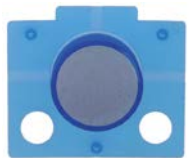
			
1			
GEV No.	112612	Ref. No.	04900707.S
description	buttons strip buttons 1 L 32mm W 37mm		

			
1			
GEV No.	112609	Ref. No.	04900704.S
description	buttons strip buttons 4 L 114mm W 37mm		

			
1			
GEV No.	112610	Ref. No.	04900705.S
description	buttons strip buttons 4 L 114mm W 37mm		

			
1			
GEV No.	112607	Ref. No.	04900702
description	buttons strip buttons 4 L 70mm W 10mm		

			
1			
GEV No.	112608	Ref. No.	04900703
description	buttons strip buttons 4 L 70mm W 10mm		

			
1			
GEV No.	112611	Ref. No.	04900706.S
description	buttons strip buttons 5 L 132mm W 37mm		

solenoid valves

solenoid valves (water)

RPE			
solenoid valves with reducers			
3-fold			
			
1			
GEV No.	370240	Ref. No.	18010079
description	solenoid valve triple straight 230VAC inlet 3/4" outlet 11.5mm t.max. 90°C RPE plastic output B 0.32-0.42l/min flow regulating valve outlet B green		





















TP			
			
1			
GEV No.	370021	Ref. No.	18010078
description	solenoid valve double straight 230VAC inlet 3/4" outlet 11.5mm DN10 TP flow regulating valve inlet white		
spare parts for	370021		
	GEV No.	371013	Ref. No.
			—
	solenoid coil TP 230VAC 50/60Hz		
accessories for	370021		
	GEV No.	371220	Ref. No.
			—
	reducer TP flow rate 3l/min red tolerance ±15%		
	GEV No.	371221	Ref. No.
			—
	reducer TP flow rate 5.5l/min yellow tolerance ±15%		
	GEV No.	371222	Ref. No.
			—
	reducer TP flow rate 6l/min grey tolerance ±15%		

Table continues overleaf





accessories for		370021		
	GEV No.	371223	Ref. No.	—
reducer TP flow rate 10l/min white tolerance ±15%				
	GEV No.	371224	Ref. No.	—
reducer TP flow rate 12l/min bronze tolerance ±15%				
	GEV No.	371225	Ref. No.	—
reducer TP flow rate 16l/min light brown tolerance ±15%				
	GEV No.	371226	Ref. No.	—
reducer TP flow rate 20l/min red tolerance ±15%				
	GEV No.	371230	Ref. No.	—
reducer TP flow rate 0.25l/min red tolerance ±25%				
	GEV No.	371231	Ref. No.	—
reducer TP flow rate 0.35l/min violet tolerance ±25%				
	GEV No.	371232	Ref. No.	—
reducer TP flow rate 0.5l/min orange tolerance ±25%				
	GEV No.	371233	Ref. No.	—
reducer TP flow rate 0.8l/min white tolerance ±25%				
	GEV No.	371234	Ref. No.	—
reducer TP flow rate 1l/min light blue tolerance ±25%				
	GEV No.	371235	Ref. No.	—
reducer TP flow rate 1.2l/min brown tolerance ±25%				
	GEV No.	371236	Ref. No.	—
reducer TP flow rate 1.5l/min light brown tolerance ±25%				
	GEV No.	371237	Ref. No.	—
reducer TP flow rate 2.5l/min yellow tolerance ±25%				
	GEV No.	371238	Ref. No.	—
reducer TP flow rate 3.4l/min dark green tolerance ±25%				
	GEV No.	371239	Ref. No.	—
reducer TP flow rate 5l/min black tolerance ±25%				
	GEV No.	371240	Ref. No.	—
reducer TP flow rate 8l/min blue tolerance ±20%				

solenoid valves with reducers



1	GEV No.	370245	Ref. No.	18010751
description solenoid valve single straight 24VAC inlet 3/4" outlet 11.5mm input 16l/min t.max. 90°C TP plastic flow regulating valve inlet light brown				

metal				
ASCO				
spare parts and accessories				
O-rings				
				
1	GEV No.	371095	Ref. No.	02290016
description O-ring Viton thickness 1.78mm ID ø 6.07mm Qty 1 pcs				

CEME				
solenoid valves				
				
1	GEV No.	370632	Ref. No.	04100067
description solenoid valve brass 3-ways 230VAC connection 1/8" L 28mm CEME type series 53 p max 12bar p min 0.1bar				

				
1	GEV No.	370238	Ref. No.	04100038
description solenoid valve brass 3-ways coffee machine parts				

LUCIFER				
spare parts and accessories				
valve bodies				
				
1	GEV No.	370061	Ref. No.	NS0401
description solenoid valve body LUCIFER-PARKER 3-ways outer cone				



ODE

2-way



1

GEV No.	370235	Ref. No.	04100012 04100022 (old version)
description	solenoid valve 2-ways 220/230 inlet 1/4" outlet 1/4" connection 1/4" L 40mm DN 2.5mm slide-on receptacle DIN -20° up to 130°C type series 21A2K0R25-XC membranes FKM (water) p max 30bar p min 0bar 50/60Hz brass		

3-way



1

GEV No.	370839	Ref. No.	04100054
description	solenoid valve brass 3-ways 230VAC connection 1/8" L 30mm DN 2.3mm ODE type series 31JN1XPV23 p max 5bar p min 0.1bar		



1

GEV No.	370838	Ref. No.	04100046
description	solenoid valve brass 3-ways 230VAC connection 1/8" L 30mm ODE type series 31JN1XPV12 p max 15bar p min 0.1bar		

solenoid valves steam (water)

21J series



1

GEV No.	370232	Ref. No.	04100042
description	solenoid valve brass 2-ways 230VAC connection 1/8" L 30mm DN 2.3mm -10 up to 140°C membranes FKM p max 18bar		

31A series



1

GEV No.	370237	Ref. No.	04100009
description	solenoid valve 3-ways 230VAC inlet 1/8" outlet 1/8" connection 1/8" DN 2.5mm slide-on receptacle DIN -10 up to 140°C ODE type series 31A coil type BDA membranes FKM (water/steam) p max 6bar p min 0.1bar		
spare parts for	370237		
	GEV No.	371150	Ref. No. —
	solenoid coil ODE 230VAC 16VA coil type BDV seat ø 13.5mm 750Ohm		
accessories for	370237		
	GEV No.	371090	Ref. No. —
	power socket plug type DIN 43650A screw		

4144XPV series



1

GEV No.	370233	Ref. No.	04100008 04100045 04100066
description	solenoid valve 2-ways 230VAC connection 1/8" DN 1.7mm -10 up to 140°C membranes FKM (water/steam) p max 15bar p min 0bar brass		

PARKER

2-way

VE-140 series



1





GEV No.	370821	Ref. No.	04100022
description	solenoid valve 2-ways 208-240 inlet 1/4" outlet 1/4" connection 1/4" L 40mm DN 3mm slide-on receptacle DIN -10 up to 140°C type series VE-140 coil type ZB09 membranes ruby p max 8bar brass		
spare parts for	370821		
	GEV No.	371029	Ref. No. —
	solenoid coil PARKER 230VAC 9VA coil type ZB09 seat ø 14mm H 33mm W 34mm D 43mm		



3-way

VE-128 series





GEV No.	370057	Ref. No.	04100017
description	solenoid valve 3-ways 230VAC body outer cone DN 1.2mm slide-on receptacle DIN -20° up to 140°C PARKER type series VE-128 coil type ZB09 membranes ruby p max 10bar brass flange 32x32mm		
spare parts for	370057		
	GEV No.	370062	Ref. No. —
	solenoid valve body PARKER 3-ways outer cone		
	GEV No.	371029	Ref. No. —
	solenoid coil PARKER 230VAC 9VA coil type ZB09 seat ø 14mm H 33mm W 34mm D 43mm		
accessories for	370057		
	GEV No.	371090	Ref. No. —
	power socket plug type DIN 43650A screw		
	GEV No.	371095	Ref. No. 02290016
	O-ring Viton thickness 1.78mm ID ø 6.07mm Qty 1 pcs		
	GEV No.	371100	Ref. No. —
	O-ring silicone thickness 1.78mm ID ø 6.07mm Qty 1 pcs		

VE-141 series



GEV No.	374076	Ref. No.	04100063
description	solenoid valve 230VAC inlet 1/4" outlet 1/4" connection 1/4" L 40mm DN 2.5mm t.max. 140°C slide-on receptacle DIN -20° up to 130°C coil type ZB09 membranes FKM (water) p max 0bar p min 7bar 50Hz		



GEV No.	370234	Ref. No.	04100011
description	solenoid valve 3-ways 230VAC connection 1/8" DN 1.2mm slide-on receptacle DIN -20° up to 130°C PARKER type series VE-141 coil type ZB09 membranes FKM (water) p max 10bar		
spare parts for	370234		
	GEV No.	371029	Ref. No. —
	solenoid coil PARKER 230VAC 9VA coil type ZB09 seat ø 14mm H 33mm W 34mm D 43mm		
accessories for	370234		
	GEV No.	371090	Ref. No. —
	power socket plug type DIN 43650A screw		

solenoid valves (various)



GEV No.	370236	Ref. No.	04100024
description	solenoid valve 2-ways 230VAC inlet 1/4" outlet 1/4" controllable		
accessories for	370236		
	GEV No.	696700	Ref. No. 04100024.P
	handle ø 25mm hole ø 5.3x6mm L 7.5mm		



GEV No.	370634	Ref. No.	04100005
description	solenoid valve 2-ways 230VAC inlet 1/4" outlet 1/4" L 35mm CEME type series 66 p max 4.5bar 50/60Hz brass		

Solenoid valve - accessories



GEV No.	528952	Ref. No.	06200036 98021000
description	mounting plate for solenoid valve		
accessories for	528952		
	GEV No.	528954	Ref. No. 07300022
	nozzle hole ø 0.8mm thread M6 thread L 6mm brass		



GEV No.	371095	Ref. No.	02290016
description	O-ring Viton thickness 1.78mm ID ø 6.07mm Qty 1 pcs		



pressure switches

for warewashing

ø51mm with coded plug



1

GEV No.	541784	Ref. No.	18010169
description	pressure control pressure range 50/20mbar ø 51mm pressure connection horizontal warewashing pressure connection ø 5.5mm at 250V 10A		



1

GEV No.	541875	Ref. No.	18010442
description	pressure control pressure range 90/30mbar connection coded plug ø 51mm pressure connection ø 6mm at 250V 10A		

ø 58mm with male faston 6.3mm

with connection horizontal



1

GEV No.	541010	Ref. No.	18000041
description	pressure control pressure range 50/30mbar connection 6mm ø 58mm pressure connection horizontal warewashing		



1

GEV No.	541165	Ref. No.	18010422
description	pressure control pressure range 60/30mbar connection 6mm ø 58mm pressure connection horizontal warewashing pressure connection ø 6mm		

for coffee machines

ø 35mm



1

GEV No.	541131	Ref. No.	09200014old
description	pressure control ø 35mm pressure range adjustable 0.2-0.9bar pressure connection vertical coffee machine parts connection 1-pole pressure connection 1/4"		

miscellaneous



1

GEV No.	541477	Ref. No.	09200014
description	pressure control pressure range 0.6bar connection 1/4" 16A 1-pole type coffee machine parts		



1

GEV No.	541021	Ref. No.	09200006 NS1201
description	pressure control pressure range adjustable 0.5-1.4bar connection 1/4" 30A 3-pole type P302 coffee machine parts SIRAI		

accessories for	541021		
GEV No.	550262	Ref. No.	—



flat gasket copper ED ø 20mm ID ø 14mm thickness 2mm



GEV No. 890100 **Ref. No.** —
PTFE tape reel L 12m W 12mm -200 up to +260°C approval DIN-DVGW, KTW temperature-resistant, elastic for fine thread thickness 0.1mm

electrodes



1

GEV No.	400020	Ref. No.	09000005
description	level electrode 1/4" total length 150mm probe L 124mm insulated probe length 26mm connection male faston 6.3mm stainless steel ø 2.5mm		



GEV No.	400595	Ref. No.	73003011
description	level electrode 1/4" total length 72mm probe L 42mm insulated probe length 26mm connection male faston 6.3mm brass ø 2.5mm		



GEV No.	698661	Ref. No.	09000007
description	level electrode threaded total length 88mm probe L 34mm ø 2.5mm thread M10x1 T2: 1/4"		

flow meters and flow sensors

flow meters

GICAR



GEV No.	400004	Ref. No.	04900027
description	flow meter thread 1/4" stainless steel with LED plug connection approval NSF		

accessories for	400004			
	GEV No.	400256	Ref. No.	—
	plug GICAR for flow meter			

motors

gear motors

for ice-cube maker

for paddles



GEV No.	500407	Ref. No.	16000018
description	gear motor LIP type 123MR 8W 220/240V voltage AC 50/60Hz 50rpm turn direction counterclockwise shaft ø 4mm shaft intake ø 6.2mm groove width 2.3mm shaft L 8mm shaft ø 4mm W 74mm		

for drink dispensers



GEV No.	500909	Ref. No.	16300028 16300077
description	gear motor KENTA type CD79F 60/68W 115/230V 50/60Hz 33/40rpm shaft ø 6x12mm L 220mm W 70mm H 105mm for drink dispenser		

for automatic coffee machines



GEV No.	500316	Ref. No.	04600001
description	gear motor LIP type 066C 73W 220/240V voltage AC 50/60Hz 12rpm L 110mm W 70mm H 85mm for coffee machine		



motors

for coffee grinders

complete



1

GEV No.	500315	Ref. No.	04500031
description	motor 250W 230V 50Hz 1 phase shaft ø 12mm shaft length 36mm thread M10L 1360rpm type D001302 ø 120mm H 190mm capacitor 10µF RPM 0.25kW		

pumps



wash and rinse pumps

ALBA (C&A)

pumps







1

GEV No.	500941	Ref. No.	18010101 18010843
description	pump inlet ø 30mm outlet ø 30mm type IM32591 230V 50Hz 1 phase 0.45kW 0.6HP L 200mm rotation direction right capacitor 12.5µF auxiliary pressure connection 11mm supporting pressure open ALBA PUMPS (C&A)		
spare parts for	500941		
	GEV No.	365014	Ref. No. 18010104
	operating capacitor capacity 12.5µF 450V tolerance 5%Hz ambient temperature max. -25 to +85°C ø 35mm L 70mm M8 plastic connection male faston 6.3mm 45S.C3DS.12.5 protection		
	GEV No.	509018	Ref. No. —
	O-ring EPDM thickness 3.53mm ID ø 107.5mm Qty 1 pcs		
	GEV No.	510692	Ref. No. 18010061
	mechanical shaft seal for shaft ø 11mm slide ring ext. ø 24mm slide ring H 13mm counter ring mounting ø 26mm height counter ring 8mm counter ring int. ø 14mm		



1

GEV No.	500940	Ref. No.	18010835
description	pump inlet ø 45mm outlet ø 40mm type 2031 230V 50Hz 1 phase 0.75kW 1HP L 200mm rotation direction right connection plug connection capacitor 12.5µF auxiliary pressure connection 10mm supporting pressure open ALBA PUMPS (C&A)		
spare parts for	500940		
	GEV No.	365014	Ref. No. 18010104
	operating capacitor capacity 12.5µF 450V tolerance 5%Hz ambient temperature max. -25 to +85°C ø 35mm L 70mm M8 plastic connection male faston 6.3mm 45S.C3DS.12.5 protection		
	GEV No.	509021	Ref. No. —
	impellor ø 102mm H 32mm shaft intake ø 9/8mm rotation direction right		
	GEV No.	510693	Ref. No. —
	mechanical shaft seal for shaft ø 12mm slide ring ext. ø 24mm slide ring H 15.5mm slide ring int. ø 11mm counter ring mounting ø 24mm height counter ring 8mm counter ring int. ø 13.5mm		
	GEV No.	521531	Ref. No. —
	pump cover ALBA PUMPS (C&A) inlet ø 45mm outlet ø 40mm turn direction right ø 153mm ID ø 127mm inner height 24mm		
	GEV No.	521709	Ref. No. —
	O-ring EPDM thickness 3mm ID ø 126mm Qty 1 pcs		

drain pumps

ASKOLL



1

GEV No.	500347	Ref. No.	18010653
description	drain pump 230V 34W		

PLASET



Image not available

1

GEV No.	500514	Ref. No.	18010378
description	drain pump inlet ø 30mm outlet ø 22mm 230V 34W		



booster pumps II

pump motors

clip connection



1	GEV No.	500317	Ref. No.	04500033
	description	pump motor RPM type C004320 120W 230V 50/60Hz connection clip capacitor 6µF		

pump heads

FLUID-O-TECH



1	GEV No.	500318	Ref. No.	01300004
	description	pump		



1	GEV No.	499153	Ref. No.	01300004
	description	pump head CB054 FLUID-O-TECH L 62mm 50l/h connection 3/8" GAS with modulator brass clip connection for coffee machine shaft ø 5x11mm NSF		



1	GEV No.	500174	Ref. No.	01300005	
	description	pump head PA104 FLUID-O-TECH L 82mm 100l/h connection 3/8" GAS with bypass brass clip connection for coffee machine shaft ø 4.8x11mm NSF			
	accessories for	500174			
		GEV No.	520126	Ref. No.	—
		clamp for pump/motor			



1	GEV No.	500211	Ref. No.	01300004
	description	pump head PO054 FLUID-O-TECH L 82mm 50l/h connection 3/8" GAS with bypass brass clip connection for coffee machine shaft ø 11mm		



1	GEV No.	500064	Ref. No.	01300006	
	description	pump head PO204 FLUID-O-TECH L 82mm 200l/h connection 3/8" GAS with bypass brass clip connection for coffee machine shaft ø 4.8x11mm			
	accessories for	500064			
		GEV No.	520126	Ref. No.	—
		clamp for pump/motor			

accessories



1	GEV No.	365015	Ref. No.	04000043 15050009
	description	operating capacitor capacity 10µF 400V tolerance 5%Hz ambient temperature max. -25 to +85°C ø 35.5mm L 59mm M8 plastic connection male faston 6.3mm protection		



1	GEV No.	365012	Ref. No.	04000010
	description	operating capacitor capacity 6.3µF 450V tolerance 5% 50Hz ambient temperature max. -25 to +85°C ø 30mm L 61mm M8 plastic connection male faston 6.3mm protection		



vibration pumps



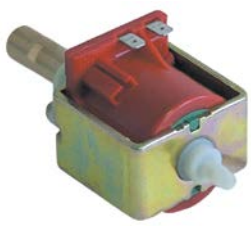

1

GEV No.	500319	Ref. No.	04800005
description	vibration pump 230V 53W 50Hz inlet \varnothing 7 outlet \varnothing 1/8" IT CEME type ET500 L 123mm brass		



1

GEV No.	500124	Ref. No.	04800005	
description	vibration pump type EX 5 230V 48W 50/60Hz inlet \varnothing 6 outlet \varnothing 1/8" IT flat seal ULKA brass L 123mm			
accessories for	500124			
	GEV No.	520152	Ref. No.	—
	hose connector Santoprene grommet \varnothing 7mm grommet length 14mm			
	GEV No.	520330	Ref. No.	—
	bracket rubber dimensions 69x44x4mm			

condensators & interference suppression filters

operating capacitors

plastic



1

GEV No.	365015	Ref. No.	04000043 15050009
description	operating capacitor capacity 10 μ F 400V tolerance 5%Hz ambient temperature max. -25 to +85°C \varnothing 35.5mm L 59mm M8 plastic connection male faston 6.3mm protection		



1

GEV No.	365014	Ref. No.	18010104
description	operating capacitor capacity 12.5 μ F 450V tolerance 5%Hz ambient temperature max. -25 to +85°C \varnothing 35mm L 70mm M8 plastic connection male faston 6.3mm 45S.C3DS.12.5 protection		



1

GEV No.	365012	Ref. No.	04000010
description	operating capacitor capacity 6.3 μ F 450V tolerance 5% 50Hz ambient temperature max. -25 to +85°C \varnothing 30mm L 61mm M8 plastic connection male faston 6.3mm protection		

filters

interference suppression filters



1

GEV No.	365046	Ref. No.	18010415
description	interference suppression filter type 10S7E-G1474253105-Q 115/250V 50/60Hz conductor 2 with E connection male faston 6.3mm L 40mm \varnothing 40mm Hmm Wmm M8 plastic Qty 1 pcs		

fuses

fine fuses



1

GEV No.	358022	Ref. No.	16300112
description	fine fuse size \varnothing 10x38mm 4A rated 500V type Gg fast-acting Qty 1 pcs		

thermal fuses



1

GEV No.	358012	Ref. No.	09500014
description	thermal fuse switch-off temp. 167°C nominalA cable length 160mm		

electric accessories

cables

PVC cable



1

GEV No.	550223	Ref. No.	04000090 04000540
description	PVC cable 5-pole 2.5mm ² L 3000mm white conductor copper wire insulation PVC permanent temperature 70°C t.max. 70°C rated 300/500V test voltage 2000V		



terminals

connection terminals with screw/faston connections



1

GEV No.	550278	Ref. No.	04000310
description	power terminal block 3-pole max. 40A max 400V connection $\phi 6\text{mm}^2$ / F6.3 temp.-resist. 150°C cross section 6mm^2		



1

GEV No.	550411	Ref. No.	18010390
description	power terminal block 6-pole max. 40A max 450V connection $\phi 6\text{mm}^2$ / F6.3 temp.-resist. 150°C cross section 6mm^2		

electronic magnets



1

GEV No.	370631	Ref. No.	04100052
description	electronic magnet 230V voltage AC 50Hz L 23mm W 19mm H 29mm		

equipment-specific units

for ice-cube maker

ice chutes

slide grates



1

GEV No.	692097	Ref. No.	16000515
description	slide grate for ice-cube maker L 160mm W 170mm H 60mm		

pan mechanics

sumps



1

GEV No.	695359	Ref. No.	16000440
description	sump for ice maker L 180mm W 180mm H 60mm EUROFRIGOR		

for espresso machines

filter holders

filter holders standard

filter holder without spout



1

GEV No.	525992	Ref. No.	N/A
description	filter holder suitable for NUOVA SIMONELLI without outlet mounting $\phi 82\text{mm}$ outlet 3/8" ID $\phi 61\text{mm}$ wedge height 11mm wedge position diagonal number of wedges 2 lever straight chrome-plated brass		

filter holders short



1

GEV No.	527132	Ref. No.	49800002
description	filter holder mounting $\phi 80\text{mm}$ hole $\phi 8\text{mm}$ ID $\phi 62\text{mm}$		



1

GEV No.	529071	Ref. No.	98005001
description	filter holder mounting $\phi 82\text{mm}$ outlet 3/8" ID $\phi 61\text{mm}$ handle M10x1.5 wedge height 11mm wedge position diagonal number of wedges 2 lever straight chrome-plated brass		





1

GEV No.	526799	Ref. No.	06200086
description	filter holder mounting $\phi 82\text{mm}$ outlet 3/8" ID $\phi 61\text{mm}$ handle M10x1.5 wedge height 7mm wedge position diagonal number of wedges 2 lever inclined chrome-plated brass		





handles			
with external thread			
			
1			
GEV No.	111053	Ref. No.	N/A
description	handle ø 36mm thread M10x1.5 thread L 15mm L 126mm black		

with bore			
			
1			
GEV No.	525036	Ref. No.	05000840
description	handle ø 33mm L 117mm black aperture 12.5mm		

			
1			
GEV No.	527133	Ref. No.	05080014
description	handle ø 34mm aperture hexagon 20mm L 102mm black		

end caps			
			
1			
GEV No.	525037	Ref. No.	05000842
description	end cap ø 38mm black		

sleeves			
			
1			
GEV No.	525038	Ref. No.	05000844
description	sleeve ø 38mm L 31mm black		

screws			
			
1			
GEV No.	525029	Ref. No.	07300601
description	thread bolt thread M10 L 85mm thread L 12mm WS 13 SS		

spouts			
with thread 3/8"			
			
1			
GEV No.	529007	Ref. No.	06200008
description	filter holder spout thread 3/8" 2-way curved/short outlet distance 45mm		

filters			
for 1 cup			
			
1			
GEV No.	527135	Ref. No.	03000321
description	coffee filter ø 70mm mounting ø 61.2mm H 21mm cups 1 amount of coffee 6g		

for 2 cups			
			
1			
GEV No.	527136	Ref. No.	03000073 03000322 40300030
description	coffee filter ø 70mm mounting ø 61mm H 22mm cups 2		

blind filters			
			
1			
GEV No.	529023	Ref. No.	03000107
description	blind filter ø 70mm mounting ø 60mm H 18mm		

filter holder springs			
			
1			
GEV No.	529079	Ref. No.	08000017
description	filter holder spring L 70mm W 60mm wire gauge ø 1.3mm for espresso filter holder		

brewing units

shower screens

flat



1

GEV No.	527107	Ref. No.	03000067
----------------	--------	-----------------	----------

description	shower screen ϕ 34mm hole ϕ 4.5mm		
--------------------	---	--	--

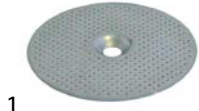

1

GEV No.	527108	Ref. No.	03000069
----------------	--------	-----------------	----------

description	shower screen ϕ 40mm hole ϕ 4.5mm flat		
--------------------	--	--	--

with upstand and central hole



1

GEV No.	527128	Ref. No.	03000066
----------------	--------	-----------------	----------

description	shower screen		
--------------------	---------------	--	--



1

GEV No.	529144	Ref. No.	03000066
----------------	--------	-----------------	----------

description	shower screen ϕ 56.5mm H 4.5mm hole ϕ 5.3mm		
--------------------	---	--	--

filter holder gaskets

flat

with external notch



1

GEV No.	528405	Ref. No.	02280020.C
----------------	--------	-----------------	------------

description	filter holder gasket D1 ϕ 73mm D2 ϕ 58mm H 7mm with outside notch Qty 1 pcs		
--------------------	---	--	--

standard



1

GEV No.	528069	Ref. No.	02280025
----------------	--------	-----------------	----------

description	filter holder gasket D1 ϕ 72.5mm D2 ϕ 58mm H 4.5mm Qty 1 pcs		
--------------------	--	--	--



1

GEV No.	528047	Ref. No.	02280020
----------------	--------	-----------------	----------

description	filter holder gasket D1 ϕ 73mm D2 ϕ 58mm H 7mm Qty 1 pcs		
--------------------	--	--	--

with cone



1

GEV No.	528036	Ref. No.	40200004
----------------	--------	-----------------	----------

description	filter holder gasket with cone D1 ϕ 70.5mm D2 ϕ 56mm H1 8.9mm H2 5.8mm Qty 1 pcs		
--------------------	--	--	--



1

GEV No.	525021	Ref. No.	02280020.V
----------------	--------	-----------------	------------

description	filter holder gasket with cone D1 ϕ 71mm D2 ϕ 56mm H1 8.2mm H2 5mm Qty 1 pcs		
--------------------	--	--	--

O-rings



1

GEV No.	510409	Ref. No.	18010746
----------------	--------	-----------------	----------

description	O-ring EPDM thickness 5.34mm ID ϕ 56.52mm Qty 1 pcs		
--------------------	--	--	--



brewing units with solenoid valve

producer-specific brewing units



1

GEV No.	525010	Ref. No.	70004010
description	brewing unit suitable for NUOVA SIMONELLI		

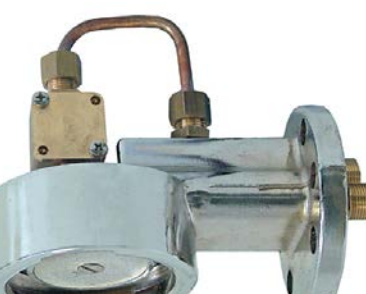

1

GEV No.	525011	Ref. No.	70004011
description	brewing unit suitable for NUOVA SIMONELLI		



1

GEV No.	525012	Ref. No.	78004000
description	brewing unit suitable for NUOVA SIMONELLI		



1

GEV No.	525013	Ref. No.	73004015
description	brewing unit suitable for NUOVA SIMONELLI		

gaskets



1

GEV No.	532554	Ref. No.	18010559
description	O-ring silicone thickness 1.5mm ID ø 4.1mm Qty 1 pcs		

nozzles



1

GEV No.	528831	Ref. No.	07300174
description	nozzle		



1

GEV No.	528954	Ref. No.	07300022
description	nozzle hole ø 0.8mm thread M6 thread L 6mm brass		



1

GEV No.	525018	Ref. No.	07300127
description	nozzle hole ø 2.5mm thread M8 thread L 8mm brass		



1

GEV No.	525017	Ref. No.	07300226
description	nozzle hole \varnothing 2mm thread M8 thread L 8mm brass		



1

GEV No.	525019	Ref. No.	07300225
description	nozzle hole \varnothing 3mm thread M8 thread L 8mm brass		



1

GEV No.	525020	Ref. No.	07300184
description	nozzle hole \varnothing 4mm thread M8 thread L 8mm brass		

components

nozzles

nozzle holders



1

GEV No.	528830	Ref. No.	07300173
description	nozzle holder		

gaskets



1

GEV No.	528158	Ref. No.	02060022
description	flat gasket		

water dispersions

water dispersions

group 3



1

GEV No.	525027	Ref. No.	07300183
description	water distributor \varnothing 57.4mm H 7.5mm 8 holes hole \varnothing 2mm mounting \varnothing 6.6mm brass		



1

GEV No.	525028	Ref. No.	07300183.5
description	water distributor \varnothing 57.4mm H 9.5mm 8 holes hole \varnothing 2mm brass		

2-piece



1

GEV No.	525033	Ref. No.	98004000
description	flange hole \varnothing 22mm \varnothing 72.5mm		



1

GEV No.	529143	Ref. No.	07300124
description	water distributor hole \varnothing 7mm 2mm brass \varnothing 21.5mm		

safety valves

safety valves

1/4"





1

GEV No.	527125	Ref. No.	98013020
description	safety valve connection 1/4" triggering pressure 1.8bar		





1/8"			
			
1			
GEV No.	525032	Ref. No.	98120001
description	safety valve connection 1/8" triggering pressure 16.5bar		

3/8"			
			
1			
GEV No.	529346	Ref. No.	98013001
description	safety valve connection 3/8" IT triggering pressure 1.8bar sealed		

			
1			
GEV No.	527977	Ref. No.	98013022
description	safety valve connection 3/8" triggering pressure 1.8bar approval CE 0036		



			
1			
GEV No.	531134	Ref. No.	98250000000040
description	safety valve kit connection 3/8" triggering pressure 1.8bar approval CE 0035 sealed		

expansion valves			
			
1			
GEV No.	529378	Ref. No.	72012007
description	expansion valve T1: 1/4" ET T2: 1/4" ET L 37mm		

with hose connection			
			
1			
GEV No.	527127	Ref. No.	73012002
description	expansion valve T1: 1/8" ET hose ø 5mm L 28mm		

drain pans			
			
1			
GEV No.	525025	Ref. No.	05000018
description	drain pan L 100mm W 80mm H 60mm		

			
1			
GEV No.	525024	Ref. No.	05000403
description	drain pan L 100mm W 80mm ø 40mm		

aerators and air bleeders			
			
1			
GEV No.	529303	Ref. No.	01000023
description	aerator and air bleeder connection 1/4" only steam		
spare parts for	529303		
	GEV No.	528687	Ref. No. —
	O-ring Viton thickness 1.78mm ID ø 3.69mm Qty 1 pcs		

boilers

boilers for espresso machines



1

GEV No.	525050	Ref. No.	75030046
description	boiler		

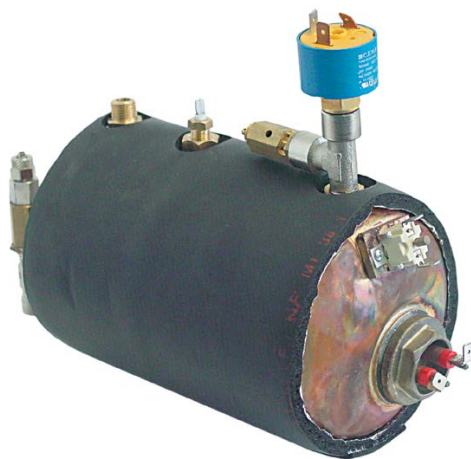



1

GEV No.	525054	Ref. No.	7903004
description	boiler		
spare parts for	525054		
	GEV No.	541131	Ref. No. 09200014old
	pressure control ø 35mm pressure range adjustable 0.2-0.9bar pressure connection vertical coffee machine parts connection 1-pole pressure connection 1/4"		



1

GEV No.	525493	Ref. No.	73003004
description	boiler 1200W 230V ø 120mm L 200mm		
spare parts for	525493		
	GEV No.	358012	Ref. No. 09500014
	thermal fuse switch-off temp. 167°C nominalA cable length 160mm		
	GEV No.	417195	Ref. No. 14100040
	heating element 1200W 230V heating circuits 1 thread 1" L 155mm W 22mm H 22mm tube ø 8.5mm thermostat sleeves ø 7mm length thermostat sleeves 160mm number of thermostat sleeves 1 ther- mostat sleeve eccentric, clinging connection male faston 6.3mm immersion heater flange with thread WS 30		
	GEV No.	541477	Ref. No. 09200014
	pressure control pressure range 0.6bar connection 1/4" 16A 1-pole type coffee machine parts		

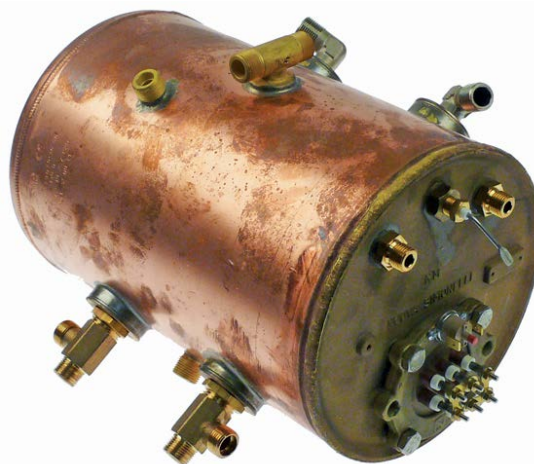

1

GEV No.	531205	Ref. No.	78030092
description	boiler 2700W 230V ø 180mm L 280mm flange 4 hole flange brewing assemblys 2-group		





1

GEV No.	525051	Ref. No.	79030023
description	boiler brewing assemblys 2		

gaskets

perforated



1

GEV No.	528809	Ref. No.	02060026
description	boiler gasket D1 ø 140mm D2 ø 110mm thickness 2mm 5 holes graphite suitable for NUOVA SIMONELLI equiv. no. 0206026		

accessories



1

GEV No.	525035	Ref. No.	07300097
description	end cap ø 14mm L 14mm		

steam/water taps

steam/water taps

steam/water taps



1

GEV No.	529663	Ref. No.	98006000 98007000 98008000
description	steam/water tap		



1

GEV No.	529765	Ref. No.	75006031 75006032
description	steam/water tap		

steam taps

steam taps (complete)



1

GEV No.	527117	Ref. No.	80006000
description	steam tap complete		





1

GEV No.	525055	Ref. No.	73006010
description	steam tap inlet 3/8" pipe chrome-plated brass pipe length 170mm tube ø 8mm		



1

GEV No.	525049	Ref. No.	78006003	
description	steam tap inlet 3/8" pipe chrome-plated brass pipe length 210mm tube ø 10mm			
spare parts for	525049			
	GEV No.	528829	Ref. No.	75006015
	steam nozzle thread 1/8" ø 16mm L 28mm 4 holes bore ø 1.5mm SS			



1

GEV No.	529662	Ref. No.	75006005
description	steam tap mounting pos. left		



1

GEV No.	525057	Ref. No.	98006020
----------------	--------	-----------------	----------

description	steam tap mounting pos. left/right without lever inlet 3/8" pipe SS pipe length 210mm tube ø 10mm		
--------------------	---	--	--

accessories for	525057		
------------------------	--------	--	--

GEV No.	525031	Ref. No.	98006022
----------------	--------	-----------------	----------



description	lever with holder mounting pos. left		
--------------------	--------------------------------------	--	--

GEV No.	525041	Ref. No.	98006021
----------------	--------	-----------------	----------



description	lever with holder mounting pos. right		
--------------------	---------------------------------------	--	--



1

GEV No.	527129	Ref. No.	73006010
----------------	--------	-----------------	----------

description	steam tap with steam pipe		
--------------------	---------------------------	--	--

components

gasket supports



1

GEV No.	525034	Ref. No.	98008004
----------------	--------	-----------------	----------

description	piston for steam-/water-tap hexagon 20 L 11mm		
--------------------	---	--	--

union nuts



1

GEV No.	528827	Ref. No.	07300296
----------------	--------	-----------------	----------

description	union nut		
--------------------	-----------	--	--

screw connections



1

GEV No.	528816	Ref. No.	07300113
----------------	--------	-----------------	----------

description	eye bolt		
--------------------	----------	--	--



1

GEV No.	528819	Ref. No.	07300107
----------------	--------	-----------------	----------

description	screw		
--------------------	-------	--	--

water taps

water taps



1

GEV No.	529661	Ref. No.	75006004 75006005 75006009 75007000 75007007 78005000 78006000
----------------	--------	-----------------	--

description	water tap		
--------------------	-----------	--	--



1

GEV No.	525056	Ref. No.	78007004
----------------	--------	-----------------	----------

description	water tap inlet 3/8" pipe chrome-plated brass pipe length 95mm tube ø 10mm		
--------------------	--	--	--



steam/water pipes

steam pipes



1

GEV No.	527119	Ref. No.	80006006 80006007
description	steam pipe		



1

GEV No.	529769	Ref. No.	75006024 75006037
description	steam pipe		



1

GEV No.	529882	Ref. No.	75006035
description	steam pipe		
accessories for	529882		

	GEV No.	528828	Ref. No.	07300030 98006B02
	steam nozzle ø 15mm L 25mm 4 holes			



1

GEV No.	529664	Ref. No.	75006010
description	steam pipe 1-group		



1

GEV No.	529665	Ref. No.	75006008
description	steam pipe 2-4-group		



1

GEV No.	529815	Ref. No.	75006012
description	steam pipe SS		



1

GEV No.	525047	Ref. No.	78006005
description	steam pipe thread 1/8" L 200mm tube ø 10mm		



1

GEV No.	525048	Ref. No.	98006010
description	steam pipe thread 3/8" L 190mm tube ø 10mm SS		



1

GEV No.	525023	Ref. No.	75006037.1
description	steam pipe thread 3/8" SS		



1

GEV No.	527130	Ref. No.	73006002
description	steam pipe thread M10x1 L 170mm tube ø 8mm		



1

GEV No.	529864	Ref. No.	75006037
description	steam pipe without nozzle		



1

GEV No.	529866	Ref. No.	78006001
description	steam pipe without nozzle		

nozzles for steam pipes



1

GEV No.	529865	Ref. No.	75006038
description	nozzle		

			
1			
GEV No.	528828	Ref. No.	07300030 98006B02
description	steam nozzle ø 15mm L 25mm 4 holes		

			
1			
GEV No.	527131	Ref. No.	73006003 73006003.12
description	steam nozzle thread 1/8" ø 15mm L 27mm 4 holes bore ø 1.2mm chrome-plated brass		

			
1			
GEV No.	528829	Ref. No.	75006015
description	steam nozzle thread 1/8" ø 16mm L 28mm 4 holes bore ø 1.5mm SS		

nozzles for water pipes

nozzles for water pipes

			
1			
GEV No.	527121	Ref. No.	75006016
description	nozzle for water pipe		

water pipes

			
1			
GEV No.	527120	Ref. No.	80007005
description	water pipe		

			
1			
GEV No.	529767	Ref. No.	75007008
description	water pipe		

			
1			
GEV No.	529768	Ref. No.	75007005
description	water pipe		

			
1			
GEV No.	525044	Ref. No.	78007005
description	water pipe L 100mm bore ø 4mm tube ø 10mm		

			
1			
GEV No.	529668	Ref. No.	75007005 78007001
description	water pipe L 145mm bore ø 12mm tube ø 8mm		

			
1			
GEV No.	525045	Ref. No.	98007007
description	water pipe thread 3/8" ø 24mm L 120mm tube ø 10mm WS 22 SS		

			
1			
GEV No.	525046	Ref. No.	98007009
description	water pipe thread 3/8" ø 24mm L 65mm tube ø 8mm WS 22 SS		

			
1			
GEV No.	527118	Ref. No.	80007000
description	water pipe with adapter		

accessories

bushes

			
1			
GEV No.	528824	Ref. No.	07300293
description	bush D1 ø 8.5mm D2 ø 12mm H 6mm brass ID ø 7mm		





 <p>Image not available</p>			
1			
GEV No.	528825	Ref. No.	07300294
description	bush SS		

springs			
			
1			
GEV No.	528823	Ref. No.	08000027
description	compression spring ø 11.8mm L 16mm wire gauge ø 1.5mm		

tube handles			
			
1			
GEV No.	525042	Ref. No.	05000001
description	tube handle for pipe ø 10mm ø 13.5mm L 50mm rubber		

			
1			
GEV No.	525043	Ref. No.	05000002
description	tube handle for pipe ø 8mm ø 13.5mm L 50mm rubber		

union nuts			
			
1			
GEV No.	528826	Ref. No.	07300295
description	union nut thread 3/8" L 21mm hole ø 12.5mm chrome-plated brass		

screw connections			
			
1			
GEV No.	531133	Ref. No.	07300466
description	double nipple for steam pipe thread 1/8" L 16mm ø 12mm ID ø 5mm		

			
1			
GEV No.	528821	Ref. No.	07300292
description	double nipple T1: 3/8" T2: M8 L 18mm stainless steel WS 22		

fine filters			
			
1			
GEV No.	528832	Ref. No.	98004001
description	fine filter flat ø 8mm		

intake valves			
accessories			
gaskets			
			
1			
GEV No.	528811	Ref. No.	02590009
description	gasket		

level glasses			
level glasses			
gaskets			
			
1			
GEV No.	529419	Ref. No.	02260024 964
description	gasket D1 ø 19mm D2 ø 11.5mm H 10.5mm water level glass suitable for NUOVA SIMONELLI equiv. no. 02260024		

level glasses (complete)			
			
1			
GEV No.	525039	Ref. No.	75010001
description	water level tube L 145mm ø 12mm thread 3/8"		

			
1			
GEV No.	525040	Ref. No.	98010030
description	water level tube L 195mm ø 12mm thread 3/8"		

level glass pipes			
			
1			
GEV No.	529421	Ref. No.	09000009
description	water level tube ø 12mm H 112mm ID ø 7.6mm		



1

GEV No.	526370	Ref. No.	09000009
description	water level tube ø 12mm H 112mm ID ø 9mm red		



1

GEV No.	529418	Ref. No.	09000010
description	water level tube ø 12mm H 135mm		

non-return valves

complete



1

GEV No.	529395	Ref. No.	98003016 98003018
description	non-return valve inlet 1/4" outlet 1/4" L 50mm		

miscellaneous

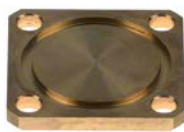

1

GEV No.	525026	Ref. No.	07300166
description	flange L 32mm W 32mm		

screw connections

double nipples



1

GEV No.	520682	Ref. No.	07300017
description	double nipple brass thread 1/4" - 3/8" Qty 1 pcs		

angle pieces



1

GEV No.	531101	Ref. No.	07300068
description	angle piece T1: 3/8" T2: 3/8" L 34mm brass Qty 1 pcs		

for coffee grinders

grinding burrs

grinding burrs straight

standard



1

GEV No.	527244	Ref. No.	15800045
description	grinding burrs pair turn direction right D1 ø 50mm ID ø 30mm H 7.5mm tooth spacing 2.5mm hole ø 4.5mm bore ø 7.5mm mounting ø 40 straight suitable for GAGGIA, BABY		



1

GEV No.	527113	Ref. No.	15050001
description	grinding burrs pair turn direction right D1 ø 64mm ID ø 37.5mm H 9mm tooth spacing 4mm hole ø 6mm bore ø 8.5mm mounting ø 49 straight		

grinding burrs holders



1

GEV No.	527115	Ref. No.	15000043
description	grinding burr holder mounting pos. lower		



1

GEV No.	527114	Ref. No.	15000044
description	grinding burr holder mounting pos. upper		



dosing containers

levers

levers



1

GEV No.	111126	Ref. No.	05000039
----------------	--------	-----------------	----------

description	lever left
--------------------	------------

coffee beans containers

container lids



1

GEV No.	527112	Ref. No.	15000050
----------------	--------	-----------------	----------

description	lid for coffee beans container
--------------------	--------------------------------

coffee beans containers



1

GEV No.	527111	Ref. No.	01100002
----------------	--------	-----------------	----------

description	coffee beans container
--------------------	------------------------

accessories for	527111
------------------------	--------

GEV No.	527112	Ref. No.	15000050
----------------	--------	-----------------	----------

description	lid for coffee beans container
--------------------	--------------------------------



1

GEV No.	531165	Ref. No.	15010002
----------------	--------	-----------------	----------

description	coffee beans container complete ø 208mm H 280mm seat ø 52mm
--------------------	---

for cup coffee machines

brewing units

brewing units

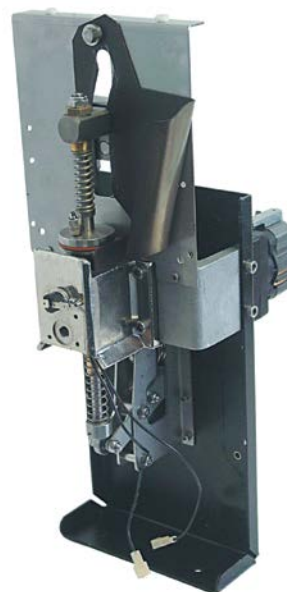

1

GEV No.	527101	Ref. No.	80004041
----------------	--------	-----------------	----------

description	brewing unit complete
--------------------	-----------------------

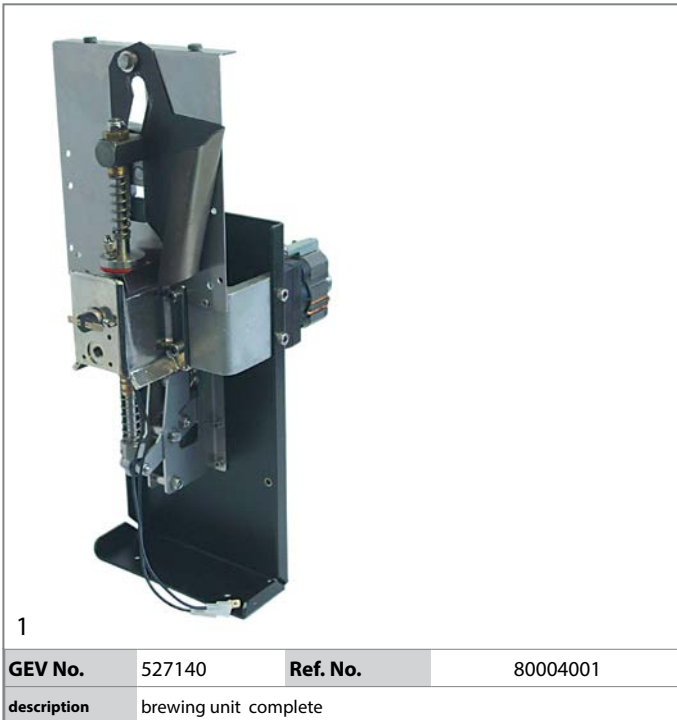

coffee spouts

coffee spouts



pistons

pistons

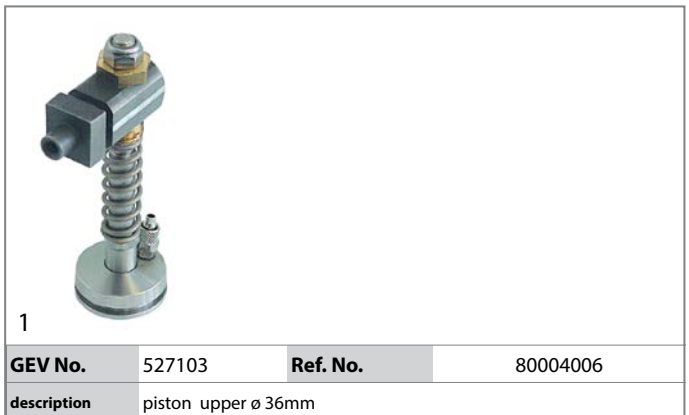



grinding units

grinding units

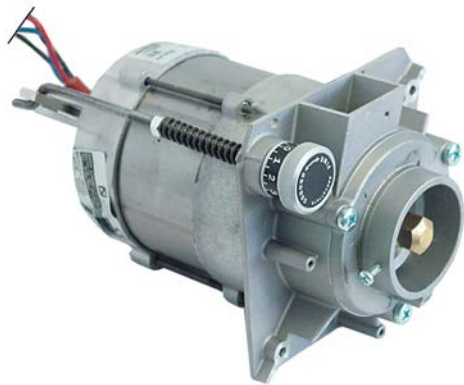

1

GEV No.	527110	Ref. No.	01100001
description	grinding unit complete for NUOVA SIMONELLI		

mechanical components



1

GEV No.	527109	Ref. No.	80004005
description	mechanism complete		

milk foamers



1

GEV No.	527116	Ref. No.	01000112
description	milk foamer suitable for NUOVA SIMONELLI Master1		

miscellaneous



1

GEV No.	696700	Ref. No.	04100024.P
description	handle \varnothing 25mm hole \varnothing 5.3x6mm L 7.5mm		

for drink dispensers

augers



1

GEV No.	650054	Ref. No.	16300107
description	auger for drink dispenser		

for tilting bratt pans

miscellaneous



1

GEV No.	523510	Ref. No.	15010034 15100086
description	deep-groove ball bearing type 6202-2RS shaft \varnothing 15mm ED \varnothing 35mm W 11mm with sealing discs deep-groove ball bearing DIN 625-1		

for dishwashers

containers

container lids



1

GEV No.	507020	Ref. No.	18010284
description	container lid suitable for rinse aid container		



1

GEV No.	507050	Ref. No.	18010414
description	lid for salt tank		

dosing containers



1

GEV No.	507016	Ref. No.	18010224
description	rinse aid container		
spare parts for	507016		
	GEV No.	507020	Ref. No. 18010284
	container lid suitable for rinse aid container		

salt tanks



1

GEV No.	524177	Ref. No.	18010512
description	lid \varnothing 69mm H 20mm for salt tank ID \varnothing 50mm		
accessories for	524177		
	GEV No.	524148	Ref. No. —
	O-ring EPDM thickness 3.53mm ID \varnothing 40.86mm Qty 1 pcs		









1

GEV No.	510018	Ref. No.	18010413
description	nut \varnothing 92mm H 10.5mm for salt tank ID \varnothing 64mm		



1

GEV No.	510929	Ref. No.	18010059 18010520
description	salt tank \varnothing 120mm H 117mm hose \varnothing 10mm mounting \varnothing 70mm overall height 157mm		
spare parts for	510929		
	GEV No.	506015	Ref. No. —
	O-ring EPDM thickness 3.53mm ID \varnothing 39.69mm Qty 1 pcs		
	GEV No.	510018	Ref. No. 18010413
	nut \varnothing 92mm H 10.5mm for salt tank ID \varnothing 64mm		
	GEV No.	524177	Ref. No. 18010512
	lid \varnothing 69mm H 20mm for salt tank ID \varnothing 50mm		
accessories for	510929		
	GEV No.	510071	Ref. No. —
	flat gasket rubber ED \varnothing 81mm ID \varnothing 68mm thickness 3mm for salt tank Qty 1 pcs		
	GEV No.	510654	Ref. No. —
	gasket H 6mm D1 \varnothing 82mm D2 \varnothing 68mm		
	GEV No.	510883	Ref. No. —
	gasket rubber ED \varnothing 86mm ID \varnothing 66mm thickness 2mm for salt tank Qty 1 pcs		

boilers

boilers for dishwashers



1

GEV No.	507107	Ref. No.	18010027 18011017
description	boiler		



1

GEV No.	507108	Ref. No.	18010130
description	boiler		



1

GEV No.	507111	Ref. No.	18010832
description	boiler		



1

GEV No.	507112	Ref. No.	18010801
description	boiler ø 150mm L 425mm		



1

GEV No.	507047	Ref. No.	18011061
description	boiler ø 160mm L 440mm		

rotation plates

rotation plates



1

GEV No.	507321	Ref. No.	18010030
description	rotation plate ø 292mm		

softener cartridges

softening columns



1

GEV No.	530000	Ref. No.	18010522
description	softener 4-fold L 380mm W 180mm		

housing and bezels

fascias



1

GEV No.	502188	Ref. No.	18010770
description	control panel LTM1600 L 400mm W 50mm H 159mm black		



1

GEV No.	502253	Ref. No.	18010846
description	control panel warewashing L 310mm W 133mm H 7mm black		

hood mechanics for dishwashers

spring holders



1

GEV No.	507156	Ref. No.	18010725
description	spring holder hood mechanics		

linkage



1





GEV No.	507158	Ref. No.	18010726
description	tie bar for hood spring		

air traps

air traps



1

GEV No.	507171	Ref. No.	18010077
description	air trap		
accessories for	507171		
	GEV No.	507052	Ref. No. 18010648
	hexagonal nut thread 3/4" Qty 1 pcs		
	GEV No.	507078	Ref. No. 18010227 18010750
	flat gasket rubber ED ø 25mm ID ø 14.5mm thickness 2.5mm Qty 1 pcs		
	GEV No.	507080	Ref. No. 18010371
	flat gasket rubber ED ø 39mm ID ø 25mm thickness 1.5mm Qty 1 pcs		
	GEV No.	507172	Ref. No. 18010217
	connection angle for air trap		
	GEV No.	507173	Ref. No. 18010226
	nut for connection angle for air trap		



1

GEV No.	524917	Ref. No.	LTM1600
description	air trap ø 60.5mm H 110mm thread 3/4" hose ø 6mm plastic		

air trap accessories



1

GEV No.	507172	Ref. No.	18010217
description	connection angle for air trap		



1

GEV No.	507173	Ref. No.	18010226
description	nut for connection angle for air trap		

door mechanics

door bumpers



1

GEV No.	507490	Ref. No.	18011009
description	door bumper H 10mm silicone L 33mm W 15mm		

door shafts



1

GEV No.	507039	Ref. No.	18010045
description	door shaft		
accessories for	507039		
	GEV No.	507040	Ref. No. 18010045
	retaining ring E D1 ø 4mm D2 ø 9mm SS DIN 6799 thickness 0.7mm		



1

GEV No.	507026	Ref. No.	18011052
description	door shaft L 175mm		
accessories for	507026		
	GEV No.	507015	Ref. No. —
	retaining ring E D1 ø 7mm D2 ø 14mm SS DIN 6799 thickness 0.9mm for shaft ø 8-11mm		

locks



1

GEV No.	506157	Ref. No.	18000017
description	door catch catch		



1

GEV No.	507011	Ref. No.	18010003
description	door catch complete door locking catch		

miscellaneous





1

GEV No.	346945	Ref. No.	18010171
description	angle piece		



			
1			
GEV No.	507034	Ref. No.	18010394
description	fastening angle for microswitch		

			
1			
GEV No.	507031	Ref. No.	18011011
description	fixing plate for door		

			
1			
GEV No.	507012	Ref. No.	18010812
description	spacer ring bush		

screw connections

			
1			
GEV No.	507057	Ref. No.	18010188
description	nut thread 1 1/2" H 14mm WS 60 ø 65mm		

			
1			
GEV No.	507058	Ref. No.	18010099
description	screw connection thread 1 1/4" H 14mm WS 55		

washing and rinsing systems

			
1			
GEV No.	507177	Ref. No.	18010023
description	hose connector brass straight		

			
1			
GEV No.	507054	Ref. No.	18010180 18010614
description	nut thread 3/8" H 10mm brass WS 20 Qty 1 pcs		

			
1			
GEV No.	517414	Ref. No.	18010640
description	rinse arm support ø 20mm H 44mm thread 1/4"/M10x1 WS 23		

			
1			
GEV No.	507175	Ref. No.	18010335
description	screw connection for rinse arm		

			
1			
GEV No.	507224	Ref. No.	18010472
description	slide ring		

			
1			
GEV No.	507235	Ref. No.	18010496
description	wash pipe		

knobs

producer-specific knobs

NUOVA SIMONELLI



1	GEV No.	111014	Ref. No.	05000064
	description	handle ø 45mm shaft ø 5x5mm shaft rectangular		

steam/water taps

steam/water taps



1	GEV No.	111127	Ref. No.	98008006
	description	knob ø 48mm black		

miscellaneous



1	GEV No.	112016	Ref. No.	05000174
	description	knob universal ø 49mm shaft ø 8x6.5mm		

handles and hand wheels

lever handles



1	GEV No.	111132	Ref. No.	05000022
	description	lever		



1	GEV No.	525031	Ref. No.	98006022
	description	lever with holder mounting pos. left		



1	GEV No.	525041	Ref. No.	98006021
	description	lever with holder mounting pos. right		



1	GEV No.	111316	Ref. No.	05000815
	description	slide shaft ø 6mm		

accessories



1	GEV No.	525030	Ref. No.	07300355
	description	bracket L 41mm W 26mm ID ø 16.5mm brass		

fittings for catering equipment

drain taps

accessories



1	GEV No.	540222	Ref. No.	18010148
	description	O-ring EPDM thickness 2.62mm ID ø 47.3mm Qty 1 pcs		



equipment feet and end caps

equipment feet with stem

 <p>1</p>			
GEV No.	802040	Ref. No.	15050013
description	equipment foot ø 20mm H 10mm mounting ø 11mm overall height 23mm rubber Qty 1 pcs		

DERBY RUOTE

spare parts and accessories

miscellaneous

 <p>1</p>			
GEV No.	700134	Ref. No.	00300018
description	nut SS thread M8 self-locking		

baskets

warewashing baskets

plastic baskets round

 <p>1</p>			
GEV No.	970812	Ref. No.	18010068 18010069
description	mix basket ED ø 367mm H 173mm seat ø 280mm mesh type wide-meshed/plastic		

plastic baskets square

mix baskets

 <p>1</p>			
GEV No.	971078	Ref. No.	18010901
description	mix basket L 400mm W 400mm H 150mm		

accessories

cutlery inserts

 <p>1</p>			
GEV No.	970349	Ref. No.	18010579
description	cutlery insert L 130mm W 57mm ømm H 110mm		

gaskets

O-rings

EPDM

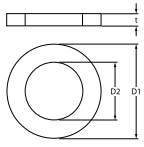
  <p>1</p>			
GEV No.	361304	Ref. No.	02280032
description	O-ring EPDM ID ø 11.11mm thickness 1.78mm Qty 1 pcs for type DIB3E/DIB5E		

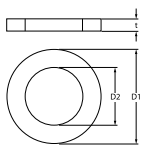
  <p>1</p>			
GEV No.	524421	Ref. No.	15100176
description	O-ring EPDM thickness 1.78mm ID ø 2.78mm Qty 1 pcs		

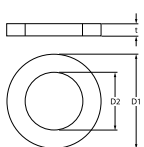
  <p>1</p>			
GEV No.	529491	Ref. No.	02280012
description	O-ring EPDM thickness 1.78mm ID ø 23.52mm Qty 1 pcs		

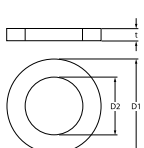
  <p>1</p>			
GEV No.	517035	Ref. No.	18010555
description	O-ring EPDM thickness 1.78mm ID ø 4.48mm Qty 1 pcs		

GEV No.	505045	Ref. No.	02280007
description	O-ring EPDM thickness 1.78mm ID ø 5.28mm Qty 1 pcs		

GEV No.	510303	Ref. No.	18010162
description	O-ring EPDM thickness 1.78mm ID ø 6.75mm Qty 1 pcs		

GEV No.	525022	Ref. No.	02280033
description	O-ring EPDM thickness 1.78mm ID ø 75.92mm Qty 1 pcs		

GEV No.	530293	Ref. No.	02280010
description	O-ring EPDM thickness 1.78mm ID ø 8.73mm Qty 1 pcs		

GEV No.	528223	Ref. No.	02280004
description	O-ring EPDM thickness 2.62mm ID ø 11.91mm Qty 1 pcs		

GEV No.	507313	Ref. No.	02280011
description	O-ring EPDM thickness 2.62mm ID ø 13.95mm Qty 1 pcs		

GEV No.	507309	Ref. No.	18010302
description	O-ring EPDM thickness 2.62mm ID ø 17.13mm Qty 1 pcs		

GEV No.	504590	Ref. No.	18010207
description	O-ring EPDM thickness 2.62mm ID ø 18.72mm Qty 1 pcs		

GEV No.	505073	Ref. No.	18010322
description	O-ring EPDM thickness 2.62mm ID ø 20.63mm Qty 1 pcs		

GEV No.	507314	Ref. No.	18010033
description	O-ring EPDM thickness 2.62mm ID ø 32.99mm		

accessories for 507314

GEV No.	507314	Ref. No.	18010033
description	O-ring EPDM thickness 2.62mm ID ø 32.99mm		

GEV No.	507315	Ref. No.	18010035
description	O-ring EPDM thickness 2.62mm ID ø 42.52mm		

GEV No.	512111	Ref. No.	18010342
description	O-ring EPDM thickness 2.62mm ID ø 45.69mm Qty 1 pcs		

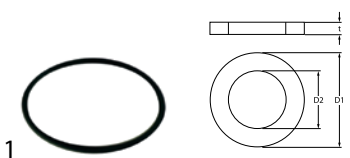
1

GEV No.	540222	Ref. No.	18010148
description	O-ring EPDM thickness 2.62mm ID ø 47.3mm Qty 1 pcs		

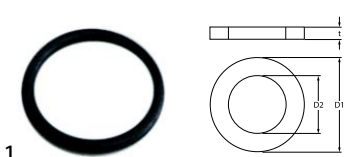

1

GEV No.	361080	Ref. No.	02280037
description	O-ring EPDM thickness 2mm ID ø 16mm Qty 1 pcs		



1

GEV No.	523012	Ref. No.	17000032
description	O-ring EPDM thickness 3.53mm ID ø 57.15mm Qty 1 pcs		



1

GEV No.	532130	Ref. No.	17000032
description	O-ring EPDM thickness 3.53mm ID ø 68.26mm Qty 10 pcs		



1

GEV No.	510409	Ref. No.	18010746
description	O-ring EPDM thickness 5.34mm ID ø 56.52mm Qty 1 pcs		

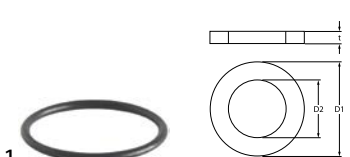

1

GEV No.	508109	Ref. No.	18010602
description	O-ring EPDM thickness 5.34mm ID ø 69.22mm Qty 1 pcs		

silicone

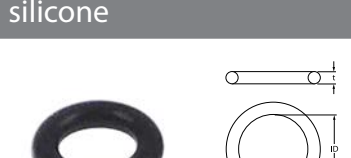

1

GEV No.	532554	Ref. No.	18010559
description	O-ring silicone thickness 1.5mm ID ø 4.1mm Qty 1 pcs		

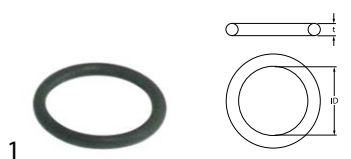

1

GEV No.	529422	Ref. No.	2280032
description	O-ring silicone thickness 1.78mm ID ø 11.11mm Qty 1 pcs		



1

GEV No.	532588	Ref. No.	02000003
description	O-ring silicone thickness 1.78mm ID ø 12.42mm Qty 1 pcs		

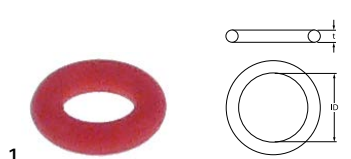

1

GEV No.	526403	Ref. No.	02280014
description	O-ring silicone thickness 1.78mm ID ø 3.69mm Qty 1 pcs		



1

GEV No.	532246	Ref. No.	02280018
description	O-ring silicone thickness 2.62mm ID ø 13.95mm Qty 10 pcs		

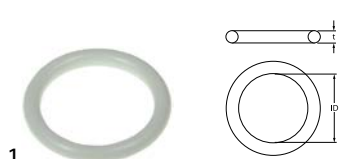

1

GEV No.	532513	Ref. No.	16300040
description	O-ring silicone thickness 2.62mm ID ø 15.88mm Qty 1 pcs food-safe white		



1

GEV No.	527123	Ref. No.	02290020
description	O-ring silicone thickness 3.53mm ID ø 34.52mm Qty 1 pcs		



1

GEV No.	532317	Ref. No.	02290021
description	O-ring silicone thickness 3.53mm ID ø 34.52mm Qty 10 pcs		

Viton

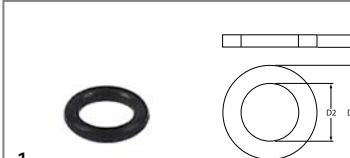

1

GEV No.	371095	Ref. No.	02290016
description	O-ring Viton thickness 1.78mm ID ø 6.07mm Qty 1 pcs		



1

GEV No.	528291	Ref. No.	02280016
description	O-ring Viton thickness 2.62mm ID ø 11.91mm Qty 1 pcs		

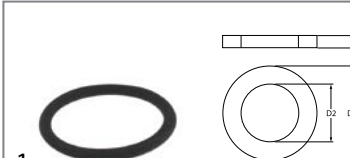

1

GEV No.	528155	Ref. No.	02280009
description	O-ring Viton thickness 3.53mm ID ø 32.93mm Qty 1 pcs		

sealing washers

fibre gaskets



1

GEV No.	507332	Ref. No.	02060029
description	flat gasket fibre ED ø 18mm ID ø 12mm thickness 2mm Qty 1 pcs		



1

GEV No.	510405	Ref. No.	18010760
description	flat gasket fibre ED ø 56mm ID ø 42mm thickness 2mm for thread 1/4" Qty 1 pcs		

rubber gaskets



1

GEV No.	507075	Ref. No.	18010936
description	flat gasket rubber ED ø 15mm ID ø 10mm thickness 2mm Qty 1 pcs		



1

GEV No.	507078	Ref. No.	18010227 18010750
description	flat gasket rubber ED ø 25mm ID ø 14.5mm thickness 2.5mm Qty 1 pcs		



1

GEV No.	507080	Ref. No.	18010371
description	flat gasket rubber ED ø 39mm ID ø 25mm thickness 1.5mm Qty 1 pcs		



1

GEV No.	521124	Ref. No.	18000026
description	flat gasket rubber ED ø 52mm ID ø 42mm thickness 6mm Qty 1 pcs		



1

GEV No.	507045	Ref. No.	18010150
description	flat gasket rubber ED ø 78mm ID ø 68mm thickness 3mm Qty 1 pcs		

PTFE gaskets





1

GEV No.	528157	Ref. No.	02060021
description	flat gasket ED ø 33.5mm ID ø 24mm thickness 1.5mm		



 <p>1</p>			
GEV No.	526400	Ref. No.	02060021
description	flat gasket PTFE ED ø 33mm ID ø 24.5mm thickness 1.5mm Qty 1 pcs		

 <p>1</p>			
GEV No.	526402	Ref. No.	02060015
description	flat gasket PTFE ED ø 67mm ID ø 54mm thickness 2mm Qty 1 pcs		

silicone gaskets			
 <p>1</p>			
GEV No.	507335	Ref. No.	18010029
description	flat gasket silicone ED ø 42mm ID ø 29mm thickness 3.5mm Qty 1 pcs		

special gaskets

group gaskets			
 <p>1</p>			
GEV No.	528156	Ref. No.	02060019
description	group gasket L 102mm W 31mm thickness 3mm fibre suitable for NUOVA SIMONELLI		

 <p>1</p>			
GEV No.	526372	Ref. No.	02060019
description	group gasket L 92mm W 30mm thickness 2mm hole distance 72mm PTFE		

gaskets for wash arm support

 <p>1</p>			
GEV No.	507255	Ref. No.	18010173
description	gasket D1 ø 45mm D2 ø 85mm thickness 2mm cork with 4 screw holes wash arm support equiv. no. LS02		



springs
torsion springs



 <p>1</p>			
GEV No.	507030	Ref. No.	18011006
description	torsion spring mounting pos. left for door		

 <p>1</p>			
GEV No.	507029	Ref. No.	18011007
description	torsion spring mounting pos. right for door		

 <p>1</p>			
GEV No.	507027	Ref. No.	18011032
description	torsion spring ø 17mm L2 38mm wire gauge ø 2mm mounting pos. right L1 10mm L3 70mm Qty 1 pcs for door		

 <p>1</p>			
GEV No.	507028	Ref. No.	18011031
description	torsion spring ø 17mm L2 70mm wire gauge ø 2mm mounting pos. left L1 10mm L3 38mm for door		

 <p>1</p>			
GEV No.	690081	Ref. No.	15320007
description	torsion spring ø 19.4mm L2 36mm wire gauge ø 3.3mm mounting pos. left L1 42mm L3 36mm Qty 1 pcs		
accessories for	690081		
	GEV No.	690080	Ref. No.
			15320008
	torsion spring ø 19.4mm L2 37mm wire gauge ø 3.4mm mounting pos. right L1 42mm L3 37mm Qty 1 pcs		

			
1			
GEV No.	690080	Ref. No.	15320008
description	torsion spring ø 19.4mm L2 37mm wire gauge ø 3.4mm mounting pos. right L1 42mm L3 37mm Qty 1 pcs		
accessories for	690080		
	GEV No.	690081	Ref. No. 15320007
	torsion spring ø 19.4mm L2 36mm wire gauge ø 3.3mm mounting pos. left L1 42mm L3 36mm Qty 1 pcs		

compression springs

			
1			
GEV No.	528810	Ref. No.	08000005 08000007
description	compression spring ø 11.5mm L 25mm wire gauge ø 1.8mm		

			
1			
GEV No.	528823	Ref. No.	08000027
description	compression spring ø 11.8mm L 16mm wire gauge ø 1.5mm		

			
1			
GEV No.	528817	Ref. No.	08000013
description	compression spring ø 20.4/15.9mm L 17mm wire gauge ø 1.7mm cone-shaped		

			
1			
GEV No.	507038	Ref. No.	18010045
description	compression spring ø 8.8mm L 31mm wire gauge ø 0.7mm		

			
1			
GEV No.	528818	Ref. No.	08000030
description	compression spring ø 9.8mm L 15mm wire gauge ø 1.1mm		

tension springs

			
1			
GEV No.	507157	Ref. No.	18010932
description	tension spring ø 37mm total length 875mm wire gauge ø 4.5mm L1 305mm L2 570mm for hood		

manometers

			
1			
GEV No.	541233	Ref. No.	09100003
description	manometer double scale ø 60mm pressure range 0-2.5 / 0-15bar connection on the backside thread 1/8"		

			
1			
GEV No.	541410	Ref. No.	N/A
description	manometer double scale ø 60mm pressure range 0-2.5 / 0-15bar connection on the backside thread 1/8"		

			
1			
GEV No.	541222	Ref. No.	N/A
description	manometer double scale ø 60mm pressure range 0-2.5 / 0-16bar connection on the backside thread 1/8"		

			
1			
GEV No.	541226	Ref. No.	N/A
description	manometer double scale ø 60mm pressure range 0-2.5 / 0-16bar connection on the backside thread 1/8"		



 <p>1</p>			
GEV No.	541227	Ref. No.	N/A
description	manometer double scale ø 60mm pressure range 0-2.5 / 0-16bar connection on the backside thread 1/8"		

dosing pumps

membrane dosing pumps

self-priming





SEKO

spare parts

 <p>1</p>			
GEV No.	361304	Ref. No.	02280032
description	O-ring EPDM ID ø 11.11mm thickness 1.78mm Qty 1 pcs for type DIB3E/DIB5E		

self-priming with supporting pressure

OMNIWASH

 <p>1</p>			
GEV No.	361054	Ref. No.	18010067
description	dosing pump rinse aid pressure connection ø 6mm suction connection ø 6mm auxiliary pressure connection 10mm		
spare parts for	361054		
	GEV No.	361308	Ref. No. 18010066
	membrane rinse aid pressure connection ømm suction connection ømm auxiliary pressure connectionmm		
	GEV No.	361348	Ref. No. 18010072
	lip valve rinse aid pressure connection ømm suction connection ømm auxiliary pressure connectionmm		
accessories for	361054		
	GEV No.	520252	Ref. No. —
	nylon hose ID ø 6mm ED ø 8mm L 5m thickness 1mm operating p. 10bar burst p. 50bar t.max. 100°C white		
	GEV No.	520278	Ref. No. —
	PVC hose ID ø 6mm ED ø 8mm L 2m thickness 1mm t.max. 60°C transparent		

 <p>1</p>			
GEV No.	361348	Ref. No.	18010072
description	lip valve rinse aid pressure connection ømm suction connection ømm auxiliary pressure connectionmm		

 <p>1</p>			
GEV No.	361308	Ref. No.	18010066
description	membrane rinse aid pressure connection ømm suction connection ømm auxiliary pressure connectionmm		

SEKO			
 <p>1</p>			
GEV No.	361304	Ref. No.	02280032
description	O-ring EPDM ID ø 11.11mm thickness 1.78mm Qty 1 pcs for type DIB3E/DIB5E		

accessories

hose couplings

metal

 <p>1</p>			
GEV No.	361171	Ref. No.	07300362
description	screw pipe fitting straight nickel-plated brass thread 1/4" hose ø 4/6mm Qty 1 pcs		

 <p>1</p>			
GEV No.	361173	Ref. No.	07300376
description	screw pipe fitting straight nickel-plated brass thread 1/8" hose ø 4/6mm Qty 1 pcs		

 <p>1</p>			
GEV No.	361182	Ref. No.	18010386
description	nut thread 1/4" H 5mm nickel-plated brass WS 17 Qty 1 pcs		



			
1			
GEV No.	361181	Ref. No.	00300005
description	nut thread 1/8" H 4.5mm nickel-plated brass WS 14 Qty 1 pcs		

industrial hoses

Niplaflex hoses

			
1			
GEV No.	530562	Ref. No.	18010021
description	pressure hose ID ø 13mm ED ø 21mm L 5m operating p. 10bar burst p. 30bar t.max. 110°C		

pressure control hoses

			
1			
GEV No.	530560	Ref. No.	18011018
description	pressure control hose ID ø 5mm ED ø 9mm L 5m operating p. 30bar burst p. 90bar temp.-resist. 60°C		

formed hoses

form L



			
1			
GEV No.	507090	Ref. No.	18010039
description	formed hose warewashing L-shape equiv. no. GA18		

			
1			
GEV No.	507095	Ref. No.	18010137
description	formed hose warewashing L-shape equiv. no. GA38		

hoses

supply hoses

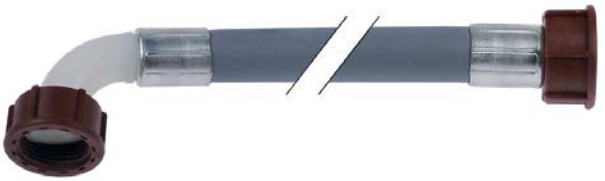
PVC supply hoses

				
1				
GEV No.	520010	Ref. No.	18010170	
description	supply hose PVC straight-curved DN13 connections 3/4" L 1500mm operating p. 10bar burst p. 32bar t.max. 90°C blue approval VDE flat seal			
accessories for	520010			
	GEV No.	520053	Ref. No.	—
	screen connection 3/4" D1 ø 26mm D2 ø 15mm Qty 10 pcs rubber thickness 8mm			
	GEV No.	520054	Ref. No.	—
	flat gasket rubber ED ø 23.5mm ID ø 14mm thickness 2.3mm Qty 10 pcs			

drain hoses

			
1			
GEV No.	507329	Ref. No.	18010379
description	drain hose DN19 L 1500mm A int. ø 19mm A ext. ø 24mm B int. ø 21mm B ext. ø 28mm outer hose ø 24mm		

			
1			
GEV No.	507207	Ref. No.	18010155
description	drain hose DN24 L 1500mm A int. ø 24mm A ext. ø 28mm B int. ø 24mm B ext. ø 28mm outer hose ø 28mm		

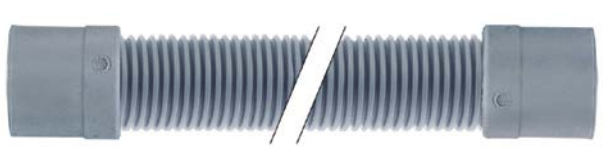
			
1			
GEV No.	507211	Ref. No.	18010156
description	drain hose DN26 L 1500mm A int. ø 33mm A ext. ø 40mm B int. ø 32mm B ext. ø 40mm outer hose ø 35mm		





1

GEV No.	507097	Ref. No.	18010819
description	formed hose warewashing L-shape equiv. no. GA538		



1

GEV No.	507103	Ref. No.	18010739
description	formed hose warewashing L-shape equiv. no. GASA8		



1

GEV No.	507205	Ref. No.	18010037
description	formed hose warewashing L-shape equiv. no. GS120 hose int. ø 25mm		



1

GEV No.	507213	Ref. No.	18010831
description	formed hose warewashing L-shape equiv. no. GS520		



1

GEV No.	507216	Ref. No.	18010829
description	formed hose warewashing L-shape equiv. no. GSMP55		

with branch



1

GEV No.	507327	Ref. No.	18010822
description	formed hose warewashing equiv. no. GLSIC4 with piggyback		

form S



1

GEV No.	507241	Ref. No.	18010740
description	formed hose S-shape warewashing		

miscellaneous



1

GEV No.	507149	Ref. No.	18010124
description	formed hose warewashing equiv. no. GL4T22		

fittings, hose and pipe connectors

hose connectors

without screw connection



1

GEV No.	504583	Ref. No.	18010749
description	Y-piece plastic hose ø 12-12-12mm		

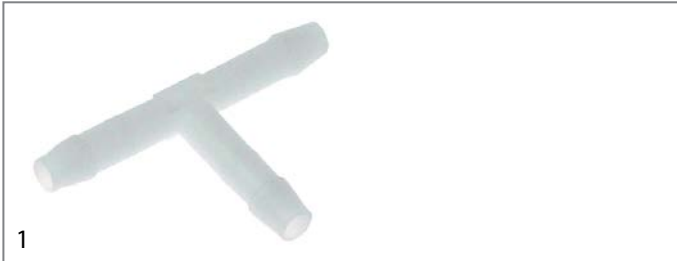

1	GEV No. 507174	Ref. No.	18010825
description	T-piece plastic hose ø 4-4-4mm 3-way		

fittings

double nipples

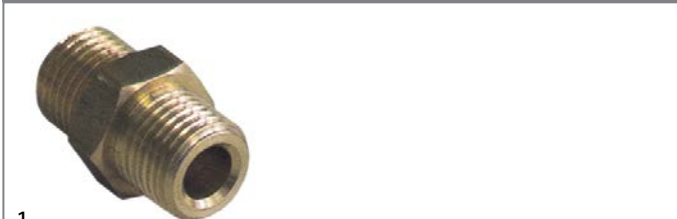

1	GEV No. 520662	Ref. No.	07300012
description	double nipple brass thread 1/4" - 1/4" Qty 1 pcs		

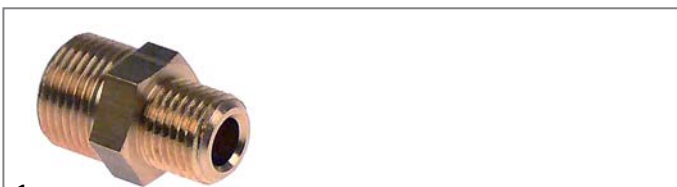

1	GEV No. 520682	Ref. No.	07300017
description	double nipple brass thread 1/4" - 3/8" Qty 1 pcs		



1	GEV No. 520663	Ref. No.	07300015
description	double nipple brass thread 3/8" - 3/8" Qty 1 pcs		

angle pieces



1	GEV No. 531101	Ref. No.	07300068
description	angle piece T1: 3/8" T2: 3/8" L 34mm brass Qty 1 pcs		

T-pieces

nickel-plated brass

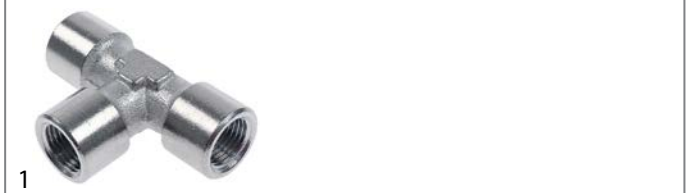

1	GEV No. 520385	Ref. No.	07300718
description	T-piece thread 1/8" IT - 1/8" IT - 1/8" IT nickel-plated brass L 35mm		

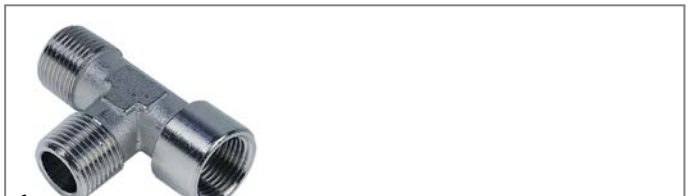

1	GEV No. 520806	Ref. No.	07300209
description	T-piece thread 3/8" ET - 3/8" ET - 3/8" IT nickel-plated brass L 52.5mm		

hose connectors

plastic



1	GEV No. 519277	Ref. No.	05000015
description	hose connector plastic angled thread 1/4" hose ø 10mm Qty 1 pcs		

nickel-plated brass

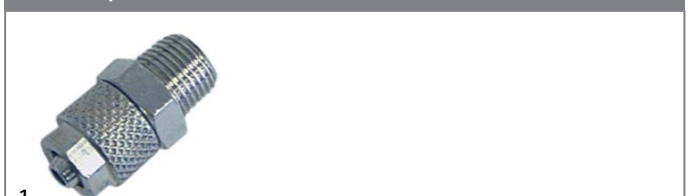



1	GEV No. 361171	Ref. No.	07300362
description	screw pipe fitting straight nickel-plated brass thread 1/4" hose ø 4/6mm Qty 1 pcs		





1	GEV No. 361173	Ref. No.	07300376
description	screw pipe fitting straight nickel-plated brass thread 1/8" hose ø 4/6mm Qty 1 pcs		



producer-specific

			
1			
GEV No.	507061	Ref. No.	18010757
description	elbow connection		
accessories for	507061		
	GEV No.	507075	Ref. No. 18010936
	flat gasket rubber ED ø 15mm ID ø 10mm thickness 2mm Qty 1 pcs		
	GEV No.	507330	Ref. No. —
	nut thread M10x1 H 7mm WS 13 stainless steel Qty 1 pcs		

			
1			
GEV No.	507210	Ref. No.	18010136
description	hose connector		

			
1			
GEV No.	507194	Ref. No.	18010718
description	hose connector thread 3/8" angled L 23mm		

			
1			
GEV No.	507105	Ref. No.	18010461
description	manifold 4-way hose ø 13-13-13-13mm plastic		

water cycle components

pressure reduction valves

pressure reduction valves

producer-specific

			
1			
GEV No.	541185	Ref. No.	01000163
description	pressure controller Metal Work series Bit MRA connection 1/4" default settingbar setting range 0-8bar p max 13bar t.max. 50°C plastic thread 1/4"		

ancillary products

silicone

food-grade silicones

			
1			
GEV No.	890113	Ref. No.	11600003
description	silicone S27 food-safe cartridge 310ml transparent		
description	<p>OTTOSEAL S 27 - cartridge 300ml - transparent</p> <p>Used for sealing in the food sector, e. g. in dairies, abattoirs, beverage and food production plants, canteen kitchens etc. and sealing in the drinking water area between ceramic coatings.</p> <ul style="list-style-type: none"> - 1-component acetate-curing silicone sealant - Tested for applications in the food and drinking water sector - Good chemical resistance, e. g. to diluted acids and bases - High resistance to notches, tension and tearing - Excellent weathering, ageing and UV-resistance - Temperature range -40°C to + 180°C 		

clamps

double wire clamps

			
1			
GEV No.	560344	Ref. No.	18010911
description	hose clamp ø 7-9mm wire gauge ø 1mm Qty 1 pcs		

measuring equipment

thermometers

built-in thermometers

			
1			
GEV No.	541086	Ref. No.	18010767
description	thermometer mounting measurements 58x25.5mm 0 up to +120°C capillary pipe 2000mm probe ø 6mm probe L 23mm		

fastening material

screws

sheet metal screws



1

GEV No.	560498	Ref. No.	15030055
description	screw \varnothing 2.2mm L 6.5mm zinc-plated Qty 1 pcs intake Phillips for plastic		

countersunk screws



1

GEV No.	560220	Ref. No.	00300021
description	countersunk screw thread M6 L 20mm SS DIN 963/ISO 2009 Qty 20 pcs intake slotted head \varnothing 11mm		

flat-headed bolts



1

GEV No.	560371	Ref. No.	00000089
description	flat-headed bolt thread M4 thread L 12mm SS DIN 7985/ISO 7045 Qty 1 pcs intake Phillips head \varnothing 8mm head thickness 3mm		

hexagonal screws



1

GEV No.	510990	Ref. No.	00000094
description	hexagonal screw thread M8 thread L 20mm SS WS 13 Qty 1 pcs DIN 933 / ISO 4017		

cylinder head bolts

DIN 912/ISO 4762



1

GEV No.	560452	Ref. No.	00000164
description	cylinder head bolt thread M3 thread L 16mm L 19mm SS Qty 1 pcs DIN 912/ISO 4762		

nuts

hexagonal nuts

DIN 934 / ISO 4032/8673



1

GEV No.	560129	Ref. No.	00000003
description	hexagonal nut thread M5 H 4mm WS 8 SS DIN/ISO DIN 934 / ISO 4032/8673 Qty 1 pcs		



1

GEV No.	517174	Ref. No.	37320800
description	nut thread M8 H 6.5mm WS 13 SS DIN/ISO DIN 934 / ISO 4032/8673 Qty 1 pcs		

DIN 985



1

GEV No.	560141	Ref. No.	00300023
description	hexagonal nut thread M5 H 5.4mm SS WS 8 Qty 20 pcs DIN/ISO DIN 985 self-locking		

hexagonal nuts inch thread



1

GEV No.	507052	Ref. No.	18010648
description	hexagonal nut thread 3/4" Qty 1 pcs		



1

GEV No.	361182	Ref. No.	18010386
description	nut thread 1/4" H 5mm nickel-plated brass WS 17 Qty 1 pcs		



1

GEV No.	361181	Ref. No.	00300005
description	nut thread 1/8" H 4.5mm nickel-plated brass WS 14 Qty 1 pcs		



			
1			
GEV No.	520234	Ref. No.	18010648
description	nut thread 3/4" H 5mm brass WS 30 Qty 1 pcs		

			
1			
GEV No.	507054	Ref. No.	18010180 18010614
description	nut thread 3/8" H 10mm brass WS 20 Qty 1 pcs		

washers

washers

miscellaneous

			
1			
GEV No.	507114	Ref. No.	18010332
description	disc D1 ø 30mm D2 ø 17mm thickness 3mm		

fasteners

clamps

double wire clamps

			
1			
GEV No.	560344	Ref. No.	18010911
description	hose clamp ø 7-9mm wire gauge ø 1mm Qty 1 pcs		

retaining rings

DIN 6799

			
1			
GEV No.	507040	Ref. No.	18010045
description	retaining ring E D1 ø 4mm D2 ø 9mm SS DIN 6799 thickness 0.7mm		

			
1			
GEV No.	518557	Ref. No.	08000015
description	retaining ring E D1 ø 5mm D2 ø 11mm SS DIN 6799 thickness 0.7mm		

consumables

sealants and adhesives

food-grade silicones

			
1			
GEV No.	890113	Ref. No.	11600003
description	silicone S27 food-safe cartridge 310ml transparent		
description	OTTOSEAL S 27 - cartridge 300ml - transparent Used for sealing in the food sector, e. g. in dairies, abattoirs, beverage and food production plants, canteen kitchens etc. and sealing in the drinking water area between ceramic coatings. - 1-component acetate-curing silicone sealant - Tested for applications in the food and drinking water sector - Good chemical resistance, e. g. to diluted acids and bases - High resistance to notches, tension and tearing - Excellent weathering, ageing and UV-resistance - Temperature range -40°C to + 180°C		

cleaning agents

detergents for milk foamers

			
1			
GEV No.	802111	Ref. No.	13200012
description	detergents for milk foamers bottle PULY MILK Plus approval NSF 1000ml		



fuses

fine fuses

ø10x38mm 500V



1

GEV No.	358022	Ref. No.	16300112
description	fine fuse size ø10x38mm 4A rated 500V type Gg fast-acting Qty 1 pcs		

thermal fuses



1

GEV No.	358012	Ref. No.	09500014
description	thermal fuse switch-off temp. 167°C nominalA cable length 160mm		

B			
bi-metal thermostats	7	hexagonal screws	64
booster pumps II	30	hose connectors	61, 62
		hose couplings	59
		hoses	60
C			
cables	31	I	
castors and bumper angles	53	immersion heating elements	5
clamps	63, 65	indicator lights	13
cleaning agents	65	indicator lights (complete)	13
condensators & interference suppression filters	31	industrial hoses	60
consumables	65		
contactors	15	L	
control equipment	12	lamps	13
control thermostats	8	LED	13
countersunk screws	64		
cylinder head bolts	64	M	
		magnetic switches	12
		measuring equipment	63
		microswitches	10
		motors	28
D			
detergents for milk foamers	65	N	
dosing pumps	59	Niplaflex hoses	60
double nipples	62	nuts	64
double wire clamps	63, 65		
drain hoses	60	O	
drain pumps	29	operating capacitors	31
		O-rings	53
E		P	
electric accessories	31	pressure control hoses	60
electrodes	27	pressure reduction valves	63, 63
electronic magnets	32	pressure switches	27
		probes	16
		programme timers	14
		pumps	29
		push/momentary push switches	9
		PVC cable	31
		PVC supply hoses	60
F		R	
fasteners	65	relays	15
fastening material	64	retaining rings	65
filters	31	rocker/momentary rocker switches	8
fine fuses	66	rotary switches	11
fittings	62		
flat-headed bolts	64	S	
float switches	11	safety bi-metal thermostats	7
flow meters	28	screws	64
food-grade silicones	63, 65	sealants and adhesives	65
formed hoses	60	sealing washers	56
fuses	31, 66	sheet metal screws	64
		silicone	63, 65
G			
gaskets for wash arm support	57		
H			
heating cartridges	5		
heating elements	3		
heating elements for coffee machine	3		
heating elements for contact grills	5		
hexagonal nuts	64		

solenoid valves	23
supply hoses	60
switches and momentary switches	8
system switches (ROLD)	11

T

terminals	32
thermal fuses	66
thermostats	7
time relays	16
timers	14
transformers	16

V

vibration pumps	31
-----------------	----

W

wash and rinse pumps	29
washers	65
water cycle components	63