



**GAS COMPONENTS**



**ELECTRIC COMPONENTS**



**WATER TECHNOLOGY**



**MECHANICAL COMPONENTS**



**TOOLS**

Spare parts suitable for

**OEM**

Find the complete and up-to-date range of products in our GEV Webshop



# Manufacturer catalogue

The most important spare parts and accessories arranged clearly for every manufacturer

- ✓ Complete product range and all appliance data always up to date in the GEV Webshop
- ✓ Alphabetical Index at the end of the catalogue

## GEV Webshop

[www.gev-online.co.uk](http://www.gev-online.co.uk)

[www.gev-online.com](http://www.gev-online.com)













- 🔍 Add to Favourites
- 🔍 Sign In with email address and usual password
- 🔍 Easy-order – place several items in your basket at the same time
- 🔍 Quick Item search – no login needed



## heating elements

### heating elements for coffee machine

 <p>1</p>			
<b>GEV No.</b>	415193	<b>Ref. No.</b>	EE003
<b>description</b>	heating element 3000W 230V heating circuits 3 mounting ø 42mm hole distance 74mm L 310mm W 35mm H 43mm L1 35mm L2 45mm L3 230mm H1 13mm hole ø 10mm connection M4 immersion heater 2 hole flange		
<b>accessories for</b>	415193		
	<b>GEV No.</b>	521103	<b>Ref. No.</b> —
	nut thread M4 H 3mm WS 7 brass Qty 20 pcs		
	<b>GEV No.</b>	521104	<b>Ref. No.</b> —
	washer ID ø 4.3mm ED ø 8mm thickness 0.5mm brass Qty 20 pcs for thread M4		
	<b>GEV No.</b>	521125	<b>Ref. No.</b> AD036
	flat gasket rubber ED ø 52mm ID ø 42.5mm thickness 4mm Qty 1 pcs		
	<b>GEV No.</b>	560111	<b>Ref. No.</b> —
	plain washer ID ø 4.3mm ED ø 9mm thickness 0.8mm SS Qty 20 pcs DIN 125A for thread M4		
	<b>GEV No.</b>	560131	<b>Ref. No.</b> —
	hexagonal nut thread M4 H 3.2mm WS 7 SS DIN/ISO DIN 934 / ISO 4032/8673 Qty 20 pcs		



 <p>1</p>			
<b>GEV No.</b>	415194	<b>Ref. No.</b>	EE005
<b>description</b>	heating element 4500W 230V heating circuits 3 mounting ø 42mm hole distance 74mm L 318mm W 32mm H 44mm L1 35mm L2 45mm L3 235mm H1 29mm H2 15mm hole ø 9mm tube ø 8.5mm connection M4 immersion heater 2 hole flange		
<b>accessories for</b>	415194		
	<b>GEV No.</b>	521103	<b>Ref. No.</b> —
	nut thread M4 H 3mm WS 7 brass Qty 20 pcs		
	<b>GEV No.</b>	521104	<b>Ref. No.</b> —
	washer ID ø 4.3mm ED ø 8mm thickness 0.5mm brass Qty 20 pcs for thread M4		
	<b>GEV No.</b>	560111	<b>Ref. No.</b> —
	plain washer ID ø 4.3mm ED ø 9mm thickness 0.8mm SS Qty 20 pcs DIN 125A for thread M4		
	<b>GEV No.</b>	560131	<b>Ref. No.</b> —
	hexagonal nut thread M4 H 3.2mm WS 7 SS DIN/ISO DIN 934 / ISO 4032/8673 Qty 20 pcs		

### heating elements for pizza ovens

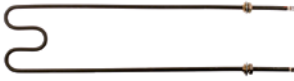

 <p>1</p>			
<b>GEV No.</b>	416461	<b>Ref. No.</b>	EE15700
<b>description</b>	heating element 1000W 230V L 473mm W 275mm thread 1/4" mounting distance 262mm connection length 40mm connection cable tube ø 8.5mm cable length 490mm heating circuits 1 dry heating element 2 hole fixing pizza oven		

 <p>1</p>			
<b>GEV No.</b>	416470	<b>Ref. No.</b>	EE10400
<b>description</b>	heating element 1100W 230V L 580mm W 160mm thread 3/8" mounting distance 151mm connection length 104mm tube ø 8.5mm heating circuits 1 dry heating element pizza oven		
<b>For models:</b>	109, 111, 66, 69, 77, 96, 99		

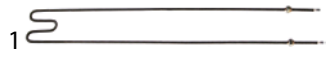

 <p>1</p>			
<b>GEV No.</b>	416466	<b>Ref. No.</b>	EE10800
<b>description</b>	heating element 1100W 230V L 880mm W 120mm thread 3/8" mounting distance 111mm connection length 104mm connection M5 tube ø 8.5mm dry heating element 2 hole fixing pizza oven		
<b>For models:</b>	109, 111, 23, 66, 69, 77, 96, 99		

 <p>1</p>			
<b>GEV No.</b>	416472	<b>Ref. No.</b>	EE10600
<b>description</b>	heating element 1100W 400V L 580mm W 165mm thread 3/8" mounting distance 157mm connection length 90mm connection male faston 6.3mm tube ø 8.5mm heating circuits 1 dry heating element 2 hole fixing		
<b>For models:</b>	96, R-109-1, R-109-2, R-109-3, R-111-1, R-111-2, R-111-3, R-66-1, R-66-2, R-66-3, R-69-1, R-69-2, R-69-3, R-77-1, R-77-2, R-77-3, R-96-1, R-96-2, R-96-3, R-99-1, R-99-2, R-99-3, RE-109-1, RE-109-2, RE-109-3, RE-111-1, RE-111-2, RE-111-3, RE-66-1, RE-66-2, RE-66-3, RE-69-1, RE-69-2, RE-69-3, RE-77-1, RE-77-2, RE-77-3, RE-96-1, RE-96-2, RE-96-3, RE-99-1, RE-99-2, RE-99-3, S-109-1, S-109-2, S-109-3, S-111-1, S-111-2, S-111-3, S-66-1...(Other models you can see in the webshop)		
<b>accessories for</b>	416472		
	<b>GEV No.</b>	361183	<b>Ref. No.</b> —
	nut thread 3/8" H 6mm nickel-plated brass WS 20 Qty 1 pcs		
	<b>GEV No.</b>	521137	<b>Ref. No.</b> —
	flat gasket fibre ED ø 20mm ID ø 18mm thickness 1.5mm for thread 3/8" Qty 1 pcs		







			
<b>GEV No.</b>	416468	<b>Ref. No.</b>	EE11000
<b>description</b>	heating element 1100W 400V L 884mm W 125mm thread 3/8" mounting distance 117mm connection length 86mm connection male faston 6.3mm tube ø 8.5mm heating circuits 1 dry heating element 2 hole fixing		
<b>For models:</b>	69, R-109-1, R-109-2, R-109-3, R-111-1, R-111-2, R-111-3, R-66-1, R-66-2, R-66-3, R-69-1, R-69-2, R-69-3, R-77-1, R-77-2, R-77-3, R-96-1, R-96-2, R-96-3, R-99-1, R-99-2, R-99-3, RE-109-1, RE-109-2, RE-109-3, RE-111-1, RE-111-2, RE-111-3, RE-66-1, RE-66-2, RE-66-3, RE-69-1, RE-69-2, RE-69-3, RE-77-1, RE-77-2, RE-77-3, RE-96-1, RE-96-2, RE-96-3, RE-99-1, RE-99-2, RE-99-3, S-109-1, S-109-2, S-109-3, S-111-1, S-111-2, S-111-3, S-66-1...(Other models you can see in the webshop)		
<b>accessories for</b>	416468		
	<b>GEV No.</b>	361183	<b>Ref. No.</b> —
	nut thread 3/8" H 6mm nickel-plated brass WS 20 Qty 1 pcs		
	<b>GEV No.</b>	521137	<b>Ref. No.</b> —
	flat gasket fibre ED ø 20mm ID ø 18mm thickness 1.5mm for thread 3/8" Qty 1 pcs		

			
<b>GEV No.</b>	420435	<b>Ref. No.</b>	EE247 EE24700
<b>description</b>	heating element 1300W 230V L 568mm W 158mm mounting distance 148mm connection F6.3 tube ø 8.5mm heating circuits 1		
<b>For models:</b>	R-109-1, R-109-2, R-109-3, R-111-1, R-111-2, R-111-3, R-66-1, R-66-2, R-66-3, R-69-1, R-69-2, R-69-3, R-77-1, R-77-2, R-77-3, R-96-1, R-96-2, R-96-3, R-99-1, R-99-2, R-99-3, RE-109-1, RE-109-2, RE-109-3, RE-111-1, RE-111-2, RE-111-3, RE-66-1, RE-66-2, RE-66-3, RE-69-1, RE-69-2, RE-69-3, RE-77-1, RE-77-2, RE-77-3, RE-96-1, RE-96-2, RE-96-3, RE-99-1, RE-99-2, RE-99-3, S-109-1, S-109-2, S-109-3, S-111-1, S-111-2, S-111-3, S-66-1, S-66-2...(Other models you can see in the webshop)		

			
<b>GEV No.</b>	416473	<b>Ref. No.</b>	EE11300
<b>description</b>	heating element 1300W 230V L 880mm W 163mm thread 3/8" mounting distance 153mm connection length 93mm connection M5 tube ø 10mm heating circuits 1 dry heating element 2 hole fixing		
<b>For models:</b>	109, 111, 66, 69, 77, 96, 99		
<b>accessories for</b>	416473		
	<b>GEV No.</b>	361183	<b>Ref. No.</b> —
	nut thread 3/8" H 6mm nickel-plated brass WS 20 Qty 1 pcs		
	<b>GEV No.</b>	521137	<b>Ref. No.</b> —
	flat gasket fibre ED ø 20mm ID ø 18mm thickness 1.5mm for thread 3/8" Qty 1 pcs		

			
<b>GEV No.</b>	420436	<b>Ref. No.</b>	EE12800
<b>description</b>	heating element 1300W 400V L 570mm W 162mm mounting distance 152mm connection F6.3 tube ø 10mm heating circuits 1		
<b>For models:</b>	R-109-1, R-109-2, R-109-3, R-111-1, R-111-2, R-111-3, R-66-1, R-66-2, R-66-3, R-69-1, R-69-2, R-69-3, R-77-1, R-77-2, R-77-3, R-96-1, R-96-2, R-96-3, R-99-1, R-99-2, R-99-3, RE-109-1, RE-109-2, RE-109-3, RE-111-1, RE-111-2, RE-111-3, RE-66-1, RE-66-2, RE-66-3, RE-69-1, RE-69-2, RE-69-3, RE-77-1, RE-77-2, RE-77-3, RE-96-1, RE-96-2, RE-96-3, RE-99-1, RE-99-2, RE-99-3, S-109-1, S-109-2, S-109-3, S-111-1, S-111-2, S-111-3, S-66-1, S-66-2...(Other models you can see in the webshop)		

			
<b>GEV No.</b>	416475	<b>Ref. No.</b>	EE11500
<b>description</b>	heating element 1300W 400V L 880mm W 160mm thread 3/8" mounting distance 155mm connection length 109mm tube ø 10mm heating circuits 1 dry heating element 2 hole fixing		
<b>For models:</b>	99		
<b>spare parts for</b>	416475		
	<b>GEV No.</b>	521137	<b>Ref. No.</b> —
	flat gasket fibre ED ø 20mm ID ø 18mm thickness 1.5mm for thread 3/8" Qty 1 pcs		
<b>accessories for</b>	416475		
	<b>GEV No.</b>	361183	<b>Ref. No.</b> —
	nut thread 3/8" H 6mm nickel-plated brass WS 20 Qty 1 pcs		

			
<b>GEV No.</b>	416474	<b>Ref. No.</b>	EE08400
<b>description</b>	heating element 1600W 230V		
<b>For models:</b>	109, 111, 66, 69, 77, 96, 99		

			
<b>GEV No.</b>	417540	<b>Ref. No.</b>	EE24400
<b>description</b>	heating element 1600W 230V L 895mm W 200mm thread 1/4" (tube ø 8mm) tube ø 8.5mm heating circuits 1		

			
<b>GEV No.</b>	416476	<b>Ref. No.</b>	EE11400
<b>description</b>	heating element 1600W 400V L 880mm W 155mm thread 3/8" mounting distance 145mm connection length 103mm tube ø 10mm heating circuits 1 dry heating element pizza oven		
<b>For models:</b>	99, R-109-1, R-109-2, R-109-3, R-111-1, R-111-2, R-111-3, R-66-1, R-66-2, R-66-3, R-69-1, R-69-2, R-69-3, R-77-1, R-77-2, R-77-3, R-96-1, R-96-2, R-96-3, R-99-1, R-99-2, R-99-3, RE-109-1, RE-109-2, RE-109-3, RE-111-1, RE-111-2, RE-111-3, RE-66-1, RE-66-2, RE-66-3, RE-69-1, RE-69-2, RE-69-3, RE-77-1, RE-77-2, RE-77-3, RE-96-1, RE-96-2, RE-96-3, RE-99-1, RE-99-2, RE-99-3, S-109-1, S-109-2, S-109-3, S-111-1, S-111-2, S-111-3, S-66-1...(Other models you can see in the webshop)		

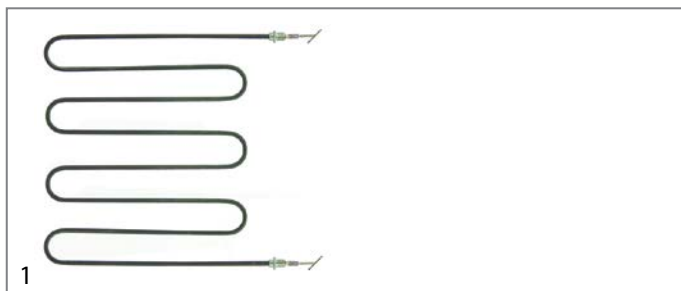

<b>GEV No.</b>	416462	<b>Ref. No.</b>	EE07000
<b>description</b>	heating element 1650W 230V L 470mm W 450mm thread 1/4" mounting distance 442mm connection length 40mm connection cable tube ø 8.5mm cable length 480mm heating circuits 1 dry heating element 2 hole fixing		
<b>spare parts for</b>	416462		
	<b>GEV No.</b>	510417	<b>Ref. No.</b> —
	flat gasket fibre ED ø 20mm ID ø 14mm thickness 2mm Qty 1 pcs		
<b>accessories for</b>	416462		
	<b>GEV No.</b>	361182	<b>Ref. No.</b> —
	nut thread 1/4" H 5mm nickel-plated brass WS 17 Qty 1 pcs		
	<b>GEV No.</b>	520228	<b>Ref. No.</b> —
	tooth lock washer ID ø 15.3mm ED ø 24mm steel Qty 1 pcs for thread M14		
	<b>GEV No.</b>	550262	<b>Ref. No.</b> —
	flat gasket copper ED ø 20mm ID ø 14mm thickness 2mm		

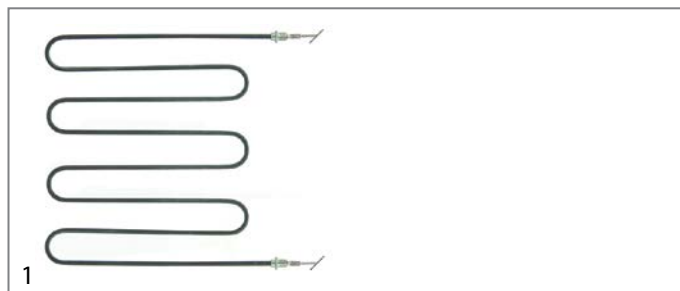

<b>GEV No.</b>	416464	<b>Ref. No.</b>	EE17700 EE28200
<b>description</b>	heating element 2000W 230V L 600mm W 572mm thread 1/4" mounting distance 563mm connection length 45mm tube ø 8.6mm cable length 643mm heating circuits 1 dry heating element 2 hole fixing		
<b>accessories for</b>	416464		
	<b>GEV No.</b>	361182	<b>Ref. No.</b> —
	nut thread 1/4" H 5mm nickel-plated brass WS 17 Qty 1 pcs		
	<b>GEV No.</b>	510417	<b>Ref. No.</b> —
	flat gasket fibre ED ø 20mm ID ø 14mm thickness 2mm Qty 1 pcs		
	<b>GEV No.</b>	520228	<b>Ref. No.</b> —
	tooth lock washer ID ø 15.3mm ED ø 24mm steel Qty 1 pcs for thread M14		
	<b>GEV No.</b>	550262	<b>Ref. No.</b> —
	flat gasket copper ED ø 20mm ID ø 14mm thickness 2mm		

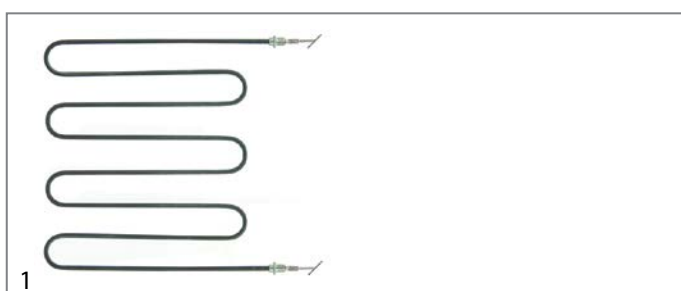

<b>GEV No.</b>	416463	<b>Ref. No.</b>	EE23000
<b>description</b>	heating element 1700W 230V mounting pos. upper pizza oven		



<b>GEV No.</b>	418889	<b>Ref. No.</b>	EE24800
<b>description</b>	heating element 2000W 230V L 880mm W 160mm thread 3/8" mounting distance 150mm connection length 105mm connection male faston 6.3mm tube ø 10mm heating circuits 1 dry heating element pizza oven		
<b>For models:</b>	R-109-1, R-109-2, R-109-3, R-111-1, R-111-2, R-111-3, R-66-1, R-66-2, R-66-3, R-69-1, R-69-2, R-69-3, R-77-1, R-77-2, R-77-3, R-96-1, R-96-2, R-96-3, R-99-1, R-99-2, R-99-3, RE-109-1, RE-109-2, RE-109-3, RE-111-1, RE-111-2, RE-111-3, RE-66-1, RE-66-2, RE-66-3, RE-69-1, RE-69-2, RE-69-3, RE-77-1, RE-77-2, RE-77-3, RE-96-1, RE-96-2, RE-96-3, RE-99-1, RE-99-2, RE-99-3, S-109-1, S-109-2, S-109-3, S-111-1, S-111-2, S-111-3, S-66-1, S-66-2...(Other models you can see in the webshop)		





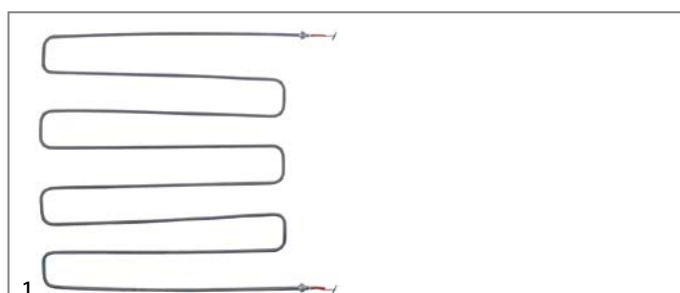

<b>GEV No.</b>	418888	<b>Ref. No.</b>	EE15000
<b>description</b>	heating element 1900W 400V L 880mm W 160mm thread 3/8" mounting distance 150mm connection length 105mm connection male faston 6.3mm tube ø 10mm heating circuits 1 dry heating element pizza oven		
<b>For models:</b>	R-109-1, R-109-2, R-109-3, R-111-1, R-111-2, R-111-3, R-66-1, R-66-2, R-66-3, R-69-1, R-69-2, R-69-3, R-77-1, R-77-2, R-77-3, R-96-1, R-96-2, R-96-3, R-99-1, R-99-2, R-99-3, RE-109-1, RE-109-2, RE-109-3, RE-111-1, RE-111-2, RE-111-3, RE-66-1, RE-66-2, RE-66-3, RE-69-1, RE-69-2, RE-69-3, RE-77-1, RE-77-2, RE-77-3, RE-96-1, RE-96-2, RE-96-3, RE-99-1, RE-99-2, RE-99-3, S-109-1, S-109-2, S-109-3, S-111-1, S-111-2, S-111-3, S-66-1, S-66-2...(Other models you can see in the webshop)		



<b>GEV No.</b>	420437	<b>Ref. No.</b>	EE28100
<b>description</b>	heating element 3000W 230V L 672mm W 657mm mounting distance 647mm tube ø 8.5mm heating circuits 1		









<b>GEV No.</b>	415804	<b>Ref. No.</b>	N/A
<b>description</b>	heating element 500W 400V L 515mm W 105mm thread 1/4" mounting distance 100mm connection length 24mm tube ø 8.5mm cable length 1000mm heating circuits 1 dry heating element 2 hole fixing		
<b>accessories for</b>	415804		
	<b>GEV No.</b>	510417	<b>Ref. No.</b> —
	flat gasket fibre ED ø 20mm ID ø 14mm thickness 2mm Qty 1 pcs		
	<b>GEV No.</b>	520228	<b>Ref. No.</b> —
	tooth lock washer ID ø 15.3mm ED ø 24mm steel Qty 1 pcs for thread M14		
	<b>GEV No.</b>	550262	<b>Ref. No.</b> —
	flat gasket copper ED ø 20mm ID ø 14mm thickness 2mm		



<b>GEV No.</b>	418640	<b>Ref. No.</b>	EE054 EE05400
<b>description</b>	heating element 600W 230V L 530mm W 106mm thread 1/4" mounting distance 98mm connection length 47mm connection cable tube ø 8.5mm cable length 980mm heating circuits 1 dry heating element 2 hole fixing		
<b>For models:</b>	MF 4		









<b>GEV No.</b>	415943	<b>Ref. No.</b>	EE13300
<b>description</b>	heating element 600W 230V L 575mm W 127mm thread 1/4" mounting distance 119mm connection length 50mm tube ø 8.5mm cable length 1180mm heating circuits 1 dry heating element 2 hole fixing		
<b>accessories for</b>	415943		
	<b>GEV No.</b>	361182	<b>Ref. No.</b> —
	nut thread 1/4" H 5mm nickel-plated brass WS 17 Qty 1 pcs		
	<b>GEV No.</b>	510417	<b>Ref. No.</b> —
	flat gasket fibre ED ø 20mm ID ø 14mm thickness 2mm Qty 1 pcs		
	<b>GEV No.</b>	520228	<b>Ref. No.</b> —
	tooth lock washer ID ø 15.3mm ED ø 24mm steel Qty 1 pcs for thread M14		
	<b>GEV No.</b>	550262	<b>Ref. No.</b> —
	flat gasket copper ED ø 20mm ID ø 14mm thickness 2mm		







<b>GEV No.</b>	415945	<b>Ref. No.</b>	EE13500
<b>description</b>	heating element 600W 400V L 575mm W 131mm thread 1/4" mounting distance 125mm connection length 34mm tube ø 8.5mm cable length 1200mm heating circuits 1 dry heating element 2 hole fixing		



<b>GEV No.</b>	415944	<b>Ref. No.</b>	EE13200
<b>description</b>	heating element 700W 230V L 580mm W 122mm thread 1/4" mounting distance 109mm connection length 45mm tube ø 8.5mm cable length 1200mm heating circuits 1 dry heating element 2 hole fixing		
<b>spare parts for</b>	415944		
	<b>GEV No.</b>	510417	<b>Ref. No.</b> —
	flat gasket fibre ED ø 20mm ID ø 14mm thickness 2mm Qty 1 pcs		
<b>accessories for</b>	415944		
	<b>GEV No.</b>	361182	<b>Ref. No.</b> —
	nut thread 1/4" H 5mm nickel-plated brass WS 17 Qty 1 pcs		
	<b>GEV No.</b>	520228	<b>Ref. No.</b> —
	tooth lock washer ID ø 15.3mm ED ø 24mm steel Qty 1 pcs for thread M14		
	<b>GEV No.</b>	521012	<b>Ref. No.</b> —
	gasket graphite ED ø 15mm ID ø 5mm thickness 1.2mm Qty 1 pcs		
	<b>GEV No.</b>	550262	<b>Ref. No.</b> —
	flat gasket copper ED ø 20mm ID ø 14mm thickness 2mm		



<b>GEV No.</b>	415946	<b>Ref. No.</b>	EE13400
<b>description</b>	heating element 700W 400V L 575mm W 120mm thread 1/4" mounting distance 112mm connection length 28mm connection cable tube ø 8.5mm cable length 1180mm heating circuits 1 dry heating element 2 hole fixing		
<b>spare parts for</b>	415946		
	<b>GEV No.</b>	510417	<b>Ref. No.</b> —
	flat gasket fibre ED ø 20mm ID ø 14mm thickness 2mm Qty 1 pcs		
<b>accessories for</b>	415946		
	<b>GEV No.</b>	361182	<b>Ref. No.</b> —
	nut thread 1/4" H 5mm nickel-plated brass WS 17 Qty 1 pcs		
	<b>GEV No.</b>	520228	<b>Ref. No.</b> —
	tooth lock washer ID ø 15.3mm ED ø 24mm steel Qty 1 pcs for thread M14		
	<b>GEV No.</b>	550262	<b>Ref. No.</b> —
	flat gasket copper ED ø 20mm ID ø 14mm thickness 2mm		







<b>GEV No.</b>	416469	<b>Ref. No.</b>	EE10500
<b>description</b>	heating element 900W 230V L 583mm W 167mm thread 3/8" mounting distance 158mm connection length 90mm connection M5 tube ø 8.7mm heating circuits 1 dry heating element 2 hole fixing		
<b>For models:</b>	109, 111, 66, 69, 77, 96, 99		
<b>accessories for</b>	416469		
	<b>GEV No.</b>	361183	<b>Ref. No.</b> —
	nut thread 3/8" H 6mm nickel-plated brass WS 20 Qty 1 pcs		



Table continues overleaf

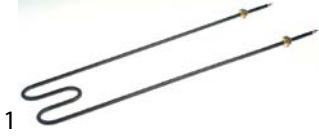

<b>accessories for</b>	416469		
	<b>GEV No.</b>	521137	<b>Ref. No.</b> —
	flat gasket fibre ED ø 20mm ID ø 18mm thickness 1.5mm for thread 3/8" Qty 1 pcs		

	1		
<b>GEV No.</b>	416465	<b>Ref. No.</b>	EE10900
<b>description</b>	heating element 900W 230V L 875mm W 125mm thread 3/8" mounting distance 120mm connection length 70mm connection M5 tube ø 8.5mm heating circuits 1 dry heating element 2 hole fixing pizza oven		
<b>For models:</b>	109, 111, 66, 69, 77, 96, 99		

	1		
<b>GEV No.</b>	416471	<b>Ref. No.</b>	EE10700
<b>description</b>	heating element 900W 400V L 580mm W 160mm thread 3/8" mounting distance 152mm connection length 86mm connection male faston 6.3mm tube ø 8.5mm heating circuits 1 dry heating element 2 hole fixing		
<b>For models:</b>	96		
<b>accessories for</b>	416471		
	<b>GEV No.</b>	361183	<b>Ref. No.</b> —
	nut thread 3/8" H 6mm nickel-plated brass WS 20 Qty 1 pcs		
	<b>GEV No.</b>	521137	<b>Ref. No.</b> —
	flat gasket fibre ED ø 20mm ID ø 18mm thickness 1.5mm for thread 3/8" Qty 1 pcs		

	1		
<b>GEV No.</b>	416467	<b>Ref. No.</b>	EE11100
<b>description</b>	heating element 900W 400V L 979mm W 120mm thread 3/8" mounting distance 112mm connection length 89mm connection male faston 6.3mm tube ø 8.5mm heating circuits 1 dry heating element 2 hole fixing		
<b>For models:</b>	69		
<b>spare parts for</b>	416467		
	<b>GEV No.</b>	521137	<b>Ref. No.</b> —
	flat gasket fibre ED ø 20mm ID ø 18mm thickness 1.5mm for thread 3/8" Qty 1 pcs		
<b>accessories for</b>	416467		
	<b>GEV No.</b>	361183	<b>Ref. No.</b> —
	nut thread 3/8" H 6mm nickel-plated brass WS 20 Qty 1 pcs		

heating elements for pizza presses

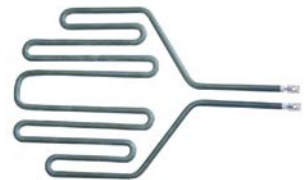
	1		
<b>GEV No.</b>	416477	<b>Ref. No.</b>	EE02800
<b>description</b>	heating element 1500W 230V L 364mm W 235mm connection M5 connection length 23mm L1 180mm L2 184mm W1 103mm W2 29mm dry heating element tube ø 8.5mm windings 5		
<b>For models:</b>	PF33MT		

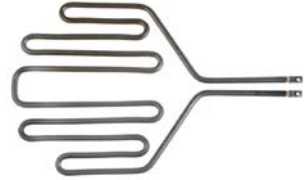
	1		
<b>GEV No.</b>	416478	<b>Ref. No.</b>	EE18100
<b>description</b>	heating element 1500W 400V L 369mm W 235mm heating circuits 1 connection M5 connection length 22mm L1 108mm L2 261mm W1 97mm W2 26mm dry heating element tube ø 8.5mm windings 5		
<b>For models:</b>	PF33MT		

	1		
<b>GEV No.</b>	416479	<b>Ref. No.</b>	EE03000 EE16300
<b>description</b>	heating element 3000W 230V L 493mm W 355mm connection M5 connection length 30mm L1 115mm L2 355mm W1 162mm W2 31mm dry heating element tube ø 10mm windings 5		
<b>For models:</b>	PF45HT, PF45MT-E		

	1		
<b>GEV No.</b>	416480	<b>Ref. No.</b>	EE16200
<b>description</b>	heating element 3000W 400V L 490mm W 332mm connection male faston connection length 25mm L1 125mm L2 365mm W1 153mm W2 26mm dry heating element tube ø 10mm windings 5		
<b>For models:</b>	PF45HT, PF45MTE, PF45MT-E		



immersion heating elements

2 hole flange 74mm

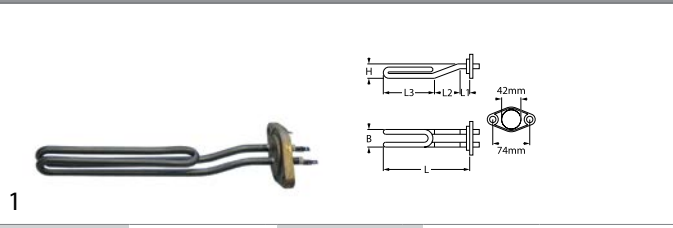

<b>GEV No.</b>	415191	<b>Ref. No.</b>	EE002
<b>description</b>	heating element 2300W 220V heating circuits 1 mounting $\varnothing$ 42mm L 240mm W 29mm H 27mm L1 35mm L2 35mm L3 170mm tube $\varnothing$ 8.5mm hole distance 74mm hole $\varnothing$ 8mm connection M4 immersion heater 2 hole flange H1 8mm H2 23mm flange length 94mm flange width 58mm		

<b>accessories for</b>	415191			
	<b>GEV No.</b>	521103	<b>Ref. No.</b>	—
	nut thread M4 H 3mm WS 7 brass Qty 20 pcs			
	<b>GEV No.</b>	521104	<b>Ref. No.</b>	—
	washer ID $\varnothing$ 4.3mm ED $\varnothing$ 8mm thickness 0.5mm brass Qty 20 pcs for thread M4			
	<b>GEV No.</b>	560111	<b>Ref. No.</b>	—
	plain washer ID $\varnothing$ 4.3mm ED $\varnothing$ 9mm thickness 0.8mm SS Qty 20 pcs DIN 125A for thread M4			
	<b>GEV No.</b>	560131	<b>Ref. No.</b>	—
	hexagonal nut thread M4 H 3.2mm WS 7 SS DIN/ISO DIN 934 / ISO 4032/8673 Qty 20 pcs			

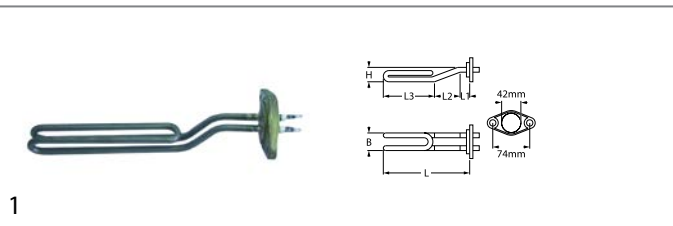

<b>GEV No.</b>	415192	<b>Ref. No.</b>	EE010
<b>description</b>	heating element 3000W 220V heating circuits 1 mounting $\varnothing$ 42mm L 225mm W 29mm H 39mm L1 20mm L2 35mm L3 170mm hole distance 74mm hole $\varnothing$ 9mm connection male faston 6.3mm immersion heater 2 hole flange		



<b>GEV No.</b>	415195	<b>Ref. No.</b>	EE001
<b>description</b>	heating element 2500W 230V heating circuits 1 thread 1" L 200mm W 20mm H 20mm tube $\varnothing$ 8.5mm connection male faston 6.3mm immersion heater flange with thread		

<b>accessories for</b>	415195			
	<b>GEV No.</b>	510404	<b>Ref. No.</b>	—
	flat gasket fibre ED $\varnothing$ 44mm ID $\varnothing$ 34mm thickness 2mm Qty 1 pcs			
	<b>GEV No.</b>	510422	<b>Ref. No.</b>	—
	gasket copper ED $\varnothing$ 37.7mm ID $\varnothing$ 32.5mm thickness 2.7mm for thread 1"			
	<b>GEV No.</b>	520233	<b>Ref. No.</b>	—
	nut thread 1" H 6mm brass WS 47 Qty 1 pcs			

accessories

sealing washers

rubber gaskets

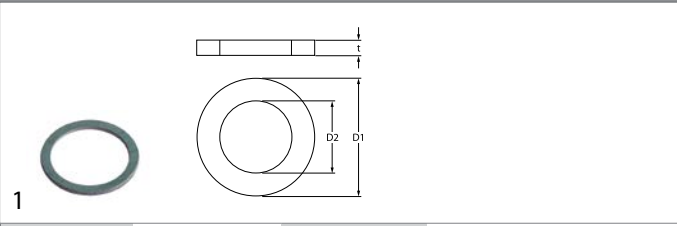

<b>GEV No.</b>	521125	<b>Ref. No.</b>	AD036
<b>description</b>	flat gasket rubber ED $\varnothing$ 52mm ID $\varnothing$ 42.5mm thickness 4mm Qty 1 pcs		

thermostats

control and safety thermostats

EGO

control thermostats

55.10/19\_ series

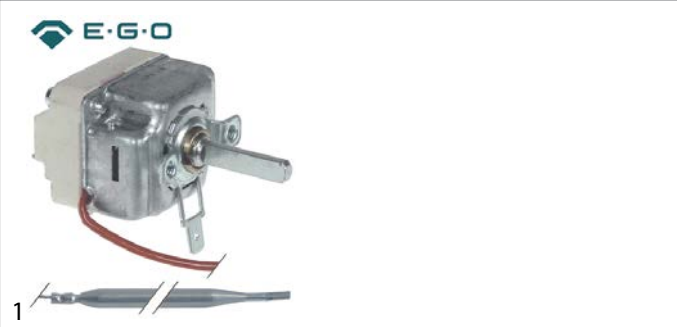

<b>GEV No.</b>	375309	<b>Ref. No.</b>	ED036R0 ED04800
<b>description</b>	thermostat t.max. 180°C temperature range 95-180°C 1-pole 1NO 16A probe $\varnothing$ 6mm probe L 130mm capillary pipe 1500mm capillary pipe isolated 1100mm gland nut shaft L 23mm shaft position upper rotation 270°		
<b>For models:</b>	PF33MT, PF45HT		

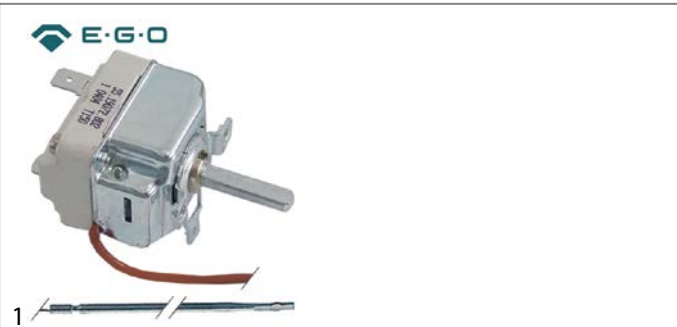

<b>GEV No.</b>	375313	<b>Ref. No.</b>	ED00700
<b>description</b>	thermostat t.max. 358°C temperature range 60-358°C 1-pole 1NO 16A probe $\varnothing$ 3.03mm probe L 178mm capillary pipe 870mm capillary pipe isolated 870mm gland nut shaft L 23mm shaft position upper rotation 270°		





<b>GEV No.</b>	376004	<b>Ref. No.</b>	ED05800
<b>description</b>	thermostat t.max. 422°C temperature range 65-422°C 1-pole 1CO 16A probe ø 4mm probe L 230mm capillary pipe 900mm capillary pipe isolated 630mm gland nut shaft L 23mm shaft position upper		

55.32\_ series



<b>GEV No.</b>	375065	<b>Ref. No.</b>	ED05500
<b>description</b>	safety thermostat switch-off temp. 500°C 3-pole 3NC 20A probe ø 4mm probe L 308mm capillary pipe 890mm capillary pipe isolated-mm gland nut probe SS		

safety thermostats

55.10/19\_ series



<b>GEV No.</b>	375311	<b>Ref. No.</b>	ED04900
<b>description</b>	safety thermostat switch-off temp. 250°C 1-pole 16A probe ø 6mm probe L 87mm capillary pipe 1470mm capillary pipe isolated 1460mm gland nut probe SS		
<b>For models:</b>	PF33MT, PF45HT, PF45MTE, PF45MT-E		

IMIT / TEMPOMATIC / ARTHERMO

control thermostats





<b>GEV No.</b>	390186	<b>Ref. No.</b>	ED002
<b>description</b>	thermostat t.max. 52°C temperature range fixed 52°C 1-pole 1CO 16A probe ø 6.5mm probe L 95mm capillary pipe 1000mm capillary pipe isolated 1000mm gland nut shaft Lmm contacts 1CO		



<b>GEV No.</b>	375191	<b>Ref. No.</b>	ED02300
<b>description</b>	safety thermostat switch-off temp. 500°C 1-pole 16A probe ø 3.9mm probe L 230mm capillary pipe 870mm capillary pipe isolated 660mm gland nut probe		
<b>For models:</b>	R-109-1, R-109-2, R-109-3, R-111-1, R-111-2, R-111-3, R-66-1, R-66-2, R-66-3, R-69-1, R-69-2, R-69-3, R-77-1, R-77-2, R-77-3, R-96-1, R-96-2, R-96-3, R-99-1, R-99-2, R-99-3, RE-109-1, RE-109-2, RE-109-3, RE-111-1, RE-111-2, RE-111-3, RE-66-1, RE-66-2, RE-66-3, RE-69-1, RE-69-2, RE-69-3, RE-77-1, RE-77-2, RE-77-3, RE-96-1, RE-96-2, RE-96-3, RE-99-1, RE-99-2, RE-99-3, S-109-1, S-109-2, S-109-3, S-111-1, S-111-2, S-111-3, S-66-1, S-66-2...(Other models you can see in the webshop)		



<b>GEV No.</b>	390006	<b>Ref. No.</b>	ED001 ED00100
<b>description</b>	thermostat t.max. 86°C temperature range 0-86°C 1-pole 1CO 16A probe ø 6.5mm probe L 95mm capillary pipe 1500mm capillary pipe isolatedmm gland nut shaft ø 6x4.6mm shaft L 19mm rotation 270°		
<b>accessories for</b>	390006		
		<b>GEV No.</b>	110100 <b>Ref. No.</b> —
			knob thermostat t.max. 90°C 0-90°C ø 42mm shaft ø 6x4.6mm shaft flat -135° black
		<b>GEV No.</b>	110105 <b>Ref. No.</b> —
			rosette knob ø 42mm ø 56mm zero mark



INVENSYS / ROBERTSHAW

control thermostats



<b>GEV No.</b>	390636	<b>Ref. No.</b>	P8905-03
<b>description</b>	thermostat t.max. 204°C temperature range 93-204°C 1-pole 1NO 0.67A probe ø 9.5mm probe L 123mm capillary pipe 915mm capillary pipe isolatedmm gland nut 1/4" NPT shaft ø 6x4.6mm shaft L 21mm shaft position lower rotation 315° probe material nickel-plated probe thread 1/4" US		



<b>GEV No.</b>	390771	<b>Ref. No.</b>	P5047585
<b>description</b>	thermostat temperature range 121-190°C 1-pole probe ø 8mm probe L 260mm capillary pipe 1200mm shaft ø 6x4.6mm shaft L 25mm shaft position lower rotation 315° operating temperature range 200-375°F		

control thermostats with actual value



<b>GEV No.</b>	379039	<b>Ref. No.</b>	ED02200
<b>description</b>	thermostat t.max. 500°C temperature range 0-500°C 1CO 5A probe ø 8mm probe L 150mm capillary pipe 1100mm mounting ø 60mm front measurements 72x72mm		
<b>For models:</b>	109, 111, 22, 23, 32, 33 220V, 33 380V, 34 220V, 34 380V, 66, 69, 77, 96, 99, SG22, SG23, SG33		

switches and momentary switches

rocker/momentary rocker switches

30x11 mm



<b>GEV No.</b>	301013	<b>Ref. No.</b>	EF02300
<b>description</b>	rocker switch mounting measurements 30x11mm black 1CO 250V 16A connection male faston 6.3mm ambient temperature max. 85/125°C protection IP40		
<b>For models:</b>	22, 23, 32, 33 220V, 33 380V, 34 220V, 34 380V, R-109-1, R-109-2, R-109-3, R-111-1, R-111-2, R-111-3, R-66-1, R-66-2, R-66-3, R-69-1, R-69-2, R-69-3, R-77-1, R-77-2, R-77-3, R-96-1, R-96-2, R-96-3, R-99-1, R-99-2, R-99-3, S-109-1, S-109-2, S-109-3, S-111-1, S-111-2, S-111-3, S-66-1, S-66-2, S-66-3, S-69-1, S-69-2, S-69-3, S-77-1, S-77-2, S-77-3, S-96-1, S-96-2, S-96-3, S-99-1, S-99-2, S-99-3, SG22...(Other models you can see in the webshop)		

30x22mm



<b>GEV No.</b>	345512	<b>Ref. No.</b>	EF00400
<b>description</b>	rocker switch mounting measurements 30x22mm orange 2NO 400V 16A illuminated 0-I connection male faston 6.3mm ambient temperature max. 85/125°C protection IP40		
<b>For models:</b>	109, 111, 22, 23, 32, 33 220V, 33 380V, 34 220V, 34 380V, 66, 69, 77, 96, 99, PF33MT, PF45MTE, PF45MT-E, R-109-1, R-109-2, R-109-3, R-111-1, R-111-2, R-111-3, R-66-1, R-66-2, R-66-3, R-69-1, R-69-2, R-69-3, R-77-1, R-77-2, R-77-3, R-96-1, R-96-2, R-96-3, R-99-1, R-99-2, R-99-3, S-109-1, S-109-2, S-109-3, S-111-1, S-111-2, S-111-3, S-66-1, S-66-2, S-66-3, S-69-1, S-69-2, S-69-3...(Other models you can see in the webshop)		



<b>GEV No.</b>	301004	<b>Ref. No.</b>	EF02400
<b>description</b>	rocker switch mounting measurements 30x22mm black 2CO 250V 16A connection male faston 6.3mm ambient temperature max. 125/55°C protection IP40		

<b>accessories for</b>	301004			
	<b>GEV No.</b>	301036	<b>Ref. No.</b>	—
	protective cover internal size 30x22mm for rocker switch mounting measurementsmm			

push/momentary push switches

ø16mm





<b>GEV No.</b>	101029	<b>Ref. No.</b>	EF04800+EF04900+5000
<b>description</b>	momentary push switch mounting ø 16mm white 1NO 250V 16A connection male faston 6.3mm protection IP40 ambient temperature max. 150°C		





miscellaneous			
			
1			
<b>GEV No.</b>	346475	<b>Ref. No.</b>	EF04400 EF08300
<b>description</b>	momentary push switch green illuminated display 220V connection male faston 6.3mm ambient temperature max. 125/85°C protection IP40		

microswitches

pin-plunger actuated			
M10			
			
1			
<b>GEV No.</b>	345032	<b>Ref. No.</b>	EG001 EG00100
<b>description</b>	microswitch with plunger thread M10x1 thread L 12mm 250V 16A 1CO connection male faston 6.3mm stroke 7mm mounting distance 22mm L 28mm ambient temperature max. 125°C type SP9603 actuating force: 180g		
<b>For models:</b>	PF33MT		

M12			
			
1			
<b>GEV No.</b>	345694	<b>Ref. No.</b>	EG03100
<b>description</b>	microswitch with plunger mounting distance 25mm thread M12x1 thread L 14mm 250V 16A 1CO connection screw stroke 4mm L 49mm ambient temperature max. 125°C type MS10 actuating force: 350g		
<b>For models:</b>	PF33MT		

roller actuated			
roller 0°			
			
1			
<b>GEV No.</b>	345693	<b>Ref. No.</b>	EG03200
<b>description</b>	microswitch with roller plunger 230V 16A 1CO connection screw ambient temperature max. 125°C thread L 14mm thread M10		
<b>For models:</b>	PF33MT, PF45HT		

roller 90°			
			
1			
<b>GEV No.</b>	347096	<b>Ref. No.</b>	EG03700
<b>description</b>	microswitch with roller plunger 250V 20A 1CO connection screw L1 49mm ambient temperature max. 125°C thread L 14.5mm thread M12x1 mounting distance 25mm actuating force: 370g type Z15G1318		
<b>For models:</b>	PF33MT		

position switches

PIZZATO			
FA series			
			
1			
<b>GEV No.</b>	345697	<b>Ref. No.</b>	EG04100 EG04410
<b>description</b>	position switch		
<b>For models:</b>	PF45MTE, PF45MT-E		

			
1			
<b>GEV No.</b>	345696	<b>Ref. No.</b>	EG04010
<b>description</b>	position switch cast aluminum 1NO/1NC 400V 3A L 86mm W 30mm H 16mm protection IP67 actuating force: 1000g screw connection mounting distance 20mm thr.ø M12mm cable 1800 thread L 15mm		
<b>For models:</b>	PF45MTE, PF45MT-E		

cam switches

on/off			
			
1			
<b>GEV No.</b>	300139	<b>Ref. No.</b>	EH01800
<b>description</b>	cam switch ON-OFF connection male faston		



## rotary switches

## BREMAS

## A1600 series



1

<b>GEV No.</b>	345762	<b>Ref. No.</b>	EH00900 EH00900+AC06200
<b>description</b>	rotary switch 3 1-0-2 sets of contacts 6 type CS0167085 400V 16A shaft ø 5x5mm shaft L 23mm shaft square connection screw		
<b>For models:</b>	109, 111, 22, 23, 32, 33 380V, 34 380V, 66, 69, 77, 96, 99, R-109-1, R-109-2, R-109-3, R-111-1, R-111-2, R-111-3, R-66-1, R-66-2, R-66-3, R-69-1, R-69-2, R-69-3, R-77-1, R-77-2, R-77-3, R-96-1, R-96-2, R-96-3, R-99-1, R-99-2, R-99-3, S-109-1, S-109-2, S-109-3, S-111-1, S-111-2, S-111-3, S-66-1, S-66-2, S-66-3, S-69-1, S-69-2, S-69-3, S-77-1, S-77-2, S-77-3, S-96-1, S-96-2...(Other models you can see in the webshop)		
<b>accessories for</b>	345762		
	<b>GEV No.</b>	110932	<b>Ref. No.</b> AC06200



1

<b>GEV No.</b>	348174	<b>Ref. No.</b>	OMEH00900
<b>description</b>	rotary switch sets of contacts 6 3 1-0-2 type CA0167085V 400V 16A shaft ø 5x5mm shaft L 23mm shaft square connection screw		

## A2500 series



1

<b>GEV No.</b>	346105	<b>Ref. No.</b>	EH00600
<b>description</b>	rotary switch 2 0-1 sets of contacts 3 type CA0250003V 690V 32A shaft ø 5x5mm shaft L 23mm shaft square connection screw		
<b>For models:</b>	PF45HT		

## miscellaneous



1

<b>GEV No.</b>	300223	<b>Ref. No.</b>	EH010 EH01000
<b>description</b>	rotary switch 3 1-0-2 500V 25A shaft ø 5x5mm shaft square connection screw ambient temperature max. 75°C		

## magnetic switches

## M12x1



1

<b>GEV No.</b>	345698	<b>Ref. No.</b>	EN06800
<b>description</b>	magnetic switch thread M12x1 1NC 24-240V AC/DCV 0.005-0.2A connection cable cable length 2000mm L 42mm		
<b>For models:</b>	PF45MTE, PF45MT-E		

## miscellaneous



1

<b>GEV No.</b>	692022	<b>Ref. No.</b>	EF057 EF05700
<b>description</b>	emergency stop switch		

## control equipment

## MOELLER/EATON

## push buttons - signal lamps



1

<b>GEV No.</b>	345705	<b>Ref. No.</b>	EF05400 EF10000 EF10010
<b>description</b>	push button mounting measurements ø22mm black tipping		
<b>For models:</b>	PF33MT, PF45MT-E		
<b>accessories for</b>	345705		
	<b>GEV No.</b>	345707	<b>Ref. No.</b> EF04010 EF09600 EF09610
	contact block 1NC/1NO		

## switch blocks





1

<b>GEV No.</b>	345707	<b>Ref. No.</b>	EF04010 EF09600 EF09610
<b>description</b>	contact block 1NC/1NO		
<b>For models:</b>	PF45MT-E		



			
1			
<b>GEV No.</b>	345706	<b>Ref. No.</b>	EF04510 EF09800 EF09810
<b>description</b>	contact block 1NO		
<b>For models:</b>	PF33MT		

			
1			
<b>GEV No.</b>	346292	<b>Ref. No.</b>	50MAA78015
<b>description</b>	contact block screw 1NO		
<b>For models:</b>	PF33MT		

			
1			
<b>GEV No.</b>	346293	<b>Ref. No.</b>	50MAA78014
<b>description</b>	contact block holder triple		
<b>For models:</b>	PF33MT		

miscellaneous

 <p>Image not available</p>			
1			
<b>GEV No.</b>	692026	<b>Ref. No.</b>	EF058 EF05800
<b>description</b>	contact block		

lamps

indicator lights

indicator lights 2-piece (lens and indicator lamp)

indicator light lenses

ø10mm (type SRZ-2)

			
1			
<b>GEV No.</b>	359358	<b>Ref. No.</b>	EL00200
<b>description</b>	indicator light housings mounting measurements ø10mm orange square		

indicator lamps for socket type SRZ / SDK / SDY / SFK

			
1			
<b>GEV No.</b>	359132	<b>Ref. No.</b>	EL00300
<b>description</b>	indicator lamp green 250V connection male faston 6.3mm protection IP54 ambient temperature max. 85°C		

indicator lights (complete)

30x11mm

			
1			
<b>GEV No.</b>	359159	<b>Ref. No.</b>	EL01200
<b>description</b>	indicator light mounting measurements 30x11mm 230V yellow connection male faston 6.3mm temp.-resist. 125°C		

			
1			
<b>GEV No.</b>	359268	<b>Ref. No.</b>	EL03500
<b>description</b>	indicator light mounting measurements 30x11mm 400V yellow		
<b>For models:</b>	PF33MT, PF45HT		

screw-on/push-on fit

halogen lamp

for socket E14 / E27

			
1			
<b>GEV No.</b>	359728	<b>Ref. No.</b>	EL06600
<b>description</b>	halogen lamp socket E14 230V 40W ø 25mm lens L 54mm L 80mm temp.-resist. 300°C Qty 1		

for socket G4 / G6.35 / G9

			
1			
<b>GEV No.</b>	359074	<b>Ref. No.</b>	EL062 EL06200
<b>description</b>	halogen lamp socket G6.35 12V 35W temp.-resist. 500°C		
<b>For models:</b>	R-109-1, R-109-2, R-109-3, R-111-1, R-111-2, R-111-3, R-66-1, R-66-2, R-66-3, R-69-1, R-69-2, R-69-3, R-77-1, R-77-2, R-77-3, R-96-1, R-96-2, R-96-3, R-99-1, R-99-2, R-99-3, RE-109-1, RE-109-2, RE-109-3, RE-111-1, RE-111-2, RE-111-3, RE-66-1, RE-66-2, RE-66-3, RE-69-1, RE-69-2, RE-69-3, RE-77-1, RE-77-2, RE-77-3, RE-96-1, RE-96-2, RE-96-3, RE-99-1, RE-99-2, RE-99-3, S-109-1, S-109-2, S-109-3, S-111-1, S-111-2, S-111-3, S-66-1, S-66-2...(Other models you can see in the webshop)		



			
1			
<b>GEV No.</b>	359946	<b>Ref. No.</b>	EL07400
<b>description</b>	halogen lamp socket G9 230V 40W temp.-resist. 300°C		

			
1			
<b>GEV No.</b>	359370	<b>Ref. No.</b>	EL04000
<b>description</b>	halogen lamp socket G6.35 12V 50W temp.-resist. 300°C ø 10mm L 44mm clear		
<b>For models:</b>	109, 111, 22, 23, 32, 33 220V, 33 380V, 34 220V, 34 380V, 66, 69, 77, 96, 99, SG22, SG23, SG33		



## oven lamps

### universal oven lamps

mounting diameter 35.5mm

			
1			
<b>GEV No.</b>	359427	<b>Ref. No.</b>	EL073R0
<b>description</b>	lamp socket socket G9 mounting ø 35.5mm connection male faston 6.3mm		

			
1			
<b>GEV No.</b>	359709	<b>Ref. No.</b>	AL19500
<b>description</b>	oven lamp glass thr.ø 33.5mm ø 42mm hard glas temp.-resist. 350°C		

			
1			
<b>GEV No.</b>	359661	<b>Ref. No.</b>	AL201 AL20100
<b>description</b>	oven lamp glass thread 32.1 ø 58mm hard glas temp.-resist. 350°C		
<b>For models:</b>	R-109-1, R-109-2, R-109-3, R-111-1, R-111-2, R-111-3, R-66-1, R-66-2, R-66-3, R-69-1, R-69-2, R-69-3, R-77-1, R-77-2, R-77-3, R-96-1, R-96-2, R-96-3, R-99-1, R-99-2, R-99-3, RE-109-1, RE-109-2, RE-109-3, RE-111-1, RE-111-2, RE-111-3, RE-66-1, RE-66-2, RE-66-3, RE-69-1, RE-69-2, RE-69-3, RE-77-1, RE-77-2, RE-77-3, RE-96-1, RE-96-2, RE-96-3, RE-99-1, RE-99-2, RE-99-3, S-109-1, S-109-2, S-109-3, S-111-1, S-111-2, S-111-3, S-66-1, S-66-2...(Other models you can see in the webshop)		
<b>accessories for</b>	359661		
		<b>GEV No.</b>	359700
		<b>Ref. No.</b>	AL26600



			
1			
<b>GEV No.</b>	359700	<b>Ref. No.</b>	AL26600
<b>description</b>	gasket for pizza oven fibre glass ID ø 32.5mm ED ø 55mm thickness 5mm		
<b>For models:</b>	R-109-1, R-109-2, R-109-3, R-111-1, R-111-2, R-111-3, R-66-1, R-66-2, R-66-3, R-69-1, R-69-2, R-69-3, R-77-1, R-77-2, R-77-3, R-96-1, R-96-2, R-96-3, R-99-1, R-99-2, R-99-3, RE-109-1, RE-109-2, RE-109-3, RE-111-1, RE-111-2, RE-111-3, RE-66-1, RE-66-2, RE-66-3, RE-69-1, RE-69-2, RE-69-3, RE-77-1, RE-77-2, RE-77-3, RE-96-1, RE-96-2, RE-96-3, RE-99-1, RE-99-2, RE-99-3, S-109-1, S-109-2, S-109-3, S-111-1, S-111-2, S-111-3, S-66-1, S-66-2...(Other models you can see in the webshop)		

## producer-specific oven lamps

### OEM

			
1			
<b>GEV No.</b>	359700	<b>Ref. No.</b>	AL26600
<b>description</b>	gasket for pizza oven fibre glass ID ø 32.5mm ED ø 55mm thickness 5mm		
<b>For models:</b>	R-109-1, R-109-2, R-109-3, R-111-1, R-111-2, R-111-3, R-66-1, R-66-2, R-66-3, R-69-1, R-69-2, R-69-3, R-77-1, R-77-2, R-77-3, R-96-1, R-96-2, R-96-3, R-99-1, R-99-2, R-99-3, RE-109-1, RE-109-2, RE-109-3, RE-111-1, RE-111-2, RE-111-3, RE-66-1, RE-66-2, RE-66-3, RE-69-1, RE-69-2, RE-69-3, RE-77-1, RE-77-2, RE-77-3, RE-96-1, RE-96-2, RE-96-3, RE-99-1, RE-99-2, RE-99-3, S-109-1, S-109-2, S-109-3, S-111-1, S-111-2, S-111-3, S-66-1, S-66-2...(Other models you can see in the webshop)		



			
1			
<b>GEV No.</b>	359639	<b>Ref. No.</b>	EL06900
<b>description</b>	lamp socket socket E14 with grip fixing		

			
1			
<b>GEV No.</b>	359661	<b>Ref. No.</b>	AL201 AL20100
<b>description</b>	oven lamp glass thread 32.1 ø 58mm hard glas temp.-resist. 350°C		
<b>For models:</b>	R-109-1, R-109-2, R-109-3, R-111-1, R-111-2, R-111-3, R-66-1, R-66-2, R-66-3, R-69-1, R-69-2, R-69-3, R-77-1, R-77-2, R-77-3, R-96-1, R-96-2, R-96-3, R-99-1, R-99-2, R-99-3, RE-109-1, RE-109-2, RE-109-3, RE-111-1, RE-111-2, RE-111-3, RE-66-1, RE-66-2, RE-66-3, RE-69-1, RE-69-2, RE-69-3, RE-77-1, RE-77-2, RE-77-3, RE-96-1, RE-96-2, RE-96-3, RE-99-1, RE-99-2, RE-99-3, S-109-1, S-109-2, S-109-3, S-111-1, S-111-2, S-111-3, S-66-1, S-66-2...(Other models you can see in the webshop)		
<b>accessories for</b>	359661		
		<b>GEV No.</b>	359700
		<b>Ref. No.</b>	AL26600



			
1			
<b>GEV No.</b>	698562	<b>Ref. No.</b>	QAT2200
<b>description</b>	reflector L 120mm W 108mm ø 120mm H 33mm for pizza oven		
<b>For models:</b>	R-109-1, R-109-2, R-109-3, R-111-1, R-111-2, R-111-3, R-66-1, R-66-2, R-66-3, R-69-1, R-69-2, R-69-3, R-77-1, R-77-2, R-77-3, R-96-1, R-96-2, R-96-3, R-99-1, R-99-2, R-99-3, RE-109-1, RE-109-2, RE-109-3, RE-111-1, RE-111-2, RE-111-3, RE-66-1, RE-66-2, RE-66-3, RE-69-1, RE-69-2, RE-69-3, RE-77-1, RE-77-2, RE-77-3, RE-96-1, RE-96-2, RE-96-3, RE-99-1, RE-99-2, RE-99-3, S-109-1, S-109-2, S-109-3, S-111-1, S-111-2, S-111-3, S-66-1, S-66-2...(Other models you can see in the webshop)		

			
1			
<b>GEV No.</b>	698561	<b>Ref. No.</b>	HAT6400 HAT6410
<b>description</b>	bracket H 40mm L 178mm W 98mm for lamp		
<b>For models:</b>	R-109-1, R-109-2, R-109-3, R-111-1, R-111-2, R-111-3, R-66-1, R-66-2, R-66-3, R-69-1, R-69-2, R-69-3, R-77-1, R-77-2, R-77-3, R-96-1, R-96-2, R-96-3, R-99-1, R-99-2, R-99-3, RE-109-1, RE-109-2, RE-109-3, RE-111-1, RE-111-2, RE-111-3, RE-66-1, RE-66-2, RE-66-3, RE-69-1, RE-69-2, RE-69-3, RE-77-1, RE-77-2, RE-77-3, RE-96-1, RE-96-2, RE-96-3, RE-99-1, RE-99-2, RE-99-3, S-109-1, S-109-2, S-109-3, S-111-1, S-111-2, S-111-3, S-66-1, S-66-2...(Other models you can see in the webshop)		

			
1			
<b>GEV No.</b>	359700	<b>Ref. No.</b>	AL26600
<b>description</b>	gasket for pizza oven fibre glass ID ø 32.5mm ED ø 55mm thickness 5mm		
<b>For models:</b>	R-109-1, R-109-2, R-109-3, R-111-1, R-111-2, R-111-3, R-66-1, R-66-2, R-66-3, R-69-1, R-69-2, R-69-3, R-77-1, R-77-2, R-77-3, R-96-1, R-96-2, R-96-3, R-99-1, R-99-2, R-99-3, RE-109-1, RE-109-2, RE-109-3, RE-111-1, RE-111-2, RE-111-3, RE-66-1, RE-66-2, RE-66-3, RE-69-1, RE-69-2, RE-69-3, RE-77-1, RE-77-2, RE-77-3, RE-96-1, RE-96-2, RE-96-3, RE-99-1, RE-99-2, RE-99-3, S-109-1, S-109-2, S-109-3, S-111-1, S-111-2, S-111-3, S-66-1, S-66-2...(Other models you can see in the webshop)		

				
1				
<b>GEV No.</b>	359320	<b>Ref. No.</b>	EI03100 EL05600	
<b>description</b>	lamp socket 24V socket G6.35 cable length 280mm connection male faston 6.3mm ø 16mm H 10mm mounting distance 26mm holder length 32mm Qty 1 pcs			
<b>For models:</b>	109, 111, 22, 23, 32, 33 220V, 33 380V, 34 220V, 34 380V, 66, 69, 77, 96, 99, R-109-1, R-109-2, R-109-3, R-111-1, R-111-2, R-111-3, R-66-1, R-66-2, R-66-3, R-69-1, R-69-2, R-69-3, R-77-1, R-77-2, R-77-3, R-96-1, R-96-2, R-96-3, R-99-1, R-99-2, R-99-3, RE-109-1, RE-109-2, RE-109-3, RE-111-1, RE-111-2, RE-111-3, RE-66-1, RE-66-2, RE-66-3, RE-69-1, RE-69-2, RE-69-3, RE-77-1, RE-77-2, RE-77-3...(Other models you can see in the webshop)			
<b>accessories for</b>	359320			
	<b>GEV No.</b>	359370	<b>Ref. No.</b>	EL04000
	halogen lamp socket G6.35 12V 50W temp.-resist. 300°C ø 10mm L 44mm clear			

<b>accessories for</b>	359320			
	<b>GEV No.</b>	359661	<b>Ref. No.</b>	AL201 AL20100
	oven lamp glass thread 32.1 ø 58mm hard glas temp.-resist. 350°C			

				
1				
<b>GEV No.</b>	359661	<b>Ref. No.</b>	AL201 AL20100	
<b>description</b>	oven lamp glass thread 32.1 ø 58mm hard glas temp.-resist. 350°C			
<b>For models:</b>	R-109-1, R-109-2, R-109-3, R-111-1, R-111-2, R-111-3, R-66-1, R-66-2, R-66-3, R-69-1, R-69-2, R-69-3, R-77-1, R-77-2, R-77-3, R-96-1, R-96-2, R-96-3, R-99-1, R-99-2, R-99-3, RE-109-1, RE-109-2, RE-109-3, RE-111-1, RE-111-2, RE-111-3, RE-66-1, RE-66-2, RE-66-3, RE-69-1, RE-69-2, RE-69-3, RE-77-1, RE-77-2, RE-77-3, RE-96-1, RE-96-2, RE-96-3, RE-99-1, RE-99-2, RE-99-3, S-109-1, S-109-2, S-109-3, S-111-1, S-111-2, S-111-3, S-66-1, S-66-2...(Other models you can see in the webshop)			
<b>accessories for</b>	359661			
	<b>GEV No.</b>	359700	<b>Ref. No.</b>	AL26600
	gasket for pizza oven fibre glass ID ø 32.5mm ED ø 55mm thickness 5mm			

			
1			
<b>GEV No.</b>	698562	<b>Ref. No.</b>	QAT2200
<b>description</b>	reflector L 120mm W 108mm ø 120mm H 33mm for pizza oven		
<b>For models:</b>	R-109-1, R-109-2, R-109-3, R-111-1, R-111-2, R-111-3, R-66-1, R-66-2, R-66-3, R-69-1, R-69-2, R-69-3, R-77-1, R-77-2, R-77-3, R-96-1, R-96-2, R-96-3, R-99-1, R-99-2, R-99-3, RE-109-1, RE-109-2, RE-109-3, RE-111-1, RE-111-2, RE-111-3, RE-66-1, RE-66-2, RE-66-3, RE-69-1, RE-69-2, RE-69-3, RE-77-1, RE-77-2, RE-77-3, RE-96-1, RE-96-2, RE-96-3, RE-99-1, RE-99-2, RE-99-3, S-109-1, S-109-2, S-109-3, S-111-1, S-111-2, S-111-3, S-66-1, S-66-2...(Other models you can see in the webshop)		

			
1			
<b>GEV No.</b>	359324	<b>Ref. No.</b>	HAT0110
<b>description</b>	frame for lamp		
<b>For models:</b>	SG22, SG23, SG33		



			
1			
<b>GEV No.</b>	359325	<b>Ref. No.</b>	AL03220
<b>description</b>	gasket		
<b>For models:</b>	SG22, SG23, SG33		

			
1			
<b>GEV No.</b>	359323	<b>Ref. No.</b>	AL04000 AL04000 + AL03220
<b>description</b>	lamp glass with gasket L 154mm W 63mm thickness 8mm		
<b>For models:</b>	22, 23, 32, 33 220V, 33 380V, 34 220V, 34 380V, SG22, SG23, SG33		

			
1			
<b>GEV No.</b>	359323	<b>Ref. No.</b>	AL04000 AL04000 + AL03220
<b>description</b>	lamp glass with gasket L 154mm W 63mm thickness 8mm		
<b>For models:</b>	22, 23, 32, 33 220V, 33 380V, 34 220V, 34 380V, SG22, SG23, SG33		

			
1			
<b>GEV No.</b>	359322	<b>Ref. No.</b>	HAT5910
<b>description</b>	lamp holder for bulb socket		
<b>For models:</b>	SG22, SG23, SG33		

			
1			
<b>GEV No.</b>	359639	<b>Ref. No.</b>	EL06900
<b>description</b>	lamp socket socket E14 with grip fixing		

			
1			
<b>GEV No.</b>	359320	<b>Ref. No.</b>	EL03100 EL05600
<b>description</b>	lamp socket 24V socket G6.35 cable length 280mm connection male faston 6.3mm ø 16mm H 10mm mounting distance 26mm holder length 32mm Qty 1 pcs		
<b>For models:</b>	109, 111, 22, 23, 32, 33 220V, 33 380V, 34 220V, 34 380V, 66, 69, 77, 96, 99, R-109-1, R-109-2, R-109-3, R-111-1, R-111-2, R-111-3, R-66-1, R-66-2, R-66-3, R-69-1, R-69-2, R-69-3, R-77-1, R-77-2, R-77-3, R-96-1, R-96-2, R-96-3, R-99-1, R-99-2, R-99-3, RE-109-1, RE-109-2, RE-109-3, RE-111-1, RE-111-2, RE-111-3, RE-66-1, RE-66-2, RE-66-3, RE-69-1, RE-69-2, RE-69-3, RE-77-1, RE-77-2, RE-77-3...(Other models you can see in the webshop)		
<b>accessories for</b>	359320		
	<b>GEV No.</b>	359370	<b>Ref. No.</b> EL04000
	<b>GEV No.</b>	359661	<b>Ref. No.</b> AL201 AL20100
oven lamp glass thread 32.1 ø 58mm hard glas temp.-resist. 350°C			

<b>lamps</b>			
<b>halogen lamps</b>			
for socket E14 / E27			
			
1			
<b>GEV No.</b>	359728	<b>Ref. No.</b>	EL06600
<b>description</b>	halogen lamp socket E14 230V 40W ø 25mm lens L 54mm L 80mm temp.-resist. 300°C Qty 1		

for socket G4 / G6.35 / G9			
			
1 <b>500°C</b>			
<b>GEV No.</b>	359074	<b>Ref. No.</b>	EL062 EL06200
<b>description</b>	halogen lamp socket G6.35 12V 35W temp.-resist. 500°C		
<b>For models:</b>	R-109-1, R-109-2, R-109-3, R-111-1, R-111-2, R-111-3, R-66-1, R-66-2, R-66-3, R-69-1, R-69-2, R-69-3, R-77-1, R-77-2, R-77-3, R-96-1, R-96-2, R-96-3, R-99-1, R-99-2, R-99-3, RE-109-1, RE-109-2, RE-109-3, RE-111-1, RE-111-2, RE-111-3, RE-66-1, RE-66-2, RE-66-3, RE-69-1, RE-69-2, RE-69-3, RE-77-1, RE-77-2, RE-77-3, RE-96-1, RE-96-2, RE-96-3, RE-99-1, RE-99-2, RE-99-3, S-109-1, S-109-2, S-109-3, S-111-1, S-111-2, S-111-3, S-66-1, S-66-2...(Other models you can see in the webshop)		

			
1			
<b>GEV No.</b>	359325	<b>Ref. No.</b>	AL03220
<b>description</b>	gasket		
<b>For models:</b>	SG22, SG23, SG33		

			
1			
<b>GEV No.</b>	359946	<b>Ref. No.</b>	EL07400
<b>description</b>	halogen lamp socket G9 230V 40W temp.-resist. 300°C		





timers

programme timers

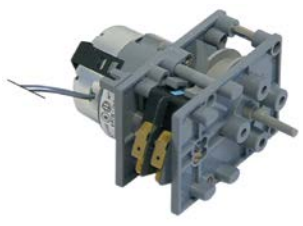

1

<b>GEV No.</b>	360035	<b>Ref. No.</b>	EC016
<b>description</b>	timer CDC 4902F engines 1 chambers 2 operation time 120s 230V shaft ø 6x4.6mm shaft L 17mm manuf. no. 4902F1 / 3322050 motor type M48L ATS		
<b>spare parts for</b>	360035		
	<b>GEV No.</b>	360083	<b>Ref. No.</b> —
	motor CDC pinion ø 4.9mm teeth 10 230V turn direction left motor ø 47mm H 19.3mm motor type M48L ATS for timer		



1

<b>GEV No.</b>	360040	<b>Ref. No.</b>	EC030
<b>description</b>	timer CDC 9003F engines 1 chambers 3 operation time 6min 230V shaft ø 6x4.6mm shaft L 21mm manuf. no. 9003F3 / PRCIH5 motor type M48R ATS		
<b>spare parts for</b>	360040		
	<b>GEV No.</b>	360118	<b>Ref. No.</b> —
	motor CDC pinion ø 4.9mm teeth 10 230V voltage AC 50/60Hz turn direction right motor ø 47mm H 19.3mm motor type M48R ATS for timer cable length 260mm 1.9/2.5W		
<b>accessories for</b>	360040		
	<b>GEV No.</b>	110197	<b>Ref. No.</b> —
	knob switch zero mark ø 42mm shaft ø 6x4.6mm shaft flat adjustable black		

contactors

ISKRA (FANAL)

power contactors



1

<b>GEV No.</b>	380204	<b>Ref. No.</b>	EN00500 EN08200
<b>description</b>	power contactor resistive load 25A 230VAC (AC3/400V) 9A/4kW main contacts 3NO auxiliary contacts 1NO connection screw connection type Fanal DSL9 10 type ISKRA KNL9 10		

LOVATO

power contactors



1

<b>GEV No.</b>	380914	<b>Ref. No.</b>	EN13900
<b>description</b>	power contactor resistive load 20A 230VAC (AC3/400V) 9A/4kW main contacts 6NO auxiliary contacts 2NC connection screw connection type 11BGR0901A230		
<b>For models:</b>	PF45MT-E		



1





<b>GEV No.</b>	380855	<b>Ref. No.</b>	EN00500 EN08200
<b>description</b>	power contactor resistive load 25A 230VAC (AC3/400V) 4.2kW main contacts 3NO auxiliary contacts 1NO		
<b>For models:</b>	109, 111, 22, 23, 32, 33 380V, 34 380V, 66, 69, 77, 96, 99, PF45HT, PF45MTE, PF45MT-E, R-109-1, R-109-2, R-109-3, R-111-1, R-111-2, R-111-3, R-66-1, R-66-2, R-66-3, R-69-1, R-69-2, R-69-3, R-77-1, R-77-2, R-77-3, R-96-1, R-96-2, R-96-3, R-99-1, R-99-2, R-99-3, S-109-1, S-109-2, S-109-3, S-111-1, S-111-2, S-111-3, S-66-1, S-66-2, S-66-3, S-69-1, S-69-2, S-69-3, S-77-1, S-77-2...(Other models you can see in the webshop)		
<b>accessories for</b>	380855		
	<b>GEV No.</b>	380055	<b>Ref. No.</b> —
	RC circuit voltage AC/DC suitable for BF09-32 rated 240V		





Table continues overleaf



<b>accessories for</b> 380855			
	<b>GEV No.</b>	380118	<b>Ref. No.</b> —
auxiliary contact contacts 1NO/1NC AC1 10A for contactors BF series connection screw type G480/11			

<b>1</b>			
	<b>GEV No.</b>	380714	<b>Ref. No.</b> EN08200 EN17000
<b>description</b> power contactor resistive load 25A 230VAC (AC3/400V) 9A/4.2kW main contacts 3NO auxiliary contacts 1NO connection screw connection type BF0910A230			



<b>auxiliary contacts</b>			
<b>1</b>			
	<b>GEV No.</b>	380057	<b>Ref. No.</b> EN13100
<b>description</b> auxiliary contact contacts 1NO/1NC AC1 10A for contactors BG series connection screw type BGX1011			
<b>For models:</b> PF45MT-E			

<b>relays</b>			
<b>power relays</b>			
<b>with bracket mounting</b>			
<b>1</b>			
	<b>GEV No.</b>	380139	<b>Ref. No.</b> EN12500
<b>description</b> power relays FINDER 230VAC 16A 2CO connection F6.3 bracket mounting dimensions 68x38.2x35.8mm manuf. no. 62.82.8.230.0000			

<b>with male contacts</b>			
<b>female contact 2.0mm</b>			
<b>1</b>			
	<b>GEV No.</b>	380377	<b>Ref. No.</b> EN01600
<b>description</b> power relays FINDER 220-240VAC 10A 2CO connection F2 plug-in connection manuf. no. 55.32.8.230.0000 94.92.3 250V			
<b>For models:</b> PF45HT, PF45MTE, PF45MT-E			
<b>accessories for</b> 380377			
	<b>GEV No.</b>	380341	<b>Ref. No.</b> —
relay socket 4-pole contacts 12 300V voltage AC 6A Italiana Relè manuf. no. ZMD4			
	<b>GEV No.</b>	380378	<b>Ref. No.</b> EN01700
relay socket 2-pole 55/85 dimensions 70.5x30x27mm 250V voltage AC 10A FINDER manuf. no. 94.72			
	<b>GEV No.</b>	380384	<b>Ref. No.</b> —
relay socket 2-pole contacts male faston 2.8mm 250V voltage AC 10A W 23mm for			
	<b>GEV No.</b>	380399	<b>Ref. No.</b> —
relay socket 4-pole dimensions 76.2x27x86.1mm 250V voltage AC 1A FINDER manuf. no. 94.94.3			

<b>relay sockets</b>			
<b>1</b>			
	<b>GEV No.</b>	380378	<b>Ref. No.</b> EN01700
<b>description</b> relay socket 2-pole 55/85 dimensions 70.5x30x27mm 250V voltage AC 10A FINDER manuf. no. 94.72			
<b>For models:</b> PF45HT, PF45MTE, PF45MT-E			
<b>accessories for</b> 380378			
	<b>GEV No.</b>	380804	<b>Ref. No.</b> —
support bracket			



			
1			
<b>GEV No.</b>	380137	<b>Ref. No.</b>	EC02700
<b>description</b>	relay socket 8-pole connection plug-in connection round 8-pole dimensions 65x28x40mm 380V voltage AC 10A Italiana Relè manuf. no. ZVE8		
<b>For models:</b>	PF33MT, PF45HT		
<b>accessories for</b>	380137		
		<b>GEV No.</b>	380805
		<b>Ref. No.</b>	—
	support bracket		

encapsulated transformers

PMA			
			
1			
<b>GEV No.</b>	379054	<b>Ref. No.</b>	EH03200
<b>description</b>	transformer primary 230VAC secondary 12VAC 3VA secondary 0.25A H 40mm L 45mm W 50mm connection screw 50/60Hz type 153/M		
<b>For models:</b>	PF45MTE		

time relays



time relays			
			
1			
<b>GEV No.</b>	360693	<b>Ref. No.</b>	EC03900
<b>description</b>	time relay CDC Sc.741 time range 3s-60min 48-230V mounting measurements 35x35mm connection P.35.002		
<b>For models:</b>	PF33MT, PF45HT		

electronic controllers

ELIWELL

universal controllers

built-in version

			
1			
<b>GEV No.</b>	379568	<b>Ref. No.</b>	ED051 ED077
<b>description</b>	electronic controller ELIWELL type ICPlus915 model ICP22JI750000 mounting measurements 71x29mm 230V voltage AC Pt100/TC (J,K) relay outputs 2 CO-8A(4) CO-8A(4) Pt100/TC (J,K,S) DI front measurements 78x37mm built-in depth 60mm mode of operation cooking protection IPx0 accuracy 1% built-in version defr. funct. no -150 to 1350°C display 3½ digits		
<b>accessories for</b>	379568		
		<b>GEV No.</b>	378065
		<b>Ref. No.</b>	—
		alarm device AKO type AKO-520641 mounting measurements 214x214mm 230V voltage AC relay outputs 1 CO-8A(4) up to 4 front measurements 222x222mm yes yes	
		<b>GEV No.</b>	378074
		<b>Ref. No.</b>	—
		temperature probe thermocouple J (Fe-CuNi) cable Vetrotex probe -50 up to +750°C cable -50 up to +350°C probe ø3x100mm cable length 3m without screw connection 2-wire	
		<b>GEV No.</b>	378075
		<b>Ref. No.</b>	—
		temperature probe thermocouple K (NiCr-Ni) cable Vetrotex probe -50 up to 1150°C cable -50 up to +350°C probe ø4.5x150mm cable length 3m without screw connection 2-wire	
		<b>GEV No.</b>	379050
		<b>Ref. No.</b>	—
		temperature probe Pt100 cable Vetrotex probe -200 up to +600°C cable -50 up to +350°C probe ø6x100mm cable length 2.7m without screw connection 3-wire	
		<b>GEV No.</b>	379062
		<b>Ref. No.</b>	—
		temperature probe thermocouple J (Fe-CuNi) cable Vetrotex probe -50 up to +750°C cable -50 up to +350°C probe ø6x50mm cable length 3m without screw connection 2-wire	

transformers

toroidal core transformers

			
1			
<b>GEV No.</b>	101028	<b>Ref. No.</b>	EH03300 EH04500 EH04510
<b>description</b>	transformer primary 0-230VAC secondary 0-12VAC 50VA H 30mm L 80mm W 80mm connection grip connection 50/60Hz type 147340F for ignition		
<b>For models:</b>	R-109-1, R-109-2, R-109-3, R-111-1, R-111-2, R-111-3, R-66-1, R-66-2, R-66-3, R-69-1, R-69-2, R-69-3, R-77-1, R-77-2, R-77-3, R-96-1, R-96-2, R-96-3, R-99-1, R-99-2, R-99-3, RE-109-1, RE-109-2, RE-109-3, RE-111-1, RE-111-2, RE-111-3, RE-66-1, RE-66-2, RE-66-3, RE-69-1, RE-69-2, RE-69-3, RE-77-1, RE-77-2, RE-77-3, RE-96-1, RE-96-2, RE-96-3, RE-99-1, RE-99-2, RE-99-3, S-109-1, S-109-2, S-109-3, S-111-1, S-111-2, S-111-3, S-66-1, S-66-2...(Other models you can see in the webshop)		

refrigeration controllers

built-in version



1			
<b>GEV No.</b>	379018	<b>Ref. No.</b>	ED05100 ED07700
<b>description</b>	electronic controller ELIWELL type EWPC902T thermocouple J		
<b>For models:</b>	PF45MT-E, R-109-1, R-109-2, R-109-3, R-111-1, R-111-2, R-111-3, R-66-1, R-66-2, R-66-3, R-69-1, R-69-2, R-69-3, R-77-1, R-77-2, R-77-3, R-96-1, R-96-2, R-96-3, R-99-1, R-99-2, R-99-3, S-109-1, S-109-2, S-109-3, S-111-1, S-111-2, S-111-3, S-66-1, S-66-2, S-66-3, S-69-1, S-69-2, S-69-3, S-77-1, S-77-2, S-77-3, S-96-1, S-96-2, S-96-3, S-99-1, S-99-2, S-99-3		

PIXSYS

universal controllers

built-in version



1			
<b>GEV No.</b>	379857	<b>Ref. No.</b>	ED01800
<b>description</b>	electronic controller PIXSYS type ATR150-2AB mounting measurements 66.5x66.5mm 24/230V voltage AC PTC/Pt100/TC(J/K/S) relay outputs 1 relay defr. funct. no display 4 digits TempIn1 yes 8A		
<b>For models:</b>	22, 23, 32, 33, 34		

SHANGFANG

accessories



1			
<b>GEV No.</b>	379054	<b>Ref. No.</b>	EH03200
<b>description</b>	transformer primary 230VAC secondary 12VAC 3VA secondary 0.25A H 40mm L 45mm W 50mm connection screw 50/60Hz type 153/M		
<b>For models:</b>	PF45MTE		

probes

producer-specific probes

probes



1			
<b>GEV No.</b>	379457	<b>Ref. No.</b>	EO23200
<b>description</b>	extension for probe		
<b>For models:</b>	PF45MTE		

1			
<b>GEV No.</b>	378457	<b>Ref. No.</b>	ED08320
<b>description</b>	temperature probe Pt1000 cable silicone probe -100 up to 450°C cable -50 up to +180°C connection plug thread probe ø3x280mm cable length 1.95m		



1			
<b>GEV No.</b>	379000	<b>Ref. No.</b>	ED07100
<b>description</b>	temperature probe thermocouple J (Fe-CuNi) cable red/blue cable length 0.7m probe ø 2mm probe L 2000mm		

1			
<b>GEV No.</b>	379451	<b>Ref. No.</b>	ED01900 ED06500
<b>description</b>	temperature probe thermocouple J cable silicone probe -50 up to 1150°C cable -50 up to +180°C connection 2-wire thread probe ø2x250mm cable length 1.5m		
<b>For models:</b>	109, 111, 66, 69, 77, 96, 99, R-109-1, R-109-2, R-109-3, R-111-1, R-111-2, R-111-3, R-66-1, R-66-2, R-66-3, R-69-1, R-69-2, R-69-3, R-77-1, R-77-2, R-77-3, R-96-1, R-96-2, R-96-3, R-99-1, R-99-2, R-99-3, RE-109-1, RE-109-2, RE-109-3, RE-111-1, RE-111-2, RE-111-3, RE-66-1, RE-66-2, RE-66-3, RE-69-1, RE-69-2, RE-69-3, RE-77-1, RE-77-2, RE-77-3, RE-96-1, RE-96-2, RE-96-3, RE-99-1, RE-99-2, RE-99-3, S-109-1...(Other models you can see in the webshop)		

1			
<b>GEV No.</b>	379454	<b>Ref. No.</b>	ED05200 ED06600
<b>description</b>	temperature probe thermocouple K (NiCr-Ni) cable silicone probe -50 up to 1150°C cable -50 up to +180°C connection male faston thread probe ø2x250mm cable length 2.5m		
<b>For models:</b>	PF45MTE, PF45MT-E		





## electronics

### PCBs

			
1			
<b>GEV No.</b>	403457	<b>Ref. No.</b>	HE185 HE18500 OMHE23400
<b>description</b>	main PCB pizza oven 430DS L 91mm W 84mm suitable for OEM 230V		

			
1			
<b>GEV No.</b>	401631	<b>Ref. No.</b>	SR8H000 SR8H510
<b>description</b>	PCB		

			
1			
<b>GEV No.</b>	401939	<b>Ref. No.</b>	HE12400
<b>description</b>	PCB		

 Image not available			
1			
<b>GEV No.</b>	692023	<b>Ref. No.</b>	R3H00 R3H0000
<b>description</b>	PCB		

### Triacs

			
1			
<b>GEV No.</b>	400576	<b>Ref. No.</b>	HE05600
<b>description</b>	Triac		
<b>For models:</b>	22, 23, 32, 33, 34		

### central units

			
1			
<b>GEV No.</b>	401092	<b>Ref. No.</b>	50PAA78246
<b>description</b>	control box 400V		

## keypads

### membrane keypads

			
1			
<b>GEV No.</b>	401420	<b>Ref. No.</b>	96.00364
<b>description</b>	membrane keypad 6 buttons		

## solenoid valves

### solenoid valves (gas)

#### ASCO

			
1			
<b>GEV No.</b>	101378	<b>Ref. No.</b>	EB01800
<b>description</b>	solenoid valve 2-ways 230VAC connection 1/2" L 58mm Asco p max 0.14bar slide-on receptacle DIN gas		
<b>For models:</b>	SG22, SG23, SG33		

→ electric components



### pressure switches

#### for warewashing

ø 58mm with male faston 6.3mm

with connection horizontal



<b>GEV No.</b>	541011	<b>Ref. No.</b>	EI002
<b>description</b>	pressure control pressure range 110/70mbar connection 6mm ø 58mm pressure connection horizontal warewashing		



<b>GEV No.</b>	541010	<b>Ref. No.</b>	EI001
<b>description</b>	pressure control pressure range 50/30mbar connection 6mm ø 58mm pressure connection horizontal warewashing		

### fans

#### axial fans

import



<b>GEV No.</b>	601080 <sup>1</sup>	<b>Ref. No.</b>	ES22700
<b>description</b>	axial fan L 119mm W 119mm H 38mm 230VAC 50/60Hz 23/20W bearing ball bearing connection male faston 2.8mm metal ADDA fan wheel ø 110mm temp.-resist. 70°C		

<b>accessories for</b>	601080			
	<b>GEV No.</b>	550898	<b>Ref. No.</b>	—
	connecting cable cable length 2000mm connection F 2.8 connection distance 7.9mm for axial flow fan			
	<b>GEV No.</b>	692519	<b>Ref. No.</b>	—
	guard L 120mm W 120mm plastic			

<sup>1</sup>with ball bearings

### motors

#### motors

universal



<b>GEV No.</b>	501371	<b>Ref. No.</b>	ES11200
<b>description</b>	motor 250W 230/400V 50Hz 3 phase shaft ø 11mm flange ø 140mm 1400rpm type 63 BA.M.E. flange B5 0.25kW		
<b>For models:</b>	PF33MT		

### pumps

#### wash and rinse pumps

FIR

pumps

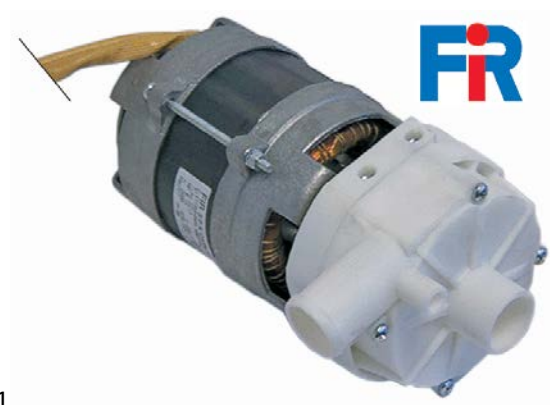







<b>GEV No.</b>	500037	<b>Ref. No.</b>	EA009
<b>description</b>	pump inlet ø 28mm outlet ø 26mm type 2211.1410 230V 50Hz 1 phase 0.074kW 0.1HP L 190mm rotation direction left capacitor 5µF FIR		

<b>spare parts for</b>	500037			
	<b>GEV No.</b>	365017	<b>Ref. No.</b>	—
	operating capacitor capacity 5µF 450V tolerance 5% 50/60Hz ambient temperature max. -25 to +85°C ø 28mm L 54mm M8 plastic connection male faston 6.3mm 16.10.08 protection			
	<b>GEV No.</b>	510384	<b>Ref. No.</b>	—
	pump cover inlet ø 28mm outlet ø 26mm ø 100mm ID ø 76mm			
	<b>GEV No.</b>	510695	<b>Ref. No.</b>	—
	mechanical shaft seal height counter ring 5.5mm ID ø 11mm			
	<b>GEV No.</b>	521203	<b>Ref. No.</b>	—
	impellor ø 72mm H 18mm thread M7 shaft ø 11mm shaft length 32mm blades 3			
	<b>GEV No.</b>	521703	<b>Ref. No.</b>	—
	pump cover gasket EPDM thickness 2.5mm ID ø 75mm Qty 1 pcs			



1

<b>GEV No.</b>	500038	<b>Ref. No.</b>	EA003
<b>description</b>	pump inlet ø 45mm outlet ø 40mm type 3911.1425 230V 50Hz 1 phase 0.55kW 0.75HP L 205mm rotation direction right capacitor 10µF FIR		
<b>spare parts for</b>	500038		
	<b>GEV No.</b>	365015	<b>Ref. No.</b> —
	operating capacitor capacity 10µF 400V tolerance 5%Hz ambient temperature max. -25 to +85°C ø 35.5mm L 59mm M8 plastic connection male faston 6.3mm protection		
	<b>GEV No.</b>	510508	<b>Ref. No.</b> —
	pump cover FIR inlet ø 45mm outlet ø 40mm pump type PU 0.5/3911 turn direction right ø 160mm ID ø 125mm inner height 25mm		
	<b>GEV No.</b>	510610	<b>Ref. No.</b> —
	impellor ø 95.5mm H 23mm shaft intake ø 9/8mm rotation direction right seat ø 16mm blades 6		
	<b>GEV No.</b>	510692	<b>Ref. No.</b> —
	mechanical shaft seal for shaft ø 11mm slide ring ext. ø 24mm slide ring H 13mm counter ring mounting ø 26mm height counter ring 8mm counter ring int. ø 14mm		
	<b>GEV No.</b>	521702	<b>Ref. No.</b> —
	pump cover gasket thickness 3.5x4.5mm Qty 1 pcs		
<b>accessories for</b>	500038		
	<b>GEV No.</b>	551286	<b>Ref. No.</b> —
	adapter L 120mm 4-pole for Meiko pump suitable for 500038 plug type dependent on equipment		

## fuses

### fine fuses

#### fine fuse holders



1

<b>GEV No.</b>	550537	<b>Ref. No.</b>	HE05800
<b>description</b>	fuse holder		
<b>For models:</b>	22, 23, 32, 33, 34		

	<b>GEV No.</b>	358383	<b>Ref. No.</b>	HE05800
<b>description</b>	fuse holder suitable fuse ø5x20mm ø 13.1mm 10A rated 250V connection soldering connection			

## gas taps

### PEL

#### 21N series



















1



<b>GEV No.</b>	101894	<b>Ref. No.</b>	GA11600
<b>description</b>	gas tap PEL type 21N gas inlet M16x1.5 (tube ø 10mm) bypass nozzle ø 0mm gas outlet M16x1.5 (tube ø 10/8mm) thermocouple connection pilot connection closed shaft ø 8x6.5mm shaft L 23/15mm shaft flat upper		
<b>spare parts for</b>	101894		
	<b>GEV No.</b>	100551	<b>Ref. No.</b> —
	bypass nozzle type PEL20/21 bore ø 0.6mm thread M5x0.5		
	<b>GEV No.</b>	101205	<b>Ref. No.</b> —
	gas tap front part shaft ø 8x6.5mm shaft L 22/15mm shaft flat upper/lower suitable for PEL20		
<b>accessories for</b>	101894		
	<b>GEV No.</b>	101278	<b>Ref. No.</b> —
	olive for pipe ø 10mm Qty 1 pcs		
	<b>GEV No.</b>	101300	<b>Ref. No.</b> —
	union nut thread M16x1.5 tube ø 10mm		
	<b>GEV No.</b>	101450	<b>Ref. No.</b> —
	olive for pipe ø 8mm L 12.7mm Qty 1 pcs ED ø 10mm		
	<b>GEV No.</b>	101451	<b>Ref. No.</b> —
	union nut thread M16x1.5 tube ø 8mm		
	<b>GEV No.</b>	110081	<b>Ref. No.</b> —
	knob ø 70mm shaft ø 8x6.5mm shaft flat universal		
	<b>GEV No.</b>	110083	<b>Ref. No.</b> —
	knob dial plate gas tap without ignition flame silver		



## 22S/O series



<b>GEV No.</b>	101086	<b>Ref. No.</b>	GA05300
<b>description</b>	gas tap PEL type 22S/O gas inlet M20x1.5 (tube ø 12mm) bypass nozzle ø 0.35mm gas outlet M20x1.5 (tube ø 12/10mm) thermocouple connection M9x1 pilot connection M10x1 shaft ø 10x8mm shaft L 25/17mm shaft flat lower		
<b>For models:</b>	SG22, SG23, SG33		
<b>spare parts for</b>	101086		
	<b>GEV No.</b>	100259	<b>Ref. No.</b> —
	bypass nozzle type PEL22 bore ø 0.35mm thread M6x0.5		
	<b>GEV No.</b>	101058	<b>Ref. No.</b> —
	magnet unit L 39mm D1 ø 15.4mm D2 ø 13.5mm suitable for PEL22/EGA24197 standard		
	<b>GEV No.</b>	101201	<b>Ref. No.</b> —
	gas tap front part shaft ø 10x8mm shaft L 25/17mm shaft flat upper/lower suitable for PEL22		
	<b>GEV No.</b>	101231	<b>Ref. No.</b> —
	thermocouple nut T1: M9x1 T2: M18x1		
	<b>GEV No.</b>	101240	<b>Ref. No.</b> —
	gas connection thread M20x1.5 tube ø 12/10mm for PEL gas taps with gasket and screws horizontal		
	<b>GEV No.</b>	101460	<b>Ref. No.</b> —
	O-ring ø 12.37mm D1 ø 2.62mm suitable for PEL22		
	<b>GEV No.</b>	101461	<b>Ref. No.</b> —
	screw kit suitable for PEL22 Qty 4 pcs		
<b>accessories for</b>	101086		
	<b>GEV No.</b>	100908	<b>Ref. No.</b> —
	union screw thread M10x1 for pipe ø 4mm Qty 1 pcs		
	<b>GEV No.</b>	100909	<b>Ref. No.</b> —
	union screw thread M10x1 for pipe ø 6mm Qty 1 pcs		
	<b>GEV No.</b>	101241	<b>Ref. No.</b> —
	gas connection thread M20x1.5 tube ø 12/10mm for PEL gas taps vertical		
	<b>GEV No.</b>	101246	<b>Ref. No.</b> —
	olive for pipe ø 4mm Qty 1 pcs		
	<b>GEV No.</b>	101248	<b>Ref. No.</b> —
	olive for pipe ø 12mm Qty 1 pcs suitable for PEL		
	<b>GEV No.</b>	101249	<b>Ref. No.</b> —
	olive for pipe ø 10mm Qty 1 pcs		
	<b>GEV No.</b>	101250	<b>Ref. No.</b> —
	union nut thread M20x1.5 for pipe ø 10mm		
	<b>GEV No.</b>	101251	<b>Ref. No.</b> —
	union nut thread M20x1.5 for pipe ø 12mm		
	<b>GEV No.</b>	101286	<b>Ref. No.</b> —
	olive ID ø 6mm Qty 1 pcs		

<b>accessories for</b>	101086		
	<b>GEV No.</b>	110080	<b>Ref. No.</b> —
	knob ø 70mm shaft ø 10x8mm shaft flat universal		
	<b>GEV No.</b>	112206	<b>Ref. No.</b> —
	knob dial plate silver gas tap PEL21/22/23 t.max.°C ED ø 63mm ID ø 45.5mm		



















<b>GEV No.</b>	101510	<b>Ref. No.</b>	GA053
<b>description</b>	gas tap PEL type 22S/O gas inlet M20x1.5 (tube ø 12mm) bypass nozzle ø 0mm gas outlet M20x1.5 (tube ø 12/10mm) thermocouple connection M9x1 pilot connection M10x1 shaft ø 10x8mm shaft L 25/17mm shaft flat lower		
<b>spare parts for</b>	101510		
	<b>GEV No.</b>	101058	<b>Ref. No.</b> —
	magnet unit L 39mm D1 ø 15.4mm D2 ø 13.5mm suitable for PEL22/EGA24197 standard		
	<b>GEV No.</b>	101201	<b>Ref. No.</b> —
	gas tap front part shaft ø 10x8mm shaft L 25/17mm shaft flat upper/lower suitable for PEL22		
	<b>GEV No.</b>	101231	<b>Ref. No.</b> —
	thermocouple nut T1: M9x1 T2: M18x1		
	<b>GEV No.</b>	101240	<b>Ref. No.</b> —
	gas connection thread M20x1.5 tube ø 12/10mm for PEL gas taps with gasket and screws horizontal		
	<b>GEV No.</b>	101460	<b>Ref. No.</b> —
	O-ring ø 12.37mm D1 ø 2.62mm suitable for PEL22		
	<b>GEV No.</b>	101461	<b>Ref. No.</b> —
	screw kit suitable for PEL22 Qty 4 pcs		
<b>accessories for</b>	101510		
	<b>GEV No.</b>	100908	<b>Ref. No.</b> —
	union screw thread M10x1 for pipe ø 4mm Qty 1 pcs		
	<b>GEV No.</b>	100909	<b>Ref. No.</b> —
	union screw thread M10x1 for pipe ø 6mm Qty 1 pcs		
	<b>GEV No.</b>	101241	<b>Ref. No.</b> —
	gas connection thread M20x1.5 tube ø 12/10mm for PEL gas taps vertical		
	<b>GEV No.</b>	101246	<b>Ref. No.</b> —
	olive for pipe ø 4mm Qty 1 pcs		
	<b>GEV No.</b>	101248	<b>Ref. No.</b> —
	olive for pipe ø 12mm Qty 1 pcs suitable for PEL		
	<b>GEV No.</b>	101249	<b>Ref. No.</b> —
	olive for pipe ø 10mm Qty 1 pcs		
	<b>GEV No.</b>	101250	<b>Ref. No.</b> —
	union nut thread M20x1.5 for pipe ø 10mm		

Table continues overleaf











accessories for		101510		
GEV No.	Ref. No.	Ref. No.	Ref. No.	—
	101251	Ref. No.	—	—
union nut thread M20x1.5 for pipe ø 12mm				
	101286	Ref. No.	—	—
olive ID ø 6mm Qty 1 pcs				
	110080	Ref. No.	—	—
knob ø 70mm shaft ø 10x8mm shaft flat universal				
	112206	Ref. No.	—	—
knob dial plate silver gas tap PEL21/22/23 t.max.°C ED ø 63mm ID ø 45.5mm				





accessories for		106033		
GEV No.	Ref. No.	Ref. No.	Ref. No.	—
	101257	Ref. No.	—	—
olive for pipe ø 20mm Qty 1 pcs				

23S/O series



GEV No.	Ref. No.	Ref. No.	Ref. No.	GA05800
1	106033	Ref. No.	Ref. No.	GA05800
<b>description</b> gas tap PEL type 23S/O gas inlet M28x1.5 (tube ø 20mm) bypass nozzle ø 0.35mm gas outlet M24x1.5 (tube ø 16/12mm) thermocouple connection M10x1 pilot connection M10x1 shaft ø 10x8mm shaft L 25/17mm shaft flat lower				

spare parts for		106033		
GEV No.	Ref. No.	Ref. No.	Ref. No.	—
	100455	Ref. No.	—	—
bypass nozzle type PEL23/24 bore ø 0.35mm thread M8x0.5				
	101059	Ref. No.	—	—
magnet unit T1: M10x1 T2: M22x1 L 46mm ø 18mm suitable for PEL23S M10x1				
	101204	Ref. No.	—	—
gas tap front part shaft ø 10x8mm shaft L 25/17mm shaft flat upper/lower suitable for PEL23S				
	101244	Ref. No.	—	—
gas connection thread M24x1.5 tube ø 12/16mm horizontal for PEL gas taps				
	101463	Ref. No.	—	—
screw suitable for PEL23S Qty 4 pcs				
	528455	Ref. No.	—	—
O-ring Viton thickness 2.62mm ID ø 18.72mm Qty 1 pcs				

accessories for		106033		
GEV No.	Ref. No.	Ref. No.	Ref. No.	—
	101252	Ref. No.	—	—
union nut thread M24x1.5 for pipe ø 12mm				
	101253	Ref. No.	—	—
union nut thread M24x1.5 PEL for pipe ø 16mm				
	101254	Ref. No.	—	—
union nut thread M28x1.5 tube ø 20mm				
	101255	Ref. No.	—	—
olive for pipe ø 12mm Qty 1 pcs				
	101256	Ref. No.	—	—
olive for pipe ø 16mm Qty 1 pcs				

gas valves and ignition boxes

gas solenoid valves

ASCO



GEV No.	Ref. No.	Ref. No.	Ref. No.	EB01800
1	101378	Ref. No.	Ref. No.	EB01800
<b>description</b> solenoid valve 2-ways 230VAC connection 1/2" L 58mm Asco p max 0.14bar slide-on receptacle DIN gas				
<b>For models:</b> SG22, SG23, SG33				

ignition parts

pilot burners

POLIDORO

pilot burners

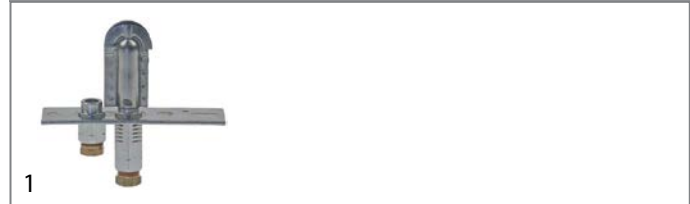

GEV No.	Ref. No.	Ref. No.	Ref. No.	GA11100
1	107577	Ref. No.	Ref. No.	GA11100
<b>description</b> pilot burner POLIDORO 2 flames code gas connection 6mm				

electrodes



GEV No.	Ref. No.	Ref. No.	Ref. No.	GA01400 GA01410
1	100750	Ref. No.	Ref. No.	GA01400 GA01410
<b>description</b> ignition electrode flange length 23mm flange width 15mm D1 ø 7mm L1 28mm L2 18mm L3 23mm L4 14mm BL1 21mm BL2 28mm fixing dimensions ø5x4mm with flange connection ø 4mm				
<b>For models:</b> SG22, SG23				

			
1			
<b>GEV No.</b>	102491	<b>Ref. No.</b>	GA29900
<b>description</b>	ignition electrode flange length 40mm flange width 19mm D1 ø 9.4mm L1 52mm BL1 50mm BL2 60mm connection male faston 2.8mm		

### ignition units

			
1			
<b>GEV No.</b>	101026	<b>Ref. No.</b>	EH02100
<b>description</b>	ignition unit outputs 4		
<b>For models:</b>	SG22, SG23, SG33		

### ignition switches

			
1			
<b>GEV No.</b>	101029	<b>Ref. No.</b>	EF04800+EF04900+5000
<b>description</b>	momentary push switch mounting ø 16mm white 1NO 250V 16A connection male faston 6.3mm protection IP40 ambient temperature max. 150°C		

### thermocouples

#### plug-in thermocouples

#### plug-in thermocouples standard

#### with barrel socket ø6(6.5)mm

#### thermocouples SIT

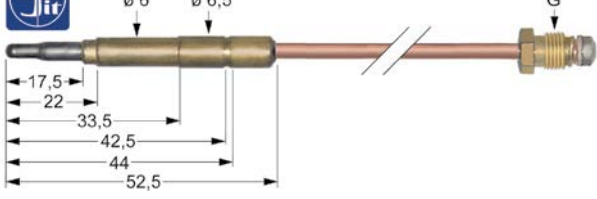
			
1			
<b>GEV No.</b>	107612	<b>Ref. No.</b>	GA24100
<b>description</b>	thermocouple SIT M9x1 L 1000mm plug connection ø6.0(6.5)mm		

### gas burners

#### bar burners

#### bar burners

			
1			
<b>GEV No.</b>	105234	<b>Ref. No.</b>	GA00800
<b>description</b>	bar burner ø 25mm Wmm Hmm L 1047mm pizza oven		
<b>For models:</b>	SG33		

			
1			
<b>GEV No.</b>	105116	<b>Ref. No.</b>	GA007 GA00700
<b>description</b>	bar burner ø 25mm Wmm Hmm L 740mm pizza oven		
<b>For models:</b>	SG22, SG23		

			
1			
<b>GEV No.</b>	105199	<b>Ref. No.</b>	GA07200
<b>description</b>	bar burner ø 50mm Wmm Hmm L 520mm flange width 57mm flange length 57mm pizza oven		
<b>For models:</b>	SG22		

			
1			
<b>GEV No.</b>	105201	<b>Ref. No.</b>	GA07100
<b>description</b>	bar burner ø 50mm Wmm Hmm L 800mm flange width 57mm flange length 57mm pizza oven		
<b>For models:</b>	SG23, SG33		



ceramic burners

accessories

burner grids



**GEV No.** 101511 **Ref. No.** KB61110

**description** burner grid L 41mm W 16mm

**For models:** SG22, SG23, SG33

sealing strips



**GEV No.** 101513 **Ref. No.** AL13600  
AL13610

**description** sealing strip L 230/310mm W 20mm thickness 3mm fibre glass

**For models:** SG22



**GEV No.** 101512 **Ref. No.** 52.00066  
AL13500  
AL13510

**description** sealing strip L 550mm W 20mm thickness 3mm fibre glass

**For models:** SG23, SG33

ceramic plates

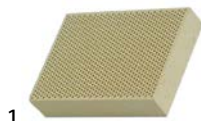

**GEV No.** 101514 **Ref. No.** GA02600

**description** ceramic plate L 68mm W 48mm H 13mm

**For models:** SG22, SG23, SG33

equipment-specific units

for vegetable slicers

ejector discs

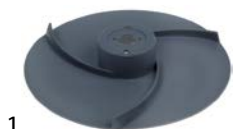

**GEV No.** 699110 **Ref. No.** 50SCA78300

**description** ejector disc flat H 10mm  $\varnothing$  200mm seat  $\varnothing$  50mm shaft diameter 19mm hole distance 39mm

for dough mixers

drive shafts



**GEV No.** 692036 **Ref. No.** AOEMKE100  
KE10000  
KE10020

**description** drive shaft D1  $\varnothing$  29mm for dough hook  $\varnothing$  20mm with flange L 140mm thread M10 D2  $\varnothing$  100mm

**For models:** R201M/T

spacer rings



**GEV No.** 692028 **Ref. No.** AE03100  
AE03120

**description** spacer bush  $\varnothing$  27mm ID  $\varnothing$  21mm H 7mm



**GEV No.** 692031 **Ref. No.** AE14700  
AE14720

**description** spacer bush  $\varnothing$  30mm D1  $\varnothing$  25mm ID  $\varnothing$  21mm H 10.6mm



**GEV No.** 697990 **Ref. No.** AE75

**description** spacer ring  $\varnothing$  35mm ID  $\varnothing$  31mm H 11mm zinc-coated steel



**GEV No.** 697991 **Ref. No.** AE76

**description** spacer ring  $\varnothing$  37mm ID  $\varnothing$  30.5mm H 20mm zinc-coated steel

## dough hooks

## with mounting groove



1

<b>GEV No.</b>	697312	<b>Ref. No.</b>	AH095 AH10
<b>description</b>	dough hook shaft $\varnothing$ 30mm usable height 435mm		

## bearing blocks



1

<b>GEV No.</b>	692038	<b>Ref. No.</b>	KE16510
<b>description</b>	bearing block		



1

<b>GEV No.</b>	692032	<b>Ref. No.</b>	KE02600 KE02620
<b>description</b>	bearing block mounting pos. upper int. $\varnothing$ 1 42mm int. $\varnothing$ 2 47mm H 60mm		

## for dough dividers



1

<b>GEV No.</b>	690884	<b>Ref. No.</b>	AH23
<b>description</b>	divider funnel portions of 120-160g $\varnothing$ 135mm L 160mm mounting distance 180mm		



1

<b>GEV No.</b>	690885	<b>Ref. No.</b>	AH24
<b>description</b>	divider funnel portions of 150-190g $\varnothing$ 135mm L 160mm mounting distance 180mm		



1

<b>GEV No.</b>	690886	<b>Ref. No.</b>	AH25
<b>description</b>	divider funnel portions of 180-220g $\varnothing$ 135mm L 160mm mounting distance 180mm		



1

<b>GEV No.</b>	690887	<b>Ref. No.</b>	AH26
<b>description</b>	divider funnel portions of 210-260g $\varnothing$ 135mm L 160mm mounting distance 180mm		



1

<b>GEV No.</b>	690888	<b>Ref. No.</b>	AH44
<b>description</b>	divider funnel portions of 240-280g ø 135mm L 160mm mounting distance 180mm		

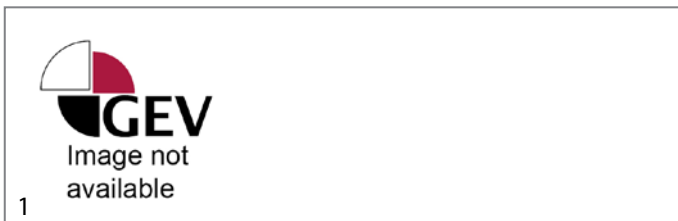

1

<b>GEV No.</b>	690881	<b>Ref. No.</b>	AH27
<b>description</b>	divider funnel portions of 50-70g		



1

<b>GEV No.</b>	690882	<b>Ref. No.</b>	AH21
<b>description</b>	divider funnel portions of 60-100g ø 135mm L 160mm mounting distance 180mm		



1

<b>GEV No.</b>	690883	<b>Ref. No.</b>	AH22
<b>description</b>	divider funnel portions of 90-130g ø 135mm L 160mm mounting distance 180mm		

for dough roller

rollers



1

<b>GEV No.</b>	692014	<b>Ref. No.</b>	RC05200 KF073
<b>description</b>	roller for dough rolling machine L 300mm ø 49mm mounting pos. bottom at the back		



1

<b>GEV No.</b>	692015	<b>Ref. No.</b>	KF072 RC048R0
<b>description</b>	roller for dough rolling machine L 306mm ø 49mm mounting pos. bottom in the front		



1

<b>GEV No.</b>	692016	<b>Ref. No.</b>	KF074 KF07400
<b>description</b>	roller for dough rolling machine mounting pos. upper at the back		



1

<b>GEV No.</b>	692017	<b>Ref. No.</b>	KF071 KF07100
<b>description</b>	roller for dough rolling machine mounting pos. upper in the front		

## holders



1

<b>GEV No.</b>	692002	<b>Ref. No.</b>	R3K10R0 RC058R0
<b>description</b>	lever hole $\varnothing$ 10mm H 20mm hole distance 31mm		

## couplings



1

<b>GEV No.</b>	692012	<b>Ref. No.</b>	KF07600	
<b>description</b>	coupling $\varnothing$ 35mm ID $\varnothing$ 25mm H 14mm			
<b>accessories for</b>	692012			
	<b>GEV No.</b>	692011	<b>Ref. No.</b>	KF07500
	coupling $\varnothing$ 41.5mm ID $\varnothing$ 25mm H 12mm			



1

<b>GEV No.</b>	692011	<b>Ref. No.</b>	KF07500	
<b>description</b>	coupling $\varnothing$ 41.5mm ID $\varnothing$ 25mm H 12mm			
<b>accessories for</b>	692011			
	<b>GEV No.</b>	692012	<b>Ref. No.</b>	KF07600
	coupling $\varnothing$ 35mm ID $\varnothing$ 25mm H 14mm			

## pinions

## rear mounting



1

<b>GEV No.</b>	692009	<b>Ref. No.</b>	KF07820
<b>description</b>	pinion		



1

<b>GEV No.</b>	692008	<b>Ref. No.</b>	KF07720
<b>description</b>	pinion $\varnothing$ 47.5mm H 34mm mounting pos. rear ID $\varnothing$ 25mm for dough roller		



1

<b>GEV No.</b>	697109	<b>Ref. No.</b>	RC057R0
<b>description</b>	pinion $\varnothing$ 47.5mm H 35mm mounting pos. rear ID $\varnothing$ 25mm for dough roller		

## front mounting



1

<b>GEV No.</b>	697108	<b>Ref. No.</b>	RC056R0
<b>description</b>	pinion $\varnothing$ 47.5mm H 35mm mounting pos. front ID $\varnothing$ 14mm for dough roller		

## springs



1

<b>GEV No.</b>	693920	<b>Ref. No.</b>	MC114 RC055R0
<b>description</b>	spring for pinion $\varnothing$ 49mm thickness 1.5mm Qty 2 pcs		

## roller covers

## upper



1

<b>GEV No.</b>	697342	<b>Ref. No.</b>	RC418R0
<b>description</b>	hand protection mounting pos. upper P30		



side parts



1			
<b>GEV No.</b>	692024	<b>Ref. No.</b>	KD05020
<b>description</b>	side panel mounting pos. right W 39mm L 125mm H 100mm F/30		



1			
<b>GEV No.</b>	692025	<b>Ref. No.</b>	KF061
<b>description</b>	side panel mounting pos. left W 25mm L 122mm H 80mm F/30		

spindles



1			
<b>GEV No.</b>	692005	<b>Ref. No.</b>	KF062 KF06200
<b>description</b>	spindle ø 24mm L 160mm		

spindles

eccentric



1			
<b>GEV No.</b>	692019	<b>Ref. No.</b>	KF063
<b>description</b>	spindle ø 25mm L 380mm mounting pos. bottom in the front eccentric for dough rolling machine		



1			
<b>GEV No.</b>	692021	<b>Ref. No.</b>	KF064 KF06400
<b>description</b>	spindle ø 25mm mounting pos. upper in the front eccentric for dough rolling machine		

cylindric



1			
<b>GEV No.</b>	692018	<b>Ref. No.</b>	KF069 KF06900
<b>description</b>	spindle ø 25mm L 350mm mounting pos. bottom at the back cylindrical for dough rolling machine		



1			
<b>GEV No.</b>	692020	<b>Ref. No.</b>	KF068 KF06800
<b>description</b>	spindle ø 25mm mounting pos. upper at the back cylindrical for dough rolling machine		

miscellaneous



1			
<b>GEV No.</b>	692007	<b>Ref. No.</b>	AD174
<b>description</b>	lid		



1			
<b>GEV No.</b>	693921	<b>Ref. No.</b>	AD174
<b>description</b>	lid for side part ø 30.5mm H 11mm		
<b>For models:</b>	PF45MTE		

for display coolers

funnels



1			
<b>GEV No.</b>	690884	<b>Ref. No.</b>	AH23
<b>description</b>	divider funnel portions of 120-160g ø 135mm L 160mm mounting distance 180mm		

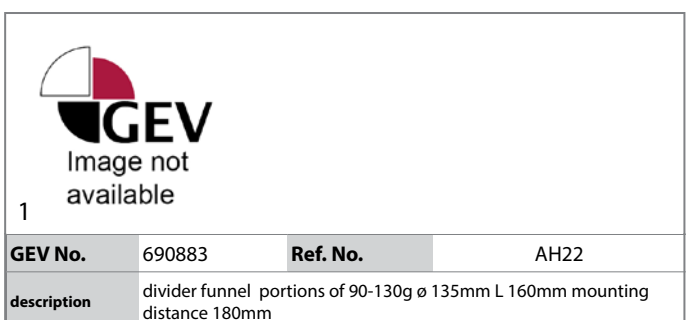
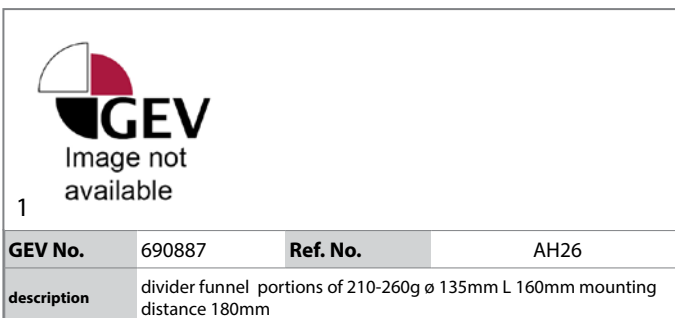
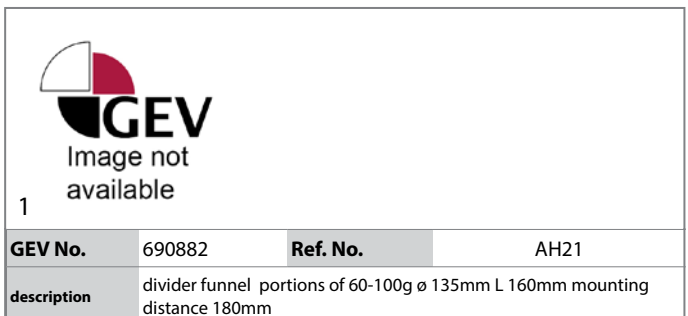
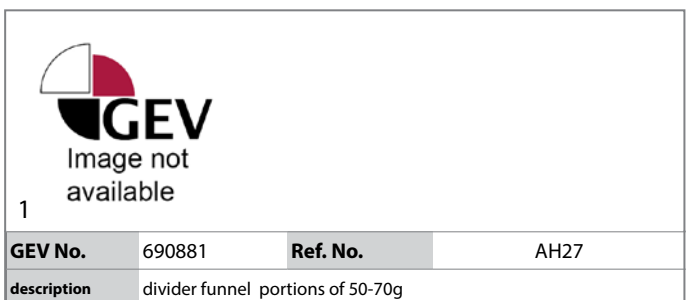





for convection ovens/combi-steamers

glass panels



1

<b>GEV No.</b>	700162	<b>Ref. No.</b>	AL01100 AL27600
<b>description</b>	glass panel L 410mm W 131mm thickness 4mm rectangular		
<b>For models:</b>	R-109-1, R-109-2, R-109-3, R-111-1, R-111-2, R-111-3, R-66-1, R-66-2, R-66-3, R-69-1, R-69-2, R-69-3, R-77-1, R-77-2, R-77-3, R-96-1, R-96-2, R-96-3, R-99-1, R-99-2, R-99-3, RE-109-1, RE-109-2, RE-109-3, RE-111-1, RE-111-2, RE-111-3, RE-66-1, RE-66-2, RE-66-3, RE-69-1, RE-69-2, RE-69-3, RE-77-1, RE-77-2, RE-77-3, RE-96-1, RE-96-2, RE-96-3, RE-99-1, RE-99-2, RE-99-3, S-109-1, S-109-2, S-109-3, S-111-1, S-111-2, S-111-3, S-66-1, S-66-2...(Other models you can see in the webshop)		

doors



1

<b>GEV No.</b>	694291	<b>Ref. No.</b>	E4M2000
<b>description</b>	stop bolt ø 11.5mm L 25mm thread M8 WS 15		

door mechanics

bolts



1

<b>GEV No.</b>	694291	<b>Ref. No.</b>	E4M2000
<b>description</b>	stop bolt ø 11.5mm L 25mm thread M8 WS 15		

for tilting bratt pans

miscellaneous



1

<b>GEV No.</b>	523510	<b>Ref. No.</b>	50IBA71269
<b>description</b>	deep-groove ball bearing type 6202-2RS shaft ø 15mm ED ø 35mm W 11mm with sealing discs deep-groove ball bearing DIN 625-1		

for pizza ovens

glass panels

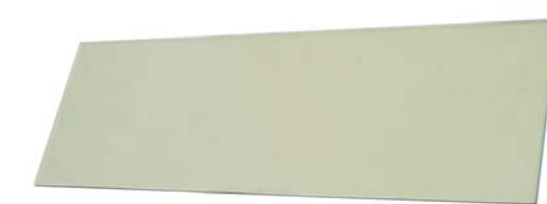

1

<b>GEV No.</b>	700162	<b>Ref. No.</b>	AL01100 AL27600
<b>description</b>	glass panel L 410mm W 131mm thickness 4mm rectangular		
<b>For models:</b>	R-109-1, R-109-2, R-109-3, R-111-1, R-111-2, R-111-3, R-66-1, R-66-2, R-66-3, R-69-1, R-69-2, R-69-3, R-77-1, R-77-2, R-77-3, R-96-1, R-96-2, R-96-3, R-99-1, R-99-2, R-99-3, RE-109-1, RE-109-2, RE-109-3, RE-111-1, RE-111-2, RE-111-3, RE-66-1, RE-66-2, RE-66-3, RE-69-1, RE-69-2, RE-69-3, RE-77-1, RE-77-2, RE-77-3, RE-96-1, RE-96-2, RE-96-3, RE-99-1, RE-99-2, RE-99-3, S-109-1, S-109-2, S-109-3, S-111-1, S-111-2, S-111-3, S-66-1, S-66-2...(Other models you can see in the webshop)		



1

<b>GEV No.</b>	700163	<b>Ref. No.</b>	AL01100
<b>description</b>	glass panel L 410mm W 133mm thickness 5mm rectangular		
<b>For models:</b>	109, 111, 22, 23, 32, 33 220V, 33 380V, 34 220V, 34 380V, 66, 69, 77, 96, 99, SG22, SG23, SG33		

firebricks



1

<b>GEV No.</b>	850007	<b>Ref. No.</b>	AL15500
<b>description</b>	firebrick L 495mm W 315mm H 14mm delivery freight forwarding company only		



1

<b>GEV No.</b>	850008	<b>Ref. No.</b>	AL14400
<b>description</b>	firebrick L 515mm W 495mm H 19mm delivery freight forwarding company only		

			
1			
<b>GEV No.</b>	850009	<b>Ref. No.</b>	AL15100
<b>description</b>	firebrick L 622mm W 606mm H 25mm delivery freight forwarding company only		
<b>For models:</b>	22, 66, R-109-1, R-109-2, R-109-3, R-111-1, R-111-2, R-111-3, R-66-1, R-66-2, R-66-3, R-69-1, R-69-2, R-69-3, R-77-1, R-77-2, R-77-3, R-96-1, R-96-2, R-96-3, R-99-1, R-99-2, R-99-3, RE-109-1, RE-109-2, RE-109-3, RE-111-1, RE-111-2, RE-111-3, RE-66-1, RE-66-2, RE-66-3, RE-69-1, RE-69-2, RE-69-3, RE-77-1, RE-77-2, RE-77-3, RE-96-1, RE-96-2, RE-96-3, RE-99-1, RE-99-2, RE-99-3, S-109-1, S-109-2, S-109-3, S-111-1, S-111-2, S-111-3...(Other models you can see in the webshop)		

			
1			
<b>GEV No.</b>	850013	<b>Ref. No.</b>	AL17900
<b>description</b>	firebrick L 913mm W 455mm H 19mm delivery freight forwarding company only		
<b>For models:</b>	33 220V, 33 380V, 99, R-109-1, R-109-2, R-109-3, R-111-1, R-111-2, R-111-3, R-66-1, R-66-2, R-66-3, R-69-1, R-69-2, R-69-3, R-77-1, R-77-2, R-77-3, R-96-1, R-96-2, R-96-3, R-99-1, R-99-2, R-99-3, RE-109-1, RE-109-2, RE-109-3, RE-111-1, RE-111-2, RE-111-3, RE-66-1, RE-66-2, RE-66-3, RE-69-1, RE-69-2, RE-69-3, RE-77-1, RE-77-2, RE-77-3, RE-96-1, RE-96-2, RE-96-3, RE-99-1, RE-99-2, RE-99-3, S-109-1, S-109-2, S-109-3, S-111-1, S-111-2...(Other models you can see in the webshop)		

			
1			
<b>GEV No.</b>	850012	<b>Ref. No.</b>	AL18200
<b>description</b>	firebrick L 913mm W 606mm H 19mm delivery freight forwarding company only		
<b>For models:</b>	23, 32, 69, 96, R-109-1, R-109-2, R-109-3, R-111-1, R-111-2, R-111-3, R-66-1, R-66-2, R-66-3, R-69-1, R-69-2, R-69-3, R-77-1, R-77-2, R-77-3, R-96-1, R-96-2, R-96-3, R-99-1, R-99-2, R-99-3, RE-109-1, RE-109-2, RE-109-3, RE-111-1, RE-111-2, RE-111-3, RE-66-1, RE-66-2, RE-66-3, RE-69-1, RE-69-2, RE-69-3, RE-77-1, RE-77-2, RE-77-3, RE-96-1, RE-96-2, RE-96-3, RE-99-1, RE-99-2, RE-99-3, S-109-1, S-109-2, S-109-3, S-111-1...(Other models you can see in the webshop)		

			
1			
<b>GEV No.</b>	850006	<b>Ref. No.</b>	AL14500
<b>description</b>	firebrick L 913mm W 606mm H 25mm delivery freight forwarding company only		

## miscellaneous

			
1			
<b>GEV No.</b>	698558	<b>Ref. No.</b>	E1K0300
<b>description</b>	bush L 20.5mm $\phi$ 16mm ID $\phi$ 10mm		

			
1			
<b>GEV No.</b>	698560	<b>Ref. No.</b>	E1K0200
<b>description</b>	hinge L 40mm W 50mm H 73mm mounting pos. left		

			
1			
<b>GEV No.</b>	698559	<b>Ref. No.</b>	E1K01 E1K0100
<b>description</b>	hinge L 40mm W 50mm H 73mm mounting pos. right		



for dishwashers

door mechanics

locks



1

<b>GEV No.</b>	506157	<b>Ref. No.</b>	AC046
<b>description</b>	door catch catch		

washing and rinsing systems



1

<b>GEV No.</b>	510194	<b>Ref. No.</b>	DB031R0
<b>description</b>	swirl		

knobs

universal knobs

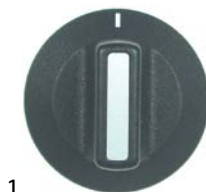

1

<b>GEV No.</b>	111985	<b>Ref. No.</b>	AC00600
<b>description</b>	knob switch zero mark t.max.°C ø 42mm shaft ø 6x4.6mm shaft flat lower black		



1

<b>GEV No.</b>	110932	<b>Ref. No.</b>	AC06200
<b>description</b>	knob switch zero mark t.max.°C ø 42mm shaft ø 6x4.6mm shaft flat upper black		
<b>For models:</b>	109, 111, 22, 23, 32, 33 380V, 34 380V, 66, 69, 77, 96, 99, PF33MT, PF45HT, R-109-1, R-109-2, R-109-3, R-111-1, R-111-2, R-111-3, R-66-1, R-66-2, R-66-3, R-69-1, R-69-2, R-69-3, R-77-1, R-77-2, R-77-3, R-96-1, R-96-2, R-96-3, R-99-1, R-99-2, R-99-3, S-109-1, S-109-2, S-109-3, S-111-1, S-111-2, S-111-3, S-66-1, S-66-2, S-66-3, S-69-1, S-69-2, S-69-3, S-77-1, S-77-2, S-77-3...(Other models you can see in the webshop)		

producer-specific knobs

OEM



1

<b>GEV No.</b>	110162	<b>Ref. No.</b>	AC05100
<b>description</b>	knob potentiometer ø 18.5mm shaft ø 6mm black		
<b>For models:</b>	22, 23, 32, 33, 34, PF33MT, PF45HT		



1

<b>GEV No.</b>	111985	<b>Ref. No.</b>	AC00600
<b>description</b>	knob switch zero mark t.max.°C ø 42mm shaft ø 6x4.6mm shaft flat lower black		



1

<b>GEV No.</b>	110932	<b>Ref. No.</b>	AC06200
<b>description</b>	knob switch zero mark t.max.°C ø 42mm shaft ø 6x4.6mm shaft flat upper black		
<b>For models:</b>	109, 111, 22, 23, 32, 33 380V, 34 380V, 66, 69, 77, 96, 99, PF33MT, PF45HT, R-109-1, R-109-2, R-109-3, R-111-1, R-111-2, R-111-3, R-66-1, R-66-2, R-66-3, R-69-1, R-69-2, R-69-3, R-77-1, R-77-2, R-77-3, R-96-1, R-96-2, R-96-3, R-99-1, R-99-2, R-99-3, S-109-1, S-109-2, S-109-3, S-111-1, S-111-2, S-111-3, S-66-1, S-66-2, S-66-3, S-69-1, S-69-2, S-69-3, S-77-1, S-77-2, S-77-3...(Other models you can see in the webshop)		

miscellaneous



1

<b>GEV No.</b>	110205	<b>Ref. No.</b>	AC04000
<b>description</b>	knob ø 27mm shaft ø 5x5mm		
<b>For models:</b>	PF45HT		

## handles and hand wheels

### cylindrical handles

#### fixed



1

<b>GEV No.</b>	690158	<b>Ref. No.</b>	AC06600
<b>description</b>	cylindrical handle thread M8 ø 29mm L 112mm		
<b>For models:</b>	22, 23, 32, 33 220V, 33 380V, 34 220V, 34 380V, R-109-1, R-109-2, R-109-3, R-111-1, R-111-2, R-111-3, R-66-1, R-66-2, R-66-3, R-69-1, R-69-2, R-69-3, R-77-1, R-77-2, R-77-3, R-96-1, R-96-2, R-96-3, R-99-1, R-99-2, R-99-3, RE-109-1, RE-109-2, RE-109-3, RE-111-1, RE-111-2, RE-111-3, RE-66-1, RE-66-2, RE-66-3, RE-69-1, RE-69-2, RE-69-3, RE-77-1, RE-77-2, RE-77-3, RE-96-1, RE-96-2, RE-96-3, RE-99-1, RE-99-2, RE-99-3, S-109-1...(Other models you can see in the webshop)		

### handle bars

#### consoles



1

<b>GEV No.</b>	690116	<b>Ref. No.</b>	HDTV0300
<b>description</b>	console for handle rod		

### door handles

#### door handles



1

<b>GEV No.</b>	690112	<b>Ref. No.</b>	H9N6020
<b>description</b>	handle		



1

<b>GEV No.</b>	691257	<b>Ref. No.</b>	HDM0010
<b>description</b>	handle		

### miscellaneous



1

<b>GEV No.</b>	690055	<b>Ref. No.</b>	H9N5020
<b>description</b>	handle holder mounting pos. right		

### accessories

#### miscellaneous



1

<b>GEV No.</b>	690149	<b>Ref. No.</b>	AC07100
<b>description</b>	hand protection for door handle		
<b>For models:</b>	22, 23, 32, 33 220V, 33 380V, 34 220V, 34 380V, R-109-1, R-109-2, R-109-3, R-111-1, R-111-2, R-111-3, R-66-1, R-66-2, R-66-3, R-69-1, R-69-2, R-69-3, R-77-1, R-77-2, R-77-3, R-96-1, R-96-2, R-96-3, R-99-1, R-99-2, R-99-3, RE-109-1, RE-109-2, RE-109-3, RE-111-1, RE-111-2, RE-111-3, RE-66-1, RE-66-2, RE-66-3, RE-69-1, RE-69-2, RE-69-3, RE-77-1, RE-77-2, RE-77-3, RE-96-1, RE-96-2, RE-96-3, RE-99-1, RE-99-2, RE-99-3, S-109-1...(Other models you can see in the webshop)		

### baskets

#### warewashing baskets

#### steel wire baskets round

#### mix baskets

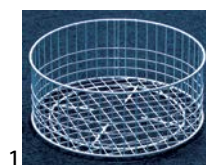

1

<b>GEV No.</b>	970579	<b>Ref. No.</b>	AB013
<b>description</b>	mix basket ED ø 360mm H 140mm seat ø 280mm		



## gaskets

### sealing washers

#### rubber gaskets



1

<b>GEV No.</b>	521125	<b>Ref. No.</b>	AD036
<b>description</b>	flat gasket rubber ED ø 52mm ID ø 42.5mm thickness 4mm Qty 1 pcs		

### shaft gaskets

#### shaft gaskets



1

<b>GEV No.</b>	516246	<b>Ref. No.</b>	50IAA71178
<b>description</b>	shaft seal ID ø 17mm ED ø 35mm thickness 7mm		

### special gaskets

#### miscellaneous



1

<b>GEV No.</b>	693441	<b>Ref. No.</b>	AL27810
<b>description</b>	gasket L 430mm W 155mm glass fibre		
<b>For models:</b>	R-109-1, R-109-2, R-109-3, R-111-1, R-111-2, R-111-3, R-66-1, R-66-2, R-66-3, R-69-1, R-69-2, R-69-3, R-77-1, R-77-2, R-77-3, R-96-1, R-96-2, R-96-3, R-99-1, R-99-2, R-99-3, RE-109-1, RE-109-2, RE-109-3, RE-111-1, RE-111-2, RE-111-3, RE-66-1, RE-66-2, RE-66-3, RE-69-1, RE-69-2, RE-69-3, RE-77-1, RE-77-2, RE-77-3, RE-96-1, RE-96-2, RE-96-3, RE-99-1, RE-99-2, RE-99-3, S-109-1, S-109-2, S-109-3, S-111-1, S-111-2, S-111-3, S-66-1, S-66-2...(Other models you can see in the webshop)		

## transmission technology and ball bearings

### ball bearings

#### deep-groove ball bearings 2RS



1

<b>GEV No.</b>	523522	<b>Ref. No.</b>	AB047 AB04700
<b>description</b>	deep-groove ball bearing type 6004-2RS shaft ø 20mm ED ø 42mm W 12mm with sealing discs deep-groove ball bearing DIN 625-1		
<b>For models:</b>	PF45MT-E		



1

<b>GEV No.</b>	523510	<b>Ref. No.</b>	50IBA71269
<b>description</b>	deep-groove ball bearing type 6202-2RS shaft ø 15mm ED ø 35mm W 11mm with sealing discs deep-groove ball bearing DIN 625-1		



1

<b>GEV No.</b>	523512	<b>Ref. No.</b>	AB04800
<b>description</b>	deep-groove ball bearing type 6204-2RS shaft ø 20mm ED ø 47mm W 14mm with sealing discs deep-groove ball bearing DIN 625-1		
<b>For models:</b>	PF45MTE, PF45MT-E		

#### deep-groove ball bearings 2Z



1

<b>GEV No.</b>	523508	<b>Ref. No.</b>	AB119 AB11900
<b>description</b>	deep-groove ball bearing shaft ø 10mm ED ø 30mm W 9mm type 6200-2Z DIN 625-1		



1

<b>GEV No.</b>	692000	<b>Ref. No.</b>	50IBA71268 AB117 AB11700
<b>description</b>	deep-groove ball bearing shaft $\varnothing$ 15mm ED $\varnothing$ 35mm W 11mm type 6202-2Z DIN 625-1		



1

<b>GEV No.</b>	692033	<b>Ref. No.</b>	AB10900 AB11400
<b>description</b>	deep-groove ball bearing shaft $\varnothing$ 25mm ED $\varnothing$ 47mm W 12mm type 6005-2Z DIN 625-1		

### thrust ball bearings



1

<b>GEV No.</b>	523536	<b>Ref. No.</b>	50IBA71241 50IBA78008
<b>description</b>	thrust ball bearing shaft $\varnothing$ 20mm ED $\varnothing$ 40mm W 14mm type 51204 DIN 711		

### drive belts

#### high-performance V-belts, cogged



1

<b>GEV No.</b>	691963	<b>Ref. No.</b>	AD184 AD18400
<b>description</b>	V-belt belt width 13mm L 1050mm H 8mm CODE AX40 profile AX/X13		
<b>For models:</b>	PF45MT-E		



1

<b>GEV No.</b>	697781	<b>Ref. No.</b>	AD088 AD08800
<b>description</b>	V-belt belt width 13mm L 890mm H 8mm CODE AX35 profile AX/X13		

### toothed belts



1

<b>GEV No.</b>	697786	<b>Ref. No.</b>	AD11800
<b>description</b>	toothed belt profile H L 762mm Hmm teeth 60 splitting rubber with textile insertion CODE H300 W 25mm		

### chains

#### roller chains 08B-2 double



1

<b>GEV No.</b>	698398	<b>Ref. No.</b>	KE03410	
<b>description</b>	chain DIN/ISO 08 B-2 splitting 1/2" / 12.7mm links 48 internal width 7.75mm roller $\varnothing$ 8.51mm double			
<b>accessories for</b>	698398			
	<b>GEV No.</b>	698399	<b>Ref. No.</b>	KE041 KE04100
	connector double DIN/ISO 08 B-2 splitting 1/2" links 1			

### connectors



1

<b>GEV No.</b>	698399	<b>Ref. No.</b>	KE041 KE04100
<b>description</b>	connector double DIN/ISO 08 B-2 splitting 1/2" links 1		

### springs

#### torsion springs



1

<b>GEV No.</b>	698557	<b>Ref. No.</b>	MD10700
<b>description</b>	spring $\varnothing$ 19.2mm L2 33.3mm wire gauge $\varnothing$ 3mm L1 48mm		



			
1			
<b>GEV No.</b>	692094	<b>Ref. No.</b>	MD04900
<b>description</b>	torsion spring ø 17mm L2 32mm wire gauge ø 2.5mm L1 45mm L3mm Qty 1 pcs		
<b>For models:</b>	R-109-1, R-109-2, R-109-3, R-111-1, R-111-2, R-111-3, R-66-1, R-66-2, R-66-3, R-69-1, R-69-2, R-69-3, R-77-1, R-77-2, R-77-3, R-96-1, R-96-2, R-96-3, R-99-1, R-99-2, R-99-3, RE-109-1, RE-109-2, RE-109-3, RE-111-1, RE-111-2, RE-111-3, RE-66-1, RE-66-2, RE-66-3, RE-69-1, RE-69-2, RE-69-3, RE-77-1, RE-77-2, RE-77-3, RE-96-1, RE-96-2, RE-96-3, RE-99-1, RE-99-2, RE-99-3, S-109-1, S-109-2, S-109-3, S-111-1, S-111-2, S-111-3, S-66-1, S-66-2...(Other models you can see in the webshop)		

			
1			
<b>GEV No.</b>	700872	<b>Ref. No.</b>	KD019 KD01900
<b>description</b>	torsion spring ø 31mm mounting pos. left		
<b>For models:</b>	PF45MT-E		

			
1			
<b>GEV No.</b>	700871	<b>Ref. No.</b>	KD018 KD01800
<b>description</b>	torsion spring ø 31mm mounting pos. right		
<b>For models:</b>	PF45MT-E		

## measuring equipment

### thermometers

#### built-in thermometers

ø60mm

			
1			
<b>GEV No.</b>	541879	<b>Ref. No.</b>	ED07500
<b>description</b>	thermometer mounting ø 60mm 0 up to +500°C probe ø 8mm probe L 155mm capillary pipe 1000mm		

## fastening material

### screws

#### countersunk screws

			
1			
<b>GEV No.</b>	692037	<b>Ref. No.</b>	MB15700 MB22000
<b>description</b>	countersunk screw thread M10 L 20mm WS 6 SS DIN 7991/ISO 10642 Qty 1 pcs intake hexagonal		

### nuts

#### knurled nuts

			
1			
<b>GEV No.</b>	691258	<b>Ref. No.</b>	HST0320
<b>description</b>	knurled nut thread M6 ø 19mm H 15mm chrome-plated steel		

### hexagonal nuts

#### DIN 934 / ISO 4032/8673

			
1			
<b>GEV No.</b>	505200	<b>Ref. No.</b>	50BBA76593
<b>description</b>	nut thread M12x1.75 H 10mm WS 19 SS DIN/ISO DIN 934 / ISO 4032/8673 Qty 1 pcs		

### washers

#### washers

#### miscellaneous

			
1			
<b>GEV No.</b>	692034	<b>Ref. No.</b>	AE14200
<b>description</b>	disc		

### fasteners

#### slot nuts

			
1			
<b>GEV No.</b>	692006	<b>Ref. No.</b>	MD048 MD04800
<b>description</b>	slot nut W 5mm H 5mm L 20mm		



1			
<b>GEV No.</b>	692035	<b>Ref. No.</b>	MD06100
<b>description</b>	slot nut W 6mm H 6mm L 25mm		

1			
<b>GEV No.</b>	560285	<b>Ref. No.</b>	MD41
<b>description</b>	slot nut W 8mm H 7mm L 30mm		

retaining rings

DIN 471

1			
<b>GEV No.</b>	691403	<b>Ref. No.</b>	MC033
<b>description</b>	retaining ring shaft ø 19mm thickness 1.2mm stainless steel DIN 471		

DIN 472

1			
<b>GEV No.</b>	698003	<b>Ref. No.</b>	50BHA76670
<b>description</b>	retaining ring bore ø 35mm thickness 1.5mm steel DIN 472		

1			
<b>GEV No.</b>	692029	<b>Ref. No.</b>	MC03500
<b>description</b>	retaining ring bore ø 47mm thickness 1.8mm steel DIN 472		
<b>For models:</b>	PF45MTE, PF45MT-E		

1			
<b>GEV No.</b>	523103	<b>Ref. No.</b>	MC043 MC04300
<b>description</b>	retaining ring bore ø 52mm thickness 2mm steel DIN 472		

miscellaneous

1			
<b>GEV No.</b>	692003	<b>Ref. No.</b>	MC062 MC06200
<b>description</b>	retaining ring		
<b>For models:</b>	PF33MT		

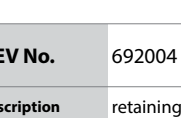

1			
<b>GEV No.</b>	692004	<b>Ref. No.</b>	MC115 MC11500
<b>description</b>	retaining ring		

roll pins

1			
<b>GEV No.</b>	692013	<b>Ref. No.</b>	MD09700
<b>description</b>	roll pin ø 3mm L 16mm		

consumables

fuses

fine fuses

fine fuse holders

1			
<b>GEV No.</b>	550537	<b>Ref. No.</b>	HE05800
<b>description</b>	fuse holder		
<b>For models:</b>	22, 23, 32, 33, 34		



<b>A</b>			
axial fans		22	
<b>B</b>			
bar burners		26	
<b>C</b>			
cam switches		11	
ceramic burners		27	
consumables		40	
contactors		17	
control equipment		12	
control thermostats		8, 9	
countersunk screws		39	
<b>E</b>			
electronic controllers		19	
<b>F</b>			
fans		22	
fasteners		39	
fastening material		39	
fine fuses		40	
fuses		23, 40	
<b>G</b>			
gas burners		26	
gas solenoid valves		25	
gas taps		23	
<b>H</b>			
halogen lamp		13	
heating elements		3	
heating elements for coffee machine		3	
heating elements for pizza ovens		3	
heating elements for pizza presses		7	
hexagonal nuts		39	
<b>I</b>			
ignition switches		26	
ignition units		26	
immersion heating elements		8	
indicator lights		13	
indicator lights (complete)		13	
<b>K</b>			
knurled nuts		39	
<b>L</b>			
lamps		13	
<b>M</b>			
magnetic switches		12	
measuring equipment		39	
microswitches		11	
motors		22	
<b>N</b>			
nuts		39	
<b>O</b>			
oven lamps		14	
<b>P</b>			
pilot burners		25	
position switches		11	
pressure switches		22	
probes		20	
programme timers		17	
pumps		22	
push/momentary push switches		10	
<b>R</b>			
relays		18	
retaining rings		40	
rocker/momentary rocker switches		10	
roll pins		40	
rotary switches		12	
<b>S</b>			
safety thermostats		9	
screws		39	
sealing washers		37	
shaft gaskets		37	
slot nuts		39	
solenoid valves		21	
switches and momentary switches		10	
<b>T</b>			
thermocouples		26	
thermostats		8	
time relays		19	
timers		17	
transformers		19	
<b>W</b>			
wash and rinse pumps		22	
washers		39	