



**GAS COMPONENTS**



**ELECTRIC COMPONENTS**



**WATER TECHNOLOGY**



**MECHANICAL COMPONENTS**



**TOOLS**

Spare parts suitable for

**OBEL**

Find the complete and up-to-date range of products in our **GEV Webshop**



Edited with the demo version of  
Infix Pro PDF Editor  
To remove this notice, visit:  
[www.iceni.com/unlock.htm](http://www.iceni.com/unlock.htm)



# Manufacturer catalogue

The most important spare parts and accessories arranged clearly for every manufacturer

- ✓ Complete product range and all appliance data always up to date in the GEV Webshop
- ✓ Alphabetical Index at the end of the catalogue

## GEV Webshop

[www.gev-online.co.uk](http://www.gev-online.co.uk)

[www.gev-online.com](http://www.gev-online.com)



- 🔍 Add to Favourites
- 🔍 Sign In with email address and usual password
- 🔍 Easy-order – place several items in your basket at the same time
- 🔍 Quick Item search – no login needed



## switches and momentary switches

### rocker/momentary rocker switches

30x22mm



1

<b>GEV No.</b>	301002	<b>Ref. No.</b>	EB079 EB079T MQ79
----------------	--------	-----------------	-------------------------

**description** rocker switch mounting measurements 30x22mm orange 2NO 250V 16A illuminated 0-I connection male faston 6.3mm ambient temperature max. 85/125°C protection IP65

**accessories for** 301002



<b>GEV No.</b>	301036	<b>Ref. No.</b>	—
----------------	--------	-----------------	---

protective cover internal size 30x22mm for rocker switch mounting measurementsmm



1

<b>GEV No.</b>	301001	<b>Ref. No.</b>	EB079
----------------	--------	-----------------	-------

**description** rocker switch mounting measurements 30x22mm red 2NO 250V 16A illuminated 0-I connection male faston 6.3mm ambient temperature max. 125/55°C protection IP65

**accessories for** 301001



<b>GEV No.</b>	301036	<b>Ref. No.</b>	—
----------------	--------	-----------------	---

protective cover internal size 30x22mm for rocker switch mounting measurementsmm

### push/momentary push switches

ø15.2mm



1

<b>GEV No.</b>	346154	<b>Ref. No.</b>	EB076M
----------------	--------	-----------------	--------

**description** momentary push switch mounting ø 15.2mm black 1NO 250V 0.7A connection screw ambient temperature max. 85°C protection IP40



1

<b>GEV No.</b>	346155	<b>Ref. No.</b>	EB076A EB077A
----------------	--------	-----------------	------------------

**description** momentary push switch mounting ø 15.2mm red 1NC 250V 0.7A connection screw ambient temperature max. 85°C protection IP40

## microswitches

### lever actuated



1

<b>GEV No.</b>	347270	<b>Ref. No.</b>	EB066MC EB068
<b>description</b>	microswitch with lever 250V 16A 1CO connection male faston 6.3mm L 22mm ambient temperature max. 120°C lever length 14.2mm		

### pin-plunger actuated



1

<b>GEV No.</b>	346156	<b>Ref. No.</b>	EB066 EB066A EB066AC
<b>description</b>	microswitch 250V 16A 1CO connection male faston 6.3mm ambient temperature max. 125°C mounting distance 22mm with plunger black		

## relays

### power relays

#### with male contacts

#### female contact 4.8mm



1

<b>GEV No.</b>	380907	<b>Ref. No.</b>	EB073 MQ74ATT
<b>description</b>	power relays 230VAC 10A 3CO raster size 10mm plug-in connection 250V connection 4.8mm		



1

<b>GEV No.</b>	380355	<b>Ref. No.</b>	EB073 EB074T
<b>description</b>	power relays 400VAC 10A 3CO raster size 10mm plug-in connection 250V connection 4.8mm		



## electronics

## PCBs



1

<b>GEV No.</b>	400568	<b>Ref. No.</b>	J693/220
<b>description</b>	PCB		

## motors

## motors

## for coffee grinders

## complete



1

<b>GEV No.</b>	500240	<b>Ref. No.</b>	DF15
<b>description</b>	motor 300W 230V 50/60Hz 1 phase shaft length 47mm thread M8L 1400rpm type 102.000C ø 125mm H 200mm 0.3kW		



1

<b>GEV No.</b>	500241	<b>Ref. No.</b>	DF15
<b>description</b>	motor 90W 230V 50Hz 1 phase shaft ø 10mm shaft length 38mm thread M8L 1340rpm type C002801 ø 95mm H 160mm capacitor 5/6µF RPM 0.09kW		

## components



1

<b>GEV No.</b>	500239	<b>Ref. No.</b>	EB73
<b>description</b>	motor 230V 50Hz 1 phase ø 100mm ID ø 65mm H 195mm shaft ø 16mm type T48		

## condensators &amp; interference suppression filters

## operating capacitors

## plastic



1

<b>GEV No.</b>	365014	<b>Ref. No.</b>	EB075
<b>description</b>	operating capacitor capacity 12.5µF 450V tolerance 5%Hz ambient temperature max. -25 to +85°C ø 35mm L 70mm M8 plastic connection male faston 6.3mm 45S.C3DS.12.5 protection		



1

<b>GEV No.</b>	365223	<b>Ref. No.</b>	EB075MG MQ75
<b>description</b>	operating capacitor capacity 16µF 400V tolerance 5% 50/60Hz ambient temperature max.°C ø 35mm L 70mm plastic connection F6.3 protection		



1

<b>GEV No.</b>	365126	<b>Ref. No.</b>	EB075MG (old version) MQ75 (old version)
<b>description</b>	operating capacitor capacity 16µF 400V tolerance 5% 50/60Hz ambient temperature max.°C ø 35mm L 70mm plastic protection		



1

<b>GEV No.</b>	365093	<b>Ref. No.</b>	DF75
<b>description</b>	operating capacitor capacity 6µF 400V tolerance 5% 50/60Hz ambient temperature max. -25 to +85°C ø 31.5mm L 55mm M8 plastic connection male faston 6.3mm protection		



## equipment-specific units

### for coffee grinders

#### grinding burrs

#### grinding burrs straight

#### standard



1

<b>GEV No.</b>	526216	<b>Ref. No.</b>	DF8
<b>description</b>	grinding burrs pair turn direction left D1 ø 50mm ID ø 30mm H 7.5mm tooth spacing 3mm hole ø 4.6mm bore ø 7.6mm mounting ø 38		



1

<b>GEV No.</b>	527229	<b>Ref. No.</b>	DF8
<b>description</b>	grinding burrs pair turn direction left D1 ø 50mm ID ø 31mm H 8mm tooth spacing 3mm hole ø 4.5mm bore ø 7.5mm mounting ø 40 suitable for RANCILIO, OBEL		



1

<b>GEV No.</b>	527233	<b>Ref. No.</b>	EB08
<b>description</b>	grinding burrs pair turn direction left D1 ø 63.5mm ID ø 37.5mm H 9mm tooth spacing 3mm hole ø 5.5mm bore ø 8.5mm mounting ø 50 straight suitable for OBEL, CARIMALI, BEZZERA, PAVONI		

#### grinding burrs holders



1

<b>GEV No.</b>	527264	<b>Ref. No.</b>	EB090
<b>description</b>	grinding burr holder type EB suitable for Obel equiv. no. EB090		



1

<b>GEV No.</b>	527265	<b>Ref. No.</b>	DF90
<b>description</b>	grinding burr holder type JUNIOR suitable for Obel equiv. no. DF90		

#### spillage trays



1

<b>GEV No.</b>	526354	<b>Ref. No.</b>	EB022
<b>description</b>	drain tray L 181mm W 154mm		

#### miscellaneous



1

<b>GEV No.</b>	526355	<b>Ref. No.</b>	DF85M
<b>description</b>	cover ø 98mm for setting ring		

#### dosing containers

#### dosing containers (complete)



1

<b>GEV No.</b>	527538	<b>Ref. No.</b>	DF71CC
<b>description</b>	dosing pump complete with lid		

<b>spare parts for</b>	527538		
<b>GEV No.</b>	527341	<b>Ref. No.</b>	DF44



glass cylinder for dosing pump ø 109mm H 88mm plexiglas



1

<b>GEV No.</b>	526365	<b>Ref. No.</b>	DF71C
<b>description</b>	dosing unit complete		



1

<b>GEV No.</b>	527537	<b>Ref. No.</b>	E71
<b>description</b>	dosing unit complete		

## dosing container lids



1

<b>GEV No.</b>	527337	<b>Ref. No.</b>	EB051
<b>description</b>	lid for dosing container ø 113mm		

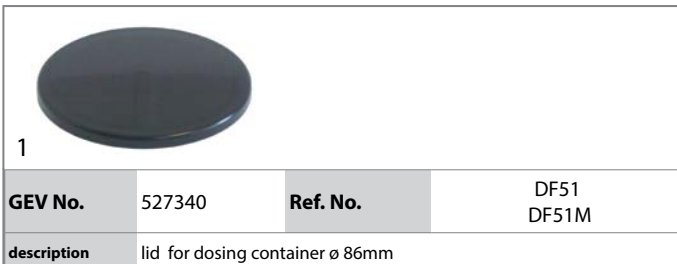

1

<b>GEV No.</b>	527340	<b>Ref. No.</b>	DF51 DF51M
<b>description</b>	lid for dosing container ø 86mm		

## adjusting screws



1

<b>GEV No.</b>	527522	<b>Ref. No.</b>	DF48 EB048
<b>description</b>	adjusting screw for dosing container thread M8 L 47mm plastic		

## springs

## group 2



1

<b>GEV No.</b>	526344	<b>Ref. No.</b>	DF70
<b>description</b>	spring L 53mm W 40mm H 6mm thickness 1mm		

## glass cylinders



1

<b>GEV No.</b>	527339	<b>Ref. No.</b>	EB094
<b>description</b>	glass cylinder		



1

<b>GEV No.</b>	527341	<b>Ref. No.</b>	DF44
<b>description</b>	glass cylinder for dosing pump ø 109mm H 88mm plexiglas		



1

<b>GEV No.</b>	527366	<b>Ref. No.</b>	9V504 EB094
<b>description</b>	glass cylinder for dosing pump ø 121mm H 116mm plexiglas		



levers

handles

			
1			
<b>GEV No.</b>	526362	<b>Ref. No.</b>	DF28
<b>description</b>	handle for lever L 37mm W 10mm H 17mm rubber		

			
1			
<b>GEV No.</b>	526363	<b>Ref. No.</b>	EB029A
<b>description</b>	handle for lever L 50mm W 10mm H 17mm rubber		

levers

			
1			
<b>GEV No.</b>	526356	<b>Ref. No.</b>	EB029P
<b>description</b>	lever left hole ø 17mm plastic		

			
1			
<b>GEV No.</b>	526357	<b>Ref. No.</b>	DF29
<b>description</b>	lever right for dosing container hole ø 17mm brass		

coffee presses

components

bolts

			
1			
<b>GEV No.</b>	526353	<b>Ref. No.</b>	EB045
<b>description</b>	bolt D1 ø 8mm D2 ø 12mm L 128mm T1: M8x1.25 T2: M8x1.25		

holders

			
1			
<b>GEV No.</b>	526358	<b>Ref. No.</b>	EB039P
<b>description</b>	bracket for coffee press H 74mm L 40mm plastic		

pressers

			
1			
<b>GEV No.</b>	527534	<b>Ref. No.</b>	E72 EB037
<b>description</b>	coffee press ø 56mm H 15.5mm thread M8		

buttons

			
1			
<b>GEV No.</b>	111308	<b>Ref. No.</b>	EB047
<b>description</b>	mushroom cap handle thread M8x1.25 handle ø 41mm L 25mm plastic black		

coffee presses

			
1			
<b>GEV No.</b>	527565	<b>Ref. No.</b>	N/A
<b>description</b>	coffee press		

			
1			
<b>GEV No.</b>	526346	<b>Ref. No.</b>	EB041
<b>description</b>	compression spring ø 10.7mm L 89mm wire gauge ø 0.8mm for coffee press		

automatic grinding

automatic grinding

			
1			
<b>GEV No.</b>	527338	<b>Ref. No.</b>	EB086
<b>description</b>	ring for dosing container ø 118mm H 19mm plastic		

sector plates

			
1			
<b>GEV No.</b>	527525	<b>Ref. No.</b>	EB060
<b>description</b>	sector plates		



1

<b>GEV No.</b>	527531	<b>Ref. No.</b>	DF60
<b>description</b>	sector plates		

ratches

ratches



1

<b>GEV No.</b>	526360	<b>Ref. No.</b>	EB092
<b>description</b>	ratchet for dosing unit $\varnothing$ 29.7mm inner cone int. $\varnothing$ 1 11.5mm int. $\varnothing$ 2 15mm H 12mm brass		



1

<b>GEV No.</b>	526361	<b>Ref. No.</b>	DF92
<b>description</b>	ratchet for dosing unit $\varnothing$ 29.7mm inner cone int. $\varnothing$ 1 12mm int. $\varnothing$ 2 15mm brass		

pins



1

<b>GEV No.</b>	526350	<b>Ref. No.</b>	EB056
<b>description</b>	pin for ratchet $\varnothing$ 4mm D2 $\varnothing$ 2.5mm L 20mm		

stars

central



1

<b>GEV No.</b>	527532	<b>Ref. No.</b>	DF59
<b>description</b>	star mounting pos. centre $\varnothing$ 103mm hole $\varnothing$ 8.2mm H 35mm		



1

<b>GEV No.</b>	527526	<b>Ref. No.</b>	EB059
<b>description</b>	star mounting pos. centre $\varnothing$ 115mm		

upper



1

<b>GEV No.</b>	527530	<b>Ref. No.</b>	DF42
<b>description</b>	star mounting pos. upper		



1

<b>GEV No.</b>	527523	<b>Ref. No.</b>	EB042
<b>description</b>	star mounting pos. upper $\varnothing$ 112mm hole $\varnothing$ 22mm		

bottom



1

<b>GEV No.</b>	527533	<b>Ref. No.</b>	DF062 DF62
<b>description</b>	star mounting pos. lower $\varnothing$ 103mm shaft $\varnothing$ 8 shaft length 100mm thread M8		



1

<b>GEV No.</b>	527528	<b>Ref. No.</b>	EB062	
<b>description</b>	star mounting pos. lower $\varnothing$ 115mm shaft $\varnothing$ 8 shaft length 111mm thread M8			
<b>accessories for</b>	527528			
	<b>GEV No.</b>	111273	<b>Ref. No.</b>	DS43 EB043
	cotter pin $\varnothing$ 1.3mm L 25mm			

accessories



1

<b>GEV No.</b>	527524	<b>Ref. No.</b>	EB050
<b>description</b>	brush L 80mm plastic		





adjustment mechanism

lockable adjustment



1

<b>GEV No.</b>	526343	<b>Ref. No.</b>	DF6
<b>description</b>	pressure pin for setting ring L 36mm W 18mm shaft ø 5mm shaft length 30mm		



1

<b>GEV No.</b>	526336	<b>Ref. No.</b>	EB06
<b>description</b>	pressure pin for setting ring L 36mm W 20mm shaft ø 5mm shaft length 30mm		

setting rings



1

<b>GEV No.</b>	527413	<b>Ref. No.</b>	EB053
<b>description</b>	setting ring suitable for Obel for EB equiv. no. EB053		



1

<b>GEV No.</b>	527414	<b>Ref. No.</b>	DF53
<b>description</b>	setting ring suitable for Obel for JUNIOR equiv. no. DF53		

accessories

stickers



1

<b>GEV No.</b>	526275	<b>Ref. No.</b>	MQ82
<b>description</b>	sticker for setting ring L 60mm W 10mm		

coffee beans containers

container lids



1

<b>GEV No.</b>	527333	<b>Ref. No.</b>	EB01
<b>description</b>	lid for coffee beans container ø 182mm		



1

<b>GEV No.</b>	527335	<b>Ref. No.</b>	DF1
<b>description</b>	lid for coffee beans container ø 182mm		

coffee beans containers



1

<b>GEV No.</b>	527336	<b>Ref. No.</b>	DF2
<b>description</b>	coffee beans container ø 125mm H 116mm seat ø 58mm		

**spare parts for** 527336



<b>GEV No.</b>	527335	<b>Ref. No.</b>	DF1
----------------	--------	-----------------	-----



lid for coffee beans container ø 182mm



1

<b>GEV No.</b>	527334	<b>Ref. No.</b>	EB02 G02
<b>description</b>	coffee beans container ø 185mm H 211mm seat ø 65mm		
<b>spare parts for</b>	527334		
	<b>GEV No.</b>	527333	<b>Ref. No.</b> EB01
	lid for coffee beans container ø 182mm		
	<b>GEV No.</b>	527567	<b>Ref. No.</b> —
	protection cap with magnet		

support for filter holder



1

<b>GEV No.</b>	527536	<b>Ref. No.</b>	DF33
<b>description</b>	bracket for filter holder L 66mm W 45mm H 17mm		



1

<b>GEV No.</b>	527535	<b>Ref. No.</b>	EB033
<b>description</b>	filter holder support for dosing pump		



1

<b>GEV No.</b>	526364	<b>Ref. No.</b>	EB033S MQ33
<b>description</b>	filter holder support for dosing unit L 140mm W 79mm H 41mm		

counters



1

<b>GEV No.</b>	526352	<b>Ref. No.</b>	EB054
<b>description</b>	counter suitable for Obel		

knobs  
steam/water taps

accessories



1

<b>GEV No.</b>	111273	<b>Ref. No.</b>	DS43 EB043
<b>description</b>	cotter pin ø 1.3mm L 25mm		

handles and hand wheels  
mushroom cap handles



1

<b>GEV No.</b>	111308	<b>Ref. No.</b>	EB047
<b>description</b>	mushroom cap handle thread M8x1.25 handle ø 41mm L 25mm plastic black		

equipment feet and end caps  
screw-in feet



1

<b>GEV No.</b>	530773	<b>Ref. No.</b>	EB019
<b>description</b>	equipment foot thread M5 ø 19mm H 18mm		



1

<b>GEV No.</b>	526345	<b>Ref. No.</b>	EB019 / old version
<b>description</b>	equipment foot thread M5 thread L 5mm ø 20mm H 12.25mm Qty 1 pcs		



equipment feet with stem

 <p>1</p>			
<b>GEV No.</b>	526359	<b>Ref. No.</b>	DF19J
<b>description</b>	equipment foot push-in ø 13mm H 4mm mounting ø 10mm overall height 11mm rubber Qty 1 pcs		

springs

compression springs

 <p>1</p>			
<b>GEV No.</b>	526346	<b>Ref. No.</b>	EB041
<b>description</b>	compression spring ø 10.7mm L 89mm wire gauge ø 0.8mm for coffee press		

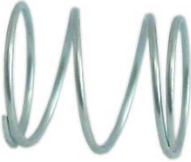
 <p>1</p>			
<b>GEV No.</b>	527527	<b>Ref. No.</b>	DF061 EB061
<b>description</b>	compression spring ø 28.9mm L 35mm wire gauge ø 1.9mm		

 <p>1</p>			
<b>GEV No.</b>	526347	<b>Ref. No.</b>	EB05
<b>description</b>	compression spring ø 4.5mm L 25mm wire gauge ø 0.55mm		

 <p>1</p>			
<b>GEV No.</b>	526349	<b>Ref. No.</b>	EB057
<b>description</b>	compression spring ø 4mm L 33mm wire gauge ø 0.3mm		

tension springs

 <p>1</p>			
<b>GEV No.</b>	526348	<b>Ref. No.</b>	EB055
<b>description</b>	tension spring ø 11mm total length 49mm wire gauge ø 1mm L1 30mm		

 <p>1</p>			
<b>GEV No.</b>	526351	<b>Ref. No.</b>	EB028
<b>description</b>	tension spring ø 5.2mm total length 51mm wire gauge ø 0.55mm L1 29mm		

fastening material

fasteners

cotter pins

 <p>1</p>			
<b>GEV No.</b>	111273	<b>Ref. No.</b>	DS43 EB043
<b>description</b>	cotter pin ø 1.3mm L 25mm		



**C**

condensators & interference suppression filters	4
cotter pins	11

**F**

fasteners	11
fastening material	11

**M**

microswitches	3
motors	4

**O**

operating capacitors	4
----------------------	---

**P**

push/momentary push switches	3
------------------------------	---

**R**

relays	3
rocker/momentary rocker switches	3

**S**

switches and momentary switches	3
---------------------------------	---