



GAS COMPONENTS



ELECTRIC COMPONENTS



WATER TECHNOLOGY



MECHANICAL COMPONENTS



TOOLS

Spare parts suitable for

PALUX

Find the complete and up-to-date range of products in our GEV Webshop



Manufacturer catalogue

The most important spare parts and accessories arranged clearly for every manufacturer

- ✓ Complete product range and all appliance data always up to date in the GEV Webshop
- ✓ Alphabetical Index at the end of the catalogue

GEV Webshop

www.gev-online.co.uk

www.gev-online.com



- 🔍 Add to Favourites
- 🔍 Sign In with email address and usual password
- 🔍 Easy-order – place several items in your basket at the same time
- 🔍 Quick Item search – no login needed



heating elements

heating elements for ovens

GEV No.	416448	Ref. No.	637742
description	heating element 1275W 230V L 325mm W 202mm flange length 225mm flange width 20mm hole distance 219mm tube ø 8.5mm heating circuits 1 hole ø 5.5mm connection M4 mounting pos. lower rectangular flange dry heating element oven		
For models:	541869, 638625		

GEV No.	415787	Ref. No.	290718
description	heating element 1450W 400V heating circuits 1 L 502mm W 455mm L1 75mm L2 427mm W1 357mm W2 98mm mounting distance 90mm thread M14x1.5 tube ø 8.5mm connection M4 mounting pos. lower-outer 2 hole fixing		
For models:	Maxima-Elektro-Backofen-700-850, Maxima-Elektro-Backofen-850		

GEV No.	415570	Ref. No.	731811
description	heating element 1500W 230V L 470mm W 200mm flange length 225mm flange width 20mm hole distance 214mm tube ø 8.3mm heating circuits 1 hole ø 6mm connection M4 mounting pos. lower rectangular flange dry heating element oven		
For models:	730416		

GEV No.	415786	Ref. No.	290696	
description	heating element 1500W 380V heating circuits 1 L 432mm W 392mm L1 135mm L2 302mm W1 322mm W2 70mm mounting distance 61mm thread M14x1.5 tube ø 8.6mm connection M4 mounting pos. upper inner dry heating element oven 2 hole fixing			
For models:	Maxima-Elektro-Backofen-700-850, Maxima-Elektro-Backofen-850			
accessories for	415786			
	GEV No.	510417	Ref. No.	—
	flat gasket fibre ED ø 20mm ID ø 14mm thickness 2mm Qty 1 pcs			

accessories for	415786			
	GEV No.	520228	Ref. No.	—
	tooth lock washer ID ø 15.3mm ED ø 24mm steel Qty 1 pcs for thread M14			
	GEV No.	520230	Ref. No.	—
	nut thread M14x1.5 H 5mm WS 19 zinc-coated steel Qty 1 pcs			
	GEV No.	521101	Ref. No.	—
	nut thread M14x1.5 H 5mm WS 19 SS Qty 1 pcs			
	GEV No.	550262	Ref. No.	—
	flat gasket copper ED ø 20mm ID ø 14mm thickness 2mm			

GEV No.	415785	Ref. No.	290688	
description	heating element 1500W 380V heating circuits 1 L 505mm W 463mm L1 75mm L2 430mm W1 357mm W2 98mm mounting distance 90mm thread M14x1.5 tube ø 8.5mm connection M4 mounting pos. upper outer dry heating element 2 hole fixing			
For models:	Maxima-Elektro-Backofen-700-850, Maxima-Elektro-Backofen-850			
spare parts for	415785			
	GEV No.	510417	Ref. No.	—
	flat gasket fibre ED ø 20mm ID ø 14mm thickness 2mm Qty 1 pcs			
accessories for	415785			
	GEV No.	520228	Ref. No.	—
	tooth lock washer ID ø 15.3mm ED ø 24mm steel Qty 1 pcs for thread M14			
	GEV No.	520230	Ref. No.	—
	nut thread M14x1.5 H 5mm WS 19 zinc-coated steel Qty 1 pcs			
	GEV No.	521101	Ref. No.	—
	nut thread M14x1.5 H 5mm WS 19 SS Qty 1 pcs			
	GEV No.	550262	Ref. No.	—
	flat gasket copper ED ø 20mm ID ø 14mm thickness 2mm			

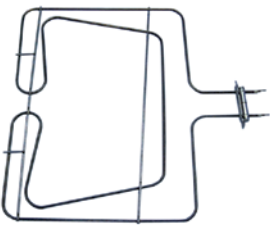





GEV No.	415995	Ref. No.	150673
description	heating element 1500W 400V heating circuits 1 L 460mm W 484mm L1 107mm L2 360mm W1 211mm W2 62mm flange length 104mm flange width 32mm hole distance 96/39mm hole ø 4mm tube ø 6.4mm connection male faston 6.3mm connection length 51mm tilt flange dry heating element		
For models:	00068x, 00099x, 00121x, 00149x, 00183x, 001864, 002046, 002682, 003131, 00314x, 750026, 750034, 750042, 750050, 750069, 750077, 750085, 750093, 750107, 750115		

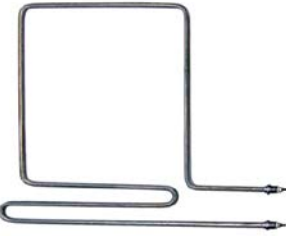







GEV No.	415810	Ref. No.	290750
description	heating element 1500W 400V heating circuits 1 L 495mm W 635mm L1 75mm L2 420mm W1 515mm W2 120mm mounting distance 100mm thread M14x1.5 tube ø 8.5mm connection M4 mounting pos. upper outer 2 hole fixing		
For models:	Maxima-Elektro-Backofen-700-850, Maxima-Elektro-Backofen-850		



GEV No.	415788	Ref. No.	290726
description	heating element 1700W 380V heating circuits 1 L 475mm W 386mm L1 140mm L2 295mm L3 40mm W1 320mm W2 66mm mounting distance 58mm thread M14x1.5 tube ø 8.5mm connection M4 mounting pos. lower-inner dry heating element 2 hole fixing		
For models:	Maxima-Elektro-Backofen-700-850, Maxima-Elektro-Backofen-850		
accessories for	415788		
	GEV No.	510417	Ref. No. —
	flat gasket fibre ED ø 20mm ID ø 14mm thickness 2mm Qty 1 pcs		
	GEV No.	520228	Ref. No. —
	tooth lock washer ID ø 15.3mm ED ø 24mm steel Qty 1 pcs for thread M14		
	GEV No.	520230	Ref. No. —
	nut thread M14x1.5 H 5mm WS 19 zinc-coated steel Qty 1 pcs		
	GEV No.	521101	Ref. No. —
	nut thread M14x1.5 H 5mm WS 19 SS Qty 1 pcs		

accessories for	415788		
	GEV No.	550262	Ref. No. —
	flat gasket copper ED ø 20mm ID ø 14mm thickness 2mm		



GEV No.	415812	Ref. No.	290777
description	heating element 1700W 400V heating circuits 1 L 495mm W 635mm L1 75mm L2 420mm W1 515mm W2 120mm mounting distance 110mm thread M14x1.5 tube ø 8.5mm connection M4 mounting pos. lower-outer dry heating element 2 hole fixing		
For models:	Maxima-Elektro-Backofen-700-850, Maxima-Elektro-Backofen-850		
accessories for	415812		
	GEV No.	510417	Ref. No. —
	flat gasket fibre ED ø 20mm ID ø 14mm thickness 2mm Qty 1 pcs		
	GEV No.	520228	Ref. No. —
	tooth lock washer ID ø 15.3mm ED ø 24mm steel Qty 1 pcs for thread M14		
	GEV No.	520230	Ref. No. —
	nut thread M14x1.5 H 5mm WS 19 zinc-coated steel Qty 1 pcs		
	GEV No.	521101	Ref. No. —
	nut thread M14x1.5 H 5mm WS 19 SS Qty 1 pcs		
	GEV No.	550262	Ref. No. —
	flat gasket copper ED ø 20mm ID ø 14mm thickness 2mm		

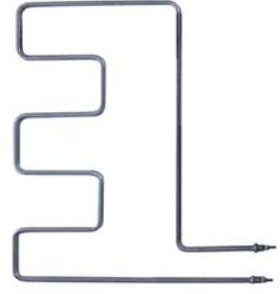









GEV No.	415811	Ref. No.	290769
description	heating element 1700W 400V L 447mm W 540mm L1 137mm L2 310mm W1 474mm W2 66mm mounting distance 58mm thread M14x1.5 tube ø 8.5mm connection M4 mounting pos. upper inner 2 hole fixing		
For models:	Maxima-Elektro-Backofen-700-850, Maxima-Elektro-Backofen-850		
accessories for	415811		
	GEV No.	510417	Ref. No. —
	flat gasket fibre ED ø 20mm ID ø 14mm thickness 2mm Qty 1 pcs		
	GEV No.	520228	Ref. No. —
	tooth lock washer ID ø 15.3mm ED ø 24mm steel Qty 1 pcs for thread M14		

Table continues overleaf



accessories for	415811		
	GEV No.	520230	Ref. No. —
	nut thread M14x1.5 H 5mm WS 19 zinc-coated steel Qty 1 pcs		
	GEV No.	521101	Ref. No. —
	nut thread M14x1.5 H 5mm WS 19 SS Qty 1 pcs		
	GEV No.	550262	Ref. No. —
	flat gasket copper ED ø 20mm ID ø 14mm thickness 2mm		

accessories for	416447		
	GEV No.	520228	Ref. No. —
	tooth lock washer ID ø 15.3mm ED ø 24mm steel Qty 1 pcs for thread M14		
	GEV No.	521101	Ref. No. —
	nut thread M14x1.5 H 5mm WS 19 SS Qty 1 pcs		
	GEV No.	550262	Ref. No. —
	flat gasket copper ED ø 20mm ID ø 14mm thickness 2mm		

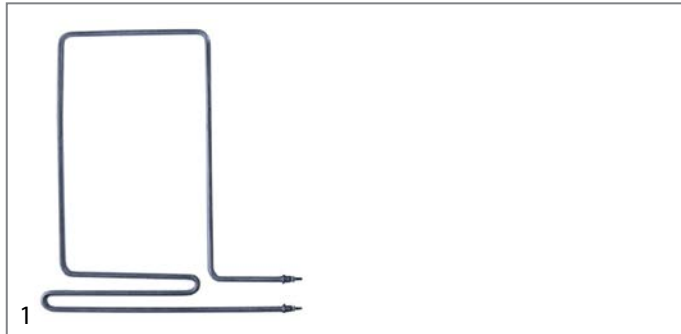

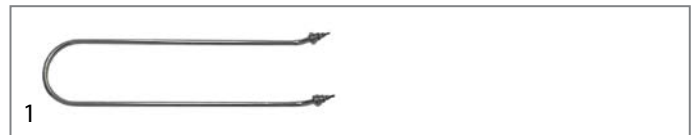

GEV No.	415813	Ref. No.	290785
description	heating element 1950W 400V heating circuits 1 L 467mm W 520mm L1 140mm L2 290mm L3 37mm W1 465mm W2 55mm mounting distance 45mm thread M14x1.5 tube ø 8.5mm connection M4 mounting pos. lower-inner dry heating element 2 hole fixing		
For models:	Maxima-Elektro-Backofen-700-850, Maxima-Elektro-Backofen-850		
accessories for	415813		
	GEV No.	510417	Ref. No. —
	flat gasket fibre ED ø 20mm ID ø 14mm thickness 2mm Qty 1 pcs		
	GEV No.	520228	Ref. No. —
	tooth lock washer ID ø 15.3mm ED ø 24mm steel Qty 1 pcs for thread M14		
	GEV No.	521101	Ref. No. —
	nut thread M14x1.5 H 5mm WS 19 SS Qty 1 pcs		
	GEV No.	550262	Ref. No. —
	flat gasket copper ED ø 20mm ID ø 14mm thickness 2mm		

heating elements for bain maries

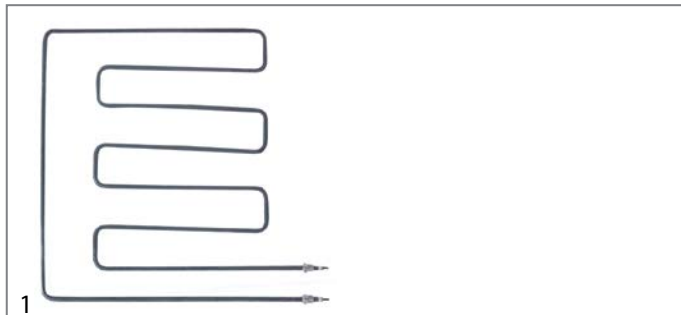

GEV No.	415420	Ref. No.	290653
description	heating element 1500W 220V heating circuits 1 L 443mm W 114mm connection M4 tube ø 8.5mm 2 hole fixing thread M14x1.5 H 22mm mounting distance 105mm		
For models:	Maxima-Elektro-Bain-Marie-700-850, Maxima-Elektro-Bain-Marie-850		
accessories for	415420		
	GEV No.	510417	Ref. No. —
	flat gasket fibre ED ø 20mm ID ø 14mm thickness 2mm Qty 1 pcs		
	GEV No.	520228	Ref. No. —
	tooth lock washer ID ø 15.3mm ED ø 24mm steel Qty 1 pcs for thread M14		
	GEV No.	520230	Ref. No. —
	nut thread M14x1.5 H 5mm WS 19 zinc-coated steel Qty 1 pcs		
	GEV No.	521101	Ref. No. —
	nut thread M14x1.5 H 5mm WS 19 SS Qty 1 pcs		
	GEV No.	550262	Ref. No. —
	flat gasket copper ED ø 20mm ID ø 14mm thickness 2mm		



GEV No.	416447	Ref. No.	637734
description	heating element 2450W 230V heating circuits 1 L 495mm W 510mm L1 65mm L2 430mm W1 440mm W2 70mm mounting distance 62mm thread M14x1.5 tube ø 8.5mm connection M4 mounting pos. upper dry heating element 2 hole fixing		
For models:	541869, 638625		
accessories for	416447		
	GEV No.	510417	Ref. No. —
	flat gasket fibre ED ø 20mm ID ø 14mm thickness 2mm Qty 1 pcs		

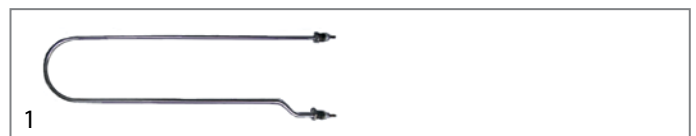









GEV No.	415421	Ref. No.	290661
description	heating element 1500W 220V heating circuits 1 L 445mm W 135mm connection M4 tube ø 8.5mm 2 hole fixing thread M14x1.5 immersion heater L1 20mm L2 50mm L3 380mm W1 20mm W2 117mm mounting distance 129mm		
For models:	Maxima-Elektro-Bain-Marie-700-850, Maxima-Elektro-Bain-Marie-850		
spare parts for	415421		
	GEV No.	510407	Ref. No. —
	flat gasket fibre ED ø 78mm ID ø 60mm thickness 2mm for heating element for thread 2" Qty 1 pcs		
accessories for	415421		
	GEV No.	510417	Ref. No. —
	flat gasket fibre ED ø 20mm ID ø 14mm thickness 2mm Qty 1 pcs		
	GEV No.	520228	Ref. No. —
	tooth lock washer ID ø 15.3mm ED ø 24mm steel Qty 1 pcs for thread M14		

Table continues overleaf





accessories for	415421		
	GEV No.	520230	Ref. No. —
	nut thread M14x1.5 H 5mm WS 19 zinc-coated steel Qty 1 pcs		
	GEV No.	521101	Ref. No. —
	nut thread M14x1.5 H 5mm WS 19 SS Qty 1 pcs		
	GEV No.	521103	Ref. No. —
	nut thread M4 H 3mm WS 7 brass Qty 20 pcs		
	GEV No.	521104	Ref. No. —
	washer ID ø 4.3mm ED ø 8mm thickness 0.5mm brass Qty 20 pcs for thread M4		
	GEV No.	550262	Ref. No. —
	flat gasket copper ED ø 20mm ID ø 14mm thickness 2mm		
	GEV No.	560111	Ref. No. —
	plain washer ID ø 4.3mm ED ø 9mm thickness 0.8mm SS Qty 20 pcs DIN 125A for thread M4		
	GEV No.	560131	Ref. No. —
	hexagonal nut thread M4 H 3.2mm WS 7 SS DIN/ISO DIN 934 / ISO 4032/8673 Qty 20 pcs		

	1		
GEV No.	415434	Ref. No.	056928
description	heating element 1500W 230V heating circuits 1 L 342mm W 79mm connection length 14mm connection male faston 6.3mm tube ø 8.5mm 2 hole fixing thread M14x1.5 immersion heater H 29mm mounting distance 72mm		
For models:	614009, 614106, 614404, 624004, 624101, 627100, Bain-Marie-614, Bain-Marie-624, Bain-Marie-626		
accessories for	415434		
	GEV No.	510417	Ref. No. —
	flat gasket fibre ED ø 20mm ID ø 14mm thickness 2mm Qty 1 pcs		
	GEV No.	520228	Ref. No. —
	tooth lock washer ID ø 15.3mm ED ø 24mm steel Qty 1 pcs for thread M14		
	GEV No.	520230	Ref. No. —
	nut thread M14x1.5 H 5mm WS 19 zinc-coated steel Qty 1 pcs		
	GEV No.	521101	Ref. No. —
	nut thread M14x1.5 H 5mm WS 19 SS Qty 1 pcs		
	GEV No.	550262	Ref. No. —
	flat gasket copper ED ø 20mm ID ø 14mm thickness 2mm		

heating elements for frying pans

	1		
GEV No.	416898	Ref. No.	501808
description	heating element 1600W 230V L 435mm W 110mm connection male faston 6.3mm tube ø 6.3mm H 93mm connection distance 104mm		
For models:	502650, 688290, Vario-Braeter-400		

	1		
GEV No.	417650	Ref. No.	501816
description	heating element 3500W 230V heating circuits 1 L 430mm W 245mm connection male faston 6.3mm tube ø 6.3mm 2. generation		
For models:	502707, 686328, Vario-Braeter-600		

	1		
GEV No.	416899	Ref. No.	501816 old
description	heating element 3500W 230V heating circuits 1 L 430mm W 245mm connection male faston 6.3mm tube ø 8.5mm 1. generation		





	1		
GEV No.	416902	Ref. No.	516392
description	heating element 4500W 230V		
For models:	516678, 639087, 699063, Vario-Braeter-plus		

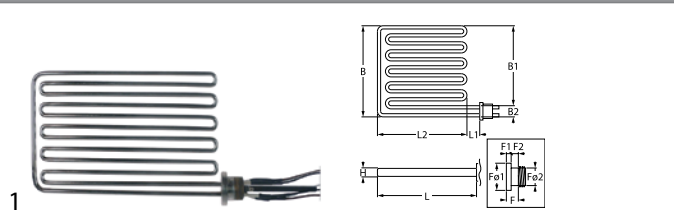

heating elements for fryers





side connection
with thread



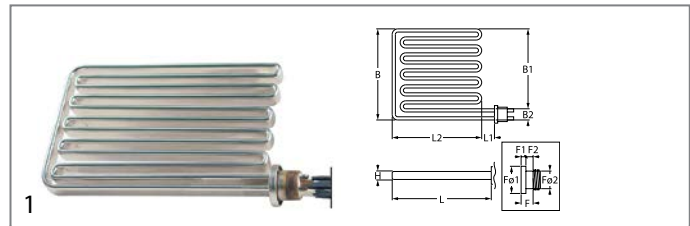



GEV No.	416909	Ref. No.	100056 257001
description	heating element 6000W 230/400V heating circuits 3 L 300mm W 185mm H 22mm flange length 20mm flange length 1 9mm flange length 2 11mm flange ø1 51mm flange ø2 36mm thermostat sleeves ø 4mm length thermostat sleeves 280/300mm number of thermostat sleeves 2 L1 15mm L2 285mm W1 162mm W2 23mm thread M36x1.5 windings 5 cable length 650mm rotation flange immersion heater for fryer/pasta cooker		
For models:	502200, 502308, 601004, 601209, 601403, 602000, 602205, 602280, 603201, 649554, 649562, 650943, 650951, 686336, 688339, 688347, 688355, 721468, 722588, Fritteuse-365, Topline-Friteuse		
accessories for	416909		
	GEV No.	521004	Ref. No. 264849
	hexagonal nut thread M36x1.5 WS 46 H 14mm brass		
	GEV No.	550673	Ref. No. 262153
	flat gasket PTFE D1 ø 46mm D2 ø 36/38.2mm thickness 5mm Qty 1 pcs mounting pos. outer		
	GEV No.	550674	Ref. No. 261033
	flat gasket PTFE ED ø 46mm ID ø 36mm thickness 4mm Qty 1 pcs mounting pos. inner		
	GEV No.	692060	Ref. No. 262161
	retaining ring brass H 10mm ID ø 36mm ED ø 50mm		

accessories for	416906		
	GEV No.	692060	Ref. No. 262161
	retaining ring brass H 10mm ID ø 36mm ED ø 50mm		

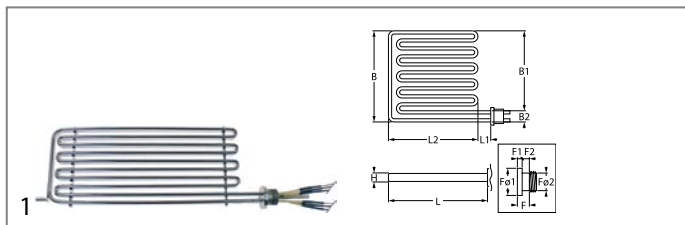

GEV No.	416910	Ref. No.	602051
description	heating element 8000W 230/400V heating circuits 3 L 300mm W 185mm H 22mm flange length 20mm flange length 1 9mm flange length 2 11mm flange ø1 51mm flange ø2 36mm thermostat sleeves ø 4mm length thermostat sleeves 280/300mm number of thermostat sleeves 2 L1 15mm L2 285mm W1 162mm W2 23mm thread M36x1.5 windings 5 cable length 650mm rotation flange immersion heater pasta cooker		
For models:	502200, 502308, 601004, 601209, 601403, 602000, 602205, 602280, 649554, 649562, 650943, 650951, 686336, 688339, 688347, 688355, 699047, 699055, 750255, Fritteuse-365, Topline-Friteuse		
accessories for	416910		
	GEV No.	521004	Ref. No. 264849
	hexagonal nut thread M36x1.5 WS 46 H 14mm brass		
	GEV No.	550673	Ref. No. 262153
	flat gasket PTFE D1 ø 46mm D2 ø 36/38.2mm thickness 5mm Qty 1 pcs mounting pos. outer		
	GEV No.	550674	Ref. No. 261033
	flat gasket PTFE ED ø 46mm ID ø 36mm thickness 4mm Qty 1 pcs mounting pos. inner		
	GEV No.	692060	Ref. No. 262161
	retaining ring brass H 10mm ID ø 36mm ED ø 50mm		



GEV No.	416906	Ref. No.	542326 618411 852716
description	heating element 7000W 230/400V heating circuits 3 mounting pos. left L 458mm W 178mm H 22mm flange length 20mm flange length 1 9.8mm flange length 2 9.7mm flange ø1 51mm flange ø2 36mm thermostat sleeves ø 5.5mm length thermostat sleeves 180/270mm number of thermostat sleeves 2 L1 43mm L2 415mm W1 155mm W2 23mm thread M36x1.5 windings 4 cable length 650mm rotation flange immersion heater for fryer/pasta cooker connection length 75mm		
For models:	503010, 503150, 517887, 637564, 657735, 686298, 688428, 700673, 702560		
accessories for	416906		
	GEV No.	521004	Ref. No. 264849
	hexagonal nut thread M36x1.5 WS 46 H 14mm brass		
	GEV No.	550673	Ref. No. 262153
	flat gasket PTFE D1 ø 46mm D2 ø 36/38.2mm thickness 5mm Qty 1 pcs mounting pos. outer		
	GEV No.	550674	Ref. No. 261033
	flat gasket PTFE ED ø 46mm ID ø 36mm thickness 4mm Qty 1 pcs mounting pos. inner		

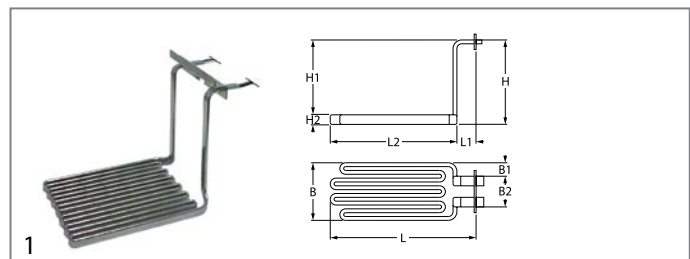

GEV No.	415444	Ref. No.	008591
description	heating element 6000W 230/400V L 272mm W 206mm H 220mm rectangular flange connection cable heating circuits 3 immersion heater L1 20mm L2 252mm hole distance 54mm hole ø 4.5mm flange length 168mm flange width 24mm		
For models:	600008, 600067, 601004, 601209, 601403, 602000, 602205, 602280, 603007, 603023, 603201, Fritteuse-600, Fritteuse-601, Fritteuse-602, Fritteuse-603		

2 hole fixing

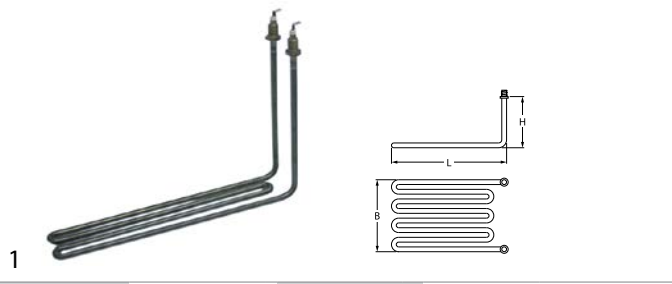

GEV No.	415443	Ref. No.	N/A
description	heating element 2000W 230V heating circuits 1 L 324mm W 62mm H 200mm thread M14x1.5 tube ø 8.5mm windings 2 mounting distance 58mm connection male faston 6.3mm 2 hole fixing fryer heaters		

accessories for	415443			
	GEV No.	510417	Ref. No.	—
	flat gasket fibre ED ø 20mm ID ø 14mm thickness 2mm Qty 1 pcs			
	GEV No.	520228	Ref. No.	—
	tooth lock washer ID ø 15.3mm ED ø 24mm steel Qty 1 pcs for thread M14			
	GEV No.	520230	Ref. No.	—
	nut thread M14x1.5 H 5mm WS 19 zinc-coated steel Qty 1 pcs			
	GEV No.	521101	Ref. No.	—
	nut thread M14x1.5 H 5mm WS 19 SS Qty 1 pcs			
	GEV No.	550262	Ref. No.	—
	flat gasket copper ED ø 20mm ID ø 14mm thickness 2mm			

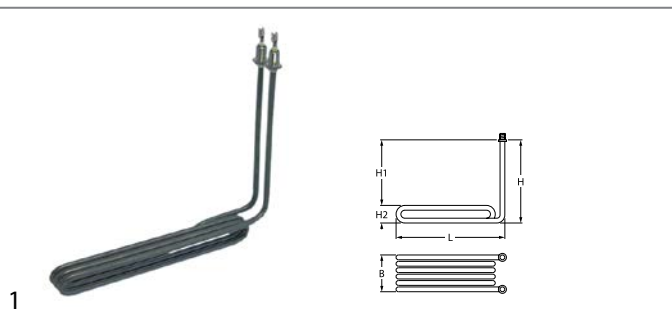

GEV No.	415591	Ref. No.	150711
description	heating element 2000W 230V heating circuits 1 L 285mm W 40mm H 240mm H1 200mm H2 40mm mounting pos. 20 thread M14x1.5 tube ø 8.5mm mounting distance 20mm windings 3 2 hole fixing connection male faston 6.3mm immersion heater		

For models:	750255, 750263, 750271, 750298			
spare parts for	415591			
	GEV No.	510417	Ref. No.	—
	flat gasket fibre ED ø 20mm ID ø 14mm thickness 2mm Qty 1 pcs			
accessories for	415591			
	GEV No.	520228	Ref. No.	—
	tooth lock washer ID ø 15.3mm ED ø 24mm steel Qty 1 pcs for thread M14			
	GEV No.	520230	Ref. No.	—
	nut thread M14x1.5 H 5mm WS 19 zinc-coated steel Qty 1 pcs			
	GEV No.	521101	Ref. No.	—
	nut thread M14x1.5 H 5mm WS 19 SS Qty 1 pcs			

accessories for	415591			
	GEV No.	550262	Ref. No.	—
	flat gasket copper ED ø 20mm ID ø 14mm thickness 2mm			

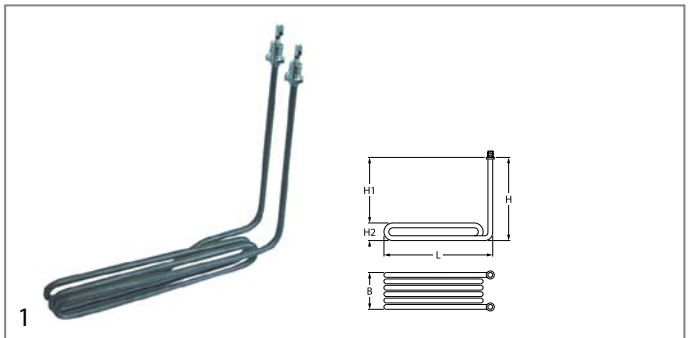

GEV No.	415978	Ref. No.	155268
description	heating element 3000W 230V heating circuits 1 L 288mm W 48mm H 243mm H1 205mm H2 38mm thread M14x1.5 tube ø 8.5mm windings 3 2 hole fixing connection male faston 6.3mm		

For models:	750255, 750263, 750271, 750298			
spare parts for	415978			
	GEV No.	510417	Ref. No.	—
	flat gasket fibre ED ø 20mm ID ø 14mm thickness 2mm Qty 1 pcs			

accessories for	415978			
	GEV No.	510417	Ref. No.	—
	flat gasket fibre ED ø 20mm ID ø 14mm thickness 2mm Qty 1 pcs			
	GEV No.	520228	Ref. No.	—
	tooth lock washer ID ø 15.3mm ED ø 24mm steel Qty 1 pcs for thread M14			
	GEV No.	520230	Ref. No.	—
	nut thread M14x1.5 H 5mm WS 19 zinc-coated steel Qty 1 pcs			
	GEV No.	521101	Ref. No.	—
	nut thread M14x1.5 H 5mm WS 19 SS Qty 1 pcs			
	GEV No.	550262	Ref. No.	—
	flat gasket copper ED ø 20mm ID ø 14mm thickness 2mm			

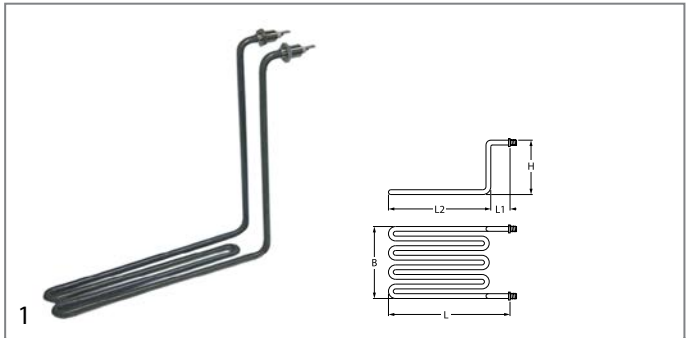



GEV No.	415474	Ref. No.	N/A
description	heating element 1660W 230V heating circuits 1 L 288mm W 66mm H 242mm L1 25mm L2 263mm thread M14x1.5 mounting distance 55mm tube ø 8.5mm windings 2 2 hole fixing connection male faston 6.3mm connection length 18mm immersion heater		



accessories for	415474			
	GEV No.	510417	Ref. No.	—
	flat gasket fibre ED ø 20mm ID ø 14mm thickness 2mm Qty 1 pcs			

Table continues overleaf

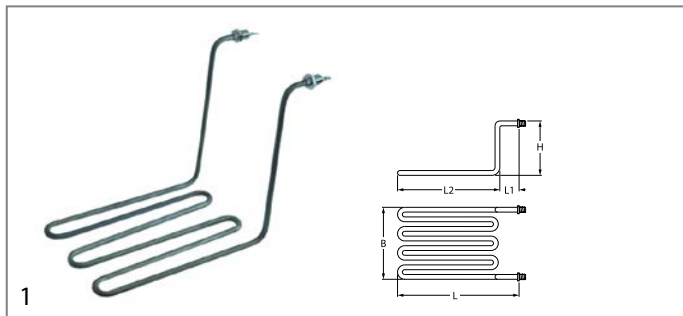

accessories for	415474		
	GEV No.	520228	Ref. No. —
	tooth lock washer ID ø 15.3mm ED ø 24mm steel Qty 1 pcs for thread M14		
	GEV No.	550262	Ref. No. —
	flat gasket copper ED ø 20mm ID ø 14mm thickness 2mm		



GEV No.	415441	Ref. No.	N/A
description	heating element 3000W 230V heating circuits 1 L 294mm W 150mm H 242mm L1 29mm L2 265mm thread M14x1.5 mounting distance 142mm tube ø 8.5mm windings 3 2 hole fixing connection male faston 6.3mm fryer heaters		
accessories for	415441		
	GEV No.	510417	Ref. No. —
	flat gasket fibre ED ø 20mm ID ø 14mm thickness 2mm Qty 1 pcs		
	GEV No.	520228	Ref. No. —
	tooth lock washer ID ø 15.3mm ED ø 24mm steel Qty 1 pcs for thread M14		
	GEV No.	520230	Ref. No. —
	nut thread M14x1.5 H 5mm WS 19 zinc-coated steel Qty 1 pcs		
	GEV No.	521101	Ref. No. —
	nut thread M14x1.5 H 5mm WS 19 SS Qty 1 pcs		
	GEV No.	550262	Ref. No. —
	flat gasket copper ED ø 20mm ID ø 14mm thickness 2mm		

heating elements for griddles



GEV No.	415435	Ref. No.	083577
description	heating element 1500W 220V heating circuits 1 L 425mm W 100mm H 28mm tube ø 9mm 2 hole fixing connection M4 thread M14x1.5 mounting distance 91mm grill dry heating element		
For models:	610003, 610038, 610402, 611018, 611050, 612006, 612057, 613002, 613088, 615005, 615013, 615056, 620009, 621005, 621056, 622001, 622052, 62510, 62520, 62530, Brater-611, Brater-621, Elektro-Waermeschrank, Frittenwanne-615, Griddle-Platte-612, Griddleplatte-622, OEWs1245-einseitig-400x1200mm, OEWs1246-einseitig-mit-Rueckwandverkleidung, sudpfanne-613, UDWE1225L, UDWE1225L-doppelseitig-Eck-640x1200mm, UDWE1225R, UDWE1225R-doppelseitig-Eck-640x1200mm, UDWF0825, UDWF0825D-doppelseitig-640x800mm, UDWs1225, UDWs1225-doppelseitig-640x1200mm, UJWF0825, UJWF0825D-einseitig-640x800mm, UEWs06-schubladenblock-640x600mm, UEWs1225, UEWs1225-doppelseitig-640x1200mm, UEWs1225-einseitig-640x1200mm, UGWf0835, UGWf0835D-Fluegeltuer-710x800mm, UGWs1235, UGWs1235-schiebetuer-710x1200mm, Wurstgrill-610, Wurstgrill-620		
spare parts for	415435		
	GEV No.	510417	Ref. No. —
	flat gasket fibre ED ø 20mm ID ø 14mm thickness 2mm Qty 1 pcs		
accessories for	415435		
	GEV No.	520228	Ref. No. —
	tooth lock washer ID ø 15.3mm ED ø 24mm steel Qty 1 pcs for thread M14		
	GEV No.	520230	Ref. No. —
	nut thread M14x1.5 H 5mm WS 19 zinc-coated steel Qty 1 pcs		
	GEV No.	521101	Ref. No. —
	nut thread M14x1.5 H 5mm WS 19 SS Qty 1 pcs		
	GEV No.	550262	Ref. No. —
	flat gasket copper ED ø 20mm ID ø 14mm thickness 2mm		









GEV No.	415434	Ref. No.	056928
description	heating element 1500W 230V heating circuits 1 L 342mm W 79mm connection length 14mm connection male faston 6.3mm tube ø 8.5mm 2 hole fixing thread M14x1.5 immersion heater H 29mm mounting distance 72mm		
For models:	614009, 614106, 614404, 624004, 624101, 627100, Bain-Marie-614, Bain-Marie-624, Bain-Marie-626		
accessories for	415434		
	GEV No.	510417	Ref. No. —
	flat gasket fibre ED ø 20mm ID ø 14mm thickness 2mm Qty 1 pcs		
	GEV No.	520228	Ref. No. —
	tooth lock washer ID ø 15.3mm ED ø 24mm steel Qty 1 pcs for thread M14		
	GEV No.	520230	Ref. No. —
	nut thread M14x1.5 H 5mm WS 19 zinc-coated steel Qty 1 pcs		

Table continues overleaf

accessories for	415434		
	GEV No.	521101	Ref. No. —
	nut thread M14x1.5 H 5mm WS 19 SS Qty 1 pcs		
	GEV No.	550262	Ref. No. —
	flat gasket copper ED ø 20mm ID ø 14mm thickness 2mm		

	1		
GEV No.	415442	Ref. No.	N/A
description	heating element 1500W 230V heating circuits 1 L 400mm W 50mm H 54mm tube ø 8.5mm connection male faston 6.3mm connection length 15mm grill connection distance 42mm dry heating element		

	1		
GEV No.	418218	Ref. No.	148040
description	heating element 1600W 230V L 433mm W 108mm H 56mm tube ø 6.3mm L1 75mm W1 15mm W2 74mm cable length 1100mm connection distance 68mm dry heating element		
For models:	626104, 626112, 626201, 626228, 626309, 626317		

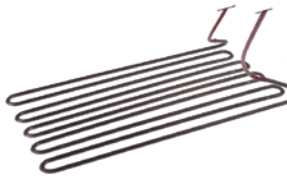
	1		
GEV No.	416896	Ref. No.	147990
description	heating element 3500W 230V heating circuits 1 L 435mm W 240mm H 45mm tube ø 6.3mm L1 50mm W1 33mm W2 175mm dry heating element		
For models:	626104, 626112, 626201, 626228, 626309, 626317, 721476, 721484, 722596, 722618		

heating elements for large hobs

	1		
GEV No.	416894	Ref. No.	602523
description	heating element 3500W 230V heating circuits 1 L 265mm W 260mm H 98mm tube ø 6.25mm mounting pos. connection length 25mm connection M4 connection distance 254mm windings 8 dry heating element		
For models:	505900, 505935, 687200, 690600, Vario-Herd		

heating elements for chicken rotisseries

	1		
GEV No.	415532	Ref. No.	103691
description	heating element 1000W 230V L 700mm W 64mm Hmm heating circuits 1 connection male faston 6.3mm dry heating element tube ø 6.3mm connection distance 59mm		
For models:	574961, Grill-680		

	1		
GEV No.	415531	Ref. No.	103640
description	heating element 1000W 230V L 725mm W 50mm Hmm heating circuits 1 connection male faston 6.3mm dry heating element tube ø 6.3mm connection distance 46mm		
For models:	Grill-681		

	1		
GEV No.	415533	Ref. No.	101575
description	heating element 1100W 230V L 727mm W 50mm Hmm heating circuits 1 connection M4 dry heating element tube ø 8.6mm connection length 19mm		
For models:	Grill-682, Grill-683		

heating elements for hot counters

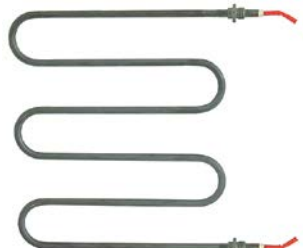
	1		
GEV No.	416510	Ref. No.	371955
description	heating element 1200W 230V heating circuits 1 L 260mm W 284mm connection length 46mm tube ø 8.5mm cable length 480mm dry heating element hot bar 2 hole fixing thread M14x1.5 mounting distance 275mm		
For models:	Heisse-Theke-HT-50-85-und-120-3		

spare parts for	416510		
	GEV No.	550262	Ref. No. —
	flat gasket copper ED ø 20mm ID ø 14mm thickness 2mm		

accessories for	416510		
------------------------	--------	--	--

	GEV No.	510417	Ref. No. —
	flat gasket fibre ED ø 20mm ID ø 14mm thickness 2mm Qty 1 pcs		

	GEV No.	520228	Ref. No. —
	tooth lock washer ID ø 15.3mm ED ø 24mm steel Qty 1 pcs for thread M14		

	GEV No.	520230	Ref. No. —
	nut thread M14x1.5 H 5mm WS 19 zinc-coated steel Qty 1 pcs		

	GEV No.	521101	Ref. No. —
	nut thread M14x1.5 H 5mm WS 19 SS Qty 1 pcs		



GEV No.	416429	Ref. No.	647918
description	heating element 1600W 230V heating circuits 1 L 300mm W 205mm W1 5mm W2 195mm tube ø 8.5mm connection male faston 6.3mm dry heating element hot bar L1 50mm L2 20mm L3 230mm 2 hole fixing thread M14x1.5 mounting distance 202mm		
For models:	361429, HTP1		

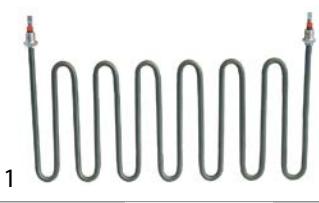











GEV No.	416430	Ref. No.	647926
description	heating element 2000W 230V L 215mm W 415mm tube ø 8.5mm connection male faston 6.3mm dry heating element hot bar 2 hole fixing thread M14x1.5 mounting distance 409mm		
For models:	361437, HTP2		



GEV No.	416512	Ref. No.	371939
description	heating element 2700W 230V heating circuits 1 L 822mm W 300mm connection length 55mm tube ø 8.6mm cable length 440mm dry heating element hot bar 2 hole fixing thread M14x1.5 mounting distance 291mm		
For models:	Heisse-Theke-HT-50-85-und-120-3		
accessories for	416512		
	GEV No.	510417	Ref. No. —
	flat gasket fibre ED ø 20mm ID ø 14mm thickness 2mm Qty 1 pcs		
	GEV No.	520228	Ref. No. —
	tooth lock washer ID ø 15.3mm ED ø 24mm steel Qty 1 pcs for thread M14		
	GEV No.	520230	Ref. No. —
	nut thread M14x1.5 H 5mm WS 19 zinc-coated steel Qty 1 pcs		
	GEV No.	521101	Ref. No. —
	nut thread M14x1.5 H 5mm WS 19 SS Qty 1 pcs		
	GEV No.	550262	Ref. No. —
	flat gasket copper ED ø 20mm ID ø 14mm thickness 2mm		

heating elements for coffee machine



GEV No.	415436	Ref. No.	381268
description	heating element 1600W 220V L 240mm W 33mm H 30mm L1 65mm L2 175mm mounting distance 25mm thread M12x1 stainless steel connection M4 tube ø 8.5mm 2 hole fixing immersion heater		
For models:	810002, 813303		
accessories for	415436		
	GEV No.	510413	Ref. No. —
	flat gasket L 43mm W 19mm hole ø 12mm hole distance 24mm copper thickness 2.3mm for heating element		
	GEV No.	510901	Ref. No. —
	O-ring EPDM thickness 2mm ID ø 13mm Qty 1 pcs		
	GEV No.	520229	Ref. No. —
	nut thread M12x1 H 4mm WS 16 zinc-coated steel Qty 1 pcs		
	GEV No.	521103	Ref. No. —
	nut thread M4 H 3mm WS 7 brass Qty 20 pcs		
	GEV No.	521104	Ref. No. —
	washer ID ø 4.3mm ED ø 8mm thickness 0.5mm brass Qty 20 pcs for thread M4		
	GEV No.	521110	Ref. No. —
	flat gasket fibre ED ø 20mm ID ø 13mm thickness 2mm Qty 1 pcs		
	GEV No.	521131	Ref. No. —
	nut thread M12x1 H 3.5mm WS 17 SS Qty 1 pcs		
	GEV No.	560111	Ref. No. —
	plain washer ID ø 4.3mm ED ø 9mm thickness 0.8mm SS Qty 20 pcs DIN 125A for thread M4		
	GEV No.	560131	Ref. No. —
	hexagonal nut thread M4 H 3.2mm WS 7 SS DIN/ISO DIN 934 / ISO 4032/8673 Qty 20 pcs		



















GEV No.	415439	Ref. No.	378577
description	heating element 2000W 230V heating circuits 1 L 342mm W 33mm H 26mm mounting distance 25mm thread M12x1 connection M4 tube ø 8.5mm 2 hole fixing immersion heater		
For models:	340022, 340030, 340049, 340057, 340073, 340xxx, 354392, 361763, 378933, 440078, 440086, 440094, 440140, 440655, 450111, 810002, 813303, 890529, 890561, 890588, Geschirrspuelautomat-700, GsP-350, Heissluftdaempfer-10x1-1, Heissluftdaempfer-20x1-1, Heissluft-daempfer-5x1-1		
spare parts for	415439		
	GEV No.	532009	Ref. No. —
	O-ring EPDM thickness 1.78mm ID ø 14mm Qty 10 pcs		
accessories for	415439		
	GEV No.	520228	Ref. No. —
	tooth lock washer ID ø 15.3mm ED ø 24mm steel Qty 1 pcs for thread M14		
	GEV No.	520229	Ref. No. —
	nut thread M12x1 H 4mm WS 16 zinc-coated steel Qty 1 pcs		

Table continues overleaf



accessories for 415439			
	GEV No.	521103	Ref. No. —
nut thread M4 H 3mm WS 7 brass Qty 20 pcs			
	GEV No.	521104	Ref. No. —
washer ID ø 4.3mm ED ø 8mm thickness 0.5mm brass Qty 20 pcs for thread M4			
	GEV No.	560111	Ref. No. —
plain washer ID ø 4.3mm ED ø 9mm thickness 0.8mm SS Qty 20 pcs DIN 125A for thread M4			
	GEV No.	560131	Ref. No. —
hexagonal nut thread M4 H 3.2mm WS 7 SS DIN/ISO DIN 934 / ISO 4032/8673 Qty 20 pcs			

			
1			
GEV No.	415437	Ref. No.	017299 378585
description	heating element 3000W 220V heating circuits 1 L 350mm W 33mm H 32mm L1 10mm L2 30mm mounting distance 25mm thread M12x1 connection M4 tube ø 8.6mm 2 hole fixing immersion heater L3 303mm connection length 20mm		
For models:	353167, 354457, 810002, 813303, 890529, 890561, 890588		
accessories for 415437			
	GEV No.	510413	Ref. No. —
flat gasket L 43mm W 19mm hole ø 12mm hole distance 24mm copper thickness 2.3mm for heating element			
	GEV No.	510901	Ref. No. —
O-ring EPDM thickness 2mm ID ø 13mm Qty 1 pcs			
	GEV No.	520229	Ref. No. —
nut thread M12x1 H 4mm WS 16 zinc-coated steel Qty 1 pcs			
	GEV No.	521103	Ref. No. —
nut thread M4 H 3mm WS 7 brass Qty 20 pcs			
	GEV No.	521104	Ref. No. —
washer ID ø 4.3mm ED ø 8mm thickness 0.5mm brass Qty 20 pcs for thread M4			
	GEV No.	521110	Ref. No. —
flat gasket fibre ED ø 20mm ID ø 13mm thickness 2mm Qty 1 pcs			
	GEV No.	521131	Ref. No. —
nut thread M12x1 H 3.5mm WS 17 SS Qty 1 pcs			
	GEV No.	560111	Ref. No. —
plain washer ID ø 4.3mm ED ø 9mm thickness 0.8mm SS Qty 20 pcs DIN 125A for thread M4			
	GEV No.	560131	Ref. No. —
hexagonal nut thread M4 H 3.2mm WS 7 SS DIN/ISO DIN 934 / ISO 4032/8673 Qty 20 pcs			

			
1			
GEV No.	415440	Ref. No.	372749
description	heating element 3300W 220V heating circuits 1 L 255mm W 67mm H 20mm L1 20mm L2 25mm L3 210mm W1 16mm W2 33mm mounting distance 25mm thread M12x1 stainless steel connection cable tube ø 8.5mm 2 hole fixing immersion heater cable length 365mm		
For models:	805149, 805300, 805408, 805459, 805556, 805xxx, Aromacarina, Aromacarina-Dampf, Aromacarina-EsA, Aromacarina-ETA, Aromacarina-ETA-EsA		
accessories for 415440			
	GEV No.	520229	Ref. No. —
nut thread M12x1 H 4mm WS 16 zinc-coated steel Qty 1 pcs			
	GEV No.	521110	Ref. No. —
flat gasket fibre ED ø 20mm ID ø 13mm thickness 2mm Qty 1 pcs			
	GEV No.	521131	Ref. No. —
nut thread M12x1 H 3.5mm WS 17 SS Qty 1 pcs			
	GEV No.	528110	Ref. No. —
O-ring EPDM thickness 2.62mm ID ø 12.37mm Qty 1 pcs			

			
1			
GEV No.	415438	Ref. No.	187003 381233
description	heating element 4000W 220V L 430mm W 30mm H 37mm mounting distance 22mm thread M12x1 connection M4 tube ø 8.5mm 2 hole fixing immersion heater		
For models:	674524, 674532, 674605, 810002, 813303, 890529, 890561, 890588, Heissluftdaempfer-10x1-1, Heissluftdaempfer-20x1-1		
accessories for 415438			
	GEV No.	510413	Ref. No. —
flat gasket L 43mm W 19mm hole ø 12mm hole distance 24mm copper thickness 2.3mm for heating element			
	GEV No.	520229	Ref. No. —
nut thread M12x1 H 4mm WS 16 zinc-coated steel Qty 1 pcs			
	GEV No.	521103	Ref. No. —
nut thread M4 H 3mm WS 7 brass Qty 20 pcs			
	GEV No.	521104	Ref. No. —
washer ID ø 4.3mm ED ø 8mm thickness 0.5mm brass Qty 20 pcs for thread M4			
	GEV No.	521110	Ref. No. —
flat gasket fibre ED ø 20mm ID ø 13mm thickness 2mm Qty 1 pcs			
	GEV No.	521131	Ref. No. —
nut thread M12x1 H 3.5mm WS 17 SS Qty 1 pcs			
	GEV No.	528110	Ref. No. —
O-ring EPDM thickness 2.62mm ID ø 12.37mm Qty 1 pcs			
	GEV No.	560111	Ref. No. —
plain washer ID ø 4.3mm ED ø 9mm thickness 0.8mm SS Qty 20 pcs DIN 125A for thread M4			
	GEV No.	560131	Ref. No. —
hexagonal nut thread M4 H 3.2mm WS 7 SS DIN/ISO DIN 934 / ISO 4032/8673 Qty 20 pcs			



heating elements for tilting bratt pan



GEV No.	415475	Ref. No.	290734
description	heating element 1670W 230V L 110mm W 430mm H 45mm connection M4 dry heating element heating circuits 1 tube ø 8.5mm W1 200mm W2 30mm mounting pos. inner connection distance 22mm		
For models:	Maxima-Elektro-Kippbratpfanne-700-850		







GEV No.	415476	Ref. No.	290742
description	heating element 1670W 230V L 650mm W 470mm H 35mm connection M4 dry heating element heating circuits 1 tube ø 8.5mm W2 45mm mounting pos. outer connection distance 37mm		
For models:	Maxima-Elektro-Kippbratpfanne-700-850		







GEV No.	415477	Ref. No.	194700
description	heating element 1670W 230V L 95mm W 465mm H 45mm connection M4 dry heating element heating circuits 1 tube ø 8.5mm W1 220mm W2 25mm connection distance 16mm		
For models:	Maxima-Elektro-Kippbratpfanne-700-850		

heating elements for pasta cookers

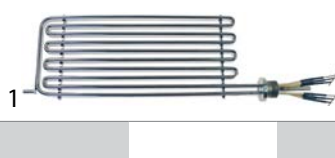





GEV No.	416909	Ref. No.	100056 257001
description	heating element 6000W 230/400V heating circuits 3 L 300mm W 185mm H 22mm flange length 20mm flange length 1 9mm flange length 2 11mm flange ø1 51mm flange ø2 36mm thermostat sleeves ø 4mm length thermostat sleeves 280/300mm number of thermostat sleeves 2 L1 15mm L2 285mm W1 162mm W2 23mm thread M36x1.5 windings 5 cable length 650mm rotation flange immersion heater for fryer/pasta cooker		
For models:	502200, 502308, 601004, 601209, 601403, 602000, 602205, 602280, 603201, 649554, 649562, 650943, 650951, 686336, 688339, 688347, 688355, 721468, 722588, Fritteuse-365, Topline-Fritteuse		
accessories for	416909		
	GEV No.	Ref. No.	264849
	hexagonal nut thread M36x1.5 WS 46 H 14mm brass		
	GEV No.	Ref. No.	262153
	flat gasket PTFE D1 ø 46mm D2 ø 36/38.2mm thickness 5mm Qty 1 pcs mounting pos. outer		
	GEV No.	Ref. No.	261033
	flat gasket PTFE ED ø 46mm ID ø 36mm thickness 4mm Qty 1 pcs mounting pos. inner		
	GEV No.	Ref. No.	262161
	retaining ring brass H 10mm ID ø 36mm ED ø 50mm		



GEV No.	416906	Ref. No.	542326 618411 852716
description	heating element 7000W 230/400V heating circuits 3 mounting pos. left L 458mm W 178mm H 22mm flange length 20mm flange length 1 9.8mm flange length 2 9.7mm flange ø1 51mm flange ø2 36mm thermostat sleeves ø 5.5mm length thermostat sleeves 180/270mm number of thermostat sleeves 2 L1 43mm L2 415mm W1 155mm W2 23mm thread M36x1.5 windings 4 cable length 650mm rotation flange immersion heater for fryer/pasta cooker connection length 75mm		
For models:	503010, 503150, 517887, 637564, 657735, 686298, 688428, 700673, 702560		
accessories for	416906		
	GEV No.	Ref. No.	264849
	hexagonal nut thread M36x1.5 WS 46 H 14mm brass		
	GEV No.	Ref. No.	262153
	flat gasket PTFE D1 ø 46mm D2 ø 36/38.2mm thickness 5mm Qty 1 pcs mounting pos. outer		
	GEV No.	Ref. No.	261033
	flat gasket PTFE ED ø 46mm ID ø 36mm thickness 4mm Qty 1 pcs mounting pos. inner		
	GEV No.	Ref. No.	262161
	retaining ring brass H 10mm ID ø 36mm ED ø 50mm		





			
GEV No.	416910	Ref. No.	602051
description	heating element 8000W 230/400V heating circuits 3 L 300mm W 185mm H 22mm flange length 20mm flange length 1 9mm flange length 2 11mm flange ø1 51mm flange ø2 36mm thermostat sleeves ø 4mm length thermostat sleeves 280/300mm number of thermostat sleeves 2 L1 15mm L2 285mm W1 162mm W2 23mm thread M36x1.5 windings 5 cable length 650mm rotation flange immersion heater pasta cooker		
For models:	502200, 502308, 601004, 601209, 601403, 602000, 602205, 602280, 649554, 649562, 650943, 650951, 686336, 688339, 688347, 688355, 699047, 699055, 750255, Fritteuse-365, Topline-Friteuse		
accessories for	416910		
	GEV No.	521004	Ref. No. 264849
	hexagonal nut thread M36x1.5 WS 46 H 14mm brass		
	GEV No.	550673	Ref. No. 262153
	flat gasket PTFE D1 ø 46mm D2 ø 36/38.2mm thickness 5mm Qty 1 pcs mounting pos. outer		
	GEV No.	550674	Ref. No. 261033
	flat gasket PTFE ED ø 46mm ID ø 36mm thickness 4mm Qty 1 pcs mounting pos. inner		
	GEV No.	692060	Ref. No. 262161
	retaining ring brass H 10mm ID ø 36mm ED ø 50mm		





heating elements for pizza ovens

			
GEV No.	415524	Ref. No.	126551
description	heating element 1100W 230V L 720mm W 200mm thread M14x1.5 mounting distance 210mm connection length 40mm tube ø 8.5mm cable length 1000mm heating circuits 1 dry heating element 2 hole fixing		
For models:	Pizza-Ofen-ELP, Pizza-Ofen-P500, Pizza-Ofen-P501, Pizza-Ofen-P502		
accessories for	415524		
	GEV No.	361182	Ref. No. —
	nut thread 1/4" H 5mm nickel-plated brass WS 17 Qty 1 pcs		
	GEV No.	510417	Ref. No. —
	flat gasket fibre ED ø 20mm ID ø 14mm thickness 2mm Qty 1 pcs		
	GEV No.	520228	Ref. No. —
	tooth lock washer ID ø 15.3mm ED ø 24mm steel Qty 1 pcs for thread M14		
	GEV No.	550262	Ref. No. —
	flat gasket copper ED ø 20mm ID ø 14mm thickness 2mm		

			
GEV No.	415525	Ref. No.	368512
description	heating element 1100W 380V L 716mm W 205mm thread M15x1 mounting distance 197mm connection length 40mm tube ø 8mm cable length 980mm heating circuits 1 dry heating element 2 hole fixing		
For models:	Pizza-Ofen-P501		

			
GEV No.	415527	Ref. No.	368539
description	heating element 1500W 220V L 720mm W 260mm thread M14x1.5 mounting distance 252mm tube ø 8.5mm cable length 1000mm heating circuits 1 dry heating element 2 hole fixing		
For models:	Pizza-Ofen-P500, Pizza-Ofen-P501, Pizza-Ofen-P502		

			
GEV No.	415526	Ref. No.	368520
description	heating element 1500W 380V L 720mm W 260mm thread M14x1.5 mounting distance 290mm connection cable tube ø 8.5mm cable length 1000mm heating circuits 1 dry heating element 2 hole fixing		
For models:	Pizza-Ofen-P502		

			
GEV No.	415528	Ref. No.	126578
description	heating element 2000W 230V L 465mm W 450mm thread M14x1.5 mounting distance 441mm connection length 36mm tube ø 8.5mm cable length 430mm heating circuits 1 dry heating element 2 hole fixing		
For models:	Pizza-Ofen-ELP		
spare parts for	415528		
	GEV No.	510417	Ref. No. —
	flat gasket fibre ED ø 20mm ID ø 14mm thickness 2mm Qty 1 pcs		
accessories for	415528		
	GEV No.	361182	Ref. No. —
	nut thread 1/4" H 5mm nickel-plated brass WS 17 Qty 1 pcs		
	GEV No.	520228	Ref. No. —
	tooth lock washer ID ø 15.3mm ED ø 24mm steel Qty 1 pcs for thread M14		
	GEV No.	550262	Ref. No. —
	flat gasket copper ED ø 20mm ID ø 14mm thickness 2mm		



heating elements for chargrills



GEV No.	415398	Ref. No.	244600
description	heating element 1280W 230V heating circuits 1 L 440mm W 112mm H 28mm windings 4 tube ømm cable length 1200/1600mm dry heating element bracket mounting connection length 45mm		
For models:	620408		



GEV No.	418771	Ref. No.	649473
description	heating element 1280W 230V heating circuits 1 L 441mm W 110mm windings 4 cable length 900mm dry heating element bracket mounting		
For models:	620424		



GEV No.	415399	Ref. No.	244619 649481
description	heating element 1600W 230V heating circuits 1 L 440mm W 145mm H 28mm windings 5 tube ømm cable length 900mm dry heating element bracket mounting		
For models:	610402, 610429		

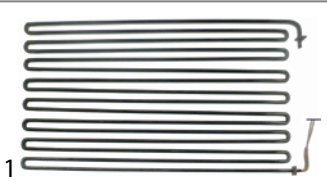

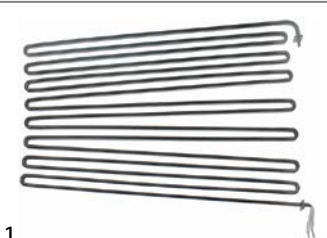

GEV No.	417649	Ref. No.	868507
description	heating element 2500W 230V heating circuits 1 L 450mm W 240mm H 14mm cable length 860mm mounting pos. left		







GEV No.	417648	Ref. No.	868523
description	heating element 2500W 230V heating circuits 1 L 450mm W 240mm H 14mm cable length 860mm mounting pos. right		



GEV No.	415358	Ref. No.	N/A	
description	heating element 2250W 230V L 485mm W 135mm L1 35mm L2 60mm L3 390mm W1 20mm W2 115mm 2 hole fixing thread M14x1.5 mounting distance 170mm connection M3 dry heating element tube ø 8.5mm windings 3 heating circuits 1 H 8.5mm			
accessories for	415358			
	GEV No.	560110	Ref. No.	—
	plain washer ID ø 3.2mm ED ø 7mm thickness 0.5mm SS Qty 20 pcs DIN 125A for thread M3			





GEV No.	415359	Ref. No.	N/A	
description	heating element 3000W 230V L 473mm W 170mm L1 15mm L2 50mm L3 410mm W1 15mm W2 160mm 2 hole fixing thread M14x1.5 mounting distance 140mm connection M3 dry heating element tube ø 8.5mm windings 4 heating circuits 1 connection length 19mm H 8.5mm			
accessories for	415359			
	GEV No.	361182	Ref. No.	—
	nut thread 1/4" H 5mm nickel-plated brass WS 17 Qty 1 pcs			
	GEV No.	510417	Ref. No.	—
	flat gasket fibre ED ø 20mm ID ø 14mm thickness 2mm Qty 1 pcs			
	GEV No.	520228	Ref. No.	—
	tooth lock washer ID ø 15.3mm ED ø 24mm steel Qty 1 pcs for thread M14			
	GEV No.	527169	Ref. No.	—
	hexagonal nut thread M3 H 2.8mm WS 5.5 brass Qty 1 pcs			
	GEV No.	550262	Ref. No.	—
	flat gasket copper ED ø 20mm ID ø 14mm thickness 2mm			
	GEV No.	560110	Ref. No.	—
	plain washer ID ø 3.2mm ED ø 7mm thickness 0.5mm SS Qty 20 pcs DIN 125A for thread M3			
	GEV No.	560130	Ref. No.	—
	hexagonal nut thread M3 H 2.4mm WS 5.5 SS DIN/ISO DIN 934 / ISO 4032/8673 Qty 20 pcs			



heating elements for salamanders/toast-





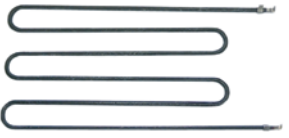

			
1			
GEV No.	416653	Ref. No.	371718
description	heating element 2000W 230V L 225mm W 283mm L1 15mm L2 210mm W1 110mm W2 63mm hole distance 96mm connection M4 tube ø 8.5mm flange length 106mm flange width 32mm heating circuits 1 hole ø 5mm tilt flange dry heating element H 8.5mm		
For models:	686026, 686034		

			
1			
GEV No.	416654	Ref. No.	371726
description	heating element 2000W 230V L 230mm W 230mm L1 22mm L2 208mm W1 83mm W2 63mm hole distance 96mm tube ø 8.5mm flange length 106mm flange width 32mm heating circuits 1 hole ø 5mm tilt flange dry heating element H 8.5mm		
For models:	686026, 686034		

			
1			
GEV No.	415539	Ref. No.	127132
description	heating element 2100W 220V heating circuits 1 L 470mm W 207mm connection male faston 6.3mm connection distance 201mm tube ø 6.3mm dry heating element H 6.3mm		
For models:	686018		

			
1			
GEV No.	415538	Ref. No.	102644
description	heating element 2200W 230V heating circuits 1 L 365mm W 178mm connection male faston 6.3mm connection distance 172mm tube ø 6.3mm dry heating element H 6.3mm		
For models:	574961, 685003		

heating elements for heated cabinets

			
1			
GEV No.	415435	Ref. No.	083577
description	heating element 1500W 220V heating circuits 1 L 425mm W 100mm H 28mm tube ø 9mm 2 hole fixing connection M4 thread M14x1.5 mounting distance 91mm grill dry heating element		
For models:	610003, 610038, 610402, 611018, 611050, 612006, 612057, 613002, 613088, 615005, 615013, 615056, 620009, 621005, 621056, 622001, 622052, 62510, 62520, 62530, Brater-611, Brater-621, Elektro-Waermeschrank, Frittenwanne-615, Griddle-Platte-612, Griddleplatte-622, OEWs1245-einseitig-400x1200mm, OEWs1246-einseitig-mit-Rueckwandverkleidung, sudpfanne-613, UDWE1225L, UDWE1225L-doppelseitig-Eck-640x1200mm, UDWE1225R, UDWE1225R-doppelseitig-Eck-640x1200mm, UDWF0825, UDWF0825D-doppelseitig-640x800mm, UDWs1225, UDWs1225-doppelseitig-640x1200mm, UEFW0825, UEFW0825D-einseitig-640x800mm, UEWs06-schubladenblock-640x600mm, UEWs1225, UEWs1225-doppelseitig-640x1200mm, UEWs1225-einseitig-640x1200mm, UGWF0835, UGWF0835D-Fluegeltuer-710x800mm, UGWs1235, UGWs1235-schiebetuer-710x1200mm, Wurstgrill-610, Wurstgrill-620		
spare parts for	415435		
	GEV No.	510417	Ref. No. —
flat gasket fibre ED ø 20mm ID ø 14mm thickness 2mm Qty 1 pcs			
accessories for	415435		
	GEV No.	520228	Ref. No. —
tooth lock washer ID ø 15.3mm ED ø 24mm steel Qty 1 pcs for thread M14			
	GEV No.	520230	Ref. No. —
nut thread M14x1.5 H 5mm WS 19 zinc-coated steel Qty 1 pcs			
	GEV No.	521101	Ref. No. —
nut thread M14x1.5 H 5mm WS 19 SS Qty 1 pcs			
	GEV No.	550262	Ref. No. —
flat gasket copper ED ø 20mm ID ø 14mm thickness 2mm			

pilot heating elements









			
1			
GEV No.	415607	Ref. No.	702188
description	heating element 500W 230V heating circuits 1 thread 3/4" L 295mm W 20mm H 19mm length thermostat sleeves 235mm thermostat sleeves ø 6mm number of thermostat sleeves 1 thermostat sleeve clinging tube ø 6.5mm immersion heater flange with thread connection length 50mm pilot heating element		
For models:	00443x, 00457x, 136581, 690570		
spare parts for	415607		
	GEV No.	510403	Ref. No. —
flat gasket fibre ED ø 36.5mm ID ø 27mm thickness 2mm Qty 1 pcs			
accessories for	415607		
	GEV No.	510421	Ref. No. —
gasket copper ED ø 31.8mm ID ø 26.4mm thickness 2.2mm for thread 3/4"			

Table continues overleaf

accessories for	415607		
	GEV No.	520234	Ref. No. —
	nut thread 3/4" H 5mm brass WS 30 Qty 1 pcs		

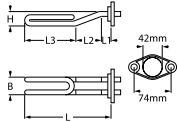

immersion heating elements



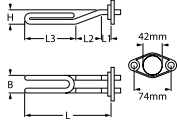

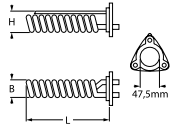

2 hole flange 74mm

			
1			
GEV No.	415191	Ref. No.	208639
description	heating element 2300W 220V heating circuits 1 mounting ϕ 42mm L 240mm W 29mm H 27mm L1 35mm L2 35mm L3 170mm tube ϕ 8.5mm hole distance 74mm hole ϕ 8mm connection M4 immersion heater 2 hole flange H1 8mm H2 23mm flange length 94mm flange width 58mm		
For models:	Glaeserspuelautomat-310, Glaeserspuelautomat-311, Glaeserspuelautomat-320, Glaeserspuelautomat-321		
accessories for	415191		
	GEV No.	521103	Ref. No. —
	nut thread M4 H 3mm WS 7 brass Qty 20 pcs		
	GEV No.	521104	Ref. No. —
	washer ID ϕ 4.3mm ED ϕ 8mm thickness 0.5mm brass Qty 20 pcs for thread M4		
	GEV No.	560111	Ref. No. —
	plain washer ID ϕ 4.3mm ED ϕ 9mm thickness 0.8mm SS Qty 20 pcs DIN 125A for thread M4		
	GEV No.	560131	Ref. No. —
	hexagonal nut thread M4 H 3.2mm WS 7 SS DIN/ISO DIN 934 / ISO 4032/8673 Qty 20 pcs		

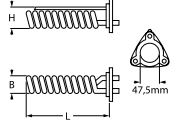
			
1			
GEV No.	415192	Ref. No.	090050
description	heating element 3000W 220V heating circuits 1 mounting ϕ 42mm L 225mm W 29mm H 39mm L1 20mm L2 35mm L3 170mm hole distance 74mm hole ϕ 9mm connection male faston 6.3mm immersion heater 2 hole flange		
For models:	Glaeserspuelautomat-310, Glaeserspuelautomat-311, Glaeserspuelautomat-320, Glaeserspuelautomat-321		

3 hole flange ϕ 47.5mm

			
1			
GEV No.	415668	Ref. No.	349801
description	heating element 2625W 230V mounting ϕ 47.5mm heating circuits 1 L 190mm W 41mm H 54mm number of thermostat sleeves 1 thermostat sleeves ϕ 7mm length thermostat sleeves 170mm thermostat sleeve eccentric, non clinging tube ϕ 6.3mm hole distance 62mm hole ϕ 8mm connection M4 3 hole flange immersion heater		
For models:	665843, 665851, Glaeserspuelautomat-325		
accessories for	415668		
	GEV No.	510562	Ref. No. —
	O-ring silicone thickness 5.34mm ID ϕ 47mm Qty 1 pcs		

				
1				
GEV No.	415002	Ref. No.	386839	
description	heating element 3000W 230V mounting ϕ 47.5mm heating circuits 1 L 198mm W 35mm H 44mm number of thermostat sleeves 1 thermostat sleeves ϕ 7mm length thermostat sleeves 175mm thermostat sleeve not clinging tube ϕ 6.3mm hole distance 64mm hole ϕ 8mm connection M4 3 hole flange immersion heater			
For models:	Glaeserspuelautomat-328			
accessories for	415002			
	GEV No.	510408	Ref. No.	349232
	O-ring EPDM thickness 5.34mm ID ϕ 47mm Qty 1 pcs			
	GEV No.	510562	Ref. No.	—
	O-ring silicone thickness 5.34mm ID ϕ 47mm Qty 1 pcs			
	GEV No.	521103	Ref. No.	—
	nut thread M4 H 3mm WS 7 brass Qty 20 pcs			
	GEV No.	521104	Ref. No.	—
	washer ID ϕ 4.3mm ED ϕ 8mm thickness 0.5mm brass Qty 20 pcs for thread M4			
	GEV No.	560111	Ref. No.	—
	plain washer ID ϕ 4.3mm ED ϕ 9mm thickness 0.8mm SS Qty 20 pcs DIN 125A for thread M4			
	GEV No.	560131	Ref. No.	—
	hexagonal nut thread M4 H 3.2mm WS 7 SS DIN/ISO DIN 934 / ISO 4032/8673 Qty 20 pcs			

with compression flange 50 x 26mm

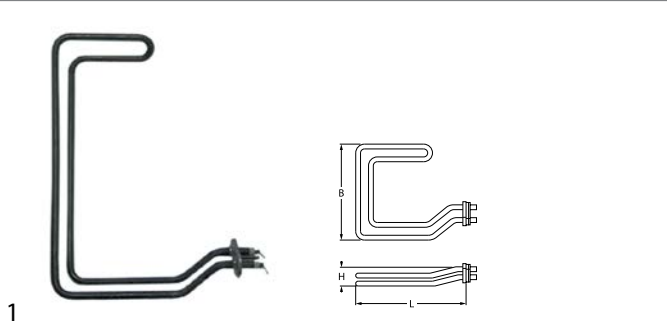

GEV No.	415396	Ref. No.	172847
description	heating element 2500W 230V heating circuits 1 flange 50x26mm L 190mm W 290mm H 47mm compression flange connection male faston 6.3mm tube ø 8.5mm immersion heater		
For models:	271500, 337xxx, Geschirrspuelautomat-335, Geschirrspuelautomat-336, GsP-500, GsP-600		
accessories for	415396		
	GEV No.	510387	Ref. No. —
	gasket L 46mm W 22mm ømm EPDM for heating element for flange 50x26mm		
	GEV No.	510388	Ref. No. —
	counterflange ømm hole distancemm perforation ømm L 43mm W 21mm SS for heating element for flange 50x26mm		

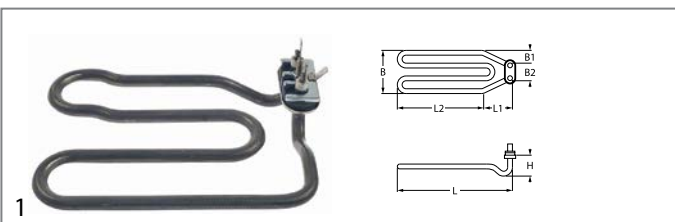

GEV No.	420464	Ref. No.	73069
description	heating element 2500W 230V heating circuits 1 screw flange 50x26mm L 170mm W 120mm H 30mm L1 50mm L2 120mm tube ø 8.5mm warewashing		
spare parts for	420464		
	GEV No.	510387	Ref. No. —
	gasket L 46mm W 22mm ømm EPDM for heating element for flange 50x26mm		
	GEV No.	510388	Ref. No. —
	counterflange ømm hole distancemm perforation ømm L 43mm W 21mm SS for heating element for flange 50x26mm		

with expansion flange 70 x 18mm



GEV No.	415225	Ref. No.	350184
description	heating element 2000W 230V heating circuits 1 flange 70x18mm L 395mm W 57mm connection male faston 6.3mm tube ø 8.5mm immersion heater expansion flange		
For models:	361763, 378933, 440078, 440086, 440094, 440140, 440655, 450111, Geschirrspuelautomat-335, Geschirrspuelautomat-336, GsP-350		
accessories for	415225		
	GEV No.	510415	Ref. No. —
	gasket L 75mm W 23mm hole distance 50mm 4 holes for heating element type DB 70 code L with thermostat sensor hole		
	GEV No.	520238	Ref. No. —
	flange L 80mm W 28mm hole distance 13mm 5 holes type DB 70 code L		



GEV No.	415431	Ref. No.	350214
description	heating element 2500W 230V heating circuits 1 flange 70x18mm L 368mm W 60mm connection male faston 6.3mm tube ø 8.5mm immersion heater expansion flange connection length 13mm TD ø 6mm		
For models:	353167, 354392, 354457, 361763, 378933, 440078, 440086, 440094, 440140, 440655, 450111, Geschirrspuelautomat-335, Geschirrspuelautomat-336, GsP-350		
accessories for	415431		
	GEV No.	510415	Ref. No. —
	gasket L 75mm W 23mm hole distance 50mm 4 holes for heating element type DB 70 code L with thermostat sensor hole		
	GEV No.	520238	Ref. No. —
	flange L 80mm W 28mm hole distance 13mm 5 holes type DB 70 code L		











GEV No.	415432	Ref. No.	350206
description	heating element 3000W 230V heating circuits 1 flange 70x18mm L 370mm W 58mm connection male faston 6.3mm tube ø 8.5mm immersion heater expansion flange connection length 17mm TD ø 6mm		
For models:	271500, 337xxx, 353167, 354392, 354457, GsP-500, GsP-600		
accessories for	415432		
	GEV No.	510415	Ref. No. —
	gasket L 75mm W 23mm hole distance 50mm 4 holes for heating element type DB 70 code L with thermostat sensor hole		
	GEV No.	520238	Ref. No. —
	flange L 80mm W 28mm hole distance 13mm 5 holes type DB 70 code L		













GEV No.	415429	Ref. No.	350176
description	heating element 4000W 230V heating circuits 2 flange 70x18mm L 370mm W 60mm H 55mm L1 20mm L2 60mm L3 290mm H1 55mm connection male faston 6.3mm immersion heater expansion flange 70x18		
For models:	353167, 354392, 354457, 361763, 378933, 440078, 440086, 440094, 440140, 440655, 450111, Geschirrspuelautomat-335, Geschirrspuelautomat-336, GsP-350		
accessories for	415429		
	GEV No.	510412	Ref. No. —
	gasket L 77mm W 24mm hole distance 50mm 5 holes for heating element type DB 70		
	GEV No.	520238	Ref. No. —
	flange L 80mm W 28mm hole distance 13mm 5 holes type DB 70 code L		





			
1			
GEV No.	415433	Ref. No.	350192
description	heating element 6000W 230V heating circuits 2 flange 70x18mm L 372mm W 58mm H 54mm L1 28mm L2 70mm L3 274mm connection male faston 6.3mm immersion heater connection length 24mm expansion flange		
For models:	271500, 337xxx, 353167, 354392, 354457, GsP-500, GsP-600		
accessories for	415433		
	GEV No.	510412	Ref. No. —
	gasket L 77mm W 24mm hole distance 50mm 5 holes for heating element type DB 70		
	GEV No.	520238	Ref. No. —
	flange L 80mm W 28mm hole distance 13mm 5 holes type DB 70 code L		

accessories for	415405		
	GEV No.	520235	Ref. No. —
	3 hole flange hole distance 70.5mm perforation ø 6.5mm ID ø 53.5mm		
	GEV No.	520236	Ref. No. —
	flange for heating element ID ø 50mm ED ø 90mm hole ø 6.5mm 3 holes		
	GEV No.	521012	Ref. No. —
	gasket graphite ED ø 15mm ID ø 5mm thickness 1.2mm Qty 1 pcs		
	GEV No.	550002	Ref. No. —
	tension strap H 10mm L 21mm W 10mm hole ø 6.5mm for heating element		
	GEV No.	550362	Ref. No. —
	blind flange ø 64mm mounting ø 47.5mm		

with round flange ø47.5mm			
			
1			
GEV No.	415604	Ref. No.	702196
description	heating element 3000W 230/400V heating circuits 3 L 160mm W 36mm H 25mm connection male faston 6.3mm immersion heater round flange mounting ø 47.5mm		
For models:	690570		
accessories for	415604		
	GEV No.	510408	Ref. No. 349232
	O-ring EPDM thickness 5.34mm ID ø 47mm Qty 1 pcs		
	GEV No.	510562	Ref. No. —
	O-ring silicone thickness 5.34mm ID ø 47mm Qty 1 pcs		
	GEV No.	520235	Ref. No. —
	3 hole flange hole distance 70.5mm perforation ø 6.5mm ID ø 53.5mm		
	GEV No.	520236	Ref. No. —
	flange for heating element ID ø 50mm ED ø 90mm hole ø 6.5mm 3 holes		
	GEV No.	550002	Ref. No. —
	tension strap H 10mm L 21mm W 10mm hole ø 6.5mm for heating element		
	GEV No.	550362	Ref. No. —
	blind flange ø 64mm mounting ø 47.5mm		



1"			
			
1			
GEV No.	415195	Ref. No.	209538
description	heating element 2500W 230V heating circuits 1 thread 1" L 200mm W 20mm H 20mm tube ø 8.5mm connection male faston 6.3mm immersion heater flange with thread		
For models:	Glaeserspuelautomat-310, Glaeserspuelautomat-311, Glaeserspuelautomat-320, Glaeserspuelautomat-321		
accessories for	415195		
	GEV No.	510404	Ref. No. —
	flat gasket fibre ED ø 44mm ID ø 34mm thickness 2mm Qty 1 pcs		
	GEV No.	510422	Ref. No. —
	gasket copper ED ø 37.7mm ID ø 32.5mm thickness 2.7mm for thread 1"		
	GEV No.	520233	Ref. No. —
	nut thread 1" H 6mm brass WS 47 Qty 1 pcs		

			
1			
GEV No.	415405	Ref. No.	826677
description	heating element 6000W 230V heating circuits 3 L 465mm W 38mm H 24mm tube ø 6.3mm connection male faston 6.3mm immersion heater round flange mounting ø 47.5mm		
For models:	00443x, 00457x, 136581		
spare parts for	415405		
	GEV No.	504148	Ref. No. —
	boiler		

1½"			
			
1			
GEV No.	415402	Ref. No.	103268 290645
description	heating element 6000W 400/230V heating circuits 3 thread 1½" L 425mm W 35mm H 35mm thermostat sleeves ø 7mm length thermostat sleeves 330mm thermostat sleeve centre not clinging tube ø 8.5mm connection M4 immersion heater flange with thread WS 60 no original spare part number of thermostat sleeves 1		
For models:	Maxima-Elektro-Kochkessel-100, Maxima-Elektro-Kochkessel-700-850, Maxima-Elektro-Kochkessel-80		
spare parts for	415402		
	GEV No.	510406	Ref. No. —
	flat gasket fibre ED ø 60mm ID ø 48mm thickness 3mm for thread 1½" Qty 1 pcs		
accessories for	415402		
	GEV No.	510424	Ref. No. —
	gasket copper ED ø 55mm ID ø 48mm thickness 2.2mm Centellen for thread 1½"		
	GEV No.	520211	Ref. No. —
	reducer thread 2" ET - 1½" IT brass		

Table continues overleaf







accessories for	415402		
	GEV No.	520212	Ref. No. —
	hexagonal nut thread 1½" brass WS 60 H 8mm		
	GEV No.	550361	Ref. No. —
	blind flange ø 58mm thread 1½"		







1	GEV No.	415010	Ref. No.	349577
description	heating element 2000W 230V heating circuits 1 L 260mm W 125mm H 20mm L1 110mm L2 150mm W1 42mm W2 83mm thread M10x1 mounting distance 70mm tube ø 6.5mm connection M4 immersion heater 2 hole fixing			
For models:	665843, 665851, Glaeserspielautomat-325, Glaeserspielautomat-328			
spare parts for	415010			
	GEV No.	510416	Ref. No.	—
	flat gasket fibre ED ø 19mm ID ø 10.5mm thickness 1.5mm for thread M10 Qty 1 pcs			
accessories for	415010			
	GEV No.	504306	Ref. No.	—
	gasket fibre ED ø 16mm ID ø 10mm thickness 2mm Qty 1 pcs			
	GEV No.	510893	Ref. No.	—
	O-ring EPDM thickness 2.62mm ID ø 9.92mm Qty 1 pcs			
	GEV No.	520231	Ref. No.	—
	nut thread M10x1 H 6mm WS 14 zinc-coated steel Qty 1 pcs			
	GEV No.	521103	Ref. No.	—
	nut thread M4 H 3mm WS 7 brass Qty 20 pcs			
	GEV No.	521104	Ref. No.	—
	washer ID ø 4.3mm ED ø 8mm thickness 0.5mm brass Qty 20 pcs for thread M4			
	GEV No.	521129	Ref. No.	—
	nut thread M10 H 6mm SS WS 17 Qty 1 pcs DIN/ISO DIN 439			
	GEV No.	560111	Ref. No.	—
	plain washer ID ø 4.3mm ED ø 9mm thickness 0.8mm SS Qty 20 pcs DIN 125A for thread M4			
	GEV No.	560131	Ref. No.	—
	hexagonal nut thread M4 H 3.2mm WS 7 SS DIN/ISO DIN 934 / ISO 4032/8673 Qty 20 pcs			



1	GEV No.	415397	Ref. No.	233978
description	heating element 2500W 230V heating circuits 1 L 273mm W 85mm thread M14x1.5 mounting distance 77mm tube ø 8.5mm connection length 15mm 2 hole fixing immersion heater connection male faston 6.3mm			
For models:	353167, 354392, 354457, 361763, 378933, 440078, 440086, 440094, 440140, 440655, 450111, Geschirrspielautomat-330, GSp-350			
spare parts for	415397			
	GEV No.	510417	Ref. No.	—
	flat gasket fibre ED ø 20mm ID ø 14mm thickness 2mm Qty 1 pcs			

accessories for	415397		
	GEV No.	361182	Ref. No. —
	nut thread 1/4" H 5mm nickel-plated brass WS 17 Qty 1 pcs		
	GEV No.	520228	Ref. No. —
	tooth lock washer ID ø 15.3mm ED ø 24mm steel Qty 1 pcs for thread M14		
	GEV No.	550262	Ref. No. —
	flat gasket copper ED ø 20mm ID ø 14mm thickness 2mm		



1	GEV No.	415438	Ref. No.	187003 381233
description	heating element 4000W 220V L 430mm W 30mm H 37mm mounting distance 22mm thread M12x1 connection M4 tube ø 8.5mm 2 hole fixing immersion heater			
For models:	674524, 674532, 674605, 810002, 813303, 890529, 890561, 890588, Heissluftdaempfer-10x1-1, Heissluftdaempfer-20x1-1			
accessories for	415438			
	GEV No.	510413	Ref. No.	—
	flat gasket L 43mm W 19mm hole ø 12mm hole distance 24mm copper thickness 2.3mm for heating element			
	GEV No.	520229	Ref. No.	—
	nut thread M12x1 H 4mm WS 16 zinc-coated steel Qty 1 pcs			
	GEV No.	521103	Ref. No.	—
	nut thread M4 H 3mm WS 7 brass Qty 20 pcs			
	GEV No.	521104	Ref. No.	—
	washer ID ø 4.3mm ED ø 8mm thickness 0.5mm brass Qty 20 pcs for thread M4			
	GEV No.	521110	Ref. No.	—
	flat gasket fibre ED ø 20mm ID ø 13mm thickness 2mm Qty 1 pcs			
	GEV No.	521131	Ref. No.	—
	nut thread M12x1 H 3.5mm WS 17 SS Qty 1 pcs			
	GEV No.	528110	Ref. No.	—
	O-ring EPDM thickness 2.62mm ID ø 12.37mm Qty 1 pcs			
	GEV No.	560111	Ref. No.	—
	plain washer ID ø 4.3mm ED ø 9mm thickness 0.8mm SS Qty 20 pcs DIN 125A for thread M4			
	GEV No.	560131	Ref. No.	—
	hexagonal nut thread M4 H 3.2mm WS 7 SS DIN/ISO DIN 934 / ISO 4032/8673 Qty 20 pcs			



heating elements for convection







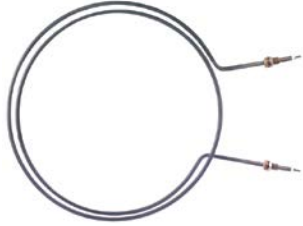

1

GEV No.	418739	Ref. No.	742414
description	heating element 10500W 230V heating circuits 3 ID ø 411mm ED ø 428mm L 480mm H 110mm L1 52mm W1 99mm H1 18mm H2 92mm flange length 130mm flange width 54mm hole distance 55mm connection M5 connection length 96mm tube ø 8.5mm convection heating element mounting thread M6 rectangular flange with thread bolt		
For models:	754595, 754609, 754676, 754681, 754692, 754706, 754749, 757365, 757373, 757381, 757403, 758736, 759201, 759678, 759686, 759694		
accessories for	418739		
	GEV No.	551240	Ref. No. —
	gasket L 129mm W 87mm D1 ø 12mm D2 ø 7mm 12 holes graphite thickness 1mm		



1

GEV No.	418766	Ref. No.	101125
description	heating element 4500W 230V heating circuits 1 ID ø 380mm ED ø 405mm L 530mm L1 100mm H 17mm thread M14x1.5 connection M4 tube ø 8.5mm		
For models:	674524, 674532, 674559, 674605, 674680, 674699, 674710, Heissluft-daempfer-10x1-1, Heissluftdaempfer-5x1-1, Heissluftdaempfer-6x1-1, Heissluftdaempfer-Varioplus-20x1-1, Heissluftgeraet-10x1-1, Heissluftgeraet-5x1-1		
spare parts for	418766		
	GEV No.	510417	Ref. No. —
	flat gasket fibre ED ø 20mm ID ø 14mm thickness 2mm Qty 1 pcs		
accessories for	418766		
	GEV No.	520228	Ref. No. —
	tooth lock washer ID ø 15.3mm ED ø 24mm steel Qty 1 pcs for thread M14		
	GEV No.	520230	Ref. No. —
	nut thread M14x1.5 H 5mm WS 19 zinc-coated steel Qty 1 pcs		
	GEV No.	521101	Ref. No. —
	nut thread M14x1.5 H 5mm WS 19 SS Qty 1 pcs		
	GEV No.	550262	Ref. No. —
	flat gasket copper ED ø 20mm ID ø 14mm thickness 2mm		







1

GEV No.	415805	Ref. No.	693383
description	heating element 5700W 230V heating circuits 3 ID ø 206mm ED ø 245mm L 290mm H 42mm L1 45mm W1 97mm H1 2mm H2 40mm flange length 110mm flange width 20mm hole distance 35mm connection male faston 6.3mm connection length 58mm tube ø 6.3mm convection heating element hole ø 6.5mm rectangular flange		
For models:	671568, 671576, 671584, 671592, 671606, 671614, 671622, 671630, 758752, 758760, 758981, 759007, 759015, 759023, 759031, 759058, 759066, 759074, 759171, 759198		



1

GEV No.	415133	Ref. No.	399329
description	heating element 1430W 230V heating circuits 1 L 85mm W 395mm connection male faston 6.3mm tube ø 6.3mm thread M10x1 2 hole fixing dry heating element mounting distance 389mm		
For models:	390003, 397776, 397784, 397792, 397806, 397814, 397822, 397830, 397849, 397857, 397865, 397873, 399019, 399027, 399035, 399043, 399051, 399078, 399086, 399094, 399108, 399116, 609544, 609552, 609560, 645893, 645907, 645915, 645923, 645931, 645958, 645966, 645974, 645982, 645990, 646024, 646032, 674710, 674788, 674818, HLD-2011		
accessories for	415133		
	GEV No.	520231	Ref. No. —
	nut thread M10x1 H 6mm WS 14 zinc-coated steel Qty 1 pcs		
	GEV No.	521129	Ref. No. —
	nut thread M10 H 6mm SS WS 17 Qty 1 pcs DIN/ISO DIN 439		
	GEV No.	528433	Ref. No. 097071
	flat gasket copper ED ø 14mm ID ø 10mm thickness 1mm		



1







GEV No.	415221	Ref. No.	332429
description	heating element 1430W 230V heating circuits 1 L 90mm W 390mm connection male faston 6.3mm tube ø 6.3mm thread M10x1 2 hole fixing dry heating element mounting distance 376mm		
For models:	674664, 674672, Heissluftdaempfer-10x1-1, Heissluftdaempfer-6x1-1		
spare parts for	415221		
	GEV No.	510416	Ref. No. —
	flat gasket fibre ED ø 19mm ID ø 10.5mm thickness 1.5mm for thread M10 Qty 1 pcs		
accessories for	415221		
	GEV No.	510893	Ref. No. —
	O-ring EPDM thickness 2.62mm ID ø 9.92mm Qty 1 pcs		



Table continues overleaf

accessories for 415221			
	GEV No.	520231	Ref. No. —
nut thread M10x1 H 6mm WS 14 zinc-coated steel Qty 1 pcs			
	GEV No.	521129	Ref. No. —
nut thread M10 H 6mm SS WS 17 Qty 1 pcs DIN/ISO DIN 439			
	GEV No.	528433	Ref. No. 097071
flat gasket copper ED ø 14mm ID ø 10mm thickness 1mm			

			
1			
GEV No.	418970	Ref. No.	585726
description	heating element 1450W 230V heating circuits 1 L 90mm W 315mm		
For models:	390003, 397229, 397237, 397245, 397253, 397261, 397288, 397296, 397318, 397326, 397334, 397342, 397350, 397776, 397784, 397792, 397806, 397814, 397822, 397830, 397849, 397857, 397865, 397873, 606316, 606324, 606332, 606340, 606359, 606367, 645893, 645907, 645915, 645923, 645931, 645958, 645966, 645974, 645982, 645990, 646024, 646032, 646040, 646059, 646067, 646768, 646776, 646784, 646792, 646806...(Other models you can see in the webshop)		

radiation heaters

square

			
1			
GEV No.	490159	Ref. No.	830127
description	radiation heater L 300mm W 300mm 3500W 230V connections 3 square without pan detection EGO		
spare parts for	490159		
	GEV No.	499157	Ref. No. —
protection pipe for temperature probe ceramic L 297mm ED ø 7mm ID ø 5mm			

			
1			
GEV No.	416911	Ref. No.	826715
description	radiation heater rectangular 3200W 400V L 420mm W 278mm		
For models:	004081, 105872		

			
1			
GEV No.	416907	Ref. No.	171646
description	radiation heater rectangular 3500W 400V L 415mm W 275mm H 46mm heating circuits 2 connections 2		
For models:	750204, 750212, 750220, 750239		

			
1			
GEV No.	416897	Ref. No.	186406
description	radiation heater rectangular 3500W 400V L 415mm W 275mm H 46mm heating circuits 2 connections 2x 2		
For models:	750336, 750352, 750360		

			
1			
GEV No.	416895	Ref. No.	159832
description	radiation heater rectangular 5200W 230V L 530mm W 300mm heating circuits 2		
For models:	750077, 750085, 750093, 750107, 750115		

1-circuit

			
1			
GEV No.	490131	Ref. No.	689181
description	radiation heater ø 250mm 2500W 400V heating circuits 1 energy regulation with temperature signalization with ribbon heater connections 2+2 connection type male faston 6.3mm EGO		
For models:	672300, 706272		



2-circuit



1

GEV No.	490028	Ref. No.	155276
description	radiation heater ø 230mm 2100W 230V heating circuits 2 energy regulation with temperature signalization partial power 650W with heating coil connections 3+2 connection type male faston 6.3mm EGO		
For models:	750077, 750085, 750093, 750107, 750115		



1

GEV No.	490068 ¹	Ref. No.	290610
description	hot plate dimensions 220x220mm 2600W 400V with spill ring connection 4 screw clamps protector yes square		
For models:	Maxima-Elektro-Herd-700-850, Maxima-Elektro-Herd-850		

¹incl. protector

hot plates

square & rectangular

with radiused edge



1

GEV No.	490067	Ref. No.	290599
description	hot plate dimensions 220x220mm 2000W 400V with spill ring connection 4 screw clamps protector no square		
For models:	Maxima-Elektro-Herd-700-850, Maxima-Elektro-Herd-850		
accessories for	490067		
	GEV No.	693464	Ref. No.
	sealing cord ø 10mm Qty supplied by meter		



1

GEV No.	490128 ¹	Ref. No.	290629
description	hot plate dimensions 300x300mm 2500W 400V with spill ring connection 4 screw clamps protector yes square		
For models:	Maxima-Elektro-Herd-700-850, Maxima-Elektro-Herd-850		

¹incl. protector



1

GEV No.	490074 ¹	Ref. No.	290637
description	hot plate dimensions 300x300mm 4000W 400V with spill ring connection 4 screw clamps protector yes square		
For models:	Maxima-Elektro-Herd-700-850, Maxima-Elektro-Herd-850		

¹incl. protector



1

GEV No.	490066 ¹	Ref. No.	081922
description	hot plate dimensions 220x220mm 2600W 230V with spill ring connection 4 screw clamps protector yes square		
For models:	616001, 616109, 623008, 623105, Elektroherd-4-Platten-623, Elektroherd-616		

¹incl. protector

round

with radiused edge

for domestic and commercial kitchens



1

GEV No.	490015	Ref. No.	290572
description	hot plate ø 180mm 1500W 400V connection 4 screw clamps with 8mm spill ring		
For models:	Maxima-Elektro-Herd-700-850, Maxima-Elektro-Herd-850		



1

GEV No.	490017	Ref. No.	290602
description	hot plate ø 180mm 2000W 400V connection 4 screw clamps with 8mm spill ring		
For models:	Maxima-Elektro-Herd-700-850, Maxima-Elektro-Herd-850		



1

GEV No.	490019	Ref. No.	290580
description	hot plate ø 220mm 2000W 400V connection 4 screw clamps with 8mm spill ring		
For models:	Maxima-Elektro-Herd-700-850, Maxima-Elektro-Herd-850		

energy regulators

EGO

1-circuit



1

GEV No.	380016	Ref. No.	201006
description	energy regulator 230V 12A dual circuit turn direction right with operation switch 1-pole		
For models:	750077, 750085, 750093, 750107, 750115		



1

GEV No.	380015	Ref. No.	314544
description	energy regulator 230V 13A single-circuit turn direction right shaft ø 6x4.6mm shaft L 23mm mounting thread M4 power release 6-100% no. 50.57021.010		
For models:	503010, 503150, 517887, 574961, 610038, 61030x, 610402, 610429, 620203, 620300, 620408, 620424, 637564, 657735, 659002, 685003, 686018, 686026, 686034, 686298, 688428, 700673, 702560, 706000, FOEM-Kippbratpfanne-Elektro, ODWB-1040-Waermebruecken, ODWB-1240-Waermebruecken, ODWB-1440-Waermebruecken, ODWB-1640-Waermebruecken, ODWB-1840-Waermebruecken, ODWB-2040-Waermebruecken, OEWB-1040-Wand-Waermeborde, OEWB-1240-Wand-Waermeborde, OEWB-1440-Wand-Waermeborde, OEWB-1640-Wand-Waermeborde, OEWB-1840-Wand-Waermeborde, OEWB-2040-Wand-Waermeborde, steakgrill-61030, steakgrill-62030		



1

GEV No.	380013	Ref. No.	689394
description	energy regulator 400V 7A single-circuit turn direction right shaft ø 6x4.6mm mounting thread M4 no. 50.57031.010		
For models:	672300, 706272		

accessories

knobs



1

GEV No.	110235	Ref. No.	341894
description	knob energy regulator 1-3 t.max.°C ø 50mm shaft ø 6x4.6mm shaft flat upper black		
For models:	610038, 610429, 620203, 620424		

thermostats

bi-metal thermostats

bi-metal thermostats



1

GEV No.	390123	Ref. No.	679194
description	bi-metal thermostat hole distance 23.8mm switch-off temp. 50°C 1NC 1-pole 16A 250V connection F6.3 2 hole fixing		



1

GEV No.	390319	Ref. No.	676551
description	bi-metal thermostat hole distance 23.8mm switch-off temp. 80°C 1NC 1-pole 16A connection F6.3 2 hole fixing		
For models:	505900, 505935, 663263, 663395, 670618, 670626, 686409, 687200, 688096, 688118, 688363, 690600, 703095, 703109, 703117, 703125, 709816, 709824, 709832, 709840, 733105, 733113, 736422, 736430		



control and safety thermostats

EGO

control thermostats

55.10/19_series



GEV No.	375070	Ref. No.	091634
description	thermostat t.max. 250°C temperature range 55-250°C 1-pole 1CO 16A probe ø 3.1mm probe L 226mm capillary pipe 1170mm capillary pipe isolated 1100mm gland nut M9x1 shaft L 23mm shaft position upper rotation 270°		
For models:	140902, 367788, 382191, 385018, 385026, 385034, 385042, 385050, 385514, 389595, 389609, 390003, 397210, 397229, 397237, 397245, 397253, 397261, 397288, 397296, 397318, 397326, 397334, 397342, 397350, 397431, 397776, 397784, 397792, 397806, 397814, 397822, 397830, 397849, 397857, 397865, 397873, 398047, 398055, 398063, 398071, 398098, 398101, 398128, 398136, 398144, 398152, 398950, 398969, 398977...(Other models you can see in the webshop)		

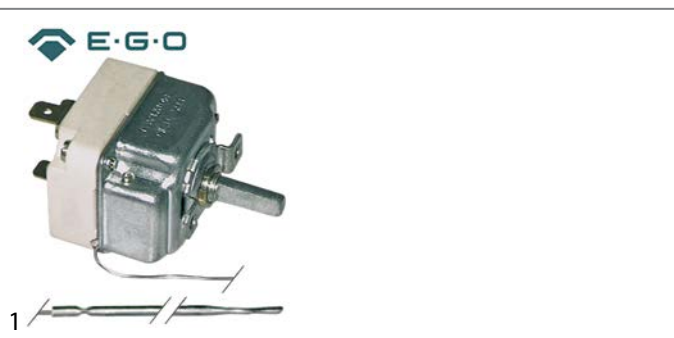

GEV No.	390307	Ref. No.	376035
description	thermostat t.max. 86°C temperature range 30-82°C 1-pole 1CO 16A probe ø 3mm probe L 156mm capillary pipe 600mm capillary pipe isolated 600mm gland nut shaft ø 6x4.6mm shaft L 8.5mm shaft position left rotation 180° outer switch eccentric 1/2"-3/4" contacts 1CO		
For models:	Glaeserspielautomat-328		



GEV No.	375135	Ref. No.	337609
description	thermostat t.max. 91°C temperature range 25-90°C 1-pole 1CO 16A probe ø 6mm probe L 174mm capillary pipe 900mm capillary pipe isolated 900mm gland nut shaft ø 6x4.6mm shaft L 23mm shaft position upper rotation 270° probe material SS		
For models:	271500, 337xxx, 340022, 340030, 340049, 340057, 340073, 340xxx, 353167, 354392, 354457, 361763, 378933, 440078, 440086, 440094, 440140, 440655, 450111, 614106, 615080, 624101, Bain-Marie-626, Frittenwanne-615, Geschirrspuelautomat-330, Geschirrspuelautomat-335, Geschirrspuelautomat-336, Geschirrspuelautomat-700, GsP-350, GsP-500, GsP-600		

55.13_series



GEV No.	375179	Ref. No.	371017
description	thermostat t.max. 131°C temperature range 80-131°C 1-pole 1NO 16A probe ø 6mm probe L 98mm capillary pipe 1730mm capillary pipe isolatedmm gland nut shaft ø 6x4.6mm shaft L 23mm shaft position upper rotation 270°		
For models:	361429, 361437, Heisse-Theke-HT-50-85-und-120-3, HTP1, HTP2		



GEV No.	375193	Ref. No.	637718
description	thermostat t.max. 300°C temperature range 50-300°C 1-pole 1NO 16A probe ø 4mm probe L 91mm capillary pipe 1130mm capillary pipe isolated 1100mm gland nut shaft L 23mm shaft position upper rotation 270°		
For models:	541869, 638625		



GEV No.	375505	Ref. No.	202029
description	thermostat t.max. 320°C temperature range 50-320°C 1-pole 1NO 16A probe ø 3mm probe L 160mm capillary pipe 870mm capillary pipe isolatedmm gland nut shaft ø 6x4.6mm shaft L 23mm shaft position upper rotation 270°		
For models:	750204, 750212, 750220, 750239, 750336, 750352, 750360		



GEV No.	375006	Ref. No.	349313
description	thermostat t.max. 85°C temperature range 30-85°C 1-pole 1CO 16A probe ø 6mm probe L 92mm capillary pipe 3150mm capillary pipe isolated 300mm gland nut shaft L 23mm shaft position upper rotation 270° probe material SS		
For models:	Glaeserspuelautomat-325		

55.14_series



GEV No.	390001	Ref. No.	349305
description	thermostat t.max. 58°C temperature range fixed 58°C 1-pole 1NC 16A probe ø 11 mm probe L 35mm capillary pipe 580mm capillary pipe isolated 580mm gland nut shaft Lmm shaft position° shaft position screw-in probe probe thread M14x1		
For models:	Glaeserspuelautomat-325, Glaeserspuelautomat-328		
accessories for	390001		
	GEV No.	510417	Ref. No. —
	flat gasket fibre ED ø 20mm ID ø 14mm thickness 2mm Qty 1 pcs		
	GEV No.	550261	Ref. No. —
	nut thread M14x1 H 4mm WS 19 SS Qty 1 pcs		

55.34_series



GEV No.	375021	Ref. No.	291706
description	thermostat t.max. 110°C temperature range 32-110°C 3-pole 3CO 16A probe ø 6mm probe L 138mm capillary pipe 2980mm capillary pipe isolated 2200mm gland nut M9x1 shaft ø 6x4.6mm shaft L 23mm shaft position upper rotation 270°		
For models:	Maxima-Elektro-Kochkessel-100, Maxima-Elektro-Kochkessel-700-850, Maxima-Elektro-Kochkessel-80		



GEV No.	375143	Ref. No.	290319
description	thermostat t.max. 110°C temperature range 32-110°C 3-pole 3NO 16A probe ø 6mm probe L 138mm capillary pipe 1480mm capillary pipe isolated 1100mm gland nut M9x1 shaft ø 6x4.6mm shaft L 23mm shaft position upper rotation 270°		
For models:	140902, 667412, 684848, 688436, 689335, 689343, 689351, 689378, 718793, Maxima-Elektro-Bain-Marie-700-850, Maxima-Elektro-Bain-Marie-850		



GEV No.	375697	Ref. No.	136840
description	thermostat t.max. 120°C temperature range fixed 120°C 2-pole 2CO 16A probe ø 3.1mm probe L 305mm capillary pipe 720mm capillary pipe isolated 600mm gland nut shaft Lmm		
For models:	502200, 502308, 601004, 601209, 601403, 602000, 602205, 602280, 603201, 649554, 649562, 650943, 650951, 686336, 688339, 688347, 688355, 699047, 699055, 721468, 722588, 750255, Fritteuse-365, Topline-Fritteuse		
accessories for	375697		
	GEV No.	550039	Ref. No. —
	probe clip for pipe ø 8.5mm for probe ø 3.1mm Qty 1 pcs		



GEV No.	375058	Ref. No.	178144
description	thermostat t.max. 185°C temperature range 95-185°C 3-pole 3NO 16A probe ø 6mm probe L 117mm capillary pipe 1480mm capillary pipe isolated 800mm gland nut shaft ø 6x4.6mm shaft L 23mm shaft position upper rotation 270°		
For models:	600008, 600067, 601004, 601209, 601403, 602000, 602205, 602280, 603007, 603023, 603201, Fritteuse-600, Fritteuse-601, Fritteuse-602, Fritteuse-603		
accessories for	375058		
	GEV No.	550148	Ref. No. —
	gland duct ET M12x0.75 IT M9x1 probe ø max. 6.5mm WS 17 silicone		

Table continues overleaf

accessories for	375058			
	GEV No.	550982	Ref. No.	—
	gasket graphite ø 7.5mm L 7mm Qty 1 pcs for gland nut			

 			
GEV No.	375390	Ref. No.	723231
description	thermostat t.max. 300°C temperature range 50-300°C 3-pole 3NO 16A probe ø 4mm probe L 292mm capillary pipe 880mm capillary pipe isolated 800mm gland nut shaft ø 6x4.6mm shaft L 23mm shaft position upper		
For models:	541869, 638625, 730416		

 			
GEV No.	375057	Ref. No.	224081
description	thermostat t.max. 300°C temperature range 60-300°C 3-pole 3NO 16A probe ø 4mm probe L 128mm capillary pipe 880mm capillary pipe isolated 800mm gland nut shaft L 23mm shaft position upper rotation 270°		
For models:	502650, 502707, 610003, 610038, 610402, 611018, 611050, 611220, 612006, 612057, 620009, 621005, 621056, 621110, 622001, 622052, 629006, 629022, 686328, 688290, Backofen-629, Brater-611, Brater-621, Griddle-Platte-612, Griddleplatte-622, Vario-Braeter-400, Vario-Braeter-600, Wurstgrill-610, Wurstgrill-620		

 			
GEV No.	390282	Ref. No.	283878
description	thermostat t.max. 300°C temperature range 95-300°C 3-pole 3CO 16A probe ø 6mm probe L 177mm capillary pipe 880mm capillary pipe isolated 800mm gland nut shaft ø 6x4.6mm shaft L 23mm shaft position upper rotation 270°		
For models:	62510, 62520, 62530, 626104, 626112, 626201, 626228, 626309, 626317, 721476, 721484, 722596, 722618		

 			
GEV No.	375026	Ref. No.	290300 291730
description	thermostat t.max. 350°C temperature range 100-350°C 3-pole 3NO 16A probe ø 6mm probe L 77mm capillary pipe 2430mm capillary pipe isolated 1100mm gland nut shaft ø 6x4.6mm shaft L 23mm shaft position upper rotation 270°		
For models:	Maxima-Elektro-Backofen-700-850, Maxima-Elektro-Backofen-850, Maxima-Elektro-Kippbratpfanne-700-850		

 			
GEV No.	375101	Ref. No.	126543
description	thermostat t.max. 360°C temperature range 140-360°C 3-pole 3NO 16A probe ø 4mm probe L 292mm capillary pipe 990mm capillary pipe isolated 500mm gland nut shaft L 23mm shaft position upper rotation 318°		
For models:	Pizza-Ofen-ELP		

 			
GEV No.	375018	Ref. No.	277096
description	thermostat t.max. 90°C temperature range fixed 55/90°C 2-pole 2CO 16A probe ø 6mm probe L 175mm capillary pipe 360mm capillary pipe isolated 210mm gland nut shaft Lmm probe material copper		
For models:	361763, 378933, 440078, 440086, 440094, 440140, 440655, 450111, Geschirrspuelautomat-330, GsP-350		



GEV No.	375174	Ref. No.	006955
description	thermostat t.max. 93°C temperature range 30-93°C 3-pole 3CO 16A probe ø 6mm probe L 235mm capillary pipe 880mm capillary pipe isolated 700mm gland nut M9x1 shaft ø 6x4.6mm shaft L 23mm shaft position upper rotation 270°		
For models:	340022, 340030, 340049, 340057, 340073, 614009, 614404, 615005, 615013, 615056, 615080, 624004, 627100, Bain-Marie-614, Bain-Marie-624, Elektro-Waermeschrank, OEWs1245-einseitig-400x1200mm, OEWs1246-einseitig-mit-Rueckwandverkleidung, UDWE1225L, UDWE1225L-doppelseitig-Eck-640x1200mm, UDWE1225R, UDWE1225R-doppelseitig-Eck-640x1200mm, UDWF0825, UDWF0825D-doppelseitig-640x800mm, UDWs1225, UDWs1225-doppelseitig-640x1200mm, UEWf0825, UEWf0825D-einseitig-640x800mm, UEWs06-schubladenblock-640x600mm, UEWs1225, UEWs1225-doppelseitig-640x1200mm, UEWs1225-einseitig-640x1200mm, UGWF0835, UGWF0835D-Fluegeltuer-710x800mm, UGWs1235, UGWs1235-schiebetuer-710x1200mm		

55.40_ series



GEV No.	375658	Ref. No.	634980
description	thermostat t.max. 300°C temperature range 60-204°C/135-300°C 4-pole 2NO/2NO 16A probe ø 4mm probe L 128mm capillary pipe 880mm capillary pipe isolated 800mm gland nut shaft ø 6x4.6mm shaft L 23mm shaft position upper rotation 310°		
For models:	503010, 503150, 517887, 637564, 657735, 686298, 688428, 700673, 702560, 705993		

safety thermostats

55.11_ series



GEV No.	375093	Ref. No.	242746
description	safety thermostat switch-off temp. 318°C 1-pole 12A probe ø 4mm probe L 111mm capillary pipe 530mm capillary pipe isolated 450mm gland nut M9x1 probe SS		

55.31_ series



GEV No.	375175	Ref. No.	294020
description	safety thermostat switch-off temp. 115°C 3-pole 20A probe ø 6mm probe L 173mm capillary pipe 830mm capillary pipe isolated 770mm gland nut probe SS		
For models:	340022, 340030, 340049, 340057, 340073, 340xxx, 353167, 354392, 354457, 361763, 378933, 440078, 440086, 440094, 440140, 440655, 450111, Elektro-Waermeschrank, Geschirrspielautomat-700, OEWs1245-einseitig-400x1200mm, OEWs1246-einseitig-mit-Rueckwandverkleidung, UDWE1225L, UDWE1225L-doppelseitig-Eck-640x1200mm, UDWE1225R, UDWE1225R-doppelseitig-Eck-640x1200mm, UDWF0825, UDWF0825D-doppelseitig-640x800mm, UDWs1225, UDWs1225-doppelseitig-640x1200mm, UEWf0825, UEWf0825D-einseitig-640x800mm, UEWs06-schubladenblock-640x600mm, UEWs1225, UEWs1225-doppelseitig-640x1200mm, UEWs1225-einseitig-640x1200mm, UGWF0835, UGWF0835D-Fluegeltuer-710x800mm, UGWs1235, UGWs1235-schiebetuer-710x1200mm		



GEV No.	375524	Ref. No.	291749
description	safety thermostat switch-off temp. 135°C 3-pole 20A probe ø 6mm probe L 173mm capillary pipe 1430mm capillary pipe isolated 800mm gland nut M9x1 probe SS		
For models:	Maxima-Elektro-Kochkessel-100, Maxima-Elektro-Kochkessel-700-850, Maxima-Elektro-Kochkessel-80		



GEV No.	375072	Ref. No.	041254
description	safety thermostat switch-off temp. 170°C 3-pole 20A probe ø 3.1mm probe L 524mm capillary pipe 350mm capillary pipe isolated 350mm gland nut probe SS		
For models:	674524, 674532, 674605, 805149, 805300, 805408, 805459, 805556, 805xxx, 810002, 813303, 890529, 890561, 890588, Aromacarina, Aromacarina-Dampf, Aromacarina-EsA, Aromacarina-ETA, Aromacarina-ETA-EsA, Heissluftdaempfer-10x1-1, Heissluftdaempfer-20x1-1, Heissluftdaempfer-5x1-1, Heissluftdaempfer-5x2-3, standkaffeemaschine-solomatic-2, standkaffeemaschine-solomatic-4		



GEV No.	375059	Ref. No.	027332
description	safety thermostat switch-off temp. 255°C 3-pole 20A probe ø 3.1mm probe L 307mm capillary pipe 730mm capillary pipe isolated 700mm gland nut probe SS		
For models:	601004, 601209, 601403, 602000, 602205, 602280, 603201, 721468, 722588, Fritteuse-365, Topline-Friteuse		



GEV No.	390066	Ref. No.	088552 088562
description	safety thermostat switch-off temp. 220°C 3-pole 20A probe ø 14mm probe L 105mm capillary pipe 820mm capillary pipe isolated 660mm gland nut probe with half round bulb		
For models:	600008, 600067, 601004, 601209, 601403, 602000, 602205, 602280, 603007, 603023, 603201, Fritteuse-600, Fritteuse-601, Fritteuse-602, Fritteuse-603		



GEV No.	375680	Ref. No.	502537
description	safety thermostat switch-off temp. 365°C 3-pole 20A probe ø 4mm probe L 100mm capillary pipe 1190mm capillary pipe isolated 400mm gland nut probe SS		
For models:	144819, 502650, 502707, 516678, 626104, 626112, 626201, 626228, 626309, 626317, 639087, 686328, 688290, 699063, 716626, 725315, 730718, 811084, Vario-Braeter-400, Vario-Braeter-600, Vario-Braeter-plus		

55.32_series



GEV No.	375258	Ref. No.	961809
description	safety thermostat switch-off temp. 232°C 3-pole 20A probe ø 6mm probe L 94mm capillary pipe 900mm capillary pipe isolated 670mm gland nut M10x1 probe SS		



GEV No.	375627	Ref. No.	603589
description	safety thermostat switch-off temp. 480°C 3-pole 20A probe ø 4mm probe L 230mm capillary pipe 890mm capillary pipe isolatedmm gland nut probe probe material SS		
For models:	503010, 503150, 515892, 515906, 517887, 637564, 657735, 686298, 688428, 689696, 700673, 702560, 705993, Vario-Griller		

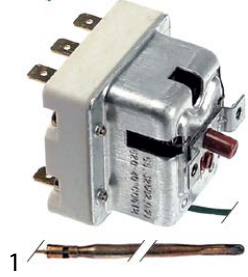

GEV No.	375681	Ref. No.	619221
description	safety thermostat switch-off temp. 520°C 3-pole 20A probe ø 3.9mm probe L 228mm capillary pipe 890mm capillary pipe isolated 400mm gland nut		
For models:	505900, 505935, 611220, 621110, 687200, 690600, Vario-Herd		

55.33_ series

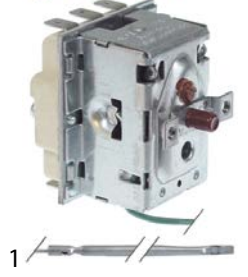

GEV No.	375698	Ref. No.	686832
description	safety thermostat switch-off temp. 250°C 3-pole 20A probe ø 3.1mm probe L 307mm capillary pipe 710mm capillary pipe isolated 700mm gland nut probe SS		
For models:	502200, 502308, 601004, 601209, 601403, 602000, 602205, 602280, 603201, 649554, 649562, 650943, 650951, 686336, 688339, 688347, 688355, 699047, 699055, 750255, Fritteuse-365		

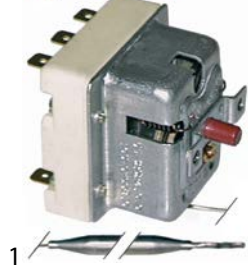

GEV No.	375516	Ref. No.	637726
description	safety thermostat switch-off temp. 250°C 3-pole 20A probe ø 6mm probe L 107mm capillary pipe 1470mm capillary pipe isolated 1100mm gland nut M9x1 probe SS		
For models:	541869, 638625, 730416		



GEV No.	375118	Ref. No.	580457
description	safety thermostat switch-off temp. 360°C 3-pole 20A probe ø 15mm probe L 8mm capillary pipe 1150mm capillary pipe isolated 1100mm gland nut probe with knob		
For models:	671568, 671576, 671584, 671592, 671606, 671614, 671622, 671630, 671649, 671657, 671665, 671673, 671681, 671711, 671746, 671754, 671762, 671770, 671789, 671797, 671800, 671819, 671827, 671835, 671843, 671851, 671878, 671886, 671894, 671908, 671916, 671975, 671983, 671991, 680583, 680591		

56._ series

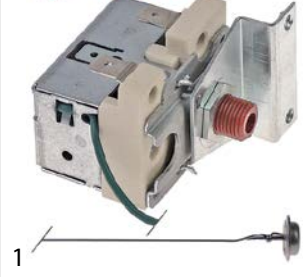

GEV No.	375889	Ref. No.	504602
description	safety thermostat switch-off temp. 360°C 1-pole 16A probe ø 15mm probe L 6.5mm capillary pipe 1140mm capillary pipe isolated 1100mm gland nut probe		
For models:	671568, 671576, 671584, 671592, 671606, 671614, 671622, 671630, 754595, 754609, 754617, 754668, 754676, 754681, 754692, 754706, 754714, 754722, 754730, 754749, 754757, 754773, 754781, 757292, 757314, 757365, 757373, 757381, 757403, 757411, 757438, 757446, 757454, 757462, 757470, 758736, 758752, 758760, 758833, 758981, 759007, 759015, 759023, 759031, 759058, 759066, 759074, 759171, 759198, 759201...(Other models you can see in the webshop)		
accessories for	375889		
	GEV No.	Ref. No.	—
	gasket PTFE ED ø 21mm ID ø 15mm thickness 3.5mm		



control thermostats with operation switch

55.13_series

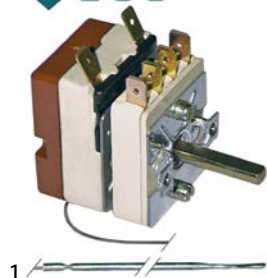

GEV No.	375073	Ref. No.	201928
description	thermostat t.max. 320°C temperature range 50-320°C 1-pole capillary pipe isolatedmm gland nut		
For models:	00068x, 00099x, 00121x, 00149x, 00183x, 001864, 002046, 002682, 00300x, 003131, 00314x, 00376x, 004081, 105716, 105759, 105872, 750026, 750034, 750042, 750050, 750069, 750077, 750085, 750093, 750107, 750115, 750336, 750352, 750360		

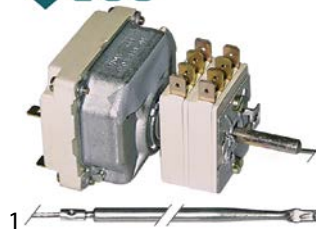

GEV No.	390266	Ref. No.	631981
description	thermostat t.max. 255°C temperature range 70-255°C 3-pole 3NO 16A probe ø 4mm probe L 128mm capillary pipe 880mm capillary pipe isolated 880mm gland nut shaft ø 6x4.6mm shaft L 23mm shaft position upper° rotation 270° outer switch 2NO/2NO		
For models:	502650, 502707, 626104, 626112, 626201, 626228, 626309, 626317, 686328, 688290, 716626, 725315, 730718, 811084		

55.34_series

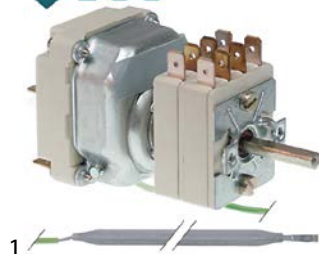

GEV No.	375592	Ref. No.	700509
description	thermostat t.max. 110°C temperature range 32-110°C 3-pole 3NO 16A probe ø 6mm probe L 138mm capillary pipe 1180mm capillary pipe isolated 1100mm gland nut shaft ø 6x4.6mm shaft L 23mm shaft position upper rotation 270° outer switch 2NO/2NO		
For models:	140902, 667412, 684848, 688436, 689335, 689343, 689351, 689378, 699020, 699039, 707503, 718793		

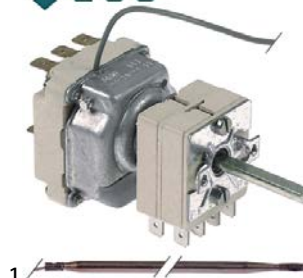

GEV No.	390530	Ref. No.	606227
description	thermostat t.max. 300°C temperature range 77-300°C 3-pole 3NO 16A probe ø 4mm probe L 128mm capillary pipe 880mm capillary pipe isolated 800mm gland nut shaft ø 6x4.6mm shaft L 33mm shaft position upper° rotation 270° outer switch 2NO/2NO		
For models:	503010, 503150, 517887, 637564, 657735, 686298, 688428, 700673, 702560		

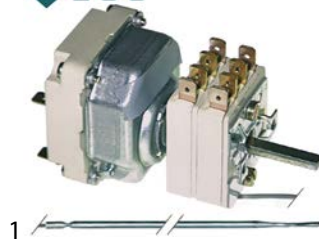

GEV No.	375023	Ref. No.	026611
description	thermostat t.max. 180°C temperature range 103-175/108-180°C 3-pole 2NO/2NO 16A probe ø 3.1mm probe L 305mm capillary pipe 720mm capillary pipe isolated 700mm gland nut shaft ø 6x4.6mm shaft L 23mm shaft position upper rotation 270° outer switch 2NO/2NO		
For models:	502200, 502308, 601004, 601209, 601403, 602000, 602205, 602280, 603201, 649554, 649562, 650943, 650951, 686336, 688339, 688347, 688355, 699047, 699055, 721468, 722588, 750255, Fritteuse-365, Topline-Friteuse		

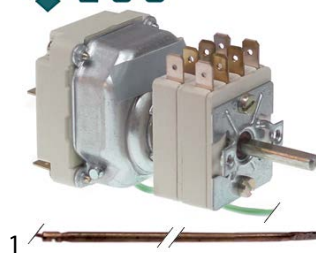

GEV No.	375691	Ref. No.	619248
description	thermostat t.max. 390°C temperature range 60-390°C 3-pole 3NO 16A probe ø 3.9mm probe L 228mm capillary pipe 1110mm capillary pipe isolated 600/700mm gland nut shaft ø 6x4.6mm shaft L 23mm shaft position upper rotation 270° outer switch 2NO/2NO		
For models:	505900, 505935, 515892, 515906, 686409, 687200, 688363, 689696, 690600, 703095, 703109, 709816, 709824, Vario-Griller, Vario-Herd		



GEV No.	375140	Ref. No.	661635
description	thermostat t.max. 650°C temperature range 50°C/50-600°C/70-650°C 3-pole 3NO 16A probe ø 4mm probe L 228mm capillary pipe 1200mm capillary pipe isolated 1200mm gland nut shaft ø 6x4.6mm shaft L 23mm shaft position left rotation 318° outer switch 2NO		
For models:	663263, 663395, 670618, 670626, 688096, 688118, 703117, 703125, 709832, 709840, 733105, 733113, 736422, 736430		



IMIT / TEMPOMATIC / ARTHERMO
control thermostats

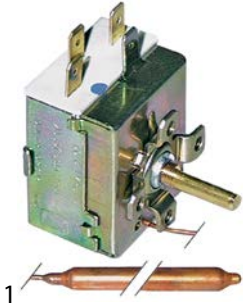

GEV No.	390186	Ref. No.	208442
description	thermostat t.max. 52°C temperature range fixed 52°C 1-pole 1CO 16A probe ø 6.5mm probe L 95mm capillary pipe 1000mm capillary pipe isolated 1000mm gland nut shaft Lmm contacts 1CO		
For models:	Glaeserspuelautomat-310, Glaeserspuelautomat-311, Glaeserspuelautomat-320, Glaeserspuelautomat-321		



GEV No.	390006	Ref. No.	208418
description	thermostat t.max. 86°C temperature range 0-86°C 1-pole 1CO 16A probe ø 6.5mm probe L 95mm capillary pipe 1500mm capillary pipe isolatedmm gland nut shaft ø 6x4.6mm shaft L 19mm rotation 270°		
For models:	Glaeserspuelautomat-310, Glaeserspuelautomat-311, Glaeserspuelautomat-320, Glaeserspuelautomat-321		

accessories for	390006			
	GEV No.	110100	Ref. No.	—
	description	knob thermostat t.max. 90°C 0-90°C ø 42mm shaft ø 6x4.6mm shaft flat -135° black		
	GEV No.	110105	Ref. No.	—
	description	rosette knob ø 42mm ø 56mm zero mark		

control thermostats with actual value



GEV No.	379034	Ref. No.	368814
description	thermostat t.max. 450°C temperature range 50-450°C 1-pole 1CO 5A probe ø 6mm probe L 30mm capillary pipe 1150mm capillary pipe isolatedmm gland nut mounting ø 80mm mounting measurements 96x96mm		
For models:	Pizza-Ofen-P501, Pizza-Ofen-P502		

accessories

protective pipes for capillary pipes



GEV No.	550146	Ref. No.	088404
description	protective pipe for capillaries thread M10x1 H1 210mm H2mm L1 25mm L2 30mm		
For models:	600008, 600067, 601004, 601209, 601403, 602000, 602205, 602280, 603007, 603023, 603201, Fritteuse-600, Fritteuse-601, Fritteuse-602, Fritteuse-603		

connecting bows



GEV No.	550059	Ref. No.	086223
description	connecting bow short for switch Qty 1 pcs		

miscellaneous



GEV No.	551115	Ref. No.	502987
description	protective plate for probe hole ø 4.4mm L 300mm W 9mm thickness 0.8mm		
For models:	502650, 502707, 686328, 688290, 716626, 811084, Vario-Braeter-400, Vario-Braeter-600		



switches and momentary switches

rocker/momentary rocker switches

30x22mm



1

GEV No.	301003	Ref. No.	053295
description	rocker switch mounting measurements 30x22mm green 2NO 250V 16A illuminated 0-I connection male faston 6.3mm ambient temperature max. 125/55°C protection IP65		
For models:	271500, 643807, 707007, 805556, 825263, Geschirrspuelautomat-330, GsP-350, GsP-500, schokomat-C		
accessories for	301003		
	GEV No.	301036	Ref. No. —
	protective cover internal size 30x22mm for rocker switch mounting measurementsmm		

push/momentary push switches

30x22mm



1

GEV No.	345863	Ref. No.	336912
description	momentary push switch mounting measurements 30x22mm clear 1NO/1NC 250V 16A illuminated connection male faston 4.8mm/6.3mm ambient temperature max. 85°C protection IP40		
For models:	361763, 367788, 378933, 382191, 385018, 385026, 385034, 385042, 385050, 385514, 397210, 397431, 440078, 440086, 440094, 440140, 440655, 450111, 606294		



1

GEV No.	301044	Ref. No.	308064
description	momentary push switch mounting measurements 30x22mm green 2NO 250V 16A illuminated		
For models:	680583, 680591, Glaeserspielautomat-325		



1

GEV No.	345865	Ref. No.	336939
description	momentary push switch mounting measurements 30x22mm yellow 1NO 250V 16A illuminated, indicator light 24V connection F4.8/F2.8 (lamp) ambient temperature max. 85°C protection IP40 1-pole		
For models:	361763, 378933, 440078, 440086, 440094, 440140, 440655, 450111, GsP-350		



1

GEV No.	301043 ¹	Ref. No.	308161
description	momentary push switch mounting measurements 30x22mm yellow 2NO 250V 16A illuminated connection male faston 6.3mm ambient temperature max. 85°C protection IP40		
For models:	Glaeserspielautomat-325, Glaeserspielautomat-328		

¹illuminated



1

GEV No.	301040 ¹	Ref. No.	266108 336904
description	push switch mounting measurements 30x22mm green 2NO 250V 16A illuminated connection male faston 6.3mm ambient temperature max. 85°C protection IP40		
For models:	340022, 340030, 340049, 340057, 340073, 353167, 354392, 354457, 361763, 378933, 440078, 440086, 440094, 440140, 440655, 450111, 643807, 668001, 669008, 707007, 825263, Glaeserspielautomat-325, Glaeserspielautomat-328, ODWB-1040-Waermebruecken, ODWB-1240-Waermebruecken, ODWB-1440-Waermebruecken, ODWB-1640-Waermebruecken, ODWB-1840-Waermebruecken, ODWB-2040-Waermebruecken, OEWB-1040-Wand-Waermeborde, OEWB-1240-Wand-Waermeborde, OEWB-1440-Wand-Waermeborde, OEWB-1640-Wand-Waermeborde, OEWB-1840-Wand-Waermeborde, OEWB-2040-Wand-Waermeborde, OEWs1245-einseitig-400x1200mm, OEWs1246-einseitig-mit-Rueckwandverkleidung, UDWE1225L, UDWE1225L-doppelseitig-Eck-640x1200mm, UDWE1225R, UDWE1225R-doppelseitig-Eck-640x1200mm, UDWF0825, UDWF0825D-doppelseitig-640x800mm, UDWs1225, UDWs1225-doppelseitig-640x1200mm, UEWF0825, UEWF0825D-einseitig-640x800mm, UEWs06-schubladenblock-640x600mm, UEWs1225, UEWs1225-doppelseitig-640x1200mm...(Other models you can see in the webshop)		

¹illuminated



1

GEV No.	301041 ¹	Ref. No.	308072
description	push switch mounting measurements 30x22mm yellow 2NO 250V 16A illuminated connection male faston 6.3mm ambient temperature max. 85°C protection IP40		
For models:	Glaeserspielautomat-325		

¹illuminated



1

GEV No.	345864 ¹	Ref. No.	336947
description	push switch mounting measurements 30x22mm yellow 2NO 250V 16A illuminated, indicator light 24V connection male faston 6.3mm ambient temperature max. 85°C protection IP40		
For models:	340022, 340030, 340049, 340057, 340073, 353167, 354392, 354457, 361763, 378933, 440078, 440086, 440094, 440140, 440655, 450111		

¹indicator light 24V



ø12mm			
			
1			
GEV No.	346594	Ref. No.	835358
description	momentary push switch mounting ø 12mm black 1NO 250V 4A connection male faston 6.3mm ambient temperature max. 85°C protection IP40		
For models:	824321, 824348		

microswitches

lever actuated

			
1			
GEV No.	345773	Ref. No.	144894 680907
description	microswitch with lever 250V 16A 1CO connection male faston 6.3mm L 60mm ambient temperature max. 125°C mounting distance 22mm actuating force: 65g lever length 51mm		
For models:	144819, 502200, 502308, 503010, 503150, 515892, 515906, 516678, 517887, 601004, 601209, 601403, 602000, 602205, 602280, 603007, 603023, 603201, 637564, 639087, 649554, 649562, 650943, 650951, 657735, 686298, 686336, 688339, 688347, 688355, 688428, 689696, 699047, 699055, 699063, 700673, 702560, 721468, 722588, 750255, Fritteuse-365, Fritteuse-600, Fritteuse-601, Fritteuse-602, Fritteuse-603, schokomat-C, Topline-Friteuse, Vario-Braeter-plus, Vario-Griller		

roller-lever actuated

heavy duty version

			
1			
GEV No.	345045	Ref. No.	163236 271551
description	microswitch with handle with a switch 250V 16A 1CO connection soldering connection L 49mm L1 55mm ambient temperature max. 85°C mounting distance 24mm type C36ZP actuating force: 95g lever length 66mm		
For models:	271500, Geschirrspuelautomat-335, Geschirrspuelautomat-336, GsP-500		

pin-plunger actuated

			
1			
GEV No.	345060	Ref. No.	242039
description	microswitch with plunger 250V 16A 1NO connection male faston 6.3mm ambient temperature max. 85°C mounting distance 22mm type BS1010 actuating force: 350g red stroke 9mm		
For models:	750255, 750263, 750271, 750298		

			
1			
GEV No.	345247	Ref. No.	218.002
description	microswitch with plunger 250V 6A 2NO connection male faston 6.3mm ambient temperature max. 85°C mounting distance 22mm type 3SE4305 actuating force: 350g black		

M10

			
1			
GEV No.	345032	Ref. No.	208477
description	microswitch with plunger thread M10x1 thread L 12mm 250V 16A 1CO connection male faston 6.3mm stroke 7mm mounting distance 22mm L 28mm ambient temperature max. 125°C type SP9603 actuating force: 180g		
For models:	Glaeserspuelautomat-310, Glaeserspuelautomat-311, Glaeserspuelautomat-320, Glaeserspuelautomat-321		

M16

			
1			
GEV No.	345046	Ref. No.	092444
description	microswitch with plunger thread M16x1 thread L 25mm 250V 5A 1NC/1NO connection male faston 6.3mm stroke 6mm ambient temperature max. 85°C actuating force: 400g		
For models:	389595, 389609, 398950, 398969, 398977, 609188, 609196, 637599, 674524, 674532, 674605, 674648, 674656, 674664, 674672, 674680, 674699, 674885, Heissluftdaempfer-10x1-1, Heissluftdaempfer-5x1-1, Heissluftdaempfer-5x2-3, Heissluftdaempfer-6x1-1, Heissluftgeraet-5x1-1, Heissluftgeraet-5x2-3		

accessories

			
1			
GEV No.	347013	Ref. No.	587141
description	lever for microswitch		
For models:	671568, 671576, 671584, 671592, 671606, 671614, 671622, 671630, 758752, 758760, 758981, 759007, 759015, 759023, 759031, 759058, 759066, 759074, 759171, 759198		



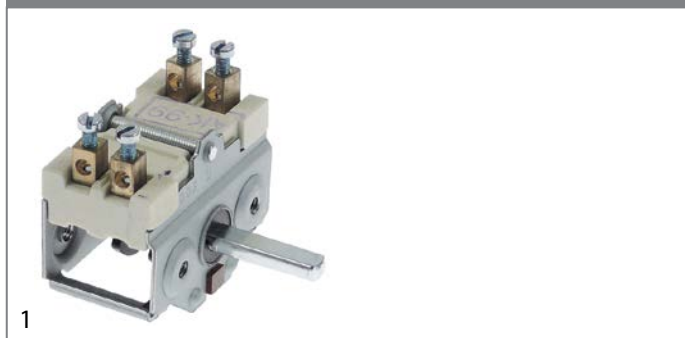

cam switches

on/off



1

GEV No.	300020	Ref. No.	291757
description	cam switch 4 operating positions 2NO sequence 0-1-0-1 16A shaft ø 6x4.6mm shaft L 23mm connection screw ceramic		
For models:	Maxima-Elektro-Kippbratpfanne-700-850, Maxima-Gas-Kippbratpfanne-neue-Ausführung-700-850		
accessories for	300020		
	GEV No.	110135	Ref. No. —
	rosette knob up to ø 52mm		
	GEV No.	110231	Ref. No. —
	knob switch 0-1-0-1 t.max.:°C°C ø 50mm shaft ø 6x4.6mm shaft flat upper black		



1

GEV No.	300021	Ref. No.	290343
description	cam switch 4 operating positions 4NO sequence 0-1-0-1 16A shaft ø 6x4.6mm shaft L 23mm connection screw ceramic		
For models:	541869, 574961, 638625, 663263, 663395, 670618, 670626, 688096, 688118, 703117, 703125, 709832, 709840, 733105, 733113, 736422, 736430, Maxima-Elektro-Kochkessel-100, Maxima-Elektro-Kochkessel-700-850, Maxima-Elektro-Kochkessel-80		



1

GEV No.	300102	Ref. No.	291722
description	cam switch 4 operating positions 4NO sequence 0-1-0-1 32A shaft ø 6x4.6mm shaft L 23mm connection screw ceramic		
For models:	144819, 516678, 639087, 699063, Maxima-Elektro-Backofen-700-850, Maxima-Elektro-Backofen-850, Maxima-Elektro-Bain-Marie-700-850, Maxima-Elektro-Bain-Marie-850, Vario-Braeter-plus		

4-position

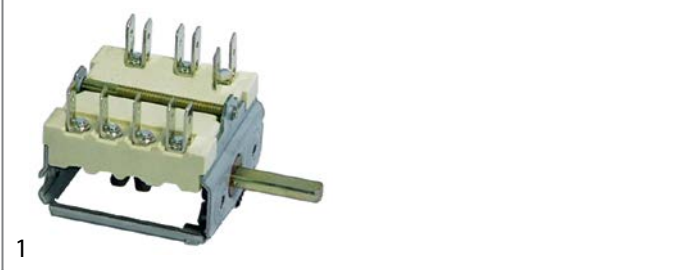

1

GEV No.	300016	Ref. No.	104248
description	cam switch 4 operating positions 1NO/2CO sequence 0-1-2-3 16A shaft ø 6x4.6mm shaft L 23mm connection male faston 6.3mm ceramic		
For models:	685003, Grill-681		

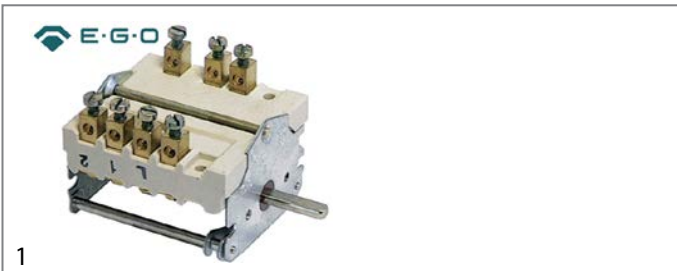

1

GEV No.	300103	Ref. No.	226491
description	cam switch 4 operating positions 1NO/2CO sequence 0-1-2-3 32A shaft ø 6x4.6mm shaft L 23mm connection screw ceramic		
For models:	541869, 638625, 730416, FOEM-Elektro-Kochplatten		



1

GEV No.	300104	Ref. No.	126608
description	cam switch 4 operating positions 3NO/1CO sequence 0-1-2-3 32A shaft ø 6x4.6mm shaft L 23mm connection screw ceramic		
For models:	Grill-682, Grill-683		

5-position

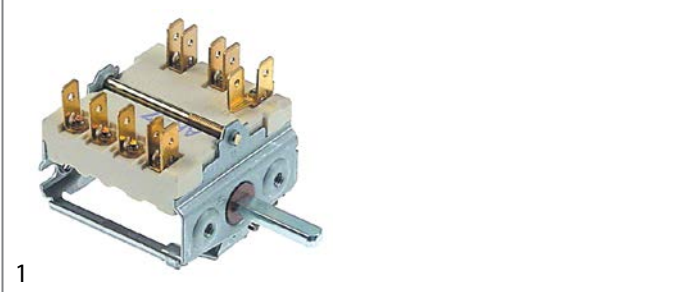

1

GEV No.	300172	Ref. No.	193224
description	cam switch 5 operating positions 1NO/2CO sequence 0-1-2-3-4 16A shaft ø 6x4.6mm shaft L 23mm connection male faston 6.3mm 5-position		
For models:	750026, 750034, 750042, 750050, 750069, 750077, 750085, 750093, 750107, 750115, AEH618		



7-position



GEV No.	300004	Ref. No.	010170 201820
description	cam switch 7 operating positions 1NO/2CO sequence 0-1-2-3-4-5-6 16A shaft ø 6x4.6mm shaft L 23mm connection male faston 6.3mm 7-position ceramic		
For models:	616001, 616109, 623008, 623105, 750077, 750085, 750093, 750107, 750115, Elektroherd-4-Platten-623, Elektroherd-616		



GEV No.	300025	Ref. No.	290335
description	cam switch 7 operating positions 1NO/2CO sequence 0-1-2-3-4-5-6 16A shaft ø 6x4.6mm shaft L 23mm connection screw 7-position ceramic		
For models:	Maxima-Elektro-Herd-700-850, Maxima-Elektro-Herd-850		

accessories for 300025

	GEV No.	112172	Ref. No.	—
	knob universal ø 70mm black without adaptor/dial plate			
	GEV No.	112213	Ref. No.	—
	knob dial plate silver switch 7-position t.max.°C ED ø 63mm ID ø 45.5mm			
	GEV No.	112311	Ref. No.	—
	knob adapter shaft ø 6x4.6mm L 0mm with spring			

4 operating positions

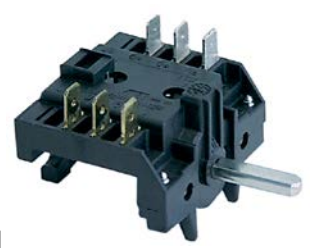

GEV No.	300033	Ref. No.	103680 370983
description	cam switch 4 operating positions 4NO sequence 0-1-2-3 16A shaft ø 6x4.6mm shaft L 23mm connection male faston 6.3mm plastic		
For models:	Heisse-Theke-HT-50-85-und-120-3		

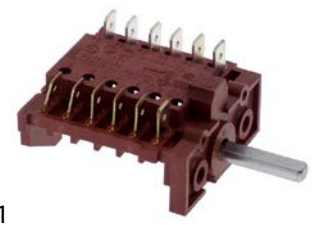

GEV No.	300057	Ref. No.	292664
description	cam switch 4 operating positions 6NO sequence 0-1-2-3 16A shaft ø 6x4.6mm shaft L 23mm connection male faston 6.3mm 6CH/141 plastic		
For models:	Heissluftdaempfer-10x1-1, Heissluftdaempfer-5x1-1, Heissluftdaempfer-5x2-3		



GEV No.	300034	Ref. No.	103772
description	cam switch 4 operating positions selector switch sequence 0-1-2-3 16A shaft ø 6x4.6mm connection male faston 6.3mm 4-pole		
For models:	Grill-680		

5 operating positions

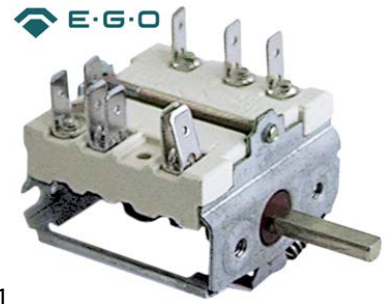

GEV No.	345199	Ref. No.	720534
description	cam switch 5 operating positions 2NO/1CO sequence 0-1-2-3-4 16A shaft ø 6x4.6mm shaft L 23mm connection male faston 6.3mm		
For models:	354716, 354724		



operation switches

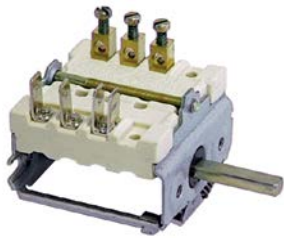

1			
GEV No.	300027	Ref. No.	086312
description	cam switch 2 operating positions 3NO 16A sequence 0-1 shaft \varnothing 6x4.6mm shaft L 23mm connection screw/F6.3 operation switch ceramic		
For models:	140902, 502650, 502707, 601004, 601209, 601403, 602000, 602205, 602280, 603007, 603023, 603201, 610003, 610038, 61030x, 610402, 611018, 611050, 612006, 612057, 613002, 613088, 614009, 614106, 614404, 615005, 615013, 615056, 615080, 620009, 620300, 621005, 621056, 622001, 622052, 624004, 624101, 62510, 62520, 62530, 626104, 626112, 626201, 626228, 626309, 626317, 627100, 629006, 629022, 667412...(Other models you can see in the webshop)		

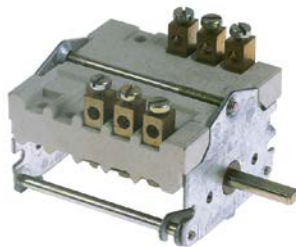

2			
GEV No.	300215	Ref. No.	010162
description	cam switch 2 operating positions sequence 0-1 3-pole ambient temperature max. 318°C		
For models:	600008, 600067, Fritteuse-600		

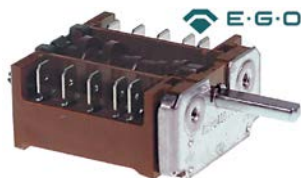

1			
GEV No.	300173	Ref. No.	634999 685380
description	cam switch 3 operating positions 4NO 16A sequence 0-1-2 shaft \varnothing 6x4.6mm shaft L 232mm connection male faston 6.3mm plastic 4-pole		
For models:	503010, 503150, 517887, 637564, 657735, 686298, 688428, 700673, 702560		

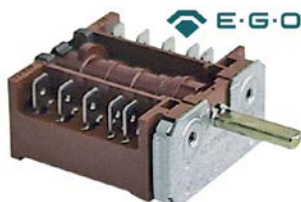

1			
GEV No.	300067	Ref. No.	N/A
description	cam switch 3 operating positions 4NO 16A sequence 0-1-2 shaft \varnothing 6x4.6mm shaft L 23mm connection male faston 6.3mm plastic		



1			
GEV No.	345321	Ref. No.	647967
description	operation switch 4 operating positions 5NO 16A sequence 0-1-2-3 shaft \varnothing 6x4.6mm shaft L 23mm connection male faston 6.3mm plastic 3-pole ambient temperature max. 300°C		

magnetic switches

36x13mm

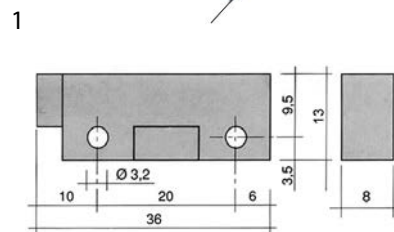

1			
GEV No.	345118 ¹	Ref. No.	376094
description	magnetic switch L 36mm W 13mm 1NO 250V 1A P max. 50W connection cable length 980mm		
For models:	665843, 665851, Glaeserspuelautomat-328		
accessories for	345118		
	GEV No.	345399	Ref. No. —
	magnet \varnothing 3.3mm L 40mm H 8mm W 13mm hole distance 30mm M3		

¹with coded connector

control equipment

SCHLEGEL

push buttons



1			
GEV No.	359183	Ref. No.	323527
description	momentary switch unit mounting measurements \varnothing 16/24x24mm type momentary anthracite/transparent square		
For models:	Heissluftdaempfer-10x1-1, Heissluftdaempfer-20x1-1, Heissluftdaempfer-5x1-1, Heissluftdaempfer-5x2-3, Heissluftgeraet-672, Heissluftgeraet-673		



1

GEV No.	346188	Ref. No.	580341
description	momentary switch unit mounting measurements ø16/24x24mm type momentary black/white square		
For models:	671568, 671576, 671584, 671592, 671606, 671614, 671622, 671630, 671649, 671657, 671665, 671673, 671681, 671711, 671746, 671754, 671789, 671797, 671800, 671819, 671827, 671835, 671843, 671851		

switch blocks



1

GEV No.	359756	Ref. No.	580384
description	contact block latching 1NO/1NC connection male faston 2.8mm illuminable socket T5.5K type BFL5		
For models:	671568, 671576, 671584, 671592, 671606, 671614, 671622, 671630, 671649, 671657, 671665, 671673, 671681, 671711, 671746, 671754, 671789, 671797, 671800, 671819, 671827, 671835, 671843, 671851		
accessories for	359756		
		GEV No.	359593
		Ref. No.	323519
	light bulb socket T5.5K 60V 0.02A		



1

GEV No.	359187	Ref. No.	323543
description	contact block latching 2NO/2NC connection male faston 2.8mm illuminable socket T5.5K type AFL2		
For models:	Heissluftdaempfer-10x1-1, Heissluftdaempfer-20x1-1, Heissluftdaempfer-5x1-1, Heissluftdaempfer-5x2-3, Heissluftgeraet-672, Heissluftgeraet-673		



1

GEV No.	359184	Ref. No.	323535
description	contact block momentary 1NC/1NO connection male faston 2.8mm socket type AT		
For models:	389595, 389609, 398950, 398969, 398977, 609188, 609196, 637599, 674648, 674656, 674664, 674680, 674885, Heissluftdaempfer-10x1-1, Heissluftdaempfer-20x1-1, Heissluftdaempfer-5x1-1, Heissluftdaempfer-5x2-3, Heissluftdaempfer-6x1-1, Heissluftdaempfer-Varioplus-20x1-1, Heissluftdaempfer-Varioplus-20x2-1, Heissluftgeraet-672, Heissluftgeraet-673		

lamps



1

GEV No.	359593	Ref. No.	323519
description	light bulb socket T5.5K 60V 0.02A		
For models:	Heissluftdaempfer-10x1-1, Heissluftdaempfer-20x1-1, Heissluftdaempfer-5x1-1, Heissluftdaempfer-5x2-3, Heissluftgeraet-672, Heissluftgeraet-673		

encoders and potentiometers



1

GEV No.	402979	Ref. No.	689416
description	potentiometer rotation 360° shaft ø 6x4.6mm shaft L 23mm		
For models:	672319, 672327, 672335, 706280, 706299, 706515, 829811, 829838, 829846, 829862, 829870, 829897		

lamps

indicator lights

indicator lights 3-piece (housing, lens and bulb)

ø16.2mm



1

GEV No.	359060	Ref. No.	101818
description	lamp socket mounting measurements ø16.2mm socket E10 connection screw		
For models:	685003, 686018, Grill-680, Grill-681, Grill-682, Grill-683, Heissluftgeraet-10x1-1, Heissluftgeraet-5x1-1, Heissluftgeraet-5x2-3, Heissluftgeraet-672, Heissluftgeraet-673, Heissluftgeraet-67310		





lamps

light bulbs





1



GEV No.	359593	Ref. No.	323519
description	light bulb socket T5.5K 60V 0.02A		
For models:	Heissluftdaempfer-10x1-1, Heissluftdaempfer-20x1-1, Heissluftdaempfer-5x1-1, Heissluftdaempfer-5x2-3, Heissluftgeraet-672, Heissluftgeraet-673		



neon light bulbs			
 <p>1</p>			
GEV No.	359600	Ref. No.	035378
description	neon light bulb socket E10 220V 0.35W clear ø 10mm L 28mm		
For models:	685003, 686018, Grill-680, Grill-681, Grill-682, Grill-683, Heissluftgeraet-10x1-1, Heissluftgeraet-5x1-1, Heissluftgeraet-5x2-3, Heissluftgeraet-672, Heissluftgeraet-673, Heissluftgeraet-67310, Wandkaffeemaschine-001		
accessories for	359600		
 <p>lamp socket mounting measurements ø16.2mm socket E10 connection screw</p>			
GEV No.	359060	Ref. No.	101818
 <p>lamp socket mounting measurements ø19.2mm socket E14 connection screw</p>			
GEV No.	359063	Ref. No.	—
 <p>lamp socket mounting measurements ø22.3mm socket E14 connection screw 250/380V ambient temperature at 1W 100°C ambient temperature at 2W 85°C</p>			
GEV No.	359064	Ref. No.	—
 <p>lamp socket mounting measurements ø16.2mm socket E10</p>			
GEV No.	359685	Ref. No.	—
 <p>lamp socket mounting measurements ø16.2mm socket Ba9s connection male faston 6.3mm</p>			
GEV No.	359832	Ref. No.	—
 <p>lamp socket mounting measurements ø18.2mm socket Ba9s connection male faston 6.3mm</p>			
GEV No.	359853	Ref. No.	—
 <p>lamp socket mounting measurements ø30.5mm 250V connection F6.3 temp.-resist. 55°C E14</p>			
GEV No.	359988	Ref. No.	—

 <p>1</p>			
GEV No.	359602	Ref. No.	006718
description	neon light bulb socket E14 230V clear ø 14mm L 30mm		
For models:	721468, 721476, 721484, 722588, 722596, 722618, Maxima-Elektro-Backofen-700-850, Maxima-Elektro-Backofen-850, Maxima-Elektro-Bain-Marie-700-850, Maxima-Elektro-Bain-Marie-850, Maxima-Elektro-Herd-700-850, Maxima-Elektro-Herd-850, Maxima-Elektro-Kippbratpfanne-700-850		

indicator lights (complete)			
ø10mm			
with plug-in socket			
 <p>1</p>			
GEV No.	359230	Ref. No.	370991
description	indicator light ø 10mm green 230V connection male faston 2.8mm Qty 1 pcs		
For models:	Heisse-Theke-HT-50-85-und-120-3		

 <p>1</p>			
GEV No.	359140	Ref. No.	091642
description	indicator light ø 10mm yellow 230V connection male faston 6.3mm Qty 1 pcs		

ø16mm			
with screw socket			
 <p>1</p>			
GEV No.	359835	Ref. No.	694339
description	indicator light ø 16mm 230V green connection male faston 6.3mm		
For models:	00068x, 00099x, 00121x, 00149x, 00183x, 001864, 002046, 002682, 00300x, 003131, 00314x, 00376x, 004081, 00443x, 00457x, 105716, 105759, 105872, 136581, 140902, 667412, 684848, 688436, 689335, 689343, 689351, 689378, 699020, 699039, 699047, 699055, 705993, 706000, 707503, 718793, 750026, 750034, 750042, 750050, 750069, 750077, 750085, 750093, 750107, 750115, 750204, 750212, 750220, 750239, 750247...(Other models you can see in the webshop)		
accessories for	359835		
 <p>nut thread M16x1 H 5.5mm WS 19</p>			
GEV No.	550559	Ref. No.	—

 <p>1</p>			
GEV No.	359834	Ref. No.	N/A
description	indicator light ø 16mm 230V yellow connection male faston 6.3mm temp.-resist. 120°C		
accessories for	359834		
 <p>nut thread M16x1 H 5.5mm WS 19</p>			
GEV No.	550559	Ref. No.	—

with plug-in socket			
 <p>1</p>			
GEV No.	359828	Ref. No.	688991
description	indicator light ø 16mm 400V green cable length 200mm cable material silicone wire		
For models:	672122, 672157, 672300, 706221, 706248, 706272		

 <p>1</p>			
GEV No.	359167	Ref. No.	699012
description	indicator light ø 16mm 230V yellow		
For models:	699020, 699039, 699047, 699055, 705993, 706000, 707503, 750255		



			
1			
GEV No.	359169	Ref. No.	249955 694320
description	indicator light ø 16mm 400V yellow		
For models:	00068x, 00099x, 00121x, 00149x, 00183x, 001864, 002046, 002682, 00300x, 003131, 00314x, 00376x, 004081, 00443x, 00457x, 105716, 105759, 105872, 136581, 140902, 667412, 684848, 688436, 689335, 689343, 689351, 689378, 699020, 699039, 699047, 699055, 707503, 718793, 750026, 750034, 750042, 750050, 750069, 750077, 750085, 750093, 750107, 750115, 750204, 750212, 750220, 750239, 750247, 750255, 750263...(Other models you can see in the webshop)		



ø22mm			
			
1			
GEV No.	359208	Ref. No.	340820
description	indicator light ø 22mm 400V clear connection screw		
For models:	721468, 721476, 721484, 722588, 722596, 722618		

22x10mm			
			
1			
GEV No.	359215	Ref. No.	080837 325708
description	indicator light mounting measurements 22x10mm 230V clear connection male faston 6.3mm		
For models:	600008, 600067, 601004, 601209, 601403, 602000, 602205, 602280, 603007, 603023, 603201, 610003, 610038, 61030x, 610402, 610429, 611018, 611050, 611220, 612006, 612057, 613002, 613088, 614009, 614106, 614404, 615005, 615013, 615056, 615080, 616001, 616109, 620009, 620203, 620300, 620408, 620424, 621005, 621056, 621110, 622001, 622052, 623008, 623105, 624004, 624101, 62510, 62520, 62530, 626104...(Other models you can see in the webshop)		

30x22mm			
			
1			
GEV No.	359156	Ref. No.	053317
description	indicator light mounting measurements 30x22mm 230V yellow connection male faston 6.3mm temp.-resist. 125/55°C type RL2		
For models:	271500, 805556, Geschirrspuelautomat-330, GsP-350, GsP-500		

miscellaneous			
			
1			
GEV No.	359429	Ref. No.	395056
description	indicator light 230V connection male faston 6.3mm mounting ø 18mm		
For models:	140902, 354643, 354651, 354678, 354686, 354694, 354708, 502200, 502308, 502650, 502707, 503010, 503150, 505900, 505935, 515892, 515906, 517887, 541869, 627984, 628018, 628026, 637564, 638625, 649554, 649562, 650129, 650137, 650145, 650153, 650943, 650951, 657735, 659002, 663263, 663395, 667412, 670618, 670626, 684848, 686247, 686298, 686328, 686336, 686409, 687200, 687960, 688096, 688118, 688290...(Other models you can see in the webshop)		

screw-on/push-on fit

neon light bulbs			
			
1			
GEV No.	359600	Ref. No.	035378
description	neon light bulb socket E10 220V 0.35W clear ø 10mm L 28mm		
For models:	685003, 686018, Grill-680, Grill-681, Grill-682, Grill-683, Heissluftgeraet-10x1-1, Heissluftgeraet-5x1-1, Heissluftgeraet-5x2-3, Heissluftgeraet-672, Heissluftgeraet-673, Heissluftgeraet-67310, Wandkaffeemaschine-001		
accessories for	359600		
	GEV No.	359060	Ref. No. 101818
	lamp socket mounting measurements ø16.2mm socket E10 connection screw		
	GEV No.	359063	Ref. No. —
	lamp socket mounting measurements ø19.2mm socket E14 connection screw		
	GEV No.	359064	Ref. No. —
	lamp socket mounting measurements ø22.3mm socket E14 connection screw 250/380V ambient temperature at 1W 100°C ambient temperature at 2W 85°C		
	GEV No.	359685	Ref. No. —
	lamp socket mounting measurements ø16.2mm socket E10		
	GEV No.	359832	Ref. No. —
	lamp socket mounting measurements ø16.2mm socket Ba9s connection male faston 6.3mm		
	GEV No.	359853	Ref. No. —
	lamp socket mounting measurements ø18.2mm socket Ba9s connection male faston 6.3mm		
	GEV No.	359988	Ref. No. —
	lamp socket mounting measurements ø30.5mm 250V connection F6.3 temp.-resist. 55°C E14		



			
1			
GEV No.	359602	Ref. No.	006718
description	neon light bulb socket E14 230V clear ø 14mm L 30mm		
For models:	721468, 721476, 721484, 722588, 722596, 722618, Maxima-Elektro-Backofen-700-850, Maxima-Elektro-Backofen-850, Maxima-Elektro-Bain-Marie-700-850, Maxima-Elektro-Bain-Marie-850, Maxima-Elektro-Herd-700-850, Maxima-Elektro-Herd-850, Maxima-Elektro-Kippbratpfanne-700-850		

light bulbs
for ovens

			
1			
GEV No.	359610	Ref. No.	047635
description	light bulb t.max. 300°C socket E14 15W 230V ø 22mm L 47mm lens L 20mm for oven lamp type Philips		
For models:	685003, 805xxx, 890502, 890510, 890529, 890553, 890561, 890588, 890596, 890618, 890626, Aromacarina, Aromacarina-Dampf, Aromacarina-EsA, Aromacarina-ETA, Aromacarina-ETA-EsA, Heissluftdaempfer-10x1-1, Heissluftdaempfer-20x1-1, Heissluftdaempfer-5x1-1, Heissluftdaempfer-5x2-3, Heissluftgeraet-10x1-1, Heissluftgeraet-5x1-1, Heissluftgeraet-5x2-3, Heissluftgeraet-672, Heissluftgeraet-673, Heissluftgeraet-67310		

			
1			
GEV No.	359612	Ref. No.	354252
description	light bulb t.max. 300°C socket E14 25W 230V ø 25mm L 56mm lens L 30mm for oven lamp type Philips		
For models:	367788, 382191, 385018, 385026, 385034, 385042, 385050, 385514, 389595, 389609, 390003, 397210, 397229, 397237, 397245, 397253, 397261, 397288, 397296, 397318, 397326, 397334, 397342, 397350, 397431, 397776, 397784, 397792, 397806, 397814, 397822, 397830, 397849, 397857, 397865, 397873, 398047, 398055, 398063, 398071, 398098, 398101, 398128, 398136, 398144, 398152, 398950, 398969, 398977, 399019...(Other models you can see in the webshop)		

for indicator lights

			
1			
GEV No.	359593	Ref. No.	323519
description	light bulb socket T5.5K 60V 0.02A		
For models:	Heissluftdaempfer-10x1-1, Heissluftdaempfer-20x1-1, Heissluftdaempfer-5x1-1, Heissluftdaempfer-5x2-3, Heissluftgeraet-672, Heissluftgeraet-673		

miscellaneous

			
1			
GEV No.	362023	Ref. No.	581488
description	light bulb socket T5.5K 48V 1.2W 0.025A		
For models:	671568, 671576, 671584, 671592, 671606, 671614, 671622, 671630, 671649, 671657, 671665, 671673, 671681, 671711, 671746, 671754, 671789, 671797, 671800, 671819, 671827, 671835, 671843, 671851, 671894, 671908, 671916, 671975, 671983, 671991, 754595, 754617, 754676, 754714, 758736, 758752, 758760, 758833, 759015, 759023, 759031, 759058, 759201, 759651		

linear lamps

infrared lamps

with base type R7s

			
1			
GEV No.	359628	Ref. No.	164941
description	infrared lamp socket R7s L 117.6mm 240V 300W IMPORT unjacketed		
For models:	Heisse-Theke-HT-50-85-und-120-3		

			
1			
GEV No.	359627	Ref. No.	971464
description	infrared lamp socket R7s L 220mm 230V 500W IMPORT		

GEV No.	359627	Ref. No.	971464
description	infrared lamp socket R7s L 220mm 230V 500W IMPORT		

with base type X lug

			
1			
GEV No.	359617	Ref. No.	104566
description	infrared lamp 1000W 220V L 365mm lens L 340mm total length 480mm with mounting strap		
For models:	Grill-681, Grill-682, Grill-683		

sockets for linear lamps

R7s

			
1			
GEV No.	359717	Ref. No.	153982
description	lamp socket socket R7s 250V ø 18mm Lmm H 31mm connection cable 320mm mounting distance 28mm holder length 37mm cable material PTFE		
For models:	Heisse-Theke-HT-50-85-und-120-3		

X lug



GEV No.	359710	Ref. No.	104574
description	lamp socket L 70mm W 70mm H 49mm mounting distance 50mm bracket mounting		
For models:	Grill-681, Grill-682, Grill-683		

fluorescent lamps

accessories

sockets





GEV No.	381156	Ref. No.	314015
description	lamp socket socket 2G11 hole distance 24mm t.max. 140°C for fluorescent lamps		

oven lamps

universal oven lamps





mounting diameter 35.5mm



GEV No.	359701	Ref. No.	100838
description	lamp socket socket E14 220-230V mounting ø 35.5mm connection male faston 6.3mm 15W		
For models:	398047, 398055, 398063, 398071, 398098, 398101, 398128, 398136, 398144, 398152, 609501, 609528, 609536, 674559, 674648, 674656, 674664, 674672, 674680, 674699, 674834, 674893, 685003, Heissluftdaempfer-10x1-1, Heissluftdaempfer-20x1-1, Heissluftdaempfer-5x1-1, Heissluftdaempfer-5x2-3, Heissluftdaempfer-6x1-1, Heissluftgeraet-10x1-1, Heissluftgeraet-5x1-1, Heissluftgeraet-5x2-3, Heissluftgeraet-672, Heissluftgeraet-673, Heissluftgeraet-67310		
accessories for	359701		
	GEV No.	359705	Ref. No. 092339
	oven lamp glass thr.ø 33.5mm ø 52mm hard glas temp.-resist. 350°C		
	GEV No.	359709	Ref. No. —
	oven lamp glass thr.ø 33.5mm ø 42mm hard glas temp.-resist. 350°C		
	GEV No.	359721	Ref. No. 316296
	gasket silicone ED ø 48mm ID ø 39.5mm thickness 5mm Qty 1 pcs		

accessories for	359701		
	GEV No.	359942	Ref. No. —
	oven lamp glass thr.ø 33.5mm ø 41mm hard glas temp.-resist. 350°C		

	GEV No.	359705	Ref. No. 092339
description	oven lamp glass thr.ø 33.5mm ø 52mm hard glas temp.-resist. 350°C		
For models:	671568, 671576, 671584, 671592, 671606, 671614, 671622, 671630, 758752, 758760, 758981, 759007, 759015, 759023, 759031, 759058, 759066, 759074, 759171, 759198, Heissluftdaempfer-10x1-1, Heissluftdaempfer-20x1-1, Heissluftdaempfer-5x1-1, Heissluftdaempfer-5x2-3		

accessories for	359705		
	GEV No.	359610	Ref. No. 047635
	light bulb t.max. 300°C socket E14 15W 230V ø 22mm L 47mm lens L 20mm for oven lamp type Philips		
	GEV No.	359700	Ref. No. —
	gasket for pizza oven fibre glass ID ø 32.5mm ED ø 55mm thickness 5mm		
	GEV No.	359721	Ref. No. 316296
	gasket silicone ED ø 48mm ID ø 39.5mm thickness 5mm Qty 1 pcs		
	GEV No.	359837	Ref. No. —
	gasket ID ø 33mm ED ø 46mm thickness 1mm graphite		
	GEV No.	359838	Ref. No. —
	gasket ID ø 33mm ED ø 45mm		

	GEV No.	359721	Ref. No. 316296
description	gasket silicone ED ø 48mm ID ø 39.5mm thickness 5mm Qty 1 pcs		
For models:	Heissluftdaempfer-10x1-1, Heissluftdaempfer-5x1-1, Heissluftdaempfer-5x2-3		

producer-specific oven lamps

PALUX

	GEV No.	359068	Ref. No. 314019
description	lamp socket with 2 hole fixing socket E14 ø 25mm		

lamps

light bulbs

PHILIPS



GEV No.	359610	Ref. No.	047635
description	light bulb t.max. 300°C socket E14 15W 230V ø 22mm L 47mm lens L 20mm for oven lamp type Philips		
For models:	685003, 805xxx, 890502, 890510, 890529, 890553, 890561, 890588, 890596, 890618, 890626, Aromacarina, Aromacarina-Dampf, Aromacarina-EsA, Aromacarina-ETA, Aromacarina-ETA-EsA, Heissluftdaempfer-10x1-1, Heissluftdaempfer-20x1-1, Heissluftdaempfer-5x1-1, Heissluftdaempfer-5x2-3, Heissluftgeraet-10x1-1, Heissluftgeraet-5x1-1, Heissluftgeraet-5x2-3, Heissluftgeraet-672, Heissluftgeraet-673, Heissluftgeraet-67310		

PHILIPS



GEV No.	359612	Ref. No.	354252
description	light bulb t.max. 300°C socket E14 25W 230V ø 25mm L 56mm lens L 30mm for oven lamp type Philips		
For models:	367788, 382191, 385018, 385026, 385034, 385042, 385050, 385514, 389595, 389609, 390003, 397210, 397229, 397237, 397245, 397253, 397261, 397288, 397296, 397318, 397326, 397334, 397342, 397350, 397431, 397776, 397784, 397792, 397806, 397814, 397822, 397830, 397849, 397857, 397865, 397873, 398047, 398055, 398063, 398071, 398098, 398101, 398128, 398136, 398144, 398152, 398950, 398969, 398977, 399019...(Other models you can see in the webshop)		

sockets

G4 / G5,3 / G6,35



GEV No.	359646	Ref. No.	577294
description	lamp socket socket G4/G5.3/G6.35 24V ø 17mm H 15mm connection cable 130mm mounting distance 26mm for halogen lamp holder length 31mm cable length 130mm		
For models:	671568, 671576, 671584, 671592, 671606, 671614, 671622, 671630, 671649, 671657, 671665, 671673, 671681, 671711, 671746, 671754, 671762, 671770, 671789, 671797, 671800, 671819, 671827, 671835, 671843, 671851, 671878, 671886, 671894, 671908, 671916, 671975, 671983, 671991, 680583, 680591, 758752, 758760, 758981, 759007, 759015, 759023, 759031, 759058, 759066, 759074, 759171, 759198		

residual heat indicators



GEV No.	359429	Ref. No.	395056
description	indicator light 230V connection male faston 6.3mm mounting ø 18mm		
For models:	140902, 354643, 354651, 354678, 354686, 354694, 354708, 502200, 502308, 502650, 502707, 503010, 503150, 505900, 505935, 515892, 515906, 517887, 541869, 627984, 628018, 628026, 637564, 638625, 649554, 649562, 650129, 650137, 650145, 650153, 650943, 650951, 657735, 659002, 663263, 663395, 667412, 670618, 670626, 684848, 686247, 686298, 686328, 686336, 686409, 687200, 687960, 688096, 688118, 688290...(Other models you can see in the webshop)		

timers

programme timers



GEV No.	360005	Ref. No.	359300
description	timer BIGATTI D94 engines 1 chambers 1 operation time 20min 230V shaft ømm shaft Lmm manuf. no. WE006 motor type 82354021L		
For models:	Glaeserspielautomat-325		



GEV No.	360349	Ref. No.	359297
description	timer CDC 11803 engines 1 chambers 3 operation time 150s 230V shaft ømm shaft Lmm manuf. no. 11803F1BEE000.0010 motor type M48R ATS type 11803F1 / 238046		
For models:	Glaeserspielautomat-325		
spare parts for	360349		
GEV No.	360673	Ref. No.	—
description	motor kit pinion ø 6.8mm teeth 15 230V voltage AC 50/60Hz turn direction clockwise motor ø 48mm H 18.5mm motor type UDS-40NE1RNZ165 cable length 150mm with holder		



GEV No.	360040	Ref. No.	256617
description	timer CDC 9003F engines 1 chambers 3 operation time 6min 230V shaft ø 6x4.6mm shaft L 21mm manuf. no. 9003F3 / PRCIH5 motor type M48R ATS		
For models:	Glaeserspielautomat-320, Glaeserspielautomat-321		
spare parts for	360040		
GEV No.	360118	Ref. No.	—
description	motor CDC pinion ø 4.9mm teeth 10 230V voltage AC 50/60Hz turn direction right motor ø 47mm H 19.3mm motor type M48R ATS for timer cable length 260mm 1.9/2.5W		
accessories for	360040		
GEV No.	110197	Ref. No.	—
description	knob switch zero mark ø 42mm shaft ø 6x4.6mm shaft flat adjustable black		



electric timers



GEV No.	350001	Ref. No.	157988
description	timer 2CO at 250V 16A permanent position yes impulse electric shaft ø 6x4.6mm shaft L 22mm mounting distance 28mm connection rear 2-pole operation time 120min		
For models:	389595, 389609, 398950, 398969, 398977, 609188, 609196, 637599, 674524, 674532, 674605, 674648, 674656, 674664, 674680, 674885, Heissluftdaempfer-10x1-1, Heissluftdaempfer-20x1-1, Heissluftdaempfer-5x1-1, Heissluftdaempfer-5x2-3, Heissluftdaempfer-6x1-1, Heissluftdaempfer-Varioplus-20x1-1, Heissluftdaempfer-Varioplus-20x2-1, Heissluftgeraet-10x1-1, Heissluftgeraet-5x1-1, Heissluftgeraet-5x2-3		

audible timers



GEV No.	350014	Ref. No.	018511 720585 836117
description	audible timer operation time 15min ø 56mm shaft ø 6x4.6mm shaft L 24mm mounting distance 28mm		
For models:	354716, 354724, 502200, 502308, 600008, 600067, 601004, 601209, 601403, 602000, 602205, 602280, 603007, 603023, 603201, 649554, 649562, 650943, 650951, 686336, 688339, 688347, 688355, Fritteuse-365, Fritteuse-600, Fritteuse-601, Fritteuse-602, Fritteuse-603, Topline-Fritteuse		

alarm devices

buzzers



GEV No.	350051	Ref. No.	091472
description	buzzer 230VAC connection male faston 6.3mm screw thread M4 buzzer 62dB		
For models:	367788, 382191, 385018, 385026, 385034, 385042, 385050, 385514, 389595, 389609, 397210, 397431, 398950, 398969, 398977, 505900, 505935, 606294, 606308, 609188, 609196, 637599, 663263, 663395, 670618, 670626, 674648, 674656, 674664, 674680, 674885, 680583, 680591, 686409, 687200, 688096, 688118, 688363, 690570, 690600, 703095, 703109, 703117, 703125, 709816, 709824, 709832, 709840, 733105, 733113...(Other models you can see in the webshop)		

contactors

ABB

power contactors



GEV No.	380104	Ref. No.	324001 523909
description	power contactor resistive load 25A 230VAC (AC3/400V) 9A/4kW main contacts 3NO auxiliary contacts 1NO connection screw connection type A9-30-10		
For models:	754730, 754749, 757292, 758752, 758760, 758981, 759007, 759015, 759023, 759031, 759058, 759066, 759074, 759171, 759198, 759678, 759686, 759694, 759708, 759716		



GEV No.	380112	Ref. No.	523895
description	power contactor resistive load 45A 230VAC (AC3/400V) 26A/11kW main contacts 3NO auxiliary contacts 1NO connection screw connection type A26-30-10		
For models:	754595, 754609, 754617, 754668, 754676, 754681, 754692, 754706, 754714, 754722, 754730, 754749, 754757, 754773, 754781, 757292, 757314, 757365, 757373, 757381, 757403, 757411, 757438, 757446, 757454, 757462, 757470, 758736, 758833, 759201, 759651, 759678, 759686, 759694, 759708, 759716		

accessories for	380112		
GEV No.	381031	Ref. No.	—
description	auxiliary contact contacts 1NO/1NC AC1 16A AC15 3A connection screw connection for contactors B6/B7/VB7		

GENERAL ELECTRIC (AEG)

power contactors



GEV No.	380231	Ref. No.	307491
description	power contactor resistive load 16A 230VAC (AC3/400V) 6A/3kW main contacts 3NO auxiliary contacts 1NC connection screw connection type AEG LS0701A		



ISKRA (FANAL)

power contactors



1

GEV No.	380423	Ref. No.	181498
description	power contactor resistive load 35A 230VAC (AC3/400V) 25A/11kW main contacts 3NO auxiliary contacts connection screw connection type Fanal DSL22 type ISKRA KNL22		
For models:	340022, 340030, 340049, 340057, 340073, 340xxx, 353167, 354392, 354457, 690570, 810002, 813303, 890502, 890510, 890529, 890553, 890561, 890588, 890596, 890618, 890626, Geschirrspuelautomat-700, Heissluftdaempfer-10x1-1, Heissluftdaempfer-5x1-1		

solid state relays

CRYDOM



1

GEV No.	402052	Ref. No.	752665
description	solid state relay CRYDOM 1 phase 90A 600V 4-32VDC L 58.6mm W 45mm screw type H12WD4890PG		

relays

power relays

with flange mounting



1

GEV No.	380131	Ref. No.	359289
description	power relays Italiana Relè 230VAC 16A 3CO connection male faston 6.3mm screw mounting manuf. no. B2-3-230AC		
For models:	Glaeserspielautomat-325		



1

GEV No.	380130	Ref. No.	376078
description	power relays Italiana Relè 230VAC 16A 3NO connection male faston 6.3mm screw mounting manuf. no. B1-3-230AC		
For models:	665843, 665851, Glaeserspielautomat-328		

with bracket mounting



1

GEV No.	380687	Ref. No.	849618
description	power relays FINDER 230VAC 30A 2NO connection F6.3 bracket mounting manuf. no. 66.82.8.230.0300		

level relays

miscellaneous



1

GEV No.	380346	Ref. No.	210153
description	level relay 1CO 230V voltage AC		
For models:	750204, 750212, 750220, 750239		

time relays

time relays



1

GEV No.	380288	Ref. No.	332615
description	time relay ELEKTRON VZE 806 time range 60s 24-250 AC/DC 5A connection cable mounting measurements DIN railmm		
For models:	389595, 389609, 398950, 398969, 398977, 609188, 609196, 637599, 674648, 674656, 674664, 674885, 680583, 680591, Heissluftdaempfer-10x1-1, Heissluftdaempfer-5x2-3, Heissluftdaempfer-6x1-1		



electric components

transformers

encapsulated transformers

multiple connections



1			
GEV No.	402051	Ref. No.	742775
description	transformer primary 230VAC secondary 16.5VAC 2x15VA connection male faston 50/60Hz		
For models:	754595, 754609, 754617, 754668, 754676, 754681, 754692, 754706, 754714, 754722, 754730, 754749, 754757, 754773, 754781, 757292, 757314, 757365, 757373, 757381, 757403, 757411, 757438, 757446, 757454, 757462, 757470, 758736, 758833, 759201, 759651, 759678, 759686, 759694, 759708, 759716		

PMA



1			
GEV No.	379054	Ref. No.	368849
description	transformer primary 230VAC secondary 12VAC 3VA secondary 0.25A H 40mm L 45mm W 50mm connection screw 50/60Hz type 153/M		
For models:	Pizza-Ofen-P501, Pizza-Ofen-P502		

electronic controllers

SHANGFANG

accessories



1			
GEV No.	379054	Ref. No.	368849
description	transformer primary 230VAC secondary 12VAC 3VA secondary 0.25A H 40mm L 45mm W 50mm connection screw 50/60Hz type 153/M		
For models:	Pizza-Ofen-P501, Pizza-Ofen-P502		

TECNOLOGIC

electronic thermometers

built-in version



1			
GEV No.	379203	Ref. No.	368830
description	thermometer TECNOLOGIC K38VFC-----E---- mounting measurements 70x28mm built-in depth 64mm 12V voltage AC/DC Pt100/TC (J,K) -200 up to +1760°C display 3½ digits 1 RoomTempIN Pt100/TC (J,K) defr. funct. no front measurements 35x78.5mm		
For models:	Pizza-Ofen-P500, Pizza-Ofen-P501, Pizza-Ofen-P502		
accessories for	379203		
	GEV No.	379050	Ref. No.
			—
	temperature probe Pt100 cable Vetrotex probe -200 up to +600°C cable -50 up to +350°C probe ø6x100mm cable length 2.7m without screw connection 3-wire		
	GEV No.	379054	Ref. No.
			368849
	transformer primary 230VAC secondary 12VAC 3VA secondary 0.25A H 40mm L 45mm W 50mm connection screw 50/60Hz type 153/M		

miscellaneous

universal controllers



1			
GEV No.	400206	Ref. No.	332143
description	electronic controller 230V TempIn1 thermocouple K (NiCr-Ni) temperature controller		
For models:	389595, 389609, 398950, 398969, 398977, 609188, 609196, 637599, 674648, 674656, 674664, 674680, 674885, Heissluftdaempfer-10x1-1, Heissluftdaempfer-5x2-3, Heissluftdaempfer-6x1-1, Heissluftdaempfer-Varioplus-20x1-1, Heissluftdaempfer-Varioplus-20x2-1		



1			
GEV No.	400114	Ref. No.	702110
description	electronic controller type Pt100		
For models:	690570		
accessories for	400114		
	GEV No.	400119	Ref. No.
			—
	keypad foil tilting bratt pan NEP203/303/603 NER080/150/250/300		



probes

producer-specific probes

probes

1 			
GEV No.	379399	Ref. No.	702285
description	temperature probe Pt100 cable PVC probe -50 up to +200°C cable -10 up to 100°C connection 2-wire thread M10x1 probe ø10x10mm cable length 1.55m		
For models:	690570		

core probes

1 			
GEV No.	379592 ¹	Ref. No.	752363
description	core temperature probe 3 point probe cable PTFE probe -40 up to +250°C cable -40 up to +250°C connection 5-wire probe ø4x100mm thread cable length 4.5m handle ø 12mm handle length 85mm		
For models:	754595, 754609, 754617, 754668, 754676, 754681, 754692, 754706, 754714, 754722, 754730, 754749, 754757, 754773, 754781, 757292, 757314, 757365, 757373, 757381, 757403, 757411, 757438, 757446, 757454, 757462, 757470, 758736, 758833, 759201, 759651, 759678, 759686, 759694, 759708, 759716		

¹ multipoint probe

1 			
GEV No.	379116	Ref. No.	32664
description	core temperature probe Pt100 cable PTFE probe -40 up to +250°C cable -40 up to +250°C connection 2-wire probe ø4x82mm thread 1/4" cable length 3m handle ø 12mm handle length 90mm		

electronics

PCBs

1 			
GEV No.	400013	Ref. No.	214582
description	PCB combi-steamer 6x1/1 5x2/3 level control		
For models:	674524, 674532, 674605, 805556, Heissluftdaempfer-10x1-1, Heissluftdaempfer-20x1-1, Heissluftdaempfer-5x1-1, Heissluftdaempfer-5x2-3		

1 			
GEV No.	361366	Ref. No.	376116 651079
description	PCB dishwasher 11F suitable for DB2 type DB2/EV1/EKP-M		
For models:	Glaeserspuelautomat-328		

1 			
GEV No.	400027	Ref. No.	317225
description	relay PCB vario cooker 516678 with relay output		
For models:	516678, 610038, 610402, 610429, 620203, 620408, 620424, 639087, 699063, Vario-Braeter-plus		

solenoid valves

solenoid valves (water)

MÜLLER

medium temperature: 90°C
duty cycle: 100%























1 				
GEV No.	370004	Ref. No.	173266 297313	
description	solenoid valve double straight 230VAC inlet 3/4" outlet 14.5mm DN10 t.max. 90°C duty cycle 100% MÜLLER			
For models:	144819, 271500, 337xxx, 340022, 340030, 340049, 340057, 340073, 340xxx, 353167, 354392, 354457, 361763, 378933, 440078, 440086, 440094, 440140, 440655, 450111, 516678, 639087, 699063, Geschirrspuelautomat-330, Geschirrspuelautomat-335, Geschirrspuelautomat-336, Geschirrspuelautomat-700, GsP-350, GsP-500, GsP-600, Vario-Braeter-plus			
spare parts for	370004			
	GEV No.	370129	Ref. No.	—
solenoid valve body double straight inlet 3/4" outlet 14.5mm DN10 t.max. 90°C duty cycle 100% MÜLLER 230V				
	GEV No.	371002	Ref. No.	—
solenoid valve holder MÜLLER flange support				
	GEV No.	371009	Ref. No.	—
compression spring for solenoid coil				
	GEV No.	371011	Ref. No.	—
spare parts kit membrane with long star star hight 8mm MÜLLER				

Table continues overleaf

spare parts for 370004			
	GEV No.	371017	Ref. No. —
solenoid coil MÜLLER 230VAC connection male faston 6.3mm			
	GEV No.	371122	Ref. No. —
solenoid valve filter ø 19mm H 10mm suitable for MÜLLER			
	GEV No.	501161	Ref. No. —
tap head for solenoid valve holder for solenoid coils			
accessories for 370004			
	GEV No.	371010	Ref. No. —
solenoid coil 230VAC connection with cable cable length 2000mm			
	GEV No.	371037	Ref. No. —
solenoid coil 24VAC 50/60Hz connection male faston 6.3mm			
	GEV No.	371038	Ref. No. —
solenoid coil 230VAC connection appliance plug			

			
1			
GEV No.	370002	Ref. No.	334944
description solenoid valve single straight 230VAC inlet 3/4" outlet 14.5mm DN10 t.max. 90°C duty cycle 100% MÜLLER			
For models: 144819, 340022, 340030, 340049, 340057, 340073, 353167, 354392, 354457, 361763, 378933, 440078, 440086, 440094, 440140, 440655, 450111			
spare parts for 370002			
	GEV No.	370127	Ref. No. —
solenoid valve body single straight inlet 3/4" outlet 14.5mm DN10 t.max. 90°C duty cycle 100% MÜLLER 230V			
	GEV No.	371002	Ref. No. —
solenoid valve holder MÜLLER flange support			
	GEV No.	371009	Ref. No. —
compression spring for solenoid coil			
	GEV No.	371011	Ref. No. —
spare parts kit membrane with long star star height 8mm MÜLLER			
	GEV No.	371017	Ref. No. —
solenoid coil MÜLLER 230VAC connection male faston 6.3mm			
	GEV No.	371122	Ref. No. —
solenoid valve filter ø 19mm H 10mm suitable for MÜLLER			
	GEV No.	501161	Ref. No. —
tap head for solenoid valve holder for solenoid coils			
accessories for 370002			
	GEV No.	371010	Ref. No. —
solenoid coil 230VAC connection with cable cable length 2000mm			
	GEV No.	371037	Ref. No. —
solenoid coil 24VAC 50/60Hz connection male faston 6.3mm			

accessories for 370002			
	GEV No.	371038	Ref. No. —
solenoid coil 230VAC connection appliance plug			





















TP			
			
1			
GEV No.	370017	Ref. No.	987017
description solenoid valve single straight 230VAC inlet 3/4" outlet 11.5mm DN10 TP p max 10bar			
spare parts for 370017			
	GEV No.	371013	Ref. No. —
solenoid coil TP 230VAC 50/60Hz			
accessories for 370017			
	GEV No.	371220	Ref. No. —
reducer TP flow rate 3l/min red tolerance ±15%			
	GEV No.	371221	Ref. No. —
reducer TP flow rate 5.5l/min yellow tolerance ±15%			
	GEV No.	371222	Ref. No. —
reducer TP flow rate 6l/min grey tolerance ±15%			
	GEV No.	371223	Ref. No. —
reducer TP flow rate 10l/min white tolerance ±15%			
	GEV No.	371224	Ref. No. —
reducer TP flow rate 12l/min bronze tolerance ±15%			
	GEV No.	371225	Ref. No. —
reducer TP flow rate 16l/min light brown tolerance ±15%			
	GEV No.	371226	Ref. No. —
reducer TP flow rate 20l/min red tolerance ±15%			
	GEV No.	371230	Ref. No. —
reducer TP flow rate 0.25l/min red tolerance ±25%			
	GEV No.	371231	Ref. No. —
reducer TP flow rate 0.35l/min violet tolerance ±25%			
	GEV No.	371232	Ref. No. —
reducer TP flow rate 0.5l/min orange tolerance ±25%			
	GEV No.	371233	Ref. No. —
reducer TP flow rate 0.8l/min white tolerance ±25%			
	GEV No.	371234	Ref. No. —
reducer TP flow rate 1l/min light blue tolerance ±25%			
	GEV No.	371235	Ref. No. —
reducer TP flow rate 1.2l/min brown tolerance ±25%			

Table continues overleaf



accessories for		370017		
GEV No.	371236	Ref. No.	—	
	reducer TP flow rate 1.5l/min light brown tolerance ±25%			
GEV No.	371237	Ref. No.	—	
	reducer TP flow rate 2.5l/min yellow tolerance ±25%			
GEV No.	371238	Ref. No.	—	
	reducer TP flow rate 3.4l/min dark green tolerance ±25%			
GEV No.	371239	Ref. No.	—	
	reducer TP flow rate 5l/min black tolerance ±25%			
GEV No.	371240	Ref. No.	—	
	reducer TP flow rate 8l/min blue tolerance ±20%			

metal			
MÜLLER			
2-way			
	1		
GEV No.	370069 ¹	Ref. No.	374806 586935
description	solenoid valve 2-ways 230VAC inlet 1/8" IT outlet 1/8" IT L 30mm water MÜLLER DN10		
For models:	367788, 382191, 385018, 385026, 385034, 385042, 385050, 385514, 389595, 389609, 390003, 397210, 397229, 397237, 397245, 397253, 397261, 397288, 397296, 397318, 397326, 397334, 397342, 397350, 397431, 397776, 397784, 397792, 397806, 397814, 397822, 397830, 397849, 397857, 397865, 397873, 398047, 398055, 398063, 398071, 398098, 398101, 398128, 398136, 398144, 398152, 398950, 398969, 398977, 399019...(Other models you can see in the webshop)		

¹with adjusting screw

	1		
GEV No.	370037 ¹	Ref. No.	079561
description	solenoid valve 2-ways 230VAC inlet 1/8" IT outlet M16x1 outer steam MÜLLER		
For models:	805149, 805300, 805408, 805459, 805xxx, 890502, 890510, 890529, 890553, 890561, 890588, 890596, 890618, 890626, Aromacarina, Aromacarina-Dampf, Aromacarina-EsA, Aromacarina-ETA, Aromacarina-ETA-EsA, Heissluftdaempfer-5x2-3		

¹with adjusting screw

pressure switches

for warewashing

ø 45mm with male faston 6.3mm

with connection horizontal

	1		
GEV No.	541014	Ref. No.	234125
description	pressure control pressure range 55/35mbar connection 6mm ø 45mm pressure connection horizontal warewashing pressure connection ø 6mm		
For models:	Geschirrspuelautomat-330		

ø 58mm with male faston 6.3mm

with connection horizontal

	1		
GEV No.	541003	Ref. No.	349399
description	pressure control pressure range 55/35mbar connection 6mm ø 58mm pressure connection horizontal warewashing pressure connection ø 6mm		
For models:	665843, 665851, Glaeserspuelautomat-325, Glaeserspuelautomat-328		

for coffee machines

ø 45mm

	1		
GEV No.	541015	Ref. No.	030422 301523
description	pressure control ø 45mm pressure range 400/360mbar pressure range 0.4/0.36bar p max 1.02bar pressure connection vertical coffee machine parts connection 1/4" 1CO suitable for Palux, Bremer pressure connection 1/4"		
For models:	674524, 674532, 674605, 805149, 805300, 805408, 805459, 805556, 805xxx, 810002, 813303, 890502, 890510, 890529, 890553, 890561, 890588, 890596, 890618, 890626, Aromacarina, Aromacarina-Dampf, Aromacarina-EsA, Aromacarina-ETA, Aromacarina-ETA-EsA, Heissluftdaempfer-10x1-1, Heissluftdaempfer-20x1-1, Heissluftdaempfer-5x1-1, Heissluftdaempfer-5x2-3, standkaffeemaschine-solomatic-2, standkaffeemaschine-solomatic-4, Wandkaffeemaschine-800		

for steam control



			
1			
GEV No.	541015	Ref. No.	030422 301523
description	pressure control ø 45mm pressure range 400/360mbar pressure range 0.4/0.36bar p max 1.02bar pressure connection vertical coffee machine parts connection 1/4" 1CO suitable for Palux, Bremer pressure connection 1/4"		
For models:	674524, 674532, 674605, 805149, 805300, 805408, 805459, 805556, 805xxx, 810002, 813303, 890502, 890510, 890529, 890553, 890561, 890588, 890596, 890618, 890626, Aromacarina, Aromacarina-Dampf, Aromacarina-EsA, Aromacarina-ETA, Aromacarina-ETA-EsA, Heissluftdaempfer-10x1-1, Heissluftdaempfer-20x1-1, Heissluftdaempfer-5x1-1, Heissluftdaempfer-5x2-3, standkaffeemaschine-solomatic-2, standkaffeemaschine-solomatic-4, Wandkaffeemaschine-800		

			
1			
GEV No.	541016	Ref. No.	702129
description	pressure control ø 45mm pressure range 480/430mbar pressure connection vertical steam control pressure range 0.48/0.43bar connection 1/4" pressure connection 1/4"		
For models:	00443x, 00457x, 136581, 690570		

			
1			
GEV No.	541342	Ref. No.	702153
description	pressure control ø 45mm reset pressure reclosing lockbar pressure connection vertical steam control pressure range 0.6/0.54bar connection 1/4" pressure connection 1/4"		
For models:	690570		

			
1			
GEV No.	541022	Ref. No.	127515
description	pressure control steam control pressure connection vertical pressure range adjustable 0.25-4.5bar connection 1/4" pressure connection 1/4" IT		
For models:	Maxima-Elektro-Kochkessel-100, Maxima-Elektro-Kochkessel-700-850, Maxima-Elektro-Kochkessel-80		

electrodes

			
1			
GEV No.	400697	Ref. No.	203858
description	level electrode PG16 total length 26mm probe L 20mm insulated probe length 5mm connection M5 ø 29mm		
For models:	750204, 750212, 750220, 750239		
spare parts for	400697		
	GEV No.	550577	Ref. No. —
	nut thread PG16 H 3mm WS 26 nickel-plated brass Qty 1 pcs mounting ømm cable ømm		

flow meters and flow sensors

flow meters

GICAR			
			
1			
GEV No.	400642	Ref. No.	027790
description	flow meter thread 1/4" plastic plug-in connection approval NSF		
For models:	805149, 805408, 805459, 805xxx, 890502, 890510, 890529, 890553, 890561, 890588, 890596, 890618, 890626, Aromacarina-EsA, Aromacarina-ETA-EsA		

fans

axial fans

import



GEV No.	601080 ¹	Ref. No.	693456
description	axial fan L 119mm W 119mm H 38mm 230VAC 50/60Hz 23/20W bearing ball bearing connection male faston 2.8mm metal ADDA fan wheel ø 110mm temp.-resist. 70°C		
For models:	671568, 671576, 671584, 671592, 671606, 671614, 671622, 671630, 758752, 758760, 758981, 759007, 759015, 759023, 759031, 759058, 759066, 759074, 759171, 759198		
accessories for	601080		
	GEV No.	550898	Ref. No. —
	connecting cable cable length 2000mm connection F 2.8 connection distance 7.9mm for axial flow fan		
	GEV No.	692519	Ref. No. —
	guard L 120mm W 120mm plastic		

¹with ball bearings

cross flow fans

ebm-papst



GEV No.	601505	Ref. No.	679178
description	cross flow fan QLN65/2400A17-3030L roller ø 65mm roller length 240mm laminated core thickness 29mm motor position right 230V/50Hz 22W refrigeration bearing silicone connection F 6.3 0 up to +60°C 230V throughput 200m ³ /h 50Hz		
For models:	354643, 354651, 354678, 354686, 354694, 354708, 505900, 505935, 650129, 650137, 650145, 650153, 663263, 663395, 670618, 670626, 686409, 687200, 688096, 688118, 688363, 690600, 696498, 703095, 703109, 703117, 703125, 709816, 709824, 709832, 709840, 716294, 716847, 733105, 733113, 733121, 733148, 733156, 733164, 736422, 736430, 736449, 736457, 736465, 736473		

COPREL

with moulded coils



GEV No.	601456	Ref. No.	202428
description	cross flow fan roller ø 45mm roller length 180mm laminated core thickness 15mm motor position right 230V/50Hz 26W universal bearing silicone connection male faston 6.3mm -30 up to +100°C 230V 50/60Hz		
For models:	750026, 750034, 750042, 750050, 750069		

hot air motors

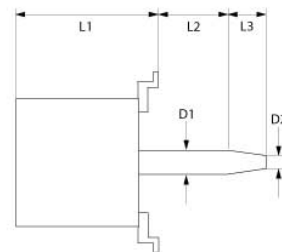

GEV No.	500102	Ref. No.	332410
description	fan motor 230-240V 1 phase 50Hz 0.09kW 1390rpm speeds 1 L1 150mm L2 32mm L3 27mm ø 125mm M10R IT 1.1A suitable capacitor 4µF/400V power input 200W at 50Hz 1390rpm type L7yzw4B-207 no. X5 D1 ø 17mm D2 ø 14mm		
For models:	385018, 385026, 385034, 385042, 385050, 385514, 390003, 397229, 397237, 397245, 397253, 397261, 397288, 397296, 397318, 397326, 397334, 397342, 397350, 397776, 397784, 397792, 397806, 397814, 397822, 397830, 397849, 397857, 397865, 397873, 399019, 399027, 399035, 399043, 399051, 399078, 399086, 399094, 399108, 399116, 606294, 606316, 606324, 606332, 606340, 606359, 606367, 609544, 609552, 609560...(Other models you can see in the webshop)		

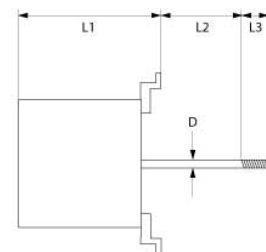

GEV No.	601474	Ref. No.	693286
description	fan motor 230V 1 phase 50/60Hz 0.03kW 3600rpm speeds 1 L1 115mm L2 20mm L3 32mm ø 12mm shaft flat length 23mm 7.5/8 0.35/0.56A suitable capacitor 3µF400V power input 75/125W at 50Hz 3600rpm type L5ow2B-317 no. W9		
For models:	671568, 671576, 671584, 671592, 671606, 671614, 671622, 671630, 758752, 758760, 758981, 759007, 759015, 759023, 759031, 759058, 759066, 759074, 759171, 759198		
accessories for	601474		
	GEV No.	602166	Ref. No. —
	fan wheel blades 9 D1 ø 175mm D2 ø 8mm D3 ø 8mm H1 30mm H2 28mm ED 6-23		



1

GEV No.	601871	Ref. No.	302821
description	fan motor 230V 1 phase 50Hz 85kW 2400rpm speeds 1 L1 85mm L2 40mm L3 33mm L4 133.5mm fan wheel ø 180mm at 50Hz 230V at 60Hz 230V at 50Hz 2600rpm at 60Hz 2850rpm type R2E180-AU01-09		
For models:	389595, 389609, 398950, 398969, 398977, 609188, 609196, 637599, 674648, 674656, 674885, Heissluftdaempfer-5x2-3, Heissluftgeraet-5x2-3		

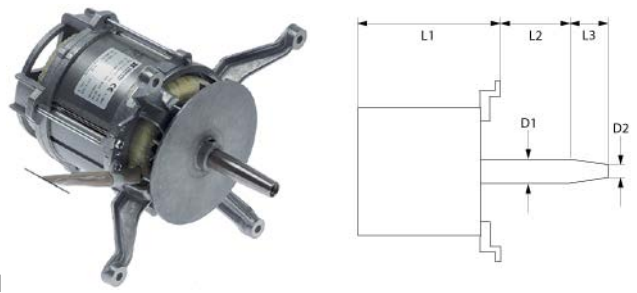

1

GEV No.	500170	Ref. No.	580287
description	fan motor 3 phase		
For models:	671649, 671657, 671665, 671673, 671681, 671711, 671746, 671754, 671762, 671770, 671789, 671797, 671800, 671819, 671827, 671835, 671843, 671851, 671878, 671886, 671894, 671908, 671916, 671975, 671983, 671991, 680583, 680591		

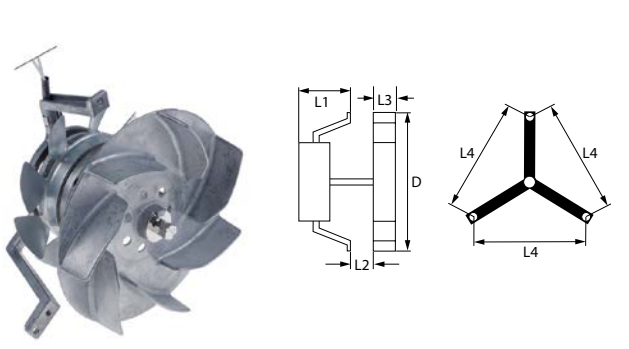

1

GEV No.	601013	Ref. No.	232572
description	hot air fan 230V 43W 0.25A L1 60mm L2 20mm L3 25mm L4 155mm fan wheel ø 150mm type R2S150-AA08-29 ebm-papst 2200rpm		
For models:	Elektro-Waermeschrank, OEWs1245-einseitig-400x1200mm, OEWs1246-einseitig-mit-Rueckwandverkleidung, UDWE1225L, UDWE1225L-doppelseitig-Eck-640x1200mm, UDWE1225R, UDWE1225R-doppelseitig-Eck-640x1200mm, UDWF0825, UDWF0825D-doppelseitig-640x800mm, UDWs1225, UDWs1225-doppelseitig-640x1200mm, UEWf0825, UEWf0825D-einseitig-640x800mm, UEWs06-schubladenblock-640x600mm, UEWs1225, UEWs1225-doppelseitig-640x1200mm, UEWs1225-einseitig-640x1200mm, UGWf0835, UGWf0835D-Fluegeltuer-710x800mm, UGWs1235, UGWs1235-schiebetuer-710x1200mm		

radial fans
miscellaneous



1

GEV No.	601475	Ref. No.	752525
description	radial fan 230V voltage AC 50/60Hz 20W H1 180mm L1 180mm D1 ø 86mm W1 40mm W2 34mm H2 122mm W3 40mm H3 172mm		
For models:	754668, 757314, 757462, 757470		

hot air fans

ebm-papst

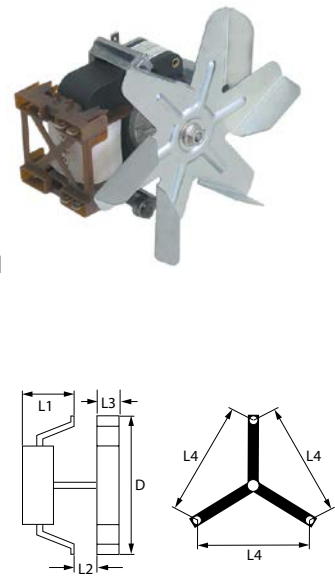

1

GEV No.	601059	Ref. No.	647896
description	hot air fan 220-230V 36W 0.26A L1 60mm L2 10mm L3 20mm L4 87mm fan wheel ø 150mm type R2K150-AN27-17 ebm-papst		
For models:	361429, 361437, HTP1, HTP2		



pumps

wash and rinse pumps

FIR

pumps



1

GEV No.	500560	Ref. No.	299200 645486
description	pump inlet ø 50mm outlet ø 37mm type B250.1500 230V 50Hz 1 phase 0.9kW 1.2HP L 265mm rotation direction left capacitor 12.5µF FIR		
For models:	271500, 337xxx, 353167, 354392, 354457, 361763, 378933, 440078, 440086, 440094, 440140, 440655, 450111, Geschirrspuelautomat-330, Geschirrspuelautomat-335, Geschirrspuelautomat-336, GsP-350, GsP-500, GsP-600		
spare parts for	500560		
	GEV No.	365014	Ref. No. —
	operating capacitor capacity 12.5µF 450V tolerance 5%Hz ambient temperature max. -25 to +85°C ø 35mm L 70mm M8 plastic connection male faston 6.3mm 45S.C3DS.12.5 protection		
	GEV No.	510693	Ref. No. 359416 441002
	mechanical shaft seal for shaft ø 12mm slide ring ext. ø 24mm slide ring H 15.5mm slide ring int. ø 11mm counter ring mounting ø 24mm height counter ring 8mm counter ring int. ø 13.5mm		
	GEV No.	521273	Ref. No. 728853
	impellor ø 103mm H 27mm rotation direction left thread M7R shaft ø 12mm shaft length 10mm blades 6		
	GEV No.	521567	Ref. No. 679623
	pump cover FIR inlet ø 50mm outlet ø 37mm ø 150mm ID ø 118mm inner height 25mm		
	GEV No.	521702	Ref. No. —
	pump cover gasket thickness 3.5x4.5mm Qty 1 pcs		

LGB

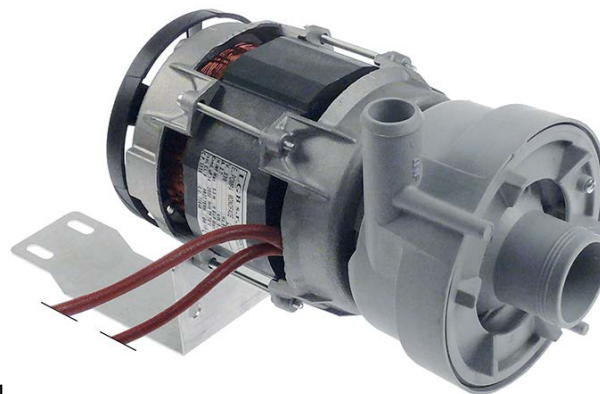

1

GEV No.	501486	Ref. No.	73048
description	pump inlet ø 42mm outlet ø 37mm type LA50 AP 230V 50Hz 1 phase 0.7kW L 220mm rotation direction right capacitor 14µF auxiliary pressure connection 8mm LGB		
spare parts for	501486		
	GEV No.	365020	Ref. No. —
	operating capacitor capacity 14µF 400V tolerance 5%Hz ambient temperature max. -25 to +85°C ø 35mm L 70mm M8 plastic connection male faston 6.3mm protection		
	GEV No.	510702	Ref. No. —
	mechanical shaft seal height counter ring 5.5mm ID ø 12mm		
	GEV No.	521024	Ref. No. —
	impellor ø 88mm H 30mm rotation direction right thread M7L shaft ø 12mm blades 6		
	GEV No.	698767	Ref. No. —
	fan blade ø 110mm H 18mm shaft intake ø 12mm plastic blades 6		
	GEV No.	698768	Ref. No. —
	pump cover LGB inlet ø 42mm pump type LA50 AP ø 115mm ID ø 36mm		
	GEV No.	698793	Ref. No. —
	pump cover outlet ø 24/36mm pump type LGB		
	GEV No.	698810	Ref. No. —
	O-ring EPDM thickness 3.56mm ID ø 112mm Qty 1 pcs		
	GEV No.	698827	Ref. No. —
	threaded ring LGB pump type LA50 ø 120mm ID ø 70mm		

→ electric components



OLYMPIA

pumps







1			
GEV No.	500003	Ref. No.	359270
description	pump inlet ø 45mm outlet ø 32mm type T30 230V 50Hz 1 phase 0.29kW 0.39HP L 190mm rotation direction right capacitor 8µF OLYMPIA		
For models:	665843, 665851, Glaeserspuelautomat-325, Glaeserspuelautomat-328		
spare parts for	500003		
	GEV No.	365013	Ref. No. —
	operating capacitor capacity 8µF 400V tolerance 5%Hz ambient temperature max. -25 to +85°C ø 31.5mm L 55mm M8 plastic connection male faston 6.3mm protection		
	GEV No.	510512	Ref. No. —
	pump cover OLYMPIA inlet ø 45mm outlet ø 31mm outlet 2 ø 24 turn direction right ø 130mm ID ø 124mm inner height 20mm		
	GEV No.	510554	Ref. No. —
	O-ring EPDM thickness 2mm ID ø 120mm Qty 1 pcs		
	GEV No.	510615	Ref. No. —
	impeller ø 90mm H 22mm rotation direction right thread M10L blades 4		
	GEV No.	510693	Ref. No. 359416 441002
	mechanical shaft seal for shaft ø 12mm slide ring ext. ø 24mm slide ring H 15.5mm slide ring int. ø 11mm counter ring mounting ø 24mm height counter ring 8mm counter ring int. ø 13.5mm		

booster pumps I



1			
GEV No.	500193	Ref. No.	958719
description	pump inlet ø 3/8" IT outlet ø 3/8" IT type C.1510 230V 50Hz 0.43kW ø 100mm L 170mm rotation direction left capacitor 10µF ALBA PUMPS (C&A)		
spare parts for	500193		
	GEV No.	550331	Ref. No. —
	protective covering 1-pole size 6.3mm straight nylon t.max. 120°C Qty 20 pcs		

accessories for	500193		
	GEV No.	365015	Ref. No. —
	operating capacitor capacity 10µF 400V tolerance 5%Hz ambient temperature max. -25 to +85°C ø 35.5mm L 59mm M8 plastic connection male faston 6.3mm protection		
	GEV No.	511279	Ref. No. —
	hose connector brass straight thread 3/8" hose ø 12mm Qty 1 pcs		
	GEV No.	520202	Ref. No. —
	hose connector nickel-plated brass straight thread 3/8" hose ø 12mm Qty 1 pcs		
	GEV No.	520204	Ref. No. —
	hose connector nickel-plated brass straight thread 3/8" hose ø 17mm Qty 1 pcs		

electric accessories

terminals

porcelain clamps

1			
GEV No.	550125	Ref. No.	151491
description	rail-mounted porcelain terminal 1-pole 10mm ² max. 57A max 400V L 25mm W 15mm H 25mm mounting distance mm Qty 1 pcs		
For models:	600008, 600067, 601004, 601209, 601403, 602000, 602205, 602280, 610003, 610038, 61030x, 610402, 611018, 611050, 612006, 612057, 616001, 620009, 620300, 621005, 621056, 622001, 622052, 623008, 624004, 627100, 629006, 629022, Backofen-629, Bain-Marie-624, Bain-Marie-626, Brater-611, Brater-621, Elektroherd-4-Platten-623, Elektroherd-616, Fritteuse-600, Fritteuse-601, Fritteuse-602, Geschirrspuelautomat-335, Geschirrspuelautomat-336, Griddle-Platte-612, Griddleplatte-622, steakgrill-61030, steakgrill-62030, Wurstgrill-610, Wurstgrill-620		

connection terminals with screw/faston connections

1			
GEV No.	550762	Ref. No.	070858
description	connection terminal 2-pole max. 16A max 400V connection ø 2.5mm ² / F6.3 temp.-resist. 150°C		
For models:	140902, 144819, 361763, 378933, 440078, 440086, 440094, 440140, 440655, 450111, 502200, 502308, 502650, 502707, 503010, 503150, 505900, 505935, 515892, 515906, 516678, 517887, 541869, 626104, 626112, 626201, 626228, 626309, 626317, 637564, 638625, 639087, 649554, 649562, 650943, 650951, 657735, 663263, 663395, 667412, 670618, 670626, 684848, 686298, 686328, 686336, 686409, 687200, 688096, 688118...(Other models you can see in the webshop)		



			
1			
GEV No.	550110	Ref. No.	002186
description	power terminal block 5-pole max. 40A max 250V connection M6/ male faston 6.3mm temp.-resist. 130°C		
For models:	140902, 144819, 353167, 354392, 354457, 354643, 354651, 354678, 354686, 354694, 354708, 361763, 378933, 440078, 440086, 440094, 440140, 440655, 450111, 502200, 502308, 502650, 502707, 503010, 503150, 505900, 505935, 515892, 515906, 516678, 517887, 541869, 601004, 601209, 601403, 602000, 602205, 602280, 603201, 610038, 610429, 611220, 614106, 615080, 616109, 620203, 620424, 621110, 623105, 624101...(Other models you can see in the webshop)		

gas taps

PEL





21S series

			
1			
GEV No.	101671	Ref. No.	252859 259934 697451
description	gas tap PEL type 21S gas inlet pipe flange ø21mm bypass nozzle ø 0.35mm gas outlet M17x1 (tube ø 10mm) thermocouple connection M8x1 pilot connection M10x1 shaft ø 6x4.6mm shaft L 30/23mm shaft flat upper		
For models:	399701, 399728, 541419, 541427, 750123, 750131, 750158, 750166, 750174, 750182, 750190, 800163, 800171, 800198, 800201, 800228, 800236, 800244, 800252, 800260, 800279, 800287, 800295		
spare parts for	101671		
	GEV No.	100408	Ref. No. 834076
	bypass nozzle type PEL20/21 bore ø 0.35mm thread M5x0.5		
	GEV No.	100908	Ref. No. —
	union screw thread M10x1 for pipe ø 4mm Qty 1 pcs		
	GEV No.	101060	Ref. No. 296864
	magnet unit standard L 39mm D1 ø 15.4mm D2 ø 11mm suitable for PEL20-21/JUNKERS/EGA		
	GEV No.	101230	Ref. No. —
	thermocouple nut T1: M8x1 T2: M18x1 aluminium		
	GEV No.	101246	Ref. No. —
	olive for pipe ø 4mm Qty 1 pcs		
	GEV No.	101803	Ref. No. —
	gas tap front part shaft ø 6x4.6mm shaft L 30/23mm shaft flat upper/lower suitable for PEL21		
accessories for	101671		
	GEV No.	100909	Ref. No. —
	union screw thread M10x1 for pipe ø 6mm Qty 1 pcs		

accessories for	101671		
	GEV No.	101278	Ref. No. —
	olive for pipe ø 10mm Qty 1 pcs		
	GEV No.	101286	Ref. No. —
	olive ID ø 6mm Qty 1 pcs		
	GEV No.	101300	Ref. No. —
	union nut thread M16x1.5 tube ø 10mm		
	GEV No.	101450	Ref. No. —
	olive for pipe ø 8mm L 12.7mm Qty 1 pcs ED ø 10mm		
	GEV No.	101451	Ref. No. —
	union nut thread M16x1.5 tube ø 8mm		
	GEV No.	110078	Ref. No. —
	knob without symbol ø 70mm shaft ø 6x4.6mm shaft flat universal		
	GEV No.	112206	Ref. No. —
	knob dial plate silver gas tap PEL21/22/23 t.max.°C ED ø 63mm ID ø 45.5mm		

			
1			
GEV No.	101611	Ref. No.	831611
description	gas tap PEL type 21S/V gas inlet pipe flange ø21mm bypass nozzle ø 0.35mm gas outlet M16x1.5 (tube ø 10/8mm) thermocouple connection M8x1 pilot connection M10x1 shaft ø 6x4.6mm shaft L 30/17.5mm shaft flat upper		
spare parts for	101611		
	GEV No.	100408	Ref. No. 834076
	bypass nozzle type PEL20/21 bore ø 0.35mm thread M5x0.5		
	GEV No.	101060	Ref. No. 296864
	magnet unit standard L 39mm D1 ø 15.4mm D2 ø 11mm suitable for PEL20-21/JUNKERS/EGA		
	GEV No.	101230	Ref. No. —
	thermocouple nut T1: M8x1 T2: M18x1 aluminium		
	GEV No.	101804	Ref. No. —
	gas tap front part shaft ø 6x4.6mm shaft L 30/12.5mm shaft flat upper/lower suitable for PEL21		
accessories for	101611		
	GEV No.	100908	Ref. No. —
	union screw thread M10x1 for pipe ø 4mm Qty 1 pcs		
	GEV No.	100909	Ref. No. —
	union screw thread M10x1 for pipe ø 6mm Qty 1 pcs		
	GEV No.	101246	Ref. No. —
	olive for pipe ø 4mm Qty 1 pcs		
	GEV No.	101278	Ref. No. —
	olive for pipe ø 10mm Qty 1 pcs		

Table continues overleaf



accessories for 101611				
	GEV No.	101286	Ref. No.	—
olive ID ø 6mm Qty 1 pcs				
	GEV No.	101300	Ref. No.	—
union nut thread M16x1.5 tube ø 10mm				
	GEV No.	101450	Ref. No.	—
olive for pipe ø 8mm L 12.7mm Qty 1 pcs ED ø 10mm				
	GEV No.	101451	Ref. No.	—
union nut thread M16x1.5 tube ø 8mm				

22S/V series



GEV No.	101087	Ref. No.	321397
description	gas tap PEL type 22S/V gas inlet M20x1.5 (tube ø 12mm) bypass nozzle ø 0.35mm gas outlet M20x1.5 (tube ø 12/10mm) thermocouple connection M9x1 pilot connection M10x1 shaft ø 10x8mm shaft L 25/17mm shaft flat upper		
For models:	910007, 910015, 910023, 910058, 910066, 910449, 910457, 910465		

spare parts for 101087				
	GEV No.	100259	Ref. No.	—
bypass nozzle type PEL22 bore ø 0.35mm thread M6x0.5				
	GEV No.	101058	Ref. No.	296872
magnet unit L 39mm D1 ø 15.4mm D2 ø 13.5mm suitable for PEL22/EGA24197 standard				
	GEV No.	101201	Ref. No.	—
gas tap front part shaft ø 10x8mm shaft L 25/17mm shaft flat upper/lower suitable for PEL22				
	GEV No.	101231	Ref. No.	—
thermocouple nut T1: M9x1 T2: M18x1				
	GEV No.	101241	Ref. No.	—
gas connection thread M20x1.5 tube ø 12/10mm for PEL gas taps vertical				
	GEV No.	101460	Ref. No.	—
O-ring ø 12.37mm D1 ø 2.62mm suitable for PEL22				
	GEV No.	101461	Ref. No.	—
screw kit suitable for PEL22 Qty 4 pcs				



accessories for 101087				
	GEV No.	100908	Ref. No.	—
union screw thread M10x1 for pipe ø 4mm Qty 1 pcs				
	GEV No.	100909	Ref. No.	—
union screw thread M10x1 for pipe ø 6mm Qty 1 pcs				
	GEV No.	101240	Ref. No.	—
gas connection thread M20x1.5 tube ø 12/10mm for PEL gas taps with gasket and screws horizontal				

accessories for 101087				
	GEV No.	101246	Ref. No.	—
olive for pipe ø 4mm Qty 1 pcs				
	GEV No.	101248	Ref. No.	—
olive for pipe ø 12mm Qty 1 pcs suitable for PEL				
	GEV No.	101249	Ref. No.	—
olive for pipe ø 10mm Qty 1 pcs				
	GEV No.	101250	Ref. No.	—
union nut thread M20x1.5 for pipe ø 10mm				
	GEV No.	101251	Ref. No.	—
union nut thread M20x1.5 for pipe ø 12mm				
	GEV No.	101286	Ref. No.	—
olive ID ø 6mm Qty 1 pcs				
	GEV No.	110080	Ref. No.	—
knob ø 70mm shaft ø 10x8mm shaft flat universal				
	GEV No.	112206	Ref. No.	—
knob dial plate silver gas tap PEL21/22/23 t.max.°C ED ø 63mm ID ø 45.5mm				

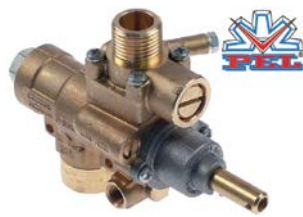
23S/V series



GEV No.	101630	Ref. No.	092415
description	gas tap PEL type 23S/V gas inlet 1/2" IT bypass nozzle ø 0.35mm gas outlet 1/2" MT (tube ø 14mm) thermocouple connection M10x1 pilot connection M10x1 shaft ø 10mm shaft L 25mm shaft flat		

spare parts for 101630				
	GEV No.	100455	Ref. No.	—
bypass nozzle type PEL23/24 bore ø 0.35mm thread M8x0.5				
	GEV No.	101059	Ref. No.	—
magnet unit T1: M10x1 T2: M22x1 L 46mm ø 18mm suitable for PEL23S M10x1				
	GEV No.	102767	Ref. No.	—
gas tap front part shaft ø 10mm shaft L 26.5mm shaft flat suitable for PEL23S				







accessories for 101630				
	GEV No.	100908	Ref. No.	—
union screw thread M10x1 for pipe ø 4mm Qty 1 pcs				
	GEV No.	100909	Ref. No.	—
union screw thread M10x1 for pipe ø 6mm Qty 1 pcs				
	GEV No.	100945	Ref. No.	—
roll pin ø 3.2mm L 10mm				

Table continues overleaf



accessories for		101630		
	GEV No.	101218	Ref. No.	—
shaft extension JUNKERS				
	GEV No.	101219	Ref. No.	—
shaft extension L 25mm JUNKERS				
	GEV No.	101246	Ref. No.	—
olive for pipe ø 4mm Qty 1 pcs				
	GEV No.	101286	Ref. No.	—
olive ID ø 6mm Qty 1 pcs				
	GEV No.	110064	Ref. No.	—
knob				
	GEV No.	110066	Ref. No.	—
knob screw				
	GEV No.	550396	Ref. No.	—
shaft extension L 25mm JUNKERS				

accessories for		101603		
	GEV No.	100943	Ref. No.	—
union nut thread M17x1 tube ø 10mm				
	GEV No.	101278	Ref. No.	—
olive for pipe ø 10mm Qty 1 pcs				
	GEV No.	110078	Ref. No.	—
knob without symbol ø 70mm shaft ø 6x4.6mm shaft flat universal				
	GEV No.	110083	Ref. No.	—
knob dial plate gas tap without ignition flame silver				

alternatives to EGA

GPEL20 series

with pipe outlet

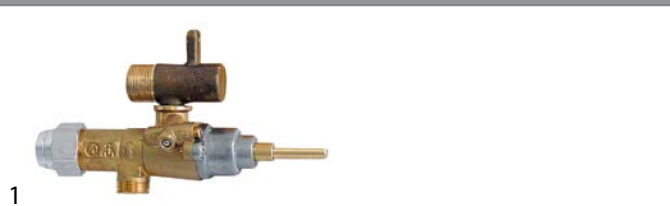

GEV No.	101603	Ref. No.	001163	
description	gas tap alternatives to EGA type GPEL20R with pipe outlet without ignition flame connection gas inlet M15x1 (tube ø 10mm) bypass nozzle ø 0.35mm gas outlet M17x1 (tube ø 10mm) thermocouple connection M8x1 shaft ø 6x4.6mm shaft L 31/23mm shaft flat upper			
For models:	645005, GasherD-645, GasherD-64502, GasherD-646			
spare parts for	101603			
	GEV No.	100408	Ref. No.	834076
bypass nozzle type PEL20/21 bore ø 0.35mm thread M5x0.5				
	GEV No.	101060	Ref. No.	296864
magnet unit standard L 39mm D1 ø 15.4mm D2 ø 11mm suitable for PEL20-21/JUNKERS/EGA				
	GEV No.	101230	Ref. No.	—
thermocouple nut T1: M8x1 T2: M18x1 aluminium				
	GEV No.	101801	Ref. No.	—
gas tap front part shaft ø 6x4.6mm shaft L 31/23mm shaft flat upper/lower suitable for PEL20				
accessories for	101603			
	GEV No.	100926	Ref. No.	—
centring piece thread M17x1				
	GEV No.	100942	Ref. No.	—
union nut thread M15x1 for pipe ø 10mm				

GPEL21 series

with pipe outlet



GEV No.	101612	Ref. No.	831743	
Alternative für 540889 Alternative für 540897				
description	gas tap alternatives to EGA type GPEL21R with pipe outlet gas inlet M15x1 (tube ø 10mm) bypass nozzle ø 0.35mm gas outlet M17x1 (tube ø 10mm) thermocouple connection M8x1 pilot connection M10x1 shaft ø 6x4.6mm shaft L 22/15mm shaft flat lower			
For models:	399604, 399612, 399701, 399728, 541419, 541427, 800163, 800171, 800198, 800201, 800228, 800236, 800244, 800252, 800260, 800279, 800287, 800295			
spare parts for	101612			
	GEV No.	100408	Ref. No.	834076
bypass nozzle type PEL20/21 bore ø 0.35mm thread M5x0.5				
	GEV No.	101060	Ref. No.	296864
magnet unit standard L 39mm D1 ø 15.4mm D2 ø 11mm suitable for PEL20-21/JUNKERS/EGA				
	GEV No.	101230	Ref. No.	—
thermocouple nut T1: M8x1 T2: M18x1 aluminium				
	GEV No.	101805	Ref. No.	—
gas tap front part shaft ø 6x4.6mm shaft L 38/15mm shaft flat upper/lower suitable for PEL21				
accessories for	101612			
	GEV No.	100908	Ref. No.	—
union screw thread M10x1 for pipe ø 4mm Qty 1 pcs				
	GEV No.	100909	Ref. No.	—
union screw thread M10x1 for pipe ø 6mm Qty 1 pcs				
	GEV No.	100926	Ref. No.	—
centring piece thread M17x1				
	GEV No.	100942	Ref. No.	—
union nut thread M15x1 for pipe ø 10mm				
	GEV No.	100943	Ref. No.	—
union nut thread M17x1 tube ø 10mm				

Table continues overleaf



accessories for		101612		
GEV No.	101246	Ref. No.	—	
	olive for pipe ø 4mm Qty 1 pcs			
GEV No.	101278	Ref. No.	—	
	olive for pipe ø 10mm Qty 1 pcs			
GEV No.	101286	Ref. No.	—	
	olive ID ø 6mm Qty 1 pcs			
GEV No.	110078	Ref. No.	—	
	knob without symbol ø 70mm shaft ø 6x4.6mm shaft flat universal			
GEV No.	112206	Ref. No.	—	
	knob dial plate silver gas tap PEL21/22/23 t.max.°C ED ø 63mm ID ø 45.5mm			

1				
GEV No.	101605	Ref. No.	N/A	
description	gas tap alternatives to EGA type GPEL21R with pipe outlet gas inlet M15x1 (tube ø 10mm) bypass nozzle ø 0.35mm gas outlet M17x1 (tube ø 10mm) thermocouple connection M8x1 pilot connection M10x1 shaft ø 6x4.6mm shaft L 30/23mm shaft flat upper			
spare parts for	101605			
	GEV No.	100408	Ref. No.	834076
	bypass nozzle type PEL20/21 bore ø 0.35mm thread M5x0.5			
	GEV No.	101060	Ref. No.	296864
	magnet unit standard L 39mm D1 ø 15.4mm D2 ø 11mm suitable for PEL20-21/JUNKERS/EGA			
	GEV No.	101230	Ref. No.	—
	thermocouple nut T1: M8x1 T2: M18x1 aluminium			
	GEV No.	101803	Ref. No.	—
	gas tap front part shaft ø 6x4.6mm shaft L 30/23mm shaft flat upper/lower suitable for PEL21			
accessories for	101605			
	GEV No.	100908	Ref. No.	—
	union screw thread M10x1 for pipe ø 4mm Qty 1 pcs			
	GEV No.	100909	Ref. No.	—
	union screw thread M10x1 for pipe ø 6mm Qty 1 pcs			
	GEV No.	100926	Ref. No.	—
	centring piece thread M17x1			
	GEV No.	100942	Ref. No.	—
	union nut thread M15x1 for pipe ø 10mm			
	GEV No.	100943	Ref. No.	—
	union nut thread M17x1 tube ø 10mm			
	GEV No.	101246	Ref. No.	—
	olive for pipe ø 4mm Qty 1 pcs			

accessories for		101605		
GEV No.	101278	Ref. No.	—	
	olive for pipe ø 10mm Qty 1 pcs			
GEV No.	101286	Ref. No.	—	
	olive ID ø 6mm Qty 1 pcs			
GEV No.	110078	Ref. No.	—	
	knob without symbol ø 70mm shaft ø 6x4.6mm shaft flat universal			
GEV No.	112206	Ref. No.	—	
	knob dial plate silver gas tap PEL21/22/23 t.max.°C ED ø 63mm ID ø 45.5mm			

GPEL22 series





with nozzle outlet

1				
GEV No.	101622	Ref. No.	290866	
description	gas tap alternatives to EGA type PEL22S with nozzle outlet (without nozzle) gas inlet M18x1.5 (tube ø 12mm) external nozzle ømm internal nozzle ømm bypass nozzle ø 0.35mm mixing pipe connection M22x1 thermocouple connection M8x1 pilot connection M10x1 shaft ø 6x4.6mm shaft L 35/21mm shaft flat upper			
For models:	Maxima-Gasherd-700, Maxima-Gasherd-850			
spare parts for	101622			
	GEV No.	100259	Ref. No.	—
	bypass nozzle type PEL22 bore ø 0.35mm thread M6x0.5			
	GEV No.	100927	Ref. No.	—
	torsion spring L 2.8-8.0mm for internal nozzle ø 3mm bore ømm			
	GEV No.	101058	Ref. No.	296872
	magnet unit L 39mm D1 ø 15.4mm D2 ø 13.5mm suitable for PEL22/EGA24197 standard			
	GEV No.	101230	Ref. No.	—
	thermocouple nut T1: M8x1 T2: M18x1 aluminium			
	GEV No.	101460	Ref. No.	—
	O-ring ø 12.37mm D1 ø 2.62mm suitable for PEL22			
	GEV No.	101527	Ref. No.	—
	O-ring Viton thickness 1.78mm ID ø 6.75mm Qty 1 pcs			
	GEV No.	101594	Ref. No.	—
	adjusting screw for internal nozzle thread M10x0.75			
	GEV No.	101823	Ref. No.	—
	gas tap front part shaft ø 6x4.6mm shaft L 35/21mm shaft flat upper/lower suitable for PEL22			
accessories for	101622			
	GEV No.	100908	Ref. No.	—
	union screw thread M10x1 for pipe ø 4mm Qty 1 pcs			

Table continues overleaf



accessories for		101622		
	GEV No.	100909	Ref. No.	—
union screw thread M10x1 for pipe ø 6mm Qty 1 pcs				
	GEV No.	100944	Ref. No.	—
union nut thread M18x1.5 for pipe ø 12mm				
	GEV No.	101246	Ref. No.	—
olive for pipe ø 4mm Qty 1 pcs				
	GEV No.	101273	Ref. No.	959715
olive for pipe ø 12mm L 9.5mm brass Qty 1 pcs suitable for universal				
	GEV No.	101286	Ref. No.	—
olive ID ø 6mm Qty 1 pcs				
	GEV No.	110078	Ref. No.	—
knob without symbol ø 70mm shaft ø 6x4.6mm shaft flat universal				
	GEV No.	112206	Ref. No.	—
knob dial plate silver gas tap PEL21/22/23 t.max.°C ED ø 63mm ID ø 45.5mm				

accessories for		101630		
	GEV No.	101246	Ref. No.	—
olive for pipe ø 4mm Qty 1 pcs				
	GEV No.	101286	Ref. No.	—
olive ID ø 6mm Qty 1 pcs				
	GEV No.	110064	Ref. No.	—
knob				
	GEV No.	110066	Ref. No.	—
knob screw				
	GEV No.	550396	Ref. No.	—
shaft extension L 25mm JUNKERS				







alternatives to JUNKERS

				
1				
GEV No.	101630	Ref. No.	092415	
description	gas tap PEL type 23S/V gas inlet 1/2" IT bypass nozzle ø 0.35mm gas outlet 1/2" MT (tube ø 14mm) thermocouple connection M10x1 pilot connection M10x1 shaft ø 10mm shaft L 25mm shaft flat			
spare parts for	101630			
	GEV No.	100455	Ref. No.	—
bypass nozzle type PEL23/24 bore ø 0.35mm thread M8x0.5				
	GEV No.	101059	Ref. No.	—
magnet unit T1: M10x1 T2: M22x1 L 46mm ø 18mm suitable for PEL23S M10x1				
	GEV No.	102767	Ref. No.	—
gas tap front part shaft ø 10mm shaft L 26.5mm shaft flat suitable for PEL23S				
accessories for	101630			
	GEV No.	100908	Ref. No.	—
union screw thread M10x1 for pipe ø 4mm Qty 1 pcs				
	GEV No.	100909	Ref. No.	—
union screw thread M10x1 for pipe ø 6mm Qty 1 pcs				
	GEV No.	100945	Ref. No.	—
roll pin ø 3.2mm L 10mm				
	GEV No.	101218	Ref. No.	—
shaft extension JUNKERS				
	GEV No.	101219	Ref. No.	—
shaft extension L 25mm JUNKERS				

EGA

24197 series

gas taps

				
1				
GEV No.	101149	Ref. No.	290874	
description	gas tap EGA type 24197 series			
For models:	Maxima-Gasherd-700, Maxima-Gasherd-850			
spare parts for	101149			
	GEV No.	101058	Ref. No.	296872
magnet unit L 39mm D1 ø 15.4mm D2 ø 13.5mm suitable for PEL22/ EGA24197 standard				
	GEV No.	101230	Ref. No.	—
thermocouple nut T1: M8x1 T2: M18x1 aluminium				
accessories for	101149			
	GEV No.	100944	Ref. No.	—
union nut thread M18x1.5 for pipe ø 12mm				
	GEV No.	101273	Ref. No.	959715
olive for pipe ø 12mm L 9.5mm brass Qty 1 pcs suitable for universal				
	GEV No.	101284	Ref. No.	—
olive for pipe ø 4mm Qty 1 pcs				
	GEV No.	101285	Ref. No.	—
union screw thread M8x1 for pipe ø 4mm Qty 1 pcs JUNKERS				

26400 series

gas taps



GEV No.	106319	Ref. No.	169498
----------------	--------	-----------------	--------

description gas tap EGA type 26400 series gas inlet 8mm pipe thermocouple connection M8 shaft ø 6x4.6mm external nozzle ø 270mm internal nozzle ø 130mm bypass nozzle ø 65mm shaft L 25mm shaft length knob 17mm shaft flat upper

For models: 640018, 642053, Gas-Brater-641, Gas-Griddleplatte-642, Gas-sudpfanne-643, Gas-Wurstgrill-640

spare parts for	106319
------------------------	--------

	GEV No.	100295	Ref. No.	169595
---	----------------	--------	-----------------	--------

gas injector thread M12x1 WS 14 bore ø 2.70mm

	GEV No.	100361	Ref. No.	—
---	----------------	--------	-----------------	---

bypass nozzle EGA type 31248 series bore ø 0.65mm

	GEV No.	101060	Ref. No.	296864
---	----------------	--------	-----------------	--------

magnet unit standard L 39mm D1 ø 15.4mm D2 ø 11mm suitable for PEL20-21/JUNKERS/EGA

	GEV No.	101230	Ref. No.	—
--	----------------	--------	-----------------	---

thermocouple nut T1: M8x1 T2: M18x1 aluminium

	GEV No.	106510	Ref. No.	—
---	----------------	--------	-----------------	---

internal nozzle bore ø 1.30mm suitable for EGA26400/26440

accessories for	106319
------------------------	--------

	GEV No.	100941	Ref. No.	—
---	----------------	--------	-----------------	---

union nut thread M15x1 for pipe ø 8mm

	GEV No.	101277	Ref. No.	—
---	----------------	--------	-----------------	---

olive ID ø 8mm Qty 1 pcs

26440 series

gas taps



GEV No.	101142	Ref. No.	081167 081426
----------------	--------	-----------------	------------------

description gas tap EGA type 26440 series

For models: Maxima-Gasherd-700-850, Maxima-Gasherd-mit-Gasbackofen, Maxima-Gasherd-neue-Ausfuehrung-700-850

spare parts for	101142
------------------------	--------

	GEV No.	101060	Ref. No.	296864
---	----------------	--------	-----------------	--------

magnet unit standard L 39mm D1 ø 15.4mm D2 ø 11mm suitable for PEL20-21/JUNKERS/EGA

	GEV No.	101230	Ref. No.	—
---	----------------	--------	-----------------	---

thermocouple nut T1: M8x1 T2: M18x1 aluminium

accessories for	101142
------------------------	--------

	GEV No.	100926	Ref. No.	—
---	----------------	--------	-----------------	---

centring piece thread M17x1

	GEV No.	100942	Ref. No.	—
---	----------------	--------	-----------------	---

union nut thread M15x1 for pipe ø 10mm

	GEV No.	101278	Ref. No.	—
---	----------------	--------	-----------------	---

olive for pipe ø 10mm Qty 1 pcs

	GEV No.	101284	Ref. No.	—
---	----------------	--------	-----------------	---

olive for pipe ø 4mm Qty 1 pcs

	GEV No.	101285	Ref. No.	—
---	----------------	--------	-----------------	---

union screw thread M8x1 for pipe ø 4mm Qty 1 pcs JUNKERS

	GEV No.	101394	Ref. No.	—
---	----------------	--------	-----------------	---

nut thread M17x1 H 3mm WS 19 brass Qty 1 pcs



GEV No.	101145	Ref. No.	540889 540897
----------------	--------	-----------------	------------------

description gas tap EGA type 26440 series

spare parts for	101145
------------------------	--------

	GEV No.	101060	Ref. No.	296864
---	----------------	--------	-----------------	--------

magnet unit standard L 39mm D1 ø 15.4mm D2 ø 11mm suitable for PEL20-21/JUNKERS/EGA

	GEV No.	101233	Ref. No.	—
---	----------------	--------	-----------------	---

union nut thread M10x1 JUNKERS

accessories for	101145
------------------------	--------

	GEV No.	100926	Ref. No.	—
---	----------------	--------	-----------------	---

centring piece thread M17x1

	GEV No.	100942	Ref. No.	—
---	----------------	--------	-----------------	---

union nut thread M15x1 for pipe ø 10mm

	GEV No.	101278	Ref. No.	—
---	----------------	--------	-----------------	---

olive for pipe ø 10mm Qty 1 pcs

	GEV No.	101284	Ref. No.	—
---	----------------	--------	-----------------	---

olive for pipe ø 4mm Qty 1 pcs

	GEV No.	101285	Ref. No.	—
---	----------------	--------	-----------------	---

union screw thread M8x1 for pipe ø 4mm Qty 1 pcs JUNKERS

	GEV No.	101394	Ref. No.	—
---	----------------	--------	-----------------	---

nut thread M17x1 H 3mm WS 19 brass Qty 1 pcs



ignition parts











pilot burners

SIT

100 series

















1

GEV No.	107137	Ref. No.	321354
description	pilot burner SIT type 100 series 1 flame LPG nozzle \varnothing 0.18mm gas connectionmm		
spare parts for	107137		
	GEV No.	100246	Ref. No. —
	pilot burner nozzle natural gas bore \varnothing 0.35mm Qty 1 pcs thread M8x0.75		
	GEV No.	100916	Ref. No. —
	compression spring for pilot burner Qty 1 pcs		
	GEV No.	100917	Ref. No. —
	gasket for pilot burner Qty 1 pcs aluminium		
	GEV No.	100918	Ref. No. —
	screw for pilot burner		
accessories for	107137		
	GEV No.	100246	Ref. No. —
	pilot burner nozzle natural gas bore \varnothing 0.35mm Qty 1 pcs thread M8x0.75		
	GEV No.	100904	Ref. No. —
	locking screw M10x1 for pipe \varnothing 4mm Qty 1 pcs		
	GEV No.	100905	Ref. No. —
	locking screw M10x1 for pipe \varnothing 6mm Qty 1 pcs		
	GEV No.	102110	Ref. No. —
	pilot tube copper pipe \varnothing 4mm thickness 1mm L 3000mm		
	GEV No.	102111	Ref. No. —
	pilot tube copper pipe \varnothing 6mm thickness 1mm L 3000mm		
	GEV No.	107171	Ref. No. —
	pilot burner nozzle SIT natural/liquid gas bore \varnothing 0.25mm Qty 1 pcs		



1

GEV No.	106907	Ref. No.	321400 321699
description	pilot burner SIT type 100 series 3 flames nozzle \varnothing 0.35mm gas connection 6mm		
For models:	710024, 710040, 710059, 710067, 910023, 910047, 910058, 910066, 910082, 910090, 910104, 910112, 910139, 910147, 910155, 910163, 910457, 910473, FOEM-Gas-Backofen		
spare parts for	106907		
	GEV No.	100246	Ref. No. —
	pilot burner nozzle natural gas bore \varnothing 0.35mm Qty 1 pcs thread M8x0.75		
	GEV No.	100855	Ref. No. —
	pilot burner bracket triple		
	GEV No.	100885	Ref. No. —
	air mixing sleeve for pilot burner Qty 1 pcs		
	GEV No.	100916	Ref. No. —
	compression spring for pilot burner Qty 1 pcs		
	GEV No.	100917	Ref. No. —
	gasket for pilot burner Qty 1 pcs aluminium		
	GEV No.	100918	Ref. No. —
	screw for pilot burner		
	GEV No.	107162	Ref. No. —
	pilot burner cap SIT 3 flames Hmm Lmm Qty 1 pcs		
accessories for	106907		
	GEV No.	100245	Ref. No. —
	pilot burner nozzle LPG code 20 bore \varnothing 0.2mm Qty 1 pcs thread M8x0.75		
	GEV No.	100904	Ref. No. —
	locking screw M10x1 for pipe \varnothing 4mm Qty 1 pcs		
	GEV No.	100905	Ref. No. —
	locking screw M10x1 for pipe \varnothing 6mm Qty 1 pcs		
	GEV No.	102110	Ref. No. —
	pilot tube copper pipe \varnothing 4mm thickness 1mm L 3000mm		
	GEV No.	102111	Ref. No. —
	pilot tube copper pipe \varnothing 6mm thickness 1mm L 3000mm		
	GEV No.	107171	Ref. No. —
	pilot burner nozzle SIT natural/liquid gas bore \varnothing 0.25mm Qty 1 pcs		
	GEV No.	107700	Ref. No. —
	pilot burner bottom part SIT 100 series nozzle \varnothing 0.25mm		
	GEV No.	107701	Ref. No. —
	pilot burner bottom part SIT 100 series nozzle \varnothing 0.2mm		

1 gas components



accessories			
ignition electrodes			
GEV No.	100706	Ref. No.	321419
description	ignition electrode connection M4 Qty 1 pcs		
For models:	710059, 710067, 710083, 910023, 910047, 910058, 910066, 910082, 910090, 910104, 910112, 910139, 910147, 910155, 910163, 910457, 910473		

JUNKERS

CB 502 series

pilot burners			
GEV No.	100125	Ref. No.	374520 606197
description	pilot burner JUNKERS type CB502024		
For models:	399604, 399612, 750301, 750328, 750379, 750387		

spare parts for 100125			
	GEV No.	100228	Ref. No. —
	pilot burner nozzle town gas gas pressure 8mbar code 4 Qty 1 pcs suitable for JUNKERS CB50203_		
	GEV No.	100719	Ref. No. 097292
	ignition electrode D1 ø 7mm D2 ø 9mm connection M4 L1 12mm L2 17mm BL1 18mm BL2 3mm BL3 23mm		
	GEV No.	100906	Ref. No. 835803
	screw connection thread M10x1 for ignition electrode brass Qty 1 pcs WS 10		
	GEV No.	100907	Ref. No. —
	screw connection thread M10x1 Qty 1 pcs type SEF 1 ømm for thermocouple		
	GEV No.	101281	Ref. No. —
	olive for pipe ø 4mm L 8.7mm Qty 1 pcs suitable for CB 502/503		
	GEV No.	101283	Ref. No. —
	union screw thread M10x1 for pipe ø 4mm Qty 1 pcs		
accessories for 100125			
	GEV No.	100220	Ref. No. —
	pilot burner nozzle LPG gas pressure 50mbar code 2 Qty 1 pcs suitable for JUNKERS CB503_		
	GEV No.	100221	Ref. No. —
	pilot burner nozzle LPG gas pressure 30mbar code 29 Qty 1 pcs suitable for JUNKERS CB50203_		
	GEV No.	100222	Ref. No. —
	pilot burner nozzle LPG gas pressure 50mbar code 5 Qty 1 pcs suitable for JUNKERS CB50203_		

accessories for 100125			
	GEV No.	100222	Ref. No. —
	pilot burner nozzle LPG gas pressure 50mbar code 5 Qty 1 pcs suitable for JUNKERS CB50203_		
	GEV No.	100223	Ref. No. —
	pilot burner nozzle natural gas gas pressure 20mbar code 3 Qty 1 pcs suitable for JUNKERS CB503_		
	GEV No.	100224	Ref. No. —
	pilot burner nozzle natural gas gas pressure 25mbar code 26 Qty 1 pcs suitable for JUNKERS CB503_		
	GEV No.	100225	Ref. No. —
	pilot burner nozzle LPG gas pressure 30mbar code 39 Qty 1 pcs suitable for JUNKERS CB503_		
	GEV No.	100226	Ref. No. —
	pilot burner nozzle LPG gas pressure 50mbar code 15 suitable for JUNKERS		
	GEV No.	100227	Ref. No. —
	pilot burner nozzle natural gas gas pressure 25mbar code 6 Qty 1 pcs suitable for JUNKERS CB50203_		
	GEV No.	100909	Ref. No. —
	union screw thread M10x1 for pipe ø 6mm Qty 1 pcs		
	GEV No.	101287	Ref. No. —
	olive for pipe ø 6mm Qty 1 pcs		

CB 503 series





pilot burners

GEV No.	100101	Ref. No.	225894
description	pilot burner JUNKERS type CB503003 LPG nozzle no.2 gas connection 4mm with primary air		
For models:	FOEM-Offenen-Brennstellen, Maxima-Gasherdd-700, Maxima-Gasherdd-850		
spare parts for 100101			
	GEV No.	100224	Ref. No. —
	pilot burner nozzle natural gas gas pressure 25mbar code 26 Qty 1 pcs suitable for JUNKERS CB503_		
	GEV No.	101281	Ref. No. —
	olive for pipe ø 4mm L 8.7mm Qty 1 pcs suitable for CB 502/503		
	GEV No.	101283	Ref. No. —
	union screw thread M10x1 for pipe ø 4mm Qty 1 pcs		
accessories for 100101			
	GEV No.	100220	Ref. No. —
	pilot burner nozzle LPG gas pressure 50mbar code 2 Qty 1 pcs suitable for JUNKERS CB503_		
	GEV No.	100221	Ref. No. —
	pilot burner nozzle LPG gas pressure 30mbar code 29 Qty 1 pcs suitable for JUNKERS CB50203_		
	GEV No.	100222	Ref. No. —
	pilot burner nozzle LPG gas pressure 50mbar code 5 Qty 1 pcs suitable for JUNKERS CB50203_		

Table continues overleaf



accessories for		100101	
	GEV No.	100223	Ref. No. —
pilot burner nozzle natural gas gas pressure 20mbar code 3 Qty 1 pcs suitable for JUNKERS CB503_			
	GEV No.	100226	Ref. No. —
pilot burner nozzle LPG gas pressure 50mbar code 15 suitable for JUNKERS			
	GEV No.	100227	Ref. No. —
pilot burner nozzle natural gas gas pressure 25mbar code 6 Qty 1 pcs suitable for JUNKERS CB50203_			
	GEV No.	100228	Ref. No. —
pilot burner nozzle town gas gas pressure 8mbar code 4 Qty 1 pcs suitable for JUNKERS CB50203_			
	GEV No.	100909	Ref. No. —
union screw thread M10x1 for pipe ø 6mm Qty 1 pcs			
	GEV No.	101287	Ref. No. —
olive for pipe ø 6mm Qty 1 pcs			
	GEV No.	102110	Ref. No. —
pilot tube copper pipe ø 4mm thickness 1mm L 3000mm			
	GEV No.	102111	Ref. No. —
pilot tube copper pipe ø 6mm thickness 1mm L 3000mm			

accessories for		100079	
	GEV No.	102110	Ref. No. —
pilot tube copper pipe ø 4mm thickness 1mm L 3000mm			
	GEV No.	102111	Ref. No. —
pilot tube copper pipe ø 6mm thickness 1mm L 3000mm			
	GEV No.	102699	Ref. No. 835765
pilot burner nozzle POLIDORO natural gas code 25.2 bore ø 2x0.25mm Qty 1 pcs 2 bores			
	GEV No.	102795	Ref. No. —
olive for pipe ø 4mm Qty 1 pcs			
	GEV No.	102797	Ref. No. —
olive for pipe ø 6mm Qty 1 pcs			
	GEV No.	106703	Ref. No. —
pilot burner nozzle POLIDORO natural gas code 27.2 bore ø 2x0.27mm Qty 1 pcs			
	GEV No.	106704	Ref. No. —
pilot burner nozzle POLIDORO LPG code 16.2 bore ø 2x0.16mm Qty 1 pcs			
	GEV No.	106763	Ref. No. —
pilot burner nozzle POLIDORO natural gas code 27.2A bore ø 2x0.27mm Qty 1 pcs			
	GEV No.	106859	Ref. No. —
pilot burner nozzle POLIDORO LPG code 24 bore ø 0.24mm Qty 1 pcs			

POLIDORO

pilot burners



GEV No.	100079	Ref. No.	834610 835838
description	pilot burner POLIDORO 3 flames code gas connectionmm		
accessories for	100079		
	GEV No.	100000	Ref. No. —
pilot burner nozzle POLIDORO LPG code 22 bore ø 0.22mm Qty 1 pcs			
	GEV No.	100208	Ref. No. —
pilot burner nozzle POLIDORO LPG code 20 bore ø 0.2mm Qty 1 pcs			
	GEV No.	100209	Ref. No. —
pilot burner nozzle POLIDORO natural gas code 40 bore ø 0.4mm Qty 1 pcs			
	GEV No.	100701	Ref. No. —
ignition electrode connection M4 Qty 1 pcs			
	GEV No.	100906	Ref. No. 835803
screw connection thread M10x1 for ignition electrode brass Qty 1 pcs WS 10			
	GEV No.	100907	Ref. No. —
screw connection thread M10x1 Qty 1 pcs type SEF 1 ømm for thermocouple			
	GEV No.	100908	Ref. No. —
union screw thread M10x1 for pipe ø 4mm Qty 1 pcs			
	GEV No.	100909	Ref. No. —
union screw thread M10x1 for pipe ø 6mm Qty 1 pcs			

producer-specific pilot burners

PALUX

Compact series



GEV No.	102956	Ref. No.	N/A
description	pilot burner type C without nozzle		



GEV No.	102957	Ref. No.	N/A
description	pilot burner type D without nozzle		











			
GEV No.	102958	Ref. No.	N/A
description	pilot burner type E without nozzle		

Practica series

			
GEV No.	107137	Ref. No.	321354
description	pilot burner SIT type 100 series 1 flame LPG nozzle ϕ 0.18mm gas connectionmm		
spare parts for	107137		
	GEV No.	100246	Ref. No. —
pilot burner nozzle natural gas bore ϕ 0.35mm Qty 1 pcs thread M8x0.75			
	GEV No.	100916	Ref. No. —
compression spring for pilot burner Qty 1 pcs			
	GEV No.	100917	Ref. No. —
gasket for pilot burner Qty 1 pcs aluminium			
	GEV No.	100918	Ref. No. —
screw for pilot burner			
accessories for	107137		
	GEV No.	100246	Ref. No. —
pilot burner nozzle natural gas bore ϕ 0.35mm Qty 1 pcs thread M8x0.75			
	GEV No.	100904	Ref. No. —
locking screw M10x1 for pipe ϕ 4mm Qty 1 pcs			
	GEV No.	100905	Ref. No. —
locking screw M10x1 for pipe ϕ 6mm Qty 1 pcs			
GEV No.	102110	Ref. No.	—
 pilot tube copper pipe ϕ 4mm thickness 1mm L 3000mm			
GEV No.	102111	Ref. No.	—
 pilot tube copper pipe ϕ 6mm thickness 1mm L 3000mm			
GEV No.	107171	Ref. No.	—
 pilot burner nozzle SIT natural/liquid gas bore ϕ 0.25mm Qty 1 pcs			

Topline series (version 1)

			
GEV No.	100088	Ref. No.	541346
description	pilot burner EGA type B		
For models:	399701, 399728, 541419, 541427, 800163, 800171, 800198, 800201, 800228, 800236, 800244, 800252, 800260, 800279, 800287, 800295		
spare parts for	100088		
	GEV No.	100961	Ref. No. 081515 360139
pilot burner head thread M7x0.75mm thread L 5mm ED ϕ 6mm ID ϕ 4.4mm total length 30mm L 20mm WS 8			
	GEV No.	101345	Ref. No. —
nut thread M15x1 H 3mm WS 19 brass Qty 1 pcs			
accessories for	100088		
	GEV No.	100270	Ref. No. 086339
pilot burner nozzle LPG bore ϕ 0.2mm thread M8x0.75 T1: M8x1			
	GEV No.	100271	Ref. No. —
pilot burner nozzle natural gas bore ϕ 0.3mm			
	GEV No.	100960	Ref. No. 082759
cover for pilot burner			
	GEV No.	101228	Ref. No. —
knurled nut thread M8x0.75 ϕ 14mm H 4mm mounting pos. outer brass			
	GEV No.	101259	Ref. No. —
union nut thread M8x1 for pipe ϕ 4mm			
	GEV No.	101284	Ref. No. —
olive for pipe ϕ 4mm Qty 1 pcs			

electrodes

			
GEV No.	100706	Ref. No.	321419
description	ignition electrode connection M4 Qty 1 pcs		
For models:	710059, 710067, 710083, 910023, 910047, 910058, 910066, 910082, 910090, 910104, 910112, 910139, 910147, 910155, 910163, 910457, 910473		

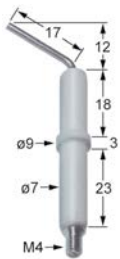
GEV No.	100719	Ref. No.	097292
description	ignition electrode D1 ø 7mm D2 ø 9mm connection M4 L1 12mm L2 17mm BL1 18mm BL2 3mm BL3 23mm		
For models:	640018, 642053, Gas-Brater-641, Gas-Griddleplatte-642, Gas-sudpfanne-643, Gas-Wurstgrill-640		



GEV No.	100741	Ref. No.	090069
description	ignition electrode D1 ø 9mm L1 8mm connection M4 PG9		
For models:	Maxima-Gas-Kippbratpfanne-neue-Ausfuehrung-700-850		



GEV No.	100906	Ref. No.	835803
description	screw connection thread M10x1 for ignition electrode brass Qty 1 pcs WS 10		



GEV No.	100005	Ref. No.	858528
description	piezoelectric igniter body plastic blowing mounting ø 22mm connection ø2.4mm cable lengthmm SIT		

miscellaneous



GEV No.	nla ¹	Ref. No.	089354 311723
description	piezoelectric igniter body metal connection F6.3x0.8 2 hole fixing ø 22mm		
For models:	640018, 642053, 645005, 710059, 710067, 710083, 750301, 750328, 750379, 750387, Gas-Brater-641, Gas-Griddleplatte-642, Gasherd-645, Gasherd-646, Gas-sudpfanne-643, Gas-Wurstgrill-640, Maxima-Gas-Bain-Marie-700-850, Maxima-Gas-Bain-Marie-850, Maxima-Gas-Kippbratpfanne-neue-Ausfuehrung-700-850		

¹no longer available





GEV No.	nla ¹	Ref. No.	833291
description	piezoelectric igniter suitable for Minisit connection F6.3x0.8 ømm		

¹no longer available

piezoelectric igniters

mounting diameter 22mm



GEV No.	100039	Ref. No.	269174
description	piezoelectric igniter body plastic blowing mounting ø 22mm connection F6.3x0.8 cable lengthmm		
For models:	Gas-Bain-Marie-644, Maxima-Gasherd-mit-Gasbackofen		
accessories for	100039		
	GEV No.	100115	Ref. No. —
	union nut ID ø M22x1mm		

thermocouples

plug-in thermocouples

plug-in thermocouples standard

with barrel socket ø5mm - type Junkers with aluminised tip

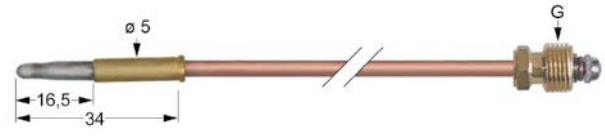

GEV No.	102205	Ref. No.	697443
description	thermocouple M8x1 L 750mm plug connection ø5.0mm		
For models:	399701, 399728, 541419, 541427, 800163, 800171, 800198, 800201, 800228, 800236, 800244, 800252, 800260, 800279, 800287, 800295		
accessories for	102205		
	GEV No.	101260	Ref. No. —
	thermocouple fitting thread M8x1 Qty 1 pcs		

with barrel socket $\varnothing 6\text{mm}$

type Junkers with aluminised tip

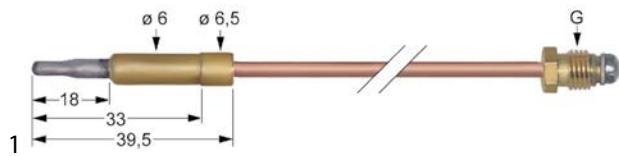

GEV No.	102218	Ref. No.	384267
description	thermocouple M8x1 L 320mm plug connection $\varnothing 6.0\text{mm}$		
For models:	750123, 750131, 750158, 750166, 750174, 750182, 750190, 750379, 750387		

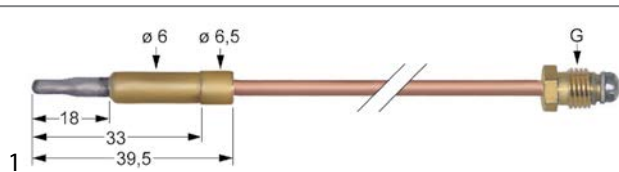

GEV No.	102220	Ref. No.	384275
description	thermocouple M8x1 L 600mm plug connection $\varnothing 6.0\text{mm}$		
For models:	750123, 750131, 750158, 750166, 750174, 750182, 750190		

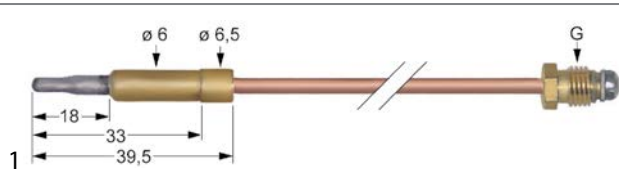

GEV No.	102221	Ref. No.	225908
description	thermocouple M8x1 L 750mm plug connection $\varnothing 6.0\text{mm}$		
For models:	FOEM-Offenen-Brennstellen		

with barrel socket $\varnothing 6(6.5)\text{mm}$

thermocouples SIT

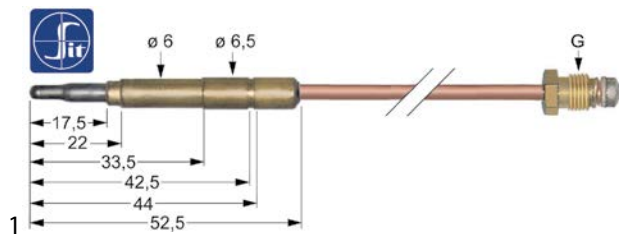

GEV No.	107609	Ref. No.	321702
description	thermocouple SIT M9x1 L 600mm plug connection $\varnothing 6.0(6.5)\text{mm}$		
For models:	710059, 710067, 910104, 910112, 910139		

plug-in thermocouples with cable link



GEV No.	102131	Ref. No.	384968
description	thermocouple with two-conductors L 1000mm plug connection $\varnothing 5.0\text{mm}$ M8x1		
For models:	750301, 750328		

threaded thermocouples

threaded thermocouples standard

with socket with thread M8x1

SIT

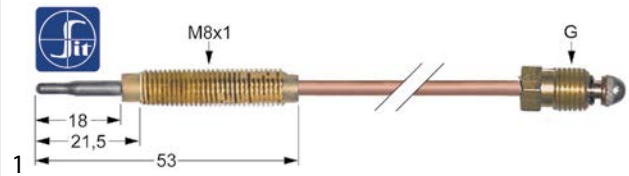

GEV No.	107645	Ref. No.	086363
description	thermocouple SIT M10x1 L 1500mm M8x1		
For models:	Maxima-Gasherd-mit-Gasbackofen		
accessories for	107645		
	GEV No.	102067	Ref. No. 054240
nut thread M8x1 H 3mm brass Qty 1 pcs type SEF 1			

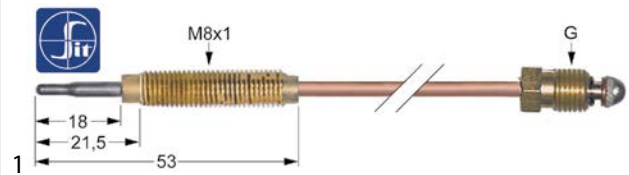

GEV No.	107632	Ref. No.	001198
description	thermocouple SIT M8x1 L 1000mm M8x1		
For models:	Gasherd-64502		
accessories for	107632		
	GEV No.	102067	Ref. No. 054240
nut thread M8x1 H 3mm brass Qty 1 pcs type SEF 1			

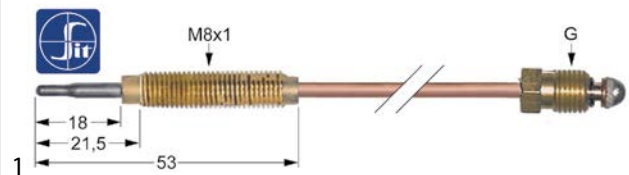

GEV No.	107633	Ref. No.	229644
description	thermocouple SIT M8x1 L 1200mm M8x1		
For models:	Gasherd-64502, Maxima-Gasherd-700, Maxima-Gasherd-850		
accessories for	107633		
	GEV No.	102067	Ref. No. 054240
nut thread M8x1 H 3mm brass Qty 1 pcs type SEF 1			

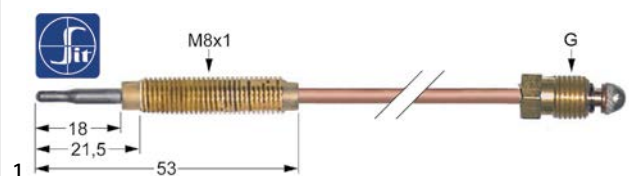

GEV No.	107629	Ref. No.	00118*
description	thermocouple SIT M8x1 L 450mm M8x1		
accessories for	107629		
	GEV No.	102067	Ref. No. 054240
nut thread M8x1 H 3mm brass Qty 1 pcs type SEF 1			



type Junkers with aluminised tip

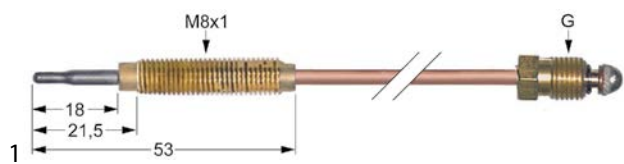

GEV No.	102233	Ref. No.	001201
description	thermocouple M8x1 L 750mm M8x1		
For models:	399701, 399728, 541419, 541427, 640018, 642053, 645005, 800163, 800171, 800198, 800201, 800228, 800236, 800244, 800252, 800260, 800279, 800287, 800295, Gas-Brater-641, Gas-Griddleplatte-642, GasherD-645, GasherD-646, Gas-Wurstgrill-640, Maxima-Gas-Bain-Marie-700-850, Maxima-Gas-Bain-Marie-850, Maxima-GasherD-700, Maxima-GasherD-700-850, Maxima-GasherD-850, Maxima-GasherD-neue-Ausfuehrung-700-850		
accessories for	102233		
	GEV No.	102067	Ref. No. 054240
	nut thread M8x1 H 3mm brass Qty 1 pcs type SEF 1		

accessories

nuts

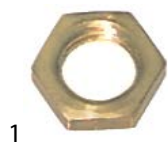

GEV No.	102067	Ref. No.	054240
description	nut thread M8x1 H 3mm brass Qty 1 pcs type SEF 1		
For models:	399701, 399728, 541419, 541427, 640018, 642053, 645005, 800163, 800171, 800198, 800201, 800228, 800236, 800244, 800252, 800260, 800279, 800287, 800295, Gas-Brater-641, Gas-Griddleplatte-642, GasherD-645, GasherD-64502, GasherD-646, Gas-sudpfanne-643, Gas-Wurstgrill-640, Maxima-GasherD-700-850, Maxima-GasherD-neue-Ausfuehrung-700-850		



GEV No.	100965	Ref. No.	054520 082953
description	thermocouple nut thread M8x1 H 15mm WS 11 brass Qty 1 pcs		
For models:	399701, 399728, 541419, 541427, 800163, 800171, 800198, 800201, 800228, 800236, 800244, 800252, 800260, 800279, 800287, 800295, Maxima-GasherD-700-850, Maxima-GasherD-neue-Ausfuehrung-700-850		

gas burners

hob burners

producer-specific hob burners

PALUX

Topline series (version 1)



GEV No.	104214	Ref. No.	540730
description	air mixing tube ID ø 12mm C		
For models:	399701, 399728, 541419, 541427, 800163, 800171, 800198, 800201, 800228, 800236, 800244, 800252, 800260, 800279, 800287, 800295		



GEV No.	104215	Ref. No.	540749
description	air mixing tube ID ø 14mm D		
For models:	399701, 399728, 541419, 541427, 800163, 800171, 800198, 800201, 800228, 800236, 800244, 800252, 800260, 800279, 800287, 800295		



GEV No.	103090	Ref. No.	290971
description	burner cap C ø 78mm		
For models:	399701, 399728, 541419, 541427, 800163, 800171, 800198, 800201, 800228, 800236, 800244, 800252, 800260, 800279, 800287, 800295, Maxima-GasherD-700, Maxima-GasherD-700-850, Maxima-GasherD-850, Maxima-GasherD-neue-Ausfuehrung-700-850		





GEV No.	103092	Ref. No.	540684
description	burner cap D ø 87mm		
For models:	399701, 399728, 541419, 541427, 800163, 800171, 800198, 800201, 800228, 800236, 800244, 800252, 800260, 800279, 800287, 800295, Maxima-GasherD-700-850, Maxima-GasherD-neue-Ausfuehrung-700-850		





GEV No.	103091	Ref. No.	290998
description	burner cap D ø 94mm with central hole		
For models:	Maxima-GasherD-700, Maxima-GasherD-850		





			
1			
GEV No.	104207	Ref. No.	081574
description	burner head C for burner cap ø 78mm H 34mm		
For models:	399701, 399728, 541419, 541427, 800163, 800171, 800198, 800201, 800228, 800236, 800244, 800252, 800260, 800279, 800287, 800295		

			
1			
GEV No.	104208	Ref. No.	540668
description	burner head D for burner cap ø 87mm H 34mm		
For models:	399701, 399728, 541419, 541427, 800163, 800171, 800198, 800201, 800228, 800236, 800244, 800252, 800260, 800279, 800287, 800295		
accessories for	104208		
	GEV No.	103092	Ref. No. 540684
burner cap D ø 87mm			

			
1			
GEV No.	104098	Ref. No.	081639
description	burner lower part		
For models:	399701, 399728, 541419, 541427, 800163, 800171, 800198, 800201, 800228, 800236, 800244, 800252, 800260, 800279, 800287, 800295, Maxima-Gas-herd-700, Maxima-Gas-herd-700-850, Maxima-Gas-herd-850, Maxima-Gas-herd-neue-Aus-fuehrung-700-850		

			
1			
GEV No.	104205	Ref. No.	084899
description	gasket C for burner head		

			
1			
GEV No.	104206	Ref. No.	081582
description	gasket D for burner head		
For models:	Maxima-Gas-herd-700-850, Maxima-Gas-herd-neue-Aus-fuehrung-700-850		

			
1			
GEV No.	104212	Ref. No.	081612
description	O-ring Viton thickness 3mm ID ø 32.5mm Qty 1 pcs		
For models:	399701, 399728, 541419, 541427, 800163, 800171, 800198, 800201, 800228, 800236, 800244, 800252, 800260, 800279, 800287, 800295, Maxima-Gas-herd-700-850, Maxima-Gas-herd-neue-Aus-fuehrung-700-850		

			
1			
GEV No.	104213	Ref. No.	540722
description	venturi C/D		
For models:	399701, 399728, 541419, 541427, 800163, 800171, 800198, 800201, 800228, 800236, 800244, 800252, 800260, 800279, 800287, 800295		

Topline series (version 2)			
			
1			
GEV No.	104520	Ref. No.	N/A
description	air mixing tube C ø 16mm		

			
Image not available			
1			
GEV No.	105596	Ref. No.	000892
description	burner cap		
For models:	645005, Gas-herd-645, Gas-herd-646		

			
1			
GEV No.	104501	Ref. No.	370312
description	burner cap C/2.3mm ø 83mm		
For models:	750123, 750131, 750158, 750166, 750174, 750182, 750190		

			
1			
GEV No.	104530	Ref. No.	838373
description	burner cap C/2.6mm ø 83mm		





			
1			
GEV No.	104506	Ref. No.	697397
description	burner cap D ø 95mm with central hole		
For models:	399701, 399728, 541419, 541427, 800163, 800171, 800198, 800201, 800228, 800236, 800244, 800252, 800260, 800279, 800287, 800295		

			
1			
GEV No.	104508	Ref. No.	697400
description	burner cap E ø 115mm with central hole		
For models:	399701, 399728, 541419, 541427, 800163, 800171, 800198, 800201, 800228, 800236, 800244, 800252, 800260, 800279, 800287, 800295		

			
1			
GEV No.	105597	Ref. No.	001511
description	burner head		
For models:	645005, GasherD-645, GasherD-646		

			
1			
GEV No.	104500	Ref. No.	370320
description	burner head C for burner cap ø 85mm		

			
1			
GEV No.	104505	Ref. No.	370614
description	burner head D for burner cap ø 95mm		
For models:	399701, 399728, 541419, 541427, 750123, 750131, 750158, 750166, 750174, 750182, 750190, 800163, 800171, 800198, 800201, 800228, 800236, 800244, 800252, 800260, 800279, 800287, 800295		

			
1			
GEV No.	104507	Ref. No.	728721 N/A
description	burner head E for burner cap ø 115mm		
For models:	399701, 399728, 541419, 541427, 800163, 800171, 800198, 800201, 800228, 800236, 800244, 800252, 800260, 800279, 800287, 800295		

			
1			
GEV No.	105595	Ref. No.	00152*
description	burner lower part		

			
1			
GEV No.	104550	Ref. No.	N/A
description	burner lower part D ID ø 16.5mm		

			
1			
GEV No.	104711	Ref. No.	728748 N/A
description	burner lower part D ID ø 16.5mm for burner cap ø 95mm		
For models:	399701, 399728, 541419, 541427, 800163, 800171, 800198, 800201, 800228, 800236, 800244, 800252, 800260, 800279, 800287, 800295		

			
1			
GEV No.	104551	Ref. No.	N/A
description	burner lower part E ID ø 18mm		

			
1			
GEV No.	104511	Ref. No.	371076
description	gasket ø 72mm ID ø 45mm for burner head H 1.2mm perforation ø 5mm		
For models:	399701, 399728, 541419, 541427, 750123, 750131, 750158, 750166, 750174, 750182, 750190, 750379, 750387, 800163, 800171, 800198, 800201, 800228, 800236, 800244, 800252, 800260, 800279, 800287, 800295		

			
1			
GEV No.	104503	Ref. No.	380148
description	nozzle holder ID ø 8mm		
For models:	399701, 399728, 541419, 541427, 750123, 750131, 750158, 750166, 750174, 750182, 750190, 800163, 800171, 800198, 800201, 800228, 800236, 800244, 800252, 800260, 800279, 800287, 800295		



reducers for pan supports



GEV No.	210015	Ref. No.	248215
description	reducer for pan support L 250mm W 250mm chrome-plated steel suitable for MKN		
For models:	Maxima-Gasherd-700, Maxima-Gasherd-850		

accessories

reducers for pan supports

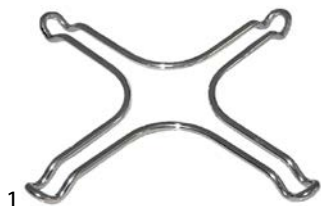

GEV No.	210015	Ref. No.	248215
description	reducer for pan support L 250mm W 250mm chrome-plated steel suitable for MKN		
For models:	Maxima-Gasherd-700, Maxima-Gasherd-850		

air mixers



GEV No.	104214	Ref. No.	540730
description	air mixing tube ID ø 12mm C		
For models:	399701, 399728, 541419, 541427, 800163, 800171, 800198, 800201, 800228, 800236, 800244, 800252, 800260, 800279, 800287, 800295		



GEV No.	104215	Ref. No.	540749
description	air mixing tube ID ø 14mm D		
For models:	399701, 399728, 541419, 541427, 800163, 800171, 800198, 800201, 800228, 800236, 800244, 800252, 800260, 800279, 800287, 800295		

bar burners

bar burners



GEV No.	105603	Ref. No.	092819
description	bar burner 6 row tilting bratt pan		
For models:	Maxima-Gas-Kippbratpfanne-neue-Ausfuehrung-700-850		

accessories

nozzle holders



GEV No.	104522	Ref. No.	N/A
description	nozzle holder ID ø 10mm ET M17x1		



GEV No.	104503	Ref. No.	380148
description	nozzle holder ID ø 8mm		
For models:	399701, 399728, 541419, 541427, 750123, 750131, 750158, 750166, 750174, 750182, 750190, 800163, 800171, 800198, 800201, 800228, 800236, 800244, 800252, 800260, 800279, 800287, 800295		



GEV No.	101152	Ref. No.	169668
description	nozzle holder without internal nozzle, without external nozzle		
For models:	399701, 399728, 541419, 541427, 800163, 800171, 800198, 800201, 800228, 800236, 800244, 800252, 800260, 800279, 800287, 800295, Gas-Bain-Marie-644, Gasherd-646		

gas nozzles

main nozzles

gas nozzles M12x1





GEV No.	100608	Ref. No.	Bohrung nach Maß
description	gas injector thread M12x1 bore custom-made		





			
1			
GEV No.	100974	Ref. No.	869899
description	gas injector thread M12x1 WS 14 bore ø 0.80mm		

			
1			
GEV No.	100300	Ref. No.	697869
description	gas injector thread M12x1 WS 14 bore ø 1.35mm		
For models:	399701, 399728, 541419, 541427, 800163, 800171, 800198, 800201, 800228, 800236, 800244, 800252, 800260, 800279, 800287, 800295		

			
1			
GEV No.	100282	Ref. No.	697842
description	gas injector thread M12x1 WS 14 bore ø 0.95mm		
For models:	399701, 399728, 541419, 541427, 750123, 750131, 750158, 750166, 750174, 750182, 750190, 800163, 800171, 800198, 800201, 800228, 800236, 800244, 800252, 800260, 800279, 800287, 800295		

			
1			
GEV No.	100700	Ref. No.	869880
description	gas injector thread M12x1 WS 14 bore ø 1.50mm		

			
1			
GEV No.	100285	Ref. No.	697834
description	gas injector thread M12x1 WS 14 bore ø 1.10mm		
For models:	399701, 399728, 541419, 541427, 800163, 800171, 800198, 800201, 800228, 800236, 800244, 800252, 800260, 800279, 800287, 800295		

			
1			
GEV No.	100301	Ref. No.	540765
description	gas injector thread M12x1 WS 14 bore ø 1.55mm		
For models:	399701, 399728, 541419, 541427, 800163, 800171, 800198, 800201, 800228, 800236, 800244, 800252, 800260, 800279, 800287, 800295		

			
1			
GEV No.	100243	Ref. No.	854409
description	gas injector thread M12x1 WS 14 bore ø 1.12mm		

			
1			
GEV No.	100239	Ref. No.	697826
description	gas injector thread M12x1 WS 14 bore ø 1.65mm		
For models:	399701, 399728, 541419, 541427, 750123, 750131, 750158, 750166, 750174, 750182, 750190, 800163, 800171, 800198, 800201, 800228, 800236, 800244, 800252, 800260, 800279, 800287, 800295		

			
1			
GEV No.	100663	Ref. No.	697877
description	gas injector thread M12x1 WS 14 bore ø 1.15mm		
For models:	399701, 399728, 541419, 541427, 800163, 800171, 800198, 800201, 800228, 800236, 800244, 800252, 800260, 800279, 800287, 800295		

			
1			
GEV No.	100289	Ref. No.	698997
description	gas injector thread M12x1 WS 14 bore ø 1.80mm		
For models:	399701, 399728, 541419, 541427, 800163, 800171, 800198, 800201, 800228, 800236, 800244, 800252, 800260, 800279, 800287, 800295		

			
1			
GEV No.	100286	Ref. No.	854395
description	gas injector thread M12x1 WS 14 bore ø 1.30mm		

			
1			
GEV No.	100302	Ref. No.	854387
description	gas injector thread M12x1 WS 14 bore ø 1.85mm		



1

GEV No.	100291	Ref. No.	697850
description	gas injector thread M12x1 WS 14 bore ø 2.00mm		
For models:	399701, 399728, 541419, 541427, 800163, 800171, 800198, 800201, 800228, 800236, 800244, 800252, 800260, 800279, 800287, 800295		



1

GEV No.	100303	Ref. No.	542857
description	gas injector thread M12x1 WS 14 bore ø 2.05mm		
For models:	399701, 399728, 541419, 541427, 800163, 800171, 800198, 800201, 800228, 800236, 800244, 800252, 800260, 800279, 800287, 800295		



1

GEV No.	100293	Ref. No.	699004
description	gas injector thread M12x1 WS 14 bore ø 2.20mm		
For models:	399701, 399728, 541419, 541427, 800163, 800171, 800198, 800201, 800228, 800236, 800244, 800252, 800260, 800279, 800287, 800295		



1

GEV No.	100295	Ref. No.	169595
description	gas injector thread M12x1 WS 14 bore ø 2.70mm		
For models:	640018, 642053, Gas-Brater-641, Gas-Griddleplatte-642, Gas-Wurstgrill-640		

gas nozzles M13x1



1

GEV No.	103276	Ref. No.	881792
description	gas injector bore ø 2.5mm WS 13		



1

GEV No.	102787	Ref. No.	881825
description	gas injector thread M13x1 bore ø 1.05mm WS 13		



1

GEV No.	102780	Ref. No.	884360
description	gas injector thread M13x1 bore ø 1.15mm WS 13		



1

GEV No.	107338	Ref. No.	880826
description	gas injector thread M13x1 bore ø 1.25mm WS 13		



1

GEV No.	102786	Ref. No.	881826
description	gas injector thread M13x1 bore ø 1.2mm WS 13		



1

GEV No.	102823	Ref. No.	881170
description	gas injector thread M13x1 bore ø 1.35mm WS 13		



1

GEV No.	102782	Ref. No.	881711
description	gas injector thread M13x1 bore ø 1.45mm WS 13		



1

GEV No.	102784	Ref. No.	881828
description	gas injector thread M13x1 bore ø 1.55mm WS 13		





1

GEV No.	107462	Ref. No.	881976
description	gas injector thread M13x1 bore ø 1.5mm WS 13		





			
1			
GEV No.	102825	Ref. No.	881788
description	gas injector thread M13x1 bore ø 1.65mm WS 13		

			
1			
GEV No.	107339	Ref. No.	881712
description	gas injector thread M13x1 bore ø 2.05mm WS 13		

			
1			
GEV No.	100108	Ref. No.	881829
description	gas injector thread M13x1 bore ø 1.6mm WS 13		

			
1			
GEV No.	100417	Ref. No.	880827
description	gas injector thread M13x1 bore ø 2.15mm WS 13		

			
1			
GEV No.	102788	Ref. No.	881787
description	gas injector thread M13x1 bore ø 1.75mm WS 13		

			
1			
GEV No.	107476	Ref. No.	881838
description	gas injector thread M13x1 bore ø 2.25mm WS 13 code 225		

			
1			
GEV No.	107684	Ref. No.	881830
description	gas injector thread M13x1 bore ø 1.7mm WS 13 code 170		

			
1			
GEV No.	109108	Ref. No.	881714
description	gas injector thread M13x1 bore ø 2.2mm WS 13		

			
1			
GEV No.	107475	Ref. No.	881834
description	gas injector thread M13x1 bore ø 1.85mm WS 13 code 185		

			
1			
GEV No.	102471	Ref. No.	881715
description	gas injector thread M13x1 bore ø 2.3mm WS 13		

			
1			
GEV No.	102783	Ref. No.	881831
description	gas injector thread M13x1 bore ø 1.8mm WS 13		

			
1			
GEV No.	103270	Ref. No.	881713
description	gas injector thread M13x1 bore ø 2.4mm WS 13		

			
1			
GEV No.	100389	Ref. No.	881835
description	gas injector thread M13x1 bore ø 1.9mm WS 13		

			
1			
GEV No.	102790	Ref. No.	881839
description	gas injector thread M13x1 bore ø 2.55mm WS 13		



1

GEV No.	107463	Ref. No.	881795
description	gas injector thread M13x1 bore ø 2.6mm WS 13		



1

GEV No.	107477	Ref. No.	881796
description	gas injector thread M13x1 bore ø 2.7mm WS 13 code 270		



1

GEV No.	100710	Ref. No.	881841
description	gas injector thread M13x1 bore ø 2.85mm WS 13		



1

GEV No.	100722	Ref. No.	881843
description	gas injector thread M13x1 bore ø 2.95mm WS 13		



1

GEV No.	102470	Ref. No.	881836
description	gas injector thread M13x1 bore ø 2mm WS 13		



1

GEV No.	107478	Ref. No.	881846
description	gas injector thread M13x1 bore ø 3.25mm WS 13 code 325		



1

GEV No.	107570	Ref. No.	882797
description	gas injector thread M13x1 bore ø 3.2mm WS 13		



1

GEV No.	103200	Ref. No.	882798
description	gas injector thread M13x1 bore ø 3.3mm WS 13		



1

GEV No.	100923	Ref. No.	881847
description	gas injector thread M13x1 bore ø 3.4mm WS 13		



1

GEV No.	106272	Ref. No.	883143
description	gas injector thread M13x1 bore ø 3.55mm WS 13		



1

GEV No.	106274	Ref. No.	883144
description	gas injector thread M13x1 bore ø 3.75mm WS 13		



1

GEV No.	106273	Ref. No.	881851
description	gas injector thread M13x1 bore ø 3.7mm WS 13		



1

GEV No.	106275	Ref. No.	881852
description	gas injector thread M13x1 bore ø 3.8mm WS 13		



1

GEV No.	107569	Ref. No.	882796
description	gas injector thread M13x1 bore ø 3mm WS 13		



pilot burner nozzles

pilot burner nozzles EGA

			
1			
GEV No.	101589	Ref. No.	697893
description	pilot burner nozzle LPG bore ø 0.18mm code 18 gas pressure 50mbar thread M5x0.8 WS 5.5		
For models:	399701, 399728, 541419, 541427, 750123, 750131, 750158, 750166, 750174, 750182, 750190, 800163, 800171, 800198, 800201, 800228, 800236, 800244, 800252, 800260, 800279, 800287, 800295		

			
1			
GEV No.	101588	Ref. No.	737038
description	pilot burner nozzle natural gas bore ø 0.32mm code 32 gas pressure 20mbar thread M5x0.8		
For models:	800163, 800171, 800198, 800201, 800228, 800236, 800244, 800252, 800260, 800279, 800287, 800295		

pilot burner nozzles POLIDORO

			
1			
GEV No.	102699	Ref. No.	835765
description	pilot burner nozzle POLIDORO natural gas code 25.2 bore ø 2x0.25mm Qty 1 pcs 2 bores		

pilot burner nozzles (other)

MKN

			
1			
GEV No.	100270	Ref. No.	086339
description	pilot burner nozzle LPG bore ø 0.2mm thread M8x0.75 T1: M8x1		
For models:	399701, 399728, 541419, 541427, 800163, 800171, 800198, 800201, 800228, 800236, 800244, 800252, 800260, 800279, 800287, 800295, Maxima-Gasherd-700-850, Maxima-Gasherd-neue-Ausfuehrung-700-850		

			
1			
GEV No.	100272	Ref. No.	086053
description	pilot burner nozzle natural gas bore ø 0.35mm		
For models:	399701, 399728, 541419, 541427, 800163, 800171, 800198, 800201, 800228, 800236, 800244, 800252, 800260, 800279, 800287, 800295, Maxima-Gasherd-700-850, Maxima-Gasherd-neue-Ausfuehrung-700-850		

bypass nozzles

bypass nozzles PEL20/21

			
1			
GEV No.	100408	Ref. No.	834076
description	bypass nozzle type PEL20/21 bore ø 0.35mm thread M5x0.5		
For models:	399604, 399612, 399701, 399728, 541419, 541427		

			
1			
GEV No.	100554	Ref. No.	833037
description	bypass nozzle type PEL20/21 bore ø 0.45mm thread M5x0.5		
For models:	800163, 800171, 800198, 800201, 800228, 800236, 800244, 800252, 800260, 800279, 800287, 800295		

			
1			
GEV No.	100553	Ref. No.	869910
description	bypass nozzle type PEL20/21 bore ø 0.4mm thread M5x0.5		

			
1			
GEV No.	100550	Ref. No.	833045
description	bypass nozzle type PEL20/21 bore ø 0.55mm thread M5x0.5		
For models:	800163, 800171, 800198, 800201, 800228, 800236, 800244, 800252, 800260, 800279, 800287, 800295		

			
1			
GEV No.	100526	Ref. No.	834084
description	bypass nozzle type PEL20/21 bore ø 0.5mm thread M5x0.5		
For models:	399604, 399612, 399701, 399728, 541419, 541427		

			
1			
GEV No.	100548	Ref. No.	833061
description	bypass nozzle type PEL20/21 bore ø 0.65mm thread M5x0.5		
For models:	800163, 800171, 800198, 800201, 800228, 800236, 800244, 800252, 800260, 800279, 800287, 800295		

			
1			
GEV No.	100551	Ref. No.	833053
description	bypass nozzle type PEL20/21 bore ø 0.6mm thread M5x0.5		
For models:	800163, 800171, 800198, 800201, 800228, 800236, 800244, 800252, 800260, 800279, 800287, 800295		

			
1			
GEV No.	100278	Ref. No.	869902
description	bypass nozzle type PEL20/21 bore ø 0.75mm thread M5x0.5		

			
1			
GEV No.	100527	Ref. No.	833088
description	bypass nozzle type PEL20/21 bore ø 0.85mm thread M5x0.5		
For models:	800163, 800171, 800198, 800201, 800228, 800236, 800244, 800252, 800260, 800279, 800287, 800295		

			
1			
GEV No.	100557	Ref. No.	833096
description	bypass nozzle type PEL20/21 bore ø 1.05mm thread M5x0.5		
For models:	800163, 800171, 800198, 800201, 800228, 800236, 800244, 800252, 800260, 800279, 800287, 800295		

			
1			
GEV No.	100532	Ref. No.	881857
description	bypass nozzle type PEL20/21 bore ø 1.2mm thread M5x0.5		

			
1			
GEV No.	100533	Ref. No.	937711
description	bypass nozzle type PEL20/21 bore ø 1.3mm thread M5x0.5		

			
1			
GEV No.	100529	Ref. No.	881486
description	bypass nozzle type PEL20/21 bore ø 1mm thread M5x0.5		

			
1			
GEV No.	106871	Ref. No.	881487
description	bypass nozzle type PEL20/21 bore ø 2.2mm thread M5x0.5		

			
1			
GEV No.	107524	Ref. No.	881859
description	bypass nozzle type PEL20/21 bore ø 2.5mm thread M5x0.5		

internal nozzles

internal nozzles for EGA gas taps/nozzle holders

EGA 26400/26440/23268

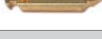
			
1			
GEV No.	100311	Ref. No.	085529
description	internal nozzle bore ø 0.80mm suitable for EGA26400/26440		
For models:	399701, 399728, 541419, 541427, 800163, 800171, 800198, 800201, 800228, 800236, 800244, 800252, 800260, 800279, 800287, 800295, Maxima-Gasherd-700-850, Maxima-Gasherd-neue-Ausfuehrung-700-850		



			
1			
GEV No.	100238	Ref. No.	085499
description	internal nozzle bore ø 1.35mm suitable for EGA 23268,26400,26440		
For models:	399701, 399728, 541419, 541427, 800163, 800171, 800198, 800201, 800228, 800236, 800244, 800252, 800260, 800279, 800287, 800295, Maxima-Gasherd-700-850, Maxima-Gasherd-neue-Ausfuehrung-700-850		

			
1			
GEV No.	100244	Ref. No.	085707
description	internal nozzle bore ø 1.85mm suitable for EGA 23268,26400,26440		
For models:	399701, 399728, 541419, 541427, 800163, 800171, 800198, 800201, 800228, 800236, 800244, 800252, 800260, 800279, 800287, 800295, Maxima-Gasherd-700-850, Maxima-Gasherd-neue-Ausfuehrung-700-850		

auxiliary gas parts

screw connections

olives

			
1			
GEV No.	101273	Ref. No.	959715
description	olive for pipe ø 12mm L 9.5mm brass Qty 1 pcs suitable for universal		
accessories for	101273		
	GEV No.	100944	Ref. No.
			—
	union nut thread M18x1.5 for pipe ø 12mm		
	GEV No.	101276	Ref. No.
			—
	union screw thread 3/8" tube ø 12mm Qty 1 pcs		

union screws

			
1			
GEV No.	100906	Ref. No.	835803
description	screw connection thread M10x1 for ignition electrode brass Qty 1 pcs WS 10		



equipment-specific units

for bain marie

spare parts and accessories



1

GEV No.	514155	Ref. No.	085618
description	gasket L 52mm W 52mm H 24mm silicone		
For models:	600008, 600067, 601004, 601209, 601403, 602000, 602205, 602280, 603007, 603023, 603201, 614009, 614404, 624004, 627100, Bain-Marie-614, Bain-Marie-624, Bain-Marie-626, Fritteuse-600, Fritteuse-601, Fritteuse-602, Fritteuse-603, Fritteuse-604, Gas-Bain-Marie-644		



1

GEV No.	514157	Ref. No.	083186
description	lid W 50mm H 65mm SS for outlet		
For models:	600008, 600067, 601004, 601209, 601403, 602000, 602205, 602280, 603007, 603023, 603201, 614009, 614404, 624004, 627100, Bain-Marie-614, Bain-Marie-624, Bain-Marie-626, Fritteuse-600, Fritteuse-601, Fritteuse-602, Fritteuse-603, Fritteuse-604, Gas-Bain-Marie-644		

housing and bezels



1

GEV No.	514156	Ref. No.	081493
description	bezel L 72mm W 55mm H 55mm plastic		
For models:	600008, 600067, 601004, 601209, 601403, 602000, 602205, 602280, 603007, 603023, 603201, 614009, 614404, 624004, 627100, Bain-Marie-614, Bain-Marie-624, Bain-Marie-626, Fritteuse-600, Fritteuse-601, Fritteuse-602, Fritteuse-603, Fritteuse-604, Gas-Bain-Marie-644		

for deep fryers

spare parts and accessories



1

GEV No.	514155	Ref. No.	085618
description	gasket L 52mm W 52mm H 24mm silicone		
For models:	600008, 600067, 601004, 601209, 601403, 602000, 602205, 602280, 603007, 603023, 603201, 614009, 614404, 624004, 627100, Bain-Marie-614, Bain-Marie-624, Bain-Marie-626, Fritteuse-600, Fritteuse-601, Fritteuse-602, Fritteuse-603, Fritteuse-604, Gas-Bain-Marie-644		



1

GEV No.	514157	Ref. No.	083186
description	lid W 50mm H 65mm SS for outlet		
For models:	600008, 600067, 601004, 601209, 601403, 602000, 602205, 602280, 603007, 603023, 603201, 614009, 614404, 624004, 627100, Bain-Marie-614, Bain-Marie-624, Bain-Marie-626, Fritteuse-600, Fritteuse-601, Fritteuse-602, Fritteuse-603, Fritteuse-604, Gas-Bain-Marie-644		

housing and bezels



1

GEV No.	514156	Ref. No.	081493
description	bezel L 72mm W 55mm H 55mm plastic		
For models:	600008, 600067, 601004, 601209, 601403, 602000, 602205, 602280, 603007, 603023, 603201, 614009, 614404, 624004, 627100, Bain-Marie-614, Bain-Marie-624, Bain-Marie-626, Fritteuse-600, Fritteuse-601, Fritteuse-602, Fritteuse-603, Fritteuse-604, Gas-Bain-Marie-644		

for convection ovens/combi-steamers

miscellaneous



1

GEV No.	692306	Ref. No.	213519
description	pipe long D1 ø 10mm D2 ø 6mm L 134mm WS 19 thread 3/8"		
For models:	389595, 389609, 390003, 397229, 397237, 397245, 397253, 397261, 397288, 397296, 397318, 397326, 397334, 397342, 397350, 397776, 397784, 397792, 397806, 397814, 397822, 397830, 397849, 397857, 397865, 397873, 398047, 398055, 398063, 398071, 398098, 398101, 398128, 398136, 398144, 398152, 398950, 398969, 398977, 399019, 399027, 399035, 399043, 399051, 399078, 399086, 399094, 399108, 399116, 606316...(Other models you can see in the webshop)		

1



for pizza ovens

firebricks



GEV No.	850022	Ref. No.	368938
description	bottom plate L 495mm W 495mm H 16mm pizza oven for ELP500		
For models:	Pizza-Ofen-ELP, Pizza-Ofen-P501		

for dishwashers

air traps

air traps



GEV No.	510103	Ref. No.	382078
description	air trap L 85mm W 20mm H 80mm hose ø 6mm plastic		
For models:	665843, 665851, Glaeserspielautomat-328		

spare parts for

GEV No.	505045	Ref. No.	—
description	O-ring EPDM thickness 1.78mm ID ø 5.28mm Qty 1 pcs		

GEV No.	505094	Ref. No.	—
description	air trap		

GEV No.	510016	Ref. No.	—
description	eye bolt for rinse aid container connection		

GEV No.	510105	Ref. No.	—
description	hose connector for air trap		

backflow preventers

backflow preventers



GEV No.	698704	Ref. No.	144993
description	air valve for drain hose D1 ø 21mm D2 ø 10.5mm		

washing and rinsing systems



GEV No.	510682	Ref. No.	173304
description	rinse jet ø 13mm H 11.5mm		
For models:	271500, 337xxx, 353167, 354392, 354457, 361763, 378933, 440078, 440086, 440094, 440655, 450111, Geschirrspuelautomat-335, GsP-500, GsP-600		



GEV No.	518079	Ref. No.	858196
description	wash arm bearing with nut		
spare parts for	518079		

GEV No.	510634	Ref. No.	—
description	wash arm bearing ø 22mm H 39mm		

GEV No.	510637	Ref. No.	—
description	nut for wash arm support		



GEV No.	698718	Ref. No.	69017
description	wash pipe mounting pos. upper ø 72x120mm L 310mm plastic thread M6		

knobs

universal knobs



GEV No.	110235	Ref. No.	341894
description	knob energy regulator 1-3 t.max.°C ø 50mm shaft ø 6x4.6mm shaft flat upper black		
For models:	610038, 610429, 620203, 620424		



1

GEV No.	110250	Ref. No.	093823
description	knob gas tap without ignition flame t.max. °C ø 50mm shaft ø 6x4.6mm shaft flat upper black		
For models:	640018, 642053, 645005, Gas-Brater-641, Gas-Griddleplatte-642, Gasherdd-645, Gasherdd-64502, Gasherdd-646, Gas-sudpfanne-643, Gas-Wurstgrill-640		



1

GEV No.	110232	Ref. No.	086517
description	knob switch 4-position t.max. °C ø 50mm shaft ø 6x4.6mm shaft flat upper black		



1

GEV No.	110241	Ref. No.	086533
description	knob thermostat t.max. 110°C ø 50mm shaft ø 6x4.6mm shaft flat upper black temperature range 30-110°C		
For models:	340xxx, 353167, 354392, 354457, 361763, 378933, 440078, 440086, 440094, 440140, 440655, 450111, 613002, 613088, 614009, 614106, 614404, 615005, 615013, 615056, 615080, 624004, 624101, 627100, Bain-Marie-614, Bain-Marie-624, Bain-Marie-626, Frittenwanne-615, Geschirrspuelautomat-700, sudpfanne-613		



1

GEV No.	110242	Ref. No.	088013
description	knob thermostat t.max. 180°C ø 50mm shaft ø 6x4.6mm shaft flat upper black temperature range 100-180°C		
For models:	600008, 600067, 601004, 601209, 601403, 602000, 602205, 602280, 603007, 603023, 603201, Fritteuse-600, Fritteuse-601, Fritteuse-602, Fritteuse-603		



1

GEV No.	110244	Ref. No.	649058
description	knob thermostat t.max. 250°C ø 50mm shaft ø 6x4.6mm shaft flat upper/lower black temperature range 30-250°C rotation 270°		
For models:	626104, 626112, 626201, 626228, 626309, 626317		



1

GEV No.	110245	Ref. No.	087432 279862
description	knob thermostat t.max. 300°C ø 50mm shaft ø 6x4.6mm shaft flat upper black temperature range 50-300°C		
For models:	610003, 610038, 610402, 611018, 611050, 611220, 612006, 612057, 620009, 621005, 621056, 621110, 622001, 622052, 62510, 62520, 62530, 626104, 626112, 626201, 626228, 626309, 626317, 629006, 629022, Backofen-629, Brater-611, Brater-621, Griddle-Platte-612, Griddleplatte-622, Grill-680, Grill-681, Grill-682, Grill-683, Heissluftgeraet-672, Heissluftgeraet-673, Heissluftgeraet-67310, Wurstgrill-610, Wurstgrill-620		

producer-specific knobs

PALUX



1

GEV No.	110235	Ref. No.	341894
description	knob energy regulator 1-3 t.max. °C ø 50mm shaft ø 6x4.6mm shaft flat upper black		
For models:	610038, 610429, 620203, 620424		



1

GEV No.	110250	Ref. No.	093823
description	knob gas tap without ignition flame t.max. °C ø 50mm shaft ø 6x4.6mm shaft flat upper black		
For models:	640018, 642053, 645005, Gas-Brater-641, Gas-Griddleplatte-642, Gasherdd-645, Gasherdd-64502, Gasherdd-646, Gas-sudpfanne-643, Gas-Wurstgrill-640		



1

GEV No.	110232	Ref. No.	086517
description	knob switch 4-position t.max. °C ø 50mm shaft ø 6x4.6mm shaft flat upper black		



1

GEV No.	111554	Ref. No.	393819
description	knob t.max. °C		
For models:	399604, 399612, 399701, 399728, 505900, 505935, 515892, 515906, 541419, 541427, 541869, 638625, 663263, 663395, 670618, 670626, 686409, 687200, 688096, 688118, 688363, 689696, 690570, 690600, 703095, 703109, 703117, 703125, 709816, 709824, 709832, 709840, 730416, 733105, 733113, 736422, 736430, Vario-Griller, Vario-Herd		



1

GEV No.	110241	Ref. No.	086533
description	knob thermostat t.max. 110°C ø 50mm shaft ø 6x4.6mm shaft flat upper black temperature range 30-110°C		
For models:	340xxx, 353167, 354392, 354457, 361763, 378933, 440078, 440086, 440094, 440140, 440655, 450111, 613002, 613088, 614009, 614106, 614404, 615005, 615013, 615056, 615080, 624004, 624101, 627100, Bain-Marie-614, Bain-Marie-624, Bain-Marie-626, Frittenwanne-615, Geschirrspuelautomat-700, sudpfanne-613		



1

GEV No.	110242	Ref. No.	088013
description	knob thermostat t.max. 180°C ø 50mm shaft ø 6x4.6mm shaft flat upper black temperature range 100-180°C		
For models:	600008, 600067, 601004, 601209, 601403, 602000, 602205, 602280, 603007, 603023, 603201, Fritteuse-600, Fritteuse-601, Fritteuse-602, Fritteuse-603		



1

GEV No.	110244	Ref. No.	649058
description	knob thermostat t.max. 250°C ø 50mm shaft ø 6x4.6mm shaft flat upper/lower black temperature range 30-250°C rotation 270°		
For models:	626104, 626112, 626201, 626228, 626309, 626317		



1

GEV No.	110245	Ref. No.	087432 279862
description	knob thermostat t.max. 300°C ø 50mm shaft ø 6x4.6mm shaft flat upper black temperature range 50-300°C		
For models:	610003, 610038, 610402, 611018, 611050, 611220, 612006, 612057, 620009, 621005, 621056, 621110, 622001, 622052, 62510, 62520, 62530, 626104, 626112, 626201, 626228, 626309, 626317, 629006, 629022, Backofen-629, Brater-611, Brater-621, Griddle-Platte-612, Griddleplatte-622, Grill-680, Grill-681, Grill-682, Grill-683, Heissluftgeraet-672, Heissluftgeraet-673, Heissluftgeraet-67310, Wurstgrill-610, Wurstgrill-620		

miscellaneous



1

GEV No.	110205	Ref. No.	301086
description	knob ø 27mm shaft ø 5x5mm		
For models:	340022, 340030, 340049, 340057, 340073, 340xxx, 640018, 642053, 645005, 649007, 650005, 685003, Gas-Brater-641, Gas-Gluehstein-grill-649, Gas-Griddleplatte-642, Gasherd-645, Gasherd-64502, Gasherd-646, Gas-sudpfanne-643, Gas-Wurstgrill-640, Geschirrspuelautomat-700, Glaeserspuelautomat-310, Glaeserspuelautomat-311, Glaeserspuelautomat-320, Glaeserspuelautomat-321, Heissluftdaempfer-10x1-1, Heissluftdaempfer-5x1-1, Heissluftdaempfer-5x2-3, Heissluftgeraet-10x1-1, Heissluftgeraet-5x1-1, Heissluftgeraet-672, Heissluftgeraet-673, Heissluftgeraet-67310, Pizza-Ofen-P500, Pizza-Ofen-P501, Pizza-Ofen-P502		



accessories

covers



GEV No.	111510	Ref. No.	748781
description	lid t.max.°C ø 37mm shaft ømm shaft flat silver for knob ELOMA		
For models:	754595, 754609, 754617, 754668, 754676, 754681, 754692, 754706, 754714, 754722, 754730, 754749, 754757, 754773, 754781, 757292, 757314, 757365, 757373, 757381, 757403, 757411, 757438, 757446, 757454, 757462, 757470, 758736, 758833, 759201, 759651, 759678, 759686, 759694, 759708, 759716		
accessories for	111510		
	GEV No.	111498	Ref. No. —
	knob t.max.°C ø 48mm shaft ø 6.5mm shaft flat blue		

handles and hand wheels

cone handles



GEV No.	540795	Ref. No.	034665
description	cylindrical handle thread M8x1.25 ø 25mm plastic L 105mm black thread L 12mm		
For models:	057436, 600008, 600067, 601004, 601209, 601403, 602000, 602205, 602280, 603007, 603023, 603201, 614009, 614404, 624004, 627100, Bain-Marie-614, Bain-Marie-624, Bain-Marie-626, Fritteuse-600, Fritteuse-601, Fritteuse-602, Fritteuse-603, Fritteuse-604, Gas-Bain-Marie-644, Wandkaffeemaschine-001, Wandkaffeemaschine-010, Wandkaffeemaschine-013		

locks

handle latches

producer-specific

PALUX



GEV No.	692744	Ref. No.	758388
description	door handle hinged at left blue		
For models:	754595, 754609, 754617, 754676, 754681, 754692, 754706, 754714, 754722, 754730, 754749, 754757, 754773, 754781, 757292, 757365, 757373, 757381, 757403, 757411, 757438, 757446, 757454, 758736, 758833, 759201, 759651, 759678, 759686, 759694, 759708, 759716		



GEV No.	691990	Ref. No.	748765
description	door handle hinged at right L 155mm W 60mm H 58mm spring length 53mm blue mounting distance 40mm mounting thread M4		
For models:	754595, 754609, 754617, 754668, 754676, 754681, 754692, 754706, 754714, 754722, 754730, 754749, 754757, 754773, 754781, 757292, 757314, 757365, 757373, 757381, 757403, 757411, 757438, 757446, 757454, 757462, 757470, 758736, 758833, 759201, 759651, 759678, 759686, 759694, 759708, 759716		
spare parts for	691990		
	GEV No.	514450	Ref. No. —
	spring for door handle ø 6mm L 61mm W 27.5mm		
accessories for	691990		
	GEV No.	111510	Ref. No. 748781
	lid t.max.°C ø 37mm shaft ømm shaft flat silver for knob ELOMA		



GEV No.	691988	Ref. No.	749532
description	door handle L 155mm W 60mm H 58mm spring length 53mm blue mounting distance 40mm spring thickness 3mm		
accessories for	691988		
	GEV No.	111510	Ref. No. 748781
	lid t.max.°C ø 37mm shaft ømm shaft flat silver for knob ELOMA		

pullouts

rollers

rollers

accessories



1

GEV No.	560133	Ref. No.	251887
description	hexagonal nut thread M6 H 5mm WS 10 SS DIN/ISO DIN 934 / ISO 4032/8673 Qty 20 pcs		
For models:	140902, 144819, 271500, 337xxx, 340022, 340030, 340049, 340057, 340073, 340xxx, 353167, 354392, 354457, 354643, 354651, 354678, 354686, 354694, 354708, 361429, 361437, 361763, 367788, 378933, 382191, 385018, 385026, 385034, 385042, 385050, 385514, 389595, 389609, 390003, 397210, 397229, 397237, 397245, 397253, 397261, 397288, 397296, 397318, 397326, 397334, 397342, 397350, 397431, 397776, 397784...(Other models you can see in the webshop)		

fittings for catering equipment

outlet taps

universal

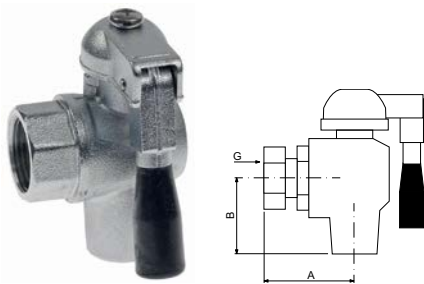

1

GEV No.	541540	Ref. No.	688916
description	outlet tap stainless steel W 38mm H 40mm thread 3/4" IT		
For models:	672343, 672351, 672378, 672386, 706523, 706531, 706558, 706566, 829854, 829900		
spare parts for	541540		
	GEV No.	697834	Ref. No. —
	cone handle thread M6x1 ø 13mm plastic L 53mm black thread L 6mm		

equipment feet and end caps

bolting feet



1

GEV No.	697868	Ref. No.	080500
description	equipment foot ømm L 72mm W 28mm H 23mm bore ø 4.4mm mounting distance 48mm Qty 1 pcs		
For models:	600008, 600067, 601004, 601209, 601403, 602000, 602205, 602280, 603007, 603023, 603201, 610003, 610038, 61030x, 610402, 610429, 611018, 611050, 612006, 612057, 613002, 613088, 614009, 614404, 615005, 615013, 615056, 615080, 616001, 616109, 620009, 620203, 620300, 620408, 620424, 621005, 621056, 622001, 622052, 623105, 624004, 62510, 62520, 62530, 626104, 626112, 626201, 626228, 626309, 626317...(Other models you can see in the webshop)		

baskets

fryer baskets

PALUX



1

GEV No.	970153	Ref. No.	271586
description	fryer basket L1 295mm W1 200mm H1 120mm L2 440mm H2 225mm		
For models:	502200, 502308, 601004, 601209, 601403, 602000, 602205, 602280, 603201, 649554, 649562, 650943, 650951, 686336, 688339, 688347, 688355, 699047, 699055, 721468, 722588, 750255, Fritteuse-365		



1

GEV No.	970155	Ref. No.	146080
description	fryer basket L1 300mm W1 200mm H1 120mm		
For models:	601004, 601209, 601403, 602000, 602205, 602280, 603007, 603023, 603201, Fritteuse-601, Fritteuse-602, Fritteuse-603		



1

GEV No.	970154	Ref. No.	006483
description	fryer basket L1 315mm W1 185mm H1 115mm		

gaskets

gaskets for heated units

door seals



1

GEV No.	900392	Ref. No.	724025
description	door seal		
For models:	541869, 638625, 730416		

GEV No.	900101	Ref. No.	382310
description	door seal profile 2070 W 645mm L 700mm external size Qty 1 10 x 1/1		
For models:	367788, 382191, 385018, 385026, 385034, 385042, 385050, 385514, 397210, 397229, 397237, 397245, 397253, 397261, 397288, 397296, 397318, 397326, 397334, 397342, 397350, 397431, 606294, 606308, 646768, 646776, 646784, 646792, 646806, 646814, 646822, 646830, 646849, 646857, 646865, 646873, 671789, 671797, 671800, 671819, 671827, 671835, 671843, 671851, 671878, 671886, 680583, 680591		

GEV No.	900865	Ref. No.	742368
description	door seal profile 2449 W 490mm L 520mm Qty 1		
For models:	754595, 754609, 754676, 754681, 754692, 754706, 754749, 757365, 757373, 757381, 757403, 758736, 759201, 759678, 759686, 759694		

GEV No.	900497	Ref. No.	742376
description	door seal profile 2449 W 520mm L 775mm Qty 1		
For models:	754617, 754714, 754722, 754730, 754757, 754773, 754781, 757292, 757411, 757438, 757446, 757454, 758833, 759651, 759708, 759716		

door seals with fixing hook

GEV No.	900390	Ref. No.	202223
description	door seal L 380mm Wmm with 5 mounting clips		
For models:	00068x, 00099x, 00121x, 00149x, 00183x, 001864, 002046, 002682, 003131, 00314x, 750026, 750034, 750042, 750050, 750069, 750077, 750085, 750093, 750107, 750115, 750166, 750190		

GEV No.	900391	Ref. No.	202290
description	door seal L 585mm Wmm with 9 mounting clips		
For models:	00068x, 00099x, 00121x, 00149x, 00183x, 001864, 002046, 002682, 003131, 00314x, 750026, 750034, 750042, 750050, 750069, 750077, 750085, 750093, 750107, 750115, 750166, 750190		

O-rings

EPDM

GEV No.	504512	Ref. No.	378674
description	O-ring EPDM thickness 1.78mm ID ø 14mm Qty 1 pcs		
For models:	340022, 340030, 340049, 340057, 340073, 340xxx, 353167, 354392, 354457, 361763, 378933, 440078, 440086, 440094, 440140, 440655, 450111, 671894, 671908, 671916, 671975, 671983, 671991, 674524, 674532, 674605, 805149, 805300, 805408, 805459, 805556, 805xxx, 810002, 813303, 890529, 890561, 890588, Aromacarina, Aromacarina-Dampf, Aromacarina-EsA, Aromacarina-ETA, Aromacarina-ETA-EsA, Geschirrspuelautomat-700, GsP-350, Heissluftdaempfer-10x1-1, Heissluftdaempfer-20x1-1, Heissluftdaempfer-5x1-1, Heissluftdaempfer-5x2-3, schokomat-C, Wandkaffeemaschine-800		

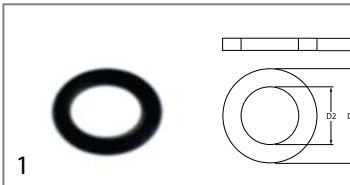

GEV No.	528485	Ref. No.	255823
description	O-ring EPDM thickness 1.78mm ID ø 6.07mm Qty 1 pcs		
For models:	271500, 337xxx, 340022, 340030, 340049, 340057, 340073, 340xxx, 353167, 354392, 354457, 361763, 378933, 440078, 440086, 440094, 440140, 440655, 450111, Geschirrspuelautomat-330, Geschirrspuelautomat-335, Geschirrspuelautomat-336, Geschirrspuelautomat-700, GsP-350, GsP-500, GsP-600		

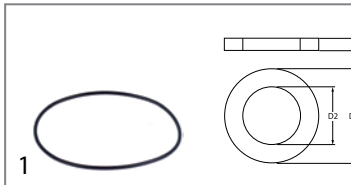

GEV No.	501000	Ref. No.	166952
description	O-ring EPDM thickness 4mm ID ø 145mm Qty 1 pcs		
For models:	271500, 337xxx, 340022, 340030, 340049, 340057, 340073, 340xxx, 353167, 354392, 354457, 361763, 378933, 440078, 440086, 440094, 440140, 440655, 450111, Geschirrspuelautomat-330, Geschirrspuelautomat-335, Geschirrspuelautomat-336, Geschirrspuelautomat-700, GsP-350, GsP-500, GsP-600		

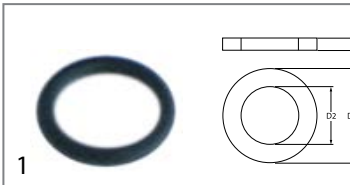

GEV No.	510177	Ref. No.	131946
description	O-ring EPDM thickness 1.78mm ID ø 7.66mm Qty 1 pcs		
For models:	337xxx, 340xxx, 665843, 665851, Geschirrspuelautomat-700, Glaeserspuelautomat-325, Glaeserspuelautomat-328, GsP-350, GsP-600		

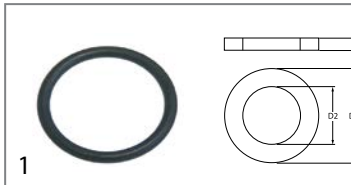

GEV No.	510408	Ref. No.	349232
description	O-ring EPDM thickness 5.34mm ID ø 47mm Qty 1 pcs		
For models:	665843, 665851, Glaeserspuelautomat-325, Glaeserspuelautomat-328		

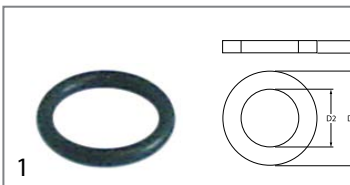

GEV No.	504574	Ref. No.	013471
description	O-ring EPDM thickness 1.78mm ID ø 9.25mm Qty 1 pcs		
For models:	140902, 367788, 382191, 385018, 385026, 385034, 385042, 385050, 385514, 389595, 389609, 390003, 397210, 397229, 397237, 397245, 397253, 397261, 397288, 397296, 397318, 397326, 397334, 397342, 397350, 397431, 397776, 397784, 397792, 397806, 397814, 397822, 397830, 397849, 397857, 397865, 397873, 398047, 398055, 398063, 398071, 398098, 398101, 398128, 398136, 398144, 398152, 398950, 398969, 398977...(Other models you can see in the webshop)		

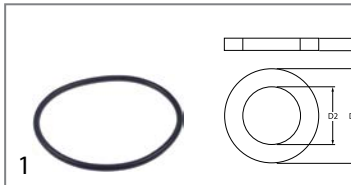

GEV No.	532601	Ref. No.	335770
description	O-ring EPDM thickness 7mm ID ø 135.89mm Qty 1 pcs		

Viton

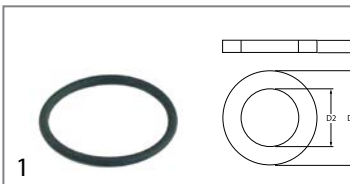

GEV No.	504561	Ref. No.	399434
description	O-ring EPDM thickness 2.62mm ID ø 29.82mm Qty 1 pcs		
For models:	144819, 385018, 385026, 385034, 385042, 385050, 385514, 389595, 389609, 390003, 397229, 397237, 397245, 397253, 397261, 397288, 397296, 397318, 397326, 397334, 397342, 397350, 397776, 397784, 397792, 397806, 397814, 397822, 397830, 397849, 397857, 397865, 397873, 398047, 398055, 398063, 398071, 398098, 398101, 398128, 398136, 398144, 398152, 398950, 398969, 398977, 399019, 399027, 399035, 399043...(Other models you can see in the webshop)		

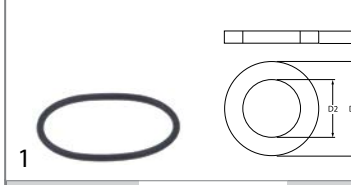

GEV No.	532624	Ref. No.	272825
description	O-ring Viton thickness 1.78mm ID ø 28.3mm Qty 1 pcs		

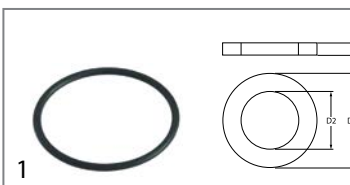

GEV No.	532067	Ref. No.	297259
description	O-ring EPDM thickness 2.62mm ID ø 37.77mm Qty 10 pcs		
For models:	271500, 337xxx, 340022, 340030, 340049, 340057, 340073, 340xxx, 353167, 354392, 354457, 361763, 378933, 440078, 440086, 440094, 440140, 440655, 450111, Geschirrspuelautomat-335, Geschirrspuelautomat-336, Geschirrspuelautomat-700, GsP-500, GsP-600		

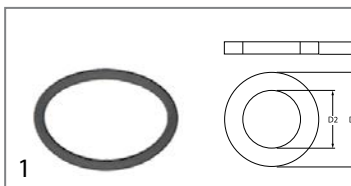

GEV No.	104212	Ref. No.	081612
description	O-ring Viton thickness 3mm ID ø 32.5mm Qty 1 pcs		
For models:	399701, 399728, 541419, 541427, 800163, 800171, 800198, 800201, 800228, 800236, 800244, 800252, 800260, 800279, 800287, 800295, Maxima-Gasherd-700-850, Maxima-Gasherd-neue-Ausfuehrung-700-850		



sealing washers

copper gaskets

DIN-7603-A



GEV No.	528433	Ref. No.	097071
description	flat gasket copper ED ø 14mm ID ø 10mm thickness 1mm		
For models:	390003, 397229, 397237, 397245, 397253, 397261, 397288, 397296, 397318, 397326, 397334, 397342, 397350, 397776, 397784, 397792, 397806, 397814, 397822, 397830, 397849, 397857, 397865, 397873, 398047, 398055, 398063, 398071, 398098, 398101, 398128, 398136, 398144, 398152, 399019, 399027, 399035, 399043, 399051, 399078, 399086, 399094, 399108, 399116, 606316, 606324, 606332, 606340, 606359, 606367...(Other models you can see in the webshop)		

PTFE gaskets



GEV No.	550674	Ref. No.	261033
description	flat gasket PTFE ED ø 46mm ID ø 36mm thickness 4mm Qty 1 pcs mounting pos. inner		
For models:	502200, 502308, 503010, 503150, 515892, 515906, 517887, 601004, 601209, 601403, 602000, 602205, 602280, 603201, 637564, 649554, 649562, 650943, 650951, 657735, 686298, 686336, 688339, 688347, 688355, 688428, 689696, 699047, 699055, 700673, 702560, 705993, 721468, 722588, 750255, Fritteuse-365, Topline-Fritteuse, Vario-Griller		

silicone gaskets



GEV No.	359721	Ref. No.	316296
description	gasket silicone ED ø 48mm ID ø 39.5mm thickness 5mm Qty 1 pcs		
For models:	Heissluftdaempfer-10x1-1, Heissluftdaempfer-5x1-1, Heissluftdaempfer-5x2-3		

springs

torsion springs

<p>Image not available</p>			
GEV No.	700188	Ref. No.	290564
description	torsion spring		
For models:	541869, 638625, 730416, Maxima-Elektro-Backofen-700-850, Maxima-Elektro-Backofen-850, Maxima-Gasherd-mit-Gasbackofen		

miscellaneous

GEV No.	700187	Ref. No.	202347
description	spring for door		
For models:	00068x, 00099x, 00121x, 00149x, 00183x, 001864, 002046, 002682, 003131, 00314x, 750026, 750034, 750042, 750050, 750069, 750077, 750085, 750093, 750107, 750115, 750166, 750190		

tension springs

GEV No.	517395	Ref. No.	019267
description	tension spring kit ø 33mm wire gauge ø 4.5mm L1 230mm		
For models:	271500, 337xxx, 353167, 354392, 354457, GsP-500, GsP-600		

GEV No.	700030	Ref. No.	G0195
description	tension spring ø 12.9mm total length 187mm wire gauge ø 2.1mm		

GEV No.	700031	Ref. No.	G0197
description	tension spring ø 15mm total length 290mm wire gauge ø 2.3mm		

GEV No.	700032	Ref. No.	G0199
description	tension spring ø 24.8mm total length 220mm wire gauge ø 3.2mm		

GEV No.	700033	Ref. No.	G0201
description	tension spring ø 30mm total length 300mm wire gauge ø 4.1mm		



hose reels and spray guns

spray guns



1

GEV No.	540301	Ref. No.	587583
description	spray gun for appliances 1/2" ET L 128mm		
For models:	671568, 671576, 671584, 671592, 671606, 671614, 671622, 671630, 671649, 671657, 671665, 671673, 671681, 671711, 671746, 671754, 671762, 671770, 671789, 671797, 671800, 671819, 671827, 671835, 671843, 671851, 671878, 671886, 671894, 671908, 671916, 671975, 671983, 671991, 680583, 680591, 754595, 754609, 754617, 754668, 754676, 754681, 754692, 754706, 754714, 754722, 754730, 754749, 754757, 754773...(Other models you can see in the webshop)		
accessories for	540301		
	GEV No.	530922	Ref. No. —
shower hose connections 1/2" L 800mm SS for combi-steamer			

dosing pumps

peristaltic dosing pumps





ASF/THOMAS

built-in version

without control



1

GEV No.	361272	Ref. No.	384615
description	dosing pump ASF/THOMAS without control 12l/h 230VAC detergent hose ø 4x7mm hose silicone type SR25 dimensions 63x124x101mm		
For models:	337xxx, 340022, 340030, 340049, 340057, 340073, 340xxx, 353167, 354392, 354457, 361763, 378933, 440078, 440086, 440094, 440140, 440655, 450111, Geschirrspuelautomat-700, GsP-350, GsP-600		
spare parts for	361272		
	GEV No.	361333	Ref. No. —
pump hose SR25 detergent hose ø 4x1.5mm hose type silicone			
	GEV No.	361335	Ref. No. —
hose guide SR25 for detergent hose type hose ø 6mm plastic 1-way/h			
	GEV No.	361336	Ref. No. —
closing clamp type SR25			
	GEV No.	361470	Ref. No. —
roller assembly type SR25 12l/h			

SEKO

built-in version

without control



1

GEV No.	361867	Ref. No.	849537
description	dosing pump SEKO without control 0.4l/h 230VAC rinse aid hose ø 4x6mm hose type D hose Sekobril suction level 1.5m type NPG 0.4 8W cable length 45mm built-in version counter pressure 1bar		
spare parts for	361867		
	GEV No.	361135	Ref. No. 850942
pump hose SEKO rinse aid hose ø 3x8mm hose ø 4x6mm hose type D hose Sekobril			

spare parts



1



GEV No.	361135	Ref. No.	850942
description	pump hose SEKO rinse aid hose ø 3x8mm hose ø 4x6mm hose type D hose Sekobril		
spare parts for	361135		
	GEV No.	361866	Ref. No. —
union nut for hose connector ø 17mm			

piston pumps

with solenoid coil



1

GEV No.	361026	Ref. No.	376108
description	dosing pump inlet 5mm outlet 5mm 230V detergent duty cycle 30% type EV1		
For models:	Glaeserspuelautomat-328		
spare parts for	361026		
	GEV No.	361365	Ref. No. 607185
solenoid coil 230VAC for type EV1			
	GEV No.	510298	Ref. No. 376167
lip valve dosing pump suitable for DB2/DS5			



spare parts



GEV No.	361113	Ref. No.	359386
description	solenoid coil 230VAC for type DB2		
For models:	665843, 665851, Glaeserspielautomat-325, Glaeserspielautomat-328		



GEV No.	361365	Ref. No.	607185
description	solenoid coil 230VAC for type EV1		
For models:	Glaeserspielautomat-328		



GEV No.	510298	Ref. No.	376167
description	lip valve dosing pump suitable for DB2/DS5		
For models:	Glaeserspielautomat-328		



GEV No.	361366	Ref. No.	376116 651079
description	PCB dishwasher 11F suitable for DB2 type DB2/EV1/EKP-M		
For models:	Glaeserspielautomat-328		

membrane dosing pumps

self-priming

various

spare parts



GEV No.	510298	Ref. No.	376167
description	lip valve dosing pump suitable for DB2/DS5		
For models:	Glaeserspielautomat-328		

self-priming with supporting pressure

ELETTROBAR



GEV No.	510298	Ref. No.	376167
description	lip valve dosing pump suitable for DB2/DS5		
For models:	Glaeserspielautomat-328		

GERMAC

spare parts





GEV No.	510298	Ref. No.	376167
description	lip valve dosing pump suitable for DB2/DS5		
For models:	Glaeserspielautomat-328		

LANG

dosing pumps



GEV No.	361012	Ref. No.	312320
description	dosing pump type N83 detergent pressure connection ø 8mm suction connection ø 8mm auxiliary pressure connection 8mm LANG		
For models:	271500, 337xxx, 340xxx, Geschirrspuelautomat-330, Geschirrspuelautomat-335, Geschirrspuelautomat-336, Geschirrspuelautomat-700, GsP-350, GsP-500, GsP-600		

spare parts for	361012			
	GEV No.	361137	Ref. No.	—
	membrane			
	GEV No.	361139	Ref. No.	194549
	hose connector complete suction connection type N83			

spare parts



GEV No.	361139	Ref. No.	194549
description	hose connector complete suction connection type N83		
For models:	271500, 337xxx, 340xxx, Geschirrspuelautomat-330, Geschirrspuelautomat-335, Geschirrspuelautomat-336, Geschirrspuelautomat-700, GsP-350, GsP-500, GsP-600		

fittings, hose and pipe connectors

fittings

reducers



1			
GEV No.	520963	Ref. No.	249696
description	reducer thread 3/4" ET - 3/8" IT nickel-plated brass total length 26.5mm WS 27 Qty 1 pcs		
For models:	367788, 382191, 385018, 385026, 385034, 385042, 385050, 385514, 389595, 389609, 390003, 397210, 397229, 397237, 397245, 397253, 397261, 397288, 397296, 397318, 397326, 397334, 397342, 397350, 397431, 397776, 397784, 397792, 397806, 397814, 397822, 397830, 397849, 397857, 397865, 397873, 398047, 398055, 398063, 398071, 398098, 398101, 398128, 398136, 398144, 398152, 398950, 398969, 398977, 399019...(Other models you can see in the webshop)		

hose connectors

brass



1			
GEV No.	513253	Ref. No.	607169
description	hose connector brass angled thread 1/4" hose ø 12mm Qty 1 pcs		
For models:	665843, 665851, Glaeserspuelautomat-328		

water cycle components

pressure reduction valves

pressure reduction valves

producer-specific



1			
GEV No.	520502	Ref. No.	384437 577316
description	pressure reduction valve Norgren series R91 connection 1/8" default settingbar setting range 0.1-3bar p max 10bar t.max. 50°C brass		
For models:	367788, 382191, 385018, 385026, 385034, 385042, 385050, 385514, 389595, 389609, 390003, 397210, 397229, 397237, 397245, 397253, 397261, 397288, 397296, 397318, 397326, 397334, 397342, 397350, 397431, 397776, 397784, 397792, 397806, 397814, 397822, 397830, 397849, 397857, 397865, 397873, 398047, 398055, 398063, 398071, 398098, 398101, 398128, 398136, 398144, 398152, 398950, 398969, 398977, 399019...(Other models you can see in the webshop)		

ancillary products

clamps

security hose clamps

SS/brass



1			
GEV No.	520071	Ref. No.	276642
description	hose clamp SS/brass ø 17-22mm width 11mm Qty 5 pcs		
For models:	340022, 340030, 340049, 340057, 340073, 353167, 354392, 354457, 361763, 378933, 398047, 398055, 398063, 398071, 398098, 398101, 398128, 398136, 398144, 398152, 440078, 440086, 440094, 440140, 440655, 450111, 609501, 609528, 609536, 671649, 671657, 671665, 671673, 671681, 671711, 671746, 671754, 671762, 671770, 671789, 671797, 671800, 671819, 671827, 671835, 671843, 671851, 671878, 671886, 671894...(Other models you can see in the webshop)		

tools

cleaning tools

scrapers



1			
GEV No.	705000	Ref. No.	051144
description	scraper for 415398		
For models:	61030x, 620300, steakgrill-61030, steakgrill-62030		

fastening material

screws

sheet metal screws



1			
GEV No.	560096	Ref. No.	011754
description	sheet metal screws ø 2.9mm L 13mm SS Qty 20 pcs DIN 7981/ISO 7049 head ø 5.6mm oval head		





1

GEV No.	560100	Ref. No.	186465
description	sheet metal screws ø 3.5mm L 19mm SS Qty 20 pcs DIN 7981/ISO 7049 head ø 6.9mm oval head		
For models:	600008, 600067, 601004, 601209, 601403, 602000, 602205, 602280, 603007, 603023, 603201, Fritteuse-365, Fritteuse-600, Fritteuse-601, Fritteuse-602, Fritteuse-603, Fritteuse-604		

grub screws

DIN 916/ISO 4029



1

GEV No.	560173	Ref. No.	588512
description	grub screw thread M4 L 10mm SS DIN 916/ISO 4029 intake internal hexagon WS 2 Qty 20 pcs		
For models:	671568, 671576, 671584, 671592, 671606, 671614, 671622, 671630, 758752, 758760, 758981, 759007, 759015, 759023, 759031, 759058, 759066, 759074, 759171, 759198		

nuts

hexagonal nuts

DIN 934 / ISO 4032/8673



1

GEV No.	560133	Ref. No.	251887
description	hexagonal nut thread M6 H 5mm WS 10 SS DIN/ISO DIN 934 / ISO 4032/8673 Qty 20 pcs		
For models:	140902, 144819, 271500, 337xxx, 340022, 340030, 340049, 340057, 340073, 340xxx, 353167, 354392, 354457, 354643, 354651, 354678, 354686, 354694, 354708, 361429, 361437, 361763, 367788, 378933, 382191, 385018, 385026, 385034, 385042, 385050, 385514, 389595, 389609, 390003, 397210, 397229, 397237, 397245, 397253, 397261, 397288, 397296, 397318, 397326, 397334, 397342, 397350, 397431, 397776, 397784, 397792, 397806, 397814, 397822, 397830, 397849, 397857, 397865...(Other models you can see in the webshop)		

hexagonal nuts metric (without norm)



1

GEV No.	102067	Ref. No.	054240
description	nut thread M8x1 H 3mm brass Qty 1 pcs type SEF 1		
For models:	399701, 399728, 541419, 541427, 640018, 642053, 645005, 800163, 800171, 800198, 800201, 800228, 800236, 800244, 800252, 800260, 800279, 800287, 800295, Gas-Brater-641, Gas-Griddleplatte-642, Gasherd-645, Gasherd-64502, Gasherd-646, Gas-sudpfanne-643, Gas-Wurstgrill-640, Maxima-Gasherd-700-850, Maxima-Gasherd-neue-Ausfuehrung-700-850		

washers

washers

DIN 9021



1

GEV No.	560117	Ref. No.	000582
description	plain washer ID ø 6.4mm ED ø 18mm thickness 1.5mm SS Qty 20 pcs DIN 9021 for thread M6		
For models:	271500, 337xxx, 340022, 340030, 340049, 340057, 340073, 340xxx, 353167, 354392, 354457, 361763, 367788, 378933, 382191, 385018, 385026, 385034, 385042, 385050, 385514, 390003, 397210, 397229, 397237, 397245, 397253, 397261, 397288, 397296, 397318, 397326, 397334, 397342, 397350, 397431, 397776, 397784, 397792, 397806, 397814, 397822, 397830, 397849, 397857, 397865, 397873, 398047, 398055, 398063...(Other models you can see in the webshop)		

tooth lock washers

DIN 6798A



1

GEV No.	560127	Ref. No.	006777
description	tooth lock washer ID ø 6.2mm ED ø 11mm SS DIN/ISO DIN 6798A Qty 20 pcs for thread M6		
For models:	140902, 144819, 271500, 337xxx, 340022, 340030, 340049, 340057, 340073, 340xxx, 353167, 354392, 354457, 361763, 367788, 378933, 382191, 385018, 385026, 385034, 385042, 385050, 385514, 389595, 389609, 390003, 397210, 397229, 397237, 397245, 397253, 397261, 397288, 397296, 397318, 397326, 397334, 397342, 397350, 397431, 397776, 397784, 397792, 397806, 397814, 397822, 397830, 397849, 397857, 397865...(Other models you can see in the webshop)		

fasteners

clamps

security hose clamps

SS/brass



1

GEV No.	520071	Ref. No.	276642
description	hose clamp SS/brass ø 17-22mm width 11mm Qty 5 pcs		
For models:	340022, 340030, 340049, 340057, 340073, 353167, 354392, 354457, 361763, 378933, 398047, 398055, 398063, 398071, 398098, 398101, 398128, 398136, 398144, 398152, 440078, 440086, 440094, 440140, 440655, 450111, 609501, 609528, 609536, 671649, 671657, 671665, 671673, 671681, 671711, 671746, 671754, 671762, 671770, 671789, 671797, 671800, 671819, 671827, 671835, 671843, 671851, 671878, 671886, 671894...(Other models you can see in the webshop)		

A			
alarm devices	44		
audible timers	44		
axial fans	51		
B			
bar burners	70		
bi-metal thermostats	24, 24		
booster pumps I	54		
C			
cam switches	35		
clamps	88, 89		
cleaning tools	88		
contactors	44		
control equipment	37		
control thermostats	25, 32		
cross flow fans	51		
D			
door seals	82		
door seals with fixing hook	83		
dosing pumps	86		
E			
electric accessories	54		
electric timers	44		
electrodes	50		
electronic controllers	46		
energy regulators	24		
F			
fans	51		
fasteners	89		
fastening material	88		
fittings	88		
flow meters	50		
fluorescent lamps	42		
G			
gas burners	67		
gas nozzles	70		
gas taps	55		
gaskets for heated units	82		
grub screws	89		
H			
heating elements	3		
heating elements for bain maries	5		
heating elements for charrills	15		
heating elements for coffee machine	11		
heating elements for convection	21		
heating elements for fryers	7		
heating elements for frying pans	6		
heating elements for griddles	9		
heating elements for heated cabinets	16		
heating elements for large hobs	10		
heating elements for ovens	3		
heating elements for pasta cookers	13		
heating elements for pizza ovens	14		
heating elements for salamanders/toasters	16		
heating elements for tilting bratt pan	13		
hexagonal nuts	89		
hob burners	67		
hose connectors	88		
hot air fans	52		
hot air motors	51		
hot plates	23		
I			
immersion heating elements	17		
indicator lights	38		
indicator lights (complete)	39		
infrared lamps	41		
L			
lamps	38		
light bulbs	41		
linear lamps	41		
M			
magnetic switches	37		
microswitches	34		
N			
neon light bulbs	39, 40		
nuts	89		
O			
O-rings	83		
oven lamps	42		
P			
piezoelectric igniters	65		
pilot burners	61		
pilot heating elements	16		
pressure reduction valves	88, 88		
pressure switches	49		
probes	47		
programme timers	43		
protective pipes for capillary pipes	32		
pumps	53		
push/momentary push switches	33		

R

radial fans	52
radiation heaters	22
reducers	88
relays	45
residual heat indicators	43
rocker/momentary rocker switches	33

S

safety thermostats	28
screws	88
sealing washers	85
security hose clamps	88, 89
sheet metal screws	88
solenoid valves	47
solid state relays	45
spray guns	86
spray guns with external thread	86
switches and momentary switches	33

T

terminals	54
thermocouples	65
thermostats	24
time relays	45
timers	43
tools	88
tooth lock washers	89
transformers	46

W

wash and rinse pumps	53
washers	89
water cycle components	88