



GAS COMPONENTS



ELECTRIC COMPONENTS



WATER TECHNOLOGY



MECHANICAL COMPONENTS



TOOLS

Spare parts suitable for

PITCO

Find the complete and up-to-date range of products in our GEV Webshop



Manufacturer catalogue

The most important spare parts and accessories arranged clearly for every manufacturer

- ✓ Complete product range and all appliance data always up to date in the GEV Webshop
- ✓ Alphabetical Index at the end of the catalogue

GEV Webshop

www.gev-online.co.uk

www.gev-online.com



- 🔍 Add to Favourites
- 🔍 Sign In with email address and usual password
- 🔍 Easy-order – place several items in your basket at the same time
- 🔍 Quick Item search – no login needed



heating elements

heating elements for fryers



1

GEV No.	420421	Ref. No.	B5307203-C
description	heating element 7000W 240V heating circuits 3 L 280mm W 158mm H 285mm flange with thread connection cable fryer hole distance 87mm hole ø 6.3mm flange length 101.5mm flange width 36mm cable length 1000mm		



1

GEV No.	420428	Ref. No.	50006614
description	heating element 8500W 230V heating circuits 3 L 355mm W 115mm H 280mm flange connection plug flange length 163mm flange width 45mm tube ø 8mm		

2 hole fixing

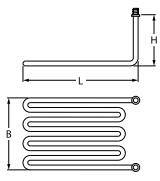
1

GEV No.	420423	Ref. No.	P5046916
description	heating element 7000W 240V heating circuits 1 L 280mm W 87mm H 295mm thread 5/8"-18UNF tube ø 11mm windings 5 fryer		

1

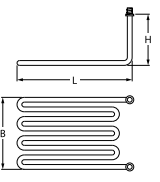
GEV No.	420427	Ref. No.	PP10904
description	heating element 8500W 230V heating circuits 3 L 260mm W 90mm H 260mm thread 3/4"-16UNF windings 4 fryer		

1

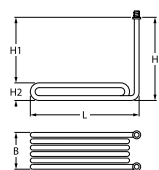
GEV No.	420425	Ref. No.	P5046921
description	heating element 5500W 240V heating circuits 1 L 265mm W 97mm H 290mm H1 220mm H2 70mm thread 5/8"-18UNF tube ø 11mm		

1

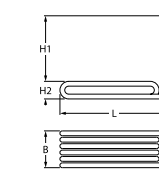
GEV No.	420424	Ref. No.	P5046902
description	heating element 6000W 240V heating circuits 1 L 365mm W 105mm H 295mm thread 5/8"-18UNF tube ø 11mm windings 4		

heating elements for pasta cookers



1

GEV No.	420426	Ref. No.	B5309305
description	heating element 2500W 230V heating circuits 1 L 310mm W 75mm H 75mm		

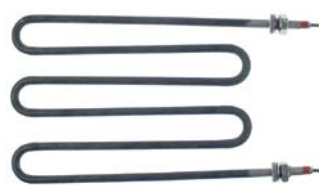

1

GEV No.	420422	Ref. No.	P5046968
description	heating element 6000W 240V heating circuits 1 L 345mm W 218mm H 25.4mm 5/8"-18UNF		



1

GEV No.	420429	Ref. No.	PP11210
description	heating element 8500W 230V heating circuits 1 L 420mm W 275mm H 31.8mm		

thermostats

bi-metal thermostats

bi-metal thermostats



GEV No.	390969	Ref. No.	PP10739
description	bi-metal thermostat hole distance 23.5mm switch-off temp. 57.2°C 1NC 1-poleAV connection F6.3 2 hole fixing		

control and safety thermostats

INVENSYS / ROBERTSHAW

control thermostats



GEV No.	390971	Ref. No.	60125402
description	thermostat t.max. 190.6°C temperature range 93-190°C 1-pole 1NO 0.67A probe ø 9.5mm probe L 120mm capillary pipe 870mm capillary pipe isolatedmm gland nut 3/8" NPT shaft L 23mm shaft position lower 200-375°F		



GEV No.	390636	Ref. No.	60125401
description	thermostat t.max. 204°C temperature range 93-204°C 1-pole 1NO 0.67A probe ø 9.5mm probe L 123mm capillary pipe 915mm capillary pipe isolatedmm gland nut 1/4" NPT shaft ø 6x4.6mm shaft L 21mm shaft position lower rotation 315° probe material nickel-plated probe thread 1/4" US		

GEV No.	580040	Ref. No.	P5047587
description	thermostat t.max. 205°C temperature range 94-205°C 1-pole 1NOA probe ø 9.5mm probe L 123mm capillary pipe 885mm capillary pipe isolatedmm gland nut 3/8" NPT shaft Lmm with knob		

safety thermostats

RANCO





GEV No.	390966	Ref. No.	60070701
description	safety thermostat switch-off temp. 121°C temperature range°C 1-poleA probe ø 6.4mm probe L 136mm capillary pipe 610mm capillary pipe isolatedmm gland nut 1/4" NPT shaft ømm probe SS		

GEV No.	390967	Ref. No.	PP11010
description	safety thermostat switch-off temp. 224°C temperature range fixed 224°C 1-pole 1COA probe ø 6.4mm probe L 118mm capillary pipe 790mm capillary pipe isolatedmm gland nut shaft ømm probe SS		

GEV No.	580045	Ref. No.	PP10084
description	safety thermostat switch-off temp. 232°C 1-pole 1COA probe ø 6.4mm probe L 120mm capillary pipe 760mm capillary pipe isolatedmm gland nut 3/8" NPT shaft ømm probe SS screw connection 1/4" 450°F		





			
1			
GEV No.	580047	Ref. No.	P5047210 PP10271
description	safety thermostat switch-off temp. 232°C 1-pole probe ø 6.4mm probe L 120mm capillary pipe 600mm 450°F		

			
1			
GEV No.	390965	Ref. No.	P5047216
description	safety thermostat switch-off temp. 232°C 1-poleA probe ø 7.93mm probe L 77mm capillary pipe 760mm capillary pipe isolatedmm gland nut shaft ømm probe SS		

switches and momentary switches

rocker/momentary rocker switches

37x21mm			
			
1			
GEV No.	348059	Ref. No.	6717337 PP10093
description	rocker switch mounting measurements 37x21mm white 1CO 250V 6A connection male faston 6.3mm ambient temperature max. 85/100°C protection IP44		

			
1			
GEV No.	348062	Ref. No.	PP11284
description	rocker switch mounting measurements 37x21mm white/black 2NO 250V 15A 0-1 connection male faston 6.3mm ambient temperature max. 125°C protection IP40		

miscellaneous

			
1			
GEV No.	348054	Ref. No.	PP10735
description	rocker switch mounting measurements 37x21mm white/black 2CO 250V 10A connection male faston 6.3mm ambient temperature max. 85/125°C protection IP44		

toggle switches

M12x0.75

			
1			
GEV No.	348060	Ref. No.	PP11175
description	momentary toggle switch thread M12 2NO 250V 10A ON-OFF male faston 6.3mm momentary		

			
1			
GEV No.	348055	Ref. No.	P5047165
description	toggle switch thread M12x0.75 2CO 250V 15A ON-ON screw		

			
1			
GEV No.	348058	Ref. No.	PP10821
description	toggle switch thread M12x0.75 3CO 250V 12A ON-OFF-ON male faston 6.3mm with neutral position		

microswitches

pin-plunger actuated

M12

			
1			
GEV No.	348061	Ref. No.	P5047170
description	microswitch with plunger mounting distance 20mm thread M12x1 thread L 14mm 250V 10A 1CO connection screw stroke 10mm L 50mm L1 50mm L2 20mm ambient temperature max. 125°C actuating force: 560g		

float switches

			
1			
GEV No.	403494	Ref. No.	P5047217
description	float switch thread 1/4" NPT 1NO ø 52mm L 90mm mounting ø 14mm 240V 0.4A cable cable length 910mm		



magnetic switches

29x19mm

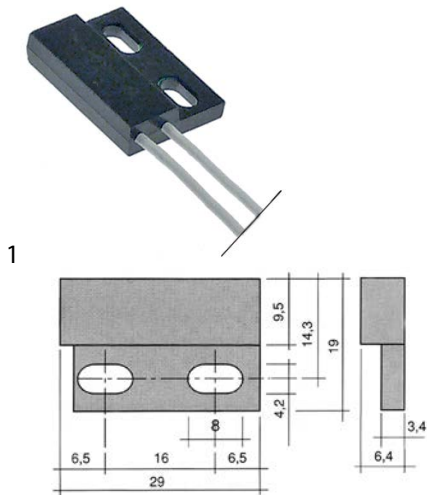

GEV No.	348050 ¹	Ref. No.	B5305001
description	magnetic switch L 29mm W 19mm 1NO 250V 0.5A P max. 10W connection plug cable length 290mm		
For models:	ME2, MEII		

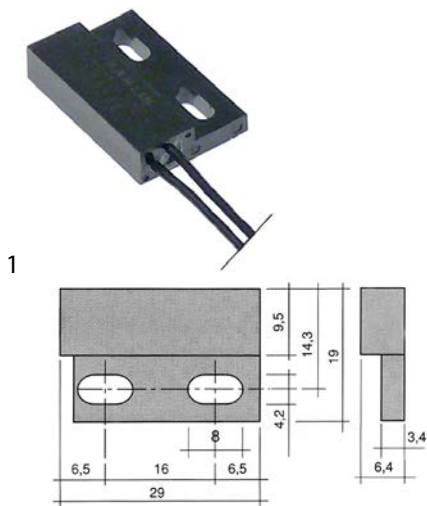
¹with coded connector

GEV No.	348049	Ref. No.	PP11164
description	magnetic switch L 29mm W 19mm 1NO 250V 1.5A P max. 50W cable length 600mm		

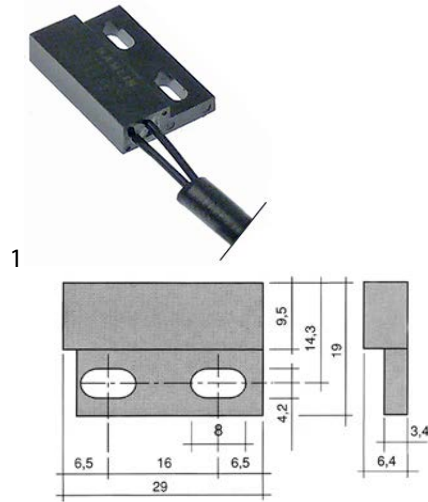

GEV No.	348051	Ref. No.	B5305002
description	magnetic switch with insulation L 29mm W 19mm 1NO 250V 0.5A P max. 10W connection plug cable length 290mm		

accessories

magnets

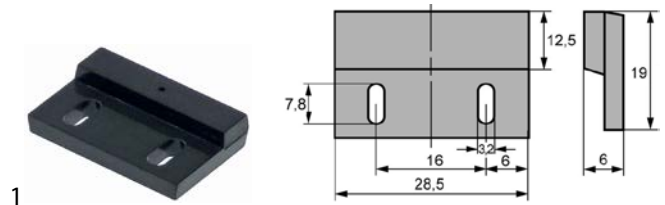

GEV No.	345700	Ref. No.	PP10263
description	magnet \varnothing mm L 29mm H 6.5mm W 19mm hole distance 16mm M3 hole \varnothing 3.5mm		
For models:	ME2, MEII		

lamps

indicator lights

indicator lights (complete)

27x12mm



GEV No.	348056	Ref. No.	P5045040
description	indicator light mounting measurements 27x12mm red 28V connection male faston 6.3mm temp.-resist. 125°C		



GEV No.	348057	Ref. No.	P5045043
description	indicator light mounting measurements 27x12mm white 28V connection male faston 6.3mm temp.-resist. 125°C		



miscellaneous



1			
GEV No.	360619	Ref. No.	PP10736
description	indicator light green 125/250V connection male faston 6.3mm		

contactors

HARTLAND

power contactors



1			
GEV No.	381278	Ref. No.	P5045352
description	power contactor resistive load 40A 120VAC 30A/10HP (AC3/240V) 30A/7.46kW main contacts 3NO auxiliary contacts connection screw clamp/male faston 6.3mm type HCCY3XT02CY		



1			
GEV No.	381277	Ref. No.	P60157202 PP10560
description	power contactor resistive load 50A 24VAC 40A/10HP (AC3/240V) 40A/7.46kW main contacts 3NO auxiliary contacts connection screw clamp/male faston 6.3mm type HCCY3XQ04CG		
For models:	ME2, MEII		

SPRECHER+SCHUH

power contactors



1			
GEV No.	381279	Ref. No.	60139201
description	power contactor resistive load 65A 24VAC (AC3/400V) 60A/18.5kW main contacts 3NO auxiliary contacts connection screw connection type CA7-37-00		
For models:	ME2, MEII		

solid state relays

CRYDOM



1			
GEV No.	381280	Ref. No.	PP11011
description	solid state relay CRYDOM 1 phase 50A 480V 18-36 VAC L 57mm W 45mm screw type HA4850E		

relays

power relays

with bracket mounting



1			
GEV No.	381290	Ref. No.	PP11058
description	power relays OMRON 24VAC 25A 1NO connection F6.3 bracket mounting at 250V 30A manuf. no. G7L-1A-TUBJ-CB 24VAC		
For models:	ME2, MEII		



1

GEV No.	381291	Ref. No.	60104701
description	power relays OMRON 24VAC 25A 2NO connection F6.3 bracket mounting at 250V 25A manuf. no. G7L-2A-TUBJ-CB 24VAC		
For models:	ME2, MEII		



1

GEV No.	381294	Ref. No.	PP11068
description	relay OMRON 24VDC 10A 2CO connection F4.8 bracket mounting manuf. no. LY2F 24DC		



1

GEV No.	381292	Ref. No.	PP11036
description	power relays OMRON 24VDC 25A 2NO connection F6.3 bracket mounting at 250V 25A manuf. no. G7L-2A-TUBJ-CB 24VDC		



1

GEV No.	381293	Ref. No.	PP11124
description	relay OMRON 24VDC 15A 1CO connection F4.8 bracket mounting manuf. no. LY1F DC24		



1

GEV No.	381295	Ref. No.	P5046687
description	relay OMRON 24VAC 10A 2CO connection F4.8 bracket mounting manuf. no. LY2 24VAC		

miscellaneous



1

GEV No.	403495	Ref. No.	60143301
description	relay reset		



1

GEV No.	381296	Ref. No.	60126001
description	relay OMRON 24VAC 10A 3CO connection F4.8 bracket mounting manuf. no. LY3F AC24		
For models:	ME2, MEII		

probes

producer-specific probes

probes

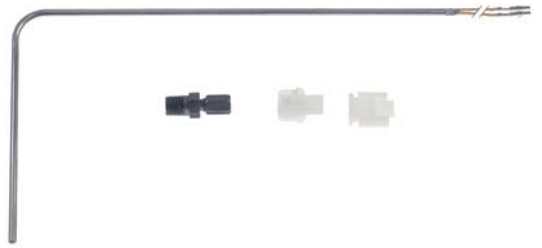

1

GEV No.	403491	Ref. No.	B6700601-C
description	temperature probe thermocouple K (NiCr-Ni) cable glass fibre probe -50 up to +750°C cable -50 up to +350°C connection 2-wire thread 1/4" NPT probe ø4.7x280mm cable length 0.315m handle ømm handle lengthmm		



core probes



GEV No.	403489	Ref. No.	60055003-C
description	temperature probe NTC 100kOhm cable PTFE probe -40 up to +120°C cable -40 up to +250°C connection 2-wire probe ø4.7x70mm thread M9 cable length 1.12m handle ømm handle lengthmm L2 65mm		



GEV No.	403490	Ref. No.	B6700602-C
description	temperature probe thermocouple K (NiCr-Ni) cable glass fibre probe -50 up to +750°C cable -50 up to +350°C connection 2-wire probe ø4.7x270mm thread cable length 0.35m handle ømm handle lengthmm		



GEV No.	403493	Ref. No.	60139801
description	temperature probe NTC 10kOhm cable PVC probe -40 up to +110°C cable -10 up to 100°C connection 2-wire probe ø4.7x270mm thread M12x1.25 cable length 0.4m handle ømm handle lengthmm		



GEV No.	403488	Ref. No.	PP10915
description	temperature probe thermocouple K (NiCr-Ni) cable glass fibre probe -50 up to +750°C cable -50 up to +350°C connection 2-wire probe ø4.7x280mm thread cable length 0.32m handle ømm handle lengthmm		



GEV No.	403492	Ref. No.	P5044882
description	temperature probe NTC 10kOhm cable PVC probe -40 up to +110°C cable -10 up to 100°C connection 2-wire probe ø4.7x270mm thread M12x1.25 cable length 0.8m handle ømm handle lengthmm		

accessories

fasteners



GEV No.	692860	Ref. No.	A3342802 PITA3342802
description	bracket for fryer mounting pos. probes L 30mm W 45mm H 22mm stainless steel hole ø 14mm mounting distance 31mm		
For models:	ME2, MEII		



GEV No.	403487	Ref. No.	B3316801-C
description	temperature probe thermocouple K (NiCr-Ni) cable glass fibre probe -50 up to +750°C cable -50 up to +350°C connection 2-wire probe ø4.7x140mm thread M9 cable length 0.27m handle ømm handle lengthmm		

electronics

PCBs



GEV No.	698535	Ref. No.	60134001
description	PCB fryer L 130mm W 90mm 24V H 55mm PITCO Qty 1 pcs		



GEV No.	698539	Ref. No.	PP11012
description	PCB fryer L 380mm W 150mm 24V H 60mm mounting pos. front PITCO Qty 1 pcs		

GEV No.	698534	Ref. No.	60126601
description	PCB fryer L 380mm W 155mm 24V H 40mm 1.67A mounting pos. front PITCO Qty 1 pcs		



GEV No.	698540	Ref. No.	PP11306
description	PCB fryer L 380mm W 160mm 24V H 55mm 1.67A mounting pos. front PITCO Qty 1 pcs		



GEV No.	698541	Ref. No.	PP11372
description	PCB fryer L 385mm W 160mm 24V H 60mm 1.67A mounting pos. front PITCO Qty 1 pcs		



GEV No.	698542	Ref. No.	PP11370
description	PCB fryer L 390mm W 155mm 24V H 55mm 1.67A mounting pos. front PITCO Qty 1 pcs		

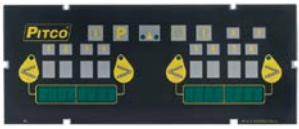

GEV No.	698536	Ref. No.	60137701-C
description	PCB fryer L 390mm W 160mm 24V H 60mm 1.67A mounting pos. front PITCO Qty 1 pcs		



GEV No.	698532	Ref. No.	60149501-CL
description	PCB fryer L 400mm W 220mm 24V H 80mm 1.2A mounting pos. front PITCO Qty 1 pcs		



GEV No.	698537	Ref. No.	60127301
description	PCB fryer L 99mm W 69mm 24V H 20mm PITCO Qty 1 pcs		
For models:	ME2, MEII		



GEV No.	698533	Ref. No.	60144002-C
description	PCB L 115mm W 70mm 24V H 20mm PITCO Qty 1 pcs		



GEV No.	698538	Ref. No.	PP10939
description	PCB L 240mm W 160mm 24V H 50mm 1.67A PITCO Qty 1 pcs		

pressure switches

for deep fryers



GEV No.	698529	Ref. No.	PP11137
description	pressure control ø 90mm 1CO connection 7/16" UNF (1/4" SAE) pressure connection 7/16" UNF (1/4" SAE)		



fans

radial fans

1

GEV No.	601971	Ref. No.	PP11129
description	radial fan 220-240V voltage AC 50Hz H1 260mm L1 220mm D1 ø 170mm W1 240mm W2 60mm H2 90mm W3 95mm H3 120mm		

motors

gear motors

miscellaneous

1

GEV No.	601970	Ref. No.	PP10930
description	gear motor PITCO type ZEM-6006-25 230V 50/60Hz shaft ø 8/9mm L 120mm W 70mm H 155mm		

motors

1

GEV No.	504785	Ref. No.	60130804
description	pump motor 240V 50Hz 1425rpm capacitorµF for oil/grease H 160mm PITCO L 240mm W 160mm 248W		
For models:	ME2, ME11		

pumps

oil pumps

1

GEV No.	501475	Ref. No.	PP10171
description	oil pump PITCO type M4C14DH4G 246W 240V 50Hz inlet ø 23mm outlet ø 21mm L 285mm		

1

GEV No.	501474	Ref. No.	60130802
description	oil pump PITCO type M4S14DH3B 248W 240V 50Hz inlet ø 23mm outlet ø 23mm L 330mm 1817l/h capacitorµF		

1

GEV No.	501473	Ref. No.	60143508
description	oil pump PITCO type SG-0510-G00WVHz inlet ø 15mm outlet ø 15mm 910l/h		

fuses

fine fuses

1

GEV No.	358840	Ref. No.	PP10122
description	fuse size ø6.3x32mm 1A slow-acting rated 250V Qty 1 pcs		

1

GEV No.	358839	Ref. No.	60132703
description	fuse size ø6.3x32mm 2.5A slow-acting rated 250V Qty 1 pcs		

→ electric components



			
1			
GEV No.	358841	Ref. No.	P5045717
description	fuse size ø6.3x32mm 2A slow-acting rated 250V Qty 1 pcs		

fine fuse holders

			
1			
GEV No.	551283	Ref. No.	P5045794
description	fuse holder suitable fuse ø6.3x32mm ø 12.5mm mounting ø 13mm 20A rated 300V connection F4.8		

			
1			
GEV No.	551282	Ref. No.	PP10765
description	fuse holder suitable fuse ø5x20mm ø 12.5mm 30A rated 32V L 57mm connection 8x5 cross section 2.5mm ²		

overload switches



			
1			
GEV No.	358179	Ref. No.	PP10470
description	overload switch 2-pole drop-away current 4A rated 250V nominal 4A connection male faston		





gas thermostats

ROBERTSHAW

			
1			
GEV No.	580041 ¹	Ref. No.	P5047588
description	gas thermostat type GSA60301800 93-204°C 200-400°F gas inlet 1/4" CCT (tube ø 1/4") bypass nozzle ømm gas outlet 1/4" CCT (tube ø 1/4") thermocouple connection pilot connection capillary pipe 30" - 760mm probe ø 3/8" - 9.5mm probe L 5 3/8" - 135mm gland nut 1/4" NPT shaft ø 6.4x4.8mm shaft L 21/21mm shaft flat upper ROBERTSHAW		
accessories for	580041		
	GEV No.	101481	Ref. No. —
	olive for pipe ø 1/4" CCT Qty 1 pcs		
	GEV No.	106109	Ref. No. —
	locking screw thread 7/16"-24 UNS for pipe ø 1/4" L 16mm brass Qty 1 pcs WS 7/16" (11.113mm) hole ø 6.4mm		

¹with gland nut 1/4" NPT

accessories for	580041		
	GEV No.	106110	Ref. No. —
	union screw tube ø 1/4"mm		
	GEV No.	580039	Ref. No. —
	knob 200-400°F ø 57mm shaft ø 6x4.6mm shaft flat lower t.max. 400°F rotation 270°		

			
1			
GEV No.	580052 ¹	Ref. No.	P5047590
description	gas thermostat type GSH30240000 t.max. 190°C 93-190°C 200-375°F gas inlet 1/4" CCT (tube ø 1/4") bypass nozzle ømm gas outlet 1/4" CCT (tube ø 1/4") thermocouple connection pilot connection capillary pipe 24" - 610mm probe ø 3/8" - 9.5mm probe L 5 3/8" - 135mm gland nut 3/8" NPT shaft ø 6.4x4.8mm shaft L 21/21mm shaft flat lower ROBERTSHAW		
accessories for	580052		
	GEV No.	101481	Ref. No. —
	olive for pipe ø 1/4" CCT Qty 1 pcs		
	GEV No.	106109	Ref. No. —
	locking screw thread 7/16"-24 UNS for pipe ø 1/4" L 16mm brass Qty 1 pcs WS 7/16" (11.113mm) hole ø 6.4mm		
	GEV No.	106110	Ref. No. —
	union screw tube ø 1/4"mm		

¹with gland box 3/8" NPT

gas valves and ignition boxes

gas control valves

HONEYWELL			
			
1			
GEV No.	107668	Ref. No.	60113503-C
description	gas valve type VR8204A natural gas 24V 50/60Hz gas inlet 1/2" NPT gas outlet 1/2" NPT thermocouple connection pilot connection 1/4" CCT pressure range 7.5-12.5mbar operator type pressure controller type automatic HONEYWELL		







ROBERTSHAW

electric controlled valves



1

GEV No.	101429	Ref. No.	P5045657	
description	gas valve 120V 50/60Hz gas inlet 3/4" gas outlet 3/4" thermocouple connection 3/8" NEF pilot connection 1/4" pipe US type 7000BMSER-120 pressure controller natural gas 3.5" W.C. suitable for ROBERTSHAW			
spare parts for	101429			
	GEV No.	101047	Ref. No.	P6071301 P6071303
	magnet unit T1: ASA 11/32 T2: M24x1 L 59mm ø 4mm suitable for ROBERTSHAW			
	GEV No.	101389	Ref. No.	—
	pressure controller natural gas suitable for ROBERTSHAW			
	GEV No.	580033	Ref. No.	P6071170 P6071267
	knob suitable for ROBERTSHAW			
accessories for	101429			
	GEV No.	580035	Ref. No.	P5047541 P5047542
	thermopile L 36" - 915mm probe ø 9mm probe L 38mm 250-750mV screw connection 7/16" connection 3/8" NEF			



1

GEV No.	107670	Ref. No.	PP10720	
description	gas valve supply 24VAC supply 12VDC gas inlet 1/2" NPT gas outlet 1/2" NPT thermocouple connection 11/32" pilot connection 1/4" CCT type 7000 BER-LP pressure controller LPG 10" W.C. suitable for PITCO			



1

GEV No.	107672	Ref. No.	PP10770	
description	gas valve supply 24VAC supplyVDC gas inlet 1/2" NPT gas outlet 1/2" NPT thermocouple connection pilot connection type 7000B DER pressure controller natural gas 3.0" W.C. suitable for PITCO			



1

GEV No.	107671	Ref. No.	PP11142	
description	gas valve supply 24VAC supplyVDC gas inlet 1/2" NPT gas outlet 1/2" NPT thermocouple connection pilot connection type U7010DER-S7B pressure controller natural gas 3.5" W.C. suitable for PITCO			

gas controlled valves

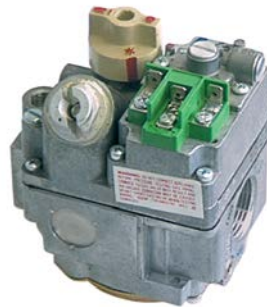

1









GEV No.	580032	Ref. No.	P5045638	
description	gas valve 50/60Hz gas inlet 1/2" gas outlet 1/2" thermocouple connection 3/8" NEF pilot connection 1/4" pipe US type 7000BMSER pressure controller natural gas 3.5" W.C. suitable for ROBERTSHAW supply 24VAC supply 12VDC			
spare parts for	580032			
	GEV No.	101047	Ref. No.	P6071301 P6071303
	magnet unit T1: ASA 11/32 T2: M24x1 L 59mm ø 4mm suitable for ROBERTSHAW			
	GEV No.	101389	Ref. No.	—
	pressure controller natural gas suitable for ROBERTSHAW			
	GEV No.	101403	Ref. No.	—
	operator 24V voltage AC natural gas suitable for ROBERTSHAW			







Table continues overleaf

spare parts for 580032					
	<table border="1"> <tr> <th>GEV No.</th> <th>580033</th> <th>Ref. No.</th> <th>P6071170 P6071267</th> </tr> </table> <p>knob suitable for ROBERTSHAW</p>	GEV No.	580033	Ref. No.	P6071170 P6071267
GEV No.	580033	Ref. No.	P6071170 P6071267		
accessories for 580032					
	<table border="1"> <tr> <th>GEV No.</th> <th>580035</th> <th>Ref. No.</th> <th>P5047541 P5047542</th> </tr> </table> <p>thermopile L 36" - 915mm probe ø 9mm probe L 38mm 250-750mV screw connection 7/16" connection 3/8" NEF</p>	GEV No.	580035	Ref. No.	P5047541 P5047542
GEV No.	580035	Ref. No.	P5047541 P5047542		

			
1			
GEV No.	106923	Ref. No.	PP10593
description	gas valve 60Hz type 7000BDER-S7A supply 24VAC		

			
1			
GEV No.	107675	Ref. No.	B8002702
description	gas valve supply Operator gas inlet 1/4" CCT outlet 1/4" CCT gas inlet 1/2" NPT gas outlet 1/2" NPT thermocouple connection 11/32" pilot connection 1/4" CCT type 7000BGOR-LP pressure controller LPG 10"W.C.		

			
1			
GEV No.	107673	Ref. No.	PP10956
description	gas valve supply Operator gas inlet 1/4" CCT outlet 1/4" CCT gas inlet 1/2" NPT gas outlet 1/2" NPT thermocouple connection 11/32" pilot connection 1/4" CCT type U7000 LP pressure controller LPG		

					
1					
GEV No.	580043	Ref. No.	P5045642 P5045659		
description	gas valve supply Operator gas inlet 1/4" CCT outlet 1/4" CCT gas inlet 3/4" NPT gas outlet 3/4" NPT thermocouple connection 3/8" NEF pilot connection 1/4" CCT type 7000BMSGOR pressure controller natural gas 3.5" W.C. suitable for ROBERTSHAW				
spare parts for 580043					
	<table border="1"> <tr> <th>GEV No.</th> <th>101042</th> <th>Ref. No.</th> <th>—</th> </tr> </table> <p>magnet unit T1: 3/8" NEF suitable for ROBERTSHAW for gas operator</p>	GEV No.	101042	Ref. No.	—
GEV No.	101042	Ref. No.	—		
	<table border="1"> <tr> <th>GEV No.</th> <th>101481</th> <th>Ref. No.</th> <th>—</th> </tr> </table> <p>olive for pipe ø 1/4" CCT Qty 1 pcs</p>	GEV No.	101481	Ref. No.	—
GEV No.	101481	Ref. No.	—		
	<table border="1"> <tr> <th>GEV No.</th> <th>106109</th> <th>Ref. No.</th> <th>—</th> </tr> </table> <p>locking screw thread 7/16"-24 UNS for pipe ø 1/4" L 16mm brass Qty 1 pcs WS 7/16" (11.113mm) hole ø 6.4mm</p>	GEV No.	106109	Ref. No.	—
GEV No.	106109	Ref. No.	—		
	<table border="1"> <tr> <th>GEV No.</th> <th>580033</th> <th>Ref. No.</th> <th>P6071170 P6071267</th> </tr> </table> <p>knob suitable for ROBERTSHAW</p>	GEV No.	580033	Ref. No.	P6071170 P6071267
GEV No.	580033	Ref. No.	P6071170 P6071267		
accessories for 580043					
	<table border="1"> <tr> <th>GEV No.</th> <th>580035</th> <th>Ref. No.</th> <th>P5047541 P5047542</th> </tr> </table> <p>thermopile L 36" - 915mm probe ø 9mm probe L 38mm 250-750mV screw connection 7/16" connection 3/8" NEF</p>	GEV No.	580035	Ref. No.	P5047541 P5047542
GEV No.	580035	Ref. No.	P5047541 P5047542		

millivolt controlled valves			
			
1			
GEV No.	107674	Ref. No.	60132902
description	gas valve supply Operator millivolt gas inlet 1/2" NPT gas outlet 1/2" NPT thermocouple connection 11/32" pilot connection 1/4" CCT type U7000MVRL pressure controller LPG 10"W.C. suitable for PITCO		







1

GEV No.	107669	Ref. No.	60132901
description	gas valve supply Operator millivolt gas inlet 1/2" NPT gas outlet 1/2" NPT thermocouple connection 1 1/32" pilot connection 1/4" CCT type U7000MVRL pressure controller natural gas 4.0" W.C. suitable for PITCO		
For models:	ME2, MEII		



1

GEV No.	580031	Ref. No.	N/A
description	gas valve supply Operator millivolt gas inlet 3/4" NPT gas outlet 3/4" NPT thermocouple connection pilot connection 1/4" CCT type 7000BMVR pressure controller natural gas 3.5" W.C. suitable for ROBERTSHAW		
spare parts for	580031		
	GEV No.	101422	Ref. No. —
	operator natural gas supply Operator millivolt		
	GEV No.	106109	Ref. No. —
	locking screw thread 7/16"-24 UNS for pipe ø 1/4" L 16mm brass Qty 1 pcs WS 7/16" (11.113mm) hole ø 6.4mm		
	GEV No.	106121	Ref. No. P6071551
	pressure controller natural gas 3.5" W.C.		
	GEV No.	580033	Ref. No. P6071170 P6071267
	knob suitable for ROBERTSHAW		

ignition boxes

miscellaneous



1

GEV No.	107658	Ref. No.	PP11145
description	ignition box GASLITER type MARK10DX-24-716-2 suitable for PITCO electrodes 1 waiting time 1s safety time 10s 24V 50/60Hz		

safety valves

miscellaneous



1

GEV No.	107667	Ref. No.	P6071776
description	safety valve BASO type G96HGA-1 pressure range 34.5mbar gas inlet 1/2" NPT gas outlet 1/2" NPT thermocouple connection natural gas 3.5"W.C.		

ignition parts

pilot burners

ROBERTSHAW

pilot burners

universal series - type 4



1

GEV No.	580050	Ref. No.	P6071451 P6071458
description	pilot burner ROBERTSHAW type 4CH-6 3 flames LPG code 16 for pipe ø 1/4" CCT		

universal series - type 6

Width of caps:
 6CH10 = 1" (25,4mm)
 6CH14 = 1½" (38,1mm)
 6CH24 = 2½" (63,5mm)
 6CH30 = 3" (76,2mm)





1

GEV No.	107677	Ref. No.	6071449
description	pilot burner ROBERTSHAW type 6CH14-6 3 flames LPG code 16 for pipe ø 1/4" CCT		





1

GEV No.	107676	Ref. No.	6071450
description	pilot burner ROBERTSHAW type 6CH14-6 3 flames natural gas code 22 for pipe ø 1/4" CCT		
accessories for	107676		
	GEV No.	106108	Ref. No. P6071666
	pilot burner nozzle natural gas code 22 suitable for ROBERTSHAW		











1

GEV No.	107396	Ref. No.	P6071452 P6071457
description	pilot burner ROBERTSHAW type 6CH24-6 3 flames natural/liquid gas code 16/26 for pipe ø 1/4" CCT		
spare parts for	107396		
	GEV No.	100277	Ref. No. —
	pilot burner nozzle natural gas code 26 suitable for ROBERTSHAW		
	GEV No.	106105	Ref. No. P6071665
	pilot burner nozzle LPG code 16 suitable for ROBERTSHAW		

universal series with electrodes





1

GEV No.	107661	Ref. No.	60130902
description	pilot burner ROBERTSHAW type 6SW14-21E 3 flames LPG code 16 for pipe ø 1/4" CCT		
spare parts for	107661		
	GEV No.	100275	Ref. No. —
	pilot burner nozzle LPG code 10 bore ø 0.1mm suitable for ROBERTSHAW		
	GEV No.	100276	Ref. No. —
	pilot burner nozzle natural gas code 18 suitable for ROBERTSHAW		
	GEV No.	100277	Ref. No. —
	pilot burner nozzle natural gas code 26 suitable for ROBERTSHAW		
	GEV No.	106105	Ref. No. P6071665
	pilot burner nozzle LPG code 16 suitable for ROBERTSHAW		
	GEV No.	106106	Ref. No. —
	pilot burner nozzle LPG code 14 suitable for ROBERTSHAW		
	GEV No.	106107	Ref. No. —
	pilot burner nozzle LPG code 11 suitable for ROBERTSHAW		
	GEV No.	106108	Ref. No. P6071666
	pilot burner nozzle natural gas code 22 suitable for ROBERTSHAW		
	GEV No.	106115	Ref. No. —
	pilot burner nozzle town gas suitable for ROBERTSHAW		



1

GEV No.	107395	Ref. No.	60130901 60130902
description	pilot burner ROBERTSHAW type 6SW14-21E 3 flames natural/liquid gas code 22/16 for pipe ø 1/4" CCT		
spare parts for	107395		
	GEV No.	106105	Ref. No. P6071665
	pilot burner nozzle LPG code 16 suitable for ROBERTSHAW		
	GEV No.	106108	Ref. No. P6071666
	pilot burner nozzle natural gas code 22 suitable for ROBERTSHAW		

1

GEV No.	107678	Ref. No.	PP11296
description	pilot burner ROBERTSHAW type W1350 3 flames code for pipe ø		









producer-specific pilot burners

PITCO

pilot burners











1

GEV No.	107662	Ref. No.	B8032104-C
description	pilot burner ROBERTSHAW type 6CH14-21 3 flames LPG nozzle 16 1/4" complete		
spare parts for	107662		
	GEV No.	100275	Ref. No. —
	pilot burner nozzle LPG code 10 bore ø 0.1mm suitable for ROBERTSHAW		
	GEV No.	100276	Ref. No. —
	pilot burner nozzle natural gas code 18 suitable for ROBERTSHAW		
	GEV No.	100277	Ref. No. —
	pilot burner nozzle natural gas code 26 suitable for ROBERTSHAW		
	GEV No.	106105	Ref. No. P6071665
	pilot burner nozzle LPG code 16 suitable for ROBERTSHAW		
	GEV No.	106106	Ref. No. —
	pilot burner nozzle LPG code 14 suitable for ROBERTSHAW		
	GEV No.	106107	Ref. No. —
	pilot burner nozzle LPG code 11 suitable for ROBERTSHAW		
	GEV No.	106108	Ref. No. P6071666
	pilot burner nozzle natural gas code 22 suitable for ROBERTSHAW		
	GEV No.	106115	Ref. No. —
	pilot burner nozzle town gas suitable for ROBERTSHAW		



1

GEV No.	107663	Ref. No.	B8032103-C
description	pilot burner ROBERTSHAW type 6CH14-21 3 flames natural gas nozzle 22 1/4" complete		
spare parts for	107663		
	GEV No.	100275	Ref. No. —
	pilot burner nozzle LPG code 10 bore ø 0.1mm suitable for ROBERTSHAW		
	GEV No.	100276	Ref. No. —
	pilot burner nozzle natural gas code 18 suitable for ROBERTSHAW		
	GEV No.	100277	Ref. No. —
	pilot burner nozzle natural gas code 26 suitable for ROBERTSHAW		
	GEV No.	106105	Ref. No. P6071665
	pilot burner nozzle LPG code 16 suitable for ROBERTSHAW		
	GEV No.	106106	Ref. No. —
	pilot burner nozzle LPG code 14 suitable for ROBERTSHAW		
	GEV No.	106107	Ref. No. —
	pilot burner nozzle LPG code 11 suitable for ROBERTSHAW		
	GEV No.	106108	Ref. No. P6071666
	pilot burner nozzle natural gas code 22 suitable for ROBERTSHAW		
	GEV No.	106115	Ref. No. —
	pilot burner nozzle town gas suitable for ROBERTSHAW		



1

GEV No.	107660	Ref. No.	B8039520-C
description	pilot burner ROBERTSHAW type 6SW1421E 3 flames natural/liquid gas nozzle 22/16 1/4" complete		



1









GEV No.	107666	Ref. No.	60130906 B8039518-C
description	pilot burner ROBERTSHAW type 6SW30-21E 3 flames LPG nozzle 16 for pipe ø 1/4" CCT 1/4" complete		
spare parts for	107666		
	GEV No.	100275	Ref. No. —
	pilot burner nozzle LPG code 10 bore ø 0.1mm suitable for ROBERTSHAW		

Table continues overleaf

spare parts for		107666	
GEV No.	100276	Ref. No.	—
	pilot burner nozzle natural gas code 18 suitable for ROBERTSHAW		
GEV No.	100277	Ref. No.	—
	pilot burner nozzle natural gas code 26 suitable for ROBERTSHAW		
GEV No.	106105	Ref. No.	P6071665
	pilot burner nozzle LPG code 16 suitable for ROBERTSHAW		
GEV No.	106106	Ref. No.	—
	pilot burner nozzle LPG code 14 suitable for ROBERTSHAW		
GEV No.	106107	Ref. No.	—
	pilot burner nozzle LPG code 11 suitable for ROBERTSHAW		
GEV No.	106108	Ref. No.	P6071666
	pilot burner nozzle natural gas code 22 suitable for ROBERTSHAW		
GEV No.	106115	Ref. No.	—
	pilot burner nozzle town gas suitable for ROBERTSHAW		

			
1			
GEV No.	107664	Ref. No.	B8039517-C
description	pilot burner ROBERTSHAW type 6SW30-21E 3 flames natural gas nozzle 22 for pipe ø 1/4" CCT 1/4" complete		
spare parts for		107664	
GEV No.	100275	Ref. No.	—
	pilot burner nozzle LPG code 10 bore ø 0.1mm suitable for ROBERTSHAW		
GEV No.	100276	Ref. No.	—
	pilot burner nozzle natural gas code 18 suitable for ROBERTSHAW		
GEV No.	100277	Ref. No.	—
	pilot burner nozzle natural gas code 26 suitable for ROBERTSHAW		
GEV No.	106105	Ref. No.	P6071665
	pilot burner nozzle LPG code 16 suitable for ROBERTSHAW		
GEV No.	106106	Ref. No.	—
	pilot burner nozzle LPG code 14 suitable for ROBERTSHAW		
GEV No.	106107	Ref. No.	—
	pilot burner nozzle LPG code 11 suitable for ROBERTSHAW		
GEV No.	106108	Ref. No.	P6071666
	pilot burner nozzle natural gas code 22 suitable for ROBERTSHAW		
GEV No.	106115	Ref. No.	—
	pilot burner nozzle town gas suitable for ROBERTSHAW		

miscellaneous

			
1			
GEV No.	104660	Ref. No.	A8035302
description	pilot burner bracket PITCO 1 burner bearing upper		

			
1			
GEV No.	104661	Ref. No.	A8027301-C
description	pilot burner bracket PITCO 1 burner bearing upper		

electrodes









			
1			
GEV No.	107665	Ref. No.	PP11131
description	ignition electrode flange length 32mm flange width 19mm D1 ø 9.3mm L1 31mm L2 16mm BL1 22mm BL2 26mm connection F6.3		
spare parts for		107665	
GEV No.	100275	Ref. No.	—
	pilot burner nozzle LPG code 10 bore ø 0.1mm suitable for ROBERTSHAW		
GEV No.	100276	Ref. No.	—
	pilot burner nozzle natural gas code 18 suitable for ROBERTSHAW		
GEV No.	100277	Ref. No.	—
	pilot burner nozzle natural gas code 26 suitable for ROBERTSHAW		
GEV No.	106105	Ref. No.	P6071665
	pilot burner nozzle LPG code 16 suitable for ROBERTSHAW		
GEV No.	106106	Ref. No.	—
	pilot burner nozzle LPG code 14 suitable for ROBERTSHAW		
GEV No.	106107	Ref. No.	—
	pilot burner nozzle LPG code 11 suitable for ROBERTSHAW		

Table continues overleaf



spare parts for 107665				
	GEV No.	106108	Ref. No.	P6071666
	pilot burner nozzle natural gas code 22 suitable for ROBERTSHAW			
	GEV No.	106115	Ref. No.	—
	pilot burner nozzle town gas suitable for ROBERTSHAW			

ignition cables

pre-assembled cables



1	GEV No.	103223	Ref. No.	60126101
	description ignition cable cable length 455mm connection F6.3mm / ø6.5mm 7mm ² silicone			

various



1	GEV No.	107654	Ref. No.	PP11128
	description ignition cable cable length 340mm ED ø 7mm insulation silicone black			

thermocouples

thermocouple sets universal

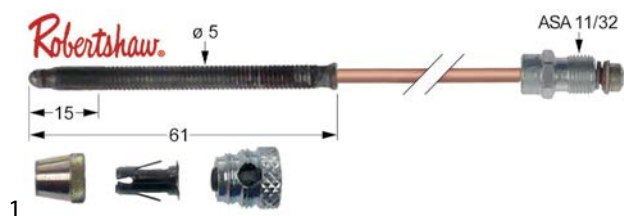

1	GEV No.	107706	Ref. No.	P5047540
	description thermocouple ROBERTSHAW 5-piece L 24" - 610mm ASA 11/32			



1	GEV No.	102281	Ref. No.	P5047540
	description thermocouple set ROBERTSHAW 5-piece L 24" - 610mm			

plug-in thermocouples

plug-in thermocouples standard

ROBERTSHAW

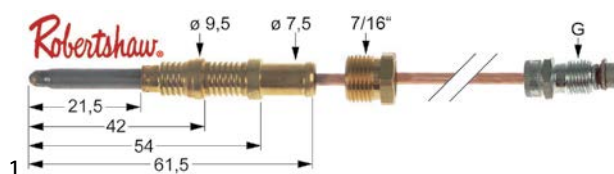

1	GEV No.	102276	Ref. No.	P5047540
	description thermocouple ROBERTSHAW ASA 11/32 L 24" - 610mm 7/16"			

thermopiles

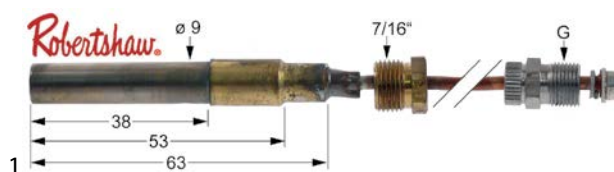

1	GEV No.	580035	Ref. No.	P5047541 P5047542
	description thermopile L 36" - 915mm probe ø 9mm probe L 38mm 250-750mV screw connection 7/16" connection 3/8" NEF			

White Rodgers

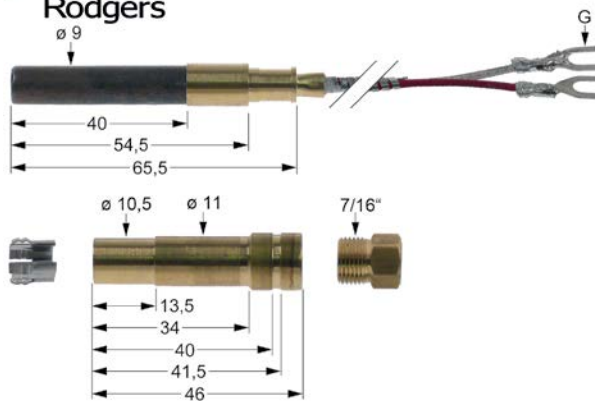

1	GEV No.	103243	Ref. No.	60125501
	description thermopile with PG9 adapter WHITE RODGERS L 36" - 915mm probe ø 9mm probe L 40mm 250-750mV screw connection 7/16" connection on spate terminals			

accessories

interrupters



1	GEV No.	580046	Ref. No.	B6779850 P6071805 P6779850 P9087601
	description extension for interrupter L 18" - 455mm			



1 gas components

gas burners

bar burners

bar burners



1

GEV No. 201100 **Ref. No.** PP10927

description bar burner L 310mm W 85mm ø 60mm Hmm fryer

tube burners



1

GEV No. 109191 **Ref. No.** B8037302-C
B8046101

description tubular burner L 277mm W 57mm H 100mm fryer oval



1

GEV No. 109190 **Ref. No.** PP10853

description tubular burner L 360mm W 67mm H 56mm fryer oval

gas nozzles

main nozzles

gas nozzles (other)



1

GEV No. 109192 **Ref. No.** PP10984

description gas injector thread 1/4" NPT WS 17 bore ø 1.15mm Qty 1 pcs



1

GEV No. 109193 **Ref. No.** PP10857

description gas injector thread 5/16" UNEF WS 9.5 bore ø 2.44mm Qty 1 pcs

pilot burner nozzles

pilot burner nozzles ROBERTSHAW



1

GEV No. 106105 **Ref. No.** P6071665

description pilot burner nozzle LPG code 16 suitable for ROBERTSHAW



1

GEV No. 106108 **Ref. No.** P6071666

description pilot burner nozzle natural gas code 22 suitable for ROBERTSHAW

pilot burner nozzles (other)

miscellaneous



1

GEV No. 103222 **Ref. No.** PP10861

description gas injector LPG bore ø 1.4mm brass

auxiliary gas parts

screw connections

adapters



1

GEV No. 107656 **Ref. No.** 60127501

description adapter thread 1/2" for gas burner brass



gas ball valves

miscellaneous



1

GEV No.	520909	Ref. No.	60128101
description	ball valve straight t-handle inlet 1/2" IT outlet 1/2" IT DN15 L 65mm brass operating p. 0.03bar		

gas lines

main gas lines

producer-specific



1

GEV No.	107659	Ref. No.	PP11257
description	gas line tube ø 19mm L 480mm W 50mm H 50mm connection 1/2"NPT-3/4"NPT		

gas hoses

miscellaneous



1

GEV No.	250081	Ref. No.	B6602403-C
description	gas hose T1: 3/8" NPSF L 260mm nominal-ø 10.5mm connection ø 14.5mm		

equipment-specific units

for deep fryers

spare parts and accessories



1

GEV No.	701428	Ref. No.	P0093300
description	nut fryer PITCO SS Qty 1 pcs		



1

GEV No.	701429	Ref. No.	P0091100
description	nut fryer PITCO SS Qty 1 pcs		



1

GEV No.	701426	Ref. No.	PP10686
description	screw fryer PITCO SS Qty 1 pcs		



1

GEV No.	701427	Ref. No.	PP10697
description	screw fryer PITCO SS Qty 1 pcs		



1

GEV No.	701424	Ref. No.	PP10687
description	screw fryer suitable for PITCO Qty 1 pcs thread 6-32x5/16		



1

GEV No.	701425	Ref. No.	P5045661
description	screw Unitrol fryer PITCO SS Qty 1 pcs		

miscellaneous



1

GEV No.	694727	Ref. No.	A8030407
description	adapter PITCO for oil drain steel L 50mm W 60mm H 60mm thread 1 1/2" mounting pos. lower		



1

GEV No.	694726	Ref. No.	PP11005
description	ball valve for oil drain steel L 250mm W 80mm H 150mm thread 1 1/2" mounting pos. lower		



1

GEV No.	694724	Ref. No.	60131007
description	ball valve for oil drain steel L 260mm W 130mm H 80mm thread 1 1/4" mounting pos. lower		



1

GEV No.	694722	Ref. No.	60131801 6717300
description	ball valve for oil tap steel L 100mm W 90mm H 55mm thread 1/2"		
For models:	ME2, MEII		



1

GEV No.	694725	Ref. No.	PITPP10962
description	ball valve PITCO for oil drain steel L 230mm W 65mm H 90mm thread 1 1/4" mounting pos. lower		



1

GEV No.	694728	Ref. No.	60144401
description	ball valve PITCO for oil drain steel L 95mm W 80mm H 120mm thread 1 1/4" mounting pos. lower		



1

GEV No.	694723	Ref. No.	B4004404-C
description	ball valve with sensor for oil drain steel L 270mm W 90mm H 85mm thread 1 1/2" mounting pos. lower		

1

GEV No.	694720	Ref. No.	B4005104
description	bar for fryer for outlet tap steel L 780mm W 30mm H 80mm mounting pos. lower		



1

GEV No.	694731	Ref. No.	B2801106-C
description	element holder E14/E14B SS L 370mm W 360mm H 120mm		



1

GEV No.	694732	Ref. No.	B2801104-C
description	element holder E14X SS L 370mm W 360mm H 120mm		



1

GEV No.	694733	Ref. No.	B4004101
description	handle rod for oil filter steel L 490mm W 190mm H 8mm		



1

GEV No.	694730	Ref. No.	B1001702
description	insert PITCO for flues plate L 230mm W 150mm H 420mm		



1

GEV No.	692534	Ref. No.	A1403202-C
description	mounting clip fryer SS L 43mm W 20mm H 14mm		



1

GEV No.	696626	Ref. No.	B6602406-C
description	pump hose complete for draining L 1500mm W 22mm		



1

GEV No.	694721	Ref. No.	B6658101-C
description	spout for oil drain steel L 240mm W 50mm H 80mm mounting pos. lower		



1

GEV No.	694729	Ref. No.	60127702
description	terminal PITCO for drain unit SS L 85mm W 85mm mounting pos. lower		
For models:	ME2, MEII		

for ovens

housing and bezels

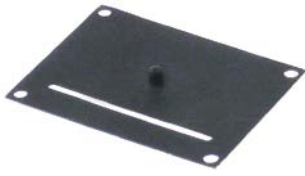

1

GEV No.	698530	Ref. No.	P6071215
description	cover L 67mm W 93mm H 0.67mm rubber		

knobs

producer-specific knobs

PITCO



1

GEV No.	111803	Ref. No.	PP10537
description	knob 100-200 shaft flat lower black shaft 6x4.6 H 22mm L 58mm Qty 1 pcs		



1

GEV No.	112142	Ref. No.	PP10782
description	knob D1 ø 31mm shaft ø specialmm		



1

GEV No.	112732	Ref. No.	PP10539
description	knob thermostat shaft ø 6.4x4.8mm temperature range 100-200°C shaft flat lower black external size 58mm H 22mm Qty 1 pcs		

handles and hand wheels

bracket handles



1

GEV No.	694718	Ref. No.	PP11332
description	pull handle for fryer L 120mm SS		

levers

with handle



1

GEV No.	111802	Ref. No.	B4000707
description	lever outlet tap steel for fryer		



1

GEV No.	111801	Ref. No.	B4003001-C
description	lever outlet tap steel for fryer operation with latch		

hinges

door bearing



1

GEV No.	694719	Ref. No.	B3801802
description	hinge L 24mm W 42mm H 64mm mounting pos. bottom left bolt 17mm bolt ø 6.3mm with bolt for fryer suitable for PITCO		



equipment feet and end caps

equipment feet

with fixing plate



1

GEV No.	701419	Ref. No.	60132401
description	equipment foot tube \varnothing 41mm plate size 83x83mm hole distance 65x65mm H 220-250mm SS Qty 1 pcs for fryer suitable for PITCO		

miscellaneous

with fixing plate

\varnothing 75mm



1

GEV No.	701420	Ref. No.	PP10808
description	swivel castor \varnothing 75mm plates fixing 82x82mm housing zinc-plated sheet steel plate size 82x82mm hole distance 66x66mm capacity 100kg bearing slide bearing wheel body polyamide tread 32 H 145-165mm wheel width 33mm Qty 1 pcs		

baskets

fryer baskets

US producers



1

GEV No.	970134	Ref. No.	P6072125
description	fryer basket L1 280mm W1 140mm H1 105mm		



1

GEV No.	970184	Ref. No.	P6072143
description	fryer basket L1 330mm W1 315mm H1 135mm		



1

GEV No.	970182	Ref. No.	P6072145
description	fryer basket L1 340mm W1 165mm H1 150mm L2 620mm H2 280mm		

shelves and shelf rails

grates

universal

without upstand



1

GEV No.	970865	Ref. No.	PP10434
description	grate W 292mm D 343mm H 9mm chrome-plated steel for fryer PITCO		



1

GEV No.	970864	Ref. No.	A4500601
description	grate W 345mm D 345mm H 10mm stainless steel crossing wires 1		
For models:	ME2, MEII		

gaskets

O-rings

Viton



1

GEV No.	532693	Ref. No.	PP10111
description	O-ring Viton thickness 2.62mm ID \varnothing 13mm Qty 1 pcs suitable for PITCO		

special gaskets

sealing discs



1	GEV No.	109189	Ref. No.	PP11181
	description	gasket ø 55mm rubber Qty 1 pcs		

1	GEV No.	358839	Ref. No.	60132703
	description	fuse size ø6.3x32mm 2.5A slow-acting rated 250V Qty 1 pcs		

1	GEV No.	358841	Ref. No.	P5045717
	description	fuse size ø6.3x32mm 2A slow-acting rated 250V Qty 1 pcs		

consumables

fuses

fine fuses

ø6.3x32mm 250V



1	GEV No.	358840	Ref. No.	PP10122
	description	fuse size ø6.3x32mm 1A slow-acting rated 250V Qty 1 pcs		

B			
bar burners	20		
bi-metal thermostats	4, 4		
C			
castors and bumper angles	25		
consumables	26		
contactors	7		
F			
fans	11		
fine fuses	26		
float switches	5		
fuses	11, 26		
G			
gas ball valves	21		
gas burners	20		
gas control valves	12		
gas hoses	21		
gas lines	21		
gas nozzles	20		
gas thermostats	12		
grates	25		
H			
heating elements	3		
heating elements for fryers	3		
heating elements for pasta cookers	3		
I			
ignition boxes	15		
ignition cables	19		
indicator lights	6		
indicator lights (complete)	6		
L			
lamps	6		
M			
magnetic switches	6		
microswitches	5		
motors	11		
O			
oil pumps	11		
O-rings	25		
P			
pilot burners	15		
pressure switches	10		
probes	8		
		pumps	11
R			
		radial fans	11
		relays	7
		rocker/momentary rocker switches	5
S			
		safety valves	15
		sealing discs	26
		shelves and shelf rails	25
		solid state relays	7
		switches and momentary switches	5
T			
		thermocouples	19
		thermostats	4
		toggle switches	5
		tube burners	20