



GAS COMPONENTS



ELECTRIC COMPONENTS



WATER TECHNOLOGY



MECHANICAL COMPONENTS



TOOLS

Spare parts suitable for

POLARIS

Find the complete and up-to-date range of products in our GEV Webshop



Manufacturer catalogue

The most important spare parts and accessories arranged clearly for every manufacturer

- ✓ Complete product range and all appliance data always up to date in the GEV Webshop
- ✓ Alphabetical Index at the end of the catalogue

GEV Webshop

www.gev-online.co.uk

www.gev-online.com



- 🔍 Add to Favourites
- 🔍 Sign In with email address and usual password
- 🔍 Easy-order – place several items in your basket at the same time
- 🔍 Quick Item search – no login needed



heating elements

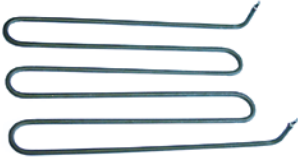

heating elements for bain maries

			
GEV No.	416797	Ref. No.	A037050
description	heating element 2000W 230V heating circuits 1 L 480mm W 275mm connection male faston 6.3mm connection length 21mm tube ø 8.5mm dry heating element H 60mm		

heating elements for fryers

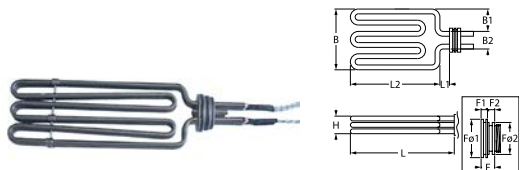
center connection

			
GEV No.	415297	Ref. No.	4185326002136 BN4185326002136 SI0108058 SIR0108058
description	heating element 6800W 230/400V heating circuits 3 L 299mm W 107mm H 35mm flange length 19.5mm flange length 1 9.5mm flange length 2 9.8mm flange ø1 62mm flange ø2 57mm thermostat sleeves ø 8.5mm sensor screw connection 2x M10x1 thermostat sleeve upper/lower L1 16mm L2 283mm W1 30mm W2 77mm thread M54x1.5 tube ø 8.5mm cable length 450mm rotation flange immersion heater		

accessories for	415297		
	GEV No.	510243	Ref. No. —
	O-ring Viton thickness 3.53mm ID ø 55.56mm Qty 1 pcs		
	GEV No.	510245	Ref. No. —
	O-ring Viton thickness 3.53mm ID ø 50.8mm Qty 1 pcs		
	GEV No.	550447	Ref. No. —
	ring nut thread M54x1.5		

heating elements for refrigeration

heating elements for defrosting

			
GEV No.	419208	Ref. No.	1666250 BN1666250
description	heating element 250W 230V L 420mm W 50mm Hmm cable length 360mm tube ø 6mm refrigerator connection F6.3		
For models:	KTAP00, KTAP00-BASE-20220501062N, KTAP01, KTAP01-205202, KTAP01-205204, KTAP01-BASE-20220901044U, KTAP02, KTAP02-600-20221205CN, KTAP02-BASE-20221301048K, KTAP03, KTAP03-BASE-2022180109UA, KTAP04, KTAP04-BASE-2022230109RY, KTAP84EN-20228403, KTAPBT02, KTAPBT03, KTAR01, KTAR02, KTAR03, KTAR04, KTARS24, KTARS35		

			
GEV No.	420528	Ref. No.	16668401 936706 997317 BN1666004 BN16668401 FR936706 FR997317
description	heating element 260W 230V L 390mm cable length 2010mm with thermal fuse		

			
GEV No.	419209	Ref. No.	1666400 BN1666400
description	heating element 270W 230V L 380mm W 120mm L1 15mm L2 365mm W1 80mm W2 50mm cable length 300mm tube ø 6mm refrigerator		
For models:	BT70G, KCTN3030-20090710, KPC30-30-20100720, KPC3030-20100720, KSABT70G-204537, KSABT70G-2045370CC4, KTN40-21090640, KTN40-210906400BAI, M70TN, TARS27-2124130027		

			
GEV No.	416376	Ref. No.	1666320 BN1666320
description	heating element 300W 230V L 430mm W 85mm connection male faston 6.3mm cable length 400mm tube ø 6.3mm defrosting H 70mm		
For models:	KTAP00, KTAP00-BASE-20220501062N, KTAP00BT-BASE-2022550105KR, KTAP01, KTAP01-BASE-20220901044U, KTAP01BT-BASE-2022590105KU, KTAP02, KTAP02-20221301P0201, KTAP02-BASE-20221301048K, KTAP02BT-BASE-2022630105KW, KTAP02-ESP45300-20221301P0202, KTAP03, KTAP03-BASE-2022180109UA, KTAP03BT-BASE-2022680109UW, KTAP04, KTAP04-BASE-2022230109RY, KTAPBT00, KTAPBT01, KTAPBT02, KTAPBT03, KTAR01, KTAR01-BASE-20201001, KTAR01N, KTAR01N-BASE-20201005043V, KTAR02, KTAR02N, KTAR02N-BASE-20201305043Y, KTAR03, KTAR03-BASE-2020180105, KTAR03N, KTAR03N-BASE-202018050441, KTAR04, KTAR04N, KTAR04N-BASE-2020230508V7, KTAR902BT-ESP66300BT-202509P0201, KTARBT02, KTARBT02-205101, KTARBT02-205102, KTARBT02-205103, KTARBT02-BASE-2025130104FU, KTARBT03, KTARBT03-BASE-2025180104FW, KTARBT04, KTARBT04-BASE-2025230104FZ, KTARBT902, KTARBT9-02-BASE-20250904MU, KTARS24-202413010480, KTARS35-2024180104HC, TSP00, TSP00-BASE-202606010BRU...(Other models you can see in the webshop)		

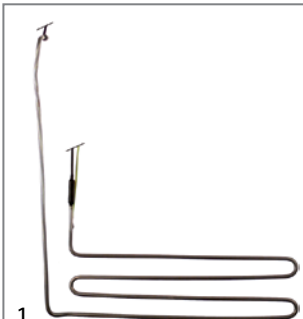

GEV No.	418752	Ref. No.	1666355 BN1666353 BN1666355 FR6621230
description	heating element 350W 230V L 395mm W 450mm L1 45mm L2 360mm W1 360mm W2 95mm cable length 1000mm tube ø 6mm defrosting connection with cable		
For models:	AFB-70-20171707G, AFN-70-20170707G, ARCO-BT140-20172404, ARCO-BT140-20172405, ARCO-BT140-BASE-20172408, ARCO-BT140-PLUS-20172409, ARCO-BT70-20171704, ARCO-BT70430-20171705, ARCO-BT70-BASE-20171708, ARCO-BT70GN2-1-2017817304, ARCO-BT70-PLUS-20171709, ARCO-TN140-BASE-20171408, ARCO-TN140-PLUS-20171409, ARCO-TN140-20171404, ARCO-TN140430-20171405, ARCO-TN70-20170704, ARCO-TN70430-20170705, ARCO-TN7070-20177040GL70, ARCO-TN70-BASE-20170708, ARCO-TN70-PLUS-20170709, ARCO-TNN70-20170706, NFB0070F, NFB0070N, NFB0070P, NFB0072F, NFB0072N, NFB0072P, NFB0140F, NFB0140N, NFB0140P, NFB0144F, NFB0144N, NFB0144P, NORD-700BT-2017817305, NORD-700BT-2017817305P, NORD-700TNN-2017807305, NORD-700TNN-2017807305P		

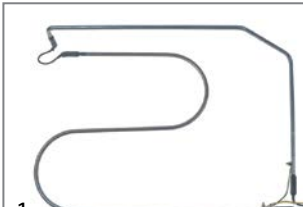

GEV No.	419207	Ref. No.	1666352 BN1666352
description	heating element 350W 230V L 510mm W 340mm connection F 2.8 cable length 1000mm tube ø 8.5mm refrigerator		

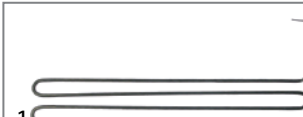

GEV No.	418576	Ref. No.	6621081 935614 FR6621081 FR935614
description	heating element 500W 230V L 100mm W 520mm L1 30mm L2 70mm W1 35mm W2 495mm cable length 1700mm defrosting		

heating elements for condensate evaporation





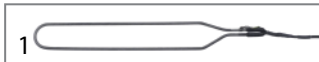

GEV No.	420170	Ref. No.	1666096 BN1666096
description	heating element 95W 230V L 400mm W 60mm cable length 4000mm tube ø 6.2mm condensate evaporation		
For models:	TARS22EP-2124091023, TARS22ES-2124091022		

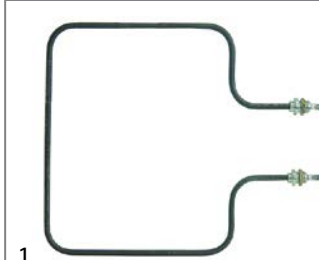

GEV No.	420095	Ref. No.	1666095 BN1666095
description	heating element 95W 230V L 445mm W 60mm H 25mm cable length 4000mm tube ø 6.2mm		
For models:	KB120-20180710, KB240-20181410, KBT140-20021410, KBT142-20021420, KBT144-20021430, KBT70-20020710, KBT72-20020720, KBTG140-20021470, KBTG70-20020770, KBTV140-20021440, KBTV70-20020730, KC105-35-20051440, KC10535-20051440, KC2545-20050710, KC3513-20050715, KC3535-20050720, KC4512-20050725, KC70-70-20051410, KC7070-20051410, KCTN10535-20031440, KCTN2545-20030725, KCTN3513-20030730, KCTN3535-20030735, KCTN45-12-20030745, KCTN4512-20030745, KCTN7070-20031410, KPBT105-35-20061420, KPBT70-70-20061410, KPTN10535-20041440, KPTN70-70-20041410, KTN140-20011400WZ, KTN140-20011410, KTN140-BASE-20011400WZ, KTN140-BASE-20011400X0, KTN140-BASE-20011400X1, KTN140-BASE-20011400X2, KTN142-20011400X0, KTN142-20011420, KTN144-20011400X1, KTN144-20011430, KTN3513-200107, KTN3513-20010735, KTN4512-200107, KTN4512-20010745, KTN70-200107003W, KTN70-20010700VF, KTN70-20010710, KTN70-210107, KTN70-BASE-20010700VX, KTN72-200107...(Other models you can see in the webshop)		

heating elements for heated cabinets



GEV No.	416787	Ref. No.	A036800	
description	heating element 420W 230V heating circuits 1 L 265mm W 245mm connection male faston 6.3mm tube ø 6.3mm 2 hole fixing thread 1/4" dry heating element heated cabinet L1 60mm L2 185mm W1 82mm W2 70mm mounting distance 64mm			
accessories for	416787			
	GEV No.	361182	Ref. No.	—
	nut thread 1/4" H 5mm nickel-plated brass WS 17 Qty 1 pcs			
	GEV No.	510417	Ref. No.	—
	flat gasket fibre ED ø 20mm ID ø 14mm thickness 2mm Qty 1 pcs			
	GEV No.	520228	Ref. No.	—
	tooth lock washer ID ø 15.3mm ED ø 24mm steel Qty 1 pcs for thread M14			
	GEV No.	550262	Ref. No.	—
	flat gasket copper ED ø 20mm ID ø 14mm thickness 2mm			



heating cables

drain heating cables



GEV No.	418570	Ref. No.	1666009 BN1666009 FR6620031
description	drain heating cable 12W 230V ø 4mm L 3190mm L1 (unheated) 1650mm L2 (heated) 1540mm defrost drain metal connection male faston		
For models:	MTTF4xN, MTTF4xP		

connection on both sides (metal braided)



GEV No.	416747	Ref. No.	1666046 BN1666046
description	heating cable 46W 230V L1 (unheated) 870mm L2 (heated) 4560mm ø 4mm L 6300mm connection male faston		
For models:	KB100-20180720, KB120-20180710, KB200-20181420, KB240-20181410, KBT120-20081410, KBT120-200814O218, KBT120-BASE-200814O218, KBT120-BASE-200814O2BT, KBT120-BASE-200814O2XU, KBT120-P0120081410, KBT122-200814O2XU, KBT122-20081420, KBT122-200814O2XU, KBT124-200814O431, KBT140-200214O11K, KBT140-20021410, KBT140-BASE-200214O11K, KBT140-BASE-200214O11L, KBT140-BASE-200214O11N, KBT142-200214O11L, KBT142-20021420, KBT144-200214O11M, KBT60-2008070124, KBT60-20080710, KBT60-BASE-2008070124, KBT60-BASE-2008070126, KBT70, KBT70-20020700YN, KBT70-20020710, KBT70-BASE-20020700YL, KBT70G-200220, KBT70G-BASE-20022001TZ, KBT72-20020720, KBTG140-20021470, KBTG70-20020770, KBTV120, KBTV120-200814O2BT, KBTV120-20081440, KBTV140-200214O11N, KBTV140-20021440, KBTV60, KBTV60-2008070126, KBTV60-20080730, KBTV60-P0120080730, KBTV70-200207, KBTV70-20020730, KBTV70-BASE-20020700YN, KC105-35-20051440, KC10535-20051440, KC6060-20091430...(Other models you can see in the webshop)		

heating cartridges



GEV No.	417227	Ref. No.	1666090 1666150 BN1666090
description	heating cartridge 90W 230V ø 12mm L 124mm thread 3/8" cable length 4000mm Hmm Wmm condensate evaporation		
For models:	KB100-20180720, KB200-20181420, KBT120-20081410, KBT120-200814O218, KBT120-BASE-200814O218, KBT120-BASE-200814O2BT, KBT120-BASE-200814O2XU, KBT120-BASE-200814O431, KBT120-P0120081410, KBT122-200814O2XU, KBT122-20081420, KBT122-200814O2XU, KBT124-200814O431, KBT124-20081430, KBT124-P0120081430, KBT140-200214O11K, KBT140-200214O11M, KBT140-20021410, KBT140-BASE-200214O11K, KBT140-BASE-200214O11L, KBT140-BASE-200214O11N, KBT142-200214O11L, KBT142-20021420, KBT144-200214O11M, KBT144-20021430, KBT40-21091640, KBT40-21091640BAJ, KBT60-2008070124, KBT60-20080710, KBT60-BASE-2008070124, KBT60-BASE-2008070126, KBT60-BASE-20080705H5, KBT62-20080705H5, KBT62-20080720, KBT62-20080705H5, KBT70, KBT70-20020700YN, KBT70-200207061E, KBT70-20020710, KBT70-BASE-20020700YL, KBT70G-200220, KBT70G-BASE-20022001TZ, KBT72-200207061E, KBT72-20020720, KBT72-210207, KBT72-BASE-200207061E, KBTG70-20020770, KBTV120, KBTV120-200814O2BT, KBTV120-20081440...(Other models you can see in the webshop)		

foil heating elements



GEV No.	417701	Ref. No.	1666273 BN1666273
description	heater mat L 430mm W 120mm 30W 230V cable length 1200mm connection male faston 6.3mm		
For models:	P105-35TNN-2047640100, P105-35TNN-BT-2047660100, P140BT-2047220101, P140BTV-2047260101, P144BT-2047360100, P70-70TNN-BT-2047560100, P70BT-2047020101, P70BTV-2046060101, P70TN-2041000101, P70TNV-2047040101, P72BT-2047120101, S140BT-2048220101, S70BT-2048020101, T105-35TNN-2046640100, T105-35TNN-BT-2046660100, T140BT-2046220100, T140BTV-2046260100, T144BT-2046xxxxxx, T70-70TNN-BT-2046560100, T70TNV-2046040100		

thermostats

control and safety thermostats

EGO

control thermostats

55.10/19_ series



GEV No.	375381	Ref. No.	A046050
description	thermostat t.max. 90°C temperature range 30-90°C 1-pole 1NO 16A probe ø 6mm probe L 130mm capillary pipe 2000mm capillary pipe isolated 2000mm gland nut shaft ø 6x4.6mm shaft L 23mm shaft position upper rotation 270°		

55.34_ series



GEV No.	375384	Ref. No.	A044601
description	thermostat t.max. 275°C temperature range 50-275°C 3-pole 3NO 16A probe ø 3mm probe L 219mm capillary pipe 900mm capillary pipe isolated 900mm gland nut shaft ø 6x4.6mm shaft L 23mm shaft position lower rotation 318° probe material SS		

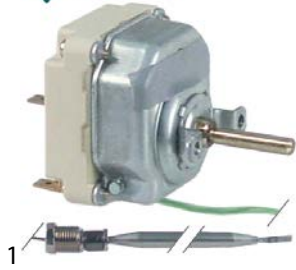

GEV No.	375411	Ref. No.	A046250
description	thermostat t.max. 93°C temperature range 30-93°C 3-pole 3NO 16A probe ø 6mm probe L 129mm capillary pipe 1480mm capillary pipe isolated 1100mm gland nut M10x1 shaft ø 6x4.6mm shaft L 23mm shaft position upper rotation 270°		

safety thermostats

55.10/19_ series

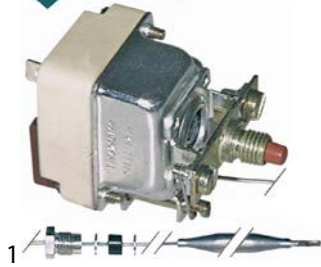

GEV No.	390061	Ref. No.	A049401
description	safety thermostat switch-off temp. 220°C 1-pole 0.5A probe ø 6mm probe L 140mm capillary pipe 900mm capillary pipe isolatedmm gland nut probe M9x1		

55.32_ series

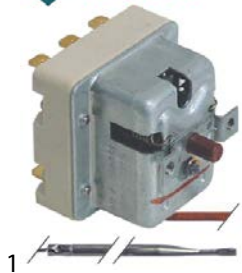

GEV No.	375228	Ref. No.	A046150
description	safety thermostat switch-off temp. 350°C 3-pole 20A probe ø 3mm probe L 188mm capillary pipe 900mm capillary pipe isolated 900mm gland nut probe SS		

refrigeration thermostats

universal without housing



GEV No.	390534	Ref. No.	16810035	
description	thermostat temperature range -35 up to +35°C probe ø6x110mm capillary pipe 1800mm PRODIGY			
For models:	ARBT70			
accessories for	390534			
	GEV No.	110305	Ref. No.	—
	knob thermostat t.max. 35°C temperature range -35 up to +35°C ø 45mm shaft ø 6x4.6mm shaft flat inclined rotation 270° white			

universal with housing



GEV No.	390538	Ref. No.	16810036
description	thermostat temperature range -35 up to +35°C probe ø6x110mm capillary pipemm PRODIGY		

accessories

gland nut accessories

washers with slot





GEV No.	510241	Ref. No.	A038803
description	washer with slot ED ø 7.8mm slit width 1.3mm Qty 10		

gaskets



GEV No.	550982	Ref. No.	A038804
description	gasket graphite ø 7.5mm L 7mm Qty 1 pcs for gland nut		



bolts with slot			
			
1			
GEV No.	520243	Ref. No.	A038801
description	bolt with slot thread M9x1 Qty 10 pcs nickel-plated brass		
accessories for	520243		
			
GEV No.	510591	Ref. No.	—
description	washer with slot ED ø 8.8mm slit width 1.2mm Qty 10		
			
GEV No.	510592	Ref. No.	—
description	gasket ø 8x8.7mm Qty 10 pcs slotted silicone		

connecting bows			
			
1			
GEV No.	550060	Ref. No.	A045900
description	connecting bow long for thermostat Qty 1 pcs		

			
1			
GEV No.	550059	Ref. No.	A045000
description	connecting bow short for switch Qty 1 pcs		

switches and momentary switches

rocker/momentary rocker switches

27.8x25mm			
			
1			
GEV No.	348221	Ref. No.	1635110 BN1635110
description	rocker switch mounting measurements 27.8x25mm black/green 1NO/indicator light 250V 16A ON-OFF connection F6.3x0.8 ambient temperature max. 100/55°C protection IP40		
For models:	140, 70, AFN-70ESx-20173707GXPS, AP-140-221314XG, AP-70TN-221307XG, B100, B120, B200, B240, BT140, BT60, BT70, BT72, BTV70, EN02TN-VCR-20208204, KBF050GB-20350103, KBF050GS-20350203, KST6-03TN-2055030CC9, KST6-04TN-2055040CCA, KTAP00, KTAP00-BASE-20220501062N, KTAP00BT-BASE-2022550105KR, KTAP01, KTAP01-205202, KTAP01-205204, KTAP01-BASE-20220901044U, KTAP01BT-BASE-2022590105KU, KTAP02, KTAP02-600-20221205CN, KTAP02-BASE-20221301048K, KTAP02BT-205301, KTAP02BT-205302, KTAP02BT-205303, KTAP02BT-BASE-2022630105KW, KTAP03, KTAP03-600-20221705CM, KTAP03-BASE-2022180109UA, KTAP03BT-BASE-2022680109UW, KTAP04, KTAP04-BASE-2022230109RY, KTAP84EN-20228403, KTAP902, KTAPBT00, KTAPBT01, KTAPBT02, KTAPBT03, KTAPBT902, KTAR00, KTAR01, KTAR01-BASE-20201001... (Other models you can see in the webshop)		

30x22mm			
			
1			
GEV No.	301314	Ref. No.	1635103 BN1635103
description	rocker switch mounting measurements 30x22mm white 2NO 250V 16A ON-OFF connection male faston 6.3mm ambient temperature max. 100/55°C protection IP40		
For models:	ARBT70, ARTN120, ARTN70, KB100-20180720, KB120-20180710, KB200-20181420, KB240-20181410, KBT120-2008140218, KBT120-BASE-2008140218, KBT120-BASE-20081402BT, KBT120-BASE-20081402XU, KBT120-BASE-2008140431, KBT120-P0120081410, KBT124-20081402XU, KBT122-20081402XU, KBT124-2008140431, KBT140-P0120081430, KBT140-200214011K, KBT140-200214011M, KBT140-20021410, KBT140-BASE-200214011K, KBT140-BASE-200214011L, KBT140-BASE-200214011N, KBT142-200214011L, KBT142-20021420, KBT144-200214011M, KBT144-20021430, KBT40-21091640, KBT40-210916400BAJ, KBT60-2008070124, KBT60-BASE-2008070124, KBT60-BASE-2008070126, KBT60-BASE-20080705H5, KBT62-20080705H5, KBT62-20080705H5, KBT70, KBT70-20020700YN, KBT70-200207061E, KBT70-20020710, KBT70-BASE-20020700YL, KBT70G-200220, KBT70G-BASE-20022001TZ, KBT72-200207061E, KBT72-20020720, KBT72-210207, KBT72-BASE-200207061E, KBTG70-20020770, KBTV120, KBTV120-20081402BT, KBTV140-200214011N... (Other models you can see in the webshop)		

microswitches

lever actuated			
			
1			
GEV No.	345044	Ref. No.	164602
description	microswitch with lever 250V 16A 1CO connection male faston 6.3mm ambient temperature max. 85°C mounting distance 25mm type C99ZP3 actuating force: 25g lever length 71mm		
For models:	ARBT70, ARTN120, ARTN70, KBT40-21091640, KBT40-210916400BAJ, KTN40-21090640, KTN40-210906400BAI, M70BT, M70TN		



with push button

switches with snap-fit



1

GEV No.	347057	Ref. No.	164606 164608 935823 936091 BN164606 BN164608 FR935823 FR936091
description	microswitch with push button 250V 2.5A 1CO connection male faston 4.8mm L 27x21mm ambient temperature max. 85°C type built-in version actuating force: 300g		
For models:	140, 70, AFB-140-20172407G, AFB-70-20171707G, AFB-70Sx-20171707GXPS, AFN-140E-20173407G, AFN-70-20170707G, AFN-70E-20173707G, AFN-70ESx-20173707GXPS, AP-140-221314XG, AP-70TN-221307XG, ARCO-BT140-20172404, ARCO-BT140-20172405, ARCO-BT140-BASE-20172408, ARCO-BT140GN2-1-2017824301, ARCO-BT140-PLUS-20172409, ARCO-BT70-20171704, ARCO-BT70430-20171705, ARCO-BT70-BASE-20171708, ARCO-BT70GN2-1-2017817304, ARCO-BT70-PLUS-20171709, ARCO-TN140.-BASE-20171408, ARCO-TN140.-PLUS-20171409, ARCO-TN140-20171404, ARCO-TN140-2017814301, ARCO-TN140430-20171405, ARCO-TN70-20170704, ARCO-TN70-2017807304, ARCO-TN70430-20170705, ARCO-TN7070-201777040GL70, ARCO-TN70-BASE-20170708, ARCO-TN70-PLUS-20170709, ARCO-TNN70-20170706, B100, B120, B200, B240, BT140, BT60, BT70, BT72, BTV70, KBF050GB-20350103, KBF050GS-20350203, KSA105-35-2045260CC0, KSA140BT-2045240C10, KSA140TN-2045140CAC, KSA70BT-2045170C0Z, KSA70TN-2045070CA9, KSABT70G-2045370CC4...(Other models you can see in the webshop)		

operation switches



1

GEV No.	300002	Ref. No.	A046001
description	cam switch 2 operating positions 4NO 16A sequence 0-1 shaft ø 6x4.6mm shaft L 23mm connection male faston 6.3mm ceramic		



1

GEV No.	300200	Ref. No.	A046000
description	operation switch 2 operating positions 2NO 16A sequence 0-1 shaft ø 6x4.6mm shaft L 23mm connection male faston 6.3mm operation switch ceramic		

cam switches

4 operating positions

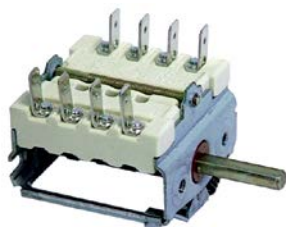

1

GEV No.	300184	Ref. No.	A046750
description	cam switch 4 operating positions sequence 0-3-2-1 shaft ø 6x4.6mm connection male faston 4-pole		



magnetic switches

36x13mm

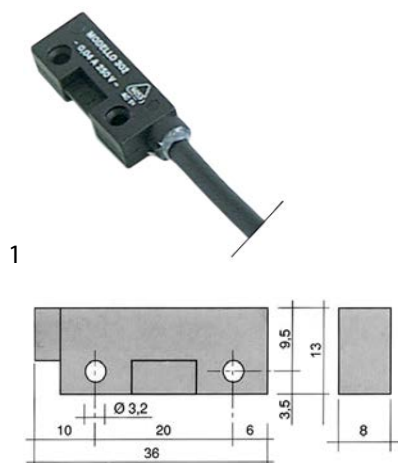

GEV No.	345335	Ref. No.	995405 FR995405
description	magnetic switch L 36mm W 13mm 1NO 250V 0.04A P max. 10W connection cable cable length 960mm		
For models:	120, 122, 201, 202, KBC051-20354051, KBC101-20354101, KBC151-20354151, KBC201-20355201, KBC201-PASS-THROUGH-20355221, KBC202-20355202, KBC202-PASS-THROUGH-20355222, KBF051-20364051, KBF051T-20363050, KBF101-20364101, KBF151-20364151, KBF201-20365201, KBF201-PASS-THROUGH-20365221, KBF202-20365202, KBF202-PASS-THROUGH-20365222, KRC201-20358201, KRC202-20358202, KRF201-20368201, KRF202-20368202, PBC051DF-ASX-203505AS, PBC081AF-ASX-203528AS, PBC121DF-ASX-203512AS, PBC122DF-ASX-223512AS, PBC161DF-ASX-203516AS, PBC201DP-20355203, PBC202DP-20355204, PBC401DCFDX-20356403, PBC402DCFDX-20356404, PBF031AF-ASX-203623AS, PBF051-AFST-AB-5GN11-BF-PDX-203626AD, PRC120AF-ASX-203530AS		
accessories for	345335		
	GEV No.	519049	Ref. No. —
	magnet ømm L 63mm H 10.7mm W 18.8mm hole distance 52mm M2 hole ø 2mm		

65x20mm

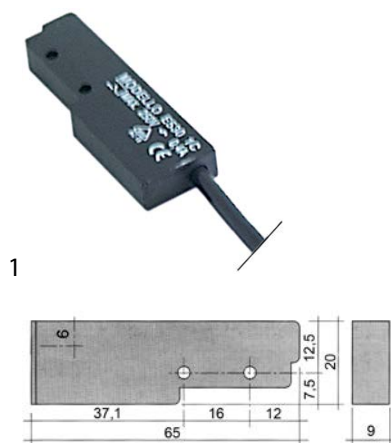

GEV No.	345116	Ref. No.	161801 BN161801
description	magnetic switch L 65mm W 20mm 1NO 250V 0.4A P max. 100W connection cable cable length 3000mm		
For models:	KB100-20180720, KB120-20180710, KB200-20181420, KB240-20181410, KBC10, KBC10-BASE-20351002PM, KBC5, KBC5-BASE-20350502PK, KBC6, KBC6-BASE-20350602PL, KBCF10, KBCF10-BASE-20361002PV, KBCF5, KBCF5-BASE-20360502PN, KBCF6, KBCF6-BASE-20360602PT, KBT120-20081410, KBT120-2008140218, KBT120-BASE-2008140218, KBT120-BASE-20081402BT, KBT120-BASE-20081402XU, KBT120-BASE-2008140431, KBT120-P0120081410, KBT122-20081402XU, KBT122-20081420, KBT122-20081402XU, KBT124-2008140431, KBT124-20081430, KBT124-P0120081430, KBT140-200214011K, KBT140-200214011M, KBT140-20021410, KBT140-BASE-200214011K, KBT140-BASE-200214011L, KBT140-BASE-200214011N, KBT142-200214011L, KBT142-20021420, KBT144-200214011M, KBT144-20021430, KBT60-2008070124, KBT60-20080710, KBT60-BASE-2008070124, KBT60-BASE-2008070126, KBT60-BASE-20080705H5, KBT62-20080705H5, KBT62-20080720, KBT62-20080705H5, KBT70, KBT70-20020700YN, KBT70-200207061E...(Other models you can see in the webshop)		
accessories for	345116		
	GEV No.	345399	Ref. No. —
	magnet ø 3.3mm L 40mm H 8mm W 13mm hole distance 30mm M3		

lamps

indicator lights

indicator lights 2-piece (lens and indicator lamp)

indicator lamps for socket type SRZ / SDK / SDY / SFK



GEV No.	359131	Ref. No.	A038506
description	indicator lamp 400V clear connection male faston 6.3mm		



indicator lights (complete)

ø12mm

with screw socket



1

GEV No.	359994	Ref. No.	A039207
description	indicator light ø 12mm 400V clear connection male faston 6.3mm		

30x22mm



1

GEV No.	359154	Ref. No.	168110001
description	indicator light mounting measurements 30x22mm 230V white connection male faston 6.3mm temp.-resist. 125/55°C type RL2		

fridge lamps



1

GEV No.	359595	Ref. No.	1640403 BN1640403
description	light bulb socket E14 15W 230-240V ø 25mm L 56mm lens L 30mm Qty 1 pcs		
For models:	AFB-140-20172407G, AFB-70-20171707G, AFB-70Sx-20171707GX-PS, AFN-140E-20173407G, AFN-70-20170707G, AFN-70E-20173707G, AFN-70ESx-20173707GXPS, ARCO-BT140-20172404, ARCO-BT140-20172405, ARCO-BT140-BASE-20172408, ARCO-BT140GN2-1-2017824301, ARCO-BT140-PLUS-20172409, ARCO-BT70-20171704, ARCO-BT70430-20171705, ARCO-BT70-BASE-20171708, ARCO-BT70GN2-1-2017817304, ARCO-BT70-PLUS-20171709, ARCO-TN140.-BASE-20171408, ARCO-TN140.-PLUS-20171409, ARCO-TN140.-20171404, ARCO-TN140-2017814301, ARCO-TN140430-20171405, ARCO-TN70-20170704, ARCO-TN70-2017807304, ARCO-TN70430-20170705, ARCO-TN70-BASE-20170708, ARCO-TN70-PLUS-20170709, ARCO-TNN70-20170706, BT140, BT60, BT70, BT70G, BT72, KSA105-35-204515, KSA105-35-2045150C0R, KSA105-35-2045260C00, KSA140BT-204524, KSA140BT-2045240BYF, KSA140BT-2045240C10, KSA140BT-2045240CAD, KSA140P-204534, KSA140P-2045340C0X, KSA140TN-204514, KSA140TN-2045140B8X, KSA140TN-2045140CAB, KSA140TN-2045140CAC, KSA35-35-204535, KSA35-35-2045350BYG, KSA70-70-204577, KSA70-70-2045770BYH...(Other models you can see in the webshop)		

producer-specific fridge lamps

POLARIS



1

GEV No.	550070	Ref. No.	165705 BN165705
description	lamp socket socket E14		
For models:	AFB-140-20172407G, AFB-70-20171707G, AFB-70Sx-20171707GX-PS, AFN-140E-20173407G, AFN-70-20170707G, AFN-70E-20173707G, AFN-70ESx-20173707GXPS, ARCO-BT140-20172404, ARCO-BT140-20172405, ARCO-BT140-BASE-20172408, ARCO-BT140GN2-1-2017824301, ARCO-BT140-PLUS-20172409, ARCO-BT70-20171704, ARCO-BT70430-20171705, ARCO-BT70-BASE-20171708, ARCO-BT70GN2-1-2017817304, ARCO-BT70-PLUS-20171709, ARCO-TN140.-BASE-20171408, ARCO-TN140.-PLUS-20171409, ARCO-TN140-20171404, ARCO-TN140-2017814301, ARCO-TN140430-20171405, ARCO-TN70-20170704, ARCO-TN70-2017807304, ARCO-TN70430-20170705, ARCO-TN70-BASE-20170708, ARCO-TN70-PLUS-20170709, ARCO-TNN70-20170706, B100, B120, B200, B240, BT140, BT60, BT70, BT70G, BT72, KSA105-35-204515, KSA105-35-2045150C0R, KSA105-35-2045260C00, KSA140BT-204524, KSA140BT-2045240BYF, KSA140BT-2045240C10, KSA140BT-2045240CAD, KSA140P-204534, KSA140P-2045340C0X, KSA140TN-204514, KSA140TN-2045140B8X, KSA140TN-2045140CAB, KSA140TN-2045140CAC...(Other models you can see in the webshop)		

timers

programme timers



1

GEV No.	360388	Ref. No.	995393 FR995393	
description	timer FIBER P25 engines 1 chambers 2 operation time 7.2h 230V shaft ø 6x4.6mm shaft L 14mm manuf. no. P255J02R0V2 motor type M51BJ0L6400 for blast chiller operation time 7.2h			
spare parts for	360388			
	GEV No.	360674	Ref. No.	—
	motor kit pinion ø 6.8mm teeth 15 230V voltage AC 50/60Hz turn direction counterclockwise motor ø 48mm H 18.5mm motor type UDS40NE1RNZ165 cable length 150mm with holder			



defrost timers

BIGATTI



1

GEV No.	360055	Ref. No.	1680381
description	defrost timer type SB3.81 defrosting interval 1-12x in 24h defrosting time 2-54min fan delaymin 230V		



1

GEV No.	360058	Ref. No.	1680382
description	defrost timer type SB3.82 defrosting interval 1-12x in 24h defrosting time 2-54min fan delay 0-15min 230V defr. funct. 1-12x per 24h		
For models:	ARBT70, ARTN120, ARTN70		

relays

power relays

with DIN rail mounting

upper

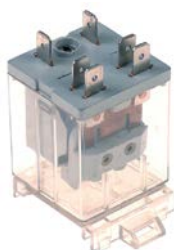

1

GEV No.	380314	Ref. No.	166550971 BN166550971
description	power relays Italiana Relè 230VAC 20A 1NC/1NO connection male faston 6.3mm DIN rail manuf. no. A1B-230AC-AD		
For models:	KB100-20180720, KB120-20180710, KB200-20181420, KB240-20181410, KBT120-20081410, KBT120-2008140218, KBT120-BASE-2008140218, KBT120-BASE-20081402BT, KBT120-BASE-20081402XU, KBT120-BASE-2008140431, KBT120-P0120081410, KBT122-20081402XU, KBT122-20081420, KBT122-20081402XU, KBT124-2008140431, KBT124-20081430, KBT124-P0120081430, KBT140-200214011K, KBT140-200214011M, KBT140-20021410, KBT140-BASE-200214011K, KBT140-BASE-200214011L, KBT140-BASE-200214011N, KBT142-200214011L, KBT142-20021420, KBT144-200214011M, KBT144-20021430, KBT40-21091640, KBT40-210916400BAJ, KBT60-2008070124, KBT60-20080710, KBT60-BASE-2008070124, KBT60-BASE-2008070126, KBT60-BASE-20080705H5, KBT62-20080705H5, KBT62-20080720, KBT62-20080705H5, KBT70, KBT70-20020700YN, KBT70-200207061E, KBT70-20020710, KBT70-BASE-20020700YL, KBT70G-200220, KBT70G-BASE-20022001TZ, KBT72-200207061E, KBT72-20020720, KBT72-210207, KBT72-BASE-200207061E, KBTG140-20021470, KBTG70-20020770...(Other models you can see in the webshop)		

lateral



1

GEV No.	380313	Ref. No.	166550972 BN166550972
description	power relays FINDER 230VAC 16A 3CO connection male faston DIN rail manuf. no. 62.83.8.230.0008		
For models:	ARBT70		

with bracket mounting



1

GEV No.	380185	Ref. No.	166560 BN166560
description	power relays Italiana Relè 230VAC 30A 1NO connection F6.3 bracket mounting dimensions 36.5x32.2x51.8mm manuf. no. A1O-230AC-FA		
For models:	KBF050GB-20350103, KBF050GS-20350203, KBT40-210916400BAJ, KTAR902BT-ESP66300BT-202509P0201, KTARB02-BASE-2025130104FU, KTARB02-20250904MU, MTTFF4xN, MTTFF4xP, SABT140-DOUBLE-DOOR-20197400KG, SABT144-BASE-201974402C2, SABT70-2017170208EB, SATNN140-2017140208DW, SATNN144-BASE-2017140208RY, SATNN70-2017070208EA, SATNN72-BASE-2017070208RX, SPA70-70TN-BT-201778030BYA, SPA70-70TN-TN-201777030BY8, SPABT140-201724030C54, SPABTV70-201717030C1C, TFT01BT-BASE-2095011070N, TFT02BT-BASE-2095021070R, TFT03BT-BASE-2095031070U, TFTP00BT-BASE-2096011070W, TFTP01BT-BASE-2096021070Z, TFTP02BT-BASE-20960310712		



transformers

encapsulated transformers

PMA



1

GEV No.	379054	Ref. No.	168305 BN168305
description	transformer primary 230VAC secondary 12VAC 3VA secondary 0.25A H 40mm L 45mm W 50mm connection screw 50/60Hz type 153/M		
For models:	KBT120-200814O218, KBT122-200814O2XU, KBT124-200814O431, KBT140-200214011K, KBT140-20021410, KBT142-200214011L, KBT142-20021420, KBT144-200214011M, KBT144-20021430, KBT40-21091640, KBT40-210916400BAJ, KBT60-2008070124, KBT62-20080705H5, KBT70, KBT70-20020710, KBT70-BASE-20020700YL, KBT70G-200220, KBT72-200207061E, KBT72-20020720, KBT72-210207, KBTV120, KBTV140-200214011N, KBTV140-20021440, KBTV60, KBTV70-200207, KC10535-20051440, KC2545-20050710, KC3513-20050715, KC3535-20050720, KC4512-20050725, KC6060-20091430, KC70-70-20051410, KC7070-20051410, KC9030-20091420, KCTN10535-20031440, KCTN2545-20030725, KCTN3030-20090710, KCTN3513-20030730, KCTN3535-20030735, KCTN4512-20030745, KCTN6060-20091410, KCTN7070-20031410, KP140-20041405, KP60-20100710, KP70-20040710, KPBT105-35-20061420, KPBT10535-20061420, KPBT2545-20060710, KPBT3513-20060720, KPBT3535-20060730...(Other models you can see in the webshop)		

electronic controllers

DIXELL

refrigeration controllers

built-in version



1

GEV No.	378228	Ref. No.	16815108 BN16815108	
description	electronic controller DIXELL XW20L-5NOC1 mounting measurements 150x30mm built-in depth 65.5mm 230V voltage AC NTC/PTC relay outputs 2 NO-20A(8) CO-8A(3) NTC/PTC DI -50 up to +150°C display 3½ digits			
For models:	ARCO-TN140.-BASE-20171408, ARCO-TN140.-PLUS-20171409, ARCO-TN140-20171404, ARCO-TN140-2017814301, ARCO-TN140430-20171405, ARCO-TN70-20170704, ARCO-TN70-2017807304, ARCO-TN70430-20170705, ARCO-TN70-BASE-20170708, ARCO-TN70-PLUS-20170709, NFB0070P, NFB0072P, NFB0140P, NFB0144P			
accessories for	378228			
	GEV No.	378194	Ref. No.	—
	temperature probe NTC 10kOhm cable PVC probe -20 up to +80°C cable -10 up to 100°C probe ø7x24.5mm cable length 1.5m without screw connection 2-wire			

accessories for	378228			
	GEV No.	379052	Ref. No.	167201 BN167201
	temperature probe PTC 1kOhm cable silicone probe -50 up to +150°C cable -50 up to +180°C probe ø6x40mm cable length 1.5m without screw connection 2-wire			
	GEV No.	379053	Ref. No.	—
	temperature probe PTC 1kOhm cable PVC probe -50 up to +150°C cable -10 up to 100°C probe ø6x30mm cable length 3m without screw connection 2-wire			
	GEV No.	379057	Ref. No.	—
	temperature probe NTC 10kOhm cable PVC probe -20 up to +80°C cable -10 up to 100°C probe ø6x25mm cable length 3m 2-wire			
	GEV No.	379064	Ref. No.	167207 167208 167210 BN167207 FR995562
	temperature probe PTC 1kOhm cable silicone probe -50 up to +150°C cable -50 up to +180°C probe ø6x40mm cable length 3m without screw connection 2-wire			
	GEV No.	379160	Ref. No.	167212 BN167212
	temperature probe NTC 10kOhm cable thermoplastic probe -40 up to +110°C cable -40 up to +110°C probe ø6x14mm cable length 1.5m without screw connection 2-wire			
	GEV No.	379161	Ref. No.	167211 BN167211
	temperature probe NTC 10kOhm cable thermoplastic probe -40 up to +110°C cable -40 up to +110°C probe ø6x14mm cable length 3m without screw connection 2-wire			
	GEV No.	379162	Ref. No.	—
	temperature probe NTC 10kOhm cable thermoplastic probe -40 up to +110°C cable -40 up to +110°C probe ø6x14mm cable length 6m 2-wire			
	GEV No.	379343	Ref. No.	—
	temperature probe NTC 10kOhm cable silicone probe -40 up to +110°C cable -50 up to +180°C probe ø6x40mm cable length 3m 2-wire			
	GEV No.	379458	Ref. No.	—
	temperature probe NTC 10kOhm cable silicone probe -40 up to +110°C cable -50 up to +180°C probe ø6x40mm cable length 1.5m without screw connection 2-wire			
	GEV No.	402818	Ref. No.	—
	programming key 4K for electronic controller DIXELL			



1				
GEV No.	402011	Ref. No.	16815100 16815107 996659 996768 BN16815100 BN16815107 FR996659 FR996768	
description	electronic controller DIXELL XW60L-5N0C1 mounting measurements 150x30mm built-in depth 50mm 230V voltage AC NTC relay outputs 4 NO-20A(8) CO-8A(3) NO-8A(3) NO-8A(3) NTC/PTC NTC/PTC DI protection IP65 -50 up to +150°C display 3½ digits			
For models:	AFB-140-20172407G, AFB-70-20171707G, AFB-70Sx-20171707GXPS, AFN-70-20170707G, ARCO-BT140-20172404, ARCO-BT140-20172405, ARCO-BT140-BASE-20172408, ARCO-BT140GN2-1-2017824301, ARCO-BT140-PLUS-20172409, ARCO-BT70-20171704, ARCO-BT70430-20171705, ARCO-BT70-BASE-20171708, ARCO-BT70GN2-1-2017817304, ARCO-BT70-PLUS-20171709, ARCO-TN7070-201777040GL70, ARCO-TNN70-20170706, KST01BT-205111, KST01BT-VCR-205701, KST01BT-VCR-205711, KST01TN-205001, KST01TN-205011, KST01TN-VCR-205601, KST01TN-VCR-205611, KST02BT-205112, KST02BT-VCR-205702, KST02BT-VCR-205712, KST02TN-205002, KST02TN-205012, KST02TNH760-205802, KST02TN-VCR-205602, KST02TN-VCR-205612, KST03BT-205113, KST03BT-VCR-205703, KST03BT-VCR-205713, KST03TN-205003, KST03TN-205013, KST03TN-VCR-205603, KST03TN-VCR-205613, KST04BT-205114, KST04BT-VCR-205714, KST04TN-205004, KST04TN-205014, KST04TN-VCR-205604, KST04TN-VCR-205614, KST-BT01, KST-BT04, KST-BT-VCR01, KST-BT-VCR02, KST-BT-VCR03, KSTP01BT-205311...(Other models you can see in the webshop)			
accessories for	402011			
	GEV No.	378194	Ref. No.	—
		temperature probe NTC 10kOhm cable PVC probe -20 up to +80°C cable -10 up to 100°C probe ø7x24.5mm cable length 1.5m without screw connection 2-wire		
	GEV No.	379057	Ref. No.	—
		temperature probe NTC 10kOhm cable PVC probe -20 up to +80°C cable -10 up to 100°C probe ø6x25mm cable length 3m 2-wire		
	GEV No.	379160	Ref. No.	167212 BN167212
		temperature probe NTC 10kOhm cable thermoplastic probe -40 up to +110°C cable -40 up to +110°C probe ø6x14mm cable length 1.5m without screw connection 2-wire		
	GEV No.	379161	Ref. No.	167211 BN167211
		temperature probe NTC 10kOhm cable thermoplastic probe -40 up to +110°C cable -40 up to +110°C probe ø6x14mm cable length 3m without screw connection 2-wire		
	GEV No.	379162	Ref. No.	—
		temperature probe NTC 10kOhm cable thermoplastic probe -40 up to +110°C cable -40 up to +110°C probe ø6x14mm cable length 6m 2-wire		
	GEV No.	379343	Ref. No.	—
		temperature probe NTC 10kOhm cable silicone probe -40 up to +110°C cable -50 up to +180°C probe ø6x40mm cable length 3m 2-wire		
	GEV No.	379458	Ref. No.	—
		temperature probe NTC 10kOhm cable silicone probe -40 up to +110°C cable -50 up to +180°C probe ø6x40mm cable length 1.5m without screw connection 2-wire		

ELIWELL

refrigeration controllers

built-in version



1				
GEV No.	379102	Ref. No.	1681109 BN1681109	
description	electronic controller ELIWELL type EWPC970 mounting measurements 71x29mm 12V relay outputs 8A			
For models:	KC3513-20050715, KC4512-20050725, KCTN2545-20030725, KCTN3513-20030730, KCTN3535-20030735, KCTN4512-20030745, KPBT3513-20060720, KPBT4512-20060740, KPTN2545-20040720, KPTN3513-20040725, KPTN3535-20040730, KTAR602, KTAR612, KTAR614, KUC3513-20150715, KUC4512-20150725, KUCTN2545-20130710, KUCTN35-13-20130715, KUCTN3513-20130715, KUCTN45-12-20130730, KUCTN4512-20130730, KUPBT3513-20160720, KUPBT4512-20160740, KUPTN2545-20140710, KUPTN35-13-20140720, KUPTN3513-20140720, KUPTN45-12-20140740, TPV16, TPV16-2128150002, TPV21, TPV21-2128210003, TPV21C, TPV21C-2128210003, TPV26C, TPV26C-2128260004			



1				
GEV No.	379570	Ref. No.	16811201 BN16811201	
description	electronic controller ELIWELL type ID961 mounting measurements 71x29mm 12V voltage AC/DC NTC/PTC relay outputs 1 relay -50 up to +150°C display 3½ digits RoomTempIN yes compressor relay 8A			
For models:	SABT70-BASE-2017170108EB, SABTV70-BASE-2017170108ER, SATN140-BASE-20196400KF, SATN140-BASE-201964013Z, SATN144-BASE-201964402BZ, SATN70-BASE-20195700F9, SATN70-BASE-2019570117, SATN72-BASE-201957202BM, SATNBT3535-BASE-20193603CV, SATNBT7070-BASE-201967803CU, SATNTN3535-BASE-20193503CP, SATNTN7070-BASE-201967703CT, STN140A, STN140-BASE-20191400KF, STN144A, STN70A, STN70-BASE-20190700F9, STN72A, STNV140A, STNV70A, TARS22-2124922, TARS22-212492208L6, TARS22-212492208VT, TARS22-21249220AO2, TARS22-21249220AO3, TARS22-21249220AO4, TARS22-21249220AO6, TARS22-KIT1, TARS22-Kit1-212492201, TARS22-KIT2, TARS22-Kit2-212492202, TARS22-KIT3, TARS22-Kit3-212492203, TARS22-KIT4, TARS22-Kit4-212492204, TARS22-KIT5, TARS22-Kit5-212492205, TARS22-KIT6, TARS22-Kit6-212492206, TARS22-KIT6-21249220AO5, TARS22-KIT7, TARS22-Kit7-212492207, TP122-TARS22-KIT5-212492208VR, VP3014N, VP3014Q, VP3018N, VP3018Q, VP3114N, VP3114Q, VP3118N...(Other models you can see in the webshop)			
accessories for	379570			
	GEV No.	379053	Ref. No.	—
		temperature probe PTC 1kOhm cable PVC probe -50 up to +150°C cable -10 up to 100°C probe ø6x30mm cable length 3m without screw connection 2-wire		
	GEV No.	379064	Ref. No.	167207 167208 167210 BN167207 FR995562
		temperature probe PTC 1kOhm cable silicone probe -50 up to +150°C cable -50 up to +180°C probe ø6x40mm cable length 3m without screw connection 2-wire		

Table continues overleaf

accessories for 379570			
GEV No.	379161	Ref. No.	167211 BN167211
temperature probe NTC 10kOhm cable thermoplastic probe -40 up to +110°C cable -40 up to +110°C probe ø6x14mm cable length 3m without screw connection 2-wire			
GEV No.	379782	Ref. No.	—
temperature probe PTC 1kOhm cable thermoplastic probe -50 up to +150°C cable -40 up to +110°C probe ø6x14mm cable length 3m 2-wire resistor 1kOhm			



1			
GEV No.	379025	Ref. No.	16814001 BN16814001
description	electronic controller ELIWELL type ID961LX mounting measurements 71x29mm 230V voltage AC NTC/PTC relay outputs 1 front measurements 76.2x35mm protection IP65 -55 up to +150°C display 3½ digits		
For models:	KTAP02-600-20221205CN, KTAP03-600-20221705CM, KTAR02-600-BASE-20201205CU, KTAR03-600-BASE-20201705DD, KTAR9-02-202009040Y, KTARI140-BASE-20210140, KTARI140-BA-SE-20210141, KTARS21-2124100021, KTN40-210906400BAI, STN1400GN2-1TH.60-201781420BU9, STN700GN2-1TH.60-201780720BU7, STNV1400GN2-1TH.60-201781420BUA, STNV700GN2-1TH.60-201780720BU8, TARS21-2124100022, TARS21-2124100023, TARS22-2124922, TARS22-212492208L6, TARS22-212492208VT, TARS22-21249220AO2, TARS22-21249220AO3, TARS22-21249220AO4, TARS22-21249220AO6, TARS22-KIT1, TARS22-Kit1-212492201, TARS22-KIT2, TARS22-Kit2-212492202, TARS22-KIT3, TARS22-Kit3-212492203, TARS22-KIT4, TARS22-Kit4-212492204, TARS22-KIT5, TARS22-Kit5-212492205, TARS22-KIT6, TARS22-Kit6-212492206, TARS22-Kit6-21249220AO5, TARS22-KIT7, TARS22-Kit7-212492207, TP122-TARS22-KIT5-212492208VR		

1			
GEV No.	379577	Ref. No.	1681108 BN1681108
description	electronic controller ELIWELL type ID974 mounting measurements 71x29mm 230V voltage AC NTC/PTC relay outputs 3 relays -50 up to +150°C display 3½ digits RoomTempIN yes DEF Probe yes DEF Relay 8A fan relay 5A compressor relay 8A		
For models:	KBT120-2008140218, KBT120-P0120081410, KBT122-20081402XU, KBT124-2008140431, KBT124-P0120081430, KBT140-200214011K, KBT142-200214011L, KBT144-200214011M, KBT60-2008070124, KBT62-20080705H5, KBT70, KBT70-20020710, KBT70-BASE-20020700YL, KBT72-200207061E, KBT72-20020720, KBT72-210207, KBTV120, KBTV140-200214011N, KBTV60, KBTV60-P0120080730, KBTV70-200207, KC10535-20051440, KC3535-20050720, KC6060-20091430, KC70-70-20051410, KC7070-20051410, KC9030-20091420, KPBT10535-20061420, KPBT3535-20060730, KPBT7070-20061410, KTAP00BT-BASE-2022550105KR, KTAP01BT-BASE-2022590105KU, KTAP02BT-205301, KTAP02BT-205302, KTAP02BT-205303, KTAP02BT-BASE-2022630105KW, KTAP03BT-BASE-2022680109UW, KTAPBT00, KTAPBT01, KTARBT02, KUBT140-20121410, KUBT142-20121420, KUBT144-20121430, KUBT70-20120712, KUBT72-20120720, KUBTV140-20121440, KUBTV70-20120730, KUC10535-20151440, KUC3535-20150720, KUC7070-20151410...(Other models you can see in the webshop)		
accessories for	379577		
GEV No.	379053	Ref. No.	—
temperature probe PTC 1kOhm cable PVC probe -50 up to +150°C cable -10 up to 100°C probe ø6x30mm cable length 3m without screw connection 2-wire			
GEV No.	379064	Ref. No.	167207 167208 167210 BN167207 FR995562
temperature probe PTC 1kOhm cable silicone probe -50 up to +150°C cable -50 up to +180°C probe ø6x40mm cable length 3m without screw connection 2-wire			
GEV No.	379161	Ref. No.	167211 BN167211
temperature probe NTC 10kOhm cable thermoplastic probe -40 up to +110°C cable -40 up to +110°C probe ø6x14mm cable length 3m without screw connection 2-wire			
GEV No.	379782	Ref. No.	—
temperature probe PTC 1kOhm cable thermoplastic probe -50 up to +150°C cable -40 up to +110°C probe ø6x14mm cable length 3m 2-wire resistor 1kOhm			



1			
GEV No.	378416	Ref. No.	FR6634510
description	electronic controller ELIWELL type ID974LX mounting measurements 71x29mm NTC(PTC) no probe -50 to +140°C display 3½ digits		

1

GEV No.	378294	Ref. No.	1681405 BN1681405
description	electronic controller ELIWELL type IWC720 mounting measurements 150x30mm 230V voltage AC NTC relay outputs 2 relays -50 up to +110°C display 3½ digits RoomTempIN yes DigilN1 yes DEF Relay 8A compressor relay 24A		



1

GEV No.	378269	Ref. No.	1681406 BN1681406
description	electronic controller ELIWELL type IWC750 mounting measurements 150x30mm 230V voltage AC NTC relay outputs 5 -50 up to +110°C display 3¾ digits RoomTempIN NTC DigilN1 yes DEF Relay 8A fan relay 8(3)A 5A 8(3)A evaporator probe NTC compressor relay 8(3)A		

EVCO - EVERY CONTROL

refrigeration controllers

built-in version



1

GEV No.	378506	Ref. No.	32140974 BN32140974
description	electronic controller EVCO type EVKB23N7PXXSX01 mounting measurements 71x29mm 230V PTC/NTC -40 up to +105°C preprogrammed		



165 x 45mm

1

GEV No.	379820	Ref. No.	1681114 BN1681114
description	electronic controller EVERY CONTROL type EVC20S35N7ALX30 mounting measurements 165x45mm 230V voltage AC NTC relay outputs 3 NO-16A(5) NO-8A(4) CO-8A(4) NTC NTC DI for fridge front measurementsmm built-in depth 56mm protection IP00 yes yes yes -40° up to 105°C display 4 digits		
For models:	P105-35TNN-2047640100, P105-35TNN-BT-2047660100, P140BT-2047220101, P140TN-2047200101, P140T-NN-2047210101, P144BT-2047360100, P144TNN-2047350100, P35-35TNN-2047440100, P35-35TNN-BT-2047460100, P70-70TNN-2047540100, P70-70TNN-BT-2047560100, P70BT-2047020101, P70TN-2041000101, P70TNN-2047010101, P72BT-2047120101, P72TNN-2047110101, S120BT-2088420100, S120TN-2088400100, S120TNN-2088410100, S140BT-2048220101, S140TN-2048200101, S60BT-2088120100, S60TN-2088100100, S60TNN-2088110100, S70BT-2048020101, S70TN-2048000101, S70TNN-2048010101		



1

GEV No.	379850	Ref. No.	936092 BN1681118 FR936092
description	electronic controller EVERY CONTROL type EVC20S35N7ALX40 mounting measurements 165x45mm 230V voltage AC NTC relay outputs 4 NO-16A(5) NO-8A(4) CO-8A(4) NO-8A(4) NTC NTC DI DI for fridge front measurementsmm built-in depth 56mm protection IP00 yes yes yes -40 up to +99°C display 4 digits		



71 x 29mm

1

GEV No.	378154	Ref. No.	1681160
description	electronic controller EVERY CONTROL type EVK203N7VXBS mounting measurements 71x29mm 230V voltage AC NTC/PTC relay outputs 3 NO-16A(5) CO-8A(4) NO-8A(4) NTC/PTC NTC/PTC DI front measurementsmm built-in depth 59mm protection IP65 yes -50 up to +150°C display 3½ digits		
For models:	M70BT, M70TN		
accessories for	378154		
	GEV No.	Ref. No.	—
	temperature probe PTC 1kOhm cable PVC probe -50 up to +150°C cable -10 up to 100°C probe ø6x30mm cable length 3m without screw connection 2-wire		
	GEV No.	Ref. No.	167207 167208 167210 BN167207 FR995562
	temperature probe PTC 1kOhm cable silicone probe -50 up to +150°C cable -50 up to +180°C probe ø6x40mm cable length 3m without screw connection 2-wire		

Table continues overleaf



accessories for 378154			
GEV No.	379161	Ref. No.	167211 BN167211
temperature probe NTC 10kOhm cable thermoplastic probe -40 up to +110°C cable -40 up to +110°C probe ø6x14mm cable length 3m without screw connection 2-wire			
GEV No.	379782	Ref. No.	—
temperature probe PTC 1kOhm cable thermoplastic probe -50 up to +150°C cable -40 up to +110°C probe ø6x14mm cable length 3m 2-wire resistor 1kOhm			



1

GEV No.	379738	Ref. No.	1681455 BN1681455 FR996193
----------------	--------	-----------------	----------------------------------

description electronic controller EVERY CONTROL type EVKB21N7PCXSX01 mounting measurements 71x29mm 230V voltage AC NTC relay outputs 1 front measurementsmm built-in depth 59mm protection IP65 preprogrammed -40 up to +105°C display 3½ digits 2 RoomTempIN NTC DEF Probe TempIN3 DEF Relay fan relay DigiIN 1 compressor relay CO-16A(5)

accessories for 379738

GEV No.	379053	Ref. No.	—
---------	--------	----------	---

temperature probe PTC 1kOhm cable PVC probe -50 up to +150°C cable -10 up to 100°C probe ø6x30mm cable length 3m without screw connection 2-wire

GEV No.	379064	Ref. No.	167207 167208 167210 BN167207 FR995562
---------	--------	----------	--

temperature probe PTC 1kOhm cable silicone probe -50 up to +150°C cable -50 up to +180°C probe ø6x40mm cable length 3m without screw connection 2-wire

GEV No.	379161	Ref. No.	167211 BN167211
---------	--------	----------	--------------------

temperature probe NTC 10kOhm cable thermoplastic probe -40 up to +110°C cable -40 up to +110°C probe ø6x14mm cable length 3m without screw connection 2-wire

GEV No.	379782	Ref. No.	—
---------	--------	----------	---

temperature probe PTC 1kOhm cable thermoplastic probe -50 up to +150°C cable -40 up to +110°C probe ø6x14mm cable length 3m 2-wire resistor 1kOhm



GEV No.	550801	Ref. No.	—
---------	--------	----------	---

PCB terminal block 3-pole raster size 5mm



GEV No.	550803	Ref. No.	—
---------	--------	----------	---

PCB terminal block 5-pole raster size 5mm

for blast chiller



1

GEV No.	378484	Ref. No.	FR6635860 FR995036
----------------	--------	-----------------	-----------------------

description electronic controller EVCO type EVK802P7 mounting measurements 71x29mm 230V voltage AC NTC/PTC relay outputs 2 NO-8A(4) CO-8A(4) NTC/PTC DI for blast freezer built-in depth 59mm protection IP65 -40 up to +105°C display 3½ digits with additional input for core temperature probe

SHANGFANG

accessories



1

GEV No.	379054	Ref. No.	168305 BN168305
----------------	--------	-----------------	--------------------

description transformer primary 230VAC secondary 12VAC 3VA secondary 0.25A H 40mm L 45mm W 50mm connection screw 50/60Hz type 153/M

For models: KBT120-2008140218, KBT122-20081402XU, KBT124-2008140431, KBT140-200214011K, KBT140-20021410, KBT142-200214011L, KBT142-20021420, KBT144-200214011M, KBT144-20021430, KBT40-21091640, KBT40-210916400BAJ, KBT60-2008070124, KBT62-20080705H5, KBT70, KBT70-20020710, KBT70-BASE-20020700YL, KBT70G-200220, KBT72-200207061E, KBT72-20020720, KBT72-210207, KBTV120, KBTV140-200214011N, KBTV140-20021440, KBTV60, KBTV70-200207, KC10535-20051440, KC2545-20050710, KC3513-20050715, KC3535-20050720, KC4512-20050725, KC6060-20091430, KC70-70-20051410, KC7070-20051410, KC9030-20091420, KCTN10535-20031440, KCTN2545-20030725, KCTN3030-20090710, KCTN3513-20030730, KCTN3535-20030735, KCTN4512-20030745, KCTN6060-20091410, KCTN7070-20031410, KP140-20041405, KP60-20100710, KP70-20040710, KPBT105-35-20061420, KPBT10535-20061420, KPBT2545-20060710, KPBT3513-20060720, KPBT3535-20060730...(Other models you can see in the webshop)

miscellaneous

refrigeration controllers



1

GEV No.	378411	Ref. No.	996380 FR996595
----------------	--------	-----------------	--------------------

description power PCB EVCO type EVC80P16P7FRL01 mounting measurements 170x120mm

For models: 120, 122, 201, 202, PBC051DF-ASX-203505AS, PBC081AF-ASX-203528AS, PBC121DF-ASX-203512AS, PBC122DF-ASX-223512AS, PBC161DF-ASX-203516AS, PBC201DP-20355203, PBC202DP-20355204, PBC401DCFDX-20356403, PBC402DCFDX-20356404, PBF031AF-ASX-203623AS, PBF051-AFST-AB-5GN11-BF-PDX-203626AD, PRC120AF-ASX-203530AS



probes

universal probes

temperature probes

GEV No.	379160	Ref. No.	167212 BN167212
description	temperature probe NTC 10kOhm cable thermoplastic probe -40 up to +110°C cable -40 up to +110°C probe ø6x14mm cable length 1.5m without screw connection 2-wire		
For models:	AFB-140-20172407G, AFN-70ESx-20173707GXPS, ARCO-BT140-20172404, ARCO-BT140-20172405, ARCO-BT140-BA-SE-20172408, ARCO-BT140-PLUS-20172409, ARCO-BT70-20171704, ARCO-BT70430-20171705, ARCO-BT70-BASE-20171708, ARCO-BT-70GN2-1-2017817304, ARCO-BT70-PLUS-20171709, ARCO-TN140-BA-SE-20171408, ARCO-TN140-PLUS-20171409, ARCO-TN140-20171404, ARCO-TN140430-20171405, ARCO-TN70-20170704, ARCO-TN70430-20170705, ARCO-TN70-BASE-20170708, ARCO-TN70-PLUS-20170709, ARCO-TNN70-20170706, B100, B120, B200, B240, BT140, BT60, BT70, BT70G, BT72, BTV70, KB100-20180720, KB120-20180710, KB200-20181420, KB240-20181410, KBT120-200814, KBT120-20081410, KBT120-BASE-2008140218, KBT120-BASE-200814022T, KBT120-BASE-20081402XU, KBT120-BASE-2008140431, KBT122-20081402XU, KBT122-20081420, KBT124-2008140431, KBT124-20081430, KBT140-200214011M, KBT140-20021410, KBT140-BASE-200214011K, KBT140-BASE-200214011L, KBT140-BASE-200214011N, KBT142-20021420...(Other models you can see in the webshop)		

GEV No.	379161	Ref. No.	167211 BN167211
description	temperature probe NTC 10kOhm cable thermoplastic probe -40 up to +110°C cable -40 up to +110°C probe ø6x14mm cable length 3m without screw connection 2-wire		
For models:	140, 70, AFB-140-20172407G, AFB-70-20171707G, AFB-70Sx-20171707GXPS, AFN-140E-20173407G, AFN-70-20170707G, AFN-70E-20173707G, AFN-70ESx-20173707GXPS, AP-140-221314XG, AP-70TN-221307XG, ARCO-BT140-20172404, ARCO-BT140-20172405, ARCO-BT140-BASE-20172408, ARCO-BT140-PLUS-20172409, ARCO-BT70-20171704, ARCO-BT70430-20171705, ARCO-BT70-BASE-20171708, ARCO-BT70GN2-1-2017817304, ARCO-BT70-PLUS-20171709, ARCO-TNN70-20170706, B100, B120, B200, B240, BT140, BT60, BT70, BT70G, BT72, BTV70, KC3513-20050715, KC3535-20050720, KCTN2545-20030725, KCTN3030-20090710, KCTN3513-20030730, KCTN3535-20030735, KCTN45-12-20030745, KPBT3513-20060720, KPBT3535c-20060730, KPC30-30-20100720, KPTN3513-20040725, KPTN3535-20040730, KSA140BT-204524, KSA140BT-2045240BYF, KSA140BT-2045240C10, KSA140BT-2045240CAD, KSA140P-204534, KSA140P-2045340C0X, KSA140TN-204514...(Other models you can see in the webshop)		

GEV No.	379142	Ref. No.	167202 BN167202
description	temperature probe PTC 1kOhm cable PVC probe -50 up to +150°C cable -10 up to 100°C probe ø6x30mm cable length 1.5m without screw connection 2-wire		
For models:	KBC10, KBC10-BASE-20351002PM, KBC5, KBC6, KBC6-BASE-20350602PL, KBCF10, KBCF10-BASE-20361002PV, KBCF5, KBCF5-BA-SE-20360502PN, KBCF6, KBCF6-BASE-20360602PT, KC2545-20050710, KPBT2545-20060710, KPTN2545-20040720, TRANSF90001MOTBT, TRANSF90001MOTTN, TRANSF90002MOTBT, TRANSF90002MOTTN, TRANSF90003MOTBT, TRANSF90003MOTTN, TRANSF90004MOTTN		

GEV No.	379052	Ref. No.	167201 BN167201
description	temperature probe PTC 1kOhm cable silicone probe -50 up to +150°C cable -50 up to +180°C probe ø6x40mm cable length 1.5m without screw connection 2-wire		
For models:	KBF050-20350503, KBF050-203505030CBO, KBF050GB-20350103, KBF050GS-20350203, KBF050GS-20350203F, KBT120-2008140218, KBT120-P0120081410, KBT122-20081402XU, KBT124-2008140431, KBT124-P0120081430, KBT140-200214011K, KBT142-200214011L, KBT144-200214011M, KBT40-21091640, KBT40-210916400BAJ, KBT60-2008070124, KBT62-20080705H5, KBT70, KBT70-20020710, KBT70-BASE-20020700YL, KBT70G-200220, KBT72-200207061E, KBT72-20020720, KBT72-210207, KBTV120, KBTV140-200214011N, KBTV60, KBTV60-P0120080730, KBTV70-200207, KC10535-20051440, KC2545-20050710, KC3513-20050715, KC3535-20050720, KC4512-20050725, KC6060-20091430, KC70-70-20051410, KC7070-20051410, KC9030-20091420, KCTN10535-20031440, KCTN2545-20030725, KCTN3030-20090710, KCTN3513-20030730, KCTN3535-20030735, KCTN4512-20030745, KCTN6060-20091410, KCTN7070-20031410, KP140-20041405, KP60-20100710, KP70-20040710, KPBT10535-20061420...(Other models you can see in the webshop)		

GEV No.	379064	Ref. No.	167207 167208 167210 BN167207 FR995562
description	temperature probe PTC 1kOhm cable silicone probe -50 up to +150°C cable -50 up to +180°C probe ø6x40mm cable length 3m without screw connection 2-wire		

producer-specific probes

core probes

GEV No.	378679	Ref. No.	965295 FR6638220 FR965295
description	core temperature probe Pt1000 connection 8-wire probe ø4x100mm cable length 5m handle ø 16mm handle length 110mm		
For models:	201, 202, PBC051DF-ASX-203505AS, PBC081AF-ASX-203528AS, PBC121DF-ASX-203512AS, PBC161DF-ASX-203516AS, PBC201DP-20355203, PBC202DP-20355204, PBC401DCFDX-20356403, PBC402DCFDX-20356404, PBF031AF-ASX-203623AS, PBF051-AFST-AB-5GN11-BF-PDX-203626AD		

1 electric components



			
1			
GEV No.	401756	Ref. No.	167230 167231 BN167230 BN167231 FR6633580 FR996070
description	core temperature probe PTC 1kOhm cable silicone probe -40 up to +120°C cable -50 up to +180°C connection 2-wire probe ø4.5x100mm thread cable length 4.5m handle ø 10mm handle length 120mm L1 150mm L2 50mm		
For models:	KBC10, KBC10-BASE-20351002PM, KBC5, KBC5-BASE-20350502PK, KBC6, KBC6-BASE-20350602PL, KBCF10, KBCF10-BASE-20361002PV, KBCF5, KBCF5-BASE-20360502PN, KBCF6, KBCF6-BASE-20360602PT, KBF050-20350503, KBF050-203505030CBO		

			
1			
GEV No.	401757	Ref. No.	995857 FR6632510 FR995857
description	power PCB blast freezer ESP2000 suitable for FRIULINOX		
For models:	KBC201-20355201, KBC201-PASS-THROUGH-20355221, KBC202-20355202, KBC202-PASS-THROUGH-20355222, KBF201-20365201, KBF201-PASS-THROUGH-20365221, KBF202-20365202, KBF202-PASS-THROUGH-20365222, KRC061-20357061, KRC101-20357101, KRC102-20357102, KRC201-20358201, KRC202-20358202, KRF061-20367061, KRF101-20367101, KRF101-PRED-20367103, KRF102-20367102, KRF201-20368201, KRF202-20368202, KUC061-20354061, KUC101-20354103, KUC102, KUF061-20364061, KUF101, KUF102		

electronics

PCBs

			
1			
GEV No.	403738	Ref. No.	FR997060
description	control PCB L 145mm W 100mm		

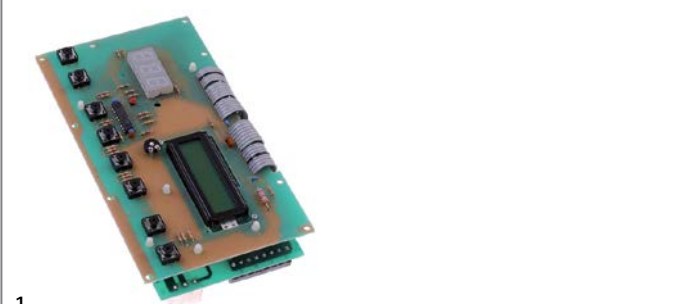
			
1			
GEV No.	401776	Ref. No.	16811299 BN16811299
description	power PCB		
For models:	BT140, BT70G, KSA105-35-2045260CC0, KSA140BT-204524, KSA140BT-2045240BYF, KSA140BT-2045240C10, KSA140BT-2045240CAD, KSA140P-204534, KSA140P-2045340C0X, KSA140TN-204514, KSA140TN-2045140B8X, KSA140TN-2045140CAB, KSA140TN-2045140CAC, KSA70BT-204517, KSA70BT-2045170BYL, KSA70BT-2045170C0Z, KSA70BT-2045170CAA, KSA70P-204527, KSA70P-2045270COW, KSA70TN-204507, KSA70TN-2045070B5E, KSA70TN-2045070C6A, KSA70TN-2045070CA9, KSABT70G-204537, KSABT70G-2045370CC4, KSAP105-35-2045250CC1, KSAP35-35-2045450CBT, KSAPC35-35-2045460CBU, P140, P70, TN70		

keypads

front foils

			
1			
GEV No.	401773	Ref. No.	14261052 BN14261052
description	front foil L 500mm W 50mm		
For models:	BT140, BT70G, KSA140BT-204524, KSA140BT-2045240BYF, KSA140BT-2045240C10, KSA140BT-2045240CAD, KSA140P-204534, KSA140P-2045340C0X, KSA140TN-204514, KSA140TN-2045140B8X, KSA140TN-2045140CAB, KSA140TN-2045140CAC, KSA70BT-204517, KSA70BT-2045170BYL, KSA70BT-2045170C0Z, KSA70BT-2045170CAA, KSA70P-204527, KSA70P-2045270COW, KSA70TN-204507, KSA70TN-2045070B5E, KSA70TN-2045070C6A, KSA70TN-2045070CA9, KSABT70G-204537, KSABT70G-2045370CC4, P140, P70, TN70		

			
1			
GEV No.	401772	Ref. No.	14261050 14261051 BN14261050
description	keypad foil blast chiller L 212mm W 102mm buttons 9 POLARIS		
For models:	KBC10, KBC10-BASE-20351002PM, KBC5, KBC5-BASE-20350502PK, KBC6, KBC6-BASE-20350602PL, KBCF10, KBCF10-BASE-20361002PV, KBCF5, KBCF5-BASE-20360502PN, KBCF6, KBCF6-BASE-20360602PT		



accessories

			
GEV No.	401777	Ref. No.	16671299 BN16671299
description	buttons strip 8 buttons L 200mm W 37mm		
For models:	BT140, BT70G, KSA105-35-2045260CC0, KSA140BT-204524, KSA140BT-2045240BYF, KSA140BT-2045240C10, KSA140BT-2045240CAD, KSA140P-204534, KSA140P-2045340C0X, KSA140TN-204514, KSA140TN-2045140B8X, KSA140TN-2045140CAB, KSA140TN-2045140CAC, KSA70BT-204517, KSA70BT-2045170BYL, KSA70BT-2045170C0Z, KSA70BT-2045170CAA, KSA70P-204527, KSA70P-2045270C0W, KSA70TN-204507, KSA70TN-2045070B5E, KSA70TN-2045070C6A, KSA70TN-2045070CA9, KSABT70G-204537, KSABT70G-2045370CC4, KSAP105-35-2045250CC1, KSAP35-35-2045450CBT, KSAPC35-35-2045460CBU, P140, P70, TN70		

solenoid valves

solenoid valves (refrigeration)

CASTEL

valve bodies

STANDARD series

suitable for refrigerants R22, R134a, R404A, R407C, R410A, R507

			
GEV No.	370382	Ref. No.	14970245
description	solenoid valve body NC type 1028/M10S p max 45bar connection 10mm soldering connection DN 3mm -35 up to +105°C L 125mm refrigeration straight CASTEL		
For models:	KBC5, KBCF5, KBCF5-BASE-20360502PN, KBT40-21091640, KBT40-210916400BAJ, KBT70G-BASE-20022001TZ, KBTG140-20021470, KBTG70-20020770, KSABT70G-2045370CC4, M70BT		
accessories for	370382		
	GEV No.	371084	Ref. No. —
	solenoid coil CASTEL 230VAC 8VA 50/60Hz connection cable 1000mm type CM2		
	GEV No.	371090	Ref. No. 14970511
	power socket plug type DIN 43650A screw		
	GEV No.	371301	Ref. No. —
	solenoid coil CASTEL 110VAC 8VA 50/60Hz seat ø 11.5mm connection DIN 43650A type HF2		
	GEV No.	371314	Ref. No. —
	solenoid coil CASTEL 240VAC 8VA 50/60Hz seat ø 11.5mm		
	GEV No.	371321	Ref. No. —
	solenoid coil CASTEL 12/24VAC 50/60Hz seat ø 11.5mm connection DIN 43650A type HF2		

spare parts and accessories

			
GEV No.	371041	Ref. No.	14970502
description	solenoid coil CASTEL 240VAC 8VA 50/60Hz seat ø 11.5mm connection DIN 43650A type HM2		
For models:	KBC10, KBC10-BASE-20351002PM, KBC5, KBC6, KBC6-BA-SE-20350602PL, KBCF10, KBCF10-BASE-20361002PV, KBCF5, KBCF5-BASE-20360502PN, KBCF6, KBCF6-BASE-20360602PT, KBT70G-BASE-20022001TZ, KBTG140-20021470, KBTG70-20020770, KSABT70G-2045370CC4, KTAR82-202082020AWO, KTAR83-202083020AWP, KTAR84-202084020AWQ, KTARS27-20282700, TPV16, TPV16-2128150002, TPV21, TPV21-2128210003, TPV21C, TPV21C-2128211003, TPV26C, TPV26C-2128260004, TSR01, TSR01-BA-SE-202108010BPA, TSR02, TSR02-202113010BGO, TSR03, TSR03-BASE-202117010BGK, TSR04, TSR04-BASE-202122010BE8		
accessories for	371041		
	GEV No.	371090	Ref. No. 14970511
	power socket plug type DIN 43650A screw		
	GEV No.	371092	Ref. No. —
	power socket plug type DIN large cable length 1000mm		

			
GEV No.	371090	Ref. No.	14970511
description	power socket plug type DIN 43650A screw		
For models:	KBC10, KBC10-BASE-20351002PM, KBC5, KBC6, KBC6-BA-SE-20350602PL, KBCF10, KBCF10-BASE-20361002PV, KBCF5, KBCF5-BASE-20360502PN, KBCF6, KBCF6-BASE-20360602PT, KBT70G-BASE-20022001TZ, KBTG140-20021470, KBTG70-20020770, KSABT70G-2045370CC4, KTAR82-202082020AWO, KTAR83-202083020AWP, KTAR84-202084020AWQ, KTARS27-20282700, TPV16, TPV16-2128150002, TPV21, TPV21-2128210003, TPV21C, TPV21C-2128211003, TPV26C, TPV26C-2128260004, TSR01, TSR01-BA-SE-202108010BPA, TSR02, TSR02-202113010BGO, TSR03, TSR03-BASE-202117010BGK, TSR04, TSR04-BASE-202122010BE8		

SANHUA

valves

			
GEV No.	370757	Ref. No.	995508 FR995508
description	solenoid valve type MDF-A03-6H001 230VAC p max 45bar pressure range 2 up to 31bar connection 10mm soldering connection -30 up to +105°C SANHUA refrigeration tube ø 10mm L 111mm		
For models:	122, PBC081AF-ASX-203528AS, PBC121DF-ASX-203512AS, PBC122DF-ASX-223512AS, PBC161DF-ASX-203516AS		



compressors

ACC/ZEL

R134A

HMBP monophase

High/Medium evaporation temperature above -20/-15 °C



GEV No.	605012	Ref. No.	141565100025 BN141565100025
description	compressor coolant R134a type GL45TB 220-240V 50Hz HMBP fully hermetic 8.4kg 1/6HP power input 342W cylinder capacity 4.5cm ³ CSIR H 175.5mmW 76W 101W 134W 175W 223W 278W 342W 413W test method ASHRAE ambient temperature max. 43°C		
For models:	SATNBT3535-BASE-20193603CV, SATNTN3535-BASE-20193503CP		



GEV No.	605007	Ref. No.	141514200595 141565100035 BN141565100035
description	compressor coolant R134a type GL60TB 220-240V 50Hz HMBP fully hermetic 9.5kg 1/5HP power input 437W cylinder capacity 5.7cm ³ CSIR H 175.5mm 95W 128W 170W 222W 284W 355W 437W 528W test method ASHRAE ambient temperature max. 43°C		
For models:	KTAR01, KTAR01-BASE-20201001, KTAR01N, KTAR01N-BASE-20201005043V, KTAR02, KTAR02N, KTAR02N-BASE-20201305043Y, KTAR03, KTAR03-BASE-2020180105, KTAR03N, KTAR03N-BASE-202018050441, KTAR04, KTAR04N, KTAR04N-BASE-2020230508V7, KTAR82-202082020AWO, KTAR902, KTAR9-02-202009040Y, KTARBTO2-205101, KTARBTO2-205102, KTARBTO2-205103, KTARBTO2-BASE-2025130104FU, KTARBTO3-BASE-2025180104FW, KTARBTO4-BASE-2025230104FZ, KTN40-21090640, KTN40-210906400BAI, TARS22E-2124091022, TARS22EP-2124091023, TARS22ES-2124091022, TARS22R-21240913, TARS22RP-21240914, TARS22RS-21240913, TFT01, TFT01-BASE-209001106V7, TFT02, TFT02-BASE-209002106XF, TFT03, TFT03-BASE-209003106XY, TFT04, TFT04-BASE-209004106YC, TP0200Q-20283200, TP0220Q-20283220, TP0224Q-20283224, TP0227Q-20283227, TP0240Q-20283240, TP0247Q-20283247, TP0270Q-20283270, TPR02-2028020007Z4, TRANSF90001MOTTN, TSP00, TSP00-BASE-202606010BRU...(Other models you can see in the webshop)		



GEV No.	605008	Ref. No.	141565100030 BN141565100030
description	compressor coolant R134a type GL80TB 220-240V 50Hz HMBP fully hermetic 9.5kg 1/5HP power input 554W cylinder capacity 7.6cm ³ CSIR H 175.5mm 165W 215W 290W 390W 500W 615W 727W 840W test method ASHRAE ambient temperature max. 43°C		
For models:	AFN-70-20170707G, AFN-70E-20173707G, AFN-70ESx-20173707GX-PS, ARCO-TN70-20170704, ARCO-TN70430-20170705, ARCO-TN7070-201777040GL70, ARCO-TN70-BASE-20170708, ARCO-TN70-PLUS-20170709, ARCO-TNN70-20170706, KC6060-20091430, KC9030-20091420, KCTN60-60-20091410, KPC90-30-20101410, KTAR01, KTAR01-BASE-20201001, KTAR01N, KTAR01N-BASE-20201005043V, KTAR02, KTAR02-600-BASE-20201205CU, KTAR02N, KTAR02N-BASE-20201305043Y, KTAR03, KTAR03-600-BASE-20201705DD, KTAR03-BASE-2020180105, KTAR03N, KTAR03N-BASE-202018050441, KTAR04, KTAR04N, KTAR04N-BASE-2020230508V7, KTAR6-03-202316010AMQ, KTAR6-03-202316010AMR, KTAR6-03-202316010AMS, KTARBTO2-205101, KTARBTO2-205102, KTARBTO2-205103, KTARBTO2-BASE-2025130104FU, KTARBTO3-BASE-2025180104FW, KTARBTO4-BASE-2025230104FZ, KTARS21-2124100021, KTARS24-202413010480, KTARS35-2024180104HC, KTN60-20070710, KTN60-BASE-20070700XE, KTN60-BASE-20070700XF, KTN62-20070700XF, KTN62-20070720, NFB0070N, NFB0070P, NFB0072N, NFB0072P...(Other models you can see in the webshop)		



1

GEV No.	605010	Ref. No.	141565100050 BN141565100050
description	compressor coolant R134a type GP12TB 220-240V 50Hz HMBP fully hermetic 11.2kg 3/8HP power input 661W cylinder capacity 12cm ³ CSIR H 203.6mmW 143W 194W 259W 339W 432W 539W 661W 796W test method ASHRAE ambient temperature max. 43°C		
For models:	AFN-140E-20173407G, ARCO-TN140.-BASE-20171408, ARCO-TN140.-PLUS-20171409, ARCO-TN140-20171404, ARCO-TN140430-20171405, KTAR01, KTAR01-BASE-20201001, KTAR01N, KTAR01N-BASE-20201005043V, KTAR02, KTAR02N, KTAR02N-BASE-20201305043Y, KTAR03, KTAR03-BASE-2020180105, KTAR03N, KTAR03N-BASE-202018050441, KTAR04, KTAR04N, KTAR04N-BASE-2020230508V7, KTAR84-202084020AWQ, KTARBT02-205101, KTARBT02-205102, KTARBT02-205103, KTARBT02-BASE-2025130104FU, KTARBT03-BASE-2025180104FW, KTARBT04-BASE-2025230104FZ, KTARS27-20282700, KTN60-BASE-20070700XH, KTNV60-20070700XH, KTNV60-20070730, NFB0140N, NFB0140P, NFB0144N, NFB0144P, S120TN-2088400100, S120TNN-2088410100, SATN140-201714020998, SATN144-BASE-20171402099A, SATNN140-2017140208DW, SATNN144-BASE-2017140208RY, SATNV140-BASE-201714020999, STN140A, STN144A, STNN140A, STNN144A, STNV140A, TFT01, TFT01-BASE-209001106V7, TFT02, TFT02-BASE-209002106XF...(Other models you can see in the webshop)		

R404a/R507

LBP monophase

Lower evaporation temperature below -20°C



1

GEV No.	605073	Ref. No.	141565100180 BN141565100180
description	compressor coolant R404a/R507 type MP14FB 220-240V 50Hz LBP fully hermetic 13.9kg 1/2HP cylinder capacity 14cm ³ CSIR H 203.6mm 439W 584W 746W 926W 1124W test method ASHRAE		
For models:	AFB-70-20171707G, AFB-70Sx-20171707GXPS, ARCO-BT70-20171704, ARCO-BT70430-20171705, ARCO-BT70-BASE-20171708, ARCO-BT70-PLUS-20171709, KTRE4-202117120G1J, NFB0070F, NFB0072F, NORD-700BT-2017817305, NORD-700BT-2017817305P, TPECO03-20261512, TPECO03-202615120G5V, TPECO04-20262012, TPECO04-202620120G5W, TRECO03-20211712, TRECO04, TRECO04-20212212, TRECO04-202122120FLN, TSR03, TSR03-BASE-202117010BGK, TSR04, TSR04-BASE-202122010BE8		

HMBP monophase

High/Medium evaporation temperature above -20/-15 °C



1

GEV No.	605014	Ref. No.	141565100027 BN141565100027
description	compressor coolant R404a/R507 type ML80TB 220-240V 50Hz HMBP fully hermetic 11.4kg 3/8HP cylinder capacity 7.57cm ³ CSIR H 175.5mmW 261W 346W 446W 561W 691W 835W 993W 1167W test method ASHRAE ambient temperature max. 43°C		



1

GEV No.	605028	Ref. No.	141565100040 BN141565100040
description	compressor coolant R404a/R507 type ML90TB 220-240V 50Hz HMBP fully hermetic 11.6kg 3/8HP cylinder capacity 8.85cm ³ CSIR H 175.5mmW 323W 418W 532W 666W 819W 990W 1181W 1391W test method ASHRAE ambient temperature max. 43°C		
For models:	KTAR83-202083020AWP, MBM8.5CC-21661500, TFT01, TFT01-BASE-209001106V7, TFT02, TFT02-BASE-209002106XF, TFT03, TFT03-BASE-209003106XY, TFT04, TFT04-BASE-209004106YC, TP0300Q-20283300, TP0320Q-20283320, TP0370Q-20283340, TP0370Q-20283370, TPR03-2028030007Z5, TRANSF90002MOTTN, TRANSF90003MOTTN		



CUBIGEL

R404a/R507

LBP monophase

Lower evaporation temperature below -20°C



GEV No.	605207	Ref. No.	14156510020
description	compressor coolant R404a/R507 type ML80FB 220-240V 50Hz LBP 10.9kg 1/4HP cylinder capacity 8.1cm ³ CSIR H 185mm 276W 314W 356W 401W 450WWWWWW test method ASHRAE ambient temperature max. 43°C		



GEV No.	605176	Ref. No.	141565100021 BN141565100021
description	compressor coolant R404a/R507 type ML90FB 220-240V 50Hz LBP 11kg 1/3HP cylinder capacity 8.85cm ³ CSIR H 198mm 305W 394W 495W 606W 729WWWWWW test method ASHRAE		
For models:	KTARI140-BASE-20210140, KTARI140-BASE-20210141, TPE-CO02-20261112, TPECO02-202611120G5U, TRECO02-20211312, TRECO02-202113120FLM, TRECO02-20221312, TRECO02-21750101, TSR02, TSR02-202113010BG0		



GEV No.	605138	Ref. No.	141565100170
description	compressor coolant R404a/R507 type MP12FB 220-240V 50Hz LBP 12kg 3/8HP cylinder capacity 12cm ³ CSIR H 215mm 381W 510W 657W 819W 999WWWWWW test method ASHRAE		
For models:	140, AP-140-221314XG, KC105-35-20051440, KC3513-20050715, KC3535-20050720, KC9030-20091420, KPBT3513-20060720, KPBT3535c-20060730, KUC105-35-20151440, KUC25-45-20150710, KUC3513-20150715, KUC35-35-20150720, KUC4512-20150725, KUPBT2545-20160710, KUPBT3513-20160720, KUPBT3535-20160730, KUPBT4512-20160740, LLP140TN, LLP140TNGN2-1-221314, SAT-NBT3535-BASE-20193603CV		



GEV No.	605075	Ref. No.	141565100195 BN141565100195
description	compressor coolant R404a/R507a type MX21FB_A 220-240V 50Hz LBP 16.5kg 3/4HP cylinder capacity 20.72cm ³ CSR H 220mm 575W 655W 742W 836W 938WWWWWW test method ASHRAE		
For models:	S120BT-2088420100, T140BT-2046220100		



EMBRACO / ASPERA

R290A

LBP monophase

Lower evaporation temperature below -20°C

R290



1

GEV No.	605204	Ref. No.	BN14156511060
description	compressor coolant R290 type NEK2160U 220-240V 50Hz LBP 11.9kg 3/4HP cylinder capacity 16.8cm ³ CSR H 206mm 508W 646W 808W 995W 1206WWWWW test method ASHRAE		

R290



1

GEV No.	605202	Ref. No.	BN14156511065
description	compressor coolant R290 type NT2170U 220-240V 50Hz LBP 17kg 3/4HP cylinder capacity 20.44cm ³ CSR H 220mm 544W 698W 883W 1097W 1340WWWWW test method ASHRAE		

MBP monophase

Medium evaporation temperature above -20°C

R290



1

GEV No.	605200	Ref. No.	BN14156511070
description	compressor coolant R290 type EMT6144U 220-240V 50Hz MBP 7.8kg 1/6HP cylinder capacity 4.5cm ³ CSIR H 166mmWW 228W 280W 342W 416W 502W 598W 705W test method EN 12900		

R404a/R507

LBP monophase

Lower evaporation temperature below -20°C



1

GEV No.	605144	Ref. No.	995745 FR6683120 FR995745
description	compressor coolant R404a/R507 type NEK2168GK 220-240V 50Hz LBP 22.9kg 3/4HP cylinder capacity 14.28cm ³ CSR H 200mm 345W 454W 587W 742W 921W 1123WWWWW		
For models:	PBF031AF-ASX-203623AS		



1

GEV No.	605174	Ref. No.	141565100200 BN141565100200 FR6681010 FR995767
description	compressor coolant R404a/R507 type NJ2192GK 220-240V 50Hz LBP 20.4kg 1 1/4HP cylinder capacity 26.2cm ³ CSR H 265mm 685W 989W 1342W 1745W 2196W 2196WWWWW		
For models:	KBT120-P0120081410, KBT124-P0120081430, KBT140-200214011M, KBT140-20021410, KBT140-BASE-200214011K, KBT140-BASE-200214011L, KBT142-20021420, KBT144-20021430, KBTV140-20021440		



1

GEV No.	605078	Ref. No.	141514202580
description	compressor coolant R404a/R507 type NT2180GK 220-240V 50Hz LBP fully hermetic 17.3kg 1HP cylinder capacity 20.44cm ³ CSIR H 221mm 515W 598W 682W 769W 859W 956WWWWW test method ASHRAE		
For models:	ROLL-IN-1P, ROLL-IN-1P-2110081205Z6, ROLL-IN-1PP, ROLL-IN-1PPM, ROLL-IN-1PPV, ROLL-IN-1PV, ROLL-IN-1PV-2110081206F1, ROLL-IN-2PPM-TN, ROLL-IN-2PPM-TN-2110162206X4, ROLL-IN-2PP-TN, ROLL-IN-2PP-TN-2110162205Z9, ROLL-IN-2PPV-TN, ROLL-IN-2PPV-TN-2110162206FC, ROLL-IN-2P-TN, ROLL-IN-2P-TN-2110161205Z8, ROLL-IN-2PV-TN, ROLL-IN-2PV-TN-2110161206F9, ROLL-INP-1P-2110082205Z7, ROLL-INP-1P-2110082206F6, ROLL-INP-1P-2110082206X3		



electric components

L'UNITE HERMETIQUE / TECUMSEH

R404A

HMBP monophase

High/Medium evaporation temperature above -20/-15 °C



GEV No.	605021	Ref. No.	141565100028
description	compressor coolant R404A type AEZ4425Z 220-240V 50Hz HMBP fully hermetic 9.8kg 1/5HP cylinder capacity 4.5cm ³ CSIR H 186mmWW 198W 263W 341W 432W 537W 629W test method EN 12900 723W		

SECOP DANFOSS

R134A

MBP monophase

Medium evaporation temperature above -20°C



GEV No.	605060	Ref. No.	141552211000 BN141552211000
description	compressor coolant R134a type NL10MF 220-240V 50/60Hz MBP fully hermetic 10.5kg 1/3HP cylinder capacity 10.1cm ³ RSIR/CSIR H 203mmWW 293W 382W 487W 611W 758W 930W 1129W test method ASHRAE (50Hz)		
For models:	KST04TN-205004, KST04TN-205014, KST04TN-VCR-205604, KST04TN-VCR-205614, KSTP04TN-205214, KSTP05TN-205205, KSTP05TN-205215, KSTS24-205424, KSTS24-2054240IDP, KSTS24-2054240JGN, KST-TN04, KST-TN-VCR04, NFS0143NG, NFS0144NG, NFS0144P		
spare parts for	605060		
	GEV No.	381530	Ref. No. —
	start relay DANFOSS 117U6022 HST		

HMBP monophase

High/Medium evaporation temperature above -20/-15 °C



GEV No.	605089	Ref. No.	141514208850 BN141514208850
description	compressor coolant R134a type NL8.4MF 220-240V 50Hz HMBP fully hermetic 10.5kg 1/4HP cylinder capacity 8.35cm ³ RSIR/CSIR H 197mmWW 235W 305W 390W 491W 610W 749W 912W test method ASHRAE		
For models:	KC105-35-20051440, KC10535-20051440, KC70-70-20051410, KC7070-20051410, KCTN10535-20031440, KCTN7070-20031410, KPTN10535-20041440, KPTN70-70-20041410, KTAR04, KTN3513-200107, KTN3513-20010735, KTN4512-200107, KTN4512-20010745, KTN70-200107003W, KTN70-20010700VF, KTN70-20010710, KTN70-210107, KTN70-BASE-20010700VX, KTN72-200107, KTN72-20010720, KTN72-BASE-20010700VF, KTNV60-20070700XH, KTNV70-200107003W, KTNV70-20010730, KTNV70-210107, KUC105-35-20151440, KUC10535-20151440, KUC70-70-20151410, KUC7070-20151410, KUCTN10535-20131440, KUCTN7070-20131410, KUPTN105-35-20141440, KUPTN10535-20141440, KUPTN70-70-20141410, KUPTN7070-20141410, KUTN3513-20110735, KUTN4512-20110770, KUTN70-20110710, KUTN72-20110720, KUTNV70-20110730, ROLL-IN-1P, ROLL-IN-1P-2110081205Z6, ROLL-IN-1PP, ROLL-IN-1PPM, ROLL-IN-1PPV, ROLL-IN-1PV, ROLL-IN-1PV-2110081206F1, ROLL-IN-2PPM-TN, ROLL-IN-2PPM-TN-2110162206X4, ROLL-IN-2PP-TN...(Other models you can see in the webshop)		
spare parts for	605089		
	GEV No.	381528	Ref. No. —
	start relay DANFOSS 117U6016 HST		



GEV No.	605077	Ref. No.	141555100030 FR6681520 FR995983
description	compressor coolant R134a type SC15G 220-240V 50Hz HMBP fully hermetic 13.1kg 3/8HP cylinder capacity 15.3cm ³ CSIR H 203mmWW 203W 358W 523W 703W 901W 1124W 1377W 1665W test method ASHRAEW 1993W		
For models:	SATN140-BASE-20196400KF, SATN140-BASE-201964013Z, SATN144-BASE-201964402BZ, STN140, STN140A-201964, STN140A-20196400KF, STN140-BASE-20191400KF, STN144A-201964, STNV140, STNV140A-201964		
spare parts for	605077		
	GEV No.	365062	Ref. No. —
	starting capacitor 80µF 220/300V 50/60Hz duty cycle 3min/1min ø 38mm L 98mm plastic connection cable 100mm		

Table continues overleaf



spare parts for 605077			
	GEV No.	380078	Ref. No. —
start relay DANFOSS 117U6005 HST			

R404a/R507

LBP monophase

Lower evaporation temperature below -20°C

			
1			
GEV No.	605058	Ref. No.	141555100055 BN141555100055
description	compressor coolant R404a/R507 type SC15CL 220-240V 50Hz LBP fully hermetic 13.8kg 1/2HP cylinder capacity 15.28cm ³ CSIR H 219mm 486W 637W 813W 1017W 1251W 1699W test method ASHRAE 175W 358W		
For models:	BT60, BT70, BT72, BTV70, KSA105-35-2045260CCO, KSA70-70PBT-2045800C0U, KSA70-70PBT-2045800CJ8, KSA70BT-204517, KSA70BT-2045170BYL, KSA70BT-2045170C0Z, KSA70BT-2045170CAA, KSAC105-35-2045160C0S, KSAC70-70-2045780BRL, KSAC70-70-2045780CJ6, KST02BT-205112, KST02BT-VCR-205702, KST02BT-VCR-205712, KST-BT-VCR02, KSTP02BT-205312, NFB0140NF, NFB0143FN, NFB0143NF, NFB0143PF, NFS140IF, NFS140NF, NFS143FN, NFS143IF, P140BT-2047220101, P140BT-2047260101, P144BT-2047360100, P70-70TNN-BT-2047560100, P70BT-2047020101, P70BT-2046060101, P70TNN-2047040101, S140BT-2048220101, S70BT-2048020101, SPA70-70TN-BT-201778030BYA, SPABT60-20171603, SPABT60-201716030C19, SPABT60-201716030C1A, SPABT60-201716030C1B, SPABT70-20171703, SPABT70-201717030BY7, SPABT72-201717030C14, SPABTV70-201717030C1C, T140BT-2046260100, T144BT-2046xxxxx, T70-70TNN-BT-2046560100, T70BT-2046020100, T70BT-2046060x00... (Other models you can see in the webshop)		
spare parts for 605058			
	GEV No.	380058	Ref. No. —
start relay DANFOSS 117U6019/F278 HST			

evaporation and condensing trays

condensing trays heated

universal

heating cartridges

			
1			
GEV No.	417227	Ref. No.	1666090 1666150 BN1666090
description	heating cartridge 90W 230V ø 12mm L 124mm thread 3/8" cable length 4000mm Hmm Wmm condensate evaporation		
For models:	KB100-20180720, KB200-20181420, KBT120-20081410, KBT120-2008140218, KBT120-BASE-2008140218, KBT120-BASE-20081402BT, KBT120-BASE-20081402XU, KBT120-BASE-2008140431, KBT120-P0120081410, KBT122-20081402XU, KBT122-20081420, KBT122-20081402XU, KBT124-2008140431, KBT124-20081430, KBT124-P0120081430, KBT140-200214011K, KBT140-200214011M, KBT140-20021410, KBT140-BASE-200214011K, KBT140-BASE-200214011L, KBT140-BASE-200214011N, KBT142-200214011L, KBT142-20021420, KBT144-200214011M, KBT144-20021430, KBT40-21091640, KBT40-210916400BAJ, KBT60-2008070124, KBT60-20080710, KBT60-BASE-2008070124, KBT60-BASE-2008070126, KBT60-BASE-20080705H5, KBT62-20080705H5, KBT62-20080720, KBT62-20080705H5, KBT70, KBT70-20020700YN, KBT70-200207061E, KBT70-20020710, KBT70-BASE-20020700YL, KBT70G-200220, KBT70G-BASE-20022001TZ, KBT72-200207061E, KBT72-20020720, KBT72-210207, KBT72-BASE-200207061E, KBTG70-20020770, KBTV120, KBTV120-20081402BT, KBTV120-20081440...(Other models you can see in the webshop)		

→ electric components



fans

axial fans

import



GEV No.	601080 ¹	Ref. No.	1648110107 MACM303000
description	axial fan L 119mm W 119mm H 38mm 230VAC 50/60Hz 23/20W bearing ball bearing connection male faston 2.8mm metal ADDA fan wheel ø 110mm temp.-resist. 70°C		
For models:	KBT40-21091640, KBT40-210916400BAJ, KTAP00BT-BASE-2022550105KR, KTAP01BT-BASE-2022590105KU, KTAP02BT-205301, KTAP02BT-205302, KTAP02BT-205303, KTAP02BT-BASE-2022630105KW, KTAP03BT-BASE-2022680109UW, KTAPBT00, KTAPBT01, KTAPBT02, KTAPBT03, KTARBT02, KTARBT03, KTARBT04, KTN40-21090640, KTN40-210906400BAI, M70TN, PIZZA160, ROLL-IN-1P, ROLL-IN-1P-2110081205Z6, ROLL-IN-1P-BT, ROLL-IN-1P-BT-2110091206GZ, ROLL-IN-1PP, ROLL-IN1PP-BT, ROLL-IN-1PPM, ROLL-IN-1PPV, ROLL-IN-1PV, ROLL-IN-1PV-2110081206F1, ROLL-IN-2PPM-TN, ROLL-IN-2PPM-TN-2110162206X4, ROLL-IN-2PP-TN, ROLL-IN-2PP-TN-2110162205Z9, ROLL-IN-2PPV-TN, ROLL-IN-2PPV-TN-2110162206FC, ROLL-IN-2P-TN, ROLL-IN-2P-TN-2110161205Z8, ROLL-IN-2PV-TN, ROLL-IN-2PV-TN-2110161206F9, ROLL-INP-1P-2110082205Z7, ROLL-INP-1P-2110082206F6, ROLL-INP-1P-2110082206X3, ROLL-INP-1P-BT-2110092206KU, TARS21, TARS21-2124100021, TARS22E-2124091022, TARS22EP-2124091023, TARS22ES-2124091022		
accessories for	601080		
	GEV No.	550898	Ref. No. —
	connecting cable cable length 2000mm connection F 2.8 connection distance 7.9mm for axial flow fan		
	GEV No.	692519	Ref. No. —
	guard L 120mm W 120mm plastic		

¹with ball bearings



GEV No.	601055 ¹	Ref. No.	1648110086 1648110150 BN1648110150
description	axial fan L 92mm W 92mm H 25mm 230VAC 50/60Hz 14.5/14W bearing ball bearing connection male faston 2.8mm metal ADDA fan wheel ø 85mm temp.-resist. 70°C		
For models:	KST01BT-VCR-205711, KST01TN-205001, KST01TN-205011, KST-01TN-VCR-205611, KST02TN-205002, KST02TN-205012, KST02TN-NH760-205802, KST02TN-VCR-205602, KST02TN-VCR-205612, KST03TN-205003, KST03TN-205013, KST03TN-VCR-205603, KST03TN-VCR-205613, KST04TN-205004, KST04TN-205014, KST04TN-VCR-205604, KST04TN-VCR-205614, KSTP01TN-205211, KSTP02TN-205212, KSTP03TN-205213, KSTP04TN-205214, KSTP05TN-205205, KSTP05TN-205215, KSTS24-205424, KSTS24-2054240IDP, KSTS24-2054240JGN, KST-TN01, KST-TN02, KST-TN03, KST-TN04, KST-TN-VCR01, KST-TN-VCR02, KST-TN-VCR03, KST-TN-VCR04, KTAR6-02-BASE-20231207MZ, KTAR6-02-BASE-20231207N0, KTAR6-02-BASE-20231207N1, KTAR6-03-202316010AMQ, KTAR6-03-202316010AMR, KTAR6-03-202316010AMS, KTAR902, KTAR9-02-202009040Y, KTARBT902, KTARI140-BASE-20210140, KTARI140-BASE-20210141, KTRE4-202117120G1J, TARS22-2124922, TARS22-212492208L6, TARS22-212492208VT, TARS22-21249220AO2... (Other models you can see in the webshop)		
accessories for	601055		
	GEV No.	550898	Ref. No. —
	connecting cable cable length 2000mm connection F 2.8 connection distance 7.9mm for axial flow fan		
	GEV No.	691103	Ref. No. —
	guard ø 90mm mounting distance 83mm for axial fan 92mm		

¹with ball bearings



refrigeration fans

refrigeration motors universal

ELCO

N series - multi fit



1

GEV No.	601430	Ref. No.	1648000510
description	fan motor ELCO 5W 230V 50/60Hz bearing slide bearing L1 48mm L2 52mm L3 79.5mm W 83mm connection cable 500mm 1300/1550rpm 5 mounting options VNT5-13/027		
For models:	KC25-45-20050710, KC45-12-20050725, KPBT25-45-20060710, KPBT4512-20060740, TARS22-2124922, TARS22-212492208L6, TARS22-212492208VT, TARS22-21249220AO2, TARS22-21249220AO3, TARS22-21249220AO4, TARS22-21249220AO6, TARS22-KIT1, TARS22-Kit1-212492201, TARS22-KIT2, TARS22-Kit2-212492202, TARS22-KIT3, TARS22-Kit3-212492203, TARS22-KIT4, TARS22-Kit4-212492204, TARS22-KIT5, TARS22-Kit5-212492205, TARS22-KIT6, TARS22-Kit6-212492206, TARS22-KIT6-21249220AO5, TARS22-KIT7, TARS22-Kit7-212492207, TP122-TARS22-KIT5-212492208VR		
spare parts for	601430		
	GEV No.	560140	Ref. No. —
	hexagonal nut thread M4 H 4.8mm SS WS 7 Qty 20 pcs DIN/ISO DIN 985 self-locking		
	GEV No.	560332	Ref. No. —
	plain washer ID ø 4.3mm ED ø 9mm thickness 0.8mm SS Qty 1 pcs		
	GEV No.	560340	Ref. No. —
	hexagonal nut thread M4 H 3.2mm WS 7 SS DIN/ISO DIN 934 / ISO 4032/8673 Qty 1 pcs		

N series - standard



1

GEV No.	601442	Ref. No.	1648001017 BN1648001017 FR6671010
description	fan motor ELCO 10W 230V 50-60Hz bearing slide bearing L1 45mm L3 83mm W 83mm cable length 1800mm 1300/1550rpm 3 mounting options VN10-20/507 triple		
For models:	140, 70, AFB-70-20171707G, AFB-70Sx-20171707GXPS, AFN-70-20170707G, AFN-70E-20173707G, AFN-70ESx-20173707GXPS, AP-140-221314XG, AP-70TN-221307XG, ARCO-BT70-20171704, ARCO-BT70430-20171705, ARCO-BT70-BASE-20171708, ARCO-BT70GN2-1-2017817304, ARCO-BT70-PLUS-20171709, ARCO-TN140-2017814301, ARCO-TN70-20170704, ARCO-TN70-2017807304, ARCO-TN70430-20170705, ARCO-TN7070-20177704, ARCO-TN7070-201777040GL70, ARCO-TN70-BASE-20170708, ARCO-TN70-PLUS-20170709, ARCO-TNBT7070-20177804, ARCO-TNN70-20170706, KSA105-35-2045150C0R, KSA105-35-2045260C0C, KSA140TN-2045140B8X, KSA140TN-2045140CAB, KSA140TN-2045140CAC, KSA70-70-2045770BYH, KSA70-70-2045770CJ5, KSA70-70PBT-2045800C0U, KSA70-70PBT-2045800CJ8, KSA70-70PTN-2045790C0T, KSA70-70PTN-2045790CJ7, KSA70BT-2045170BYL, KSA70BT-2045170C0Z, KSA70BT-2045170CAA, KSA70P-2045270C0W, KSA70TN-2045070B5E, KSA70TN-2045070C6A, KSA70TN-2045070CA9, KSAC105-35-2045160C0S, KSAC70-70-2045780BRL, KSAC70-70-2045780CJ6, KSACTN70-70-2045770EVM0, KSAP105-35-2045250CC1, KSAP35-35-2045450CBT, KSAPC35-35-2045460CBU, K TAR6-03-202316010AMQ...		
	(Other models you can see in the webshop)		



IMPORT

multi fit fan motors



1

GEV No.	601022	Ref. No.	1648001010 1648001015 BN1648001015
description	fan motor 10W 230V 50-60Hz L1 44mm L2 54mm L3 85mm W 84mm cable length 500mm 1300rpm YZF10-20-18/26 5 mounting options bearing slide bearing		
For models:	AFN-70ESx-20173707GXPS, B100, B120, BT140, BT60, BT70G, KB100-20180720, KB120-20180710, KB200-20181420, KB240-20181410, KBC5, KBC5-BASE-20350502PK, KBCF5, KBCF5-BASE-20360502PN, KBT120-BASE-2008140218, KBT120-BASE-20081402BT, KBT120-BASE-20081402XU, KBT120-BASE-2008140431, KBT122-20081402XU, KBT124-2008140431, KBT40-21091640, KBT40-210916400BAJ, KBT60-2008070124, KBT60-20080710, KBT60-BASE-2008070124, KBT60-BASE-2008070126, KBT60-BASE-20080705H5, KBT62-20080705H5, KBT62-20080720, KBT62-20080705H5, KBT70-20020700YN, KBT70-200207061E, KBT70-20020710, KBT70-BASE-20020700YL, KBT70G-BASE-20022001TZ, KBT72-20020720, KBT72-BASE-200207061E, KBTG140-20021470, KBTV120-20081402BT, KBTV60-2008070126, KBTV60-20080730, KBTV60-P0120080730, KBTV70-20020730, KBTV70-BASE-20020700YN, KC105-35-20051440, KC10535-20051440, KC25-45-20050710, KC2545-20050710, KC3513-20050715, KC3535-20050720...(Other models you can see in the webshop)		

accessories

fan wheels

aluminium

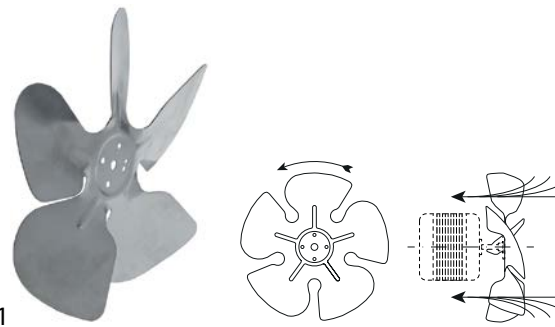

1

GEV No.	601070	Ref. No.	1495200028 FR925648
description	fan wheel sucking ø 200mm fan wheel mounting 25.4mm blade angle 28° W 38mm aluminium		
For models:	KBT40-21091640, KBT40-210916400BAJ, KC25-45-20050710, KC2545-20050710, KC3513-20050715, KC3535-20050720, KC45-12-20050725, KC4512-20050725, KCTN10535-20031440, KCTN2545-20030725, KCTN3030-20090710, KCTN3513-20030730, KCTN3535-20030735, KCTN45-12-20030745, KCTN4512-20030745, KPBT105-35-20061420, KPBT10535-20061420, KPBT25-45-20060710, KPBT2545-20060710, KPBT3513-20060720, KPBT3535-20060730, KPBT3535c-20060730, KPBT4512-20060740, KPC30-30-20100720, KPC3030-20100720, KPC90-30-20101410, KPC9030-20101410, KPTN10535-20041440, KPTN25-45-20040720, KPTN2545-20040720, KPTN3513-20040725, KPTN3535-20040730, KTAP902, KTAR902, KTAR902-202009040Y, KTAR902BT-ESP66300BT-202509P0201, KTARB7902, KTARB79-02-BASE-20250904MU, KTARS21-2124100021, KTN40-21090640, KTN40-210906400BAI, KUC25-45-20150710, KUC2545-20150710, KUC3513-20150715, KUC35-35-20150720, KUC3535-20150720, KUC4512-20150725, KUUCTN10535-20131440, KUUCTN2545-20130710...(Other models you can see in the webshop)		



2

GEV No.	601023	Ref. No.	1648000514 1648001600 BN1648000514 BN1648001600 MA25314399
description	fan motor 16W 230V 50-60Hz L1 45mm L2 61mm L3 92mm W 84mm cable length 500mm 1300rpm YZF16-25-18/26 5 mounting options bearing slide bearing		
For models:	BT70G, KBF050-20350503, KBF050-20350503OCBO, KB-F050GB-20350103, KBF050GS-20350203, KBF050GS-20350203F, KBT120-2008140218, KBT120-BASE-2008140218, KBT120-BASE-20081402BT, KBT120-BASE-20081402XU, KBT120-BASE-2008140431, KBT122-20081402XU, KBT122-20081402XU, KBT124-2008140431, KBT140-200214011K, KBT142-200214011L, KBT144-200214011M, KBT60-BASE-2008070126, KBT70, KBT70-20020700YN, KBT70-200207061E, KBT70-20020710, KBT70-BASE-20020700YL, KBT70G-200220, KBT70G-BASE-20022001TZ, KBT72-200207061E, KBT72-20020720, KBT72-210207, KBT72-BASE-200207061E, KBTG140-20021470, KBTG70-20020770, KBTV120, KBTV120-20081402BT, KBTV140-200214011N, KBTV60, KBTV60-2008070126, KBTV70-200207, KBTV70-20020730, KBTV70-BASE-20020700YN, KC70-70-20051410, KC7070-20051410, KPBT105-35-20061420, KPBT10535-20061420, KPBT70-70-20061410, KPBT7070-20061410, KSABT70G-204537, KSABT70G-2045370CC4, KTARB703, KTARB703-BASE-2025180104FW, KTARB704...(Other models you can see in the webshop)		

GEV No.	601282	Ref. No.	1495200034 BN1495200034
description	fan wheel sucking ø 200mm fan wheel mounting 25.4mm blade angle 34° W 44mm aluminium		
For models:	AFN-140E-20173407G, AFN-70-20170707G, AFN-70E-20173707G, AFN-70ESx-20173707GXPS, AP-70TN-221307XG, ARCO-TN140-BASE-20171408, ARCO-TN140-PLUS-20171409, ARCO-TN140-20171404, ARCO-TN140430-20171405, ARCO-TN70-20170704, ARCO-TN70430-20170705, ARCO-TN7070-201777040GL70, ARCO-TN70-BASE-20170708, ARCO-TN70-PLUS-20170709, ARCO-TNN70-20170706, BT140, KSA105-35-2045150C0R, KSA105-35-2045260C0, KSA140BT-204524, KSA140BT-2045240BYF, KSA140BT-2045240C10, KSA140BT-2045240CAD, KSA140P-204534, KSA140P-2045340C0X, KSA140TN-204514, KSA140TN-2045140B8X, KSA140TN-2045140CAB, KSA140TN-2045140CAC, KSA70-70-2045770BYH, KSA70-70-2045770CJ5, KSA70-70PBT-2045800COU, KSA70-70PBT-2045800CJ8, KSA70-70PTN-2045790C0T, KSA70-70PTN-2045790CJ7, KSA70BT-204517, KSA70BT-2045170BYL, KSA70BT-2045170C0Z, KSA70BT-2045170CAA, KSA70P-204527, KSA70P-2045270C0W, KSA70TN-204507, KSA70TN-2045070B5E, KSA70TN-2045070C6A, KSA70TN-2045070CA9, KSAC105-35-2045160C0S, KSAC70-70-2045780BRL, KSAC70-70-2045780CJ6, KSAP105-35-2045250CC1, KSAP35-35-2045450CBT, KSAPC35-35-2045460CBU...(Other models you can see in the webshop)		

GEV No.	601172	Ref. No.	1495230034 BN1495230034
description	fan wheel sucking ø 230mm fan wheel mounting 25.4mm blade angle 34° W 50mm aluminium		
For models:	140, 70, AFB-70-20171707G, AFB-70Sx-20171707GXPS, AP-140-221314XG, ARCO-BT70-20171704, ARCO-BT70430-20171705, ARCO-BT70-BASE-20171708, ARCO-BT70GN2-1-2017817304, ARCO-BT70-PLUS-20171709, ARCO-TN140-2017814301, ARCO-TN70-2017807304, ARTN120, ARTN70, BT140, BT70G, KB100-20180720, KB120-20180710, KB200-20181420, KB240-20181410, KBT120-20081410, KBT120-BASE-2008140218, KBT120-BASE-20081402BT, KBT120-BASE-20081402XU, KBT120-BASE-2008140431, KBT120-P0120081410, KBT122-20081402XU, KBT122-20081420, KBT124-2008140431, KBT124-20081430, KBT124-P0120081430, KBT140-200214011M, KBT140-20021410, KBT140-BASE-200214011K, KBT140-BASE-200214011L, KBT140-BASE-200214011N, KBT142-20021420, KBT144-20021430, KBT60-2008070124, KBT60-20080710, KBT60-BASE-2008070124, KBT60-BASE-2008070126, KBT60-BASE-20080705H5, KBT62-20080705H5, KBT62-20080720, KBT62-20080705H5, KBT70-20020700YN, KBT70-200207061E, KBT70-20020710, KBT70-BASE-20020700YL...(Other models you can see in the webshop)		

GEV No.	601387	Ref. No.	1495254028 BN1495254028
description	fan wheel sucking ø 254mm fan wheel mounting 25.4mm blade angle 34° W 50mm aluminium		
For models:	BT70G, KBF050-20350503, KBF050-203505030CBO, KBF050GB-20350103, KBF050GS-20350203, KBF050GS-20350203F, KBT120-2008140218, KBT120-BASE-2008140218, KBT120-BASE-20081402BT, KBT120-BASE-20081402XU, KBT120-BASE-2008140431, KBT122-20081402XU, KBT122-20081402XU, KBT124-2008140431, KBT140-200214011K, KBT142-200214011L, KBT144-200214011M, KBT60-BASE-2008070126, KBT70, KBT70-20020700YN, KBT70-200207061E, KBT70-20020710, KBT70-BASE-20020700YL, KBT70G-200220, KBT70G-BASE-20022001TZ, KBT72-200207061E, KBT72-20020720, KBT72-210207, KBT72-BASE-200207061E, KBTG140-20021470, KBTG70-20020770, KBTV120, KBTV120-20081402BT, KBTV140-200214011N, KBTV60-2008070126, KBTV70-200207, KBTV70-20020730, KBTV70-BASE-20020700YN, KC6060-20091430, KC70-70-20051410, KC7070-20051410, KPBT105-35-20061420, KPBT10535-20061420, KPBT70-70-20061410, KPBT7070-20061410, KSABT70G-204537, KSABT70G-2045370CC4, KTARBTO3, KTARBTO3-BASE-2025180104FW, KTARBTO4...(Other models you can see in the webshop)		

cooling motors (various)

accessories for cooling fan

GEV No.	601814	Ref. No.	1433116050 BN1433116050
description	guard ø 250mm H 23mm mounting distance 234mm		
For models:	S120BT-2088420100, S120TN-2088400100, S120TNN-2088410100, S60BT-2088120100, S60TN-2088100100, S60TNN-2088110100		



cold air circulating fans (complete)

ebm-papst

A2E series

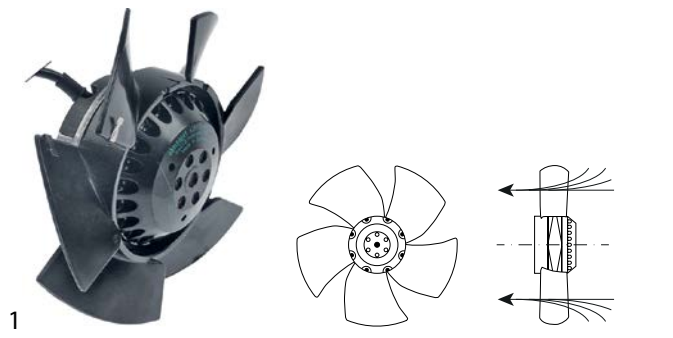

GEV No.	601963	Ref. No.	1648112000 BN1648112000
description	fan A2E170AF23-01 fan wheel ø 170mm blades 6 230V 50Hz 50/46W 2500rpm cable length 400mm ebm-papst sucking suitable capacitor 1.5µF		
For models:	KBC5, KBC5-BASE-20350502PK, KBCF5, KBCF5-BASE-20360502PN		
spare parts for	601963		
	GEV No.	365171	Ref. No. —
	capacitor capacity 1.5µF 400V tolerance 5% 50/60Hz ambient temperature max. -40 up to +85°C ø 25mm L 50mm M8 plastic connection cable 250mm MLR25PRL		

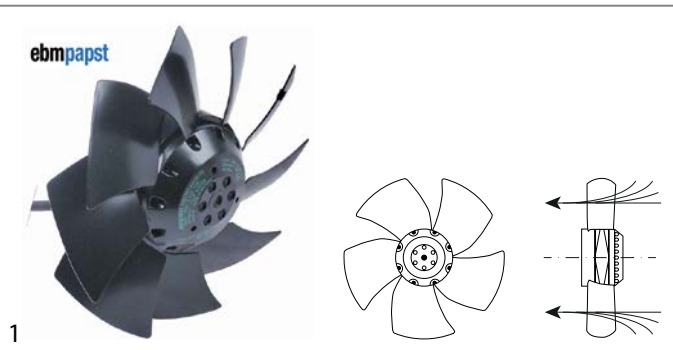

GEV No.	601535	Ref. No.	1648112005 BN1648112005
description	fan A2E200-AH38-01 fan wheel ø 200mm blades 9 230V 60Hz 78W 2600rpm cable length 450mm ebm-papst sucking suitable capacitor 1.5µF		
For models:	KBC10, KBC10-BASE-20351002PM, KBC6, KBC6-BASE-20350602PL, KBCF10, KBCF10-BASE-20361002PV, KBCF6, KBCF6-BASE-20360602PT		
spare parts for	601535		
	GEV No.	365008	Ref. No. —
	operating capacitor capacity 1.5µF 400V tolerance 5% 50/60Hz ambient temperature max. -25 to +85°C ø 25mm L 75mm M8 aluminium connection cable 300mm MKP protection IP65		

S6E series

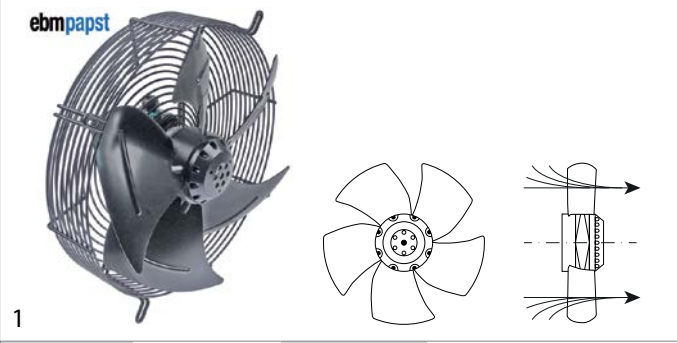

GEV No.	601624	Ref. No.	1648112008 BN1648112008
description	fan S6E330-AP02-34 fan wheel ø 330mm blades 5 230V 50Hz 65W 940rpm cable length 420mm ebm-papst blowing suitable capacitor 2µF		
For models:	KBC10, KBC10-BASE-20351002PM, KBC6, KBC6-BASE-20350602PL, KBCF10, KBCF10-BASE-20361002PV, KBCF6, KBCF6-BASE-20360602PT		

HIDRIA

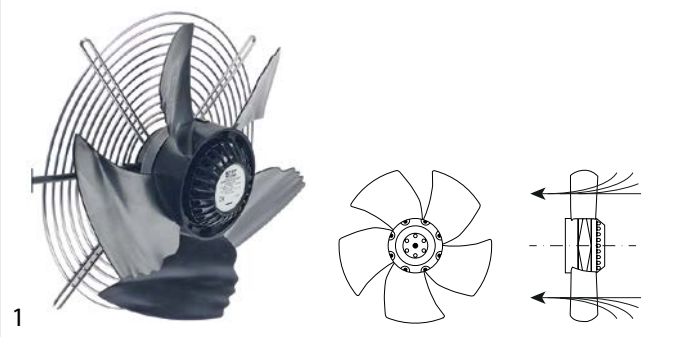

GEV No.	602029	Ref. No.	FR6678370
description	fan type R09R-30SPB-4M-3509 fan wheel ø 300mm 230V 50/60Hz 80W ø 105mm suitable capacitor 2.5µF HIDRIA suitable for blast chiller 1370rpm H 90mm cable length 1800mm mounting distance 255mm		

miscellaneous



GEV No.	601858	Ref. No.	996074 FR6671580 FR996074
description	fan 52W REH190X62-1CN fan wheel ø 190mm blades 16 230V 50/60Hz input current 0.39/0.49A H 70mm 2600/2900rpm connection 4-wire cable length 450mm rotation direction right XFAN with capacitor suitable capacitor 2.5µF		
For models:	030, KBF030-20362030, PBF030-AFG-20362231		
spare parts for	601858		
	GEV No.	365170	Ref. No. —
	capacitor capacity 2µF 425V tolerance 5% 50/60Hz ambient temperature max. -25 to +85°C ø 25mm L 49mm M8 plastic connection cable 250mm 416.17.74 protection		



cross flow fans

ebm-papst



1

GEV No.	601000	Ref. No.	1648106045 BN1648106045
description	cross flow fan ebm-papst QLK45/0006-2513 roller ø 45mm roller length 60mm laminated core thickness 13mm motor position left 230V/50Hz 15W refrigeration bearing rubber connection male faston 6.3mm airflow 36m ³ /h 0 up to +60°C		
For models:	KTAP00, KTAP00-BASE-20220501062N, KTAP01, KTAP01-205202, KTAP01-205204, KTAP01-BASE-20220901044U, KTAP02, KTAP02-600-20221205CN, KTAP02-BASE-20221301048K, KTAP03, KTAP03-BASE-2022180109UA, KTAP04, KTAP04-BASE-2022230109RY, KTAP84EN-20228403, KTAR01, KTAR02, KTAR03, KTAR03-BA-SE-2020180105, KTAR04, KTAR602, KTAR612, KTAR614, KTARS24, KTARS35		

EMMEVI - FERGAS

with moulded coils



1

GEV No.	601110	Ref. No.	1648106018 BN1648106018
description	cross flow fan TGO 60/1-180/20 roller ø 60mm roller length 180mm laminated core thickness 20mm motor position left 230V/50Hz 28W refrigeration bearing rubber connection male faston 6.3mm -30 up to +100°C 230V cable length 1800mm		
For models:	KC105-35-20051440, KC10535-20051440, KC3535-20050720, KC6060-20091430, KC70-70-20051410, KC7070-20051410, KC9030-20091420, KCTN10535-20031440, KCTN2545-20030725, KCTN3030-20090710, KCTN3513-20030730, KCTN3535-20030735, KCTN45-12-20030745, KCTN60-60-20091410, KCTN6060-20091410, KCTN7070-20031410, KP140-20041405, KP60-20100710, KP70-20040710, KPBT105-35-20061420, KPBT25-45-20060710, KPBT3513-20060720, KPBT3535c-20060730, KPBT70-70-20061410, KPBT7070-20061410, KPC30-30-20100720, KPC90-30-20101410, KPC9030-20101410, KPTN10535-20041440, KPTN25-45-20040720, KPTN3513-20040725, KPTN3535-20040730, KPTN70-70-20041410, KPTN7070-20041410, KTAP02-600-20221205CN, KTAP03-600-20221705CM, KTAP82, KTAP82-202282020AWR, KTAP83, KTAP83-202283020AWS, KTAP84, KTAP84-202284020AWT, KTAR01, KTAR01-BASE-20201001, KTAR01N, KTAR01N-BASE-20201005043V, KTAR02, KTAR02-600-BA-SE-20201205CU, KTAR02N, KTAR02N-BASE-20201305043Y...(Other models you can see in the webshop)		

COPREL

with moulded coils



1

GEV No.	601399	Ref. No.	6670250 FR6670250
description	cross flow fan COPREL TFL roller ø 60mm roller length 270mm laminated core thickness 35mm motor position left 230V/50Hz 49W refrigeration bearing rubber connection cable 2700mm coil type impregnated -10 up to +60°C		
For models:	P35-35TNN-2047440100, P35-35TNN-BT-2047460100, T35-35TNN-2046440100, T35-35TNN-BT-2046460100		

electric accessories

terminals

connection terminals with screw/faston connections



1

GEV No.	550349	Ref. No.	A036204
description	power terminal block 4-pole max. 40A max 400V connection ø6mm ² / F6.3 temp.-resist. 150°C cross section 6mm ²		



1

GEV No.	550977 ¹	Ref. No.	A036206
description	power terminal block 6-pole max. 40A max 450V connection ø6mm ² / F6.3 temp.-resist. 150°C cross section 6mm ² with ground lug		

¹with ground lug



gas taps

PEL

21S series







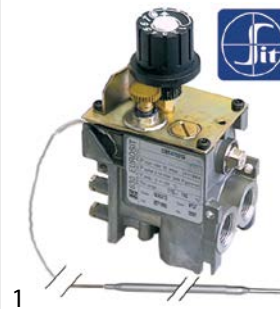

GEV No.	101095	Ref. No.	A011490
description	gas tap PEL type 21S gas inlet M16x1.5 (tube ø 10mm) bypass nozzle ø 0.35mm gas outlet M16x1.5 (tube ø 10/8mm) thermocouple connection M8x1 pilot connection M10x1 shaft ø 8x6.5mm shaft L 22/15mm shaft flat lower		
spare parts for	101095		
	GEV No.	100408	Ref. No. —
	bypass nozzle type PEL20/21 bore ø 0.35mm thread M5x0.5		
	GEV No.	101060	Ref. No. —
	magnet unit standard L 39mm D1 ø 15.4mm D2 ø 11mm suitable for PEL20-21/JUNKERS/EGA		
	GEV No.	101206	Ref. No. —
	gas tap front part shaft ø 8x6.5mm shaft L 22/15mm shaft flat upper/lower suitable for PEL21		
	GEV No.	101230	Ref. No. —
	thermocouple nut T1: M8x1 T2: M18x1 aluminium		
accessories for	101095		
	GEV No.	100908	Ref. No. A016110 A017000
	union screw thread M10x1 for pipe ø 4mm Qty 1 pcs		
	GEV No.	100909	Ref. No. —
	union screw thread M10x1 for pipe ø 6mm Qty 1 pcs		
	GEV No.	101246	Ref. No. A016120
	olive for pipe ø 4mm Qty 1 pcs		
	GEV No.	101278	Ref. No. A011480
	olive for pipe ø 10mm Qty 1 pcs		
	GEV No.	101286	Ref. No. —
	olive ID ø 6mm Qty 1 pcs		
	GEV No.	101300	Ref. No. A011485
	union nut thread M16x1.5 tube ø 10mm		
	GEV No.	101450	Ref. No. —
	olive for pipe ø 8mm L 12.7mm Qty 1 pcs ED ø 10mm		
	GEV No.	101451	Ref. No. —
	union nut thread M16x1.5 tube ø 8mm		
	GEV No.	110081	Ref. No. —
	knob ø 70mm shaft ø 8x6.5mm shaft flat universal		
	GEV No.	112206	Ref. No. —
	knob dial plate silver gas tap PEL21/22/23 t.max.°C ED ø 63mm ID ø 45.5mm		

gas thermostats

SIT

630 Eurosit series



GEV No.	101188	Ref. No.	8219900
description	gas thermostat type 630 Eurosit series t.max. 190°C 110-190°C gas inlet 3/8" gas outlet 3/8" thermocouple connection M9x1 pilot connection M10x1 probe ø 4mm probe L 202mm capillary pipe 1050mm SIT		
accessories for	101188		
	GEV No.	100904	Ref. No. A011608
	locking screw M10x1 for pipe ø 4mm Qty 1 pcs		
	GEV No.	100905	Ref. No. —
	locking screw M10x1 for pipe ø 6mm Qty 1 pcs		
	GEV No.	101273	Ref. No. A011625
	olive for pipe ø 12mm L 9.5mm brass Qty 1 pcs suitable for universal		
	GEV No.	101276	Ref. No. A011620
	union screw thread 3/8" tube ø 12mm Qty 1 pcs		
	GEV No.	101333	Ref. No. —
	plug thread 3/8" with O-ring		



















GEV No.	101125	Ref. No.	8219950
description	gas thermostat type 630 Eurosit series t.max. 340°C 100-340°C gas inlet 3/8" gas outlet 3/8" thermocouple connection M9x1 pilot connection M10x1 probe ø 4mm probe L 72mm capillary pipe 1050mm SIT		
accessories for	101125		
	GEV No.	100825	Ref. No. —
	gas tap spindle shaft ø 8x6.5mm shaft L 22/14mm suitable for EUROSIT		
	GEV No.	100904	Ref. No. A011608
	locking screw M10x1 for pipe ø 4mm Qty 1 pcs		
	GEV No.	100905	Ref. No. —
	locking screw M10x1 for pipe ø 6mm Qty 1 pcs		

Table continues overleaf



accessories for		101125		
	GEV No.	100949	Ref. No.	—
gasket suitable for 630 Eurosit series				
	GEV No.	101273	Ref. No.	A011625
olive for pipe ø 12mm L 9.5mm brass Qty 1 pcs suitable for universal				
	GEV No.	101276	Ref. No.	A011620
union screw thread 3/8" tube ø 12mm Qty 1 pcs				
	GEV No.	101333	Ref. No.	—
plug thread 3/8" with O-ring				
	GEV No.	101390	Ref. No.	—
gas tap spindle shaft ø 6x4.6mm shaft L 32/15mm gas tap with ignition flame suitable for ZANUSSI, MARENO for gas thermostat EUROSIT				
	GEV No.	101392	Ref. No.	—
adapter suitable for 630 Eurosit series				
	GEV No.	110357	Ref. No.	—
gas tap spindle shaft ø 8x6.5mm shaft L 36/12mm suitable for 630 Eurosit series				
	GEV No.	110358	Ref. No.	—
adapter shaft ø 10x8mm shaft L 29/18mm suitable for 630 Eurosit series				

accessories for		107701		
	GEV No.	100904	Ref. No.	A011608
locking screw M10x1 for pipe ø 4mm Qty 1 pcs				
	GEV No.	100905	Ref. No.	—
locking screw M10x1 for pipe ø 6mm Qty 1 pcs				
	GEV No.	102110	Ref. No.	—
pilot tube copper pipe ø 4mm thickness 1mm L 3000mm				
	GEV No.	102111	Ref. No.	—
pilot tube copper pipe ø 6mm thickness 1mm L 3000mm				
	GEV No.	102742	Ref. No.	—
pilot burner nozzle LPG code 25 bore ø 0.25mm Qty 1 pcs				

ignition parts



pilot burners

SIT

100 series

accessories

pilot burner bottom parts

	1			
GEV No.	107701	Ref. No.	2510359	
description pilot burner bottom part SIT 100 series nozzle ø 0.2mm				
spare parts for		107701		
	GEV No.	100245	Ref. No.	—
pilot burner nozzle LPG code 20 bore ø 0.2mm Qty 1 pcs thread M8x0.75				
	GEV No.	100916	Ref. No.	—
compression spring for pilot burner Qty 1 pcs				
	GEV No.	100917	Ref. No.	—
gasket for pilot burner Qty 1 pcs aluminium				
	GEV No.	100918	Ref. No.	—
screw for pilot burner				
accessories for		107701		
	GEV No.	100246	Ref. No.	—
pilot burner nozzle natural gas bore ø 0.35mm Qty 1 pcs thread M8x0.75				

ignition electrodes



GEV No.	100707	Ref. No.	A013302
description ignition electrode D1 ø 7mm D2 ø 9mm connection ø 2.4mm L1 14mm L2 6mm BL1 18mm BL2 3mm BL3 23mm to clip Qty 1 pcs			

POLIDORO

pilot burners





	1			
GEV No.	100076	Ref. No.	A013220	
description pilot burner POLIDORO 3 flames natural gas code 29.2 gas connection 6mm				
spare parts for		100076		
	GEV No.	100907	Ref. No.	—
screw connection thread M10x1 Qty 1 pcs type SEF 1 ømm for thermocouple				
accessories for		100076		
	GEV No.	100000	Ref. No.	—
pilot burner nozzle POLIDORO LPG code 22 bore ø 0.22mm Qty 1 pcs				
	GEV No.	100208	Ref. No.	—
pilot burner nozzle POLIDORO LPG code 20 bore ø 0.2mm Qty 1 pcs				
	GEV No.	100209	Ref. No.	—
pilot burner nozzle POLIDORO natural gas code 40 bore ø 0.4mm Qty 1 pcs				

Table continues overleaf

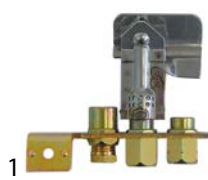

accessories for		100076		
	GEV No.	100701	Ref. No.	—
	ignition electrode connection M4 Qty 1 pcs			
	GEV No.	100906	Ref. No.	—
	screw connection thread M10x1 for ignition electrode brass Qty 1 pcs WS 10			
	GEV No.	100907	Ref. No.	—
	screw connection thread M10x1 Qty 1 pcs type SEF 1 0mm for thermocouple			
	GEV No.	100908	Ref. No.	A016110 A017000
	union screw thread M10x1 for pipe 4mm Qty 1 pcs			
	GEV No.	100909	Ref. No.	—
	union screw thread M10x1 for pipe 6mm Qty 1 pcs			
	GEV No.	102110	Ref. No.	—
	pilot tube copper pipe 4mm thickness 1mm L 3000mm			
	GEV No.	102111	Ref. No.	—
	pilot tube copper pipe 6mm thickness 1mm L 3000mm			
	GEV No.	102508	Ref. No.	—
	union screw thread M10x1 for pipe 4mm Qty 5 pcs			
	GEV No.	102509	Ref. No.	—
	union screw thread M10x1 for pipe 6mm Qty 5 pcs			
	GEV No.	102699	Ref. No.	—
	pilot burner nozzle POLIDORO natural gas code 25.2 bore 2x0.25mm Qty 1 pcs 2 bores			
	GEV No.	102795	Ref. No.	—
	olive for pipe 4mm Qty 1 pcs			
	GEV No.	102797	Ref. No.	—
	olive for pipe 6mm Qty 1 pcs			
	GEV No.	106703	Ref. No.	A013230
	pilot burner nozzle POLIDORO natural gas code 27.2 bore 2x0.27mm Qty 1 pcs			
	GEV No.	106704	Ref. No.	A013240
	pilot burner nozzle POLIDORO LPG code 16.2 bore 2x0.16mm Qty 1 pcs			
	GEV No.	106763	Ref. No.	—
	pilot burner nozzle POLIDORO natural gas code 27.2A bore 2x0.27mm Qty 1 pcs			
	GEV No.	106859	Ref. No.	—
	pilot burner nozzle POLIDORO LPG code 24 bore 0.24mm Qty 1 pcs			

electrodes

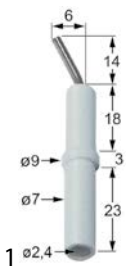

GEV No.	100707	Ref. No.	A013302
description	ignition electrode D1 7mm D2 9mm connection 2.4mm L1 14mm L2 6mm BL1 18mm BL2 3mm BL3 23mm to clip Qty 1 pcs		

ignition cables

pre-assembled cables



GEV No.	102181	Ref. No.	A041410
description	ignition cable cable length 1500mm connection 2.4mm / 2.4mm		



GEV No.	100016	Ref. No.	2510698
description	ignition cable cable length 900mm connection 2.4mm / 2.4mm		

piezoelectric igniters

mounting diameter 18mm



GEV No.	100009	Ref. No.	A041105	
description	piezoelectric igniter body plastic blowing mounting 18mm connection 2.4mm front measurements 26mm M18x1.5			
accessories for	100009			
	GEV No.	101339	Ref. No.	—
	cover cap for piezoelectric igniter			
	GEV No.	106869	Ref. No.	—
	cover cap for piezoelectric igniter ID 22mm ED 35mm H 25mm			
	GEV No.	107931	Ref. No.	—
	cover cap for piezoelectric igniter ID 21mm ED 36mm			



thermocouples

plug-in thermocouples

plug-in thermocouples standard

with barrel socket $\varnothing 6(6.5)$ mm

thermocouples SIT

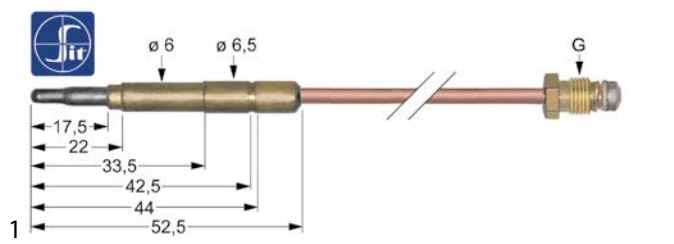

GEV No.	107608	Ref. No.	A011912
description	thermocouple SIT M9x1 L 500mm plug connection $\varnothing 6.0(6.5)$ mm		

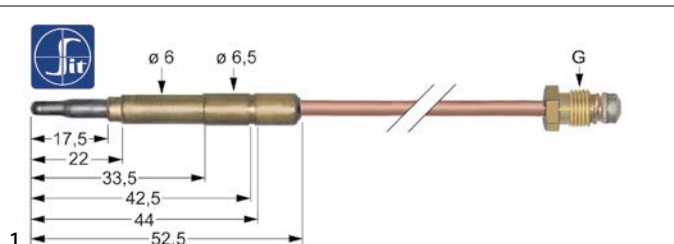

GEV No.	107609	Ref. No.	A011909
description	thermocouple SIT M9x1 L 600mm plug connection $\varnothing 6.0(6.5)$ mm		

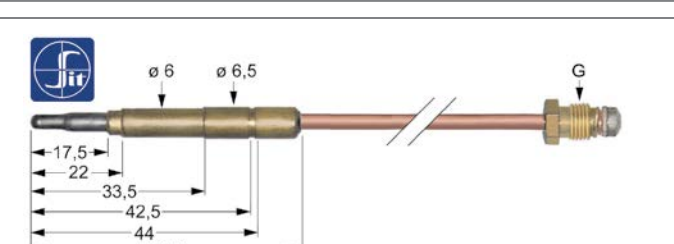

GEV No.	107611	Ref. No.	A011904
description	thermocouple SIT M9x1 L 850mm plug connection $\varnothing 6.0(6.5)$ mm		

thermocouples with aluminised tip

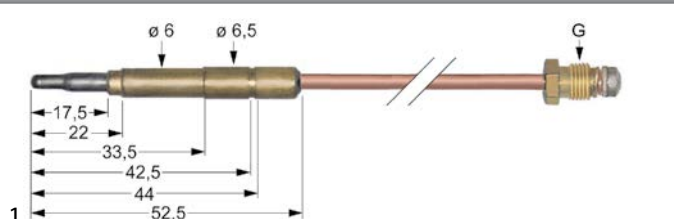

GEV No.	102045	Ref. No.	A011800
description	thermocouple M9x1 L 1500mm plug connection $\varnothing 6.0(6.5)$ mm		

gas burners

bar burners

bar burners



GEV No.	103154	Ref. No.	2519430
description	bar burner $\varnothing 40$ mm Wmm Hmm L 420mm flange width 43mm flange length 43mm fryer		



GEV No.	105436	Ref. No.	2510697
description	bar burner $\varnothing 50$ mm Wmm Hmm L 608mm flange width 71mm gas range flange $\varnothing 75$ mm		

accessories

nozzle holders



GEV No.	105290	Ref. No.	A014708
description	nozzle holder nozzle mounting M11x1		

accessories for	105290		
GEV No.	105280	Ref. No.	2510351



burner head C for burner cap $\varnothing 80$ mm 3.5kW

GEV No.	105281	Ref. No.	2510352
----------------	--------	-----------------	---------



burner cap C $\varnothing 80$ mm 3.5kW with central hole ID $\varnothing 32$ mm

GEV No.	105283	Ref. No.	2510354
----------------	--------	-----------------	---------



burner head D for burner cap $\varnothing 105$ mm 5.6kW

GEV No.	105284	Ref. No.	2510355
----------------	--------	-----------------	---------



burner cap ID $\varnothing 54$ mm D $\varnothing 105$ mm 5.6kW with central hole

GEV No.	105285	Ref. No.	2510353
----------------	--------	-----------------	---------



venturi D for burner cap $\varnothing 105$ mm 5.6kW

GEV No.	105286	Ref. No.	—
----------------	--------	-----------------	---





burner head E for burner cap $\varnothing 125$ mm 7kW

GEV No.	105287	Ref. No.	—
----------------	--------	-----------------	---



burner cap E $\varnothing 125$ mm 7kW with central hole

Table continues overleaf

accessories for	105290		
	GEV No.	105288	Ref. No. —
	venturi E for burner cap ø 125mm 7kW		
	GEV No.	105289	Ref. No. 2519002
	air mixing sleeve L 50mm ED ø 45mm ID ø 42mm aluminium		

gas nozzles

main nozzles

gas nozzles M11x1

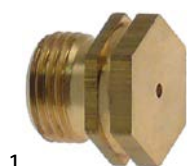

1	GEV No.	106642	Ref. No.	2510368
	description	gas injector thread M11x1 WS 13 bore ø 1.05mm		



1	GEV No.	100682	Ref. No.	2510370
	description	gas injector thread M11x1 WS 13 bore ø 1.15mm		



1	GEV No.	100686	Ref. No.	2510367
	description	gas injector thread M11x1 WS 13 bore ø 1.7mm		

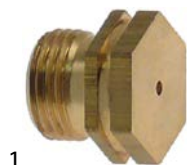

1	GEV No.	100689	Ref. No.	2510369
	description	gas injector thread M11x1 WS 13 bore ø 1.85mm		

pilot burner nozzles

pilot burner nozzles POLIDORO



1	GEV No.	106704	Ref. No.	A013240
	description	pilot burner nozzle POLIDORO LPG code 16.2 bore ø 2x0.16mm Qty 1 pcs		



1	GEV No.	106703	Ref. No.	A013230
	description	pilot burner nozzle POLIDORO natural gas code 27.2 bore ø 2x0.27mm Qty 1 pcs		

pilot burner nozzles SIT

100 series



1	GEV No.	107170	Ref. No.	A013103
	description	pilot burner nozzle SIT natural gas bore ø 0.35mm Qty 1 pcs		

auxiliary gas parts

screw connections

olives





1	GEV No.	101249	Ref. No.	A011470
	description	olive for pipe ø 10mm Qty 1 pcs		

accessories for	101249			
	GEV No.	101250	Ref. No.	A011475
	union nut thread M20x1.5 for pipe ø 10mm			



1	GEV No.	101278	Ref. No.	A011480
	description	olive for pipe ø 10mm Qty 1 pcs		



accessories for	101278			
	GEV No.	100943	Ref. No.	—
	union nut thread M17x1 tube ø 10mm			

	GEV No.	101300	Ref. No.	A011485
	union nut thread M16x1.5 tube ø 10mm			



	GEV No.	101478	Ref. No.	—
	union nut thread 3/8" for pipe ø 10mm			







			
1			
GEV No.	106638	Ref. No.	A016300
description	olive for pipe ø 12mm L 10mm Qty 1 pcs		



			
1			
GEV No.	101273	Ref. No.	A011625
description	olive for pipe ø 12mm L 9.5mm brass Qty 1 pcs suitable for universal		
accessories for	101273		
	GEV No.	100944	Ref. No. —
union nut thread M18x1.5 for pipe ø 12mm			
	GEV No.	101276	Ref. No. A011620
union screw thread 3/8" tube ø 12mm Qty 1 pcs			

			
1			
GEV No.	106637	Ref. No.	A016900
description	olive for pipe ø 4mm L 7mm Qty 1 pcs		

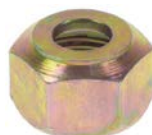
			
1			
GEV No.	101246	Ref. No.	A016120
description	olive for pipe ø 4mm Qty 1 pcs		
accessories for	101246		
	GEV No.	100908	Ref. No. A016110 A017000
union screw thread M10x1 for pipe ø 4mm Qty 1 pcs			

union nuts			
			
1			
GEV No.	101300	Ref. No.	A011485
description	union nut thread M16x1.5 tube ø 10mm		
accessories for	101300		
	GEV No.	101278	Ref. No. A011480
olive for pipe ø 10mm Qty 1 pcs			

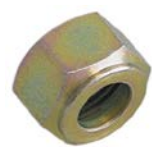
			
1			
GEV No.	101250	Ref. No.	A011475
description	union nut thread M20x1.5 for pipe ø 10mm		
accessories for	101250		
	GEV No.	101249	Ref. No. A011470
olive for pipe ø 10mm Qty 1 pcs			

			
1			
GEV No.	101251	Ref. No.	A016200
description	union nut thread M20x1.5 for pipe ø 12mm		
accessories for	101251		
	GEV No.	101248	Ref. No. —
olive for pipe ø 12mm Qty 1 pcs suitable for PEL			

union screws			
			
1			
GEV No.	100904	Ref. No.	A011608
description	locking screw M10x1 for pipe ø 4mm Qty 1 pcs		

			
1			
GEV No.	100908	Ref. No.	A016110 A017000
description	union screw thread M10x1 for pipe ø 4mm Qty 1 pcs		
accessories for	100908		
	GEV No.	100897	Ref. No. —
olive for pipe ø 4mm Qty 1 pcs for pilot burner			
	GEV No.	101246	Ref. No. A016120
olive for pipe ø 4mm Qty 1 pcs			
	GEV No.	101280	Ref. No. —
olive for pipe ø 4mm Qty 1 pcs			
	GEV No.	101282	Ref. No. —
olive for pipe ø 4mm L 7.4mm Qty 1 pcs			

equipment-specific units

for fridges

housing and bezels

miscellaneous

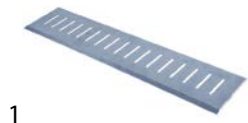

1

GEV No.	691590	Ref. No.	33277017 BN33277017
description	protective plate L 580mm H 125mm		
For models:	ARCO-BT140-20172404, ARCO-BT140-20172405, ARCO-BT140-BA-SE-20172408, ARCO-BT140-PLUS-20172409, ARCO-BT70-20171704, ARCO-BT70430-20171705, ARCO-BT70-BASE-20171708, ARCO-BT70-PLUS-20171709, ARCO-TN140.-BASE-20171408, ARCO-TN140.-PLUS-20171409, ARCO-TN140-20171404, ARCO-TN140430-20171405, ARCO-TN70-20170704, ARCO-TN70430-20170705, ARCO-TN70-BA-SE-20170708, ARCO-TN70-PLUS-20170709, ARCO-TNN70-20170706, NFB0070F, NFB0070N, NFB0070P, NFB0072F, NFB0072N, NFB0072P, NFB0140F, NFB0140N, NFB0140P, NFB0144F, NFB0144N, NFB0144P, NORD-700BT-2017817305, NORD-700BT-2017817305P, NORD-700TNN-2017807305, NORD-700TNN-2017807305P		

for cold storage cells

pressure compensation valves



1

GEV No.	750332	Ref. No.	14970302 BN14970302 FR4750450
description	pressure compensation valve mounting ø 61mm MiniElebar T.N. unheated for walk-in fridge +1 up to +10°C built-in depth 60mm mounting pos. horizontal		
For models:	ARBT70, KBT120-20081410, KBT120-2008140218, KBT120-BA-SE-2008140218, KBT120-BASE-20081402BT, KBT120-BASE-20081402XU, KBT120-BASE-2008140431, KBT120-P0120081410, KBT122-20081402XU, KBT122-20081420, KBT122-20081402XU, KBT124-2008140431, KBT124-20081430, KBT124-P0120081430, KBT140-200214011K, KBT140-200214011M, KBT140-20021410, KBT140-BASE-200214011K, KBT140-BASE-200214011L, KBT140-BA-SE-200214011N, KBT142-200214011L, KBT142-20021420, KBT144-200214011M, KBT144-20021430, KBT60-2008070124, KBT60-20080710, KBT60-BASE-2008070124, KBT60-BASE-2008070126, KBT60-BASE-20080705H5, KBT62-20080705H5, KBT62-20080720, KBT62-20080705H5, KBT70, KBT70-20020700YN, KBT70-200207061E, KBT70-20020710, KBT70-BASE-20020700YL, KBT70G-200220, KBT70G-BASE-20022001TZ, KBT72-200207061E, KBT72-20020720, KBT72-210207, KBT72-BASE-200207061E, KBTG140-20021470, KBTG70-20020770, KBTV120, KBTV120-20081402BT, KBTV120-20081440, KBTV140-200214011N, KBTV140-20021440...(Other models you can see in the webshop)		
spare parts for	750332		
	GEV No.	750335	Ref. No. —
	ventilation grille suitable for MiniElebar ø 86mm mounting distance 69.5mm H 14.5mm		

knobs

accessories

gaskets



1

GEV No.	112529	Ref. No.	2519490
description	gasket for knob rubber D1 ø 36mm D2 ø 46mm thickness 9mm		

handles and hand wheels

cylindrical handles

fixed



1

GEV No.	540235	Ref. No.	A019302
description	cylindrical handle thread M6 ø 17mm L 40mm		

bracket handles



1

GEV No.	691327	Ref. No.	8222510
description	pull handle L 119mm H 37mm mounting distance 105mm handle M6		

locks

locking devices

producer-specific

POLARIS



1

GEV No.	695426	Ref. No.	1483010 BN1483010
description	housing plastic grey		
For models:	ARCO-BT140-20172404, ARCO-BT140-20172405, ARCO-BT140-BASE-20172408, ARCO-BT140-PLUS-20172409, ARCO-BT70-20171704, ARCO-BT70430-20171705, ARCO-BT70-BASE-20171708, ARCO-BT70-PLUS-20171709, ARCO-TN140.-BASE-20171408, ARCO-TN140.-PLUS-20171409, ARCO-TN140-20171404, ARCO-TN140430-20171405, ARCO-TN70-20170704, ARCO-TN70430-20170705, ARCO-TN70-BASE-20170708, ARCO-TN70-PLUS-20170709, ARCO-TNN70-20170706, NFB0070F, NFB0070N, NFB0070P, NFB0072F, NFB0072N, NFB0072P, NFB0140F, NFB0140N, NFB0140P, NFB0144F, NFB0144N, NFB0144P, NORD-700BT-2017817305, NORD-700BT-2017817305P, NORD-700TNN-2017807305, NORD-700TNN-2017807305P		



2

GEV No.	690462	Ref. No.	1483001 1483003 BN1483001 BN1483003	
description	key cylinder ø 23mm thread M19x1 mounting measurements 16.5x19mm hub 38-45mm shaft ø 11mm thread L 12mm			
For models:	AFN-70ESx-20173707GXPS, ARBT144, ARBT70, ARBT72, ARTN120, ARTN140, ARTN210, ARTN60, ARTN72, BT140, BT60, BT70, BT72, KB100-20180720, KB120-20180710, KB200-20181420, KB240-20181410, KBT120-200814, KBT120-20081410, KBT120-2008140218, KBT120-BASE-2008140218, KBT120-BASE-20081402BT, KBT120-BASE-20081402XU, KBT120-BASE-2008140431, KBT120-P0120081410, KBT122-20081402XU, KBT122-20081420, KBT122-20081402XU, KBT124-2008140431, KBT124-20081430, KBT124-P0120081430, KBT140-200214011K, KBT140-200214011M, KBT140-20021410, KBT140-BASE-200214011K, KBT140-BASE-200214011L, KBT140-BASE-200214011N, KBT142-200214011L, KBT142-20021420, KBT144-200214011M, KBT144-20021430, KBT40-21091640, KBT40-210916400BAJ, KBT60-2008070124, KBT60-20080710, KBT60-BASE-2008070124, KBT60-BASE-2008070126, KBT60-BASE-20080705H5, KBT62-20080705H5, KBT62-20080720...(Other models you can see in the webshop)			
spare parts for	690462			
	GEV No.	691589	Ref. No.	1483009 BN1483009
spare keys for key cylinder 690462 key number 9233				

	GEV No.	690825	Ref. No.	6440320 FR6440320 FR935400
description	key cylinder with slide latch ø 23mm thread M19x1 mounting measurements 16.5x19mm hub 30-37mm shaft ø 11mm thread L 22mm			
For models:	P105-35TNN-2047640100, P105-35TNN-BT-2047660100, P140BT-2047220101, P140BTV-2047260101, P140TN-2047200101, P140TNN-2047210101, P140TNNV-2047240101, P144BT-2047360100, P144TNN-2047350100, P35-35TNN-2047440100, P35-35TNN-BT-2047460100, P70-70TNN-2047540100, P70-70TNN-BT-2047560100, P70BT-2047020101, P70BTV-2046060101, P70TN-2041000101, P70TNN-2047010101, P70TNNV-2047040101, P72BT-2047120101, P72TNN-2047110101, S120BT-2088420100, S120TN-2088400100, S120TNN-2088410100, S140BT-2048220101, S140TN-2048200101, S60BT-2088120100, S60TN-2088100100, S60TNN-2088110100, S70BT-2048020101, S70TN-2048000101, S70TNN-2048010101, T140BTV-2046260100, T140TNN-2046240100, T35-35TNN-2046440100, T70BTV-2046060x00, T70TNN-2046040100			

	GEV No.	690637	Ref. No.	14830061 BN14830061
description	key cylinder with slide latch ø 23mm thread M19x1 mounting measurements 16.5x19mm hub 38-45mm shaft ø 11mm thread L 24mm			
For models:	AFB-140-20172407G, AFB-70-20171707G, AFB-70Sx-20171707GXPS, AFN-140E-20173407G, AFN-70-20170707G, AFN-70E-20173707G, AFN-70ESx-20173707GXPS, ARCO-BT140GN2-1-2017824301, ARCO-BT70GN2-1-2017817304, ARCO-TN140-2017814301, ARCO-TN70-2017807304, ARCO-TN7070-201777040GL70, BT140, BT70G, KSA140BT-204524, KSA140BT-2045240BYF, KSA140BT-2045240C10, KSA140BT-2045240CAD, KSA140P-204534, KSA140P-2045340C0X, KSA140TN-204514, KSA140TN-2045140B8X, KSA140TN-2045140CAB, KSA140TN-2045140CAC, KSA70BT-204517, KSA70BT-2045170BYL, KSA70BT-2045170C0Z, KSA70BT-2045170CAA, KSA70P-204527, KSA70P-2045270COW, KSA70TN-204507, KSA70TN-2045070B5E, KSA70TN-2045070C6A, KSA70TN-2045070CA9, KSA70G-204537, KSA70G-2045370CC4, KSA70G-204570EVM0, NFB0072FN, NFB0072NI, NFB0072NN, NFB0072PF, NFB0072PN, NFB0072PP, NFB0140NF, NFB0140NI, NFB0143FN, NFB0143NF, NFB0143NN, NFB0143PF, NFB0143PN...(Other models you can see in the webshop)			

	GEV No.	691589	Ref. No.	1483009 BN1483009
description	spare keys for key cylinder 690462 key number 9233			
For models:	AFN-70ESx-20173707GXPS, ARCO-BT140-20172404, ARCO-BT140-20172405, ARCO-BT140-BASE-20172408, ARCO-BT140-PLUS-20172409, ARCO-BT70-20171704, ARCO-BT70430-20171705, ARCO-BT70-BASE-20171708, ARCO-BT70-PLUS-20171709, ARCO-TN140.-BASE-20171408, ARCO-TN140.-PLUS-20171409, ARCO-TN140-20171404, ARCO-TN140430-20171405, ARCO-TN70-20170704, ARCO-TN70430-20170705, ARCO-TN70-BASE-20170708, ARCO-TN70-PLUS-20170709, ARCO-TNN70-20170706, B100, B120, B200, B240, BT140, BT60, BT70, BT72, BTV70, NFB0070F, NFB0070N, NFB0070P, NFB0072F, NFB0072N, NFB0072P, NFB0140F, NFB0140N, NFB0140P, NFB0144F, NFB0144N, NFB0144P, NORD-700BT-2017817305, NORD-700BT-2017817305P, NORD-700TNN-2017807305, NORD-700TNN-2017807305P, SPA120TN-201712030C17, SPA120TN-201712030C18, SPA120TNV-201712030CC3, SPA60TN-201706030C16, SPA60TNV-201706030CC2, SPA70TN-20170703, SPAB100-201706030CBR...(Other models you can see in the webshop)			

mechanical components, equipment accessories

hinges

spring assisted hinges

universal

CAFF/FERMOD

group 2

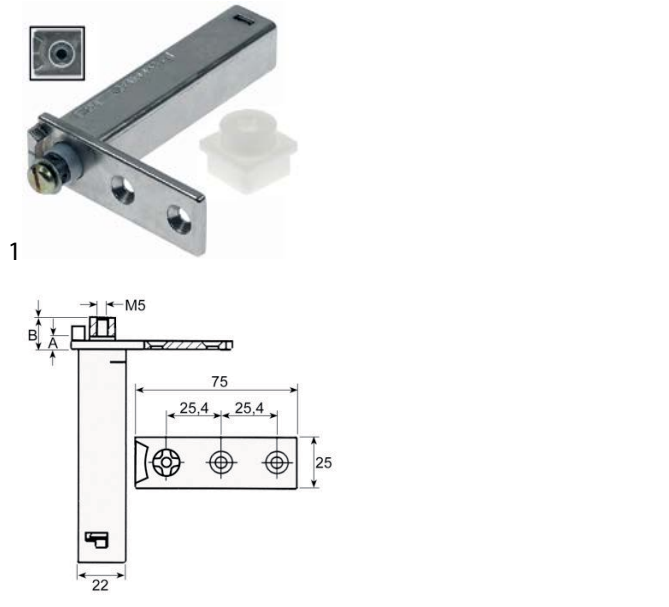

GEV No.	690494	Ref. No.	1412001 BN1412001
description	spring assisted hinge series 175 mounting pos. left/right torx L 75mm W 25.6mm H 100mm A 4mm B 11mm mounting measurements 22x22mm intake torx refrigeration units mounting distance 25mm		
For models:	ARBT144, ARBT70, ARBT72, ARTN120, ARTN140, ARTN210, ARTN60, ARTN70, ARTN72, KBC10, KBC10-BASE-20351002PM, KBC5, KBC5-BASE-20350502PK, KBC6, KBC6-BASE-20350602PL, KBCF10, KBCF10-BASE-20361002PV, KBCF5, KBCF5-BASE-20360502PN, KBCF6, KBCF6-BASE-20360602PT, KBT120-20081410, KBT120-2008140218, KBT120-BASE-2008140218, KBT120-BASE-20081402XU, KBT120-BASE-2008140431, KBT120-P0120081410, KBT122-20081402XU, KBT122-20081420, KBT122-20081402XU, KBT124-2008140431, KBT124-20081430, KBT124-P0120081430, KBT140-200214011K, KBT140-200214011M, KBT140-20021410, KBT140-BASE-200214011K, KBT140-BASE-200214011L, KBT142-200214011L, KBT142-20021420, KBT144-200214011M, KBT144-20021430, KBT40-21091640, KBT40-210916400BAJ, KBT60-2008070124, KBT60-20080710, KBT60-BASE-2008070124, KBT60-BASE-20080705H5, KBT62-20080705H5, KBT62-20080720...(Other models you can see in the webshop)		

INTERKLIMAT

hinges

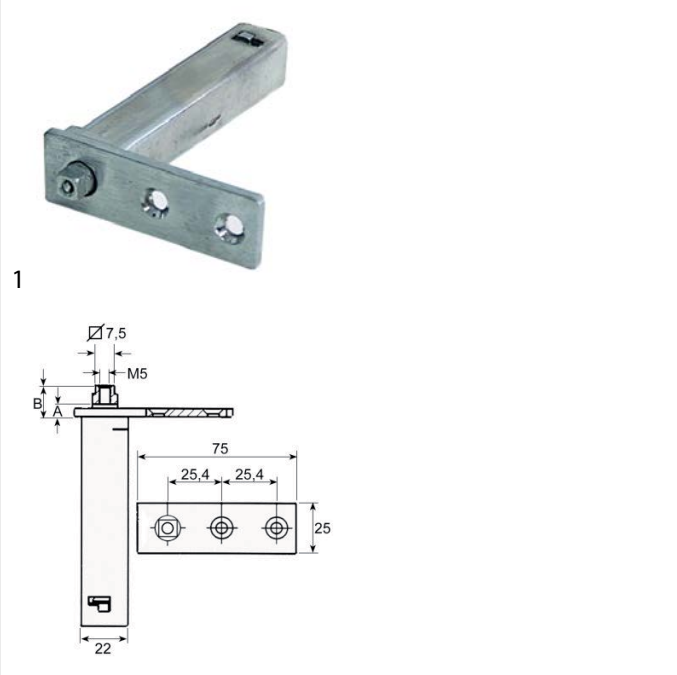

GEV No.	690714	Ref. No.	1412050 2476700 BN1412050 MA2476700
description	spring assisted hinge series 28XC mounting pos. left/right L 75mm W 25mm H 103mm A 8mm B 11mm intake 7.5x7.5 refrigeration units mounting distance 25mm		
For models:	KBF050-20350503, KBF050-20350503CBO, KBF050GB-20350103, KBF050GS-20350203, KBF050GS-20350203F, SABT140-BASE-2017240108EL, SABT140-DOUBLE-DOOR-20197400KG, SABT144-BASE-201974402C2, SABT70-2017170208EB, SABT70-BASE-2017170108EB, SABT70-SINGLE-DOOR-20196700HC, SABT72-BASE-201967202BW, SABTV70-BASE-2017170108ER, SATN140-201714020998, SATN140-BASE-20196400KF, SATN144-BASE-20171402099A, SATN144-BASE-201964402BZ, SATN70-201707020994, SATN70-BASE-20195700F9, SATN72-BASE-201707020997, SATN72-BASE-201957202BM, SATNBT3535-BASE-20193603CV, SATNBT7070-BASE-201967803CU, SATNN140-2017140208DW, SATNN144-BASE-2017140208RY, SATNN70-2017070208EA, SATNN72-BASE-2017070208RX, SATNTN3535-BASE-20193503CP, SATNTN7070-BASE-201967703CT, SBE140-BASE-20178242, SBT140A, SBT140A-201974, SBT144A, SBT144A-201974, SBT700GN2-1TH.60-201781720BUB, SBT70A, SBT70A-201967, SBT70A-20196700HC, SBT70AT-201967T, SBT72A, SBT72A-201967, SBTV140A, SBTV70A, SC3535A-201936, SC7070A-2019678, SCTN3535A-201935, SCTN3535A-20193503CP, SCTN7070A-2019677, STN140, STN1400GN2-1TH.60-201781420BU9...(Other models you can see in the webshop)		

oven hinges

GEV No.	700001	Ref. No.	A035930
description	opposite support L 118mm W 17mm mounting distance 94mm		

GEV No.	700006	Ref. No.	A035910
description	oven hinge mounting distance 173mm mounting distance 2 105mm lug mounting 14mm lever length 120mm groove distance 11mm spring thickness 3.5mm mounting ear position left spring length 112mm W 25mm		
accessories for	700006		

	GEV No.	700001	Ref. No.	A035930
	opposite support L 118mm W 17mm mounting distance 94mm			
	GEV No.	700007	Ref. No.	A035920
	oven hinge mounting distance 173mm mounting distance 2 105mm lug mounting 14mm lever length 120mm groove distance 11mm spring thickness 3.5mm mounting ear position right spring length 112mm W 25mm			

GEV No.	700007	Ref. No.	A035920
description	oven hinge mounting distance 173mm mounting distance 2 105mm lug mounting 14mm lever length 120mm groove distance 11mm spring thickness 3.5mm mounting ear position right spring length 112mm W 25mm		
accessories for	700007		

	GEV No.	700001	Ref. No.	A035930
	opposite support L 118mm W 17mm mounting distance 94mm			

door bearing

GEV No.	701437	Ref. No.	1412262 BN1412262
description	door hinge L 45mm W 35mm mounting pos. upper bolt 14.5mm bolt ø 6mm refrigerator		
For models:	KST01BT-205111, KST01BT-VCR-205711, KST01TN-205001, KST01TN-205011, KST01TN-VCR-205611, KST02BT-205112, KST02BT-VCR-205702, KST02BT-VCR-205712, KST02TN-205002, KST02TN-205012, KST02TNH760-205802, KST02TN-VCR-205602, KST02TN-VCR-205612, KST03BT-205113, KST03BT-VCR-205713, KST03TN-205003, KST03TN-205013, KST03TN-VCR-205603, KST03TN-VCR-205613, KST04BT-205114, KST04TN-205004, KST04TN-205014, KST04TN-VCR-205604, KST04TN-VCR-205614, KST-BT01, KST-BT04, KST-BT-VCR01, KST-BT-VCR02, KST-BT-VCR03, KSTP01BT-205311, KSTP01TN-205211, KSTP02BT-205312, KSTP02TN-205212, KSTP03-205203, KSTP03BT-205313, KSTP03TN-205213, KSTP04TN-205214, KSTP05TN-205205, KSTP05TN-205215, KSTS24-205424, KSTS24-2054240IDP, KSTS24-2054240JGN, KST-TN01, KST-TN02, KST-TN03, KST-TN04, KST-TN-VCR01, KST-TN-VCR02, KST-TN-VCR03, KST-TN-VCR04...(Other models you can see in the webshop)		

GEV No.	701436	Ref. No.	14850012 BN14850012
description	door hinge L 60mm W 30mm mounting pos. upper bolt 14mm bolt ø 15mm suitable for refrigerator		
For models:	P105-35TNN-2047640100, P105-35TNN-BT-2047660100, P140BT-2047220101, P140TN-2047200101, P140TNN-2047210101, P144BT-2047360100, P144TNN-2047350100, P35-35TNN-2047440100, P35-35TNN-BT-2047460100, P70-70TNN-2047540100, P70-70TNN-BT-2047560100, P70BT-2047020101, P70TN-2041000101, P70TNN-2047010101, P72BT-2047120101, P72TNN-2047110101, S120BT-2088420100, S120TN-2088400100, S120TNN-2088410100, S140BT-2048220101, S140TN-2048200101, S60BT-2088120100, S60TN-2088100100, S60TNN-2088110100, S70BT-2048020101, S70TN-2048000101, S70TNN-2048010101, T105-35TNN-2046640100, T105-35TNN-BT-2046660100, T140BT-2046220100, T140ITT-2046230100, T140TNN-2046210100, T144BT-2046xxxxxx, T144TNN-2046350100, T35-35TNN-2046440100, T35-35TNN-BT-2046460100, T70-70TNN-2046540100, T70-70TNN-BT-2046560100, T70BT-2046020100, T70ITT-2046030100, T70TNN-2046010100, T72BT-2046120x00, T72TNN-2046110100		



1

GEV No.	699245	Ref. No.	32213056 BN32213056
description	hinge L 58.5mm W 35mm H 109mm mounting pos. lower bolt 94mm bolt ø 8mm with accessories		
For models:	KST01BT-205111, KST01BT-VCR-205711, KST01TN-205001, KST01TN-205011, KST01TN-VCR-205611, KST02BT-205112, KST02BT-VCR-205702, KST02BT-VCR-205712, KST02TN-205002, KST02TN-205012, KST02TNH760-205802, KST02TN-VCR-205602, KST02TN-VCR-205612, KST03BT-205113, KST03BT-VCR-205713, KST03TN-205003, KST03TN-205013, KST03TN-VCR-205603, KST03TN-VCR-205613, KST04BT-205114, KST04TN-205004, KST04TN-205014, KST04TN-VCR-205604, KST04TN-VCR-205614, KST-BT01, KST-BT04, KST-BT-VCR01, KST-BT-VCR02, KST-BT-VCR03, KSTP01BT-205311, KSTP01TN-205211, KSTP02BT-205312, KSTP02TN-205212, KSTP03-205203, KSTP03BT-205313, KSTP03TN-205213, KSTP04TN-205214, KSTP05TN-205205, KSTP05TN-205215, KSTS24-205424, KSTS24-2054240IDP, KSTS24-2054240JGN, KST-TN01, KST-TN02, KST-TN03, KST-TN04, KST-TN-VCR01, KST-TN-VCR02, KST-TN-VCR03, KST-TN-VCR04...(Other models you can see in the webshop)		



1

GEV No.	692174	Ref. No.	14850003 BN14850003
description	hinge mounting pos. upper left with bolt		
For models:	ARCO-BT140-20172404, ARCO-BT140-20172405, ARCO-BT140-BASE-20172408, ARCO-BT140GN2-1-2017824301, ARCO-BT140-PLUS-20172409, ARCO-BT70-20171704, ARCO-BT70430-20171705, ARCO-BT70-BASE-20171708, ARCO-BT70-PLUS-20171709, ARCO-TN140.-BASE-20171408, ARCO-TN140.-PLUS-20171409, ARCO-TN140-20171404, ARCO-TN140-2017814301, ARCO-TN140430-20171405, ARCO-TN70-20170704, ARCO-TN70430-20170705, ARCO-TN7070-20177040GL70, ARCO-TN70-BASE-20170708, ARCO-TN70-PLUS-20170709, ARCO-TNN70-20170706, NFB0070F, NFB0070N, NFB0070P, NFB0072F, NFB0072N, NFB0072P, NFB0140F, NFB0140N, NFB0140P, NFB0144F, NFB0144N, NFB0144P, NORD-700BT-2017817305, NORD-700BT-2017817305P, NORD-700TNN-2017807305, NORD-700TNN-2017807305P		



2

GEV No.	690538	Ref. No.	32140098 BN32140098
description	hinge mounting pos. bottom left with bolt		
For models:	ARCO-BT140-20172404, ARCO-BT140-20172405, ARCO-BT140-BASE-20172408, ARCO-BT140-PLUS-20172409, ARCO-TN140.-BASE-20171408, ARCO-TN140.-PLUS-20171409, ARCO-TN140-20171404, ARCO-TN140430-20171405, NFB0140F, NFB0140N, NFB0140P, NFB0144F, NFB0144N, NFB0144P		



1

GEV No.	690539	Ref. No.	14850002 BN14850002
description	hinge mounting pos. upper right with bolt		
For models:	ARCO-BT140-20172404, ARCO-BT140-20172405, ARCO-BT140-BASE-20172408, ARCO-BT140GN2-1-2017824301, ARCO-BT140-PLUS-20172409, ARCO-BT70-20171704, ARCO-BT70430-20171705, ARCO-BT70-BASE-20171708, ARCO-BT70GN2-1-2017817304, ARCO-BT70-PLUS-20171709, ARCO-TN140.-BASE-20171408, ARCO-TN140.-PLUS-20171409, ARCO-TN140-20171404, ARCO-TN140-2017814301, ARCO-TN140430-20171405, ARCO-TN70-20170704, ARCO-TN70-2017807304, ARCO-TN70430-20170705, ARCO-TN7070-20177040GL70, ARCO-TN70-BASE-20170708, ARCO-TN70-PLUS-20170709, ARCO-TNN70-20170706, NFB0070F, NFB0070N, NFB0070P, NFB0072F, NFB0072N, NFB0072P, NFB0140F, NFB0140N, NFB0140P, NFB0144F, NFB0144N, NFB0144P, NORD-700BT-2017817305, NORD-700BT-2017817305P, NORD-700TNN-2017807305, NORD-700TNN-2017807305P		



1

GEV No.	690537	Ref. No.	32140097 BN32140097
description	hinge mounting pos. bottom right with bolt		
For models:	ARCO-BT140-20172404, ARCO-BT140-20172405, ARCO-BT140-BASE-20172408, ARCO-BT140-PLUS-20172409, ARCO-BT70-20171704, ARCO-BT70430-20171705, ARCO-BT70-BASE-20171708, ARCO-BT70-PLUS-20171709, ARCO-TN140.-BASE-20171408, ARCO-TN140.-PLUS-20171409, ARCO-TN140-20171404, ARCO-TN140430-20171405, ARCO-TN70-20170704, ARCO-TN70430-20170705, ARCO-TN70-BASE-20170708, ARCO-TN70-PLUS-20170709, ARCO-TNN70-20170706, NFB0070N, NFB0070P, NFB0072F, NFB0072N, NFB0072P, NFB0140F, NFB0140N, NFB0140P, NFB0144F, NFB0144N, NFB0144P		



1

GEV No.	692428	Ref. No.	14850010 BN14850010
description	hinge mounting pos. upper right with bolt		



pullouts

drawer slides

universal

compeX

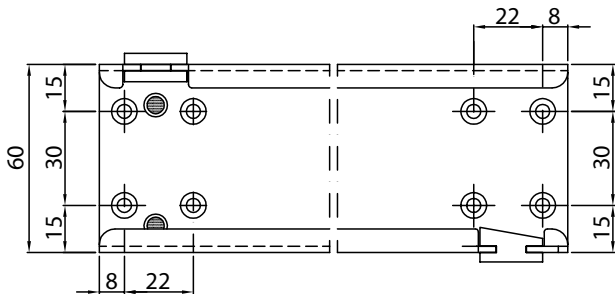

GEV No.	690753 ¹	Ref. No.	BN144906+1449081
description	telescopic slide pair L 550mm pull-out length 610mm total length 1160mm Qty 1 pair capacity 50kg H 60mm SS telescopic		
spare parts for	690753		
	GEV No.	690750	Ref. No. —
	stop fortelescopic rail L 20mm plastic H 12mm D 9mm		
	GEV No.	696333	Ref. No. —
	stop fortelescopic rail L 20mm plastic H 15mm D 8mm		

¹multiple slide (60mm more than nominal length)

equipment feet and end caps

equipment feet

with screw mounting

components



GEV No.	700103	Ref. No.	1467001
description	equipment foot tube ø 56mm plate sizemm hole distancemm H 130mm SS size 2" Qty 1 pcs		
For models:	ARBT144, ARBT70, ARBT72, ARTN120, ARTN140, ARTN210, ARTN60, ARTN70, ARTN72, KBT120-P0120081410, KBT124-P0120081430, KC25-45-20050710, KC45-12-20050725, KPBT25-45-20060710, KPBT4512-20060740, KTN70-20010710, KTN72-20010720, KTNV140-2001440, KTNV70-20010730, M70BT, M70TN, TAR02S, TAR132, TAR82, TAR83		

with fixing plate



GEV No.	701204	Ref. No.	2519500
description	equipment foot tube ø 52mm plate size 67x67mm hole distance 51x51mm H 120-190mm SS size 2" Qty 1 pcs		



GEV No.	700220	Ref. No.	1467516 BN1467516
description	equipment foot tube ø 64mm plate size 76/90mm hole distance 60x80mm H 115-170mm SS size 2 1/2" Qty 1 pcs		

For models:
 AFB-140-20172407G, AFB-70-20171707G, AFB-70Sx-20171707GX-PS, AFN-140E-20173407G, AFN-70-20170707G, AFN-70E-20173707G, AFN-70ESx-20173707GXPS, ARCO-BT140-20172404, ARCO-BT140-20172405, ARCO-BT140-BASE-20172408, ARCO-BT140GN2-1-2017824301, ARCO-BT140-PLUS-20172409, ARCO-BT70-20171704, ARCO-BT70430-20171705, ARCO-BT70-BASE-20171708, ARCO-BT70GN2-1-2017817304, ARCO-BT70-PLUS-20171709, ARCO-TN140-BASE-20171408, ARCO-TN140-PLUS-20171409, ARCO-TN140-20171404, ARCO-TN140-2017814301, ARCO-TN140430-20171405, ARCO-TN70-20170704, ARCO-TN70-2017807304, ARCO-TN70430-20170705, ARCO-TN7070-201777040GL70, ARCO-TN70-BASE-20170708, ARCO-TN70-PLUS-20170709, ARCO-TNN70-20170706, KSA105-35-2045150COR, KSA105-35-2045260CC0, KSA140BT-2045240BYF, KSA140BT-2045240C10, KSA140BT-2045240CAD, KSA140P-2045340COX, KSA140TN-2045140B8X, KSA140TN-2045140CAB, KSA140TN-2045140CAC, KSA35-35-2045350BYG, KSA70-70-2045770BYH, KSA70-70-2045770CJ5, KSA70-70PBT-2045800C0U, KSA70-70PBT-2045800CJ8, KSA70-70PTN-2045790C0T, KSA70-70PTN-2045790CJ7, KSA70BT-2045170BYL, KSA70BT-2045170C0Z, KSA70BT-2045170CAA, KSA70P-2045270C0W, KSA70TN-2045070B5E...(Other models you can see in the webshop)

components



GEV No.	700103	Ref. No.	1467001
description	equipment foot tube ø 56mm plate sizemm hole distancemm H 130mm SS size 2" Qty 1 pcs		
For models:	ARBT144, ARBT70, ARBT72, ARTN120, ARTN140, ARTN210, ARTN60, ARTN70, ARTN72, KBT120-P0120081410, KBT124-P0120081430, KC25-45-20050710, KC45-12-20050725, KPBT25-45-20060710, KPBT4512-20060740, KTN70-20010710, KTN72-20010720, KTNV140-2001440, KTNV70-20010730, M70BT, M70TN, TAR02S, TAR132, TAR82, TAR83		

DERBY RUOTE

with fixing plate

chrome-plated steel



GEV No.	700851	Ref. No.	147802 BN147802
description	swivel castor with brake ø 80mm with flange plate bearing slide bearing		
For models:	KBC10, KBC10-BASE-20351002PM, KBC5, KBC6, KBC6-BASE-20350602PL, KBCF10, KBCF10-BASE-20361002PV, KBCF5, KBCF5-BASE-20360502PN, KBCF6, KBCF6-BASE-20360602PT, KTAP00, KTAP00-BASE-20220501062N, KTAP00BT-BASE-2022550105KR, KTAP01, KTAP01-205202, KTAP01-205204, KTAP01-BASE-20220901044U, KTAP01BT-BASE-2022590105KU, KTAP02, KTAP02-600-20221205CN, KTAP02-BASE-20221301048K, KTAP02BT-205301, KTAP02BT-205302, KTAP02BT-205303, KTAP02BT-BASE-2022630105KW, KTAP03, KTAP03-BASE-2022180109UA, KTAP03BT-BASE-2022680109UW, KTAP04, KTAP04-BASE-2022230109RY, KTAP84EN-20228403, KTAPBT00, KTAPBT01, KTAPBT02, KTAPBT03, KTAR01, KTAR01-BASE-20201001, KTAR01N, KTAR01N-BASE-20201005043V, KTAR02, KTAR02N, KTAR02N-BASE-20201305043Y, KTAR03, KTAR03-BASE-2020180105, KTAR03N, KTAR03N-BASE-202018050441, KTAR04, KTAR04N, KTAR04N-BASE-2020230508V7...(Other models you can see in the webshop)		

TENTE

with fixing plate

chrome-plated steel



GEV No.	700214	Ref. No.	147805 BN147805
description	swivel castor ø 100mm plate fixing housing zinc-plated sheet steel plate size 105x85mm hole distance 60x78mm capacity 80kg bearing slide bearing wheel body polypropylene tread TPE tyres H 128mm wheel width 32mm		
For models:	140, 70, ARCO-BT140-20172404, ARCO-BT140-20172405, ARCO-BT140-BASE-20172408, ARCO-BT140-PLUS-20172409, ARCO-BT70-20171704, ARCO-BT70430-20171705, ARCO-BT70-BASE-20171708, ARCO-BT70-PLUS-20171709, ARCO-TN140-BASE-20171408, ARCO-TN140-PLUS-20171409, ARCO-TN140-20171404, ARCO-TN140430-20171405, ARCO-TN70-20170704, ARCO-TN70430-20170705, ARCO-TN70-BASE-20170708, ARCO-TN70-PLUS-20170709, ARCO-TNN70-20170706, KBC10, KBC10-BASE-20351002PM, KBC5, KBC6, KBC6-BASE-20350602PL, KBCF10, KBCF10-BASE-20361002PV, KBCF5, KBCF5-BASE-20360502PN, KBCF6, KBCF6-BASE-20360602PT, KST6-02TN-2055020CYA, KTAP00, KTAP00-BASE-20220501062N, KTAP00BT-BASE-2022550105KR, KTAP01, KTAP01-205202, KTAP01-205204, KTAP01-BASE-20220901044U, KTAP01BT-BASE-2022590105KU, KTAP02, KTAP02-600-20221205CN, KTAP02-BASE-20221301048K, KTAP02BT-205301, KTAP02BT-205302, KTAP02BT-205303, KTAP02BT-BASE-2022630105KW, KTAP03, KTAP03-BASE-2022180109UA, KTAP03BT-BASE-2022680109UW, KTAP04...(Other models you can see in the webshop)		



GEV No.	700852	Ref. No.	147801 BN147801
description	swivel castor without brake ø 80mm with flange plate		
For models:	KBC10, KBC10-BASE-20351002PM, KBC5, KBC6, KBC6-BASE-20350602PL, KBCF10, KBCF10-BASE-20361002PV, KBCF5, KBCF5-BASE-20360502PN, KBCF6, KBCF6-BASE-20360602PT, KTAP00, KTAP00-BASE-20220501062N, KTAP00BT-BASE-2022550105KR, KTAP01, KTAP01-205202, KTAP01-205204, KTAP01-BASE-20220901044U, KTAP01BT-BASE-2022590105KU, KTAP02, KTAP02-600-20221205CN, KTAP02-BASE-20221301048K, KTAP02BT-205301, KTAP02BT-205302, KTAP02BT-205303, KTAP02BT-BASE-2022630105KW, KTAP03, KTAP03-BASE-2022180109UA, KTAP03BT-BASE-2022680109UW, KTAP04, KTAP04-BASE-2022230109RY, KTAP84EN-20228403, KTAPBT00, KTAPBT01, KTAPBT02, KTAPBT03, KTAR01, KTAR01-BASE-20201001, KTAR01N, KTAR01N-BASE-20201005043V, KTAR02, KTAR02N, KTAR02N-BASE-20201305043Y, KTAR03, KTAR03-BASE-2020180105, KTAR03N, KTAR03N-BASE-202018050441, KTAR04, KTAR04N, KTAR04N-BASE-2020230508V7...(Other models you can see in the webshop)		



GEV No.	700213 ¹	Ref. No.	147806 BN147806
description	swivel castor with swivel brake ø 100mm plate fixing housing zinc-plated sheet steel plate size 105x85mm hole distance 60x78mm capacity 80kg bearing slide bearing wheel body polypropylene tread TPE tyres H 128mm wheel width 32mm Qty 1 pcs		
For models:	140, 70, ARCO-BT140-20172404, ARCO-BT140-20172405, ARCO-BT140-BASE-20172408, ARCO-BT140-PLUS-20172409, ARCO-BT70-20171704, ARCO-BT70430-20171705, ARCO-BT70-BASE-20171708, ARCO-BT70-PLUS-20171709, ARCO-TN140-BASE-20171408, ARCO-TN140-PLUS-20171409, ARCO-TN140-20171404, ARCO-TN140430-20171405, ARCO-TN70-20170704, ARCO-TN70430-20170705, ARCO-TN70-BASE-20170708, ARCO-TN70-PLUS-20170709, ARCO-TNN70-20170706, KBC10, KBC10-BASE-20351002PM, KBC5, KBC6, KBC6-BASE-20350602PL, KBCF10, KBCF10-BASE-20361002PV, KBCF5, KBCF5-BASE-20360502PN, KBCF6, KBCF6-BASE-20360602PT, KST6-02TN-2055020CYA, KTAP00, KTAP00-BASE-20220501062N, KTAP00BT-BASE-2022550105KR, KTAP01, KTAP01-205202, KTAP01-205204, KTAP01-BASE-20220901044U, KTAP01BT-BASE-2022590105KU, KTAP02, KTAP02-600-20221205CN, KTAP02-BASE-20221301048K, KTAP02BT-205301, KTAP02BT-205302, KTAP02BT-205303, KTAP02BT-BASE-2022630105KW, KTAP03, KTAP03-BASE-2022180109UA, KTAP03BT-BASE-2022680109UW, KTAP04...(Other models you can see in the webshop)		

¹with swivel brake



shelves and shelf rails

grates

universal

without upstand



GEV No.	970126	Ref. No.	1440165530 BN1440165530
description	grate W 530mm D 650mm GN 2/1 plastic-coated steel wire gauge frame 8mm lengthwise wires gauge 5mm crossing wires 2 white suitable for refrigerator		
For models:	SPEBTG70, SPEBTG70-204538		
accessories for	970126		
	GEV No.	690330	Ref. No. —
	rack L 1000mm W 22mm H 4mm aperture 3x8mm hole distance 12.5mm stainless steel		
	GEV No.	694700	Ref. No. —
	shelf support L 31/28mm W 22mm H 18mm SS Qty 12 pcs		
	GEV No.	694701	Ref. No. —
	shelf support L 31/28mm W 22mm H 17mm SS with hook Qty 12 pcs		

with upstand



GEV No.	970807	Ref. No.	1440050530 BN1440050530
description	grate W 530mm D 500mm H 40mm plastic-coated steel wire gauge frame 8.8mm lengthwise wires gauge 4.8mm crossing wires 1 grey		
For models:	KBT120-2008140218, KBT122-20081402XU, KBT124-2008140431, KBT60-2008070124, KBT62-20080705H5, KBTV120, KBTV60, KC6060-20091430, KC9030-20091420, KCTN3030-20090710, KCTN6060-20091410, KPC3030-20100720, KPC9030-20101410, KTN120, KTN122-200714011U, KTN124-20071400XM, KTN60-20070700XE, KTN60-BASE-20070700XE, KTNV120, KTNV60-20070700XH		

GEV No.	970626	Ref. No.	1440065530 BN1440065530
description	grate W 650mm D 530mm GN 2/1 plastic-coated steel with hinge camp crossing wires 2 grey suitable for refrigerator		
For models:	140, 70, AP-140-221314XG, AP-70TN-221307XG, ARCO-BT140-20172404, ARCO-BT140-20172405, ARCO-BT140-BASE-20172408, ARCO-BT140-PLUS-20172409, ARCO-BT70-20171704, ARCO-BT70430-20171705, ARCO-BT70-BASE-20171708, ARCO-BT70-PLUS-20171709, ARCO-TN140.-BASE-20171408, ARCO-TN140.-PLUS-20171409, ARCO-TN140-20171404, ARCO-TN140430-20171405, ARCO-TN70-20170704, ARCO-TN70430-20170705, ARCO-TN70-BASE-20170708, ARCO-TN70-PLUS-20170709, ARCO-TNN70-20170706, BT140, BT144, BT70, BT72, KTN70-20010710, KTN72-20010720, KTNV140-2001440, KTNV70-20010730, LLP140TN, LLP140T-NGN2-1-221314, LLP70TN, LLP70TNGN2-1-221307, M70BT, M70TN, NFB0070F, NFB0070N, NFB0070P, NFB0072F, NFB0072FN, NFB0072N, NFB0072NI, NFB0072NN, NFB0072P, NFB0072PF, NFB0072PN, NFB0072PP, NFB0140F, NFB0140N, NFB0140NF...(Other models you can see in the webshop)		

producer-specific



GEV No.	970662	Ref. No.	1440055530 1440055535 BN1440055530 BN1440055535
description	grate W 530mm D 550mm with layer RILSAN		
For models:	ARTN120, ARTN60		

grid attachments





GEV No.	970661	Ref. No.	33510070 BN33510070
description	bearing rail L 600mm H 34.2mm W 17mm		
For models:	KBT140-200214011K, KBT142-200214011L, KBT144-200214011M, KBT70, KBT70-20020710, KBT70-BASE-20020700YL, KBT72-200207061E, KBT72-20020720, KBT72-210207, KBTV140-200214011N, KBTV70-200207, KC10535-20051440, KC2545-20050710, KC3513-20050715, KC3535-20050720, KC4512-20050725, KC70-70-20051410, KC7070-20051410, KCTN10535-20031440, KCTN2545-20030725, KCTN3535-20030735, KCTN7070-20031410, KP70-20040710, KPBT10535-20061420, KPBT2545-20060710, KPBT3513-20060720, KPBT3535-20060730, KPBT4512-20060740, KPBT7070-20061410, KPTN10535-20041440, KPTN2545-20040720, KPTN3535-20040730, KPTN7070-20041410, KTN122-200714011U, KTN140-20011400WZ, KTN140-BASE-20011400WZ, KTN142-20011400X0, KTN144-20011400X1, KTN3513-200107, KTN4512-200107, KTN70-200107003W, KTN70-20010710, KTN70-210107, KTN70-BASE-20010700VX, KTN72-200107, KTN72-20010720, KTNV140-20011400X2, KTNV140-2001440, KTNV70-200107003W, KTNV70-20010730...(Other models you can see in the webshop)		

shelf rails and supports

producer-specific

			
GEV No.	690258	Ref. No.	1231190 FR1231190
description	guide U-shape L 615mm W 13mm H 20mm mounting pos. left/right		
For models:	P105-35TNN-2047640100, P105-35TNN-BT-2047660100, P140BT-2047220101, P140BT-2047260101, P140TN-2047200101, P140TNN-2047210101, P140TNV-2047240101, P144BT-2047360100, P144TNN-2047350100, P35-35TNN-2047440100, P35-35TNN- BT-2047460100, P70-70TNN-2047540100, P70-70TNN- BT-2047560100, P70BT-2047020101, P70BT-2046060101, P70TN-2041000101, P70TNN-2047010101, P70TNV-2047040101, P72BT-2047120101, P72TNN-2047110101, S140BT-2048220101, S140TN-2048200101, S70BT-2048020101, S70TN-2048000101, S70TNN-2048010101, T105-35TNN-2046640100, T105-35TNN- BT-2046660100, T140BT-2046220100, T140BT-2046260100, T140ITT-2046230100, T140TNN-2046210100, T140TNV-2046240100, T144BT-2046xxxxxx, T144TNN-2046350100, T35-35TNN-2046440100, T35-35TNN-BT-2046460100, T70-70TNN-2046540100, T70- 70TNN-BT-2046560100, T70BT-2046020100, T70BT-2046060x00, T70ITT-2046030100, T70TNN-2046010100, T70TNV-2046040100, T72BT-2046120x00, T72TNN-2046110100		

			
GEV No.	700847	Ref. No.	3351100000 BN3351100000
description	pair of setting bar		
For models:	ARTN120, ARTN60		

			
GEV No.	690745	Ref. No.	33510060 BN33510060
description	pair of setting bar U-shape L 470mm W 15mm inner height 21mm		
For models:	KBT120-2008140218, KBT122-20081402XU, KBT124-2008140431, KBT60-2008070124, KBT62-20080705H5, KBTV120, KBTV60, KC6060-20091430, KC9030-20091420, KCTN3030-20090710, KCTN6060-20091410, KP60-20100710, KPC3030-20100720, KPC9030- 20101410, KTN120, KTN120-20071410, KTN122-20071420, KTN124- 20071400XM, KTN60-20070710, KTN60-200707OOXE, KTN60-BASE- 20070700XE, KTN62-200707OOXF, KTNV120, KTNV60-200707OOXH		

 <p>Image not available</p>			
GEV No.	700846	Ref. No.	3351300030 BN3351300030
description	pair of setting bar U-shape L 540mm W 30mm		
For models:	TAR02S, TAR132, TARS27-2124130027		

			
GEV No.	690566	Ref. No.	33510071 BN33510071
description	pair of setting bar U-shape L 615mm W 26mm inner height 18mm mounting pos. left/right		
For models:	ARCO-BT140-20172404, ARCO-BT140-20172405, ARCO-BT140-BA- SE-20172408, ARCO-BT140-PLUS-20172409, ARCO-BT70-20171704, ARCO-BT70430-20171705, ARCO-BT70-BASE-20171708, ARCO- BT70-PLUS-20171709, ARCO-TN140-BASE-20171408, ARCO-TN140- PLUS-20171409, ARCO-TN140-20171404, ARCO-TN140430-20171405, ARCO-TN70-20170704, ARCO-TN70430-20170705, ARCO-TN70-BA- SE-20170708, ARCO-TN70-PLUS-20170709, ARCO-TNN70-20170706, NFB0070F, NFB0070N, NFB0070P, NFB0072F, NFB0072FN, NFB0072N, NFB0072NI, NFB0072NN, NFB0072P, NFB0072PF, NFB0072PN, NFB- 0072PP, NFB0140F, NFB0140N, NFB0140NF, NFB0140NI, NFB0140P, NFB0143FN, NFB0143NF, NFB0143NN, NFB0143PF, NFB0143PN, NFB0143PP, NFB0144F, NFB0144N, NFB0144P, NFB0144PF, NFB0144PN, NFS0072FG, NFS0072NG, NFS0143FG, NFS0143I, NFS0143NG, NFS0144FG...(Other models you can see in the webshop)		

			
GEV No.	700327	Ref. No.	33580092 BN33580092
description	rack L 1260mm W 35mm mounting pos. left		
For models:	ARCO-BT140-20172404, ARCO-BT140-20172405, ARCO-BT140-BA- SE-20172408, ARCO-BT140-PLUS-20172409, ARCO-BT70-20171704, ARCO-BT70430-20171705, ARCO-BT70-BASE-20171708, ARCO- BT70-PLUS-20171709, ARCO-TN140-BASE-20171408, ARCO-TN140- PLUS-20171409, ARCO-TN140-20171404, ARCO-TN140430-20171405, ARCO-TN70-20170704, ARCO-TN70430-20170705, ARCO-TN70-BA- SE-20170708, ARCO-TN70-PLUS-20170709, ARCO-TNN70-20170706, NFB0070F, NFB0070N, NFB0070P, NFB0072F, NFB0072FN, NFB0072N, NFB0072NI, NFB0072NN, NFB0072P, NFB0072PF, NFB0072PN, NFB- 0072PP, NFB0140F, NFB0140N, NFB0140NF, NFB0140NI, NFB0140P, NFB0143FN, NFB0143NF, NFB0143NN, NFB0143PF, NFB0143PN, NFB0143PP, NFB0144F, NFB0144N, NFB0144P, NFB0144PF, NFB0144PN, NFS0072FG, NFS0072NG, NFS0143FG, NFS0143I, NFS0143NG, NFS0144FG...		



GEV No.	700326	Ref. No.	33580091 BN33580091
description	rack L 1260mm W 35mm mounting pos. right		
For models:	ARCO-BT140-20172404, ARCO-BT140-20172405, ARCO-BT140-BA-SE-20172408, ARCO-BT140-PLUS-20172409, ARCO-BT70-20171704, ARCO-BT70430-20171705, ARCO-BT70-BASE-20171708, ARCO-BT70-PLUS-20171709, ARCO-TN140.-BASE-20171408, ARCO-TN140.-PLUS-20171409, ARCO-TN140-20171404, ARCO-TN140430-20171405, ARCO-TN70-20170704, ARCO-TN70430-20170705, ARCO-TN70-BA-SE-20170708, ARCO-TN70-PLUS-20170709, ARCO-TNN70-20170706, NFB0070F, NFB0070N, NFB0070P, NFB0072F, NFB0072N, NFB0072P, NFB0140F, NFB0140N, NFB0140P, NFB0144F, NFB0144N, NFB0144P, NORD-700BT-2017817305, NORD-700BT-2017817305P, NORD-700TNN-2017807305, NORD-700TNN-2017807305P		

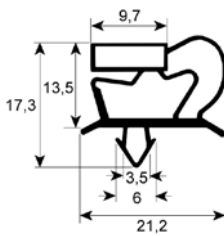

GEV No.	900347	Ref. No.	14414300200 BN14414300200
description	refrigeration gasket profile 9048 W 178mm L 396mm plug size		
For models:	KTAP00, KTAP00-BASE-20220501062N, KTAP01, KTAP01-205202, KTAP01-205204, KTAP01-BASE-20220901044U, KTAP02, KTAP02-600-20221205CN, KTAP02-BASE-20221301048K, KTAP03, KTAP03-BASE-2022180109UA, KTAP04, KTAP04-BASE-2022230109RY, KTAP84EN-20228403, KTAPBT00, KTAPBT01, KTAPBT02, KTAPBT03, KTAR00, KTAR01, KTAR01-BASE-20201001, KTAR01N, KTAR01N-BASE-20201005043V, KTAR02, KTAR02N, KTAR02N-BASE-20201305043Y, KTAR03, KTAR03-BASE-2020180105, KTAR03N, KTAR03N-BASE-202018050441, KTAR04, KTAR04N, KTAR04N-BASE-2020230508V7, KTAR602, KTAR6-02-BASE-20231207N0, KTAR6-02-BASE-20231207N1, KTAR6-03-202316010AMR, KTAR6-03-202316010AMS, KTAR612, KTAR614, KTARBT02, KTARBT02-205101, KTARBT02-205102, KTARBT02-205103, KTARBT02-BASE-2025130104FU, KTARBT03, KTARBT03-BASE-2025180104FW, KTARBT04, KTARBT04-BASE-2025230104FZ, KTARS24-202413010480...(Other models you can see in the webshop)		

gaskets

refrigeration gaskets

plug-in gaskets

profile 9048

We offer custom-made gaskets for this profile

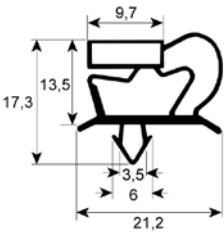

GEV No.	901021	Ref. No.	14414300150 BN14414300150
description	refrigeration gasket profile 9048 W 142mm L 396mm plug size		
For models:	KTAP00, KTAP00-BASE-20220501062N, KTAP01, KTAP01-205202, KTAP01-205204, KTAP01-BASE-20220901044U, KTAP02, KTAP02-600-20221205CN, KTAP02-BASE-20221301048K, KTAP03, KTAP03-BASE-2022180109UA, KTAP04, KTAP04-BASE-2022230109RY, KTAP84EN-20228403, KTAPBT00, KTAPBT01, KTAPBT02, KTAPBT03, KTAR00, KTAR01, KTAR01-BASE-20201001, KTAR01N, KTAR01N-BASE-20201005043V, KTAR02, KTAR02N, KTAR02N-BASE-20201305043Y, KTAR03, KTAR03-BASE-2020180105, KTAR03N, KTAR03N-BASE-202018050441, KTAR04, KTAR04N, KTAR04N-BASE-2020230508V7, KTARBT02, KTARBT02-205101, KTARBT02-205102, KTARBT02-205103, KTARBT02-BASE-2025130104FU, KTARBT03, KTARBT03-BASE-2025180104FW, KTARBT04, KTARBT04-BASE-2025230104FZ, TSP00, TSP00-BASE-202606010BRU, TSP01, TSP01-BASE-202611010BRY, TSP02, TSP02-BASE-202615010BS8, TSP03, TSP03-BASE-202620010BSK...(Other models you can see in the webshop)		

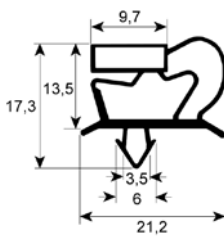

GEV No.	900360	Ref. No.	14411990418 BN14411990418
description	refrigeration gasket profile 9048 W 186mm L 405mm plug size size 1/3		
For models:	TAR132		

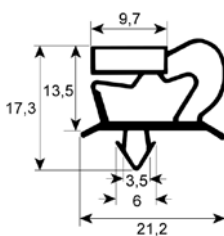

GEV No.	900846	Ref. No.	14416800214 BN14416800214
description	refrigeration gasket profile 9048 W 218mm L 684mm plug size drawer		
For models:	KC3513-20050715, KC4512-20050725, KCTN3513-20030730, KCTN4512-20030745, KCTN4512-20030745, KPBT3513-20060720, KPBT4512-20060740, KPTN3513-20040725, KTN3513-200107, KTN3513-20010735, KTN4512-200107, KTN4512-20010745, KUC3513-20150715, KUC4512-20150725, KUCTN3513-20130715, KUCTN3513-20130715, KUCTN4512-20130730, KU-CTN4512-20130730, KUPBT3513-20160720, KUPBT4512-20160740, KUPTN3513-20140720, KUPTN3513-20140720, KUPTN4512-20140740, KUTN3513-20110735, KUTN4512-20110770		

GEV No.	900918	Ref. No.	14415396253 BN14415396253
description	refrigeration gasket profile 9048 W 260mm L 390mm plug size plug-in gasket		

GEV No.	900548	Ref. No.	14414300290 BN14414300290
description	refrigeration gasket profile 9048 W 267mm L 394mm plug size		
For models:	KTAP00, KTAP00-BASE-20220501062N, KTAP01, KTAP01-205202, KTAP01-205204, KTAP01-BASE-20220901044U, KTAP02, KTAP02-600-20221205CN, KTAP02-BASE-20221301048K, KTAP03, KTAP03-BASE-2022180109UA, KTAP04, KTAP04-BASE-2022230109RY, KTAP84EN-20228403, KTAPBT00, KTAPBT01, KTAPBT02, KTAPBT03, KTAR00, KTAR01, KTAR01-BASE-20201001, KTAR01N, KTAR01N-BASE-20201005043V, KTAR02, KTAR02N, KTAR02N-BASE-20201305043Y, KTAR03, KTAR03-BASE-2020180105, KTAR03N, KTAR03N-BASE-202018050441, KTAR04, KTAR04N, KTAR04N-BASE-2020230508V7, KTARBT02, KTARBT02-205101, KTARBT02-205102, KTARBT02-205103, KTARBT02-BASE-2025130104FU, KTARBT03, KTARBT03-BASE-2025180104FW, KTARBT04, KTARBT04-BASE-2025230104FZ, TSP00, TSP00-BASE-202606010BRU, TSP01, TSP01-BASE-202611010BRV, TSP02, TSP02-BASE-202615010BS8, TSP03, TSP03-BASE-202620010BSK...(Other models you can see in the webshop)		

GEV No.	900849	Ref. No.	14415396291 BN14415396291
description	refrigeration gasket profile 9048 W 278mm L 396mm plug size drawer		
For models:	TFT01, TFT01-BASE-209001106V7, TFT02, TFT02-BASE-209002106XF, TFT03, TFT03-BASE-209003106XY, TFT04, TFT04-BASE-209004106YC, TFTP00, TFTP00-BASE-209101106YW, TFTP01, TFTP01-BASE-209102106Z7, TFTP02, TFTP02-BASE-209103106ZN, TFTP03, TFTP03-BASE-20910410705, TRANSF90001MOTTN, TRANSF90002MOTTN, TRANSF90003MOTTN, TRANSF90004MOTTN		

GEV No.	900845	Ref. No.	14414240286 BN14414240286
description	refrigeration gasket profile 9048 W 289mm L 426mm plug size drawer		
For models:	KTARS21-2124100021, TARS21, TARS21-2124100021, TARS21-2124100022, TARS21-2124100023		

GEV No.	900836	Ref. No.	14413090501 BN14413090501
description	refrigeration gasket profile 9048 W 295mm L 485mm plug size		

GEV No.	900359	Ref. No.	14413090418 BN14413090418
description	refrigeration gasket profile 9048 W 296mm L 405mm plug size drawer size 1/2		
For models:	TAR02S, TARS27-2124130027		

GEV No.	901018	Ref. No.	14416070295 BN14416070295
description	refrigeration gasket profile 9048 W 296mm L 607mm plug size		



GEV No.	901778	Ref. No.	14412950408 BN14412950408
description	refrigeration gasket profile 9048 W 300mm L 410mm plug size		

GEV No.	900831	Ref. No.	14414300390 BN14414300390
description	refrigeration gasket profile 9048 W 354mm L 396mm plug size drawer size 2/3		

For models: KTAP00, KTAP00-BASE-20220501062N, KTAP01, KTAP01-205202, KTAP01-205204, KTAP01-BASE-20220901044U, KTAP02, KTAP02-600-20221205CN, KTAP02-BASE-20221301048K, KTAP03, KTAP03-BASE-2022180109UA, KTAP04, KTAP04-BASE-2022230109RY, KTAP84EN-20228403, KTAPBT00, KTAPBT01, KTAPBT02, KTAPBT03, KTAR00, KTAR01, KTAR01-BASE-20201001, KTAR01N, KTAR01N-BASE-20201005043V, KTAR02, KTAR02N, KTAR02N-BASE-20201305043Y, KTAR03, KTAR03-BASE-2020180105, KTAR03N, KTAR03N-BASE-202018050441, KTAR04, KTAR04N, KTAR04N-BASE-2020230508V7, KTARBT02, KTARBT02-205101, KTARBT02-205102, KTARBT02-205103, KTARBT02-BASE-2025130104FU, KTARBT03, KTARBT03-BASE-2025180104FW, KTARBT04, KTARBT04-BASE-2025230104FZ, TSP00, TSP00-BASE-202606010BRU, TSP01, TSP01-BASE-202611010BRV, TSP02, TSP02-BASE-202615010BS8, TSP03, TSP03-BASE-202620010BSK...(Other models you can see in the webshop)

GEV No.	900842	Ref. No.	14413690499 925633 BN14413690499 FR925633
description	refrigeration gasket profile 9048 W 370mm L 500mm plug size		
For models:	TARS22-2124922, TARS22-212492208L6, TARS22-212492208VT, TARS22-21249220AO2, TARS22-21249220AO3, TARS22-21249220AO4, TARS22-21249220AO6, TARS22-KIT1, TARS22-Kit1-212492201, TARS22-KIT2, TARS22-Kit2-212492202, TARS22-KIT3, TARS22-Kit3-212492203, TARS22-KIT4, TARS22-Kit4-212492204, TARS22-KIT5, TARS22-Kit5-212492205, TARS22-KIT6, TARS22-Kit6-212492206, TARS22-KIT6-21249220AO5, TARS22-KIT7, TARS22-Kit7-212492207, TP122-TARS22-KIT5-212492208VR		

GEV No.	901172	Ref. No.	14414300254 BN14414300254
description	refrigeration gasket profile 9048 W 383mm L 254mm plug size		

For models: KST01BT-205111, KST01BT-VCR-205701, KST01BT-VCR-205711, KST01TN-205001, KST01TN-205011, KST01TN-VCR-205601, KST01TN-VCR-205611, KST02BT-205112, KST02BT-VCR-205702, KST02BT-VCR-205712, KST02TN-205002, KST02TN-205012, KST02TNH760-205802, KST02TN-VCR-205602, KST02TN-VCR-205612, KST03BT-205113, KST03BT-VCR-205703, KST03BT-VCR-205713, KST03TN-205003, KST03TN-205013, KST03TN-VCR-205603, KST03TN-VCR-205613, KST04BT-205114, KST04BT-VCR-205714, KST04TN-205004, KST04TN-205014, KST04TN-VCR-205604, KST04TN-VCR-205614, KST-BT01, KST-BT04, KST-BT-VCR01, KST-BT-VCR02, KST-BT-VCR03, KSTP01BT-205311, KSTP01TN-205211, KSTP02BT-205312, KSTP02TN-205212, KSTP03-205203, KSTP03BT-205313, KSTP03TN-205213, KSTP04TN-205214, KSTP05TN-205205, KSTP05TN-205215, KSTS24-205424, KSTS24-2054240IDP, KSTS24-2054240JGN, KST-TN01, KST-TN02, KST-TN03, KST-TN04...(Other models you can see in the webshop)

GEV No.	901173	Ref. No.	14414300569 926058 BN14414300569 FR926058
description	refrigeration gasket profile 9048 W 383mm L 569mm plug size		

For models: KST01BT-205111, KST01BT-VCR-205711, KST01TN-205001, KST01TN-205011, KST01TN-VCR-205611, KST02BT-205112, KST02BT-VCR-205702, KST02BT-VCR-205712, KST02TN-205002, KST02TN-205012, KST02TNH760-205802, KST02TN-VCR-205602, KST02TN-VCR-205612, KST03BT-205113, KST03BT-VCR-205713, KST03TN-205003, KST03TN-205013, KST03TN-VCR-205603, KST03TN-VCR-205613, KST04BT-205114, KST04TN-205004, KST04TN-205014, KST04TN-VCR-205604, KST04TN-VCR-205614, KST-BT01, KST-BT04, KST-BT-VCR01, KST-BT-VCR02, KST-BT-VCR03, KSTP01BT-205311, KSTP01TN-205211, KSTP02BT-205312, KSTP02TN-205212, KSTP03-205203, KSTP03BT-205313, KSTP03TN-205213, KSTP04TN-205214, KSTP05TN-205205, KSTP05TN-205215, KSTS24-205424, KSTS24-2054240IDP, KSTS24-2054240JGN, KST-TN01, KST-TN02, KST-TN03, KST-TN04, KST-TN-VCR01, KST-TN-VCR02, KST-TN-VCR03, KST-TN-VCR04...(Other models you can see in the webshop)

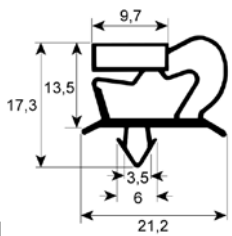

GEV No.	901234	Ref. No.	14416600390 BN14416600390
description	refrigeration gasket profile 9048 W 390mm L 660mm plug size for blast chiller		
For models:	KBC5, KBC5-BASE-20350502PK, KBCF5, KBCF5-BASE-20360502PN		

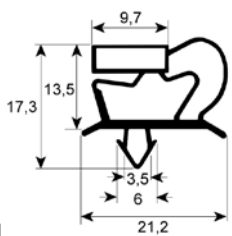

GEV No.	900734	Ref. No.	14415396458 BN14415396458
description	refrigeration gasket profile 9048 W 396mm L 458mm plug size		
For models:	KTAP902, KTAPBT902, KTAR902, KTAR9-02-202009040Y, KTAR902BT-ESP66300BT-202509P0201, KTARBT902, KTARBT9-02-BASE-20250904MU		

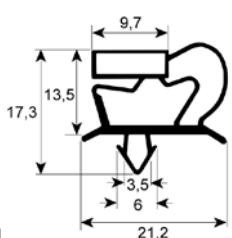

GEV No.	900731	Ref. No.	14414300620 926005 BN14414300620 FR926005
description	refrigeration gasket profile 9048 W 396mm L 566mm plug size		
For models:	KST6-02TN-2055020CYA, KST6-03TN-2055030CC9, KST6-04TN-2055040CCA, KTAP00, KTAP00-BASE-20220501062N, KTAP00BT-BASE-2022550105KR, KTAP01, KTAP01-205202, KTAP01-205204, KTAP01-BASE-20220901044U, KTAP01BT-BASE-2022590105KU, KTAP02, KTAP02-20221301P0201, KTAP02-600-20221205CN, KTAP02-BASE-20221301048K, KTAP02BT-205301, KTAP02BT-205302, KTAP02BT-205303, KTAP02BT-BASE-2022630105KW, KTAP02-ESP45300-20221301P0202, KTAP03, KTAP03-600-20221705CM, KTAP03-BASE-2022180109UA, KTAP03BT-BASE-2022680109UW, KTAP04, KTAP04-BASE-2022230109RY, KTAP84EN-20228403, KTAPBT00, KTAPBT01, KTAPBT02, KTAPBT03, KTAR01, KTAR01N, KTAR01N-BASE-20201005043V, KTAR02, KTAR02-600-BASE-20201205CU, KTAR02N, KTAR02N-BASE-20201305043Y, KTAR03, KTAR03-600-BASE-20201705DD, KTAR03N, KTAR03N-BA-SE-202018050441, KTAR04, KTAR04N, KTAR04N-BASE-2020230508V7, KTARBT02, KTARBT02-BASE-2025130104FU, KTARBT03, KTARBT03-BASE-2025180104FW, KTARBT04...(Other models you can see in the webshop)		

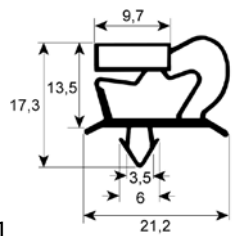

GEV No.	901020	Ref. No.	14414020516 BN14414020516
description	refrigeration gasket profile 9048 W 402mm L 516mm plug size		

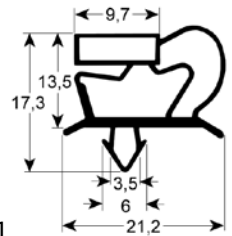

GEV No.	902145	Ref. No.	14416070406 BN14416070406
description	refrigeration gasket profile 9048 W 403mm L 607mm plug size		

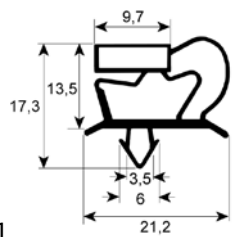

GEV No.	900358	Ref. No.	14414180418 BN14414180418
description	refrigeration gasket profile 9048 W 405mm L 405mm plug size drawer size 2/3		
For models:	TAR132		

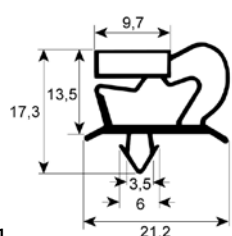

GEV No.	900830	Ref. No.	14414080540 BN14414080540
description	refrigeration gasket profile 9048 W 405mm L 535mm plug size door		
For models:	PIZZA160, TARS22E-2124091022, TARS22EP-2124091023, TARS22ES-2124091022, TARS22R-21240913, TARS22RP-21240914, TARS22RS-21240913		

GEV No.	900357	Ref. No.	14414180640 BN14414180640
description	refrigeration gasket profile 9048 W 405mm L 627mm plug size door for refrigerated counter size 1/1		
For models:	TAR02S, TAR132, TARS27-2124130027		

GEV No.	900832	Ref. No.	14415396405 BN14415396405
description	refrigeration gasket profile 9048 W 471mm L 626mm plug size door		
For models:	KTAP82-202282020AWR, KTAP83-202283020AWS, KTAP84-202284020AWT, KTAR82-202082020AWO, KTAR83-202083020AWP, KTAR84-202084020AWQ, KTARS27-20282700, TP0200Q-20283200, TP0220Q-20283220, TP0224Q-20283224, TP0227Q-20283227, TP0240Q-20283240, TP0247Q-20283247, TP0270Q-20283270, TP0300Q-20283300, TP0320Q-20283320, TP0370Q-20283340, TP0370Q-20283370, TPP02-2028220007Z7, TPP03-2028230007Z8, TPP04-2028240009UZ, TPR02-2028020007Z4, TPR03-2028030007Z5, TPR04-2028040009V0		

GEV No.	900844	Ref. No.	14414240610 BN14414240610
description	refrigeration gasket profile 9048 W 426mm L 612mm plug size door		
For models:	KTARS21-2124100021, TARS21, TARS21-2124100021, TARS21-2124100022, TARS21-2124100023		

GEV No.	901014	Ref. No.	14416800487 BN14416800487
description	refrigeration gasket profile 9048 W 494mm L 684mm plug size		
For models:	KC2545-20050710, KCTN2545-20030725, KPBT2545-20060710, KPTN25-45-20040720, KPTN2545-20040720, KUC25-45-20150710, KUC2545-20150710, KUCTN2545-20130710, KUPBT2545-20160710, KUPTN2545-20140710		

GEV No.	901019	Ref. No.	14414600640 BN14414600640
description	refrigeration gasket profile 9048 W 450mm L 626mm plug size		

GEV No.	901016	Ref. No.	14414990738 BN14414990738
description	refrigeration gasket profile 9048 W 499mm L 738mm plug size		

GEV No.	901061	Ref. No.	14415465626 BN14415465626
description	refrigeration gasket profile 9048 W 468mm L 636mm plug size		
For models:	KTAP82, KTAP82-202282020AWR, KTAP83, KTAP83-202283020AWS, KTAP84, KTAP84-202284020AWT		

GEV No.	901233	Ref. No.	14417000520 BN14417000520
description	refrigeration gasket profile 9048 W 520mm L 700mm plug size for blast chiller		
For models:	KBC6, KBC6-BASE-20350602PL, KBCF6, KBCF6-BASE-20360602PT		

GEV No.	901015	Ref. No.	14415601460 BN14415601460
description	refrigeration gasket profile 9048 W 560mm L 1460mm plug size		
For models:	KBT40-21091640, KBT40-210916400BAJ, KTN40-21090640, KTN40-210906400BAI		

GEV No.	900838	Ref. No.	14416451606 BN14416451606
description	refrigeration gasket profile 9048 W 606mm L 1566mm plug size		
For models:	SABT140-DOUBLE-DOOR-20197400KG, SABT70-SINGLE-DOOR-20196700HC, SATN140-BASE-20196400KF, SATN70-BASE-20195700F9, SATNBT7070-BASE-201967803CU, SATNTN7070-BASE-201967703CT, SBT140A-201974, SBT70A-201967, SBT70A-20196700HC, SB-T70AT-201967T, SC7070A-2019678, SCTN7070A-2019677, STN140, STN140A-201964, STN140A-20196400KF, STN140-BASE-20191400KF, STN70, STN70A-201957, STN70A-20195700F9, STN70-BASE-20190700F9		

GEV No.	900839	Ref. No.	14415990738 14416451604 BN14415990738 BN14416451604
description	refrigeration gasket profile 9048 W 606mm L 744mm plug size door		
For models:	BT72, NFB0072F, NFB0072N, NFB0072P, NFB0144F, NFB0144N, NFB0144P, SABT144-BASE-201974402C2, SABT72-BASE-201967202BW, SATN144-BASE-20171402099A, SATN144-BASE-201964402BZ, SATN72-BASE-201707020997, SATN72-BASE-201957202BM, SATNBT3535-BASE-20193603CV, SATNN144-BASE-2017140208RY, SATNN72-BASE-2017070208RX, SATNTN3535-BASE-20193503CP, SBT144A, SBT144A-201974, SBT72A, SBT72A-201967, SC3535A-201936, SCTN3535A-201935, SCTN3535A-20193503CP, SPA120TN-201712030C18, SPA60TN-201706030C16, SPABT120-201722030C1F, SPABT140-201724030C15, SPABT60-201716030C1A, SPABT72-201717030C14, SPAC35-35-201736030BYB, SPATN120-RPPC-201742030CML, SPATN140-201714030C13, SPATN140-201734030CMM, SPATN60-RPPC-201746030CMJ, SPATN70-201737030CMK, SPATNN72-201707030BW5, SPATN-TN35-35-201735030BY2, STN144A, STN144A-201964, STN72A, STN72A-201957, STNN140A, STNN144A, STNN72A, TNN72		

GEV No.	901017	Ref. No.	14416070626 BN14416070626
description	refrigeration gasket profile 9048 W 607mm L 626mm plug size		

GEV No.	900833	Ref. No.	14416191489 BN14416191489
description	refrigeration gasket profile 9048 W 619mm L 1489mm plug size door		
For models:	BT140, BT70G, KSA105-35-2045150C0R, KSA105-35-2045260CC0, KSA140BT-204524, KSA140BT-2045240BYF, KSA140BT-2045240C10, KSA140BT-2045240CAD, KSA140P-204534, KSA140P-2045340C0X, KSA140TN-204514, KSA140TN-2045140B8X, KSA140TN-2045140CAB, KSA140TN-2045140CAC, KSA70-70-2045770BYH, KSA70-70-2045770CJ5, KSA70-70PBT-2045800C0U, KSA70-70PBT-2045800CJ8, KSA70-70PTN-2045790C0T, KSA70-70PTN-2045790CJ7, KSA70BT-204517, KSA70BT-2045170BYL, KSA70BT-2045170C0Z, KSA70BT-2045170CAA, KSA70P-204527, KSA70P-2045270C0W, KSA70TN-204507, KSA70TN-2045070B5E, KSA70TN-2045070C6A, KSA70TN-2045070CA9, KSABT70G-204537, KSABT70G-2045370CC4, KSAC105-35-2045160C05, KSAC70-70-2045780BRL, KSAC70-70-2045780CJ6, KSAP105-35-2045250CC1, NFB0072FN, NFB0072NI, NFB0072NN, NFB0072PF, NFB0072PN, NFB0072PP, NFB0140NF, NFB0140NI, NFB0143FN, NFB0143NF, NFB0143NN, NFB0143PF, NFB0143PN, NFB0143PP..(Other models you can see in the webshop)		

GEV No.	900795	Ref. No.	14416451605 BN14416451605
description	refrigeration gasket profile 9048 W 645mm L 1605mm plug size door		

GEV No.	900356	Ref. No.	14416761594 BN14416761594
description	refrigeration gasket profile 9048 W 660mm L 1580mm plug size		
For models:	ARBT70, ARTN120, ARTN140, ARTN210, ARTN60, ARTN70, M70BT, M70TN		



GEV No.	900355	Ref. No.	14416760784 BN14416760784
description	refrigeration gasket profile 9048 W 663mm L 767mm plug size		
For models:	ARBT144, ARBT72, ARTN72		

GEV No.	901013	Ref. No.	14416801032 BN14416801032
description	refrigeration gasket profile 9048 W 684mm L 1031mm plug size		
For models:	KC2545-20050710, KC4512-20050725, KCTN2545-20030725, KCTN45-12-20030745, KCTN4512-20030745, KPBT2545-20060710, KPBT4512-20060740, KPTN25-45-20040720, KPTN2545-20040720, KTN3513-200107, KTN4512-20010745, KUC25-45-20150710, KUC2545-20150710, KUC4512-20150725, KU-CTN2545-20130710, KUCTN45-12-20130730, KUCTN4512-20130730, KUPBT2545-20160710, KUPBT4512-20160740, KUPTN2545-20140710, KUPTN45-12-20140740, KUTN4512-20110770		

GEV No.	900732	Ref. No.	14416801580 BN14416801580
description	refrigeration gasket profile 9048 W 684mm L 1584mm plug size		
For models:	KBT120-20081410, KBT120-2008140218, KBT120-BASE-2008140218, KBT120-BASE-20081402XU, KBT120-P0120081410, KBT122-20081402XU, KBT122-20081420, KBT122-20081402XU, KBT140-200214011K, KBT140-20021410, KBT140-BASE-200214011K, KBT140-BASE-200214011L, KBT142-200214011L, KBT142-20021420, KBT60-2008070124, KBT60-20080710, KBT60-BASE-2008070124, KBT70, KBT70-20020710, KBT70-BASE-20020700YL, KBT70G-200220, KBT70G-BASE-20022001TZ, KBT72-20020720, KBTG140-20021470, KBTG70-20020770, KC105-35-20051440, KC10535-20051440, KC6060-20091430, KC70-70-20051410, KC7070-20051410, KC9030-20091420, KCTN10535-20031440, KCTN60-60-20091410, KCTN6060-20091410, KCTN7070-20031410, KP140-20041405, KP60-20100710, KP70-20040710, KPBT105-35-20061420, KPBT10535-20061420, KPBT70-70-20061410, KPBT7070-20061410, KPC90-30-20101410, KPC9030-20101410, KPTN10535-20041440, KPTN70-70-20041410, KPTN7070-20041410, KTN120, KTN120-20071410, KTN120-BASE-20071400XK...(Other models you can see in the webshop)		

GEV No.	900733	Ref. No.	14416800759 BN14416800759
description	refrigeration gasket profile 9048 W 684mm L 762mm plug size		
For models:	KBT120-BASE-20081402XU, KBT120-BASE-2008140431, KBT122-20081402XU, KBT122-20081420, KBT122-20081402XU, KBT124-2008140431, KBT124-20081430, KBT124-P0120081430, KBT140-200214011M, KBT140-BASE-200214011L, KBT142-200214011L, KBT142-20021420, KBT144-200214011M, KBT144-20021430, KBT60-BASE-20080705H5, KBT62-20080705H5, KBT62-20080720, KBT62-20080705H5, KBT70-200207061E, KBT72-200207061E, KBT72-20020720, KBT72-210207, KBT72-BASE-200207061E, KC105-35-20051440, KC10535-20051440, KC3513-20050715, KC3535-20050720, KC9030-20091420, KCTN10535-20031440, KCTN3030-20090710, KCTN3513-20030730, KCTN3535-20030735, KPBT105-35-20061420, KPBT10535-20061420, KPBT3513-20060720, KPBT3535-20060730, KPBT3535c-20060730, KPC30-30-20100720, KPC3030-20100720, KPC90-30-20101410, KPC9030-20101410, KPTN10535-20041440, KPTN3513-20040725, KPTN3535-20040730, KTN120-BASE-20071400XM, KTN120-BASE-200714011U, KTN122-200714011U, KTN122-20071420, KTN124-20071400XM, KTN124-20071430...(Other models you can see in the webshop)		

GEV No.	900841	Ref. No.	14417000780 BN14417000780
description	refrigeration gasket profile 9048 W 700mm L 780mm plug size		
For models:	KBC10, KBC10-BASE-20351002PM, KBCF10, KBCF10-BA-SE-20361002PV		

GEV No.	900837	Ref. No.	14417321850 BN14417321850
description	refrigeration gasket profile 9048 W 732mm L 1848mm plug size		

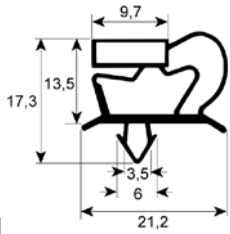

GEV No.	900847	Ref. No.	14417511862 BN14417511862
description	refrigeration gasket profile 9048 W 751mm L 1862mm plug size door		
For models:	ROLL-IN-1P, ROLL-IN-1P-2110081205Z6, ROLL-IN-1P-BT, ROLL-IN-1P-BT-2110091206GZ, ROLL-IN-1PP, ROLL-IN1PP-BT, ROLL-IN-1PPM, ROLL-IN-1PPV, ROLL-IN-1PV, ROLL-IN-1PV-2110081206F1, ROLL-IN-2PPM-TN, ROLL-IN-2PPM-TN-2110162206X4, ROLL-IN-2PP-TN, ROLL-IN-2PP-TN-2110162205Z9, ROLL-IN-2PPV-TN, ROLL-IN-2PPV-TN-2110162206FC, ROLL-IN-2P-TN, ROLL-IN-2P-TN-2110161205Z8, ROLL-IN-2PV-TN, ROLL-IN-2PV-TN-2110161206F9, ROLL-INP-1P-2110082205Z7, ROLL-INP-1P-2110082206F6, ROLL-INP-1P-2110082206X3, ROLL-INP-1P-BT-2110092206KU		

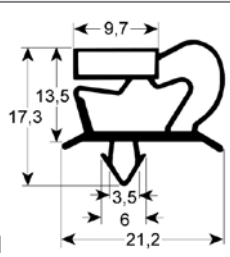

GEV No.	902258	Ref. No.	N/A
description	refrigeration gasket profile 9048 Wmm L 2500mm		

profile 9703

We offer custom-made gaskets for this profile

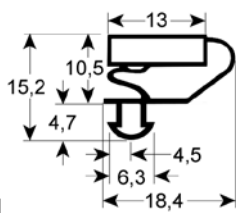

GEV No.	901022	Ref. No.	14426761594 BN14426761594
description	refrigeration gasket profile 9703 W 676mm L 1594mm plug size		
For models:	KTNV140-2001440, KTNV70-20010730		

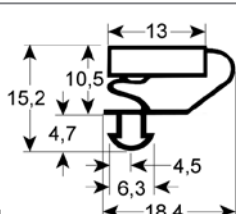

GEV No.	900843	Ref. No.	14426761595 BN14426761595
description	refrigeration gasket profile 9703 W 712mm L 1610mm plug size door		
For models:	KBTV120, KBTV140-200214011N, KBTV60, KBTV70-200207, KTNV70-200107003W, KTNV120, KTNV140-20011400X2, KTNV60-20070700XH, KTNV70-200107003W, KTNV70-210107, KUBTV140-20121440, KUBTV70-20120730, KUTNV140-20111440, KUTNV70-20110730		

profile 9704

We offer custom-made gaskets for this profile

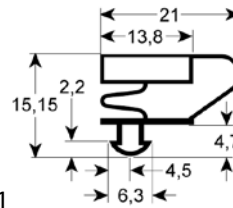

GEV No.	902299	Ref. No.	N/A
description	refrigeration gasket profile 9704 Wmm L 2500mm		

profile 9794

We offer custom-made gaskets for this profile

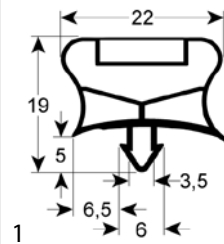

GEV No.	901525	Ref. No.	14415991560 936087 BN14415991560 FR936087
description	gasket profile 9794 W 570mm L 1500mm plug size		
For models:	P105-35TNN-2047640100, P105-35TNN-BT-2047660100, P140BT-2047220101, P140BT-2047260101, P140TN-2047200101, P140TNN-2047210101, P140TNV-2047240101, P70-70TNN-2047540100, P70BT-2047020101, P70BT-2046060101, P70TN-2041000101, P70TNN-2047010101, P70TNV-2047040101, S120BT-2088420100, S120TN-2088400100, S120TNN-2088410100, S140BT-2048220101, S140TN-2048200101, S60BT-2088120100, S60TN-2088100100, S60TNN-2088110100, S70BT-2048020101, S70TN-2048000101, S70TNN-2048010101, T105-35TNN-2046640100, T105-35TNN-BT-2046660100, T140BT-2046220100, T140BT-2046260100, T140ITT-2046230100, T140TNN-2046210100, T140TNV-2046240100, T70-70TNN-2046540100, T70-70TNN-BT-2046560100, T70BT-2046020100, T70BT-2046060x00, T70ITT-2046030100, T70TNN-2046010100, T70TNV-2046040100		

GEV No.	902391	Ref. No.	14414300149 BN14414300149
description	refrigeration gasket profile 9794 W 150mm L 380mm		
For models:	KST01BT-205111, KST01BT-VCR-205711, KST01TN-205001, KST01TN-205011, KST01TN-VCR-205611, KST02BT-205112, KST02BT-VCR-205702, KST02BT-VCR-205712, KST02TN-205002, KST02TN-205012, KST02TNH760-205802, KST02TN-VCR-205602, KST02TN-VCR-205612, KST03BT-205113, KST03BT-VCR-205713, KST03TN-205003, KST03TN-205013, KST03TN-VCR-205603, KST03TN-VCR-205613, KST04BT-205114, KST04TN-205004, KST04TN-205014, KST04TN-VCR-205604, KST04TN-VCR-205614, KST-BT01, KST-BT04, KST-BT-VCR01, KST-BT-VCR02, KST-BT-VCR03, KSTP01BT-205311, KSTP01TN-205211, KSTP02BT-205312, KSTP02TN-205212, KSTP03-205203, KSTP03BT-205313, KSTP03TN-205213, KSTP04TN-205214, KSTP05TN-205205, KSTP05TN-205215, KSTS24-205424, KSTS24-2054240IDP, KSTS24-2054240JGN, KST-TN01, KST-TN02, KST-TN03, KST-TN04, KST-TN-VCR01, KST-TN-VCR02, KST-TN-VCR03, KST-TN-VCR04...(Other models you can see in the webshop)		

GEV No.	901413	Ref. No.	14415010640 BN14415010640
description	refrigeration gasket profile 9794 W 480mm L 625mm plug size		
For models:	TAR83, TPV16, TPV16-2128150002, TPV21, TPV21-2128210003, TPV21C, TPV21C-2128211003, TPV26C, TPV26C-2128260004		

GEV No.	901367	Ref. No.	14416690388 BN14416690388
description	refrigeration gasket profile 9794 W 385mm L 665mm plug size		
For models:	KBF050-20350503, KBF050-203505030CBO, KBF050GB-20350103, KBF050GS-20350203, KBF050GS-20350203F		

GEV No.	901838	Ref. No.	1441571718 935204 BN1441571718 FR935204
description	refrigeration gasket profile 9794 W 571mm L 718mm		
For models:	P105-35TNN-2047640100, P105-35TNN-BT-2047660100, P144BT-2047360100, P144TNN-2047350100, P35-35TNN-2047440100, P35-35TNN-BT-2047460100, P70-70TNN-BT-2047560100, P72BT-2047120101, P72TNN-2047110101, T105-35TNN-2046640100, T105-35TNN-BT-2046660100, T144BT-2046xxxxxx, T144TNN-2046350100, T35-35TNN-2046440100, T35-35TNN-BT-2046460100, T72BT-2046120x00, T72TNN-2046110100		

GEV No.	900684	Ref. No.	077925281 077FR925281 4500661 BN077FR925281 FR4500661
description	refrigeration gasket profile 9794 W 390mm L 580mm plug size		

GEV No.	900344	Ref. No.	14415991559 5700033 935168 BN14415991559 FR935168
description	refrigeration gasket profile 9794 W 595mm L 1565mm plug size		
For models:	140, 70, AFB-140-20172407G, AFB-70-20171707G, AFB-70Sx-20171707GXPS, AFN-140E-20173407G, AFN-70-20170707G, AFN-70E-20173707G, AFN-70ESx-20173707GXPS, AP-140-221314XG, AP-70TN-221307XG, ARCO-BT140-20172404, ARCO-BT140-20172405, ARCO-BT140-BASE-20172408, ARCO-BT140GN2-1-2017824301, ARCO-BT140-PLUS-20172409, ARCO-BT70-20171704, ARCO-BT70430-20171705, ARCO-BT70-BASE-20171708, ARCO-BT70GN2-1-2017817304, ARCO-BT70-PLUS-20171709, ARCO-TN140-BASE-20171408, ARCO-TN140-PLUS-20171409, ARCO-TN140-20171404, ARCO-TN140-2017814301, ARCO-TN140430-20171405, ARCO-TN70-20170704, ARCO-TN70-2017807304, ARCO-TN70430-20170705, ARCO-TN7070-201777040GL70, ARCO-TN70-BASE-20170708, ARCO-TN70-PLUS-20170709, ARCO-TNN70-20170706, BT140, BT60, BT70, BTV70, LLP140TN, LLP140TNGN2-1-221314, LLP140TNR290-221334, LLP70TN, LLP70T-NGN2-1-221307, LLP70TNR290-221327, NFB0070F, NFB0070N, NFB0070P, NFB0140F, NFB0140N, NFB0140P, NORD-700BT-2017817305...(Other models you can see in the webshop)		

GEV No.	902523	Ref. No.	14414580620 915259 BN14414580620 FR915259
description	refrigeration gasket profile 9794 W 450mm L 613mm plug size		

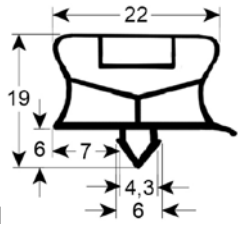

GEV No.	900612	Ref. No.	4500651 975004 FR4500651 FR975004
description	refrigeration gasket profile 9794 W 755mm L 1820mm plug size		

profile 9794Z (blast freezer)

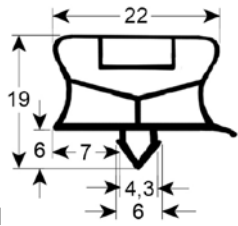

GEV No.	901800 ¹	Ref. No.	4501512 996457 FR4501512 FR996457
description	blast freezer gasket profile 9794Z W 847mm L 685mm for blast chiller suitable for FRIULINOX		
For models:	120, 122, PBC121DF-ASX-203512AS, PBC122DF-ASX-223512AS, PRC120AF-ASX-203530AS		

¹for blast freezer

profile 9195

We offer custom-made gaskets for this profile

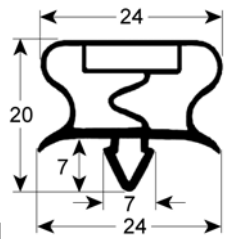

GEV No.	902435	Ref. No.	996453 FR996453
description	refrigeration gasket profile 9195 W 400mm L 690mm		
For models:	PBC051DF-ASX-203505AS, PBF051-AFST-AB-5GN11-BF-PDX-203626AD		

gaskets for heated units

door seals

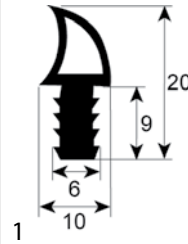

GEV No.	900829	Ref. No.	2510674 BN2510674
description	door seal profile 2741 Qty supplied by meter		

O-rings

EPDM

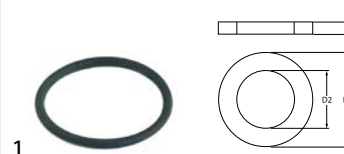

GEV No.	504561	Ref. No.	8217550
description	O-ring EPDM thickness 2.62mm ID ø 29.82mm Qty 1 pcs		

sealing cords

round



GEV No.	691631	Ref. No.	A098400
description	sealing cord round ø 16mm braided L 1m Qty 1		

evaporators

for fridges

producer-specific



GEV No.	750267	Ref. No.	14330309240 BN14330309240
description	evaporator		



1

GEV No.	750271	Ref. No.	1433070702 BN1433070702
description	evaporator		
For models:	SABT70-2017170208EB, SATN70-201707020994, SATN72-BA-SE-201707020997, SATNN70-2017070208EA, SATNN72-BA-SE-2017070208RX, SATNV70-BASE-201707020995, SBT70A, SBT72A, SBTV70A, STN70A, STN72A, STNN70A, STNN70A-2017070208EA, STNN72A, STNV70A		



1

GEV No.	750386	Ref. No.	14330210187 BN14330210187
description	evaporator L 350mm W 90mm H 375mm Dmm overall width 395mm connection 3/8"mm mounting distance 1 350mm		
For models:	KTAP00, KTAP00-BASE-20220501062N, KTAP00BT-BASE-2022550105KR, KTAP01, KTAP01-BASE-20220901044U, KTAP01BT-BASE-2022590105KU, KTAP02, KTAP02-20221301P0201, KTAP02-BASE-20221301048K, KTAP02BT-BASE-2022630105KW, KTAP02-ESP45300-20221301P0202, KTAP03, KTAP03-BASE-2022180109UA, KTAP03BT-BASE-2022680109UW, KTAP04, KTAP04-BASE-2022230109RY, KTAP902, KTAPBT00, KTAPBT01, KTAPBT02, KTAPBT03, KTAPBT902, KTAR01N, KTAR02N, KTAR03, KTAR03-BA-SE-2020180105, KTAR03N, KTAR03N-BASE-202018050441, KTAR04, KTAR04N, KTAR04N-BASE-2020230508V7, KTARS35-2024180104HC		



1

GEV No.	750305	Ref. No.	14330070134 935879 BN14330070134 BN14330070334 FR935879
description	evaporator L 300mm W 195mm H 235mm		
For models:	KSA105-35-2045150C0R, KSA105-35-2045260CC0, KSA70-70-2045770BYH, KSA70-70-2045770CJ5, KSA70-70PBT-2045800C0U, KSA70-70PBT-2045800CJ8, KSA70-70PTN-2045790C0T, KSA70-70PTN-2045790CJ7, KSA70BT-204517, KSA70BT-2045170BYL, KSA70BT-2045170C0Z, KSA70BT-2045170CAA, KSA70P-204527, KSA70P-2045270C0W, KSA70TN-204507, KSA70TN-2045070B5E, KSA70TN-2045070C6A, KSA70TN-2045070CA9, KSAC105-35-2045160C0S, KSAC70-70-2045780BRL, KSAC70-70-2045780CJ6, KSAP105-35-2045250CC1, KSAP35-35-2045450CBT, KSAPC35-35-2045460CBU, NFB0072FN, NFB0072NI, NFB0072NN, NFB0072PF, NFB0072PN, NFB0072PP, NFB0140NF, NFB0140NI, NFB0143FN, NFB0143NF, NFB0143NN, NFB0143PF, NFB0143PN, NFS0072FG, NFS140IF, NFS140IN, NFS140NF, NFS140NP, NFS140PN, NFS143FN, NFS143IF, NFS143IN, NFS143PN, NFS72FI, NFS72FN, NFS72NI...(Other models you can see in the webshop)		



1

GEV No.	750269	Ref. No.	14330210171 14330210179 14330210186 BN14330210179 BN14330210186
description	evaporator L 350mm W 90mm H 375mm overall width 400mm connection 3/8"mm mounting distance 1 350mm with boiler		
For models:	KTAP00, KTAP01, KTAP02, KTAP03, KTAP04, KTAR00, KTAR01, KTAR01-BASE-20201001, KTAR01N, KTAR01N-BASE-20201005043V, KTAR02, KTAR02N, KTAR02N-BASE-20201305043Y, KTAR03, KTAR03-BASE-2020180105, KTAR03N, KTAR03N-BASE-202018050441, KTAR04, KTAR04N, KTAR04N-BASE-2020230508V7, KTAR902, KTARBT02, KTARBT02-205101, KTARBT02-205102, KTARBT02-205103, KTARBT02-BASE-2025130104FU, KTARBT03, KTARBT03-BASE-2025180104FW, KTARBT04, KTARBT04-BASE-2025230104FZ, KTARBT902, KTARS24, KTARS24-202413010480, KTARS35, KTARS35-2024180104HC, TSP00, TSP00-BASE-202606010BRU, TSP01, TSP01-BASE-202611010BRY, TSP02, TSP02-BASE-202615010BS8, TSP03, TSP03-BASE-202620010BSK, TSR01, TSR01-BASE-20210801, TSR01-BASE-202108010BPA, TSR02, TSR02-202113010BGO, TSR03, TSR03-BASE-202117010BGK...(Other models you can see in the webshop)		



1

GEV No.	750306	Ref. No.	14330210175 BN14330210175
description	evaporator L 380mm W 75mm H 270mm		
For models:	KTAR01, KTARS21-2124100021, TARS21, TARS21-2124100021, TARS21-2124100022, TARS21-2124100023, TARS22E-2124091022, TARS22EP-2124091023, TARS22ES-2124091022		



1

GEV No.	750292	Ref. No.	14330210167 14330210168 14330210169 BN14330210167 BN14330210168 BN14330210169
description	evaporator L 400mm W 70mm H 390mm		
For models:	KTAP02-600-20221205CN, KTAP03-600-20221705CM, KTAR03-600-BASE-20201705DD		



1

GEV No.	750104	Ref. No.	14330570134 935869 BN14330570134 FR935869
description	evaporator L 410mm W 120mm H 490mm complete with fan		
For models:	AFB-70-20171707G, AFB-70Sx-20171707GXPS, AFN-70-20170707G, AFN-70ESx-20173707GXPS, ARCO-BT70-20171704, ARCO-BT70430-20171705, ARCO-BT70-BASE-20171708, ARCO-BT70GN2-1-2017817304, ARCO-BT70-PLUS-20171709, ARCO-TN70-2017807304, ARCO-TN7070-20177704, ARCO-TNBT7070-20177804, ARCO-TNN70-20170706, B100, B120, BT60, BT70, BT72, BTV70, NFB0070F, NFB0070N, NFB0072F, NFB0072N, NORD-700BT-2017817305, NORD-700BT-2017817305P, NORD-700TNN-2017807305, NORD-700TNN-2017807305P, SPA60TN-201706030C16, SPA60TNV-201706030CC2, SPA70-70TN-BT-201778030BYA, SPA70-70TN-TN-201777030BY8, SPA70TN-20170703, SPAB100-201706030CBR, SPAB120-201707030CBS, SPABT120-20172203, SPABT120-201722030C1E, SPABT120-201722030C1F, SPABT120-201722030C1G, SPABT60-20171603, SPABT60-201716030C19, SPABT60-201716030C1A, SPABT60-201716030C1B, SPABT70-20171703, SPABT70-201717030BY7, SPABT70-20171707, SPABT72-201717030C14, SPABTV70-201717030C1C, SPATN60-20170603, SPATN60-RPPC-20174603, SPATN60-RPPC-201746030CMF...(Other models you can see in the webshop)		



1

GEV No.	750103	Ref. No.	14330570135 BN14330570135
description	evaporator L 410mm W 120mm H 490mm IN 53W / OUT 10W complete with fan		
For models:	AFN-70E-20173707G, AFN-70ESx-20173707GXPS, ARCO-TN70-20170704, ARCO-TN70430-20170705, ARCO-TN7070-201777040GL70, ARCO-TN70-BASE-20170708, ARCO-TN70-PLUS-20170709, NFB0070P, NFB0072P		



1

GEV No.	750366	Ref. No.	14330540140 BN14330540140
description	evaporator L 430mm W 140mm H 230mm		
For models:	P140TN-2047200101, P140TNV-2047240101, S140TN-2048200101, T140BT-2046220100, T140TNV-2046240100		



1

GEV No.	750362	Ref. No.	1433110401 BN1433110401
description	evaporator L 435mm W 405mm H 120mm complete with fan		
For models:	KC25-45-20050710, KC2545-20050710, KCTN2545-20030725, KCTN3535-20030735, KPTN25-45-20040720, KPTN2545-20040720, KPTN3535-20040730, KUC25-45-20150710, KUC2545-20150710, KU-CTN2545-20130710, KUCTN3535-20130720, KUPTN2545-20140710, KUPTN35-35-20140730, KUPTN3535-20140730, TN70, TN72		



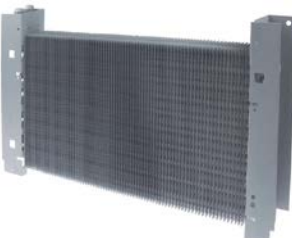

1

GEV No.	750268	Ref. No.	14330312410 BN14330312410
description	evaporator L 500mm W 70mm H 160mm		
For models:	SABT70-BASE-20196701ZW, SABT70-SINGLE-DOOR-20196700HC, SABT72-BASE-201967202BW, SATN140-BASE-20196400KF, SATN140-BASE-201964013Z, SATN144-BASE-201964402BZ, SATN70-BASE-20195700F9, SATN70-BASE-2019570117, SATN72-BASE-201957202BM, SATNBT3535-BASE-20193603CV, SATNBT7070-BASE-201967803CU, SATNTN3535-BASE-20193503CP, SATNTN7070-BASE-201967703CT, SBT70A-201967, SBT70A-20196700HC, SBT70AT-201967T, SBT72A-201967, SBTV70A-201967, SC7070A-2019678, SCTN7070A-2019677, STN140, STN140A-201964, STN140A-20196400KF, STN140-BASE-20191400KF, STN144A-201964, STN70, STN70A-201957, STN70A-20195700F9, STN70-BASE-20190700F9, STN72A-201957, STNV140, STNV140A-201964, STNV70, STNV70A-201957		

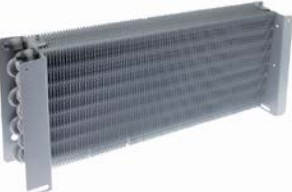

1

GEV No.	750363	Ref. No.	14330210292 BN14330210292
description	evaporator L 520mm W 60mm H 300mm		



1

GEV No.	750239	Ref. No.	935613 FR6524980 FR935613
description	evaporator L 535mm W 95mm H 210mm		



1

GEV No.	750547	Ref. No.	14330540134 BN14330540134
description	evaporator L 550mm W 400mm H 115mm suitable for POLARIS		
For models:	AFB-140-20172407G, AFN-140E-20173407G, ARCO-BT140-20172404, ARCO-BT140-20172405, ARCO-BT140-BASE-20172408, ARCO-BT140GN2-1-2017824301, ARCO-BT140-PLUS-20172409, ARCO-TN140-BASE-20171408, ARCO-TN140-PLUS-20171409, ARCO-TN140-20171404, ARCO-TN140-2017814301, ARCO-TN140430-20171405, ARCO-TNN140-20171406, B200, B240, BT140, NFB0140F, NFB0140N, NFB0140P, NFB0144F, NFB0144N, NFB0144P, SPA120TN-201712030C17, SPA120TN-201712030C18, SPA120TNV-201712030CC3, SPAB200-201712030CBP, SPAB240-201714030CBQ, SPABT120-201722030C1E, SPABT120-201722030C1F, SPABT120-201722030C1G, SPABT140-20172403, SPABT140-201724030BW2, SPABT140-201724030C15, SPABT140-201724030C54, SPABT140-20172407, SPATN120-20171203, SPATN120-RPPC-20174203, SPATN120-RPPC-201742030CMG, SPATN120-RPPC-201742030CML, SPATN140-201714030C13, SPATN140-201714030CA8, SPATN140-20171407, SPATN140-20173403, SPATN140-201734030CMH, SPATN140-201734030CMM, SPATN140-RPPC-20173407, SPATNN140-201714030C12, TN120, TN140, TNN140... (Other models you can see in the webshop)		

evaporation and condensing trays

evaporation trays



1

GEV No.	694334	Ref. No.	32107060 BN32107060
description	evaporation tray L 450mm W 595mm for fridge		
For models:	KC6060-20091430, KC9030-20091420, KCTN6060-20091410, KP60-20100710, KPC9030-20101410, KTN120, KTN120-20071410, KTN122-200714011U, KTN122-20071420, KTN60-20070710, KTN60-20070700XE, KTN60-BASE-20070700XE, KTN62-20070700XF, KTNV120, KTNV60-20070700XH		





1



GEV No.	750225	Ref. No.	1405020090 995605 BN1405020090 FR995605
description	evaporation tray L 520mm W 68mm H 28mm		
For models:	EN02TN-VCR-20208204, KST01TN-205001, KST01TN-VCR-205601, KST02TN-205002, KST02TN-VCR-205602, KST03TN-205003, KST03TN-VCR-205603, KST04TN-205004, KST04TN-VCR-205604, KSTP03-205203, KSTP05TN-205205, KTAP01-205201, KTAP01-205202, KTAP01-205204, KTAP84EN-20228403, KTAR82EN-20208203, KTAR84EN-20208403		

			
GEV No.	694346	Ref. No.	144501 32107070 BN144501 BN32107070
description	evaporation tray L 600mm W 599mm for evaporator		
For models:	KC105-35-20051440, KC10535-20051440, KC70-70-20051410, KC7070-20051410, KC9030-20091420, KCTN10535-20031440, KCTN7070-20031410, KP140-20041405, KP70-20040710, KPBT70-70-20061410, KPBT7070-20061410, KPC90-30-20101410, KPTN10535-20041440, KPTN70-70-20041410, KPTN7070-20041410, KTN140-20011400WZ, KTN140-20011410, KTN140-BASE-20011400WZ, KTN140-BASE-20011400X0, KTN140-BASE-20011400X1, KTN140-BASE-20011400X2, KTN142-20011400X0, KTN142-20011420, KTN144-20011400X1, KTN144-20011430, KTN3513-200107, KTN3513-20010735, KTN4512-200107, KTN4512-20010745, KTN70-200107003W, KTN70-20010700VF, KTN70-20010710, KTN70-210107, KTN70-BASE-20010700VX, KTN72-200107, KTN72-20010720, KTN72-BASE-20010700VF, KTNV140-20011400X2, KTNV140-20011440, KTNV140-2001440, KTNV70-200107003W, KTNV70-20010730, KTNV70-210107, KUC105-35-20151440, KUC10535-20151440, KUC70-70-20151410, KUC7070-20151410, KUCTN10535-20131440, KUCTN7070-20131410, KUP70-20140750...(Other models you can see in the webshop)		

springs

torsion springs

			
GEV No.	690272	Ref. No.	1412084 BN1412084
description	torsion spring ø 15mm L2 80mm wire gauge ø 2.5mm mounting pos. left L1 27mm L3 16mm		
For models:	140, 70, AFB-140-20172407G, AFB-70Sx-20171707GXPS, AFN-140E-20173407G, AFN-70ESx-20173707GXPS, AP-140-221314XG, AP-70TN-221307XG, ARCO-BT140-20172404, ARCO-BT140-20172405, ARCO-BT140-BASE-20172408, ARCO-BT140GN2-1-2017824301, ARCO-BT140-PLUS-20172409, ARCO-BT70-20171704, ARCO-BT70430-20171705, ARCO-BT70-BASE-20171708, ARCO-BT70-PLUS-20171709, ARCO-TN140-BASE-20171408, ARCO-TN140-PLUS-20171409, ARCO-TN140-20171404, ARCO-TN140-2017814301, ARCO-TN140430-20171405, ARCO-TN70-20170704, ARCO-TN70430-20170705, ARCO-TN7070-20177040GL70, ARCO-TN70-BASE-20170708, ARCO-TN70-PLUS-20170709, ARCO-TNN70-20170706, BT140, BT60, BT70, BT70G, BT72, KSA105-35-2045150C0R, KSA105-35-2045260C0C, KSA140BT-204524, KSA140BT-2045240BYF, KSA140BT-2045240C10, KSA140BT-2045240CAD, KSA140P-204534, KSA140P-2045340C0X, KSA140TN-204514, KSA140TN-2045140B8X, KSA140TN-2045140CAB, KSA140TN-2045140CAC, KSA70-70-2045770BYH, KSA70-70-2045770CJ5, KSA70-70PBT-2045800C0U, KSA70-70PBT-2045800CJ8, KSA70-70PTN-2045790C0T...(Other models you can see in the webshop)		
accessories for	690272		
	GEV No.	690271	Ref. No. 1412083 935696 BN1412083 FR935696
	torsion spring ø 15mm L2 80mm wire gauge ø 2.5mm mounting pos. right L1 27mm L3 16mm		

			
GEV No.	690271	Ref. No.	1412083 935696 BN1412083 FR935696
description	torsion spring ø 15mm L2 80mm wire gauge ø 2.5mm mounting pos. right L1 27mm L3 16mm		
For models:	120, 122, 140, 70, AFB-140-20172407G, AFB-70-20171707G, AFN-140E-20173407G, AFN-70-20170707G, AFN-70E-20173707G, AFN-70ESx-20173707GXPS, AP-140-221314XG, AP-70TN-221307XG, ARCO-BT140-20172404, ARCO-BT140-20172405, ARCO-BT140-BASE-20172408, ARCO-BT140GN2-1-2017824301, ARCO-BT140-PLUS-20172409, ARCO-BT70-20171704, ARCO-BT70430-20171705, ARCO-BT70-BASE-20171708, ARCO-BT70GN2-1-2017817304, ARCO-BT70-PLUS-20171709, ARCO-TN140-BASE-20171408, ARCO-TN140-PLUS-20171409, ARCO-TN140-20171404, ARCO-TN140-2017814301, ARCO-TN140430-20171405, ARCO-TN70-20170704, ARCO-TN70-2017807304, ARCO-TN70430-20170705, ARCO-TN7070-20177040GL70, ARCO-TN70-BASE-20170708, ARCO-TN70-PLUS-20170709, ARCO-TNN70-20170706, BT140, BT60, BT70, BT70G, BT72, KSA105-35-2045150C0R, KSA105-35-2045260C0C, KSA140BT-204524, KSA140BT-2045240BYF, KSA140BT-2045240C10, KSA140BT-2045240CAD, KSA140P-204534, KSA140P-2045340C0X, KSA140TN-204514, KSA140TN-2045140B8X, KSA140TN-2045140CAB...(Other models you can see in the webshop)		
accessories for	690271		
	GEV No.	690272	Ref. No. 1412084 BN1412084
	torsion spring ø 15mm L2 80mm wire gauge ø 2.5mm mounting pos. left L1 27mm L3 16mm		

valves and tank inlets

shut-off valves

universal

			
GEV No.	540415	Ref. No.	A022453
description	star handle connection cold total lengthmm mounting pos. shaft diameter 7x7mm ø 55mm 35 built-in depth 22mm		

inlet taps

			
GEV No.	514408	Ref. No.	A022910
description	inlet spout connection 3/8" ET tube ø 12mm projection 58mm overall height 76mm spout height 30mm rotation°		



fastening material

nuts

hexagonal nuts

hexagonal nuts metric (without norm)



1

GEV No.	101345	Ref. No.	A010820
description	nut thread M15x1 H 3mm WS 19 brass Qty 1 pcs		

A			
axial fans	26	indicator lights	9
B		indicator lights (complete)	10
bar burners	35	inlet spouts	60
C		inlet taps	60
cam switches	8	L	
castors and bumper angles	44	lamps	9
cold air circulating fans (complete)	30	M	
compressors	20	magnetic switches	9
condensing trays heated	25	microswitches	7
control thermostats	5	N	
cross flow fans	31	nuts	61
D		O	
defrost timers	11	O-rings	56
door seals	56	oven hinges	41
E		P	
electric accessories	31	piezoelectric igniters	34
electronic controllers	12	pilot burners	33
evaporators	56	plug-in gaskets	47
F		probes	17
fans	26	programme timers	10
fastening material	61	R	
foil heating elements	5	refrigeration fans	27
fridge lamps	10	refrigeration gaskets	47
G		refrigeration motors universal	27
gas burners	35	refrigeration thermostats	6
gas nozzles	36	relays	11
gas taps	32	rocker/momentary rocker switches	7
gas thermostats	32	S	
gaskets for heated units	56	safety thermostats	6
grates	45	sealing cords	56
H		shelves and shelf rails	45
heating cables	5	shut-off valves	60
heating cartridges	5	solenoid valves	19
heating elements	3	spring assisted hinges	40
heating elements for bain maries	3	switches and momentary switches	7
heating elements for condensate evaporation	4	T	
heating elements for defrosting	3	temperature probes	17
heating elements for fryers	3	terminals	31
heating elements for heated cabinets	4	thermocouples	35
heating elements for refrigeration	3	thermostats	5
hexagonal nuts	61	timers	10
I		transformers	12
ignition cables	34	U	
		universal probes	17

V

valves and tank inlets

60